

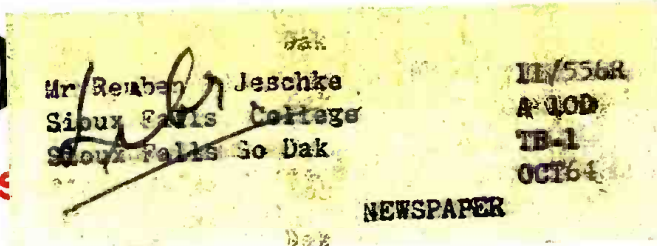

BRO
THE BUSINESS



NG
RADIO

MARCH 23, 1964

FTC, hostile and aggressive, draws bead on cigarette ads at hearing 27

Back to school for admen as NAB teaches A B C's of piggybacks 40

PERSPECTIVE ON THE NEWS: perplexing problem of living with CATV 60

New power in AB-PT emerges as Simon buys 100,000 shares 68

COMPLETE INDEX PAGE 7



'Total national market' is no longer the key approach to Marketing. Today, successful national advertisers sell America's markets individually. These markets are as varied as their climate, customs, buying patterns and viewing habits. That's why Spot Television is unmatched for local impact and flexibility.

NEW YORK • CHICAGO • ATLANTA • BOSTON • DALLAS • DETROIT
LOS ANGELES • PHILADELPHIA • SAN FRANCISCO • ST. LOUIS

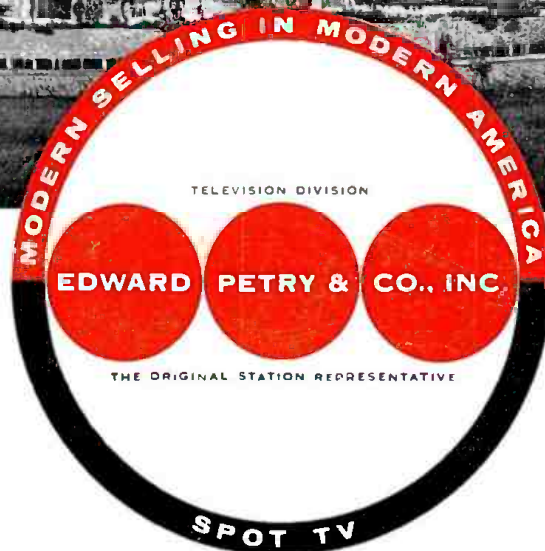

WTR EFFIGIES

Wheeling

A SERIES OF FRAMEABLE ADworld CLOSE-UPS!

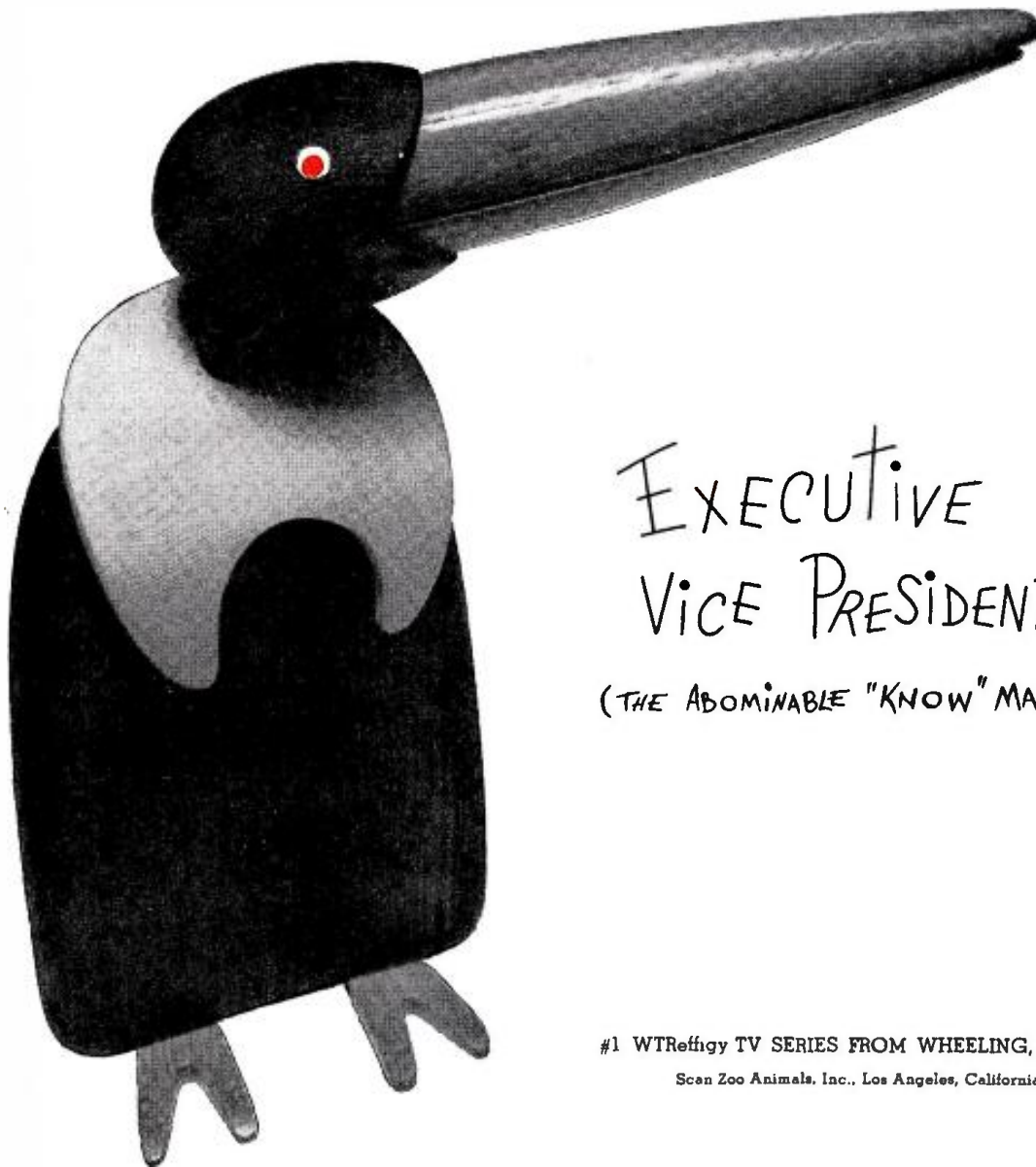

EXECUTIVE
VICE PRESIDENT
(THE ABOMINABLE "KNOW" MAN!)

#1 WTReffigy TV SERIES FROM WHEELING, W. VA.

Scan Zoo Animals, Inc., Los Angeles, California

NEW TOWER . . . 529,300 TV HOMES

Greater WTRF-TV Wheeling/Steubenville Industrial Ohio Valley . . .

A lively buying audience spending 5 $\frac{1}{3}$ Billion Dollars Annually . . .

Merchandising . . . Promotion . . . Rated Favorite!

WTRF-TV Wheeling!

Represented Nationally by



316,000 watts



network color



(RED EYED SET? Write for your frameable
WTReffigies, our ad-world close-up series!)

WHEELING 7, WEST VIRGINIA

wtrf ⁷ tv
CHANNEL 7

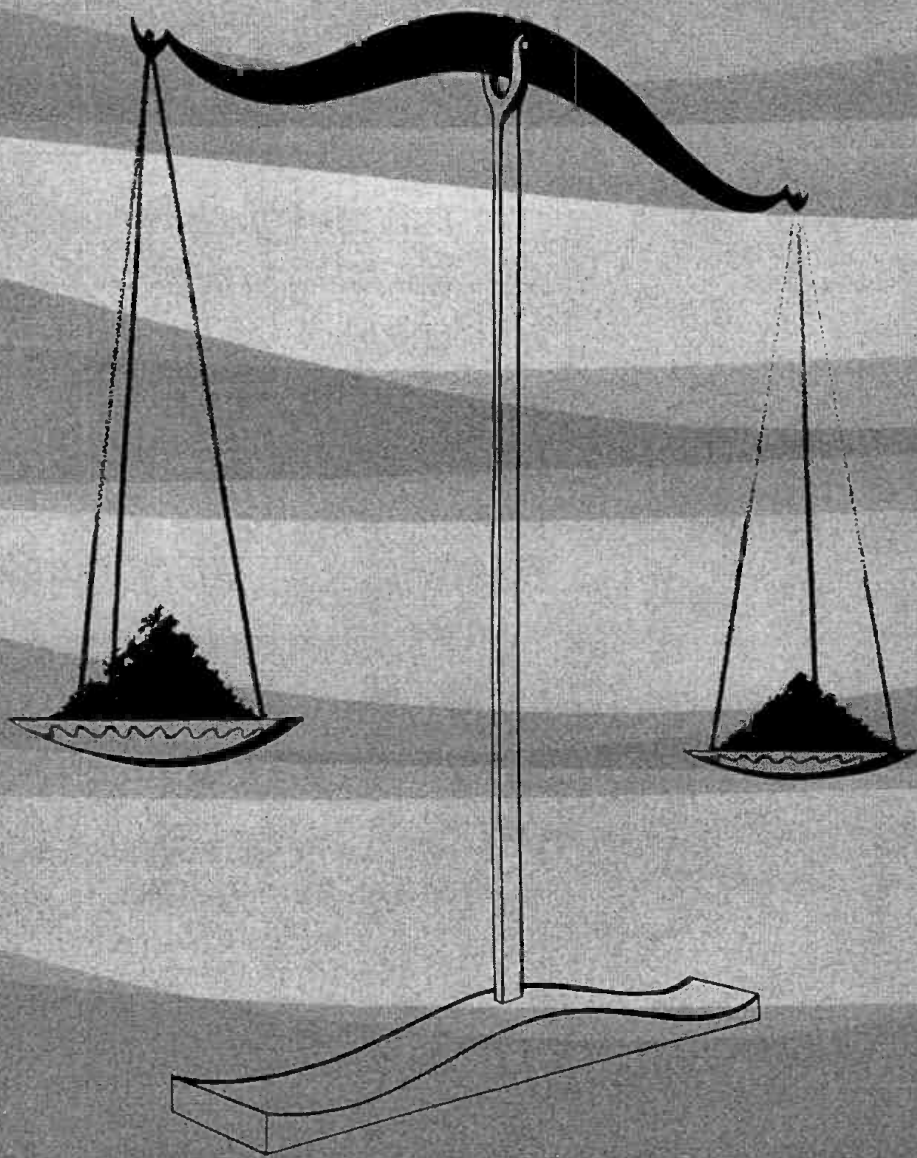

DIMENSIONS : WEIGHT

The measure of weight in broadcasting is not so much concerned with grams or ounces or numbers as it is with balance. In Houston, **DIMENSION: WEIGHT** is **KTRK TV**



Cosmetics

astrigent • perfume

moisturizer • viscous • powder

EMOLLIENT • LANOLIN • JASMINE

lotion • fragrance • solubilizer

PENETRANT • EMULSIFIER • CREAM

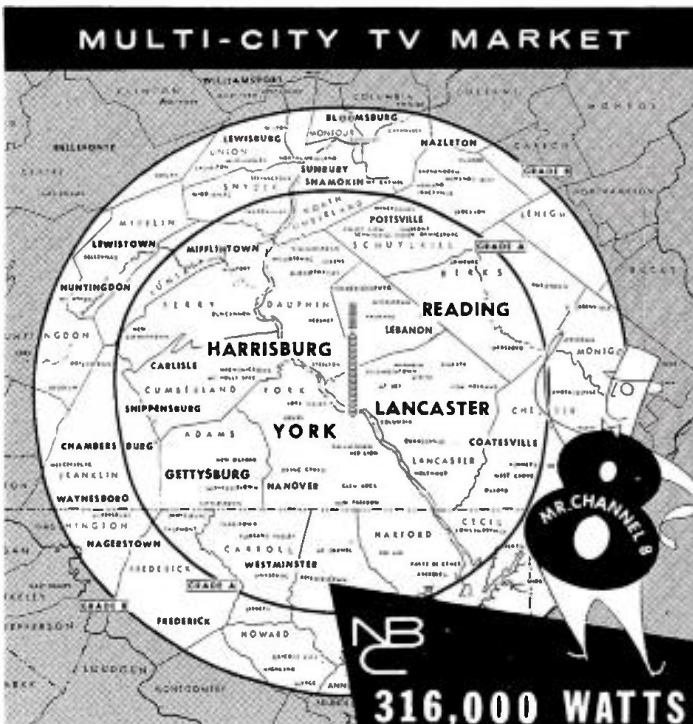

**Whatever your business language,
WGAL-TV translates it into sales**

Channel 8 speaks the language of the people in its widespread multi-city market. Viewers listen, understand, and respond. To prove it, Channel 8 telecasts sales messages for practically any product you can name.

WGAL-TV
Channel 8
Lancaster, Pa.

STEINMAN STATION • Clair McCollough, Pres.

Representative: The MEEKER Company, Inc.
New York / Chicago / Los Angeles / San Francisco

All those CATV problems

FCC will launch wide-ranging inquiry soon in effort to develop fundamental policy for dealing with community antenna television systems. Staff is now drafting notice of inquiry, which will seek comments on host of questions that have been getting increasing attention at FCC. List isn't yet complete, but it's said to include: joint ownership of CATV and television station in same community, CATV's impact on TV table of station allocations, CATV's potential for pay TV, origination of programming by CATV system, and relationship of FCC multiple-ownership rules to those in CATV business.

Many of these questions are involved in proposed sale of H&B Communications Corp., owner of some 37 CATV systems, to RKO General, which owns 27 CATV systems in addition to its broadcasting interests. As result, commission has notified both parties decision on transfer application is being deferred pending decision on policy matters.

Ends don't meet

Unless federal pay-raise bill, voted down two weeks ago by House of Representatives, is revived and passed, FCC may lose one or more of its members. Some have said privately they can't afford to continue in government service on \$20,000 annual salary, and had been counting on \$10,000 increase provided for in bill.

Record of service

Numerical measurement of on-air public service done by TV stations will become available soon—and lots of people may be surprised. Broadcast Advertisers Reports (BAR) plans to conduct study, based on its monitoring records. In pilot examination of one three-station market, BAR found one-week total of 243 announcements for 53 different organizations from Ad Council to YMCA. Based on normal commercial load in same market, that's one public service announcement for every five commercials—and BAR officials think ratio may be even higher in other markets.

Incidentally, BAR has signed new deal with code authority of National Association of Broadcasters for monitoring of TV code subscribers. Two organizations parted company in March 1962, with charge by BAR that NAB was uninterested in enforcing commercial standards. New contract will "increase and intensify" TV

CLOSED CIRCUIT*

monitoring and will complement NAB agreement with Air Check Services Corp. of Chicago, which primarily monitors radio. BAR will monitor each TV subscriber in top 75 markets at least twice year for NAB, leaving code staff free for smaller markets.

Household words

Radio Free Europe officials are exulting over results of recent Gallup poll that showed 80% of U. S. public is familiar with RFE and its purposes. This widespread awareness is attributed in large measure to RFE fundraising drives conducted on American radio and TV stations.

All the way?

Should Broadcast Rating Council concern itself with use of ratings in addition to setting standards and auditing for reliability? Question is subject of correspondence among Representative Paul G. Rogers (D-Fla.), rating subcommittee member who has been keeping close eye on situation, National Association of Broadcasters President LeRoy Collins and Rating Council Chairman Donald H. McGannon, who is Westinghouse Broadcasting Co. president.

Question, in view of some observers, really hasn't been answered. Several members of House rating unit favor Federal Trade Commission's June 13, 1963, statement that broadcasters who represent themselves as market leaders must make responsible effort to see their facts are right. Messrs. Collins and McGannon have worked hard for audit procedures with teeth so that broadcasters can be assured that ratings winning Rating Council seal are reliable. But what if broadcaster misuses good data? FTC is ready to move against false advertising. But, Mr. Rogers wonders, if broadcasting is to be self-regulating, is there not a role here for Rating Council?

Made in . . .

Legislation that could drive TV film-makers and even stations to distraction by requiring films or commercials made abroad in whole or in part to be labeled as to country of origin, has been revived in House with hearings to be scheduled before House Commerce Committee's Subcommittee on Commerce and Finance, of which Representative Harley O. Staggers (D-W.Va.) is chairman. Six

virtually identical bills are before committee, with Representative Everett G. Burkhalter (D-Calif.) now spearheading drive for consideration.

Measure, designed to halt so-called "runaway" production of motion picture films, is supported by labor groups centered in Hollywood and would cover not only new film but clips used from stock. Burkhalter measure (HR 7672) would authorize Federal Trade Commission to prescribe how films exhibited, either in theaters or on air, would have to be identified sequence-by-sequence and would also cover any advertisements of films to require display of each country in which picture was photographed.

A crash avoided

Radio stations across country are beginning to express dissatisfaction with Radio Advertising Bureau and National Association of Broadcasters because planned \$200,000 study or radio research methodology hasn't gotten off ground. After months of negotiation, NAB agreed to go in with RAB in research of researchers (BROADCASTING, Nov. 4, 1963) but little has been accomplished since. Delay has been attributed to failure of 10-man steering committee representing both groups to actively push what was to have been crash program.

Share-the-networks

There's nothing fundamentally new in FCC Chairman E. William Henry's pet plan for bolstering UHF by force-feeding of network service. Back in 1950, before FCC had created U service, commission proposed rule to equalize market access among then-existing four TV networks. To help ABC and DuMont get exposure on few stations then on air, FCC proposed to make stations take some shows from every network and limit amount of programming they could take from any one. Years later FCC buried that rulemaking—after DuMont had quit networking.

Similarities between 1950 plan and Mr. Henry's 1964 version are striking. Mr. Henry has suggested that in biggest 18 markets now having only two VHF's, network service be parcelled out so that third stations—which would be U's—would get as much network service as V's. Chairman is getting as much resistance from CBS and NBC now as his predecessors got in 1950 (see story page 78).

... now sold nationally by



Number 1 in
Shreveport, Louisiana*

KEEL

(50,000 watts at 710 KC)

a subsidiary of



*proudly appoints
H-R Representatives, Inc. as
exclusive national representatives
effective immediately.*

*LATEST HOOPER, JULY 1962
AUDIENCE MEASUREMENT DATA ARE ESTIMATES ONLY, SUBJECT TO DEFECTS
AND LIMITATIONS OF SOURCE MATERIAL AND METHODS. HENCE, THEY MAY
NOT BE ACCURATE MEASURES OF THE TRUE AUDIENCE.

WEEK IN BRIEF

Hearing on FTC proposals to require health warnings in cigarette advertising generates lots of heat. Opponents claim move is illegal; Tobacco Institute says radio-TV advertising may have to be deleted. See . . .

TOBACCO MILLIONS THREATENED . . . 27

Advertising men flock to Waldorf Astoria to hear about piggybacks. Bell urges continuing liaison with code authority to spell out what may and what may not be done. See . . .

TEACHING ABOUT PIGGYBACKS . . . 40

New York good music station announces it'll carry hard liquor advertising and almost immediately its availabilities are sold out. Pleas to reverse decision are unavailing. See . . .

WQXR SCHEDULES LIQUOR ADS . . . 42

Pay TV activity is all over the lot. Pinto relates experiences in Hartford. STV steps up campaign to win subscribers in California. RKO General files antitrust suit against exhibitors. See . . .

MOVES ON PAY TV FRONT . . . 54-55

Fundamental questions on CATV arising to haunt FCC. Major one: does it frustrate nationwide allocation plan? FCC and NCTA thought they had legislative program worked out, but NAB dashed it. See . . .

WHAT TO DO ABOUT CATV . . . 60

Norton Simon of Hunt Foods acquires 100,000 shares of AB-PT, leading to speculation he wants in on board. Industrialist has reputation for making companies leaders in their fields. See . . .

IS SIMON MOVING IN? . . . 68

Commission decision to duplicate 13 clear channel frequencies is subject of conversation between House committeemen and FCC in closed session on Hill. FCC is adamant, is word. See . . .

BEHIND CLOSED DOORS . . . 65

Court upholds FCC in refusal to renew license of WDKD in notorious Charlie Walker case, but ducks constitutional point. Sustains commission on misrepresentation issue. See . . .

COURT BACKS FCC . . . 88

Henry is pushing plan to establish dual affiliations to help UHF. Invites network chiefs to meet with him to go over ideas, especially in markets where there are two VHF's. See . . .

NETWORKS TO MEET WITH HENRY . . . 78

Just good enough isn't enough anymore. Creativity that puts the ball out of the ball park is the need today in commercial advertising. That's plea of Norton J. Wolf of Benton & Bowles. See . . .

CREATIVE REVOLUTION ARRIVES . . . 24

DEPARTMENTS

AT DEADLINE	9	THE MEDIA	54
BROADCAST ADVERTISING	27	MONDAY MEMO	24
BUSINESS BRIEFLY	48	OPEN MIKE	18
CHANGING HANDS	58	PROGRAMING	78
CLOSED CIRCUIT	5	RADIO SERIES SALES	90
DATEBOOK	14	WEEK'S HEADLINERS	10
EDITORIAL PAGE	112	WEEK'S PROFILE	111
EQUIPMENT & ENGINEERING	92		
FANFARE	90		
FATES & FORTUNES	93		
FILM SALES	90		
FINANCIAL REPORTS	68		
FOR THE RECORD	98		
LEAD STORY	27		



BROADCASTING

THE BUSINESSWEEKLY OF TELEVISION AND RADIO

Published every Monday, 53rd issue (Yearbook Number) published in November by BROADCASTING PUBLICATIONS INC. Second-class postage paid at Washington, D. C., and additional offices.

Subscription prices: Annual subscription for 52 weekly issues \$8.50. Annual subscription including Yearbook Number \$13.50. Add \$2.00 per year for Canada and \$4.00 for all other countries. Subscriber's occupation required. Regular issues 50 cents per copy. Yearbook Number \$5.00 per copy.

Subscription orders and address changes: Send to BROADCASTING Circulation Dept., 1735 DeSales Street, N.W., Washington, D. C., 20036. On changes, please include both old and new addresses plus address label from front cover of magazine.

**WTIC MEANS
GREATEST COVERAGE**

TOP PERSONALITIES

ADULT ACCEPTANCE

DEDICATED SERVICE

**IN RICH, RICH
SOUTHERN
NEW ENGLAND**

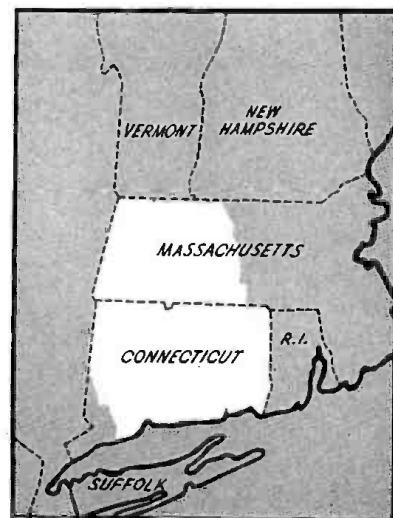

WTIC  **50,000 watts**

HARTFORD, CONNECTICUT

REPRESENTED BY THE HENRY I. CRISTAL COMPANY

TAME protests bill to control CATV

Television Antenna Manufacturers Institute (TAME) went on record Friday (March 20) against proposed bill providing for FCC regulation of community antenna television systems (see page 60).

Morton Leslie, acting chairman of TAME, said group feels bill prepared by staffs of FCC and National Community Television Association is "inadequate." Mr. Leslie said TAME "echoes" view of National Association of Broadcasters that draft of bill puts too much stress on "nonduplication" (BROADCASTING, March 16).

Mr. Leslie said TAME favors legislation that would empower commission to license CATV's. He said this would be necessary to assure effective regulation.

TAME officials discussed these views with FCC members and staff Thursday (March 19). Mr. Leslie said commission's reaction was that licensing power could not be won from Congress and that, if it were, licensing of CATV's would impose "mountainous" burden on commission.

Mr. Leslie, executive of JFD Electronics, Brooklyn, said commission should have authority to fit CATV's into overall TV allocations structure. He also said commission should be empowered to set and maintain technical standards for CATV's.

Mr. Leslie said TAME counsel is preparing draft bill that will be submitted to commission.

Democrats sign DDB as '64 campaign agency

Selection of Doyle Dane Bernbach Inc., New York, to handle advertising and promotion account of Democratic National Committee for 1964 campaign was announced Friday (March 20) after weeks of discussions with at least four agencies.

DDB ranked 27th in BROADCASTING's poll of top 50 agencies in radio-TV billings and was chosen "basically for their proven record of performance in creative advertising with emphasis on their media department—which was critical," said Lloyd Wright, committee advertising coordinator. Creativity plus spot buying know-how were uppermost

Nielsen in New Hampshire

ABC-TV circulated Nielsen 30-market survey figures Friday (March 20) showing ABC News' coverage of New Hampshire presidential primary with edge over NBC (9.6 rating and 28.7 share for ABC and 7.0 and 20.9 for NBC) but behind CBS, which had 11.7 rating and 34.9 share. ABC claimed similar network ranking on three-network telecast of *Conversation with the President* on March 15.

in minds of Democrats making decision (CLOSED CIRCUIT, March 16).

Guild, Bascom & Bonfigli of New York had account in 1960 when network and spot expenditures hit \$6.2 million.

Finding program segments in fall broadcast schedules will be difficult, but major part of buying will be in spot, Mr. Wright believes.

Herald-Traveler stock sold to stations' rep

John Blair was reported late Friday (March 20) to have bought substantial block of stock in Herald-Traveler Corp., licensee of WHDH-AM-TV Boston and publisher of *Boston Herald and Traveler*. Blair represents WHDH stations.

Purchase understood to involve about 50,000 shares, representing something less than 10% of total outstanding. Herald-Traveler is on over-the-counter market, with Thursday quotations as 32½ bid, 35½ asked.

It was unknown whether Blair purchase was made personally, for corporation or for pension fund.

Herald-Traveler is fighting to keep channel 5 in Boston; it now is undergoing battle with other applicants for that channel. It was penalized by FCC for alleged off-record contacts with FCC commissioners.

Swift to introduce dog's Arf

Swift & Co., Chicago, through Earle Ludgin & Co. there, plans to spend some \$3 million starting next fall in heavy campaign to introduce new Arf

brand canned dog food in East and Midwest with spot TV to get about 85% of budget. About 50-60 markets will be involved. Swift will outspend all other brands in initial 10-week flights, match other brands in following flights of four weeks on, four weeks off air.

Piggybacks defended as cheap, effective

Samuel Thurm, advertising vice president, Lever Bros., New York, last Friday (March 20) stated advertiser's case for use of piggyback commercials on TV.

During question period at third annual Collegiate Broadcasters Conference (see page 66), Mr. Thurm said Lever Bros. uses piggybacks because research has shown 30-second commercials to be "not less effective" than minute spots. Because 30-second commercials cost about four-fifths as much as minute announcements, Mr. Thurm said it was more economical to buy full minutes and use piggyback commercials in them.

As long as piggybacks do not fall below 50% of efficiency advertisement would attain if used separately, Mr. Thurm said, Lever Bros. would continue to use them.

Conference was sponsored by International Radio and Television Society.

End in sight for panel on TV program form

Special committee working on revision of FCC's proposed TV program reporting form hoped to complete work and have its version of form in hands of FCC Chairman E. William Henry by this morning (Monday).

Frank Fletcher, communications attorney and spokesman for group, said Friday (March 20) that proposed revision was then undergoing draft (see page 79).

He said Chairman Henry would probably distribute copies of committee's product to commissioners this week. Mr. Fletcher also expressed hope committee's form could be issued as further notice of proposed rulemaking prior to National Association of Broadcasters Convention, which begins April 5 at Conrad Hilton in Chicago.

Committee, composed of representatives of Federal Communications Bar

WEEK'S HEADLINERS



Mr. Bartlett

Walter E. Bartlett, VP and general manager of WLWC(TV) Columbus, Ohio, appointed to new post of VP in charge of TV for Crosley Broadcasting Corp., with headquarters in Cincinnati.

Richard E. Reed, WLWC sales manager, named to succeed Mr. Bartlett as outlet's general manager. Also announced was appointment of **E. V. (Gene) McPherson** as director of news and special projects, replacing **Gilbert W. Kingsbury**, who has resigned. Mr. Bartlett joined Crosley in 1953 as sales department. His new responsibilities include supervision of four Crosley TV stations: WLWT(TV) Cincinnati; WLWD(TV) Dayton, WLWC(TV) Columbus and WLWI(TV) Indianapolis. Mr. Reed joined Crosley in 1953 as sales-program coordinator at WLWD. He was appointed WLWC sales manager in 1960. Mr. McPherson, formerly with program department of WBNS-TV Columbus, Ohio, joined Crosley in 1962 as head of its newly established documentary unit. His duties now include supervision of all news and documentary activities and special projects.

Robert F. Lewine, who resigned fortnight ago as VP in charge of programming for CBS-TV, Hollywood (BROADCASTING, March 16), has become partner in Creative Management Associates Ltd., international talent agency. With headquarters at organization's Beverly Hills office, Mr. Lewine will function in



Mr. Lewine

dual capacity as executive VP of CMA-TV Ltd. and as VP of CMA's agency operation in charge of television. He will leave shortly to meet with CMA executives in firm's New York and London offices and discuss TV plans with several of agency's creative and performing clients, which include such personalities as Henry Fonda, Peter Falk, Robert Goulet, Leslie Caron, Judy Garland, Phil Silvers, Richard Burton, among others.



Mr. Shafto

succeeds **B. Cathoun Hipp**, who becomes board chairman. Mr. Shafto, whose broadcast career began with WIS Columbia, S. C., in 1932, has served as executive VP of BCS since 1957, is currently member of NAB's Future of TV in America Committee, member of board of directors of Broadcast Music Inc. (BMI), and in 1959 was chairman of NAB's TV board. Broadcasting Co. of the South owns and operates WIS-AM-TV Columbia, S. C.; WSFA-TV Montgomery, Ala., and community antenna TV systems in Florence, S. C., and Ocala, Fla., with CATV system now under construction in Sumter, S. C.

George Reedy, longtime aide to President Johnson and son of late George Reedy, Washington commentator for Blue Network and Arrowhead Network in Wisconsin, is new presidential news secretary. He succeeds **Pierre Salinger**, who resigned to run for Democratic nomination for U. S. senator in his native California. Mr. Reedy is 46 years



Mr. Reedy



Mr. Salinger

old, 1938 graduate of University of Chicago, Capitol Hill reporter for old United Press from 1939 to 1951 when he joined staff of then Senate Democratic leader Lyndon Johnson. He served as staff director of Senate Democratic Policy Committee. When Senator Johnson became Vice President, Mr. Reedy was named special assistant to Vice President with assignment to Space Council. Leaving with Mr. Salinger was **Andrew T. Hatcher**, associate news secretary. **Malcolm Kilduff**, third member of Salinger team, continues with Mr. Reedy at White House.



Mr. Johnson

Carl Johnson Jr., president of McCann-Erickson-Hakuhodo, Tokyo, for past three years, appointed executive VP in charge of mid-west region of McCann-Erickson, with headquarters in Chicago. He replaces **Draper Daniels**, who resigned earlier this month (BROADCASTING, March 2). Mr. Johnson joined McCann-Erickson in 1956, earlier had been with Young & Rubicam, Affiliated Retailers Inc. and Montgomery Ward. **James P. Farley**, executive vice president of McCann-Erickson-Hakuhodo, will be confirmed as Tokyo agency's new president succeeding Mr. Johnson at May board meeting.

For other personnel changes of the week see FATES & FORTUNES

Association, National Association of Broadcasters and FCC staff, was set up two months ago to attempt to clarify and simplify FCC's proposed form.

Similar committee is expected to be established to work on commission's proposed AM-FM reporting form. FCC has endorsed this proposal, and Maurice Jansky, first vice president of FCBA, said association's executive committee would discuss idea at meeting this week.

Nielsen, Rating Council in 'successful' session

Meeting between Broadcast Rating Council Inc. and A. C. Nielsen Co. officials, held Friday to consider proposed procedures for auditing and accrediting ratings companies, was described by council officials as "successful."

Like earlier council sessions with Pulse, American Research Bureau,

Sindlinger and Hooper (BROADCASTING, March 16), it was said to have resulted in certain clarifying changes but no substantive revisions.

Earlier in week Nielsen official had said he anticipated no major difficulties in reaching agreement (see page 62).

Council will meet March 31 to organize committee under Hugh M. Belleville Jr. of NBC to plan accreditation procedures for ratings firms that work on nonsyndicated basis.

*Television is the only
efficient way to reach the
49-county North Florida/
South Georgia regional market,
and WJXT, Jacksonville
is the only television station
to blanket the total area*

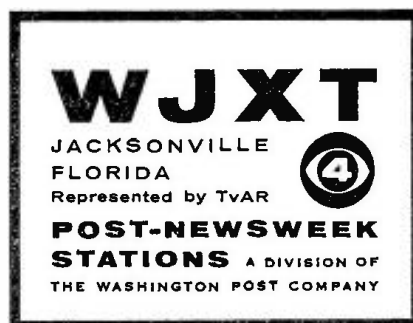

HOW TO IDENTIFY A NETWORK

One of the most exciting ways to identify NBC Television is to watch the next World Series. Or the Summer Olympics from Tokyo. Or weekly NCAA football this Fall.

In fact, this network can be recognized at just about every top-flight athletic event in the coming year.

Our football coverage, for instance, will range from 29 national and regional NCAA games to at least eight post-season contests, including the Rose, Sugar, Orange and Sun Bowls. And in the Fall of 1965 an unprecedented five-year contract with the American Football League will add professional football to this network's gridiron agenda.

In baseball, NBC will again televise Saturday and Sunday Major League clashes beginning in a few weeks, then will cover the All-Star Game in mid-Summer and the World Series in October.

Such annual golf classics as the National Open, Las Vegas Tournament of Champions and the Bing Crosby Pro-Am Tournament are slated for the NBC cameras exclusively next season, while "The Wonderful World of Golf" will present top-money matches from around the globe every Sunday afternoon.

The tennis world's big event—the U.S.L.T.A. National Championships from Forest Hills—will once again be an NBC exclusive in September.

And every Saturday through the year, the "NBC Sports Special" focuses on athletic pursuits ranging from basketball to motor-cycle racing.

All in all, there are more than 300 hours of sports coverage, mostly in color, included in NBC's diversified schedule next season.

Which leaves the nation's sports fans with only one problem: not how to identify this network — but how to keep up with it.

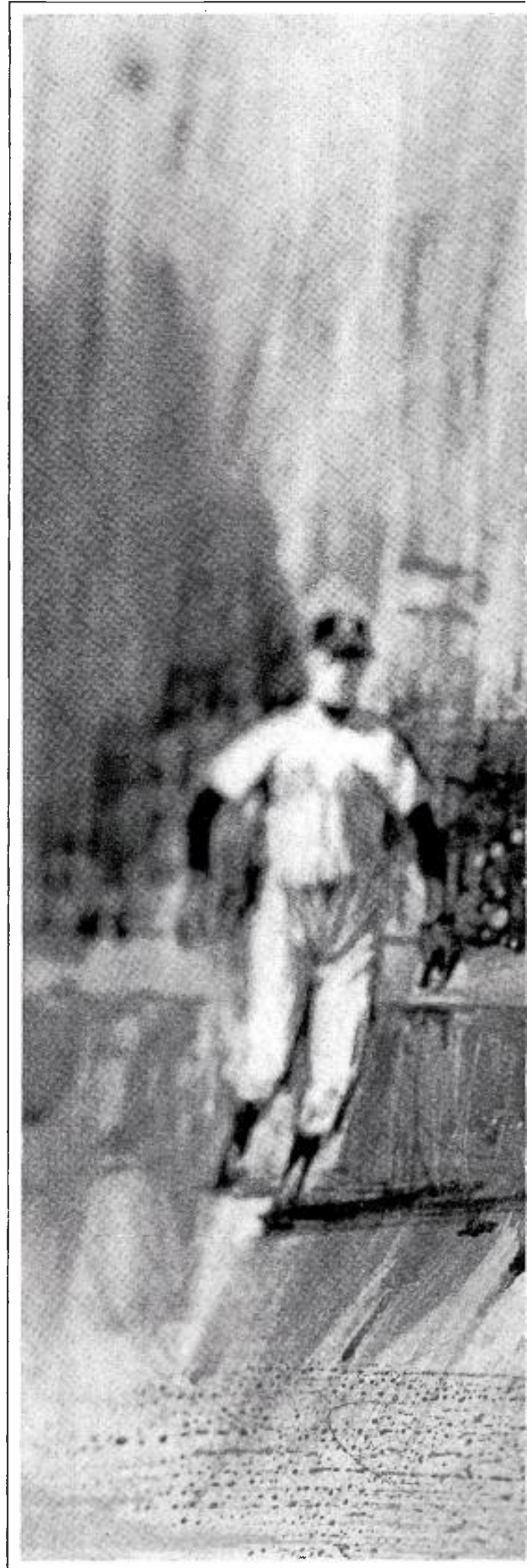

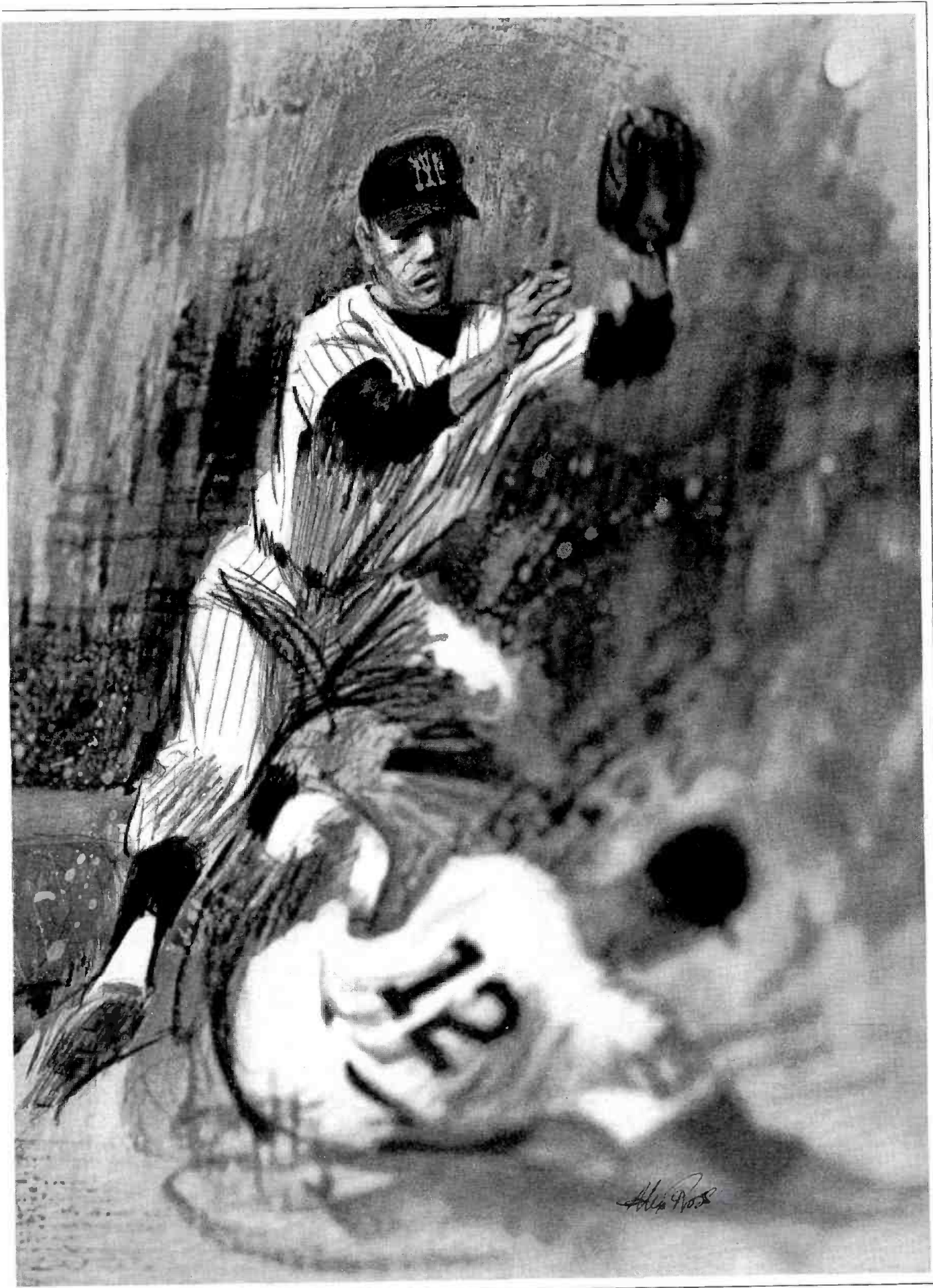

Look to NBC for the best combination of news, information and entertainment.

DATEBOOK

**OOH!
OOH!
OOH!**

Toody and Muldoon, those soft-hearted, scatter-brained patrolmen, have an unerring instinct for being in the wrong place . . . at the wrong time. Except for two things. They're great at building audiences and selling blue-chip sponsors.



CALL CAR 54/NBC FILMS

for your tower requirements check **ROHN SYSTEMS** ✓

A complete tower erection service that has these special advantages:

- ✓ DEPENDABILITY
- ✓ RELIABILITY
- ✓ COMPLETE ENGINEERING
- ✓ COAST TO COAST SERVICE

Be sure to obtain price quotations and engineering assistance for your complete tower needs from America's foremost tower erection service.

ROHN SYSTEMS, INC.
6712 W. Plank Road Peoria, Illinois

A calendar of important meetings and events in the field of communications.
■Indicates first or revised listing.

MARCH

March 23—Awards dinner of the **Alfred I. duPont Awards Foundation**. Newton N. Minow, former FCC chairman and now executive vice president and general counsel of Encyclopaedia Britannica, will address dinner in first major speech to industry since leaving FCC (see story, this issue). Mayflower hotel, Washington.

March 23-26—International convention of **Institute of Electrical and Electronics Engineers**, New York Hilton and New York Coliseum. More than 1,000 exhibitors expected to display about \$20 million worth of electrical and electronic equipment.

March 24—Annual stockholders meeting, **Gross Telecasting Inc.**, for election of directors, amendment of articles of incorporation relating to class B common stock dividends and conversion rights and to transact other business. Lansing, Mich.

■March 25—First annual creative clinic sponsored by **WHK Cleveland**. Speakers include Mel Blanc of Mel Blanc Associates, Hollywood, "History of Humorous Broadcast Advertising;" Al Sarason of Kenyon & Eckhardt, New York, "Radio . . . its relationship to TV and print;" Richard Mercer of BBDO, New York, "The creative thinking behind the Campbell's Soups, Pepsi-Cola and Lucky Strike commercials;" Duke Marx of Gustav Marx Advertising, Milwaukee, "The only thing I know . . . selling, writing, producing for local radio," and Nelson Winkless of Leo Burnett Inc., Chicago, "How to sell 'Corn' on radio."

■March 25-26—**National Community Television Association** board of directors meets in Washington to discuss community antenna television legislation and its own comments on FCC rulemaking to govern grants in microwave services to systems supplying CATV systems with facilities.

March 26—First radio day seminar of **American College of Radio Arts, Crafts and Sciences**, Chicago. Agency-advertiser will discuss successful radio selling today. Arthur Godfrey will be guest speaker.

APRIL

April 1—**Nebraska Broadcasters Association-Nebraska University Journalism School** copywriters' clinic, Nebraska Center for Continuing Education. Lincoln.

April 3—Deadline for reply comments

on **FCC** rulemaking to authorize use of unattended, automatic mobile relay stations.

April 3—New deadline for comments on UHF allocations tables proposed by **FCC** and **National Association of Educational Broadcasters**.

April 3—New deadline for comments on **FCC** rulemaking to authorize six UHF channels for airborne ETV in six midwestern states.

■April 3—Meeting of the **National Association of FM Broadcasters**, 9 a.m., Waldorf room, Conrad Hilton hotel, Chicago.

■April 3—Meeting of the **Association for Professional Broadcasting Education**, 2:30 p.m., room 9, Conrad Hilton hotel, Chicago.

April 3-4—**Arkansas AP Broadcasters**, Little Rock.

April 3-5—**National Association of TV & Radio Farm Directors**, Atlanta.

■April 4—Technical conference of the **Association of Maximum Service Telecasters**, 1 p.m.; **AMST** board of directors meeting, 6:30 p.m. Sheraton-Blackstone hotel, Chicago.

■April 5—First annual general membership meeting of the **Institute of Broadcast Engineers**, 2:30 p.m., Williford Parlor C, Conrad Hilton hotel, Chicago.

■April 5—Ninth annual membership meeting of the **Association of Maximum Service Telecasters**. Jack Harris, **KPRC-AM-TV Houston** and **AMST** president, will preside. Reports on current and future activities of the association will be presented by Lester W. Lindow, executive director, and Ernest W. Jennes, legal counsel. 8:30 a.m., Beverly room, Conrad Hilton hotel, Chicago.

■April 5—Annual meeting of the board of directors of the **Association on Broadcasting Standards**, 2:30-3:30 p.m.; **ABS** annual membership meeting, 4-5 p.m.; special meeting of the **ABS** board of directors, 5-5:30 p.m. Beverly room, Conrad Hilton hotel, Chicago.

April 5-8—Annual convention of the **National Association of Broadcasters**, Conrad Hilton hotel, Chicago.

April 5-8—**Television Film Exhibit—1964**. Reception April 5, 4-7 p.m., for TV station officials by distributors participating in **TFE-'64**. Great Hall, Pick-Congress hotel, Chicago.

April 5-8—West Coast meeting of **Association of National Advertisers**, Del Monte Lodge, Pebble Beach, Calif.

■April 5-8—Annual meeting of **Canadi-**

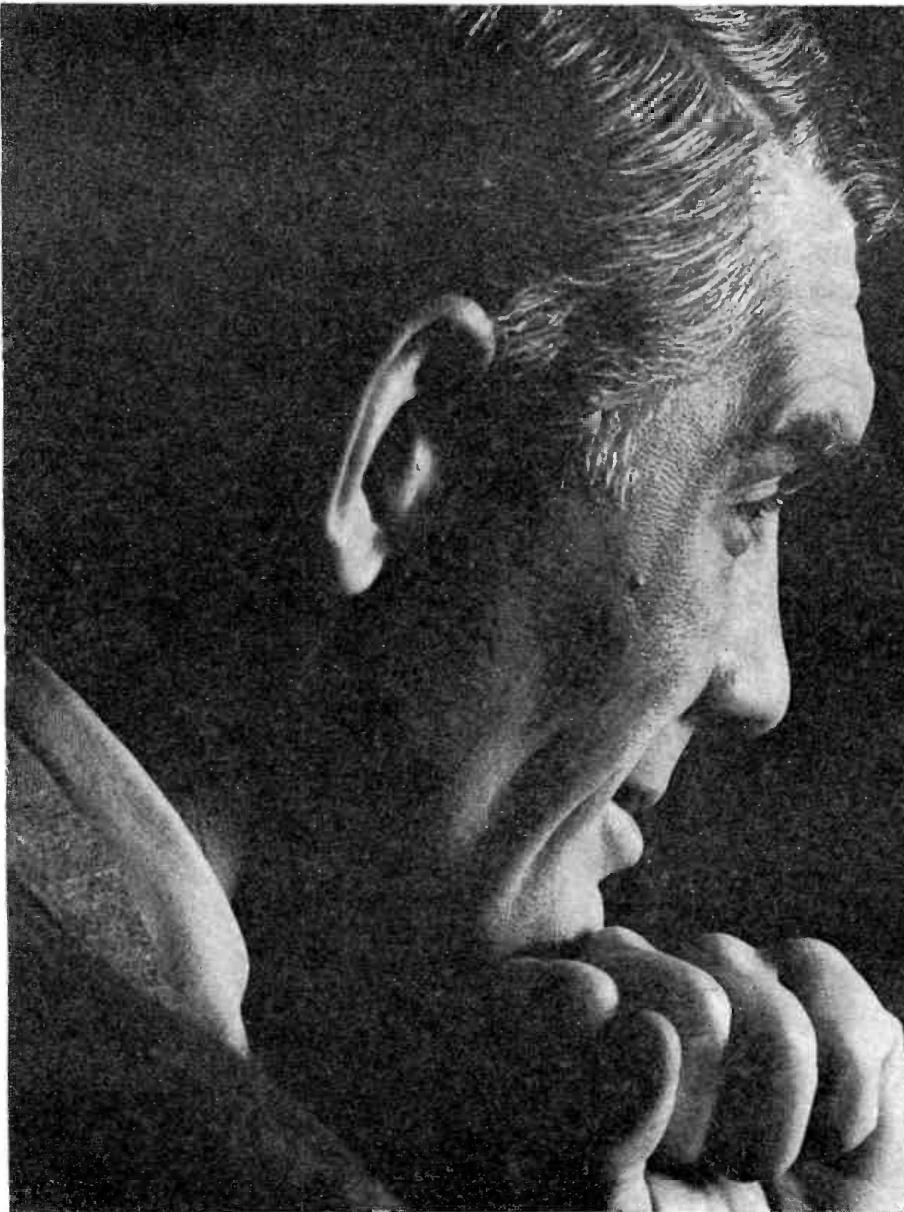

Why risk building your own representation?

Here's a better way

How often have you said "Wouldn't it be wonderful if we had salesmen in the national field who really had our interests at heart?"

You are not alone in your feelings. The big group operators such as Westinghouse, Storer, RKO General, Metromedia and others must also have felt they needed more interest, time and effort in their representation. They built their own national organizations to get it.

At first glance, this might seem like the happy solution to your problem. The advantages are obvious. *But can you afford the risks? Can you risk finding the right men with the right talents to represent you the way you want to be represented? Can you risk being rigidly*

committed to an expensive organization that often may not be able to give you all the flexibility and depth of coverage you need? Can you risk losing the stimulating fire of competition?

Let us show you a better way to enjoy the benefits of this same concentrated small group attention and interest without the excessive cost and risk of setting up your own national organization.

Because we, like the groups, will never represent more than fifteen stations, we can give you almost every advantage you would have with your own private representation plus some nice extras as well. We can give you the time, the interest and the ability to

concentrate on your needs in the national field, plus the great advantage of established professional experience gained through more than thirty years of service to the industry.

We have the men, the offices and the facilities to make our interest your interest . . . our organization your organization. You can have these advantages immediately, *without risk*, if you call or write any one of our offices.

Paul H. Raymer Company, Inc.

Station Representatives Since 1932



New York
Chicago
Detroit
Atlanta
Dallas
San Francisco
Hollywood

well-wishers



love

WGY 810 KC
50 KW

and so do housewives, doctors, students, executives, farmers, and secretaries in the 25 counties surrounding Albany, Schenectady, and Troy. Ask Henry I. Christal.

A GENERAL ELECTRIC STATION

pole-vaulters



love

WGY 810 KC
50 KW

and so do housewives, doctors, students, executives, farmers, and secretaries in the 25 counties surrounding Albany, Schenectady, and Troy. Ask Henry I. Christal.

A GENERAL ELECTRIC STATION

basket-weavers



love

WGY 810 KC
50 KW

and so do housewives, doctors, students, executives, farmers, and secretaries in the 25 counties surrounding Albany, Schenectady, and Troy. Ask Henry I. Christal.

A GENERAL ELECTRIC STATION

women-drivers



love

WGY 810 KC
50 KW

and so do housewives, doctors, students, executives, farmers, and secretaries in the 25 counties surrounding Albany, Schenectady, and Troy. Ask Henry I. Christal.

A GENERAL ELECTRIC STATION

an Association of Broadcasters, Chateau Frontenac hotel, Quebec City.

April 6-9—Thirty-first annual **National Premium Buyers Exposition**, under auspices of National Premium Sales Executives, the Premium Advertising Association of America and Trading Stamp Institute of America. More than 600 exhibitors are expected to participate. McCormick Place, Chicago.

April 8—**Academy of Television Arts and Sciences**, Hollywood chapter. Dr. Lee A. Du Bridge, president, Community Television of Southern California, and James Robertson, general manager of KCET(TV), ch. 28 ETV, will discuss plans for the fall opening of station. Hollywood Palladium, 8 p.m.

April 9—Annual stockholders meeting of **Avco Corp.**, Hotel DuPont, Wilmington, Del.

April 11—**Michigan AP Broadcasters Association**, Kellogg Center, East Lansing.

April 11—**Alabama AP Broadcasters**, Birmingham.

April 12—Old-timers get-together, 40th anniversary of **WLS Chicago**, Sherman House hotel, Chicago. Old-timers committee is headed by Glenn Q. Snyder, George Cook, Bill Nelson and George Biggar. Contact: Mr. Biggar, **WLBK DeKalb, Ill.**

April 12-17—Ninety-fifth technical conference of **Society of Motion Picture and Television Engineers**. John M. Waner of Eastman Kodak Co., Hollywood, is program chairman. Papers committee chairman is C. Loren Graham of Kodak Color Technology Department in Rochester, N. Y. Ambassador hotel, Los Angeles.

April 13—Newsmaker luncheon of **International Radio & Television Society**. Robert Moses, president of New York World's Fair 1964-1965 Corp., is speaker. Waldorf Astoria, New York.

April 13—Deadline for comments on FCC rulemaking to require public notice be given when applying for new or modified station call letters.

April 15—Deadline for submission of summaries and abstracts of technical papers for inclusion in program of **Western Electronic Show and Convention** in Los Angeles, Aug. 25-28.

April 15—Annual stockholders meeting of **General Telephone & Electronics Corp.**, Fort Wayne, Ind.

April 15-25—International motion picture, TV film and documentary market, Milan, Italy.

April 16-17—Annual meeting of **Chesapeake AP Broadcasters Association**, Sheraton Belvedere hotel, Baltimore.

April 17-18—Fourteenth annual **Radio-**

NEW 1964 AYER DIRECTORY JUST OUT

**126,000 new facts not in the 1963 Edition • 379 new publications
70 new maps in color • 1600 pages of classified and cross-indexed data**

New 96th Annual Edition of the most complete and authoritative single source of information on the newspapers and magazines of the United States and its territories. Also Canada, Bermuda, Panama and the Philippine Islands.

729,000 live facts include

- **More than 22,200 publications** with names and addresses, editors, publishers, subscription prices, circulation figures and sizes. Including over 9,600 periodicals and 12,500 daily, semiweekly, triweekly and weekly newspapers.

Just the postage saved on mailings to publications which have expired since last year could pay for your Ayer Directory.

- **Profitable market profiles** include industries and agricultural products of every town and city listed. Also airline and rail services.

Banking data, motor vehicle registration, number of telephones and other facts on larger market areas. Latest special population reports.

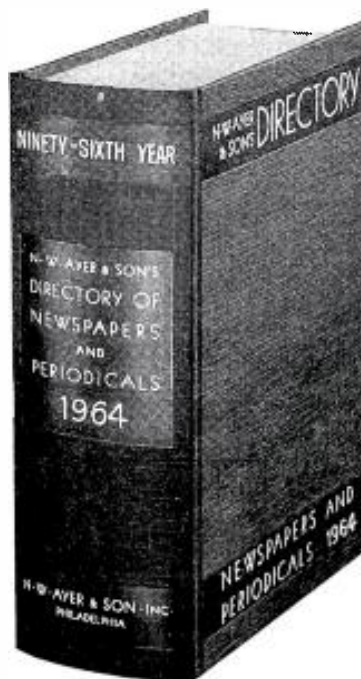

Actual size is 6 $\frac{1}{2}$ " x 9 $\frac{3}{4}$ " x 3 $\frac{1}{4}$ "
1600 pages

- **Special interest groups:** Periodical lists for college, fraternal, labor, religious, trade, technical groups. Also foreign languages, hobbies and sports.

- **Order your 1964 Ayer Directory now!** Still only \$30, postpaid within the U.S.A. Order from N. W. Ayer & Son, Inc., Dept. B, Washington Square West, Philadelphia, Pa. 19106.

- **A word of appreciation** to those who ordered the 1963 Edition. Our sincere regrets to those whose orders came in too late to fill. Last year's Edition was sold out despite the largest printing in history. Please order your 1964 copy of the Ayer Directory as early as possible.

MANY USERS IN MANY FIELDS YEAR AFTER YEAR • ADVERTISERS • ADVERTISING AGENCIES • BANKERS
LIBRARIES • BUSINESS FIRMS • PUBLISHERS • MARKET ANALYSTS • PUBLIC RELATIONS COUNSELORS • CHAMBERS
OF COMMERCE • SCHOOLS • COLLEGES AND UNIVERSITIES • GOVERNMENT AGENCIES IN ALL PARTS OF THE WORLD

Our News
includes
the
Fine Print!

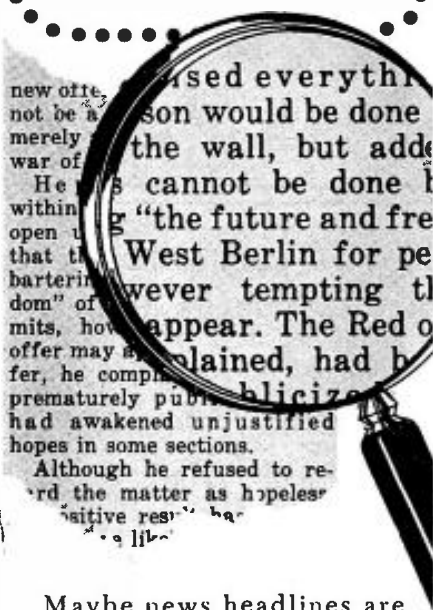

Maybe news headlines are enough for some people. But not for our listeners. That's why we have some 54 local and "world-wide" newsmen reporting all that happens — when and where it happens. And we give them plenty of reporting time — three full hours of news *twice daily* plus 15 minute newscasts every hour. With this News-in-Depth concept, we deliver just about the most important group of listener-customers in all Los Angeles. Call the Katz Agency for full details.

KABC
RADIO 79

*The Conversation Station
of Los Angeles*

AN ABC OWNED RADIO STATION

Television Conference and Banquet of Radio-Television Guild of San Francisco State College. For additional information, write Ronald Denman, chairman.

April 17-18 — Two-day management seminar entitled "The Marketing Revolution In Electronics" by central division of **Association of Electronic Manufacturers**, Pheasant Run Lodge and Country Club, St. Charles, Ill.

April 17-19—Joint meeting of **Mississippi Association of Broadcasters** and **Louisiana Association of Broadcasters**. Speakers include NAB President LeRoy Collins, FCC Chairman E. William Henry and Representative Walter Rogers (D-Tex.). Broadwater hotel, Biloxi, Miss.

April 17-24—The **Golden Rose of Montreux** international TV competition, sponsored by the city of Montreux (Switzerland) and the Swiss Radio and Television Corp., Montreux.

April 19-25 — **Television Newfilm Workshop**, Center for Continuing Education, University of Oklahoma, Norman.

■April 20—New deadline for comments on FCC rulemaking to govern grants in microwave services to systems supplying community antenna operators with facilities. Former deadline was March 25.

April 21-24—**Alpha Epsilon Rho**, hon-

orary radio-TV fraternity, annual national convention in Los Angeles at Hollywood Roosevelt hotel.

April 22-23—Board of directors meeting of the **Television Bureau of Advertising**, The Greenbrier, White Sulphur Springs, W. Va.

April 23—Deadline for reply comments on FCC rulemaking to require public notice be given when applying for new or modified station call letters.

April 23-25—Annual meeting of **American Association of Advertising Agencies**, The Greenbrier, White Sulphur Springs, W. Va.

April 23-26—**Western States Advertising Agencies Association** 14th annual conference. Speakers include: Ernest Loen, management consultant; Sol Dutka, Audits & Surveys; E. B. Weiss, Doyle Dane Bernbach; Riviera hotel, Palm Springs, Calif.

April 24—Spring conference of **Oregon Association of Broadcasters**, Village Green motor hotel, Cottage Grove, Ore.

April 24—**Pennsylvania AP Broadcasters Association** meeting, Boiling Springs.

April 25—**Texas Community Antenna Television Association** convention to New Hamilton hotel, Laredo.

■ Indicates first or revised listing.

OPEN MIKE

Taxes and assets

EDITOR: The article in BROADCASTING, Feb. 17 on the general aspects of station brokerage and changing ownership was immensely interesting and extremely well written.

One point, however, was not touched upon which might be of interest to people concerned with such matters . . . the change in the tax laws regarding the sale of depreciated assets, which was put into the tax bill of 1961. This provides that in the event of a sale of a depreciated asset, the depreciation charges taken on that asset from Jan. 1, 1962 shall be added back to the taxable income of the corporation and treated as ordinary income.

This has a sharp effect on the sales prices of properties and obviously . . . its impact is going to be greater to the point, perhaps, of making sales in the future much less profitable than they have been in the past. Already, with just two years elapsed time, the effect is marked.

In handling sales of property, there are, of course, two ways to go. In one, the seller throws his corporation into dissolution out of which the assets, physical and otherwise, are sold and the pro-

ceeds distributed. If this method is followed under the present tax laws, the seller then refigures his income tax return for the years back to Jan. 1, 1962, and finds himself with a fine fat assessment on his hands.

The other way . . . is for the seller to sell the stock of his corporation, in which event he has no problems under the present setup. Nor does the new owner of the stock unless and until he collapses his purchase into another entity so that he may achieve a new depreciation base. At this point, the new owner finds that he must file new tax returns for the years since Jan. 1, 1962, and pull into taxable income all of the depreciation taken since then.—*Arthur B. Hogan, president, The Albert Zugsmith Communications Corp., Burbank, Calif.*

Splicing ethics

EDITOR: Your story on the "conference on newfilm standards" held recently in New York (BROADCASTING, March 9) includes the following paragraph:

"Mr. Smith said stock film could be inserted into newly filmed story scenes if this increased the effectiveness of a story without distorting it. The tech-

UNITED
ARTISTS

SHOWCASE 2

JOHN WAYNE WILLIAM HOLDEN
THE HORSE SOLDIERS

Here's John Ford at his best—
with his three favorite ingredients
for a successful motion picture:
Battle, Bravado and John Wayne.

Running time:
119 MINUTES



WRITE, WIRE OR PHONE

**U.A.A. UNITED ARTISTS
ASSOCIATED**

a division of UNITED ARTISTS TELEVISION, INC.
355 Madison Avenue, New York 22, N.Y. • Area Code 212 • 688-4700

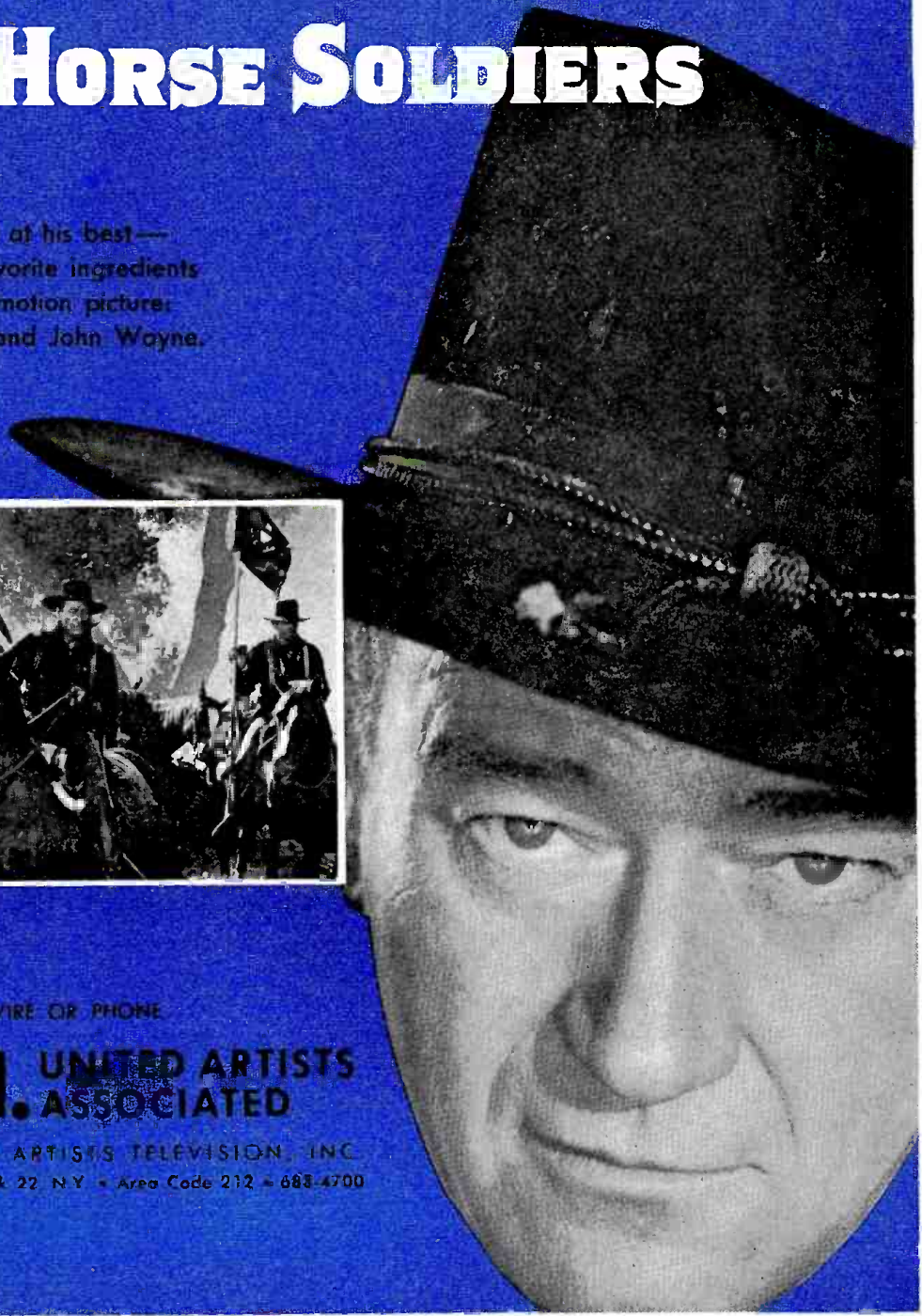

RCA announces...an all new

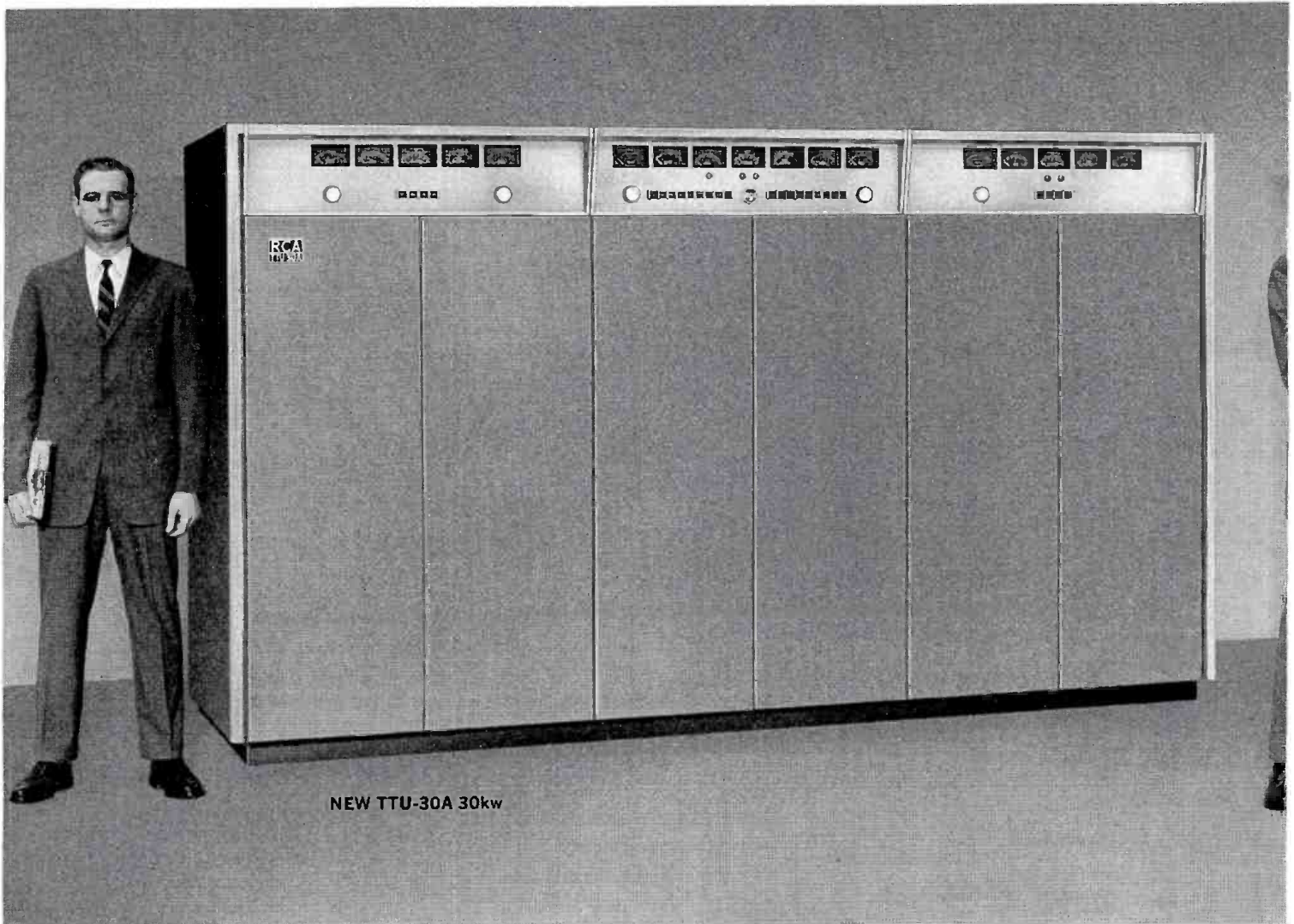

Here's the most exciting news in UHF since the first Ultra High Frequency TV station went on the air over a decade ago! These new transmitters, with important design innovations, are keyed to the accelerating market. You'll like their new size with eye-level, easy-to-read meters, their new steel/blue color, their new ease of operation and economy. All are designed for remote control, all use Direct FM aural modulation for the finest sound.

THE TTU-30A is the only UHF transmitter with vapor-cooled, long-life Integral-Cavity Klystrons. The Klystrons are pretuned and can be replaced in a matter of minutes. They are guaranteed for up to 8,000 hours. Available on lease if preferred. Silicon rectifier power supply with plug-in modules also is a feature of this transmitter. Vapor cooling assures the highest cooling efficiency. Altogether, the TTU-30A is the finest UHF transmitter of its class ever offered.

UHF stations in the U.S. use more RCA transmitters than all other makes combined.

line of UHF transmitters!

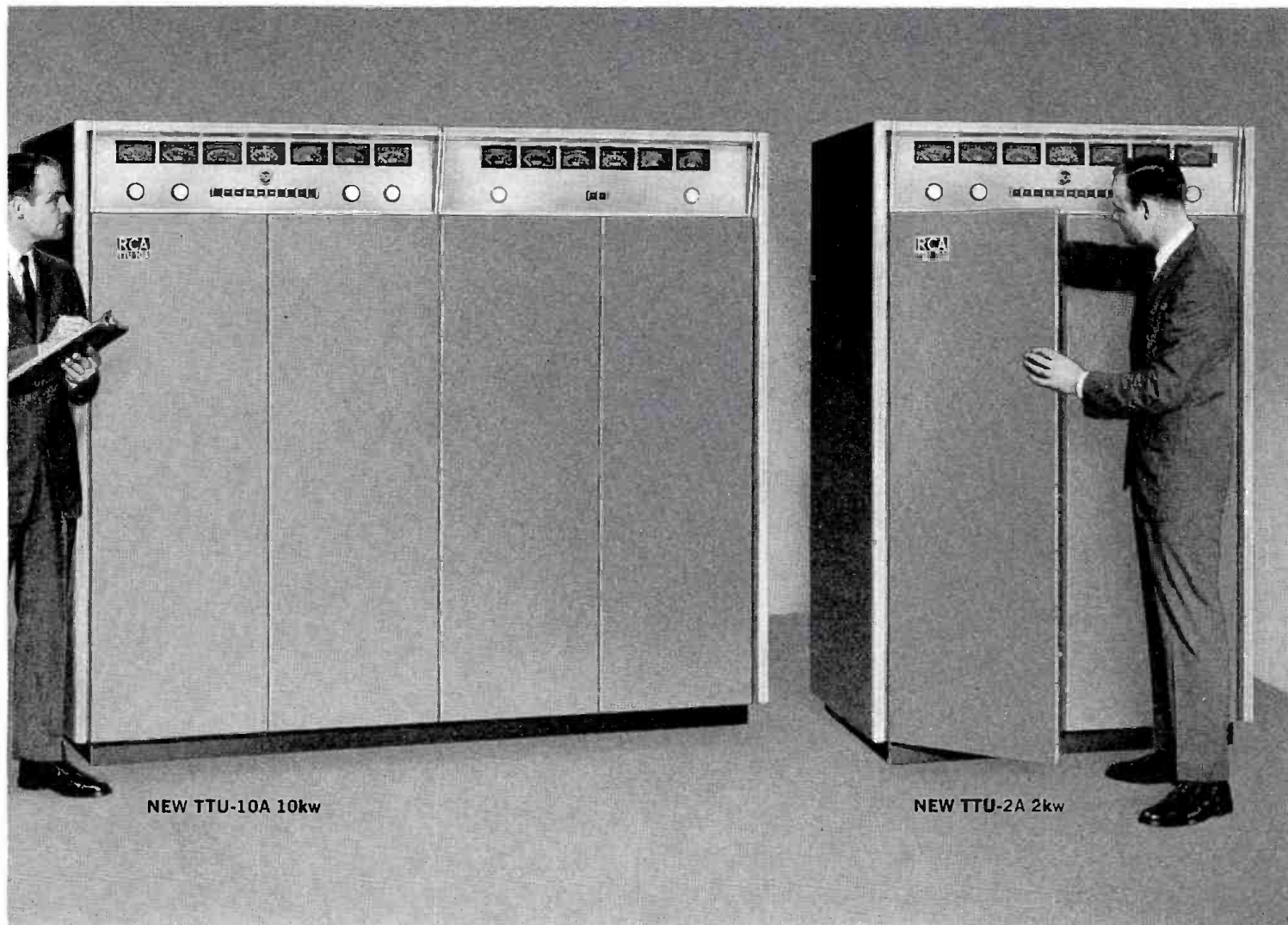

THE TTU-10A is the first 10 kw UHF that is completely air cooled. It needs less than half the space of its 12 kw water-cooled predecessor and has the lowest operating cost of any 10 kw. The TTU-10A uses less input power than the previous 12 kw and is lower priced than any transmitter of similar power.

THE TTU-2A is a real honey! Much smaller than the 1 kw that it replaces, this 2 kw, with plug-in silicon rectifiers, offers twice the power in $\frac{2}{3}$ the space! It has the lowest operating tube cost and

lowest input power requirements of any transmitter on the market today. And it can be easily expanded into a 10 kw at modest expense.

RCA UHF transmitters are the best performing UHF transmitters now in operation, and this new line, with its design innovations, promises even more! Find out all about these distinctive new UHF transmitters from your Broadcast Representative. RCA Broadcast and Television Equipment, Building 15-5, Camden, N. J.



The Most Trusted Name in Television

RCA chooses Varian klystrons for 30kW UHF TV

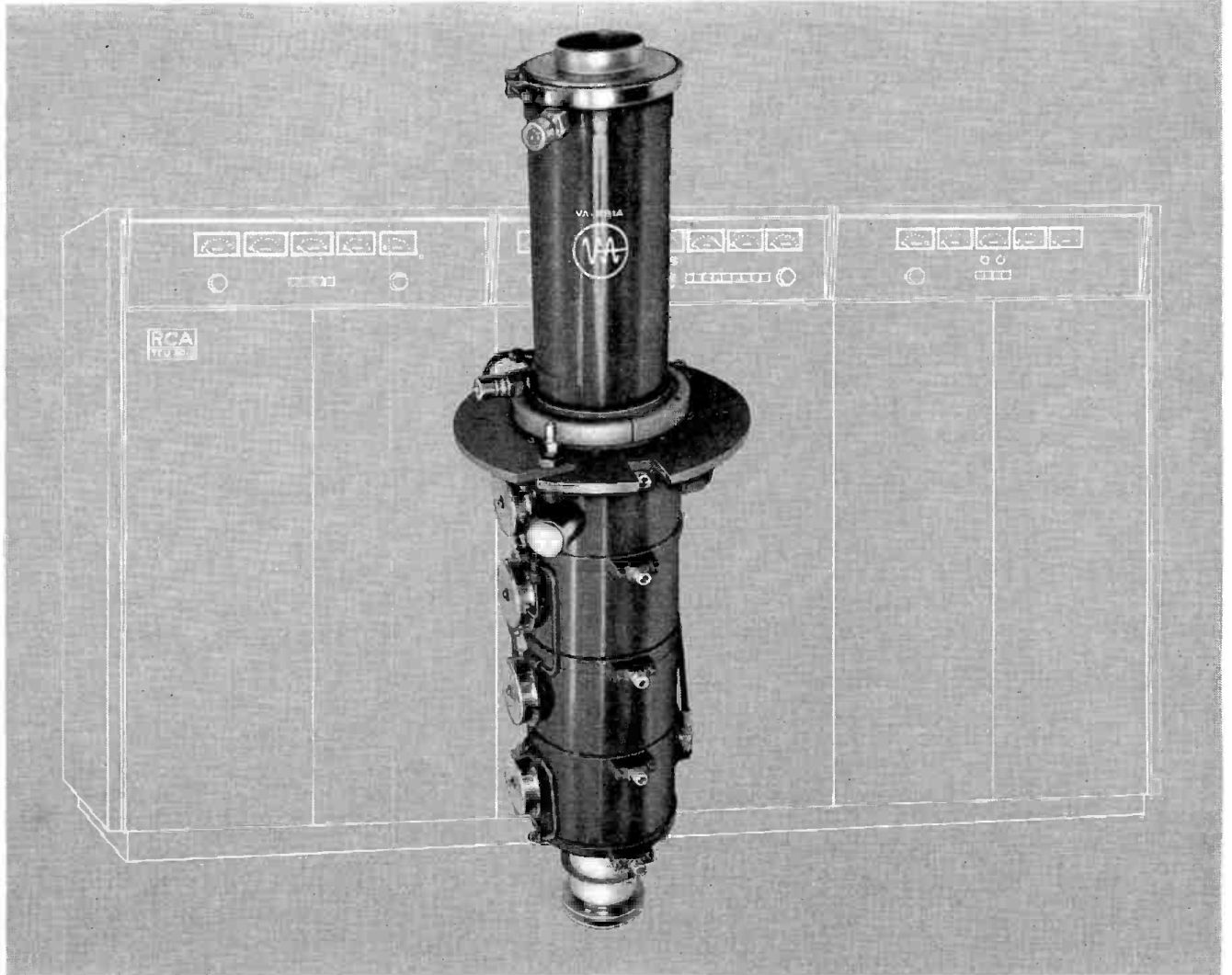

- Simple installation and operation
- Reliability and ruggedness
- Low hourly operating cost
- The coverage afforded by 30 KILOWATTS

FOR THESE AND MANY OTHER REASONS, RCA HAS SELECTED VARIAN'S NEW VAPOR-COOLED KLYSTRONS, VA-890A, VA-891A, VA-892A FOR THE NEWEST HIGH POWER UHF-TV TRANSMITTERS. NOW AVAILABLE FOR ALL CHANNELS.

VARIAN  TUBE division 
ASSOCIATES PALO ALTO, CALIF.

EXECUTIVE OFFICES 611 HANSEN WAY, PALO ALTO, CALIF.

Microwave Tube Group:

PALO ALTO TUBE DIVISION • BOMAC DIVISION • S.F.O. LABORATORIES, INC. • SEMICON ASSOCIATES, INC. • SOLIO STATE PRODUCTS • VARIAN ASSOCIATES OF CANADA, LTD. IN EUROPE: VARIAN A. G., ZUG, SWITZERLAND.

nique can increase the film editor's role in telling a story, which . . . is limited to the pictures he has of it."

This is an erroneous interpretation of Mr. Smith's presentation . . . [which] was concerned with the unintended and unpredictable impressions and illusions which are frequently created accidentally by haphazard newsfilm editing. To illustrate this problem he edited actual newsfilm in several different ways so that, in each case, the implication of a particular scene-to-scene relationship was considerably altered. In one or two examples he inserted stock footage which had nothing whatsoever to do with the original news story simply to prove that when projected, motion picture scenes which have been spliced together create a new meaning out of their relationship as seen by the viewer.

The purpose of this illustration was in no way to suggest that such an intentional disregard for professional ethics in broadcast journalism is ever desirable, no matter how effective an experiment it may seem to be. . . — Robert J. Shafer, chairman, RTNDA, Time-Life Newsfilm Standards Conference, New York.

A second look

EDITOR: . . . President Johnson's "special" Sunday, March 15 began at a different time on each of the three television networks. NBC began first, with CBS a full 20 seconds later, and ABC four seconds after CBS.

Although each network utilized the same video tape copy, many viewers may have been perplexed to see a different image on each . . . network . . . in actual fact they were merely viewing a different chronological sequence of each of the tape copies.

Perhaps NBC rebelled against CBS, since CBS always begins its *CBS Evening News with Walter Cronkite* before NBC begins its *Huntley-Brinkley Report* each weekday evening. But one may wonder, why does ABC always seem to be last?—Richard Drost, president, Videochex, Chicago.

Call letter curiosity

EDITOR: I am preparing some material concerning the origin and application of radio and TV station call letters.

An example of what I am looking for is: WDGO Cleveland was owned by Douglas G. Owett. But since it was purchased by the Seaway Broadcasting Corp., its call letters have been changed to WCLV. —Peter R. Joyes, 12511 Clifton Boulevard, Lakewood, Ohio.

(More on call letters may be found in BROADCASTING, Nov. 25, 4, 1963)

BROADCASTING, March 23, 1964

BROADCASTING PUBLICATIONS INC.

PRESIDENT SOL TAISHOFF
VICE PRESIDENT MAURY LONG
VICE PRESIDENT EDWIN H. JAMES
VICE PRESIDENT WINFIELD R. LEVI
SECRETARY LAWRENCE B. TAISHOFF
TREASURER B. T. TAISHOFF
COMPTROLLER IRVING C. MILLER
ASST. TREASURER JOANNE T. COWAN



Executive and publication headquarters: BROADCASTING-TELECASTING Bldg., 1735 DeSales Street, N.W., Washington, D. C. ZIP code 20036. Telephone: 202 Metropolitan 8-1022.

EDITOR AND PUBLISHER
Sol Taishoff

Editorial

VICE PRESIDENT AND EXECUTIVE EDITOR
Edwin H. James

EDITORIAL DIRECTOR (New York)
Rufus Crater

MANAGING EDITOR
Art King

SENIOR EDITORS: Bruce Robertson (Hollywood), Frederick M. Fitzgerald, Earl B. Abrams, Lawrence Christopher (Chicago), Dawson Nall, Len Zeidenberg, David Berlyn (New York), Rocco Famighetti (New York). ASSOCIATE EDITORS: Sid Booth, Sherm Brodey, George Darlington; STAFF WRITERS: Gary Campbell, Barry Crickmer, Jim deBettencourt, Larry Michie; EDITORIAL ASSISTANTS: Sonya Lee Brockstein, Tanii Oman, Victor Rossi; SECRETARY TO THE PUBLISHER: Gladys Hall.

Business

VICE PRESIDENT AND GENERAL MANAGER
Maury Long

VICE PRESIDENT AND SALES MANAGER
Winfield R. Levi (New York)

ASSISTANT PUBLISHER
Lawrence B. Taishoff

SOUTHERN SALES MANAGER: Ed Sellers; PRODUCTION MANAGER: George L. Dant; TRAFFIC MANAGER: Hatty Stevens; ADVERTISING ASSISTANTS: Robert Sandor, Richard LePere, Carol Ann Cunningham, Claudette Artini; SECRETARY TO THE GENERAL MANAGER: Doris Kelly.

COMPTROLLER: Irving C. Miller; ASSISTANT AUDITOR: Eunice Weston.

Publications and Circulation

DIRECTOR OF PUBLICATIONS
John P. Cosgrove

William Criger, David A. Cusick, Christer Jonsson, David Lambert, Edith Liu, Natalie D. Lucenko, German Rojas, James Williams.

Bureaus

New York: 444 Madison Avenue, ZIP code 10022. Telephone: 212 Plaza 5-8354.

EDITORIAL DIRECTOR: Rufus Crater; SENIOR EDITORS: David Berlyn, Rocco Famighetti; STAFF WRITERS: Jerry Beigel, John Gardiner, Charles E. Karp, Ellen R. McCormick. ASSISTANT: Francis Bonovitch.

VICE PRESIDENT AND SALES MANAGER: Winfield R. Levi; INSTITUTIONAL SALES MANAGER: Eleanor R. Manning; ADVERTISING REPRESENTATIVE: Robert T. Fennimore; ADVERTISING ASSISTANT: Beryl W. Stern.

Chicago: 360 North Michigan Avenue, ZIP code 60601. Telephone: 312 Central 6-4115.

SENIOR EDITOR: Lawrence Christopher; MIDWEST SALES MANAGER: Warren W. Middleton; ASSISTANT: Rose Adragna.

Hollywood: 1680 North Vine Street, ZIP code 90028. Telephone: 213 Hollywood 3-3148

SENIOR EDITOR: Bruce Robertson; WESTERN SALES MANAGER: Bill Merritt; ASSISTANT: Gail Learman.

Toronto: 11 Burton Road, Zone 10. Telephone: 416 Hudson 9-2694. CORRESPONDENT: James Montagnes.

BROADCASTING* Magazine was founded in 1931 by Broadcasting Publications Inc., using the title BROADCASTING*—The News Magazine of the Fifth Estate. Broadcast Advertising* was acquired in 1932. Broadcast Reporter in 1933 and Telecast* in 1953. BROADCASTING-TELECASTING* was introduced in 1946.

*Reg. U. S. Patent Office
Copyright 1964: Broadcasting Publications Inc.

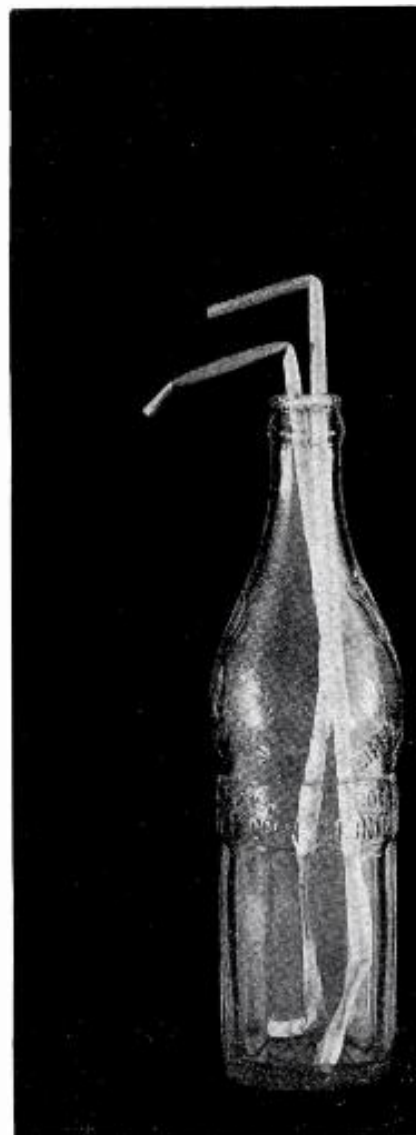

KONO SELLS

Why? KONO is the station listeners listen to; a station that stimulates, entertains, and informs. It offers diversified programming, timed to capture all age groups when they are most receptive. It breaks away from corny cliches and fussy formats. It appeals to everyone by being exuberant, not extravagant—dynamic in depth rather than merely daring in scope. KONO sells its sponsors' products because a receptive audience is a responsive audience—a KONO audience!

For complete details contact Kotz Agency.

KONO

860 KC • 5000 Watts • San Antonio

(OPEN MIKE) 23

The creative revolution has arrived

Somewhere west of Lexington Avenue, a writer is hunched over his typewriter plotting the commercial that is going to revolutionize advertising. If he succeeds (and he'd better), he'll just about keep up with today's demand.

For in today's competition for the millions of eyes and ears and dollars at the business end of the TV tube, merely good isn't nearly good enough. Nothing short of brilliant will do.

That's why more and more creative directors are encouraging their writers to explore, to stay loose, to go way out. And to be perfectly fair, that's why more and more writers are getting their creative directors to let them explore, stay loose, go way out. In short, get the revolution on the road.

Hard Core ■ Behind the creative revolution is a hard core of writers, art directors and producers with a singularly hard-nosed point of view: They must have the notion that advertising, must be built on a strong, basic selling idea—and that it must be new and surprising, different and dramatic, and hit one over the fence every time you come to bat. As most people know, this is impossible. But luckily the true revolutionist doesn't know it.

Sometimes he does, indeed, fall on his face. The creative revolution involves certain risks: you either make it very big—or fail very big. This means that both understanding and support from agency management and client are absolutely essential. But the rewards of success are tremendous. And it is a fine thing for a man to know that one day he will tell his grandson that he was there the day they planned the revolution.

What's so Revolutionary? ■ As we all know (or keep saying we know) advertising is at its poorest and most ineffective when it gets into a rut, when it runs to stereotypes, when one product in a category looks like any other. And, conversely, advertising is at its best when—in its own time and in its own category—it is deft, bright, original, dramatic . . . revolutionary.

A few examples:

■ Auto tires, to our mind, always led pretty racy lives—but you'd never have known it from the tire commercials. Then came the revolution—and Go-Go-Goodyear.

■ Not long ago, most coffee commercials looked pretty much alike: man drinks coffee and winks broadly to show how he-man good it is. Then along came Yuban with those aged beans that

couldn't wink very well—but, boy, you could almost smell and taste them through the screen. And then along came Instant Maxwell House—and our cup runneth over.

■ For a time too long for anyone to be proud of, headache remedy commercials looked like painful animations out of a 1905 edition of *Popular Anatomy*. Then Bufferin started to talk to real people who had real headaches. And they talked to us in a quiet sympathetic voice—and what blessed relief it's been for us all ever since.

■ Take the case of cola advertising. Who among us can remember what any of it looked like—until Pepsi got hip and made us all think young (including Coke).

■ Beauty soap commercials have a cliché heritage that's as old and bland as a soap opera. Suddenly Zest burst on the screen with an exciting, outdoor look that made you feel really clean just to look at it. Then Dial came on with a new new idea that almost revolutionized people. (At least those who like people.) And now with Zest again—getting us all worked up into a shampoo lather—soap advertising will never be the same.

There's one big trouble with any revolution, however. Once it looks like a winner, everybody wants in, and one of three things happens. First, it is imitated: brazenly, slavishly, usually badly. Second, it finds itself hailed as the only safe, practical, tried and true solution for all products, for all problems, for all time. Third, and best of all for all of us, somebody pulls off a coup and tops it! Then back to the plotting board and another revolution.

How to Start a Revolution ■ Sorry, there is no handbook; but here are a few

likely areas if you'd like to try a little boring from within.

■ Humor. Handle with care. Jack Benny is funny; it only took him his entire 39 years to create his style and his reputation. You have an entire 60 seconds. Schweppes has made it; so has Gravy Train; so can you.

■ Slice of life. When handled with finesse, this much-maligned technique is a powerful way to register your selling message. And why not? People understand it, identify with it, believe it. But only when it's simple, meaningful, and believable. If there's to be a revolution here, it will most likely come in technique, casting, and direction. Oxydol and, of all people, Bromo-Seltzer have been sending out interesting signals of things to come.

■ Announcer-presented. Since about the mid '50's, most of us put the stand-up announcer out in the barn along with the snake oil. Then along came Barbara Baxley. Some revolution!

Film and tape and animators and optical technicians offer us ways to present our messages we haven't yet dreamed of. But we have to supply the drama, the impact, the action—for technique alone is meaningless to the viewer. Above all we must state our message simply and clearly, because only people are listening. And every revolution, to be successful, needs the support of the people.

Today, with television calling people to action seven or more times every 30 minutes, you begin to see the real creative problem. The people are surrounded. How do you reach them? How do you get your message through to them? Come join the revolution and see!



Norton J. Wolf is a vice president and creative supervisor at Benton & Bowles, New York. Mr. Wolf joined B&B as a print copywriter in 1950, a time he describes as "those dim dark days when print was holy writ and TV was black magic." He was made group head in 1953, and became supervisor in 1958. His assignments include a wide variety of brands on the agency's Procter & Gamble, General Foods, Norwich Pharmacal, Sterling Drug, and Beech-Nut Life Savers accounts.



Quality . . . by any measurement . . . is on the record at WELI. The station that the adult, purchasing power audience in New Haven depends on . . . The station that makes New Haven a better buy.

National:  Representatives

Boston: Eckels & Company

The Sound of New Haven WELI 960/5000 watts



10

GOVERNMENT

Mayor Lloyd M. Allen, South Bend
Mayor Margaret Prickett, Mishawaka
Mayor John Weaver, Elkhart
U. S. Congressman John Brademas

EDUCATION

Dr. Alex Jardine,
Supt. of Schools, South Bend
Joseph C. Rice,
Supt. of Schools, Elkhart
Dr. John Young,
Supt. of Schools, Mishawaka

RELIGION

Msgr. John Sabb, Vicar General,
Ft. Wayne-South Bend Diocese
Rabbi Albert Shulman,
Temple Beth-el, South Bend
Rev. Ronald Liechty,
Elkhart County Council of Churches

CHAMBERS OF COMMERCE

Ken Burch,
Dir., South Bend-Mishawaka
Keith Meade, Dir., Elkhart

FARM AGENTS

Leo Selfenright, Elkhart County
Dwight Miller, St. Joseph County

BUSINESS

Paul D. Gilbert, Pres.,
Gilbert's Clothing, Inc., South Bend
Charles Judd, President,
Judd Drug Co., Elkhart

LABOR

Stanley Ladd, President, AFL-CIO,
St. Joseph County, South Bend

Community leaders salute WSJV's 10th Anniversary!

This month, these outstanding community leaders took to the air to pay tribute to WSJV on its 10th Anniversary. This kind of "home-town" recognition isn't surprising from this loyal Hoosier market, South Bend-Mishawaka-Elkhart. Why? Because community involvement has been part and parcel of WSJV since 1954. And, listen — *the allegiance this station has won from its viewers always rubs off on its advertisers!* Call ATS today.

Follow the leaders to this topflight TV station!



WSJV-TV

SOUTH BEND-**28** ABC
ELKHART

Represented by Advertising Time Sales



JOHN F. DILLE, JR., PRESIDENT • A MEMBER STATION OF THE COMMUNICANA GROUP

FTC threatens tobacco millions

Proposed rules would virtually end radio-TV cigarette advertising, Tobacco Institute witness implies in testimony at Washington hearing

The Federal Trade Commission and the billion-dollar tobacco industry are on a collision course that promises to cause reverberations from the smallest southern hamlet to New York's Madison Avenue.

The government agency seems determined to adopt rules requiring cigarette manufacturers to warn consumers—in every radio and television commercial and every printed advertisement—that smoking is dangerous to health.

And, the tobacco industry and many others are just as determined to prove that such a requirement is illegal. Both sides agree that the final decision will probably not be made until the highest court in the land has acted. Lined up with the federal agency are medical men, researchers, sociologists, the U. S. Public Health Service and a few members of Congress.

Counsel for the Tobacco Institute implied last week the end result of such restrictions would be the end of all cigarette advertising on radio and television. Joining the institute in claiming the proposed rules are illegal are communications media, trade associations and governors and congressmen from the tobacco-producing states.

FTC Hearings ■ Battle lines were formed in Washington as the FTC held three days of hearings on its proposed rules to require all cigarette ads and packages to include a warning that smoking is dangerous to health (BROADCASTING, March 16, et seq.). Three of the four commissioners (there is one FTC vacancy) were openly antagonistic toward spokesmen for the Tobacco Institute (Washington attorney H. Thomas Austern), Association of National Advertisers (Gilbert H. Weil) and Radio Advertising Bureau (President Edmund Bunker).

FTC Chairman Paul Rand Dixon and Commissioner Philip Elman complained that the cigarette industry had sent a "lawyer to argue legalities" instead of a scientist to discuss the merits of a blue-ribbon government research report which found that cigarette smoking causes lung cancer and contributes to other diseases. It was this report to the

U. S. surgeon general early this year (BROADCASTING, Jan. 20) which prompted the FTC rulemaking.

The commissioners expressed "surprise" that no witnesses challenged the findings of the surgeon general's committee of 10 doctors and scientists. They, in turn, were accused by tobacco-belt congressmen of already having their minds made up to adopt the



"Plain as the nose on your face," FTC Chairman Paul Rand Dixon told a witness last week who maintained that proposed rules on cigarette advertising are ambiguous. He and fellow Commissioner Philip Elman chastised lawyers who told the FTC that it has overstepped its legal mandate from Congress. The chairman said that he is "really disappointed" with the bar.

proposed rules before hearing the statements made last week.

Pros and Cons ■ The 30 witnesses were about equally divided for and against the proposed rules. The main arguments of those opposing the FTC were that the government agency does not have the authority to adopt such rules against an entire industry; that only Congress should take such an action; that such warnings are unnecessary because the public is fully informed of the smoking hazard, and that the economic impact of a curtailment of the tobacco industry must be considered.

Those favoring the rules said that such warnings are necessary to protect the public, particularly teenagers. Several doctors said the proposed rules did not go far enough—that cigarette commercials should be prohibited on TV altogether. They expressed "grave concern" that broadcast commercials more than offset the impact on the public of the report on the consequences of smoking.

Mr. Bunker was the only broadcast industry spokesman to testify in person at last week's hearing but the National Association of Broadcasters and the TV Bureau of Advertising filed statements for the record. NAB asked the FTC to withdraw the proposed rules and instead send recommendations to Congress for necessary legislation.

If the commission adopts the rules, the NAB said, the protracted legal controversy which will follow will create "prolonged uncertainties for advertisers and grave dilemmas for broadcasters." The outcome, NAB pointed out, may remain unknown for years with stations caught in the middle.

In 1963 tobacco advertisers spent \$110 million in television advertising and \$25 million in radio, according to accepted industry reports.

The record in the proceeding will remain open until April 15 and interested parties may file statements until that date.

'Full Accord' ■ The Public Health Service is in "full accord with the general objectives" of the proposed FTC



Gov. Harrison

Gov. Sanford

Two governors from tobacco states, Albertis Harrison, of Virginia, and Terry Sanford, of North Carolina, urged the FTC last week not to adopt any rules which would curtail the tobacco industry. Both challenged the FTC's legal



Mr. Weil



Mr. Bunker

grounds to require cigarette commercials to include a health warning, as did spokesmen from advertising, Gilbert Weil of the Association of National Advertisers and Edmund Bunker, Radio Advertising Bureau.

restrictions against cigarette advertising, Assistant Surgeon General James M. Hundley told the commissioners. He said he knows of no cigarette presently on the market which is not a health hazard and that a "safe" filter would make smoking "like a drink of hot water, I suppose."

Dr. Hundley, working chairman of the blue-ribbon team of doctors and scientists which prepared the report to the surgeon general, gave a history of preparations for the study and its purpose. The study was to be done "in such a way that something might be settled no matter what conclusions the committee might reach," he said. The health service feels that authoritative conclusive results were reached. "I am not aware of any major substantive flaw or criticism thus far discovered," Dr. Hundley said.

All available facts must be kept before the people and this is why ciga-

rette advertisements should include the proposed warnings, the PHS official said. The health service feels that advertising is a "determining" factor in the consumption of cigarettes, he said.

Frequent Interruptions - Mr. Austern, an expert on the FTC act, was interrupted repeatedly in his argument that the FTC has gone beyond its authority. He, as spokesman for the tobacco industry, was criticized for refusing to discuss the findings in the surgeon general's report and for not offering alternative rules.

Mr. Austern made three main points: (1) the FTC was attempting to do violence to the rights of parties under the Trade Commission Act and the Administrative Procedures Act by illegally legislating the proposed rules; (2) the industry should be permitted to regulate its own advertising, and (3) the public interest requires that Congress develop any specific action, even if the FTC

did have the authority.

Countless times during Mr. Austern's appearance, the proceeding erupted into debate, with Commissioner Everette MacIntyre joining Messrs. Dixon and Elman in attacking the Tobacco Institute position. These debates were primarily over "substantive" rules, which if violated would be punished by the FTC but which were termed guidelines with no force of law. The commissioners never clarified these rules, although Mr. Austern and other witnesses maintained there is no doubt that the proposals are legislative in nature.

The labeling and advertising warnings are "ambiguous, impracticable in terms of compliance and unsupported by demonstrated fact as distinguished from the asserted beliefs of the commission," Mr. Austern charged. "As to the statutory power, we respectfully submit that . . . the commission is not exercising the authority conferred upon it by Congress.



Rep. Lennon



Sen. Neuberger



Mr. Hundley



Mr. Austern

Members of Congress were on opposite sides last week as Representative Alton Lennon (D-N.C.) accused the FTC of prejudging the cigarette issue while Senator Maurine Neuberger (D-Ore.) told the commissioners they have a unique opportunity to show that the almighty dollar

doesn't always prevail. Assistant Surgeon General James Hundley said there is no safe number of cigarettes for moderate smokers while H. Thomas Austern, for the Tobacco Institute, found himself engaged in numerous debates with the commissioners on a matter of law.

It is plainly legislating.”

Rule 1 is “a stark assertion” that the FTC has the power to legislate that every package of cigarettes and every advertisement must be labeled in the specific language the commission prescribes—without a complaint, without evidentiary hearings, without factual findings “and solely on the commission’s legislative determination of an across-the-board requirement for an entire industry,” the Tobacco Institute spokesman said.

Legislative History ■ Mr. Austern said the legislative history of the FTC “makes it abundantly clear not only that the commission does not have the power, but also that Congress specifically was asked to grant it and repeatedly refused to do so.”

The commissioners stoutly defended their proposal and Chairman Dixon asked: “Do you think we would have embarked on this if we didn’t have the power to do so?”

The government men were critical of the tobacco industry’s argument for self-regulation. Mr. Austern said that since the report was issued Jan. 11, the industry has been “intensively engaged” in the development of its own advertising guidelines and asked the commission to await this development.

Commissioner Elman derided such efforts and asked why the industry had waited so long when there were reports linking cancer with smoking a decade back.

Mr. Austern also had a “why” in his testimony. Why, he asked, would a TV announcement which simply referred to “Brand X” have to be followed by a health warning. “The asserted basis . . . can be found only in a series of commission ‘beliefs.’” These beliefs are not predicated, as required by law, upon evidence.

One of the FTC’s asserted “beliefs,” Mr. Austern said, embraces a “wholly new theory of advertising law.” This, he said, is the commission’s statement that “much current advertising . . . may create a psychological and social barrier to the consuming public’s understanding . . . of the risks involved in smoking. “What in the world does it mean?” Mr. Austern asked without getting an answer.

It has not been established, he said, that every cigarette spot on radio and TV must carry the warning specified by the FTC “in order to retain public consciousness of the asserted problems of smoking and health.”

Faces and Noses ■ Rule two “is either so ambiguous that it contributes nothing or else it is so comprehensively rigid as to prescribe all cigarette advertising,” Mr. Austern said.

Mr. Austern said that cigarette advertising does not in any way claim that

smoking promotes good health nor that the advertising brands are “not a hazard to health.” He said cigarette manufacturers are thoroughly confused over what would be permissible in commercials if rules 1 and 2 are adopted and that “it is difficult to envisage any form of advertising, other than mere mention of a brand name, that might not be subject to challenge.”

The end result of all three rules “appears to be to foreclose virtually every form of cigarette advertising that shows anything in the video or in pictorial form or makes any statement whatever beyond the required caution.”

In response, Commissioner Elman

comments (BROADCASTING, Jan. 27), the NAB maintained. If the FTC holds that cigarette advertising is against the public interest, then the advertising “should be attacked directly because of specifically alleged unacceptable attributes,” the NAB statement continued.

“Guidelines controlling the nature of the advertising messages themselves would appear to be a far more effective and reasonable remedy.”

The problems of law and policy involved can be dealt with only by Congress and for this reason the NAB asked the FTC to withdraw its controversial “proposed trade regulation rules for advertising and labeling of cigarettes

FTC’s proposed rules for cigarette advertising

Text of the proposed FTC rules covering cigarette advertising and labeling follows:

RULE 1. Either one of the following statements shall appear, clearly and prominently, in every cigarette advertisement and on every pack, box, carton and other container in which cigarettes are sold to the public:

(a) “Caution—cigarette smoking is a health hazard: The Surgeon General’s Advisory Committee on Smoking and Health has found that ‘cigarette smoking contributes substantially to mortality from certain specific diseases and to the overall death rate’”; or

(b) “Caution: Cigarette smoking is dangerous to health. It may cause death from cancer and other diseases.”

RULE 2. No cigarette advertisement shall state or imply, by words, pictures, symbols, sounds, devices or demonstrations, or any combination thereof, that smoking the advertised cigarettes

(a) promotes good health or phys-

ical well-being.

(b) is not a hazard to health, or

(c) is less of a hazard to health than smoking other brands, except that a specific and factual claim respecting the health consequences of smoking the advertised cigarettes may be advertised if

(1) the advertiser, before making the claim, has substantial and reliable evidence to prove the accuracy and significance of the claim, and

(2) all facts material to the health consequences of smoking the advertised cigarettes are clearly, prominently and intelligibly disclosed in close conjunction with the claim.

RULE 3. No cigarette advertisement shall contain any statement as to the quantity of any cigarette-smoke ingredients (e.g., tars and nicotine) which has not been verified in accordance with a uniform and reliable testing procedure approved by the Federal Trade Commission.

asked if the FTC should take such a conclusion into consideration “if it happens to be so.”

Dixon Quoted ■ Chairman Dixon last fall told a Senate subcommittee that the FTC presently does not have the power to issue substantive rules, the NAB reminded the trade commission in contending that the proposed rules are lacking legal supports. Yet, the NAB’s prepared statement said, the FTC “evidently wants to legislate binding rules, having the force of law, regulating the content of advertising in all media by an important industry.”

The “binding nature” of the proposed rules is apparent from the official comments accompanying the request for

and instead to develop a report with appropriate recommendations to the Congress.” Such recommendations should evolve from consultation with all affected business groups and others “interested in an atmosphere of calm and constructive cooperation to achieve a common objective in the public interest.”

The NAB statement, signed by General Counsel Douglas Anello, pledged the “fullest cooperation” of the broadcast industry to this end.

The NAB cited the radio and TV codes as signifying the “industry’s recognition of its own responsibilities.” Radio-TV broadcasters have been concerned for some time with the possible

BANKING TYCOONS

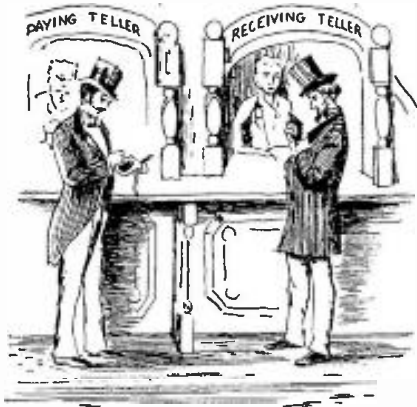

buy WNBC-TV. Top names in the banking business know it's the most efficient means of making new friends and customers among New Yorkers. Among the prominent tycoons:

Amalgamated Bank of N. Y.
Bowery Savings Bank
Bankers Trust Co.
Chase Manhattan Bank
Chemical Bank N. Y.
Trust Co.
City Federal
Savings & Loan Assoc.
First National City Bank
Manufacturers Hanover
Trust Co.
New York State
Savings Banks Assoc.

Take a tip from the Banking Tycoons: whatever the product or service you sell, viewer interest is greater on WNBC-TV.

4

WNBC-TV
NEW YORK

smoking health hazard and their own responsibility in the area, the NAB said.

AMA Takes Sides ■ The witness who apparently came the closest to shaking the resolve of the FTC panel to enact its proposals never even entered the hearing room. Dr. F. J. L. Blasingame, executive vice president of the American Medical Association, filed a statement on behalf of the AMA that unequivocally aligned the medical group with the tobacco industry.

"With respect to cigarettes, cautionary labeling cannot be anticipated to serve the public interest with any particular degree of success," the statement said. Research, AMA indicated, offers the only solution to the smoking-health problem that the FTC is attempting to tackle.

FTC members showed great interest in the statement, and Commissioner MacIntyre said it "perplexed" him. Doctors testifying in favor of the FTC proposals at the hearing were asked about the AMA position, but they said they hadn't seen the statement and could only suppose that the AMA was taking a conservative, go-slow approach to the problem. But Representative Frank Thompson Jr. (D-N.J.) later charged that the AMA was trading its statement for the votes of the tobacco state congressmen against the administration's medicare proposal. AMA said Mr. Thompson's accusation was "ridiculous."

Testimony so strong that it went far beyond the bounds of mere support for the FTC proposals was offered by Mildred E. Brady, an assistant director of Consumers Union of the U. S. Inc., a nonprofit organization that publishes the monthly *Consumer Reports* and other publications designed to inform the consumer.

"The efforts made by radio and television in years past to foster public awareness of the health hazards associated with smoking have been practically nil," she asserted, and "cigarette advertising over television and radio should be banned entirely." She said that "the failure of television and radio to follow upon the impact of the surgeon general's report with an educational program in depth constitutes a betrayal of public responsibility."

'Far Cry' ■ The ANA's Mr. Weil charged the FTC is straying into an area which is a "far cry from its jurisdiction" when the agency attempts to rule on the psychological and social affect of advertising on the public. This causes the ANA concern, he said, because such a consideration has nothing to do with deceptive or misleading statements over which the federal agency has jurisdiction.

He said the FTC's notice and proposed rules are "vague, general and ambiguous" as to what is meant and how the trade commission plans to use them.

It is "inescapable," Mr. Weil said, that the proposed rules "derogate from a party's rights and do violence" to the mandate from Congress to the FTC.

As they did with Mr. Austern, Commissioners Dixon and Elman questioned Mr. Weil sharply on his contention that the FTC had gone beyond its legal authority.

Mr. Weil countered that he was not expressing false fears and cited the FTC's own language as "classically statutory" to back his contention the commission had proposed legislative rules. "We have a right to worry," he said, because the FTC has not limited the proposed rules to "guidelines."

The ANA would be very much for guidelines—as opposed to substantive rules—which would not have force of law. Enabling legislation did not give the FTC the broad powers contemplated in the proposed cigarette advertising rules, Mr. Weil maintained.

"You and I didn't go to the same law school," Commissioner Elman pointed out.

As had other witnesses, the ANA spokesman maintained the cigarette manufacturers are not obligated to inform the public of the alleged health hazards of smoking because consumers already are well aware of the dangers. Therefore, he argued, there is no deception involved in cigarette commercials sans warnings.

Arthur B. Hanson, general counsel of the American Newspaper Publishers Association, said that the FTC with its cigarette proposals is exceeding its authority and may be infringing on the freedom of speech guaranteed by the First Amendment. Mr. Hanson said "this proceeding seems to be an attack . . . on the extensive use of advertising and particularly on its successful use." Individual cigarette advertisements fall under the jurisdiction of the FTC, he said, but such general restrictions as proposed should be left to Congress.

"If the FTC can under the law state to any industry what its advertisements must or must not contain, and do this in the absence of legally established procedures consonant with the due process clause of the Constitution," Mr. Hanson stated, "then it must be assumed that it can do this for all industry and, for that matter, all advertisers in this country under similar circumstances."

North Carolina Attacks ■ The country's major tobacco-producing state, North Carolina, sent its governor, four congressmen and Farm Bureau to the trade commission hearing.

Representative Alton Lennon (D-N.C.), who said he was appearing for "tobacco growers and their families," charged that the commissioners already have made up their minds on the subject before listening to the testimony. He also attacked the government report

A Metro Radio Sales man takes more of your time

He has the markets buyers want. He knows his station and his proposals show it. They are fully researched and tailored to a specific account. He usually gets more time, air time, from mediagen for these selected stations in these major markets. WNEW, NEW YORK; KLAC, LOS ANGELES; WIP, PHILADELPHIA; WKYC, CLEVELAND; WCBM, BALTIMORE; KMBC, KANSAS CITY; WDRC, HARTFORD.

Metro Radio Sales

H.D. "BUD" NEUWIRTH, VICE PRESIDENT AND DIRECTOR

OFFICES: NEW YORK, CHICAGO, BOSTON, PHILADELPHIA, ST. LOUIS, DETROIT, LOS ANGELES AND SAN-FRANCISCO.

as "containing not a single, new finding" and the trade commission for breaking faith with both Presidents Kennedy and Johnson.

He forecast "breadlines within 60 days" if the tobacco growers are curtailed and another congressman said such government action would be contrary to the President's antipoverty crusade. The spokesmen from the tobacco states—including Virginia Governor Albertis Harrison and Kentucky Governor Edward Breathitt—all stressed the economic and tax importance of tobacco and related industries.

Senator Maurine Neuberger (D-Ore.), on the other hand, told the FTC that it has a chance to determine if the "almighty dollar" or the public's health will prevail. She said she has no doubt that the FTC has the authority to adopt the rules it has proposed and that she and 10 other senators are sponsoring legislation to help the commission "to enforce those rules promptly and efficiently." The bill also is designed to help the FTC "extricate itself from the legal morass into which industry is apparently determined to draw it," Senator Neuberger said.

She devoted much of her three-page statement to a criticism of the position taken by the Tobacco Institute (BROADCASTING, March 16).

Representative Lennon urged the commissioners to "be realistic" before they destroy the economy of the tobacco states. He questioned the FTC on its "premature hearing" since government agencies were supposed to make recommendations on a course of action to the secretary of Health, Education & Welfare.

In addition, he said to the commissioners, "you do not have the authority to do what you propose to do. Not now. Not now."

North Carolina Governor Terry Sanford charged the blue-ribbon report is based on "circumstantial evidence and statistical associations." He said all the evidence is not in and the people in the 21 states which produce tobacco products must be protected. "We ask moderation from the FTC," he said.

"In the light of existing knowledge, I say with all respect . . . that I hope you will not assume the burden of proof for labeling cigarettes as a health hazard."

Moderation Harmless ■ The governors and congressmen argued that smoking in moderation does not constitute a health hazard and that continued research is necessary to point up this fact.

Governor Harrison said "I do not feel this commission, or any other regulatory body, should adopt any rule or regulation which would directly or indirectly have the effect of prohibition." The Virginia chief executive, who owns a tobacco farm, said the proposed warn-

Tax take continues down

Tax takes from cigarette sales continued a dramatic nose dive in February, it was reported last week even as the Federal Trade Commission was conducting a hearing in Washington on cigarette labeling and advertising (see page 27). Similar tax revenues were also down in January over the same month a year ago (BROADCASTING, Feb. 17).

The National Tobacco Tax Association, Chicago, said that cigarette tax revenues for February, compared with the same month in 1963, declined 10-14.9% in 10 states, 15-19.9% in nine states and 20-29.9% in four states.

The sharpest declines in cigarettes sales were reported in Iowa, down 31.6%, and the District of Columbia, down 30%.

ings would have an adverse affect on radio and TV programing by causing a loss in revenues.

Because of the "tremendous economic implications," the FTC should move with extreme caution on this matter "of major and grave significance," he said.

Tobacco is not only a crop but "a way of life for countless Kentucky farmers," Governor Breathitt told the FTC in a prepared statement delivered for him by the state's adjutant general. However, he said that even if Kentucky was not a tobacco growing state, he still would be against the proposed FTC rules.

"This is an attempt to police an entire industry by imposing on its products regulations that do not apply to other products and to force companies which are a part of that industry to advertise against themselves if they advertise at all," Governor Breathitt charged. "Such labeling and advertising regulations are not needed. . . . Do we need to label with a skull and crossbones all materials ingested by the human body because of the risk of unwise use or overindulgence?"

Representatives L. H. Fountain (D-N.C.) and Roy A. Taylor (D-N.C.) both called for more research before any premature restrictions are adopted. Congressman Fountain said the government should spend more money to find ways to "eliminate such hazards as do exist. . ." and that even if the FTC did have the authority to act, the problem is so big that it should be left up to Congress.

The last witness at the hearing, Representative Horace R. Kornegay (D-N.C.) called the advisory committee's report "inconclusive." He attacked the FTC rulemaking and said restrictions

welcome to

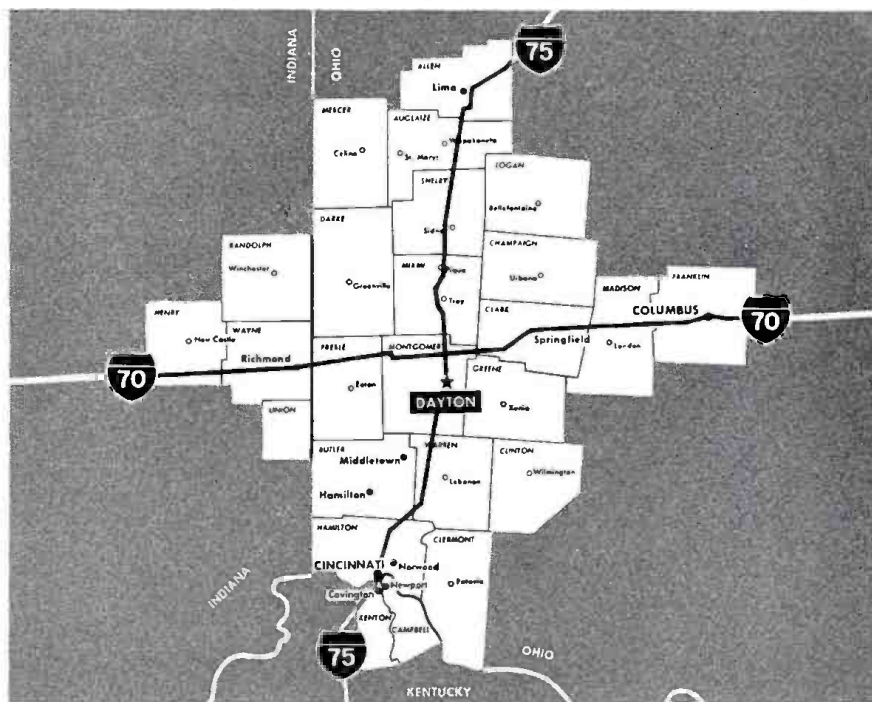

Megacity

... the tenth largest consumer market in America

Within seventy miles of the intersection of Interstate routes 70 and 75 are the business centers of **seven** metropolitan areas . . . three and one-half million people . . . **tenth** largest consumer market in America! ■ Situated in the geographical center of Megacity 70-75 are the transmitters of WHIO-TV, AM, FM—**powered** to reach a huge segment of this concentrated audience with a total buying power of over **seven billion**. ■ Let George P. Hollingbery tell you how efficiently and economically you can reach it. ■ Megacity 70-75!

WHIO-TV • CBS • CHANNEL 7

WHIO

WHIO-AM-FM • DAYTON, OHIO

Associated with WSB, WSB-TV, Atlanta, WSOC-TV, Charlotte, WIOD-AM-FM, Miami, and KTVU, San Francisco-Oakland

1104 FT.



SITUATION COMEDY IS NO LAUGHING MATTER

IT'S A TYPICAL Thursday night on ABC. Fred and Wilma Flintstone have their camping trip ruined by the "good deeds" of a troop of Stone Age boy scouts.

Donna Reed gets Trisha, her tomboy ward, into a boys club by dressing her as a girl.

A group of teen-agers is astonished when the *chaperone* actually *saves* their party on *My Three Sons*.

It's a typical Thursday night on ABC—people are watching in 20,000,000 American homes.

Situation comedy has hit its stride on the new ABC. Add hits like *Ozzie and Harriet*, *McHale's Navy*,

Patty Duke and *The Farmer's Daughter* to the lineup above and you have an original and durable group of situation comedies.

The Adventures of Ozzie and Harriet is the oldest continuing situation comedy in the business. It has been on the air 12 years. Millions of American families have watched the Nelson family grow up right along with themselves.

Donna Reed, looked on as a neighbor by millions more, has been a favorite for 6 years. *The Flintstones* was television's *first* "adult cartoon" show. After four



ABC takes situation comedy seriously. For example, every Thursday night Donna Reed, Fred Flintstone and Fred MacMurray take their fun into 20,000,000 different American living rooms—20,000,000 good reasons why you should take ABC's situation comedy seriously, too.

years, it's still the most popular. McHale's Navy, after its successful premiere in 1962, is attracting even larger audiences this year.

The new Patty Duke Show, starring a teen-age Academy Award winner, is one of the big hits of the current year and, along with every single one of our situation comedies, will be back next season.

What's most important is that ABC uses these programs to their *best* advantage. We schedule them in blocks. We like to get people in a good mood *and* keep them there. Result: ABC situation comedies

average a 32.6 rating in large-family homes of five or more members.

Situation comedy has played a big part in the success of the new ABC. ABC has played a big part in the success of situation comedy. We have made it original, exciting, wholesome, and *fun*. This has kept sponsors like Campbell's Soup smiling for six consecutive years. That keeps us smiling, too.

ABC Television Network 

would seriously injure "one of the nation's most important industries."

B. C. Mangum, president of the North Carolina Farm Bureau, cited statistics to show the importance of tobacco income to that state and the U. S. as a whole. "With no more conclusive and scientific information than we now have, it would seem to be very inappropriate and drastic. . ." to take action at this time, he said.

"At least for the past 40 years, the tobacco industry has shown the morals of a barracuda," Dr. Michael Shimkin of the Fels Research Institute, Temple University, charged. A retired official of the Public Health Service, Dr. Shimkin said it is "high time" for the government to place restrictions on cigarette advertising.

Popular ■ "TV made smoking the thing to do. . ." among teenagers, a Harvard University researcher told the FTC in support of the advertising curbs. Dr. Eva J. Sabler, senior research associate in epidemiology at Harvard, said cigarette commercials on TV have a strong impact on youngsters.

She reported on studies of Newton, Mass., school students seeking answers to why they smoked which found that the habit is socially motivated. The Newton study disclosed that 40% of junior high students watch TV more than 25 hours a week and one-fourth of the high school students watch a similar amount, she said.

Dr. E. L. Wynder of the Sloan-Kettering Institute for Cancer Research, New York, supported the FTC proposals and advocated the formation of an advisory committee to inform the FTC on the effectiveness of future tobacco research.

Sidney R. Katz of New York, testifying as a private citizen, said he hoped the FCC would "outlaw all television and radio cigarette commercials," and that he had enlisted the aid of his congressman, Representative Leonard Farbstein (D-N.Y.), in urging the FCC to act.

The "proposed rules may have a crippling impact on the distribution of most of the consumer soft goods in this country," said Joseph Kolodny, man-

aging director of the National Association of Tobacco Distributors.

The Tobacco Workers International Union, representing about 30,000 members, filed a statement opposing the FTC proposals, which it noted could have "a vital impact on many diverse interests."

Asks Caution ■ Rand Development Corp., a Cleveland research firm, was represented by its president, H. J. Rand, who urged the FTC to line the iron hand of its proposals with at least a little velvet. His company's research indicates a safer cigarette may be possible, he said, and the present draft of the FTC rules would make it difficult for such a future cigarette to advertise.

Dr. J. Allen Cook, a professor of marketing at the University of Maryland, told the FTC panel that "the proposed trade regulation rules represent the most equitable solution for both the public and the tobacco industry."

The "strong support" of the American Cancer Society for the FTC proposals was articulated by Dr. Wendell G. Scott, president of the group, who said that only a thorough public education program could crack the barrier of ignorance around the issue of smoking and health.

If the FTC doesn't enact its restrictions on cigarette labeling and advertising, the specter of conflicting local laws likely will be loosed on the country, the FTC panel was warned by Dr. George James, New York City's commissioner of health. If the federal government doesn't act quickly, New York City would consider such rules and other localities would probably follow suit.

Radio Hit Hardest ■ The effect of the FTC proposals would be "harshes on radio" because of the impossibility of incorporating the health warnings in spot announcements, the panel was told by Edmund C. Bunker, president of Radio Advertising Bureau. Challenging the FTC's authority to adopt the regulations, Mr. Bunker said "it is erroneous . . . to assume that substantially all present and future [cigarette] advertising, no matter what its content, is and will be 'unfair or deceptive' without caution warnings.

Under the aggressive questioning of Commissioner Elman, Mr. Bunker admitted that he wanted the FTC to consider cigarette advertising on a case-by-case basis and not make a general rule. Commissioner Elman picked up and forcefully redeposited a pile of papers before him, then slumped back in his chair, evidently, too exasperated for the moment to continue the questioning. Chairman Dixon also prodded Mr. Bunker, asking him if radio could not sell its time to sponsors other than tobacco companies if the rules were adopted. Mr. Bunker allowed that it would be an extremely difficult task to



Armour's sausage can with zipped in flavor

Described as the first major breakthrough in food canning in over 40 years, a new zip top aluminum can for Vienna sausages and potted meat of Armour Grocery Products Co., Chicago, will be introduced nationally starting next month. Six-week schedules of television spots in about 40 to 50 markets, some radio and local newspaper ads are being placed through Foote, Cone & Belding, Chicago. The annual advertis-

ing budget is under \$2 million.

The new can will be demonstrated in TV commercials filmed at Cascade Pictures, Hollywood. It is a distant cousin of the new zip top aluminum beer can recently introduced by a number of breweries across the country. Prime time participations also have been bought on ABC-TV in June and July to help promote the new Armour can.

THE GAMUT OF MUSICAL EXPRESSION IS REPRESENTED BY COLUMBIA RECORDS

A matchless array of the world's most renowned recording artists make up the Columbia Records catalog, the most exciting and comprehensive in the industry. There is someone and something to appeal to every type of audience taste. It spans the spectrum of entertainment and includes Popular, Masterworks, Country & Western, Jazz, Folk, Operatic, Original Broadway Cast and Film Sound Track Scores, Comedy and Religious music. By subscribing to our service you command the best means to make listeners seek your station out and then stay tuned in for program after program. But the time to act is now. Your response before May 1, 1964 will allow you to take advantage of a special 10% reduction in our regular yearly rates. Check your mail now for the 1964 Brochure.

COLUMBIA RECORDS BROADCAST SERVICES 799 Seventh Avenue, New York, New York 10019

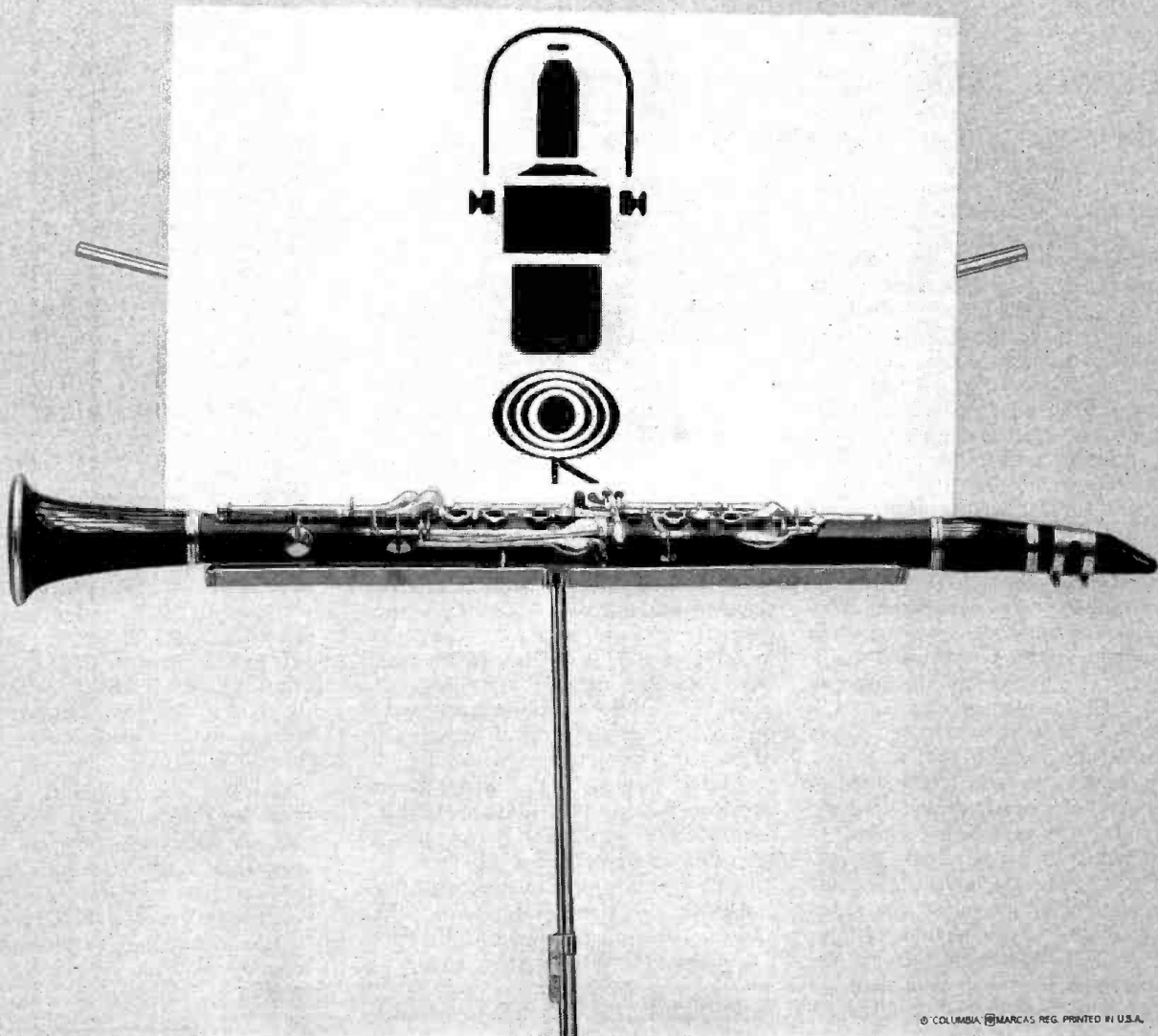

© COLUMBIA RECORDS REG. PRINTED IN U.S.A.

take up the slack.

The Television Bureau of Advertising, RAB's TV counterpart, filed a statement last week that had been made available earlier (BROADCASTING, March 16). The crux of TvB's stand was that "We cannot accept the concept that advertising has the additional function of displaying the limitations of the product or service being offered . . . as long as the product or service is legally acceptable and the advertising is not false and misleading."

Malcolm L. Fleischer, managing director of the Retail Tobacco Dealers of America Inc., argued that cigarette sales are a "local" concern and that such restrictions as proposed by the FTC properly can be imposed only by Congress. And, he said, the caution warnings on labels and in advertising are unnecessary because the publication of the surgeon general's report was so widely reported that virtually everyone has heard of the link between smoking and health.

An official of the Methodist church said that if the FTC passes the cigarette advertising buck to Congress, the tobacco industry "is confident that its \$8 billion cudgel can effectively block any

meaningful control legislation."

Dr. Lester L. Keyser, of the Methodist Board of Christian Social Concerns and director of Southern Methodist University's student health center, said tobacco firms use "every device to convince the young person that smoking is an answer to some of his deepest emotional needs." The force of this advertising, he said, overwhelms the effectiveness of occasional news reports linking smoking and various diseases.

Drs. Fred G. Bock and Saxon Graham, both of the Roswell Park Memorial Institute, a Buffalo cancer clinic and research center, testified in favor of the FTC proposals, and the latter said all cigarette advertising should be banned. Both agreed that massive cigarette advertising campaigns tend to obscure the importance of the surgeon general's report in the public mind, and Dr. Bock added that the report was "conservative to the extreme" in deploring cigarette smoking. It could have gone much further, he asserted.

Dr. Ronald E. Vincent, also of Roswell Park, read a statement favorable to the FTC proposals prepared by Dr. George E. Moore, institute director.

cept would take a long step toward fixing broadcast responsibility where it belongs — on the broadcaster — rather than the advertiser. It would put the broadcaster in the driver's seat. And it would help to free the creative people in the medium from noncreative interference."

The "series of accidents" in broadcasting's early days which, he said, led to the advertisers' involvement in broadcasting's editorial content, "must not be permitted to stunt the growth of mass electronic media and deny to its owners, the American people, the soaring potential of television."

"This potential," he said, "will never be achieved until the artists and writers are free to contribute their best to the medium, uninhibited by enervating taboos and unrestricted by commercial formulas aimed at selling more soap and toothpaste."

Bates goes Australian

Ted Bates & Co., New York, last week confirmed that it will enter into a merger agreement with George Patterson Pty. Ltd. of Australia to form a new international advertising agency of George Patterson-Bates Pty. Ltd.

The Patterson company, Australia's largest advertising agency, has capitalized billings of more than \$20 million.

Rosser Reeves, chairman of the board of Bates, said the merger would boost the company into third place in international billings with more than \$60 million, and total billings of about \$210 million.

Look who's back in Washington for a day

MINOW PLUGS AGAIN FOR MAGAZINE CONCEPT ON TV

Newton N. Minow was due to return to the familiar surroundings of Washington Monday (March 23) to deliver a speech advocating a proposal he often supported in his days as chairman of the FCC—the magazine concept of advertising in broadcasting.

"Both broadcaster and advertiser would benefit" from the magazine concept, he said in his prepared text, "for television would become a more honest, more attractive medium for the creative artist. And more honesty, creativity and truth for the artist means more service to the public interest for the viewer."

Mr. Minow, who left the FCC last June, after 2½ years as chairman, to become an executive vice president and general counsel of Encyclopaedia Britannica, in Chicago, was scheduled to speak in Washington, at the Alfred I. duPont Awards Foundation dinner (BROADCASTING, March 16).

The former chairman, after cataloguing a series of cases in which dramatic television programs were changed to accommodate sponsors, said, in his prepared text: "The tragedy is that radio and television did not inherit the proud tradition of the press—that there must be a wall of separation between the advertiser and the editorial content."

Separation Needed ■ He said the ad-

vertiser should be separated from the program, and that commercials should be placed where they "fit most logically into a program."

"For the magazine concept," he added, "it is none of the sponsor's business whether the villain smokes filtered or nonfiltered cigarettes. He can be involved only in one thing that is his legitimate concern: the sale of his goods and services to consumers through the use of television to stimulate desire in his potential customers."

Mr. Minow would not deny all sponsors the opportunity to identify with, and be responsible for, a program. "The Hallmark theater is the most conspicuous example of a first-rate, artistic program where the sponsor takes pride in bringing quality to the public, with freedom to the artist."

Mr. Minow said the magazine concept would not solve all of television's problems. The "basic problem" in TV, he said is created by the broadcaster's desire to reach "most of the audience most of the time" and can only be cured by using more television channels to provide diversity of choice for smaller audiences. And this wider choice, he added, will evolve through UHF television, educational television and pay-TV.

But he went on, "the magazine con-

La Choy enters spot TV

Beatrice Foods Co.'s La Choy Food Products Division, Archbald, Ohio, a heavy print advertiser, has increased its budget by about 20% for the new fiscal year starting this month in order to buy schedules of 10, 20 and 60 second television spots in selected markets to help promote the La Choy line of Chinese food dishes. Placed through Maxon Inc., Detroit, the billings for all media total less than \$1 million.

La Choy also continues its cooperative merchandising program and will schedule radio spots in a number of markets, according to the division's general manager, Gordon E. Swaney. About three-fourths of La Choy's total budget is going into print.

Adults Only

The latest Pulse shows WIP Radio reaches 23% more adults, morning to night, than any other station in the Greater Philadelphia area.*

We planned it that way.

Our programming is a careful blending of the news, the music and the personalities that attract and hold listeners, *and* keep cash registers ringing all over the Delaware Valley. Nice things happen to people who advertise on WIP Radio.

WIP/610

610 AM/93.3 FM, HARVEY L. GLASCOCK, V.P. & GENERAL MANAGER, REPRESENTED NATIONALLY BY METRO RADIO SALES
METROPOLITAN BROADCASTING RADIO, A DIVISION OF METROMEDIA, INC.

* OCT/NOV/DEC PULSE, AVG. QTR. HOUR 6 AM - 8 PM



Discussing the difference between a piggyback and integrated commercial at NAB's New York meeting on multiple-product announcements were (l-r): Howard H. Bell, NAB code authority director; Stockton Helffrich, manager of New York code authority office; Samuel Novenstern, associate media manager, Lever Bros., New York; Ed Fleri, associate media director, BBDO, New



York; A. L. (Fred) Plant, vice president, advertising, Block Drug Co., Jersey City, N. J.; Newman F. McEvoy, senior vice president and director of media, Cunningham & Walsh, New York, and Lawrence Rogers, TV code board member from Taft Broadcasting Co. Picture at right shows part of the crowd of more than 600 advertising executives who attended the meeting.

Teaching admen about piggybacks

600 MEET TO GET THE WORD ON MULTIPLE-PRODUCT SPOTS

Officials of the code authority of the National Association of Broadcasters last week urged advertisers and agencies to maintain a "continuing dialogue" with code executives as a means of achieving a complete understanding of the television code's new amendment on multiple-product announcements.

The proposal to open up and sustain a two-way communications channel between the advertising industry and the NAB authorities was sounded by Howard H. Bell, code authority director, and echoed by Edward H. Bronson, television code manager, and Stockton Helffrich, manager, New York code authority office, during a meeting called last Thursday afternoon (March 19) to explain the new amendment on multiple-product announcements.

More than 600 executives employed by advertising agencies, TV film and tape producers, station representatives and code subscriber clearance personnel attended the meeting at the Waldorf-Astoria hotel in New York.

Copies of a special question-and-answer document on multiple-product announcements were distributed during the meeting. The three code authority officials spoke briefly on the wording of the new amendment, and commercials exemplifying so-called piggyback and integrated treatments were shown. A question period concluded the meeting.

The multiple-product announcement amendment, it was stressed, does not prohibit piggyback announcements but requires that they be counted as two announcements under the code. The code bans more than three consecutive announcements within a program in prime time or more than two commercials at the station break. The amend-

ment is effective Sept. 1.

Mr. Bell called upon the advertising industry for its co-operation in enforcing the code. He urged that all facets of the advertising fraternity become acquainted with the contents of the code and, when a question arises, he suggested that it be referred to a code office for discussion and clarification. He also recommended that advertisers and agencies "promote the code to the general public and to the special publics you reach."

Unity in Theme ■ Several questions from the floor sought to elicit whether a hypothetical commercial described by the speakers would be classified as piggyback or integrated. Mr. Helffrich, who generally answered these questions, emphasized that in general, commercial integration is achieved when the announcement throughout sustains a unifying theme which describes the related nature, purpose or use of the advertised products or services. He qualified this definition by saying: "But, of course, it

depends on the execution. It depends on how it is done. There is not one answer to the question."

Another questioner wanted to know who makes the "definitive judgment as to whether a commercial is piggyback or integrated." Mr. Helffrich replied that "it's the network and leading station continuity acceptance personnel."

This prompted another query: "Isn't it possible that one network might classify a commercial one way and another network another way?" Mr. Helffrich in conceding such an eventuality, offered this suggestion: "It would be a good idea to submit a proposed commercial to two networks and perhaps even to the NAB to get a cross section of opinion."

Another question was: "Is it possible that even if the NAB and a network agree that a commercial is integrated, some stations might insist it's a piggyback?" Mr. Helffrich replied that it was possible, because some stations have "even more stringent rules than the NAB code. We require stations to adhere to our standards, but a station may have stricter standards."

In answer to another question, Mr. Bell said an effort will be made to keep the American Association of Advertising Agencies, the Association of National Advertisers and other interested groups abreast of the latest developments in the area of multiple-product announcements through the "TV Code News," informal meetings and through a stepped-up program of publicity. One member of the audience sought to learn the latest NAB move regarding "clutter," he was told that a meeting on this subject has been scheduled after the NAB convention next month.

Corinthian: no piggybacks

Corinthian Broadcasting Corp. has gone one step farther than the National Association of Broadcasters, which says piggyback announcements must be counted as two commercials, and announced it will in the future flatly refuse all piggybacks.

C. Wrede Petersmeyer, Corinthian president, said the multi-product announcements defined as piggybacks by the NAB "contribute substantially to the appearance of overcommercialization. . . ."



What Kind of Figgers Do You Prefer?

NATCH, you've already got all the market and rating numbers in your files for the fabulous Fargo-Moorhead area—but there are lots of other figgers that really mean *a great deal more* when you're picking radio stations in this area.

So we've published a little folder that gives a lot of others. Such as the number of awards from our local Advertising Club, won over recent years—

the astonishing number of *people* on our staff—the number in our News Department—the number of adult programs—the number of people in our (exclusive!) Farm Department, and other things like that which explain the *adult* preferences throughout the great Red River Valley.

Ask PGW for a copy!

WDAY

5000 WATTS • 970 KILOCYCLES • NBC

FARGO, N. D.



PETERS, GRIFFIN, WOODWARD, INC.,
Exclusive National Representatives

WQXR's schedule runneth over

New York station posts sold-out sign for liquor advertising amid trade association protests

WQXR New York, which is drawing fire from the National Association of Advertisers and other groups for announcing plans to accept liquor advertising, reported late last week that all its time periods made available for liquor commercials have been sold out.

The station said that 13-week program schedules have been purchased by two advertisers of hard liquor: Muirhead Importers Ltd., New York, through Kenyon & Eckhardt, that city, and Schenley Industries, New York, through Norman, Craig & Kummel, also of New York. According to WQXR, both advertisers have options for renewal and are expected to take at least a full year of sponsorships, which would represent about \$70,000 in time purchases. The accounts start on WQXR in early April.

In announcing WQXR's decision to carry liquor commercials after 10:30 p.m. Monday-Saturday, the station's general manager, Elliott M. Sanger, Sr., said the move does not actually represent any great change in policy. Mr. Sanger said the station, for many years, has had a liberal outlook on such advertising and has been presenting commercials for cordials and liquors. He added: "The reason for this long-established policy is that the programming of WQXR attracts a mature audience and we have always recognized that these people are sophisticated."

Although reaction to WQXR's announcement was mixed, several broadcasters in the New York area applauded it as a move in the right direction.

Representative Emanuel Celler (D-N.Y.) telephoned the station to offer his congratulations on the new advertising policy. Representative Celler said there is no logic in keeping liquor advertising off the air if it can be placed in the print media.

The NAB was prompt to voice its opposition. NAB President LeRoy Collins appealed to the station to reverse its decision. And, Howard H. Bell, NAB code authority director, said that moral persuasion would appear to be NAB's only recourse to bring about a reversal of WQXR's position and in line with the gentlemen's agreement that since the 1930's has virtually kept liquor commercials off radio and TV. Another important negative vote was cast by the Distilled Spirits Institute, long a foe of such advertising.

Mr. Collins sent the following telegram to Mr. Sanger:

"I am extremely disappointed by re-

ports that WQXR will accept hard liquor advertising, and strongly urge that you reconsider any such action. There is admittedly considerable pressure within the industry for similar action, and therefore your position will strongly tend to undermine mature and responsible self-regulatory action within the entire broadcasting industry. Present long-standing, nationwide policy of the broadcasting industry of refusing hard liquor advertising is based on many factors. Expediency should not be allowed to override these soundly based decisions reached after repeated and



WQXR's Sanger

thoughtful examination by broadcasters over many years. The broadcast media have demonstrated their impact in encouraging consumer demand. The increased consumption of hard liquor by young or old is easily demonstrated to be damaging to the public interest. It has been a source of great pride and credit that our industry has voluntarily

by-passed profits from this type of advertising in promoting the public good. Please do not break down the gates there with your highly respected station."

Ban Shaken ■ The long-standing voluntary ban on liquor advertising by broadcasters has been shaken to some extent by WQXR's announcement. Though other stations have accepted liquor advertising from time to time, the WQXR announcement attracted special attention because of its ownership and its program position. The station is owned by the *New York Times* and its programming caters largely to classical, or "good music," tastes. The station duplicates its AM programming on FM including FM stereo.

WQXR has been a member of the NAB for several years but has not subscribed to the NAB code because the code also bans advertising for such alcoholic products as cordials.

The question of whether liquor advertising should be permitted on radio and television has cropped up regularly over the years. One recent example was WOMT Manitowoc, Wis., which planned to start carrying such commercials Nov. 1, 1958 (BROADCASTING, Oct. 20, 1958). That announcement precipitated comment very similar to that being generated by the WQXR case.

More complaints from the NAB were heard in August 1961 when WNTA(TV) New York (now educational WNDT[TV] Newark-New York) started telecasting commercials for Old Hickory bourbon (BROADCASTING, Sept. 4, 1961). And the issue was brought up again later that year when a campaign for Banister liquors was started on WVNJ Newark (BROADCASTING, Oct. 23, 1961).

But liquor advertising on the air is not rare as it may seem. One example is the experience of WCNO(FM) Canton, Ohio. Last year it carried a 13-week schedule for Schenley and, according to W. B. Steis, general manager of the station, "I received not a single complaint." The reason that the FM was used instead of the daytimer WCNS, Mr. Steis explained, is that Ohio liquor laws forbid liquor advertising on the air before 10 p.m. Mr. Steis said he quit the NAB two years ago over the liquor issue.

NAB code drops boom on Falstaff laughter

RULES BEER RADIO SPOTS ARE UNACCEPTABLE

Some of the laughter on the West Coast was a little hollow last week.

A Falstaff beer "Sound of Laughter" radio campaign, started early in the month on 65 stations in California (BROADCASTING, March 2), ran afoul of the National Association of Broadcasters radio code authority, which ruled that the spots were unsuitable for broad-

cast. A complementary television campaign was approved by the NAB.

The uproar was touched off in Los Angeles, where KFI refused to accept the beer commercials and sent them to the NAB for a ruling. A station spokesman said the spots ran for several days before the agency, Wade Advertising, Los Angeles, was asked for new adver-

WHO'S ON FIRST?

G.E. FIRST

ON THE MARKET...

WSM-TV

NASHVILLE, TENN.

FIRST

ON THE AIR...

**WITH TV's FIRST
4-VIDICON COLOR FILM
CAMERA SYSTEM**

This transistorized 4-V camera overcomes the two greatest problems existing in color film today: registration and monochrome resolution. Some of the other stations who are first in their own markets with the G-E 4-V include: KMSP-TV, Minneapolis; WAST, Albany; WJXT, Jacksonville; WGEM-TV, Quincy, Ill.; WRGB, Schenectady; WRAL-TV, Raleigh; WESH-TV, Daytona Beach; WFIL-TV, Philadelphia; WNBF-TV, Birmingham; WAGA-TV, Atlanta; WWJ-TV, Detroit; WFBG-TV, Altoona; WJW-TV, Cleveland; KTVT, Fort Worth.



PE-24-A/B

GENERAL  ELECTRIC

G.E. FIRST

ON THE MARKET

KERO-TV

BAKERSFIELD, CALIF.

FIRST

ON THE AIR

**WITH TV's ONLY
2nd GENERATION UHF
KLYSTRON TRANSMITTER
AND UHF ZIG-ZAG ANTENNA**

In the early 1950's G. E. pioneered UHF television Klystron Transmitters. Now—14 years later—others are catching up. G. E.'s second generation units are setting new standards for performance, stability, economy and compactness. Today, the transmitter and G. E.'s new high-gain, directional Zig-Zag Panel Antenna enable KERO-TV to increase overall market coverage beyond its previous VHF pattern. Four other stations will be first in their markets with G-E second-generation Klystron Transmitters by June.

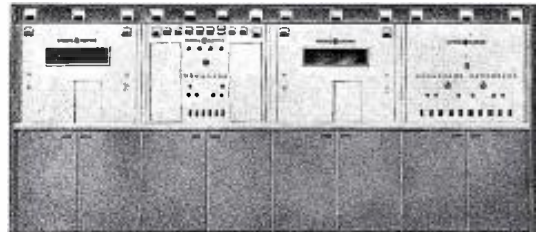

TT-57-A



Zig-Zag Antenna

GENERAL  ELECTRIC

G.E. FIRST

ON THE MARKET...

ABC-TV

WASHINGTON, D. C.

FIRST

ON THE AIR...

**WITH TV's
FIRST PROFESSIONAL
TRANSISTORIZED STUDIO
VIDICON CAMERA**

First on the air—first in network operation. The PE-23-A/B/C system can do 80% of network or station studio programs—at operating cost as much as 90% less than a comparable image orthicon camera system and 50% less initial cost. Transistorized... eliminates day-to-day drift, reduces set-up time, saves up to 14 cubic feet of rack space.



PE-23-A/B/C

GENERAL  ELECTRIC

G.E. FIRST

ON THE MARKET...

WGR-TV

BUFFALO, N. Y.

FIRST

ON THE AIR...

**WITH G-E
2nd GENERATION
TRANSISTORIZED
AUDIO EQUIPMENT**

In 1958, G.E. was the first to introduce transistorized Studio Audio Equipment, now used by hundreds of stations. Today, the BC-31-B Stereo Console, part of the **second generation** of G.E.'s complete transistorized line, offers broadcasters the widest range of inputs, controls and functions available today—for either stereo or monaural, single or dual channel, in AM, FM, TV studios or master control audio systems.

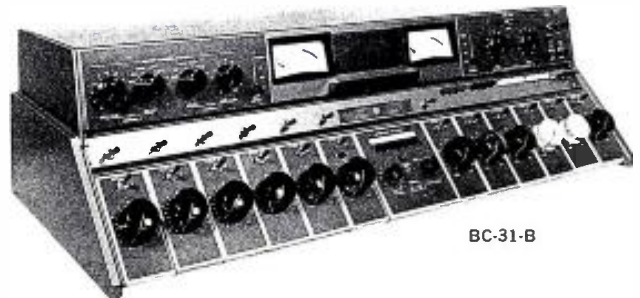

BC-31-B

GENERAL  ELECTRIC

G.E. FIRST

ON THE MARKET...

WCTV

TALLAHASSEE, FLA.

FIRST

ON THE AIR...

WITH TV'S FIRST TRANSISTORIZED STUDIO VIDEO EQUIPMENT

In 1958, G.E. introduced television's first transistorized Studio Video Equipment, the Sync Generator, a unit which was 50% smaller and used less than one-half the power of previous models. To provide greater performance, economy and reliability, G. E. has continued to pioneer the design, development and improvement of transistorized broadcast equipment such as cameras, video distribution amplifiers, processing amplifiers, and power supplies.

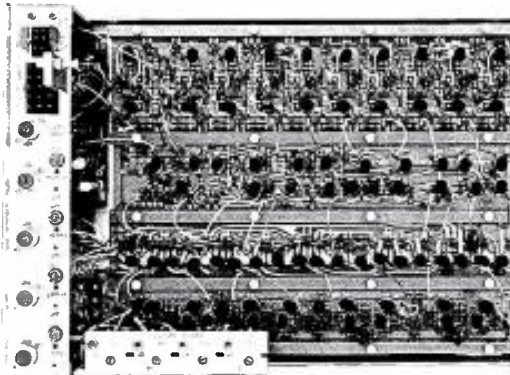

PG-5-B Second Generation Sync Generator

GENERAL  ELECTRIC

G.E. FIRST

ON THE MARKET WITH

UHF side-fire helical antenna
(1951)

VHF high-channel helical antenna
(1955)

"I.O. Guard" pickup tube life-extender
(1957)

VHF low-channel helical antenna
(1958)

Use of transistors in color studio
camera (1958)

Use of transistors in monochrome
studio I.O. camera (1958)

Transistorized remote vidicon studio
camera (1961)

Transistorized monochrome film
camera (1961)

VHF low- and high-channel Zig-Zag
Panel Antennas (1963)

FOLLOW THE LEADER...

for the newest and finest in television equipment for broadcast and other applications... General Electric, pioneer in television progress. For further information on the complete line, contact your G-E Broadcast Equipment Representative, or: General Electric Company, Visual Communication Products, 212 West Division Street, Syracuse, New York 13204.

GENERAL  ELECTRIC

tising copy. The agency decided to drop KFI from its list instead.

The Falstaff radio spots are 30 seconds in length and all have the same dialogue with different types of background music. They begin with a woman laughing. She then says, "I just love it. [Laughter.] Can't help it. [Woman laughing.] I've got an idea. [Woman's voice, more laughter.] I've got a great idea. [Male laughter.] Hey, Charley, draw a Falstaff. [Man's voice followed by man and woman laughing.]" Charles Stone, NAB's radio code division manager, said the spots "give the impression of intoxication in both laughter and dialogue."

Of the Los Angeles stations carrying the radio spots—KNX, KFWB, KRLA and KMPC—the three code subscribers dropped the spots, leaving them on KRLA only. The radio campaign is also on stations in Hawaii and Nevada.

Wade Advertising just got the Falstaff account last fall and the "Sound of Laughter" campaign is its first major effort. The agency said last week that it has had no word from any station outside Los Angeles except KFMB-AM-TV San Diego, which rejected the TV as well as the radio spots. Wade, however, is sure the other code stations will be cutting the commercials, so new ones are being prepared—still the "Sound of Laughter" but in a form the agency hopes will be more acceptable. The present spots will continue indefinitely on noncode stations.

The boiling pot of controversy over the spots was stirred by ads in the Los Angeles press. On March 10 Falstaff ran an ad stating that the "Sound of Laughter" commercials "are threatened by censorship. One big powerful Los Angeles radio station has banned them. There is danger that Californians may not be permitted to hear them on other stations." The ad claims the spots were successfully tested in San Bernardino and Blythe, both California. It asks the public to listen "while they are still on the air—and then to make your own judgments."

The next day KLAC Los Angeles ran an ad headed "Falstaff unfair to Free Fun," the text of which said that "KLAC creator of Free Fun for lo these many months, is being discriminated against . . . KLAC is really for Free Fun; does this mean that the Falstaff Brewing Corp. really is not—are they just being crassly commercial?" The ad ended by saying that "we'll be very glad to carry the Falstaff commercials . . ."

Last Tuesday (March 17), Falstaff ran another newspaper ad, headed "Falstaff caught in middle of radio ban on 'Laughter'." Falstaff said it was "in a most perplexing position . . . on the one hand, a broadcasters' group is recommending that the 'Sound of Laughter'

Study finds TV hits hard but irritates

Television advertising continues to have higher "impact" than that of other media, but TV is in third place behind newspapers and magazines in "favorable associations," according to a study released last week by a Chicago motivational research firm, Louis Cheskin Associates.

The report is the sixth of its kind since 1957. In all six Cheskin studies TV has scored the highest in impact—the total number of either favorable or unfavorable associations cited by the respondents. TV advertising scored highest in favorable associations in the 1957 report but fell to third place in that category in all five subsequent reports.

Radio and billboard advertising in turn have ranked below the other three major media in favorable associations in all six studies, Cheskin said. In the 1964 report, however, radio ranked third in impact. Newspapers were second in impact; magazines scored lowest of all.

The new report is based on an attitude survey conducted in January among 5,919 men and women (equally divided).

"Among both men and women, newspaper advertising has the largest number of associations with 'true,' 'informative,' 'sincere,' 'bene-

ficial,' 'honest' and 'important,' the report said. Television advertising "has the largest number of associations with 'pleasing' and 'liked best,'" it continued, but TV also scored highest in association with terms like these: false, irritating, insincere, in bad taste, deceptive.

The Cheskin report showed that TV scored 84% favorable associations in the original 1957 study but dropped to 49% in the second study in 1960 and scored 55% in 1961, 56% in 1962, 55% in 1963 and 53% this year. All surveys were made in January each year. Newspapers scored highest in favorable associations with 81% this year and magazines were second with 70%.

In commenting on its 1964 report, the Cheskin organization concluded:

"This series of media studies indicates the possibility that the TV commercial is a much greater irritant, when it interrupts an enjoyable program, than the ad is in a newspaper or magazine. Also, there are indications in this study and in other studies that there is more irritation caused by advertising on TV than there is by ads in print media."

A spokesman said the Cheskin organization had done the survey at its own expense.

commercials be banned on California stations. On the other hand, radio stations which are not yet carrying the Falstaff commercials are demanding a chance to do so—just to prove they believe in . . . laughter." KLAC on Wednesday (March 18) took another ad, this one reporting that starting the next day KLAC would start carrying the Falstaff commercials.

Western Electric buys local TV shows

Western Electric, New York, through Cunningham & Walsh, that city, plans this year to expand a current advertising campaign built around sponsorship of prime-time television programs produced at the local level. C&W last week reported great success for the campaign, which was designed to inform viewers in Western Electric plant cities of the firm's "activities in the community."

The local-sponsorship approach was

started by Western Electric, a manufacturing unit of the Bell System, during the fourth quarter of 1963. Involved were 10 local-interest programs presented by six stations in three plant cities. C&W said the program schedule will be expanded this year to include 48 shows in eight cities. More than 15 stations will carry the programs. The agency this year, as it did in 1963, will work to clear prime-time slots for the shows at the stations concerned.

A major part of the localized programming campaign is the production of "on-location" commercials devoted to local activities. The Western Electric campaign also features close cooperation with the stations in promotion of the programs.

Stations presenting the Western Electric-sponsored programs last year were: KOCO-TV Oklahoma City, *Oklahoma Hootenanny*; wow-TV Omaha, *Livestock: Money-Maker of the Midlands*; KCMO-TV Kansas City, Mo., *Year in Review*; KWTV(TV) Oklahoma City, *Oklahoma and Water*; KETV(TV) Omaha, *Omaha Our Mission in Medicine*; and WDAF-TV Kansas City, *Kansas City*

and *All That Jazz*. Besides these cities, Western Electric locally produced programs will be seen this year in Indianapolis, Baltimore, Atlanta, Columbus, Ohio and Winston-Salem, N. C.

Richard Depew, vice president in charge of programming at C&W, said last week that viewers appreciate sponsorship of programs dealing with subjects of local interest when the shows are well produced and publicized. He added: "Thus, Western Electric enhances its status as a member of each plant community."

Cotton council to spend \$25,000 for co-op TV

The National Cotton Council of America, New York, said last week it will contribute \$25,000 in cooperative funds for televised fashion shows to be produced by 33 retail stores in as many markets this spring.

A cotton council representative said the money had been provided by the Cotton Producers Institute. Under the cooperative plan the cotton council donates to each participating retailer twice the cost of a half hour of day time on the station to be used.

The council offers advice on the choice of station, but final decision belongs to the retailer.

As conceived, the project will enable the retailers to carry half-hour daytime shows and help underwrite a portion of the production costs involved.

Aim advertising at educational levels

Advertisers and their agencies should concentrate greater attention on the "educational explosion" and plan their campaigns with appeals to various levels of schooling, David C. Stewart, president of Kenyon & Eckhardt, told a meeting of the San Francisco Advertising Club last Wednesday (March 18).

Mr. Stewart offered statistics to show the upgrading in educational levels over the past 30 years, and described briefly K&E research designed to elicit reactions to specific TV commercials and printed advertisements by men and women with varied school backgrounds. The conclusion of the studies, he said, was that "the difference in reaction to advertising among lower and higher educational groups is much greater than expected" and in general, the fast-growing group of better-educated persons is "less susceptible to advertising gimmicks and is more discriminating in their judgments."

Newspaper reps ask why agencies buy TV

Why, if rating figures are unreliable estimates of television audiences, does your agency put such a heavy concentration of its billings into TV?

That question was directed last week at Paul E. J. Gerhold, research director of the J. Walter Thompson Co., New York, which funneled approximately \$145 million into television last year. He was asked by a newspaper salesman at a seminar on television measurement organized by the New York American Association of Newspaper Representatives.

Mr. Gerhold's answer: "In the best judgment of the principals of the agency and of certain client companies, television is in one specific case after another a more attractive advertising buy."

Mr. Gerhold and Jules Fine, associate media director of Ogilvy, Benson & Mather, answered questions of the newspaper representatives after panel commentary moderated by W. E. (Pete) Matthews, former Young & Rubicam media director.

Mr. Fine offered much the same answer to the why-use-television question. "Because it has worked," he said. "The minute television stops performing," he added, "you'll find money leaving it."

One newspaper rep asked what measurements newspapers ought to be pitching to agencies and their clients in their effort to garner a greater share of advertising revenue.

Mr. Gerhold replied that print ought to be supplying data on the results of advertiser buys of extended and repeated newspaper schedules. He said he strongly suspected that a major problem of newspapers is that so many advertisers use them on special occasions rather than on a continuing basis.

Wide Support ■ The fact that television requires a broad base of advertiser support, he suggested, has had a great deal to do with the commercial success of the medium.

Mr. Gerhold praised the conceptual basis of current research projects which poll consumers of certain products and attempt to find the media they use, but said some of these are still very primitive.

The extremely long questionnaires to be filled out in many cases and questions about consumption of products which many people consider personal, he suggested, are reasons to question their validity.

Commenting on the use which agencies make of rating data, Mr. Fine pointed to the problem presented by bigger clients who have seven or eight

levels of management which must pass on an agency's proposed advertising plans. In some instances, he said, these client reviews are made without the presence of an agency representative. In such cases, he noted, the agency is forced to supply some sort of factual inference documenting the media choice, and ratings do provide directional indications for planning.

Another seminar is planned by the newspaper representatives in New York March 31 on the subject of television selling. It will be the fifth in a scheduled series of eight which are being held on alternate Tuesdays.

Rep appointments . . .

■ WNDU-AM-TV South Bend, Ind.: Adam Young Inc., New York.

■ KIXL Dallas: Avery-Knodel Inc.: New York, effective April 1.

■ KEEL Shreveport, La.: H-R Representatives Inc., New York.

■ WDEE New Haven, Conn.: Mort Bassett & Co., New York.

■ WITH Baltimore; WLEE Richmond, Va.; WXEX-TV Petersburg-Richmond, Va.; WHIS-AM-TV Bluefield, W. Va.; WUSN-TV Charleston, S. C.; WHTN-TV Huntington, W. Va., and KTTS-AM-TV Springfield, Mo.: Select Stations Representatives, New York, as regional representative.

■ WHAY New Britain, Conn.: Bill Creed Associates Inc., Boston, as New England representative.

■ KFDI Wichita, Kan.: Adam Young Inc., New York.

Business briefly . . .

General Mills, Minneapolis, through Needham, Louis & Brorby, Chicago, will purchase nighttime TV spots in addition to network schedules on CBS-TV and NBC-TV starting in mid-April to promote a new line of Betty Crocker cake frosting mixes.

Xerox Corp., Rochester, N. Y., through Papert, Koenig, Lois, New York, will sponsor *Boxing's Last Round* (April 28, 10-11 p.m. EDT), an NBC News color special narrated by David Brinkley on whether boxing should be outlawed as a sport.

Ford Motor Co., through J. Walter Thompson, Detroit, has renewed its sponsorship in *Hazel*, starring Shirley Booth. The show begins its fourth season on NBC-TV next fall (Thursday, 9:30-10 p.m. EST).

Armstrong Cork Co., Lancaster, Pa., has renewed its alternate sponsorship of the *Danny Kaye Show* (Wednesday,

One of a kindness

Florence has more than meets the eye of those
who buy by Standard Metro Areas.
She's extra-metropolitan—an agricultural-
industrial area transcending city limits, forming
the largest U.S. market served
by a single station:

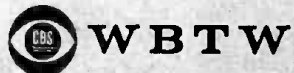

Florence, South Carolina

*Channel 13 • Maximum power • Maximum value
Represented nationally by Young Television Corp.*

*A Jefferson Standard Station affiliated with
WBT and WBTW, Charlotte*





"In 1956, NBC began to lead the field (of news) and now, with the results of the New Hampshire primary part of history, it is evident that it still does. In serious Chet Huntley and witty David Brinkley, NBC has a team of newsmen unequalled in appeal. And furthermore, this network has the solidest, most comprehensive fact-gathering organization to back them on the channels." (Ben Gross, New York Daily News)

The Big Difference

The mission of NBC News is to cover the news fully, accurately and responsibly; to report significant devel-

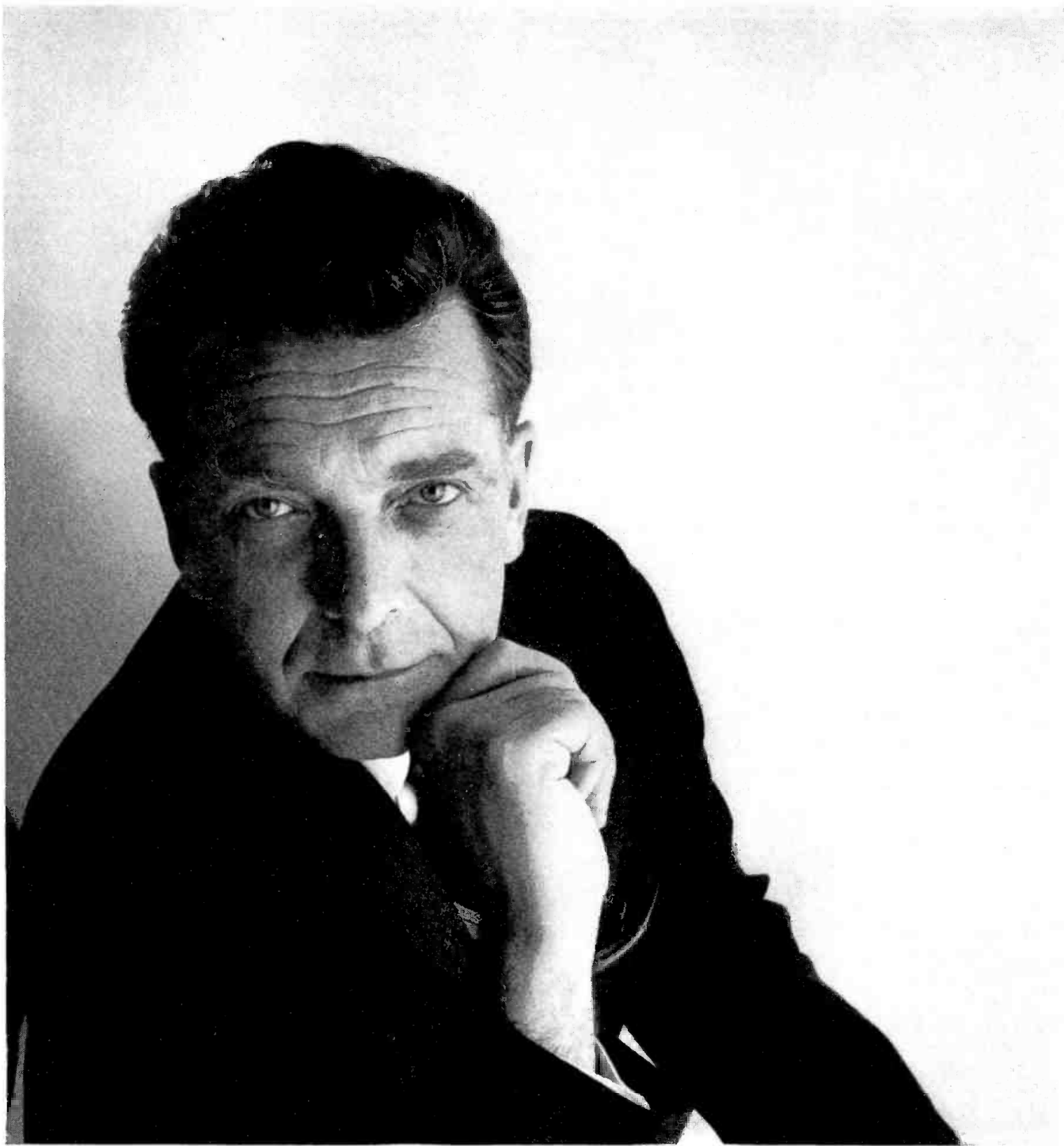

opments as soon as their meaning is clear; but not to put "scoops" ahead of thoroughness.

On Tuesday night it was the seasoned, intelligent work of men like David Brinkley (in Washington), Chet Huntley (in New York) and Frank McGee (in Manchester, New Hampshire)—backed by the resources of NBC News and sophisticated computer equipment—that made this network's coverage so distinguished an achievement.

In the words of one reviewer, while one network, "was first on the air with the flat, magic-brained conclusion

Lodge would win, NBC again had the most solid, complete, simplest coverage." (Jack O'Brian, *New York Journal American*)

That is why, on Tuesday night, whenever the three television networks were covering the primary returns at the same time, NBC drew the largest audience.*

It was by far the most *unsurprising* aspect of the entire evening.

*Based on audience estimates provided by New York Nielsen and New York Arbitron, the only data available. Audience and related data are based on estimates provided by the rating services indicated and are subject to the qualifications issued by these services. Copies of such qualifications are available on request.



Look to NBC for the best combination of news, entertainment and information.

Radio-TV spots sell human-hair women's wigs

Richard Hartwich is using spot radio and TV so that people will get into his hair, and it looks as if he's succeeding.

Mr. Hartwich heads a New York-based firm that manufactures human-hair wigs for men and women, and his agency, Johnston Inc., New York, says that live, minute commercials during the past year have been "very successful" in spurring sales.

Hartwich commercials have been broadcast by such stations as WGN-TV Chicago, WITH Baltimore and WOR New York, and an expansion is

expected this year. Spot advertising is used because the firm has salons in only four cities: Baltimore, Chicago, New York and San Francisco.

Though not yet on the air in San Francisco, the advertiser hopes to be in the near future.

The agency said all broadcasting commercial stress in the current Hartwich campaign is placed on fashion wigs for women. The pattern usually involves sponsorship in women's daytime shows, such as WOR's *Arlene Francis Show* and WGN-TV's *Virginia Gale Show*.

10-11 p.m. EST) on CBS-TV for next season. Armstrong Cork will also co-sponsor a weekly variety show in the time period for nine weeks during the summer. Agency: BBDO, New York.

NBC-TV last week sold out sponsorship of *Another World*, a new daytime series that will premiere May 4 (3-3:30 p.m. EST, Monday through Friday). New advertisers not previously announced are **American Home Products Corp.** through Ted Bates; **Glenbrook Labs Division of Sterling Drug Co.** through Cunningham & Walsh; **Morton Salt Co.** through Needham, Louis & Brorby, and **Derby Foods** through McCann-Erickson.

Dominion Electric Corp., Mansfield, Ohio, through Howard Swink Advertising, Marion, Ohio, plans a nationwide advertising campaign for its appliances to run from April 27 to June 9. The company will use NBC's *Today* and *Tonight* shows for the fourth consecutive year.

Glamorene, Clifton, N. J., through Fletcher Richards, Calkins & Holden, has allocated \$50,000 for spot radio in conjunction with an advertising campaign for the company's household cleaning products.

Agency appointments . . .

▪ The Kaumagraph Co., Wilmington, Del., names The Bruns Advertising Agency, New York, to handle advertising for new line of Iron-on Transfers. Test market spot TV campaigns directed at the children's and teen-age market are scheduled for Columbia, S. C., and Birmingham, Ala. A nationwide spot TV campaign is planned for later this year.

▪ Carlton House, luxury apartment hotel, New York, names Needham & Grohmann, New York, to handle advertising of the hotel and Ritz Carlton

restaurants. Advertising plans include spot radio.

▪ **Econo-Car International**, Elizabeth, N. J., has appointed Mogul Williams & Saylor, New York, as its advertising agency. The auto rental company has allocated a \$950,000 advertising budget for the balance of 1964. MW&S said a selective use of TV and radio in key markets is included in tentative media plans.

Also in advertising . . .

Morris agency named ▪ The William Morris Agency last week was appointed U. S. sales representative for the Fourth Network's telecasts of at least 13 Canadian Football League games on Saturday afternoons next season.

Agency change ▪ Kaiser Jeep Corp., which bills an estimated \$2.7 million in TV, has announced it will discontinue using Norman, Craig & Kummel because of marketing policy differences. No new agency has been selected.

Agency sold ▪ Cooke/Irwin Inc., Beverly Hills, Calif., has announced its purchase of Levitt & Brandt Inc., Los Angeles. Combined billings, Cooke/Irwin said, are almost \$2 million. The Levitt & Brandt staff will be retained with Charles Levitt, L&B president, becoming senior vice president of Cooke/Irwin.

Agencies merge ▪ Two San Francisco advertising agencies, Clint Sherwood Advertising Agency and Cancilla, Gore & Knapp Inc., have merged, with Clint Sherwood becoming a partner in CG&K. After the merger the agency has 36 active accounts with an estimated 1964 billing of more than \$650,000.

New name ▪ Carl Nelson & Associates Inc., Milwaukee advertising agency,

has changed its name to John H. Crowley & Associates Inc.

UN campaign ▪ The Advertising Council's new volunteer agency on the United Nations campaign is Papert, Koenig, Lois, New York. Campaign account supervisor E. E. Spitzer said 1964 campaign is set for September.

Frank wants fast, fast relief from turkeys

Clinton E. Frank, president of the Chicago-based advertising agency bearing his name, told the Western States Advertising Agencies Association in Los Angeles last week that he is deeply concerned about the present methods of buying network TV programs.

"We think it somewhat unfair that we are forced to commit our client for an unknown property six months before our show goes on the air without any guarantee of the audience," he said. Although mindful of the networks' problems involved, Mr. Frank asked, "if the audience is lower than expected, should advertisers get a refund? Or, if the audience turns out higher than expected is the network entitled to charge for additional audience?"

Mr. Frank noted that "the swing here can be enormous" and suggested that the problem concerns all agencies, including the largest, "regardless of the pap of some of them about their programming departments. Some programming departments I know of have come up with their full share of turkeys just as have all the networks in spite of the utmost care and thought devoted to this problem."

A similar appeal to let sponsors get out from under bad shows was issued last month by Leonard S. Matthews, executive vice president, Leo Burnett Co., Chicago (BROADCASTING, Feb. 17).

TV exposure for Roi-Tans

American Tobacco Co. has announced plan to run extensive spot television campaign this year for its Roi-Tan cigars. The marketing plan also calls for use of spot radio.

The company says its cigar business for the first two months of 1964 ran 40% ahead of the same period last year, and that its annual volume in cigars now exceeds \$50 million. American Tobacco also reported the manufacture of a new little cigar with a filter tip which is close to the marketing stage. Gardner Advertising, New York, is agency for American's cigar division and also handles the company's new Carlton charcoal-filter cigarette.

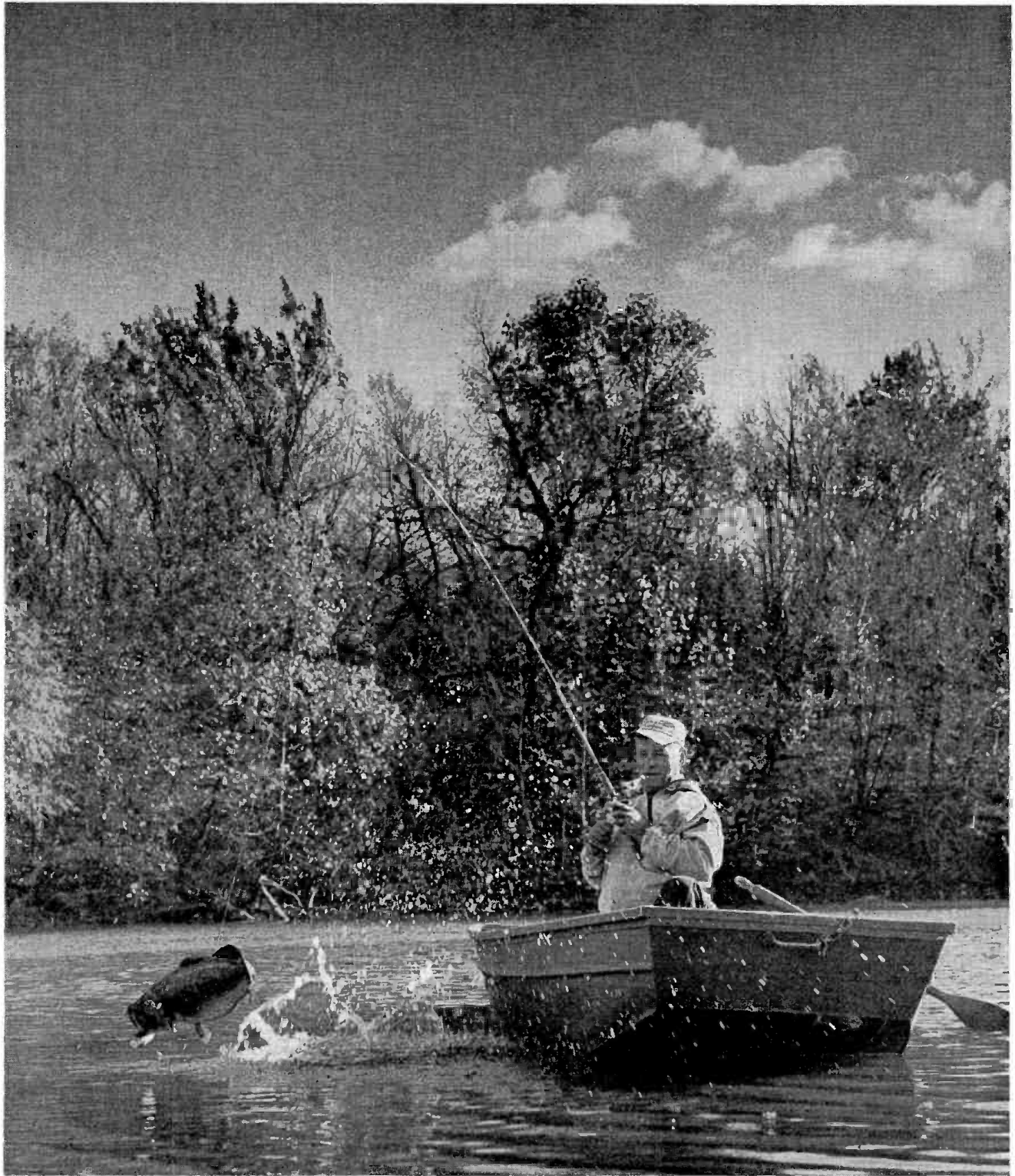

THE BIG ONES are in Kansas

A lot of things have changed in Kansas. Few people think of the great plains as a water wonderland . . . but it is. Literally thousands of miles of shoreline of new man-made lakes attract fishermen and tourists from all over the U.S.

Yes, things are changing in Kansas and at WIBW radio and television.

The big one in Kansas is WIBW radio and television. Perhaps it's time to take a second look at the new, bigger market served by WIBW. For case history proof, ask Avery-Knodel to show you how you can buy dominant coverage day and night radio and television, with the big buy in Kansas.



RADIO AM•FM•TELEVISION

Topeka, Kansas

A division of Stauffer Publications
Represented nationally by Avery-Knodel

Pay TV: helpmate to free TV?

An on-the-air pay operator sees peaceful coexistence and mutual growth for free and fee television systems

Pay TV is going to be a boon, not a bane, to advertising, John H. Pinto, vice president of RKO General Phonevision Co., told the Hollywood Advertising Club Monday (March 16). And his words carried weight, because he is in charge of the experimental on-the-air pay TV operation in Hartford, Conn., in which RKO General is a partner with Zenith Radio Corp.

The three-year experiment is now nearly 19-months old, Mr. Pinto said, and when it is concluded it will have cost the underwriters some \$10 million which he described not as a loss but as an unprofitable investment.

He expressed the belief that at the end of the Hartford experiment in June of 1965 RKO General will seek pay TV operations in other major markets across the country on a regular basis, utilizing what has been learned in Hartford in its programing.

The Phonevision experiment utilizes WHCT(TV) Hartford, UHF (ch. 18), Mr. Pinto said. There is a four-hour afternoon period of "free" programing to comply with the FCC requirement of a minimum of 28 hours a week of program service from any commercial TV station, with the pay TV programing for about five hours of evening time each night, plus Saturday and Sunday matinees. Motion pictures made for theater exhibition account for about 85% of the pay TV programs; special events such as prize fights draw the biggest audience.

Mr. Pinto hit hard at charges of anti-pay TV interests that costs to subscribers will amount to \$1,000 or more a year. "In Hartford the average expenditure by subscribers runs less than \$120 annually," he stated, adding "that includes installation, rental, service and program expenditures."

Mr. Pinto said that of the more than 51 million TV homes in the country, "tonight the sets in half of them will be black—principally because their owners do not care for what is offered. We believe we can bring many of these lost souls back to the box. If we can, it will not only serve the interests of viewers but of everyone in any phase of the television and advertising business. If the TV habit can be even partially re-established, advertisers will have expanded opportunity to sell via commercial TV.

"Also the challenge of pay TV will

spur commercial TV to create new and more effective means for reaching viewers' minds and pocketbooks."

Mr. Pinto believes that commercials will not be used on pay TV. "The FCC has ruled against it and in the case of over-the-wire systems such as the one starting here [Subscription Television Inc., which has a July 1 starting date in Los Angeles and San Francisco] it would not seem in the best interests of operators to ever allow commercials to arouse the wrath of David Ogilvy and others who do not want to pay to see them—especially when they will continue to be profuse on commercial TV."

The entrance of the networks into the pay TV field, which Mr. Pinto considers inevitable once the "independents get through doing the monkey-paw

work," will "further expand opportunities for everyone in the broadcast field," he stated. Pay TV will also provide many opportunities to researchers through the auditioning of pilot shows, special surveys, testing and other forms of market and product research. Pay TV operators will themselves swell the coffers of advertising media in trying to sell their service and their programs to the public, he said, commenting that "certainly commercial TV would be an especially effective salesman."

In a fiction-versus-fact presentation, he rebutted the arguments of the anti-pay TV forces, such as the one that pay TV will destroy free TV by taking its top talent and programs. "Pay TV can succeed only if it supplements commercial TV," he stated. "Since our business is based on the premise that people will spend only a few hours with pay TV a week, there will still be many, many hours left for watching commercial TV. These hours must be programmed. It is not in the best interests of pay TV to raid commercial TV . . ."

RKO sues to free first-run films for pay TV

RKO General charged last week that theater exhibitors and some Hollywood producers were conspiring to keep first-run film out of the pay TV market.

In a civic antitrust suit against two film producers, a film distributor and 17 exhibitors, exhibitor-associations and exhibitor-anti-pay TV groups, RKO General claimed that the defendant motion picture theater owners and operators "have carried on a deliberate and organized campaign to prevent, delay, obstruct and impede subscription television operations on a nationwide basis or even on a trial basis in Hartford."

RKO General's WHCT(TV) Hartford, Conn., since the middle of 1962 has been operating the only on-the-air pay TV operation utilizing the Zenith Phonevision system. It has about 5,000 subscribers, according to John B. Poor, president of RKO General Inc. Mr. Poor also has said that "the response of the public to the trial . . . has been such as to give great promise that if subscription television is afforded a fair chance to compete with motion picture theaters in obtaining film product it could become one of the phe-

nominal successes of our generation."

This is the second antitrust suit filed against theater owners charging a conspiracy against pay TV. Last December, Subscription TV Inc., the West Coast firm which plans to wire up Los Angeles and San Francisco for paid programing, filed a triple damage antitrust suit against a group of theater exhibitors and associations seeking \$117 million in total damages (BROADCASTING, Dec. 23, 1963).

Although the RKO General suit asks for damages, no figure is given. The amount of such damages, the complaint says, cannot be accurately determined at this time. When such amounts are ascertained, the document reads, the complaint will be amended to specify damages.

Since 1960, the RKO General complaint, filed March 19 in U. S. District Court in Hartford, says the exhibitors and organizations named have "engaged in concerted efforts to erect a fence around their industry to keep out newcomers and thus prevent competition with their theater operations. . . ."

No First Run ■ The two film makers named as defendants in the suit

A rumble over pay in California

The conflict gets more bitter as STV puts on a drive to sign up customers for its wired pay TV project

With a little more than three months left before the planned introduction of pay TV in California, the battle between the pro-and-anti-pay-TV forces is gathering momentum. Last week there were these developments:

- Subscription Television Inc., which has announced a July 1 starting date for its pay TV system, started a hard-sell campaign for customers by offering them special installation rates.

- STV's contract with Pacific Telephone & Telegraph Co., for transmission facilities was set for a public hearing by the California Public Utilities Commission.

- The company was the subject of an investors' report from Century Securities Co., Beverly Hills, Calif.

- The Citizens Committee for Free TV topped the 400,000 mark in signatures requesting a vote in California's November election to outlaw pay TV

in that state. California law requires 468,259 signatures to get the question on the ballot. The vote would come four months after STV's announced starting date. Added support was given the citizen committee's efforts by the Television Accessory Manufacturers Institute.

- A pro-pay TV group of Hollywood labor unions accused theater owners of attempting to prevent competition with "theater pay TV" through their opposition to STV.

- And, another organization favoring pay TV, the Academy of Subscription Television, was formed.

The contract of Subscription Television Inc. with Pacific Telephone & Telegraph Co. for facilities to transmit closed-circuit pay TV programs via cables and wires from STV studios in Hollywood to the homes of subscribers in a southwestern section of Los An-

are Twentieth Century-Fox Film Corp. and Universal Pictures Co. Also named is Universal Film Exchanges Inc. The complaint charges that they have refused to furnish RKO General with first-run features for the pay TV demonstration.

Other Hollywood producers have permitted the Hartford test to show first-run pictures on a subsequent-run basis, it was understood.

Also named as defendants are: Theater Owners of America, Motion Picture Theater Owners of Connecticut, Allied States Association of Motion Picture Exhibitors, Allied Theaters of Connecticut Inc., Stanley Warner Corp., Stanley Warner Management Corp., Burnside Theater Inc., New England Theaters Inc., Loew's Theaters Inc., Poli-New England Theaters Inc., Lockwood and Gordon Enterprises Inc., E. M. Loew's Enterprises Inc., Manchester Drive-In Theater Corp., Outdoor Theater Corp., Elmwood Theater Corp., Connecticut Committee Against Pay TV, Joint Committee on Toll Television.

In addition to the conspiracy charge, RKO General contends that the defendants' alleged actions have injured the public. The Hartford subscription TV test, it says, is for the purpose of gathering meaningful data on the public's willingness to

pay for television programs on a per program basis so that the FCC and Congress can determine whether pay TV is in the public interest. Interference with this test, RKO General says, would prevent these agencies and the public from coming to a free and independent judgment on the issue.

RKO General asked the court to enjoin the defendants from carrying out the alleged combination and conspiracy to restrain trade and to create a monopoly.

Specifically, RKO General charges the defendants with applying economic pressures and threats of reprisals against producers and distributors to keep film off WHCT, or at least to prevent the pay TV station from telecasting the films before they are shown first in motion picture theaters. The exhibitors and groups are also charged with inducing and compelling producers and distributors to enter into an "arbitrary, fixed and inflexible" system of clearances which discriminate in favor of exhibitors and against subscription television.

The complaint charges that exhibitors through various means have attempted to ensure that feature motion-picture films are shown only in movie houses.

Defendants have 30 days to file replies to the RKO complaint.

geles adjoining Santa Monica (BROADCASTING, Feb. 24) will be the subject of a hearing by the California Public Utilities Commission to be held Wednesday (March 25) in the state office building in Los Angeles.

Direct Mail ▪ Meanwhile, STV has sent letters to residents of the area for which PT&T facilities have been ordered offering them special charter subscriptions at \$5 as "total cost of installation," contrasted with the regular STV charge of \$10 for installation and \$1 a week for maintenance.

"You pay only for programs for a full year (52 weeks) from the date STV service reaches your set," the letter states. "By subscribing now you save and have a full year, maintenance free, to enjoy and evaluate our service."

Service will commence July 1, 1964, and subscribers will receive periodic program guides to STV service on each of the three channels the company plans to use, which it states are "additional channels of information and entertainment that will in no way replace what you now see for free. You will always be able to enjoy your choice of programs on commercial TV, as well as the high quality programing schedule STV will make available to you." STV also promises that the installation of its program selector requires no modification of the TV set and in no way interferes with the reception of programs broadcast by commercial stations.

"The response has been surprisingly strong," Robert MacLeod, vice president of STV, said late last week. He declined to reveal the number of respondents but said "we are tremendously encouraged."

Stock Sale ▪ STV was also the subject of a "Report to Investors" issued by Century Securities Co., Beverly Hills, Calif., brokerage firm, which offered, in advertisements on Los Angeles newspaper financial pages, to send the report on request. The report starts out: "Subscription Television Inc. is a new company, well financed and staffed, which is embarked in a new industry." It continues to describe STV's financing, operations, programing and management, including this paragraph:

"Management's formula for making STV a financial success is to present the best available programing in five major categories: mass entertainment that's too expensive for commercial TV, such as good first-run movies and hit stage shows; local sports coverage including the Dodgers and the Giants but also other professional and amateur sports events; cultural attractions such as opera and ballet; self-improvement and instruction; and nonfiction programing such as travelogues, commentaries, etc."

Mentioning the effort of "some mo-

tion picture theater owners" to "have paid-TV outlawed by legislation," the report notes that "there are other hurdles ahead for the company. Much of the programming will be completely new, without precedent in commercial TV. No one really knows how much people will pay to have their own private home theaters.

"We feel, however, in the face of these uncertainties that STV can succeed," the Century Securities report concludes. "While Subscription Television common stock is highly speculative, we consider it an interesting speculation in a pioneering venture." STV stock was offered to the public last October at \$12 a share, dropped to 8¾ before the end of the year and early last week was quoted as 10½ bid, 12½ asked.

One statement in the report, that STV "need only obtain the permission of municipal authorities before launching full-scale operations," is incorrect. The amendment to the state's revenue and taxation code adopted by the California legislature and signed into law by the governor in July 1963 permits establishment of closed-circuit pay TV operations within the state in return for payments of 1% of gross receipts to the state and another 1% to each local agency, city or county, without need

to apply for permission to each city and county board.

"That amendment brought Subscription Television to California," Mr. MacLeod has said. "It enabled a new business—and one that starts out with \$20 million might almost be called a new big business—to come into the state."

Petition against Pay ■ There are those who hope to get the state legislature to reverse itself. On March 10, the Citizens' Committee for Free TV had obtained signatures of 407,507 registered voters, Don Belding, statewide chairman, reported. Mr. Belding, who has engaged in various civic campaigns since his retirement from Foote, Cone & Belding in 1957, predicted that the requirement of 468,259 signatures would be "substantially exceeded" by April 21, deadline for filing original petitions with the registrar of voters.

"With the continued support we are receiving from public spirited people everywhere, it appears certain this measure will be placed on the Nov. 3 general election ballot," Mr. Belding predicted. A committee spokesman last week said that although no later tally has been made, it seems probable that over 500,000 signatures have already been collected. An average is necessary, as inevitably many names will be stricken from the list in the official

check, which requires the signatures to correspond exactly with those in the registration lists.

Unions for Pay ■ Hollywood unions representing more than 20,000 members have completed the organization of the Fair Trial for Pay TV Committee in opposition to the theater owners, whom the fair trial group accuses of attempting to use the California initiative process to prevent competition with their highly profitable "theater pay TV." Founding members of the Fair Trial for Pay TV Committee are: American Federation of Musicians, Hollywood AFL Film Council, Writers Guild of America, West, Directors Guild of America, Actors Equity Association, Screen Actors Guild, Screen Extras Guild, Basic Crafts of the Hollywood Motion Picture Industry, American Guild of Musical Artists, International Photographers Local 659 IATSE, Publicists Association Local 818 IATSE.

The Fair Trial for Pay TV Committee said: "The organized theater owners, who profit considerably by theater pay TV, are seeking by an initiative measure to prevent other forms of pay TV from competing with theater pay TV. The Fair Trial for Pay TV Committee is not opposed to theater pay TV or commercial television. We favor the widest possible tests of all forms of pay TV, believing that the public should not be denied the right to decide by actual viewing if it wishes to patronize this new medium of selective communication, education and entertainment. We are opposed to the theater owners' attempt to monopolize pay TV by forcing Californians to patronize theaters for pay TV events. We are opposed to the theater owners' sponsored initiative measure which seeks to outlaw all forms of pay TV except their own."

On the other side, the Television Accessory Manufacturers Institute has endorsed the initiative campaign to repeal California's pay TV law, Mr. Belding, of the Citizens' Committee for Free TV announced. Morton Leslie, national president of TAME, stated: "There is no doubt in our industry that pay TV will wipe out free TV as we know it and severely curtail the production of television sets in the United States. It is certain that pay TV will pirate the major attractions on free TV and leave millions of viewers without adequate programming. This can only result in a drastic reduction of the number of TV sets in use."

TAME joined the National Association of Broadcasters, the California Federation of Women's Clubs, the supervisors of San Francisco, Los Angeles and Sacramento (all California) and other groups in supporting the drive to outlaw pay TV in California.

Another organization, the Academy

FCC gets off to slow start on filing fees

The FCC's application filing fee schedule got off to a slow start last Tuesday (March 17) with the collection of only \$34 at the commission's Washington offices. It seems that many applicants, the vast majority of which were nonbroadcast, weren't aware of the need to submit a filing fee along with an application.

The second day, fee collections gained momentum with the total reaching around \$630. However, the stack of unpaid for applications greatly exceeded the height of the paid for applications.

Curtis B. Plummer, executive director of the FCC, said last week that the commission expects to collect in the neighborhood of \$3,750,000 annually in the form of filing fees. Mr. Plummer pointed out that very little of that sum, however, would be accumulated from broadcast applications—amateur, industrial and other nonbroadcast application will make up the vast bulk of the income.

Meanwhile on Capitol Hill statements supporting legislation to prohibit the FCC's imposition of filing

fees were added to the files of the House Commerce Committee. HR 6697, subject of a hearing earlier this month (BROADCASTING, March 9), was opposed only by FCC Chairman E. William Henry. Broadcasters and nonbroadcast licensees alike have supported the legislation.

Broadcasters filing statements last week were all from Idaho: Daniel C. Libeg, president and general manager, KSNB Pocatello; Clair B. Hull, general manager, KCID Caldwell; James M. Davidson, manager, KIDO Boise; R. W. Burden Jr., general manager, KEEP Twin Falls, and Earl Glade Jr., secretary-treasurer, KBOI (TV) Boise.

The American Bar Association supported HR 6697 and called for "a new and fresh approach to the problem of fees and charges by administrative agencies."

HR 834, Representative J. Arthur Younger's (R-Calif.) bill to authorize federal agencies to impose fees, has been made part of the hearing, but no comments favoring it had been filed through last Thursday (March 19).

CALL THE DOCTOR!

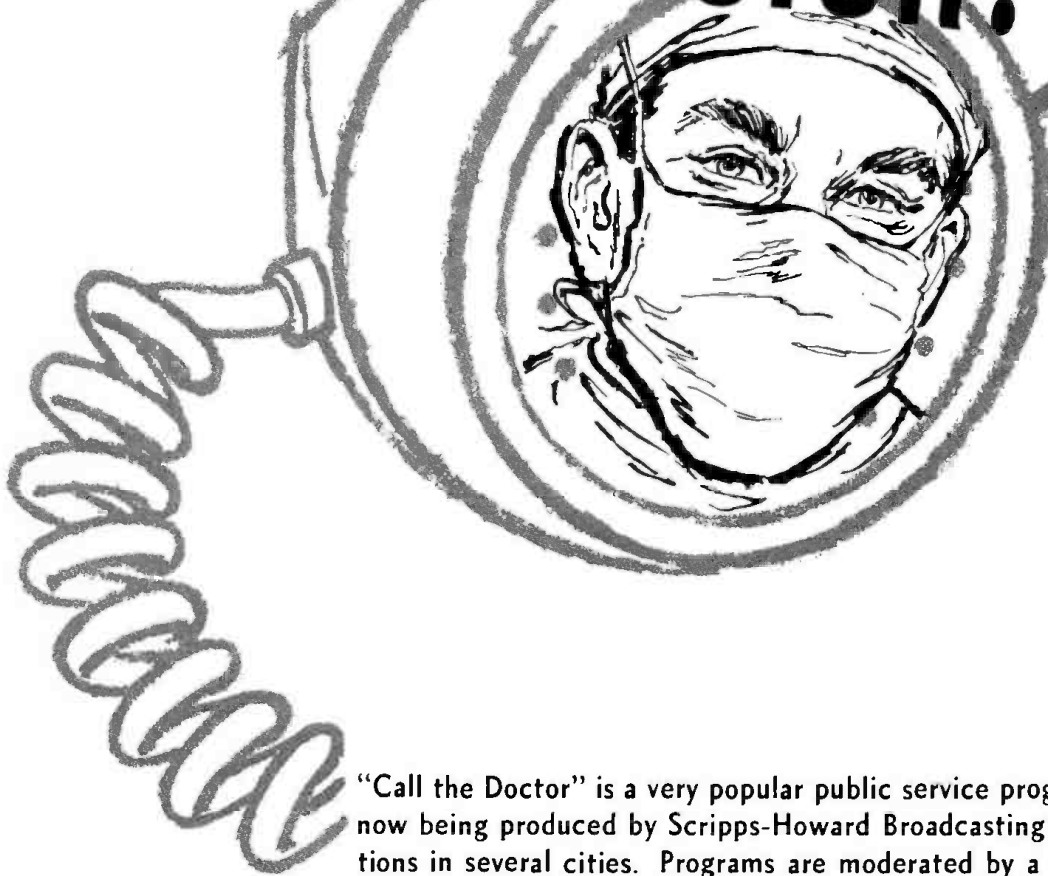

"Call the Doctor" is a very popular public service program now being produced by Scripps-Howard Broadcasting stations in several cities. Programs are moderated by a well known local area physician, and many major health problems are interestingly discussed by a panel of American Medical Association specialists. Video and Audio tapes of these programs are available without charge to stations interested in producing their own "live" version.

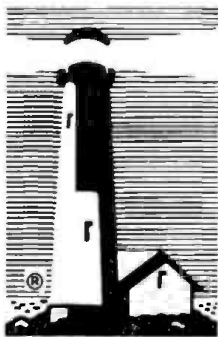

For further details and requests, please write:

"Call the Doctor"

Scripps-Howard Broadcasting Co.

2345 Symmes Street

Cincinnati, Ohio 45206

SCRIPPS-HOWARD BROADCASTING CO.

WCPO-AM-FM-TV CINCINNATI; WEWS-TV CLEVELAND;

WMC-AM-FM-WMCT-TV MEMPHIS; WNOX KNOXVILLE;

WPTV-TV PALM BEACH

for Subscription Television, was announced, with Dr. Robert Ramsey, former president of Woodbury College, Los Angeles, as its executive director. Dr. Ramsey said the group will serve pay TV in a manner similar to the Academy of Motion Picture Arts & Sciences in motion pictures. "As an independent research and information center, it will seek to foster an understanding of the wide range of cultural benefits that will accrue to the American public through subscription television."

The new organization was greeted with a derisive blast by the Citizens Committee for Free TV. Frederick C. Dockweiler, Southern California chairman of the CCFTV, labeled it as a pay TV front "hiding behind the sham of fictitious public service."

The Academy for Subscription Television is located at 607 South Hobart Boulevard, Los Angeles. Telephone: Dunkirk 6-1036.

CBS Radio to add 3 affiliates

One New Hampshire and two Maine stations will join the CBS Radio network, effective March 29.

WLNH Laconia, N. H., currently af-

filiated with ABC, is a daytime station operating on 1350 kc at 5 kw.

WFAU Augusta and WCOU Lewiston, both Maine, are owned by Twin City Broadcasting Co. and operate with 1 kw during the day and 250 w at night. WFAU operates on 1340 kc and WCOU is on 1240 kc.

L.A. ETV station opens drive for \$1 million

A drive to raise a minimum of \$1 million for KCET(TV) Los Angeles, UHF educational TV station now under construction, was announced Wednesday (March 18) by Dr. Lee A. Dubridge, board chairman of Community Television of Southern California. "The \$1 million fund drive is to meet the local operating expenses for the first two years, beginning in September when channel 28 will be seen on television screens for the first time," Dr. Dubridge said. Capital fund needs for construction of the station's physical facilities have already been raised, he reported. Gifts of \$250,000 each were received from CBS, NBC and Metromedia and one of \$100,000 from KCOP(TV) Los

Angeles, plus a grant of \$468,790 from the Department of Health, Education & Welfare.

The station has set Sept. 28 as target date for the start of regular programming, according to Rose Blythe, executive secretary.

Operation will start with a teacher training program at 8:30 a.m. weekdays. From 9 a.m. to 3 p.m. the station will provide in-school instructional programming. A second teacher training period will be at 3-4 p.m., then adult education for housewives, shut-ins and others from 4-6 p.m. Children's programming will last through the dinner hour. Three to four hours of cultural programming for the adult home audience will follow with signoff about 11 p.m.

Mrs. Blythe said about 175,000 homes in the Los Angeles area are able to receive UHF TV programs. Since all TV sets shipped across state lines after April must be all-channel sets, the UHF audience can be expected to grow rapidly, she said.

The in-school programming, Mrs. Blythe said, will be planned and produced by the various Southern California city and county school boards participating in the program. For the past six years the programming has been conducted in time purchased from KCOP(TV) Los Angeles. School receivers are now being equipped for UHF reception to enable them to get service from KCET, but there is a possibility that some use of KCOP may continue.

Much of the cultural programming planned for the prime evening hours by KCET will come from National Educational Television.

Changing hands

ANNOUNCED ■ The following sales of station interests were reported last week subject to FCC approval:

■ KACL Santa Barbara, Calif.: Sold by Roy Dolley to John S. Minor for \$130,000. Mr. Minor is a Cincinnati businessman. KACL operates daytime only on 1290 kc with 5 kw. Brokers: Wilt Gunzendorfer & Associates, for the seller; R. C. Crisler & Co., for the buyer.

■ WAUC Wauchula, Fla.: Sold by Robert S. Taylor and associates to Mr. and Mrs. Royce D. Plummer for \$30,000. Mr. Plummer has been in radio in Georgia. Mr. Taylor owns majority interest in WLOW Aiken and WALD Waltherboro, both South Carolina. WAUC is a 500 w daytimer on 1310 kc. Broker: Chapman Co.

APPROVED ■ The following transfer of station interests was among those approved by the FCC last week (for other commission activities see FOR

Outstanding Values in Radio-TV Properties

CALIFORNIA EXCLUSIVES

Dominant number 1 on every score full-timer with excellent cash flow. Best facility in solid growth market. Big regional coverage. Good leases. Terms available. Mean temperature 72°.

Single station market. Fulltime coverage. Fine real estate plus new equipment. Needs experienced owner-manager. \$100,000 cash down. Mean temperature 68°.

Fine fulltime facility. Strong coastal growth area. At this price all cash will be needed. Best potential between San Francisco and Los Angeles. Mean temperature 70°.

SOUTHERN CALIFORNIA

\$550,000

NORTHERN CALIFORNIA

\$275,000

CENTRAL CALIFORNIA

\$250,000

BLACKBURN & Company, Inc.

**RADIO • TV • CATV • NEWSPAPER BROKERS
NEGOTIATIONS • FINANCING • APPRAISALS**

WASHINGTON, D.C.

James W. Blackburn
Jack V. Harvey
Joseph M. Sitrick
2CA Building
Federal 3-9270

CHICAGO

H. W. Casill
William B. Ryan
Hub Jackson
333 N. Michigan Ave
Chicago, Illinois
Financial 6-6460

ATLANTA

Clifford B. Marshall
Stanley Whitaker
John G. Williams
1102 Healey Bldg.
Jackson 5-1576

BEVERLY HILLS

Colin M. Selph
C. Bennett Larson
Bank of Amer. Bldg.
9465 Wilshire Blvd.
Beverly Hills, Calif.
CRestview 4-8151

■ WEW St. Louis: Sold by J. Alvin Koenig and others to Charles P. Stanley and associates for \$468,400. Mr. Stanley is general manager of WEW and has minor interests in other Franklin Broadcasting Co. (parent of WEW) stations: WLOD Pompano Beach, Fla.; KOMA Tulsa, Okla., and WWOM New Orleans. WEW, founded in 1921, operates daytime only on 770 kc with 1 kw. The grant was conditioned on Mrs. Martin O'Reilly Browne withdrawing from the buying group.

FCC grants stays for Estes's licenses

The FCC last week granted Edwin H. Estes's request for a stay of the non-renewal and revocation, respectively, of his licenses for WMOZ Mobile, Ala., and WPFA Pensacola, Fla., until 30 days following the close of all litigation. The effective date had been March 31.

The commission ordered the penalties in a unanimous four-commissioner decision based on what the decision termed a "record of attempted fraud and deception virtually without equal in commission history." The commission found that forged composite week program logs had been used in the license renewal application of WMOZ (BROADCASTING, Feb. 17). The revocation of WPFA's license was based on the evidence, disqualifying Mr. Estes to be a licensee, discovered in the WMOZ hearing.

Mr. Estes asked for the stay when he pleaded for a reconsideration and rehearing of the case. The licensee believes that the WMOZ hearing failed "to secure a 'full and true disclosure of facts'" and that the revocation of WPFA was an arbitrary and unprecedented commission action (BROADCASTING, March 16).

FCC told to find source of Farina's funds

A U. S. court of appeals told the FCC last week to inquire further into a question whether money an applicant for a radio station said he had at home was his, or came from a third party.

The court remanded the case involving the 1963 grant of 1460 kc (with 5 kw daytime only) to WJZZ Mt. Holly, N. J., and said it would retain jurisdiction.

Issued originally two weeks ago and then withdrawn (BROADCASTING, March 16), the decision issued again last week included a concurring opinion by Cir-

cuit Judge J. Skelly Wright which was not included in the first issuance. The majority opinion was written by Circuit Judge Warren E. Burger for himself and Judge Wilbur K. Miller.

The question at issue is whether John J. Farina, principal owner of WJZZ, misrepresented his finances. In his application he said he had \$54,000 on deposit in a bank. Actually, according to testimony, Mr. Farina had \$1,000 in a bank and \$53,000 in a "receptacle" at home. The commission accepted his explanation that he had misunderstood the specifics of the question on the application form.

Mr. Farina, according to a footnote to the decision, delivered \$53,000 in cash in a satchel to his lawyer after filing the application.

The court recommended that the FCC have the examiner reopen the case to determine the details of Mr. Farina's funds at home and his arrangements with his family, financial arrangements for future operations, organizational expenses and surveys on community needs.

Judge Wright said he was reluctant to agree with the majority since the subjects scheduled for review already had been passed on by the commission, but he said, further inquiry may clear the air and dispel some of the doubts.

Four file cross-suit against Hebenstreit

Four minority stockholders in New Mexico Broadcasting Co. have filed a cross-suit against the firm's major owner, A. R. Hebenstreit (60%), claiming that he has agreed to sell the station for \$2.75 million and should do it.

The action filed in U. S. District Court, Albuquerque, N. M., is in answer to a breach of contract suit filed last month by James Gilmore, of Gilmore Broadcasting Co., Joplin, Mo., the prospective buyer (BROADCASTING, March 2).

Involved are KGGM-AM-TV Albuquerque and KVSF(TV) Sante Fe, N. M. Both stations are licensed to the New Mexico firm.

The minority stockholders are asking from Mr. Hebenstreit: S. P. Vidal Jr., \$257,040; U. S. Senator Clinton P. Anderson (D-N.M.), \$126,000; Shelburne P. Anderson, the senator's son, \$53,928; and Maurice Liberman, \$127,008.

Mr. Gilmore, who owns KODE-AM-TV Joplin, Mo., claims in his suit that he has a valid contract to buy the New Mexico stations and that Bruce Hebenstreit persuaded his father to reverse himself on the contract.

EXCLUSIVE BROADCAST PROPERTIES!

MIDWEST—AM-FM combination with excellent coverage of prosperous marketing area. Sale includes another allied business plus heavy assets including real estate. Total price of \$135,000 cash. **Contact—John D. Stebins in our Chicago office.**

EAST—Absentee owned daytimer located in thriving industrial community. Would reflect owner-operator cash flow of approximately \$17,000. Priced at \$95,000 with \$20,000 down and a long payout. **Contact—Barry Winton in our Washington office.**

Floumilton-Loudis

& ASSOCIATES, INC.

John F. Hardesty, President

NEGOTIATIONS • APPRAISALS • FINANCING OF CHOICE PROPERTIES

WASHINGTON, D.C.
1737 DeSales St., N.W.
EXecutive 3-3456

CHICAGO
Tribune Tower
DElaware 7-2754

DALLAS
1511 Bryan St.
Riverside 8-1175

SAN FRANCISCO
111 Sutter St.
EXBrook 2-5671

RADIO • TV • CATV • NEWSPAPERS

America's Most Experienced Media Brokers

What to do with community television

IT'S DESTINED FOR FEDERAL REGULATION—BUT HOW MUCH?

Community antenna television systems, which once were regarded as mom and pop operations of strictly local influence, have developed into a significant force that is commanding the attention of the federal government.

With modern CATV's delivering as many as six or more signals from distant television stations, some members of the FCC have begun to wonder whether CATV is making hash of the commission's television allocations system. The spread of large CATV systems has also raised the possibility of their conversion into wired pay TV that could cover whole sections of the country.

In addition, although some broadcasters are engaged in fierce competition with CATV's, others have joined the CATV ranks—and in the process have raised the question of whether they are circumventing the commission's multiple ownership rules limiting the number of TV outlets a licensee may own.

The FCC, which lacked the power (and the incentive) to keep the CATV genie in the bottle, is now casting about for ways of controlling it. The question is: How?

Legislative Approach ■ One proposed device is legislation that would enable the commission to afford television stations protection from CATV's. The commission already has authority to provide this protection against CATV's served by microwaves, over which the FCC has jurisdiction. And the commission now conditions microwave grants on the CATV's promise not to relay a program for a period of 15 days before and after the local station broadcasts it.

But legislation would make clear the commission's authority to regulate all CATV's, including those that pick up their signals off the air. In addition, some commissioners feel legislation would constitute a clear mandate from Congress to regulate CATV's. The commission has received a number of inquiries from senators and congressmen reporting complaints from constituents about FCC regulation of CATV's.

And until two weeks ago, the commission's chances of getting a bill

seemed bright. FCC staffers and representatives of the National Community Television Association had been negotiating the provisions of a draft bill for almost a year, and agreement was in sight.

But then, the National Association of Broadcasters entered the picture, and in effect, told the FCC and NCTA their proposed draft bill would never do, and that a new, tougher approach was needed (BROADCASTING, March 16).

As a result, there is little chance that any CATV bill will be enacted in this session of Congress. The members of Congress directly concerned with the proposed legislation—Senator John O. Pastore (D-R. I.), chairman of the Senate Communications Subcommittee, and Representative Oren Harris (D-Ark.), chairman of the House Commerce Committee—have made it clear they want the parties involved to agree on a bill in advance of its introduction in Congress.

And the difference in approach between the NAB and FCC-NCTA seems so fundamental that commission officials, at least, doubt that the necessary agreement can be reached—certainly not soon enough for Congress to act during this session.

Rival Views ■ Both approaches would result in protection of local stations from CATV competition. But the FCC-NCTA bill stresses non-duplication; the NAB, on the other hand, emphasizes the importance of maintaining the priorities established in the commission's 1952 table of allocations, which sought to provide for (a) one broadcast signal to all communities, (b) one local TV station; (c) two or more services wherever possible (d) two or more local stations when possible.

The differences stem largely from the conflicting motives of the NCTA and NAB in seeking legislation. The cable operators want a bill not because they like the idea of being regulated but because they don't want to be subjected to different sets of regulation in each of the 50 states. A federal act would do much to stabilize conditions in the industry. And since NCTA backing is needed to assure

passage of legislation, the cable operators were in a position to attempt to keep the commission's regulatory authority to a minimum.

The NAB, however, is concerned with protection of broadcasters—even if some NAB members are important CATV operators—and the TV table of allocations. As a result, the association feels the nonduplication provision in the draft bill is inadequate. NAB officials say that a CATV system that relayed a half-dozen signals into a small market would overwhelm the local station, regardless of the amount of nonduplication required. But if the priorities in commission's table of allocations were maintained, the security of the station would be assured.

The NAB has in the past also expressed the view that CATV's originating programming should be considered as engaging in pay TV, and that pay TV should be barred by law from private homes. However, it wasn't clear last week whether the NAB had decided to press for such legislation.

Neither the FCC nor the NCTA has officially endorsed the work of their representatives. But it's assumed both would have approved the suggested bill if the NAB hadn't thrown the monkey wrench.

Limited Authority ■ The FCC-NCTA draft bill would empower the commission to establish rules requiring CATV's to protect local stations. However, this authority would be limited in an initial period, during which the commission could issue rules that would apply only to CATV's within 15 miles of a station. And the protection, by rule, would be limited to prohibiting simultaneous nonduplication to requiring the CATV to carry the station's signals on the cable.

But during this period, the commission could provide additional protection—either to stations outside the 15-mile radius or to outlets that wanted more than simultaneous nonduplication—on a case-by-case basis. And the commission could also provide interim relief if the station involved could establish that such relief was necessary while the case was being litigated.

The FCC and NCTA representatives hadn't agreed on how long this

Group titans clash on CATV

Reinsch Pa. microwave plan
ripped by McCollough, who
says it may turn to pay TV

initial period should last. The FCC argued for two years for CATV's served by microwaves and four years for those that pick up their signal directly from the originating station. The NCTA officials urged initial periods of three and five years.

The FCC-NCTA bill also provides for protection for CATV's. It would, for instance, permit the commission to waive the rules if a CATV system could prove it was at an economic disadvantage.

Compromise Bill ■ This reflects the compromise nature of the bill—a condition further indicated in the report drafted for submission to Congress along with the measure. The report stresses that the purpose of the bill is twofold —“to foster and protect the public interest in broadcast service and to promote the orderly development of community antenna systems as a part of the national television system.”

The report also emphasizes that the legislation is not intended as a substitute for “the best possible solution”—the good-faith resolution by the broadcaster and CATV operator of the problems in their particular area.

The NAB has not yet put its legislative proposals in draft form, and association officials last week said they didn't think this job could be completed until after the NAB convention, April 5-8, in Chicago. However, members of the association's Future of TV in America Committee discussed some of their ideas at the meeting in which they told the commission they would oppose the FCC-NCTA draft bill.

The committee members at that time stressed the need for maintaining the priorities in the 1952 table of allocations. And one way this could be accomplished, they said, would be to require CATV's proposing to go into business to reach agreements both with the stations whose signals would be picked up and the stations whose markets they would serve. Differences that couldn't be resolved would be referred to the commission.

The theory behind this proposal, as one commission official said later, is that the legitimate self-interest of the stations and the goals of the table of allocations would be in accord.

Others in the Act ■ The FCC, NCTA and NAB don't exhaust the list of those interested in the proposed CATV bill. Last week, representatives of the Television Antenna Manufacturers Institute (TAME) in a meeting with commission members, recom-

mended the stiffest provisions yet. TAME's members make home TV antennas—which are of no value to homes wired for CATV.

The TAME officials said the commission should have authority to license CATV's and have complete regulatory authority over them. This authority would extend to CATV systems' impact on the table of allocations and, by inference, to their potential as pay-TV organizations. The organization would also have the FCC set technical standards for CATV's. TAME's view, reportedly, is that CATV's should be considered as an integral part of the TV allocations structure—and regulated as such.

Some commissioners say they are not particularly disturbed by the impasse that has been reached in the efforts to reach agreement on a bill. They point out that the commission can continue to condition microwave grants on the CATV's agreement to protect local TV stations.

But there is still the feeling that a bill would, at the very least, clarify the commission's authority and constitute a congressional mandate. And there is probably a feeling of frustration on the part of NCTA officials, who were close to an agreement with the commission.

The FCC and the NCTA might have saved themselves from the present awkward situation if they had brought the NAB into their discussions much earlier. The FCC-NCTA talks began almost a year ago. But it wasn't until last month that the NAB was invited to express its views—and then only after it became known that the association's Future of TV in America Committee favored a different approach from that which the FCC-NCTA negotiators were taking.

The NAB itself is, in a sense, “fractionalized,” with a number of its members already in the CATV business, some on a substantial scale. The division of opinion on CATV among broadcasters was dramatized last week in the FCC action brought by WGAL-TV Lancaster, Pa., against the Cox stations (see story at right on this page).

The FCC still assumes the association would still speak with a powerful voice in behalf of the broadcasters in any appearance on Capitol Hill. Said one commissioner, in speculating on a head-to-head clash of views between NAB and the NCTA before a congressional committee, “They'd kill each other off.”

Two large broadcasting group owners collided last week over the question of community antenna systems.

WGAL-TV Lancaster, Pa., one of the Steinman stations, challenged Cox Broadcasting Corp.'s plans to use microwaves to relay the programs of independent New York and Philadelphia stations to CATV's in Pennsylvania (BROADCASTING, Feb. 24).

WGAL-TV, in a petition filed with the FCC, asked that the Cox application for the microwave stations be set for hearing. The station contended that the commission rules are inadequate to deal with the “potential which is implicit” in Cox's over-all plan.

WGAL-TV said the proposal could re-



Mr. McCollough

Mr. Reinsch

sult in “enormous” economic advantages for a “few originating stations,” and could lead to a “gigantic subscription television network at any time without prior approval of any governmental agency.”

The station also said that the Cox plan would result in the public's dependence on a few rather than many television stations, “a result diametrically contrary to commission policy, which is aimed at creating and providing outlets in as many communities as possible.”

Contenders Of Note ■ Both Steinman Stations and Cox are headed by well-known broadcasters. Clair R. McCollough, president of Steinman, the National Association of Broadcasters' Man of the Year for 1960, has been chairman of the NAB boards and is now chairman of the television code board. J. Leonard Reinsch, president of Cox Broadcasting, has served as chairman of the U. S. Advisory Com-

mission on Information and was recently appointed by President Johnson to the post of executive director of the Democratic National Convention. Steinman stations include five AM's, three FM's and three TV's; Cox's, four AM's, four FM's and four TV's.

Cox, acting through its subsidiary organization, Video Service Co., of Dayton, Ohio, has applied for common carrier microwave relay stations to carry the signals of WOR-TV and WPIX(TV) both New York, and Philadelphia's educational station, WUHY-TV to CATV's in Chambersburg and Tyrone, Pa. Cox owns the CATV in Tyrone.

But WGAL-TV notes that the 200-mile system would cost \$199,550 and estimates that the combined yearly income from the two CATV's would be less than the cost of operating the system. Therefore, the station contends, Cox expects to serve additional CATV's along the microwave route.

WGAL-TV also said that the commission should consider the Cox applications for microwave stations to relay programs from television stations in Chicago, and in Cleveland, Columbus and Dayton, all Ohio, to CATV's in a number of Ohio communities (BROADCASTING, Feb. 24).

(The Cox applications originally included a request for a microwave station to relay signals to a CATV system Cox planned to build in Dayton. However, two weeks ago the commission announced Cox had withdrawn its application for the Dayton link.)

End Result ■ WGAL-TV said it would be "unrealistic" to make a judgment on the ultimate impact of Cox's proposals without considering "both branches of its planned system and the New York to Chicago chain which would be created thereby." Actually, a 250-mile gap would separate the two branches. But WGAL-TV said this could be closed "easily."

WGAL-TV said the Cox applications would, if granted, result in immediate competition for the station from the CATV in Chambersburg, a community of 17,670, which is within WGAL-TV's Grade B contour. In addition, the station said, it would face competition from other CATV's "within its coverage area which undoubtedly would seek to utilize the microwave service."

Reason for Petition ■ The station said it based its argument for a hearing not on the contention that the Cox company "seeks to violate" any rules, but on the ground "that there are insufficient rules and controls now although they are desperately needed. . ."

WGAL-TV asserted that the regulation to which the holder of a common carrier authorization is subject "is wholly inadequate to cope with the potential dissemination of programming to millions of CATV subscribers. This is the crux

of the problem now before the commission.

"Both directly and indirectly, Video Service would be performing the function of a broadcaster, but it would be subject to only common carrier regulation," WGAL-TV said, adding: "Moreover, unlike the classic common carrier . . . Video Service for all practical purposes would decide what programming would be transmitted along its potential New York-Chicago routes." The station said that much of the programming could be originated by the corporate parent or by Video Service itself on a closed-circuit basis.

New Approach ■ WGAL-TV stressed that the Cox application differs from those of CATV operators who in the past merely sought to bring television to remote and unserved areas. "The honeymoon" of that era between broadcasters and CATV operators "is over," WGAL-TV said.

The new dream, as typified by the Cox application, according to WGAL-TV, is the wired presentation in substantial communities of television programs that cannot be received by off-the-air pickup.

In requesting a hearing, WGAL-TV asked the commission to look into most of the questions generally raised in connection with the current trend to large CATV ownerships:

- What effect would a grant have on the commission's table of TV allocations?

- Would the proposed microwave system result in suppressing the growth of local television stations along its route?

- Should the application be granted "in the absence of a clearly demonstrated need for the programming which the applicant proposes to transmit"?

- Since CATV operators can, and do, originate programming, should the commission require separation of ownership of CATV systems and common carrier microwave relays, and should the commission prevent the connection by microwave of multiple CATV systems if any one of them originates programming?

- Is the proposed microwave system, "standing alone or considered in conjunction" with existing or future operations, intended as an ultimate vehicle for a pay-TV system and, if so, would the requested grant be in the public interest?

Besides WGAL-AM-FM-TV, the Steinman stations include WLEV-TV Bethlehem, WKBO Harrisburg, WORK York, WEST-AM-FM Easton, all Pennsylvania; WDEL-AM-FM Wilmington, Del.; KOAT-TV Albuquerque, N. M., and KVOA-TV Tucson, Ariz.

The Cox stations include KTVU(TV) Oakland-San Francisco; WSB-AM-FM-TV Atlanta; WHIO-AM-FM-TV Dayton, Ohio; WSOC-AM-FM-TV Charlotte, N. C., and WIOD-AM-FM Miami.

Some broadcasters are joining TAME movement

A movement by the Television Antenna Manufacturers Institute (TAME) to enlist the support of broadcasters in its opposition to community antenna television has caught on in widely scattered areas, most recently in New Mexico.

There, according to John Deme, president and general manager of KAVE-AM-TV Carlsbad, N. M., he has been fighting a CATV system and has been "working closely with TAME. . . We feel the time has come to retaliate and put up a strong fight to restrain CATV." KAVE's campaign includes newspaper ads and spots on its own stations.

TAME, which sent representatives to discuss legislative proposals for federal CATV regulation with the FCC last week (see page 60), is pushing ahead in its effort to win broadcaster support. The organization has been providing a supply of "Keep TV Free . . . Fight U-Pay TV" kits that include mats for newspaper ads to electronic dealers and local TAME organizations since the first of the year. Now, however, free ET's featuring editorials are being made available to radio and TV stations, according to Morton Leslie, acting TAME chairman and sales manager of JFD Electronics, Brooklyn, N. Y. Visual material for TV stations also is being prepared, Mr. Leslie said.

Nielsen, Rating Council reported near agreement

Only minor areas remain to be resolved before A. C. Nielsen Co. agrees to the auditing and accreditation procedures of the Broadcast Rating Council, Henry Rahmel, Nielsen executive vice president, said last week. Contrary to published reports that Nielsen was seeking major concessions from the council (CLOSED CIRCUIT, March 9), Mr. Rahmel said that he is "unaware of any points of estrangement."

Nielsen and the council planned to meet last Friday (March 20) to work out final plans on the independent audits. Both groups predicted that an agreement would be reached in the immediate future. Mr. Rahmel said that Nielsen understands the need by broadcasters for an audit and that the only problem remaining is agreement on the interpretations to be placed on specific language relating to procedure.

He said that Nielsen has answered fully and completely all questions asked by the Rating Council and that the research firm will continue to cooperate in the future.

GATES

NEW FM-5G

5000 WATT FM BROADCAST

TRANSMITTER

WITH DIRECT CRYSTAL CONTROLLED CASCADE FM EXCITER



GATES NEW FM FIVE-G... A DYNAMIC TRANSMITTER FOR A NEW ERA OF FM BROADCASTING

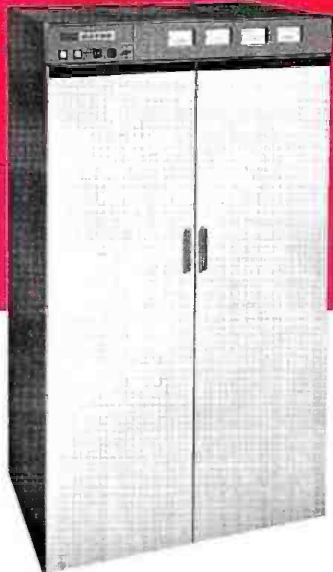

This new 5 KW FM transmitter from Gates is the result of *Value Analysis* . . . a concept in product development and manufacturing that has created a superior product with greater value and increased quality. In *Five-G*, more of your equipment dollar is devoted to putting the FM signal on-the-air.

FIVE-G is equipped to fill every transmitting need. Here is a brief review of some significant steps forward in FM:

DIRECT CRYSTAL CONTROLLED CASCADE FM EXCITER: Gates proven direct crystal controlled cascade FM exciters are used by more prominent FM broadcast stations from coast-to-coast, by more stereo stations and stations broadcasting SCA services than any other exciter. Cascade modulation uses two separate phase modulators with the same modulating signal applied to both stages. Performance capabilities are double and produce outstanding advantages over other FM exciters such as; better frequency stability, improved low frequency response and simplified circuitry. Within a matter of minutes, *Five-G* may be equipped for stereo by simply adding the Gates stereo generator in the space provided.

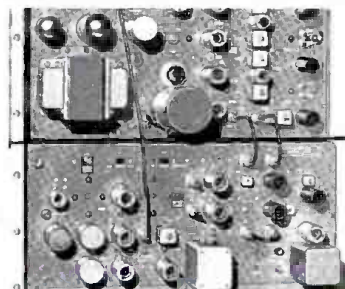

COMPONENTS PAR EXCELLENCE: One look at the names of the manufacturers supplying components for the *Five-G* will confirm the judgment exercised by the Gates *Value Analysis* team in selecting and testing the materials that make-up this advanced transmitter. The power-packed *Five-G* utilizes a final tube (4CX5000A) that others often choose for a ten kilowatt transmitter. In-

ternal design is compact, yet ample room is provided for easy maintenance and cool operation.

SELF-CONTAINED: *Five-G* is completely self-con-

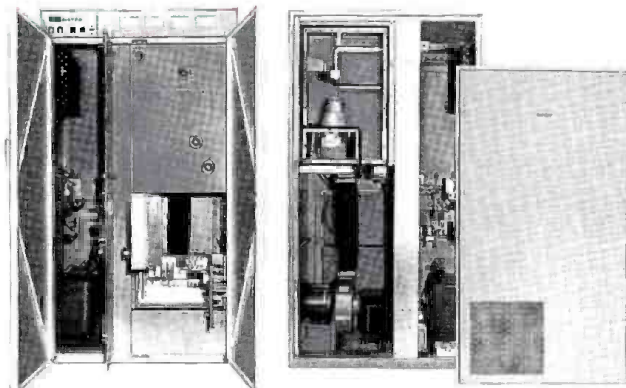

tained. The plate transformer, blowers and stereo generating/ SCA* equipment are all contained in the beautifully styled cabinet. Here is the first transmitter allowing maintenance and service from both the front and rear. A full length front access door is fully interlocked and all components are within easy reach. No additional equipment is required in the transmitter for remote control. Simply connect the *Five-G* to a transmitter control unit, tie in the telephone line to the studio and you are ready for complete remote control operation.

PUSHBUTTON OPERATION: Daily operation is simple. On-off functions are controlled by the four lighted pushbuttons at the top left of the transmitter. No need to open the front doors when turning *Five-G* on or off.



WANT THE WHOLE STORY? Write for Adv. 139 and read how *Value Analysis* created a new transmitter for the new era of FM.

* Optional.

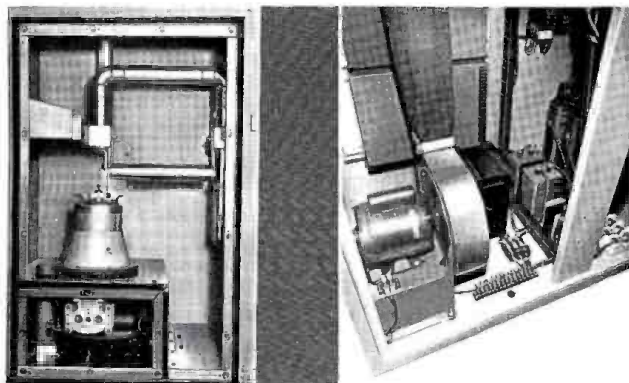

HARRIS
INTERTYPE CORPORATION

GATES

GATES RADIO COMPANY
QUINCY, ILLINOIS 62302
OFFICES: NEW YORK, HOUSTON, LOS ANGELES
WASHINGTON, D. C., FORT WORTH, PHOENIX
CORPORATION, NEW YORK CITY, IN CANADA
CANADIAN PATENT COMPANY, MONTREAL

Behind closed Capitol Hill doors

House Commerce Committee members question FCC on duplication of 13 of 25 clear channel radio stations

For three hours last week six members of the FCC sat in the House Commerce Committee hearing room and explained why they believed in—and would stick by—their Sept. 14, 1961, decision to duplicate 13 of the 25 radio clear channels.

Committee members at the closed session, who for almost three years have been urging the FCC to reverse its position, found the commission adamant, but willing to listen to new proposals the committee might have, if any, for providing service to white areas.

Prodded about delay in acting on petitions of three to-be-duplicated independent clear-channel stations seeking experimental higher power—750 kw—the commissioners were asked to take another look at the whole clear-channel issue.

What appeared to have prompted Thursday's (March 19) private session was the FCC's reply, through a senator, to a clear-channel licensee's inquiry about what was happening to its request for experimental higher power. The apparent answer—that the FCC was moving ahead toward duplication and had the petition under consideration—came to the attention of representatives who oppose the FCC's policy. They then arranged the confrontation with the commission.

How valuable the meeting was seemed in doubt to some. Many congressmen would not discuss it. One, mindful that the commission had more or less reaffirmed its position last year in a letter of its own to Representative Oren Harris (D-Ark.), committee chairman, said he thought the afternoon was "a waste of time." And a Republican who doesn't mind seeing a regulatory agency headed by a Democrat take a few licks from Congress once in a while characterized the session as a "kick [FCC Chairman E. William] Henry day."

It was understood that the entire session, frequently interrupted by votes on the House floor which required the representatives' attendance, was devoted solely to discussion of clear-channel policy.

The meeting was private and no transcript of what transpired was recorded. Participants, in addition to committee and FCC staff, included: FCC commissioners Lee Loevinger, Robert E. Lee, Frederick W. Ford, Kenneth A. Cox, Rosel H. Hyde and Chairman Henry; Representatives Har-

ris, John B. Bennett (R-Mich.), Jr. Arthur Younger (R-Calif.), John E. Moss (D-Calif.), John Dingell (D-Mich.), William L. Springer (R-Ill.), Walter Rogers (D-Tex.), Horace R. Kornegay (D-N.C.), Gillis W. Long (D-La.) and Ancher Nelsen (R-Minn.).

Representatives Bennett and Harris were firm in their questioning of Chairman Henry, but Representative Dingell, one of the House's strongest clear-channel advocates, was generally credited with carrying the ball Thursday. The meeting began with a status report on the clear-channel situation. When it seemed, however, that the commissioners were not being responsive to Representative Dingell's questions, Representative Harris picked up the FCC's letter to Senator Paul H. Douglas (D-Ill.) and read it aloud to the commissioners. This letter, which has not been made public, is understood to say that the commission plans to follow through on duplication and has not yet decided what to do about separate petitions by independent clears scheduled for duplication for 1) 750 kw power on an experimental basis and 2) lifting the 50 kw ceiling on all stations.

The letter, from Chairman Henry to Senator Douglas, was written last month in response to the senator's inquiry on clear channels on behalf of a constituent, Ward Quaal, president of WGN Inc., licensee of WGN Chicago, one of the independent clears that has petitioned for experimental higher power (BROADCASTING, Oct. 28, 1963). Others in this group: WLW Cincinnati and WJR Detroit. Stations seeking a rulemaking to lift the 50 kw ceiling are WSM Nashville, WCCO Minneapolis and WWL New Orleans.

Representative Dingell spoke in behalf of WJR, for whose 760 kc assignment the FCC has proposed duplication by KFMB San Diego. KFMB, now on 540 kc, must be shifted because of its conflict with a Mexican-U. S. agreement which requires geographical separation on separate channels.

Representative Dingell told the commission that it should not duplicate the clears, and said granting experimental higher power would help the stations overcome interference he said they are having with Latin and South American high-power stations that are not party to an international agreement on channel assignments. When the commissioners said they have no evidence that interference is a problem, Representative

Nominees confirmed

The Senate last week confirmed the nominations of A. Leon Higginbotham Jr., former Federal Trade Commission member, and John Morgan Davis, former Pennsylvania broadcaster, National Association of Broadcasters general counsel and lieutenant governor of Pennsylvania, to fill vacancies among U. S. district judges for the Eastern District of Pennsylvania. Both were given recess appointments by President Johnson after the Senate failed to act on nominations by President Kennedy last year.

Dingell said he had tape recordings to prove it. The FCC said the matter would receive careful attention.

Until last week, the committee had not referred to the clear-channel controversy since the FCC responded to Representative Harris's letter last year. The committee chairman, who had engineered a moratorium on duplication from July 1962-63, had suggested at its expiration last year that the commission hold up still longer pending development of new information. But the commission voted 3-2 to reply that, barring legislation, it would proceed with duplication of the clear channels (BROADCASTING, July 8, 1963).

Reynolds and GOP ask for Jenkins testimony

Senate Republicans and a suburban Washington insurance salesman renewed their pleas last week that Walter E. Jenkins, personal aide to President Johnson, be called to testify in the Senate Rules and Administration Committee's investigation of the outside business dealings of Robert G. (Bobby) Baker, former secretary to the Senate Democratic majority.

The committee, which until strenuous Republican opposition developed seemed headed toward ending the hearing last week, has scheduled a meeting today (March 23). It is expected to consider whether to invite Mr. Jenkins or any one of more than a dozen persons the Republicans want to call before the committee.

Don B. Reynolds, Silver Spring, Md., insurance salesman, asked Senator Everett B. Jordan (D-N.C.), chairman, to "clarify beyond any reasonable doubt the truthfulness to the statements I made under oath in the matter pertaining to the purchase of TV time

arranged by Walter Jenkins and the question of debates requested by Mr. Jenkins and Bobby Baker, as furnished in my supplemental affidavits."

Mr. Reynolds has testified—and Mr. Jenkins has denied, although through affidavit and not through testimony before the committee—that Mr. Jenkins persuaded him to purchase time on KTBC-TV Austin, Tex., in 1957 after he had sold Lyndon B. Johnson, then a senator and Democratic majority leader, \$100,000 in life insurance. The station was, and still is, principally owned by the Johnson family and Mr. Jenkins is a stockholder (BROADCASTING, 27).

In his letter Mr. Reynolds added, "I know that my statements are completely true and I respectfully request that you either call Mr. Jenkins before your committee and question him under oath, or that you issue a categorical statement to me which shall be published, that all of my testimony . . . is true and correct. . . ."

Alan Freed indicted on income tax evasion

A federal grand jury in New York last week indicted Alan Freed, a one-time leading disk jockey, on charges of evading \$37,920 in income taxes for 1957 through 1959.

In 1962 Mr. Freed received a six-month suspended sentence and a \$300 fine after pleading guilty to commercial bribery in connection with payola he received from record companies. The charges in the new indictment, according to Robert J. McGuire, assistant U. S. attorney, resulted in large part from Mr. Freed's failure to report the payola income he received from companies for promoting their records on his radio programs.

The evasion centered mainly on alleged fraudulent deductions as business expenses for sums paid by Mr. Freed to his first wife for the support of their children, Mr. McGuire stated.

April 20 new deadline for comments on CATV

The FCC last week extended until April 20 the deadline for comments on its proposed rulemaking to govern grants to microwave services supplying facilities to community antenna systems.

A March 25 deadline was extended in face of the commission's continued negotiations with the National Community Television Association to develop compromise legislation—for presenta-

tion to Congress—that would give the FCC regulatory power over CATV (BROADCASTING, March 16).

The two rulemakings would require that grants to common carrier and business radio microwave services be conditioned on the CATV served not duplicating, for a 15-day period before and after, the programing of a local station, within the station's grade A service area. It would also require that the CATV carry the signal of the local station if so requested (BROADCASTING, Jan. 13). Reply comments are due May 11.

145 in L.A. chapter of Broadcast Pioneers

The new Los Angeles chapter of the Broadcast Pioneers has a membership of 145, Van C. Newkirk, temporary president of the chapter, reported to a meeting Wednesday (March 18). Carl Haverlin, who retired Jan. 1 as president of Broadcast Music Inc. and returned to California, where he had been active in radio in the 1920's and 1930's, proposed that a committee be appointed to collect all available material about Southern California's "superlative" record in broadcasting.

The session was the first general meeting since the organizational meeting in December (BROADCASTING, Dec. 9, 1963). Mr. Newkirk and the other temporary officers and directors elected then will serve until May 27, when permanent officers will be elected.

Brooklyn College opens TV production center

Brooklyn College, New York, last week officially opened a new television center which includes approximately \$500,000 worth of broadcast equipment—most of it supplied by RCA.

The new production center is built around two studios, the largest of which has more than 2,000 square feet of floor space. There are also two fully equipped control rooms and several electronic apparatus rooms, announcing booths and dressing rooms. RCA equipment at the center includes: three TK-60 image orthicon cameras, three TK-15 vidicon cameras, two TV film systems, two TV tape recorders and a master control switching system.

Some of the planned activities for students at the new center include: the production of taped educational programs to be used in departments of the college; the production of taped programs to be aired as a community serv-

ice on WNYC-TV, WNDT(TV) and other educational stations in the New York area; and the taping of programs on contract with outside agencies, such as the New York State Education Department. At the present time the center does not operate its own transmitter.

Speakers at the center's dedication ceremonies March 19 were Donald H. McGannon, president of Westinghouse Broadcasting Co.; Seymour Siegel, director of Municipal Broadcasting System (WNYC-AM-FM-TV) New York; Harry D. Gideonse, president of Brooklyn College, and Abraham S. Goodhart, dean of studies at Brooklyn College.

College broadcasters meet in New York

More than 125 students from some 60 colleges around the country attended the third annual Collegiate Broadcasters Conference in New York last Thursday and Friday to discuss with broadcasting professionals some of the problems that face college radio stations. The conference was held under the auspices of the International Radio and Television Society.

Panel discussions on station operations, the sounds of modern radio, sales techniques and getting a job after graduation dominated the conference.

A principal speaker was FCC Commissioner Kenneth A. Cox, who told the collegians that, like commercial broadcasters, their primary responsibilities were to maintain "high technical standards" and to use the criteria of what is in the public interest when devising program schedules. Mr. Cox said college students might be "getting a break" in not having enough money to use the different rating services to help determine what programs would be most popular with their audiences.

While noting that programing on commercial and college stations might have a "better balance," Mr. Cox stressed that most programs naturally will be of a popular entertainment nature because they are the kind the majority of the people want.

AWRT prepares for visitors

Women broadcasters from Israel, Yugoslavia, Argentina and Poland will visit the U. S. this spring as guests of the American Women in Radio and Television Educational Foundation in cooperation with the State Department, as part of the foundation's international broadcasters program.

The visitors will tour the country for 60 days studying radio-TV operations and techniques.



Puzzle for Easter Egg-Heads

An eccentric client turned up at WMAL-TV recently with his annual offering of brightly colored eggs, to be divided among those on the staff who have children. To complicate matters, our eccentric attached certain stipulations to his gift. There are 40 eggs in the bag, he informs us, 16 blue, 14 red and 10 green. We can take as many as we want so long as we assure him that at least eight of any one color and six of another will remain in the bag.

Lack of maneuvering room in the bag (the eggs are Grade AA, extra large, and the bag is Grade B, small) makes the pragmatic approach of counting the remainder after each pick impracticable. What is the largest number the staff may remove from the bag at random and still be certain of fulfilling the donor's conditions?

Last one to solve this is a rotten egg. Address answers to:

Puzzle #100, WMAL-TV, Washington, D. C. 20008

Bag your full share of the prize Washington audience with a prime-time spot schedule on WMAL-TV: "News 7" (6 to 7 p.m., Mon.-Fri.) and its popular follow-up, "The Comedy Hour" (7 to 7:30 p.m.). Check with Harrington, Righter & Parsons, Inc.

Puzzle adaptation courtesy Dover Publications, New York, N. Y. 10014

wmal-tv 

Evening Star Broadcasting Company WASHINGTON, D. C.
Represented by: HARRINGTON, RIGHTER & PARSONS, Inc.

Affiliated with WMAL and WMAL-FM, Washington, D. C.; WSVA-TV and WSVA, Harrisonburg, Va.

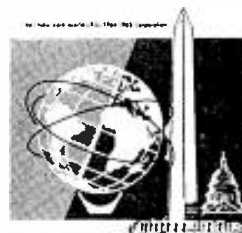

SEE THE
WORLD'S FAIR AND
WASHINGTON, D.C., TOO

Is Simon moving in on AB-PT?

Or is his purchase of 100,000 shares and request for a place on the board merely the investment of a man who knows a good potential when he sees it?

A purchase in excess of 100,000 shares of American Broadcasting-Paramount Theaters stock by West Coast industrialist Norton Simon through McCall Corp. touched off speculation last week about what his next move may be.

A check of AB-PT authorities as well as a sampling of Wall Street opinion yielded a consensus that Mr. Simon is pushing for representation on the board. But, they said, the stock purchase also appears to represent a long-term investment decision in a company with potential rather than a possible opening move in a plan to gain control of the board of directors. Mr. Simon is president of Hunt Foods & Industries, Fullerton, Calif., an advertiser on AB-PT's subsidiary ABC-TV. Hunt Foods owns 35.5% of McCall Corp.

An American Broadcasting spokesman questioned last week said the 100,000 figure was a reasonably close estimate of the number of shares involved in the McCall Corp. transaction. Mr. Simon's 100,000-plus shares make him a larger shareholder than any single director now sitting on the AB-PT board. Board Chairman Leonard Goldenson owns 55,727 shares and has options for 39,795 more. Several reports have indicated that Gustave Levy, a partner in Goldman Sachs & Co., New York brokerage house, would be Mr. Simon's choice as his representative on the AB-PT board. Presented with this possibility Mr. Levy declined to comment.

Simon's Background - Mr. Simon's history of earlier media investment might suggest a second look at his possible goals as an AB-PT stockholder. When he acquired interest in McCall Corp. several years ago it was reported that his acquaintance with the magazine medium as an advertiser had provoked his desire to become an owner in the magazine field.

Hunt Foods has alternate week half-hour sponsorship in ABC-TV's *My Three Sons* and has renewed the contract for the 1964-65 season. For 1962, Television Bureau of Advertising figures show the company spent approximately \$1.1 million in spot television but used no network. For 1963 it is estimated

that Hunt Foods split a similar \$1.1 million television budget evenly between network and spot.

After Mr. Simon first bought into McCall in 1954, the firm's *McCall's* magazine weathered a rocky period which came to a head in 1958 with the resignation of editor Otis Wiese and the appointment of Herbert Mayes as his successor. Mr. Mayes' appointment was announced by Arthur B. Langlie,



Norton Simon
Buys AB-PT stock

former governor of Washington, who himself had been appointed a year earlier by Mr. Simon to head the corporation.

Between 1958 and 1960, McCall's moved up to number one position among women's service magazines in terms of advertising revenue. Much of that rise was attributed to Mr. Simon's behind-the-scenes activity and the men he put in control.

One thing is felt sure about the Simon investment in McCall's; it was not conceived as a short term quick-money plan. He sharply reduced dividends to plow money back into the company's activities.

Besides *McCall's* magazine, the company owns *The Saturday Review* and does printing and lithography for other magazines. In 1962, the last year for

which official figures are available, McCall Corp. had sales of \$107.3 million and a net income after taxes of \$1.9 million. The company had total assets of \$75.5 million as of the end of 1962.

Mr. Simon is chairman of the McCall Corp. executive committee. Five of the 18 McCall directors are Hunt Food representatives and have been on the board since 1956.

Not Passive - A further accounting of Mr. Simon's financial history indicates that it has not been his custom to remain a passive investor.

A Hunt Food investment in Wesson Oil & Snowdrift (shortening) culminated in 1960 in a merger of the two companies after a period of five or six years which included board representation. Another investment in Ohio Match resulted in that company's merger into Hunt Foods in May 1956. Hunt Foods also owns glass and metal container plants and a paint and glass manufacturer.

In its last fiscal year, which ended June 30, 1963, Hunt Foods had gross sales of \$403.2 million, and net income of \$8.3 million. It had total assets at that time of \$359.6 million, and an earned surplus of \$58.8 million. For the six month period this year, Hunt Foods had total revenues of \$196 million, and a net of \$3.3 million.

Mr. Simon, with an initial purchase of about 10% of Wheeling Steel's stock last year, was elected a director of Wheeling at the company's latest board meeting. He is also a director of Northern Pacific Railway.

The some 100,000 shares of AB-PT now held by McCall Corp. take on added significance, in the opinion of Wall Street observers, in light of AB-PT's cumulative voting practice for board members. This permits a shareholder to support board nominees with any distribution of his total vote allotment he chooses. Thus a shareholder may throw the full weight of his support behind a single nominee.

AB-PT currently has 4,557,444 common shares outstanding and to insure presentation on the company's 14-man board a shareholder would need approximately one-fourteenth of that num-

Presenting SPOTMASTER '64

Your Key to Pushbutton Broadcasting

SEE THE WORLD'S MOST RESPECTED LINE OF CARTRIDGE TAPE EQUIPMENT AT THE NAB SHOW



500 A Compact Record/Playback Unit



505 A Compact Playback Unit

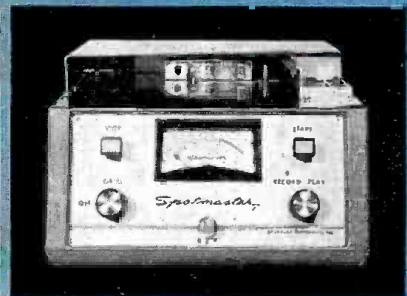

500 A-DL Compact Delayed-Programming Model

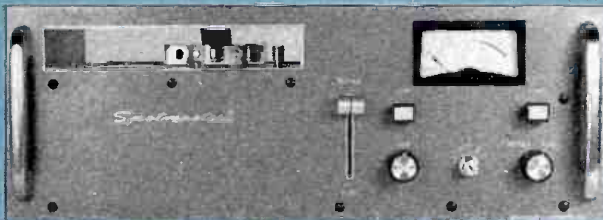

500 A-R Rack Mount Record/Playback Unit

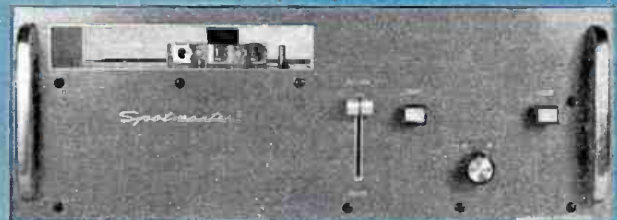

505 A-R Rack Mount Playback Unit

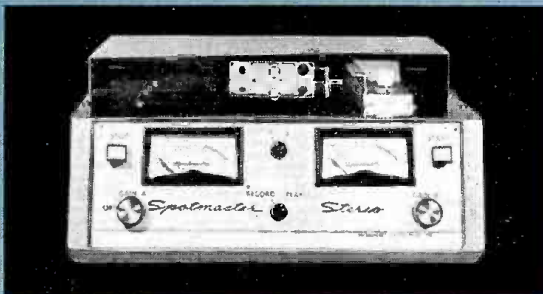

500 A-S Stereo Record/Playback Unit (playback only models also available).

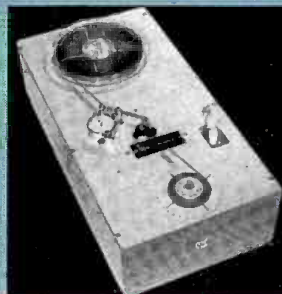

TP-1A Tape Cartridge Winder

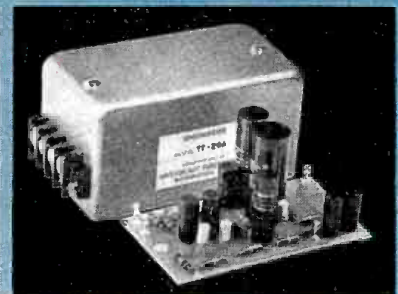

TT-20A Equalized Turntable Pre-amplifier

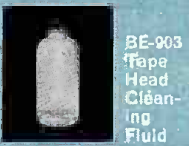

BE-903
Tape
Head
Cleaning
Fluid



300, 600, 1200 and
Special Tape
Cartridges

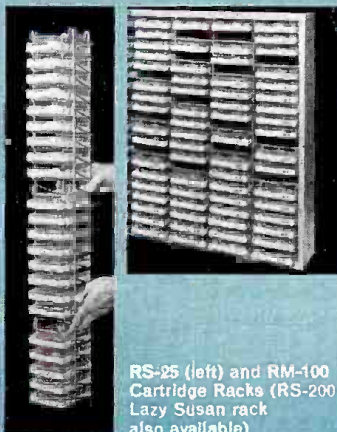

RS-25 (left) and RM-100
Cartridge Racks (RS-200
Lazy Susan rack
also available)

Spotmaster

SPOTMASTER cartridge tape equipment, the preferred choice on five continents, is today serving more than 600 broadcast stations. The reason is a simple one: rugged quality, equal to the toughest demands of studio or field. Designed by broadcast engineers for the broadcast industry, SPOTMASTER equipment gives you trouble-free pushbutton broadcasting... helps end all your headaches with disk transcriptions and reel-to-reel tape.

More information? ... just write, wire or call
BROADCAST ELECTRONICS, INC.

8800 Brookville Road, Silver Spring, Maryland Phone: Area Code 301 JU 8-4983

Sold nationally by:

VISUAL ELECTRONICS

356 W. 40th St., New York, N. Y.

Canada:

**Northern Electric
COMPANY LIMITED**

Branches from coast-to-coast
in Canada

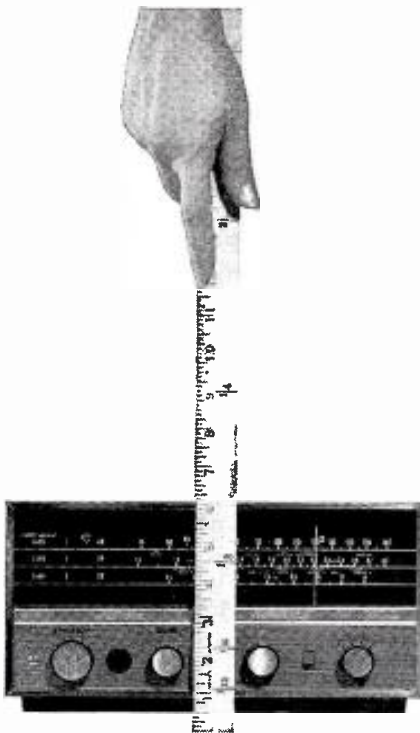

BEST WAY TO MEASURE RADIO...

is with the new WLW "Radio Value Yardstick"—developed by the Crosley Broadcasting Corporation with the assistance of 25 media directors, plus reps and research organizations. This simple, fast method enables timebuyers to measure radio stations' qualitative and quantitative value—not on the usual cost-per-thousand based on audience numbers alone, but also on eight other factors. It supplements an agency's normal procedure of matching radio station information to its client's needs.

*Another example of
Crosley 42 years
of leadership*



CINCINNATI

Nation's Highest Fidelity Radio Station

CROSLY COLOR TV NETWORK

WLW-D	WLW-I	WLW-C	WLW-T
Dayton	Indianapolis	Columbus	Cincinnati

CROSLY BROADCASTING CORPORATION
a subsidiary of Arco

SEC January report of stock transactions

The Securities & Exchange Commission has reported the following January stock transactions by officers and directors of broadcasting and allied companies in its February issue of *Official Summary* (all common stock unless otherwise indicated):

Capitol Cities Broadcasting Corp.—Daniel B. Burke bought 300 over varying periods from May 3, 1963 to Jan. 7, holds 600; J. Floyd Fletcher sold 200 on April 22, 1963, retains 32,561; Donald A. Pels exercised option to acquire 750,

holds 3,250; Charles Pogan exercised option to acquire 1,000, holds 1,600.

CBS Inc.—Edmund H. Pugh Jr. sold 2,900, retains 3,888.

MPO Videotronics—Gerald Hirschfeld bought 5,000 and sold 1,250, retains 51,242.

Metromedia—Stanley Landow bought 100, holds 600; bought 45 as trust for children, total 45; Mary L. McKenna bought 100, holds 1,650 (Mrs. McKenna's husband holds 350); John W. Kluge, bought \$100,000 in 6% convertible subordinated debentures, holds \$100,000.

Reeves Broadcasting—Morris Schechter bought \$1,000 of 6% convertible subordinated debentures, holds \$3,000.

Rollins Broadcasting—O. Wayne Rollins sold 2,500, retains 547,060.

ber. According to Mr. Goldenson, 350,000 shares would be required to assure a seat on the board.

Mr. Goldenson also notes there are other investors in the company with holdings equal to those of Mr. Simon. He attributed recent activity in the stock to a feeling in Wall Street that the shares have been undervalued.

Present Holdings ■ Holdings of current directors and officers of AB-PT reported by the company last May totaled 76,707 shares. The Edward J. Noble Foundation also owns 212,293 shares. The executive director and a trustee of the foundation, Alger Chapman, is also a director of AB-PT. Another American Broadcasting director, Robert H. Hinckley, who holds 2,652 shares, is also a trustee of the Noble Foundation. In addition, Mr. Chapman is executor of the estate of Edward J. Noble, which owns 9,495 shares.

Other major stockholders: Simon B. Siegel, executive vice president of the corporation, 6,627 shares plus options for 11,938 shares; James G. Riddell, vice president of the ABC Division, 2,309 shares plus options for 3,183 shares; Everett H. Erlick, vice president and general counsel of AB-PT, 105 shares plus options for 7,803 shares; David B. Wallerstein, president, Balaban & Katz Corp. (midwest theatre chain), 3,061 shares; A. H. Blank, director, Tri-States Theatre Corp., a subsidiary of AB-PT, 2,007 shares; John A. Coleman, senior partner of Adler, Coleman & Co. (brokerage firm) and chairman of executive committee of AB-PT, 1,062 shares.

There was a report circulating in Wall Street last week that other investors may join with Mr. Simon in purchasing further AB-PT shares.

A high-placed official of McCall Corp. would not confirm that the company was seeking representation on the AB-PT board, but said "that would be a reasonable assumption." He said Mc-

Call's had not yet seen the list of directors for whom AB-PT management would request proxy support in its pre-annual meeting mailings. The AB-PT stockholder meeting will be held in May.

A source close to management in AB-PT has indicated that the board nominee slate will be "normal." The company isn't planning any deviation because of Mr. Simon, he said. Gustave Levy, he averred, is not a nominee of Mr. Simon. But he added that Mr. Levy has been considered for some time as a possible AB-PT board member and is a man of the caliber the present management would like to see on the board.

Another representative of the company indicated that Mr. Goldenson and Mr. Levy are personal friends.

One report was that no Simon representative has yet been included on the list.

No Surprise ■ There was general agreement among security analysts in New York last week that the Simon-McCall purchase had not come as a surprise at AB-PT or its board chairman Leonard Goldenson. Asked if Mr. Goldenson or a representative of AB-PT had met with Mr. Simon before his stock acquisition, a spokesman said the company had no comment.

However it is understood from a source close to AB-PT that the subject of Mr. Simon's holding came up at an executive meeting of the company over a month ago, that at that time it was mentioned that Mr. Simon owned in the neighborhood of 100,000 shares and had asked for representation on the board. Reportedly, no recommendation was made at that time.

The value of AB-PT shares stood at 36¼ at mid-week last week. On March 10, prior to the flurry of interest provoked by published reports of Mr. Simon's activity in the issue, the stock closed at 34 7/8.

The purchase by Mr. Simon was



Do you sell spaghetti in Boston?

If your profit sauce is thin because of high advertising costs, here's something to wrap around your sales fork: WMEX serves up the largest portion of the five-county Boston mass market — the audience of big, young, growing families — at the lowest cost per thousand!

Whatever you sell, use your noodle and call your McGavren-Guild man for the full WMEX story.

The New Boston is tuned to

WMEX
RADIO

made on the open market and represented an investment of more than \$3.5 million. A number of analysts as well as AB-PT sources pointed to the possibility that AB-PT has been an underpriced stock in terms of the company's actual worth and potential. While its book value is about \$26 per share, its actual value, when its owned and operated station properties are considered, may be as much as \$75 per share.

Mr. Simon was not available last week for answers to inquiries on the stock transaction.

IRS says it won't follow court ruling

The Internal Revenue Service officially announced last week that it will not follow the decision of a federal judge permitting broadcasters to amortize the cost of acquiring a TV grant.

This was the ruling by U. S. District Judge Frank W. Wilson authorizing WDEF Chattanooga, Tenn., to amortize the cost of acquiring a TV license over the period of construction and first license (BROADCASTING, April 29, 1963).

IRS said that it would retain its posi-

tion that "if the expenditures result in obtaining permission to use the television facility, the amounts thereof constitute a part of the cost basis of an asset of a permanent nature and a deduction for depreciation thereon is not allowable, since the useful life of a television license is of indeterminate duration." IRS also alluded to the 1959 appeals court ruling upholding a U. S. Tax Court decision disallowing KWTX-TV Waco, Tex., the right to depreciate its costs in securing its TV license.

Although no appeal from the Chattanooga case was taken, IRS said the decision will not be followed as a precedent in similar cases.

WDEF sought to amortize \$21,787.17 spent in securing its TV grant. Under Judge Wilson's decision, it was authorized to depreciate this amount over a 44-month period (20 months for the CP and construction and 24 months for the first license period).

C-C broadcasting income up

Broadcasting represented 4% of the total \$105.16 million sales of Crowell-Collier Publishing Co., the annual report for 1963 issued last week shows.

Revenues from broadcasting amounted to \$4,385,000 which is, the company says, an improvement of 22% over 1962.

The annual stockholders meeting will be held April 2 in New York.

Twelve months ended Dec. 31, 1963:

	1963	1962
Earned per share*	\$ 1.31	\$.91**
Sales and revenues	105,161,062	96,672,880
Total costs and expense	94,002,548	87,882,831
Income before federal and foreign income taxes	9,032,404	6,619,877
Net income	4,437,404	3,086,667†

*Based on 3,390,657 shares outstanding, compared to 3,386,812 in 1962.

**Adjusted to reflect 4% stock dividend in 1963.

† Excluding special credit of \$731,552, equal to 22 cents a share.

Movielab earnings up 23.4%

Movielab Inc., a processing firm handling 16 mm and 35 mm black and white and color film for TV commercials, industrial, educational, religious and government films, has reported that sales and earnings reached new highs in 1963.

Sales were up 5.2%, and earnings 23.4%, Saul Jeffee, president, announced. Mr. Jeffee also reported that the company board voted a 4% stock dividend on common stock, payable March 30 to stockholders of record March 9.

Twelve months ended Dec. 31, 1963:

	1963	1962
Earned per share*	\$ 1.02	\$ 0.82
Sales	6,887,244	6,547,000
Earnings	360,710	292,278

*Based on 354,445 shares outstanding.

Desilu report shows earnings up

Increase in revenues and earnings were reported by Desilu Productions Inc. for the first nine months of the fiscal year ended Jan. 25.

The doubling of net income comes about, it was explained, because of cost adjustments which totaled a loss of \$1,850,006 in the last fiscal year ended April 27, 1963.

Lucille Ball, president of Desilu, reported that two of five half-hour pilots are still in a "potential sales position." All costs relating to unsold pilots have been charged against the nine months of the current fiscal year. Miss Ball also stated that the *Lucy Show* will continue over CBS-TV next season (BROADCASTING, March 9) under a newly negotiated agreement more favorable to Desilu than the present contract.

The annual meeting of Desilu will take place in Hollywood Aug. 18.

Nine months ended Jan. 25:

	1964	1963
Earned per share*	\$0.63	\$0.34
Gross revenues	17,077,792	15,794,836
Net income	764,880	415,812

*Based on 1,213,631 shares outstanding as of Jan. 25, compared to 1,233,631 for same date in 1963.

Hazeltine income drops

Sales by U. S. manufacturers of color TV sets reached about 800,000 in 1963, it was reported by Hazeltine Corp., Little Neck, N. Y., in its annual report. The color TV figure, which is expected to go to 1.2 million in 1964, Hazeltine said, is based to a major extent on "important" patents of Hazeltine Research Inc., a subsidiary of the corporation.

Hazeltine had a gross income of \$43.9 million in 1963 with net income after taxes of \$1.3 million (86 cents a share). These were down from 1962 when gross income was \$47.9 million and net income \$2 million (\$1.28 a share).

The annual stockholders meeting of Hazeltine will be held April 14 in Dover, Del.

Decca Records' annual report

A consolidated annual report for Decca Records Inc., New York, and its subsidiary, Universal Pictures, shows income up \$1,185,083 on a revenue increase of \$1,455,077.

Twelve months ended Dec. 31, 1963:

	1963	1962
Earned per share*	\$4.45	\$3.68
Net Income	6,800,364	5,615,281
Income	102,840,982	101,385,915

*Shares outstanding 1,527,401 both years.

in person

**HILDEGARDE
WARREN
COVINGTON
MARCO RIZO**

**SESAC
CELEBRITY
SUITE**

NAB • CHICAGO

35 db stereo separation

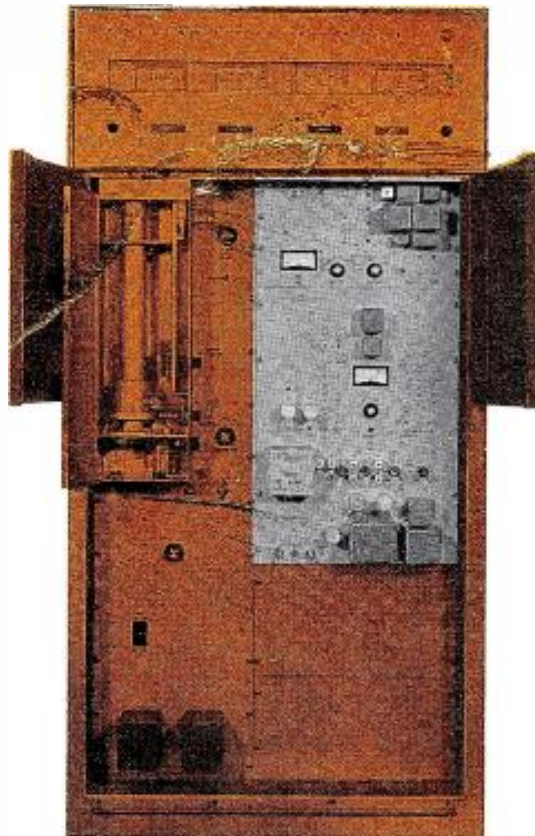

We guarantee it!

Visit our booth at the N.A.B., April 5-8.

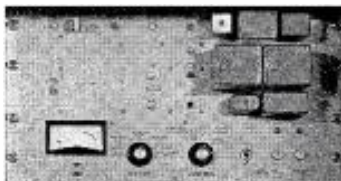

Collins guarantees 35 db stereo separation without frequency multiplication with the new A830-2, 10-watt exciter, and the 786M-1 stereo generator. In fact, a typical Collins transmitter gives 40 db separation; Collins *guaranteed* separation is 5.3 db more than the FCC requires!

The wideband direct FM exciter accepts a composite stereo signal without auxiliary modulators for both stereo and SCA channels. There are no frequency multipliers to compound oscillator drift. Output frequency is attained by mixing the 14 mc modulated signal with the output of a 74 to 94 mc-range crystal oscillator.

Stereo and SCA subcarriers are fed directly into the exciter with main channel audio — *as a composite signal*. The A830-2 exciter is flat within ± 0.5 db for any frequency from 30 to 75,000 cps, providing unmatched monaural, stereo and SCA performance.

Another feature of Collins FM transmitters is the 786M-1 solid state stereo generator. The 786M-1 feeds monaural audio and the subchannel to the exciter as a composite signal. A time-division system eliminates costly and unstable dual channels and does not require matrix networks or frequent adjustment.

Contact your Collins sales engineer for details.

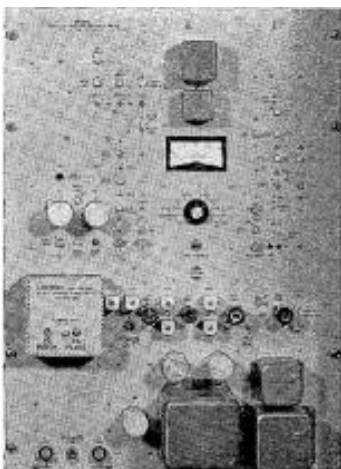

COLLINS RADIO COMPANY
Broadcast Communication
Division, Dallas • Cedar Rapids
Los Angeles • New York
International Division, Dallas



30 Years in the Broadcast Business

CBS Inc. plans to diversify

New York analysts hear Stanton paint rosy future for all divisions

Diversification into new businesses as well as maintaining a leading position in its present businesses is an important current goal of CBS, President Frank Stanton said Thursday night in a presentation to the New York Society of Security Analysts.

Dr. Stanton reported, in answer to a question, that "developments" are afoot in the CBS Laboratories that "could easily generate a new business" for CBS. He did not elaborate.

He also said that CBS is investigating a number of opportunities for diversification but that details could not be divulged. These, he said, are not in the "mechanical or manufacturing direction" but in the areas of "ideas and creativeness" where CBS feels it has strengths that would be valuable.

Merle S. Jones, president of the CBS Television Stations Division, meanwhile told the analysts in a separate report on his unit that CBS has taken an option on a community antenna TV operation in Vancouver, B. C., that feeds programs of seven U. S. and Canadian sta-



CBS Inc.'s Stanton
Diversification ahead

tions to 17,000 subscribers. The system has expansion plans that could bring its total to 75,000 subscribers, Mr. Jones said.

Economic Trends ■ Strong trends evident in the national economy and in national advertising he indicated, add to the bright prospects for both broadcast media and for CBS's networks and stations as well as for its phonograph records division and other interests both

domestically and overseas.

Overall, he said, CBS Inc.'s first quarter this year is "running ahead of our 1963 first quarter, which was our best quarter up to now."

In answer to questions Dr. Stanton said he lacked "the wisdom" to foretell the future of tobacco advertising—which he said represents about 10% of CBS-TV network business—but that he had seen no signs of a cutback and had, in fact, seen "some signs to the contrary."

Asked about the outlook for UHF, he estimated that in five years 50% of TV sets may be equipped for UHF, in which case he thought "some UHF stations will begin to come back into the marketplace." He felt that "10 years down the road" there's a place for UHF, but that "we mustn't smother the child to death with kindness." The "great mistake," he added, was in mixing UHF and VHF stations in the same markets.

Income Growth ■ Summarizing CBS corporate financial history, Dr. Stanton reported that between 1949 and 1963, net income per share has risen by approximately 600%, net income by 900% and net worth by 550%.

Dr. Stanton was accompanied by key executives who supplemented his presentation with short reports on their respective units. In addition to Mr. Jones, these included James T. Aubrey Jr., president of the CBS-TV network; Goddard Lieberman, president of Columbia Records; Edmund W. Pugh Jr., CBS Inc. vice president for finance, and George Arkedis, vice president of the CBS Radio division.

Gen. Sarnoff sells 60,000 RCA shares

Brigadier General David Sarnoff, board chairman of RCA, sold 60,000 shares of his RCA common stock in February, it was revealed last week.

Chairman Sarnoff's holding in the corporation, reported in the RCA notice of annual meeting and proxy statement mailed to shareholders March 2 amounted to 197,235 common shares.

A report to the New York Stock Exchange shows his present holding to be 137,235 shares.

Mr. Sarnoff said he now owns 45,000 more shares than he held a year ago and that he has an option to buy 74,832 more shares. He indicated that he intends to purchase these shares before the expiration of his option on June 30, 1965.

Other sales reported by the NYSE: William S. Paley, chairman, CBS Inc., 51,400 reducing CBS holdings to 1,391,968; Samuel R. Dean, treasurer, CBS Inc., 3,400, reducing holdings to 3,556.

CBS proxy statement discloses salaries

William S. Paley, chairman, and Frank Stanton, president of CBS Inc. received salaries of \$150,000 each in 1963 with additional compensation of \$175,000 each, a proxy statement disclosed last week.

Of the additional compensation, both Messrs. Paley and Stanton received \$161,875 during the year, with \$13,125 held as deferred compensation.

Other remuneration to officers of CBS Inc. during the year:

James T. Aubrey Jr., president, CBS Television Network, \$124,904 plus \$100,000 in additional compensation all paid out; Arthur Hull Hayes, president, CBS Radio Division, \$65,000 plus \$50,000 (with \$35,000 paid out); Merle S. Jones, president, CBS Television Stations Division, \$114,942 plus \$65,000

(with \$28,750 paid out); Richard S. Salant, president of CBS News (now assistant to Mr. Stanton), \$60,000 plus \$37,500 (with \$28,125 paid out); Goddard Lieberman, president, Columbia Records, \$60,000 plus \$50,000 (with \$12,500 paid out).

The proxy statement also shows that Messrs. Jones and Salant exercised options for stock during the year: Mr. Jones, on March 28, 1963, purchased 6,380 shares of CBS common at \$25.96 (it was selling for \$53.37 that day on the New York Stock Exchange); Mr. Salant exercised his option on Aug. 27, 1963 to buy 5,402 share at \$40.20 (it was selling for \$70 on the stock exchange that day).

The CBS stockholders meeting is scheduled to be held in Chicago on April 15.

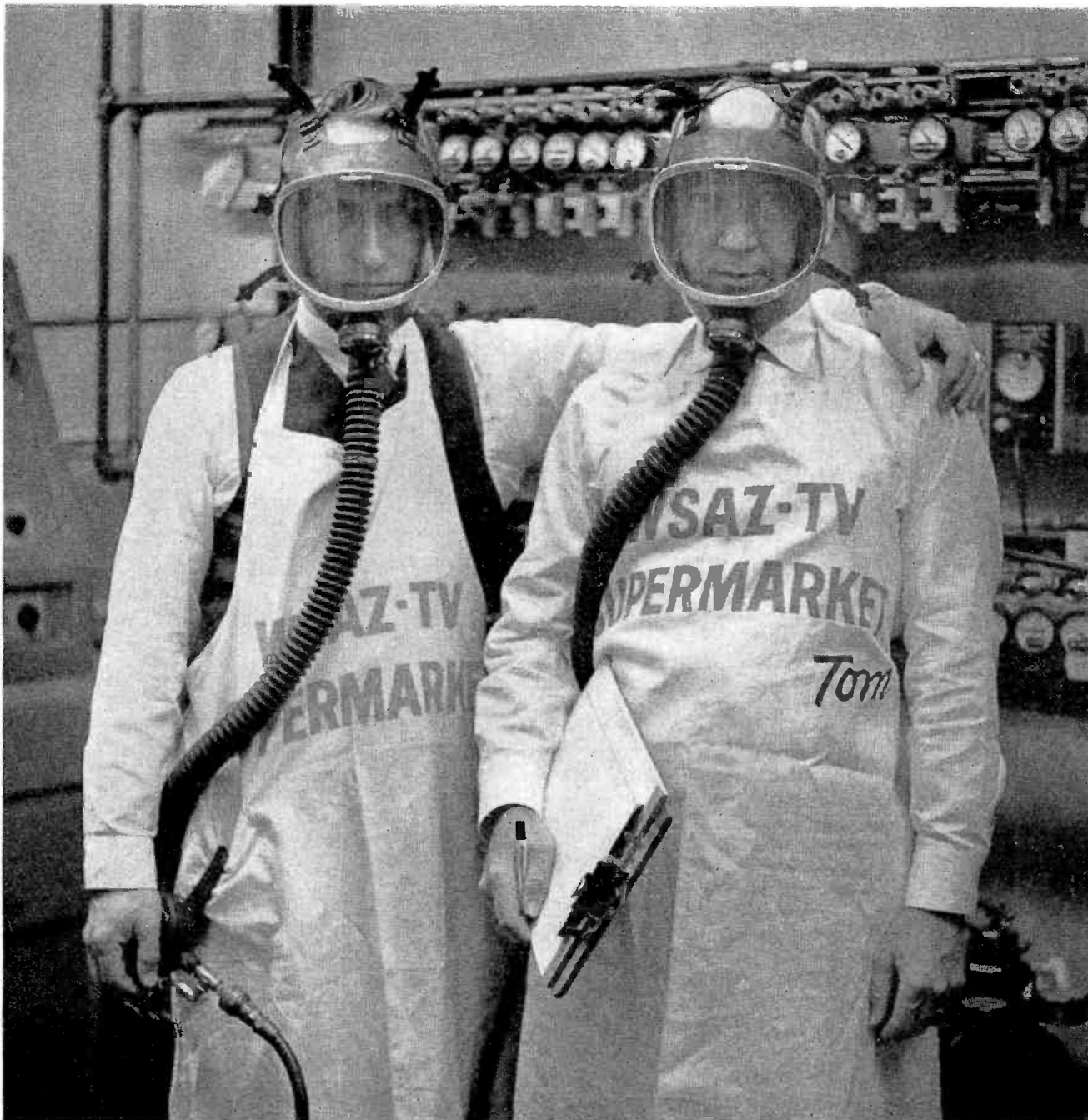

“Welcome to our ‘Smart’ Shoppe.”

170 Ph.D.s work here.

You're looking inside Union Carbide's South Charleston Technical Center in the heart of Supermarket. The two apron-clad Martians you see are actually Supermarket proprietors Tom Garten (right, General Manager) and John Sinclair (Charleston Manager, WSAZ-TV) modeling the latest in Ph.D. gas masks.

And what they're acting out for you is an invasion of Supermarket by over 11,000 skilled workers who are employed by Union Carbide. And by thousands of chemists, metallurgists and physicists who work

for Allied Chemical & Dye, Monsanto, American Cyanamid, Pittsburgh Coke & Chemical and du Pont.

As well as by other high salaried "ists" who are continually drawn to this 72-county four-state area by a growing number of research and development-minded manufacturers.

Speaking of skilled workers, call a Katz Agency man. He knows all about Supermarket—its 2 million people who spend over \$2 billion a year.* And WSAZ-TV, Charleston-Huntington, W. Va., a Goodwill Station and NBC Primary, the only station that reaches all of these people.

*SRDS

SUPERMARKET SERVED BY SUPERSTATION WSAZ-TV 3

What can
**BUSINESS
PAPER
ADVERTISING**
do for
YOU?

1 It can let you

ACTUALLY REACH

a great many more people
than you ever could with
sales calls or direct mail.

2 It can reach a lot more of the

RIGHT PEOPLE

the ones who are likely to
be interested in what
you're selling.

3 It can get your story to them

FAST

while it's news and pertinent
to decisions they must make.

4 It can get your story to them

FREQUENTLY

often enough to penetrate and
start them thinking about you.

5 It can let you tell them your

WHOLE STORY

presented as you want,
stressing the facts you
want them to know.

6 It reaches these people at
the best of all times—
when they're

RECEPTIVE

thinking about business,
less likely to be interrupted.

7 It reaches them in an atmosphere of
IMMEDIACY
that's generated by news reporting . . . news they must know if they are to be successful in their business.

8 It reaches them, too, within a climate they accept as authoritative and dependable—thereby giving
BELIEVEABILITY
to your advertising.

9 It reaches them when their minds are attuned to noting and remembering facts—which means
MEMORABILITY
for your advertising.

10 It reaches them in a medium with
LONG READING LIFE
because good business papers are saved, referred to, directed to the attention of others.

11 It reaches them at
LOW COST
far below the cost-per-contact of salesman's calls and individual presentations.

12 It reaches,
ISSUE AFTER ISSUE
many influential but busy people not accessible to the most ingenious salesman or the most convincing presentation.

NOT ALL BUSINESS PAPERS do all these things equally well. In each field, there is a leader—and this leader selectively attracts the major share of men and women who are leaders themselves.

Your best index of a business paper's worth is the *PAID* circulation it commands. People *pay* for a publication because they value it, want it, depend upon it as a reliable source of facts. Only *quality* of editorial coverage can make this possible.

IN THE BUSINESS OF BROADCAST ADVERTISING the leader is BROADCASTING. Through the pages of BROADCASTING, your own advertising reaches more than *twice* the paid circulation among vital agency-&-advertiser readers than any other TV-radio publication can offer. And at a cost-per-contact less than *half* that of any other.

This is the largest audience with the greatest potential at the biggest economy. BROADCASTING delivers it—*along with every one of the advantages listed!*

BROADCASTING



THE BUSINESSWEEKLY OF
TELEVISION AND RADIO

1735 DeSales Street, N.W., Washington 6, D.C.

Network heads to visit Henry

They'll discuss plans to make their programs available to UHF stations in 18 major markets

The heads of the three TV networks have accepted FCC Chairman E. William Henry's invitation to discuss plans for making network programs available to UHF stations in major markets. But CBS President Frank Stanton and NBC Chairman Robert W. Sarnoff are expected to spend their time with the commission expressing their opposition to the so-called program-sharing and market-sharing plans under discussion at the FCC.

Dr. Stanton served notice of his intentions in a letter he delivered personally to Chairman Henry at the FCC on March 13. He is also said to have called on several commissioners individually last week to discuss the two plans for aiding UHF—and his reaction to them.

Only Leonard Goldenson, president of American Broadcasting-Paramount Theaters, is expected to support the proposals. The market-sharing plan, under which each of the networks would have an equal number of VHF and UHF affiliates in the top markets having only two VHF stations, is an ABC creation.

Arrangements have not been made for the commission to meet with the

network chiefs. But it appeared likely last week that separate sessions would be set up for each of them. Dr. Stanton has said he would meet "separately" with the commission.

Asks Views ■ Chairman Henry asked the three network heads to express their views on the various proposals that have been advanced for aiding existing UHF stations and encouraging new ones to come on the air by assuring them of network programs.

Under the program-sharing plan, stations in the top 18 markets having two VHF stations would be prohibited from taking more than one-third of their network programming from one network. A network that wanted total exposure would have to make one-third of its output available to the UHF television outlet.

The market-sharing plan would affect the same 18 markets, and would result in each of the networks having 12 VHF and six UHF affiliates. Since CBS and NBC have more VHF affiliates among the 18 markets than ABC, they would be obliged to transfer some of their affiliations from VHF to UHF stations.

NBC and CBS feel both plans to be an unwarranted intrusion into the affil-

iation arrangements between network and stations. Some network officials also point out that implementation of the plans would present extremely difficult, if not impossible, problems.

No Freedom to Negotiate ■ They say that networks and stations obliged by the FCC to affiliate with each other under the market-sharing plan would have little or no freedom left to negotiate terms. And, they add, who is deciding which network affiliates with which station?

A similar question relating to the program-sharing plan is, who is to decide which network programs are to be seen on which stations?

Some commission officials share these misgivings. One noted that programs taken off a VHF station and placed on a UHF might be lost to "hundreds of thousands" of viewers living beyond the range of that outlet. "Can you imagine the outcry we'd hear?" he added.

Dr. Stanton, in his letter to Chairman Henry, said he was fundamentally opposed to the proposals and that no purpose would be served in his discussing the specifics of either one. However, he also said he would be willing to give his reasons for objecting to the plans and to discuss CBS's policy for making programs available to UHF stations.

Chairman Henry, in reply, said he understood Dr. Stanton's position but would still appreciate hearing his views.

Detailed survey not needed on TV program reporting form

A special committee working on a revision of the FCC's proposed TV program reporting form will suggest that the commission consider eliminating from that document the questions requiring broadcasters to make a detailed survey of community needs.

Frank Fletcher, spokesman for the group, said the committee will recommend a more general inquiry into how licensees relate programing to community needs. He said this could involve a more thorough discussion of decisions regarding past programing.

The questions in the proposed form requiring broadcasters to list in detail their activities in determining community needs and wants have generated considerable opposition among broadcasters and communica-

tions attorneys. They feel the survey would impose an unwarranted burden on licensees.

Mr. Fletcher said the committee feels broadcasters should be allowed "more flexibility" in reporting to the commission on their programing decisions. He said "no survey would be required" to answer the questions the committee is proposing.

The committee has not settled on a final recommendation regarding questions about past programing. Mr. Fletcher said the committee has a number of alternative proposals in mind, but wants to determine first "how much depth the commission wants to go into" in this matter.

The committee, set up last month on the recommendation of the National Association of Broadcasters, is composed of members of the com-

munications bar, the National Association of Broadcasters and FCC staff members. Mr. Fletcher said all but the FCC staffers agree on "minimizing the requirements" of the form.

The committee, which was scheduled to meet Friday (March 20) to put its recommendations into final shape, expects to meet with members of the commission on the proposed form revision this week.

The special committee hopes the commission will put out the revised form as a notice of further proposed rulemaking and to consider it at the oral proceeding it has scheduled on the program form.

The commission last week rescheduled the date of the oral proceeding, from April 16 to May 18, to allow time for the committee to finish its work.



Courtesy of The Detroit Institute of Arts

**"OLD
PEASANT
WOMAN
PRAYING"**

by Paula Modersohn-Becker demonstrates a vivid reaction against late 19th century naturalism. Painted in 1906, its decorative flatness and strong linear emphasis are reminiscent of both Gauguin and Van Gogh.

in a class by itself

Masterpiece — *exceptional skill, far-reaching values.* This is the quality of WWJ radio-television service—in entertainment, news, sports, information, and public affairs programming. The results are impressive—in audience loyalty and community stature, and in sales impact for the advertiser on WWJ Radio and Television.

WWJ and WWJ-TV
THE NEWS STATIONS

Owned and Operated by The Detroit News • Affiliated with NBC • National Representatives: Peters, Griffin, Woodward, Inc.

Only the title was unchanged

Loevinger unworried about fertilizing wasteland; wants radio-TV to provide news

The subject was "Broadcast News—What Is Needed?" But before panelists FCC Commissioner Lee Loevinger and Lawrence Laurent, radio-TV critic of the *Washington Post*, were through, the discussion often crashed through into the question of Broadcasting's Role—What Is It?

Commissioner Loevinger, echoing sentiments he expressed in his Lincoln, N.M., speech last summer (BROADCAST-

ING, Sept. 2, 1963), said broadcasting's social importance lay in its function as a news medium, not as a purveyor of entertainment.

"The kind of social license I would exact from broadcasters," he said, turning to Mr. Laurent, "is not that broadcasting serve me the kind of entertainment I want . . . or that you and Minow want to make the green shoots grow in the wasteland—it's that broadcasting provide news." The commissioner makes no secret of his feeling that former Chairman Newton N. Minow was wrong in attempting to prod broadcasters into presenting "better" entertainment.

Straw Slams — Broadcasters are providing news now, Mr. Laurent shot back. "You are knocking down a straw man." At another point he sought to make clear he does not expect broadcasters to put on Shakespeare all the time—but occasionally, at least.

Others participating in the panel discussion were Edward Ryan, president of Radio-Television News Directors Association and general manager of news for WTOP-AM-FM-TV Washington, and Esther Van Wagoner Tufty, of the Tufty News Bureau. James Grant, Washington representative of Time-Life Broadcast, was moderator. The discussion was co-sponsored by the Washington Chapter of American Women in Radio and Television and the Broadcasters Club.

In discussing what broadcast news does need, Commissioner Loevinger again harked back to his Lincoln speech, in which he called for new ideas and techniques to present the news on radio and television. He also expressed outrage at newscasters who "give a little bit of news," then launch into a commercial.

Mr. Laurent said broadcasting should "continue to separate reporters from sponsors and to protect newsmen against economic reprisal" for a job too well done. But he also lamented what he considers the lack of quality commentators—men, he said, like Edward R. Murrow and Eric Sevareid. "What we have now," he said, "is a corporate committee type of opinion."

Mr. Ryan said there is a need for broadcast newsmen who understand the news and can present it well. He also said local stations should seek to dig more deeply under the surface of local news. Mrs. Tufty said the "real growth" potential of broadcast news is in the local field. She also said stations ought to use wire copy not as the finished product, but as material from which they could develop their own stories.

FCC told eavesdrop bill would restrict news

CBS believes that the FCC, in trying to guard privacy by prohibiting the use of radio devices for eavesdropping, could greatly restrict broadcasters' ability to gather and report news.

The network's comments were filed last week in opposition to the commission's proposed rulemaking to prohibit use of radio devices to listen in on conversations, unless one or more persons participating has given permission for the outside party to listen in.

CBS said that the commission, in proposing the rulemaking, "failed to recognize the unfavorable and restrictive effects which the proposed rules will have on the news-gathering and news-reporting activities of broadcasters." The network asked how broadcasters could continue to freely report political conventions, parades, sport events or other large gatherings of persons where conversations may be overheard. CBS said that it never would have been

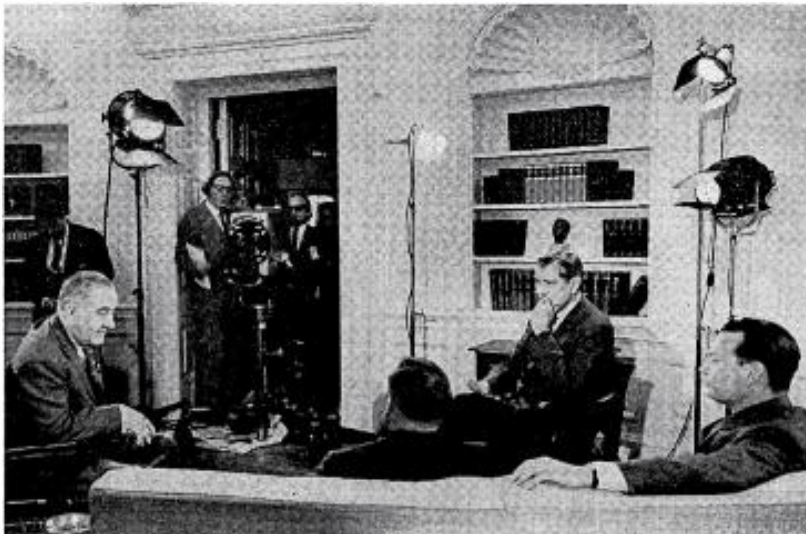

Johnson pleased with TV 'Conversation'

President Johnson was "very pleased" with the reaction to the all-network interview televised March 15, according to Pierre Salinger, news secretary (until last Thursday) to the President. Mr. Salinger said he saw the first 70 telegrams that came in after the telecast "and they were all approving."

The interview, similar to the one done with President Kennedy in December 1962, was taped the day before the telecast in the President's office. The networks edited the tape down to 60-minute running time, and in one instance, it's understood, changed the sequence.

It's also understood that the networks were informed, during planning for the session, that the White House would have no objection if they wanted to offer "equal time" to the Republicans. There has been no such request thus far. Shown here is the scene in the President's office as the *Conversation With the President* was being taped with (l to r): the President, Bill Lawrence, ABC (back to camera); Eric Sevareid, CBS, and David Brinkley, NBC. Standing in doorway with headphones is Fred W. Friendly, president of CBS News, who produced the program for the network pool.

A. M. PENROSE & CO. INC., NEW YORK, N. Y.
86 PROOF. 100% GRAIN NEUTRAL SPIRITS



It's on the verge of being rather popular. Better hurry.

able to produce *CBS Reports'* "Biography of a Bookie Joint" without the aid of eavesdropping devices used by reporters. The network concluded that the proposed rules could prohibit further such programing.

The Association of the Bar of the City of New York, also commenting, commended the commission's intent, but urged that the present rulemaking proceeding be dropped in favor of a congressional hearing, or failing that a hearing by the commission. The bar association said that the rulemaking, as it stands, will be of little value in guarding privacy due to the proposals limitations.

Mark Century has new radio package

Mark Century Inc., New York, last week announced it will introduce a new radio programing package called "Festival Radio" at the National Association of Broadcasters convention in Chicago.

Mark Century's "Radio a la Carte" package—its first—is now in more than 150 major markets in the U. S., Canada and in Australia. The company specializes in radio programing services for which it signs two-year contracts providing exclusivity for stations in their markets.

The new radio package provides entertainment briefs, units running in length from 45 seconds to 4 minutes. Categories include comedy, drama, production and commercial music, sports features, contests, commercials and seasonal campaigns.

A series of drama "shows" contain 4 minutes of dramatized story and allows for a 1-minute commercial. The short dramatic "Playhouse 5" segments, each of which are complete entities, were devised in preference to longer shows because "radio listeners today will not sit for half-hour or 15-minute

4 Star sets screenings

Four Star Distribution Corp. is broadening its approach on sales of syndicated programs by initiating a plan to screen its properties for station representatives. The first screening will be for the company's new off-network property, *Ensign O'Toole* on March 31 in New York.

Len Firestone, vice president and general manager of Four Star Distribution, pointed out that for more than a year the company has been supplying reps with detailed rating information and background material on their syndicated series and described the screenings as an extension of its service. He added that "it makes sense" to permit reps to screen programs since their recommendations carry weight in the selection of properties by stations and reps ultimately have to sell spots within shows to national advertisers.

programs," Milton Herson, Mark Century's president explained.

In addition, Mark Century's new package contains documentary vignettes, including actual recordings denoting historic events in history. Also being introduced is "Encore," a station identification package for stations.

AFTRA preparing for strike against KLAC

Strike of the American Federation of Television and Radio Artists against KLAC Los Angeles is imminent, Claude McCue, executive secretary of the Los Angeles local, said Thursday (March 19). Crux of the dispute, he said, is

the refusal of KLAC to renew its contract with a provision allowing AFTRA members to respect the picket lines of other unions in cases of sanctioned labor disputes, an issue on which the local conducted a four-month strike against KFWB Los Angeles in 1961.

The strike against KLAC was authorized by the Los Angeles AFTRA members some time ago and called Tuesday (March 17) by the board of the local which, at the same time, approved new contracts with KTLA(TV) and KCOP(TV) Los Angeles, but withheld approval of one with KTTV(TV) Los Angeles, which like KLAC is owned by Metromedia Inc. A steering committee of the Los Angeles county Federation of Labor has unanimously recommended strike action.

UAW protests show cancellation by WCBM

The United Automobile Workers, AFL-CIO, has turned to the FCC in reaction to the cancellation of its sponsored program *Eye Opener* by Metromedia Inc.'s WCBM Baltimore. The union last week asked the commission to intercede, preventing the termination of the program as of last Friday (March 20), and to begin a license revocation proceeding on the ground that WCBM has failed to meet its program commitments.

The UAW told the commission that WCBM's refusal to continue the program will deprive the Baltimore area, which is heavily populated by industrial workers, of a union program that has been on the station for over six years. The union said that Metromedia promised to continue substantially the same programing as was existing when it acquired WCBM-AM-FM late last year. The UAW said that the "proposed cancellation will create a serious program imbalance by removing the only regular union program on a station more than one-third of whose audience is blue collar workers. The misrepresentation and the program imbalance create dual grounds for commission jurisdiction and concern."

The union said that although Metromedia told the commission, in the license assignment application, that it planned only minor program changes "at the present time" its program exhibit deleted *Eye Opener*. The planned cancellation, UAW added, was thus concealed from both the commission and the union.

The UAW said that it has been given no reason for the cancellation of *Eye Opener* and was given only "last-minute notice of termination. . . . We ask the commission to invoke its jurisdiction in this matter to prevent WCBM's termina-



CONTRAST

Now there's a brighter picture in this vital Fifth Largest California market. And 65,000 sets are equipped to see your spots before their eyes!

CHANNEL 18 / the one to watch in
KCHU-TV / San Bernardino—Riverside
16 HOURS A DAY 7—DAYS A WEEK

REPRESENTED BY SAVALLI / GATES

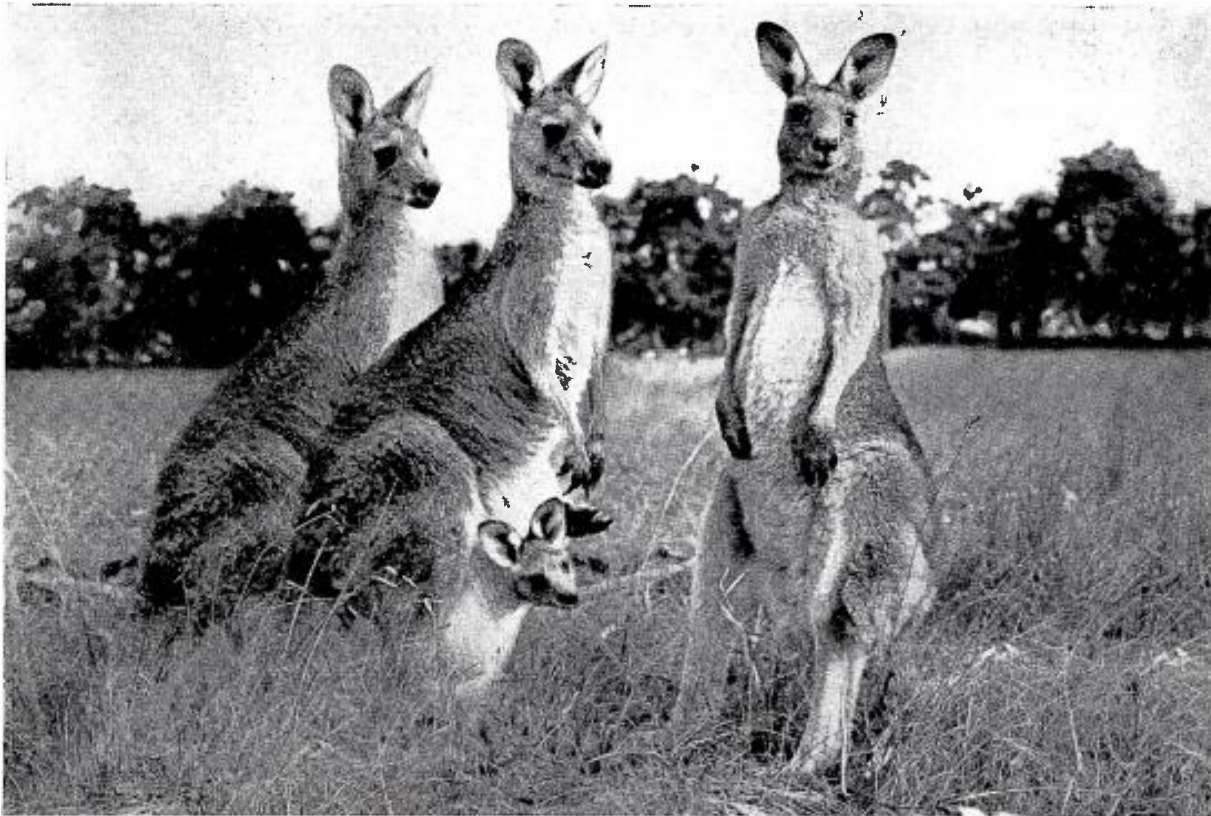

...and now a few words from Woolloomooloo.

Until last December it was almost impossible to get a transpacific call in or out of Woolloomooloo, Australia—a suburb of Sydney. Many Australians had to cancel business and personal calls to other countries after hours of fruitless waiting because of overloaded radio circuits. Now COMPAC and ITT have changed all that.

COMPAC is a new submarine cable system that extends Britain's communications link with Canada to the Pacific dominions of Australia, New Zealand and Fiji.

It is the first underwater cable to be laid across the Pacific to Australia, reaching out 9,400 miles.

An ITT British company supplied a major portion of the cable, and telephone and terminal facilities for COMPAC, plus 224 submerged repeaters and 34 submerged equalizers. These repeaters and equalizers are designed to function without interruption or maintenance for at least 20 years.

ITT System companies have laced the world's oceans with telephone and telegraph cable, wired continents, even bounced telephone, TV and data information off the troposphere. In fact

8,000 ITT scientists in 26 countries have built, installed and operated virtually every kind of communications known. ITT—world's largest international supplier of electronic and telecommunication equipment. International Telephone and Telegraph Corporation. World Headquarters: 320 Park Avenue, New York, New York 10022.

worldwide electronics and telecommunications



tion of *Eye Opener*, and to assure that the program is continued at its regular hour until the pending issues are resolved."

A Matter of Timing ■ In its written protest to WCBM, the union said that termination of the program was scheduled for the very day on which the UAW National Convention was to convene in Atlantic City. The UAW said that at the convention important policy questions would be discussed, particularly in a year when many major contracts are up for negotiation, that could be reported to Baltimore members via the union's program.

"Particularly disturbing," the union told WCBM, "is your flat cancellation with no opportunity to negotiate any of the factors upon which discontinuance may rest, including time and cost. Refusal to give us opportunity to alter the contract in any respect in which WCBM is dissatisfied with it leads us to question motive of the discontinuance at a crucial time for the union and in an election year."

The union also accused the station of making an about face on a promise to allow the UAW to continue the program on an interim basis until another station could be found to carry it.

FCC asked to clarify copyrights on CATV's

If the FCC adopts pending rulemakings that would govern grants to microwave services supplying facilities to community antenna systems, United Artists Associated Inc. last week asked the commission to attach an "authoritative explanation" that the microwave permit was not a license to the CATV to use copyrighted programming without permission.

The film company's concern centered on CATV pick-ups for copyrighted programming by television stations carried on the antenna system. UAA said that permission given to a TV station to air a film isn't extended to any relay service.

UAA suggested that the commission insert the following language in its proposed rulemakings:

"An authorization under these rules and regulations is not in derogation of any copyright or other private proprietary interest in any material in the program content of television signals so authorized to be relayed to a CATV system, and is granted without prejudice

to any right or other private proprietary interest to forbid any use thereof by any relay station or CATV system without the license or other permit of such owner."

UAA is presently suing, before a New York court, the Fortnightly Corp. with infringement of the film company's copyright in motion picture telecasts by KDKA-TV, WTAE(TV) and WHIC(TV), all Pittsburgh, WSTV(TV) Steubenville, Ohio, and WTRF-TV Wheeling, W. Va. The five TV stations are carried by Fortnightly's CATV system servicing Clarksburg and Fairmont, both West Virginia. UAA believes that permission must be received from it before any of its copyrighted films may be re-broadcast.

Syndicated instructions

Triangle Stations will produce and syndicate 13 half-hour telecasts of basic instruction in various sports. The series, directed at teen-agers, will be ready for distribution June 1.

Bob Rambo, physical education instructor at the University of Pennsylvania, is host and producer of the series. Subjects include baseball, basketball, bowling, boxing and football.

If you had the Quality touch

You'd have a full-time staff of 154 professional people vitally and busily concerned every day with the extensive operation of a 3-phase television station — one stationary and two on wheels. Recently, a family portrait seemed like a great idea; but it turned into a frustrating experience. Here's what we were up against.

Nos. 1-12 — Mobile cruiser (No. 155) crew in Vail, Colo., taping show for "ABC Wide World of Sports."

Nos. 13-25 — Cruiser (No. 156) production crew on commercial location, Fort Worth.

CBS-owned TV stations plan program exchange

The sixth annual Public Affairs Program Exchange by the five CBS owned television stations will get underway at WCBS-TV New York and KNXT(TV) Los Angeles on April 18, WBBM-TV Chicago and WCAU-TV Philadelphia on April 25 and KMOX-TV St. Louis on May 2.

Each station will provide the others with 20 half-hour local public affairs programs, amounting to two hours of programming over a 20-week period for all the stations.

WCBS-TV will supply 20 segments of *The American Musical Theater*, produced in cooperation with New York City's board of education. The program traces the history of musical productions in the U. S.

KNXT(TV)'s *Sum and Substance* series was produced in association with the University of Southern California. The program reviews the lives of various public figures.

The developments of science are illustrated in WBBM-TV's *Science Unlimited* series, produced in association with

Loyola University.

WCAU-TV, in association with Philadelphia's Institute for the Advancement of Human Potential, produced *Love to Read*, a series designated to motivate the reading habits of pre-school age children.

Food for Fun, produced by KMOX-TV and the *St. Louis Globe Democrat*, is a series on cooking hints and recipes.

Program notes . . .

Shakespeare wins ■ WINS New York will premiere *Shakespeare's People*, a half-hour series featuring recordings of Shakespearian readings on March 29. The 13-week series will later be released into national syndication.

Historical drama ■ A series of 15-minute radio dramas, titled *Flashback in History!*, is being distributed by the Broadcast Foundation of America, New York, a nonprofit organization, to stations throughout the country. The series, produced by more than 20 countries throughout the world, dramatizes significant events in world history.

World War I ■ 20th Century-Fox Television has announced its release of *The*

War to End All Wars, a one-hour documentary about World War I. The program, produced by Fox Movietone, is narrated by Quentin Reynolds.

New action features ■ Video Artists Inc., New York, has placed into TV distribution seven action-adventure films that have ended their theatrical runs in the U. S. The package includes *The Angry Silence* with Pier Angeli and Richard Attenborough; *It Takes a Thief* with Jayne Mansfield and Anthony Quayle and *Mania* with Donald Pleasence and June Laverick.

Visiting doctor ■ The Scripps-Howard Broadcasting Co. is making available audio and video tapes of its live program, *Call the Doctor*, to other broadcasting stations wishing to produce similar shows. The program format, featuring a panel of medical experts answering telephone inquiries about health, began on WCPO-TV Cincinnati and is now used on the other Scripps-Howard stations.

Documentary available ■ Color documentary of American doctors' volunteer eye treatment work through Focus Inc. in Haiti is being offered as a half-hour TV program by the University of

155

108 151 100 61 77 94 154 128 49 152 66 149

159

160

Nos. 26-43 — Newsmen anchored to typewriters or cameras or on assignment in Newsmobiles (Nos. 157-160).

Nos. 44-64 — Production crew in studio for local programs, commercial tapings.

Nos. 65-70 — Sales force on the street — selling!

Nos. 71-80 — Traffic, continuity, promotion, programming involved with new campaign.

Nos. 81-154 — Other departments carrying on regular duties.

Fact is, we couldn't even roust enough of them outside to fake a good shot. But, that's the way with a quality operation. Everyone's busy and concerned with a prize final product. Gives you that Quality Touch. Want it, too? Call Petry.

WFAA-TV

The Quality Station serving the Dallas-Fort Worth Market

ABC, Channel 8, Communications Center / Broadcast Services of The Dallas Morning News/Represented by Edward Petry & Co., Inc.

Illinois College of Medicine, Chicago. Radio series also is available.

New office ■ Pintoff Productions is moving its operations to new facilities at 339 East 48th Street, New York. The firm will continue film animation and optical operations and expand to live-action filming.

Movie version ■ A version of Revue's *McHale's Navy* (on ABC-TV) will soon be seen as a full-length motion picture. Ed Montagne, who produces the TV series for Revue, will produce and direct the Technicolor movie version, which will star Ernest Borgnine and the other members of the television cast.

Shortened show ■ A revised 30-minute version of the *NBC Sports Special* will be telecast by NBC-TV, beginning April 18 (5:30-6 p.m.), and continuing through the summer when the network carries weekend baseball games. Each program will concentrate on one sports event. Peter Molnar will continue as producer, with Bud Palmer retained as host.

Rights purchased ■ M and A Alexander Productions, Hollywood, has obtained the rights to 118 half-hour segments of *Fireside Theatre* from Proc-

ter & Gamble Co. for whom the series was originally produced.

New location ■ Heller-Ferguson Inc., producer of radio production aids, promotion spots, musical signatures and commercials, has moved to 1606 North Highland Avenue, Hollywood.

Poverty film ■ The Area Redevelopment Administration of the U. S. Department of Commerce has released a 30-minute documentary dealing with the national war on poverty. "The Rising Tide" was produced for the ARA by Somerset Productions, Princeton, N. J. Narrated by NBC's Chet Huntley, the film is a report on an effort by several groups in New Bedford, Mass., to rebuild the city's economy.

Series planned ■ CBS-TV and singer-comedienne Dorothy Loudon will develop a new series for the network for the 1965-66 season. Miss Loudon is a regular performer on the *Garry Moore Show*, which ends its long run on CBS-TV this spring.

ABC-TV to give fall preview to affiliates

ABC-TV affiliates will get a preview of the network's plans for the coming season at a special meeting in Chicago April 4, the day before the opening of the National Association of Broadcasters convention.

ABC-TV speakers at the meeting will be Robert L. Coe, vice president in charge of TV station relations; Thomas W. Moore, president of ABC-TV; Elmer W. Lower, president of ABC News, Special Events and Public Affairs; Edgar Scherick, vice president in charge of programming, and Armand Grant, vice president in charge of daytime programming.

Prior to the network meeting, the ABC-TV Affiliates Association will hold a closed session that morning to conduct annual elections.

At a dinner that night, Mr. Moore will award special recognition plaques to stations that have been primary ABC-TV affiliates for 10 years.

Series on succession made available by RKO

Presidential succession and disability are reviewed by 28 prominent political leaders and scholars in a series of two-minute programs produced by RKO General Broadcasting for its five TV and seven radio stations.

In Search of a Solution: Presidential Succession and Disability, a series of 30 programs, also will be available on film

and tape to any station requesting it, according to Hathaway Watson, RKO General president.

The Voice of America, Radio Liberty, Radio Free Europe, Radio New York World Wide and the Armed Forces Radio Network, which broadcast an earlier RKO General series on civil rights with a similar format, also will rebroadcast the new series, the company said.

Among participants in the series are eight U. S. senators, former Vice President Richard M. Nixon, House Speaker John W. McCormack, historians and professors of political science and government.

Desilu Sales enters TV feature field

Desilu Sales Inc., Hollywood, is entering TV feature film distribution with *Three for the Money*, three 90-minute pictures derived from *The Untouchables* and previously distributed only in theatrical release. Titles of the package are "The Scarface Mob," "Alcatraz Express" and "The Gun of Zangara."

Richard Dinsmore, vice president and general manager of Desilu Sales, reported that 33 major market pre-release sales have been made for *Three for the Money*. Stations which have acquired the package include WNEW-TV New York; KTTV-TV Los Angeles; KGO-TV San Francisco; KMBC-TV Kansas City, Mo.; KLZ-TV Denver; KCPX-TV Salt Lake City; KSD-TV St. Louis; WJBK-TV Detroit; WTTG-TV Washington, and WHEN-TV Syracuse, N. Y.

ITC planning new cycle of Stafford specials

The success of the one-hour *Jo Stafford* musical specials has prompted Independent Television Corp. to plan a new series of Stafford programs, Abe Mandell, ITC executive vice president, announced last week.

Mr. Mandell revealed that sales on each of the eight programs has averaged \$200,000 on a worldwide basis to date, with grosses on each in the United States amounting to about \$150,000. The specials have been sold to regional advertisers which have bought them in 85 major markets.

ITC intends to produce 13 additional Stafford specials. The first group was produced in London, but the new cycle will be made in Hollywood, according to Mr. Mandell. He noted that many network affiliates have pre-empted programs to substitute the specials.



DELIVERED BY
WREX-TV Channel 13

NEW DEVELOPMENT

- New Chrysler assembly plant — 6000 new jobs in 1964
- New \$8 million hospital.
- New Gates Rubber Plant, Freeport, Ill. — 500 new jobs.

THE MARKET

- 58th in U. S. in E.B.I. per capita
- 78th in U. S. in E.B.I. per household
- \$1,480,547,000 market.

WREX-TV COVERAGE

- Blanketing Northern Illinois and Southern Wisconsin — the rich industrial and agricultural heartland of Mid-America.



JOE M. BAISCH, V.P. & GEN. MGR.
Represented by H-R Television, Inc.
MEMBER GANNETT GROUP

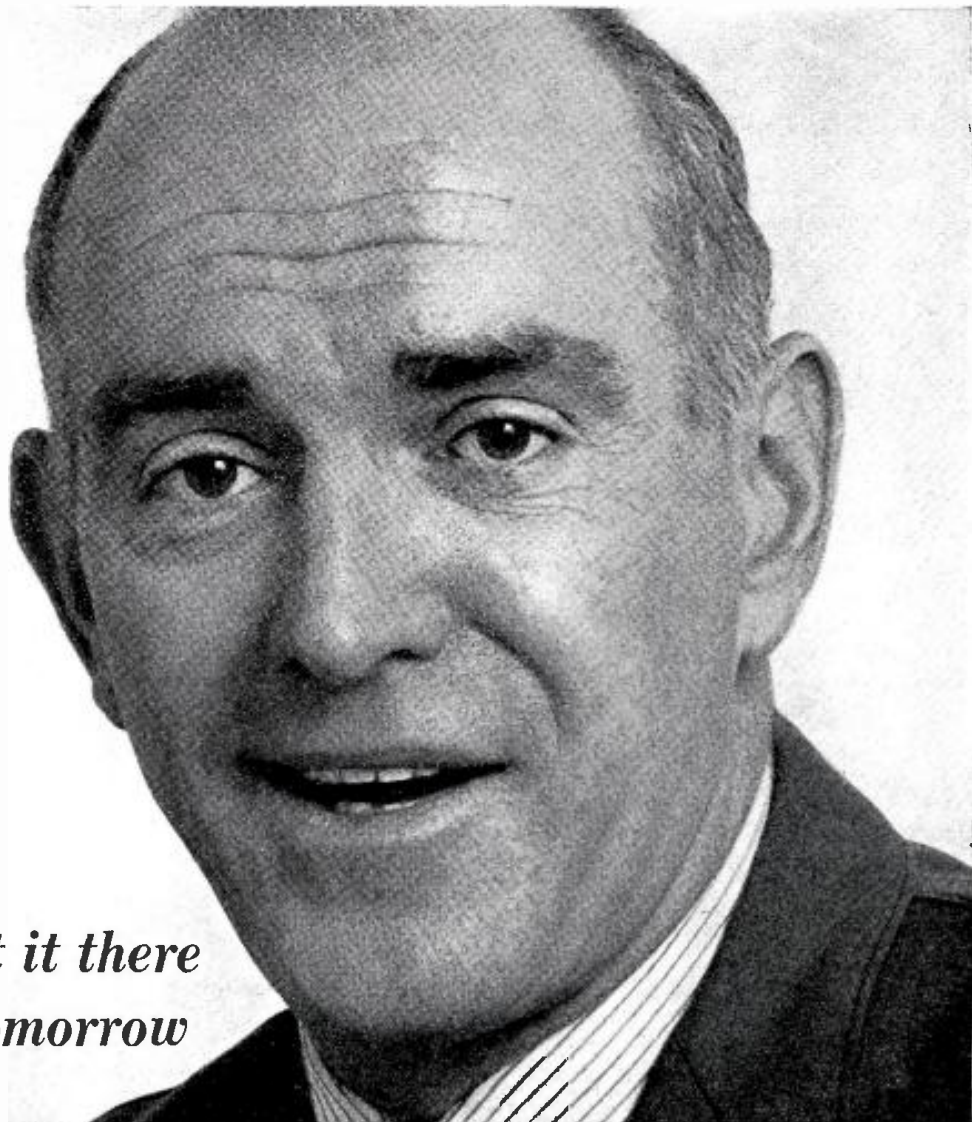

*“I can get it there
tomorrow*

...that’s why I ship by Greyhound Package Express!”

You can depend on Greyhound Package Express to get your shipment where it’s going, FAST! Packages you ship hundreds of miles, often arrive the very same day.

Your shipment travels aboard regular Greyhound buses on fast, frequent schedules. Greyhound buses travel over a million miles a day, providing package express service to thousands of communities not reached by any other form of public transportation.

Ship anytime, twenty-four hours a day, seven days a week, week-ends and holidays. Improve your customer service. Save time and money too! Ship by Greyhound Package Express. Convenient C.O.D., Collect, Prepaid or special charge account service.

For information on service, rates and routes, call Greyhound or write today: Greyhound Package Express, Dept. 8-C, 140 S. Dearborn St., Chicago 3, Ill.

It’s there in hours...and costs you less

For Example: Buses Daily	Running Time	10 lbs.	20 lbs.	30 lbs.*
NEW YORK—PHILADELPHIA	32 2 hrs.	\$1.25	\$1.40	\$1.65
LOS ANGELES—SAN DIEGO	42 2 hrs. 30 min.	1.15	1.25	1.45
CHICAGO—MILWAUKEE	14 1 hr. 50 min.	1.20	1.40	1.60
ATLANTA—BIRMINGHAM	10 3 hrs. 45 min.	1.50	1.65	1.90

*Other low rates up to 100 lbs.



One of a series of messages depicting another growing service of The Greyhound Corporation.

Court backs FCC refusal to renew license

SUPPORTS UNFIT LICENSEE CHARGE AGAINST ROBINSON

A federal court in Washington last week upheld the FCC in its Kingstree, S. C., decision but skipped entirely the freedom of speech issue.

The three-judge U. S. Court of Appeals panel said that the owner of WDKD Kingstree had misrepresented to the FCC that he knew of the broadcasts of disk jockey Charlie Walker and that the commission was correct in refusing to renew the WDKD license.

The court was unanimous in its decision with one judge asserting that the court also should have backed the commission in its deprivation of the license of WDKD because of the broadcasts of the disk jockey.

This was Circuit Judge Wilbur K. Miller who concluded his concurring opinion with: "I do not think that denying renewal of a license because of the station's broadcast of obscene, indecent or profane language—a serious criminal offense—can properly be called program censorship. But, if it can be so denominated, then I think censorship to that extent is not only permissible but required in the public interest. Freedom of speech does not legalize using the public airways to peddle filth."

Vernon K. Wilkinson, attorney for E. G. Robinson Jr., licensee of WDKD, said last week that a request for review by the entire nine-judge circuit court, or by the U. S. Supreme Court was under study.

Heralded as a direct confrontation between a broadcaster and the FCC on the First Amendment issue, the case attracted the attention of the American Civil Liberties Union which filed a brief as a friend of the court asking that the decision be remanded to the commission because its standards on the off-color jokes of the disk jockey

were vague.

Barneyard Humor ■ The case began two years ago when tapes of the Charlie Walker show on WDKD were sent to the FCC. Renewal proceedings were held in Kingstree and the commission ruled that Mr. Robinson had permitted his disk jockey to broadcast programs that were "coarse, vulgar and suggestive of indecent double meanings." It also ruled that Mr. Robinson was guilty of misrepresentations in stating he did not know of the off-color jokes and that he had never heard complaints.

The court in its per curiam opinion concluded:

"We intimate no views on whether the commission could have denied the applications if Robinson had been truthful. . . . We hold only that Robinson's willingness to deceive the commission justified its conclusion that he did not possess the requisite qualifications to be a licensee and that a grant of his applications would not serve the public interest."

Last December, a federal district court found Walker guilty of violating the obscenity statute in his broadcasts over WDKD. He was sentenced to five years imprisonment but put on probation. He is appealing this sentence.

Mother, apple pie and Ed Sullivan

CBS-TV and Sullivan Productions last week signed a new long-term contract which network President James T. Aubrey Jr. said means that the *Ed Sullivan Show* will continue every Sunday night (8-9 p.m. EST) "for just as long" as Mr. Sullivan desires.

The program is one of TV's oldest,

dating back to June 1948.

CBS-TV also last week joined NBC-TV in formally locking up its evening schedule for the 1964-65 season. However, another change may occur at ABC-TV, where the Rod Serling-produced half hour titled *Witches, Warlocks and Werewolves* (Friday, 9-9:30 p.m. EST), reportedly will be dropped for another entry.

The only changes in the CBS-TV schedule involve new title selections (BROADCASTING, March 9).

A comedy series Sunday night (9:30-10 p.m. EST) with William Bendix and Martha Raye has been titled *Bill and Martha; Lawmaker*, a series about a state legislator (Mondays, 10-11 p.m.), is now *Slattery's People; Gomer* (Friday, 9:30-10 p.m.) now is *Gomer Pyle*; and *The Reporter*, a dramatic series about a big-town newspaper man (Fridays, 10-11 p.m.), has been re-titled *Yours Truly, Danny Taylor*.

Steve Allen to be host of CBS-TV's 'Secret'

Steve Allen last week signed with CBS-TV to host the network's *I've Got a Secret* program (Mondays, 8-8:30 p.m. EST). He also extended his contract to do the syndicated taped *The Steve Allen Show* for Westinghouse Broadcasting Co. for "a substantial period of time beyond July 1, 1965."

Mr. Allen will join the *I've Got a Secret* show next fall when it begins its 13th season on CBS-TV. He will replace Garry Moore, who bows out of the series this summer. Westinghouse waived the exclusive provision of its contract with Mr. Allen to allow him to do the series.

The 90-minute *Steve Allen Show*, in its second season, is carried by 43 stations.

Headliners awards announced for radio-TV

The National Headliners Club, Atlantic City, at its 30th annual awards program April 4 at the Colton Manor hotel in that city, will present 27 Headliner awards, two citations for reporting and photography and a number of plaques to the broadcasting and newspaper industries for outstanding news coverage and reporting during 1963.

In radio categories, awards will go to:

CBS-owned KNX Los Angeles, for consistently outstanding coverage of news events; WSAC Fort Knox, Ky., and Byron E. Cowan, president, for consistently outstanding editorials, and WAIT Chicago, and Maurice Rosenfield,

*More than a decade of Constructive Service
to Broadcasters and the Broadcasting Industry*

HOWARD E. STARK

Brokers—Consultants

50 EAST 58TH STREET

NEW YORK, N. Y.

ELDORADO 5-0405

FUTURAMA

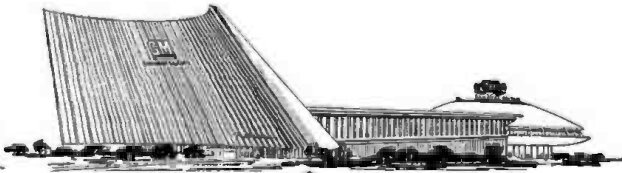

Created by the People of General Motors—One of the highlights of the World's Fair will be the General Motors Futurama. This magnificent, ultra-modern building and the wonders it contains represent the skill and work of GM people—*stylists, engineers, scientists, architects, show specialists.*

The building is 680 feet in length (a very long par three on any golf course). It's 200 feet wide (forty more than a football field), and from the stark beauty of the ten-story-high canopy entrance to the wide scope of the domed pavilion at the rear, it expresses one thing very clearly: *tomorrow!*

A high spot of the Futurama is a ride that surrounds you with wonders. In an unforgettable experience, you'll be carried through time and space—through desert and jungle—to polar regions and across the ocean floor. In a single day this dramatic ride can accommodate 70,000 people—the entire population, for instance, of Muncie, Indiana or Boulder, Colorado.

In the Futurama's Avenue of Progress, you'll see the newest sources of power described and demonstrated in fascinating ways. Also shown are research projects in transportation mobility, including a vehicle traversing jungle terrain and a moon-rover conquering a rugged lunar landscape. At the Futurama you can visit a host of other colorful displays designed to attract, interest and challenge the imagination of every member of your family.

Futurama, in an inspiring way, symbolizes the progress of GM. And the major reason behind this progress is people—the people of General Motors.

GENERAL MOTORS IS PEOPLE ...

Making Better Things For You

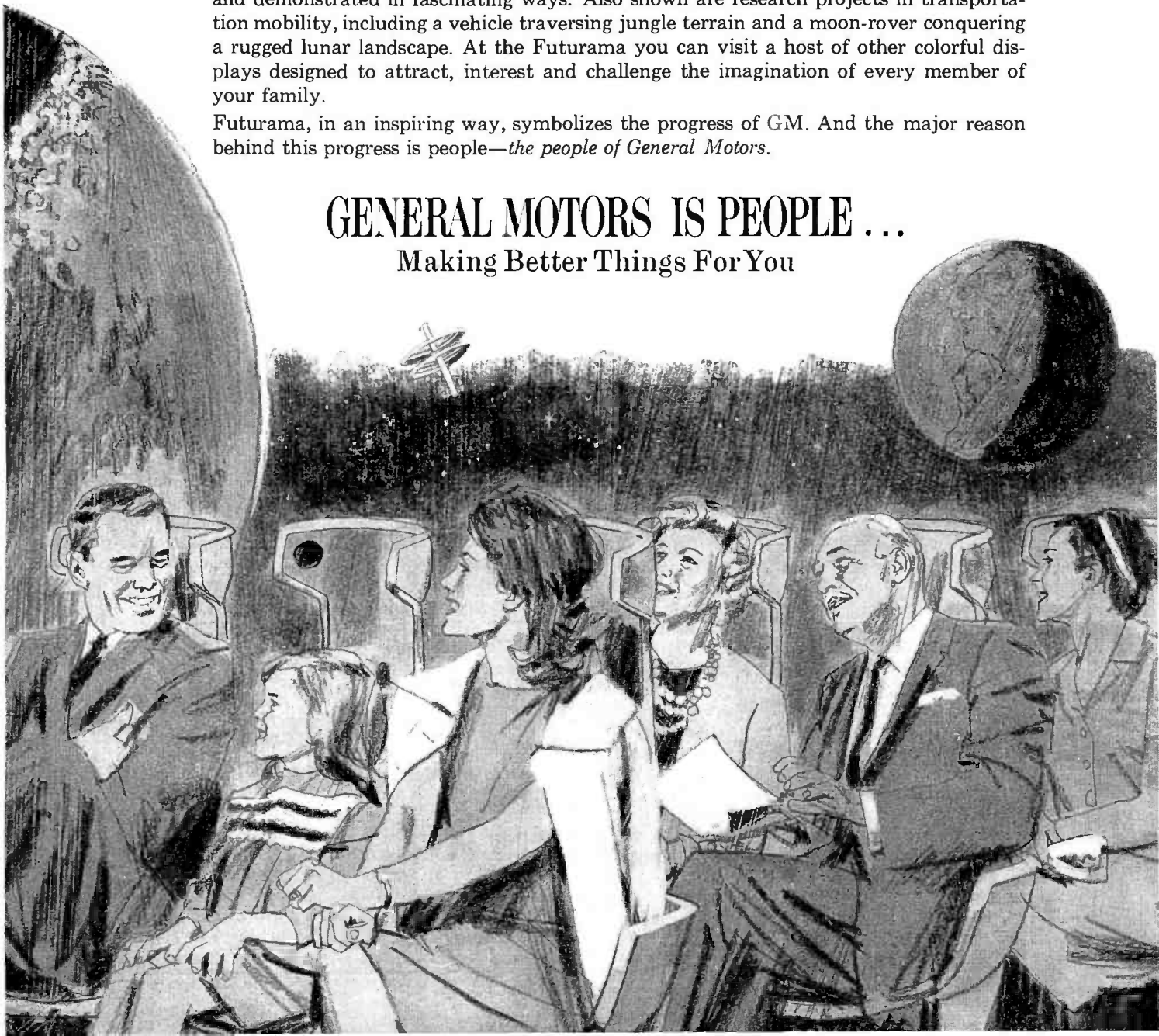

executive director, the public service award for its successful campaign to free a man facing death for murder following conviction eight years earlier.

TV awards were voted for:

ABC-owned WXYZ-TV Detroit and John F. Pival, president, for outstanding TV editorials; KMSB-TV Minneapolis, for public service as exemplified by *The Forgotten*, a special program which brought to light conditions in a Minnesota security hospital, and to NBC-owned WRCV-TV Philadelphia and Robert J. Shafer, news director, for consistently outstanding coverage of news events as exemplified by its comprehensive coverage of two miners imprisoned in an abandoned shaft.

After deliberating over the vast number of entries submitted relating to the assassination of President Kennedy, the Headliner judges voted a blanket award to radio and TV stations through the National Association of Broadcasters, and to newspapers through the American Newspaper Publishers Association.

Radio series sales . . .

The Shadow (Charles Michelson): Sold to WRCR St. Paul.

The Green Hornet (Charles Michelson): Sold to KFQD Anchorage, Alaska.

Sherlock Holmes (Charles Michelson): Sold to KXRO Aberdeen, Wash., and CHML Hamilton, Ont.

Murder, justice and TV—a newsy trio

The Jack Ruby trial for the murder of Lee Harvey Oswald, accused slayer of President Kennedy, ended as it began, on television. And television, apparently, will figure largely in the appeal.

New Ruby counsel Percy Foreman, Houston criminal lawyer, said last week that he will base his appeal on two major grounds; one of them that the trial court permitted 11 persons who had witnessed the shooting of Lee Harvey Oswald on television, to serve on the jury.

One camera was permitted into the courtroom on a pool basis to cover the verdict. The event was transmitted live to TV viewers throughout the nation, with networks breaking into programs to bring viewers to the courtroom. The TV audience saw Criminal District Judge Joseph B. Brown take his seat at the bench, the jury file in, the judge ask whether a verdict had been reached, the answering "yes" from the jury foreman, the handing of the verdict to the judge, and his reading of the result ("guilty as charged . . . death penalty"), the judge asking the jury if this was their unanimous decision and having them hold up their right hands.

At this point the judge adjourned the court, but the TV coverage continued, showing the bedlam that erupted in the

courtroom including defense attorney Melvin Belli's outburst to massed newsmen.

During an interview on the steps of the courthouse Judge Brown charged that broadcasters had broken their agreement to turn off the camera after court was adjourned.

Film sales . . .

Volume 9 (Seven Arts): Sold to KLZ-TV Denver; KGW-TV Portland, Ore.; KCRA-TV Sacramento, Calif.; WDAU-TV Scranton, Pa.; KGMB-TV Honolulu; WBAY-TV Green Bay, Wis., and WSSH-TV Portland, Me. Now in 14 markets.

Battle Line (Official Films): Sold to WVUE-TV New Orleans; WTPA-TV Harrisburg-York-Lebanon, Pa.; KCTV-TV San Angelo, Tex.; KPAR-TV Sweetwater, Tex.; WLTV-TV Bowling Green, Ky.; WDAM-TV Laurel-Hattiesburg, Miss., and WDXI-TV Jackson, Tenn. Now in 141 markets.

Bomba the Jungle Boy (Allied Artists): Sold to KTNT-TV Tacoma-Seattle; KBOI-TV Boise, Idaho; WHNB-TV New Britain, Conn.; KOLO-TV Reno; KHVH-TV Honolulu, and WBRC-TV Birmingham, Ala. Now in 91 markets.

Banner Features (Banner Films): Sold to WWL-TV New Orleans.

Bold Journey (Banner Films): Sold to KOMO-TV Seattle.

FANFARE

ABC to push radio as hometown product

20-MINUTE FILM PRODUCED FOR SIX OWNED STATIONS

ABC has begun a grass roots campaign for radio on behalf of its owned stations, the network said last week.

The campaign, which features a newly produced 20-minute color and sound film, "Saga in Sound," was to receive its initial push at a presentation luncheon Friday (March 20) in New York. Leonard H. Goldenson, president of American Broadcasting-Paramount Theaters Inc., and Harold L. Neal Jr., president of ABC-owned radio stations division, were to preside.

The new presentation seeks to increase awareness and appreciation of "community leaders and the general public" of both radio's involvement and influence in community affairs.

Mr. Goldenson said last week that radio's ability and willingness to serve the community interest "is not generally appreciated by the general public or . . . by those civic leaders who con-

stantly rely upon radio for accurate, immediate and unbiased reporting of news and information. . . ."

ABC produced the film for each of its six owned radio stations: WABC New York, KQV Pittsburgh, WXYZ Detroit, WLS Chicago, KGO San Francisco and KABC Los Angeles.

Tells the Role ■ The film documents radio's beginning and its dramatic role in more recent American history and places emphasis on changes radio has undergone in the last decade, while illustrating the new function radio plays today in American lives.

Mr. Goldenson emphasized that most radio listeners and others outside of the broadcasting and advertising businesses are not aware that "today's radio is almost as different from radio a decade ago as it is from television."

Mr. Neal said station people in most ABC Radio markets are already show-

ing the film to local community groups as the core of a larger presentation that explains specifically what the station is doing in the community. ABC has "how to do it" manuals for station employees in their presentations. Mail brochures are being sent to community groups inviting them to see the film. Additionally, a 24-page brochure available for distribution parallels the film and contains other information.

Radio industry people, ABC said, will be shown the film on April 7 in Chicago during the National Association of Broadcasters convention.

Radio month kits go to 2,000 stations

The most complete radio month kit ever produced by the National Association of Broadcasters went into the mail last week to the NAB's more than 2,000 radio member stations.

Designed for use during National

Radio Month in May, the kit contains two records and a 40-page booklet to promote the 1964 theme, "Radio, Your Constant Companion."

The jingle series, created by Scott-Textor Productions Inc., New York, has six versions covering a variety of musical styles from rock 'n' roll to country and western to a concerto.

The U. S. Army band and chorus are featured on the second record in "The Broadcaster's March," a composition especially composed for the industry by Major Samuel Laboda, the band's assistant leader. Also on that record are patriotic music selections and production aids for use in locally produced programs.

The records are available in stereo for FM members.

Included in the booklet is a special page telling broadcasters how they can get complete 65-piece arrangements of the new march including a sheet of formations and routines to present to local high school and college marching bands.

Also in the booklet are graphic aids, spot and tie-in announcements, news releases, fact sheet, window display designs and radio month stamps for use by stations on correspondence.

SCBA going on road with new presentation

A new presentation of the Southern California Broadcasters Association was previewed Thursday (March 19) at the SCBA monthly luncheon meeting. Other showings will be in Chicago, March 30-April 1; Minneapolis, April 2; St. Louis, April 3; Detroit, April 8-9, and other cities, with a three-week stay in New York during May. Robert Light, SCBA president, will present the slide film report, titled "L. A. Is Different," in other cities as he did to his own membership.

In addition to the familiar differences of more colorful dwellings and clothing to be found in Los Angeles, palm trees in place of elms or oaks, smog in place of rain or sleet, Mr. Light cited other differences of more primary interest to buyers of advertising: The growth of the market in population (54%) and effective buying income (120%) in the last decade; the outdoor living, with radio an integral part; the fact that nobody walks, few use public transportation and everybody drives, with radio essential as a guide as well as companion; a higher percentage of

adults (and so more radio listeners): more newspaper confusion, more TV dilution, more people buying more radios and more advertisers using radio more successfully and at lower costs than in almost any other major market.

Drumbeats . . .

Toots for tots ■ WGMS-AM-FM Washington plans to present its traditional Tiny Tots Concert on Easter Sunday. The concert features the National Symphony Orchestra. The program includes music and commentary especially for youngsters, who will be able to examine the instruments and question the musicians between performances.

Miss Vacation ■ The Georgia Association of Broadcasters in cooperation with the state of Georgia is conducting a statewide competition to find a Miss Vacation in Georgia, an official goodwill and hospitality queen. Some 175 Georgia stations will promote the contest.

Local circus ■ WSFA-TV Montgomery, Ala., received more than 750 entries in a "Win a Circus in Your Backyard" contest conducted on its *Storybook Castle* children's show.

ANOTHER FILMLINE FIRST!

The REVOLUTIONARY R-36

DEVELOPS 16MM FILM AT 2160 FT. PER HR.
NEGATIVE FILM AT 3000 FT. PER HR.
POSITIVE FILM AT 3600 FT. PER HR.

Super Speed—Super Quality. The R-36 is the answer to the film industry's exacting requirements for increased speed and quality in reversal processing. It is ideal for military, industrial and commercial use. The Filmline R-36 gives you performance that never existed before. You must see it in action . . . see its results to believe it. Write or phone today.

- **EXCLUSIVE OVERDRIVE TRANSPORT SYSTEM** eliminates film breakage, automatically compensates for elongation—tank footage stays constant.
- **OPERATES** at 83°F at better than 60 ft. per min.
- **EASY TO OPERATE** . . . needs no attention.
- **COMPLETE DAYLIGHT OPERATION** on all emulsions—no darkroom necessary.
- **FEED IN AND DRY BOX ELEVATOR**, plus 1200' magazine permits continuous processing.
- **TEMPERATURE CONTROL SYSTEM** controls heating and cooling of all chemical solutions.
- **VARIABLE SPEED DRIVE**, development times from 1½ to 15 minutes.



Milford, Connecticut

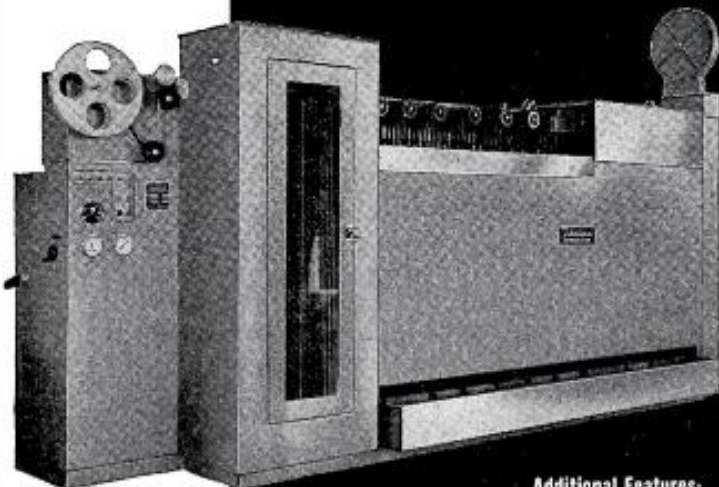

K-87

Recent Filmline Installations:

- N. A. S. A. Huntsville, Ala.
- Reeves Sound, N. Y. C.
- Thiokol Chemical Co.
- WHYN-TV, KNDO-TV, WFMY-TV
- Moral Rearmament

Dept. B323-64

FAST!
MODEL R-36
REVERSAL FILM
PROCESSOR

Additional Features:
• Forced Warm Air Dry Box • Filtered Air Supply
• 316 Stainless Steel Construction • Film Speed tachometer • Two developer pumps • Built in air compressor • Bottom drain valves and drain trough
• Rotary Oilless air compressor • Dry box and solution thermometers • Plumbed for continuous replenishment • Weight: Approx. 1150 lbs. • Size: 9'4" x 33" x 55½" • Only \$7950.00 F.O.B. Milford, Conn.

WHEN YOU BUY QUALITY—FILMLINE COSTS LESS

re dundancy

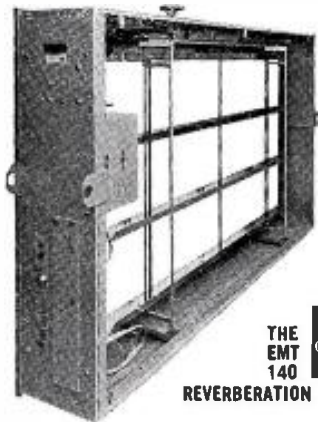

THE
EMT
140
REVERBERATION UNIT

Redundancy to some is unnecessary repetition. To AM broadcasters, energy "repetition" means a louder fringe area signal—which means more sales power. Increasing audio redundancy with the world famous EMT 140 reverberation unit means a "more live" station sound. ■ For FM stereocasters, the two channel unit also adds true stereo dimension—even to mono material. No moving parts means no "on-air" failure worries. Management: Write for details and demo disk.

GOTHAM
AUDIO CORPORATION
2 WEST 46th STREET, NEW YORK, N. Y., 10036
TELEPHONE: 212-CO 5-4111
Demonstration in Booth 59W at NAB

EQUIPMENT & ENGINEERING

Color set shipments up 41% for RCA

Raymond Saxon, president, RCA Sales Corp., last week reported a 41% increase in color set sales to distributors for January-February 1964 against the same period last year.

He said RCA estimates its share of the national television market as one out of every four dollars spent by consumers for American models. Although much of the sales volume in TV sets for the two-month period could be attributed to record color set sales, he noted that "exceptional" black-and-white set sales are also contributing to RCA's high market penetration.

Mr. Saxon said RCA expects the federal tax cut to add \$7 billion to the durable goods business volume in 1964.

Shipments of television sets by RCA last month were 19% higher than any previous February.

FCC asking 5% reduction on all-channel set tax

The FCC is seeking legislation to cut the excise tax on all-channel television receivers from 10% to 5% (BROADCASTING, March 16). A draft bill to accomplish this was submitted to the Bureau of Budget last week for clearance by the administration.

The commission said the proposed tax cut would tend to equalize the cost

between the all-channel and the VHF-only sets. Under a 1962 law, all sets manufactured after April 30 for shipments in interstate commerce must be capable of receiving all 82 channels.

In submitting its tax-cutting proposal, the FCC said it wasn't wedded to the 5% figure and would be ready to consider alternative suggestions.

Originally, the commission had proposed repeal of the entire 10% excise tax. However, commission officials were informed that the price reduction resulting from complete repeal would be greater than the cost of the UHF tuner. On a \$200 set, the 10% cut would mean a price drop of \$20. A tuner costs the manufacturer \$8 to \$10.

30 new 'flea power' frequencies approved

The manufacturers radio service received last week from the FCC 30 additional frequencies in the 72-76 mc band for 1 w, or "flea power," mobile stations.

The commission said, in approving the pending rulemaking, that operation of such stations will be limited to the premises of a factory or manufacturing area, "in order to minimize the possibility of interference with TV reception on channels 4 and 5." The 72-76 mc band separates the two VHF television channels. "In the event such interference results, the user must eliminate it, even to the extent of going off the air," the commission said.

January TV-radio production, sales figures

There were 88,977 color TV receivers produced in January, the Electronic Industries Association reported last week—the first time it has announced color TV production.

This was included in the total of 731,057 television receivers made during the first month of this year. Of this total, 116,218 units were all-channel, compared to 58,032 all-channel sets made in January 1963, and 135,690 for December 1963.

Both the production and sales of monochrome TV receivers were up in January over the same month in 1963. This was true, also, of radio production and sales.

The January figures as released by the association:

January 1964 Production		
TV	(color)	(UHF)
731,057	(88,977)	(116,281)
Radio		(FM)
1,413,293**		(151,343)

January 1963 Production		
TV	(color)	(UHF)
484,415†	(—)	(58,032)
Radio		(FM)
1,229,507		(87,641)

January 1964 Sales		
TV	(color)	(UHF)
588,555	(—)	(—)
Radio		(FM)
544,815*		(—)

January 1963 Sales		
TV	(color)	(UHF)
503,821	(—)	(—)
Radio		(FM)
453,348		(—)

*Excludes auto radios.

**Includes 700,848 auto radios in January 1964, compared to 594,505 in January 1963.

†Does not include color receivers.

FATES & FORTUNES

BROADCAST ADVERTISING



Mr. Nettore

Fred L. Nettore, general sales manager of ABC-TV Spot Sales, New York, elected VP and general sales manager. Mr. Nettore joined organization in 1961 as eastern sales manager.

Albert V. Cole appointed radio-TV manager for Hollywood office of Campbell-Ewald Co. succeeding **Richard Eastland**. **Warren Rebell**, formerly with Fletcher Richards, Calkins & Holden, New York, joins C-E, that city, as account supervisor. **John D. Meyer**, VP-director of marketing at Griswold-Ewald Co., Cleveland, joins Campbell-Ewald in Detroit as supervisor on agency's Marathon Oil account. **John Clason** elected C-E's VP-personnel and training. **Mary Barto**, with C-E for four years, named manager of broadcast production and traffic in San Francisco office.

John Wayne Jones joins American Tobacco Co., New York, as executive assistant in PR and communications. He was formerly PR executive on corporate accounts at Fred Rosen Associates, that city.

Richard C. Ryan named VP of Swan & Mason Adv., Tulsa, Okla. Before joining firm, Mr. Ryan was executive VP at Phillips Adv., that city.

Jean Boutyette, press officer with American Association of Advertising Agencies, New York, joins Foote, Cone & Belding, that city, as associate director of public relations, effective today (March 23). Mr. Boutyette has been on AAAA executive staff, in charge of public relations, for past eight years.

Mayer Levinton named to newly created post of research manager of Television Advertising Representatives, New York. Mr. Levinton joined firm in 1959 as sales analyst.

Bill Brittain, formerly of WSM Nashville, joins WDXI Jackson, Tenn., as sales representative.

Wallace T. Drew joins Lennen & Newell, New York, as senior VP and management account supervisor on

Warner-Lambert Pharmaceutical account. He was formerly VP for marketing and member of board of directors at Coty Inc., that city.

William S. Watchman promoted to group product manager in new products department of household products division of Colgate-Palmolive, New York. Mr. Watchman was formerly senior product manager in department. Prior to joining Colgate in 1963 he was VP and account supervisor at Kenyon & Eckhardt, that city.

William R. Baker Jr., honorary chairman, Benton & Bowles, re-elected board chairman of The Advertising Council for second term ending March 1965. New directors added to council's board include **Arthur Hull Hayes**, CBS Radio president; **Harold Neal**, president, ABC owned radio stations; **Henry M. Schachte**, VP and director, J. Walter Thompson Co., and **Wilson A. Shelton**, president, Compton Advertising. Council is nonprofit organization of advertising business supporting public interest campaigns.

George E. Hamm joins Lennen & Newell, New York, as senior VP and management supervisor on Stockely-Van Camp account. Before joining L&N he was VP and account supervisor at Leo Burnett, that city.

Robert A. Jelinek, since June 1962 director of contracts, talents and rights for business affairs department of CBS-TV network, promoted to director of business affairs. **Bernard Krause** named to newly created position of director of contracts and negotiations. He was director of business affairs-administration.

Charles F. Barry named manager of Los Angeles office of Grant Webb & Co., station representative, New York.

James H. Wood Jr. and **Gregory Harbaugh** join WBAL-TV Baltimore as account executives.

Ted Fortin joins Kudner Agency, New York, as copywriter. He was formerly at Gray & Rogers, Philadelphia, in same capacity.



Mr. Goodman

Trevor Goodman, VP-managing director of Toronto office of Young & Rubicam, transfers to agency's Los Angeles office as VP-account supervisor. He is succeeded in Toronto by **Bob Chaney**, who is leaving BBDO, New York, where he has served as VP-director of business development and assistant to president. **John H. Weiser**, VP of Erwin Wasey, Ruthrauff & Ryan, joins Y&R's contact

We're proud
of our four

Stainless TOWERS*

... say these
leading
broadcasters



JOSEPH L. FLOYD
President
Midcontinent Broadcasting Co.

KELO-TV
SIOUX FALLS, S. D.



N. L. (Larry) BENTSON
Vice President
Midcontinent Broadcasting Co.

*All custom—including our new 1200-footer!

If you're planning towers of any kind, take advantage of STAINLESS' experience in designing and fabricating the world's tallest structures.

 Get your free book describing these installations.

Stainless, inc.

NORTH WALES • PENNSYLVANIA
In Canada: Walsan, Ltd., Carleton Place, Ont.

The GREEN HORNET
Radio Mystery Series
IS BACK ON THE AIR!
Now available for local purchase.
CHARLES MICHELSON, INC.
45 West 45th St., New York 36 • PLaza 7-0695



department in Los Angeles. **Edward B. Shaw** transfers from Y&R's New York office to Los Angeles as marketing director.

Edward Dooley, William Hammond, James E. Kleid, and Thomas J. Wood elected VP's of J. Walter Thompson, New York. All were formerly account supervisors.



Rep. Wilson

and will serve as consultant. Mr. Wilson, who will continue to serve in Congress and currently is seeking re-election to his seventh term, originally joined Tolle in 1945 and became partner and VP in 1947. He resigned in 1952 prior to campaigning for his first congressional term.

Alfred J. Sturm joins Fuller & Smith & Ross, New York, as VP and director of research. Mr. Sturm was formerly at Lever Brothers where he supervised research development. Prior to that he was research account executive at J. Walter Thompson, New York.

John D. Kettell, account executive for seven years at Kettell-Carter, station representative, Boston, elected VP.

Dr. Virginia Miles and Sylvia Simmons elected VP's at Young & Rubicam, New York. Miss Miles is in special planning department. Miss Simmons is assistant to Y&R president.

Phillip Reich, formerly head of his own agency, joins M. M. Fisher Associates, Chicago, as VP.

John Sbarra, formerly account executive at KRUX Phoenix, joins sales staff of WGSM Huntington, N. Y.

Lewis P. Birchfield, regional director with Radio Advertising Bureau, New York, since 1961, named RAB's director of member development.



Mr. Birchfield

Lilyan Browne and Floyd Stone join copy department of J. M. Mathes Inc., New York.

Robert P. Hurley, member of account executive group at Maxon Inc., Detroit, elected VP.

Paul A. Orio joins radio sales staff of Venard, Torbet & McConnell, station representative, New York. He was formerly account executive for American Book-Stratford Press of New York.

Award for Storer

George B. Storer Sr., Storer Broadcasting Co. board chairman, will receive this year's Broadcaster Citation from the Broadcast Pioneers, according to Pioneers President Ernest Lee Jahncke Jr. The award will be presented at the NAB convention, April 7, during the Broadcast Pioneers' Twenty-third Annual Awards Banquet, to be held in the Grand Ballroom of Chicago's Conrad Hilton Hotel.

Other awards are going to the late Dr. W. R. G. Baker of General Electric (Hall of Fame), to be accepted by Robert C. Wilson, radio and TV manager for GE; Congressman Walter Rogers (D.-Tex.) (special citation); and the Bell Telephone system (special citation), accepted by AT&T Board Chairman Frederick R. Kappel.



Mr. Goodman

Burton W. Goodman, since 1957 advertising manager of Englander Co., Chicago bedding firm, joins Sealy Inc., that city, in same capacity. He succeeds **Gerald C. Shappel**, who resigned.

Thomas Gorman, formerly with Colgate-Palmolive Co. as member of product management group, joins Sullivan, Stauffer, Colwell & Bayles, New York, as executive on Johnson & Johnson account group.

Fred Rowe of Tracy-Locke Co., Dallas, elected chairman of southwest council of American Association of Advertising Agencies. **Don O'Brien** of McCann-Erickson, Houston, was elected vice chairman of council, and **Mitchell Williamson** of Humphrey, Williamson & Gibson, Oklahoma City, re-elected secretary-treasurer.

Jack Hetherington, head of his own regional station representative firm in St. Louis, assumes additional duties as manager of Select Station Representatives' newly established office in that city at 8138 Normal Dr. Telephone: (314) 843-2400.

Norm Hankoff, formerly of sales staff of KCRA Sacramento, Calif., joins KGMS, that city, as account executive.

Antho C. Lunt, formerly account executive and copywriter at Fuller & Smith & Ross, New York, named director of press relations and editor of publications for Association of National Advertisers, that city. He succeeds

Alvin A. Dann, who has joined Infoplan division of The Interpublic Group of Cos., New York.

Robert Usedom named advertising and promotion manager for new beverage division of California Packing Corp., San Francisco.

Richard Seclow, formerly of Ogilvy, Benson & Mather, joins Carl Ally Inc., New York, as account supervisor.

Larry Barrett, Chicago sales service representative of NBC-TV for past year, promoted to sales service manager of central sales for network.



Mr. Schlosser

Don S. Schlosser appointed director of advertising and sales development for ABC Radio network, with headquarters in New York. He has served as advertising coordinator and manager of sales development since July 1961.

Charles Coyle, senior product manager at Lever Brothers, joins Doyle Dane Bernbach, New York, as account supervisor.

Donald Grenley named director of PR for Kircher, Helton & Collett, Dayton, Ohio.

John Bergin and Ralph Rewcastle, both VP-associate creative directors at BBDO, New York, elected to agency's board of directors.

Peter Boyle named sales manager of WING Dayton, Ohio.

Kenneth Welch, formerly VP of Advertising Counselors of Arizona Inc., Phoenix, joins Kenneth G. Patton/Adv., that city, as account executive.



Mr. Atchison

Richard D. Atchison, senior account executive at KABC-TV Los Angeles, promoted to sales manager, replacing **John E. Campbell**, who earlier had been named general sales manager of WBKB(TV) Chicago.

Both stations are owned by ABC.

Maurice Bowers, formerly of BBDO, Los Angeles, joins Wade Adv., that city, effective today (March 16) as media supervisor for Falstaff Brewing Corp.

Alfred L. Howard and Elliot W. Reed, join Grey Adv., New York. Mr. Reed, account supervisor, was previously senior VP at Lennen & Newell. Mr. Howard, creative supervisor, was formerly VP in copy department at William Esty, New York.

James Duffy, manager of advertising and sales promotion for TV prod-

ucts division of Corning Glass Works, Corning, N. Y., appointed manager of advertising coordination for company.

Morrison H. Beach, second VP in executive department of The Travelers Insurance Cos., Hartford, Conn., since August 1962, elected VP in that department. **Dr. Thomas Malone**, director of Travelers research department, and **Herbert J. Kramer**, director of public information and advertising, elected second VP's.

William Watson, executive VP-account supervisor at Erwin Wasey, Ruthrauff & Ryan, working in both Chicago and New York, joins New York office of Gardner Adv. as account supervisor.

Jordan Masee, **James Steuer** and **Howard Sutton**, all associate research directors in New York office of Doherty, Clifford, Steers & Shenfield, elected vice presidents.

Steve Rubinkam, formerly with The Pulse Inc., Chicago, joins WAAF, that city, as account executive.

Howard A. James, formerly operator of his own radio-TV news service at Michigan State Capitol, Lansing, joins Montgomery Ward & Co. as public relations manager for firm's Chicago metropolitan district.

Gretchen Fine, formerly publicity director of KNX Los Angeles, and **Akiko Sullivan**, previously with J. W. Raymond Adv., have formed Fine and Sullivan as publicity-PR firm at 5746 Sunset Blvd., Hollywood. Telephone is 466-1324.

Michael Volpe, merchandising manager at KTTV(TV) Los Angeles, promoted to account executive. Mr. Volpe, prior to joining KTTV three years ago, was with sales division of Gerber Co.

Frank Adrana, formerly communications research specialist with J. Walter Thompson Co., New York, joins Audience Studies Inc., TV program and commercial pretesting service, as director of organization's newly formed Chicago division.

William J. Ferguson Jr., senior media buyer in New York office of Young & Rubicam, transfers to agency's Chicago office as supervisor in media relations department.

THE MEDIA

Ronald Ostrow joins ABC in New York as manager of data processing department. He was formerly director of data processing placement and executive recruiting at International Skill Agency, that city.

Stuart L. Pittman, assistant secretary of defense for civil defense, has resigned, effective April 1, to return to

private law practice. Appointed to Department of Defense post in 1961, Mr. Pittman is responsible for supplying radio-TV stations with civil defense information. President Johnson has not yet appointed Mr. Pittman's successor.



Mr. Marshall



Mr. Richardson

Laurence E. Richardson, VP - general executive of Post-Newsweek Stations (WTOP - AM - FM - TV Washington and WJXT [TV] Jacksonville, Fla.), named VP-general manager of WJXT, effective Jan. 3, 1965



Mr. Hudgens

(CLOSED CIRCUIT, March 16). He will replace **Glenn Marshall**, WJXT president, who has expressed desire to discontinue responsibility for daily management and operation of station, but will continue as its president, VP of Post-Newsweek Stations and member of board of The Washington Post Co., parent firm. Mr. Richardson will move to Jacksonville in July and work with Mr. Marshall during remainder of year. Effective March 29, **James A. Hudgens**, associate in Washington law firm of Amram, Hahn & Sundlun and formerly with office of opinions and review at FCC, joins Post-Newsweek Stations as VP, replacing Mr. Richardson.

Fulton Wilkins, general manager of KEX Portland, Ore., elected VP of licensee Golden West Broadcasters.

James Nathan, with sales staff of WINN Louisville, Ky., since 1953, appointed to new post of station manager.



Mr. Brakefield

Charles W. Brakefield, general manager of Cowles-owned WREC - AM - TV Memphis, Tenn., elected VP of Cowles Magazines and Broadcasting Inc., New York. Mr. Brakefield joined WREC in 1951, will continue to manage Memphis facilities.

Jack Cain, sales manager of WSMI Litchfield-Hillsboro, Ill., promoted to assistant manager-program director.

Arthur R. Hook, program manager, promoted to station manager of WTTV (TV) Bloomington-Indianapolis, Ind.

G. Richard Swift joins KROD-TV El Paso, Tex., as general manager. He was formerly president of TV division

in person

DUKE ELLINGTON

KAI WINDING

JOHN HAMMOND, JR.

SESAC CELEBRITY SUITE

NAB • CHICAGO

Here's the Answer To Libel Suits:

One slip of the lip, however accidental, can bring about court action—with you as the defendant in a libel suit. It can be costly enough to be disastrous. Now you can hold your loss on any claim to an agreed amount you carry yourself, and let Employers Reinsurance handle the excess. This specially designed policy provides economical protection against losses due to libel, slander, invasion of privacy, piracy, violation of copyright. For details and rates, contact:

EMPLOYERS REINSURANCE CORPORATION

21 West 10th., KANSAS CITY, MO.

NEW YORK, 111 John • SAN FRANCISCO, 220 Montgomery
CHICAGO, 175 W. Jackson • ATLANTA, 34 Peachtree, N. E.

of The Bolling Co., New York. Before joining Bolling, Mr. Swift had been general manager of WCBS-TV New York.

Rod Innes joins WTAL Tallahassee, Fla., as station manager.

INTERNATIONAL

John Willoughby, managing director of Needham, Louis & Brorby of Canada Ltd., Toronto, elected president and managing director.

William Wallace, senior executive at J. Walter Thompson Co. Ltd., Montreal, elected VP and general manager of Breithaupt, Milson & Benson Ltd., that city.

William Saviak, commercial manager of CKRM Regina, Sask., to national sales supervisor of CKWX Vancouver, B. C.

T. A. Steele named manager of newly opened Calgary, Alberta, office of McLaren Advertising Co. Ltd., Toronto.

Les J. Farewell elected VP of McCann-Erickson (Canada) Ltd., and manager of Vancouver, B. C., office.

PROGRAMMING

Joseph Stamler joins Triangle Program Sales, New York, as account executive. Mr. Stamler was formerly general manager of WABC-TV, that city.

Dean McCarthy, director of operations at WITI-TV Milwaukee, appointed program director of WJBK-TV Detroit, effective April 13. Both stations are owned by Storer Broadcasting Co. Mr. McCarthy replaces WJBK-TV interim program director, **Bob Guy**, who returns to full-time duties as Storer's program development manager.

C. Scott Fletcher, former president of Fund for Adult Education and be-



Mr. McCarthy

fore that president of Encyclopaedia Britannica Films, appointed acting president of Educational Television Stations, newly formed division of National Association of Educational Broadcasters, Washington.

Tom Costigan, formerly with CBS News, forms his own New York radio-TV production company. Organization will produce documentaries and special events programs. Mr. Costigan had been with CBS News for past 10 years.

Stuart M. Miller, formerly producer at KTTV(TV) Los Angeles, joins Charles M. Stern Agency, Hollywood talent representative firm, as head of newly organized motion picture and television department. **Lillian Donnelly**, PR director of Stern agency, now heads new children's department.

Michael A. Cimino, formerly with Ferro, Mohammed & Schwartz, New York, joins MPO Videotronics, that city, as staff director.

Bernard L. Kowalski and **Bruce Geller** named producers of CBS-TV's *Rawhide* series, succeeding **Vincent Finnely**, who completed contract. Among others, Messrs. Kowalski and Geller have jointly produced episodes of *The Dick Powell Theater* and *Four Star Theater*.

Maria Little joins Ivan Tors Films Inc., Hollywood, to assist producer-director Leon Benson as story editor on MGM-TV's new *Flipper* series for NBC-TV presentation next fall.

Jack L. Katz, former film director at KMTV(TV) Omaha, named program director of KMA Shenandoah, Iowa.

Bob Lyte elected VP-western division sales manager for Mel Blanc Associates, Hollywood production company. He also serves as sales director of Blanc's New Sound of Selling division.

Dan Schuffman resigns as program manager of ABC-owned WBKB(TV) Chicago. No future plans announced.

Donald White Jr., news and pro-

gram director of WIPS Ticonderoga, N. Y., named production manager of WGAN Portland, Me.

Joe Cooper, formerly of WQAD-TV Moline, Ill., named production supervisor of KSOO-TV Sioux Falls, S. D.

Jim Avis of Logos Ltd., videotape production facility, Washington, joins WFBM-TV Indianapolis as producer-director.

Dick Clark, host of *American Bandstand* on ABC-TV, named host of Goodson-Todman's new half-hour game series, *Missing Links*, on same network, beginning March 30.

Harry Goldenberg appointed manager of operations, advertising and sales promotion for Columbia Records, New York. **Charles Burr** named director of special projects.

Bob Maxwell named host of MGM-TV's *Made In America* weekly half-hour series which starts Sunday (April 5) on CBS-TV.

Aaron Spelling, staff producer at Four Star Television, North Hollywood, Calif., signs new contract to serve additionally as executive assistant to Thomas J. McDermott, Four Star president, in development of new programs.

George Pell joins WTAL Tallahassee, Fla., as program director.

Fred Broski named program director of KBEA Mission, Kan., and KBEY-FM Kansas City, Mo.

Bob Holliday named program director of WING Dayton, Ohio.

Stanley Kauffmann, commentator and critic on *The Art of Film* on WNBT (TV) Newark-New York, awarded Ford Foundation Fellowship. Award enables Mr. Kauffmann to travel in Europe for observation of and discussions with film directors, producers, writers and actors. Foundation says fellowship winners receive from \$3,200 to \$10,000.

Frank Scott, news director of KBON Omaha, named program director. As news director, Mr. Scott is succeeded by **Bryce Brasel**. **Jim Price** appointed music director.

Bill Brown named manager of program department of WSJS Winston-Salem, N. C., succeeding **Hank Pointel**, who resigned.

Arthur Bell named controller of Walter Reade-Sterling Inc., New York, succeeding **Seymour J. Smith**, who resigned.

Lawrence Laurent, radio-TV editor of *Washington (D.C.) Post*, appointed chairman of editorial board of *Television Quarterly*, journal of National Academy of Television Arts and Sciences. He replaces **Max Wylie**, program supervisor of Lennen & Newell, New



SEE US AT THE 1964 NAB CONVENTION
BOOTH 73 WEST



INTERNATIONAL GOOD MUSIC, INC.
BELLINGHAM, WASHINGTON, 98225

POST OFFICE BOX 943
AREA CODE 206 PHONE 733-4567

York, who was forced to resign because of business affairs.

Mary G. Dooling, artist manager, elected president of Southern California chapter of American Women in Radio and Television.

Mike Nebbia, for past four years cameraman with Elliot-Unger-Elliott, commercial production division of Screen Gems Inc., New York, promoted to producer-director-cameraman.

Bill Brown named manager of wsjs Winston-Salem, N. C., program department. He was formerly in radio-TV news department. Mr. Brown succeeds **Hank Pointel** who resigned.

Irving Klein named VP in charge of creative services at Independent Television Corp., New York. Mr. Klein had been president of Donall & Harman, that city, agency handling ITC account.

NEWS

George Lewin, formerly news director of KTLA(TV) Los Angeles, joins KHJ-TV, that city, as news editor. He had previously been news writer for NBC-TV, Burbank, and West Coast news director of ABC Radio network.

Chuck Crouse, announcer at WCLV Cleveland, promoted to news director.

William D. Kosick named night news editor at KDKA-AM-FM Pittsburgh.

Ward Oury, former newspaperman who for past year has been on sales staff of WTAQ La Grange, Ill., named news editor of station, succeeding late **Vince Essig**.

Dean Naven, program director at KMA Shenandoah, Iowa, promoted to news and special projects director.

Terry Drinkwater, CBS newsman, named western field manager of CBS News election unit. Based in Los Angeles, he will work on planning of campaign coverage in 13 western states.

George E. White named news and public affairs director of WJLB Detroit.

Joe Browder, member of news department of WCKT(TV) Miami for past three years, joins news staff of WIOD, that city. **Les Smith**, WIOD news director, named southern divisional representative on watchdog committee of AP Radio-TV Association.

Henry Walter named editorial research director of WMCA New York.

David Burke, former sports director of WENT Gloversville, N. Y., named news director of WSET Glens Falls, N.Y.

Peter Wood, TV news reporter with British Broadcasting Corp., London, appointed director of newly established

New York office of Independent Television News, British commercial network's news unit.

Andy Benedict, newsman formerly with WHM New York, appointed news director for Long Island Network stations WGSM Huntington and WGBB Freeport, both New York.

Dan Blackburn, formerly night news editor at wowo Fort Wayne, Ind., joins WBBM Chicago as news editor.

Charles Allen Jr. named Pinellas county news bureau chief for WTVT (TV) Tampa-St. Petersburg, Fla.

FANFARE

Dick Paul, director of advertising and promotional services for WAVY-TV Norfolk, Va., named secretary of NBC Affiliates promotion committee. **Charles Cash**, promotion manager of WSB-TV Atlanta, named to NBC promotion managers committee, succeeding **James Knight**, formerly of WTRF-TV Wheeling, W. Va.

Joseph S. D'Aleo, for past three years director of financial PR for Sydney S. Baron & Co., New York PR agency, joins staff of Robert S. Tappinger Associates, that city.

Paul Vodicka, formerly publicity director at WBBM Chicago, joins WFMT (FM) there as promotion manager.

Donn R. Shelton, formerly promotion manager of WITI-TV Milwaukee, appointed to similar post at WJZ-TV Baltimore, replacing **James Q. Frost**, who resigned to join W. B. Doner & Co., that city.

Don Roessner, account executive in New York office of Infoplan, PR division of The Interpublic Group, has been transferred to organization's Los Angeles office in same capacity.

Harry Carlson joins Wolcott & Associates Inc., New York PR firm, as executive VP in charge of eastern operations. Mr. Carlson was formerly presi-

dent of General Public Relations, PR division of Benton & Bowles, that city.

David Murdock named director of publicity for WIP-AM-FM Philadelphia.

Mary Neal named promotion coordinator and publicity director of WTRF-TV Wheeling, W. Va.

EQUIPMENT & ENGINEERING

Joseph L. Stern named director of engineering for CBS-TV Stations Division. Mr. Stern, who joined CBS in February 1946 as project engineer in general engineering department, has been manager of TV radio frequency systems group.

Somers S. Smith, technician at KNXT (TV) Los Angeles, promoted to assistant supervisor of video tape recording operations.

Charles Lipow, previously with The Camera Mart Inc., New York, joins Birns & Sawyer Cine Equipment Co., Los Angeles, as assistant to Jack Birns, president.

John J. McLernon named western district distributor sales manager for RCA electronic components and devices, replacing **Charles A. Brokaw**, who retires this month after 34 years with RCA. **Carl A. Steurnagel** appointed to newly created post of manager of RCA communications systems manufacturing, with headquarters at Camden, N. J.

DEATHS

William F. Blowitz, 48, partner in Hollywood publicity firm of Blowitz, Thomas & Canton, died March 14 in Roosevelt Hospital, New York, from injuries suffered four days earlier when he was hit by automobile on Fifth Avenue at 57th Street.

Jack Jerome Gross, 61, motion picture and TV producer, died March 11 of heart attack in London, England, where he and his partner, Phil Krasne,



were preparing theatrical picture for production. As TV production firm during 1950's Gross-Krasne turned out such TV series as *Big Town*, *Mayor of the Town*, *O'Henry Playhouse* and *Jungle Boy*.

Edwin Hart Jenks, 33, announcer and newscaster at WOW-AM-FM-TV Omaha, was killed March 17 in automobile accident in that city.

Senator James M. Mead, 68, former chairman of Federal Trade Commission, died March 15 at General Hospital in Lakeland, Fla. Mr. Mead, who served in Senate during World War II as Democrat from New York, was appointed to FTC in 1949 and year later became chairman. He resigned as FTC chairman in 1952 when President Eisenhower was elected to office but

remained commissioner until 1955.



Mr. Moffat

Lloyd E. Moffat, 55, president of Moffat Broadcasting Ltd. (CKY Winnipeg, Manitoba, and CKLG Vancouver, B. C.), president of CHED Edmonton, Alberta, and VP-treasurer of CJAY-TV Winnipeg, died March 8 of heart attack while vacationing in Hawaii. Mr. Moffat entered broadcast field in 1931, formerly served as director of Canadian Television Network and of Canadian Association of Broadcasters. His brother, Jack, is president of CHAB-AM-TV Moose Jaw, Saskatchewan, and his daughter, Mrs. James Pryor, is seeking to buy CKXL Calgary, Alberta.

Dr. Paul Kurzweg, president of Arcadian Television Corp., owner and operator of KATC(TV) Lafayette, La., died March 16 at his home in that city.

Charles B. Ganz, 59, VP of Magna Ltd., Los Angeles advertising agency, died March 13.

Sid Nierman, 52, staff musician at WBBM Chicago for more than 20 years, died March 16 of cancer.

John P. Sommerer, 55, quality control manager for RCA Victor in New York, died March 15 at Englewood (N.J.) Hospital after suffering heart attack.

C. Ralph Beamon, 53, secretary-treasurer of WTAR-AM-FM-TV Norfolk, Va., died March 11 at his home in that city. He had been ill for two weeks.

FOR THE RECORD

STATION AUTHORIZATIONS, APPLICATIONS

As compiled by BROADCASTING, March 12 through March 18 and based on filings, authorizations and other actions of the FCC during that period.

This department includes data on new stations, changes in existing stations, ownership changes, hearing cases, rules and standards changes, routine roundup of other commission activity.

Abbreviations: DA—directional antenna. CP—construction permit. ERP—effective radiated power. VHF—very high frequency. UHF—ultra high frequency. ant.—antenna. aur.—aural. vis.—visual. kw—kilowatts. w—watts. mc—megacycles. D—day. N—night. LS—local sunset. mod.—modification. trans.—transmitter. unl.—unlimited hours. kc—kilocycles. SCA—subsidiary communications authorization. SSA—special service authorization. STA—special temporary authorization. SH—specified hours. *educational. Ann.—announced.

New TV stations

ACTIONS BY FCC

Wildwood, N. J.—Francis J. Matrangola. Granted CP for new TV on UHF channel 40 (626-632 mc); ERP 8 kw vis., 1.4 kw aur. Ant. height above average terrain 200 feet. above ground 223 feet. P. O. address 3010 New Jersey Avenue, Wildwood. Estimated

construction cost \$140,127; first year operating cost \$55,000; revenue \$60,000. Studio and trans. location both Wildwood. Geographic coordinates 38° 59' 33" north latitude, 74° 48' 48" west longitude. Type trans. RCA TTU-1B, type ant. Co-El CO-20UD. Legal counsel Harry J. Daly, Washington; consulting engineer Glenn W. Winter, York, Pa. Mr. Matrangola, sole owner, is licensee of WCMC-AM-FM Wildwood. Action March 11.

APPLICATIONS

Anniston, Ala.—William A. and George K. Chapman, d/b as Chapman Radio & Television Co., UHF channel 70 (806-812 mc); ERP 22.03 kw vis., 13.21 kw aur. Ant. height above average terrain 862 feet, above ground 218 feet. P. O. address Box 3297, Birmingham, Ala. Estimated construction cost \$24,950; first year operating cost \$25,000; revenue \$50,000. Studio and trans. locations both Anniston. Geographic coordinates 33° 40' 53" north latitude, 85° 48' 58" west longitude. Type trans. RCA TTU-1B, type ant. RCA TFU-27DH. Legal counsel (none listed); consulting engineer William A. Chapman. Principals: William A. and George K. Chapman (each 50%). Chapman Radio & TV is licensee of WCRT-AM-FM Birmingham, Ala. Ann. March 18.

New Orleans, La.—Channel 26 Inc. UHF channel 26 (542-548 mc); ERP 234 kw vis., 23.4 kw aur. Ant. height above average terrain 402 feet, above ground 426 feet. P. O. address c/o David W. Wagenvoord, 614 North Rampart Street, New Orleans. Estimated construction cost \$205,500; first year operating cost \$175,000; revenue \$180,000. Studio and trans. location both New Orleans. Geo-

graphic coordinates 29° 57' 09" north latitude, 90° 04' 21" west longitude. Type trans. ITA TVV-12-A, type ant. CO-EL CO 22 SUL. Legal counsel McKenna & Wilkinson, Washington; consulting engineer L. J. N. du Treil & Associates, New Orleans. Principals: David W. Wagenvoord (45%), George D. Venturatos (30%) and Myrtle Robbert Westenberg (25%). Mr. Wagenvoord has interest in Wagenvoord Broadcasting Inc. and WWOM New Orleans; Mrs. Westenberg also has interest in Wagenvoord Broadcasting (which has contracted to purchase WWOM from WWOM Inc. and has been granted commission approval for the assignment); Mr. Venturatos is local business man. Ann. March 17.

Existing AM stations

ACTIONS BY FCC

KIBE, Palo Alto, Calif.—Designated for hearing application to increase power on 1220 kc, D, from 1 kw to 5 kw; made KLIP Fowler, Calif., party to proceeding. Action March 18.

KVOP Plainview, Tex.—Granted increased daytime power on 1400 kc from 250 w to 1 kw, continued nighttime operation with 250 w; conditions. Action March 18.

New FM stations

ACTIONS BY FCC

Tucson, Ariz.—WGAL Television Inc. Granted CP for new FM on 94.9 mc, channel 235; ERP 13.14 kw. Ant. height above average terrain 3,685 feet. P. O. address 209 W. Elm St., Tucson. Estimated cost of construction \$43,918; first year operating cost \$19,000; revenue predicted to be from \$5,000 to \$10,000. Applicant is licensee of WGAL-TV Lancaster, Pa., KVOA-TV Tucson and KOAT-TV Albuquerque, N. M.; has been granted CP for new FM station in Albuquerque (see below). Action March 18.

Kokomo, Ind.—Booth Broadcasting Co. Granted CP for new FM on 93.5 mc, channel 228, 3 kw. Ant. height above average terrain 182 feet. P. O. address c/o J. L. Booth, 2300 Buhl Building, Detroit 26. Estimated construction cost \$14,850; first year operating cost \$10,000; revenue \$15,000. Applicant is licensee of WIOU Kokomo. Action March 18.

Plainfield, Ind.—James T. Barlow. Granted CP for new FM on 98.3 mc, channel 252A, 3 kw. Ant. height above average terrain 200 feet. P. O. address 863 Walton Drive, Plainfield. Estimated construction cost \$21,465; first year operating cost \$26,000; revenue \$32,000. Mr. Barlow is sole owner. Action March 11.

Whitesburg, Ky.—Folkways Broadcasting Inc. Granted CP for new FM on 103.9 mc, channel 280, 208 w. Ant. height above average terrain 938 feet. P. O. address Box 660, Whitesburg, Ky. Estimated construction cost \$9,146; first year operating cost \$7,500; rev-

EDWIN TORNBERG

& COMPANY, INC.

**Negotiators For The Purchase And Sale Of
Radio And TV Stations**

Appraisers • Financial Advisors

New York—60 East 42nd St., New York 17, N. Y. • MU 7-4242
West Coast—1357 Jewell Ave., Pacific Grove, Calif. • FR 5-3164
Washington—711 14th St., N.W., Washington, D.C. • DI 7-8531



enue \$8,800. Applicant is licensee of WTCW Whitesburg. Action March 11.

Rolla, Mo.—Rolla Broadcasters. Granted CP for new FM on 94.3 mc, channel 232, 2.82 kw. Ant. height above average terrain 293 feet. P. O. address c/o Roy D. Stanley, 614 Pine Street, Suite 209, Rolla. Estimated construction cost \$12,318; first year operating cost \$3,000; revenue \$5,000. Applicant is licensee of KCLU Rolla. Action March 11.

Albuquerque, N. M.—WGAL Television Inc. Granted CP for new FM on 100.3 mc, channel 282, ERP 8.9 kw. Ant. height above average terrain 4,162. P. O. address Clair R. McCollough, 8 W. King St., Lancaster, Pa. Estimated cost of construction \$44,218; first year operating cost \$19,000; revenue is predicted to range from \$5,000 to \$10,000. Applicant is licensee of WGAL-TV Lancaster, Pa., KOAT-TV Albuquerque, and KVOA-TV Tucson, Ariz., and has been granted CP for new FM in Tucson (see above). Action March 18.

Harrisburg, Pa.—Hudson Broadcasting Corp. Granted CP for new FM on 99.3 mc, ch. 257, 3 kw. Ant. height above average terrain 91 feet. P. O. address Box 3433, Harrisburg. Estimated construction cost \$28,100; first year operating cost \$25,000; revenue \$25,000. Principals: James A. McKenna Jr. (80%) and Edgar K. Smith (20%). Applicant owns WCMB & WDTV(TV), both Harrisburg. Mr. McKenna is majority owner of KEVE Golden Valley, Minn., and WAWA West Allis, Wis. Action March 18.

Forth Worth, Tex.—KNOK Broadcasting Inc. Granted CP for new FM on 107.9 mc, (ch. 300) 33.36 kw. Ant. height above average terrain 215 feet. P. O. address 38 Chatham Rd., Short Hills, N. J. Estimated construction cost \$20,992. Applicant, large corporation with no majority stockholder, owns KNOK Ft. Worth. Action March 11.

APPLICATIONS

Clanton, Ala.—Sam H. Beard. 97.7 mc, channel 249A, ERP 3 kw, unil. Ant. height above average terrain 243 feet. P. O. address Route 2, Clanton. Estimated construction cost \$5,200; first year operating cost \$6,000; revenue \$6,000. Principal: Sam H. Beard (100%). Mr. Beard is local businessman. Ann. March 18.

Dothan, Ala.—WOOF Trust. 99.7 mc, channel 259, ERP 100 kw, unil. Ant. height above average terrain 342 feet. P. O. address Box 1427, Dothan. Estimated construction cost \$10,665; first year operating cost \$16,055; revenue \$26,000. Principal: Agnes W. Simpson, trustee. Trustee is general manager of WOOF Dothan. Ann. March 12.

Fayetteville, Ark.—H. Weldon Stamps. 92.1 mc, channel 221, ERP 3 kw, unil. Ant. height above average terrain 129 feet. P. O. address Box 1128, Fayetteville. Estimated construction cost \$9,500; first year operating cost \$8,000; revenue \$7,500. Principal: H. Weldon Stamps (100%). Mr. Stamps is licensee of KFAY Fayetteville. Ann. March 17.

Orlando, Fla.—Orlando Radio & Television Corp. 105.1 mc, channel 286, ERP 100 kw, unil. Ant. height above average terrain 436 feet. P. O. address Gene Cook, Fort Gatlin Hotel, Orlando. Estimated construction cost \$62,747; first year operating cost \$30,000; revenue \$30,000. Principals: Gordon Sherman and Melvin Feldman (each 50%). Orlando Radio & TV is licensee of WHY Orlando. Messrs. Sherman and Feldman have interest in WMAV Springfield, Ill. Ann. March 13.

Tampa, Fla.—Melvin B. Warner tr/as Warner Brothers Station. 94.9 mc, channel 235, ERP 100 kw. Ant. height above average terrain 276 feet. P. O. address 757 North La Cienega Boulevard, Los Angeles 46, Calif. Estimated construction cost \$50,875; first year operating cost \$56,280; revenue \$81,224. Principal: Melvin B. Warner (100%). Mr. Warner has California business interests. Ann. March 16.

Valdosta, Ga.—W. G. O. V. Inc. 92.9 mc, channel 225, ERP 27.42 kw, unil. Ant. height above average terrain 293 feet. P. O. address J. P. Gunn, Box 217, Miami, Fla. (33142). Estimated construction cost \$21,705; first year operating cost \$4,000; revenue \$22,500. Principals: E. D. Rivers Jr. (99.98%), Marie Bie Rivers (.01%) and Hubert Ulmer (.01%). Principals have same interest in WGUN Decatur and WEAS Savannah, both Georgia. WAM Memphis, Tenn., and WSWN Belle Glade, Fla. Ann. March 18.

Louisville, Ky.—WHAS Inc. 97.5 mc, channel 248, ERP 100 kw, unil. Ant. height above average terrain 505 feet. P. O. address 525 West Broadway, Louisville. 40202. Estimated construction cost \$79,570; first year operating cost \$139,000; revenue \$35,000. Principals:

George Barry Bingham (41%) and as trustee for Mary C. Bingham, et al (18.2%), Mary C. Bingham (16.7%), Robert Bingham III (3.9%), G. B. Bingham Jr., Sarah B. Ellsworth, Jonathan W. Bingham and Eleanor M. Bingham (each 2.8%) and others. WHAS Inc. is licensee of WHAS-AM-TV Louisville. Ann. March 6.

Houma, La.—KCIL Inc. 107.1 mc, channel 296A, ERP 3 kw, unil. Ant. height above average terrain 145 feet. P. O. address Box 1031, Houma. Estimated construction cost \$9,531; first year operating cost \$1,500; revenue \$2,500. Principal: Denver T. Brannen (100%). KCIL Inc. is licensee of WYNE Baton Rouge, and KCIL Houma, both Louisiana. Ann. March 18.

Thibodaux, La.—Delta Broadcasters Inc. 106.3 mc, channel 292A, ERP 3 kw, unil. Ant. height above average terrain 284 feet. P. O. address Raymond Saadi, Box 471, Thibodaux. Estimated construction cost \$14,200; first year operating cost \$10,000; revenue \$12,000. Principals: Fred H. Block, Edward R. Jackson and Sam M. Lawrason (each 33⅓%). Delta Broadcasters is licensee of KTIB Thibodaux. Ann. March 12.

Northampton, Mass.—Pioneer Valley Broadcasting Co. 99.3 mc, channel 257A, ERP 3 kw, unil. Ant. height above average terrain 300 feet. P. O. address Alexander W. Milne, 78 Main Street, Northampton. Estimated construction cost \$25,408; first year operating cost and revenue estimates not listed. Principals: Nathan W. (86%) and John W. Williams (33%) and Jane S. Foskitt (1%). Pioneer Valley Broadcasting is licensee of WHMP Northampton. Ann. March 18.

Huntingdon, Pa.—Huntingdon Broadcasters Inc. 97.1 mc, channel 244A, ERP 3 kw, unil. Ant. height above average terrain minus 153 feet. P. O. address WHUN, 400 Washington Street, Huntingdon. Estimated construction cost \$13,652; first year operating cost \$10,000; revenue \$8,000. Principal: Joseph F. Biddle Publishing Co. (100%). Joseph F. Biddle Publishing is owned by John H. Biddle, Anne B. Pullinger, Josephine B. McMeen, Sarah B. Tenevek and Elizabeth B. McKee (each 20%); Huntingdon Broadcasters is licensee of WHUN Huntingdon. Mr. John H. Biddle also has interests in Wbfd Bedford, WCPA Clearfield and Wdad Indiana, all Pennsylvania. Ann. March 18.

Ownership changes

ACTIONS BY FCC

WMMW Meriden, Conn.—Granted transfer of control of licensee corporation, Meriden-Wallingford Radio Inc., from Arnold and Edna Hartley (each 9%), Allen E. Wolin (18%) and Sylvia P. and G. Summer Collins (each 9%) to Hall Syndicate Inc. (46% before transfer, 100% after). Consideration to be determined at closing. Hall Inc., New York syndicated-newspaper-column enterprise 100% owned by Robert M. Hall, is simultaneously selling its minority interests in KATZ St. Louis and KCOR San Antonio, Tex., to Hartley group, which also has interest in these stations. Action March 12.

KLEE Ottumwa, Iowa—Granted assignment of license from Thomas L. Davis and Ray Freedman (each 50%), d/b as Kleeco Radio, to Kleeco Radio Inc., same ownership. No financial consideration involved. Action March 18.

WEW St. Louis—Granted transfer of control of licensee corporation, Radio WEW Inc., from Franklin Broadcasting Co. (100%),

owned by J. Alvin Koenig and others, to Charles P. Stanley (51%) and others. Consideration \$468,400. Mr. Stanley is presently vice president and minority stockholder of Franklin Broadcasting and general manager of WEW. Action March 18.

WBRJ Marietta, Ohio—Granted assignment of CP from Will P., William E. and Betty C. McKinney, Jane M. and Daniel W. Burton, and Robert E. and Ruth M. Schornstheimer (each 14.28%), d/b as The Radio-casters, to 5kw Inc., owned by Times Co. (68.15%), Will P. (4.55%) and Betty C. McKinney (9.10%), Robert E. and Ruth M. Schornstheimer (each 4.55%), and Daniel W. Burton (9.10%). Consideration \$15,000. Stockholders of Times Co. are all partners of assignor. Times Co. is publisher of *Marietta Times*. Action March 12.

WFIG-AM-FM Sumter, S. C.—Granted transfer of control of licensee corporation, Radio Station WFIG Inc., from Fulton B. Jr., and John S. Creech and J. S. Brody (53%, 10%, and 31%, respectively), to Harvey Ray Laughter (51%) and Thomas Paul Tisdale (49%). Consideration: \$145,150. Mr. Laughter has interest in WYCL York, S. C., is applicant for CP to operate WRPL Charlotte, N. C., and applicant for facilities of WBMT Black Mountain, N. C. Mr. Tisdale has interest in Swannanoa Valley Broadcasting and is local businessman. Action March 18.

KBAL San Saba, Tex.—Granted assignment of license from H. A. Stephens (50%) and Reuben Senterfitt (50%), d/b as San Saba County Broadcasting Co., to H. A. Stevens (100%), tr/as company of same name. Consideration \$20,000. Action March 12.

WBOY-AM-TV Clarksburg, W. Va.—Granted assignment of licenses from Berkman family (40.75%) and others, d/b as Rust Craft Broadcasting Co., to Marlon R. Ascoli (80%) and others, tr/as Northern West Virginia Radio Broadcasting Co. (AM) and Northern West Virginia TV Broadcasting Co. (TV); proposed assignees are subsidiaries of Fortnightly Corp. Consideration \$825,000. Fortnightly owns CATV systems in Clarksburg and Fairmont, both West Virginia, and Reporter magazine. Action March 13.

WVWV Grafton, W. Va.—Granted transfer of control of licensee corp., WVWV Inc., from Patrick W. and Jean S. Larkin (each 35%) to Jean S. Larkin (70%), executrix of estate of Patrick W. Larkin. No financial consideration involved. Action March 12.

APPLICATIONS

KUZZ Bakersfield, Calif.—Seeks assignment of license from Valley Radio Corp., owned by Joseph M. Arnoff (67.5%), Herbert Henson (25%) and Arthur Toll (7.5%), to Thunderbird Broadcasting Co., owned by Gerald T. Hill (80%) and Doris M. Griffiths (20%). Consideration \$98,000. Mr. Hill is vice president of Griffiths, Lilly & Hill Inc., Los Angeles advertising agency; has other business interests. Miss Griffiths has interest in Griffiths, Lilly & Hill and other enterprises. Ann. March 18.

WLKB Decatur, Ga.—Seeks assignment of license from Samuel C. Chafin and N. W. Griffin (each 50%), d/b as DeKalb Broadcasting Co., to Joel E. Lawhon (100%). Consideration \$55,000. Mr. Lawhon is employee of WFBC-TV Greenville, S. C. Ann. March 18.

WJOL-AM-FM Joliet, Ill.—Seeks assignment of license from WJOL Inc., owned by Joseph F. Novy and Jerome F. Cerny (each

"The MONEY
MAKER" ...
from **CRC**

If you haven't heard about CRC's fantastic Commercial Service and Production Library, both of us are losing money!

Write, wire or phone collect for details.

Commercial Recording Corporation • P. O. Box 6726 • Dallas 19, Texas • RI 8-8004

SUMMARY OF COMMERCIAL BROADCASTING

Compiled by BROADCASTING, March 18

	Lic.	ON AIR CP's	NOT ON AIR CP's	TOTAL APPLICATIONS for new stations
AM	3,866	77	102	295
FM	1,117	40	141	275
TV	521 ¹	61	80	128

OPERATING TELEVISION STATIONS

Compiled by BROADCASTING, March 18

	VHF	UHF	TV
Commercial	477	95 ²	572 ¹
Noncommercial	53	29	82

COMMERCIAL STATION BOXSCORE

Compiled by FCC, Feb. 29

	AM	FM	TV
Licensed (all on air)	3,866	1,119	521 ¹
CP's on air (new stations)	77	40	61
CP's not on air (new stations)	102	127	79
Total authorized stations	4,045	1,286	661
Applications for new stations (not in hearing)	189	240	58
Applications for new stations (in hearing)	100	21	66
Total applications for new stations	289	261	124
Applications for major changes (not in hearing)	201	55	48
Applications for major changes (in hearing)	43	1	6
Total applications for major changes	244	56	54
Licenses deleted	1	0	0
CP's deleted	0	0	0

¹ Does not include six licensed stations off air.

² Includes three noncommercial stations operating on commercial channels.

50%), to Publishing Enterprises Inc., owned by John P. (30.85%) and Virginia S. Harris (28.31%), Virginia H. Rayl (12.66%), Platt & Co., trustee for John G. Harris (12.41%), estate of Sue Catherine Harris (6.52%) and others. Consideration \$560,000. Publishing Enterprises Inc. is applicant for purchase of KTOP Topeka, Kan. Mr. J. P. Harris has interests in following: KTVH Hutchinson, Kan.; KBUR Burlington, Iowa; KMCD Fairfield, Iowa; KIUL Garden City, Kan. Miss. V. H. Rayl has interests in KIUL, KBUR and KMCD. Miss. V. S. Harris has interest in KIUL. Estate of Sue C. Harris has interest in KIUL. Ann. March 12.

KRCB Council Bluffs, Iowa—Seeks relinquishment of negative control of licensee corporation, Council Bluffs Broadcasting Co., by Abe Slusky and Clair J. Gross (each 50% before sale, 40% after) through sale of treasury stock to J. LeRoy Spurgeon (20% after). Consideration \$10,000. Mr. Spurgeon is employe of KMEO Omaha. Ann. March 18.

WAVE-AM-TV Louisville, Ky., WFIE-TV Evansville, Ind., and WFRV-TV Green Bay, Wis.—Seek transfer of control of licensee corporations, WAVE Inc., WFIE Inc., and Valley Broadcasting Inc., respectively, from George W. Norton Jr. (100%), deceased, to Citizens Fidelity Bank and Trust Co., executor, Louisville. Mr. Norton owned WAVE Inc., which owned WFIE Inc. and Valley Broadcasting. No financial consideration involved. Ann. March 13.

KVBR Brainerd, Minn.—Seeks acquisition of negative control of permittee corporation, Greater Minnesota Broadcasting Corp., by Charles B. Persons (25% before purchase, 50% after) through sale of stock by Alver G. Leighton (25% before). Consideration \$384. Remaining stock is owned by Kendall M. Light (50%). Ann. March 18.

WMOU-AM-FM Berlin, N. H.—Seeks assignment of license from Berlin Broadcasting Co., owned by John (52.33%) and Elizabeth Bowman (47.67%), to Coos County Broadcasting Inc., owned by Thomas S. Christensen (100%). Consideration \$89,569. Mr. Christensen is former advertising manager of Phillip Morris Inc., New York. Mr. Bowman owns license of WLTN Littleton, N. H. Ann. March 16.

KBBS Buffalo, Wyo.—Seeks assignment of license from Northern Wyoming Broadcasting Corp., owned by Malcolm D. Wyman

(27.9%), Jack Rosenthal and Edward H. Weinberg (each 27.6%), Donald E. Hoffman (8.8%) and Jeanette Maxwell (8.1%), to KBBS Inc., owned by Jeanette Maxwell (100%). Consideration \$37,500 and surrender of 24 shares of assignee's stock in Northern Wyoming Broadcasting. Ann. March 18.

WBUT-AM-FM Butler, Pa.—Seeks transfer of control of licensee corporation, WBUT Inc., from J. Patrick Beacom (10% before sale, 50% after), Klon O. Row and James S. Beattie (each 45% before), to J. Patrick Beacom and Larry M. Berg (50% after). Consideration \$4,900 and assumption of liabilities. Mr. Beacom has interest in WVVW Grafton and WJPB-TV Fairmont, both West Virginia; Mr. Berg is employe of WCAO Baltimore. Ann. March 18.

WTRB Ripley, Tenn.—Seeks assignment of license from Shelby McCallum, Smith J. Dunn and John L. Stewart (each 33⅓%), d/b as Lauderdale Broadcasting Co., to Smith J. Dunn (51%) and John L. Stewart (49%), d/b as company of same name. No financial consideration listed. Ann. March 18.

KEYS Corpus Christi, Tex.—Seeks assignment of license from Charles W. (25%), V. L. (50%) and James V. Rossi (25%), d/b as Nueces Broadcasting Co., to Charles W. (25%) and James V. Rossi individually as partner (25%) and as executor (50%) of estate of V. L. Rossi, deceased, d/b as company of same name. No financial consideration involved. Ann. March 16.

WJHL-TV Johnson City-Kingsport, Tenn.-Bristol, Va.—Seeks assignment of license from WJHL Inc., owned by W. H. Lancaster Jr. (58.5%) and Sr. (41.5%), to Roy H. Park Broadcasting of Tri-Cities Inc. (100%). Consideration \$2,500,000. Roy H. Park Broadcasting is wholly owned by State and Aurora Inc., which is in turn owned by Roy H. Park (100%). Mr. Park also is president of WGTC, WNCT-FM-TV Greenville, N. C.; has interest in WDEF-AM-TV Chattanooga, Tenn., and WECT-TV Wilmington, N. C. Ann. March 11.

WTID Newport News, Va.—Seeks assignment of license from Twelve Seventy Inc., owned by Max Reznick (52.6%) and George E. Dail (47.4%), to Armistead Broadcasting Corp., owned by James Armistead Mitchell (100%). Consideration \$176,000. Mr. Mitchell is Culpeper, Va., businessman. Ann. March 16.

KIRO-AM-FM-TV Seattle—Seeks assignment of licenses from Queen City Broad-

casting Co. to KIRO Inc. Consideration stock transfer. Queen City is owned (97%) by Wasatch Radio and Television Co., Utah. Wasatch intends to merge with Queen City, dissolving latter and changing name of former to KIRO Inc. Following merger, Wasatch will be owned by Corporation of President of Church of Jesus Christ of Latter-Day Saints (98.8%) and others. Ann. March 18.

Hearing cases

DESIGNATED FOR HEARING

WLAD, The Berkshire Broadcasting Corp., Danbury, Conn.; WCHA, Chambersburg Broadcasting Co., Chambersburg, Pa.; WKDN, South Jersey Broadcasting Co., Camden, N. J.; Eaglecon, Rockville, Conn.—Designated for consolidated hearing applications of WLAD, WCHA, and WKDN to increase power on 800 kc, D—WLAD from 250 w to 1 kw; WCHA, from 1 kw to 5 kw; and WKDN from 1 kw to 5 kw with DA; and Eaglecon for new daytime station on 800 kc, 1 kw, DA; issues include Sect. 73.28 (d) (3) 10-percent rule determination; made WGY Schenectady, N. Y., WCCM Lawrence, Mass., and WCBG Chambersburg, Pa., latter filed opposing petition, parties to proceeding. Action March 18.

OTHER ACTIONS

■ By order, commission postponed, from April 16 to May 18, oral argument on its proposed program statement for commercial TV broadcast application forms. Since early February joint committee composed of members of commission staff, broadcasters and members of communications bar have been working to see if TV form somewhat simpler than that proposed can be evolved, which will get needed information with less burden on applicants, and its work is nearing completion. Date for persons to notify commission in writing of intended appearances at this oral proceeding will now be up to May 1. Last date for submission of written statements will be May 18. Action March 18.

■ Commission invited comments to proposed rulemaking looking toward amending FM table of assignments based on petitions by (1) Lester Sumrall Evangelists Association Inc., to substitute channel 276A for 252A in South Bend, Ind., and (2) Louis W. Skelly, permittee of WFIZ (FM) on channel 285A in Conneaut, Ohio, to substitute 288A for 285A in that city and 272A for 288A in Erie, Pa. Action March 18.

■ By memorandum opinion and order, commission denied petition by John Brown Schools of California Inc. (KGER), Long Beach, Calif., for stay of Jan. 9 grant of assignment of license of KREL (formerly KBUC), Corona, Calif., from Radion Broadcasting Inc. to Major Market Stations Inc. John Brown Schools has pending petition for reconsideration. Action March 18.

■ By memorandum opinion and order in proceedings on revocation of license of WTIF Inc. (WTIF), Tifton, Ga., WDMG Inc., for renewal of license of WDMG Douglas, Ga., WMEN Inc., for renewal of license of WMEN Tallahassee, Fla., and B. F. J. Timm for new AM in Jacksonville, Fla., commission, at request by petitioners WTIF et al., gave expeditious consideration to their pleadings, but denied in all respects their request for bill of particulars and other relief; also denied their application for review of chief hearing examiner's March 9 order directing that proceedings be moved to Douglas, Ga., upon their completion in Tifton. Action March 18.

■ By order, commission granted petition for stay of its action, announced Feb. 4, which revoked license of WPFA Pensacola, Fla., and denied renewal of license of WMOZ Mobile, Ala., to have become effective March 31. Stay is for 30 days after disposition of petition for reconsideration or, in event of court appeal, until 30 days after any judicial affirmation of commission's action. Both stations are owned by Edwin H. Estes. Commissioner Loevinger not participating. Action March 18.

■ By memorandum opinion and order, commission granted request by Community Radio of Saratoga Springs, New York, Inc., Saratoga Springs, N. Y., for waiver of AM "freeze" rule and granted Community temporary operating authority to operate facilities (900 kc, 250 w-D) formerly occupied by WSPN Saratoga Springs, in accordance with terms of former license for facilities. On Feb. 20, Spa Broadcasters Inc.

PROFESSIONAL CARDS

JANSKY & BAILEY
Offices and Laboratories
1339 Wisconsin Ave., N.W.
Washington 7, D.C. Federal 3-4800
Member AFCEE

JAMES C. McNARY
Consulting Engineer
National Press Bldg.
Wash. 4, D. C.
Telephone District 7-1205
Member AFCEE

—Established 1926—
PAUL GODLEY CO.
Upper Montclair, N. J.
Pilgrim 6-3000
Laboratories, Great Notch, N. J.
Member AFCEE

GEORGE C. DAVIS
CONSULTING ENGINEERS
RADIO & TELEVISION
527 Munsey Bldg.
Sterling 3-0111
Washington 4, D. C.
Member AFCEE

**COMMERCIAL RADIO
EQUIPMENT CO.**
Everett L. Dillard, Gen. Mgr.
Edward F. Lorentz, Chief Engr.
INTERNATIONAL BLDG.
DI 7-1319
WASHINGTON 4, D. C.
Member AFCEE

A. D. Ring & Associates
42 Years' Experience in Radio
Engineering
1710 H St., N.W. 298-6850
WASHINGTON 6, D. C.
Member AFCEE

GAUTNEY & JONES
CONSULTING RADIO ENGINEERS
930 Warner Bldg. National 8-7757
Washington 4, D. C.
Member AFCEE

Lohnes & Culver
Munsey Building District 7-8215
Washington 4, D. C.
Member AFCEE

L. H. Carr & Associates
Consulting
Radio & Television
Engineers
Washington 6, D. C. Fort Evans
1000 Conn. Ave. Leesburg, Va.
Member AFCEE

KEAR & KENNEDY
1302 18th St., N.W. Hudson 3-9000
WASHINGTON 6, D. C.
Member AFCEE

A. EARL CULLUM, JR.
CONSULTING ENGINEERS
INWOOD POST OFFICE
DALLAS 9, TEXAS
MElrose 1-8360
Member AFCEE

GUY C. HUTCHESON
P.O. Box 32 CRestview 4-8721
1100 W. Abram
ARLINGTON, TEXAS

**SILLIMAN, MOFFET
& KOWALSKI**
1405 G St., N.W.
Republic 7-6646
Washington 5, D. C.
Member AFCEE

GEO. P. ADAIR ENG. CO.
CONSULTING ENGINEERS
Radio-Television
Communications-Electronics
901 20th St., N.W.
Washington, D. C.
Federal 3-1116
Member AFCEE

WALTER F. KEAN
CONSULTING RADIO ENGINEERS
Associate
George M. Sklom
19 E. Quincy St. Hickory 7-2401
Riverside, Ill. (A Chicago suburb)
Member AFCEE

HAMMETT & EDISON
CONSULTING RADIO ENGINEERS
Box 68, International Airport
San Francisco 28, California
Diamond 2-5208
Member AFCEE

JOHN B. HEFFELFINGER
9208 Wyoming Pl. Hiland 4-7010
KANSAS CITY 14, MISSOURI

**JULES COHEN
& ASSOCIATES**
9th Floor, Securities Bldg.
729 15th St., N.W., 393-4616
Washington 5, D. C.
Member AFCEE

CARL E. SMITH
CONSULTING RADIO ENGINEERS
8200 Snowville Road
Cleveland 41, Ohio
Phone: 216-526-4386
Member AFCEE

VIR N. JAMES
CONSULTING RADIO ENGINEERS
Applications and Field Engineering
345 Colorado Blvd.—80206
Phone: (Area Code 303) 333-5562
DENVER, COLORADO
Member AFCEE

A. E. Towne Assocs., Inc.
TELEVISION and RADIO
ENGINEERING CONSULTANTS
420 Taylor St.
San Francisco 2, Calif.
PR 5-3100

PETE JOHNSON
Consulting am-fm-tv Engineers
Applications—Field Engineering
Suite 601 Kanawha Hotel Bldg.
Charleston, W.Va. Dickens 2-6281

MERL SAXON
CONSULTING RADIO ENGINEER
622 Hoskins Street
Lufkin, Texas
NEptune 4-4242 NEptune 4-9558

WILLIAM B. CARR
Consulting Engineer
AM—FM—TV
Microwave
P. O. Box 13287
Fort Worth 18, Texas
BUtler 1-1551

**RAYMOND E. ROHRER
& Associates**
Consulting Radio Engineers
436 Wyatt Bldg.
Washington 5, D. C.
Phone: 347-9061
Member AFCEE

E. HAROLD MUNN, JR.
BROADCAST ENGINEERING
CONSULTANT
Box 220
Coldwater, Michigan
Phone: BRoadway 8-6733

**JOHN H. MULLANEY
and ASSOCIATES**
A Division of Multronics, Inc.
Multronics Building
5712 Frederick Ave., Rockville, Md.
(a suburb of Washington)
Phone: 301 427-4666
Member AFCEE

OSCAR LEON CUELLAR
AM-FM-TV
889 El Puente Lane P.O. Box 888
Phone (Area Code 602) 623-1121
Tucson, Arizona—85713
Member IEEE

**Service
Directory**

**COMMERCIAL RADIO
MONITORING CO.**
PRECISION FREQUENCY
MEASUREMENTS
AM-FM-TV
103 S. Market St.,
Lee's Summit, Mo.
Phone Kansas City, LaClede 4-3777

**CAMBRIDGE CRYSTALS
PRECISION FREQUENCY
MEASURING SERVICE**
SPECIALISTS FOR AM-FM-TV
445 Concord Ave.,
Cambridge 38, Mass.
Phone TRowbridge 6-2810

PAUL DEAN FORD
Broadcast Engineering Consultant
R. R. 2, Box 27 47885
West Terre Haute, Indiana
Drexel 7597

surrendered its license authorization for WSPN and on March 3 license was cancelled and call letters deleted. Action March 18.

Routine roundup

ACTIONS BY REVIEW BOARD

■ By memorandum opinion and order denied motion by Ultravision Broadcasting Co. to enlarge issues in Buffalo TV channel 29 proceeding. Action March 17.

■ By memorandum opinion and order in consolidated proceeding on AM applications of Southern Radio and Television Co., Lehigh Acres, and Robert Hecksher (WMYR), Fort Myers, both Florida, in Dockets 14909-10, denied petition by WMYR for severance and grant of its application. Member Nelson not participating. Action March 17.

■ Granted petition by D. H. Overmyer to extend time to March 23 to file responses to petitions by Springfield Television Broadcasting Corp. to (1) add issue and (2) for amendment or clarification of issues in Toledo, Ohio, TV channel 79 proceeding. Member Nelson not participating. Action March 17.

■ Rescheduled March 31 oral argument for March 23 in proceeding on AM application of Easton Broadcasting Co. (WEMD), Easton, Md. Action March 17.

■ By memorandum opinion and order, denied motion by Trans-Tel Corp. to delete overlap issue (Issue 9) in Paterson, N. J., UHF-TV proceeding in Dockets 15089 et al. Member Nelson abstained from voting. Action March 13.

■ Granted motion by Integrated Communications Systems Inc., of Massachusetts, to extend time for 10 days (to and including March 27) to file responses to (1) motion by WGBH Educational Foundation to enlarge issues and to delete issue and (2) motion by United Artists Broadcasting Inc. to enlarge issues in Boston TV channel 44 proceeding. Action March 13.

■ Granted petition by Cobb County Broadcasting Co. to extend time to March 25 to file responses to Marietta Broadcasting Inc. (WBIE), petition to enlarge issues in proceeding on their applications in Marietta, Ga. Action March 13.

ACTIONS ON MOTIONS

By Chief Hearing Examiner
James D. Cunningham

■ Designated examiner Jay A. Kyle to preside at hearing in proceeding on applications of KTIV Television Co. (KTIV) and Peoples Broadcasting Corp. (KVTV), both Sioux City, and Central Broadcasting Co. (WHO-TV), Des Moines, Iowa, to make changes in facilities of their stations; scheduled prehearing conference for April 6 and hearing for May 11. Action March 16.

■ Designated examiner Elizabeth C. Smith to preside at hearing in proceeding on application of Grayson Enterprises Inc. to change trans. site of KWAB(TV) (ch. 4) Big Spring, Tex., increase power and make other changes in facilities; scheduled prehearing conference for April 2 and hearing for May 4. Action March 9.

By Hearing Examiner Charles J. Frederick
■ In proceeding on applications of Cleveland Broadcasting Inc. and Community

Telecasters of Cleveland Inc. for new TV on channel 19 in Cleveland, granted request of Cleveland Broadcasting Inc. and scheduled further hearing conference for March 18 for purpose of oral argument on petition of Community Telecasters for leave to amend application. Action March 13.

By Hearing Examiner Walther W. Guenther

■ Issued memorandum formalizing rulings made March 4 and 5 in proceeding on application of Bay Shore Broadcasting Co. for new AM in Hayward, Calif., rejecting applicant's Exhibit 15. Revised and denying motion for reconsideration of rejection. Action March 13.

By Hearing Examiner Isadore A. Honig

■ On own motion, scheduled hearing after remand for March 12 in proceeding on applications for new AM's of WEXC Inc., Depew, N. Y., et al. Action March 10.

By Hearing Examiner H. Gifford Irion

■ Granted request of American Colonial Broadcasting Corp. for special further prehearing conference for March 16 in proceeding on application to change trans. site and ant. height of WSUR-TV (ch. 9) Ponce, P. R. Action March 11.

By Hearing Examiner David I. Kraushaar

■ In Paterson, N. J., UHF-TV proceeding in Dockets 15089 et al, granted petition by Spanish International Television Inc. for leave to amend application to reflect current residence of officer, director and 5% stockholder; and by separate order, on own motion, in accordance with agreements reached at March 13 further prehearing conference, scheduled hearing for June 29, and June 5 for exchange of direct case exhibits. Action March 13.

By Hearing Examiner Jay A. Kyle

■ Granted request by American Broadcasting-Paramount Theatres Inc. (KGO-TV), San Francisco, for further prehearing conference on March 23 in proceeding in its application and that of Chronicle Publishing Co. (KRON-TV), San Francisco. Action March 16.

By Hearing Examiner Forest L. McClenning

■ Formalized by order certain agreements reached at March 11 prehearing conference in Toledo, Ohio, TV channel 79 proceeding, and continued April 20 hearing to May 11. Action March 11.

By Hearing Examiner
Chester F. Naumowicz Jr.

■ On own motion, advanced April 15 prehearing conference to April 13 in proceeding on AM applications of Northwestern Indiana Radio Inc., Valparaiso, Ind., et al. Action March 12.

By Hearing Examiner Sol Schildhouse

■ In proceeding on applications of Integrated Communication Systems Inc. of Massachusetts, United Artists Broadcasting Inc. and WGBH Educational Foundation for new TV's to operate on channel 44 in Boston, in Dockets 15323-5, granted request by Integrated to extend time to March 23 to file oppositions to WGBH motion to enlarge issues; by separate order, granted petition by

broadcast bureau to extent of extending time from March 12 to March 17 to respond to petition by Integrated for leave to amend its application. Action March 13.

By Hearing Examiner Elizabeth C. Smith

■ Pursuant to agreement reached at March 16 prehearing conference in proceeding on application of Spartan Radiocasting Co. for new TV broadcast translator, continued March 31 hearing to date to be fixed at May 1 further prehearing conference. Action March 16.

■ In proceeding on applications of Paul Dean Ford and J. T. Winchester, Charles H. Chamberlain and Brown Publishing Co. for new FM's in London and Urbana, respectively, all Ohio, in Dockets 15279-15281, granted joint motion to continue, among other procedural dates, April 20 hearing to May 20. Action March 13.

By Office of Opinions and Review

■ In proceeding on application of City of New York Municipal Broadcasting System (WNYC), New York, for SSA to operate additional hours from 6 a.m. (EST) to sunrise New York City and from sunset Minneapolis, Minn., to 10 p.m. (EST), and petition of Midwest Radio-Television, Inc. (WCCO), Minneapolis, to cancel SSA and deny or withhold action on application for extension of SSA without hearing; and, in any event, to hold any hearings on limited, non-comparative issues, granted motion by WNYC to extend time from Feb. 25 to March 17 to file amendment to its application and new application seeking regular licensing of presunrise and post-sunset operations. Action March 17.

■ Granted motion by South Florida Television Corp. to extend time to March 23 to file replies to joint petition to reopen record in Miami TV channel 10 proceeding. Action March 13.

BROADCAST ACTIONS

by Broadcast Bureau
Actions of March 17

■ Granted renewal of licenses for following: WAAX Gadsden, Ala.; WAJF Decatur, Ala.; WAPI-AM-FM Birmingham, Ala.; WBBQ-FM and SCA, Augusta, Ga.; WBRJ Jesup, Ga.; WBHP Huntsville, Ala.; WBRC-AM-FM Birmingham, Ala.; WBYG Savannah; WDEC Americus, Ga.; WELR Roanoke, Ala.; WFDX Huntsville, Ala.; WGBA Columbus, Ga.; WGHC Clayton, Ga.; WGSV Guntersville, Ala.; WGPC Albany, Ga.; WHRT Hartselle, Ala.; WIRB Enterprise, Ala.; WJAZ Selma, Ala.; WCOH-FM Newnan, Ga.; WHMA-FM Anniston, Ala.; WLBB Carrollton, Ga.; WLFA Lafayette, Ga.; WMAZ-AM-FM Macon, Ga.; WMRE Monroe, Ga.; WMVG Milledgeville, Ga.; WMPAX Thomasville, Ga.; WPLK Rockmart, Ga.; WPRN Butler, Ala.; WRGA Rome, Ga.; WRWJ Selma, Ala.; WSFT Thomaston, Ga.; WSGN Birmingham, Ala.; WELB Elba, Ala.; *WABE(FM) Atlanta; WAMI Opp, Ala.; WAUD Auburn, Ala.; WAZA Bainbridge, Ga.; WBBT Lyons, Ga.; WBHB Fitzgerald, Ga.; WBMK West Point, Ga.; WBYE Calera, Ala.; WCQS Alma, Ga.; WETU Wetumpka, Ala.; WFEB Sylacauga, Ala.; WGAU Athens, Ga.; WGF5 Covington, Ga.; WGST Atlanta; WGYV Greenville, Ala.; WHEP Foley, Ala.; WHMA Anniston, Ala.; WIMO Winder, Ga.; WJAM Marion, Ala.; WJBB Haleyville, Ala.; WEAS Savannah, Ga.; WLAG-FM, and SCA, LaGrange, Ga.; WLET Tooca, Ga.; WLYB Albany, Ga.; WMFC Monroeville, Ala.; WMTM Moultrie, Ga.; WNEA Newnan, Ga.; WPFE Eastman, Ga.; WPLO Atlanta; WRAB Arab, Ala.; WROM Rome, Ga.; WSAV Savannah, Ga.; WSGA Savannah, Ga.; WSNE Cumming, Ga.; WSNT Sandersville, Ga.; WULA Eufaula, Ala.; WSYL Sylvania, Ga.; WTJH East Point, Ga.; WTWA Thomaston, Ga.; WWWB Jasper, Ala.; WCRT Birmingham, Ala.; WLET-FM Toocoo, Ga.; WMES Ashburn, Ga.; WCHK Canton, Ga.; WGUN Decatur, Ga.; WAVQ(FM) Atlanta; WCOH Newnan, Ga.; WGAD Gadsden, Ala.; WGWC Selma, Ala.; WKLY Hartwell, Ga.; WOOF Dothan, Ala.; WWNS Statesboro, Ga.; WJHO Opelika, Ala.; KBBM(FM) Hayward, Calif.; KQIK Lakeview, Ore.; KSTN Stockton, Calif.; WFAX Falls Church, Va.; WGVA Geneva, N. Y.; WPAP Fernandina Beach, Fla.; WSOK Savannah, Ga.; WTRP LaGrange, Ga.; WTOC Savannah, Ga.; WWGS Tifton, Ga.; WWWR Russellville, Ala.; WRBL-FM and SCA, Columbus, Ga.; WBLA Augusta, Ga.; WEYY Talladega, Ala.; WALA Mobile, Ala.; WACL Waycross, Ga.; WBSG Blackshear, Ga.; WFOM Marietta, Ga.; WGAU-FM Athens, Ga.; WJAT Swainsboro, Ga.; WNUZ Talladega, Ala.; WTB

SUBSCRIPTION APPLICATION

BROADCASTING *The Businessweekly of Television and Radio*
1735 DeSales Street, N.W., Washington, D. C., 20036

Please start my subscription immediately for—

- | | | |
|---|--|---|
| <input type="checkbox"/> 52 weekly issues \$8.50 | <input type="checkbox"/> 104 weekly issues \$14.00 | <input type="checkbox"/> Payment attached |
| <input type="checkbox"/> 52 issues & 1964 Yearbook \$13.50 | | <input type="checkbox"/> Please bill |
| <input type="checkbox"/> 1964 Yearbook \$5.00 (so long as supply lasts) | | |

name _____ title/position* _____

address Business
 Home

city _____ state _____ zip code _____

company name _____

*Occupation Required

Troy, Ala.; WXLI Dublin, Ga.; KGOS Torrington, Wyo.; KEED-FM Springfield-Eugene, Ore.; KSON San Diego, Calif.; WALY Herkimer, N. Y.; WZOK Jacksonville, Fla.; WKDE Altavista, Va.; WTOA(FM) and SCA, Trenton, N. J.; WFRB Frostburg, Md.

KZTV(TV) Corpus Christi, Tex.—Granted CP to change ant. height to 950 feet, and make other equipment changes.

WKVM San Juan, P. R.—Granted CP to change ant.-trans. location to Santa Rosa Barrio, P. R., and make changes in ant. system (increase height).

WADM Decatur, Ind.—Granted mod. of CP to make changes in ant. system (increase height; delete top loading), make changes in ground system, and change studio location; remote control permitted; conditions.

Actions of March 16

WHMC Gaithersburg, Md.—Granted license for AM station.

KXMB-TV Bismarck, N. D.—Granted license covering redescription of trans. location as 5 miles east and 2 miles south of St. Anthony.

WREV-FM Reidsville, N. C.—Granted license covering use of old trans. as auxiliary trans. at main trans. location.

WHHT Lucedale, Miss.—Granted license covering increase in power and installation of new trans.

WAYE Dundalk, Md.—Granted license covering increase in power, changes in DA and ground systems, and change studio and station location to Baltimore.

WJLK Asbury Park, N. J.—Granted license covering increase in daytime power, installation DA-D and new trans. (specify type trans.); remote control permitted while using non-DA; conditions; and license covering use of old main trans. at present main trans. location as auxiliary trans.; remote control permitted (non-DA), night and day.

WMNB-FM North Adams, Mass.—Granted mod. of CP to install new ant.; ERP 1 kw (horizontal polarization) and 850 v (vertical polarization).

KNEV(FM) Reno, Nev.—Granted mod. of CP to move ant.-trans. location and decrease ant. height to minus 690 feet; remote control permitted (by employees of station only).

WDXL-FM Lexington, Tenn.—Granted mod. of CP to change type trans. and type ant.; ERP 3 kw.

Following were granted extensions of completion dates as shown: WROB West Point, Miss., to May 31, and W74AF, Springfield Television Broadcasting Corp., Adams, Mass., to Sept. 16.

Granted renewal of license for following: KICA Clovis, N. M.; WAMR Venice, Fla.; WDMS Lynchburg, Va.; WFRC Reidsville, N. C.; WHPB Belton, S. C.; WKWS Rocky Mount, Va.; WMOD Moundsville, W. Va.; WPIC-AM-FM Sharon, Pa.; WPVA Colonial Heights-Petersburg, Va.; and KXMB-TV Bismarck, N. D.

Ashland TV Club, Coal Creek, Home Creek, Otter Creek and Ashland, Mont.—Granted CP for new VHF-TV translator on channel 4, to rebroadcast programs of KULR-TV (ch. 8), Billings, Mont.

Actions of March 13

WMTN-FM Morristown, Tenn.—Granted SCA on sub-carrier frequency of 67 kc.

Granted renewal of licenses for following: WLOB-FM Portland, Me.; WKVA Lewistown, Pa.; WLOD Pompano Beach, Fla.; *WUSC-FM Columbia, S. C.; WABB Mobile; WABT Tuskegee; WAGF Dothan; WARF Jasper; WBCA Bay Minette, all Alabama; WBLJ Dalton, Ga.; WCRI Scottsboro, WCRF-TV and SCA, Birmingham, both Alabama; WDUN-AM-FM Gainesville, Ga.; WEBJ Brewton, Ala.; WERD Atlanta, Ga.; WFKK Pell City, Ala.; WGGG Gainesville, Ga.; WKSK West Jefferson, N. C.; WLBZ Bangor, Me.; WXTR Pawtucket, R. I.; WYCR(FM) York-Hanover, Pa.; WABF Fairhope; WACT Tuscaloosa; WAJM-FM and SCA, Montgomery; WATM Atmore, all Alabama; WBIE-FM Marietta, Ga.; WBLO Evergreen; WCRL Oneonta; WCTA and alternate main, WCTA-FM Andalusia, all Alabama; WEAD College Park, Ga.; WEUP Huntsville; WFMH-AM-FM Cullman, both Alabama; WGIC Brunswick; WGML Hinesville; WGPC-FM Albany, all Georgia; WHBB Selma; WJLD Homewood; WKRG and alternate main, WKRG-FM and SCA, Mobile; WNDA(FM) Huntsville, all Alabama; WPEH Louisville, Ga.; WRAG Carrollton, Ala.; WSEM Donalsonville; WVOH Hazlehurst, both Georgia; WWWB-FM Jasper; WWWF Fayette; WBAM Montgomery;

WJOF(FM) Athens; all Alabama; WHAB Baxley, Ga.; WJDB Thomasville; WJLN(FM) Birmingham; WJMW Athens; WLIQ Mobile; WMGY Montgomery; WOZK Ozark, all Alabama; WPLO-FM Atlanta, Ga.; WROS Scottsboro, Ala.; WSIZ Ocilla, Ga.; WVOK Birmingham, Ala.; WTOCFM and SCA, Savannah; WAUG Augusta, both Georgia; WFFA Fort Payne; WTHG Jackson, both Alabama.

Granted renewal of licenses for following TV translators: K09GC, K09FC, Midnight Sun Broadcasters Inc., Soldatna, Kenai and Nanana, Alaska; K70BS, K74BA, K76BB, K74BC, Kaiser Industries Corp., Naalehu and Volcano Area, Pahala, Honohina and Lihue, Kauai, Hawaii; K05AQ, K11CC, East Linn Community Telecasters Inc., Sweet Home, Ore.; K06BF, Paisley TV, Inc., Paisley, Ore.; K05BQ, Wildhorse Farmers TV Assn., Athena, Weston and Adams, Ore.; K73AE, K79AJ, Redmond JC-TV Inc., Redmond and

ETV fund grant

Following grant for matching federal funds for educational television has been announced by Department of Health, Education and Welfare: Calais, Me.—University of Maine: for \$109,736 to help establish educational TV station on channel 13; total project cost \$146,315.

Prineville, Ore.; K77AP, Umattila Rural Television Inc., Rural area near Pendleton, Ore.; K08DL, K10EK, K12DO, K70CH, K76BF, K79AN, K81AK, Translator TV Unlimited Inc., Westport, Grayland, Ocosta, Ocean Shores, Ocean City, Copalis, Pacific Beach, Aberdeen, Hoquiam, Montesano and Central Park, all Washington; K78AR, Radio Honolulu Ltd., Lihue, Kauai, Hawaii; K70BW, K82AM, Honolulu Star-Bulletin Inc., Lihue, Kauai, and Waimea, Hawaii; K11BH, K13BF, Diamond TV Corp., Oregon Corp., Diamond Valley, Harney County, Ore.; K04AE, K06AB, K09AE, K11AH, F.L.C.R. Community TV Inc., Long Creek, Ore.; K02AP, K04AW, K05AN, Siuslaw Translator Inc., Swisshome, Ore.; K71AT, K76AT, Countywide TV Inc., Burns, Ore.; K71AG, K73AJ, K77AH South Lane Television Inc., Cottage Grove, Ore.; K08CR, K10DC, K12CP, Danville Television Assn., Danville, Wash.; K03BG, K07EF, Tunnel TV Assn., Farming community SSW of Chelan Butte, Wash.; K08BQ, Lapwai Valley TV Assn., Lapwai, Idaho.

WLOB-FM Portland, Me.—Granted license covering changes in ant. and trans. location; specify ERP as 2.8 kw, and ant. height as 77 feet.

K80AW Dubuque, Iowa—Granted license covering changes for UHF-TV translator.

K76AM Tillamook, Ore.—Granted license for UHF-TV translator signal booster No. 1.

L. B. Wilson Inc. Cincinnati—Granted CPs and licenses for new low power auxiliaries.

WCPC Houston, Miss.—Granted CP to install auxiliary trans., using DA-D, at main trans. site.

KFLA Scott City, Kan.—Granted CP to make changes in ant. system (increase height); condition.

KCON Conway, Ark.—Granted CP to change ant.-trans. location 1,986 feet from present site; remote control permitted; condition.

KBRO Bremerton, Wash.—Granted CP to change ant.-trans. location; remote control permitted.

WANN Annapolis, Md.—Granted CP to make changes in daytime directional ant. pattern.

KNDR(FM) Des Moines, Iowa—Granted CP to change ant.-trans. location, install new ant., increase ERP to 5 kw, and decrease ant. height to 105 feet.

*WMTI(FM) Norfolk, Va.—Granted CP to install new trans., increase ERP to 50 kw, and decrease ant. height to 115 feet.

K09EK San Luis, Colo.—Granted CP to replace expired permit for new VHF-TV translator.

W73AE, W82AE Springfield and Amherst, Mass.—Granted CPs to replace expired permits for new UHF-TV translators.

K04BV Tierral-Deb-Mar and Sandlake, Ore.—Granted CP to make changes in ant. system for VHF-TV translator.

WVCA-FM Gloucester, Mass.—Granted mod. of CP to change studio and ant.-trans.

location, type trans. and type ant., increase ERP to 1.20 kw, and decrease ant. height to 53 feet; conditions.

WAWR-FM Bowling Green, Ohio—Granted mod. of CP to change type ant., and main studio location; remote control permitted.

Actions of March 13

*WMEM-TV Presque Isle, Me.—Granted CP to replace expired permit for new non-commercial educational TV.

WBOY-TV Clarksburg, W. Va.—Granted renewal of licenses.

Golden Rule Translator Inc. Mill City and Lyons-Mehama, Ore.—Granted CPs for new UHF-TV translators on channel 72, to rebroadcast programs of KATU(TV), channel 2, Portland; on channel 74 to rebroadcast programs of KOIN-TV, channel 6, Portland; on channel 78 to rebroadcast programs of KGW-TV, channel 8; and on channel 78 to rebroadcast programs of KPTV(TV), channel 12, Portland, all Oregon.

Granted licenses for following VHF-TV translators: W08AI, WIIC Inc., Connelville, Pa.; W13AK, United Television of New Hampshire Inc., Manchester, N. H.; K11GG, K13FX, Shoshone River Power Inc., Upper South Fork of Shoshone River and Valley, Wyo.

Granted licenses for following UHF-TV translators: K74CC, K and M Electronics Co., Columbus, Neb.; K79AW, K82AU, Tahoe Translator Co., Bijou, Calif.

Actions of March 12

Granted renewal of licenses for following: KPOJ-FM Portland, Ore.; KBBI(FM) Los Angeles; W1XX Oakland Park, Fla.; WMOV Ravenswood, W. Va.; *WUNC(FM) and SCA, Chapel Hill, N. C.; WLOF Orlando, Fla.; WBAG Burlington-Graham, N. C.; WLCM Lancaster, S. C.; WSBS Great Barrington, Mass.; WGTC and auxiliary, Greenville, N. C.; *WICB(FM) Ithaca, N. Y.

WLEW Bad Axe, Mich.—Granted license covering use of old main trans. as auxiliary trans. at main trans. site.

KPOJ-FM Portland, Ore.—Granted license covering installation of new ant.

WMOE Mobile, Ala.—Granted extension of completion date to May 15; without prejudice to such further action as commission

Continued on page 109

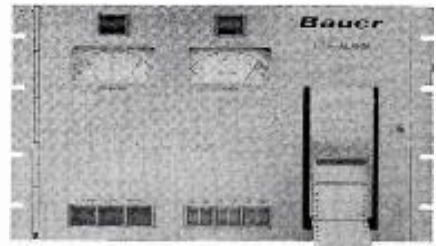

NEW..... SIMPLE METHOD TO LOG TRANSMITTER READINGS

The Bauer "Log Alarm" is simple . . . accurate . . . easy to operate . . . permits better use of your manpower . . . meets all FCC requirements for automatic logging devices . . . all in 10 1/2" of rack space.

Complete Details Available on Request!

Bauer
ELECTRONICS
CORPORATION

1663 Industrial Road, San Carlos, California
Area Code 415 591-9466

CLASSIFIED ADVERTISEMENTS

(Payable in advance. Checks and money orders only.) (FINAL DEADLINE—Monday preceding publication date.)

- SITUATIONS WANTED 20¢ per word—\$2.00 minimum • HELP WANTED 25¢ per word—\$2.00 minimum.
 - DISPLAY ads \$20.00 per inch—STATIONS FOR SALE, WANTED TO BUY STATIONS & EMPLOYMENT AGENCIES advertising require display space.
 - All other classifications, 30¢ per word—\$4.00 minimum.
 - No charge for blind box number. Send replies to *Broadcasting*, 1735 DeSales St., N.W., Washington, D. C. 20036.
- APPLICANTS: If transcriptions or bulk packages submitted, \$1.00 charge for mailing (Forward remittance separately, please). All transcriptions, photos etc., sent to box numbers are sent at owner's risk. BROADCASTING expressly repudiates any liability or responsibility for their custody or return.

RADIO—Help Wanted

Management

Management opportunity for hard-hitting hustler, well oriented in sales, with management background or qualifications. Work with me in sales, prove you've "got it," and complete management will be turned over in six months or less. Rocky Mountain area. Strictly confidential. Box C-315, BROADCASTING.

Sales manager wanted for Western Massachusetts station. Write Box C-349, BROADCASTING.

Sales manager radio major Midwest market. Aggressive news operation. Top fifty. Experience essential. Excellent opportunity for advancement. Send pic and resume Box C-353, BROADCASTING.

Sales

Detroit. Experienced top salesman, capable of management. Good salary plus with top station, multiple chain. Please write fully. Box B-262, BROADCASTING.

Aggressive salesman . . . capable of becoming sales manager . . . needed by growing good music station in Penna.'s 3rd market . . . good chance for small market man to move up. Send details & resume first letter to Box C-99, BROADCASTING.

California major market—fulltime well established adult radio station in fast growing area. Needs sharp, energetic, experienced time salesman. Substantial guarantee, commission, and a future with an expanding organization. An opportunity seldom seen in this market. If not interested in making above-average income do not apply. Send complete resume to Box C-121, BROADCASTING.

Excellent permanent sales opportunity. Residence Salt Lake City. All replies held in strictest confidence. Box C-236, BROADCASTING.

If you're a good sales-announcer combo, there's a great opportunity for you at a progressive, middle of the roader. Send resume and tape. Box C-272, BROADCASTING.

The man I am looking for is probably manager or sales manager, and cracker-jack, ambitious and successful salesman who is dreaming of owning his own station. To the right man I have a once in a lifetime opportunity. As soon as you prove yourself as local sales manager you can become junior partner and part owner of a station that is fast becoming the most accepted station in the capitol city of the Southern market. All replies will be kept confidential so please tell all in the first letter. Send to Box C-307, BROADCASTING.

S.F. Bay area suburb needs ethical account exec. More hard work than high pressure wanted. Good deal for right guy. AM, adult, growing. Personal data and details. Box C-332, BROADCASTING.

Aggressive salesman needed for growing FM in New York metropolitan area. Base and good commission rate. Only those interested in hard work and working into sales manager position need apply. Send resume and photo to Box C-346, BROADCASTING.

Sunny California need self starting experienced time salesman. Good deal for right man with ideas and imagination. This is an immediate opening if you qualify. Call, wire or write John Karr, KASK Radio, Ontario, California.

Sales—(Cont'd)

Work and play in colorful Colorado, vacationland of the booming Rocky Mountain empire. Opportunity for salesman-announcer with production experience. Write KCOL, Fort Collins, Colorado.

Experienced salesman-announcer. Adult operation. KDWA, Hastings, Minnesota.

Salesmen needed for fastest growing country radio in market of 512,000. Number of sponsors has tripled in last six months. Will give experienced man capable of producing, \$500 per month guarantee on a 20% commission basis, plus good base of on the air accounts. Write all details to the nation's 73rd market. KWNT Country Radio, 1019 Mound St., Davenport, Iowa.

Salesman-airman . . . progressive, youthful, medium market station wants ambitious time salesman with air ability for limited number of shows. Job has potential to become number two man at station for hardworker. Contact Richard Scholem, WTIG, Massillon, Ohio, TE 2-5023.

Announcers

Have you worked for a top 40 station without top 40 music? It will be the most challenging and stimulating experience of your life if you are truly talented and are prepared to pay the price of success. Midwestern kilowatt. Box C-209, BROADCASTING.

Experience for day shift or middle of the road music format at Wisconsin station, Box C-217, BROADCASTING.

Experienced announcer with first phone and production know-how. If you'll work hard, you will have a steady, good paying position with a growing group of Texas stations. Need tape, resume and picture. Box C-245, BROADCASTING.

Big power West Coast station needs top men—immediate opening—send tape and resume to Box C-291, BROADCASTING.

We have opening for experienced radio manager with sales potential in Midwest college town. Opening available now. Box C-310, BROADCASTING.

Intelligent beginner wanting to learn? Here's that job you've wanted. Continuity, production, traffic, news. Also need newsman. Lower Midwest, small market. Box C-313, BROADCASTING.

Top 25 market, looking for "team"—one, two may apply if aggressive, want job. Earnings commensurate performance and salesability. No drinkers. Complete resume, photo, recent air check. All returned with reply. Box C-331, BROADCASTING.

Morning man for adult sound indie in top 5 Eastern market. Personality, smooth, good music knowledge, tight production. Tape, resume, picture to Box C-362, BROADCASTING.

Are you ready? To make your move? To the big time? Major market. Fast growing group. Opportunity unlimited for the man who can inject personality into good music format and entertain. 5 figure salary to start. Send tape you think represents your work and include resume. All replies confidential. Box C-370, BROADCASTING.

Announcers—(Cont'd)

Opportunity for married staff announcer. Outline experience. KFRO, Longview, Texas.

Opportunity at small market desert station. Announcing, local news, production. Tape resume and salary required to KIOT, Barstow, Calif.

Announcers—Staffing new FM. Send tape, photo, resume. K SIS, Sedalia, Missouri.

Announcer with first phone, no maintenance, WAMD, Aberdeen, Md.

Need immediately newsman-announcer to gather, write and report for quality news operation. Send resume, tape, photo. WASA, Havre de Grace, Md.

Immediate opening 5 kw daytimer—traffic, continuity, relief announcing. Start \$85.00 weekly. Send information and copy sample to WGVM, Box 247, Greenville, Miss.

Announcer. Live, swinging personality, top 40 operation. WHSL, Wilmington, N. C.

Experienced announcer by Chicagoland station. Capable of doing a good modern pop show. Must have individual sound, good mature humor, knowledge of today's music, ability and interest in sports. Send tape and resume to Program Director, WJOB Radio, Hammond, Indiana.

Announcer wanted. 2 years minimum experience. Send tape and references to Barry Medlin, WLCM, Lancaster, S. C.

Need top deejay for top station in medium Florida market, bright happy modern sound our speciality. Send tape, resume, references to WONN, Box 2038, Lakeland, Fla.

Immediate opening first phone announcer for evening shift pay commensurate with ability adult quality format on fringe of major market. Resume and tape to Gerry Grainger, WWCA Gary, Indiana.

Suburban Milwaukee station beginning operations approximately April 5th, growing weary of auditioning "ticky-tacky" morning men. If you are a young, literate, knowledgeable, polished, interesting personality looking for a bright future, airmail tape and resume to WYLO, Jackson, Wisconsin.

Principal instructor, nationally known radio institute will critique, return, your half hour air check. \$5.00. Cutler, 2743 Welborn, Dallas, 75219

Technical

Working first phone with announcing ability . . . Salary open . . . progressive, middle of roader AM-FM operation in fast growing Florida market. Send resume and tape. Box C-287, BROADCASTING.

Chief engineer, Major Ohio market AM-FM operation (non-directional) has excellent opportunity for top engineer with experience in construction AM, FM, Multiplex. Maintenance, but no board work. Send complete application, salary requirements, photo to Box C-304, BROADCASTING.

Technical—(Cont'd)

Wanted chief engineer. 5 thousand watt directional AM station. University town in the Northwest. FM and TV being applied for. Must have prior chief experience. Box C-364, BROADCASTING.

Immediate opening for experienced Chief Engineer. Primary duty maintenance but prefer man capable of some announcing. Better than average salary. Send resume and history of recent earnings to: Jim McDonald, WKNY, P.O. Box 418, Kingston, N.Y.

The Institute of Broadcast Engineers has been formed. Plan to attend first general meeting NAB, 2:30 p.m. Williford Room, Hilton Hotel April 5. Engineer's membership information from IBE Box 1841, Annapolis, Md.

Production—Programing, Others

Newsman for aggressive midwest metropolitan network affiliate. Good salary. Station adding to local news staff. Box C-268, BROADCASTING.

Newsman, major network owned radio-TV station. Send resume, tape. Must be good writer, on-air. Box C-341, BROADCASTING.

Need immediately—good newsman for news editor's position and air work. Professional delivery and public relations ability important. Opening at regional station in desirable Northern Midwest, 2 station market. Box C-347, BROADCASTING.

Young newsman: Earn a Master's degree and \$3,000 a year. Graduate assistantships in broadcast news open in professional school of journalism at a major university. Graduate study includes work in newsrooms of large commercial stations in the nation's biggest cities. If you have some professional experience, a bachelor's degree, and a "B" average in college, you're eligible. Box C-354, BROADCASTING.

Continuity director, experienced, major market Eastern seaboard. Heavy production, creative, hard, soft sell, some air, no prima donna. Gal OK, samples, resume, tapes, picture to Box C-363, BROADCASTING.

Immediate opening, like yesterday! For good local newsman. . . . Complete charge . . . suburban Los Angeles full timer . . . if you are ready for work call John Karr. . . KASK Radio, Ontario, California.

News writer and reporter—full time position—salary plus talent—complete charge of news operation. Write personal data and sample news copy to radio station WVAM, Altoona, Pennsylvania.

RADIO—Situations Wanted

Management

Manager-sales manager. 18 years radio, ten management. Successful local/national sales, programing, promotion, single and competitive markets. Age 39, Box C-294, BROADCASTING.

Manager, 17 years, all phases, new construction, heavy sales. Prefer Northeast. Immediate availability. Box C-338, BROADCASTING.

General management wanted by all-around radio man. Completely experienced, especially sales. Box C-350, BROADCASTING.

Attention! Successful manager wishes relocation. Proven record, never operated at loss! 21 years in radio, 14 years management. Currently in major market, 50 kw, desire return to smaller market, 1, 5, or 10 kw. Not afraid of competitive market. Desire management for absentee owner who needs man he can depend on. Wife experienced in radio and available as man-wife team. Accent on sales and good production. Box C-357, BROADCASTING.

RADIO—Situations Wanted

Management—(Cont'd)

14 years diversified radio experience. Married, mid-thirties, first phone, broad academic background. Will accept offer East of Mississippi. \$8,000.00 min. or percentage. Box C-361, BROADCASTING.

Attention California station owners! Top flight manager-sales manager wishes move up. Heavy on sales and organization. Former employers agree. Now General Sales Manager, KMYC-KRFD P.O. Box 631, Marysville, California. Current employers know of this ad. Address replies Dick Kelly.

Sales

Sales—radio and/or television, total 15 years experience in all phases of radio and TV operation including administrative capacity and sales. Seeking permanent position in larger market with opportunity for advancement. Box C-215, BROADCASTING.

College graduate (radio speech) with 2 years announcing experience seeking sales trainees position with reputable, adult radio-TV station. Box C-336, BROADCASTING.

Announcers

Mature 16 year old boy desires summer dj show on rock 'n roll station. Capable of DJ show and production. Tape and resume available upon request. Box C-183, BROADCASTING.

Experienced announcer, first phone, chief available April first, replies answered. Box C-249, BROADCASTING.

DJ—wants to swing with top 40. One year middle of road experience. Single. Box C-256, BROADCASTING.

Negro: age 42, family . . . Wisconsin resident . . . employed public affairs . . . production . . . news, jazz expert, television experience. Desires only lucrative non-stereotype position. Excellent references. Cultured pleasant voice. Box C-259, BROADCASTING.

5 year jock desires station that knows the score. Box C-296, BROADCASTING.

Wanted: C/W slot-sales by versatile announcer-musician. CMA member, 18 years broadcasting. Box C-298, BROADCASTING.

First phone. Grantham graduate. Willing to learn announcing. Seeks permanent position in central Virginia. Available April 1st. Box C-299, BROADCASTING.

Experienced announcer/dj, news, strong on sports. Married, reliable. Prefer Southwest but will consider other areas. Top 40—middle of the road. 1st phone. Box C-302, BROADCASTING.

Summer—21 years old, college junior, NYU, desires dj show. 300 miles NYC. Prefer rock. Great personality. 3 years experience. Box C-305, BROADCASTING.

Sportscaster-dj, bright personality, versatile, professional attitude, not a floater, willing worker. Box C-306, BROADCASTING.

Dave Allen is looking. If you have a progressive organization and want an aggressive jock, write Box C-311, BROADCASTING.

Announcer—mature voice with good training, experience in broadcasting, seeks connection with broadcasting station offering challenging position. N.Y. City area preferred. Box C-316, BROADCASTING.

Solid operation, good market, tell all, major experience, 2nd phone, married. Box C-318, BROADCASTING.

Reliable, experienced announcer: Pleasant voice, effective language, excellent references. Prefer good music station. Box C-319, BROADCASTING.

DJ/announcer. Bright personality, fast production, tight board. Authoritative news. Not a prima donna. Box C-320, BROADCASTING.

Announcers—(Cont'd)

Announcer-dj. One year college. Broadcasting school graduate. Looking for a start. Capable, dependable, hard working. Box C-321, BROADCASTING.

6 years announcing experience. Good voice and personality. Married man. Box C-328, BROADCASTING.

DJ, good news delivery, tight board, some experience, listens good. Box C-328, BROADCASTING.

Number one personality in twelve station market, with bright tasteful humorous approach. Box C-330, BROADCASTING.

Experienced, versatile oldman, tight board, strong on news, not a floater. Presently #1 morning man on 50 kw. Box C-333, BROADCASTING.

Announcer D.J. looking for top 40 station willing to give chance. Good voice & potential, 4 months experience. Minimum salary. Box C-334, BROADCASTING.

Versatile engineer announcer, six years experience. Good news and commercial delivery. Interested in permanency. College. Box C-340, BROADCASTING.

Country D.J.—10 yrs., top market experience—musician—best references. Box C-344, BROADCASTING.

Experienced first-phone announcer, experienced news director, sales experience, looking for play by play opportunity, excellent references. Box C-351, BROADCASTING.

Announcer, now employed as pd. No rock. Family. Prefer Southeast. Box C-367, BROADCASTING.

Ohio, Midwest. Sportscasting, sales—guaranteed high income on sports. Two years at present location, 24, college graduate. Professional delivery, knows sports! Top sales too, seeks larger market. Bob Grimm, 1174 Linwood, Columbus, Ohio, Hickory 4-3021.

Clutched in hand—brand new 1st phone. Will move out with great vigor. My domain U.S.A. 6 years experience—various formats—major markets. Prefer large operation—not necessary. Married—want to settle. Mark Troy, P.O.B. 7673, Atlanta 9, Ga.

Experienced combo, 3 years, tight board, good maintenance. Must use wheelchair at all times. Prefer night operation in Southeast. Tape and resume on request. All replies considered and answered. Call or write Bill Burnette, WGML, Hinesville, Ga.

Announcer—1st class ticket, some sports, 2½ yrs. experience. Family man, prefer Midwest. 515-236-6372.

Personality deejay seeking change. Offer eight years experience for secure position, good salary. Prefer middle-road programing or subuded top 40. Good news delivery. Major markets only. First ticket. 502-896-1917.

Experienced third phone: DJ, news, combo, versatile, top 40, R&B, big voice with level head will relocate anywhere. Negro, reply: Box 89, Bronx 53, New York.

Sportscaster—dj with personality needs more experience. Looking for small market in New England or east. Age 25. Nick Cornett, 9 Holly St. Lawrence, Mass. 617-682-3125.

Technical

Technical-programing specialist will build or rebuild your facility in either or both departments. Exceptional challenge with matching salary sought, consideration given to term offers. Intimate with AM-FM-stereo & custom station design, veteran in modern formats. Top references. Box C-219, BROADCASTING.

High power experienced first class phone seeking position. Chief engineer or assistant. No announcing. \$135 week. Box C-232, BROADCASTING.

First phone—13 years experience—AM, FM and directional. Maintenance, construction, production—3½ years chief. Box C-265, BROADCASTING.

RADIO—Situations Wanted

Technical—(Cont'd)

South Florida, experience 1st ticket, age 43, car, married, last job 5 kw Gates directional. Box C-325, BROADCASTING.

Just received first phone, have TV repair and parts experience. Desire position with radio or TV station. Will travel. Box C-343, BROADCASTING.

Female, first phone, BA (journalism speech production). Amateur experience. Anywhere. Box C-365, BROADCASTING.

Fifteen years experience. Two as chief. Like announcing but voice is poor. McClain GL 9-8243, Kokomo, Ind.

First phone trainee, will travel, radio or TV. Technical school graduate. Two years radio, "board" operator. Gary McClendon, 210 Rose Road, Albertville, Ala. 878-1221.

Production—Programing, Others

Programing-Technical Specialist will build or rebuild you facility in either or both departments. Exceptional challenge with matching salary sought, consideration given to term offers. Intimate with modern formats, versed in AM-FM stereo, custom station design. Top references. Box C-218, BROADCASTING.

Modern C&W pd/dj—first phone—3 years major market—will build ratings with exciting C&W format. Prefer Western U. S. Box C-297, BROADCASTING.

Five years experience, most phases radio. Want program or production management. Offer sincere, dedicated approach, ideas and ability in production, writing, announcing. Currently in top twenty market. Married, no children. Looking for 25th to 40th market but will consider smaller with opportunities and reasonable salary. Anywhere but South. Box C-300, BROADCASTING.

Experienced sports play-by-play, news and announcing. Married. 1st phone. Box C-301, BROADCASTING.

Program director, great production, build image, ratings, billing, excellent background. Box C-303, BROADCASTING.

News director—TV/AM. Reporter, writer, newscaster, department supervision. No personal problems. Dependable performance. Start \$700. Box C-329, BROADCASTING.

Young enthusiastic music man, desires a position as music director at a popular music station in the Midwest or West. Three years experience in music at top station in the top 35 markets. Also can swing as jock if necessary. Good references—can help your station get ahead. Box C-339, BROADCASTING.

Program director/air personality 100% record of results and ratings. Modern radio with showmanship. Former programing consultant. I specialize in sick ratings and format changes. Revitalize and reorganize with me. Young, married, not too expensive, but very good. Let's talk! Box C-348, BROADCASTING.

Presently employed PD, 4 years experience, desires East Coast opportunity. Strong on production, promotion and personality. Box C-352, BROADCASTING.

Newsman—married, 31, family, seeks larger market. Six years experience, all phases radio, news, including considerable interview experience. Authoritative delivery and copy. Prefer Midwest, however all inquires considered. Box C-356, BROADCASTING.

TELEVISION—Help Wanted

Sales

East central Midwest TV station, top 25 market, has current opening for salesman with experience. Young man in smaller market and all others, will be considered for active account list. Reply in full to Box C-292, BROADCASTING.

TELEVISION—Help Wanted

Announcers

Southeastern network affiliate seeking announcers with news, weather & MC experience. Send resume, photo and audio or video tape to Box B-85, BROADCASTING.

Technical

Experienced TV engineers required by major East Coast network station for April through October period. Good Salaries and working conditions with potential for permanent employment. Must have 1st class FCC phone license. Box B-177, BROADCASTING.

TV transmitter technician at least 4 years experience RCA transmitters and associated equipment. Leading southern California station, excellent working conditions, insurance, pension, for right man. Box C-241, BROADCASTING.

Chief engineer, UHF, must be good supervisor as well as studio and transmitter technician. Small staff. Box C-312, BROADCASTING.

Chief engineer—major market Midwest. Broad technical experience and management capabilities. Should have experience with UHF, VHF, FM, AM, microwave and video taping. Box C-322, BROADCASTING.

TV broadcast engineer—Willing to take trainee or experienced young man with first class license for major Midwest television station outlets. Box C-324, BROADCASTING.

TV technician. Modern CATV system in progressive Southeastern city offers opportunity for advancement, pleasant healthful living to a well-trained man disciplined in maintaining high quality video and reliable performance. Prefer family man. Please write experience, age, technical training and expected compensation in first letter. We shall reply Box C-368, BROADCASTING.

Studio engineer: Must have first phone license and reasonable television experience. Prefer man with VTR knowledge. Send resume to Ward Bledsoe, KERO-TV, Bakersfield, California.

Immediate opening for experienced studio man with maintenance and video tape background. A permanent position and in a progressive station. Contact immediately. Howard McClure, Chief engineer, KLYD-TV, 2831 Eye St., Bakersfield, Calif.

Assistant chief. Good opportunity for hard worker with solid background in broadcast engineering, including television studio and transmitter maintenance and operations. Bright future with VHF-TV and AM operation in Pacific Northwest. Send complete resume and photo in confidence to Ellis Feinstein, KMED TV/AM, Medford, Oregon.

Stable transmitter supervisor to live at transmitter site. Residence and utilities furnished. Maintenance and partial operating shift. Good opportunity for capable engineer. Send details airmail or call manager, KSWSTV, 622-6450, Roswell, N. M.

Have immediate opening for one TV engineer. Must have first phone. Contact Bill Elks, WECT, Wilmington, N. C.

Need two first phone engineers immediately. One permanent and one vacation relief. Permanent man must be experienced. Will consider recent technical school graduate for vacation relief job. Send full information first letter. Contact R. Truscott, WITI-TV, 5445 N. 27th St., Milwaukee, Wis.

Midwest UHF has opening for engineer with first class license. Position requires operation of AM-FM-TV control rooms and transmitters. Experience in radio or TV desired but others will be considered. Pat Finnegan, CE, WLBC-AM-FM-TV Muncie, Indiana.

TV broadcast equipment engineers—Need engineers for design development field service and test work. Ideal location in university town with many cultural and education advantages. E. M. Sears, Box 62, Bloomington, Ind.

Production—Programing, Others

Have opening for top quality director-producer on staff of Midwest TV station. Man selected should be able to create selling commercials and work with clients. This is a real opportunity for a pro. Send resume, references, pix and all pertinent information. Box C-286, BROADCASTING.

Southeastern VHF city of over 100,000 needs combination booth man and sports director. Base plus talent. Send resume, photo and audio or video tape to Box C-290, BROADCASTING.

Creative TV artist—Experienced commercial layouts, hot-press—some freehand and photo experience helpful. Excellent opportunity. Also need good copywriter. Send full resume to Box C-314, BROADCASTING.

Continuity writers—For both radio and TV. Midwest area. Experience preferred. Will consider all interested and potentially capable applicants. Desire man for TV, woman for radio. Excellent opportunities. Box C-323, BROADCASTING.

Southeastern VHF seeking good beat and on camera newsmen capable of filming, editing, writing, and gathering news. Send resume photo and audio or video tape to Box C-342, BROADCASTING.

Young newsmen: Earn a Master's degree and \$3,000 a year. Graduate assistantships in broadcast news open in professional school of journalism at a major university. Graduate study includes work in newsrooms of large commercial stations in the nation's biggest cities. If you have some professional experience, a bachelor's degree, and a "B" average in college, you're eligible. Box C-355, BROADCASTING.

TELEVISION—Situations Wanted

Management

Top record in local and regional sales, consistently. Excellent media and personal history. Seek sales management opportunity. Box C-335, BROADCASTING.

TV pioneer station operator, 20 years experience, all phases television since 1948, many awards, TV firsts, owned major market radio, available for managerial position. Family man, 39. Personal meeting arranged at convention or otherwise. Your reply held in strictest confidence. Box C-359, BROADCASTING.

Sales

Sales exec. AM-TV, prefers Southern California-Arizona areas. Exceptional record with proven stability covers agency, station and representative successes. Full details and understandable reasons for change await your inquiry. Income requirements moderate. Box C-345, BROADCASTING.

Announcers

Staff member on vacation? Let me fill. On-camera TV announcer-mc. I write excellent copy. Desire June, July and August work in or around New York to attend World's Fair. In broadcasting five years. Will consider radio. Box C-113, BROADCASTING.

Children's personality (who likes children) mimic, comic, artist, presently employed. Box C-358, BROADCASTING.

Technical

Chief engineer. 16 years experience all phases. Looking for top position in Midwest or Northeast. Available for interview at NAB. Box C-134, BROADCASTING.

Triangle stations TV weatherman available soon. 11 years experience. All phases of broadcasting. Highest recommendations. Box C-295, BROADCASTING.

Transmitter engineer, mature, dependable. Operation and maintenance. Minimum of supervision. Any area. J. Benonis, 3809 Riedel Ave., Lake Worth, Fla. 305-585-1623

Production—Programing, Others

News director: Experienced investigative reporter seeks news-in-depth opportunity. 13 years, excellent airwork, references. Box C-103, BROADCASTING.

WANTED TO BUY

Equipment

Wanted: an Ampex/alto-fonic, 450 series continuous play tape reproducer, state age, condition and price. Box C-201, BROADCASTING.

Wanted: Used 3 1/2 inch transmission line. Reply Box C-234, BROADCASTING.

Wanted: One 200' self supporting tower capable of supporting 10' microwave dish. Also need a complete 2000 mc. 10 watt microwave system in good condition. Contact Chief Engineer, WJBF-TV, Augusta, Ga.

VHF TV transmitters, cameras, all studio equipment, test equipment, relay xmtrs, antennas, Technical Systems Corp., 42 W. 15th St., N.Y. 11, N.Y. CH 2-1949.

Wanted: All equipment for FM station. 1, 3, or 5 kw xmtr. Tower, antenna and monitors. Quote price and condition. Box C-309, BROADCASTING.

Wanted: used Shaffer 800 or 1200 automation system or equivalent with Ampex transports. Five to seven KC FM transmitter. Obsolete non-multiplex FM driver in working condition. KFLY, Corvallis, Oregon.

Tape automation equipment adaptable to stereo. Also need mono audio equipment. WLRW-FM, Champaign, Ill.

FOR SALE

Equipment

UHF 1 kw Continental transmitter modified for color, presently tuned for Channel 18. Offering does not include the filter-plexer. Transmitter in excellent condition—\$9,500.00. Contact J. W. Robertson, Chief Engineer, WLEX-TV, Lexington, Kentucky.

Television/radio transmitters, cameras, microwave, tubes, audio, monitors. Electrofind, 440 Columbus Ave., N.Y.C.

Xmission Line; Teflon insulated, 1 1/2" rigid, 51.5 Ohm flanged with bullets and all hardware. New—unused, 20 foot length for \$40.00. Quantity discounts. Stock list available. Sierra-Western Electric, 1401 Middle Harbor Road, Oakland 20, California, Templebar 2-3527.

Hellax coaxial cable, HJ5-50 type, new, 85 1/2 ft. FOB, E.E.E.E., P.O. Box 2025, La Mesa, Calif.

Duplicators—Ampex S3200 master. Demo units. Brand new at cost. Call or write Mr. Cook, Shrader Sound, Inc., 2803 M St., N.W., Washington, D. C. Phone area 202-965-1300.

Image orthicons, used, all guaranteed working order, 40 available on "as is" basis, \$40 each, FOB Chicago. Chief Engineer, WTTW, 1761 E. Museum Drive, Chicago, Ill.

Ampex F-4460 portable: Unused, unsuitable our application. In warranty, purchased December 10th. \$450.00. Audio Development Co., 44 Roydon, Merrick, N. Y.

For sale: RCA type TTU1B UHF 1 kilowatt transmitter, excellent condition—\$15,000. Box C-308, BROADCASTING.

4 16 inch Empire and Gray arms. 3 Recokut 16 inch turntables complete. 2 continuous play tape decks (background music). Make offer. WLIR, Garden City, New York.

For Sales: 2 ea. 343 tubes. Brand new with only 1000 hours service. \$150 ea. Also sockets for same. Contact R. E. Owens, 421-1750, Cincinnati, 1906 Highland Ave.

Mobile broadcasting studio in excellent condition. Studio lounge, heat and air-conditioning, fully equipped or stripped, 25 feet long. Box C-317, BROADCASTING.

Collins announcer, ideal for remotes, two turntables, two mike inputs, good condition, best offer over \$500. F.O.B. Liberal. John B. Gray, KLIB Radio, Liberal, Kansas.

RCA-BTR-11A remote control system. Original condition and configuration. New cost \$1075, sell for \$575.00. KLBS, 1428 La Sierra Dr., Sacramento 25, Calif.

FOR SALE

Equipment—(Cont'd)

Gates automatic turntable. Perfect for top 40. Top condition. \$650.00. Request full details. Box C-327, BROADCASTING.

Ampex—Aitec—Langevin—Electrovoice—Bogen—etc. Check our prices on broadcast equipment. PCN 7403 Oakland Station, Pittsburgh, Pa. 15213

Seeburg Select-O-Matic 200, with Seeburg Hi-fidelity 20 watt amplifier. Both in excellent condition—\$600.00. Two Gates turntables and gray arms, fair condition—\$60.00. Will ship. Contact radio station WMRE Monroe, Georgia.

Remember us? We are back. Visit our new store located mid Manhattan. TV, AM-FM xmtrs, test equipment, studio equip., tubes, components. The best in used equipment. Communication and short wave a specialty. We like to export. Technical Systems Corp., 42 W. 15th St., N.Y. 11, N.Y. CH 2-1949.

FM antenna turnable to 92.7 mc. Any number of bays. Also have 97.3 two-bay to sell. KVMA, Magnolia, Ark.

5 kw RCA type BTA 5-F. Would be interested in a good used 1000 watt transmitter as part payment. Best offer. Contact Joe Dressler for more information. WZOK, Jacksonville, Fla.

MISCELLANEOUS

30,000 Professional Comedy Lines! Topical laugh service featuring deejay comment, introductions. Free catalog. Orben Comedy Books, Atlantic Beach, N. Y.

Need help? 1000 Super dooper hooper scooper one liners exclusive in your market. Free sample. Lyn Publications, 2221, Steiner St., San Francisco.

168 hours—A complete summary of the week in review, accenting the major stories of the past 168 hours. A perfect 15 minute program, spaced with actualities, and the sounds of the news—Air Mail Special Delivery for weekend broadcasting. Top audience response—added depth and prestige—amazingly low cost. Write Box N-125, BROADCASTING.

Customized news-weather-sports intros/extras for your special clients. \$10 with your copy. Satisfaction or recut. Six Twenty Nine Productions, Pensacola, Florida.

Wanted: Used correspondence course looking toward obtaining 1st class license. Reply Box C-235, BROADCASTING.

Station breaks—A collection of one-line comedy pieces for breaks, station IDs., dead spots, etc.—\$5.00—Snow-Biz Comedy Service, (Dept. SB), 65 Parkway Court, Brooklyn, N. Y. 11235

INSTRUCTIONS

FCC first phone license preparation by correspondence or in resident classes. Grantham Schools are located in Los Angeles, Seattle, Kansas City and Washington. For free 44-page brochure write Dept. 4-K, Grantham Schools, 3123 Gillham Road, Kansas City, Missouri.

The nationally known 6 weeks Elkins training for an FCC First Class License. Outstanding theory and laboratory instructions. Elkins Radio License School of New Orleans, 333 Saint Charles, New Orleans, Louisiana.

Be prepared. First class FCC license in six weeks. Top quality theory and laboratory training. Elkins Radio License School of Atlanta, 1139 Spring St., N.W., Atlanta, Georgia.

FCC first phone license in six weeks. Guaranteed instruction in theory and laboratory methods by master teachers. G.I. approved. Request free brochure. Elkins Radio License School, 2603 Inwood Road, Dallas, Texas.

INSTRUCTIONS—(Cont'd)

Elkins Radio License School of Chicago—Six weeks quality instruction in laboratory methods and theory leading to the FCC First Class License. 14 East Jackson St., Chicago 4, Illinois.

Announcing, programing, console operation Twelve weeks intensive, practical training. Finest, most modern equipment available. G. I. approved. Elkins School of Broadcasting, 2603 Inwood Road, Dallas 35, Texas.

San Francisco's Chris Borden School continues top placement record. Proven 1st phone and "modern" sound. Illustrated brochure, 259 Geary St.

Announcing, programing, first phone, all phases electronics. Thorough, intensive practical training. Methods and results proved many times. Free placement service. Allied Technical Schools, 207 Madison, Memphis, Tennessee.

Since 1946. Original course for FCC first phone operator license in six weeks. Over 420 hours instruction and over 200 hours guided discussion at school. Reservations required. Enrolling now for classes starting May 13, July 15 & September 23. For information, references and reservations, write William B. Ogden Radio Operational Engineering School, 1150 West Olive Ave., Burbank, California.

Why waste time and money? Come to beautiful sunny Sarasota and get your FCC 1st class radio-telephone license in 5 weeks. Complete tuition \$295. Your license is guaranteed or a complete refund. Write Dwain Glenn at his new beautiful location, Radio Engineering Institute, Box 3855, 1336 Main St., Sarasota, Fla.

Special accelerated first phone preparation available at Los Angeles Division of Grantham Schools. New classes begin May 18 and July 20. Lab training and advanced electronics available after first phone course, to those who wish to continue. For free brochure, write: Dept. 4-B, Grantham Schools, 1505 N. Western Ave., Los Angeles, Calif. 90027

Train now in N.Y.C. for FCC first phone license. Proven methods, proven results. Day and evening classes. Placement assistance, Announcer Training Studios, 25 W. 43rd, N. Y. OX 5-9245.

Intensive thirteen week course in announcing, control board operation, production, news and copy writing. All new and most modern equipment, facilities. Graduates enter first jobs with confidence. P. L. Hughes, Director, Broadcasting Institute of America, Inc., P. O. B. 53321, New Orleans 50, Louisiana.

America's pioneer. 1st in broadcasting since 1934. National Academy of Broadcasting, 814 H St. NW. Washington 1, D. C.

Pittsburgh, FCC first class "success-proven" accelerated course now in Pittsburgh. Day or evening. Free placement. For brochure, write American Electronics School, 415 Smithfield St., Pittsburgh 22, Pa. Phone 281-5422.

FCC license in six weeks. Total cost \$285.00. Complete combination course, DJ, newscasting, etc. Total cost \$450.00. Train in fabulous Houston. Houston Institute of Electronics and Broadcasting, 904 M and M Building, Houston, Texas. CA-7-0529.

Train on KWSK: Enroll now. class starts April 6th. Announcing, controls, news, copy, tapes, remotes, logs, traffic, sales, FCC rules, third ticket. We know our business! Placement service, Clem Morgan, KWSK, Pratt, Kansas.

RADIO—Help Wanted**Sales****FUTURE REP BRANCH MANAGERS**

Our regional rep offices are growing and we're ready to open more of them as soon as we can train qualified men. Our personnel needs have tripled in the last year-and-a-half. Loads of opportunity for good hard workers who know their business.

Write: Len Auerbach, President

REGIONAL REPS ASSOC.

2nd Floor Fidelity Bldg.
Cleveland 14, O.

(Ohio Stations Representatives, Inc.)

(Penn State Reps, Inc.)

(Indiana Division)

TOP MEDIA SALESMAN

Progressive Eastern Radio Station seeks man now selling time or space to Chicago Advertisers and Agencies. Relocate Chicago. Some Travel. Good future with good company. For Chicago Interview week of March 23, call or wire Kenneth M Cooper, WICC Radio, Fairfield, (Bridgeport), Connecticut.

SALES!!! REPS.

Manufacturer of professional broadcast-quality equipment including Tape Cartridge, Audio Console, and related Studio Equipment looking for boosted sales in New England and N. Y., Penna. & Mid Atlantic, Texas & Southwest, Nebraska & Midwest. Primarily broadcast, but commercial adaptation also. Attractive straight commission. Interviews at NAB Chicago, April 5-8, or send references and full resume.

SPARTA ELECTRONIC CORPORATION

6450 Freeport Blvd.
Sacramento, Calif. 95822

Announcers**RADIO NEWS DIRECTOR
TOP 25 MARKET**

Professional news man capable of quality air work, as well as administration of aggressive news department. College graduate. Good practical experience. Send resume, picture and tape to:

Box C-293, BROADCASTING

Production—Programing, Others**No. 1 rated WNOE**

New Orleans, needs versatile, creative, competent, cooperative production director. Must have production and promotion work. If you really want to move into a top notch organization, and have the ability. Send tape and resume immediately to:

B. M. Sammers, WNOE
New Orleans, Louisiana

TELEVISION—Help Wanted**Sales****CAN YOU SELL
TV PROGRAMMING**

Leading TV film distributor seeks to expand its Account Executive force. Broadcast or print media sales experience helpful. If you are young, aggressive, enthusiastic, have the stamina our industry requires, are free to travel and most important of all, demonstrate growth potential, you may fit our bill. Write sufficient details about yourself to warrant an interview.

Box C-228, BROADCASTING

Announcers**OPENING
FOR TV ANNOUNCER**

WSM-TV, Nashville, Tennessee, wants to add personable, experienced man (under 30!) to present staff. This station, oldest in market, is noted for live programming. Send resume (including family status, education, experience and references, a recent photograph and audio tape) to ...

Jud Collins
WSM-TV
Nashville, Tennessee

Technical**Television/Field Broadcast
Engineers**

Video and RCA Television Tape installation and maintenance experience required. Considerable travel involved. Openings in East. Send resume to: Mr. D. K. Thorne, RCA Service Company, Cherry Hill, Camden 8, New Jersey.

An Equal Opportunity Employer

Production—Programing, Others**WRITER PRODUCER**

Top television station in major mid-west market seeks a first-rate writer-producer for its documentary unit. Must have strong working experience in all aspects of the field. If you're the top man in your market and ready to move up, we'd like to hear from you. Please send full details of broadcast experience and productions to:

Box C-197, BROADCASTING

FOR SALE—Equipment**\$99.00 Wollensak**

Tape Recorder! New! 4-speeds—push button—electric—nartb equalization +3 DB 80-12,000 cycles. 20 lb. portable with microphone, etc. 7" reel capacity. \$99.00 certified check or money order for prepaid delivery or \$10.00 deposit, \$89.00 C. O. D. Tower Distributors, Box 125, Lafayette Hill, Penna. 19444.

**FOR SALE
TV STUDIO
EQUIPMENT**

Used in closed circuit telecasts only limited number of hours.

2 COMPLETE DU MONT IMAGE ORTHONIC CAMERA CHAINS (camera head, both friction head and balance head with ball bearing pan, auxiliary pick-up units, low voltage power supply units, portable sync. generators, Du-mittors, and all interconnecting cables).

PLUS: 2 each 50mm, 90mm, and 135mm lenses. 4 sets telephone headsets with 5' cords. RCA pedestal dolly, tripod and trucking dolly.

STUDIO LIGHTS: 4 Baby Keglites, 1-44N8 TVG Kliegl spots, 3-44N6 Kliegl spots, 2 TV-1155G Scoops, 1 B&M stand with strip-lights.

BOOMS: 2 E. J. Baughman 10' micro booms with sponge rubber hangers and Electrovoice mikes.

Available as complete camera chains or as individual units.

NORTHWEST SCHOOLS

1221 N. W. 21st Avenue
Portland, Oregon
Area Code 503, Capitol 6-4811

**AIR-CONVERSION EQUIPMENT FOR TTS
TRANSMITTER**

Equipment tested-proven-accepted in major TV markets coast-to-coast.

Inquire: David I. Green Engrg. Co.
So. 3711 Latawah
Spokane, Wash. 99203

EMPLOYMENT SERVICE**MOVE TO THE ROCKIES!!!**

We are the only agency in the seven-state Rocky Mountain area specializing in radio and TV personnel. Immediate openings for Managers, Salesmen, Engineers, Traffic, Copy, and other categories. Send inquiry and resume to:

RADIO AND TV DIVISION
COLORADO BUSINESS INSTITUTE
SUITE 641 EQUITABLE BLDG.
DENVER, COLORADO 80202

■ THE ONE SERVICE DEVOTED SOLELY TO BROADCASTERS ■ JOB HUNTERS AND THOSE PRESENTLY WORKING BUT READY TO MOVE ■ MANAGERS TO TRAFFIC GIRLS ■ THE INDUSTRY'S BEST ARE IN OUR FILES ■ ■ ■ ■ ■ BROADCAST PERSONNEL AGENCY ■ SHERLEE BARISH, DIRECTOR ■ 527 MADISON AVE. ■ NEW YORK, N. Y. 10022 ■ ■ ■ ■ ■

WANTED TO BUY—Stations

Radio Station

Wanted direct from owners. Please give complete details first letter. Qualified buyer. Reply in confidence to:

Box B-248, BROADCASTING

CASH

Or terms for fulltimers in California Growth Areas. Want stations now.

Box C-369, BROADCASTING

TV STATION

Wanted direct from owners. Please give complete details first letter. Reply in confidence to:

Box B-247, BROADCASTING

RADIO STATION WANTED

I'm interested in healthy medium-sized AM in growth market. Owner please reply in confidence to:

Box C-337, BROADCASTING

FOR SALE—Stations

TAMPA, FLORIDA

10,000 Watts—Non-directional day—1550 KC. New equipment—building—studios. Florida's largest industrial city. Ideal opportunity for Country—Western—Religious format. Priced at book value for quick sale. contact: John McLendon—Box 197 Jackson, Miss.—601-948-1617.

WEST COAST MAJOR METRO

5,000 watt fulltime station in one of the great growth markets of the West. Well-established and showing steady increases. Asking \$550,000 on terms to reliable broadcaster.

BOX C-213, BROADCASTING

HALF INTEREST

New York 1 KW daytimer in rapidly growing single station market only 50 miles from N. Y. C. Valuable real estate includes attractive combination studio-transmitter building.

Box C-360, BROADCASTING

C. P. FOR SALE AT COST

5 KW 2-tower daytimer, 1280 kc. Spokane, Washington. Construction almost completed. Trade area 350,000 . . . rich market. D. Berthoff, 4104 N. "K" St., Spokane Wash. Phone FA 7-1018.

STATIONS FOR SALE

1. ISLAND STATION. Fulltime. \$75,000. Excellent terms.
2. WESTERN METROPOLITAN. Daytime. \$150,000. 29% down.

**NEED HELP?
LOOKING FOR A JOB?
SOMETHING TO BUY OR SELL?**

**For Best Results
You Can't Top A
CLASSIFIED AD**

in

BROADCASTING
THE BUSINESSWEEKLY OF TELEVISION AND RADIO

FOR SALE—Stations—(Cont'd)

CALIFORNIA CLASS-B FM PERMIT

Assigned to San Jose on 106.5 MC. Signal will cover large metro area from San Francisco south. Available for actual out-of-pocket costs of less than \$10,000. Quick action necessary.

Box C-366, BROADCASTING

RADIO STATION FOR SALE

Southern California desert radio station for sale. No. 1 in county. Grossed \$96,000 in 1961, new averaging \$6000 per month. 1 kw daytime now, can go 5 kw; also night. Small staff. Excellent money-maker with vast potential for owner-manager. Present owners unable to devote enough time to operation. \$86,000 for 60%. \$44,000 cash. Additional stock available. FM application ready to be filed. Send proof financial ability.

Box C-244, BROADCASTING

THE PIONEER FIRM OF TELEVISION AND RADIO MANAGEMENT CONSULTANTS ESTABLISHED 1946

Negotiations Management Appraisals Financing

HOWARD S. FRAZIER, INC.

1736 Wisconsin Ave., N.W.
Washington 7, D. C.

Pa.	single	daytime	\$ 60M	terms
Me.	single	fulltime	100M	28M
Miss.	medium	daytime	80M	SOLD
South	metro	FM	45M	15M
S.E.	Top 50	daytime	237M	29%

buying and selling, check with

✓ **CHAPMAN COMPANY INC**
2045 PEACHTREE RD., ATLANTA, GA. 30309

To buy or sell Radio and/or TV properties contact:

PATT McDONALD CO.
P. O. BOX 9266 - GL 3-8080
AUSTIN 56, TEXAS

Continued from page 103

may deem appropriate with respect to WMOE/WMOZ call letter dispute currently pending before commission.

WCOP Boston—Granted request to cancel license covering operation of auxiliary trans.

■ Following were granted extensions of completion dates: WIVI Christiansted, V. I., to April 25; WBRN Big Rapids, Mich., to May 15; KPOS Post, Tex., to July 7; WJBL Holland, Mich., to May 17; WPRT Prestonsburg, Ky., to June 10; WCET Roanoke Rapids, N. C., to July 1; WOLF Syracuse, N. Y., to April 30; KHFH Sierra Vista, Ariz., to June 28; KWAM Memphis, to Aug. 12; WRSJ-FM Bayonne, F. R., to May 1; WROW-FM Albany, N. Y., to Sept. 24.

Washington County Television Dept. Rural Juab and Sanpete Counties, Utah—Granted CP for new UHF TV translator on channel 75 to rebroadcast programs of KCPX-TV, channel 4, Salt Lake City.

Actions of March 11

■ Granted CPs for following new VHF TV translators: Cody TV Club, channel 13, Cody, Wyo., to rebroadcast programs of KTWO-TV (ch. 2), Casper, Wyo.; Northern Television Inc., channel 4, Talkeetna, Alaska, to rebroadcast programs of KTVA (TV) (ch. 11), Anchorage, Alaska; Shoshone River Power Inc., on channels 7 and 9, Clarks Fork Area of Yellowstone River, and Sugarloaf Mountain Area, Wyo., KOOK-TV (ch. 2), and KULR-TV (ch. 8), both Billings, Montana, respectively.

Barbourville Area Television Corp. Barbourville, Ky.—Granted CP for new VHF TV translator on channel 7 to rebroadcast programs of WATE-TV, channel 6, Knoxville, Tenn.

■ Granted renewal of licensee for following: WDEV (alternate main and auxiliary), Waterbury, Vt., *WFSU-TV, KJE-44, Tallahassee, WJBS Crestview, WKAT-FM and SCA, Miami Beach, WKIS-FM Orlando, WNSM Valparaiso-Niceville, WWVL-FM Ft. Lauderdale, WBAR Bartow, *WFSU-FM Tallahassee, WIVY and auxiliary, Jacksonville, WKAT, auxiliary and alternate main, Miami Beach, WKWF Key West, WFLA Plant City, WYAK(FM) and SCA, Sarasota, all Florida.

WINF-AM-FM Manchester, Conn.—Granted mod. of license to change name to Information Radio of Connecticut Inc.

K08ES Red River, N. M.—Granted CP to change frequency to channel 8, primary TV station to KGGM (ch. 18), Albuquerque, N. M., trans. location and make changes in ant. system for VHF TV translator.

*KCSM-TV San Mateo, Calif.—Granted mod. of CP to change ERP to 13.8 kw visual, and 7.4 kw aural; make changes in ant. structure and heights; describe trans. and studio locations, and change ant. height to 380 feet.

WCTS-FM Minneapolis—Granted mod. of CP to decrease ERP to 21.5 kw, increase ant. height to 430 feet, move ant.-trans. location to approximately 1 mile south of New Brighton, Minn., install new trans. and new ant., and make changes in ant. system (increase height).

WWOG(FM) Boca Raton, Fla.—Granted mod. of CP to change name to Bibletown, U.S.A. Inc.

■ Following were granted extensions of completion dates: KPRC-TV (main trans. and ant.) Houston, to June 30; KICU-TV Visalia, Calif., to July 1; WFIV Kissimmee, Fla., to Aug. 31; WCND Shelbyville, Ky., to April 30; KSGM Chester, Ill., to April 30; KABL Oakland, Calif., to July 29; WNDY Indianapolis, to June 23; WRAN Dover, N. J., to Sept. 15; WRHC Jacksonville, Fla., to Aug. 17; KNOP North Platte, Neb., to July 1; *WPHS(FM) Warren, Mich., to April 20; KBLE-FM Seattle, to May 1; WWOG(FM) Boca Raton, Fla., to June 30; WGEE-FM Indianapolis, to May 13; KRON-FM San Francisco, to Sept. 16.

Actions of March 9

■ Granted CPs for following new VHF TV translators: Woody Creek Recreation Assn., on channel 3, Pitkin County Rural Area, Colo., to rebroadcast programs of KREX-TV (ch. 13), Grand Junction, Colo.; West Daniels TV, on channel 13, Peerless and Richland, Mont., KUMV-TV (ch. 8), Williston, N. D.

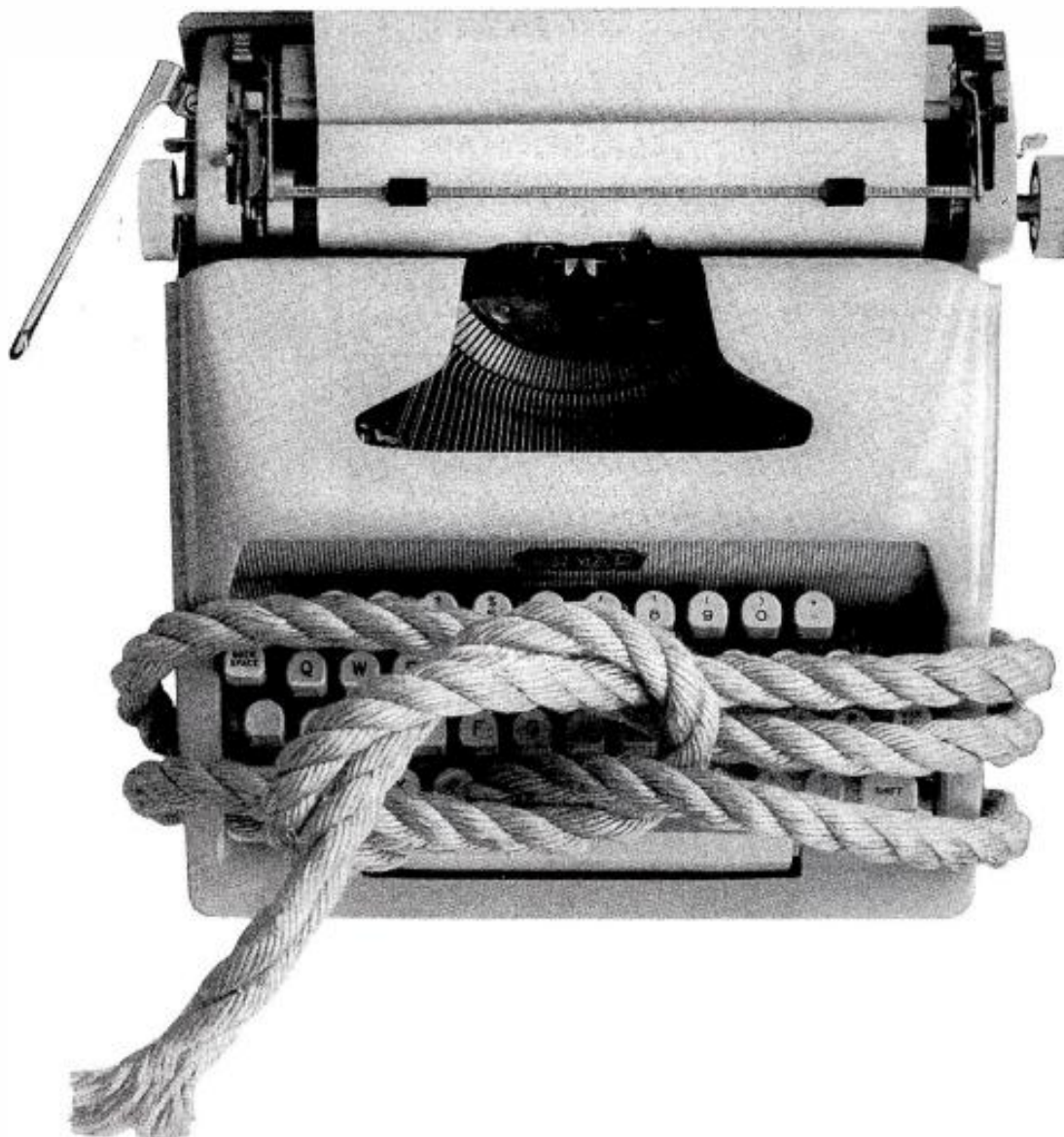

The communications tie-up that could choke our economy.

"Business has failed in one aspect of its communications," a leading corporate executive said recently, "and that is winning public understanding of our business system."

Example: the public greatly *under*-estimates the positive function of profits, and immensely *over*-estimates their size. Misunderstanding in this one area alone can lead to ill-advised wage demands and strikes, and a shrinkage in the capital investment which is the life-blood of our economy.

To help relieve this critical shortage of knowledge, the non-profit, non-political American Economic Foundation is building the Hall of Free Enterprise (shown under construction in the small illustration) at the New York World's Fair. It will be the first structure to visualize

and dramatize the principles of private, competitive capitalism—first to use modern audio-video techniques to show what makes the profit and loss system tick.

The Hall will cost \$2.1 million, and is supported by voluntary contributions. Write for more information or send your tax-deductible check to: Hall of Free Enterprise, Dept. CW, American Economic Foundation, 51 East 42nd St., New York 17, N.Y.



TYPOGRAPHY FOR THIS MESSAGE CONTRIBUTED BY TRI-ARTS PRESS, INC., N.Y.C. ENGRAVING BY BECK ENGRAVING CO., N.Y.C., ELECTRO BY REILLY ELECTROTYPE, N.Y.C.

On Friday, June 29, 1962, Jack Smock put in his last day as vice president of Young & Rubicam and head of that agency's Los Angeles office. On Monday, July 2, 1962, Mr. Smock put in his first day as president of Smock, Debnam & Waddell. With him at the new agency were 18 others who, the previous week, had been employed at Y&R. Their duties there had chiefly concerned the advertising of the Union Oil Co. of California and would continue to be so at SD&W, where Union Oil was the first account.

Normally, when a top executive at one agency leaves to open his own shop and takes along a major account, charges of unfair tactics, and worse, are a routine sequel. But no such cries were heard in July 1962. On the contrary, Y&R gave Smock, Debnam & Waddell its blessing and used its influence to get the new agency immediate admittance into the American Association of Advertising Agencies, usually a two-year procedure.

Union or Gulf? — The reason for Y&R's abnormal attitude was that Union Oil's change of agencies had been a Y&R decision. Gulf Oil Corp., longtime client of Y&R in New York, had purchased Wilshire Oil Co. of California and was planning to move the Gulf brands of gasoline and motor oil into the West, where they would become competitive with Union's "76" products and create a client conflict. So Y&R had to make a choice and since Gulf's advertising budget was nearly four times that of Union (roughly \$11 million to \$3 million at that time), the choice came easily.

As a matter of record, Jack Smock's association with Union Oil goes back to the late 1930's and to Lord & Thomas, Los Angeles, where "I was a combination writer-account executive with Union as one of my accounts." When, in 1943, Lord & Thomas became Foote, Cone & Belding, Union and Jack Smock both continued with the agency, where he successively became account supervisor, vice president and director. In 1953, Mr. Smock moved to Young & Rubicam as Los Angeles manager and, six months later, Union Oil also moved to Y&R. "I sometimes feel that I've been working for Union Oil all my life," he said with a smile.

Radio Pioneer — Union Oil has been a radio advertiser for almost as long as radio has been an advertising medium and since the end of World War II has become probably the major sponsor of sports broadcasts west of the Rockies: "From amateur tennis to professional football, from the sport of kings to the great American game, you name it and Union Oil has sponsored it, on radio and, in recent years, on television too," Mr. Smock has said. "But television has

In Union there is strength from radio-TV

never been permitted to push radio out of the Union schedule and so long as I have anything to say about it, it never will. We've had some great experiences with radio."

One was in connection with Union Oil's co-sponsorship of the play-by-play broadcasts of the games of the Los Angeles Dodgers on a special radio network of about 20 stations fed by KFI Los Angeles, which began in 1960. (The Dodger's advertising is also handled by Smock, Debnam & Waddell.) During this particular season, a series of sports

booklets, "The Dodgers Family Albums," with stories and pictures of the individual team members, was distributed weekly at service stations flying the sign of the "76." In one of the albums the plates of the pictures of pitchers Sandy Koufax and Don Drysdale somehow got reversed, turning left-handed Koufax into a right-hander and Drysdale into a southpaw. Sportscaster Vin Scully laughingly reported on the air that the new booklet contained "a glaring mistake" and offered two tickets for a game to the first 20 listeners who found the mistake and wrote him about it.

Radio Pulls — "That was on a Friday," Mr. Smock related. "By Monday, we had 5,000 replies. By Wednesday, when we stopped counting, the total was much higher. Think of it. More than 5,000 people had gone out to '76' stations to get the books, then had taken them home, found the error and then had written a letter to Vin, found a stamp and mailed it. All because of a single announcement on the radio.

"Because of experiences like that—and believe me, there are lots of them—we at Smock, Debnam and Waddell are firm believers in radio today and see it becoming even stronger in the future. That's why we use it for Captain Kitt cat food as well as for Union Oil."

Television, Mr. Smock feels, is on the verge of a change that will be as dramatic "but hopefully not as traumatic," as the change which radio went through in the early 1950's, when TV became a national medium of entertainment and advertising. Television's new look, he believes, will come as a result of two new factors, both imminent. One is the requirement that, after April 30, only all-channel TV sets may be shipped interstate.

"This," Mr. Smock commented, "means there'll soon be a sizable audience able to receive UHF programs and when the audience is there the programs won't be far behind. UHF stations will go on the air rapidly and for the first time we'll see specialized stations in television such as we have had in radio. An example is KMEX-TV (ch. 34) here in Los Angeles, dedicated to the Spanish-speaking audience."

The other new influence is pay TV, "and that too will be specialized television. In fact, I might say special event television, for I can't see it as a regular five-to-midnight operation night after night. There just isn't that amount of extra-special programming available, and it's got to be extra-special to get people to pay to see it when commercial television is there for free.

"I don't see any real threat to our present system of television, supported by advertising, in pay TV. Eventually, American television will be a combination of the two," Mr. Smock thinks.

WEEK'S PROFILE



Jack Walter Smock—president, Smock, Debnam & Waddell, Los Angeles; b. Nov. 19, 1909, Des Moines, Iowa; U. of Wisconsin (English major); BA, 1931; m. Margaret McKay, July 24, 1934; children—Jack Jr., 26; Juli, 23; Peter C., 16; writer, California State Emergency Relief Organization, 1934; publicity man, Palos Verdes Estates, 1935; dealer service, Washington State Apple Advertising Commission, 1937; copywriter-account executive, Lord & Thomas, Los Angeles, 1938-1943; account supervisor, VP, director, Foote, Cone & Belding, 1943-1952; VP in charge of Los Angeles office, Young & Rubicam, 1953-1962; president, Smock, Debnam & Waddell, July 1962; organizations—Chi Psi, California Club, Valley Hunt Club of Pasadena; director, Los Angeles YMCA; trustee, Pasadena Art Museum; vice chairman, California Council on Criminal Delinquency; director, Town Hall; past chairman (1960-61) Pacific Region, American Association of Advertising Agencies.

Popping the code

MEre mention of hard liquor advertising on the air is the equivalent of mashing the panic button. Bells ring, whistles howl, the WCTU and church groups march, and threats of "appropriate legislation" to bar John Barleycorn from the air erupt on Capitol Hill.

Last week the respected WQXR New York, owned by the respected *New York Times*, announced it would accept whiskey commercials after 10:30 p.m. Reaction was immediate although not widespread. All were caught by surprise because WQXR was just about the last station that would be expected to make the leap.

Though we imagine the roof will cave in on us again (it happened first in 1957) we must state our admiration for WQXR and its operating head, Elliott M. Sanger Sr. for courage and candor. WQXR is a quality station which directs its appeal to a preponderantly adult good-music audience. It is located in the nation's largest market with the largest choice of AM, FM and TV services.

What WQXR does and the reaction to it will be observed with interest by broadcasters, by distillers and, of course, by the anti-alcoholic beverage groups. If it works, many broadcasters will consider how they can best tap this new revenue source.

Therein lies the danger. No legal question now is involved. Liquor is a legitimate product and brands are advertised in other media—with some exceptions.

It would be the height of imprudence for stations to rush into hard liquor advertising. Certainly networks will not, if only because they cannot commit affiliates.

Mr. Sanger concluded that in a market like New York, with his format, time placement and copy control, he would encounter no insurmountable problems. There are other stations in large markets with similar appeals that could accommodate and control liquor commercials.

But it would be suicidal for stations with "modern" formats that appeal to teen-agers to solicit such business. It's our guess that distillers, who have most at stake, would avoid them anyway.

The key words in liquor advertising on the air are taste, judgment, discretion and responsibility. And even these might not be enough in a fight with what has been a most effective and ubiquitous lobby.

Tax logic prevails

A FACT of television economic life has at last been given legal recognition in the U. S. Tax Court's decision that network affiliation contracts are assets of determinable value and determinable life and are therefore depreciable. As reported in BROADCASTING last week, Corinthian Broadcasting won this important point in a case involving two of its stations.

Corinthian had ascribed a value of \$4,650,000 to CBS affiliations for WISH-TV Indianapolis and WANE-TV Fort Wayne, Ind., which Corinthian bought (with their companion radio stations) for \$10 million. The tax court ruled that Corinthian's position, though contested by the Internal Revenue Service, was correct and that the affiliations could be depreciated over a life of 20 years at one-twentieth of their total value per year.

This ruling, if it survives appeals, could lead to substantial tax savings for Corinthian and for many other station owners. On the two Indiana stations, for example, Corinthian will be able to charge some \$230,000 a year to depreciation of its affiliations and thus reduce its taxable income by that amount. Other station owners who have acquired properties in recent years and have claimed de-

ductions for depreciation of affiliations will benefit if the Corinthian case stands, and so will future station buyers.

Corinthian has already spent more than \$200,000 in legal fees to get this important decision. If Internal Revenue decides to appeal, Corinthian ought not to be asked to bear the whole cost of litigation that is as much in many other station owners' interest as in Corinthian's. Some of the \$2 million budget of the National Association of Broadcasters could be put to good use in this case.

Send him a sympathy card

THE agency for Hallmark Cards, which has acquired a considerable reputation (not to mention dominance in the greeting-card business) from its sponsorship of high-budgeted television specials, has proposed a new television rate structure to provide discounts for quality as well as for quantity. As suggested by the agency, equal incentives in the form of rate reductions ought to be given the advertiser such as Hallmark that buys a few expensive programs each year and the advertiser that buys participations week after week in cheaper shows that are aimed at the mass audience.

It is a nice idea, and it made an interesting speech by Homer R. Heck, of Foote, Cone & Belding, Hallmark's agency, to the Chicago chapter of the American Women in Radio and Television. Like a lot of nice ideas, however, this one ignores a number of practical points.

Mr. Heck complained of rising costs of production and time, but he failed to mention that the number of viewers reached by Hallmark advertising has risen by a larger margin than that of the increase in Hallmark's television costs. For example, an NBC spokesman pointed out last week, Hallmark's audience for "Abe Lincoln in Illinois" last February, was 39% bigger than for its celebrated "Little Moon of Alban" in March 1958. ("Little Moon" was played again last week, but national audience figures were not immediately available.) In the same span of years Hallmark's time costs increased 36% and, as nearly as NBC can figure, its program costs went up some 30%.

It is true, as Mr. Heck said, that the *Hallmark Hall of Fame* has given television some of its finest hours. It is also true that television has given Hallmark advertising impact that it could have acquired in no other way. Hallmark and its agency can hardly be blamed for wishing that television costs would come down, just as the American shopper may wish for the return of the nickel greeting card. In the reality of present prices and values, neither wish is apt to come true.



Drawn for BROADCASTING by Sid Hix
 "Today's editorial is 'What happened to old-fashioned Yankee thrift?' His wife just bought a mink coat!"



When **Bob Ryan** says
 "Go out and buy it",
 people go out and buy it!

KSTP-TV's award-winning newscaster, Bob Ryan, reports the "News Picture" at 6:00 p.m., Monday through Friday.

His average rating for the five days is an outstanding 18.7, or 119,940 television homes delivered with each telecast!*

These unmatched ratings are the result of KSTP-TV's 16-year leadership in news gathering, editing and reporting.

Northwest viewers depend on KSTP-TV for information (and entertainment) just as advertisers depend on KSTP-TV to sell their products — most effectively, most efficiently.

Represented nationally by Edward Petry & Co., Inc.

* Nielsen Station Index, Dec. 9-22 and 30 to January 12, 1964, Average Week.

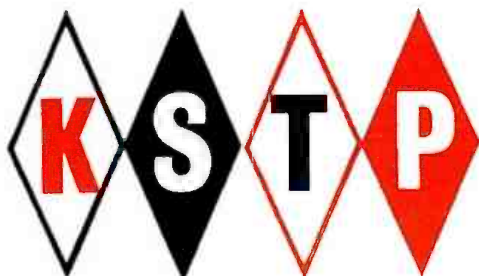

TELEVISION • CHANNEL 5 • NBC
100,000 WATTS • MINNEAPOLIS • ST. PAUL

HUBBARD BROADCASTING, INC.

**HEART
of the
PIEDMONT**

⊙
Danville, Va.

WYPR

Greensboro, N. C. Durham, N. C.

⊙
WPET

⊙
WSSB

*A LEADER IN EVERY CITY
A GIANT IN THE PIEDMONT*

*One of America's richest and fastest growing
areas. King of the industrial South.*

Beattie **B**roadcasting **C**ompany

now
represented
by



adam young inc.

NEW YORK • CHICAGO • ATLANTA • BOSTON • DALLAS • DETROIT • LOS ANGELES • ST. LOUIS • SAN FRANCISCO

REPRESENTING RADIO AND TV STATIONS