



# BROADCASTING

THE BUSINESS

AND RADIO

U.S. Air Force  
Air University Lib  
63-8999  
Serial Acq Section  
Maxwell AFB Ala

5/2763  
3Y 100  
11515  
MAY64 CIN

NEWSPAPER

AUGUST 12, 1963

Fall spot TV selling: It's running 7 to 10% ahead of last year ..... 29

Radio drama's comeback gets a strong assist as ABC schedules daily series ..... 64

Richardson compounds federal remedies if ratings ills aren't cured ..... 34

NAACP, CORE converge on radio-television in Los Angeles, N.Y. .... 62

COMPLETE INDEX PAGE 7

## MAXIMUM RESPONSE —that's advertising efficiency.



# WBAL-TV BALTIMORE

MARYLAND'S NUMBER ONE CHANNEL OF COMMUNICATION

# *Time Buyers' Bonanza* *one-minute availabilities*

## wmal-tv

WASHINGTON, D. C.

Call Harrington, Righter & Parsons Inc. for 1-minute spot avails on more than 26-hours of new local programming each week. (Some 20-sec. and 10-sec. avails, too.)

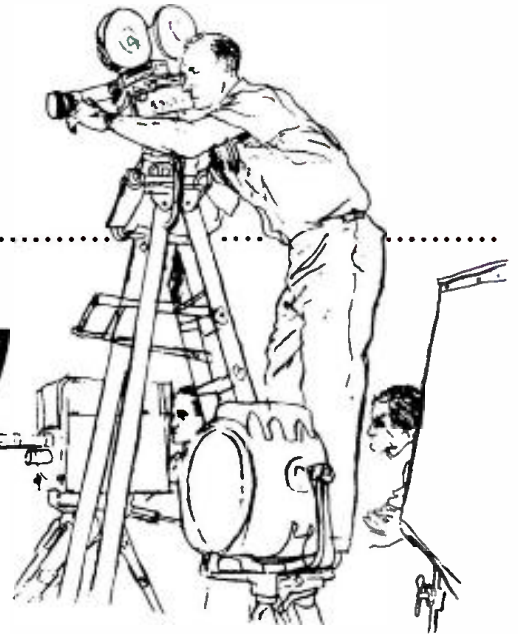

# NEWS 7

6:30-7:30 PM  
MONDAY THRU FRIDAY

Early-evening 1-hour newscast re-designed to even better present the news. Flexible format with the importance of news item determining its position and length. New format tailormade for participating sponsors.

## THE SALES ACTION HOUR

5:30-6:30 PM, MONDAY THRU FRIDAY Different show each day: Cheyenne, Surfside 6, Adventures in Paradise, Checkmate, Maverick



1ST RUN MGM  
30/63 MOVIE  
11:30 PM  
Friday



NAKED  
CITY  
10:30 PM Thursday  
11:30 PM Saturday



DICK POWELL  
THEATRE  
11:15 PM  
Sunday



THE  
FUNNY COMPANY  
8:00-9:00 AM  
(M-F)



DIVORCE  
COURT  
1:30-2:30 PM  
(M-F)



BACHELOR  
FATHER  
5:00-5:30 PM  
(M-F)

# wmal-tv abc

The Evening Star Broadcasting Co., Washington, D. C.

BALTIMORE'S BEST INFORMED ADULTS PREFER  
WCBM'S TOTAL NEWS COVERAGE! 17 HOURS OF  
LOCAL AND REGIONAL NEWS... PLUS 15 HOURS  
OF CBS NEWS... ADD UP TO A TOTAL OF 32 HOURS  
OF NEWS EVERY WEEK ON WCBM. BALTIMORE'S  
LARGEST RADIO NEWS TEAM GATHERS THE NEWS  
STATE-WIDE AND CITY-WIDE... THEN REPORTS IT  
IN DEPTH... ADULT STYLE. THIS KIND OF NEWS...  
PLUS QUALITY MUSIC, PLEASING PERSONALITIES,  
INTERESTING FEATURES... CONSISTENTLY DELIVERS  
THE ADULT AUDIENCE... PEOPLE WITH MONEY TO  
SPEND FOR YOUR PRODUCTS AND SERVICES!

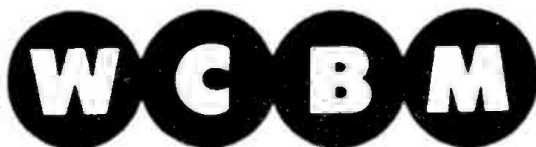

*National Sales Representative*

**Metro Radio Sales**

A SERVICE OF METROPOLITAN BROADCASTING

A CBS RADIO AFFILIATE • 10,000 Watts on 68 KC & 106.5 FM • Baltimore 13, Maryland

**GREATER  
CAPACITY  
TO RENDER SERVICE**



**WGAL-TV does the *BIG*-selling job**

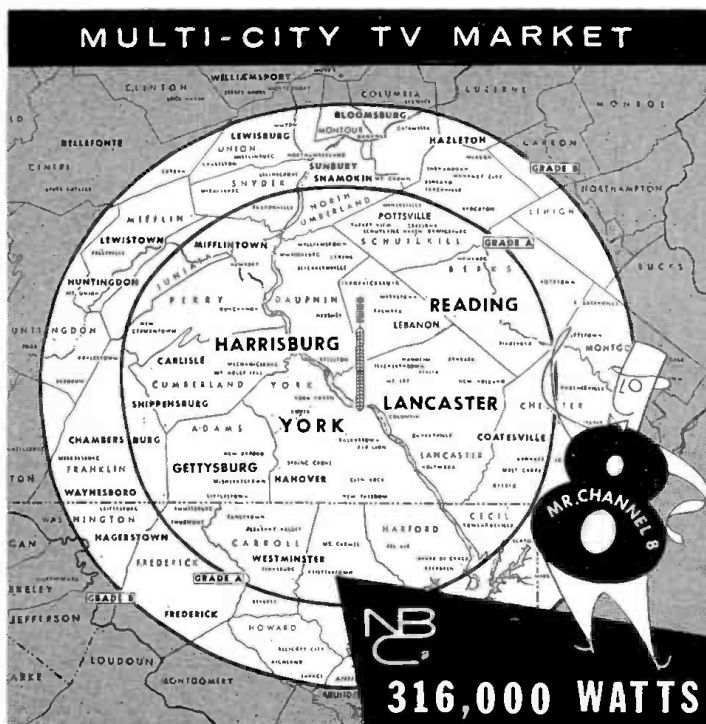

This **CHANNEL 8** station is more powerful than any other station in its market, has more viewers in its area than all other stations combined. Hundreds of advertisers rely on its alert ability to create business. So can you. Buy the big-selling medium. Advertise on WGAL-TV.

**WGAL-TV**  
**Channel 8**  
**Lancaster, Pa.**  
STEINMAN STATION • Clair McCollough, Pres.

Representative: The MEEKER Company, Inc. • New York • Chicago • Los Angeles • San Francisco

Astute observers of television network programming plans report that there now are enough scripts or pilots committed for 1964-65 to program all three networks' nighttime schedules that season—given general expectation of carryovers from this coming season. That's one side of coin, however. Other: More than half of commitments won't materialize on schedules, and new deals will be made. But already it's obvious that networks are committing earlier than ever in continuing effort to minimize rise of new program development by taking time to polish products before they reach air. Wrapup of some pilots will come as soon as middle or end of December.

*From early sketches on drawing board, it would appear that in 1964-65 situation comedies will continue in half-hour format, with one-hour and occasional 90-minute lengths reserved for thrillers and adventures. Emphasis is still on all types of private eyes, with trend toward international intrigue. Latter interest has been sparked by boxoffice success of "Dr. No," motion picture that dramatizes adventures of James Bond, British Secret Service agent in Ian Fleming's novels.*

## Reinsch appointment due

Expected soon is formal announcement of appointment of J. Leonard Reinsch, executive director of Cox broadcasting stations, as executive director of 1964 Democratic national convention. Mr. Reinsch in past few weeks has participated in conferences at White House and Democratic National Committee on convention plans, and on Aug. 21 will make another trip to Atlantic City to meet with networks on arrangements for coverage of convention which begins Aug. 24, 1964.

*Mr. Reinsch was executive director of both 1956 and 1960 conventions and has been associated with Democratic political convention and campaign activities since 1944. He handled arrangements for "Great Debates" between candidates Kennedy and Nixon in 1960 campaign.*

## Sweeney keeps pay-out

Kinks that had developed in administration of former president Kevin B. Sweeney's deferred-compensation agreement with Radio Advertising Bureau appeared to have been smoothed out last week. They were subject of special meeting Monday in New York between Mr. Sweeney, now president of KGLM and KBIG(FM) Avalon-Los Angeles, and RAB's executive committee headed by Harold Krelstein of Plough Inc. Under agree-

ment reached before he left RAB last Feb. 28, Mr. Sweeney is to get contract as consultant for about eight years—for reported total payment of some \$90,000, with customary proviso that he not compete with RAB during that period. Details reportedly were worked out in Monday's meeting.

*Reports that executive committee admonished Mr. Sweeney against publicly criticizing RAB were discounted. Subject did come up, based on speech he made—just three days before—belittling RAB's current plans for \$200,000 radio audience research methodology study (BROADCASTING, Aug. 5). He reportedly assured committeemen that in same speech he also said it was only one he'd be making for long time.*

## Proof of performance

Exploration of new, uniform system in certifying performance of stations' spot TV schedules may get another go-round within next few weeks by informal agency-advertiser-broadcaster group. First such session was held late last June (BROADCASTING, July 1) at invitation of Newman F. McEvoy, senior vice president at Cunningham & Walsh, New York. Several agency-advertiser participants then met with broadcast representatives in general discussion of how certification of spot TV schedules could be improved. Some agencies have been thinking along lines of uniform system set up and paid for by broadcasters.

## Drop-in precedent?

Recent action of FCC in approving short-spaced operation of ch. 5 KOCO-TV Enid by authorizing removal to Oklahoma City antenna farm could but does not necessarily portend new majority on FCC in favor of short-space drop-ins. FCC voted 5-1 for move (BROADCASTING, July 29) but did so because previous standard separation action would have reduced KOCO's coverage both in Oklahoma City and Enid due to limitation on antenna height required by Civil Aeronautics Board. It's contended that action establishes no drop-in precedent since FCC previously had authorized short-space move for two stations in Albany, N.Y., area—WTEN(TV) and WAST(TV)—as well as WTEV(TV) New Bedford-Providence.

*Not directly effected by Oklahoma City action are seven drop-ins of new stations in major two-station markets, to be considered when FCC reconvenes in fall. Oral arguments on these drop-ins have been set for Oct. 4 at request of new Commissioner Lee Loevinger,*

*who then would be qualified to vote. Prior to that argument, FCC must act on motion filed by Association of Maximum Service Telecasters to forestall participation in these cases by Commissioner Ken Cox because of his prior status as Broadcast Bureau chief. At staff level, betting is that Commissioner Cox won't disqualify himself and won't be disqualified. Fact that Chairman E. William Henry and Commissioner Robert T. Bartley, who previously had voted against drop-ins, voted for short separation move-in for KOCO-TV has both sides wondering.*

## Deals all over

Five separately owned television stations—two in South and one each in Rocky Mountain area and East and West Coasts—involving total outlay of about \$25 million may change hands in next few weeks. Last week negotiations were in progress for sale of properties (of which four are VHF) with prospects that transfer applications might be ready when FCC reconvenes after Labor Day.

## Graham's legacy

Philip L. Graham, brilliant young president of Washington Post Co. (WTOP-AM-FM-TV Washington; WJXT (TV) Jacksonville), who ended his life Aug. 3, figured importantly behind scenes in broadcast affairs. Although he left operations of Post-Newsweek stations to John S. Hayes, president of broadcast division and chairman of Washington Post Co. executive committee, Mr. Graham frequently participated in policy discussions with important personages, both inside government and in industry.

*LeRoy Collins owes his selection as president of National Association of Broadcasters to Mr. Graham. Both Floridians, Mr. Graham proposed Gov. Collins for NAB presidency and largely ramrodded appointment through NAB selection committee in late 1960—after death of former NAB president, Harold E. Fellows.*

## Magazine concept

As part of biggest advertising and promotion campaign in its history, ABC-TV has bought 10 pages in September *Reader's Digest* to promote its new fall program schedule and especially its 14 new nighttime shows. It's said to be biggest consecutive-page, non-insert ad *Digest* ever carried. Cost, estimated at about \$385,000, is being paid by ABC-TV in addition to other promotion activities including contributions to affiliates' co-op advertising in newspapers and *TV Guide*.

# The Flagship and The Saint

With only a single hour of available time and a choice of all the one-hour series now being offered, WNBC-TV, New York, flagship station of the NBC-TV network, bought THE SAINT, starring Roger Moore.



PETER M. AFFE, station manager WNBC-TV, tells why...

"This brand new series seems ideal for Sunday night on our station... it is singularly skillful, fast-paced, professional series with just about universal appeal."

WNBC WNBC-FM WNBC-TV  
NATIONAL BROADCASTING COMPANY, INC.  
RCA Building, Radio City, New York 20, N.Y., Circle 7-8300  
July 24, 1963

PETER M. AFFE  
Station Manager  
WNBC-TV

Mr. Abe Mandell  
Executive Vice-President  
Independent Television Corp.  
555 Madison Avenue  
New York 22, New York

Dear Abe:

I think you know how pleased we are that THE SAINT is joining us this Fall. This brand new series seems ideal for Sunday night on our station.

WNBC-TV proved last season that in the 11:15 PM Sunday night period an hour-long dramatic feature could gain an impressive audience (and advertiser) following in competition with the movies generally shown at that time. After intensive investigation, we concluded that THE SAINT represents the soundest successor to "Desilu Playhouse" and the strongest, most logical addition to a Fall schedule that we consider our most exciting in years.

Our choice was, of course, based in large measure on the wide popularity of THE SAINT -- well-established through the years on radio, ten full-length feature films, world wide syndication in newspapers and magazines -- as well as the inherent attractiveness of the character as portrayed by Roger Moore and the final, compelling fact that this is a singularly skillful, fast-paced, professional series with just about universal TV appeal.

All of us at WNBC-TV are enthusiastic about the advent of THE SAINT. We anticipate that Sunday nights on WNBC-TV will be even more successful than ever in the coming season.

Sincerely,



**I** INDEPENDENT  
**T** TELEVISION  
**C** CORPORATION

555 Madison Avenue • New York 22, N.Y. • PLaza 5-2100  
17 Ch Cumberland Place • London W1 • Ambassador 8040  
100 University Avenue • Toronto 1, Ontario • EMpire 2-1166  
Mexico City • Paris • Rome • Buenos Aires • Sydney  
and offices in principal cities in 45 countries around the world

# WEEK IN BRIEF

Fall buying season for TV spots zooms along, with some estimates that fourth quarter will be 7-10% ahead of same period last year. Early fall programing start helps stir busy activity. See . . .

## MORE SPOT TV THIS FALL . . . 29

Los Angeles session with broadcasters, agencies and unions seen as significant with presence of NAACP president. In New York breakthrough is accomplished in Lever Brothers commercial. See . . .

## NEGROES STEP UP DRIVE . . . 62

Congressional hearings on editorializing in abeyance as dozens of broadcasters seek to air views in support of editorializing with "minimum" regulation. Rex Howell stirs Republicans. See . . .

## WAITING ON RAILROAD . . . 42

Staff report on ratings investigation is in draft form and contains recommendations to require licensing of research firms if industry's auditing plans aren't truly successful. See . . .

## INTERIM RATINGS REPORT . . . 34

Whitman turns to radio on sustained basis to sell its chocolates. Normally a heavy holiday timebuyer, company is now convinced that radio offers flexibility and mobility for limited budget. See . . .

## WHITMAN TURNS TO RADIO . . . 31

NAB code group establishes guides for arthritis and rheumatism advertising. Recommendations were coordinated with advertising agencies and are endorsed by Arthritis and Rheumatism Foundation. See . . .

## GUIDES FOR A AND R ADS . . . 32

Wife's feathery hat gets in eye of AMA delegate and now Television News Art Inc. is up to its drawing boards in public service cartoon spot TV business. Ranallo tells of ABA campaign and others. See . . .

## JOBS FOR PROFESSIONAL GROUPS . . . 62

Former VOA chief says it should concentrate on English-only programs, cut out multitude of foreign language broadcasts. Allen maintains this is most efficient way to reach overseas listeners. See . . .

## BRICKBATS AND ROSES FOR USIA . . . 46

Advertisers meet with FCC chairman in "instructive" session. Purpose is to get acquainted. Discussion between Henry and broadcast committee of AAAA ranges from option time to UHF. See . . .

## HENRY AND AAAA GROUP MEET . . . 31

Control of Washington Post Co. and Post-Newsweek Stations goes to Katherine Graham. Will of late president gives widow voting majority. She says no changes to be made in management or policies. See . . .

## GRAHAM'S WIDOW GETS CONTROL . . . 56

## DEPARTMENTS

AT DEADLINE .....	9	THE MEDIA .....	56
BROADCAST ADVERTISING .....	29	MONDAY MEMO .....	26
CHANGING HANDS .....	60	OPEN MIKE .....	21
CLOSED CIRCUIT .....	5	OUR RESPECTS .....	91
DATEBOOK .....	14	PROGRAMING .....	62
EDITORIAL PAGE .....	92	WEEK'S HEADLINERS .....	10
EQUIPMENT & ENGINEERING ....	66		
FATES & FORTUNES .....	71		
FILM SALES .....	65		
FINANCIAL REPORTS .....	70		
FOR THE RECORD .....	78		
GOVERNMENT .....	34		
INTERNATIONAL .....	67		
LEAD STORY .....	29		



## BROADCASTING

THE BUSINESSWEEKLY OF TELEVISION AND RADIO

Published every Monday, 53d issue (Yearbook Number) published in November by BROADCASTING PUBLICATIONS INC. Second-class postage paid at Washington, D. C., and additional offices.

Subscription prices: Annual subscription for 52 weekly issues \$8.50. Annual subscription including Yearbook Number \$13.50. Add \$2.00 per year for Canada and \$4.00 for all other countries. Subscriber's occupation required. Regular issues 50 cents per copy. Yearbook Number \$5.00 per copy.

Subscription orders and address changes: Send to BROADCASTING Circulation Dept., 1735 DeSales Street, N.W., Washington, D. C., 20036. On changes, please include both old and new addresses plus address label from front cover of magazine.

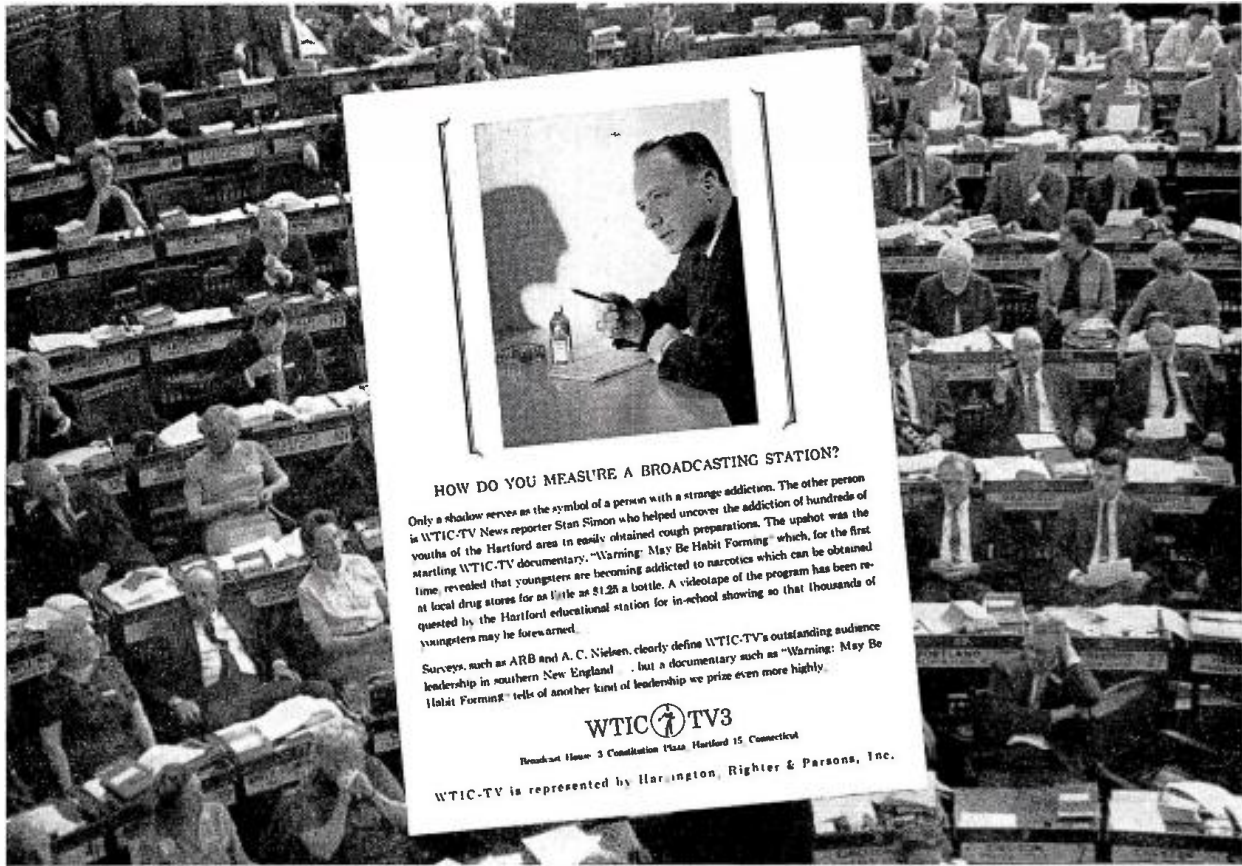

## WE ANSWERED OUR OWN QUESTION!

This ad posed a question of its readers last February. We'd like to tell you the result of the WTIC-TV documentary which alerted viewers to the fact that youngsters were becoming drug addicts through easy-to-obtain cough medicines, available without prescription. Before the 1963 Connecticut General Assembly adjourned, it enacted legislation which now makes it virtually impossible for persons to purchase such preparations without a physician's prescription. In fact, Governor John N. Dempsey stated that the program, "in no small measure was responsible for this law." So we'd like to answer our own question. It seems to us that one measure of a broadcasting station is the positive action its programs inspire.



Broadcast House, 3 Constitution Plaza, Hartford 15, Connecticut

WTIC-TV is represented by Harrington, Richter & Parsons, Inc.



## BOOM FALLS ON THREE N.Y. STATIONS

### Examiner finds hidden ownership and misrepresentation

FCC hearing examiner Friday (Aug. 9) recommended revocation of construction permit, denial of license renewal, denial of application for change in facilities and denial of application for new facilities, all involving three New York state stations.

In initial decision, Hearing Examiner Herbert Sharfman recommended that construction permit of WJZR Johnstown be revoked; that license renewal of WSPN Saratoga Springs be denied; that request of WSPN to change facilities be denied and that application of WSRA Saratoga Springs to move to Troy, N.Y., be denied. Both Saratoga Springs stations are dark.

Involved are character qualifications of Martin A. Karig. Mr. Sharfman found that Mr. Karig failed to keep FCC informed of his interests in these stations and continued to hold them after he had been told to dispose of all but one. He was found to own Johnstown with partial ownership in two Saratoga Springs outlets.

WSRA applied for new facility on 900

kc in Troy, allowing WSPN to take over its present 120 kc frequency at Saratoga Springs. WSPN is now on 900 kc in that city. WSPN also applied for renewal of license.

Examiner Sharfman found that Mr. Karig's interest in two Saratoga Springs stations were in violation of FCC rules prohibiting ownership of more than one facility in same community. He also found that Mr. Karig also misrepresented finances of WSRA and applicant's ability to construct.

When Mr. Karig acquired 50% interest in WSRA permission was based on condition that he dispose of his 12.5% of WSPN, however, he also was creditor to extent of \$6,369 and had option to buy 76 shares more (positive control). Mr. Karig failed to inform FCC of facts, and continued to hold these interests in WSPN, examiner said.

Mr. Karig had become sole source of operating capital for both WSPN and WSRA, and continued to be prime adviser on stations' business, examiner ruled.

## House unit agrees on tax reductions

Revisions of tax laws given tentative agreement by House Ways and Means Committee Friday (Aug. 9) would mean savings for individuals and corporations in broadcasting.

Fifty-two percent tax on corporate income would be cut to 48%. Tax rates for individuals would be reduced from present 20-91% to 15-75%.

Committee already had tentatively agreed on provision for income averaging to help those who make sizable money all at once but face years of substantially less income. New amendment on that provision would exempt income earned on wagering; earlier committee said income from gifts or bequests would not be eligible either.

## Pulse asked about unpublished surveys

Southern Nevada Broadcasters Association has asked The Pulse Inc. for "full and detailed explanation" of reason why last three Pulse surveys of Henderson-Las Vegas area have been "scrapped."

Nevada broadcasters noted that Pulse surveys for December 1962, April 1963

and July 1963 were never published and said it is "time we find out just exactly why." Joseph W. McMurray, KORK Las Vegas, president of SNBA, asked Pulse President Sydney Roslow that diaries and other pertinent information be made available for "our examination so that we might determine just what the discrepancies are." Last published Pulse survey of area was in June 1962.

Other stations signing letter to Pulse were KTOO Henderson and KLUC, KVEG, KRAM, KLAS and KENO, all Las Vegas.

## General Mills sponsors Winter Olympics on NBC

General Mills will sponsor NBC Radio's 12-day coverage of 1964 International Winter Olympics. Network plans 100 five-minute reports from Austria, where games will be held.

Advance broadcasts from Olympic site will be carried starting Jan. 25, four days before reports of actual games begin. Programs will be aired between 3 and 9 p.m. weekdays and throughout *Monitor* program over weekend. Knox Reeves, Minneapolis, is agency.

## Chunky buys spots on ABC-TV

Chunky Corp., Brooklyn, has purchased participations in four ABC-TV programs: *Trail Master*, *Price Is Right*, *Beany and Cecil* and *Discovery*, to ad-

### Syndicate Louis special

Screen Gems, New York, has acquired world-wide distribution rights to *In This Corner: Joe Louis* from Metromedia Inc., producer of two-hour TV special.

Acquisition marks first time that Screen Gems will distribute single special.

Program has been telecast on Metromedia's outlets in New York, Los Angeles, Washington, Kansas City, Sacramento, Peoria and Decatur, Ill.

vertise its Chunky, Bit-O-Honey, Kit Kat and Chocolate Sponge candy bars. Spot TV will be used in major markets. J. Walter Thompson, New York, is agency.

## Screen Actors receive peak residuals for July

Residual payments for TV reruns distributed to members by Screen Actors Guild reached all-time high of \$861,521 in July, 42% above July 1962.

For first nine months of SAG's fiscal year, TV residuals totaled \$5,600,577, up 28% from like period of last year. Current fiscal year residuals are expected to exceed 1962's \$6,052,665.

Covering TV entertainment films only, these residuals do not include payments for theatrical movies shown on television or fees for reuse of filmed TV commercials.

## Set makers cooperating on all band units: Lee

Television set manufacturers appear to be cooperating fully with spirit of all-channel set law which goes into effect April 30, 1964, FCC Commissioner Robert E. Lee said Friday (Aug. 9) in talk before public relations institute of American Bar Association in Chicago. He said he has been talking to nearly all manufacturers and no one is attempting to circumvent law which will require all new TV sets in U.S. to tune full VHF and UHF channel range.

During panel discussion on how ABA can improve its public relations through more effective use of radio and TV, Joe Baisch, WREX-TV Rockford, Ill., noted that broadcasters and bar have somewhat common problem of "tarnished" public image. He said "we need each other's mutual shoulder of support and cooperation."

Others on Friday panel included Ben

## WEEK'S HEADLINERS



Mr. Wodlinger



Mr. Krivin

**Albert P. Krivin**, VP-general manager of KMBC-TV Kansas City, named VP-general manager of KTTV(TV) Los Angeles, and **Mark Wodlinger**, VP-general manager of WZZM-TV Grand Rapids, Mich., succeeds Mr. Krivin in Kansas City. **Harold C. Sundberg**, WZZM-TV general sales manager, elected VP-general manager (CLOSED CIRCUIT, Aug. 5). Stations are owned by Metro-media Inc. Mr. Krivin, former general sales manager of KYW-TV Cleveland, was appointed to KMBC-TV post in 1961.



Mrs. Bullitt



Mr. Bullitt

**Stimson Bullitt**, former chairman of KREM Broadcasting Co. (KREM-AM-FM-TV Spokane), elected president, succeeding **Louis Wasmer**, who resigned. **Mrs. A. Scott Bullitt** becomes board chairman of KREM Broadcasting, post she also holds with KING Broadcasting

Co., majority stockholder in KREM Broadcasting. Mr. Bullitt is president of KING Broadcasting which operates Crown Stations (KING-AM-FM-TV Seattle, KGW-AM-TV Portland, Ore., and KREM-AM-FM-TV Spokane). **Alexander P. Hunter** continues as station manager of KREM stations. **Ancil H. Payne**, assistant to VP in charge of business division of KING Broadcasting, elected VP. He succeeds **Henry B. Owen**, who continues as executive VP and board member, chairman of administrative committee of profit sharing trust and in charge of personnel.



Mr. Flouton



Mr. Shelton

**Barton A. Cummings**, president of Compton Adv., New York, elected board chairman and chief executive officer in reorganization announced last week. **Wilson A. Shelton**, executive VP, elected president, and **Allen F. Flouton**, executive VP, becomes vice chairman of board, and shares top management duties with Messrs. Cummings and Shelton. **John A. Hise Jr.** and **Willard J. Heggen**, both



Mr. Cummings

senior VP's, elected executive VP's, and **H. Reginald Bankart**, senior VP, named chairman of marketing plans board.

**Donald H. McGannon**, president and chief executive officer of Westinghouse Broadcasting Co. (Group W), elected also to serve as chairman of board. In that post, he succeeds **E. V. Huggins**,



Mr. McGannon

who also was executive VP of Westinghouse Electric Corp. and who resigned last month (BROADCASTING, July 1). Mr. McGannon will report to Donald C. Burnham, newly elected president of Westinghouse Electric Corp. and now also elected to board of broadcasting subsidiary company. Also on board from Westinghouse Electric: **Gwilym A. Price**, board chairman, and **George C. Main**, VP-finance. On board from Group W: **Rolland V. Tooke** and **Larry H. Israel**, executive VP's; **W. S. Swartley**, VP-Boston; **A. W. Dannenbaum**, VP-sales; **Richard Pack**, VP-programming; **Ralph N. Harmon**, VP-engineering, and **Ralph L. Atlass**, VP-Chicago. Mr. McGannon, who had served DuMont Television Network from 1952-55 in executive capacity, joined WBC in March of 1955 as VP and general executive, and has been president and director of company since November of that year. Group W, wholly owned subsidiary of Westinghouse Electric, operates KDKA-AM-FM-TV Pittsburgh; WJZ-TV Baltimore; WBZ-AM-FM-TV Boston; WIND Chicago; KYW-AM-FM-TV Cleveland; wowo Ft. Wayne; KPIX(TV) San Francisco, and WINS New York.

For other personnel changes of the week see **FATES & FORTUNES**

Berentson, WGN-TV Chicago; Steve Rowan, KMOX St. Louis, Howard Frederick, WIRL Peoria, Ill., E. A. Richter, past executive secretary of Missouri Broadcasters Association, and Charles Ranallo, Television News Art Inc., Cleveland (see story page 62).

### Gardner units revert

Gardner Adv., St. Louis, which little over year ago consolidated its media and research departments into several combination media-research groups of equal but separate rank, has quietly unconsolidated them and is returning to traditional former status. Full personnel and operational details expected in few weeks.

### Lestoil appoints FSR

Lestoil Products has appointed Fuller & Smith & Ross, New York, as agency for 12 products, among them Red Cap, Refresh-R air fresheners and Red Cap window cleaner, Quintone paste polish and Scuffy liquid shoe polish, Sawyer's household ammonia, and Cando metal and silver polishes. Budget plans have not yet been developed for products all of which were newly acquired by Lestoil.

### Clark named host of 100 Grand

Jack Clark named by ABC-TV as host of network's new big-money quiz show next fall (100 Grand, Sunday,

10-10:30 p.m. under sponsorship of El Producto and Alberto-Culver, through Compton Adv.). Mr. Clark has been announcer and master of ceremonies on *Password* and *To Tell The Truth* game shows. 100 Grand goes on ABC-TV Sept. 15.

### Buys repeat of 'Tunnel'

In unusual daytime buy, American Home Products, through William Esty Co., both New York, has purchased full sponsorship of repeat telecast of award-winning *The Tunnel* special on NBC-TV. It will be broadcast Oct. 20 at 3:30-5 p.m. Esty handles Dristan cold tablets for American Home Products' Whitehall Division.

## Tall "Farm"

Quaker Oats Company's towering elevators hold about 10 million bushels of grain. They're part of the world's largest oatery—20 buildings on 15 acres in downtown Cedar Rapids. Grain purchases amounted to about \$30,000,000 in a recent year.

On any given day some 75% of the families in the U. S. have one or more Quaker Oats Co. products in their pantries. Besides world-famous Quaker Oats oatmeal, the company's ready-to-eat cereals include Puffed Wheat and Rice, Muffets, Pack-O-Ten and Life Cereal. The firm name is connected with more than 200 different food, feed, pet food and chemical products. Worldwide sales last year were \$364,693,000. The Cedar Rapids plant alone employs 1,275 people.

Next time you think of Iowa *only* as the place where tall corn grows, think again. It's the place where farming is certainly important—but manufacturing produces five times as much personal income (about \$5 billion vs. \$1 billion annually).

WMT-TV's sponsors advise wage-earners and farmers alike about keeping their income in circulation.

WMT-TV • Cedar Rapids—Waterloo  
CBS Television for Eastern Iowa

Represented by the Katz Agency  
Affiliated with WMT-AM; WMT-FM;  
K-WMT, Fort Dodge; WEBC, Duluth.



**CONTACT THESE STATION REPS FOR AVAILABILITIES**

STATION	CITY	NATIONAL REP.	TIME SLOT & DAY
WMAR-TV	Baltimore, Maryland	THE KATZ AGENCY, INC.	11:20 p.m. Sun.
KVOS-TV	Bellingham, Wash.	PETERS, GRIFFIN, WOODWARD, INC.	9:30 p.m. Thurs.
WCSC-TV	Charleston, S. C.	PETERS, GRIFFIN, WOODWARD, INC.	Prime Time TBA
WNBQ-TV	Chicago, Ill.	NBC SPOT SALES	10:45 p.m. Sun.
WHIO-TV	Dayton, Ohio	GEO. P. HOLLINGBERY CO.	10:00 p.m. Fri.
KCTO-TV	Denver, Colo.	ADAM YOUNG, INC.	6:30 p.m. Tues.
WOI-TV	Des Moines-Ames, Iowa	H-R TELEVISION, INC.	9:30 p.m. Sun.
KDAL-TV	Duluth, Minnesota	EDWARD PETRY & CO., INC.	TBA
WINK-TV	Ft. Myers, Fla.	THE MEEKER COMPANY	7:00 p.m. Thurs.
WBAP-TV	Ft. Worth, Texas	PETERS, GRIFFIN, WOODWARD, INC.	TBA
KMJ-TV	Fresno, Calif.	THE KATZ AGENCY, INC.	TBA
WOOD-TV	Grand Rapids, Mich.	THE KATZ AGENCY, INC.	10:00 p.m. Mon.
WDAF-TV	Kansas City, Mo.	EDWARD PETRY & CO., INC.	10:15 p.m. Sun.
WGAL-TV	Lancaster, Penn.	THE MEEKER COMPANY	TBA
KOLN-TV	Lincoln, Neb.	AVERY KNODEL, INC.	9:00 p.m. Mon.
KCOP-TV	Los Angeles, Calif.	EDWARD PETRY & CO., INC.	Prime Time TBA
WMAZ-TV	Macon, Georgia	AVERY KNODEL, INC.	7:30 p.m. Wed.
WKOW-TV	Madison, Wis.	ADAM YOUNG, INC.	10:30 p.m. Thurs.
WTCN-TV	Minneapolis, Minn.	THE KATZ AGENCY, INC.	TBA
WPIX-TV	New York, N. Y.	PETERS, GRIFFIN, WOODWARD, INC.	Prime Time TBA
WAVY-TV	Norfolk, Va.	H-R TELEVISION, INC.	11:15 p.m. Sat.
WRCV-TV	Philadelphia, Penn.	NBC SPOT SALES	11:15 p.m. Sun.
KPHO-TV	Phoenix, Ariz.	THE KATZ AGENCY, INC.	8:30 p.m. Sun.
KTVU-TV	San Francisco, Calif.	H-R TELEVISION, INC.	TBA
KTNT-TV	Seattle, Wash.	PAUL H. RAYMER CO., INC.	TBA
KTBS-TV	Shreveport, La.	THE KATZ AGENCY, INC.	9:00 p.m. Thurs.
WHYN-TV	Springfield, Mass.	ADVERTISING TIME SALES, INC.	6:30 p.m.
WTVT-TV	Tampa, Florida	THE KATZ AGENCY, INC.	Prime Time TBA
WMAL-TV	Washington, D. C.	HARRINGTON, RIGHTER & PARSONS, INC.	11:30 p.m. Sun.
KIVA-TV	Yuma, Ariz.	GEO. P. HOLLINGBERY CO.	TBA

For busy time buyers, a "see-at-a-glance" chart to help you fill your Fall spot needs . . .

**PRIME  
TIME SPOTS  
ON THE  
DICK POWELL  
THEATRE MAY  
STILL BE  
AVAILABLE  
ON THESE  
STATIONS**

For stations'  
 Fall programming  
**TELEVISION'S FINEST  
 SERIES OF DRAMAS**  
 now available on an  
 individual market basis

*The*  
**DICK  
 POWELL**  
*Theatre*



The above news as it appeared in the broadcast trade papers, and the "see-at-a-glance" chart on the left, clearly indicates the important time slots in which this series will be programmed. Join these fine stations by programming THE DICK POWELL THEATRE. It will bring quality, prestige and more national spot business for your station.

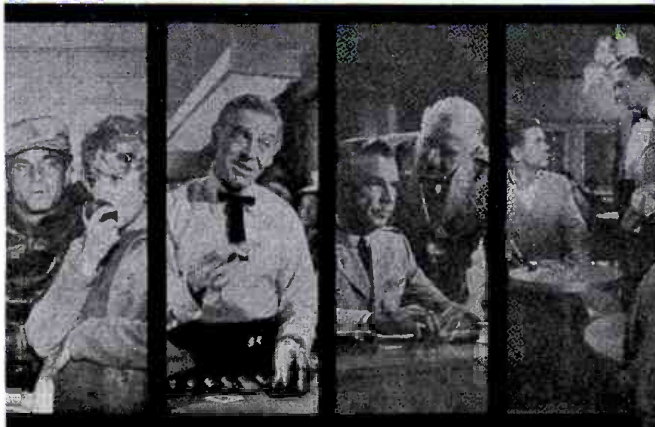

"PROVEN PROGRAMMING" FROM

A SUBSIDIARY OF FOUR STAR TELEVISION

600 FIFTH AVENUE  
 NEW YORK  
 20  
 NEW YORK  
 LT 1-8530

**LOS ANGELES**  
(and advertisers)  
**LIKE US**  
**BECAUSE...**

*we accept our responsibility to our community. (During 1962, KABC Radio donated free time to over 248 worthy community projects.)*

*As a result, advertisers respect us for our continuing participation in community affairs.*

Represented Nationally  
by the Katz Agency

**KABC**  
conversation  
**RADIO 79**

AN ABC OWNED RADIO STATION

## DATEBOOK

A calendar of important meetings and events in the field of communications

\*Indicates first or revised listing

### AUGUST

Aug. 11-15—Second annual NCTA Management Institute, sponsored by National Community Television Association in cooperation with the extension division of University of Wisconsin, Madison.

Aug. 14—Second annual TV Day, Georgia Association of Broadcasters, Macon.

Aug. 14—Communications committee meet- of the American Bar Association, Conrad Hilton hotel, Chicago. Speaker will be FCC Chairman E. William Henry.

Aug. 19—Eighth annual Distributor-Manu- facturer-Representative conference, Jack Tar hotel, San Francisco. Chairman of the conference planners is Elvin W. Feige, president of Elmar Electronics of Oakland.

Aug. 20—Annual stockholders meeting, Desilu Productions Inc., Hollywood.

Aug. 20-23—Western Electric Show and Convention (WESCON), San Francisco's Cow Palace. Papers include: "Telstar" by Irwin Welber of Bell Telephone Labora- tories; "Relay" by Warren Schreiner of RCA; "Syncom" by Dr. Harold A. Rosen of Hughes Aircraft Co.; "Comsat" by Wilbur L. Pritchard of Aerospace Corp.; "Commer- cial Communications Satellites" by Beards- ley Graham of Spindletop Research.

Aug. 23-24—Oklahoma Broadcasters As- sociation convention, Western Hills State Lodge, Wagoner. Speakers include Okla- homa Governor Henry Bellmon, Ed Bunker, president of Radio Advertising Bureau, and Robert Richardson, special counsel to the House Subcommittee on Investigations.

Aug. 26-27—Television Affiliates Corp. West Coast programing conference, Hilton Inn, San Francisco.

Aug. 27—Board of Broadcast Governors hearing, Ottawa, Canada.

### SEPTEMBER

Sept. 1—Deadline for comments on FAA proposed criteria for establishment of tele- vision antenna farms.

Sept. 5-8—Annual fall meeting of West Virginia Broadcasters Association, The Greenbrier, White Sulphur Springs.

Sept. 6-7—Fall meeting of Arkansas Broad- casters Association, Holiday Inn, North Little Rock. LeRoy Collins, NAB president, will be principal speaker.

Sept. 6-7—Arkansas AP Broadcasters As- sociation. Principal speaker is AP Assistant General Manager Louis J. Kramp.

Sept. 7—American Women in Radio and Television's Educational Foundation board of trustees meeting, New York City.

Sept. 8-11—Western Association of Broad- casters annual meeting, Jasper Park Lodge, Jasper, Alberta, Canada.

Sept. 9—Effective date of new instruction- al television service using 31 channels in 2500-2690 mc band.

Sept. 9-12—New York Premium Show, New York Coliseum.

Sept. 10—Premium advertising conference of the Premium Advertising Association of America, New York Coliseum.

Sept. 10-12—Fall meeting of Electronic In- dustries Association, Biltmore hotel, New York City.

Sept. 11-14—Eighteenth international con- ference and workshop of Radio-Television News Directors Association, Radisson hotel, Minneapolis.

Sept. 12—Luncheon meeting, Federal Com- munications Bar Association. FCC Com-

missioner Lee Loevinger, speaker. National Press Club, Washington.

Sept. 12-15—Annual fall convention, Mich- igan Association of Broadcasters, Hidden Valley, Gaylord, Mich.

Sept. 13-22—International Radio, Television & Electronics Exhibition (FIRATO) at the R.A.I. Building in Amsterdam. Live TV pro- grams will be broadcast from a special studio to be set up at the show. This will be carried out by the Netherlands Tele- vision Foundation in cooperation with Dutch television channels.

Sept. 14-15—Southwest regional confer- ence. American Women in Radio and Tele- vision, Houston.

Sept. 15-16—New York State AP Broad- casters Association, Gran-View motel, Ogdensburg. Don Jamieson, president of the Canadian Association of Broadcasters, will be the speaker at the Sunday evening banquet. Sunday afternoon and Monday morning will be taken up with business sessions, followed by a tour of the St. Lawrence Seaway aboard a United States Coast Guard vessel.

Sept. 15-17—Louisiana Association of Broad- casters convention, Sheraton Charles hotel, New Orleans.

Sept. 16—New deadline for comments on FCC's proposal to control the development of AM and FM radio services.

Sept. 17—Annual stockholders meeting. Rollins Broadcasting Co., Bank of Delaware Building, Wilmington, Del.

Sept. 17-19—American Association of Ad- vertising Agencies' western region meeting. Mark Hopkins hotel, San Francisco.

Sept. 20-22—American Women in Radio and Television southern area conference, Co- lumbus, Ga.

Sept. 23-25—Nevada Broadcasters Associa- tion first annual convention, Hotel Sahara, Las Vegas.

Sept. 26-27—Association of National Ad- vertisers' workshop on advertising planning and administration, Nassau Inn, Princeton.

\*Sept. 29-Oct. 2—Eighteenth annual Trans- portation and Logistics Forum of the Na- tional Defense Transportation Association, Chicago. Representative Oren Harris (D- Ark.), chairman of the House Commerce Committee, will be presented the associa- tion's National Transportation Award.

Sept. 30-Oct. 1—Seventeenth annual con- vention of the New Jersey Broadcasters As- sociation, Colony motel, Atlantic City, N. J.

Sept. 30-Oct. 4—Georgia Association of Broadcasters' regional meetings (Athens, Rome, Thomaston, Albany, Statesboro) featuring sales clinic with Fred A. Palmer.

### OCTOBER

Oct. 1—Advertising Research Foundation's

#### NAB CONFERENCE DATES

National Association of Broad- casters fall conference dates:

Oct. 14-15, Statler-Hilton hotel, Hartford, Conn.

Oct. 17-18, Leamington hotel, Min- neapolis.

Oct. 21-22, Pittsburgh Hilton hotel, Pittsburgh.

Oct. 24-25, Americana hotel, Miami Beach.

Nov. 14-15, Dinkler-Andrew Jack- son hotel, Nashville.

Nov. 18-19, Texas hotel, Fort Worth.

Nov. 21-22, Cosmopolitan hotel, Denver.

Nov. 25-26, Fairmont hotel, San Francisco.



## “For Courage and Devotion”

*Telephone men and women  
fulfill a long tradition*

The first telephone call ever made was a call for help as Alexander Graham Bell spilled acid on his clothes: “Come here, Mr. Watson, I want you!”

Ever since that fateful evening in 1876, telephone people have been responding to calls for help—and training to supply it.

A tradition of service—a knowledge of first aid—an instinct to help—these keep operators at their posts in fire or flood—send linemen out to battle blizzards or hurricanes—and save lives many times in many ways.

Over the years, the Bell System has awarded 1,896 medals to employees for courage, initiative and accomplishment—for being good neighbors both on the job and off it. Here are some recent winners:



**Kenneth E. Ferguson, Installer-Repairman, Newport News, Virginia.** En route to a repair job, he came upon a burning house where a blind, bedridden woman lay helpless. Ripping out a window, he and a policeman entered the flaming room. They were forced out by intense heat and smoke. Mr. Ferguson ran to a nearby house for blankets. Wrapped in wet blankets, the two men re-entered and rescued the woman.



**Mrs. Dorothy Crozier, Operator, San Rafael, California.** She took a call from a frantic mother whose small son had stopped breathing. After notifying both ambulance and fire department, Mrs. Crozier realized that traffic was heavy and time short. Over the telephone, she taught the mother mouth-to-mouth resuscitation. The boy was breathing when firemen arrived. Doctors credit his life to her alertness.



**Charles J. Gilman, Communications Serviceman, Bellwood, Illinois.** Driving to an assignment, he saw an overturned car and found a man under it bleeding profusely. Cautioning bystanders not to smoke, he helped remove the victim. The man’s arm was almost severed below the shoulder and he seemed in shock. Mr. Gilman applied a tourniquet and kept pressure on it until an ambulance arrived.



**Leonard C. Jones, Supplies Serviceman, Morgantown, West Virginia.** He noticed a neighboring house on fire. Rushing to it, he helped a father rescue three young children. Then he plunged back into the burning building and, guided only by cries through the choking smoke, found and saved another child who was hiding under a couch in the blazing living room. Minutes after he left, the wooden house collapsed.



**Franklin Daniel Gurtner, Station Installer, Auburn, Washington.** He heard a request for emergency breathing equipment on his radio monitor and hurried to the address, where a baby was strangling. He found the child’s air passage was blocked, cleared it, and successfully administered mouth-to-mouth resuscitation. Then the fire department arrived and applied oxygen to help overcome shock.



## BELL TELEPHONE SYSTEM

*Owned by more than two million Americans*

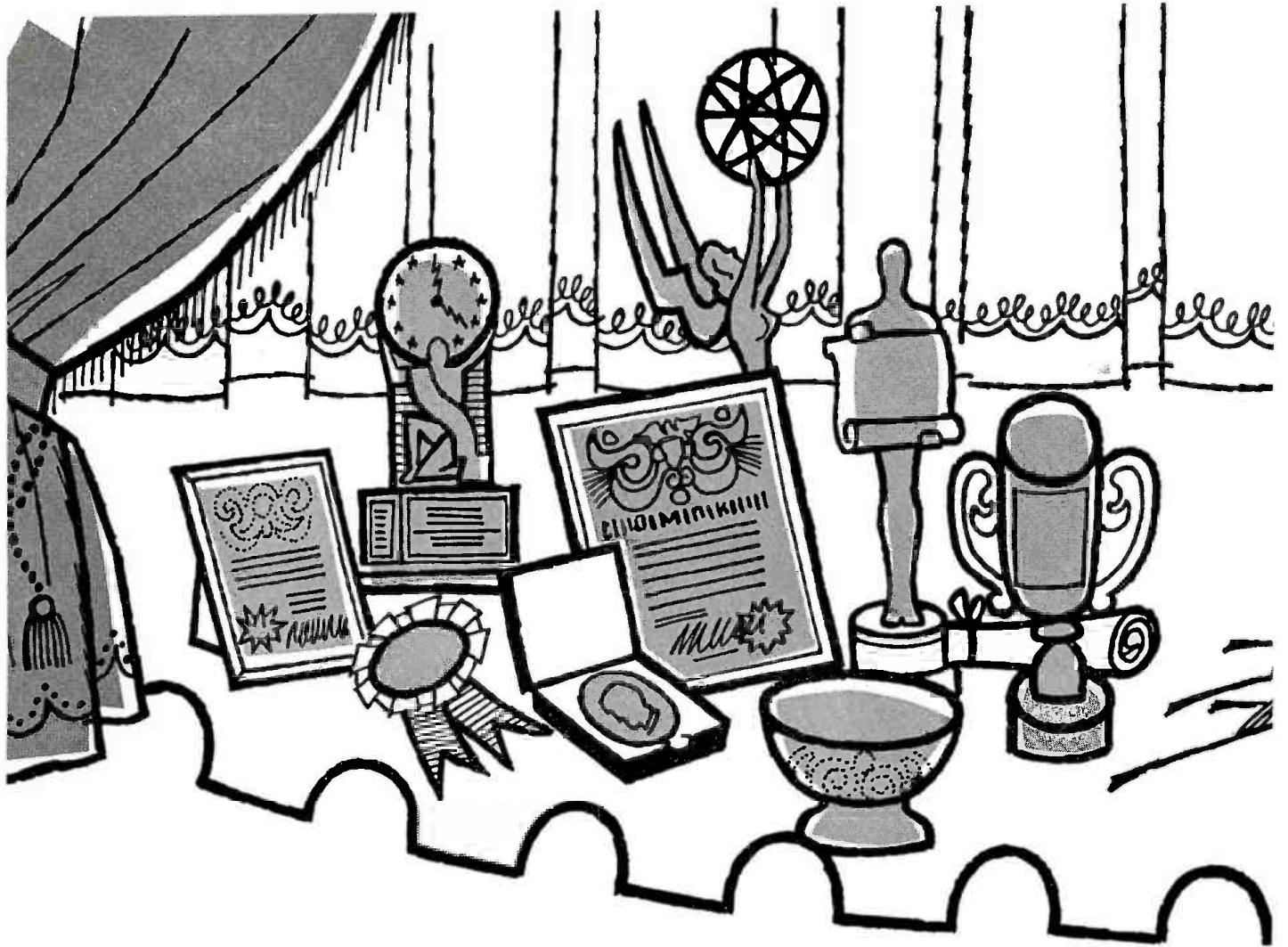

## *They love us in Chicago, Philadelphia,*

And appreciate us. And showed their appreciation in the form of awards too numerous for us to mention, but not...being in show business...to brag about.

Emmy came to our five stations seven times in the past twelve months. The International Police Chiefs cited us in Washington, and the Veterans of Foreign Wars in New York. We received five awards from the Illinois Associated Press in Chicago; five from the National Press Photographers in Philadelphia; and three from the National Association For Better Radio and Television in Los Angeles. We won the Ohio State and Freedoms Foundation Awards several times.

*P. S. 138 big "Thank You's" to the awarding organizations.*



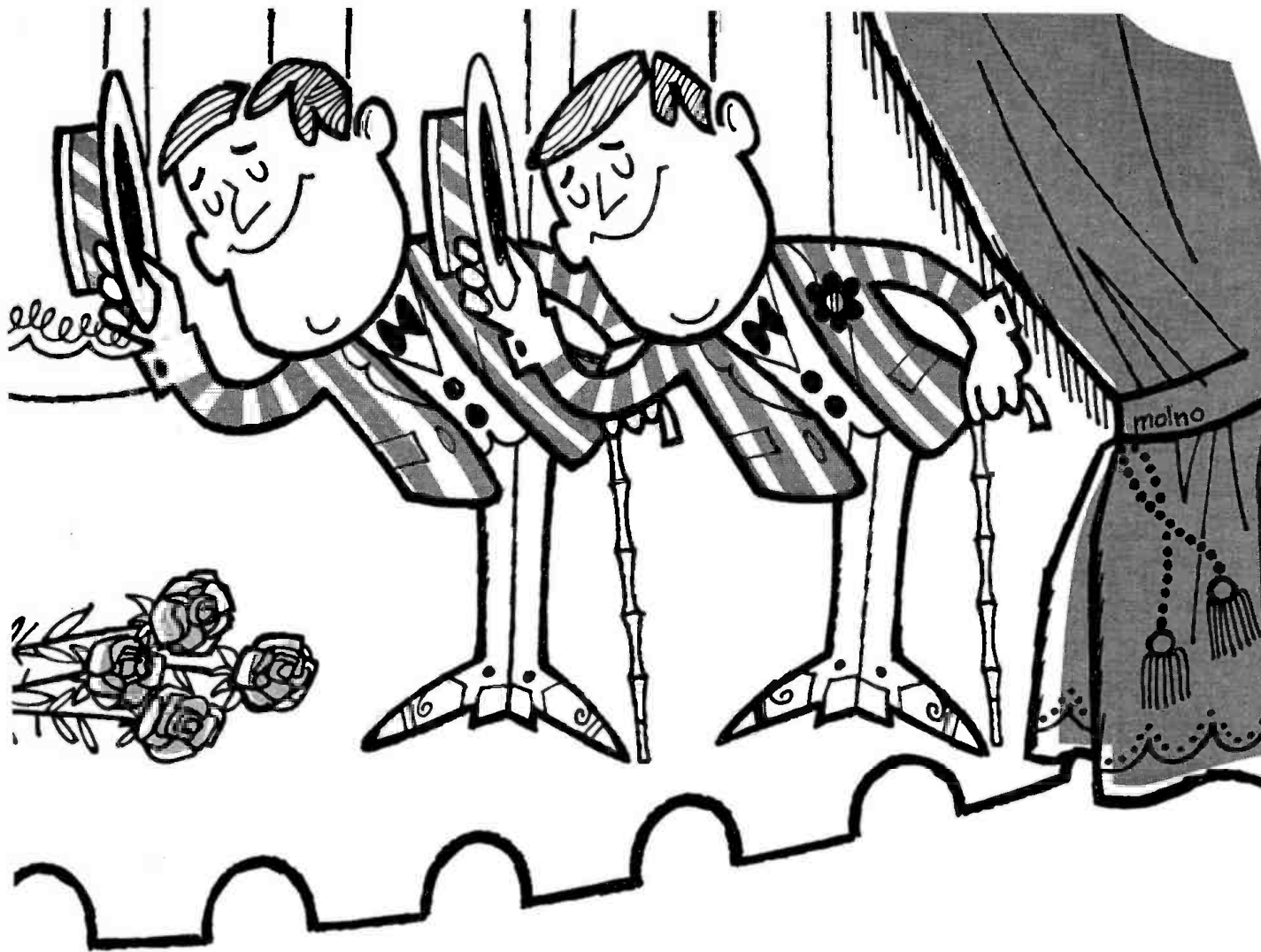

## *Washington, Los Angeles and New York*

And so it went . . . to the tune of 138 major awards in the past year. We don't mind taking a few bows, not for our bulging trophy cases, but for the recognition of our efforts in serving our communities. Some awards were for fine entertainment; some for popular personalities; a great many for public service. If we may say so ourselves . . . a nice balance.

Applause from professional and other organizations is music to our ears, but we appreciate equally the requests for advice and help. In fact, we constantly solicit the chance to work with all the various segments of our communities. Our role is to provide entertainment and service.

### **NBC OWNED STATIONS**



WNBC-TV, NEW YORK  
WRCV-TV, PHILADELPHIA  
WRC-TV, WASHINGTON  
WNBQ, CHICAGO  
KNBC, LOS ANGELES

# NEGROES

respond more aggressively to Negro voices. It's good business to include the Negro station in your general market buy. (They're usually low CPM in general market surveys.)

Our salesmen visit our stations.

Station Reps

## BOB DORE

ASSOCIATES

11 WEST 42nd STREET, NEW YORK 36, N. Y.  
CHICAGO LOS ANGELES SAN FRANCISCO



### WHY SALES CLIMB ALONG THE SKYLINE

You really go places in this "one-buy" TV market with Gasoline and Petroleum sales as large as the 16th metro area and Automotive sales that rank 19th!

## SKYLINE

TV NETWORK

P.O. BOX 2181 • IDAHO FALLS, IDAHO  
CALL MEL WRIGHT, AREA CODE 208-523-4867

Call your Hollingbery office or Art Moore in the Northwest or John L. McGuire in Denver.

KOOK Billings / KFBB Great Falls / KXLF Butte  
KID Idaho Falls / KBLL Helena / KMVT Twin Falls

conference, Hotel Commodore, New York.

\*Oct. 1-2—Tenth annual convention of CBS Radio Affiliates Association, New York Hilton hotel, New York City.

\*Oct. 3-4—Annual fall convention of Missouri Broadcasters Association, Missouri hotel, Jefferson City.

Oct. 4-6—American Women in Radio and Television east-central area conference, Coach House Inn, Milwaukee.

Oct. 4-6—American Women in Radio and Television New England conference, Chat-ham Bars Inn, Cape Cod, Mass.

\*Oct. 7-9—Annual fall meeting of the Kentucky Broadcasters Association, Owensboro Downtown Motel, Owensboro, Ky. The program begins at 5 p.m. Oct. 7 with a meeting of the board of directors.

Oct. 8-10—International Film Festival, Barbizon Plaza hotel, New York.

Oct. 11-13—American Women in Radio and Television west-central area conference, Holiday Inn South, Des Moines, Iowa.

Oct. 13-18—Second Advanced Advertising Management Course of the Association of National Advertisers, Hotel Moraine-on-the-Lake, Highland Park, Ill. R. P. Campbell, advertising manager for Post division of General Foods Corp., heads the subcommittee which is planning this course.

Oct. 14-18—Ninety-fourth convention of the Society of Motion Picture and Television Engineers, Somerset hotel, Boston.

Oct. 14-18—Fifteenth annual fall convention of Audio Engineering Society, Barbizon Plaza hotel, New York.

Oct. 16—Deadline for reply comments on FCC's rulemaking to control the development of AM and FM radio services.

Oct. 17-18—American Association of Advertising Agencies (AAAA) central region meeting, Sheraton hotel, Chicago.

\*Oct. 18—Effective date of FCC rule allowing employment of part-time engineers at certain AM and FM stations. Extended from former date of Aug. 19.

Oct. 18—Indiana Associated Press Radio-TV Association, French Lick.

Oct. 20-21—Meeting of Texas Association of Broadcasters, Cabana hotel, Dallas.

Oct. 24—Fourth Armed Forces Television Conference, sponsored by U. S. Air Force. Lowry Air Force Base, Denver, Colo. The conference will deal primarily with educational and technical uses of television by the military services. A trip to the Air Force Academy's closed-circuit television installation is also planned.

Oct. 25-27—American Women in Radio and Television board of directors meeting, Mayo hotel, Tulsa, Okla.

Oct. 28-30—National Electronics Conference, McCormick Place, Chicago.

Oct. 28-30—Third annual meeting, Institute of Broadcasting Financial Management, New York Hilton at Rockefeller Center.

Oct. 31-Nov. 1—Electron Devices Meeting of the Institute of Electrical and Electronics Engineers, Sheraton Park hotel, Washington, D. C. Speakers include John Hornbeck, formerly of Bell Telephone Labs and now president of Bellcom Inc., "Electron Devices for Space Applications"; Victor H. Grinich, Fairchild Semiconductors, "Why Field Effect Transistors?" and Lester F. Eastman, Cornell University, "Super Power Microwave Tubes." Program chairman for the meeting is Mason A. Clark, Hewlett-Packard Associates, Palo Alto, Calif.

#### NOVEMBER

Nov. 1-2—Oregon Association of Broadcasters convention, Hilton hotel, Portland.

Nov. 1-2—Grand Ole Opry 38th anniversary celebration, Nashville. Agenda includes expanded seminar of sales and programing.

#### RAB MANAGEMENT CONFERENCES

Sept. 9-10—The Homestead, Hot Springs, Va.; Sept. 12-13, The Hilton Inn, airport, Atlanta.

Sept. 16-17—The Holiday Inn-Central, Dallas.

Sept. 23-24—Gideon-Putnam, Saratoga Springs, N. Y.

Sept. 30-Oct. 1—O'Hare Inn, airport, Chicago; Oct. 3-4, Rickey's Hyatt House hotel, Palo Alto, Calif.; Oct. 7-8, Town House Motor hotel, Omaha.

Oct. 14-15—The Executive Inn, Detroit, Mich.

Nov. 4-5—Central Canadian Broadcasters Association management and engineering convention, Royal York hotel, Toronto.

Nov. 6-7—American Association of Advertising Agencies (AAAA) eastern annual meeting, Waldorf-Astoria, New York.

Nov. 6-9—National convention of Sigma Delta Chi, professional journalistic society, Golden Triangle Motel, Norfolk, Va. Dr. Glenn T. Seaborg, chairman of the Atomic Energy Commission, will be featured speaker at the Nov. 7 luncheon.

Nov. 10-12—ACRTF Convention, Quebec City, Canada.

Nov. 10-13—Annual meeting of the Association of National Advertisers, The Homestead, Hot Springs, Va.

Nov. 17-20—National Association of Educational Broadcasters national convention, Hotel Schroeder, Milwaukee, Wis. Banquet speaker is FCC Chairman E. William Henry.

Nov. 17-20—Broadcasters Promotion Association annual convention, Jack Tar hotel, San Francisco. Joseph P. Constantino, KTVU(TV) Oakland-San Francisco, is convention general chairman.

Nov. 20—American Association of Advertising Agencies (AAAA) east-central region meeting, Statler Hilton, Cleveland.

Nov. 22—National Academy of Television Arts and Sciences, New York chapter, holds "Close-Up" dinner and show lampooning comedian Jackie Gleason. Hilton hotel, New York.

Nov. 22-23—Combined meeting of Wisconsin Associated Press newspaper and broadcasting members, Milwaukee.

#### DECEMBER

Dec. 3-5—Winter conference of Electronic Industries Association, Statler-Hilton hotel, Los Angeles.

Dec. 5-6—Fourteenth conference of the Professional Technical Group on Vehicular Communications, Adolphus hotel, Dallas.

Dec. 6—Association of National Advertisers' workshop on planning and evaluation, The Plaza, New York City.

#### JANUARY 1964

Jan. 21-23—National Religious Broadcasters convention, Mayflower hotel, Washington.

Jan. 21-23—Nineteenth annual Georgia Radio-TV Institute, co-sponsored by the Georgia Association of Broadcasters and the Henry Grady School of Journalism, University of Georgia, Athens.

Jan. 24-26—Mid-winter convention of the Advertising Association of the West, Bakersfield, Calif.

Jan. 24-26—American Women in Radio and Television board of directors meeting, New York Hilton hotel.

#### FEBRUARY

Feb. 5-7—National Winter Convention on Military Electronics, Ambassador hotel, Los Angeles. C. D. Perrine, executive vice president of General Dynamics/Pomona, is convention chairman.

**wsai #1** IN CINCINNATI  
**45% SHARE** **17<sup>th</sup> MARKET**  
**IN THE USA**  
 PULSE: Cincinnati Metro,  
 March-April '63 (see graph)

Consisting  
 of  
 #1 Share  
 of the  
 affluent  
 18-49 year old  
 audience!\*

Family  
 Size  
 #1 Share of  
 households  
 with 3 or  
 more  
 members.\*



PULSE: CINCINNATI METRO, MARCH-  
 APRIL '63 TOTAL RATED TIME PERIODS

...the **BUYING POWER**  
 of cincinnati  
 ... that's why  
**wsai**  
 is THE BUY!

the largest  
 SHARE of  
 any RADIO  
 STATION  
 in the top  
 20 markets\*\*

For all the facts  
 call robert e.  
 eastman &  
 co., inc.  
 or  
 Richard Nason,  
 President.  
 Lee C. Hanson,  
 Gen. Sales Mgr.

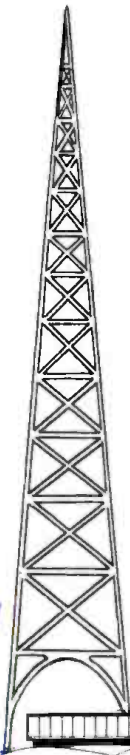

*Radio*  
 in cincinnati

\* Cincinnati PULSE LQR, NOV., 1962  
 \*\* LATEST PULSE IN EACH MARKET, ALL RATED TIME PERIODS.  
 (Subject to usual Pulse margin of error.)

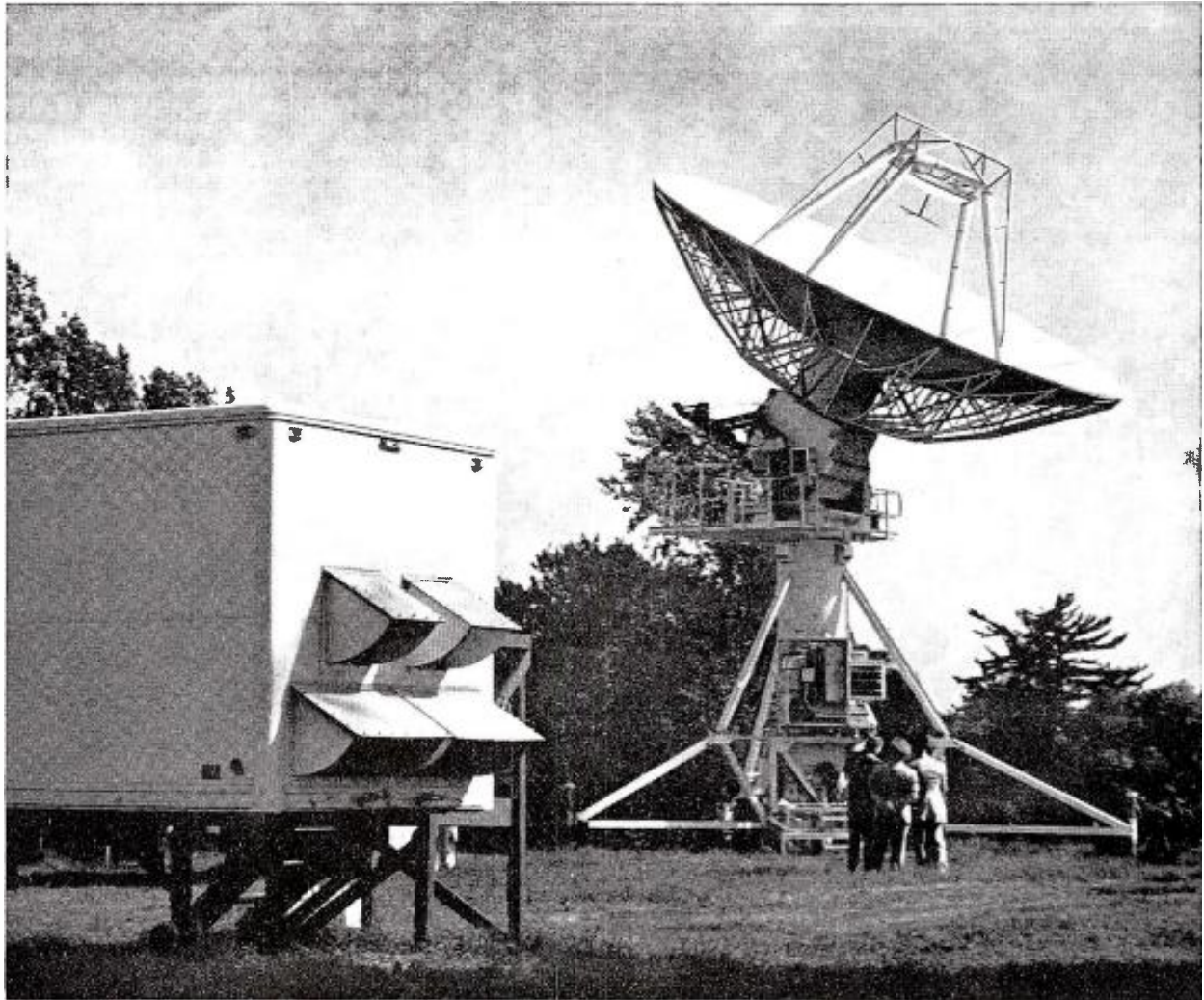

## A voice in space for every nation

A dramatic advance by an ITT System company permits any nation in the world to share in the myriad advantages of communication by satellite.

For ITT has conceived and developed an entirely new kind of satellite communications terminal. Easily transportable, it can be shipped anywhere. It can be erected in 24 hours. Its cost: modest. Now telephone, telegraph and data channels routed through space can be made available between remote and distant points all over the globe.

This new universal ground station—the first of its kind—is a complete, self-contained terminal for transmissions to and from satellites. First used in intercontinental voice transmis-

sion with NASA's Project Relay, minor adaptations will permit the equipment to work with other communications satellites yet to come. Installed in Brazil, it has already been responsible for the first link through space between the two Americas!

ITT is active in virtually every area of the U. S. space effort—from ground control to the production of complete satellites . . . from the development of tiny components to the management of missile ranges thousands of miles long. It's a natural role for the world's largest international supplier of electronics and telecommunications.

International Telephone and Telegraph Corporation. World Headquarters: 320 Park Avenue, New York 22, New York.

worldwide electronics and telecommunications

**Editorial reprint**

EDITOR: Please send me six reprints of your editorial, "Pressures." (BROADCASTING, July 22). I plan to send these to our congressmen—*Andrew Jarema, president, WKOP Binghamton, N.Y.*

**A nice round sum?**

EDITOR: Congratulations to WQIZ St. George, S. C., for its action against SESAC. It is entertaining to note that SESAC charged us with exactly 18 violations versus WQIZ's 17 after monitoring the smallest of our four stations, WMGW Meadville, Pa. Could it be that SESAC has found \$4,000 a nice round sum with which to coerce and threaten a station? We never play any known SESAC controlled music. Other broadcasters should follow suit. The real power of the copyright licenser is the federal law setting a minimum of \$250 damages per violation. If we can get this one clause removed, they are dead. Simply rephrase the law to let the federal courts decide the amount of damages, if any. The courts should set damages per violation at approximately the rate we pay ASCAP or BMI per selection—a few cents.—*William H. Rich, president, Regional Broadcasters Inc., New York.*

**FM report**

EDITOR: FM coverage (SPECIAL REPORT, July 29) is the finest yet. With your permission, we're going to adopt the heading on your editorial "FM for forward motion." We have just completed our own survey that's even an eye-opener for us "enthusiastic independent operators." Please send 20 reprints as soon as possible, and I have a hunch we'll be back for more.—*Jim Hodges, general manager, KHIQ(FM) Sacramento Calif.* (Permission granted.)

EDITOR: The special report was amazingly complete. Our order for 100 copies is enclosed. Here in Tidewater, Virginia, (Norfolk, Newport News, Portsmouth, Virginia Beach, Hampton and Chesapeake) we have 11 AM stations and nine FM stations in operation. Only one FM station duplicates the programming of an AM affiliate on a fulltime basis. Seven of the FM signals are completely different from AM.—*Harrison W. Moore Jr., manager WRVC-FM Norfolk, Va.*

EDITOR: We have been FM representatives for nearly two years and we include among our stations the only Metromedia property not repped by Metro Broadcast Sales (KMBC-FM Kansas City, Mo.), the third place stations in San Francisco and Los Angeles and a number of other top FM facilities in major markets around the country. In short,

we are old hands in FM. Mention is made on page 56 that "National selling will be tough until more national reps get into the act. . ." I take exception to this by saying (again) that until stations realize they cannot be sold without research, national selling will indeed be tough. The number of reps has very little to do with the problem.—*Bob Richer, Robert Richer Representatives Inc., New York.*

EDITOR: [You are] to be congratulated for doing such an intelligent job covering the blooming FM medium. Your article will serve to document the status that FM already has obtained and the many unexploited uses to which it may be successfully applied.—*Marshall M. Carpenter Jr. president and general manager, WDTM(FM) Detroit.*

EDITOR: We are grateful for the research reflected in your "FM Today" article. However, I feel the San Francisco-Oakland FM market deserves more than the 15 lines it got. Saturation is about 50%, but your quote of Gary Gielow of KPEN(FM) (and I think he has been misquoted) would lead us to believe there are only 225,000 FM homes in the area instead of about 450,000. Stereo-wise, five San Francisco FM stations (KBCO, KFOG, KMPX, KPEN, KSFR) broadcast their entire schedules in stereo. I don't think it is equalled anywhere. In addition, a San Francisco educational outlet (KXXX) transmits in stereo and KAFE has a partial stereo schedule.—*Pete Taylor, program director, KFOG(FM) San Francisco.*

EDITOR: The national advertiser list of those using FM has certainly grown. Your story mentions Philip Morris, Texaco, United Air Lines, Allied Chemicals, Mazola, P. Lorillard, Curtis Publishing and others. We would appreciate your readers knowing that these above named advertisers were all sold on FM through FM Group Sales Inc., and that until FM/GS, had not used FM radio before. Your article mentioned something about us "selling numbers," and we do. But we sell "large numbers" as well. Our Los Angeles group of six FM stations shows 54,000 FM homes delivered per average quarter-hour between 6 and 10 p.m. Monday through Friday according to Pulse, and it is this type of mass audience that we are currently selling to mass advertisers. FM radio through the group sales concept can right now, compete with all other media for national advertisers.—*Art Sakelson, president, FM Group Sales Inc., New York.*

EDITOR: Your special report on FM was superbly done. A very detailed and knowledgeable report on the future of FM.—*Ronald L. Sack, manager of pro-*



Mr. Bernard Rubin, *President, BERNIES Belair Road Chevrolet, Baltimore*

*"BERNIES Belair Road Chevrolet uses WFBR to bring in new prospects who are able to buy; to help us surpass our quotas. We have learned we can depend on WFBR for profitable results."*

Mr. Rubin is a regular and longtime advertiser on WFBR, Baltimore, which carried more local advertising volume during the first six months of 1963 than during any corresponding period in the station's 41 year history.

You too can sell an important segment of the Maryland market on WFBR. So join our host of friendly and happy local advertisers. Call your Blair man.



**BALTIMORE**

# VIP

## PROGRAMING

“VARIED  
INTERESTING  
PROGRAMING”

..... is another  
reason why  
more advertisers  
are investing more  
dollars on WSUN  
Radio than at  
any time in our  
35 year history

ONE OF THE NATION'S  
GREAT STATIONS

# WSUN

5 KW 620 KC

Broadcasting 24 hours daily!  
TAMPA—ST. PETERSBURG

Get all the facts from

Natl. Rep: VENARD, TORBET & McCONNELL  
S. E. Rep: JAMES S. AYERS

motion and publicity, ABC-Owned  
Radio Stations, New York.

EDITOR: Speaking for the FM Broadcasters of Greater Kansas City, of which I am chairman of the board, and as station director of KMBC-FM, I would like to present the FM case for Kansas City, which has five separately programmed FM stations. They are KCMK, which is a fulltime country and western station; KCMO-FM, which is middle of the road format (including classics) and is stereo from 6:30 a.m. to midnight Monday-Friday and 8 a.m. to midnight on Saturdays and Sunday; KXTR, a fulltime classic station; KCJC another middle of the road varied programmed station, and KMBC-FM, with adult-oriented music and regularly scheduled news, 24 hours a day with stereo from 6 a.m. to 1 a.m. It is interesting that all five separately programmed FM stations appear in Hooper reports regularly. Set penetration in the Kansas City market is estimated at better than 170,000 homes. In a check with the three automobile manufacturers in this area, automobile FM units, through April 1, have been delivered in more than 2,800 cars.—Chris J. Stolfa, station director, KMBC-FM Kansas City.

### Mid-South report

EDITOR: My compliments on the June 17 Mid-South market story. It was handled well and touched on the high points.—Edward Phelan, manager, KOKY Little Rock, Ark.

EDITOR: . . . Truly outstanding, requiring a great deal of careful thought and consecrated reporting. A job well done.—Eugene R. Bertermann, president, National Religious Broadcasters, St. Louis.

### BOOK NOTES

“Dictionary of Electronics Communications Terms,” compiled by the Howard W. Sams engineering staff. Howard W. Sams & Co., 4300 West 62nd Street, Indianapolis 6, Ind. 160 pp. \$3.95.

More than 2,500 terms related to the communications field are included in this book with concise definitions that serve the needs of both technical and non-technical people. Many slang and colloquial terms which have found their way into common usage are also listed.

“Dictionary of Modern Acronyms & Abbreviations,” by Milton W. Goldstein. Howard W. Sams Co., 4300 West 62nd Street, Indianapolis 6, Ind. 160 pp. \$4.95.

Another of the many reference volumes by Sams, this one deciphers coined words and abbreviations commonly used in the language of our modern world (e.g., sonar stands for sound navigation and ranging).

### BROADCASTING PUBLICATIONS INC.

PRESIDENT . . . . . SOL TAISSHOFF  
VICE PRESIDENT . . . . . MAURY LONG  
VICE PRESIDENT . . . . . EDWIN H. JAMES  
SECRETARY . . . . . H. H. TASH  
TREASURER . . . . . B. T. TAISSHOFF  
COMPTROLLER . . . . . IRVING C. MILLER  
ASST. SEC.-TREAS. . . . . LAWRENCE B. TAISSHOFF

## BROADCASTING

THE BUSINESSWEEKLY OF TELEVISION AND RADIO  
Executive and publication headquarters:  
BROADCASTING-TELECASTING Bldg., 1735 DeSales  
Street, N.W., Washington, D. C. ZIP code  
20036. Telephone: 202 Metropolitan 8-1022.

### EDITOR AND PUBLISHER

Sol Taishoff

### Editorial

VICE PRESIDENT AND EXECUTIVE EDITOR  
Edwin H. James

EDITORIAL DIRECTOR (New York)  
Rufus Crater

MANAGING EDITOR  
Art King

SENIOR EDITORS: J. Frank Beatty, Bruce Robertson (Hollywood), Frederick M. Fitzgerald, Earl B. Abrams, Lawrence Christopher (Chicago), Dawson Nail; ASSOCIATE EDITORS: George Darlington, Leonard Zeidenberg; STAFF WRITERS: Sid Booth, Sherm Brodey, Gary Campbell, Jim deBettencourt, Larry Michie; EDITORIAL ASSISTANTS: Natalie D. Lucenko, Tanii Orman, Judi Sue Robin, Chuck Shaffer; SECRETARY TO THE PUBLISHER: Gladys Hall.

### Business

VICE PRESIDENT AND GENERAL MANAGER  
Maury Long

VICE PRESIDENT AND SALES MANAGER  
Winfield R. Levi (New York)

ASSISTANT PUBLISHER  
Lawrence B. Taishoff

SOUTHERN SALES MANAGER: Ed Sellers; PRODUCTION MANAGER: George L. Dant; TRAFFIC MANAGER: Harry Stevens; ADVERTISING ASSISTANTS: Robert Sandor, Carol Ann Jenkins, Ken Albright; SECRETARY TO THE GENERAL MANAGER: Doris Kelly.

COMPTROLLER: Irving C. Miller; ASSISTANT AUDITOR: Eunice Weston.

### Publications and Circulation

DIRECTOR OF PUBLICATIONS  
John P. Cosgrove

CIRCULATION MANAGER: Frank N. Gentile; CIRCULATION ASSISTANTS: Edith Liu, Dave Lambert, German Rojas, Joan Chang, Bruce Kennedy, Marc Beaulieu.

### Bureaus

New York: 444 Madison Avenue, ZIP code 10022. Telephone: 212 Plaza 5-8354.

EDITORIAL DIRECTOR: Rufus Crater; BUREAU NEWS MANAGER: David W. Berlyn; ASSOCIATE EDITOR: Rocco Famighetti; STAFF WRITERS: John Gardiner, Phil Grose, Larry Littman, Ellen R. McCormick. ASSISTANT: Frances Bonovitch.

WESTERN PRESIDENT AND SALES MANAGER: Winfield R. Levi; EASTERN SALES MANAGER: Don Kuyk; INSTITUTIONAL SALES MANAGER: Eleanor R. Manning; ADVERTISING ASSISTANT: Beryl W. Stern.

Chicago: 360 North Michigan Avenue, ZIP code 60601. Telephone 312 Central 6-4115.

SENIOR EDITOR: Lawrence Christopher; MIDWEST SALES MANAGER: Warren W. Middleton; ASSISTANT: Rose Adragna.

Hollywood: 1680 North Vine Street, ZIP code 90028. Telephone: 213 Hollywood 3-3148.

SENIOR EDITOR: Bruce Robertson. WESTERN SALES MANAGER: Bill Merritt; ASSISTANT: Gail Leatham.

London: 11 Boston Road, Zone III. Telephone: 416 Hudson 9-2694. CORRESPONDENT: James Montanes.

BROADCASTING Magazine was founded in 1931 by Broadcasting Publications Inc. using the title BROADCASTING.—The News Magazine of the Fifth Estate Broadcast Advertising\* was acquired in 1932. Broadcast Reporter in 1933 and Telecast\* in 1953. BROADCASTING-TELECASTING\* was introduced in 1946.

\*Reg U. S. Patent Office

Copyright 1963: Broadcasting Publications Inc

BROADCASTING, August 12, 1963

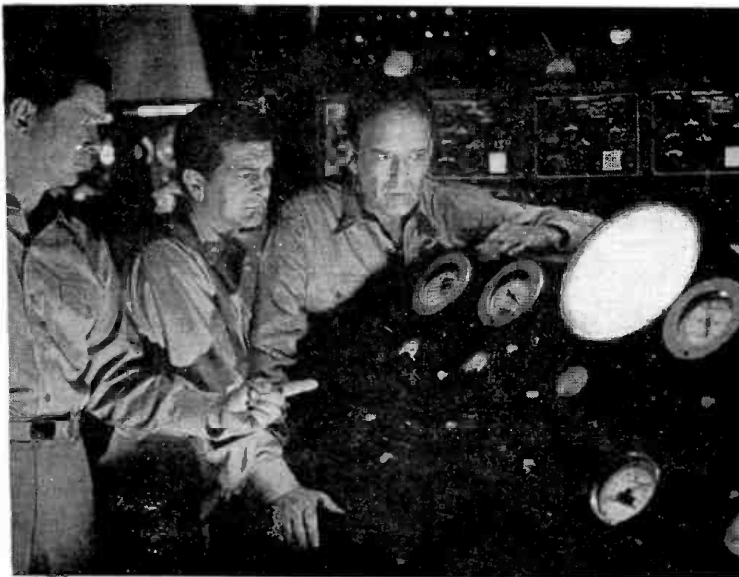

**NEW ON 2  
IN BALTIMORE!**

# "TWILIGHT MOVIE"

**Every Monday through Friday  
4:30 to 6:00 P.M.  
beginning September 2**

*Here is a great opportunity to sell all types of products and services in this important market! The time is right... the films are right! These film packages have never been aired before in this Channel 2 area, but have proven track records in other cities throughout the country!*



**Spectacular proven film  
packages—exclusive in this  
Channel 2 market area**

*Variety is the keynote on this five-times-a-week show! "SCIENCE FICTION THEATER" features suspense with well chosen, top-notch scripts... plus chillers, thrillers, and spine tinglers galore... plus the fun-loving "BOWERY BOYS" ...plus "BOMBA THE JUNGLE BOY", Sabu, and others. It all adds up to great daily shows backed by...*

**A BIG PROMOTIONAL CAMPAIGN!**



**No Wonder—In Maryland Most People Watch**

**WMAR-TV** 

Channel 2—Sunpapers Television

Television Park, 6400 York Road, Baltimore 12, Md.

Represented Nationally by THE KATZ AGENCY, INC.





# Can't mistake his hat...

The Crosley salesman's.

Because he wears only one.

That of WLW Radio or WLW Television.

The Crosley Broadcasting Corporation has its own sales force.

So when you call a WLW Radio or TV salesman, you *get* a WLW Radio or TV salesman. A man who is a vital member of Crosley Broadcasting . . . who knows his station . . . knows his market . . .

knows his facts and figures. In short, knows his stuff. His briefcase is an open and shut case for Crosley—containing complete information on the WLW Stations and markets—specific, detailed, important—which adds up to fast cooperation and results for you and your product.

Crosley's sales division is constantly interested in the development of easier buying techniques, and is now working on experimental broadcast research with advertisers—an area unique to our industry. When Crosley started its own national sales organization over 20 years ago it was a revolutionary move, now widely acclaimed. Just another example of the outstanding leadership and spirit of the WLW Radio and TV Stations—which have made Crosley Broadcasting “prime time” in every category!



## CROSLEY COLOR TV NETWORK



NATION'S  
HIGHEST  
FIDELITY  
RADIO  
STATION

CROSLEY BROADCASTING CORPORATION • A SUBSIDIARY OF **Arco**

## Don't let advertising's cost spiral dilute its efficiency

Advertising's present period of growth and prosperity is a good time to re-examine the fundamental trends in our business to insure that we will be strong and prosperous in the future. One immediate concern: advertising's rising cost.

Advertising is a business service which plays its part along with scientific development, manufacturing, finance and other business elements. It is subject to the same economic laws. Its costs must be commensurate with the service it performs.

The rising costs are of two kinds. There are the actual dollar increases in what the advertiser pays and there are some slack-filled packages, some reduced values which he receives.

**Chain Reaction** ■ The difficulty in combating rising costs is that they occur in so many separate items dealt with by many separate buyers.

The cost of art and photography, I'm told, has increased about 74% from 1945-1960. The cost of a set of four-color lead mold electros rose 133% between 1947-1963. The cost of typography is estimated to have risen 137% between 1945-1962. One investigator suggests that the cost of a magazine schedule rose 89% between 1946-1960 and the cost of a business paper schedule rose 86% between 1946-1956 and has undoubtedly since risen still higher.

If the advertiser is using television the same problem appears in different ways. Let's take, for example, the cost of preparing a filmed commercial for broadcasting. A book on TV production about a dozen years ago exclaimed in amazement a commercial had cost \$7,500 to produce. Today that commercial would cost at least \$15,000—maybe more.

Some commercials produced in recent years have cost as much as \$50,000. The average advertiser is paying about 85% more for a filmed minute spot than 10 years ago.

How have these costs built up? In one area alone, for example, the basic union rate for on-camera performers in 1955 was \$70. Today it is \$95. For an off-camera performer, the increase is from \$45 to \$70. These may seem modest.

**Use Fee Spiral** ■ But this is where the old joke applies—it isn't the original cost, it's the upkeep. In TV the upkeep is use fees. One agency recently calculated that a year's output of commercials which cost \$700,000 to produce required payment of another \$1.5 million in use fees.

Does this mean that media and sup-

pliers are making an unreasonable increase in profit? I doubt it very much. In many areas I suspect the rate of profit is substantially less.

It might be argued that costs have risen only in proportion. But the test of advertising value is the cost of advertising vs. dollars of goods sold by the advertiser. Unless we believe that a reader or viewer has unlimited capacity to comprehend and retain messages, we are obliged to believe that the competition of other advertising and promotional elements surrounding the advertising must inevitably subdivide the effective communication of the advertising message and thereby reduce its selling impact.

I think all of us have been concerned about too many commercials, station breaks and ID's in TV broadcasting. These divide the attention and memory capacity of the audience and inevitably reduce the value of the advertiser's message. But when we add the show bumpers, promotion for other shows, promotion for color TV, production credits, titles and billboards, the straws on the camel's back begin to build up in a pretty dangerous fashion.

**Breaking Point** ■ If the cost of advertising is steadily going up and if internal competition within the medium is steadily reducing the attention which any advertisement can hope to secure, can the effectiveness of advertising be maintained? If it cannot be maintained, can we expect our clients to use more and more of our services?

One large advertiser has several quite different lines of products. He has given me the figures to compare the dollars of sales he achieved per dollar of advertising in 1962 as against 1948.

In category A, he had in 1948 \$14.40 in sales for each dollar expended in advertising. By 1962 that ratio had declined to \$8 of sales per dollar of ad-

vertising. In category B, his sales dollars per advertising dollar had diminished during the same period from \$60 to \$25. In category C, a more cheerful picture. Sales per dollar of advertising had diminished only from \$7 to \$5.

These figures are from a successful company whose over-all earnings are very good. But if we measure profit dollars in relation to advertising dollars we find that the dollars of profit per dollar of advertising declined about a third in the first category and about 50% in the second. In the third category, this company had an increase of dollars of profit per dollar of advertising; but it is clear, since the sales per dollar of advertising declined, that other economies produced the profit.

**\$1.55 Gets Dollar's Worth** ■ Another of the world's largest advertisers has given me figures showing the percentage of sales spent on advertising from 1948 to 1961. With three exceptions these percentages have gone up every year during that period. And in 1962 this company spent \$1.55 in advertising to produce the sales achieved by a dollar in 1948.

I look forward to the day when a producer of TV commercial films will come to our office suggesting more efficient methods of production through which we can cooperate to reduce the cost of filmed commercials.

I look forward to the day when the negotiating committees of the unions who serve the many different parts of the advertising complex will consider the dangerous effect of rising costs upon the volume of their work and the volume of advertising business.

I look forward to the day when broadcasters will ruthlessly weed out the extraneous elements in the program hour so that the messages of the advertiser can have a full and fair share of the audience's attention.

Arthur E. Tatham is board chairman of Tatham-Laird and he presently is chairman of the American Association of Advertising Agencies. He also is past director of the Association of National Advertisers. A graduate of Northwestern University, Mr. Tatham was in charge of advertising-merchandising for Kendall Co.'s Bauer & Black Division until 1938 when he joined Young & Rubicam. After World War II Navy service, he and Kenneth Laird Jr. formed Tatham-Laird.





## It Takes RPM To Move The Goods!

Ratings ...

Programming ...

Merchandising ...



... the three-way push that moves the goods over WELI's RPM Radio! Depend on BIG-Buy WELI to deliver the rich, New Haven-centered market!

National Sales: H-R Representatives, Inc.; Boston: Eckels & Co.

**WELI** 5000 WATTS / THE SOUND OF NEW HAVEN / 960 K.C.



**Hottest  
TV Station  
in the  
Quad-Cities**

(Rock Island, Moline,  
East Moline, Illinois  
and Davenport, Iowa)

We're burning all the old record books for business activity. Availabilities have been nearly SRO for first half of 1963. Reasons for our banner year: (1) audience knowledge that Channel 4 is WORTH WATCHING! (2) outstanding sales results for local and national advertisers (3) affiliation with CBS, a scorching good network. One more item: the Quad-Cities market. No cold potato, this one! Employment has just hit a new ten-year high, and business is terrific. Call Avery-Knodel, or Maurice Corken at WHBF-TV, Rock Island, Illinois.



# 7 to 10% more spot TV this fall

- Agencies, advertisers, representatives all report increases
- Year's totals will beat 1962, SRA and TvB executives agree
- Buyers activity spurred by early opening of network programs

The fall buying season for spot television is in full swing—probably the busiest in television history.

Agency after agency, and many advertisers, reported last week that they currently are in the midst of planning and placing autumn and year-end campaigns that, by most estimates, will push 1963's spot television spending to a record high.

Television sales sources, almost uniformly reporting gains in fall selling, estimated fourth-quarter sales would be 7 to 10% ahead of the same period a year ago. Their estimates for the full year ranged from \$750 million to more than \$820 million, as against approximately \$721.2 million.

A number of station representatives, advertisers and agencies reported that fall spot schedules are benefiting this year from early starting dates for the three TV networks' new fall schedules. By Oct. 1, practically all network prime-time shows will have started their new cycles, whereas in past years many programs, especially on ABC-TV, have been introduced in October.

**Campaigns Advanced** ■ The stepped-up starting dates for new network programs were said to have prompted a number of spot advertisers to advance their campaigns accordingly. Several were said to be scheduling the start of their spot drives about two weeks earlier than usual. When this happens, authorities said, it usually means that much more spot activity because advertisers usually do not tend to compensate for an early start by a comparably early stop.

The earlier spot starts were credited by some observers with a considerable share of the improved outlook for the fall season. One station sales representative thought it would help put spot business in September alone 25% ahead of last September's figure.

Many executives in both selling and buying reported desirable major-market spot availabilities in short supply.

To keep their schedules from being frozen out or forced into less desirable time periods, some agencies have moved up both their buying and the starting dates of their campaigns.

Lever Bros., leading spot TV advertiser, though not appreciably boosting its spot expenditure for the fall, has found it necessary to keep close watch on its buying to preserve its franchises on certain time periods. This is reported to be the situation among other top advertisers.

BBDO, which anticipates a 5-10% increase in its spot TV volume this fall, acknowledged that its buyers in certain instances have had to begin earlier in fall planning and seek an advance in commitments because of this tightening up.

**Prognostications** ■ On the basis of current spot activity officials of both the Station Representatives Association and the Television Bureau of Advertising anticipated new records for 1963.

Norman E. Cash, TvB president, expected the figures to show a 15% gain for spot TV in this year's second quarter, with 10% gains in both the third and fourth quarters. On top of a 20% gain already reported for the first quarter, when TvB's spot estimates reached \$219.7 million (BROADCASTING, June

17), these increases would mean spot billings of \$217 million in the second quarter, \$167 million in the third and \$217 million in the fourth—a full-year total of almost \$821 million.

Mr. Cash said that "the number of new products breaking in is forcing spot television to a new all-time high. The gains are reflected in new buying patterns, creative selling efforts, and more stations being added to existing market lineups. TvB admits the greatest proof of television's selling power is the American businessman's dollar investment."

Lawrence Webb, managing director of SRA, was enthusiastic but somewhat more conservative in his dollar estimates. He said: "That the year 1963 will set a new record in spot television time sales appears to be an almost established fact, based on current available information covering the final-quarter buying this year. With last-quarter spot investments accounting for slightly more than 25% of the year's total, conservative estimates put the gross dollar volume figure for the last quarter at

## Spot flying high, trade heads agree



Bright prospects for spot television were predicted for the fourth quarter by well informed top executives of the Television Bureau of Advertising and the Station Representatives Association.

Lawrence Webb, managing director of SRA (l), expected "a new record in spot television time sales" in 1963. A gross dollar figure of \$211 million for the final three months and \$750 million for spot TV for the year was his prediction.

Norman E. Cash, TvB president (r), expected a 10% gain in spot business the final three months of this year as compared with last. His figures were \$217 million for the quarter and \$821 million for 1963.



## 7 TO 10% MORE SPOT TV THIS FALL continued

about \$211 million and the total figure for the year at slightly more than \$750 million.

"Most of the 50 major agencies report increases in spot TV expenditures for the last quarter. Minute avails are scarce in most markets except in fringe time periods, and desirable 20 seconds are at a premium."

**Big Chips At Bates** ■ Ted Bates & Co., biggest spot agency, expects to maintain its spot TV placements at their 1962 level, when the year's total came to about \$48 million.

Bates expects its Boyle-Midway Division of American Home Products, Colgate-Palmolive and Carter Products accounts to bill about the same in spot as last year, with Carter possibly adding to its network investment. A sizeable chunk of the Colgate billings will go behind a new product, Code 10 hair dressing, with its introduction in a spot campaign that is expected to go national in the fall.

Louis Marx toys, also handled by Bates, puts all of its budget into spot TV and expects to increase the total by 15 to 20% this year. It's buying in 25 markets in 13-week flights, using minute announcements in varying frequencies.

International Latex, another Bates account, is expected to continue the general spot TV pattern followed last year but may increase the schedule from 39 weeks to 52. Company is in 75 markets with 15 to 20 one-minute spots a week. Bras and girdles will continue to get about 70% of the TV budget.

Although details were not immediately available, other Bates clients known to be planning new fall TV drives included Continental Baking, Brown & Williamson's Viceroy and Kool cigarettes, Colgate's Rapid Shave.

A spokesman for J. Walter Thompson, while unable to pinpoint details, generalized for the agency that it will be a "big season in spot TV for our major clients."

**Up At BBDO** ■ At BBDO the high fall activity in spot is pegged at 5-10% over that of last year. A spokesman at the agency said that the major markets already are "tight" and reported such clients as Lever Bros., Campbell Soup (in spot TV for the first time), Pepsi-Cola, Shaeffer Pen, B. F. Goodrich, A. C. Gilbert (new to spot TV) and Alberto-Culver (regular and new products) as among its top blue-chips in spot this fall.

Young & Rubicam, through a media executive, reported its buying staff was "up to its ears in spot availabilities—in their 'acquisition' or their purchase." The spot leaders at Y&R are American

Home Products, Procter & Gamble, General Foods and Bristol-Myers.

At Benton & Bowles, Post cereals is hiking its full-year spot budget about 20%, using some 150 markets with three to a dozen announcements in each market each week. Procter & Gamble is said to be budgeting 7 to 10% more in spot TV this year, on lineups of from 100 to 150 stations. Maxwell House coffee is reported up 5%, Gaines Dog Food up 10%. Philip Morris reportedly is holding to its 1962 levels but Norwich Pharmacal has cut its spot budget by 15 to 20% and moved more heavily into network. Texaco's emphasis on sports continues to be predominantly in network sponsorships.

N. W. Ayer & Son, Foote, Cone &

### Buying by computer

The business of judging comparative efficiency of plans for spot television buying has been simplified in some agencies by the use of computers.

The understanding of computers has been simplified for laymen by a booklet entitled "How the Elephant Bought His Spots," prepared by Young & Rubicam and available to newspapers, publications and any other interested parties.

The booklet follows the typical procedure, via computer, for the actual purchase of one spot buy—for Sarong girdles—in one market—Boston—from its inception to its eventual appearance on the television screen.

Involved are the selection of the proper length and type of commercial, and the decision as to the type of viewer sought, and the frequency and reach of the message—all done prior to computer intervention.

Then, feeding all possible financial data into the machine, plus the desired reach and frequency, the agency calls upon the computer to furnish the answers as to the most efficient way of reaching its desired objectives within a given budget.

According to the booklet, the computer "does not supersede a media buyer's judgment" in evaluating programs, markets, or stations. Its value lies "in its ability to do tremendous quantities of analytical arithmetic with unparalleled speed and chilling accuracy."

Belding, and Geyer, Morey, Ballard were among the agencies expecting their billing to maintain approximately last year's level, with no significant variation up or down.

Papert, Koenig, Lois estimates its spot TV buying is at about the same pace as last year. Pharmacraft may be down slightly, but not much, while National Dairy's Breakstone Foods will be up. Clark Oil is using television for the first time, McGregor sportswear will be making its entry with a 15 to 20-market campaign, and National Sugar will maintain its 1962 level.

**Active Accounts** ■ At Fuller & Smith & Ross, American Chicle is using nighttime minutes in 50 markets, Lestoil is moving in 30 markets with a bigger spot budget and is looking for higher-rated periods than last year, and National Cotton, Elmer's Glue-All and the National Oil Fuel Institute are among advertisers with spot TV drives running or planned.

Warwick & Legler authorities reported their spot billings are down, chiefly because of increased use of network participations, radio spot billings also were reported up. Mail Pouch Tobacco was one account for which W&L was said to be placing a fall TV test campaign in "a few" markets.

Among cigarette accounts, P. Lorillard was reported to be buying no spot at the moment, though authorities indicated this situation may—or may not—change almost momentarily. Agency is Lennen & Newell.

Another cigarette, American Tobacco's Dual Filter Tareyton, reportedly has scheduled an extensive campaign in 60 markets in its first use of spot television. The account, currently at Lawrence C. Gumbinner agency, moves Nov. 1 to BBDO (BROADCASTING, Aug. 5).

Other advertisers for which fall spot activity was reported included:

Lever Bros., according to unofficial accounts, will be placing as much spot TV volume this year as it did a year ago, when it put an estimated \$19 million gross in spot TV. For Lever, this means also a continuation of its spot spending level in the fall. Lever agencies are finding desired availabilities "more difficult" and the company is aware of the need to keep what franchises it has had in spot TV schedules.

Lever's "All" detergent continues as a heavy spot TV leader in the company's array of some 15-20 brands now active in the medium.

Prestone Antifreeze, through William Esty Co., is using spot TV again as a supplement to its network advertising, putting about the same amount and proportion of its budget into spot this year as last.

Beecham Products, through Kenyon & Eckhardt, is expanding its spot cover-

## Whitman turns to radio after Sampler sample

Convinced that radio offers the necessary flexibility and mobility within a limited budget, Whitman Chocolates has upset its traditional advertising practices to make room for a campaign on ABC Radio for at least several months' duration.

Normally a heavy advertiser during holidays only, Whitman announced early in July a series of 22 announcements to be carried on ABC emphasizing the theme, "You don't need a reason or a season to give the Whitman Sampler."

Last week, Price Heppé, Whitman advertising manager, said the radio announcements had received considerable response from local salesmen already. "Their overwhelming enthusiasm and initial results tend to bear out the faith in our new con-

cept," he said.

The advertising, placed through N. W. Ayer, Philadelphia, came as a result of three separate studies conducted by the company and agency. "All concluded," said Mr. Heppé, "that the company could sell far more Samplers by spreading its advertising throughout the year and still maintain its traditional advertising hold on holidays."

Mr. Heppé said that the network radio advertising would be supplemented by television advertising during the holiday season. He noted that more than half of the Sampler advertising budget, largest in the product's history, was going into network radio, with the rest split between spot radio and television.

Whitman's network radio adver-

tising is being aired during drive time newscasts and weekend sports shows, with a particular effort being made to reach the male adult audience.

The exact allocation for radio has not been determined since the increase in sugar prices is expected to have some effect on company budgets, including advertising. Whitman does expect the radio drive to run more than six months and that its broadcast billings for this year will be around \$750,000. Spending in broadcasting last year was negligible.

"After careful research," Mr. Heppé said, "we determined that radio rather than any other medium had the flexibility, mobility and reach to give Whitman the audience it wanted at a cost within its budget."

age and this fall will be branching out from midwest markets to other regional areas for Brylcreem and MacLean's toothpaste.

H. J. Heinz baby foods will start as early as Sept. 2 in a spot TV campaign

that's expected to go through April. Doyle Dane Bernbach has just been assigned the account.

In the array of P&G accounts, Crisco Oil was said to be unusually heavy in spot TV this fall.

## HENRY AND AAAA GROUP MEET IN N.Y.

### Wide range of topics discussed at informal gathering

An off-the-record discussion described as "instructive on both sides" was held in New York last Monday (Aug. 5) between FCC Chairman E. William Henry and the Broadcast Committee of the American Association of Advertising Agencies.

Chairman Henry went to New York at the invitation of Committee Chairman Sylvester (Pat) Weaver, of McCann-Erickson International. The same 4A committee met with former FCC Chairman Newton N. Minow, at the latter's request, early in the Minow tenure.

Purpose of the four-hour meeting was for an exchange of views on subjects of common interest to the advertisers and the government and to give the committee members a chance to meet Chairman Henry. The chairman said he noted a lack of unanimity of views among the agency men and AAAA emphasized that it takes no official position on any of the matters discussed.

Noting their own lack of a united position, one committee member said Chairman Henry probably was convinced that the advertising industry segments are as hard to bring together as members of the FCC on given issues. It was felt that the divergent views ex-

pressed by the agency executives helped to demonstrate to the chairman that none of the solutions to the problems discussed are simple.

There was no meeting "agenda," but the key subjects discussed included option time, ratings and ratings services, commercial clutter, FCC encouragement of the development of UHF, quality programing and its saleability to advertisers, FCC emphasis on locally produced programs, children's shows, self regulation, the FCC's proposal to adopt limits on commercial time and advertiser influence over program content.

All members of the AAAA Broadcast Committee were present, except David Miller of Young & Rubicam and AAAA President John Crichton. Members of the AAAA committee present were Chairman Weaver; Richard A. R. Pinkham of Ted Bates & Co., vice chairman; Charles C. Barry, Young & Rubicam; Philip H. Cohen, Sullivan, Stauffer, Colwell & Bayles; Robert L. Foreman, BBDO; Henry G. Fownes, MacManus, John & Adams; Alfred L. Hollender, Grey Adv.; William H. Hylan and Ruth Jones, J. Walter Thompson Co.; Edward H. Mahoney, Fuller & Smith & Ross, and Lee M. Rich, Benton & Bowles.

## New Furness agency to stress marketing

Stan Furness, former director of marketing and advertising for Revlon's Thayer Laboratories, has formed the Stanley S. Furness Associates agency. Offices of the new agency are at 663 Fifth Avenue, New York, and at Jericho, Long Island. Mr. Furness says the firm will emphasize marketing aspects in its campaigns.

V.I.P. Service Drug Stores, Sulray Inc. and Maradel's Commerce Drug Division have signed with the new agency.

## Billy Graham TV special

Billy Graham Evangelist Associations, Minneapolis, is buying time on about 200 TV stations to carry a one-hour program in early September based on a Billy Graham crusade starting Aug. 15 in Los Angeles. Some 50-75 Canadian and other foreign stations also will be used. The regular weekly *Hour of Decision* radio program continues on more than 800 stations here and abroad. Agency: Walter F. Bennett & Co., Chicago.

## New rep firm in Dallas

A new regional sales organization for radio and TV stations, Mario Messina Co., has been formed by Mario Messina in Dallas.

A native of Dallas, Mr. Messina has worked for Tracy-Locke-Dawson, Pepsi-Cola Co. and Atlantic & Pacific Tea Co. Since 1951 he has specialized in regional advertising sales for newspapers, radio and television stations.

## A guide for rheumatism and arthritis ads

### NAB CODE HEAD SAYS IT'S NOT 'DOGMA'

Guidelines for the advertising of medicines for treatment of arthritis and rheumatism were announced last week by the National Association of Broadcasters. They were developed by the NAB code authority in cooperation with advertising agencies and have been endorsed by the Arthritis and Rheumatism Foundation.

Robert D. Swezey, code director, and Dr. R. W. Lamont-Havers, the foundation's medical director, said the guidelines "will promote more responsible TV advertising in a most delicate field." They also will help broadcasters achieve more effective self regulation, Mr. Swezey said.

He emphasized that the suggested guides are not "dogma," but general principles which can be changed as the need arises. The guidelines follow:

"A large number of people in this country suffer from some form of arthritis and rheumatism. Many have the potentially serious forms of these diseases which result in progressive crippling. As yet, the causes of arthritis and rheumatism have not been discovered. Also, there is no completely satisfactory means of treatment for all

cases. Recognizing this, the code authority endorses the following common sense guidelines designed to assist advertisers and broadcasters in the preparation and evaluation of television commercials.

#### "SEEK—Audio and Video

"1. Positive disclosure that the effectiveness of a product, in its recommended dosage or application, is limited to the temporary relief of minor aches and pains of arthritis and rheumatism.

"2. Copy claims and video dramatizations consistent with limitations and directions for product use as shown on labeling.

"3. Substantiation of product performance claims based upon bona fide clinical studies, testimony of medical experts qualified by experience and training or adequate references to medical literature.

"4. To advise sufferers of serious or prolonged arthritic or rheumatic aches and pains to see a physician for proper guidance and care.

#### "AVOID—Audio and Video

"1. Any implication that a product, in its recommended dosage or application, will do more than give temporary

### Dial-a-program

Advertisers disenchanted with broadcast ratings now have the opportunity to evaluate Cincinnati radio stations by a new method—listening to the programs. And they don't even have to leave their offices across the country.

WCKY Cincinnati's engineering department has developed a monitoring device which can tune in all area radio stations, and an advertiser who wishes to compare programming in the market has only to call Miss Allee Sayers of WCKY at 241-6565, area code 513, to hear any area station he names.

relief of minor aches and pains; references to treating the cause or in any way having an effect on the disease process.

"2. Any implication which would tend to negate the concept that the product does more than relieve minor aches and pains. This could include the use of such terms as 'agonizing,' 'torture,' and before and after comparisons demonstrating a dramatic, marked improvement of joint movement.

"3. Any implication that the product will work where others have failed, claims of effectiveness implied by references to 'secret discovery,' 'like magic' or 'miracle drugs.'

"4. Use of clinical studies not based upon adequate number of cases, not employing controls and accurate statistical analysis of the results, as substantiation of product performance claims.

"5. Use of testimonials to support product claims that cannot also be substantiated by bona fide clinical studies, testimony of medical experts qualified by experience and training or adequate references to medical literature.

"6. Any claims that products such as bath salts, food supplements and devices such as vibrators, water agitators, in themselves, are effective in the treatment of arthritis and rheumatism."

### RAB opens membership to allied field groups

The Radio Advertising Bureau is opening its membership rolls, effective today (Aug. 12), to people and organizations allied to the radio business. The new "associate" membership is a departure by RAB which up to this time had restricted itself to radio stations, networks and station representatives.

Edmund C. Bunker, RAB's president, said the move was partly based on the "urgent need for additional financial support of RAB at this juncture of ra-

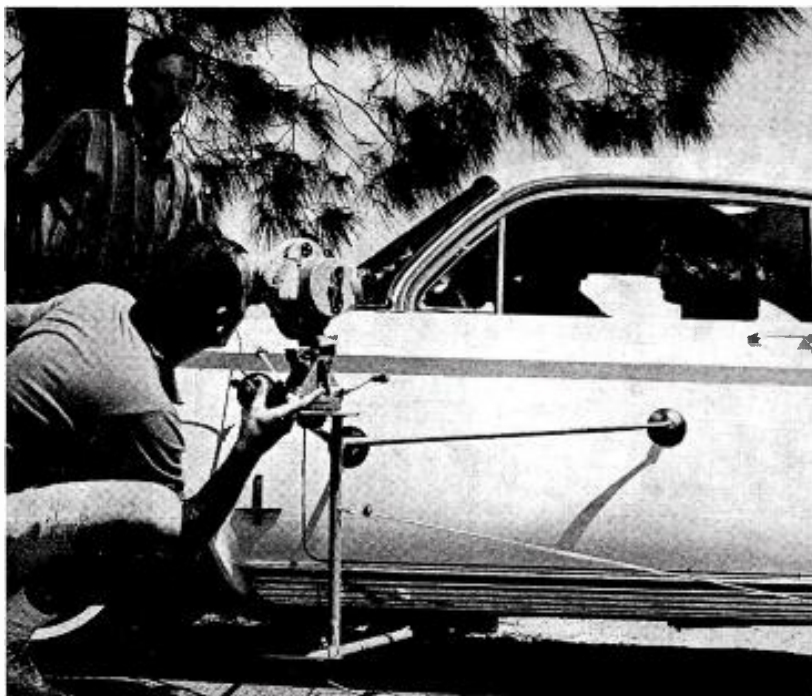

### Sidemount used for commercials

Filmex Inc., New York, is using a "rig" to show the casual, natural expressions of driver and passenger of this Chevy II automobile. Using wires, strings and suction cup, the

camera will record the actors' moves with the car in motion. Marshall Stone (l) is director and Jack Horton is cameraman. Chevrolet's agency is Campbell-Ewald, Detroit.



# For the fourth consecutive year Charlotte's WSOC-TV dominates awards in annual Southern News Photography Competition

Do you like to look at the news? Hear about it? If you were one of the some three million people within our viewing area, chances are you would satisfy your liking by setting your dial on Channel 9. Charlotte's WSOC-TV is the news station of the Carolinas.

This year, WSOC-TV cameramen swept eight of the ten first and second place awards offered in the competition open to television photographers throughout the South. This brand of local and regional reporting awards advertisers, too. With big audiences; dependable, able to buy. Let this great area station of the nation induce them to buy from you. Schedule WSOC-TV.

#### JOHN CLIFFORD

Named "Southern TV Photographer of the year"  
1st—General News Film, "Gantt at Clemson"  
1st—Feature News, "Last Day of Summer"

#### MIKE O'HARA

1st—Sports News, "Round the Mountain"

#### BOB MORSE

2nd—Sports News, "Tally Ho!"

#### GEORGE CARRAS

2nd—Feature News, "River Boat"

#### JOHN CLIFFORD—STEVE DELANEY

1st—Team Filming, "The Lord is Dead"

#### STEVE DELANEY—FRED BARBER

2nd—Team Filming, "Storm"



## Paint store chain sticks with TV after strike

"Immediate and impressive" sales results through the use of television during the New York newspaper shutdown have prompted Martin Paint Stores to move into TV on a large scale this year.

The paint store chain, which had never used television prior to the strike, has added \$150,000-\$200,000 to its advertising budget since the beginning of the shutdown for schedules on New York stations on a 52-week basis.

The company began using minute and 10-second commercials on

WNBC-TV during the first week of July. The campaign will continue on that station through next July with 35 commercials going each week. Additional schedules will begin on WNEW-TV and WPIX(TV) later this month, with 13-week flights on each station. Total volume will be 65 announcements weekly.

Martin entered TV during the waning days of the newspaper strike with a series of 10-second announcements on WPIX, WNEW-TV and WABC-TV. At the conclusion of the strike it stayed on WNBC-TV and WPIX.

dio's history." He cited the \$200,000 radio methodology study plus anticipated costs of other research plans and said, "in addition, we must push harder in our sales efforts in order to heighten advertiser awareness of radio's strength as an advertising medium."

Mr. Bunker said he saw additional support coming from "those whose prosperity is dependent on the radio medium," mentioning as some examples the following: communications attorneys, program syndicators, station brokers, producers of commercials and station sales aids and equipment manufacturers.

He said associate members would be entitled to RAB's sales promotion material and would have the bureau's library facilities at their disposal.

### Agency appointments . . .

▪ The Dorothy Gray division of Lehn & Fink Products Corp. has appointed C. J. La Roche & Co. for its line of

cosmetic products. The account, which bills approximately \$1 million, left McCann-Erickson in May.

▪ The Texas 65 Health Insurance Association has named Tracy-Locke Inc., Dallas, to handle advertising.

### Rep appointments . . .

▪ WLTV(TV) Bowling Green, Ky.: Vic Piano Associates Inc., New York, appointed national representatives.

▪ WSEE-TV Erie, Pa.: Kettell-Carter Inc., Boston, as New England representative.

▪ WHAT Philadelphia: The Bolling Co., New York, as national representative.

▪ WFEA Manchester, N. H.: Avery-Knodel Inc., New York, as national representative.

▪ KATN Boise, Idaho: Ewing/Radio, Los Angeles, country-western radio station representative organization, as its sales representative.

## Gumbinner recoups part of lost billings

Lawrence C. Gumbinner agency which lost the American Tobacco Dual Filter Tareyton account and its estimated \$7- to \$12-million in billings (BROADCASTING, Aug. 5) was assigned two new accounts last week.

Sudden Beauty, a cosmetic of Whitehall Laboratories, and Brioschi, an anti-acid distributed by Ceribelli & Co., each with billings said to be under \$1 million, have been assigned to the Gumbinner agency.

The Sudden Beauty account was formerly handled by Ted Bates and Brioschi by Ellington & Co. The Gumbinner agency says campaigns including network and spot TV for Sudden Beauty and radio and TV spot for Brioschi are planned.

### Also in advertising . . .

**New agency** ▪ Calvert-Stearns Inc., new advertising and public relations agency, has been formed by Torrey Stearns and Patricia Calvert with offices at 1 East 53d Street, New York. Mr. Stearns was public relations director of Adams & Keyes Inc. where he handled Ethiopian Airlines account. Miss Calvert has headed her own company for the past four years.

**Joins TVB** ▪ Metropolitan Broadcasting Stations (division of Metromedia Inc.) has joined the Television Bureau of Advertising, TVB and Metropolitan announced today (Aug. 12). TV stations are WNEW-TV New York; WTTG Washington; KTTV Los Angeles; KMBC-TV Kansas City, Mo.; KOVR Stockton, Calif.; WTVP Decatur, and WTVH Peoria, both Illinois.

## GOVERNMENT

# INTERIM RATINGS REPORT

## Richardson draft has 27 recommendations; urges government action if broadcasters don't act

An interim report which is now being prepared on a congressional investigation of broadcast audience measurement can be expected to convince anyone who thinks Congress has forgotten about ratings that he's quite mistaken.

The report, in draft form and still incomplete, includes 27 recommendations on ratings—everything from government regulation of ratings firms (if industry fails to straighten things out) to requirements on the size of type raters use to explain their techniques in their reports.

Robert E. L. Richardson, associate counsel of the House Special Subcom-

mittee on Investigations, took the document last weekend to New York where he was to consult with Dr. Herbert Arkin, a professor of business statistics at the City College of New York, who was special consultant to the subcommittee during its hearing this spring (BROADCASTING, Feb. 18, et seq.).

The hearing climaxed more than 18 months of intensive investigation. It ran on and off for almost four months and was recessed after FCC Chairman E. William Henry testified that broadcast licensees would be held responsible for the use of ratings in advertising and sales presentations made by them or in

their behalf by representatives (BROADCASTING, June 24).

**A Few Shocks** ▪ Mr. Richardson, author of a rough draft of the report and its recommendations, said last week that he proposed the kind of standards and procedures which a reasonable person might think that honest and efficient research companies would do on their own without government requirement. He said, however, that he thought the document contained a few "shocks." Broadcasters would in general welcome it, Mr. Richardson thought. Advertising agencies and research companies might have some "squawks."

Asked when the report might be released, Mr. Richardson said that that was difficult to tell. The subcommittee members, all on the House Commerce Committee which has been tied up with a heavy legislative load, have not met to consider their ratings course since

# WE'RE ON THE AIR !!

Only 12 days old and coverage and reception reports are outstanding.

First coincidentals show

## WQAD-TV (Quad-Cities)

already producing big audience!

### ALL-STAR FOOTBALL

(ARB Telephone coincidental, 9:30-10 P.M., Friday, Aug. 2, 1963)

	Rating	Share
<b>WQAD-TV</b>	<b>29</b>	<b>59%</b>
Station A	14	29%
Station B	6	12%

### BEN CASEY

(ARB Telephone coincidental, 9:30-10 P.M., Monday, Aug. 5, 1963)

	Rating	Share
<b>WQAD-TV</b>	<b>17</b>	<b>33%</b>
Station A	18	35%
Station B	16	31%

(Audience measurement data are estimates only, subject to defects and limitations of source material and methods. Hence, they may not be accurate measures of the true audience).

**WQAD-TV** carries the complete ABC line-up in Quad-Cities—Moline, East Moline, Rock Island and Davenport.

**Frank P. Schreiber, President & Gen. Mgr.—Les C. Rau, Director of Sales**

For choicest availabilities call your



man.

June. But individual congressmen have told reporters that the subcommittee has no intention of dropping the ratings problem.

Broadcasters asked for and were given an opportunity to try to come up with a solution when Governor LeRoy Collins, president of the National Association of Broadcasters, and Edmund Bunker, president of the Radio Advertising Bureau, both outlined their plans for improvement. The subcommittee's recess was intended to give broadcasters an opportunity to show what they can do.

Mr. Richardson's recommendations are based in part on his observations at the hearing, where he conducted much of the staff questioning, and on his work as one of the two subcommittee investigators who prepared the bulk of the material used in the hearing. His recommendations do not at this point necessarily reflect the subcommittee's thinking, although members were in considerable agreement on criticisms which its staff leveled at the research companies.

**Key Recommendations** ■ If broadcasters are unable to solve the ratings problem by regulating the research companies through an audit of their procedures and new requirements for research standards, then the government should. Mr. Richardson notes that Governor Collins testified under questioning by Representative Paul G. Rogers (D-Fla.): "Well, we would certainly like to try our hand at the free, voluntary way. But I do not hesitate to say to you that personally, if it took a licensing program to give the broadcaster a sounder assurance of accuracy in these ratings, I personally would not look upon that with disfavor."

Research companies would have to provide full disclosure of their sampling, editing and tabulating procedures. Mr. Richardson took issue with an audit

plan proposed by the A. C. Nielsen Co., biggest of the rating firms (BROADCASTING, July 29). He said the raters should not sit on an industry committee. Contrary to a Nielsen proposal Mr. Richardson said that an auditing service should not be financially responsible for actions arising from the reports it audits. Nor, he said, should the researchers be given an opportunity to review audit reports prior to publication, as Nielsen recommended. Nielsen said this would be advisable for advance comment or clarification.

Along with full disclosure of their methods, research companies should be required to provide clearly written summaries of what they did to produce their reports, and this information should be printed prominently inside each report and set in the same size type as other editorial material. Broadcasters have told the subcommittee that they don't really understand ratings, and these researcher statements would be helpful in keeping broadcasters informed, Mr. Richardson said. Ratings research is not as difficult as researchers have made it out to be, and broadcasters should know this, he said.

Broadcasters should remain responsible for the accuracy and use of all reports they utilize in advertising and sales. This recommendation agrees with policies announced by the FCC and the Federal Trade Commission (BROADCASTING, June 17).

One device which Mr. Richardson believes would be especially helpful in pointing out that ratings figures are only estimates and lack the precision their use seems to have given them, would be to require that all figures, percentages, averages and the like be expressed in ranges. Ranges would be a constant reminder that the figures represent estimates, he said.

Researchers should provide com-

plete information on the size of their samples. Samples for audience composition data should be broken down. For example, Mr. Richardson explained, if a report stated that X% of a station's audience was in certain income group, the report should indicate how large a sample was used to determine this estimate.

## Transcripts aplenty, but still no report

The Senate Juvenile Delinquency Subcommittee, which has yet to release a report on the effects of TV violence and crime on children, has obtained permission to do some other publishing.

The subcommittee is printing another 3,000 copies of its 957-page hearing transcript, the testimony of the much-publicized 1961 and 1962 sessions on television.

The subcommittee already has printed 1,000 copies at a cost of \$4,597 but it wanted to run off another 4,000. However the Senate Rules and Administration Committee, on a note of economy, asked Senator Thomas J. Dodd (D-Conn.), subcommittee chairman, if he couldn't get along with just 3,000 more copies. The senator amended his request and it was approved.

The cost of 3,000 more copies: \$6,227.46.

A revised version of a subcommittee report has been on Senator Dodd's desk since December, but has not been released (CLOSED CIRCUIT, Dec. 24, 1962).

## New bill would set up Department of Consumers

Representative Benjamin S. Rosenthal (D-N.Y.), who sponsored a bill to set up an Office of Consumers in June, has introduced new legislation which would set up not just an office—but an entire Department of Consumers to be headed by a secretary with cabinet rank.

The new bill, HR 7879, has been referred to the House Government Operations Committee where Representative Rosenthal, a committee member, believes it stands a better chance of obtaining a hearing than his earlier proposal, HR 6865, which was sent to the Commerce Committee. Representative Oren Harris (D-Ark.), Commerce chairman, wasn't very interested in conducting a hearing, Representative Rosenthal said last week.

The new proposal would shift several existing government offices to the new department: the Food and Drug Administration, the Division of Prices and Cost of Living of the Bureau of Labor Statistics of the Department of Labor,

## Henry doesn't hanker for the House

Representative Clifford Davis (D-Tenn.) can relax. FCC Chairman E. William Henry last week denied as "absolutely untrue" a Republican report that he planned to run against the conservative Democrat from Memphis in the 1964 primary.

Chairman Henry said his disavowal of any plans to run for Congress was emphatic and final. "I am not leaving the door open at all to make such a campaign. I plan to be right here [FCC] . . ." through the expiration of his current term in June 1969, he said.

*Newsletter*, weekly publication of the Republican Congressional Campaign Committee, reported last week

that Mr. Henry was named FCC chairman to "help build up his political stature" in preparation for a 1964 campaign against Representative Davis. Chairman Henry was appointed to the FCC in August 1962, just a few weeks after he had directed the unsuccessful primary campaign of Ross Pritchard against Representative Davis.

Chairman Henry said that this political activity on his part had nothing to do with his appointment to the commission. A major factor, however, was the chairman's activities in 1960 on behalf of presidential candidate John F. Kennedy, for whom he worked full time.

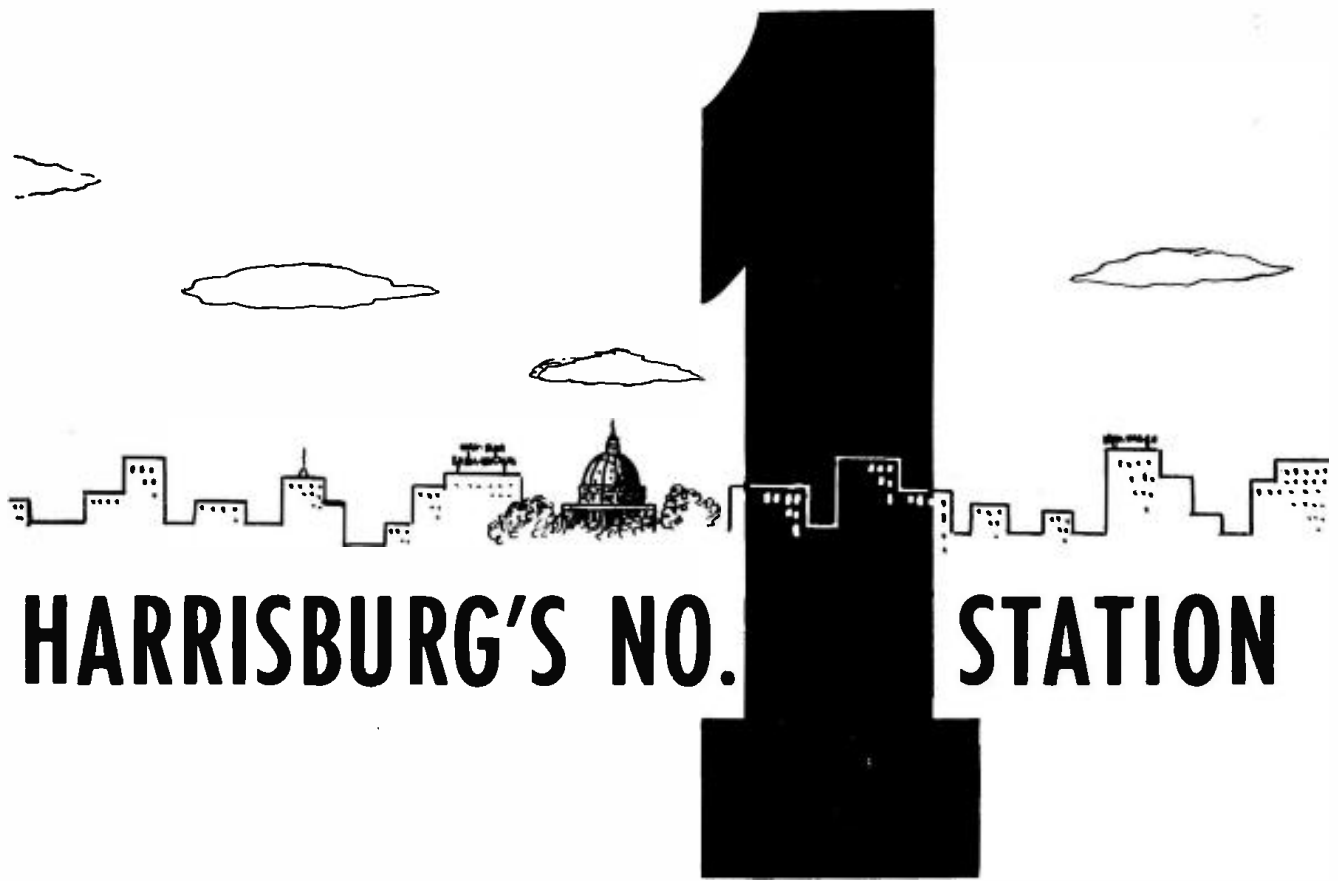

# HARRISBURG'S NO. 1 STATION

## WTPA-TV LOCAL PROGRAMING DELIVERS 151% MORE HOMES

(MONDAY THRU SUNDAY, 5:00 P.M. TO 7:30 P.M.)

THAN THE OTHER HARRISBURG STATION\*

*represented by*

*HARRINGTON, RIGHTER & PARSONS*



\*ARB FEBRUARY AND MARCH 1963

## JEFFREY HUNTER AS "TEMPLE HOUSTON"

### *Lawyer on Horseback*

As a real-life lawyer in the rowdy West of the 1880's, Temple Houston once demonstrated the perils of the quick draw by suddenly whipping out a .45 and firing a few rounds (of blanks) at judge and jury. Nobody slept while *he* was on.

Any lawman with that much theatrical savvy must have sensed he'd one day be the hero of a television series—and he was so right.

Now, some 80 years afterward, the full-hour "Temple Houston" will be taking its place among NBC-TV's new offerings for the Fall.

There's no record that General Sam Houston (our hero's father) ever referred to Temple as "my son, the lawyer," but well he might have. For, as roving defense counsel in actions ranging from land-rights squabbles to murder cases, Temple built a reputation as one of the Southwest's most resourceful fighters for justice.



In the television series, he'll be played by Jeffrey Hunter, currently being seen as Sgt. Fuller in Darryl Zanuck's "The Longest Day." Like NBC-TV's Dick Chamberlain, Jack Ging and James Drury, young Hunter has the looks and talent that virtually insure a tremendous following.

The series' co-star—in the role of an itinerant U.S. Marshal—is Jack Elam ("male" spelled backwards), the "J. D. Smith" of TV's "The Dakotas."

Most of the "Temple Houston" story-lines will

originate in actual court cases of the period, giving the dramas a strong flavor of authenticity. Helping the series achieve and maintain this flavor will be its executive producer—fellow by the name of Jack Webb. Mr. Webb's documentary-style "Dragnet", also presented on NBC-TV, was restricted to a Los Angeles setting and ran for a mere seven years; "Temple Houston" will be roaming the entire Southwest. Write your own editorial.



*Look to NBC for the best combination of news, information and entertainment.*

## 16-year-old ham raises congressman's ire

A 16-year-old ham operator in Elizabeth Borough, Pa., has been causing considerable disturbance for the past year to local television reception. And he may have set off more static than just reception interference.

Representative Elmer J. Holland (D-Pa.) reported to the House last Tuesday (Aug. 6) that Charles Seaman, operating the amateur station K31OP, has been creating quite a problem for his constituents in Elizabeth Borough. Representative Holland has taken his case to FCC Chairman E. William Henry who has promised to bring the matter before the commission.

Mr. Seaman's operation is in the 50-54 mc band which is adjacent to channel 2 on which KDKA-TV Pittsburgh operates and is interfering with the aural, and at times the visual, reception of area television sets. Representative Holland charged that he has deliberately stepped up his power "blasting TV reception off the air."

The FCC has made at least eight checks on Mr. Seaman's doings, of which several were entirely secret, and have found him to be within his license. The agency said it has asked the young man to stay within the lower portion of his band and he has complied.

**Threatened Legislation** - Representative Holland, however, is still anxious to see something done and has requested Representative Oren

Harris (D-Ark.), chairman of the House Commerce Committee, to recommend legislation which would give the commission the power to take effective remedial measures.

At the present time the only possible recourse the FCC could have, since Mr. Seaman has been found to have a legal operation, would be to modify his license under the public interest provisions of commission rules.

The commission has been doing more, however, than just checking. An agency source said that the commission, through the cooperation of TV set manufacturers, procured some 128 high-pass filters on a gratis basis for listeners who made their troubles known.

In a further step the commission's Buffalo field office tested the high-pass filters in the company of the Elizabeth Borough council at a location selected by the council and reception was clear. But the council, it would seem, was not convinced. It has voted a resolution urging communities to pass laws against interference by ham operators.

KDKA-TV has made no complaint to the commission concerning the operation of K31OP. The commission said the TV station puts a highly receivable signal over the area.

The FCC reportedly handles thousands of interference complaints but this one appears to have caused one of the biggest uproars to date and still has not been settled.

## Governors favor Sec. 315 suspension

Senate Commerce Committee records showed last week that 30 governors would like to see Section 315's equal time requirement for political candidates suspended for gubernatorial races as well as presidential, vice presidential and congressional races.

Only one governor who commented, Nelson A. Rockefeller (R) of New York, opposed the suspension down to the governor level. He favored suspension for president and vice presidential races (BROADCASTING, Aug. 5).

The governors' comments were solicited by Senator John O. Pastore (D-R.I.), chairman of the Communications Subcommittee, for a hearing on legislation to suspend or repeal Section 315 (BROADCASTING, July 1). Although the hearing has been concluded, the subcommittee has not had an opportunity to meet on the proposals because of hearings on railroad work rules and civil rights legislation.

Favoring suspension which would include gubernatorial races (S 252): George C. Wallace of Alabama (D), William A. Egan of Alaska (D), Paul Fannin of Arizona (R), Edmund G. (Pat) Brown of California (D), John A. Love of Colorado (R), John N. Dempsey of Connecticut (D), Carl Sanders of Georgia (D), Robert E. Smylie of Idaho (R), Otto Kerner of Illinois (D), Matthew E. Welsh of Indiana (D), John Anderson Jr. of Kansas (R), Bert T. Combs of Kentucky (D), J. Millard Tawes of Maryland (D), Endicott Peabody of Massachusetts (D), John M. Dalton of Missouri (D), Tim M. Babcock of Montana (R), Frank B. Morrison of Nebraska (D), John W. King of New Hampshire (D), Richard J. Hughes of New Jersey (D), Terry Sanford of North Carolina (D), William L. Guy of North Dakota (D), Henry Bellmon of Oklahoma (R), Mark O. Hatfield of Oregon (R), John H. Chafee of Rhode Island (R), Donald Russell of South Carolina (D), Frank G. Clement of Tennessee (D), John Connally of Texas (D), George Dewey Clyde of Utah (R), Albert D. Rosellini of Washington (D) and William W. Barron of West Virginia (D).

Those who corresponded with the committee but expressed no view on the proposals included Farris Bryant of Florida (D), John A. Burns of Hawaii (D) and John W. Reynolds of Wisconsin (D).

There were no responses from the governors of Arkansas, Delaware, Iowa, Louisiana, Maine, Michigan, Minnesota, Mississippi, Nevada, New Mexico, Ohio, Pennsylvania, South Dakota, Vermont, Virginia and Wyoming.

the Home Economics Research Branch and the Human Nutrition Research Branch of the Agricultural Research Service and elements of the Bureau of Standards engaged in research or testing of consumer articles.

Senator Estes Kefauver (D-Tenn.), who introduced legislation similar to Representative Rosenthal's first proposal with the backing of 22 co-sponsors (BROADCASTING, June 10), said then that he had abandoned his efforts in earlier years to set up a Department of Consumers because the transfer of existing government offices was met by "considerable objection." The Senate Government Operations Committee has not set a date to hear Senator Kefauver's bill (the proposal for an Office of Consumers).

One of the bases for consumer protection legislation which Senator Kefauver has cited is a failure of "house counsel" within regulatory agencies such as the FCC to provide "adequate legal protection for the consumer" in developing hearing records.

## Democrats told to take complaints to FCC

Democratic congressmen were advised last week to complain to the FCC if they feel that the party or the individual member of Congress has been treated unfairly by radio or TV.

Samuel Brightman of the Democratic National Committee sent to Democratic legislators a copy of the FCC's controversial policy statement delineating a broadcaster's responsibilities under the fairness doctrine to present all sides of controversial issues (BROADCASTING, Aug. 5, July 29). In an accompanying letter, Mr. Brightman said the national committee has received "quite a few complaints about unfairness."

He told the Democratic members of Congress the FCC statement was being sent to them because of the complaints received by the committee. "I hope you will keep it in your files in the event you feel any programing in your area has been unfair to yourself or the Democratic Party," he said.



# FIRST EVERY DAY... And Here's Why...



- **EXCITING, COLORFUL LOCAL PROGRAMMING**

Central New York's greatest news department; Upstate New York's only live musical variety show; celebrity-filled live women's show; outstanding documentaries that out-rate network programs.

- **GREATEST TV PERSONALITIES**

Fred Hillegas, Joel Mareiniss, Jerry Barsha and experienced news staff of seven; Denny Sullivan and the WSYR Gang, musical variety show starring Eileen Wehner and Fred Krick; Bill O'Donnell, sports; Ed Murphy, movies and weather; Kay Russell, women; "Salty Sam," Popeye host. Central New York's greatest salesmen!

- **BEST TECHNICAL FACILITIES**

In Central New York — first with color; first with video tape; first with a modern, completely-equipped TV center and the only channel with maximum power at maximum height.

- **EXPERIENCE AND "KNOW-HOW"**

A top-flight veteran staff directed by executives averaging more than 20 years at WSYR-TV. No "Johnny-come-latelies," these.

- **OVERWHELMING SUPERIORITY**

\*WSYR-TV delivers 38 per cent more homes than the No. 2 station.



24 Counties
656,700 TV Homes
2,470,800 in Population
\$4,813,849,000 in Buying Power
\$3,129,621,000 in Retail Sales

\*ARB MARKET REPORT  
MARCH, 1963

# WSYR • TV

Channel 3 • NBC Affiliate • 100 KW  
**SYRACUSE, N. Y.**  
Plus WSYE-TV channel 18 ELMIRA, N. Y.

Get the Full Story from HARRINGTON, RIGHTER & PARSONS

# Editorializing 'waiting on the railroad'

## BROADCASTERS PREPARE FOR NEXT HEARING PHASE

A second phase of a House hearing on broadcast editorializing was still sidetracked last week while the Commerce Committee turned its attention to problems surrounding new railroad work rules.

Representative Walter E. Rogers (D-Tex.), chairman of the Communications and Power Subcommittee, said he intended to resume the hearing as soon as time could be found. More than a dozen broadcasters have requested an opportunity to testify, Representative Rogers said, including groups from Georgia, South Carolina and North Carolina. The National Broadcast Editorial Conference held in Athens, Ga., last month, stirred regional and national interest in the congressional hearing

continuation of editorializing. "It is a well known fact that the Democratic party has gained the support of a substantial segment of the print media. . . . We have fared well with the broadcast medium, particularly among individual stations at the community level. Admittedly we have not done so with the networks," Mr. Howell said.

Republicans should be wary of efforts "to intimidate [broadcasters] into silence," he warned. "This is a repeat performance of the gag rule by the FCC during the Roosevelt dynasty" when the agency banned editorializing in the Mayflower Decision of 1941. "You may be sure the New Frontiersmen among the broadcasters are not worried about possible recrimination,

witness to testify against editorializing during the subcommittee's first hearing, said last week that he was "intensely disappointed" that broadcasters failed to see that he was standing up for them. Editorializing can only lead to more government regulation, Representative Hemphill said. First it will be an examination at license renewal time of what a licensee said in his editorials; then an intrusion into programing and finally "they'll be controlling your rates," the congressman said.

Representative Hemphill said he has discussed editorializing with broadcaster friends for some time. Some larger stations are able to hire competent staff to do a professional job in editorializing, he said. What he's worried about, Representative Hemphill said, are little stations which may feel less obligated to be properly responsible in their editorializing. And their efforts are what bring on demands for regulation, he explained.

Woke Charleston, S. C., not in Representative Hemphill's congressional district, attacked his stand and called on its listeners to write their representatives in support of editorializing.

Charles H. Crutchfield, president of Jefferson Standard Broadcasting Co., wrote the congressman that he "couldn't disagree with you more on this subject. . . . If Congress legislates against radio and television editorializing, one of our most important tools in keeping the public informed will have been destroyed."

Asked about statements criticizing his hearing, Representative Rogers said Thursday (Aug. 8), "I think there's been quite a bit of misunderstanding . . . on the purpose of these hearings. . . . I think some broadcasters have thought we wanted to meddle with their business."

The subcommittee chairman added, "The whole hearing was set up in the first place to help the broadcaster. . . . I think a lot of people are looking for a fight that isn't there. . . . If they want to be belligerent with everybody who's trying to help them, that's fine and dandy."

In other developments related to the hearing, Robert E. Kintner, president of NBC, advised the managers of his network's owned stations and news executives about NBC's position on editorializing (not done on NBC) and emphasized that NBC has "serious concern in principle with government intervention." Programing in news and public affairs can be safeguarded from intervention "by continual adherence, in letter and spirit to the long-established NBC policies" of objectivity and responsibility, Mr. Kintner wrote.

Representative Oren Harris (D-Ark.), chairman of the Commerce Committee, chose an appearance on KMOX St. Louis



U. S. Representative Hemphill



Colorado Representative Howell

They differ on editorializing for same reason: to protect broadcasters.

(BROADCASTING, Aug. 5, July 29).

Support for the continuation of editorializing with a minimum of regulation has been coming from varied sources.

Representative W. J. Bryan Dorn (D-S.C.) vigorously attacked "proposals and regulatory practices that would drive editorials from the air." He said, "This is a Fascist concept to intimidate those who do not agree and is a threat to all free speech" (see story, page 44).

Rex G. Howell, a Republican member of the Colorado house and president of KREX-AM-FM-TV Grand Junction, KREY-TV Montrose and KGLN Glenwood Springs, all Colorado, has written all Republican members of Congress that they should protect themselves and their party by supporting the

and as a result will continue to vigorously endorse candidates and issues."

In a statement prepared for his expected forthcoming appearance before the subcommittee, Mr. Howell backed the fairness doctrine and urged a reaffirmation of the present FCC policy "as adequate and deserving of commendation."

The steering committee of the editorial conference, which plans another conference next year, will meet in Washington Aug. 22, ostensibly to discuss the next conference and name a chairman. It was thought unlikely, however, that the committee would pass up an opportunity to discuss editorializing with congressmen.

**Just Trying to Help** ■ Representative Robert W. Hemphill (D-S.C.), the only



**CAN YOU THINK OF A FASTER WAY  
TO TURN OTHER LAWN PRODUCT  
DEALERS GREEN WITH ENVY?**

Just a few spots during a WTMJ-TV telecast of a Milwaukee Braves baseball game. That's all it took to seed the Milwaukee market for LIFE grass fertilizer and GUARD crabgrass killer. Sales soared for dealers of these two LAWNHOUSE products. And in the words of a company sales representative: "The Braves telecast on WTMJ-TV was the most effective short cut we could have taken to generate maximum sales volume and dealer cooperation at the critical time when our relatively short selling season was just beginning." The response convinced LAWNHOUSE to carry a continuous spot program. It's the kind of response you can expect with WTMJ-TV in Milwaukee... one of the top ten metropolitan areas in many measures of sales per household. See for yourself... take a short cut to sales with WTMJ-TV.

**MILWAUKEE RESPONDS TO WTMJ-TV  
CHANNEL 4**

THE MILWAUKEE JOURNAL STATION  
WTMJ-AM-FM  
NBC in Milwaukee

Represented by: HARRINGTON, RIGHTER & PARSONS — New York  
Chicago • San Francisco • Atlanta • Boston • St. Louis • Los Angeles

## Rep. Dorn defends radio-TV editorials in House speech

Representative W. J. Bryan Dorn (D-S.C.) rose to the defense of broadcast editorializing in a brief speech on the floor of the House Tuesday (Aug. 6). He said broadcasters who choose to editorialize "should not be harassed, intimidated or censored by the federal government."

Representative Dorn also said congressmen have been guilty of favoring newspapers in their releasing of news. "Radio and television broadcasters have very definitely been the victims of discrimination in the news," he said.

The complete text of Representative Dorn's remarks follows:

"Mr. Speaker, radio and television broadcasters should be protected and encouraged in their constitutional right of free speech. The right of broadcasters to editorialize is a basic, fundamental, and essential freedom

guaranteed by the Constitution. I have been shocked and alarmed at proposals and regulatory practices that would drive editorials from the airways. This is a fascist concept to intimidate those who do not agree and is a threat to all free speech. Sinister suggestions have been proposed that broadcasters be completely controlled by a powerful, growing, centralized federal autocracy—sinister suggestions from those who would not dare propose book burning or censorship of editorials in periodicals and newspapers.

"Mr. Speaker, many radio and television stations do not avail themselves of the privilege of editorializing. This is their prerogative and is a manifestation of the freedom of choice. However, I strongly feel that those who desire to editorialize should not be harassed, intimidated or censored by the federal government.

"Mr. Speaker, in times past we all know that broadcasters have been discriminated against in their access to the news. We can recall times when they have been treated as an unwanted stepchild here in this very Capitol. We have all been guilty of rushing to the great metropolitan press or to our favorite correspondents with our choicest news items. Radio and television broadcasters have very definitely been the victims of discrimination in the news. It is high time that this Congress makes sure that the right to editorialize be defended and maintained. Mr. Speaker, no single sentence in the Constitution means more to me than 'Congress shall make no law abridging the freedom of speech or of the press.' Mr. Speaker, it is our duty, as Members of the Congress, to see that no regulatory agency or bureaucrat abridges this sacred right in the field of broadcasting."

to re-emphasize his contention that the committee "should insist on the fairness doctrine" in striving to provide clearer guidelines for editorializing.

A guest on *At Your Service*, KMOX's discussion and listener call-in program, Representative Harris discussed broadcasting and editorializing with Robert Hyland, station manager and CBS vice president.

## AMST defends plea for no vote from Cox

Those opposed to Commissioner Kenneth A. Cox's abstention from the VHF drop-in case, mainly ABC, have missed the point, the Association of Maximum Service Telecasters told the FCC.

AMST has asked that Commissioner Cox, who voted for the drop-ins, not participate because of his former connection with the case as chief of the Broadcast Bureau. ABC and a number of others charged the AMST request was "an attempt to control the result" in the case (BROADCASTING, Aug. 5).

AMST last week denied this. It said that it was only interested in achieving "basic fairness" in the proceeding and for that end it is necessary that Commissioner Cox not participate. AMST defended its position regarding the Sangamon case, which involved the transfer of a VHF channel from Springfield, Ill., to St. Louis, saying that, as in that case, the drop-in matter is not merely a rulemaking but is an adjudicatory matter. The drop-in case involves many private claims to valuable privileges AMST declared. The "vigor" with

which the prospective applicants have fought for the channels and the fear of existing stations about interference from the short-spacing prove that point, the association said.

AMST warned that failure to disqualify Commissioner Cox could shake the public's confidence in the commission's processes. The "principle of prior connection does not depend upon the existence of bias," it said, and added that it would be difficult to expect Commissioner Cox to judge the case because of his definite approval while chief of the bureau.

AMST said that it would be going to extremes to argue that if Commissioner Cox is disqualified, so should other commissioners. The same principle could be applied to the FCC staff.

### 'Not one word'

Two Southern congressmen criticized CBS-TV, NBC-TV and the *Washington Post* Thursday (Aug. 8) for "not carrying one word" about Wednesday's five-hour floor debate on the Pentagon's new antidiscrimination directive.

Representative F. Edward Herbert (D-La.) said he didn't watch ABC-TV. Representative Joe D. Wagoner (D-La.) said the *Post* avoided the story, but the newspaper said it ran in early editions. Joseph McCaffery's *Capitol Today* newscast was complimented for carrying it.

The commission has also been notified by 13 of the parties involved in the drop-in proceeding that they will participate in the oral argument on the denial to be held Oct. 4. They are ABC, Megacity Television Inc., Gem City Television Co. and Greater Dayton Broadcasting Corp., prospective applicants for channel 11 in Dayton, Ohio; Magic City Television Corp. and Birmingham Television Corp., channel 3 Birmingham, Ala.; Peninsular Life Broadcasting Co. and New Horizons Telecasting, channel 10 Jacksonville, Fla.; Penn Traffic Co. and Rivoli Realty Co. (WARD-TV [ch. 56]), channel 8 Johnstown, Pa.; the Electronic Industries Association, consumer products division, and Century Advertising Co., channel 6, Charlotte, N. C., and Taft Broadcasting.

### KGLC hearing plans

The FCC's chief hearing examiner, James D. Cunningham, last week set the stage for the commission's inquiry into the proposed sale of KGLC Miami, Okla. (BROADCASTING, Aug. 5).

He named Hearing Examiner H. Gifford Irion to preside over the hearing, set the preliminary conference for Sept. 17 in Washington and designated Oct. 14 for the hearing to begin in Miami. The hearing is to determine if the sale by Miami Broadcasting Co. would result in a concentration of media control. KGLC is the town's only radio station and Miami Newspapers Inc., the proposed buyer, is the publisher of the *Miami News Record*, its only newspaper.

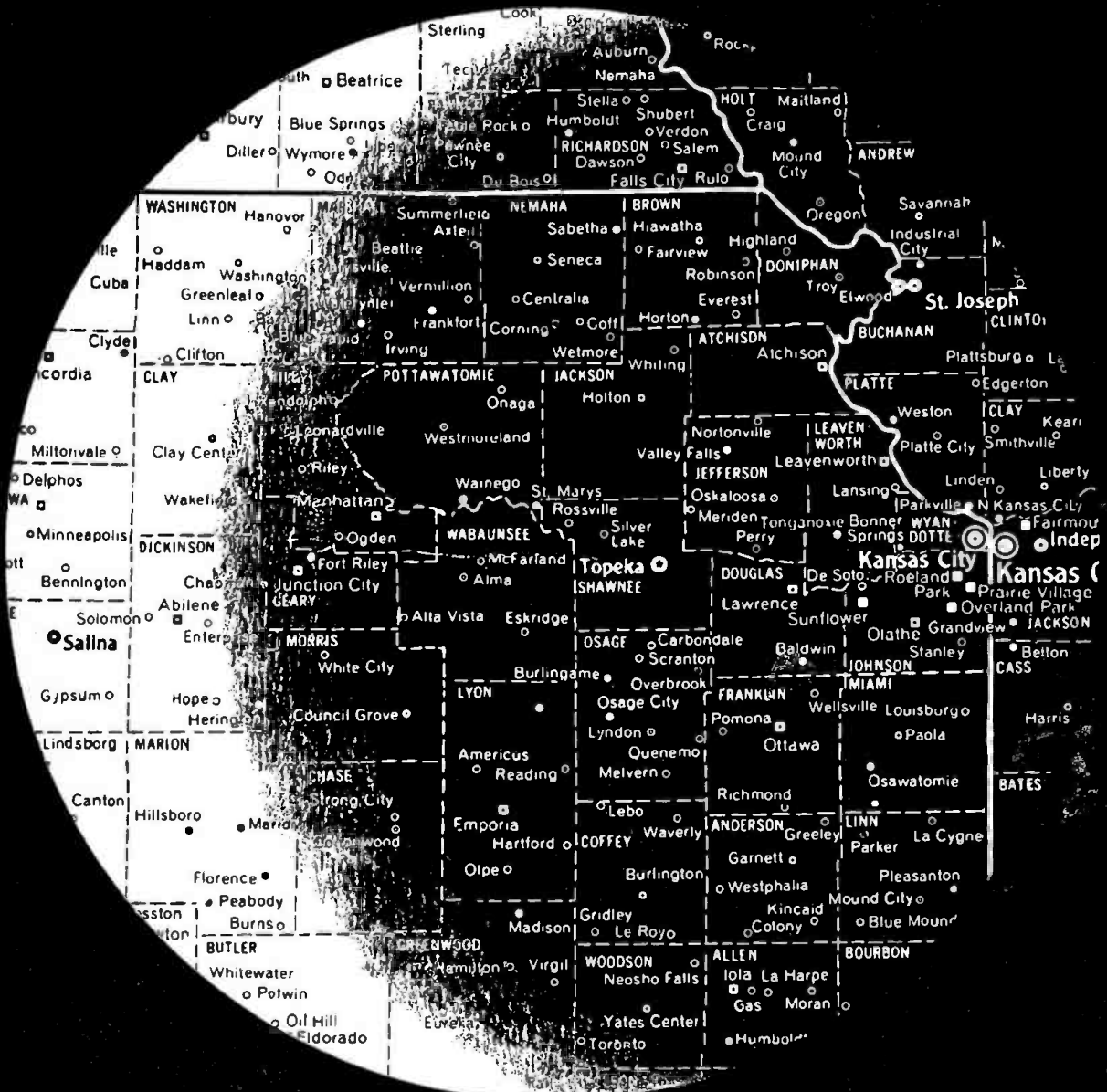

# NEW MOON

## over Kansas

The new, moon-shaped area on the map is plus-coverage from WIBW's new tall tower 1614 feet above downtown Topeka—an effective gain of 522 feet. We've moved west 18 miles into the Kansas Flint Hills to create a new moon of coverage, that provides you with *50,000 more TV homes* at no extra cost. The new Topeka market reports will reflect this increased coverage.

The new tower and transmitter, with full power, (316,000 watts), is now in operation! Ask Avery-Knodel to show you the WIBW-TV bonus coverage today!



**TELEVISION**

RADIO • AM • FM

Topeka, Kansas

Broadcast Services of Stauffer Publications  
Represented Nationally by Avery-Knodel.

# BRICKBATS AND ROSES FOR USIA

## Former VOA director recommends foreign-language cutback

The U. S. Information Agency, which marked its 10th anniversary earlier this month, picked up some bouquets and a few brickbats along the way. But major attention was given the agency by one of its former directors who focused most of his comments last week at the Voice of America, the USIA's radio arm.

George V. Allen, director of the VOA from 1948-50 and head of the USIA from 1957-60, said the Voice would gain credibility if it abandoned its policy of programing propaganda in 35 foreign languages and concentrated primarily on an objective, unemotional news report in English—even if this loses some listeners in the process. He said the main reason the VOA does so much foreign-language programing is because of pressure from Congress and constituents with strong ties to countries controlled by Communist regimes.

The money spent to maintain the VOA's 36 language desks, each of which is staffed by between eight and 20 specialists, could be saved and better spent elsewhere, Mr. Allen said. His remarks were contained in a guest article carried by the *New York Herald Tribune* on Sunday (Aug. 4).

Mr. Allen's suggestions didn't sit well with Representative John Rooney (D-N.Y.), chairman of the House appropriations subcommittee which pretty well controls the USIA budget. "He [Mr. Allen] never suggested a way to save a nickel when he was there [as director]." Representative Rooney said in an interview Thursday (Aug. 8). There is plenty wrong with the USIA,

but it's not in the use of foreign languages for the VOA, he said.

"I've said several times," Representative Rooney continued, "that the Lord Himself couldn't come down from on high and run that agency without somebody criticizing Him."

Edward R. Murrow, described as the agency's "able director" by Mr. Allen, would not comment on the article last week. He was understood, however, to be willing to discuss it if requested by the Senate appropriations subcommittee which has yet to hear his agency's budget request for fiscal 1964. (The subcommittee reported last week no date has been set for that hearing.)

In his article Mr. Allen, now president of the Tobacco Institute, said the VOA's trouble today is the same one he encountered when he ran it—its multi-language propaganda effort satisfies the emotional urge of America's refugees from Communism to "damn the dictatorship from which they fled." But this is "largely a waste of time and effort," Mr. Allen says, because foreign audiences know that the programs are especially prepared in their own languages and the audiences discount them as propaganda.

"An Israeli friend of mine, in commenting on the VOA programs he heard in Israel, said he always wondered what we were telling the Arabs," he said.

"Above all, let there be no more crusades," Mr. Allen said. The massive attack on Cuban Premier Fidel Castro during the missile crisis last year, to which 10 U. S. commercial

stations contributed their facilities (BROADCASTING, Oct. 29, 1962, et seq.), "actually did more harm than good . . . and nothing could have helped Castro more," he said.

Voice broadcasts "should be, to the maximum extent feasible worldwide in scope, should be applicable to American as well as foreign ears, and should be as unemotionally objective as the first news agency dispatch intended for publication in any newspaper, anywhere. Then and only then, will [the] USIA gain maximum credibility."

Commenting further on Mr. Allen's suggestions, particularly on his contention that reduction of foreign language programing could save money, Representative Rooney said, "He never suggested a way to save a nickel when he was there. . . . He has tried more ways to extract money from the U. S. Treasury than anyone else in the State Department."

Asked about Mr. Murrow's statements earlier this year that the House cut his budget request, Representative Rooney said, "Every dime they've ever asked for has been granted in the years the Voice has been around. . . . They've never been cut 15 cents."

## Henry, Lee, Loevinger at Chicago bar meeting

Three members of the FCC are among speakers appearing before the annual convention of the American Bar Association in Chicago. Commissioner Robert E. Lee spoke Friday on allocations (see AT DEADLINE) and this Wednesday Chairman E. William Henry and Commissioner Lee Loevinger are to speak.

Chairman Henry will address the ABA committee on communications at 10 a.m. Wednesday at the Conrad Hilton. Henry thrice declined ABA's invitation because of other business but finally was induced to appear at the behest of a personal friend, Jefferson Davis, general counsel of Southern Bell Telephone Co., Atlanta, an ABA source said.

Mr. Davis heads the ABA communications committee which concerns itself with the legal aspects of all forms of electronic communication. Mr. Henry is expected to discuss international communications developments.

Mr. Loevinger is to talk before ABA's special committee on electronic data retrieval at 9:30 a.m. Wednesday at the Sheraton-Blackstone. He had accepted the invitation while still assistant attorney general with Justice Department's antitrust division.

The ABA meetings last week and this include numerous events by 17 groups and 70 different committees. About 15,000 lawyers are attending.

## A dream-come-true bill for politicians

An idea that may bring much joy to major political candidates is being entertained by FCC Chairman E. William Henry. Chairman Henry's idea, if enacted, would require television stations to provide free time in direct proportion to the amount of time purchased by candidates.

The idea, which was described as being only that, could conceivably cut political campaign television costs by half. Television expenditures in the 1962 primary and general campaign were \$12.5 million, according to the FCC (BROADCASTING, June 10).

Such a proposal is not new and has often been discussed when the subject of political campaigns has arisen in Congress and elsewhere.

Senator Thomas H. Kuchel (R-Calif.) has conducted his own investigation into a free time proposal, particularly at the grass roots level. Senator Kuchel reportedly sought broadcaster views. Although he has not released a report, at least one recipient of his inquiry said he was opposed to any government mandate that he give free time to candidates and questioned why print media should not be subject to a similar requirement.

Chairman Henry had in mind only major political candidates and has not been in touch with Senator Kuchel during the latter's study. He also has not discussed the matter, at least not officially, with the other commissioners.

the announcer is 17 . . .



the crew is too. They're part of the Junior Achievement group of high school students who write, produce, direct, star in and sell their own programs on KMTV. These programs are a Junior Achievement first for Omaha. They are typical of the imaginative local presentations which help make KMTV first choice with viewers and advertisers.

Achievements of all KMTV programs are listed in the current ARB.\* For example, ARB's Spot Buying Guide shows KMTV has more top-rated availabilities than the other Omaha stations combined.

For greater achievements in Omaha, see Petry about KMTV!

\*Jan. '63

Reproduced by courtesy of KMTV  
Omaha, Nebraska

...the Camera, the TK-60!

You'd expect it to be! Wherever TV achievement and youthful imagination are highlighted, this deluxe new RCA camera is pretty sure to be at the scene.



The Most Trusted Name in Television

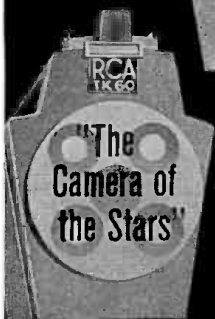

## Two San Diego congressmen bury the hatchet

Two feuding U. S. Representatives from San Diego, one a liberal Democrat and a former broadcast newsman, and the other a Republican party leader and still an advertising executive, have called off their once-bitter conflict and agreed to forget the whole thing as best they can.

Representative Lionel Van Deerlin (D-Calif.), the newsman, and Representative Bob Wilson (R-Calif.), chairman of the Republican Con-

gressional Campaign Committee, signed a statement which recognizes that the two men retain their partisan differences but pledges them to work for their community.

Representative Van Deerlin has been a news director and commentator for radio and television stations in the San Diego area. Representative Wilson has remained a partner in Champ, Wilson and Slocum, a San Diego advertising agency.

The men have been political foes since Representative Van Deerlin tried to unseat Representative Wilson several years ago and failed. He remained critical of the congressman in his role as a commentator and newsman.

In the heat of last year's campaign in which Representative Van Deerlin defeated Representative Wilson's brother Dick in a contest for a new district seat, the Democrat filed a libel suit against four persons, including both Wilsons. The suit claimed that 100,000 copies of a right-wing "smear sheet" were distributed just before election day last year which charged Mr. Van Deerlin with "sympathy for Communist organizations and Communist front groups." Neither Wilson's name was connected with the pamphlet.

The statement of friendship which the two congressmen have signed states that Representative Van Deerlin has dismissed his suit. The document also said, "Bob Wilson states

that he has known Van Deerlin a long time—and, while differing with him politically, has never felt Van Deerlin to be anything less than a loyal American."

Representative Van Deerlin said last week that the agreement had been worked out by the two congressmen's lawyers. Both had been told by San Diego leaders that the feud was detrimental to the city's representation in Congress.



Representative Wilson



Representative Van Deerlin

## Obscenity bill revived by District committee

A renewed effort of the House District of Columbia Committee to enact broad legislation in Congress against indecency would make it a crime to televise "obscene, lewd or indecent . . . or immoral" material.

Similar legislation originated in the committee last year and was defeated by presidential veto (BROADCASTING, Oct. 22, 1962). Now the committee has passed a sweeping omnibus crime bill which includes a re-worked version of its 1962 anti-indecency legislation. The new bill, HR 7525, was introduced by Representative Basil L. Whitener (D-N.C.) and is scheduled to be brought to the House floor today (Monday).

A communications lawyer whose firm fought last year's bill says the new version is unnecessary because anti-obscenity laws already exist. However, if police authorities seize on some phrases in the new bill to go beyond prohibiting

obscenity, they would certainly be acting unconstitutionally, according to Vernon C. Kohlhaas, a partner in Pierson, Ball & Dowd, Washington law firm which opposed last year's obscenity bill for WWDC-AM-FM Washington.

Some committee members have attacked almost all of the bill's provisions, including the "indecent publications" section, which is the one of concern to broadcasters.

If the bill passes the House—and opponents have pledged a strong fight—the Senate's District committee intends to hold hearings of its own, especially on the indecent publications section. The Senate unit has differed with its House counterpart in earlier attempts to legislate in the indecency area. The House group held hearings on certain provisions of the crime bill this spring, but its only public sessions on the indecent publications section were conducted last summer (BROADCASTING, Aug. 6, 1962).

Representative John Dowdy (D-Tex.), author of last year's bill and

prime mover on the 1963 indecency section, has said that its supporters hope that the law would serve as a model for other communities. It is not aimed at broadcasters, Representative Dowdy said, but at purveyors of pornography and similar obscene materials.

But it is clear that the bill's language includes broadcasting and other media. It would make it a crime punishable by up to \$5,000 fine and two years imprisonment to exhibit lewd or indecent materials, to advertise their display or anything "containing obscene, indecent, or lascivious language, postures or suggestions or otherwise offending public decency."

These broad phrases, notably "otherwise offending public decency," are subject to wide interpretation and they are what opponents find especially objectionable. Mr. Kohlhaas pointed out that the U. S. Supreme Court has very carefully limited the definition of obscenity; many phrases in the bill are not within that definition.



# There's a **TOWERING** change in ALBANY · SCHENECTADY · TROY

The W-TEN tower has been moved to the heart of this \$3 billion metro marketing area . . . providing a more efficient advertising buy than ever before on a facility second to none!

Your BLAIR-TV man has all the facts about "better-reach" in this vital market of over 1,000,000 viewers. See him now . . . in time to cash in on the new selling season!



represented by BLAIR-TV

## **W-TEN** *cbs*

a service of CAPITAL CITIES BROADCASTING

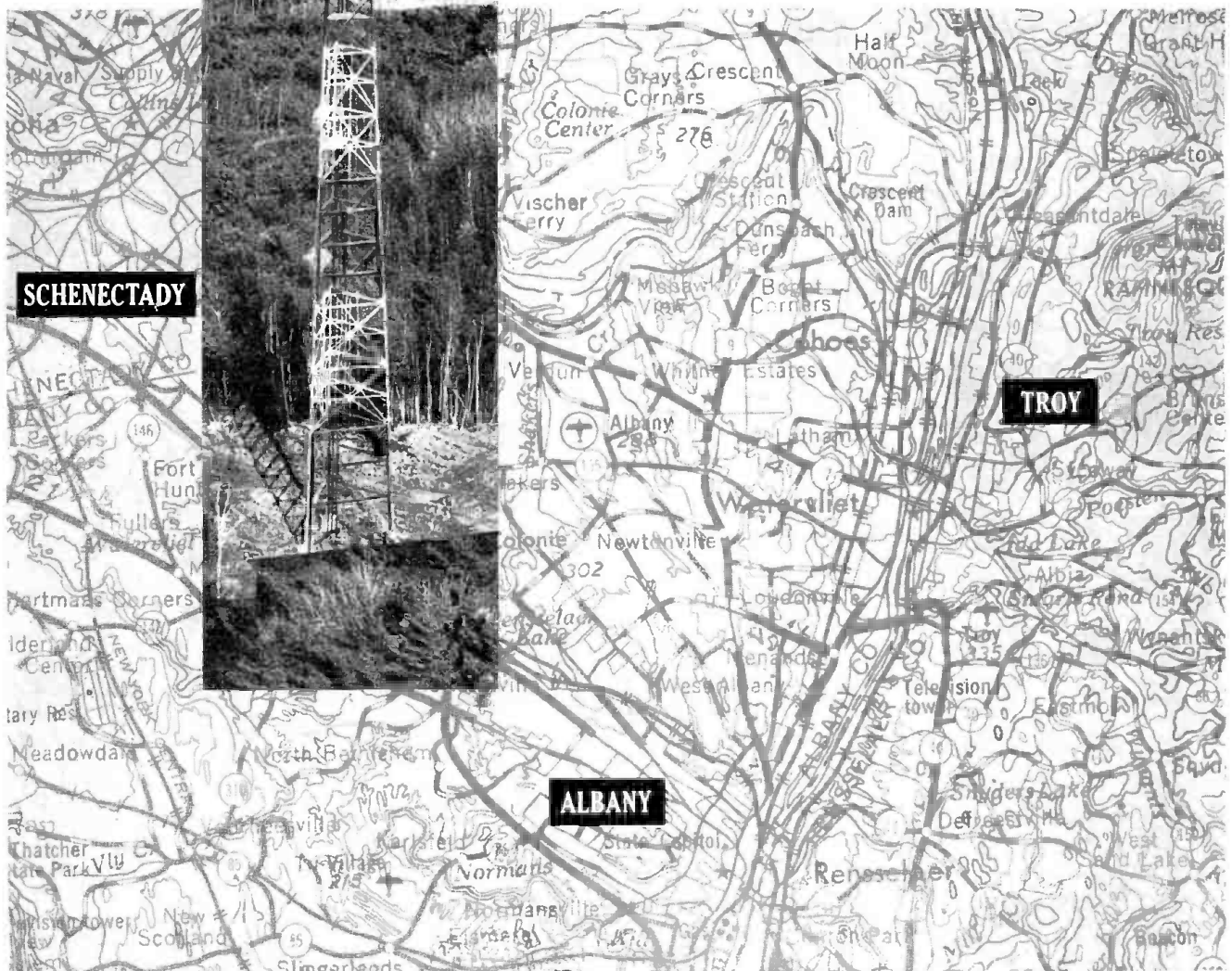

## Comsat criticizes FCC 'interference'

### WANTS TO START SALE OF STOCK EARLY NEXT YEAR

The Communications Satellite Corp. told the FCC last week—politely of course—that it ought not to stick its nose into other people's affairs. At the same time, in answer to an FCC inquiry late in July (BROADCASTING, Aug. 5), it said it hoped, under the proper conditions, to begin selling stock in the corporation in the early part of 1964.

This position was expressed in a letter to FCC Chairman E. William Henry from Comsat chairman Leo D. Welch which answered FCC charges that the corporation has been slow in offering stock to the public. The commission implied that the incorporators are making decisions that rightfully should be left to directors who will operate the corporation after stock is sold.

Mr. Welch wrote last week that Comsat is striving to make a stock offer just as soon as it will be practicable. He said that there are many technical and economic factors involved which must be thoroughly studied before an offer is made. Mr. Welch assured the commission that "In recognizing the essential nature of these factors, the directors are not seeking to prolong their own tenure."

Mr. Welch pointed out the youth of the corporation as well as the fact that space communications is in only an

"experimental" state of development. This is only the first step in creating a "commercial" system of space communications, he said.

**Impeding Progress** ■ Mr. Welch was disturbed by the stipulations that the commission attached to an order issued July 24 authorizing Comsat to borrow \$600,000. The FCC said that only \$100,000 could be used for operating expenses and that the rest was for research and design study contracts. The agency also said that it would probably not authorize further loans until definite plans for a stock issue have been made. Mr. Welch said that "the subjection of the corporation in the future to specific directions of this nature would place the commission in direct management of the corporation's affairs."

This was not intended by Congress when it passed the Communications Satellite Act, Mr. Welch contended. He said that he hoped the commission would recognize "that such an invasion of the managerial functions of the corporation would make impossible the effective discharge of the responsibilities of those charged with the conduct of the corporation's affairs."

Mr. Welch suggested that in the future any differences of opinion should

be mutually discussed by the corporation directors and representatives of the government, including the FCC.

Comsat last week announced the first corporation study awards to AT&T, Hughes Aircraft Co. and RCA.

A group of senators, who have fought Comsat since it was established after prolonged debate last year, forced the Senate to postpone a vote on a space budget authorization bill Thursday (Aug. 8).

Senator Estes Kefauver (D-Tenn.), principal opponent to the private corporation and spokesman for 14 senators supporting his position, introduced an amendment to the bill, which would authorize the National Aeronautics and Space Administration to spend \$5.5 billion in fiscal 1964.

The Kefauver amendment, expected to be voted on Friday (Aug. 9), would require the space corporation to reimburse NASA for a "fair share" of research and development of communications satellites. Since the corporation has a government-guaranteed monopoly in the field, it is the only party which stands to benefit from government research, Senator Kefauver said.

The bill, as approved by the Senate Aeronautical and Space Sciences Committee, authorizes \$44 million for communications satellite research.

## FCC advises TV station to be a little patient

The FCC, acting as referee in the scrimmage between CBS-TV and WPSD-TV Paducah, Ky., has told the station to be patient in awaiting the agency's decision.

CBS-TV's refusal to allow the telecast to the Paducah area of the home games of the St. Louis (football) Cardinals has prompted the NBC-TV outlet to protest to the FCC and file complaint with the Justice Department asking for an antitrust investigation (BROADCASTING, July 15, 8). The Paducah station had asked the commission to reach a decision before the start of the National Football League season.

WPSD-TV is 135 miles from St. Louis and KFVS-TV Cape Girardeau, Mo., a CBS-TV outlet, is 85 miles away. The stations' coverage areas overlap, and the Kentucky station asks that CBS-TV allow one of the stations to carry the games so area football fans can have the opportunity to see Cardinal home games. KFVS-TV is blacked out because of its proximity to St. Louis, although it does not fall within the 75-mile radius usually denied football games.

The commission's decision to go slow noted that the antitrust complaint filed by WPSD-TV "entails liaison with the Department of Justice."



## Party celebrates WTTG's new studios

The humor of Bennet Korn, president of Metropolitan Broadcasting Television, broke up FCC Chairman E. William Henry and two other guests at a party honoring his visit to WTTG(TV) Washington's new studios last week. Left to right: Mr.

Korn, Chairman Henry, Senator Estes Kefauver (D-Tenn.) and FCC Commissioner Lee Loevinger. The party was held at the Georgetown home of Lawrence Fraiberg, vice-president and general manager of the Washington TV station.

Continental's 5/10 kw AM Transmitter uses the "Regulinear\*" cathode-follower screen modulation circuit. 

Using modern tetrodes and small low-powered modulation tubes, it is simpler than plate modulation and has no iron core components.

It permits overall feedback from transmitter output to audio input which results in very low noise and harmonic distortion. It eliminates the necessity of neutralization. By virtue of its constant power consumption regardless of percent of modulation, it minimizes power line regulation problems and carrier shift is less than 1%. It withstands overmodulation of continuous tone at any audio frequency for long periods without damage. End result? The Sound of Quality.  \*U. S. Pat. No. 2,918,631

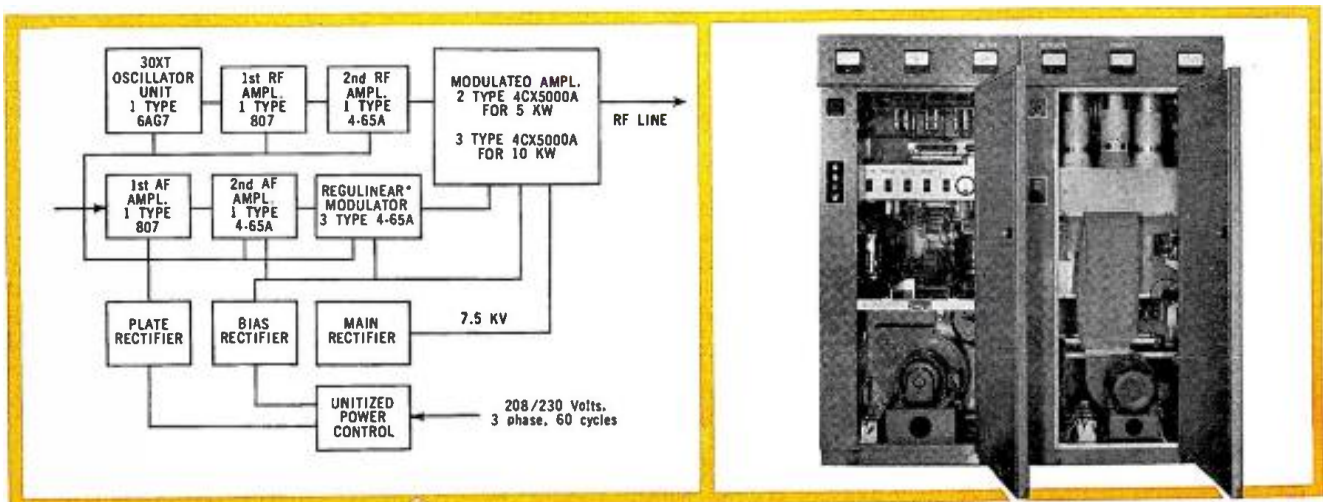

**Continental Electronics** 

MANUFACTURING COMPANY • MAILING ADDRESS: BOX 17040 • DALLAS 17, TEXAS  
 4212 S. BUCKNER BLVD. • EV 1-7161 • LTV SUBSIDIARY OF LING-TEMCO-VOUGHT, INC.  
 Designers and Builders of the World's Most Powerful Radio Transmitters

FACTS PROVE

CONCLUSIVELY!

K-NUZ

IS HOUSTON'S

No. 1 ADULT

AUDIENCE

BUY!

Here are the latest facts and figures on cost per thousand—

### TOTAL ADULT WOMEN IN MORNING TRAFFIC TIME

delivered by Houston radio stations. K-NUZ again is conclusively Houston's NO. 1 BUY!

MON.-FRI. — 6-9 AM

STATION	COST PER THOUSAND
K-NUZ	\$2.74
Ind. "A"	\$4.08
Net. "A"	\$5.80
Ind. "B"	\$7.08
Ind. "C"	\$6.76

SOURCE:

First Houston LQR-100 Metro Area Pulse, Oct., 1962, women 35 years and over. Based on schedule of 12 one-minute announcements per week for 13 weeks, from rates published in SRDS, Feb., 1963.



THE KATZ AGENCY INC.

NATIONAL REPRESENTATIVE

IN HOUSTON call

DAVE MORRIS JA 3-2581

K-NUZ

## Proposed conclusions filed in Miami case

### APPLICANTS ATTACK WLBW-TV'S BID FOR RENEWAL

The status of L. B. Wilson Inc. as an applicant for renewal of the license of WLBW-TV (ch. 10) Miami, was attacked last week by three other applicants for the VHF facility.

In proposed conclusions filed with Hearing Examiner H. Gifford Irion, the three applicants for the WLBW-TV facility contended that L. B. Wilson Inc. must be considered just another applicant. This is due, they claimed, because the FCC gave WLBW-TV an initial four-month license (instead of the usual three years).

In rebutting this argument, L. B. Wilson maintained that it has a special position in the proceedings as a licensee applying for renewal. Under FCC policy and equity, L. B. Wilson said, it should be granted a renewal of its license unless there are "compelling reasons" otherwise.

The Wilson company received the Miami channel 10 grant in 1960 after the FCC disqualified the other contenders in the original hearing (including National Airlines which received the 1957 grant for the same facility) because they were found to have engaged in off-the-record contacts with FCC commissioners.

In issuing the grant to L. B. Wilson, the only one of the four original applicants found to be untarred by the ex parte charges, the commission awarded the initial license for only four months.

When the short-term license came up for renewal, three applicants filed against WLBW-TV: Miami Television Corp. and Civic Television Inc., both with a large number of local businessmen as stockholders, and South Florida Television Corp., 80% owned by William B. MacDonald Jr., a financier with real estate investments and other interests.

L. B. Wilson is principally owned by C. H. Topmiller, Thomas A. Welstead and Jeanette Heinze. It also owns WCKY Cincinnati.

**No Recommendation** — The Broadcast Bureau filed no conclusions in the case. It submitted a statement, however, that it considered Civic Television and South Florida Television financially qualified. This was one of the issues in the hearing.

L. B. Wilson claimed it should have its license renewed because it showed superior qualifications in integration of ownership and management, broadcast experience, past broadcast record, and above all, it stressed, "none of the other applicants have been able to 'conceive' a paper proposal superior to Wilson's actual record."

Miami Television claimed it should receive preference because of the civic

and governmental activities of its stockholders in the Miami area, diverse interests of its stockholders, their scheduled participation in local programming through working committees and their relative youth.

Civic Television claimed it should be preferred because of its integration of ownership and management, the civic participation of its stockholders and their experience in the operation of TV stations.

South Florida contended that it should be preferred because of local ownership, participation of stockholders in local activities, diversity of business interests, integration of ownership and management and the broadcast experience of stockholders.

The other applicants also claimed generally that L. B. Wilson should be denied its renewal primarily because it was deficient in local ownership and in programming. Two of the applicants, Civic and South Florida, stressed a possible conflict of interest involving Sol Taishoff, editor and publisher of BROADCASTING and TELEVISION magazines. Mr. Taishoff, through a family trust, is an 11.3% owner of L. B. Wilson Inc. This interest was a bequest from Mr. Wilson who died in 1954.

### WPAZ asks federal court to hear news case

WPAZ Pottstown, Pa., has asked a federal court to hear the suit filed against it by the Pottstown Mercury charging that the station was "pirating" the newspaper's news. The station filed a petition in the U.S. District Court in Philadelphia asking that the federal court assert jurisdiction on the ground that the newspaper's allegations involve the federal copyright laws.

The newspaper charges that WPAZ used local news items from its pages without permission. This is denied by the radio station. WPAZ asked the local court to dismiss the complaint because of the copyright angle, but this the local court refused to do. A Pennsylvania Supreme Court ruling last month upheld the local court (BROADCASTING, July 8).

### Bill would require airing of national anthem

Radio and television stations would be required to play the "Star Spangled Banner" at the opening and close of each broadcast day under terms of a bill introduced Thursday (Aug. 8) by Representative John W. Wyder (R-N.Y.).

The bill, HR 8010, provides that stations which broadcast 24 hours a day,

would carry the national anthem at least once a day. Many U. S. stations open and close with the anthem.

Another congressman, Representative Frank T. Bow (R-Ohio), noted on the floor of the House late last month that he had been told some stations were signing off and on the air with Lester Lanin's recording of "Hail to the Chief," a presidential salute.

Mr. Lanin's office in New York said last week that the recordings were mailed out as a promotion. The office said neither it nor Mr. Lanin had any idea how many stations are using it.

## FCC actions concern microwave and CATV

Microwave relay stations designed to serve community antenna television systems last week figured in three separate actions by the FCC.

Hearing Examiner Asher H. Ende in an initial decision advocated denying renewal of licenses for common carrier microwave facilities which serve CATV outlets at Page, Winslow, Holbrook and Cottonwood, all Arizona.

The hearing examiner found that the microwave facilities, owned by Bruce Merrill, could not show public need for their services. When the licenses came up for renewal several years ago, Mr. Merrill owned the CATV systems as well. When the commission enunciated the policy that microwave stations in the common carrier band had to devote 50% or more of their services to the public in order to qualify for automatic renewal, Mr. Merrill sold the microwave and CATV systems to Vumore Inc. (RKO General), though he leased the microwave operations back, Examiner Ende said, so the two enterprises would be under separate control.

Examiner Ende said that Mr. Merrill had wanted to devote his time and money to other business, and retained nominal control of the microwave facilities only to allow Vumore to use them for CATV purposes. Hence, the hearing examiner said, the microwave services are not justified by public need and should therefore not be renewed.

The relationship between the owners of microwave facilities and CATV systems also figured in a decision by the FCC's Review Board. W. A. Henley's applications to build common carrier stations near Kerrville and Midway, both Texas, were referred by the board to a hearing examiner with an admonition to inquire into the control of Mr. Henley's company and the CATV system he is to serve, Junction Cable View of Junction, Tex.

The only microwave grant—in the Business Radio Service, a different section of the electronic spectrum than

# New!

## from SPOTMASTER the 500A and 505A Cartridge Tape Systems



500A—complete recorder playback unit

*Spotmaster*

505A—playback unit



Now advanced design and modular construction assure split-second operation, outstanding dependability, high fidelity reproduction.

With sleek new eye-appeal to match its ease of operation, the 500A series joins the SPOTMASTER family of equipment. On five continents, more stations use more SPOTMASTERS than any other cartridge tape systems.

Features: Compact Design . . . Quality Engineered . . . Field Tested, Field Proven . . . Modular Construction . . . Easy Maintenance . . . Most Complete Line . . . Competitive Prices . . . Lease or Purchase . . . Iron-clad, Full Year Guarantee.

### AND NOW— "INSTANT CENSORING"

... with the optional SPOTMASTER 500 DL Delayed Programmer. Designed to permit a 6-second to 16-minute delay in the broadcast of program material, the 500 DL lets you delete objectionable language, preserve continuity of programs interrupted for local news bulletins, and meet many other delayed programming requirements. With the DL function turned off, the unit operates as a complete 500A recorder/playback.

For complete details and specifications, write or phone:



**BROADCAST ELECTRONICS, INC.**

8800 Brookville Road, Silver Spring, Maryland

Area Code 301: JUniper 8-4983

Sold nationally by:

**VISUAL ELECTRONICS**

356 W. 40th St., New York, N.Y.

Canada:

**Northern Electric  
COMPANY LIMITED**

branches from coast-to-coast in Canada

# How DO You snare a Gold-Crested Budgetspender?

## *Here is a story with a purpose:*

Once upon a short time ago there was this fellow, you see, and he built up quite a reputation for himself by the way he kept capturing that most elusive of all birds, the gold-crested budgetspender. The other ornithologists (who were usually happy enough just having a lark) began to grow jealous. "How," they asked archly—his name is Fred K. Archly—"do you manage to find so many gold-crested budgetspenders?"

"Well, sir," said Fred (a quiet, courteous fellow), "I just ask myself: 'If I were a gold-crested budgetspender, where would I go?' Then I do. And they have. It's all just a simple matter of media strategy!"

## *Your advertising story has a purpose, too.*

That's why this thinly-disguised allegory carries a message for you. There are all kinds of gold-crested budgetspenders flying around the firmament of the broadcast business. Some have bigger wingspreads than others—which makes them more desirable (albeit more elusive).

As everyone knows, a gold-crested budgetspender in the hand is worth a whole flock hidden behind a door marked "Radio-TV Department" or "General Manager" (depending which side of the street you're selling). And—at risk of scuttling Fred K. Archly's secret—you just have to know when and where you can find gold-crested budgetspenders at rest. Then you go there. And they're receptive.

The "when" is the time they happen to be in need of specific, up-to-date, indubitably accurate facts about the broadcast business. Which, in their case, is often.

The "where" is the place most of them go to find such information—a rich feeder of factual nourishment known to them (and, we hope, you) as BROADCASTING Yearbook. Like the reliable oak tree, it's a perennial mainstay that puts forth new,

fresh foliage every year. It has been doing this more and more comprehensively for the past 33 years—which is only one reason why so many gold-crested budgetspenders are attracted to its authoritative boughs . . . uh, pages. (Allegory can sometimes be tricky.)

## *And—would you believe it?—WE also have a purpose.*

The 1964 BROADCASTING Yearbook will displace the best selling 1963 BROADCASTING Yearbook come next December 1. Every gold-crested budgetspender worth his salt will then send the old, frayed copy to his company's Reference Library, putting the bright, mint-new, bigger-than-ever edition within easy reach on his desk.

When he opens it (which could be a dozen times a day), his mind attuned to matters of budget-spending—will you be there? With your story? With the kind of facts about yourself to influence his decisions?

Fred K. Archly will. He's already sent in his space reservation for the 1964 BROADCASTING Yearbook, smart fellow. But there are quite a few other prominent, advantageous positions still open. We can't guarantee for how long. (Here is a happy case where the early bird gets something really worthwhile for his foresight.) Lots of people are interested in making profitable contact with gold-crested budgetspenders. Some of them are probably those birds of prey you call competitors.

You can read a frank appraisal of the 1964 BROADCASTING Yearbook's virtues in the column at right. The average reader will absorb all the facts in 47.3 seconds. But if you read faster, you can reserve your space that much sooner. Never put off until tomorrow what you can do TODAY—particularly when you're invited to call your nearest BROADCASTING office collect. (We also accept postage-due mail.)



Some anonymous genius (with a flair for descriptive precision) has aptly called this—

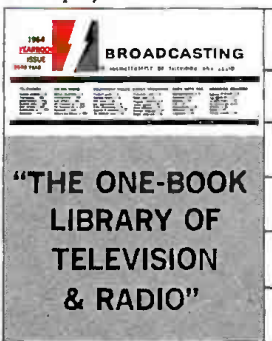

**WHY?** Because the 1964 BROADCASTING Yearbook is a veritable library of 50 separate directories, comprising the most complete assembly of information about the radio and TV business ever published . . . yet all compacted with editorial skill into a single, easy-to-use volume.

The 1964 BROADCASTING Yearbook (biggest yet) will have nearly 650 pages, two-thirds of a million words, all tabbed for instant reference under six main sections:

- A. Television Facilities
- B. AM/FM Radio Facilities
- C. Broadcast Equipment/FCC Rules
- D. Codes/Program Services
- E. Representatives/Networks/Trade Groups
- F. Agencies/Advertisers/Billings

In short, this unique one-book encyclopedia covers every possible background fact needed by people who work with, and in, the world of broadcasting. No other reference work even approaches the thoroughness with which it documents the radio-TV business, including associated arts and services.

Your advertisement, strategically placed in the 1964 BROADCASTING Yearbook, will keep making multiple impressions throughout the whole 12-month life of this remarkable source book. It can be one of your most successful promotional investments because it delivers your story at the very times the people who buy are most receptive.

**Circulation:** 20,000 copies

**Publication:** December 1

**Rates:** same as BROADCASTING Magazine.

**Deadline:** final date is October 1; if advance proofs are required, September 15.

**Special Positions:** subject to immediate space reservation. Write, wire or phone your nearest BROADCASTING advertising office (Washington, New York, Chicago or Hollywood).

**Recommendation:** Reserve the position you want—**TODAY**—before somebody else gets it!



## BROADCASTING YEARBOOK

1735 DeSales Street, N.W., Washington 6, D. C.

New York — Chicago — Hollywood

common carrier reservations — was made by the Safety and Special Radio Services Bureau to I. W. Brayer. Mr. Brayer is the owner of a CATV system at Williams, Ariz. The grant was conditioned to the stipulations, voluntarily accepted by Mr. Brayer, that the CATV facility would not broadcast simultaneously or 30 days in advance the programs of any TV station if the station's Grade A contour included the CATV operation. The CATV system must also carry the signal of such a station without any material loss of quality if the station requests. These conditions are contained in the FCC's proposed rule-making on CATV (BROADCASTING, Dec. 17, 1962), recently challenged by Wen-tronics Inc. (BROADCASTING, July 1).

### A watchdog for the budget

A bill to set up a Joint Committee on the Budget, made up of seven members each from the appropriations committees of the House and Senate, was introduced in the House Tuesday (Aug. 6) by Representative Seymour Halpern (R-N.Y.). In addition to preparing analyses of the budgets of all U. S. agencies, the committee would review all fiscal and budgetary information and messages prepared by the executive branch.

## Senate votes \$7 million for ETV KILLS PROXMIRE AMENDMENT TO CUT \$2 MILLION

Federal funds for educational television are headed for a Senate-House conference committee following Senate action last week recommending \$7 million for the program during fiscal 1964. This is \$2 million more than voted by the House as part of an overall appropriations bill for the Department of Health, Education and Welfare.

A program of matching federal funds for ETV was authorized by Congress in 1961 to be administered by HEW and \$1.5 million was appropriated last year. The department has not made any grants under the program. Three additional applications for federal money were filed last week, making a total of 17 pending. A HEW spokesman said the first grants probably would be made late this month. The 17 applications seek a total of \$3,155,418 for either the construction of new ETV stations or the improvement of existing facilities.

The \$7 million voted by the Senate is intended to provide 27 grants for new stations and 18 for expansion of existing stations. Senator William Proxmire (D-Wis.) offered an amendment on the Senate floor reducing the appropriation to the \$5 million approved by the

House. The amendment was defeated.

Also last week, the National Association for the Advancement of Colored People withdrew plans to protest three applications now pending with HEW (BROADCASTING, Aug. 5). NAACP had received an extension until Aug. 30 to comment on requests for federal funds for WHRO-TV Hampton, Va., and new outlets in Charleston and Greenville, both South Carolina. In asking for the extension, the NAACP said that the stations are located in areas which practice school segregation and that most likely the TV stations would be used in the same way.

In withdrawing its plans to file a protest, the NAACP said that it did not want to prevent the stations involved from completing their plans or obstruct them in any way.

New applications received by HEW: University of Utah for \$246,131 to expand the facilities of KUED (ch. 7) Salt Lake City.

Miami (Ohio) University for \$127,504 to improve WMUB-TV (ch. 14) Oxford, Ohio.

Delta (Michigan) College for \$187,049 to build a new station on channel 19 in Bay City, Mich.

## THE MEDIA

### GRAHAM'S WIDOW GETS 'POST' CONTROL

Will retain present management and policies

Voting control of the Washington Post Co. (Post-Newsweek Stations) has passed to Mrs. Katherine Meyer Graham, widow of Philip L. Graham, president and chief executive officer,

who took his own life Aug. 3. Mrs. Graham controls 55% of the voting stock of the company, all of which is in a trust. The details became known last week when Mr. Graham's will was

filed in federal court in Washington.

Mrs. Graham announced last Wednesday that the policies and management of the company would remain unchanged. She is the daughter of the late Eugene Meyer who bought the failing Washington newspaper at public auction in 1933.

The Washington Post Co. owns WTOP-AM-FM-TV Washington, WJXT(TV) Jacksonville, Fla., publishes the *Washington Post*, and owns *Newsweek* and *Art News* and *Portfolio* magazines.

John S. Hayes, president of the Post-Newsweek Stations, is an executive vice president, chairman of the executive committee and a member of the board of the Washington Post Co. Also a member of the Washington Post Co. board is Glenn H. Marshall Jr., president of WJXT.

Mr. Graham was an active leader in Washington and national affairs. He was a friend of both President Kennedy and Vice President Johnson and was said to have had a hand in arranging the Kennedy-Johnson ticket at the 1960 Democratic National Convention.

A long-time resident of Florida, Mr. Graham is understood to have been instrumental in suggesting the name of Governor LeRoy Collins to the NAB committee seeking a president for the association following the death in 1960



Mrs. Graham



Mr. Graham



Caught with our personalities <sup>your salesmen</sup> showing...



Howard Tupper



Dave Kidd



Charles John Stevenson

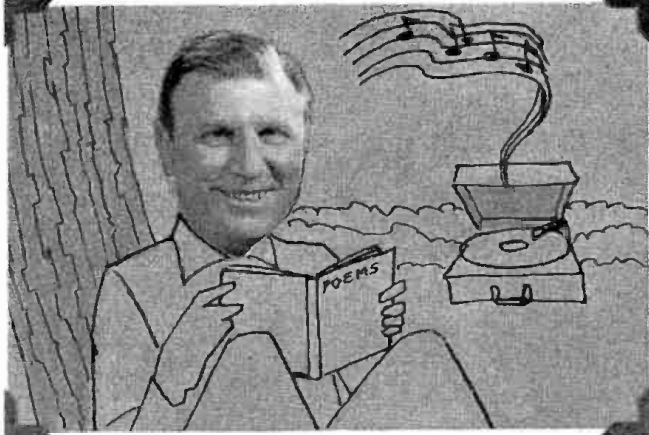

Leon Kelly



Bill Edwardsen



Don Tuttle



Martha Brooks



Randy English

We're caught and rather proud of having one of the most versatile groups of special people in radio. This is a favorite page from the family album of the area's foremost station, WGY.

From dawn 'til long after dark WGY's personalities pinpoint your sales message to specific buying groups. Full range programming makes WGY the most listenable station in the Northeastern New York and Western New England market.

810 KC • 50 KW  
**WGY**

A GENERAL ELECTRIC STATION  
ALBANY • SCHENECTADY • TROY  
Represented by Henry I. Christal Company

## TV 'reruns' teach copyediting

Reruns have invaded the closed circuit educational television field, and while the shows are old, the students are new.

At the University of Missouri School of Journalism, 22 teachers taking courses under a *Wall Street Journal* grant have learned copyediting through TV. The teachers saw eight taped lectures of the 30 shown to the regular beginning copy classes.

The instructor, Dale R. Spencer, said using TV in this manner "to teach one of the basic disciplines of journalism" allows him to do some

of the things that are not possible in a regular lecture session.

By watching the television set the students see Mr. Spencer editing copy and can then follow the markings and editings on their copy. In addition to the taped classes, there are two weekly local live lab periods.

The eternal scholastic problem of keeping textbooks current with the times is also found on the television courses. But the revision may be simpler and less costly. Four or five new tapes will be made for use in the fall semester, bringing the subject up to date.

of Harold Fellows.

Governor Collins, who just returned from Europe, issued a statement last Tuesday from Tallahassee, Fla., in which he said Mr. Graham's death was an "extremely heavy" personal loss and leaves "a real void in the whole communications industry."

Memorial services for Mr. Graham were held last Wednesday at Washington Cathedral (Episcopal) in Washington. Among those attending was President Kennedy.

**Born in South Dakota.** ■ Mr. Graham was born July 18, 1915, in South Dakota, but was taken to Florida by his parents when he was six years old. He was graduated from the University of Florida in 1936, and Harvard Law School, where he was editor of the *Law Review*, in 1939. He was a law clerk to U. S. Supreme Court Justices Stanley Reed and Felix Frankfurter.

In 1942 he enlisted in the Army Air Corps as a private and when the war ended in 1945 he was a major in the intelligence staff of the Far Eastern Air Force.

He married Katherine Meyer in 1940. He was named president and publisher of the *Post* in 1946. He relinquished the title of publisher in 1961.

Under Mr. Graham's leadership the *Post* became one of the country's leading newspapers and entered television and radio seriously. In 1954 it bought out its only morning competition, the *Washington Times-Herald*, from the late Colonel Robert McCormick. In 1961 it acquired *Newsweek* magazine, and last year *Art News* and *Portfolio*.

Although it had owned the then WINX-AM-FM in Washington for several years, in 1950 the *Post* and CBS (as a 45% owner) bought the channel 9 WOIC(TV) from Bamberger Broadcasting Service Inc. for \$1.4 million. Four years later the *Post* bought out the CBS interest for \$3.5 million. In 1953, it bought the then WMBR-AM-FM-TV Jacksonville from Ed Norton, Frank

King and Glenn H. Marshall Jr. for \$2.47 million; later it sold off the radio stations to WWDC Inc. (WWDC-AM-FM Washington) for \$375,000. Only three months ago, WWDC Inc. sold the Jacksonville radio stations to Charles E. Smith (WTMA-AM-FM Charleston, S.C.) for \$400,000.

**Comsat Chairman** ■ Mr. Graham's interests and activities ranged far. When the Communications Satellite Corp. was first established, Mr. Graham was named by the President as chairman of the incorporators. He resigned last January due to his ill health.

He also was a director of the National Press Building Corp. and of the Advertising Council Inc., a trustee of the Committee for Economic Development, the University of Chicago, George Washington University (in Washington) and the RAND Corp. He was a member of the National Press Club, Metropolitan Club and Burning Tree Club.

In addition to his widow, Mr. Graham leaves four children.

## Jefferson Standard gives gear to S.C. ETV

Jefferson Standard Broadcasting Co. has donated TV equipment valued at more than \$47,500 to the South Carolina Educational Television Center, according to Charles H. Crutchfield, Jefferson Standard Broadcast president.

Equipment includes a complete television transmitter and associated parts, projectors, monitors and other gear. The South Carolina Educational Television Commission is planning a channel 29 UHF at Greenville and a channel 7 VHF in Charleston.

R. Lynn Kalmbach, general manager of the television center, noted the timeliness of the donation "since my budget was cut nearly \$65,000 in this legislative session."

Jefferson Standard owns and operates WBT-AM-FM and WBT(TV) Charlotte, N.C., and WBTW(TV) Florence, S.C.

## WFIL-TV wants fewer ratings reports

Larger samples and fewer reports might spell greater accuracy in broadcast ratings, WFIL-TV Philadelphia has suggested to the American Research Bureau, which now supplies the station's television data.

The proposal advanced by the station asks for a reduction of ARB reports on the Philadelphia market from 10 to four a year, but a sample enlarged from 490 units to 2,400 units. The revenue realized by ARB would remain the same.

WFIL-TV said the adoption of its suggestion would "provide greater stability and validity to demographic data" and would keep the cost of the reports within the economic limits of both the stations and the research organization. And whenever it uses ARB statistics in printed matter, the station said, it will include a note cautioning that the figures are only estimates.

## Pulse realigns method of audience measurement

The Pulse Inc. announced last week that it was discontinuing coincidental interviews and increasing its roster reconstruction (aided recall) interviewing in its audience measurements. It said the change, yielding a larger sample for each quarter-hour's ratings base, was effective Aug. 1 in most markets, and will be made Sept. 1 in the rest.

Pulse said its two years' experience with coincidental interviewing showed that it added nothing to the information gained by the firm's roster reconstruction interviewing. The change, officials said, is "part of a continuing process whereby radio audience research may have a maximum of clarity, dependability and usefulness as a tool in management and sales."

## Rough waters for WAME, but it won't give up

WAME Miami, suing two major broadcast audience research companies, had its complaint against The Pulse Inc. dismissed from the Circuit Court of Dade county Monday (Aug. 5), but the station's lawyers promised that WAME would bring charges in the U.S. District Court. A Pulse motion to dismiss because of lack of jurisdiction was pending when WAME asked dismissal.

Later in the day the station was told that its complaint in the same federal court against the A. C. Nielsen Co. was too lengthy and too broad. WAME was given 30 days to amend its filing.

The station filed separate suits against

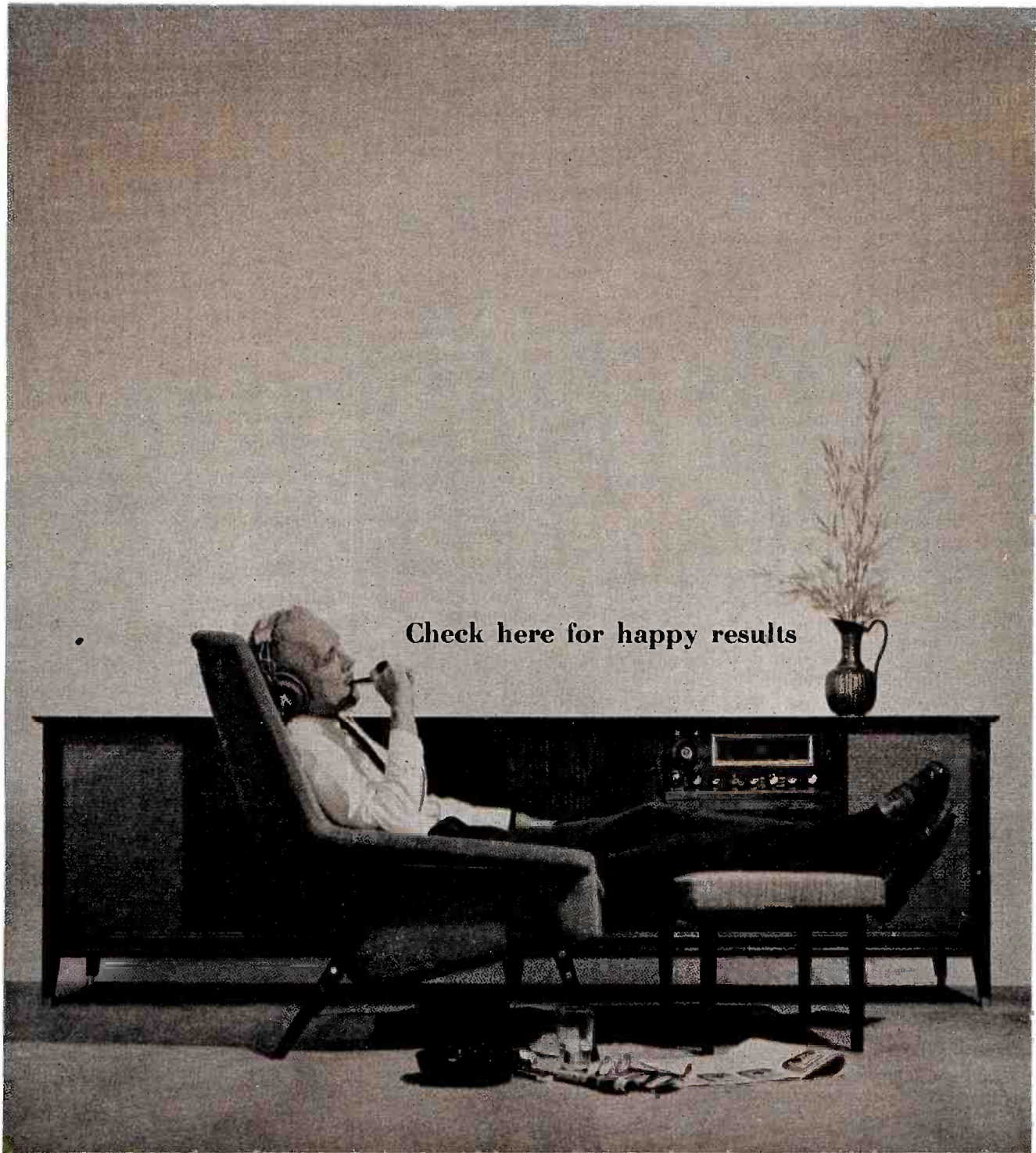

Check here for happy results

Your listening audience is the most valuable asset you have. Keeping them happy and loyal is a combination of many things, not the least of which is the equipment you have in your station. Happy listeners mean happy advertisers. □ With Collins equipment, you broadcast the cleanest sig-

nal on the air. We've added two new pieces of equipment to our line... the 900C-1 FM Stereo Modulation Monitor and the 26U-2 Stereo Limiting Amplifier. □ When quality sound is what you're after, go Collins. Let us tell you what Collins transmitters, stereo generators, broadband excitors, the

new monitor and limiter can do for your station. Call or write today.

---

**COLLINS RADIO COMPANY**  
Cedar Rapids • Dallas • Los Angeles  
• New York • International, Dallas



both companies in the circuit court this spring (BROADCASTING, May 6, et seq), but has been unable to get beyond defendant motions for dismissal. WAME is asking \$250,000 each from Nielsen and Pulse, charging them with misrepresenting their surveys for metropolitan Miami between 1959 and 1963.

Irving J. Whitman, WAME attorney, said last week that the station's early difficulties in shaping its complaint and getting into the proper court have not been unexpected. He explained that there is no precedent for the actions.

WAME brought the suits against Pulse and Nielsen in the midst of a lengthy hearing on audience research which was conducted by the House Special Subcommittee on Investigations, headed by Representative Oren Harris (D-Ark.) (BROADCASTING, Feb. 18, et seq.). Both firms were principals in the subcommittee hearing.

### Pulse gives Tucson group some 'courtesy' answers

The Pulse Inc. has informed Tucson (Arizona) Broadcasters Inc. that questionnaires, with respondents masked out, upon which a March Pulse rating of Tucson stations was based, are available for inspection in New York.

Nine of 10 Tucson radio stations had questioned the survey, which showed

### Kintner tours Europe

Robert E. Kintner, president of NBC, was to leave New York last Friday (Aug. 9) on a three-week trip to Europe where he will meet with NBC News officials and correspondents in four cities.

Mr. Kintner will inspect NBC operations in Rome, London, Paris and Berlin. In Rome, Mr. Kintner will meet with correspondent Irving R. Levine. He will confer with correspondent Kenneth Bernstein and Gerald Adler, director of European operations of NBC International, London. He will then travel to Paris where he will meet with Bernard Frizell, bureau chief and to Germany for meetings with correspondent Welles Hagen and Gary Stindt, chief of NBC News Film in Central Europe.

one station jumping from seventh to first in the market with no promotions or change in format (BROADCASTING, July 1). TBI had asked Pulse for a satisfactory explanation of "procedures" used in the March survey and of the "radical difference" in ratings since an October 1962 survey of the same mar-

ket. They also asked for a description of the sample size, how it was selected and the names of those interviewed.

Dr. Sydney Roslow, president of Pulse, replied that "as a matter of courtesy, I am affording you answers to those questions which we as a responsible organization may give you." He said sample size is explained in the report itself, which shows 193 plus 45 roster reconstruction interviews totalling 238 and 781 house-to-house coincidental interviews. Sample areas were selected by a counting procedure, using 1960 census data, Dr. Roslow said.

The Pulse letter to TBI did not discuss the "radical differences" in the two surveys, six months apart. TBI has formed a special investigating committee on the Pulse survey headed by Harry Chambers, president of KTNB. KTKT had ordered both the October and March Pulse ratings and it dropped from a 48 share of audience at night to a 13 share last March.

### Changing hands . . .

**ANNOUNCED** ■ *The following sales of station interests were reported last week subject to FCC approval:*

■ KVII(TV) Amarillo, Tex.: Sold by Trigg-Vaughn group to John B. Walton Jr. for \$1.25 million. Mr. Walton owns KVKM-AM-TV Monahans-Odessa, and KFNE-FM Big Springs, both Texas. Trigg-Vaughn (Cecil L. Trigg, Jack C. Vaughn) owns KROD-AM-TV El Paso, KOSA-AM-TV Odessa, both Texas, and KRNO San Bernardino, Calif. The Trigg-Vaughn group acquired KVII in 1958 from John L. McCarty and associates for \$136,052. KVII, on channel 7, began operating in 1957 and is affiliated with ABC-TV.

■ WKTG Thomasville, Ga.: Sold by Mrs. Eunice M. Martin and associates to Mrs. Lem J. Clark of Macon, Ga., and group for \$95,000. WKTG operates on 730 kc with 1 kw daytime only. Broker was Chapman Co.

### Russells buy CATV system

Frank M. Russell, former NBC Washington vice president, and his wife, Phoebe, have purchased CATV systems in Norton and Appalachia, Va. The price was not disclosed. This gives them their third interest in a cable system. Mrs. Russell owns 50% of a CATV operation in Ellington, Wash. The Virginia systems, which are interconnected, have about 1,000 connections. They were bought from Harold C. Bailey, who owns a system in Pineville, Ky. Mr. Russell, since his retirement as NBC vice president July 1, 1958, has acted as Washington consultant for RCA-NBC, Jerrold Electronics and other entities.

## our business is to help you do business

One of Blackburn & Co.'s primary functions is to put before the buyer or seller of a communications medium the facts he needs to do business. Any transaction involves some element of risk. But it is considerably narrowed when all of the pros—and cons—are out in the open. Protect your investment by consulting Blackburn first.

**BLACKBURN & Company, Inc.**  
**RADIO • TV • CATV • NEWSPAPER BROKERS**  
**NEGOTIATIONS • FINANCING • APPRAISALS**

#### WASHINGTON, D.C.

James W. Blackburn  
 Jack V. Harvey  
 Joseph M. Sitrick  
 RCA Building  
 FEederal 3-9270

#### CHICAGO

H. W. Cassill  
 William B. Ryan  
 Hub Jackson  
 333 N. Michigan Ave.  
 Chicago, Illinois  
 Financial 6-6460

#### ATLANTA

Clifford B. Marshall  
 Stanley Whitaker  
 John C. Williams  
 1102 Healey Bldg.  
 Jackson 5-1576

#### BEVERLY HILLS

Colin M. Selph  
 C. Bennett Larson  
 Bank of America Bldg.  
 9465 Wilshire Blvd.  
 Beverly Hills, Calif.  
 CRestview 4-8151

## CBS, IBEW stop contract talks

Negotiations between CBS and the International Brotherhood of Electrical Workers have been broken off, following a failure of company and union representatives to agree on terms of a new contract for the technical employes at the CBS radio and TV networks and the CBS-owned radio and TV stations, to succeed the agreement that expired at midnight of July 31. Work has continued without interruption since that date under an agreement that the terms of the former contract shall remain in effect until a new one is adopted or until formal notice is given of a desire for termination.

Breakdown of negotiations, which had been held in Hollywood during the last two weeks in July, are reportedly the result of differences in the company and union views of a satisfactory wage increase over the present base scale of \$200 a week. IBEW is said to have proposed a new two-year contract calling for an increase of \$15 the first year and another increase of the same amount the second year. CBS is reported to have proposed a three-year agreement, with an increase of \$8 the first year, \$3 the second and none the third year. CBS negotiators are also said to have flatly rejected the IBEW demand for a four-day, 32-hour work week. The company, in what was described as a "precedent-breaking proposal," offered a sabbatical vacation plan for workers with 25 years or more of service, which would give these men 10-week vacations with pay every five years.

The previous contract was a 2½-year agreement that went into effect Feb. 1, 1961, at which time the IBEW members employed by CBS received a \$10 weekly increase (from \$190 to \$200) plus fringe benefits including medical and hospitalization insurance and substantial improvements in the arrangements for severance pay for those workers laid off by the company (BROADCASTING, Feb. 20, 1961).

## TIO's Danish has high hopes for future

Roy Danish, director of the Television Information Office, expressed the hope last week that "the day may yet come" when broadcasters will be accorded the respect and confidence given to other professional men.

"Ordinarily there is a presumption in favor of the competence and professional judgment of the attorney, the doctor, the accountant," he told the commencement convocation of the Syra-

## Way to make more dough

Broadcasting and baking ovens may not seem to go together, but there's one broadcaster who has made the move. He's J. B. Fuqua, owner of WJBF(TV) Augusta, Ga., who has bought 100% of Claussen Bakeries Inc., for more than \$5 million. The 122-year-old baking firm is headquartered in Augusta and serves Savannah, Charleston and Greenville areas.

The present \$400,000 Claussen advertising budget, Mr. Fuqua said, will be increased, with greater emphasis to be placed on the broadcast media. At present Claussen uses 12 TV stations and a large number of radio stations in South Carolina and Georgia.

The bakery officially was bought by Georgia-Carolina Broadcasting Co., licensee of the channel 6 Augusta station. Mr. Fuqua also owns WROZ Evansville, Ind.

cuse (N.Y.) University Radio-TV Center last Thursday.

But with broadcasters, he noted, the

government grants a license and then seems to say: "Well, we don't really trust you—or our own judgment. So we'll just have to keep a careful eye on you."

Mr. Danish also disclosed that a recent TIO survey of TV station executives discovered, among other things, that the average broadcaster spends "at least an hour each day in community activities."

## Radio banned on buses

The portable radio, banned from Baltimore city buses earlier this year, now finds itself unwanted on Columbus, Ohio, public conveyances. Declaring "the world we live in is noisy enough," C. Howard Johnson Jr., the city's utilities director, has placed signs requesting passengers to keep the sets off. If the request doesn't work, warns Mr. Johnson, more drastic steps will be taken.

## KBAT to join ABC

KBAT San Antonio, Tex., will be affiliated with ABC starting Sept. 16. The station operates with 50 kw daytime and 10 kw nighttime on 680 kc. KBAT is owned and operated by Texas Star Broadcasting Co. Roy Hofheinz is president; W. Robert McKinsey is station manager.

## EXCLUSIVE BROADCAST PROPERTIES!

### SUNNY WESTERN STATE

—Fulltime, high powered, radio station with regional coverage of strong growth area. Present owners put this facility on the air many years ago but equipment is new. \$35,000.00 of land and building included. Showed \$40,000.00—plus cash flow on gross of \$164,000.00. Priced at \$310,000.00 with 29% down and balance over ten years. *Contact—John F. Hardeisty in our San Francisco office!*

### MIDWEST

—Daytime only radio station serving trading area of 100,000. This well equipped facility grossed close to \$50,000.00 in 1962 and is priced at \$80,000.00 with 29% down. *Contact—Richard A. Shaheen in our Chicago office!*

*Floumilton-Loundis*

& ASSOCIATES, INC.

*John F. Hardeisty, President*

NEGOTIATIONS • APPRAISALS • FINANCING OF CHOICE PROPERTIES

WASHINGTON, D.C.  
1737 DeSales St., N.W.  
Executive 3-3456

CHICAGO  
Tribune Tower  
Delaware 7-2754

DALLAS  
1511 Bryan St.  
Riverside 8-1175

SAN FRANCISCO  
111 Sutter St.  
EXbrook 2-5671

**RADIO • TV • CATV • NEWSPAPERS**

*America's Most Experienced Media Brokers*

# Negroes step up drives on radio-TV

## CORE BIDS FOR JOBS IN COMMERCIALS; NAACP MAKES BROAD DEMANDS

Two powerful Negro movements are converging on television and radio to gain added recognition for their race in employment and representation in programs and commercials.

In Los Angeles, the National Association for the Advancement of Colored People—which has been negotiating with employers and unions in film production—turned its attention to broadcasting last week. At a meeting scheduled for last Friday (Aug. 9), the NAACP was to present demands to advertising agencies, broadcasters and labor groups in radio and television. That the NAACP attached special significance to the Los Angeles meeting was indicated by the planned appearance of Roy Wilkins, NAACP president. Mr. Wilkins has not been present at the meetings with the film industry.

In New York, the Congress of Racial Equality (CORE) has begun a

campaign to place Negro performers in commercials. The campaign has already had results. Lever Bros. has prepared a commercial featuring a Negro for presentation on network television next fall.

**NAACP in Los Angeles** ■ Arrangements for Friday's meeting in Los Angeles were made by that city's local of the American Federation of Television and Radio Artists, acting at NAACP's request. AFTRA sent invitations to some 300 representatives of advertising agencies, stations, networks, unions and other organizations in the broadcast field.

James Tolbert, president of the Hollywood-Beverly Hills chapter of the NAACP, said earlier in the week that he hoped to persuade the broadcasting business in the West that the integration of Negroes was "good business as well as good morals." Mr. Tolbert said

that the sizable Negro population in the Los Angeles area "represents a good market for the goods and services of organizations that the Negro feels treat him fairly.

"The inclusion of Negroes along with whites in training and orientation programs set up by stations, networks, agencies and unions is long overdue," Mr. Tolbert said.

**CORE in New York** ■ In the East the campaign for Negro representation in television advertising made progress when it was revealed that Lever Bros. had taped a commercial featuring a Negro performer for showing on CBS-TV's *Art Linkletter's House Party* next fall. The commercial is for Lever's All detergent.

It was also learned that the New York chapter of the Congress of Racial Equality plans to meet with another major TV advertiser early this week to

## How public service cartoons do a job for professional groups

"Almost overnight we've become the country's largest producer of public service television spots. And it all started because my wife wore her big feathered hat to the Radio-Television News Directors Association's 1961 fall convention in Washington."

That's how Charles A. Ranallo, vice president of Television News Art Inc., Cleveland, recalls his young company's brief but successful history in the TV cartoon animation business for several major professional organizations. He described the firm's new public service cartoon

series of spots for the American Bar Association last Friday during an ABA public relations institute in Chicago. FCC Commissioner Robert E. Lee also participated (see **AT DEADLINE**).

"It seems that the feathers in my wife's hat tickled the eye of Dick Reinauer, then radio-TV director for the American Medical Association," Mr. Ranallo said. Mr. Reinauer halted his inspection tour of the RTNDA exhibits long enough to comment about the hat and discover Mr. Ranallo and his company's cartoon product.

The result of that chance 1961 RTNDA meeting: Television News Art dropped its growing business of supplying some two dozen TV stations with still cartoons each day on current news events and went into cartoon animation.

The initial product was a public service spot series for the American Medical Association.

The AMA series of educational TV spots deals with such broad topics as medical quackery, the medicine chest at home, sun bathing, artificial respiration etc. They are produced one each month and now run

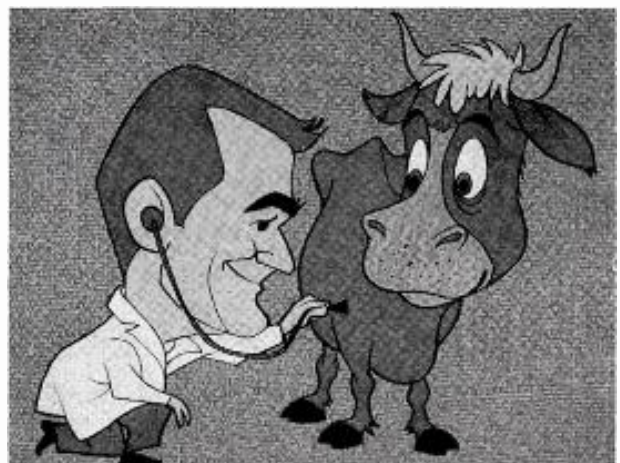
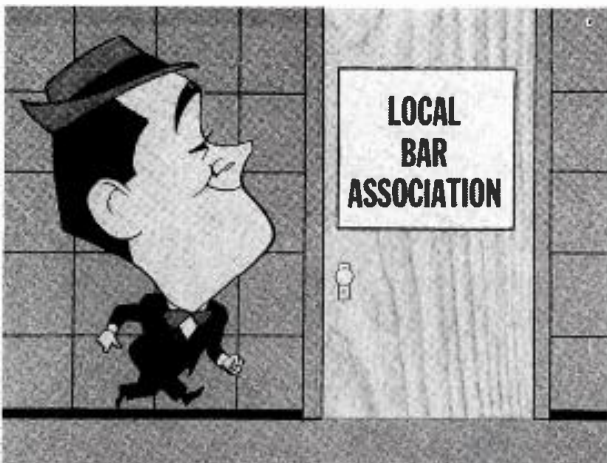

discuss that company's plans on the casting of Negroes in its television commercials.

The company will be selected from a number of prominent broadcast users, including Procter & Gamble, Colgate-Palmolive, General Foods, General Mills and Best Foods, according to a reliable source.

A spokesman for CORE pointed out that the companies being reviewed are all heavy television advertisers and manufacturers of consumer products. The choice of the firm will be based on the amount of money it spends in television advertising, its record on representation of Negroes in its commercials, and the significance attached to its corporate name.

**Threat of Boycott** ■ He said that CORE was ready to initiate its program of "selective purchasing" if it could not come to a favorable agreement with the company. In this effort, he added, CORE has enlisted the support of a number of community organizations and unions including the Protestant Council of New York, United Federation of Teachers and the Brotherhood of Sleeping Car Porters.

Lever Bros. has been reviewing the

matter, however, since last May in an effort to discover whether it "might be good business to use a broader representation of America in its advertising," the company spokesman said.

James Farmer, national director of CORE, and P. Jay Sidney, a Negro actor and consultant to the organization, met with officials of Lever earlier this month. Lever informed Mr. Farmer that it was making the commercial and agreed to have it on the air between Sept. 15 and Sept. 30, according to a reliable source.

The commercial will feature Art Linkletter standing in the audience with a Negro woman who says that she is a user of All.

Lever, in addition to making the new commercial, is sending letters to its six advertising agencies informing them of its decision to "take affirmative action" in the representation of minority races on TV.

The company, which is the third largest advertiser in television, reportedly is also notifying the networks and independent producers of its desire to "mirror fully a representative cross-section of America" in its programs.

**The Film Campaign** ■ Although the

NAACP in Los Angeles was primarily interested last week in its new move against broadcasting, it has not abandoned its campaign for recognition in the production of television and theatrical films.

The association has met with film producers and unions (BROADCASTING, Aug. 5, July 29, 22). Asked about progress on that front, the NAACP's Tolbert said last week that the immediate goal "is to make everyone in the film industry aware that the time has come to give employment opportunities to Negroes. We expect the guilds and unions to alert their members through their various bulletins and publications. Personal contacts will be used to get the message to studio heads, production officials and that kind of executive in employer organizations. We've been promised this kind of cooperation and we expect to get it."

No date has been set for the next meeting of the studio producers committee established at the meeting of July 31, he said, but one probably will be held within the next week or two.

Mr. Tolbert said that although a number of studio unions have held meetings to discuss the proposal that they add Negro members at least in the one-to-nine proportion of Negroes in the U. S., none of them had reported to the NAACP what the outcome of the meetings has been. Mostly, it has been negative, with the adoption of resolutions expressing sympathy with the aspirations of Negroes to work in motion pictures, but stating that such hopes are impractical at this time.

**Publicists' Action** ■ One exception was the action taken last week by the Publicists Association, Local 818 of the International Alliance of Theatrical Stage Employees, whose executive board issued a statement expressing "the basic right of all qualified persons of any race, creed or religion to belong to any union and be given equal opportunities for employment without any designation as to the proportion of races or minority representation on individual crews or projects."

Pointing out that its own membership has always been open to all, the publicists' board proposed that "the interest of all minorities in regard to employment opportunities in the motion picture industry should be safeguarded by an overall committee representing all of the unions who, in turn, will work with all bona fide representatives of minority groups."

The proposal that decertification actions be filed with the National Labor Relations Board against unions discriminating against Negroes will not be acted on immediately, Mr. Tolbert said. Robert Carter, general counsel of the NAACP, will be in Los Angeles following the demonstration scheduled to

on 330 television stations.

Additional cartoon public service spots now are being produced and distributed by TNA for the American Dental Association (200 stations), American Veterinary Medical Association (205 stations) and the American Bar Association (started in May and now on about 250 stations). Mr. Reinauer is handling radio-TV for ABA this week during the group's convention in Chicago.

Mr. Ranallo formerly was TV producer-director for Storer Broadcasting Co. for 11 years, working at WJW-TV Cleveland. It was at WJW-TV that he got to know Rick Reinert, who now is president of TNA. Mr. Reinert was art director for Storer there and earlier had been with MGM's Terrytoons in Hollywood. They left Storer and formed TNA in 1960. TNA also has done industrial cartoon films for Chrysler Corp. and Republic Steel.

Mr. Ranallo said that six months after the AMA spots started he surveyed the TV stations carrying them and found they were being used an average of 13 times a month per station. AMA's spots in 1964 will include four in color. All TNA animations for TV until now have been black-and-white.

Television's great public service

spirit was cited by Mr. Ranallo during his talk before the ABA institute Friday. He explained that ABA has just embarked upon a regular spot series as a result of the tremendous station response to the initial spot distributed earlier this year in behalf of ABA for "Law Day, May 1, 1963." Local bar groups help defray print costs for ABA in some areas.

"The ABA and broadcasters may not be in agreement on Canon 35 which stops radio and television from courtroom coverage," Mr. Ranallo observed, "but there certainly is no disagreement over the importance of public service."

ABA's spots deal with such topics as jury duty, legal responsibilities when one gets married, auto accidents, credit cards etc.

Mr. Ranallo told the ABA meeting he has just surveyed stations using the new ABA spots and has found the frequency rate on 110 out of some 250 stations carrying them averages nine exposures per month per station. If bought commercially the monthly time costs to ABA would top \$400,000, he estimated.

And that is a lot of feathers for television's cap, too, Mr. Ranallo told the ABA.

take place Aug. 28 in Washington, and the matter will be reviewed by him then. Meanwhile, Mr. Tolbert reported, the NAACP is encouraging Negroes with the qualification for membership in the studio craft unions to apply for membership.

"No union is going to be able any longer to hide behind a statement that the only reason is has no Negro members is that no Negro has applied for membership," the NAACP official stated. "We're going to see that membership applications are filed, and we'll know who filed them, and we'll also know what action was taken on them. Then we can guide ourselves accordingly."

## CBS has problems with Garland show

For the second time in three weeks, CBS-TV found itself in the market for a producer last week.

The resignation of George Schlatter, producer of the *Judy Garland Show*, and his staff of three writers, marked the second of the network's new programs for the fall to lose its producer in mid-stream.

Earlier, John Houseman resigned his post as producer of *The Great Adventure* series, after the completion of six of the programs, and he was replaced by Bert Granet.

Mr. Schlatter's resignation followed completion of five taped programs, and was prompted by what the network called a difference of opinion about the future course of the production. CBS-TV moved quickly to fill the vacancy by offering Norman Jewison the post as executive producer and Gary Smith

the job of producer, but as of late last week no word had been received from either of the men. According to the offer, the new producers would appoint their own writers to complete the show's staff.

Writers resigning from the Garland show were John Bradford, head writer, and Tom and Frank Waldman. One report indicated that Cy Howard had been asked if he would be interested in writing special material for the show, but he made no immediate answer.

## Actors' pact may be reopened for pay TV

If subscription television becomes a reality, the way is cleared for a return trip to the negotiating table to pinpoint the method of payment to union screen actors.

The new collective bargaining agreement reached by negotiating committees of the Screen Actors Guild, the Motion Picture Producers Association and the Alliance of Television Film Producers sets the framework for such definitive talks at any warranted time even though the news actors' contract runs for two years.

The pact, subject to ratification by the boards of the three organizations and by the membership of SAG, provides that it may be reopened for a discussion of terms for pay TV by either party, on due notice after Dec. 31, 1963. And, if no agreement is reached within 60 days, either side may cancel the entire contract. It also calls for any producer of motion pictures intended primarily for pay television to negotiate terms with SAG before employing any

actors and, if no agreement is reached within 60 days, SAG may tell its members not to work for that producer.

This falls far short of the SAG demand at the opening of contract negotiations in March. At that time, the guild announced that it was asking for payment to actors of 6% of the worldwide gross receipts from pay TV (minus distribution expenses of not more than 40% of the gross) in addition to the original pay the actors receive for making the picture. SAG also asked that when the picture was first released to pay TV, the producer pay each actor a sum not less than 75% of the applicable minimum compensation as a "nonreturnable advance" against his share in the worldwide gross. (The SAG contract continues the previous provision that actors receive 6% of world gross [less 40%] resulting from the sale of theatrical movies to free TV, but without advance payment.)

The new contract is retroactive to Aug. 1, 1963, and runs through July 31, 1965.

The contract also calls for a nondiscrimination policy in casting by the producers. A new provision in the contract permits the present 50-50 allocation of employers' contributions to the SAG health and welfare plan and its pension plan to be changed by mutual agreement between the guild and the producers.

## Warner Bros. Records, Sinatra's Reprise merge

Warner Bros. Records and Reprise Records Co. will merge into a single company, Warner Bros. Records-Reprise Co., early next month, it was announced last week by Jack L. Warner, president, Warner Bros., and Frank Sinatra, owner of Reprise Records.

John (Mike) Maitland, president of Warner Bros. Records, will be president of the combined company and Morris Ostin will continue to head operations of the Reprise division, with both labels remaining active and no changes contemplated in distributors, foreign licensees or personnel.

A separate agreement calls for the employment of Mr. Sinatra as a consultant on theatrical and TV pictures to Warner Bros. Pictures. A third deal, still under discussion, would have Warner Bros., finance and distribute films produced by Sinatra Enterprises.

## Drama specials get sponsors

United Artists Television reported last week that its six one-hour Wolper-UA-TV dramatic specials, scheduled for distribution in November 1963, are already fully sponsored in 33 markets. The company reported further that stations in 36 markets had cleared prime time for their presentation.

## RADIO DRAMA TO RETURN ON ABC

Network schedules daily anthology series for fall

ABC Radio today (Aug. 12) announced its plans to schedule dramatic programs in the fall (CLOSED CIRCUIT, July 15).

Frank Maguire, who heads the network's newly created special program feature department, said ABC Radio will inaugurate a "modern, daily drama anthology" series. The series — *The Mind's Eye*—will be broadcast Monday through Friday at 10:05-10:55 p.m., each show being completely independent of any others in the series. The dramatic productions will be in the mystery category ranging from science fiction to horror to detective thrillers. The programs will be offered to affiliates for sale to local clients.

Robert R. Pauley, ABC Radio's president, said a go ahead was given plans after affiliates showed favorable response in a polling (the network

broadcast a five-minute segment closed-circuit to stations asking for their response—76 initially responding in the affirmative).

Mr. Maguire said a five-minute pilot would be broadcast closed-circuit to affiliates within the next two weeks. It was indicated that ABC Radio is considering its new series as a "showcase" for actors and authors. A 16-man production staff is being organized to assure two production units, each operating simultaneously but on different individual programs within the series.

Mr. Maguire emphasized that the planned series will not represent a return to "old-time" radio drama but, with it, he said, "we are stepping way out front in programing procedure." He asserted the series will make use of creative ideas and top production values.



## Even brave men tremble

It's still hard to understand that strange phenomenon in the broadcast business known as "mike fright," particularly when it affects a person whose fame rests on daredevil courage.

Craig Breedlove set a world land speed record in Utah driving his jet-engine racer at 407 miles an hour on the salt flats. He was interviewed soon after for Mutual's *The World Today* (8:05-8:30 p.m., EDT), but it was necessary to retape a four-minute segment three times because of Mr. Breedlove's extreme nervousness. He later apologized to Louise Barry, the program's producer, explaining that he was "frightened" by microphones.

## Georgia ETV's to decide fate of feature movies

A special meeting of the regents of the University System of Georgia will be held in Atlanta tomorrow (Tuesday) to "take whatever action is necessary" in a dispute over the use of feature movies on Georgia's three educational TV stations.

Last spring the Georgia Association of Broadcasters protested the use of movies, some of which had been purchased by commercial outlets, during prime time on the ETV stations (BROADCASTING, May 6). A GAB spokesman said that since the earlier complaint to the regents, the three TV stations—WGTV Athens, WETV Atlanta and WXGA-TV Waycross—had reduced the use of movies to a single night per week. All three stations are programmed during evening hours by WGTV.

Tuesday's meeting has been called by James A. Dunlap, chairman of the board of regents. Raymond E. Carow, WALB-TV Albany and president of the GAB, and Jack Williams, GAB executive secretary, have been invited to attend.

## WJOR loses ASCAP case

A U. S. district court in Michigan has awarded three publisher members of ASCAP a \$750 judgment against WJOR South Haven, Mich., for unauthorized broadcast of three ASCAP songs. Judge W. Wallace Kent also ordered WJOR to pay \$200 in attorneys' fees and court costs.

The songs involved are "S Wonderful" (World Music Corp.), "My Funny Valentine" (Chappel & Co.) and "The Guns of Navarone" (Columbia Pictures Music Corp.). Judge Kent also granted the publishers an injunction which restrains WJOR from broadcasting the three songs in the future.

BROADCASTING, August 12, 1963

## Program notes...

**Sacramento news bureau** ■ KNXT(TV) Los Angeles is establishing a fulltime broadcast news bureau in Sacramento, capital of California. The bureau, consisting of a reporter-cameraman team will be located in the state capitol building to provide daily film coverage of government activities for KNXT's *The Big News*, which is extending its air time from 60 to 90 minutes Sept. 2, and other news programs. The bureau is expected to be in full operation by Aug. 19, according to Roy Heatley, KNXT director of news.

**'Bachelors' for '64-'65** ■ Tandem Enterprises Inc. and United Artists Television Inc. have reached a joint agreement to produce a half-hour television comedy series for the 1964-65 season, *The Bachelors*. Bud Yorkin and Norman Lear will develop and produce the new series.

**Venice award to NBC-TV** ■ NBC News' *Polaris Submarine: Journal of an Undersea Voyage* was awarded the first prize for best documentary at 1963 Venice Film Festival. Aired on NBC-TV last December, the program competed with documentaries from 25 countries. It was produced by Lou Hazam. Associate producer was Daniel Karasik.

## Film sales...

*Debbie Drake* (Banner Films): Sold to WUSN-TV Charleston, S. C.; WRAL-TV Raleigh, N. C.; KZTV(TV) Corpus Christi, Tex.; WMBD-TV Peoria, Ill. and WKBT(TV) La Crosse, Wis. Now sold in 115 markets.

*Bold Journey* (Banner Films): Sold to WTCN-TV Minneapolis-St. Paul; WCIA(TV) Champaign, Ill.; KOAT-TV Albuquerque, N. M. and KBLU-TV Yuma, Ariz. Now sold in 92 markets.

*I Search For Adventure* (Banner Films): Sold to KREM-TV Spokane, Wash. and WTCN-TV Minneapolis-St. Paul. Now sold in 51 markets.

*Tarzan Features* (Banner Films): Sold to KBLU-TV Yuma, Ariz. and WQAD-TV Moline, Ill. Now sold in 143 markets.

*Jungle Girl* (Banner Films): Sold to WQAD-TV Moline, Ill. Now sold in 21 markets.

*Ripcord* (Economee): Sold to KCOP(TV) Los Angeles; WTVN(TV) Columbus, Ohio; WAGA-TV Atlanta; WKJG-TV Fort Wayne, Ind.; KFMB-TV San Diego; KPX(TV) San Francisco; WCKT(TV) Miami; KERO-TV Bakersfield, Calif.; WNEP-TV Scranton-Wilkes-Barre, Pa. and WDSU-TV New Orleans.

Volume 7 (Seven Arts Associated):

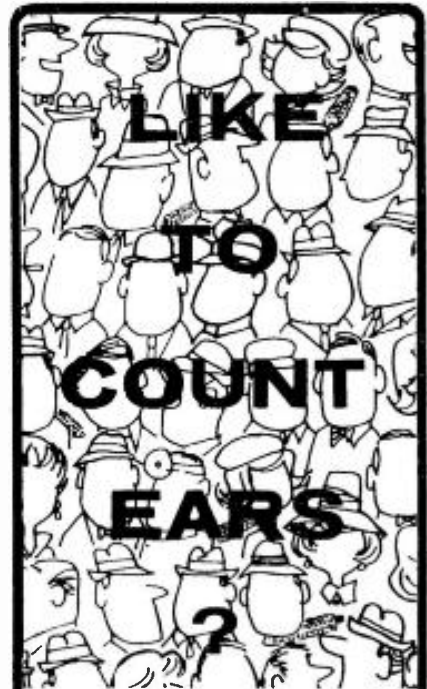

Then enter the most rewarding contest of all Time (Buyers)!

WANT CLUES?  
HERE'S AN EARFUL!

These ears represent only one five hundred thousandth of the ears to be heard from in North Carolina's Triple Rich New Bern, Greenville, Washington Market. Ears that are ready to perk up and listen to your message... your clients!

Want to listen to some happy sponsors? Then lend an ear to more news about the first full service ABC-TV Station in Eastern North Carolina. Coming September 1 to New Bern!

GET RICH CONTEST! 5003 PRIZES!

**First Prize:** A Case of Imported Martini Olives Stuffed with Cocktail Almonds.

**Second Prize:** A Case of Deluxe Martini Olives Stuffed with Cocktail Onions.

**Third Prize:** A Case of Compact Martini Olives Plain.

To the first 5,000 Runners-up—A case of genuine North Carolina wood toothpicks for use with all three classes of olives.

In case of draw—duplicate olives will be awarded. Winners may substitute lemon peels or onions (unstuffed). Send your Count-The-Ears-and-Get-Rich Entry now to:

GET RICH CONTEST

Broadcasting Magazine  
1735 DeSales St. N. W.  
Washington, D. C.

CHANNEL 12

**W N B E**  
Greenville—NEW BERN—Washington

Sold to WTMJ-TV Milwaukee; WTVJ (TV) Miami; WLOS-TV Asheville, N. C.; WEEK-TV Peoria, Ill.; KGBB-TV Honolulu and KVIQ-TV Eureka, Calif. Now sold in 25 markets.

**Volumes 4 and 5** (Seven Arts Associated): Sold to WFGA-TV Jacksonville, Fla.; WFMV-TV Greensboro, N. C. and KVKM-TV Monahans, Tex. Volumes 4 and 5 now in 83 and 81 markets respectively.

**Volume 3** (Seven Arts Associated): Sold to WJW-TV Cleveland; WMTV (TV) Madison, Wis. and KVKM-TV Monahans, Tex. Now sold in 108 markets.

**Volume 2** (Seven Arts Associated):

Sold to KEZI-TV Eugene, Ore. and KVKM-TV Monahans, Tex. Now sold in 117 markets.

**Volume 1** (Seven Arts Associated): Sold to KVKM-TV Monahans, Tex. Now sold in 141 markets.

**Superman** (Flamingo Telefilm Sales): Sold to WRVA-TV Richmond, Va.; WTTG (TV) Washington; KOVR (TV) Stockton-Sacramento, Calif.; KOB-TV Albuquerque, N. M.; WLOS-TV Asheville, N. C.; WROC-TV Rochester, N. Y.; KTVB (TV) Boise, Idaho; KTBS-TV Shreveport, La.; KFSA-TV Fort Smith, Ark.; KOLO-TV Reno; KMJ-TV Fresno, Calif.; WLBZ-TV Bangor, Me.; WMT-TV Cedar Rapids-

Waterloo, Iowa; KCPX-TV Salt Lake City and KOAM-TV Pittsburg, Kan. Now in 115 markets.

## 'Battle Line' in 51 markets

Official Films announced last week that its new *Battle Line* series which will begin in the fall now has been sold in 51 markets. The list includes New York, Dallas, Denver, Seattle, Boston, Cleveland, St. Louis, Atlanta and Detroit.

Four of 39 episodes in the war series are completed and another four will be prepared by the September premiere date for the new series.

## EQUIPMENT & ENGINEERING

### First Syncom II relays labeled as successes

America's new stationary communications satellite twice last week successfully transmitted still photographs between the United States and Nigeria, as well as teletype news dispatches.

On Aug. 4, Syncom II relayed a picture of President Kennedy from Lakehurst to the U. S. S. Kingsport, anchored in Lagos harbor. A photograph of Nigeria's governor-general was simultaneously moved from Nigeria to an Army Signal Corps ground station at Lakehurst, N. J.

On Aug. 8, the Associated Press transmitted a picture of the Nigerian ambassador to the United Nations and the son of the Nigerian governor general from Lakehurst to Nigeria.

Reception of the pictures in both instances was termed excellent.

Syncom II, launched July 26 from Cape Canaveral, Fla., is in orbit about 22,800 miles above the earth. When it reaches the desired position at 55° west longitude ground commands by scientists of the National Aeronautics & Space Administration will fire gas jets to "lower" the satellite to its proper 22,300 mile high orbit, where it will "hover" over the earth with little perceptible movement. The synchronous satellite was built for NASA by Hughes Aircraft Co.

### Technical topics...

**New film editor** ■ Harwald Co., Evanston, Ill., last week introduced a new 16mm film editing machine designed for TV stations and producers which features solid state circuits and several other improvements over its earlier model Q unit. Price: \$5,450.

**Award winner** ■ A portable video tape recorder designed and produced by Machtronics Inc. of Mountain View, Calif., has won the 1963 pacesetter

award for the fifth annual Wescon industrial design competition. Kurt R. Machein of Machtronics was the project engineering supervisor. The design was created and carried out by Robert Montgomery, design director, and his colleagues at the San Francisco industrial design firm of Hisata, Ishimaru, Montgomery and Marsh.

**Altec Lansing expands** ■ Altec Lansing Corp., subsidiary of Ling Temco Vought and a major manufacturer of amplifiers, speaker systems, microphones and other sound equipment for use in studio, stage or home, has acquired Gonset Inc., communications equipment manufacturer, formerly a division of Young Spring & Wire Corp. Gonset operations will be moved from Burbank, Calif., to a new building with more than 50,000 square feet of space at Altec Lansing's location in Anaheim, Calif.

**Film protection** ■ National Educational Television & Radio Center, Ann Arbor, Mich., has obtained a franchise from Panafilm Inc. for installation of that company's Perma Film and Perma New equipment at NET's Ann Arbor film center. Panafilm says it has now made 67 such installations in 24 countries.

**Stereo receiver** ■ McMartin Industries, Omaha, announced last week it now is producing its new TBM-1500 FM stereo rebroadcast receiver which enables an FM station to directly retransmit an FM stereo multiplex program without first demodulating and then regenerating the composite wave form. The unit first was displayed last April at NAB's Chicago convention. Price: \$450.

**New all-channel converters** ■ Jerrold Electronics Corp. has announced its entrance into the all-channel UHF converter market with the introduction of two models. The Super-Vista model is designed specifically for "weak signal areas" and the Vista model for strong

signal areas. Both models are mounted on top of the set and cover the complete UHF band. Jerrold also offers converters for translators.

**Zenith antennas** ■ Entry of Zenith into the antenna business with a full line of VHF, UHF, FM and stereo-FM antennas has been announced by L. C. Truesdell, president of Zenith Sales Corp. Complete lines of accessories also will be carried.

### Low-speed hi fi stereo

A new tape recorder capable of recording high fidelity stereo sound at 1 7/8 inches-per-second (one-quarter normal tape speed) to get up to eight hours of music on a single reel of tape has been introduced by Roberts Electronics, Los Angeles. New recorder (Model 770) utilizes a third head—the Roberts Crossfield head—to separate the recording and bias functions usually combined in a single head and so prevents the erasure of high frequencies occurring in other recorders. Robert G. Metzner, Roberts president, said. Model 770 operates at speeds of 7 1/2 and 3 1/2 as well as 1 7/8 IPS (with a 15 IPS kit available) and has an automatic shutoff switch for nonattended recording. The unit can be rack mounted.

### New film editor

A projectola with a large picture, permitting three or four people to sit in on the editing of 16mm sound film, has been developed by S.O.S. Photo-Cine-Optics Inc., New York and Hollywood. Priced at \$679, the S.O.S. TV News-film Projectola Editing/Timer unit has two-sprocket unitized timer/synchronizer, special circuit 10 w amplifier to mix any two tracks, built-in magnetic heads, optical soundhead, among other improvements. An alternate model, with a magnetic head built into each sprocket but without optical head, is available for \$629.

## NO AUTOMATIC RENEWALS—ITA'S HILL

Current British commercial contracts expire next July

There will be no rubber-stamp approvals when the present British commercial television companies seek renewal of their broadcast contracts, according to Lord Hill of Luton, new chairman of the Independent Television Authority.

Lord Hill, who took over July 1 as head of ITA, which oversees commercial television contractors in Great Britain, sounded this warning last week at his first news conference since becoming chairman. He emphasized that "present companies and new companies are to apply for any area they choose . . . and there will be a fair field for all."

Lord Hill pointed out that there will be a second network that could start sometime between autumn 1966 and the middle of 1967, but in the meanwhile there would be no big alteration in the structure of the commercial network.

Contracts of the 15 present companies expire at the end of July 1964. Applications will be invited for new contracts in September. Because of the possible start of a second network these contracts will have a three-year life.

subject to conditions relating to uncertainty about a new network.

Lord Hill explained that there was now a question whether there should be "a fundamental recasting of the pattern from next July, bearing in mind that a drastic reshaping is likely to occur two or three years later." It would be wrong to do anything which prejudiced the long term plan, he said. Describing the near future as "an interim period during which the second phase will be planned" and a time when the expanded competition of BBC-TV will be felt, Lord Hill said the Authority had decided not to submit commercial television to two upheavals in a few years. With a few changes, the existing allocation of days and hours in the different network areas will continue during the interim period, he declared.

Lord Hill stressed he was speaking of the pattern of broadcasting, not of companies. Present companies and new ones could apply for any area they wished.

When there is a second network there possibly could be "six or more" companies broadcasting seven days a

week, operating in competing pairs in the three major network regions, he said. An unspecified fourth region might also get all-week competition.

The new ITA chairman announced several regulatory changes in commercial television. He said he will: set up British television's first viewers' council to advise ITA on programming; regulate prices charged by big companies for programs carried by smaller companies; cut transmitter use rentals paid to ITA by smaller companies and increase those paid by bigger companies; instruct companies to screen educational programs produced by outside sources, including universities.

To make improvements and prepare for a second network, ITA will need \$22.4 million a year, \$7 million more than at present, it was said.

## Calcutta transmitter poses problem to Voice

The Indian government wants to alter the terms of a contract under which the Voice of America would construct a 1 megawatt transmitter in Calcutta, Prime Minister Nehru said last week.

It was not revealed what provisions

### WORLD'S SMALLEST LIGHTEST TRANSISTOR TELEVISION RECEIVER

Compare the unmatched specifications below !  
Dimensions are 6 in. wide x 6 3/4 in. deep x 4 1/2 in. high.  
Weight only 5 1/2 lbs. (with A.C. power source 7 1/2 lbs.)

Superior Local and Suburban Reception with build in Mesa-Transistor super high sensitive, which gives you a brighter, clearer picture plus rich contrasts between black and white shades. Square-cornered tube prevent picture corners from being cut off.

MICRO 6 may be used outdoors as well, and within your automobile with MITSUBISHI's special car accessories. For the image is clear and vibration proof.

Enjoy your vacation with this handsome MICRO TV and take it along wherever you go.



MITSUBISHI  
MICRO SIX



**MITSUBISHI ELECTRIC CORPORATION**

Head Office: Mitsubishi Denki Bldg., Marunouchi, Tokyo Cable Address: MELCO TOKYO

of the contract prompted this, but the issue seemed to hinge on India's policy of foreign nonalignment. Communist union leaders in the country organized protests on the grounds that the transmitter was "a clear infringement on our sovereignty."

The transmitter is planned to counter Communist Chinese propaganda broadcasts aimed at India, which explains in part why Communists in India strongly oppose the transmitter.

Under a provision of the contract, the Voice of America would be allowed to relay three to four peak hours daily of the station's broadcasts for the next five years, a clause which reportedly has been protested also.

## Cubans jamming WBT's Russian language shows

Russian language broadcasts intended to reach Soviet personnel in Cuba and beamed from WBT Charlotte, N. C., have been subjected to extensive jamming operations, according to a letter from the Navy Department to the station.

Charles Crutchfield, president of the Jefferson Standard Broadcasting Co., which operates WBT, said the letter also revealed that the broadcasts have been monitored since May 24 at the U. S.

Naval Base at Guantanamo Bay, Cuba, and that further monitoring will be done to determine whether the jamming is effective throughout the island.

If so, the programs will be rescheduled for different, random times, to confound the jamming procedures. The programs, which began on April 15, are beamed to Cuba daily at 12:30-12:45 p.m. and 4:45-5 p.m. EST. They are prepared by Radio Liberty in New York, and narrated by Boris Orshansky, a former Soviet Army captain. The programs are fed by land line from

## Training for Colombian ETV starts in Nebraska

The University of Nebraska's KUON-TV Lincoln is being used this month as a technical guinea pig by the U. S. Peace Corps for a pilot project to train nearly three dozen people who will later operate an educational TV system in Colombia. The training program began last Monday.

Peace Corps Director Sargent Shriver said during an interview on KUON-TV Aug. 2 that if the Colombia ETV project is successful it may be duplicated in a number of under-developed areas around the world. The trainees, including 18 Americans and

16 Colombians, are to operate two ETV stations in Bogota which are expected to reach 85% of the country's 16 million people.

During their training at KUON-TV this month, the Peace Corps members will study live production, film and video-tape techniques. Some also will study receiver servicing and station maintenance. Part of the time when KUON-TV is off the air it will function as a closed-circuit preview of the eventual Bogota operation. Network feeds for the training are being supplied by KOLN-TV Lincoln.

New York to Charlotte, and feature news and background on international events, as well as coverage of the Soviet domestic scene.

## Abroad in brief...

**New film service** ■ Editing Associates has been formed at Toronto to provide complete editing services to producers of TV commercials, TV film programs and motion pictures. Donald Ginsberg, formerly of the National Film Board, Ottawa, has formed the new company at 47 Dundonald Street, Toronto 5. Company does work in both English and French.

**Rep appointments** ■ CKEY Toronto, Ont., has appointed All-Canada Radio & Television Ltd., Toronto, as representatives in the United States and Canada, except Toronto. CFPA Port Arthur, Ont., has appointed Cam Logan & Associates Ltd., Toronto and Montreal, as station representative.

**Nielsen survey** ■ A. C. Nielsen Co. of Canada Ltd., Toronto, is to make a cross-Canada study of radio and television station audiences during November and December for release early in 1964. About 50,000 homes are to be sampled for both radio and TV reception by mail ballot for in-home as well as out-of-home listening and viewing for all family members. Total daytime and nighttime circulation of each station will be reported, as well as the weekly circulation.

**Canadian fact book** ■ A 40-page fact book on broadcasting in Canada has been prepared and published by All-Canada Radio and Television Ltd., Toronto, Ont. The booklet gives a brief history of Canadian broadcasting, its various royal commission inquiries, broadcasting legislation and regulations, sales and audience measurement services, market data by provinces, networks, and lists all radio and television stations. The last two pages are de-



**WAVE RADIO AND TV**



**PROGRAM FOR THE**



**VERY BEST**



**AUDIENCE**

**LOUISVILLE**

**BOTH NBC**

**BOTH REPRESENTED BY THE KATZ AGENCY**

(Antique type from the Robinson-Pforzheimer Collection.)



voted to the representative firm and the All-Canada offices in Canada and the United States.

**Parliament on TV?** ■ Prime Minister Harold Macmillan has suggested that there should be inter-party talks when the British Parliament meets again next October on the advisability of televising a short edited program of proceedings in the House of Commons. Labor leader Harold Wilson has said his party would be glad to take part. Insisting that this was a matter for the whole House and not just the government, Mr. Macmillan said the talks would be aimed at getting the general view of the House.

**Swedes in New York** ■ A New York studio will be opened in December by the Swedish Broadcasting Co., Sweden's noncommercial radio-TV network. It will be located in the Sperry Rand Building, 1290 Avenue of the Americas. The studio will tape television interviews and broadcast radio news reports directly to Sweden. The network, which has been represented in New York for more than 10 years, also has an office in Washington.

**K&E in Central America** ■ Kenyon & Eckhard-Novas, Interamericana, has been appointed for Colgate-Palmolive products in Guatemala, Honduras, El Salvador, Nicaragua, Costa Rica and Panama. K&E has set up operating subsidiaries in Central America to service the account.

**Promotion group** ■ An association aimed at promoting the interests of the 11 smaller television companies in the United Kingdom has been formed. It is called the British Regional Television Association. Marquess Townshend, chairman of Anglia Television Ltd., is the chairman of the new association for the first year.

**Rate increase** ■ The Austrian Broadcasting Service has announced a rate increase of 30% to 40% for its commercial television operations. The Austrian service is still fighting a financing gap which is resulting from a low growth rate in TV set circulation. Service is paid partly by set license fees and partly by commercial income. The number of licensed TV sets in Austria is now estimated at over 500,000 with a monthly increase rate of an estimated 20,000.

**Commercial TV's audience** ■ Three out of every four homes in the United Kingdom commercial network areas can now watch commercial television. Latest Television Audience Measurement Ltd. figures show that commercial network programs can be seen by 12,633,000 homes, 91% of all television homes in areas covered by the network. TAM

estimates that 41,020,000 viewers are now able to watch commercial television in the United Kingdom.

**BBC-TV cuts reruns** ■ During this summer repeat programs will account for 3.4% of prime viewing time, 7:30 to 10 p.m. on BBC-TV. This compares with 3.5% last year and 4.8% in 1961.

**Films on display** ■ The semi-annual International Film, TV-Film and Documentary Market exhibit will be held in Milan, Italy, on Oct. 14-24. Distributors in TV films and motion pictures may make arrangements to show their product by writing MIFED, Largo Domodossola 1, Milan, Italy. Last April 179 distributors from 54 foreign countries, including the U. S., displayed 1,526 TV and motion picture subjects.

### Sales of own sets up

Made-in-Canada receiving set sales in the first five months exceeded the same period last year, according to the Dominion Bureau of Statistics, Ottawa. TV set sales totalled 146,970 in the January-May period this year as against 140,509 last year. Canadian-made radio receiver sales totalled 272,944 this year, compared with 237,648 in the first five months of 1962. Sales of radio sets were up in all categories except portables.

## International role of radio-tv cited

Donald H. McGannon, president of Westinghouse Broadcasting (Group W) called for "an electronic rainbow of hope" throughout the world instead of "a rain of fall-out" last week in an address to a communications specialist seminar in Boston.

Mr. McGannon said the mushrooming number of radio and television receivers throughout the world is leading to stronger international bonds in both educational and entertainment areas. With broadening international understanding, he said, governments may someday use the electronic media for "round tables of the world" effectively aiding the work of the United Nations.

## British programmer awards \$32,200

Southern Television Ltd., one of Britain's commercial television companies, has made grants totaling \$32,200 in the past year to the arts and sciences. Among the awards were \$3,500 each to the Universities of Southampton and Sussex, \$2,800 each to the Chichester Festival Theater and Bournemouth Symphony Orchestra.

## 11 of the Top 15 Shows in Sioux City are on KTIV

If you want to reach the big Sioux City market: Buy KTIV! ARB's March 1963 study reveals that 11 of Sioux City's top 15 shows will be carried by KTIV this Summer. This viewership, plus our proven sales ability, makes KTIV the best station for your Siouxland schedule.

And you can count on KTIV for continuing leadership in Siouxland. From Fall '58 through Spring '63, KTIV ranked first in 10 straight ARB studies!



National Representative:  
George P. Hollingbery

Regional Representatives:  
Harry S. Hyett Co.,  
Minneapolis  
Soderlund Co., Omaha  
Eugene F. Gray Co.,  
Kansas City, Mo.

## Russians stop jamming Voice of America

The present feeling of a goodwill on the part of the Soviet Union would seem to have gone a step further with announcement that it has ceased to "jam" Voice of America programs directed behind the Iron Curtain.

An American diplomat in Moscow last week reported that the Soviet Union has notified the International Telecommunications Union that the jamming was stopped. This is the first time the jamming has been ceased since Premier Nikita Khrushchev's 1959 visit to the United States. However, Soviet satellite countries are still jamming.

The BBC also announced that its Russian language programing is now getting through intact, although this is not the case with Radio Free Europe or Radio Liberty.

## German firm courts Yanks

Bavaria Atelier GmbH, German TV and film production company, is offering American producers use of its studios in Munich for independent pro-

duction and has also announced interest in co-production deals with American companies.

The German producer reported last week that negotiations are in progress for distribution of some of its TV productions in this country.

## Brochures mailed for commercial contest

The fourth annual International Broadcasting Awards competition, sponsored by the Hollywood Advertising Club, has been officially opened by this year's general chairman, John T. Reynolds, CBS-TV senior vice president, Hollywood. Brochures announcing the competition, open to all commercials for radio and television produced anywhere in the world and broadcast between Dec. 1, 1962, and Nov. 30, 1963, are going into the mail this month to 12,000 broadcasters, advertising agencies and commercial production firms. Return postcards included with the brochures will bring kits with full information to anyone interested in entering one or more commercials in this year's competition. Deadline for entries is Dec. 1. Awards to the best-of-class

commercials in 14 TV and 8 radio categories, plus special trophy awards for the best use of color, best use of music and the best public service spots, as well as sweepstake awards for the world's best radio and TV commercials, will be presented Feb. 25, 1964, at an IBA banquet at the Hollywood Palladium.

Brochures and entry kits can be obtained from the Hollywood Advertising Club, 6362 Hollywood Blvd., Hollywood 90028, California, USA. Cable address is HADCIBA.

## CBC names Weed U.S. rep

The Canadian Broadcasting Corp.'s owned and operated English language TV stations have appointed Weed & Co., New York, as sales representative in the United States effective last week.

According to the rep firm this marks the first time the CBC has appointed a U. S. representative for its stations. The TV stations to be represented by Weed are CBLT Toronto, Ont.; CBMT Montreal, Que.; CBUT Vancouver, B.C.; CBOT Ottawa, Ont.; CBWT Winnipeg, Man.; CBXT Edmonton, Alberta; CBHT Halifax, N. S. and CBYT Corner Brook, Newfoundland.

## FINANCIAL REPORTS

### Zenith 6-month profit exceeds \$7.6 million COLOR TV SALES RESPONSIBLE FOR NEW RECORD

Sparked by a rapid growth in color television, Zenith Radio Corp. established a 45-year company record in both sales and earnings for the first half of 1963.

Distributor unit sales to dealers of Zenith color TV receivers increased nearly 100% over the similar 1962 period. In the black-and-white TV set field, Zenith factory shipments and distributor sales to dealers reached new highs for a six month period. New first half records were also established in production, factory shipments and distributor sales of Zenith stereo high-fidelity instruments.

Production of color TV picture tubes

has begun at a recently completed addition to the Rauland Corp.'s manufacturing facility in Chicago. Rauland is a subsidiary of Zenith.

Net consolidated earnings for six months ended June 30:

	1963	1962
Earned per share	\$ .84	\$ .77
Total sales	166,289,000.00	145,997,000.00
Net earnings after federal income tax	7,654,000.00	6,983,000.00

### Trans-Lux near '62 pace

Trans-Lux Corp. reports net income after taxes for the six months ended June 30 of \$343,092. This includes

\$92,546 of nonrecurring net income and is the equivalent of 48 cents a share on 718,037 shares of common stock outstanding at the close of the period. For the corresponding period last year, net earnings were \$358,795, including \$11,100 of nonrecurring net income, equal to 50 cents a share.

### Macfadden-Bartell turns from loss to profit

An increase in broadcasting revenues and profits helped Macfadden-Bartell Corp. turn losses to profits in the past six months. The company's three radio stations increased operating profits from \$94,104 to \$294,282, a gain of 213% in the first half of 1963 compared to the similar period in 1962.

The company's report for the six months ended June 30:

	1963	1962 (loss)
Earned per share*	\$ 0.394	\$ (0.20)
Net revenue	12,083,250	11,229,928
Expenses	11,353,587	11,461,554
Operating profit before depreciation	729,663	(231,626)
Depreciation	102,656	162,003
Net income after taxes	627,007	(393,629)
Cash flow generated from operations	729,663	(231,626)

\*Based on 1,591,472 shares outstanding as of June 30, 1963, compared to 1,968,598 shares outstanding at same period in 1962.

### July SEC report on stock transfers

The following purchases and sales of common stock by officers and directors of registered companies in broadcasting and allied fields have been announced by the Securities & Exchange Commission in its July Official Summary:

American Broadcasting - Paramount Theatres—W. P. Marshall, bought 100, holds 313.  
Capital Cities Broadcasting Corp.—

Lowell J. Thomas, sold 64,003, retains 52,764 (BROADCASTING, May 20).  
H&B American Corp. (controlled by RKO General)—David E. Bright, bought 29,400, holds 215,180; Video Independent Theatres (RKO General subsidiary), bought 122,500, holds 466,355; Video Independent Theatres, bought \$6,130 6% convertible debentures, holds \$1,164,034.  
Macfadden-Bartell—Gerald A. Bartell, bought 305, holds 222,377.  
Plough Inc.—H. R. Krelstein, acquired 8,000 through option, holds 14,000.  
Reeves Broadcasting & Development Corp.—T. J. Stephenson Jr. Corp., sold 50,000, holds none.

## Audio Devices Inc.'s first half report

Audio Devices Inc. reports initial commercial sales of an improved lubricated tape for use in cartridges have been good. It also announced that it has made arrangements to purchase the assets of Sound Corp. of America, Worcester, Mass., manufacturer of cartridges for magnetic tape.

Six months ended June 30:

	1963	1962
Earned per share* \$	0.28	0.26
Sales, less returns, discounts and allowances	4,004,449.56	4,070,102.60
Costs of goods sold and selling, general and administrative expenses (including depreciation of \$105,271.31 in 1963 and \$97,118.63 in 1962 on fixed assets)	3,503,293.81	3,585,545.39
Interest expense (net)	31,551.20	38,361.34
Net income before federal income taxes	469,604.55	446,195.87
Provision for federal income taxes	227,000.00	223,000.00
Net income	242,604.55	223,195.87

\*Based on 868,371 shares outstanding as of June 30.

## Crowell-Collier unit reports good first half

The broadcasting division of Crowell-Collier Publishing Co. had "good gains in sales and profits" in the first half of 1963, Raymond C. Hagel, president of the company, has reported in issuing six months financial figures.

Six months ended June 30:

Earned per	1963	1962

share*	\$	.28	\$	.26
Sales and revenues	47,627,107.00		39,976,276.00	
Income before federal and foreign income taxes	1,891,972.00		1,939,559.00	
Net income	912,972.00		898,859.00	

\*On 3,257,881 shares outstanding as of June 30.

## Admiral report cites color set sales rise

Color TV receiver sales for Admiral Corp. during 1963's first half were double the same period last year, Admiral said last week in a report showing improved sales and profits for the Chicago firm as a whole. Admiral also said the outlook for consumer product sales during the second half is better than at any time in recent years.

Six months ended June 30:

	1963	1962
Earned per share after taxes	\$ .60	\$ .35
Earned before taxes	3,006,922	2,590,784*
Consolidated sales	100,418,045	94,740,193

\*Restated to exclude accounts of Admiral Italiana subsidiary closed at end of 1962.

## Strong second quarter

Teleprompter Corp., New York, has issued a report for the six months ended June 30:

	1963	.09
Earned per share		
Gross revenues	2,715,040.00	
Net income (including non-recurring gain from sale of Houghton, Mich., CATV)	69,224.00	

For second quarter, ended June 30:

	1963	.20
Earned per share		
Sales	1,472,045.00	
Operating profit	7,317.00	
Net earnings (including special credit of \$142,594 from sale of Houghton, Mich., CATV)	149,911.00	

No quarterly report was issued in 1962.

## FATES & FORTUNES ©

### BROADCAST ADVERTISING

Charles J. Allen, executive VP of John W. Shaw Adv., Chicago, elected president and chief executive officer, succeeding John W. Shaw, head of his own agency since 1946, who is retiring but will continue as consultant. Norman R. Anderson and Jaye S. Niefeld, both senior VP's, have been given new assignments. Mr. Anderson becomes executive vice president for client services; Mr. Niefeld becomes executive vice president for marketing and administration.



Mr. Allen

Ron T. Smith, former president and partner of Smith and Dorian Inc., New York advertising agency, joins Martin R. Klitten Co., Los Angeles advertising agency, as vice president.

Stanley G. Swanberg retires as executive VP, director and manager of San

Francisco office of Botsford, Constantine & Gardner.

Joel S. Seiden, account supervisor at Friend-Reiss Adv., New York, elected to newly created post of VP in charge of internal services. Catherine Jackson, media supervisor, promoted to director of research and media.

Ellis O. Moore, former VP and director of press and publicity for NBC, joins public relations department of Standard Oil Co. of New Jersey, effective Sept. 3, with headquarters in company's New York offices. Mr. Ellis resigned NBC post last month (BROADCASTING, July 8) over differences in policy. He was replaced at NBC by Merryle S. Rukeyser Jr., former director of program publicity for NBC press department. Mr. Moore joined NBC in 1952 and was elected VP in December 1962.



Mr. Moore

**W** UNDUPLICATED  
Wonderful ABC-TV Coverage  
**F** of 18 counties  
Florida in the  
**T** rich expanding  
Tele CENTRAL FLORIDA  
Vision commercial,  
**9** agriculture and  
SPACE AGE  
MARKET

ORLANDO - FLORIDA  
Phone: Adam Young, Inc.

## SPOTMASTER Tape Cartridge Winder



The new Model TP-1A is a rugged, dependable and field tested unit. It is easy to operate and fills a need in every station using cartridge equipment. Will handle all reel sizes. High speed winding at 22 1/2" per second. Worn tape in old cartridges is easy to replace. New or old cartridges may be wound to any length. Tape Timer with minute and second calibration optional and extra. Installed on winder or available as accessory. TP-1A is \$94.50, with Tape Timer \$119.50.

Write or wire for complete details.

*Spotmaster*

**BROADCAST ELECTRONICS, INC.**  
8800 Brookville Road  
Silver Spring, Maryland

**Cyril Wagner**, central sales manager for NBC-TV, elected president of Chicago's Broadcast Advertising Club, replacing **Bill Wyatt**, A. C. Nielsen Co.

**J. K. Billings**, formerly head of his own creative consultant firm, Emprise Associates, Evergreen, Colo., elected VP of Savage-Dow Inc., Omaha advertising agency.



Mr. Gorey

**Thomas R. Gorey** and **John C. Trindl Jr.** elected VP's of Needham, Louis & Brorby, Chicago. Mr. Gorey is an art supervisor; Mr. Trindl is associate copy director.



Mr. Trindl

**Robert A. Bott**, member of New York staff of Young & Rubicam, appointed manager of agency's newly formed field contact department. New department will provide 13 fulltime advertising representatives who will work exclusively with Chrysler and Imperial dealers throughout country. Assisting Mr. Bott will be **E. P. Simoni**, assistant manager, who will have supervision over Detroit; **Paul J. Dougherty**, eastern area supervisor; **James A. Gundry**, southeastern area; **Alan A. Appleton**, midwest area; and **Edwin R. Ratcliffe**, western area. Mr. Bott joined Y&R in Detroit in 1956.

**Newell T. Schwin**, VP of Associates Investment Co., South Bend, Ind., and former director of sales for production department of CBS-TV, joins Pacific Finance Corp., Los Angeles, as VP and manager of PR and advertising.

**Martin J. Foody**, member of media department of Ted Bates & Co., joins advertising department of Liggett & Myers Tobacco Co., New York.

**Donald E. Lindstrom**, advertising manager of James B. Beam Distilling

Co. for past year and before that with Edward H. Weiss & Co., joins Clinton E. Frank Inc., Chicago, as account executive. **Logan M. Sellers**, formerly TV art director at Young & Rubicam, Chicago, joins Frank as art director.

The Advertising Research Foundation New York, announced last Wednesday that due to increased technical work load, five individuals have been added to ARF technical committee. They are **Donald A. Chase**, Kimberly-Clark Corp.; **Joseph Denny**, Fletcher Richards, Calkins & Holden; **August A. Fink Jr.**, Medical Economics Inc.; **Edgar Gunther**, *Fortune* Magazine; and **Arthur Koponen**, Colgate-Palmolive Co.

**David Nagata**, film production supervisor for Saul Bass & Associates, named TV production supervisor at Doyle Dane Bernbach, Los Angeles.



Mr. Kramer

**C. Frank Kramer Jr.**, executive VP of Reuell Estill & Co., New York public relations and development firm, appointed VP and chief executive officer of New York operations of Reuter & Bragdon Inc., Pittsburgh-based advertising and marketing agency. The appointment was announced by Henry F. Reuter, president of agency, which recently purchased New York firm of Carl P. Oswald & Associates. All New York operations are being consolidated in new offices at 527 Madison Avenue. Mr. Kramer is former executive VP of U.S.O.

**H. Earl Hodgson**, former president of Aubrey, Finley, Marley & Hodgson, Chicago, joins Fuller & Smith & Ross, that city, as VP. **John J. Poister**, FSR-Pittsburgh VP and group supervisor in charge of Aluminum Co. of America account, elected senior VP for client service, a newly created position, at FSR corporate headquarters in New York. **George Sapin**, account execu-

tive in FSR's Boston office, elected VP. Mr. Sapin joined agency in 1960. **William Caro**, who left San Francisco office of FSR last year to join Dancer-Fitzgerald-Sample, named media buyer for FSR in Los Angeles.



Mr. Maggini

**Donald J. Maggini** joins Geyer, Morey, Ballard Inc., New York, as VP. Mr. Maggini had been vice chairman of plans board at Kenyon & Eckhardt, that city.

**Michael G. McDonald**, previously with McCann-Erickson, joins J. M. Mathes Inc., New York, as account executive. **Gabriel Massimi**, copy group head at BBDO, joins Mathes in same capacity. **Frada Sklar** named copywriter. She was formerly senior copywriter for *Esquire* Magazine.

**Ted Pollack**, sales development director at WISH-TV Indianapolis, joins Bob Long Associates, advertising and public relations firm, that city, as radio-television director.

**Lyn Gross**, media director, transfers from San Francisco headquarters of Guild, Bascom & Bonfigli, to agency's Seattle office. Mr. Gross assumes duties of media director on Carling Brewing Co., Pacific Northwest Bell Telephone and Seattle Trust & Savings Bank accounts. **Jerry Gilley**, of GB&B's Seattle media staff, moves to San Francisco as associate media director.



Mr. Hoblar

**Edward W. Hoblar**, VP with Needham, Louis & Brorby, Chicago, joins Foote, Cone & Belding there as account supervisor on Kitchens of Sara Lee products.

**Daniel I. Knight** resigns as broadcast director of MacManus, John & Adams, Chicago.

**Bill Sassos** and **Bill Hines** appointed media buyers at Fuller & Smith & Ross, New York. Mr. Sassos was formerly space buyer with Doyle Dane Bernbach. Mr. Hines had been with Lenzen & Newell, both New York.

**R. D. Nardelli** named assistant to director of media planning at Street & Finney, New York. Mr. Nardelli was formerly with Ogilvy, Benson & Mather, that city, as media buyer.

**Paul Keller**, research director of Reach, McClinton & Co., New York, appointed to new post of director of research and media. Reporting to Mr. Keller in new alignment will be William Overmyer, media director, and Barbara Marsak, associate research director. Mr.





Keller, who also is vice president and secretary of corporation, joined Reach, McClinton in 1957.

**Philip S. Reach**, formerly account supervisor at Fletcher Richards, Calkins & Holden, San Francisco, named marketing director in BBDO's Los Angeles office.

**A. E. Roeder** joins Sullivan, Stauffer, Colwell & Bayles, New York, as marketing group supervisor. Mr. Roeder was formerly merchandising supervisor at Benton & Bowles, that city.

**Dale Clark, William Tompkins and Murray Head** join Franznick-Meden Inc., New York, as administrative director, art director and production manager, respectively.

**Theresa Falgiatore** appointed media director of Wermen & Schorr Inc., Philadelphia, in realignment of agency's media department which consolidates print and broadcast media responsibilities. She succeeds **Helen Carroll**, who retired June 1. Miss Falgiatore joined Wermen & Schorr in 1961 from Richard K. Manoff Inc., New York. Assisting her will be **Peter Holland** and **Grace Mathias**, and **Shirley Weiner**, who joins W&S from Lennen & Newell, New York, where she served as media coordinator.



Miss Falgiatore

**Clare Acton** joins Leo Burnett Co., Chicago, as copy supervisor. Mr. Acton formerly had been with BBDO and McCann-Erickson there.

**Clare Acton** joins Leo Burnett Co., Chicago, as copy supervisor. Mr. Acton formerly had been with BBDO and McCann-Erickson there.

**THE MEDIA**



Mr. Carnegie

**Jack Carnegie**, for past two years station manager of KXYZ-AM-FM Houston, elected VP and general manager. **Dick Morrison**, KXYZ sales manager since last November, promoted to regional sales manager and director of merchandising for KXYZ and KBEA Mission, Kan. Both stations are owned by Public Radio Corp. Prior to joining KXYZ Mr. Carnegie was program director of KABL San Francisco. Mr. Morrison is former VP of Richard H. Ullman Co., national program distributors.

**Bill Sadler** appointed manager of KELI Tulsa, Okla.

**Richard A. Keating**, account executive at WNAC Boston and former New England manager for The Bolling Co. and Henry I. Christal Co., elected president and sales manager of Bill Creed Associates, Boston-based radio-TV sta-

**AM Radio Sales adds 4 in expansion program**



Mr. Busch

Mr. Hodges

Mr. Dragomier

Mr. Sloan

AM Radio Sales announced expansion moves last week affecting company's offices in New York, Chicago and San Francisco.

**John F. Sloan** joins firm's New York office as account executive. He was formerly VP-sales manager of WPAT Paterson, N. J. **John Dragomier**, TV sales manager at Venard, Torbet and McConnell, is added to AM Radio's Chicago office as account executive. **Pat Hodges** moves

from sales position at KSFO San Francisco to account executive duties at AM Radio in same city. **Max Busch**, formerly in sales promotion department of CBS Radio, named director of sales presentations in new business and marketing department of rep firm's New York office. **Wilmot H. Losee**, president of AM Radio Sales, said increased volume of business had dictated expansion program.

tion representative. **William A. Creed** remains as treasurer and general manager and **George B. Cookman**, account executive, elected vice president.



Mr. Sundberg

**Harold C. Sundberg** elected VP and general manager of WZZM-TV Grand Rapids, Mich. Mr. Sundberg joined station in January as general sales manager after serving for two years as general manager of WMBD-AM-TV Peoria, Ill.

**James E. Szabo**, former general manager of WABC-TV New York, joins WOR-TV, that city, as manager of special sales. **Leslie L. Dunier** joins sales staff of station. He was previously VP in charge of radio-TV at Mogul, Williams and Saylor, New York.

**James A. Gunn** appointed general sales manager of KMCS-FM Seattle, Wash. Mr. Gunn formerly served as general sales manager of KONA-TV Honolulu, Hawaii, and general manager of KVAN Portland, Ore.

**Carl C. Smith**, former account executive at KAC Tulsa, Okla., joins KRAV, that city, as sales manager.



Mr. Tincher

**Robert R. Tincher**, VP of broadcasting division of Cowles Magazines and Broadcasting, New York, transferred to Cowles station WREC-AM-TV Memphis as director of public affairs. Mr. Tincher joined Cowles in 1935, serving with various broadcasting properties. He moved to New York headquarters of parent company in

**R. C. CRISLER & CO., INC.**

BUSINESS BROKERS FOR TV & RADIO PROPERTIES  
 LICENSED SECURITIES DEALERS  
 UNDERWRITING — FINANCING

**CINCINNATI—**

Richard C. Crisler, Paul E. Wagner, Alex Howard  
 5th/3rd Bank Building, phone 381-7775

**NEW YORK—**

733 Third Avenue, Suite 2105, phone MUrray Hill 7-8436

January 1961. **Billy W. Miller** joins WREC-AM-TV in newly created position of business manager.

**James E. Watson**, sales analyst with NBC Radio since 1960, promoted to manager of sales development.

**Lewis C. Greist**, with The Katz Agency in New York, joins WKDN Camden, N. J., as commercial manager.

**Jack Taylor** appointed national radio sales executive in San Francisco office of RKO General Broadcasting.

**Jack D. Pohle** appointed manager of Peters, Griffin, Woodward's radio office in Los Angeles, replacing **Robert G. Hinds**, who resigned. Mr. Pohle joins PGW after seven year association with CBS in Los Angeles, having served as merchandising manager and national sales representative for CBS-owned KNX-AM-FM, and subsequently account executive with CBS Radio Spot Sales.



Mr. Pohle

**Barry D. Stigers**, program manager of WBEC Pittsfield, Mass., promoted to sales service manager.

**Gerard Riley**, timebuyer with Leo Burnett Co., Chicago, joins WBBM-TV there as account executive. **Steven Orr**,

formerly sales service manager for Blair TV, also joins WBBM-TV sales staff.

**Richard H. Wheat**, account executive with WMAQ Chicago for two years, named to Chicago sales staff of NBC Radio Spot Sales.

**George H. Williams**, assistant sales manager of KDKA-AM-FM Pittsburgh since December 1961, promoted to sales manager. **Richard K. Ross**, KDKA account executive, succeeds Mr. Williams as assistant sales manager. Before joining Westinghouse's Pittsburgh radio outlets, Mr. Williams served as national sales manager for WWJ Detroit. Mr. Ross joined KDKA in 1957 from KQV, that city, where he was account executive.



Mr. Williams

**Leo Collins**, promotion manager and director of press information and public affairs at WXYZ Detroit, joins WABC-TV New York as director of advertising and promotion. **Mary Coyne** appointed director of community affairs for WABC-TV. She was formerly on-the-air promotion manager at station.

**Robert Shea**, formerly of Sports Network Inc., New York, joins WKBW-TV Buffalo as staff director.



Mr. DeMuth

**Thomas A. DeMuth**, local sales manager of WAVE Louisville, Ky., promoted to sales manager. Mr. DeMuth joined station in January 1959 as member of sales staff and was appointed to his present post in December 1962. His responsibilities will include local, national spot, and network sales.

**Bill Sikes**, producer-director with KAKE-TV Wichita, Kan., named program director of KARD-TV there and Kansas State Network.

**Larry Saunders**, local sales manager of WTAR - AM - FM Norfolk-Newport News, Va., since Sept. 1961, promoted to general sales manager. **Ronald W. Philips**, WTAR-TV account executive since 1959, appointed local sales manager for that outlet. Mr. Saunders joined WTAR in 1955 as announcer. Mr. Philips is former sales manager of WBOF Virginia Beach, Va.



Mr. Saunders

**William McLean Jr.**, formerly of WTAR-TV Norfolk-Newport News and WAVY-TV Portsmouth, both Virginia, joins WNBE-TV New Bern, N. C., as producer-director and set designer.

**Bob Martin** elected VP of KOOL Radio-Television Inc. (KOOL-AM-FM-TV Phoenix) and assistant to president of KOLD-AM-TV Tucson, Ariz. Stations are owned by Gene Autry group. For past two years Mr. Martin has served as director of programing, promotion and operations for Arizona Broadcasting Network, comprised of KOOL-AM-FM-TV and KOLD-AM-TV, and has been dividing his time between stations. He began his broadcast career with CBS-TV network in 1946.



Mr. Martin

**Carl Barger**, former program director and air personality at WFDF Flint, Mich., joins air staff of WJR Detroit.



Mr. Jones

**Donald (Gene) Jones**, member of sales department of KMOX St. Louis, appointed manager of St. Louis regional office of Avery-Knodel Inc., national radio-TV sales representatives. Before joining KMOX Mr. Jones was timebuyer for KPLR-TV St. Louis.

**Bob Palmer**, formerly of KMPC Los Angeles, joins KLAC-AM-FM, that city, as creative director. **Ken Reed**, WKW St. Louis, joins KLAC as air personality. Mr. Reed replaces **Stan Warwick**, who moves to station's news department.

**James E. Blake** appointed general sales manager of KSTP-AM-TV Minneapolis. **Byron E. Anderson**, radio sales manager, succeeds Mr. Blake as national sales manager of stations.



Mr. Blake

**Stanley Levey** appointed correspondent on CBS Radio's *This Week In Business* series (Saturdays, 10:30-10:35 a.m.).

**Richard A. Feleppa** named sales promotion manager of WOR-AM-TV Boston.

**Jack Devereaux** and **Hans B. Peterson** join WPRO-TV Providence, R. I., as art director and assistant promotion director, respectively. Mr. Devereaux was art director for past six years for WJAR-TV Providence. Mr. Peterson was just released from U. S. Air Force.

**Marshall (Mike) Leckner** elected VP of New York office of Vic Piano Associates. Mr. Leckner was formerly director of 40-Plus of New York Inc. **Lou Allen**, VP for Midwest division of rep firm, moves to new office 35 East Wacker Drive, Chicago.



Straight Music organized in basic categories. You order what you want, play it in the order you determine, add your own voices for a completely live, local sound. And cheaper than you can produce it yourself.

Suitable with ATC, Schaffer, Alto Phonic, and most other automation systems. Or with

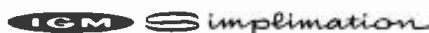

Main Office and Plant P.O. Box 943 Bellingham, Wash. 733-4567 (Area 206) In New York City TELE-MEASUREMENTS, Inc. 45 W. 45th St. 581-9020 (Area 212)

**Bill Wright**, national sales manager of WHN New York, joins WIBG Philadelphia as air personality.

**Richard F. Polgreen**, account executive at WNYX-TV Syracuse, N. Y., promoted to local sales manager. Mr. Polgreen, former assistant general manager and director of sales for WFBL Syracuse, joined WNYX-TV in Sept. 1962.



Mr. Polgreen



Mr. Winckler

**Reavis Winckler**, publicity director of KTTV(TV) Los Angeles for past 10 years, appointed director of promotion and public relations. He will be responsible for press information, advertising, broadcast publicity, and sales and station promotion, under outlet's new organizational setup. Before joining KTTV in 1953, Mr. Winckler was director of public relations and advertising for Jerry Fairbanks Productions.

**Stephen R. Rintoul**, vice president and New York radio sales manager of Venard, Torbet & McConnell, station representative, moves to firm's Chicago office as radio sales manager and is succeeded as New York sales manager by **Brock Petersen**, account executive in New York office past four years. **Dan Ruffa**, of firm's Chicago radio sales force, moves into Chicago TV office. **Lloyd George Venard**, president, said transfer of Mr. Rintoul was designed to enable **Howard B. Meyers**, Midwest vice president, to devote more time to television.

## EQUIPMENT & ENGINEERING

**M. E. Karns** appointed to newly created position of VP in charge of licensing for RCA, New York. **Stephen S. Barone** named division VP for license operations of RCA International division, filling vacancy created by Mr. Karns' promotion. Mr. Karns, a veteran of 30 years service with RCA, was appointed to his former post in 1960. Mr. Barone was licensing manager for corporation's international division. He joined RCA in 1945 as attorney in law department.



Mr. Karns

**D. Brainerd Holmes**, whose resignation as director of nation's manned space flight program becomes effective Sept. 15, elected senior VP and director of Raytheon Co., Boston. Mr. Holmes will join Raytheon Oct. 1. Prior to join-

## RCA appoints 5 to newly created division

RCA announced five staff appointments to its newly created commercial receiving tube and semiconductor division. They are: **Frank R. Buchanan**, formerly controller of semiconductor and materials division, named financial and planning controls manager; **Harold A. DeMooy**, manager of receiving tube operations for RCA electron tube division, to manager of receiving tube operations department; **Norval H. Green**, manager of commercial semiconductor products department of semiconductor and materials division, to manager of commercial semiconductor operations department; **George J. Janoff**, manager of mar-

ket planning for entertainment tube products department of RCA electron tube division, to manager of marketing department; and **Kenneth M. McLaughlin**, manager of computer products department for RCA semiconductor and materials division, appointed manager of memory products staff at Needham, Mass.

The new division, one of five operating units of RCA electronic components and devices organization, is responsible for engineering, manufacturing, marketing, and sales of receiving tubes, memory products and semi-conductors for communications, computers, consumer products and TV picture tubes.

ing NASA he was with RCA. **George Ingram Jr.**, vice president in charge of finance for Raytheon, elected senior vice president and director.

**Frank B. Parrish**, sales promotion manager of Gates Radio Co., Quincy, Ill., named advertising manager. Mr. Parrish joined Harris-Intertype Corp., parent company, in 1961.



Mr. Parker

**Thomas A. Parker**, a 25-year veteran in broadcast tower construction field in both the U. S. and Canada, appointed construction manager at Tower Communications Co., Sioux City, Iowa. Mr. Parker will be responsible for all field construction with continental U. S. for Tower Communications Co.

**Dr. Robert R. Moats**, director of cross field device department at Sylvania Electric Products, Mountain View, Calif., joins Eitel-McCullough Inc., San Carlos, Calif., as senior research scientist.

## PROGRAMING

**Jack Allen** appointed national sales representative for Alexander Film Co. of Colorado Springs, Colo., with headquarters in Indianapolis.

**Morty Gunty** signed to host *The Funny Company*, children's show on WOR-TV New York (Monday-Friday, 3:30-5 p.m.).

**James F. Hoffman**, director for promotion and research for KTTV(TV) Los Angeles, resigns to become West Coast sales manager for newly established Los Angeles sales headquarters of Peter M. Robeck & Co., distributors and producers of TV programs. Mr. Hoffman, with KTTV for 11 years, for-

merly served as assistant national sales manager and local account executive.

**Wallace R. Fanning**, moderator of WRC-TV Washington's *Georgetown University Forum* (Sundays, 12:30-1 p.m.) and *NBC Farm Review* on NBC Radio network (Sundays, 11:15-11:30 a.m.), assumes added duties at WRC-TV as editor-producer of *News 4 Washington*, station's expanded early evening half-hour news program starting this fall (Monday-Friday, 6-6:30 p.m.).

## SPOTMASTER



Tape  
Cartridge  
Racks



... from  
industry's  
most comprehensive  
line of cartridge tape equipment.

Enjoy finger-tip convenience with RM-100 wall-mount racks. Store 100 cartridges in minimum space (modular construction permits table-top mounting as well); \$40.00 per rack. Extra rack sections available at \$12.90. Spotmaster Lazy Susan revolving cartridge rack holds 200 cartridges. Price: \$145.50. Write or wire for complete details.

*Spotmaster*

**BROADCAST ELECTRONICS, INC.**  
8800 Brookville Road  
Silver Spring, Maryland



Mr. Kuralt      Mr. Schakne      Mr. Eismann      Mr. Rudd      Mr. Rather

## CBS shuffles newsmen, forms news bureau

Assignment changes involving several CBS News correspondents (CLOSED CIRCUIT, Aug. 5) were announced last week by CBS News President Richard S. Salant.

**Charles Kuralt**, who has covered Latin and South America for CBS News for past two years, named chief West Coast correspondent in Los Angeles. **Robert Schakne** named West Coast bureau manager, with **Irving Drasnin** as field producer; **Murray Fromson**, reporter; and **Jerry Sims**, cameraman, in addition to current staff headed by **Fred Dieterich**. **Bernard Eismann**, chief correspondent of CBS News' Midwest bureau (Chicago), has been assigned to New York bureau. Replacing Mr. Eismann in Chicago will

be **Hughes Rudd**, formerly chief correspondent of southern bureau. **Russ Bensley** appointed Chicago bureau manager.

The Southern and Southwest bureaus will be consolidated and based in New Orleans, with **Dan Rather**, formerly chief correspondent of Southwest bureau, as chief correspondent in New Orleans. **Nelson Benton** has been appointed bureau manager, and **Lew Wood**, field producer.

The CBS News bureau will be housed in new facilities now being constructed by WWL-TV, the CBS-TV network affiliate in New Orleans. Assigned to the New Orleans bureau will be camera crews in Texas, Kansas and Alabama.

**Leonard Soforo**, chief engineer and staff announcer at KGRT Las Cruces, N. M., joins Snazelle Productions, San Francisco, as sales manager for newly formed Kinescope Recording division.

**Don Redell**, formerly of Producers Studio and Radio Features Associates, joins Tele-Tape Productions, New York, in sales and production capacity.

**Joe McKay**, formerly with CBS, Grant Adv. and Kling Studios, joins sales staff of Shield Productions, Chicago. **James Rhodes**, formerly of WISE Asheville, N. C. joins Shield's production staff.

**Dennis Marlas** joins Film-Makers

Inc., Chicago production company, as producer-director. Mr. Marlas was formerly with Fred Niles Communications Center, that city.

**Walter Burr**, formerly producer-director of commercials at Leo Burnett Co., appointed director of live action film commercial division of Hanna-Barbera Productions, Hollywood.

**Marion Hargrove** named writer for pilot episode of *John Stryker*, hour-long espionage series being developed for CBS-TV by Daystar Productions. **Walter Grauman** will direct pilot to be produced by Daystar President **Leslie Stevens**, who will serve as executive

producer of series, with Mr. Grauman as producer.

**William Gordon**, assistant story editor of *The Richard Boone Show*, named acting editor-in-chief. He temporarily replaces **Clifford Odets**, who is recovering from recent operation.

**Joseph Dackow**, most recently associated with CBS-TV, joins Warner Brothers as producer of new TV series, *Temple Houston*, co-starring **Jeffrey Hunter** and **Jack Elam** for NBC-TV. Mr. Dackow formerly served as executive assistant to **Martin Manulis** at 20th Century-Fox and as producer of *The Outlaws* for NBC-TV.

**Robert Lane** named producer NBC-TV's new color show, *Merv Griffin's Word For Word* (Monday-Friday, 10:30 a.m. EDT). He has been head writer on *Play Your Hunch* for five years.

**Luis Santeiro** appointed treasurer and **Lois Talbot** named research director of America's Productions Inc., producers of Spanish radio programs for U. S. government and commercial purposes, Miami, Fla.

**Ferdinand L. Manning**, former lighting director at CBS-TV, New York, for 11 years, joins staff of Videotape Productions of New York Inc.

## NEWS

**Jack E. Krueger** appointed to newly created position of manager of radio-TV news for The Journal Co. Stations (WTMJ-AM-FM-TV Milwaukee). **Arthur L. Olszyk** named editor of radio-TV news, and **James Schlosser** continues as assistant editor.

**Malcolm R. Johnson**, night manager, appointed manager of NBC News, New York. Mr. Johnson joined network news division in April 1962.

**Joseph T. Loughlin**, director of news and public affairs for WTVT(TV) Tampa-St. Petersburg, Fla., named director of news for WCBS-TV New York. Mr. Loughlin will head department which will function independent of network operation in reorganization which goes into effect September 2.

**David McLean**, news producer at KPX(TV) San Francisco, joins news department of KGO-TV, that city, as writer-producer for station's new *90 For News* program. Before joining KPX Mr. McLean was radio-TV director of Meyer Adv. in Louisiana.

**David A. Dary**, news director for KWFT Wichita Falls, Tex., joins WRC-AM-FM-TV Washington as manager of local news. He succeeds **Wallace Fanning**, who moves to editor-producer post.

**Dan Bloom** named producer of CBS News special reports. Mr. Bloom, currently producer of *CBS Sunday News*

*More than a decade of Constructive Service  
to Broadcasters and the Broadcasting Industry*

**HOWARD E. STARK**

*Brokers—Consultants*

50 EAST 58TH STREET

NEW YORK, N. Y.

ELDORADO 5-0405

with *Harry Reasoner* and the *CBS Saturday News with Robert Trout*, will handle special reports of major national and international events, presidential news conferences, and other news material for network news division.

**Jack Bates**, former news director of KFOR Lincoln, Neb., joins news staff of KRON-TV San Francisco.

**Bob Guidry**, air personality and assistant news director at KROD El Paso, Tex., promoted to news director.

**James W. Smalling**, former news director at WWNC Asheville, N. C., joins WLOS-TV, that city, as news reporter and photographer.

**Brook Stevens**, for two years night news editor at WNOR Norfolk, Va., joins staff of WPET Greensboro, N. C.

**Al Knight** joins news staff of WTAR-AM-FM-TV Norfolk-Newport News, Va.

**J. Paul Huddleston** joins news staff of KLAC-AM-FM Los Angeles.

**Mel Pinsler** joins news staff of KTVU (TV) Oakland-San Francisco. He had previously served as news writer at KIDD Monterey, KTVR Turlock and KGO-TV San Francisco, all California.

## INTERNATIONAL

**R. H. M. Kindersley, R. Telford** and **Dr. E. Eastwood** elected to board of directors of Marconi's Wireless Telegraph Co. Ltd., London. Mr. Kindersley is managing director of Lazard Brothers and Co. Ltd. Messrs. Telford and Eastwood serve respectively as general manager and director of engineering and research for Marconi Co.

**James J. Drain**, creative director of Foote, Cone & Belding, Toronto, elected VP. Mr. Drain has been with agency 13 years and formerly served in Chicago office.

**Terry Bate**, national sales manager of CHQM Vancouver, B. C., named manager of newly formed Quality Broadcast Sales Ltd., Toronto station

representative firm. Mr. Bate will represent CHQM and CJQM-AM-FM Winnipeg, Man., when that station goes on air in November. **John Grant**, retail sales representative at CHQM, promoted to national sales manager.

**Bruce McLeod** named manager of CHIC Brampton, Ont., succeeding **John Fox**, who resigned.

**Dennis Scuse**, U. S. representative for British Broadcasting Corp. since last July, appointed general manager of BBC Television Enterprises, succeeding **Ronald Waldman**, who becomes managing director of British Commonwealth International Newsfilm Agency (Visnews), London. Mr. Scuse, who joined BBC in 1947, previously held executive positions with planning and light entertainment departments. BBC Television Enterprises is jointly owned by BBC, Australian Broadcasting Commission, Canadian Broadcasting Corp., Rank Organization and Reuters, the British international news agency.

**Alex R. Findlay**, formerly of CKRC Winnipeg, Man., and **Ronald A. Gauley** join television sales staff of All-Canada Radio and Television Ltd., Toronto.

**Karl Haas**, director of fine arts for WJR Detroit, takes leave of absence to serve as consultant for new cultural development project of Ford Foundation in Berlin, Germany.

## ALLIED FIELDS



Dr. Strohmeier

**Dr. Gustav H. Strohmeier** elected VP of IIT Research Institute, Chicago. Dr. Strohmeier will continue as director of IITRI's defense research and also as director for branch offices and area representatives in Washington, D. C., Los Angeles, Dayton, Houston, Huntsville and Paris, France. He joined organization in 1955 as research consultant after serving as scientific consultant to Air Material Command in Dayton, Ohio. IIT Research Institute's new Washington office was opened last month at 1755 Massachusetts Avenue, N.W., under supervision of **Andrew D. Farrell**, former Washington representative for Bendix Corp. Four IITRI research directors were promoted to new VP posts: **Virgil H. Disney**, electronics; **George S. Gordon**, chemistry; **Donald J. McPherson**, materials; and **Leonard Reiffel**, physics.

**Peter L. Raphael**, project director at Alfred Politz Research Inc., joins Audits & Surveys Co., New York, as project director in consumer survey division.

**W. H. Mullen**, director of magazine advertising bureau of Magazine Pub-

lishers Association, joins media audit service of Alfred Politz Research as account executive.

**Jack R. Crosby**, community antenna TV operator and general manager of KDLK Del Rio, Tex., named chairman of research council of National Community TV Association. Mr. Crosby succeeds **Al Ricci**, Keene, N. H., who remains as member. Added to council, raising membership to 11, were **George Barko**, Meadville, Pa., former NCTA president, and **M. William Adler**, Weston, W. Va.

**Herbert E. Forrest**, member of Washington, D. C., communications law firm of Welch, Mott & Morgan since August 1955, named partner. Mr. Forrest received his LL.B. degree from George Washington University Law School in 1952. Books he has written include "Governmental Regulation of the Program Content of Television Broadcasting."



Mr. Forrest

## GOVERNMENT

**Otis T. Hanson**, chief of emergency communications systems division of FCC's Office of Emergency Communications, named chief of changed aural facilities branch, Broadcast Bureau.

## Here's the Answer To Libel Suits:

One slip of the lip, however accidental, can bring about court action—with you as the defendant in a libel suit. It can be costly enough to be disastrous. Now you can hold your loss on any claim to an agreed amount you carry yourself, and let Employers Reinsurance handle the excess. This specially designed policy provides economical protection against losses due to libel, slander, invasion of privacy, piracy, violation of copyright. For details and rates, contact:

**EMPLOYERS REINSURANCE CORPORATION**  
21 West 10th, KANSAS CITY, MO.  
NEW YORK, 111 John • SAN FRANCISCO, 320 Montgomery  
CHICAGO, 175 W Jackson • ATLANTA, 34 Peachtree, N. E.



**RETARDED CHILDREN CAN BE HELPED**

SUPPORT YOUR LOCAL ASSOCIATION FOR RETARDED CHILDREN

## DEATHS

**Robert P. Lytle**, 53, VP and director of Public Relations Counselors Inc., Pittsburgh, died Aug. 6 of heart attack at his home in Whitehall, Pa. Mr. Lytle, former VP and general manager of New York office of Ketchum, MacLeod & Grove, joined Public Relations Counselors, a subsidiary of Vic Maitland & Associates, in 1960 as managing director. He was elected VP in 1962.

**Stanley Schlenker**, 56, VP and general manager of Fort Worth, Tex., office of Fuller & Smith & Ross, died July 6 of heart attack while undergoing routine physical examination.

**William J. O'Donnell**, 55, VP and management supervisor at BBDO, New

York, died July 31 of heart attack. Mr. O'Donnell joined agency in 1925. He subsequently moved to media department, becoming media director in 1939, account executive in 1942 and was elected vice president and assistant to president in 1958.

**Helen Shields**, character actress in TV and Broadway roles, died Aug. 8 in St. Clare's Hospital, New York. Miss Shields held leading character parts on daytime TV in *From These Roots*, *As The World Turns*, and *Edge of Night*.

**Harry M. Anger**, an old-time vaudeville performer who became executive producer of Perry Como TV show, died July 22 at his home in New York. In 1930's and '40's Mr. Anger aided in production of Red Skelton and Abbott

and Costello movies in Hollywood. In 1947 he joined General Artists Corp. and became VP in 1950. Later he formed Harry Anger Associates.

**Robert Mears Jr.**, 84, president of his own New York advertising agency, died Aug. 3 of cancer at St. Mary's Hospital in Galesburg, Ill. Mr. Mears formed agency in 1915.

**Fern Gable**, former home service director at wowo Ft. Wayne, Ind., died July 31 at Parkview Memorial Hospital, that city.

**Anthony Sebastian**, 35, production manager of WHOT Youngstown, Ohio, died July 30 as result of injuries sustained in West Virginia automobile accident. He also served on staffs of WJET Erie, Pa., and WEEP Pittsburgh.

## FOR THE RECORD

### STATION AUTHORIZATIONS, APPLICATIONS

As compiled by BROADCASTING Aug. 1 through Aug. 7 and based on filings, authorizations and other actions of the FCC during that period.

This department includes data on new stations, changes in existing stations, ownership changes, hearing cases, rules and standards changes, routine roundup of other commission activity. Abbreviations: DA—directional antenna. CP—construction permit. ERP—effective radiated power. VHF—very high frequency. UHF—ultra high frequency. ant.—antenna. aur.—aural. vis.—visual. kw—kilowatts. w—watts. mc—megacycles. D—day. N—night. LS—local sunset. mod.—modification. trans.—transmitter. unl.—unlimited hours. kc—kilocycles. SCA—subsidiary communications authorization. SSA—special service authorization. STA—special temporary authorization. SH—specified hours. \*—educational. Ann.—Announced.

#### New AM stations

##### ACTIONS BY FCC

**Cathedral City, Calif.**—Glen Barnett. Granted CP for new AM on 1340 kc, 250 w, unl.; conditions. P. O. address Box 2805, Palm Springs, Calif. Estimated construction cost \$14,410; first year operating cost \$41,340; revenue \$55,000. Mr. Barnett, sole owner, is radio engineer. Action July 31.

**Kissimmee, Fla.**—Radio Florida Broadcasters. Granted CP for new AM on 1080 kc, 5 kw-D; P.O. c/o Edward C. Allmon, 824 King Richard Road, Eau Gallie, Fla. Estimated construction cost \$35,150; first

year operating cost \$31,200; revenue \$36,000. Edward C. Allmon, sole owner, also owns WBGC Chipley and WNSM Valparaiso-Niceville, both Florida. Action July 31.

**Geneseo, Ill.**—Geneseo Broadcasting Co. Granted CP for new AM on 1500 kc, 250 w-D. P.O. address 116 1/2 South State Street, Geneseo. Estimated construction cost \$34,533; first year operating cost \$36,000; revenue \$40,000. Principals: Ernest G. Swint and Dale R. Swanson (each 50%). Mr. Swint owns two-way radio firm; Mr. Swanson owns drugstore. Action Aug. 2.

**Paoli, Ind.**—King & King. Granted CP for new AM on 1560 kc, 250 w-D; conditions. P.O. address R. R. 2, English, Ind. Estimated construction cost \$10,428; first year operating cost \$23,099; revenue \$40,000. Principals: Z. Denzel King and Virginia A. King (each 50%). Mr. King is electrician and minister; Mrs. King is housewife. Action Aug. 2.

**Kennett, Mo.**—Boothel Broadcasting Co. Granted CP for new AM on 1540 kc, 1 kw-D. P. O. address William L. Miller, 408 N. Thompson, Hemet, Calif. Estimated construction cost \$18,729; first year operating cost \$28,000; revenue \$36,000. Applicant is William L. Miller, former 50% owner of KHSJ Hemet, Calif. Jan. 30 initial decision looked toward grant. Action July 31.

#### Existing AM stations

##### APPLICATIONS

**KLMO Longmont, Colo.**—CP to change frequency from 1050 kc to 1060 kc, increase power from 250 w to 10 kw, install new trans. and change ant. from shunt to series excited. Ann. Aug. 6.

**WPRY Perry, Fla.**—CP to increase daytime power from 250 w to 1 kw, install new trans. Ann. Aug. 7.

#### New FM stations

##### ACTIONS BY FCC

**Belgrade, Mont.**—Christian Enterprises Inc. Granted CP for new FM on 96.7 mc, 16 kw. Ant. height above average terrain 195 feet; conditions. P. O. address 21 North 27 Street, Billings, Mont. Estimated construction cost \$10,672; first year operating cost \$5,900; revenue \$5,900. Principals: non-profit religious organization's board of directors. Also see grant in Billings below. Action July 31.

**Billings, Mont.**—Christian Enterprises Inc. Granted CP for new FM on 97.1 mc, 16 kw. Ant. height above average terrain minus 30 feet; conditions. P. O. address 21 North 27th Street, Billings. Estimated construction cost \$17,677; first year operating cost \$5,900; revenue \$5,900. Principals: non-profit religious organization's board of directors. Also see Belgrade, Mont., grant above. Action July 31.

##### APPLICATIONS

\***Mount Vernon, Iowa**—Cornell College. 89.7 mc, channel 209, 10 w. Ant. height above average terrain 88 feet. P. O. address Mount Vernon. Estimated construction cost \$4,800; first year operating cost \$1,600. Principals: board of trustees. Ann. Aug. 1.

**Sedalia, Mo.**—Yates Broadcasting Co. 92.1 mc, channel 221, 2.67 kw. Ant. height above average terrain 278 feet. P. O. address Radio Station KZSIS Sedalia, Box 207. Estimated construction cost \$13,061; first year operating cost \$22,500; revenue \$35,000. Principals: Carl W. Yates Jr. and Christine Yates (each 50%), equal owners of KZSIS. Ann. Aug. 6.

**San Antonio, Tex.**—Harry Pennington Jr. 96.1 mc, channel 241, 29,925 kw. Ant. height above average terrain 213.4 feet. P. O. address 134 Agarita Street, San Antonio. Estimated construction cost \$27,450; first year operating cost \$3,600; revenue \$17,500. Mr. Pennington, sole owner, does contract photographs and sound recordings. Ann. Aug. 6.

#### Ownership changes

##### ACTIONS BY FCC

**KKTV(TV) Colorado Springs**—Granted transfer of control of licensee corporation, TV Colorado Inc., to Communications Systems Inc. For other information see KFMH (FM) Colorado Springs and KGHF Pueblo, Colo., grants below. Action July 31.

**KFMH(FM) Colorado Springs**—Granted transfer of control of TV Colorado Inc. (parent corporation of licensee, KFMH Inc.) to Communications Systems Inc. For other information see KKTV(TV) Colorado Springs and KGHF Pueblo, Colo., grants. Action July 31.

**KGHF Pueblo, Colo.**—Granted transfer of control of TV Colorado Inc. (616 shares issued), (parent corporation of licensee, KGHF Inc.) from Gifford Phillips (280 shares), James D. Russell (130), Betty Z. Russell (150) and Robert D. Ellis (56) to Willard W. Garvey (100%). tr/as Communications Systems Inc. Consideration \$885,000. Price also includes KKTV(TV) and KFMH(FM) Colorado Springs, Colo. Also see those grants above. Mr. Garvey

## EDWIN TORNBERG & COMPANY, INC.

Negotiators For The Purchase And Sale Of  
Radio And TV Stations  
Appraisers • Financial Advisors

New York—60 East 42nd St., New York 17, N. Y. • MU 7-4242  
West Coast—1357 Jewell Ave., Pacific Grove, Calif. • FR 5-3164  
Washington—711 14th St., N.W., Washington, D.C. • DI 7-8531



has extensive investments outside broadcast industry. Action July 31.

**KNDR(FM) Des Moines, Iowa**—Granted assignment of license from New Directions Broadcasting Corp. to Charles Funaro (100%), trustee in bankruptcy. No financial consideration involved. Action July 31.

**KUXL Golden Valley, Minn.**—Granted assignment of license from C. J. Lanphier (100%), d/b as C. J. Lanphier Inc., to Edward Skotch (100%). Consideration \$100,000. Mr. Skotch is freelance radio producer. Action Aug. 1.

**APPLICATIONS**

**KAAB Hot Springs, Ark.**—Seeks transfer of control of licensee corporation, Phoenix Inc., from Harmon I. Moseley II (100%) to W. E. Hussman (26.66%) and others, tr/as Camden Radio Inc. Consideration \$500 and assumption of debt. Principals of assignee (licensee of KAMD Camden, Ark.) have interests in KCMC Texarkana, Tex., KTAL-FM Shreveport, La., KTAL-TV Shreveport-Texarkana and wide holdings in Southern newspapers. Ann. Aug. 1.

**KTVU(TV) Oakland, Calif.**—Seeks transfer of control of licensee corporation, San Francisco-Oakland Television Inc., from Ward D. Ingram, William D. Pabst, Edwin W. Pauley (each 25%) and others to Miami Valley Broadcasting Corp. (100%), large corporation with no majority stockholder. Consideration \$12,360,000. Miami Valley owns WHIO-AM-FM-TV Dayton, Ohio, and WSOC-AM-FM-TV Charlotte, N. C.; minority stockholders have wide broadcast interests. Ann. Aug. 5.

**KSMN Mason City, Iowa**—Seeks assignment of license from Donald F. Blanchard and Harry Campbell (each 50%), d/b as Land O'Corn Broadcasters Inc., to Hayward L. Talley (100%), tr/as North Central Iowa Broadcasting Co. Consideration \$170,000. Mr. Talley is majority owner of WSMI-AM-FM Litchfield, Ill., and owns KXGI Fort Madison, Iowa. Ann. Aug. 5.

**WPHN Liberty, Ky.**—Seeks assignment of CP from J. T. Whitlock (52%), W. B. Kelly and J. B. Crawley (each 24%), d/b as Patrick Henry Broadcasting Co., to Messrs. Whitlock, Kelly and Crawley (each 33 1/3%), tr/as company of same name. Consideration: partners will assume equal share of expenses. Ann. Aug. 6.

**WVOC Battle Creek, Mich.**—Seeks assignment of CP from Don F. Price (100%) to Mr. Price (75%), Evangeline and B. Burdette Price (20% and 5% respectively.) tr/as WVOC Inc. No financial consideration involved. Ann. Aug. 6.

**WPNC Plymouth, N. C.**—Seeks assignment of license from Harry A. Epperson Sr. (100%) to son, Ralph D. Epperson (100%). Consideration \$53,000. R. D. Epperson owns WPAQ Mt. Airy, N. C. Ann. Aug. 2.

**KVII(TV) Amarillo, Tex.**—Seeks assignment of license from Cecil L. Trigg (25.72%), Dave G. Scribner (20%) and others, d/b as Southwest States Inc., to John B. Walton Jr. (100%). Consideration \$1,250,000. Mr. Walton owns KVKM-AM-TV Monahan and 1/3 of KFNE-FM Big Spring, Tex. Ann. Aug. 1.

**WNNT Warsaw, Va.**—Seeks assignment of license from Patricia P. Headley, executrix of estate of Grayson Headley (100%), deceased, to Mrs. Headley (100%), tr/as Northern Neck & Tidewater Broadcasting Co. No financial consideration involved. Ann. Aug. 2.

**KCDI Kirkland, Wash.**—Seeks transfer of control of permittee corporation, Carl-Dek Inc., from Carl E. Haymond (51%), Dexter Haymond and Jack H. Goetz (each 20%) and Arthur Balinger (9%) to Gordon B. Sherwood Jr., Edward R. Hopple and Media Management Corp. (each 33 1/3%); Media Management is owned 50% each by Jack L. and Ada Stoll. Messrs. Sherwood and Hopple have interests in KWAC Bakersfield, Calif.; Mr. Stoll owns media brokerage firm. Ann. Aug. 2.

**Hearing cases**

**INITIAL DECISIONS**

■ Hearing Examiner Chester F. Naumowicz Jr. issued initial decision looking toward granting application of William D. Mangold, d/b as Pinellas Radio Co., for new daytime AM on 570 kc, 500 w, DA, in Pinellas Park, Fla.; conditions include precluding pre-sunrise operation with daytime facilities pending final decision in Doc. 14419, and program tests not to be authorized until permittee has shown William D. Mangold has divested all interest in and severed all connection with WILZ St. Petersburg Beach, Fla. Action Aug. 1.

■ Hearing Examiner Chester F. Naumowicz Jr. issued initial decision looking toward granting application of Southwestern Broadcasting Co. of Mississippi to increase power of WAPE McComb, Miss., from 1 kw to 5 kw, continued operation on 980 kc, D; conditions include precluding pre-sunrise operation with daytime facilities pending final decision in Doc. 14419. Action Aug. 1.

■ Hearing Examiner Jay A. Kyle issued initial decision looking toward granting application of KDIA Inc. to increase power of KDIA Oakland, Calif., on 1310 kc, unl., from 1 kw to 5 kw, DA-1; condition. Action Aug. 1.

■ Hearing Examiner Basil P. Cooper issued initial decision looking toward granting application of Wells, Waller & Ballard Inc. to increase daytime power of KEEB Jacksonville, Tex., from 250 w to 1 kw, continued operation on 1400 kc with 250 w-N; conditions. Action Aug. 1.

■ Hearing Examiner Charles J. Frederick issued initial decision looking toward denying for failure to prosecute application of Hugh Jordan Stock for new AM on 740 kc, 1 kw-D, in Riverton, Wyo. Action Aug. 1.

**DESIGNATED FOR HEARING**

■ Commission designated for hearing applications for assignments of KGLC Miami, Okla., from Miami Broadcasting Co. to Miami Newspapers Inc. Issue is to determine whether grant would create concentration

**Two from FM table**

The FM table of assignments adopted by the FCC and released on Aug. 1 (BROADCASTING, July 29) has been reduced by two assignments. Channel 247 in Lake Charles, La., and channel 287A in Lynn, Mass., were deleted by the commission in taking final action on the table.

of control of media of mass communication in Miami contrary to public interest. Comr. Bartley not participating; Comr. Lee dissented. Action Aug. 1.

**OTHER ACTIONS**

■ Commission postponed from Sept. 19 to Oct. 4 oral argument on various petitions for reconsideration of May 29 report and order which denied short-spaced VHF channel drop-ins for Johnstown, Pa.; Baton Rouge; Dayton, Ohio; Jacksonville, Fla.; Birmingham, Ala.; Knoxville, Tenn., and Charlotte, N. C. Action Aug. 1.

■ By memorandum opinion and order, commission denied petitions by King Broadcasting Co. (KGV-TV, ch. 8) and Oregon Television Inc. (KPTV-TV, ch. 12), both Portland, Ore., for stay of June 26 action granting application of Fisher Broadcasting Co. to change trans. site of KATU (TV) (ch. 2) Portland from site about

14 miles northeast of city on Livingston Mountain to site in Portland, and increase ant. height from 1,090 feet to 1,550 feet. Petitioners failed to substantiate claim that areas beyond mountains are receiving any usable signal therefore alleged creation of "white" area is not substantiated, and have not raised matters which were not considered at time June 26 action was taken. Consequently, commission is of view no basis has been shown for believing petitioners are likely to succeed on merits of pending petitions for reconsideration. Comrs. Bartley and Lee dissented. Action Aug. 1.

■ Commission denied motion by Paducah Newspapers Inc. for expeditious action on complaint that CBS, in combination with National Football League, have imposed TV "blackout" upon WPSD-TV Paducah, Ky., and Paducah area and so deprived people of half of otherwise available telecasts of NFL football games. Action Aug. 1.

**Routine roundup**

**ACTIONS BY REVIEW BOARD**

■ Granted petition by Billy Walker, Prattville, Ala., to extend time to Aug. 22 to file replies to exceptions to initial decision in proceeding on AM application and that of Prattville Broadcasting Co., Prattville. Action Aug. 6.

■ Granted petition by Broadcast Bureau to extend time to Aug. 12 to reply to opposition of James S. Rivers Inc. (WJAZ), Albany, Ga., to appeal of Broadcast Bureau from ruling of hearing examiner in proceeding on WJAZ's AM application. Action Aug. 6.

■ Granted petition by C. M. Taylor, Blountville, Tenn., to extend time to Aug. 28 to file opposition to Holston Broadcasting Corp., Elizabethton, Tenn., petition to enlarge issues in proceeding on AM applications. Action Aug. 5.

■ By memorandum opinion and order, granted joint petition by Kansas Broadcasters Inc. and Salina Radio Inc., applicants for new AM stations on 910 kc, 500 w, DA, D, in Salina, Kan., for approval of agreement to extent whereby Kansas Broadcasters would withdraw application in consideration of merger in which Kansas stockholders would trade shares for 50% stock interest in Salina Radio; dismissed Kansas Broadcasters application with prejudice; retained in hearing status Salina application. Action Aug. 5.

■ By memorandum opinion and order denied motion by O. K. Broadcasting Corp. (WEEL), Fairfax, Va., to enlarge issues in proceeding on AM application. Board Member Nelson not participating. Action Aug. 1.

■ Granted petition by Arthur D. Smith Jr. (WMTS), Murfreesboro, Tenn., to extend time to Aug. 19 to file oppositions to petition by North Alabama Broadcasting Co. to enlarge issues in proceeding on WMTS' AM application. Action Aug. 1.

■ By memorandum opinion and order in proceeding on AM applications of Southern Radio & Television Co., Lehigh Acres, and Robert Hecksher (WMYR), Fort Myers, both Florida, in Docs. 14909-10, (1) granted petition by Broadcast Bureau to modify and enlarge issues to extent that (a) hearing issues No. 6 is modified to determine whether present or proposed 25 m/vm contours of applicants would overlap, in contravention

**SUBSCRIPTION APPLICATION**

**BROADCASTING The Businessweekly of Television and Radio**

1735 DeSales Street, N.W., Washington, D. C., 20036

Please start my subscription immediately for—

- 52 weekly issues \$8.50     104 weekly issues \$14.00     Payment attached
- 52 issues & 1964 Yearbook \$13.50     Please bill
- 1963 Yearbook \$5.00 (so long as supply lasts)

name \_\_\_\_\_ title/position\* \_\_\_\_\_

address  Business  
 Home \_\_\_\_\_

city \_\_\_\_\_ zone \_\_\_\_\_ state \_\_\_\_\_

company name \_\_\_\_\_

\*Occupation Required

of Sect. 3.37 of rules, and if so whether circumstances exist which would warrant waiver of section; (b) enlarged issues to determine whether instant proposal of Southern Radio would provide coverage of city sought to be served, as required by Sect. 3.188(b)(2) of rules, and, if not, whether circumstances exist which would warrant waiver of section; (2) ruled that bureau's request for determination of extent of coverage which Southern proposal would provide to city of Fort Myers should in first instance be addressed to examiner rather than to Review Board; and (3) accepted bureau's late filed pleading. Board Member Nelson not participating. Action July 31.

■ By members Nelson, Pincock and Slone, adopted decision denying application of Wright & Maltz Inc. to change operation of WRRB Mt. Clemens, Mich., on 1430 kc with 500 w, from daytime to unl., DA-2. April 26 initial decision looked toward granting application. Action July 31.

#### ACTIONS ON MOTIONS

■ Commission, by office of opinions and review, granted petition by Kent-Ravenna Broadcasting Co. to extend time from Aug. 5 to Aug. 12 to file replies to exceptions to initial decision in Kent-Canton-Kent-Ravenna, Ohio. AM proceeding. Action Aug. 2.

By Chief Hearing Examiner  
James D. Cunningham

■ Designated Examiner H. Gifford Irion to preside at hearing in proceeding on applications for assignments of KGLC Miami, Okla., from Miami Broadcasting Co. to Miami Newspapers Inc.; scheduled prehearing conference for Sept. 17 in Washington and hearing for Oct. 14 in Miami. Action Aug. 2.

■ Designated Examiner Sol Schildhouse to preside at hearing in proceeding on applications of WEAT-TV Inc. (WEAT-TV) and Scripps-Howard Broadcasting Co. (WPTV [TV]), both West Palm Beach, Fla., to change trans. location, increase ant. height, and make other changes; scheduled prehearing conference for Sept. 17 and hearing for Oct. 22. Action Aug. 1.

■ Designated Examiner Thomas H. Donahue to preside at hearing in proceeding on

AM application of S & S Broadcasting Co. (WTAQ), La Grange, Ill.; scheduled prehearing conference for Sept. 13 and hearing for Oct. 8. Action July 30.

■ Designated Examiner David I. Kraushaar to preside at hearing in proceeding on AM application of Raul Santiago Roman, Vega Baja, P. R.; scheduled prehearing conference for Sept. 13 and hearing for Oct. 3. Action July 30.

By Hearing Examiner Basil P. Cooper

■ Granted petition by Broadcast Bureau to accept proposed findings of fact and conclusions filed one day late in proceeding on AM application of WKYR Inc. (WKYR), Cumberland, Md. Action July 30.

By Hearing Examiner Thomas H. Donahue

■ Pursuant to agreements reached at July 31 hearing in proceeding on AM application of James S. Rivers Inc. (WJAZ), Albany, Ga., scheduled Sept. 6 for record to be automatically closed unless Broadcast Bureau timely files request for further hearing, Sept. 20 to file proposed findings, and Oct. 10 for replies. Action Aug. 1.

By Hearing Examiner Charles J. Frederick

■ Granted joint motion to correct transcript of record filed by Central Wisconsin Television Inc. and Midcontinent Broadcasting Co. in proceeding on Central Wisconsin's application for additional time to construct WCWT (channel 9) Wausau, Wis., and for assignment of license to Midcontinent. Action Aug. 6.

By Hearing Examiner Walther W. Guenther

■ In proceeding on AM applications of Abacoa Radio Corp. (WRAI), Rio Piedras (San Juan), and Mid-Ocean Broadcasting Corp., San Juan, both Puerto Rico, in Docs. 14977-8, dismissed as moot (a) request by Abacoa for consideration of opposition to (1) Mid-Ocean Broadcasting Corp.'s motion for issuance of order by hearing examiner that depositions not be taken as desired by Abacoa; and (2) Broadcast Bureau's opposition to notice, submitting similar motion; and (b) opposition to referenced pleadings. Action Aug. 2.

■ By memorandum opinion and order in proceeding on AM applications of Abacoa

Radio Corp. (WRAI), Rio Piedras (San Juan), and Mid-Ocean Broadcasting Corp., San Juan, both Puerto Rico, in Docs. 14977-8. (1) denied request by Abacoa for oral argument on notice to take depositions in San Juan, (2) granted motions by Mid-Ocean and Broadcast Bureau, respectively, requesting issuance of order by hearing examiner that depositions not be taken, (3) ordered that depositions shall not be taken and (4) ordered that grant of motions is without prejudice to issuance of another notice by Abacoa in compliance with requirements of Sect. 1.122 of rules. Action July 31.

By Hearing Examiner Isadore A. Honig

■ Granted request by Verne M. Miller, Crystal Bay, Nev., that examiner issue further order providing for submission of another progress report on taking of pertinent field intensity measurements in proceeding on AM application, and directed applicant to submit further progress report by Sept. 10, together with proposal of date for further hearing conference, with service of copies to be made to all other parties. Action Aug. 1.

■ Granted request by Delaware Valley Broadcasting Co. (WAAT), Trenton, N. J., to extend from Aug. 2 to Aug. 9 time to file proposed findings and from Aug. 16 to Aug. 23 for replies in proceeding on AM application. Action Aug. 2.

By Hearing Examiner Jay A. Kyle

■ Accepted and received in record proposed stipulation by Radio Elizabeth Inc. in Matawan-Somerville-Elizabeth, N. J., AM proceeding. Action Aug. 1.

By Hearing Examiner  
Chester F. Naumowicz Jr.

■ Granted request by Broadcast Bureau to extend time to Aug. 13 to file proposed findings and to Aug. 21 for replies in proceeding on AM application of Golden Triangle Broadcasting Inc. (WEEP), Mt. Oliver, Pa. Action Aug. 1.

By Hearing Examiner Sol Schildhouse

■ Pursuant to agreements reached at July 31 prehearing conference in proceeding on AM application of WGUN Inc. (WGUN), Decatur, Ga., in Doc. 15116, scheduled certain procedural dates and continued Sept. 11 hearing to Sept. 24. Action July 31.

#### BROADCAST ACTIONS by Broadcast Bureau

##### Actions of Aug. 6

WTTT Amherst, Mass.—Granted license and redescribe trans. and main studio location.

WKWK Wheeling, W. Va.—Granted license covering increase in daytime power.

WOC Davenport, Iowa—Granted licenses covering installation of new main trans. and installation of old main trans. as aux. trans.; redescribe trans. location.

WJPA Washington, Pa.—Granted licenses covering increase in daytime power, installation of new trans. (specify type trans.), specify main studio location and redescribe trans. location; and use of old main trans. as aux. trans. at main site; remote control permitted.

WSWN Belle Glade, Fla.—Granted license covering change in ant.-trans. location and studio location, and make changes in ground system.

WKBI St. Marys, Pa.—Granted licenses covering use of presently licensed trans. as main trans. daytime and nighttime, and use of presently licensed trans. as aux. trans.

WLAR Athens, Tenn.—Granted license covering installation of old main trans. as aux. trans.

WCTC New Brunswick, N. J.—Granted aux. trans. license covering use of old main trans. as aux. daytime and alternate main nighttime trans. at main trans. site.

WMOC Chattanooga—Granted license covering use of old main trans. as aux. trans. at main trans. site; remote control permitted; redescribe trans. and main studio locations, and specify remote control point.

WEA Plainfield, N. J.—Granted license covering installation of new aux. trans. and specify type trans.

WBBL Richmond, Va.—Granted mod. of license to change name to Grace Covenant Presbyterian Church, James W. Gordon Jr., Legal Agent.

WRIZ Coral Gables, Fla.—Granted extension of completion date to Dec. 20.

##### Actions of Aug. 5

KDSN Denison, Iowa—Granted license covering change in frequency, change from

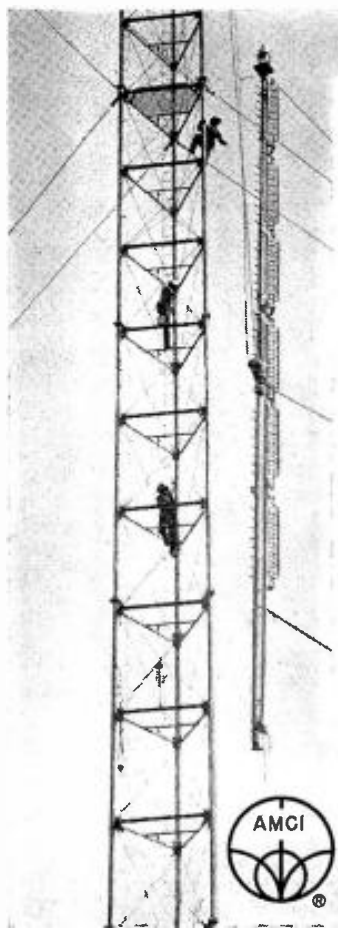

## AMCI antennas for TV and FM

- Omnidirectional TV and FM Transmitting Antennas
  - Directional TV and FM Transmitting Antennas
  - Tower-mounted TV and FM Transmitting Antennas
  - Standby TV and FM Transmitting Antennas
  - Duplexers
  - Vestigial Sideband Filters
  - Coaxial Switches and Transfer Panels
  - Power Dividers and other Fittings
- Write for information and catalog.



**ALFORD**  
Manufacturing Company

299 ATLANTIC AVE., BOSTON, MASSACHUSETTS



# PROFESSIONAL CARDS

<p><b>JANSKY &amp; BAILEY</b> Offices and Laboratories 1339 Wisconsin Ave., N.W. Washington 7, D.C. Federal 3-4800 <i>Member AFCEE</i></p>	<p><b>JAMES C. McNARY</b> Consulting Engineer National Press Bldg. Wash. 4, D. C. Telephone District 7-1205 <i>Member AFCEE</i></p>	<p>—Established 1926— <b>PAUL GODLEY CO.</b> Upper Montclair, N. J. Pilgrim 6-3000 Laboratories, Great Notch, N. J. <i>Member AFCEE</i></p>	<p><b>GEORGE C. DAVIS</b> CONSULTING ENGINEERS RADIO &amp; TELEVISION 527 Munsey Bldg. Sterling 3-0111 Washington 4, D. C. <i>Member AFCEE</i></p>
<p><b>COMMERCIAL RADIO EQUIPMENT CO.</b> Everett L. Dillard, Gen. Mgr. Edward F. Lorentz, Chief Engr. INTERNATIONAL BLDG. #1 7-1319 WASHINGTON 4, D. C. <i>Member AFCEE</i></p>	<p><b>A. D. Ring &amp; Associates</b> 41 Years' Experience in Radio Engineering 1710 H St., N.W. 298-6850 WASHINGTON 6, D. C. <i>Member AFCEE</i></p>	<p><b>GAUTNEY &amp; JONES</b> CONSULTING RADIO ENGINEERS 930 Warner Bldg. National 8-7757 Washington 4, D. C. <i>Member AFCEE</i></p>	<p><b>Lohnes &amp; Culver</b> Munsey Building District 7-8215 Washington 4, D. C. <i>Member AFCEE</i></p>
<p><b>L. H. Carr &amp; Associates</b> Consulting Radio &amp; Television Engineers Washington 6, D. C. Fort Evans 1000 Conn. Ave. Leesburg, Va. <i>Member AFCEE</i></p>	<p><b>KEAR &amp; KENNEDY</b> 1302 18th St., N.W. Hudson 3-9000 WASHINGTON 6, D. C. <i>Member AFCEE</i></p>	<p><b>A. EARL CULLUM, JR.</b> CONSULTING ENGINEERS INWOOD POST OFFICE DALLAS 9, TEXAS MElrose 1-8360 <i>Member AFCEE</i></p>	<p><b>GUY C. HUTCHESON</b> P.O. Box 32 CRestview 4-8721 1100 W. Abram ARLINGTON, TEXAS</p>
<p><b>SILLIMAN, MOFFET &amp; KOWALSKI</b> 1405 G St., N.W. Republic 7-6646 Washington 5, D. C. <i>Member AFCEE</i></p>	<p><b>GEO. P. ADAIR ENG. CO.</b> CONSULTING ENGINEERS Radio-Television Communications-Electronics 901 20th St., N.W. Washington, D. C. Federal 3-1116 <i>Member AFCEE</i></p>	<p><b>WALTER F. KEAN</b> CONSULTING RADIO ENGINEERS Associate George M. Sklom 19 E. Quincy St. Hickory 7-2401 Riverside, Ill. (A Chicago suburb) <i>Member AFCEE</i></p>	<p><b>HAMMETT &amp; EDISON</b> CONSULTING RADIO ENGINEERS Box 68, International Airport San Francisco 28, California Diamond 2-5208 <i>Member AFCEE</i></p>
<p><b>JOHN B. HEFFELFINGER</b> 9208 Wyoming Pl. Hiland 4-7010 KANSAS CITY 14, MISSOURI</p>	<p><b>JULES COHEN &amp; ASSOCIATES</b> 9th Floor, Securities Bldg. 729 15th St., N.W., 393-4616 Washington 5, D. C. <i>Member AFCEE</i></p>	<p><b>CARL E. SMITH</b> CONSULTING RADIO ENGINEERS 8200 Snowville Road Cleveland 41, Ohio Phone: 216-526-4386 <i>Member AFCEE</i></p>	<p><b>J. G. ROUNTREE</b> CONSULTING ENGINEER P.O. Box 9044 Austin 56, Texas GLendale 2-3073</p>
<p><b>YIR N. JAMES</b> CONSULTING RADIO ENGINEERS Applications and Field Engineering 232 S. Jasmine St. Phone: (Area Code 303) 333-5562 DENVER 22, COLORADO <i>Member AFCEE</i></p>	<p><b>A. E. Towne Assocs., Inc.</b> TELEVISION and RADIO ENGINEERING CONSULTANTS 420 Taylor St. San Francisco 2, Calif. PR 5-3100</p>	<p><b>PETE JOHNSON</b> Consulting am-fm-tv Engineers Applications—Field Engineering Suite 601 Kanawha Hotel Bldg. Charleston, W.Va. Dickens 2-6281</p>	<p><b>MERL SAXON</b> CONSULTING RADIO ENGINEER 622 Hoskins Street Lufkin, Texas NEptune 4-4242 NEptune 4-9558</p>
<p><b>WILLIAM B. CARR</b> Consulting Engineer AM—FM—TV Microwave P. O. Box 13287 Fort Worth 18, Texas BUtler 1-1551</p>	<p><b>RAYMOND E. ROHRER &amp; Associates</b> Consulting Radio Engineers 436 Wyatt Bldg. Washington 5, D. C. Phone: 347-9061 <i>Member AFCEE</i></p>	<p><b>E. HAROLD MUNN, JR.</b> BROADCAST ENGINEERING CONSULTANT Box 220 Coldwater, Michigan Phone: BRoadway 8-6733</p>	<p><b>JOHN H. MULLANEY and ASSOCIATES</b> A Division of Multronics, Inc. Multronics Building 5712 Frederick Ave. Rockville, Md. (a suburb of Washington) Phone: 301 427-4666 <i>Member AFCEE</i></p>

## Service Directory

<p><b>COMMERCIAL RADIO MONITORING CO.</b> PRECISION FREQUENCY MEASUREMENTS AM-FM-TV 103 S. Market St., Lee's Summit, Mo. Phone Kansas City, Laclade 4-3777</p>	<p><b>CAMBRIDGE CRYSTALS' PRECISION FREQUENCY MEASURING SERVICE</b> SPECIALISTS FOR AM-FM-TV 445 Concord Ave., Cambridge 38, Mass. Phone TRowbridge 6-2810</p>	<p>contact BROADCASTING MAGAZINE 1735 DeSales St. N.W. Washington, D. C. 20036 for availabilities Phone: ME 8-1022</p>	<p><b>PAUL DEAN FORD</b> Broadcast Engineering Consultant 4341 South 8th Street Terre Haute, Indiana Wabash 2643</p>
<p><b>BARKLEY &amp; DEXTER LABS., INC.</b> Donald P. Wise James M. Moran Consulting, Research &amp; Development for Broadcasting, Industry &amp; Government 50 Frankfort St. Diamond 3-3716 Fitchburg, Massachusetts</p>			

## SUMMARY OF COMMERCIAL BROADCASTING

Compiled by BROADCASTING, Aug. 7

	Lic.	ON AIR CP's	NOT ON AIR CP's	TOTAL APPLICATIONS for new stations
AM	3,813	47	158	336
FM	1,096	24	90	190
TV	522 <sup>1</sup>	53	85	115

## OPERATING TELEVISION STATIONS

Compiled by BROADCASTING, Aug. 7

	VHF	UHF	TOTAL TV
Commercial	484	91	578
Non-commercial	47	21	68 <sup>2</sup>

## COMMERCIAL STATION BOXSCORE

Compiled by FCC June 30

	AM	FM	TV
Licensed (all on air)	3,809	1,090	519
CP's on air (new stations)	51	30	56
CP's not on air (new stations)	137	87	85
Total authorized stations	3,997	1,207	660 <sup>1</sup>
Applications for new stations (not in hearing)	210	178	67
Applications for new stations (in hearing)	146	13	53
Total applications for new stations	356	191	120
Applications for major changes (not in hearing)	254	90	47
Applications for major changes (in hearing)	54	3	8
Total applications for major changes	308	93	55
Licenses deleted	0	2	0
CP's deleted	1	2	0

<sup>1</sup>Does not include six licensed stations off air

<sup>2</sup>Includes three stations operating on unreserved channels

K09EE, K11FF, Superior TV Booster Club, Superior; K09AV, Swan Hill T.V. Club Inc., Rural Area of Swan River and Swan Lake; K07FL, K09FQ, K11FQ, Thompson Falls T.V. District, Thompson Falls and Thompson River area; K11EQ, Rocky Point TV Club, Alzada; K09CB, K06BG, Roy T.V. Tax District, Horse Ranch area, Roy and rural area East of Roy; K07AM, Loma TV Club, Loma; K10DA, Winnett Community TV System, Winnett; K09EI, K11AP, Tru-Vue Television Association, White Sulphur Springs; K08AI, St. Regis TV Booster Club, St. Regis, and change type ant.; K12AN, Scobey Television Corp., Scobey and vicinity, Poplar Valley area, Four Butte area and Julia area; K07EN, Somers TV Translator Club, Somers; K07CC, Warland TV Club, Warland; K11FS, K13AN, Roundup Television Association Inc., Roundup.

■ Granted CP's to replace expired permits for following new VHF TV translator stations: K02CZ, Junior Chamber of Commerce, Neligh, Neb.; K06BK, Rocky Point TV Club, Rocky Point-New Haven, Wyo.

■ Following TV stations were granted extensions of completion dates as shown: KNMT Walker, Minn., to Dec. 15; WIBF-TV Jenkintown, Pa., to Dec. 31.

KLMB Lamar, Colo.—Granted request to continue existing pre-sunrise operation with non-DA and reduced power of 1 kw between 4 a.m. and local sunrise until final decision is reached in Doc. 14419 or until directed to terminate such operation, whichever occurs first.

■ Granted licenses for following VHF TV translator stations: K07BO, K09AZ, Polson TV Improvement Association, Polson, Mont., and change type trans. for K07BO; K13DJ, K09CP, K11CW, Park Non-Profit TV Inc., Livingston, Mont.

### Actions of Aug. 1

■ Granted licenses for following VHF TV translator stations: K08DQ, Shelby TV Club Inc., Shelby, and change type trans.; K10ED, Lower Rosebud TV Club Inc., Lower Rosebud Creek Rural Community, and specify type trans.; K09CC, Kevin Television Association, Kevin; K07BX, Harlem T.V. Club, Harlem; K07DW, Gardiner Community TV Association, Gardiner; K11CH, Birney TV Club, Birney; K09ET, Box Elder T.V. Club, Box Elder; K06BC, K09BW, K11CB, Forsyth Community TV Relay System Inc., Forsyth; K11DX, K13DR, Denton T.V. Association, Denton; K09BF, Deer Lodge Community T.V., Deer Lodge; K08DT, Conrad TV Club, Conrad; K07CL, K09CG, Choteau Junior Chamber of Commerce, Choteau; K11CC, Checkerboard TV, Rural Area of Checkerboard; K06AA, K07AI, K10AC, Broadus TV Club, Broadus, and change primary station to KULR-TV (ch. 8) Billings, all Montana, for K07AI; K06CD, Otter Television Association, Sayle, Quietus, Otter, all Montana and Pasaic, Wyo., and specify type trans.; K12CQ, Broadus TV Club, Broadus Rural area, and change primary station to KULR-TV (ch. 8) Billings, both Montana.

W70AH, W74AH, W72AC Eau Gallie-Melbourne, Fla.—Granted licenses for UHF TV translator stations.

K09FJ, K09FK, K09FL, K06DM Pioche, Ursine, Caliente and Panaca, all Nevada—Granted mod. of CP's to change primary TV station to KLAS-TV (ch. 8) Las Vegas for VHF TV translator stations and frequency to channel 6 for K06DM.

### Actions of July 31

WAMV East St. Louis, Ill.—Granted increased daytime power on 1490 kc, from 500 w to 1 kw, continued nighttime operation with 250 w; conditions.

WNBC-TV New York—Granted renewal of license (main trans. and ant. and aux. trans.), including auxiliaries, for normal license term; without prejudice to such action as commission may deem warranted as result of final determinations: (1) with respect to conclusions and recommendations set forth in report of network study staff; (2) with respect to related studies and inquiries now being considered or conducted by commission; (3) with respect to pending antitrust matters relating to NBC and RCA; and (4) without prejudice to whatever action, if any, may be taken by commission with respect to pending complaint of Liberal Party of New York State.

■ Granted renewal of licenses for following Pennsylvania stations: WAEB Allentown; KDKA-FM Pittsburgh; WAVL Apollo; WFBC-TV Altoona; WCMB Harrisburg; WFIL-TV Philadelphia; WCRO Johnstown; WLYH-TV Lancaster; WHYL Carlisle; WTAE-TV Pittsburgh; WLYC Williamsport; KDKA-TV Pittsburgh; WVAM Allentown; WGMR-FM Tyrone; WHAT Philadel-

DA to non-DA and make changes in ground system.

KXO El Centro, Calif.—Granted license covering changes in ant. system.

KZUN Opportunity, Wash.—Granted license covering changes in ant. system (increase height).

KCID Caldwell, Idaho—Granted license covering installation of old main trans. as alternate main nighttime and aux. daytime trans.

KBUR Burlington, Iowa—Granted license covering installation of former main trans. for KMCD Fairfield, Iowa, as aux. trans.

WTND Orangeburg, S. C.—Granted license covering installation of new trans. for aux. purposes only.

KBBW(FM) San Diego—Granted license covering changes in ERP, frequency, ant. height, ant.-trans. and studio location, type trans. and type ant., and ant. system; remote control permitted.

KFBK-FM Sacramento, Calif.—Granted license covering use of old main trans. as aux. trans.

KOOL-FM Phoenix, Ariz.—Granted license covering increase in ERP and installation of new trans.

Hubbard Broadcasting Inc., St. Paul—Granted CP and license to install 2 Comrex trans. and specify power as 0.6 w for low power aux. station.

\*WTHS(FM) Miami—Granted CP to make changes in transmitting equipment.

KIKK Pasadena, Tex.—Granted CP to change ant.-trans. and main studio locations, make changes in ground and ant. systems; conditions.

KHAR Anchorage, Alaska—Granted CP to change ant.-trans. and studio locations, and make changes in ground system; remote control permitted.

KMEN San Bernardino, Calif.—Granted CP to install aux. trans. at main trans. site.

WRGB(TV) Schenectady, N. Y.—Granted mod. of CP to install precise frequency control equipment (main trans. and ant.).

WLSB Copperhill, Tenn.—Granted extension of authority to sign-off at 8 p.m. for period ending Nov. 1.

■ Granted licenses for following: KKOK Lompoc, Calif., redescribe trans. location

and specify main studio location same as trans. locations; KGKO Benton, Ark., redescribe trans. location and specify type trans.

■ Granted licenses for following: KRGN (FM) Las Vegas and redescribe trans. and studio locations; WCMR-FM Elkhart, Ind.; KCKN-FM Kansas City, Kan.

■ Following stations were granted extensions of completion dates as shown: WMBO-FM Auburn, N. Y., to Dec. 28; KCHV Coachella, Calif., to Nov. 2; WPRT Prestonsburg, Ky., to Dec. 10; WTOD Toledo, Ohio, to Aug. 31; KMIA Milan, N. M., to Feb. 5, 1964; WIVI Christiansted, V. I., to Nov. 26; WBLF Bellefonte, Pa., to Oct. 30; WKRC Cincinnati, Ohio, to Dec. 5; KABL Oakland, Calif., to Jan. 29, 1964; KOAD Lemoore, Calif., to Nov. 11.

### Actions of Aug. 2

KCRM Crane, Tex.—Granted CP to change frequency from 1380 kc to 970 kc, continued operation with 1 kw-D, make changes in ant. system (increase height) and in ground system; condition.

\*WARC(FM) Meadville, Pa.—Granted license.

WCRO Johnstown, Pa.—Granted license covering use of old main trans. as aux. trans. at main trans. site; remote control permitted.

K79AV Nashua and Fort Peck, both Montana—Granted license for UHF TV translator station.

Upper Colorado River TV Association, Derby Mesa (near Burns), Rural area between Dotsero and Carlsburg, all Colorado—Granted CP's for new VHF TV translator stations, on chs. 9 and 12, to translate programs of KFBC-TV (ch. 5) Cheyenne, Wyo.

K73BB, K77BH, K83AT Farmington-Bloomfield Highway and Huerrfano-Bloomfield Highway area, both New Mexico—Granted CP's to replace expired permits for new UHF TV translator stations.

■ Granted licenses for following: WYDD (FM) New Kensington, Pa., and redescribe trans. location as Glassmere, Pa.; WEND-FM Ebensburg, Pa.

■ Granted licenses for the following: Montana VHF TV translator stations:

phia; WSAJ Grove City; WAMO Pittsburgh; WACB Kittanning; WWCN Clarion; KDKA Pittsburgh; WKMC Roaring Spring; WAZL Hazleton; WPIT Pittsburgh; WBUT Butler; WVCH Chester; WCHA Chambersburg; WWSW Pittsburgh; WEEP Pittsburgh; WGPA Bethlehem; WEST Easton; WYNS Leighton; WFIL Philadelphia; WESA Charleroi; WHGB Harrisburg; WFLN Philadelphia; WHP Harrisburg; WEDO McKeesport; WHUM Reading; WFLN-FM Philadelphia; WJPA Washington; WFMZ(FM) Allentown; WMGW Meadville; WFI(FM) Philadelphia; WORK York; WCHA-FM Chambersburg; WSBA York; WFIL-FM Philadelphia; \*WQED (TV) Pittsburgh; WSBA-FM York; \*WQEX (TV) Pittsburgh; WPBS(FM) Philadelphia; \*WUHY-TV Philadelphia; WKJF(FM) Pittsburgh; \*WDFM(FM) State College; WAMO-FM Pittsburgh; \*WHHS(FM) Havertown; WGBI-FM Scranton; \*WDUQ(FM) Pittsburgh; WJAC-FM Johnstown; \*WUHY-FM Philadelphia; WHLM-FM Bloomsburg; WMSP(FM) Harrisburg; WAEB-FM Allentown, Pa.; WERE-FM Wilkes-Barre; WBUT-FM Butler; WFBG-FM Altoona; also renewed: WKEN Dover, Del.

WJAS Pittsburgh—Granted renewal of license; without prejudice to such action as commission may deem warranted as result of final determinations: (1) with respect to conclusions and recommendations set forth in report of network study staff; (2) with respect to related studies and inquiries now being considered or conducted by commission; and (3) with respect to pending antitrust matters relating to NBC and RCA.

WCAU-AM-TV Philadelphia—Granted renewal of licenses including aux., and TV station including aux.; without prejudice to such action as commission may deem warranted as result of final determinations: (1) with respect to conclusions and recommendations set forth in report of network study staff; (2) with respect to related studies and inquiries now being considered or conducted by commission; (3) with respect to pending antitrust matters relating to CBS; and (4) with respect to application of Secs. 3.658(a) and (e) of commission's rules to certain amendments to affiliation contracts proposed by CBS.

K75BA, K78AY, K82AS Childress, Tex.—Granted licenses for UHF TV translator stations.

KETV(TV) Omaha—Granted mod. of licenses to change name to Herald Corp.

KCND-TV Pembina, N. D.—Granted CP to replace expired permit to make changes in TV station.

WTXL West Springfield, Mass.—Granted CP to change presently licensed trans. to main daytime and aux. nighttime trans.

WQIK Jacksonville, Fla.—Granted CP to change ant.-trans. location, make changes in ant. system (increase height), relocate tower at trans. site, and make changes in ground system; remote control permitted.

WCVI Connellsville, Pa.—Granted CP to install aux. trans. at main trans. location; remote control permitted.

Texhoma TV Translators Inc., Guymon and Straight, both Oklahoma—Granted CP's for new VHF TV translator stations, on channels 5, 9, and 13, to translate programs of KGNC-TV (ch. 4), KVII(TV) (ch. 7) and KFDA-TV (ch. 10), all Amarillo, Tex.

KGOL Palm Desert, Calif.—Granted mod. of CP to move ant.-trans. site 525 feet east of present site.

KGUC Gunnison, Colo.—Granted authority to operate with 7 a.m. sign-on to 7 p.m. sign-off, Mon. through Sat., for period ending Oct. 31.

WMPP Chicago Heights, Ill.—Granted extension of completion date to Sept. 30.

WNBC-TV New York—Granted license covering changes (main trans. and ant.); without prejudice to such action as commission may deem warranted as result of final determinations: (1) with respect to conclusions and recommendations set forth in report of network study staff; (2) with respect to related studies and inquiries now being considered or conducted by commission; (3) with respect to pending antitrust matters relating to NBC and RCA; and (4) without prejudice to whatever action, if any, may be taken by commission with respect to pending complaint of Liberal Party of New York State.

Granted CP's to replace expired permits for new VHF TV translator stations: K05BV, Silver Peak Television District, Silver Peak, Nev.; K08CT, K10DE, K12DL, Duchesne City, Duchesne City and Straw-

berry River area, Utah; K08EK, K12EE, Rangely Area TV Association, Blue Mountain, Rangely Rural Area, Rangely and Artesia, both Colorado, and change frequencies to channels 8 and 12, respectively; change type trans. and make changes in ant. system; and specify primary TV stations as KUTV(TV) (ch. 2) and KSL-TV (ch. 5), both Salt Lake City, respectively.

#### Actions of July 25

KXAB-TV Aberdeen, S. D.—Granted mod. of CP to change ERP to 295 kw vis. and 148 kw aur. and make changes in ant. system.

#### Action of July 25

WIIIC Inc. Freeport, Pa.—Granted CP for new VHF TV translator station, on channel 8, to translate programs of WIIIC(TV) (ch. 11) Pittsburgh.

### Fine

By memorandum opinion and order and notice of apparent liability, commission (1) notified Herbert M. Hoppe, tr/as Tri-County Broadcasting Co., he faces forfeiture of \$100 for repeated violations of Sec. 310(b) of communications act and commission rules by effecting assignment of CP of WVAL Sauk Rapids, Minn., from Hoppe and Carl A. Nierengarten to Hoppe without first applying for or obtaining commission consent; afforded Hoppe 30 days to reply; (2) granted application to cover unauthorized assignment nunc pro tunc; (3) dismissed as moot application for extension of time to construct station; and (4) denied opposing petitions of WJON Broadcasting Inc. (WJON), St. Cloud, Minn. By telegram, authorized WVAL to conduct program test operation in accordance with CP pending further action on license application BL-9909. Action Aug. 1.

### Rulemakings

#### FINALIZED

By report and order, commission finalized rulemaking in Doc. 14991 and as-

signed and reserved channel \*33 for non-commercial educational use in Hazard, Ky., and deleted presently reserved channel \*19 from city. Kentucky Authority for Educational Television had petitioned for substitution because of adjacent channel interference on channel \*19 with WLEX-TV (ch. 18) Lexington. By separate notice of proposed rulemaking, commission severed from above proceeding amended petition by Kentucky Authority seeking assignment and reservation of channel \*19 at Ashland, Ky., in addition to city's present educational channel \*78. However, to be consistent with proposals which commission might make in further notice of proposed rulemaking in Doc. 14229 concerning fostering expanded use of UHF channels, commission invited comments to modified proposal to substitute channel \*19 for channel \*78 for educational use in Ashland and delete latter channel. Canadian concurrence would be required for channel \*19 assignment. There is nothing to prevent comments in proceeding from urging that two educationally reserved channels be assigned to Ashland. Action Aug. 1.

### POSTPONED

Commission postponed for 60 days from Aug. 19 effectiveness of rules adopted July 10 in Doc. 14746 relating to trans. operator requirements for certain AM and FM stations. Postponement does not affect the commission's action of July 10 in Doc. 14661 which, among other things, instituted requirement for 5-day-per-week inspection of AM and FM trans. equipment. Action Aug. 1.

### PETITIONS FOR RULEMAKINGS FILED

E Pluribus Unum Enterprises Inc., Phoenix, Ariz.—Requests amendment of rules to assign channel 14 to Phoenix from Holbrook, Ariz., and replace channel 14 in Holbrook with channel 19. Received July 25.

KBMF-FM Pampa, Tex.—Requests amendment of rules to allocate channel 261 "A" to Spearman, Tex., and delete channel 262 from Pampa. Received July 31.

*Return to Elegance*  
WITH HERNANDO COURTRIGHT

The discriminating traveler will find at the newly cosmopolitan Beverly Wilshire Hotel all the concepts of gracious hospitality for which Hernando Courtright is famous: impeccable, personalized service, splendid surroundings, and above all, cuisine par excellence. Classic elegance is the heart of the Beverly Wilshire—amplified by subtle luxury and unparalleled attention to your comfort and privacy. Make your next visit to Los Angeles verily a return to elegance at the Beverly Wilshire—in the heart of fashionable Beverly Hills, where every conceivable convenience is at hand or in strolling distance.

HERNANDO COURTRIGHT'S  
*Beverly Wilshire Hotel*  
BEVERLY HILLS, CALIFORNIA

# CLASSIFIED ADVERTISEMENTS

(Payable in advance. Checks and money orders only.) (FINAL DEADLINE—Monday preceding publication date.)

- SITUATIONS WANTED 20¢ per word—\$2.00 minimum • HELP WANTED 25¢ per word—\$2.00 minimum.
  - DISPLAY ads \$20.00 per inch—STATIONS FOR SALE and WANTED TO BUY STATIONS & EMPLOYMENT AGENCIES advertising require display space.
  - All other classifications, 30¢ per word—\$4.00 minimum.
  - No charge for blind box number. Send replies to *Broadcasting*, 1735 DeSales St., N.W., Washington, D. C., 20036.
- APPLICANTS: If transcriptions or bulk packages submitted, \$1.00 charge for mailing (Forward remittance separately, please). All transcriptions, photos, etc., sent to box numbers are sent at owner's risk. BROADCASTING expressly repudiates any liability or responsibility for their custody or return.

## RADIO

### Help Wanted—Management

**Management opportunity.** Wanted: A sales-partner, with experience in sales field proven. Preferably family man. Must have cash to invest. 20% stock available to right party, with possibility of 50%. Station value \$75,000.00 in market of 3 other locals. Located in Utah in 2nd largest metropolitan area. 125,000 population. Box J-3, BROADCASTING.

**Wanted manager for aggressive Illinois station** with metropolitan service areas population in excess of 200,000. Must be capable of directing sales, news and programing departments and be good at promotion. Well established operation. Middle of the road music, fine news reputation. Salary open. Write Box J-131, BROADCASTING.

**Wanted: assistant manager for station in large Illinois city.** Should be strong in programing, promotion and news. Salary in accord with ability and experience. Fine opportunity for sharp, competent broadcaster. Write Box J-132, BROADCASTING.

**Manager for small market station on west coast.** Prefer man with first phone license, experience in sales and programing. Box K-26, BROADCASTING.

**Manager and staff wanted for new Xenia, Ohio, am, WGIC, on air soon.** Details to Box K-38, BROADCASTING.

**Seeking manager for Iowa station.** Must have successful record as manager or sales manager. Box K-126, BROADCASTING.

**\$10,000 to \$15,000 or more as manager of successful station in upper midwest.** Compensation based on cash flow. Box K-127, BROADCASTING.

### Sales

**Columbus, Ohio . . . Immediate opening for good salesman, management experience or ready.** Top independent. Growing chain, good salary plus. Please write fully. Box G-13, BROADCASTING.

**Sales promotion writer, strong on research, sales presentation and ideas in top five market.** Box H-128, BROADCASTING.

**Salesman-announcer; excellent deal for experienced combination salesman-announcer at top-rated modern music station, medium Pennsylvania market.** J-330, BROADCASTING.

**Religious time salesman to sell preachers for Southern California's leading religious station.** \$500 per mo. draw against lib. commission. Car furnished if necessary. Send resume and snapshot. Box J-333, BROADCASTING.

**Negro-appeal radio station has opening for experienced salesman.** Draw against liberal commission. In market with no competition. In top 100 markets. Southeast USA. Send photo and resume at once to Box K-68, BROADCASTING.

**Salesman, combo engineer/announcer, salary, talent, commission.** Hard intelligent work will earn ever increasing large income. N.Y. state fulltimer. Box K-83, BROADCASTING.

**Hottest station in top 10 (New England) needs strong tiger.** If you can interpret ratings and results, you'll make over \$20,000. Box K-120, BROADCASTING.

### Help Wanted—(Cont'd)

#### Sales

**WGEE Indianapolis, Indiana.** Protected, active account list, salary plus commission, insurance program, retirement plan, opportunity for advancement in 7 station group. Write: Arnold C. Johnson, 4800 E. Raymond St.

**The door's open . . . Here's an opportunity for the salesman looking for a chance to grow with a growing organization.** If you can sell, follow-up, and become part of the community—Here's the doorway. A talented staff—some of the best announcers and newsmen anywhere! Management one of the nation's most active in broadcast circles. Our town is a quad city area of more than 35,000 located 75 miles from Chicago. Great place to live, great people—this may be your doorway to success. Send photo and resume to Bill Dahlsten, WLPO, LaSalle, Illinois.

**Excellent opportunity at No. 1 5 kw station.** Resort town. Combination salesman-announcer. Must have 1st phone ticket. Must have good voice, experienced style. Base salary for announce shift, commission on all sales. Opportunity for advancement in multi-station operation. Prefer college graduate—business administration, but not essential. Send photograph, tape, personal and business references, full background and experience 1st letter. WPCF, Box 1430, Panama City, Fla.

**Southern group—5 Top-rated stations located in metro markets seeking 2 pro type executive salesman with excellent background and experience.** High guarantee—insurance—moving expenses—opportunity for management. Send complete resume, late photograph, references, in confidence. McLendon Broadcasting Co., General Offices, suites 960-980 Milner Bldg., Jackson, Mississippi.

**Opportunities for producers in sales and management.** Get details. Write: Broadcast Employment Service, 4825 10th Ave. S., Minneapolis Minnesota. 55417.

#### Announcers

**Classical music man with solid combo operate-announce commercial experience.** Smooth delivery and voice, must be sophisticated in classical music programing. References and resume only. Box J-158, BROADCASTING.

**Florida resort area daytimer needs announcer.** Send tape, resume and snapshot. State minimum starting salary. Box J-312, BROADCASTING.

**Swinging dee-jay for high-rated number one, top forty station, medium Pennsylvania market; salary open.** Box J-329, BROADCASTING.

**Top rated station in eastern Pennsylvania with heavy accent on news, sports, special events and specialized programming has an immediate opening for topnotch announcer with solid experience authoritative voice and ad lib ability.** Excellent salary and talent. Send resume tape and picture to Box K-1, BROADCASTING.

**Announcer with news gathering-writing ability wanted for Florida east coast fulltimer.** Airmail tape, resume, sample news copy and salary requirements. Box K-3, BROADCASTING.

**Announcer with versatility who likes small town living and can settle into small market Pennsylvania operation.** Married man preferred. Send tape, details of experience, salary requirements. Box K-5, BROADCASTING.

### Help Wanted—(Cont'd)

#### Announcers

**Grand opportunity for experienced morning man to join progressive good music multiple station organization in upper midwest.** Immediate opening. Salary open for right man. Send air-check, picture and resume. Box K-8, BROADCASTING.

**September opening for staff announcer for upstate New York colleegetown station.** dj and news experience a must. Send tape and resume. Box K-11, BROADCASTING.

**Announcer-salesman. Small Michigan station.** Salary plus commission. Excellent income for hard worker. Send tape, resume, references. Box K-62, BROADCASTING.

**The big opportunity . . . one of the nations fastest growing stations in small middle Atlantic community with a big market . . . needs announcer-salesman at once.** If you have guts and imagination and want to grow, send tape and resume to Box K-142, BROADCASTING.

**Immediate opening at station KOH, Reno.** First FCC ticket required. Permanent position, excellent company benefits. Apply in person or send detailed resume to station manager or: Personnel Department, McClatchy Broadcasting Co., 21st & Q. Sacramento, Calif.

**Immediate opening experienced announcer with production experience.** Character must bear investigation. No floaters. Beautiful city. Mild climate. Gateway to Sequoia and Kings Canyon parks. KONG-AM & FM, Visalia, Calif.

**Applications now being accepted—Tape, resume, and picture.** Fast, happy, modern operation. #1 in nine station market. No phone calls. Reply: Station director. KQEO, Albuquerque, N. M.

**Immediate opening for announcer-newsman.** Contact Bill Tedrick, KWRT, Boonville, Mo.

**Wanted: Announcer with first class license.** Station WAMD, Aberdeen, Md.

**Suburban Chicago. Combo first class.** Permanent. Tape, complete information now. WEAW, Evanston, Ill.

**3 negro dj's wanted. Must have experience, good references for major market.** Contact Program Manager, WHH, Norfolk, Va., 625-4231, immediately.

**WIRL, Peoria, Illinois needs an afternoon drive-time, seasoned, clever personality.** Send resume and tape immediately.

**Announcer, 1st phone—5,000 watt midwest independent has immediate opening.** Emphasis on air work, little maintenance. Run own board. Send tape, photo, references, complete resume, first letter, WMIX, Mt. Vernon, Illinois.

**Annrc-newsman. Ability to gather, write, and deliver local news for well equipped station; tape-recorders, beepers, remote link, etc., WNJH, Hammonton, N. J.**

**Annrc-engineer. Some announcing experience and first ticket for station just gone 1000 watts.** WNJH, Hammonton, N. J.

**Combo man, give details letter immediately.** Joe Leonard WWIZ, Lorain, Ohio. Top pay.

---

**Help Wanted—(Cont'd)**

---

**Announcers**

Excellent opportunity at #1 5 kw station. Resort town. Combination salesman-announcer. Must have 1st phone ticket. Must have good voice, experienced style. Base salary for announce shift, commission on all sales. Opportunity for advancement in multi-station operation. Prefer college grad. Business administration but not essential. Send photograph, tape, personal and business references, full background and experience 1st letter. WPCF, Box 1430, Panama City, Florida.

Announcer with 1st class license. Immediate opening. Morning shift. Tightly formatted good music station. Rush resume and tape to Mr. Irv Laing, WQTE, P.O.B. 306, Monroe, Mich.

Young announcer—salesman. Guarantee \$100 weekly to start. WSTU, Stuart, Fla.

Attention combo men: Going regional (d.a.)—need two 1st ticket announcers—start Sept. 15th. Personal audition and interview necessary—reply to Alfred Eyre, Station Manager, WTOR, Torrington, Conn. 06791.

Earn extra money. National research service needs correspondents, all areas, to keep us informed of local broadcast activities. Good fees. Write for application. Reports, Box 57, Inwood Station, New York, 34.

Top-rated negro group—needs r&b man with teenage appeal immediately. If you are a real swinger—stuck in a small market and want to move up—send tape—resume—to Program Director, Box 197, Jackson, Miss. Preference to area applicants.

Pro's needed. We serve 600 stations. Free registration. Pick your job. Broadcast Employment Service, 4825 10th Ave. S., Minneapolis, Minn. 55417.

DJ's learn the professional way to introduce a record. 300 interchangeable, intelligent intros by excellent writers for vocals and instrumentals. \$3.95. Broadcast Intros, 975 North 35th, Milwaukee 8, Wisconsin.

---

**Technical**

---

Chief engineer for directional am in major midwest market, who knows all phases of maintenance. Prefer one who is good announcer, and can do some production. Box J-105, BROADCASTING.

Chief engineer for full maintenance and announcing radio. Mississippi. Send tape of voice and qualifications. Box J-320, BROADCASTING.

If you are a hard working, conscientious engineer with first ticket capable of taking full charge of am and fm equipment . . . if you can handle a smooth board . . . if you know good music . . . if you would like to live in one of the finest cities in California . . . you are our man. Send tape and complete resume immediately. Box K-35, BROADCASTING.

Alert, responsible engineer-announcer-citizen. Small market, Kansas am/fm station. Good job. Send complete application. Box K-36, BROADCASTING.

Chief engineer, 1kw, 100 miles from New York, \$125. Box K-77, BROADCASTING.

Engineer would like chief job, experienced am-fm maintenance. Also mobile communications service. Prefer western, southwestern, plains or midwest states. First phone. Box K-88, BROADCASTING.

Chief engineer. No announcing. Top rated station. Major market. Must know all phases maintenance. Prefer man with Schafer automation experience. Stable, highly respected group. Box K-113, BROADCASTING.

Experienced chief engineer for Alaska am-tv. Light announcing. Send resume to KINY, 231 S. Franklin St., Juneau, Alaska.

---

**Help Wanted—(Cont'd)**

---

**Technical**

Chief engineer needed for large operation in small market of 13,000. Opportunity to work with best equipment and design a new studio location. Salary open but a minimum of \$550 per month. Must have had 5 years chief's experience and be available for personal interview. Call or write J. A. Shepherd, KNCM, Moberly, Missouri.

Engineer capable of maintenance, remotes, etc., and preferably capable of limited announcing. WSIR, Winter Haven, Fla.

1st ticket transmitter job immediately available new 5000 watt station. Contact: Art Silver, 221 Witherspoon St., Princeton, N. J., phone 924-3600.

Engineers needed, all broadcast categories. Jobs countrywide. Write: Broadcast Employment Service, 4825 10 Ave. S., Minneapolis, Minn. 55417.

Chief engineer with some announcing duties. An ideal spot for the right man in a good, efficient small market station. Recently moved to new studios and offices, with improved equipment, in a new building. Write KTTN, Trenton, Missouri or call Elmwood 9-2261 for details.

Radio Transmitter and Receiver Operating and Maintenance Technicians. The United States Information Agency (Voice of America) needs Radio Transmitter and Receiver Operating and Maintenance Technicians for relay stations in Greenville, North Carolina; Marathon, Florida; Dixon and Delano, California; and Bethany, Ohio. These positions for operation and maintenance of high power transmitters and receiver stations require a minimum of five years of responsible technical operating and maintenance experience. Experience at commercial point-to-point communication transmitter stations or as a transmitter development and/or test engineer is also qualifying. Salary determined by applicant's experience and ability. Present rate range is \$6344 to \$10,504 per year; promotional opportunity. Positions are in Career Civil Service, and therefore, appointments are made thru competitive examination. Must be American citizen. To apply for this nonwritten examination, please request Announcement No. 283B and application forms from your nearest U. S. Civil Service Commission Representative's Office or write to The Executive Secretary, Board of U. S. Civil Service Examiners, U. S. Information Agency, Washington 25, D. C.

---

**Production—Programing, Others**

---

News editor wanted for 111 kilowatt metropolitan, strong in news coverage. Progressive, long established station with 3 professional newsmen. Salary excellent, merit raises. Give full details of experience and references in 1st letter to Box J-133, BROADCASTING.

Top news personality for Florida market. Must be authoritative newscaster for on air work with growing department. Write Box K-92, BROADCASTING, giving experience, salary requirements, and include photograph, audiotape, and film or vtr if available.

News Director, top 40, top rated. Must have bold voice, hard worker, build strong dept., tape, resume Box K-121, BROADCASTING.

Network affiliated station, medium metro/eastern market, needs newsmen/director who can dig out the stories, write, compile, deliver newscast with authority and personality. Send resume, picture, references and tape. Prima donnas need not apply. Box K-122, BROADCASTING.

Virginia radio-tv station needs manager for news department. Must be 35 or over and have radio—not necessarily tv—experience. Write Box K-125, BROADCASTING.

Major Michigan radio and TV combo needs capable newscaster-reporter strong on civic and government affairs. Send resume, tape and expected salary range to Box K-130, BROADCASTING.

---

**Help Wanted—(Cont'd)**

---

**Production, Programing & Others**

Major station on NYC fringe—We concentrate on news, are looking for experienced man to do same. Must have polished, authoritative delivery, must be able to gather and write local news. Opportunity to do news specials, editorials, sports, too. Only replies which include audition tape, not less than 5" reel and preferably air check, will be considered. Complete resume to Box K-141, BROADCASTING.

Experienced news director. Emphasize local coverage and airing. Some staff duties. KHAS Radio, Hasting, Neb.

2 positions open. Sportscaster must know play by play and be willing to build audience with new ideas. Weatherman needed who can speak authoritatively and is personable, send video audiotapes and resumes to KUTV, Salt Lake City.

Experienced reliable man as continuity director immediately. Prefer man who can develop and record production spots but will consider woman. Excellent working conditions. Contact Jim Heaton, KVGB, Great Bend, Kan.

News and sportscaster as assistant to news director. Will employ young man with little experience if he has good voice and eager to work. Maximum starting salary \$75 a week. Apply H. M. Thauer, WGHQ, Kingston, N. Y.

WIRK, West Palm Beach, has immediate opening for a real pro. Must be strong on production and news. Send tape of dj, news and production, plus resume. Full time, format, pop music operation.

Can you gather & write local news? Write and produce good production spots using complete sound and music libraries and then do a 2½ hour teen show that will keep 'em talking and of course furnish a good credit reference? Good your hired! Call immediately 606-789-5311 and ask for Mr. Fyffe. We need you by Sept. 1st.

---

**SITUATIONS WANTED**

---

**Management**

General/sales manager. 51 years old. 30 years in radio. . . 17 years in management. Immensely capable, experienced, cost conscious, efficient, aggressive, adaptable, diplomatic, competitive, civic-minded and ingenious. Available August 15. Present station being sold. Prefer city 50,000 or more. Write/wire Box J-313, BROADCASTING.

Pittsburgh program director strong in promotion, production, news and sales, desires station manager's position in metropolitan market. College graduate, married, 35 years old, references. Box J-367, BROADCASTING.

Mr. Station Owner . . . Looking for a heavy-weight? California major market broadcast executive seeking change to medium sized market. In-depth experience in am-fm-tv top management. Very strong on local, regional and national sales plus programming, promotion, etc. Currently vp and manager of broadcasting company. Interested in top management post with possibility of participating in ownership in California am or tv station. Outstanding reputation in industry. 35, family, college graduate. Box K-9, BROADCASTING.

Manager. Experienced. I can solve your problems. Sales, programing, promotions, personnel, public relations. Solid background. Box K-23, BROADCASTING.

Attention Texas broadcasters: 7 years in engineering, programing, management and major markets. Three years college (E.E.), first phone, and family. Want station in small but competitive market. Wait Andrus, 1317 Laurel, LaMarque, Texas. (713) WE 5-3532.

**Situations Wanted—(Cont'd)****Management**

Two man management team. Salesman with first phone, pd top quality announcer. Have worked together past 7 years. Total 25 years broadcast experience. Top references. Box K-78, BROADCASTING.

Management or sales—no big talker. A "doer." Have business head with 16 years experience. Consider medium or large market only. Box K-82, BROADCASTING.

Creative broadcast salesman, management executive with strong station, group, and syndication background seeking challenging position as manager or administrative assistant to manager. Top contacts agencies, reps, networks. Thorough knowledge all operational phases. Personally known at virtually every major station in U.S. and Canada. Personable, works well with people. Family, now New York but will relocate for right opportunity. Write Box K-128, BROADCASTING.

Don't forget to check K-143s display ad on page 93, this issue.

**Sales**

Salesman, dedicated, competent, 6 years radio, license, 5 year chain station reference, capable with copy, radio school graduate, anywhere. Box K-108, BROADCASTING.

Account executive heavy time sales experience with major New York stations. High level agency and client contacts. Sales job wanted in New York City only. Box K-131, BROADCASTING.

**Announcers**

Sports announcer with 8 years experience including sales. Excellent references. Strong on news. Capable dj. Box J-276, BROADCASTING.

Young announcer. One year experience. Seeking to relocate. Single, mature voice. Bright personality. Box K-27, BROADCASTING.

1st phone personality—college, draft free, 6 years experience in the top 50 markets. Box K-28, BROADCASTING.

Are you looking for a Pro? I'm your man. 10 years experience. Box K-69, BROADCASTING.

Sportscaster, dj. First phone. Experienced. Personality. College graduate. Any format. Box K-70, BROADCASTING.

Beginning announcer recently finished announcing school can do play by play in addition to news and dj work. Knows board, married will relocate. Box K-74, BROADCASTING.

Energetic sportsman who can double as dj now available. Box K-75, BROADCASTING.

First phone—play-by-play sports announcer—married with family—fantastic sports and radio background—double in news—production—sales or board work. Available immediately. Box K-96 BROADCASTING.

Country and western announcer with vast sports, play-by-play and news experience. First phone—family man—no drinker—prefer larger market—consider all offers. Box K-97, BROADCASTING.

Top 40 dj-announcer, tight production and fast board. A broadcast graduate and wants to swing. Box K-98, BROADCASTING.

Versatile, experienced radio-tv announcer—all phases. 14 years in broadcasting—9 in Cincinnati. Excel in polished, dignified approach to news and commercials. Married, 2 children, dependable. References, recommendations, and resume on request. Available immediately. Box K-101, BROADCASTING.

First phone announcer—limited experience; 6 to midnight shift only. Box K-104, BROADCASTING.

**Situations Wanted—(Cont'd)****Announcers**

Midwest (Mich.) preferred by play-by-play specialist. Very good news, good music. Fully experienced. Box K-105, BROADCASTING.

Dj-5 years experience . . . all areas considered . . . modern format. Box K-110, BROADCASTING.

Imaginative—adaptable: first phone announcer, time sales, copy writer. College trained, ten years experience. Age 33, married, three children. Box K-112, BROADCASTING.

5 year's experience—TV live sports show, commercials, fm serious music show, am straight announce—easy, quiet delivery. Currently employed in major market 50 kw am-fm-tv at \$7,000. University BFA degree in radio/tv. Age 24, married, draft free. Seeking position with chance for advancement into programing, production. Box K-116, BROADCASTING.

First ticket announcer. 15 years experience Kentucky, Wyoming, Oklahoma. Good music or c&w personality or both. Available immediately with references. Box K-118, BROADCASTING.

Immediately! Experienced swing personality. Bright, tight, modern professional sound. Crack newsmen. Will travel. Box K-91, BROADCASTING.

Dj announcer, newsmen, combo man have restricted radio telephone permit. N. Y. area. Box K-129, BROADCASTING.

Now working in New York, seeks less frantic life for family and self. In radio since 1946. If you need an exceptional voice (but no prima donna) with a first ticket, strong on news and good music, sober, mature family man, contact Box K-132, BROADCASTING.

Modern young negro disc jockey. Currently employed in N.Y.C. Rated #2 by pulse available September. Box K-133, BROADCASTING.

Announcer with 1st phone. Desires north-west location. Wash., Oregon, Idaho, N. Calif. etc. Trained announcers training studio, N. Y. Box K-134, BROADCASTING.

Morning personality, number one all surveys, all segments. Tasteful comic approach. Big smiling voice. Box K-135, BROADCASTING.

Available October 1st—Professional network—quality newscaster, also middle of road record show. Sixteen years exp. Former general manager and station owner, desires position away from front desk and back on board or news mike. Prefer New England or middle Atlantic area, will consider any offer. If personal interview required, will share expense. If out of requested area, the trip at your expense. Tape available immediately. Will sell on own time at 20% commission. Exp. in all phases of radio. Minimum salary \$150.00 week. Box K-140, BROADCASTING.

Experienced announcer wants job. 10 years present station. 373-0974, Monroe, La.

Combo man experienced air personality with first phone available now. Don't wait, phone 305-632-3788.

Experienced top 40 personality dj with 5 years experience available August 15th. Excellent references. Happy, bright, tight, experienced. Reason for leaving gladly given upon request. Good news and production. Write Tom Shafer, KNOE, Monroe, La., or call 1-501-325-0101.

Negro, female, recent announcing school graduate. Spirituals preferred, consider other. Please call or write Eula Coss, Orchard 3-1918, 5101 Crane St., Houston 26, Tex.

C&W jock, 8 months experience, available Sept. 1st. Phone Charles Ashcraft at AL 5-8071 in mornings. Duncan, Okla.

Hire bright, happy me! First phone! Johnny Bowles, Mt. Sterling, Ky., 606-1150.

**Situations Wanted—(Cont'd)****Announcers**

Bright announcer/pd. 10 years experience, want to settle in east with growing outfit. Brad Harris 277 Van Siclen Ave., Brooklyn 7, N. Y., Hyacinth 8-5479.

**Technical**

Former engineer in charge all maintenance mega watt uhf transmitter complex, desires new construction and or maintenance position Con. U. S. or overseas. U. S. citizen, presently employed in private industry and holds security clearance. Box J-271, BROADCASTING.

First class license. No broadcasting experience. Presently radio operator. Desire broadcast engineering work. Married. No children. Box K-72, BROADCASTING.

First phone, 12 yrs. in radio, 7 as chief, want to relocate in or near coastal area. No announcing experience. \$110 min. Box K-87, BROADCASTING.

Engineer, capable, experienced, southeast, available soon due to chain reorganization. Box K-114, BROADCASTING.

Administrative chief available, 15 years experience backed by top references in the am-fm broadcast field. Can handle technical personnel group stations and license proofs with renewals. Will only consider a direct interview with ownership. Box K-123, BROADCASTING.

Chief engineer: 10 years building construction and high power directional antenna c.p. experienced. Know how on cost cutting maintenance and managerial assistance. Reliable and references. Box K-124, BROADCASTING.

Available—primary light engineering, FCC first class. Willing to learn broadcasting. Leon Bashaw, 1312 Belgrade, Orlando, Fla.

**Production—Programing, Others**

Sportscaster: 8 years experience play by play, all major sports. College graduate . . . family man . . . sponsors references. Box J-328, BROADCASTING.

Experienced sports announcer specializing in play-by-play basketball, please note, will do sports only and will make season commitment only. Will consider any market big or small any locality. Prefer Indiana. Box K-2, BROADCASTING.

Veteran, 25, BA degree, two years play-by-play collegiate football, basketball, hockey, baseball, seeks sports position. Box K-25, BROADCASTING.

Versatile, top-notch, sports play-by-play man with stimulating, accurate, and authoritative presentation. Major college experience in football, basketball, plus all other sports. Available immediately. Excellent references. Box K-32, BROADCASTING.

Needed—a permanent position with established radio-tv operation, preferably in news and sports—over 10 years radio, some tv. Box K-80, BROADCASTING.

News. (Gather, write broadcast) Upper-midwest. Eight years experience . . . 3 as director. Seeking larger market. Married, age 30. Personal interview preferred. Box K-73, BROADCASTING.

Attention: Station with a future! Top market personality desires position with a mature, top-idea crew that's radio minded. No madness, looking for hook-up that has its feet on the ground. Six years experience in commercial radio. Production Mgr. with north California outfit at present. Want to step up to programing. All replies answered with tape and information. Box K-76, BROADCASTING.

Can write . . . can shoot film . . . can gather and deliver news, radio or tv. Veteran newsmen with 7 years experience. No drifter, married, one child, military obligation completed. Presently employed, no chance for advancement in current job. Prefers West, will go anywhere. Write Box K-89, BROADCASTING.

## Situations Wanted—(Cont'd)

### Production—Programing, Others

Newsman. Announcing school and college graduate, 28. Year experience. First phone, no maintenance. Box K-53, BROADCASTING.

Sportscaster—play by play radio and/or tv. 15 years radio, 10 years tv. 10 years with present employer in large radio-tv market. Box K-90, BROADCASTING.

Copywriter: Over 7 years broadcasting experience. Prestige and gimmick copy. Production, public relations, key account servicing. Single. Box K-99, BROADCASTING.

HA! ha! ha! ha! Two man comedy team. Guaranteed laughs—I tell 'em—he laughs. Major markets. Box K-102, BROADCASTING.

Newsman. Heavy experience. First phone. Board sports. Middle Atlantic seaboard. Box K-103, BROADCASTING.

Director of photography . . . Seeking responsible position with organization producing tv films and documentaries. Ten years tv experience, over forty documentaries, many awards. Strong production background includes editing, directing, animation, commercials. Opportunity for advancement essential. Married, age 35, degree. Samples and resume upon request. Box K-106, BROADCASTING.

50 kw am experienced newscaster seeks hot am or tv assignment. Box K-107, BROADCASTING.

Experienced, young broadcaster is looking for an opportunity to produce commercials and special programs (and possibly program music) for an "adult appeal" radio station. Write Box K-109, BROADCASTING.

Sincere, experienced pd-dj seeks post with medium market station. Thorough knowledge of music. Pleasant voice, smooth delivery. Production-minded, detail-conscious. Mature, dependable. M.S. degree. Family man, age 26. Available now. Box K-111, BROADCASTING.

Public affairs special events director. 5 years in radio. College graduate. 30, veteran. Presently working in top 40 market station. Experienced in and can do all aspects of news. Also can write and produce low budget prestige shows. Do public relations. Can do some sports. Excellent record, references. Imagination, integrity, creativity. Excellent appearance. Box K-115, BROADCASTING.

Ambitious broadcaster seeks advancement. Desire television opportunity, radio management or program directorship in small-medium market. Programing-news-sports-production experience. Complete resume and references on request. Box K-117, BROADCASTING.

News director, sports play-by-play. Experienced all phases radio. Young, married, aggressive, want permanent position with good small or medium market station. Box K-119, BROADCASTING.

5 years experience all phases, family man, 31, mature, northeast. Box K-137, BROADCASTING.

Presently employed, news, sports director, desires change. Top references . . . mature . . . best in business . . . no small markets . . . guaranteed results. Box K-138, BROADCASTING.

40 year "old" announcer-newsman-program director, 15 years radio experience, desires to return to radio from newspaper and pr work. Available now. Prefer Southwest Ronald F. Ripley, Box 1751, Hobbs, New Mexico.

## TELEVISION

### Help Wanted—Sales

WCKT-TV Miami is looking or capable local salesman. Must have proven sales record. Good draw and commission arrangement. Reply with complete resume and recent photo to Chas. Phillips, P. O. B. 1118, Miami, Fla. 33138.

## TELEVISION

### Help Wanted—Announcers

Southeast network affiliate needs man with experience in public affairs programing and news. Please send resume, picture, references and audio tape to Box K-13, BROADCASTING.

Experienced announcer for commercials, weather and interviews. Send photo and tape, film or video tape to Program Director, WFRV-TV, Green Bay, Wisconsin.

### Technical

Transmitter operator—Central Texas max. power vhf, RCA equipment. New installation—near large lake. Contact Bob L'Roy, KLRN-TV, Star Rt. 2, New Braunfels, Tex.

Immediate opening for first phone engineer. Technical ability important. Experience desired, but will consider inexperienced graduate of good technical school. Contact Chief Engineer, KTAL-TV, Shreveport, La.

Permanent position available immediately for engineer with first class license and experience in video switching. Contact E. M. Tink, Dir. of Eng., KWVL-TV, Waterloo, Iowa.

Immediate openings for experienced tv engineers in Ampex vtr's, camera, video and maintenance. Please forward resume and references to Mr. Cliff Paul, Tele-Prompter Corporation, Sands Office center, South Memorial Parkway, Huntsville, Alabama.

Very unusual opportunity for several aggressive and qualified electronics men to own and operate franchised branches of our 17-year-old electronics home-study school. Write for free details. CSOE, Box 10634, Jackson 9, Miss.

### Production, Programing & Others

Sports director for top midwest TV station. Two station market. Send resume, picture, tape, visual material if available. References. Box K-94, BROADCASTING.

Newsman—Need experienced reporter—gathering, writing and filming news for combined radio television operation. Some on-air. Bob Ellis, KKTU-KGHF, Lincoln 2-5570, Pueblo, Colorado.

## TELEVISION

### Situations Wanted—Management

Mr. Station owner . . . Looking for a heavyweight? California major market broadcast executive seeking change to medium sized market. In depth experience in am-fm-tv top management. Very strong on local, regional and national sales plus programing, promotion, etc. Currently vp and manager of broadcasting company. Interested in top management post with possibility of participation in ownership in California am or tv station. Outstanding reputation in industry. 35, family, college graduate. Box K-9, BROADCASTING.

General-sales manager, Major market experience. 23 years in broadcasting, 13 TV management. Age 43. Box K-16, BROADCASTING.

TV or TV-radio general manager wants new challenge in medium market. Twenty-one years in broadcasting, last 19 same company. Currently managing 1 TV and 2 radio stations for newspaper-owned company. Reliable, dedicated. 38 years old, best references. Personal interview upon request. Box K-45, BROADCASTING.

### Sales

Competent, experienced in all phases television sales. Excellent personal and business history. Full industry references. Consider right change prior to fall school term. Box K-81, BROADCASTING.

## Situations Wanted—(Cont'd)

### Announcers

Newsman-announcer with definite "class" and style wishes to join progressive tv station in small-medium market. Conscientious, eager. Immediate availability. Will settle. Box K-71, BROADCASTING.

### Technical

Permanent transmitter job wanted. Experienced transmitter operation, maintenance, construction and installation. Box J-327, BROADCASTING.

Have you opportunity for engineer with 12 years TV experience including color, planning, construction? Last 4 years assistant chief. Box K-34, BROADCASTING.

Help! Tired of dead end job! Well qualified assist. chief desires challenging position. Excellent references. Box K-86, BROADCASTING.

Chief engineer position wanted. 8 years experience am-fm-tv. 2 years as chief. Qualified to install, operate and maintain any television station. Presently in computer field. Box K-93, BROADCASTING.

### Production, Programing & Others

Television sports director available. Complete knowledge of film; authoritative play-by-play; intelligent editorialist. Will create excellent image in sports minded market. Box J-296, BROADCASTING.

Television childrens show personality with proven format. A top rated, easy to sell entertaining show for kids. Available September first. Box J-306, BROADCASTING.

Experienced news director: Now heading vhf-am newroom. Top-rated newscaster, investigative reporter. Seek news directorship/staff job major market. Box K-80, BROADCASTING.

Operations manager, strong in organization, training, personnel management. Eight years commercial, educational, military TV as producer-director-writer. Excellent references, resume. B.A., 27, available now. Box K-139, BROADCASTING.

Due to program emphasis changes this tv station has a top kid personality available effective mid-August. I can strongly recommend John Stikes as a popular emcee of live kid shows and an individual of excellent moral character. His availability does not reflect a lack of commercial success with his show or any personality conflict with station personnel, but is due to all-over program changes in our early evening period. If interested in a strong children's personality please call either John Stikes or me collect. Phone FA 2-8828, Columbus, Georgia. Joe Windsor, G.M.

## WANTED TO BUY

### Equipment

Wanted: 150 foot tower console, microphones and other related equipment. Building new station, Box H-149, BROADCASTING.

Raytheon or RCA microwave STL wanted immediately. Box J-202, BROADCASTING or call EN 2-5680, N.Y.C.

Frequency, modulation and phase monitors, Clark 120 or RCA WX2 field strength meter. Console, turntables, limiter etc. State manufacturer, model condition and price. Box J-350, BROADCASTING.

Wanted: Used video-tape recorder, broadcast model. Contact William Lewis, Chief engineer for tv, bureau of audio-visual instruction. University of Colorado, Boulder, Colorado.

Records wanted! Top dollar for all lp's and 45's! Pop, r & r. c & w, classical, etc. Cash for all. Send approximate/library for our bid. M.T.S., 1518 Broadway, Sacramento 18, Calif.

## WANTED TO BUY

### Equipment

Setting up fm station. Need all equipment fr. mic. to antenna. Will pay cash. Box K-79, BROADCASTING.

AM frequency and modulation monitors in operational condition, 20 years old maximum. W. S. Cook, 2423 Airport Rd., Colorado Springs, Colorado.

Lampkin frequency meter—p.p.m.—modulation meter in good operating condition or equivalent. Box K-95, BROADCASTING.

Wanted: RCA TT-5A or Federal 5 kilowatt, high-band television transmitter. Must be in operating condition. Box K-100, BROADCASTING.

Overseas missionary organization needs audio equipment. Monitor and p.a. amplifiers, mixing board, tape recorders, microphones and components. Will gratefully accept in any condition. Donations tax deductible. Will pay shipping charges. P.O.B. 15-M, Pasadena, Calif.

Need 3 TK-31 (RCA) field camera control chassis. Contact WCCO-TV Eng. Dir., 50 South 9 Street, Minneapolis 2, Minn.

Used Nagra tape recorder. Sync or non-sync. Give condition and price in first letter. P.O.B. 15-M, Pasadena, Calif.

Wanted for ready cash—New and used transmitting tubes. Write Coloramic Electronics, 243 Harrison Ave., Garfield, N. J., 471-2022.

## For Sale

### Equipment

Xmission Line; Teflon insulated, 1 1/2" rigid, 51.5 Ohm flanged with bullets and all hardware. New—unused. 20 foot length for \$40.00. Quantity discounts. Stock list available. Sierra-Western Electric, 1401 Middle Harbor Road, Oakland 20, California. Telephone 2-3527.

Television/radio transmitters, cameras, microwave, tubes, audio, monitors. Electrofind, 440 Columbus Ave., N.Y.C.

Complete Gates remote control system RDC-10c with frequency and modulation extension meters, all necessary pads for mounting in transmitter of 1000 watts or less, and rack for mounting studio components. Best offer. KVOU, Uvalde, Texas.

Recording/film studio equipment/parts. List. Ken-Del Productions, 515 Shipley, Wilmington, Del.

10' watt, 950.5 mc G.E. model 4BT9A1—includes fm transmitter and receiver with two dishes 1 G.E. 3BT3B—3 sk fm transmitter; also 200 ft. 1 1/2" feed line. Box K-14, BROADCASTING.

Complete Gates RCM20 remote system, including meters, shunts, motors. Good condition. \$500. WAAA, Winston-Salem, N. C.

Gates Sta-level 1st class condition . . . full details Box 900, Sharon, Penna.

One 30 kw 230 volt 3-phase power plant. Contact radio station WKEU, Griffin, Ga.

Mohawk Midgetape battery portable recorder, new carrying case. Complete with microphone and cartridges. Excellent condition. Cost \$200. Priced at \$70. KSEO, Durant, Oklahoma.

RCA type BA-25A AGC program amplifier currently in use, complete with schismatic and instruction book. 1st check for \$100 buys it. FOB WXVA, Charles Town, W. Va.

RCA TTU 1B uhf tv transmitter complete except for meters and blower. Needs approximately \$1000 in parts and 100 hrs. of engineers labor. Sold as is or will rebuild under contract. For info call W. S. Ward, JO 2-2000, 7505 Carroll St., Tacoma Park, Md.

## For Sale—(Cont'd)

### Equipment

RCA TT5A tuned to channel 2. Priced to sell quickly. Box K-84, BROADCASTING.

Package deal—all equipment like new. Gates "Gateway" audio console & desk, Gates CB 525 turntable & cabinet, Ampex model 351 recorder console, RCA model 77D microphone, 2—RCA 12 inch speakers & slopedwall enclosure. Total: \$3600.00 Box J-136, BROADCASTING.

### Miscellaneous

30,000 Professional Comedy Lines! Topical laugh service featuring deejay comment, introductions. Free catalog. Orben Comedy Books, Atlantic Beach, N. Y.

Need help? 1000 Super dooper hooper scooper one liners exclusive in your market. Free sample. Lyn Publications, 2221, Steiner St., San Francisco.

Audition tapes prepared, duplicated, edited. Resumes written, printed. DJ jobs available. Darden Assocs., P. O. B. 231, Roosevelt, N. Y.

We are all radio men (and women) who have decided to syndicate our shows, produce customized commercials, too. Cost? Ridiculously low. Write for details and samples. Six Twenty Nine Productions, Pensacola, Fla.

## INSTRUCTIONS

FCC first phone license preparation by correspondence or in resident classes. Grantham Schools are located in Los Angeles, Seattle, Kansas City and Washington. For free 44-page brochure write: Dept. 3-K, Grantham Schools, 3123 Gillham Road, Kansas City, Missouri.

Elkins training now in New Orleans for FCC First Class License in 6 weeks. Nationally known for top quality theory and laboratory instructions. Elkins Radio School, 333 Saint Charles, New Orleans, Louisiana.

Be prepared. First class FCC license in six weeks. Top quality theory and laboratory training. Elkins Radio License School of Atlanta, 1139 Spring St., N.W., Atlanta, Georgia.

FCC first phone license in six weeks. Guaranteed instruction in theory and laboratory methods by master teachers. G. I. approved. Request free brochure. Elkins Radio License School, 2603 Inwood Road, Dallas, Texas.

Elkins Radio License School of Chicago—Six weeks quality instruction in laboratory methods and theory leading to the FCC First Class License. 14 East Jackson St., Chicago 4, Illinois.

Announcing programing, console operation. Twelve weeks intensive, practical training. Finest, most modern equipment available. G. I. approved. Elkins School of Broadcasting, 2603 Inwood Road, Dallas 35, Texas.

Since 1937 Hollywood's oldest school devoted exclusively to Radio and Telecommunications. Graduates on more than 1000 stations. Ratio of jobs to graduates approximately six to one. Day and night classes. Write for 40 page brochure and Graduate placement list. Don Martin School of Radio and Television Arts & Sciences, 1653 North Cherokee, Hollywood, California.

save time! Save money! You get an FCC first class license in just five (5) weeks with R. E. I. training in beautiful Sarasota. Affiliated with modern, commercial station. Free placement. Radio Engineering Institute of Florida, Inc., 135 Pineapple Ave., P. O. B. 1058, Sarasota, Florida.

Since 1946. Original course for FCC first phone operator license in six weeks. Over 420 hours instruction and over 200 hours guided discussion at school. Reservations required. Enrolling now for classes starting October 9 and January 8. For information, references and reservations, write William B. Oden Radio Operational Engineering School, 1150 West Olive Ave., Burbank, California.

## INSTRUCTIONS—(Cont'd)

San Francisco's Chris Borden School teaches you what you want: 1st phone and "modern" sound. Jobs a plenty. Free placement. Illustrated brochure. 259 Geary Street.

Announcing, programing, first phone, all phases electronics. Thorough, intensive practical training. Methods and results proved many times. Free placement service. Allied Technical Schools, 207 Madison, Memphis, Tennessee.

Special accelerated schedule. The Los Angeles Division of Grantham Schools is now offering the proven Grantham first class license course in a special accelerated schedule. Taught by a top notch instructor, this class is "success tested" for the man who must get his first phone in a hurry. For free brochure write: Dept. 3-B Grantham School of Electronics, 1505 N. Western Ave., Los Angeles 27, California.

Jobs waiting for first phone men. Six weeks gets you license in only school with operating 5 kw station. One price includes everything, even room and board. Can be financed. American Academy of Electronics, WLIQ, Sheraton Battle House, Mobile, Alabama.

FCC license in six weeks. Total cost \$285. Our graduates get their licenses and they know electronics. Houston Institute of Electronics, 652 M and M Building, Houston, Texas. CA 7-0529.

Train now in N.Y.C. for FCC first phone license. Proven methods, proven results. Day and evening classes. Placement assistance. Announcer Training Studios, 25 W. 43rd, N. Y. OX 5-9245.

Pittsburgh. FCC first class "success-proven" accelerated course now in Pittsburgh. Day or evening. Free placement. For brochure, write American Electronics School, 415 Smithfield St., Pittsburgh 22, Pa. Phone 281-5422.

## Help Wanted

### Sales

#### CAN YOU DO EVERYTHING!

BRAND NEW ONE-STATION MARKET IN WEST CHESTER, PA. PHILADELPHIA VICINITY DAYTIMER QUALITY MUSIC-NEWS RADIO STATION REQUIRES IMMEDIATELY COMBINATION DJ/SALESMEN AND/OR WRITERS/PROGRAMERS WITH IMAGINATION. GREAT OPPORTUNITY FOR YOUNG MEN WHO WANT TO BUILD FOR THE FUTURE. WORKING DIRECTLY WITH TOP EXECUTIVES OF THE BROADCASTING AND BUSINESS WORLD. CULTURE UNLIMITED IF YOU CAN PRODUCE. RUSH TAPE AND RESUME TO:  
BOX K-148, BROADCASTING.

## Announcers

### Network O & O

in major market offers challenge, hard work, little pay, great opportunity to start with new all-talk format. Send resume, tape, to  
BOX J-220, BROADCASTING.

## TOP-NOTCH D. J.

must have 1st class ticket. Capable of handling excellent teen-age audience. We're not a top 40 operation however. We can meet demand of salary if you qualify. 5000 watt, WIOU, CBS affiliate. Only station in Kokomo, Ind. 60,000 population. Telephone collect Mr. Jeffery, evenings only GL 9-5322. Character references required and excellent voice. No amateurs please!



## NEWSMAN WANTED

50,000 WATT MID-WEST METRO STATION WANTS AGGRESSIVE NEWS-CASTER WITH WRITING AND GATHERING ABILITY. MUST HAVE AUTHORITATIVE VOICE. MINIMUM OF FIVE YEARS EXPERIENCE AND COLLEGE GRADUATE PREFERRED.

SEND AUDITION, SAMPLE OF WRITING, AND SALARY EXPECTED.

BOX K-67, BROADCASTING

### Technical

#### ENGINEER

Strictly maintenance, construction and things technical. Two-station operation looking toward expansion wants competent 1st class man. 40 miles west of Philadelphia. Paid Vacation, profit sharing and other fringe benefits. WCOJ, Coatesville, Pa.

### Situations Wanted—Management

#### VETERAN BROADCASTER

7 years diversified experience all phases, seeks managerial position. Currently PD of top station in top 30 markets. Age 28. family. Sober, reliable, conscientiously hard worker. Excellent references. All Replies will be answered and held in strict confidence.

BOX K-143, BROADCASTING

### TELEVISION

#### Situations Wanted—Management

#### TV STATION MANAGER

Age 37, Married, Degrees in Management, Excellent References, and 16 continuous years of diversified TV Experience in Administration, Programming, Production, Film Buying, NAB Code Affairs, and over all VHF Operations. Resume and personal interview upon request.

BOX K-145, BROADCASTING

### WANTED TO BUY

#### Stations

MEDIUM to MEDIUM—LARGE market, good facility, growth potential, preferably North East. To be second station in planned expansion. We're large company with diversified interests, able and ready to buy. Replies confidential.

Box K-64, BROADCASTING

### For Sale

#### Stations

#### FOR SALE

MAJOR SOUTHERN MARKET AM high power facility minimum cash—extended terms to properly qualified purchaser  
Box J-298, BROADCASTING.

#### CALIFORNIA KILOWATT

Daytime station in active growth area needs resident owner-manager for development of full potential. Total price of \$125,000 is 1½ times average annual gross. Excellent terms available.

BOX K-144, BROADCASTING

### For Sale Stations—(Cont'd)

#### THE PIONEER FIRM OF TELEVISION AND RADIO MANAGEMENT CONSULTANTS ESTABLISHED 1946

Negotiations Management  
Appraisals Financing

HOWARD S. FRAZIER, INC.

1736 Wisconsin Ave., N.W.  
Washington 7, D. C.

### For Sale Stations—(Cont'd)

#### RACE STATIONS

Chain operation spinning off 3 stations in top metro markets Eastern half United States—Competitive and non-competitive situations. Answer only if financially qualified.

BOX K-85, BROADCASTING

#### New England Daytimer

Profitable Small Market 250w \$100,000 includes valuable land and physical assets all owned by station. 29% down and favorable terms on balance. Ideal for husband-wife owner combination.

Box K-147, BROADCASTING

#### FIVE-COUNTY

regional station, in rich upper Midwest area. 5,000 city, 18,000 county, 55,000 radio homes served. Fixed sign-on, \$5,000 monthly gross. Ideal owner-manager situation, making money. Total cost, terms over six years, \$75,000. Deal direct with owner in confidence.

BOX K-146, BROADCASTING

To buy or sell Radio and/or TV properties contact:

PATT McDONALD CO.  
P. O. BOX 9266 - GL 3-808  
AUSTIN 56, TEXAS

### STATIONS FOR SALE

NEW ENGLAND. Exclusive. Fulltime. Priced at \$125,000. 29% down.  
CALIFORNIA. Medium market. Daytime. Priced at \$78,500. 40% down.

JACK L. STOLL & ASSOCS.

6381 Hollywood Blvd.  
Los Angeles 28, California

Fla.	single	daytime	\$ 70M	terms
Ill.	small	daytime	85M	terms
Vt.	small	fulltime	100M	29%
S. E.	small	profitable	90M	cash
Mass.	medium	regional	185M	29%
Pa.	metro	daytime	155M	25M
S. E.	metro	race	275M	29%

And others.

CHAPMAN COMPANY  
2045 Peachtree Rd. N.E., Atlanta 9, Ga.

## YOUR HANDY CLASSIFIED AD ORDER FORM

#### ISSUE DATE(s)

TF (until forbid)

#### RATES

Situations Wanted—20¢ per word—\$2.00 minimum (Payments in advance)

Help Wanted—25¢ per word—\$2.00 minimum

Display ads \$20.00 per inch—STATIONS FOR SALE and WANTED to BUY advertising require display space. Situations Wanted—(Payment in advance)

1"  2"  3"  4"  other

All other classifications 30¢ per word—\$4.00 minimum

Attach ad copy to classified form

(No charge for blind box number)

Indicate whether Radio or TV

Radio

TV

#### HELP WANTED

- management  
 sales  
 announcers  
 technical  
 production-programming

#### SITUATIONS WANTED

- management  
 sales  
 announcers  
 technical  
 production-programming

#### FOR SALE

equipment

#### WANTED TO BUY

stations  
 equipment

#### ADDITIONAL CATEGORIES

Instructions  
 Business Opportunity  
 Miscellaneous

BROADCASTING MAGAZINE, 1735 DeSales St., N.W., Washington 6, D. C.

#### NAME

#### COMPANY

#### ADDRESS

Remittance enclosed \$

Bill

4-29

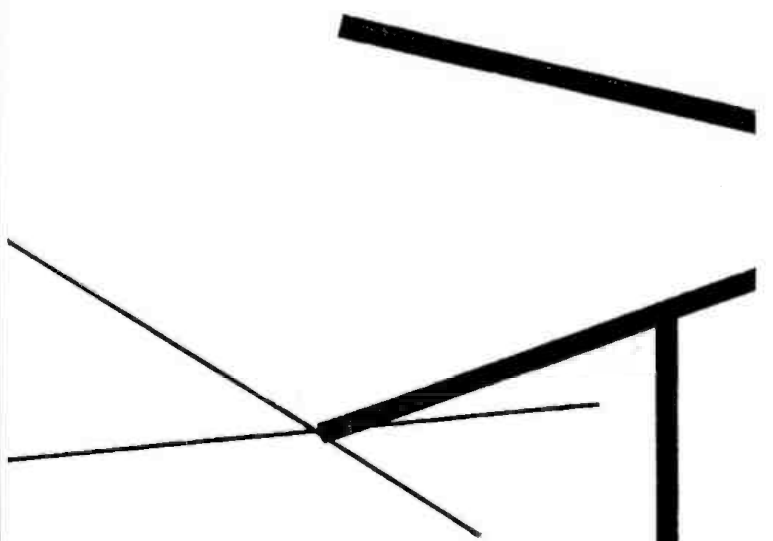

# SUSIE

*...one of 268\*  
syndicated  
TV film series  
which use*

# BMI

*licensed music  
and were  
telecast locally  
during the past year*

*\*out of a total of 390  
syndicated TV film series*



\*

## BROADCAST MUSIC, INC.

589 FIFTH AVENUE • NEW YORK 17, NEW YORK

CHICAGO • LOS ANGELES • NASHVILLE • TORONTO • MONTREAL

## OUR RESPECTS to Horace Styles Fitzpatrick

### He sees 'responsibility' when he looks at his license

Wherever the remote unit of WSLs-TV Roanoke, Va., goes on location, a station executive in the person of Horace Fitzpatrick is almost sure to be there.

Vice President-Manager Fitzpatrick is not a member of the remote crew nor is he there to check on their efficiency or general demeanor. He is just so intimately associated with his industry and his job that he likes to keep close touch with WSLs-TV operations and the public the station serves.

In addition to his "fire" calls with the remote crew, Mr. Fitzpatrick also travels extensively throughout the WSLs-TV coverage area to keep in personal touch with the people. "He is a rather stupendous little guy [5' 5"] who looks at that FCC license on the wall and sees the word 'responsibility,'" a close associate and friend said last week.

The WSLs-TV vice president is highly respected in both the industry and Roanoke for his extreme loyalty toward those who have his confidence. He has strong likes and dislikes and is most energetic in the support of his "causes."

"He is outstanding in his desire to assist others," according to James Moore, president of the Shenandoah Life Stations (WSLS-AM-FM-TV) and Mr. Fitzpatrick's boss ever since the latter entered broadcasting. "Not only is he loyal, but he has applied boundless energy and tenacity to everything he has done."

**Permanent Spot** ■ Horace Styles Fitzpatrick has been associated with the Shenandoah Life Stations for nearly half of his 50 years, an age he attained just yesterday (Aug. 11). He left a promising career with a power company in 1940 to join WSLs as a salesman when that station first went on the air. After holding down many jobs and titles in the interim, he was made vice president of Shenandoah Life Stations Inc. in 1959 and has been WSLs-TV's only manager since the station went on the air in 1952.

Fitz was born in Roanoke in 1913 and graduated from that city's Jefferson High School in 1933 as a football and basketball star. Early in life he showed a flair as a promoter, a sideline he has continued to pursue throughout his life. While in high school he sold newspapers, worked in various retail stores and gas stations and booked local bands and dances.

Young Fitz went against the wishes of his family and turned down a scholarship to Roanoke College offered because of his athletic prowess. Instead, he attacked the business world as office boy for the Appalachian Electric Power Co. He wasn't office boy for long, how-

ever, rising to head of the billing department.

His dance promotions went big league, too, as he jumped from local talent to such name bands as Johnny Long, Guy Lombardo, Sammy Kaye and others. Mr. Fitzpatrick also was gaining a Roanoke-wide reputation as a top salesman which served him well when WSLs was constructed in 1940.

The late Paul Buford, first WSLs president, suggested to his manager, Mr. Moore, that Mr. Fitzpatrick would make a good radio salesman and as a result Fitz joined the new voice in Roanoke.

**Still Selling** ■ He has been selling very successfully ever since. Knocking on doors that others would bypass, Mr. Fitzpatrick quickly became a leading radio salesman of co-op time. The then new ABC network conducted many contests for local salesmen and Fitz won more than his share of prizes, many of which still adorn the Fitzpatrick home.

He still has a reputation among NBC-TV affiliates as "that guy who is always selling." The statement is literally true, witnessed by the fact that just last week Mr. Fitzpatrick made a sales trip to South Carolina and Georgia.

The Fitzpatrick promotion abilities have benefited the city of Roanoke as well as servicemen during World War II. In 1944 he became manager of the Academy of Music and brought many "firsts" in cultural productions and legitimate plays to Roanoke. During the same period he organized, promoted and transported entertainment

acts to area military bases.

His "star" continued to rise at WSLs, also. In 1945 he was named assistant commercial manager and three years later he was promoted to commercial manager. Shenandoah Life Insurance Co. had been a one-third owner of WSLs (FM was added in 1947) from the start, and in October 1952 acquired 100% of the stations. Just two months later, WSLs-TV went on the air and Mr. Fitzpatrick was named manager of the combined AM-FM-TV operations. He has since dropped the radio reins.

**A Crisis** ■ WSLs-TV had been on the air only 15 minutes before Manager Fitzpatrick had to face his first major crisis. A freak thunderstorm knocked the station off the air, but before the lightning had stopped Mr. Fitzpatrick was on the way to RCA in Camden, N. J., for replacement parts. WSLs-TV was back on the air the next day to stay.

Mr. Fitzpatrick is convinced that the people in WSLs-TV's coverage area look upon the station as tops in public service, the one thing of which he is proudest. And, he says, "TV has only scratched the surface of its potential power to serve the public. There is no other medium that can compare with it. The same applies to the variety of entertainment television offers. It is unsurpassed."

A strong supporter of the National Association of Broadcasters and its industry codes, Mr. Fitzpatrick feels the NAB has done an "excellent job." The greatest strides made in self-improvement of the industry have been made through the NAB, he feels.

Another important facet of the Fitzpatrick image of public service is the broadcasting of editorial opinion. WSLs-TV airs a daily editorial.

Mr. Fitzpatrick is the current president of the Virginia Association of Broadcasters and plans to devote a lot of time before next spring to two VAB goals: increased membership and a standardized savings time plan in Virginia.

He also is president of the Sales and Marketing Executives Club of Roanoke and a charter member of the Roanoke Advertising Club.

Early in 1938 Fitz went on a blind date with a student nurse at the Lewis-Gale Hospital in Roanoke, and before the year was over she had become Mrs. Fitzpatrick. His marriage to Marie DeHart was kept a tight secret for several months because of hospital rules against married student nurses.

When Fitz is not selling TV, he often can be found on the golf course (low '80's) or bowling (160 average).



Mr. Fitzpatrick

Up in smoke

**I**N their advertising and public relations the tobacco companies, it seems to us, are running scared—too scared for their own good.

Their sudden emphasis on smoking as an "adult" pleasure, including their decision to withdraw completely from campus promotions, was obviously a concession to the save-the-youth wing of cigarette critics. But instead of stopping criticism, concessions sometimes lead to assumptions that are even more damaging. The cigarette companies' indirect acknowledgement that smoking may not be good for pre-adults inevitably raises questions about just how good they think it is for anybody else.

Against this nervous background, Lucky Strike's new advertising theme, emphasizing that "Smoking's a pleasure meant for adults" (BROADCASTING, Aug. 5), looks capable of developing into the biggest boomerang outside of the Australian bush, accomplishing the exact opposite of its stated purpose. The copy, by BBDO, certainly is not apt to alienate any sizable group between the ages of 12 and 20 with its claim that "Luckies separate the men from the boys—but not from the girls."

If this tack seems cynical, or appeals to ages it professes to avoid, we venture that it's because it attempts to articulate an impossible policy—that of trying to separate the too-young from the old-enough when nobody knows which is which. The futility of trying to eliminate appeals to youth is evident now as never before.

Let us make it unmistakably clear that we are defending, not questioning, the right of tobacco companies to advertise their products in any truthful and tasteful way they wish. Cigarettes have been accused repeatedly of being harmful to health—but they have not been proved guilty. The surgeon general's commission, which may supply a definitive answer, is still deliberating. At least until its report is in, tobacco products are entitled to the same latitude in their advertising as banks or soaps or Smokey Bear.

Can 30 governors be wrong?

**I**N the din of recent arguments over broadcast editorializing—and attempts by Congress to curb it—little has been heard about other legislation to change the political broadcasting law. Editorializing and political broadcasting are parts of the journalistic function of radio and television. To the degree that either is regulated by the government, the effectiveness of broadcast journalism is impaired.

Pending in the Senate are several bills that would make adjustments in the existing law that governs political broadcasting. They range from one—the most desirable but least likely to pass at this time—that would repeal Section 315 altogether to one that would suspend Section 315 in its application to candidates for the Presidency and Vice Presidency in 1964. The latter has been passed by the House.

Within recent weeks still another bill has received important support from the governors of 30 states. This bill would repeal Section 315 in its application to candidates for the Presidency, Vice Presidency, U. S. Senate and House and all state governorships. The author of the bill is Senator John O. Pastore (D-R.I.), chairman of the Senate Communications Subcommittee. The 30 governors who have advised Senator Pastore of their support for his bill add up to a formidable array of political influence.

With that kind of backing, the Pastore bill cannot be ignored. But still more pressure is needed to force the movement of the legislation through the Senate, and even more than that to get it some attention in the House.

It was only after intense effort by broadcasters that the

Congress was persuaded to make permanent liberalizations of Section 315 in 1959 and temporary suspension of the law's application to presidential and vice presidential candidates in 1960. It will take at least as much effort to get Congress to move again. The chance for passage of the Pastore bill is slight at best. There is no chance at all unless broadcasters go into action.

Small thanks

**C**ONELRAD—the coined word meaning "control of electromagnetic radiation"—expired last week.

Its greatest claim to glory was that during the dozen years of its existence the occasion never arose for its activation, which was to alert the public in the event of an enemy bombing attack.

Last Monday, when Conelrad was terminated, the Emergency Broadcast System took over as the new standby broadcast service. Some 1,400 AM and 200 FM stations now hold interim authorization from the FCC for EBS. All stations, including TV, later will be eligible to qualify for EBS, but with TV stations utilizing only their audio transmissions.

The new emergency system has much to commend it. Its purpose is to fulfill national security requirements while providing for transmission of vital information to the public. It is basically under civilian rather than military control.

Actually, it replaces an obsolete system. Conelrad might have been a good idea in 1951. But that belonged to the bomber era. The advent of the missile which can travel a calculated course to any given target area terminated the need for Conelrad.

All that is history, although it isn't necessarily recorded. Some 1,400 AM stations spent over \$20 million in implementing the Conelrad program.

In announcing 10 days ago that Conelrad was out and EBS in, the FCC in a public notice expressed its "appreciation to all who have participated in this patriotic effort."

These broadcasters, we submit, are entitled to more formal and appropriate recognition for their contributions in time, money and equipment. An inscribed certificate or perhaps a personal letter would be more suitable recognition.

With or without such an expression, old Conelrad stations generally will cooperate in the new EBS structure. And, as was the case with Conelrad, they will do so in the hope that the day will never dawn for its use.



Sid Hix

Drawn for BROADCASTING by Sid Hix  
 "Having trouble with the cameraman. . . . He wants a seat belt put on our new camera!"

**A symbol of quality...**



**HUBBARD BROADCASTING, INC.**

**KSTP RADIO  
KSTP TELEVISION**  
Minneapolis-St. Paul, Minnesota

**KOB RADIO  
KOB TELEVISION**  
Albuquerque, New Mexico

**W.GTO RADIO**  
Cypress Gardens, Florida

*Represented by*



*The Original Station Representative*

**DID YOU SAY  
OVER  
\$1,000,000  
MR. YOUNG?**

Sounds staggering, but it's true. That's the additional new business we "creatively sold" for our television stations last year. Our experienced Sales Development Division is a highly skilled "task force" with a proven record of performance — ready to go to work for you.

Interested?

**adam young inc.**

NEW YORK • CHICAGO • ATLANTA • BOSTON • DALLAS



DETROIT • LOS ANGELES • ST. LOUIS • SAN FRANCISCO

REPRESENTING RADIO AND TV STATIONS