

DECEMBER 14, 1959

MORNINGSIDE COLLEGE
LIBRARY
SIOUX CITY IOWA

THIRTY-FIVE CENTS

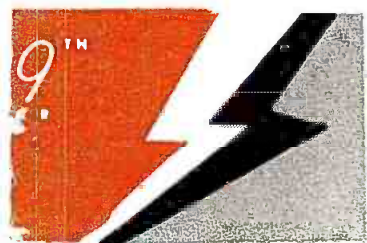

BROOKINGS

THE BUSINESS AND RADIO

NEWSPAPER
DECEMBER 15, 1959
NO. 1308
1959

Morningside College
Library
Sioux City 6 Iowa

Have the radio-tv crises crippled time sales?

Page 29

Lestail to try out radio with Louisville test

Page 29

Spot tv running 21.9% ahead of '58's pace

Page 34

Aubrey closeup: a profile of CBS-TV's head

Page 44

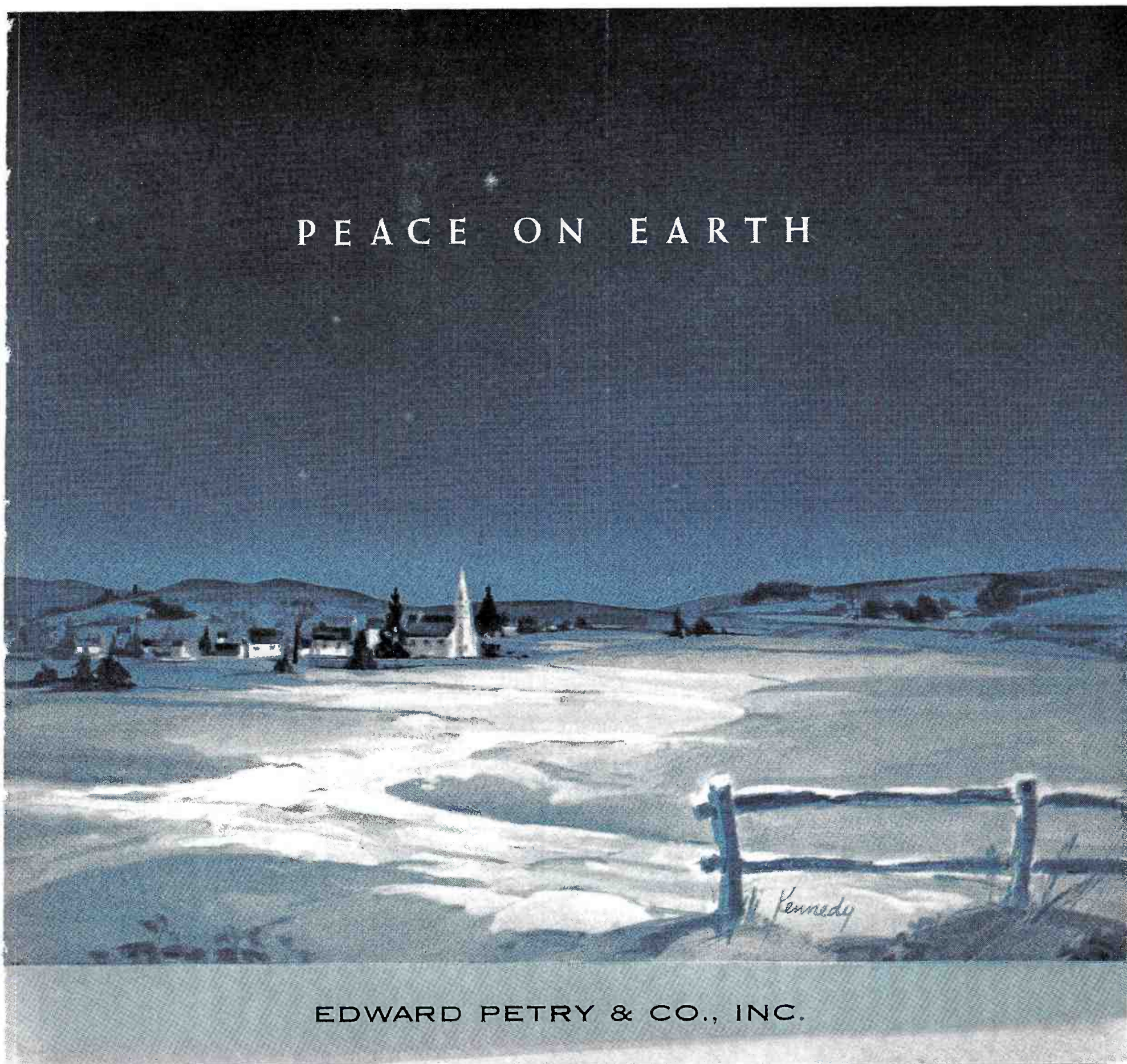

PEACE ON EARTH

EDWARD PETRY & CO., INC.

*Like the immortal riders themselves, one **PONY EXPRESS** episode picks up where the last one left off. Running skirmishes with Indians, bushwhackers, and the forces of nature over a 1,966-mile trail provide compelling action for scene after scene, episode after episode. The gripping dramas of **PONY EXPRESS** have no need for contrived situations. Their springboard for action and reality is indelibly inscribed in the history of the West. NBC Television Films, A Division of **CNP** California National Productions, Inc.*



Buy ST. LOUIS à La CARD*

Represented
Nationally By
BLARE-TV



Drawn By BRANHAM

She is Trying To Say
MERRY CHRISTMAS

VERY SUAVE MALE MODEL
HOLDING T.V. RATE CARD.
The SUIT is
Continental, if you
Will Pardon The
Expression.

***KTVI**
Rate CARD

Your ABSOLUTE LOWEST
Cost Per Thousand

TV Buy in
ST. LOUIS

YES, ABSOLUTELY
yes, LOWEST.
YES.

KTVI

St. Louis
channel 2

from ^{*}17,500
to ^{*}675,000
in **TEN YEARS**

***TV HOMES**

. . . that's how the Dallas-Fort Worth Market, dominated since 1949 by KRLD-TV, has grown.

Since KRLD-TV beamed its first program to a scattering of "wealthy Texans", there has been a "measured preference" for Channel 4 in Dallas. That's why KRLD-TV has the greatest TV circulation of any station in the great Southwest.

Get into the booming, BUYING Dallas-Fort Worth Market . . . get in there best with KRLD-TV.

Ask a Branham man.

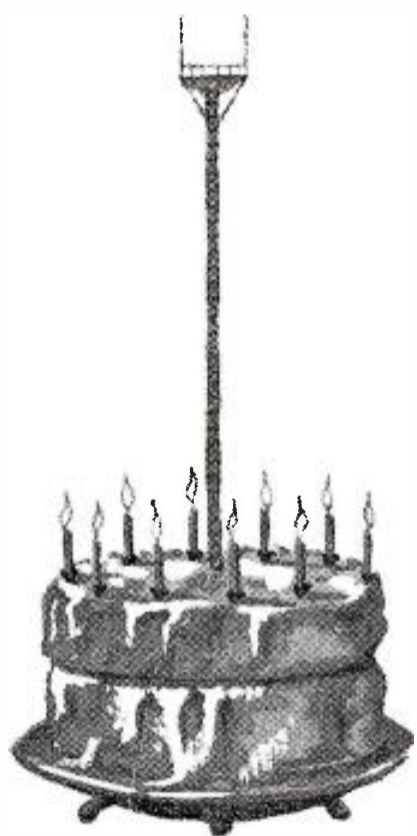

KRLD-TV

represented nationally by the Branham Company

THE DALLAS TIMES HERALD STATIONS



Channel 4, Dallas

Clyde W. Rembert
President

MAXIMUM POWER TV-Twin to KRLD radio 1080, CBS outlet with 50,000 watts.

CLOSED CIRCUIT®

Summit for radio-tv • Unless current plans go awry, there'll be joint meeting in Washington in late December or early January of key officials of every trade group and association in broadcasting (other than fraternal or service groups) to consider plans and policies in current crisis. Group would meet at call of NAB through its task force, chair-manned by President Harold E. Fellows.

Brought together at unprecedented session under NAB "umbrella" would be selected officers and directors of Radio Advertising Bureau, Television Bureau of Advertising, newly created Television Information Office, Television Code Review Board, Assn. of Maximum Service Telecasters, Clear Channel Broadcasting Service, Community Broadcasters Assn., Daytime Broadcasters Assn., radio and television affiliate advisory committees representing each of networks (totaling seven) and possibly Joint Committee on Educational Television, Federal Communications Bar Assn. and Assn. of Federal Communications Consulting Engineers. Networks would be represented through directorships on NAB and other organizations.

Another swap? • NBC, under court mandate to dispose of its Philadelphia properties (WRCV-AM-TV) is receiving offers from numerous organizations and syndicates but, as of last week, nothing approaching contract signing had been achieved. One proposal reportedly under consideration would involve tax-free exchange of RKO Tele-radio Pictures Inc.'s WNAC-AM-TV-WKRO (FM) Boston for Philadelphia properties. Handling inquiries and negotiations for NBC is P. A. (Buddy) Sugg, executive vice president, NBC owned and operated stations and spot sales.

NBC also has received proposals involving WRC-AM-FM-TV Washington. While network does not have "for sale" sign on Washington properties, it's assumed that in effort to upgrade its owned and operated stations it would look in direction of San Francisco and Detroit, as well as Boston. With only three vhs, Detroit doesn't provide prospect, but San Francisco now has four v's and many eyes have been turned toward ch. 2 KTVU, now operating as independent and owned by Pabst-Ingrim-Pauley group.

Network reps • Now that CBS has

elected to accept FCC order prohibiting tv networks from representing affiliates in spot sales (story page 56), CBS-represented stations are reviving talk about where to turn for new rep set-up. Some are strongly for creation of new representation firm, perhaps to be headed by executives now with CBS Tv Spot Sales. At least one station now represented by NBC Spot has expressed interest in joining such a group, on assumption FCC order will stick, despite NBC opposition [BROADCASTING, Dec. 7]. Meanwhile, established reps are making earnest bids for \$15 million in spot billing on stations now represented by CBS and NBC spot divisions.

How to get floor • RAB is taking no chances on getting through to managements of companies it wants to sell on radio's advertising usefulness. Its new \$1,125,000 budget includes \$1,000 appropriation for purchase of common stock—not for income or capital gains, but as door opener for sales presentations. Thus if management won't even listen to radio pitches, RAB will at least be able to talk to stockholders about it at their annual meetings. Such companies reportedly are few, but stock investment is seen as indication of lengths to which RAB plans to go in expanded selling campaign for 1960. (See page 48).

Nobody's ready to talk about it, but RAB board members reportedly have asked staff executives to draft affirmative program to combat unfavorable, and in board's opinion unjustified, criticism of radio in newspapers and in government circles. Trend of board thinking said to run toward \$50,000 educational campaign designed to undo any damage that may be done among either public or advertisers, and there's possibility that program, when completed, will be held for use on stand-by basis as board sees need for it.

Out of mothballs • Intensity of payola-rigging agitation prompted NAB to speed overhauling of Standards of Good Practice for Radio Broadcasters. Best guess now is that standards committee, which meets Dec. 16 instead of in January as originally planned, will insert strong language against payola and deceptive programming techniques. Phony contests and rehearsed interviews also are due for stiffened language. At weekend 627 radio stations of 1,530 NAB am members were subscribers. Unlike

tv code, radio subscription is open only to stations belonging to NAB.

Minute avails • Some radio stations are receiving national spot revenue that's "spillover" from advertiser money originally pegged for spot television. This is what's happened in certain cases say media planners who are in on development: Agency and client, after agreeing on competitive copy points they want to tick off in minimum of one-minute tv commercial, find desirable periods to be scarce so they retain their copy message but tailor it for sound and for radio's supply of open one-minute announcements.

Oversights • House Legislative Oversight Subcommittee is getting impatient at delay by two of last month's witnesses in supplying additional information requested by members. Subcommittee has written NBC President Robert E. Kintner prodding note asking again for (1) copy of network contract with Charles Van Doren and (2) any NBC inter-office memos on actions taken by network when rigging charges were first made by Herbert Stempel against *Twenty-One*. Few days earlier, subcommittee termed as "incomplete," and refused to accept, data offered by lawyer for Hess Bros. department store, Allentown, Pa., in answer to request for list of all names, amounts and programs involved in payments by owner Max Hess for tv plugs.

Another blast • There's additional attack on FCC coming from other than Washington sources next week. Fund for the Republic is releasing 39-page edited transcript giving commentary by former FCC officials (including ex-chairman James Lawrence Fly and ex-commissioner Clifford J. Durr) and others known in regulatory or broadcast field. Report is said to contain intense criticism of FCC for alleged failure to take steps to see that various broadcasters have discharged programming responsibilities in public interest. Note: Taping of Fund's sessions was made before quiz scandals broke.

Up for grabs • Radio coverage of Orange and Cotton Bowl football games Jan. 1 may become available for local sale this week. CBS Radio, which will cover, has quietly notified affiliates they may sell one or both games on co-op basis if network has not found sponsors by Wednesday (Dec. 16).

*Any way you look at it Ben ...
in Detroit you know
where you're going
with WJBK-TV.
They lead the
market consistently.*

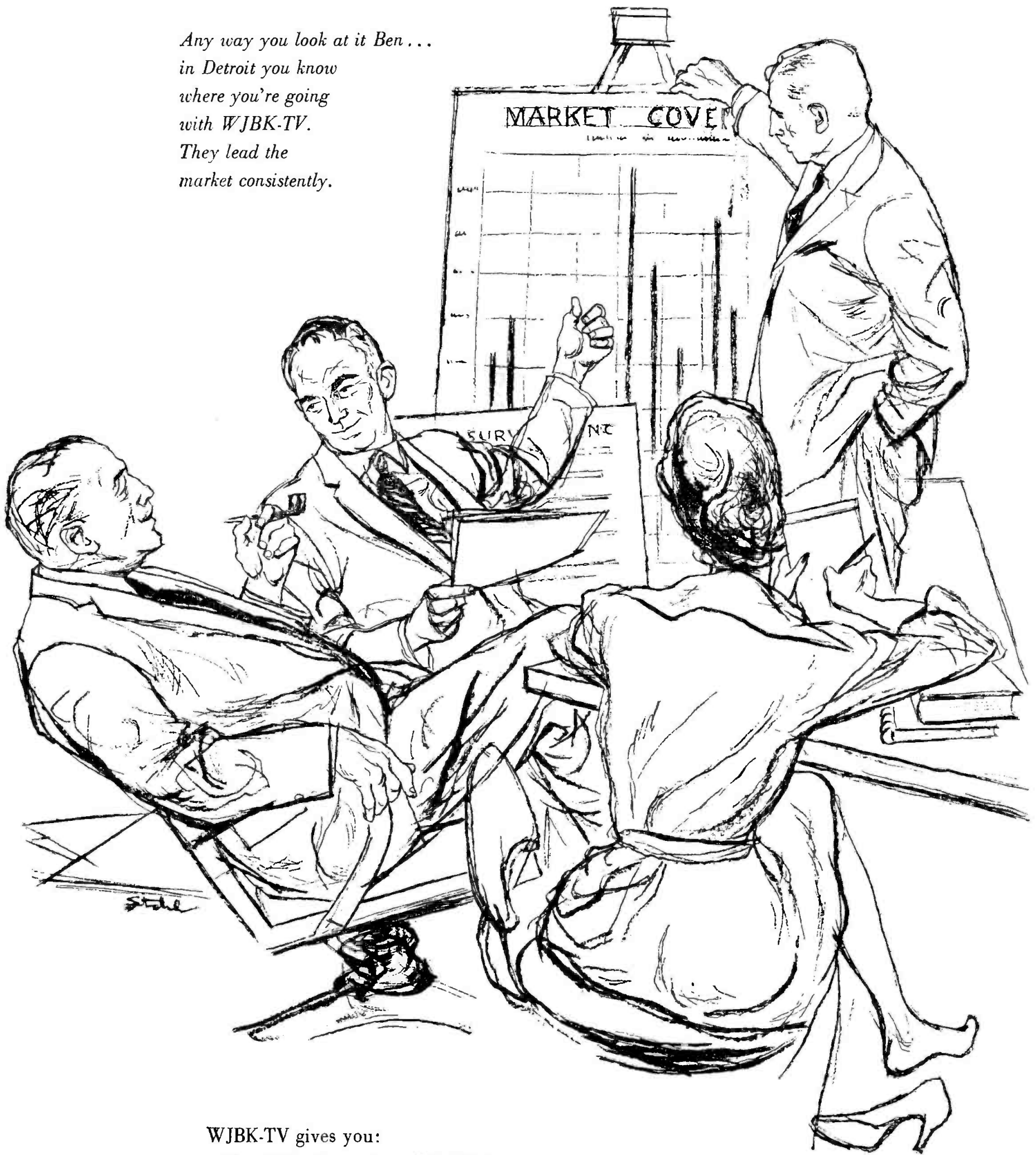

WJBK-TV gives you:

- The CBS address for 1,900,000 homes.
- 9 billion dollars of purchasing power.
- The nation's fifth largest market.

WJBK-TV *call Katz*
DETROIT CHANNEL 2

a **STORER** station

National Sales Offices:

625 Madison Ave., N.Y. 22 • 230 N. Michigan Ave., Chicago 1

WEEK IN BRIEF



MR. MULLINS

Keep 'thimking' • There has been a singular lack of activity on the part of broadcasters in searching out new fields for their services, Thomas M. Mullins, president of Mullins/Earl Assoc. asserts in this week's MONDAY MEMO. 'Seek and ye shall find,' is the essence of the Mullins approach to increased radio advertising—keeping your eyes opened for "sleepers" hidden among the products you are now promoting. Page 27.

Broadcast business fine • Roundup of top major markets and station representatives shows faith of agencies, sponsors and public hasn't been shaken by quiz-payola investigations, judging by solid December billings and good prospects for 1960. Page 29.

Lestoil in radio • Liquid detergent manufacturer Adell Chemical plans its first pilot use of spot radio. Up to now it's been deep in spot tv along with nibbles in newspapers. Page 29.

Spot revenue snowball • In tv, spot gross billing continues unprecedented climb, gains 18% in third quarter, maintains pace for nine months that is 21.9% above last year's period. Page 34.

Stanton-Cowan hassle • Wrangle over Louis Cowan's return to work as CBS-TV network head breaks into open as he releases resignation letter and CBS President Frank Stanton issues reply. Page 46. James T. Aubrey Jr. named network president. Profile page 44.

CBS won't contest FCC • Network decides against a hassle over FCC's order prohibiting representation of its affiliates. Page 56.

FCC classroom • A parade of campus intellectuals, religious leaders, and civic figures lined up outside Hearing Room B of the ICC Building last week to give the FCC recommendations on a general cleanup of broadcasting. All had proposals of varying quality and length. Most meant well. Few said anything new. Page 64.

Blue Book revisited • What was in the little book that caused the great war? History of the FCC's 1946 programming manual, now out of print, out of use but, owing to several mentions at last week's hearing, not out of mind. Page 66.

Case of the unsent letter • Key document in St. Louis ch. 2 case shown never to have been sent. But two other damaging *ex parte* communications found and inserted in record as rehearing gets underway in Philadelphia. Page 84.

Payola hearing weeks away • Oversight's Chairman Harris sees no hearings for five or six weeks. Staffer Richard Goodwin quits in wake of *Life* magazine article. Page 88.

Damages out in \$150 million suit • Judge rules songwriters in six-year-old antitrust suit against BMI and broadcasters have no standing to sue for damages on performance-rights issues; lets other charges go to trial. Both sides claim sweeping victory. Page 92.

DEPARTMENTS

AT DEADLINE	9	THE MEDIA	44
BROADCAST ADVERTISING	29	MONDAY MEMO	27
BUSINESS BRIEFLY	40	OPEN MIKE	20
CHANGING HANDS	54	OUR RESPECTS	135
CLOSED CIRCUIT	5	PROGRAMMING	92
COLORCASTING	98		
DATEBOOK	17		
EDITORIAL PAGE	136		
FANFARE	120		
FATES & FORTUNES	104		
FOR THE RECORD	122		
GOVERNMENT	64		
LEAD STORY	29		
INTERNATIONAL	91		



EFFECTIVE COVERAGE!

WILX-TV

Channel 10

Completely Covers Michigan's
Rich GOLDEN TRIANGLE with
a City Grade Signal!

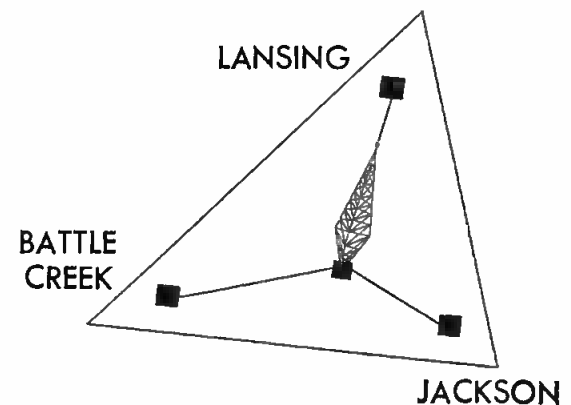

WILX-TV

Serves and Sells
Michigan's No. 1
Market outside Detroit

SOME PRIME TIME
STILL AVAILABLE

contact
VENARD, RINTOUL & McCONNELL, INC.

WILX-TV

Channel 10

Associated with
WILS—Lansing
WPON—Pontiac

FOR
THE

SEVENTH

CONSECUTIVE
YEAR—

REGIONAL RADIO WOW

IS SELLING TO



MORE LISTENERS

than the Next TWO Omaha Stations Combined!



MORE LISTENERS

*than the COMBINED Audiences of 67 other
Stations in the Fabulously RICH*

103 County WOW
Service Area!

*Ask your John Blair man to show you
Twelve New Radio WOW Audience Studies*

★ 6 am to 6 pm Monday through Friday
Pulse of WOW Area—Jan. Feb. 1959

REGIONAL RADIO

FRANK P. FOGARTY, Vice President and General Manager
BILL WISEMAN, Sales Manager
JOHN BLAIR & COMPANY, Representatives

WOW

Omaha
CBS
AFFILIATE
IN OMAHA AND
103 COUNTIES

A MEREDITH STATION — affiliated with Better Homes and Gardens and Successful Farming Magazines

FCC IN RATINGS, PROGRAMS?

Two educators favor government surveys, laws on what shows to be seen and when

Government should finance and oversee all ratings, surveys and research into radio and tv, two college professors told FCC Friday (Dec. 11) in that agency's broadcasting hearings.

Also, both said, FCC should require networks and stations in same market to program different types of entertainment at specified hours so public would have choice. Prof. Ithiel Poole, MIT professor of political science, said research has proven that when culture program is only one available, people will watch and thereby benefit.

He said research and ratings should become function of government—possibly farmed out to foundations—with budget “in the millions.” Prof. Poole also proposed federal-supported nationwide educational tv network of boosters and satellites.

His views were supported by Virginia U. Economics Prof. Percy Tannenbaum who charged that tv's problem is dependency on ratings. Ratings should not be in hands of private individuals, he said, because profit motive may affect results.

Commissioners hit Poole-Tannenbaum proposals as “censorship” and “disturbing.”

Theodore Peterson, dean of College of Journalism and Communications, U. of Illinois, said: “Too many broadcasters and advertising men alike regard the airwaves as an adjunct of the marketing system . . .” To put advertising in proper perspective, Commission should lend its weight in getting admen out of programming.

Prof. Peterson also advocated direct regulation of networks, closer scrutiny of applications and license renewals and clearer definition by Congress of Commission's responsibilities.

Dr. Sydney Head, Miami (Florida) U. director of broadcasting, said licensee should be relieved of sole responsibility for programming by placing liability directly on networks. He endorsed proposals of Dr. Peterson and others for direct network regulation and divorce of advertisers from programming.

William F. Lynch, S. J., Georgetown U., and author of *The Image Industries*, said that “it is the basically mediocre image of ourselves and the image of this nation, as it is being projected to our-

selves and to the world by tv, that is bothering millions of Americans.”

Father Lynch recommended establishment of national committee to issue annual or semi-annual reports on achievement or lack of achievement of industry and “some bold, positive and creative strokes on the part of the industry itself.”

Prof. Reuel Denney, U. of Chicago, author of *The Astonished Muse* a book about mass media, thought that foundation headed by industry “is the best solution in sight for many of our difficulties.” Closer regulation and control of broadcasting by government is not answer, he said.

He did ask, however, for requirement that all programs be labeled as to agencies involved, production costs, credit lists and extent of audience.

Ronald Coase, economics professor at U. of Virginia, told Commission permission for broadcasters to use spectrum should be auctioned to highest bidder as only reasonable way to operate in U.S. economy. He also advocated pay tv and thorough investigation of programming.

Books banned

Radio & Television Executives Society in New York last week ran afoul of postal laws while conducting its third annual Christmas raffle.

It has been customary for RTES members to mail books of raffle tickets (10 tickets per book at \$1 per ticket) to acquaintances they think may buy. Post Office last week advised RTES that mails could not carry lottery material. Reportedly Post Office acted on complaint of Ashtabula, Ohio, broadcaster who got raffle book in mail.

RTES advised members last week to circulate books by messenger or in person. Drawing at annual Christmas party Dec. 16 will award such prizes as Rambler, Fiat, tv sets and radios. In past years RTES has raised \$8,000-\$10,000 for welfare fund.

Hearings resume today (Monday) in FCC's main hearing room, Rm. 7134 of Post Office Bldg., at 10 a.m.

Future witnesses • Two industry-oriented witnesses, first yet, are scheduled to appear before FCC in its programming study this week. They are Ralph Renick, Radio-Tv News Directors Assn., and Erwin Y. Franckel, Erwin Franckel Productions.

Others announced for first two days: Prof. Elmer E. Smead, Dartmouth College; John Fischer, *Harper's Magazine*; Eric Larrabee, *American Heritage*; Watson Davis, Science Service; Dr. Walter W. Eshelman, National Education Assn.; Mrs. Pauline S. Weeden, Links Inc. (women's organization), all today (Dec. 14); Mr. Renick, Prof. Robert Gessner, New York U.; Dr. Stanley I. Stuber, Council of Churches, Kansas City; Harold E. Younkman, Madison County (Ohio) Schools; Mr. Franckel, and Rabbi Maurice Eisendrath, Union of American Hebrew Congregations, all tomorrow (Dec. 15).

On Dec. 17, it was learned, Gloria Parker, who has picketed New York networks at times, will appear. So also, it was understood, will Chicago perennial political candidate Lar Daly.

Donald McGannon, Westinghouse Broadcasting Co. president and chairman of NAB's Tv Code Review Board is scheduled to appear Dec. 18. Representatives of advertising organization are also tentatively scheduled for same day.

NAB and other major broadcasting representatives will appear after first of year, it is understood.

Account exec named in FTC complaint

Federal Trade Commission today (Dec. 14) announced filing of false advertising complaint against tobacco company, its advertising agency and account executive who, government said, was responsible for purported deceptive advertisement.

Complaint was filed against Brown & Williamson Tobacco Co., Ted Bates & Co., and David Loomis, Bates vice president and account executive. Advertising challenged was for Life cigarettes.

Although not first time advertising agency has been made party to complaint, this is first time in recent years account executive has been joined with advertiser and agency as party.

Complaint charges newspaper, magazine, radio and tv advertising for Life

AT DEADLINE CONTINUED

cigarettes falsely represent U.S. government endorsement for Life's "Millicel Super Filter." Also singled out in charges is tv demonstration in which two types of filters, one Life's, are shown in test tubes in which drops of water are being released. Commercial purportedly shows Life filter as having more absorption, thus lending credence to claim that its filter gives least tar and nicotine to smoker. Demonstration does not prove this at all, FTC said.

Mr. Loomis was identified as vice president and account executive of Bates agency who, allegedly, was responsible for or active in dissemination of challenged advertising.

Celler hits alliance of press and radio-tv

Bill aimed at preventing newspapers and magazines from owning "substantial portion of tv and radio" in "any area" will be introduced next January by Rep. Emanuel Celler (D-N.Y.), he is announcing today. But he said he will ask that bill be referred to House Commerce Committee, not House Antitrust Subcommittee which he heads.

Although bill apparently hasn't been drafted, there is possibility it may apply on broader scale than newspaper or magazine ownership of stations in single community. In obvious reference to recent exchanges between NBC Board Chairman Robert Sarnoff and

multiple-station-owner Time Inc. (*Time*, *Life*, *Fortune*), Rep. Celler said House tv quiz hearings have shown "many news periodicals are also the owners of tv and radio stations. . . . It was not the purpose of Congress . . . to sanction control of radio or tv by newspapers or magazines."

Citing posthumously-published statement by late Sen. Robert A. Taft that he failed to get GOP presidential nomination because of hostility of press, Rep. Celler said: "Tv reaches homes to an even greater degree than the press, and perhaps more effectively. . . . In any area, the man who controls both press and tv has an inordinate influence over [its] political, economic and cultural destiny."

He said his bill will not be directed against newspaper radio-tv ownership per se, such as *New York Times* ownership of WQXR, but where press holds "substantial" part of radio-tv facilities in community.

RCA consent decree in payola reported

First break in payola scandal loomed this week with authoritative reports RCA has signed consent judgment with Federal Trade Commission. Confirmation was lacking from both RCA and FTC.

FTC issued complaints earlier this month against RCA and two other rec-

ord companies, plus six record distributors, charging pay-offs to disc jockeys for playing their records (*BROADCASTING*, Dec. 7). This constitutes unfair trade practice and deception, FTC charged.

In addition to RCA, other record companies were London Records, New York, and Bernard Lowe Inc. (Cameo label), Philadelphia. Distributors were: Edward Barsky, Chips Distributing Co., David Rosen Inc., Universal Records Distributors Inc., and Sparks Music Distributors Inc., all Philadelphia, and Main Line Cleveland Inc., Cleveland.

Terms of rumored RCA consent decree could not be learned, but normally respondent accepts FTC cease and desist order against controverted practice, but does not acknowledge wrong doing.

Procedure usually is for FTC staff and respondent's lawyers to draft consent judgment. This is then submitted to FTC commissioners for approval. FTC commissioners meet regularly Tuesdays and Thursdays of each week.

FTC complaint was filed same week that trade agency chairman, Earl W. Kintner, announced his agency was making "intensive" investigation of payola.

Lorillard ad boss out

Thomas Tausig has resigned as advertising manager of P. Lorillard Co., New York. Though company has not announced his resignation, it was learned last Friday that Mr. Tausig has left company. Lorillard is major broadcast advertiser.

WEEK'S HEADLINERS



MR. ATLASS



MR. GEORGE



MR. WOOD

H. LESLIE ATLASS, broadcasting pioneer, vp and general manager of WBBM-AM-FM-TV and vp in charge of CBS central division, retires Dec. 31. CLARK GEORGE, vp and general manager of KNXT (TV) Los Angeles, succeeds him at WBBM-TV. ROBERT WOOD, sales manager of KNXT, elected vp and general manager of that station.

Mr. Atlass and his brother Ralph first licensed WBBM in Lincoln, Ill., in 1923. It operated then on 500 w and was one of the most powerful outlets in U.S. They sold part interest to CBS in 1929, and remainder in 1931. Two years later, Mr. Atlass was elected vp and placed in charge of what was then CBS' western division; he was named to present post with WBBM-TV when it was acquired by CBS in February 1953. Mr. Atlass is also vp of CBS Radio Div.; upon his retirement, E.H. SHOMO, vp and assistant general

manager, will become general manager of WBBM.

Mr. George joined CBS sales staff in 1946, was named eastern representative for KNX Los Angeles and Columbia Pacific Network in 1951, eastern sales manager of CBS Tv Spot Sales in 1952 and general manager in 1954. He was named to his present post last June. Mr. Wood, his successor, has been sales manager of KNXT since 1954. Previously he was account executive in New York office of CBS Tv Spot Sales.

HERBERT ZELTNER, vp and assistant media director of Lennen & Newell, N.Y., since November 1958, promoted to director of media, succeeding ANTHONY DEPIERRO, who has resigned. Mr. Zeltner joined agency in July 1956 as media supervisor on Colgate and Lorillard accounts. Earlier he had been media supervisor with Procter & Gamble, Cincinnati, for four years.

JAMES T. AUBREY JR. named president of CBS-TV network, on heels of resignation of LOUIS G. COWAN. Mr. Cowan, whose programming creations include \$64,000 *Question* and radio's *Quiz Kids*, quit in public tiff with CBS Inc. President Frank Stanton (story page 46, 48-49). Mr. Aubrey, executive vp who had been active operating head of network during Mr. Cowan's recent illness, formerly was with CBS-owned KNX and KNXT (TV) Los Angeles and also once served as programming and talent vp of ABC-TV.

FOR OTHER NEWS OF PEOPLE SEE FATES & FORTUNES



...collected by the National Association of Broadcasters

Black is black . . . white is white. It's the myriad shades of gray in between that give the trouble.

Now is the time when all of us in the broadcasting industry must take a close hard look at our policies and practices to see where they fall on the "gray scale." Everything that we do . . . every picture we show on the screen . . . every sound we put on the air must be measured against the scale of our personal, individual consciences. Not the Federal Code . . . not the Industry Code . . . but a private moral code. Self-regulation must start at home.

We're writing this out of self-interest. Interest in the tremendous investment of money and of audience trust and loyalty, built up through a company history that began almost 40 years ago.

And never in all that time, have we been so conscious of the fact that even one wrong is more sensational than a thousand rights. That a few broadcasters, who selfishly walk in the twilight shades of the gray area, can drag us closer to the strangling web of governmental regulation that is being spun for us.

How can we combat this?

We must all participate. None of us can afford to be spectators. No station manager, no matter how dedicated . . . no small group . . . can fight the industry's battle alone.

We must all practice self-control, through strict application of a personal moral code. We must all demonstrate self-regulation, through vigorous and whole-hearted support of the National Association of Broadcasters, and rigid adherence to its standards of conduct.

If you don't belong to the NAB . . . join. Subscribe to the Radio and Television Codes of Good Practice and live up to them.

Individually and collectively, we must be vigilant and aware of the "gray area." We must protect each other with truth, dignity and honesty.



WKY Television System, Inc.

WKY-TV WKY Radio

OKLAHOMA CITY, OKLA.

WTVT

TAMPA-ST. PETERSBURG, FLA.

REPRESENTED BY THE KATZ AGENCY

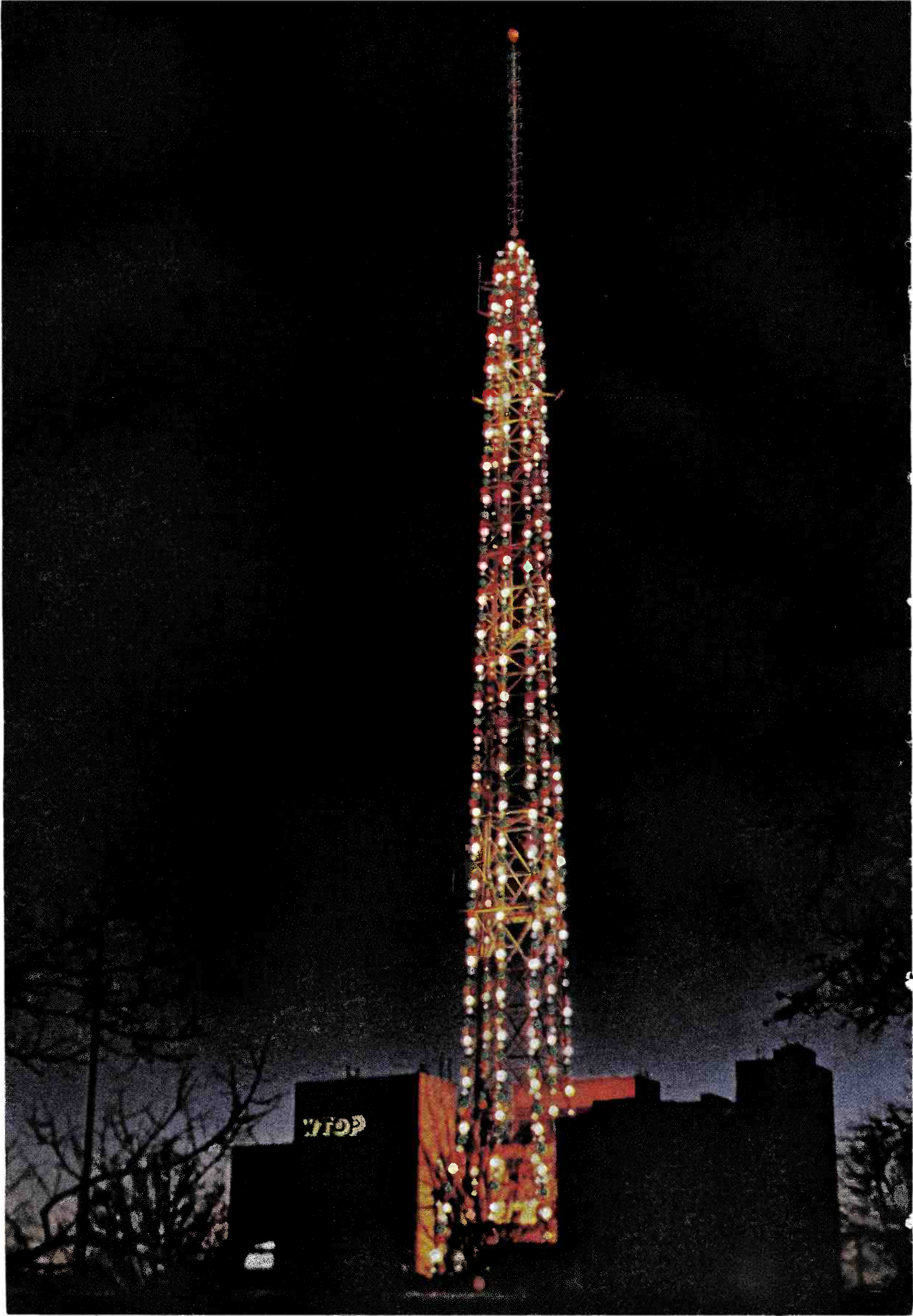



CHRISTMAS TOWER

Come Christmas Season
the WTOP-TV tower
becomes part of Washington's
holiday scene.

Merry Christmas!



Color Photograph By C. Middleton Hunt

OPERATED BY THE WASHINGTON POST BROADCAST DIVISION:

WTOP-TV, Channel 9, Washington, D.C.

WJXT, Channel 4, Jacksonville, Florida

WTOP Radio, Washington

GREAT MUSIC FROM CHICAGO

Sundays—8 to 9 p.m., the finest musical series ever seen on television, featuring:

- The Chicago Symphony Orchestra.
- Deems Taylor, commentator.
- World-famous conductors—Dr. Fritz Reiner, Sir Thomas Beecham, Sir John Barbirolli, Howard Barlow, Alfred Wallenstein, Walter Hendl, Andre Kostelanetz, Arthur Fiedler, Robert Trendler, Igor Markevitch and Izler Solomon.
- Renowned artists of the opera and concert stages—Dorothy Kirsten, John McCollum, Grant Johannsen, Byron Janis, William Miller, Walter Hendl, Rosalind Elias and George Tozzi.
- World's best jazz artists—Count Basie, Woody Herman, Joe Williams, Kai Winding, Sarah Vaughn, and Cozy Cole.

Another example of *responsibility* to the community we serve.

Live and in color on

WGN-TV
CHANNEL 9



441 N. Michigan Ave.—Chicago 11, Ill.

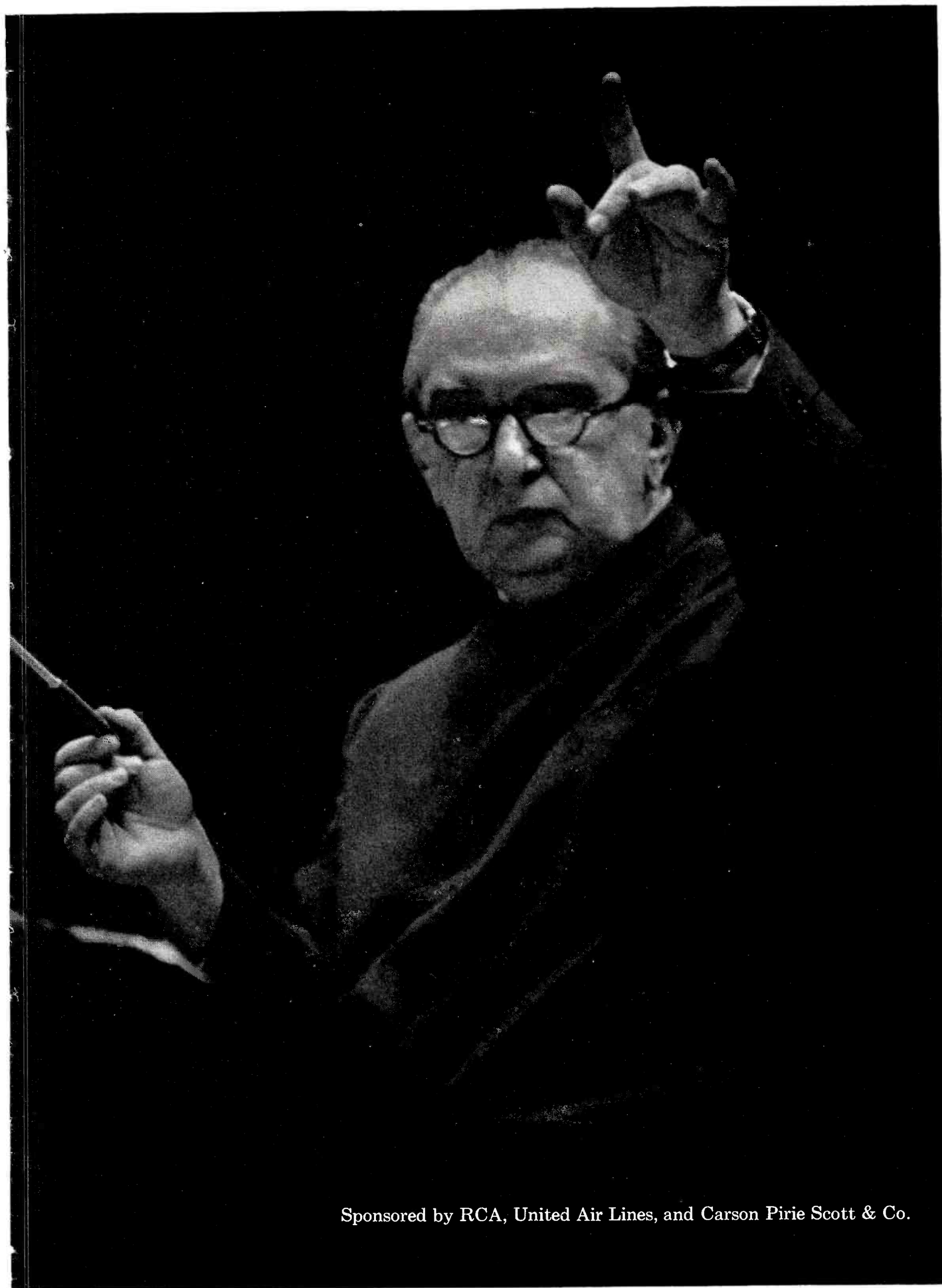

Sponsored by RCA, United Air Lines, and Carson Pirie Scott & Co.

It Communicates!

Missing front tooth to the contrary, the combination of miss and mistletoe demonstrates a high order of communication. So does WOOD-TV, even without the mistletoe. Ask anyone in Western Michigan. Or, get your Katz man on the horn. Communication in this part of the world is his specialty.

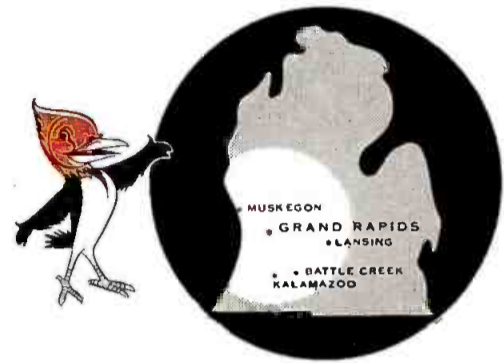

WOOD **AM**
TV

WOODland Center,
Grand Rapids, Michigan

WOOD-TV—NBC for Western and
Central Michigan: Grand Rapids,
Battle Creek, Kalamazoo, Muskegon
and Lansing. WOOD-Radio — NBC.



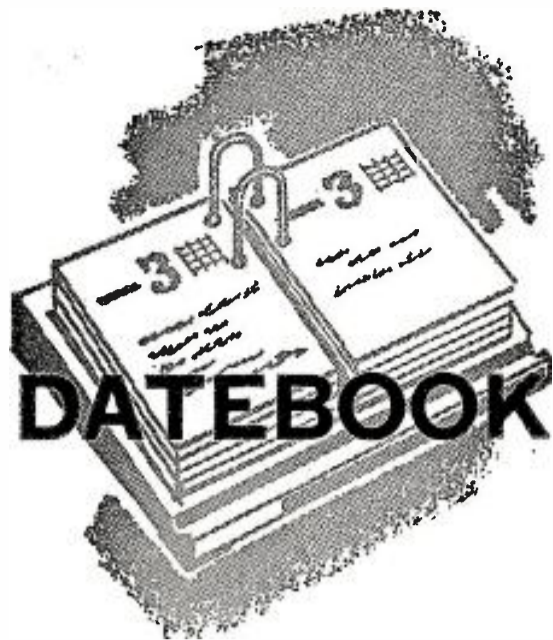

**A CALENDAR OF MEETINGS AND EVENTS
IN BROADCASTING AND RELATED FIELDS**
(*Indicates first or revised listing)

Dec. 14—Comments due at FCC on proposal to delete ch. 6 assignment to New Bedford, Mass.
Dec. 15—Radio & Television Executives Society timebuying-selling seminar. Kevin B. Sweeney, president, Radio Adv. Bureau, presents latest radio data. Hotel Lexington, New York, noon-2 p.m.
Dec. 15-16—Senate committee on communications holds hearings on tv boosters and community tv systems in Casper, Wyo. Sen. Gale McGee (D-Wyo.) will preside.
*Dec. 16—Greater Los Angeles Press Club, dinner meeting at club headquarters in Hotel Ambassador there. Panel discussion on whether interviews with visiting celebrities should be separate for press and broadcast reporters or joint for all media.
*Dec. 27-30—American Marketing Assn. Marketing Education Div. winter conference, Willard Hotel, Washington.
*Dec. 28-29—Alpha Epsilon Rho (national honorary radio-tv fraternity) western states regional convention, U. of Southern California Telecommunications Dept. and CBS Tv City, Los Angeles.
Dec. 31—Academy of Television Arts & Sciences New Year's Eve ball, Beverly Hilton Hotel, Beverly Hills, Calif.

JANUARY 1960

Jan. 5—Radio & Television Executives Society timebuying-selling seminar. Louis Hausman, director, Television Information Office, and Gilbert Seldes, author, critic and director of Annenberg School of Communications, U. of Pennsylvania, provide "A Critique At Mid-Season." Hotel Lexington, New York, noon-2 p.m.
Jan. 6-9—High Fidelity Music Show, Shrine Exposition Hall, Los Angeles. Sponsor: Institute of High Fidelity Manufacturers.
*Jan. 8—Federal Communications Bar Assn. Annual meeting and banquet, Statler Hotel, Washington.
Jan. 8—Academy of Television Arts & Sciences "close-up" dinner-show testimonial to Arthur Godfrey, Waldorf Astoria, New York. (Rescheduled from original announcement for Dec. 4 at Seventh Regiment Armory.)
Jan. 10-14—National Retail Merchants Assn., 49th annual convention, Hotel Statler-Hilton, New York. Sales promotion division board of directors meet there on 13th.
*Jan. 11—Comments due in FCC rulemaking to authorize vhf translators with a maximum power of 1 w.
Jan. 12—Radio & Television Executives Society timebuying-selling seminar. H. P. Lasker, vice president in charge of sales, Crosley Broadcasting Corp., and William E. (Pete) Matthews, vice president-director, media relations-planning, Young & Rubicam, view "How Many Commercials Make Too Many?" Hotel Lexington, New York, noon-2 p.m.
Jan. 13—Canadian Board of Broadcast Governors opens public hearings for second tv license in Winnipeg.
Jan. 18—Canadian Board of Broadcast Governors opens public hearings for second tv license in Vancouver.
Jan. 19—Los Angeles, Hollywood and Los Angeles Women's Ad Clubs joint luncheon meeting,

BROADCASTING, December 14, 1959

Hotel Statler, with Richard Ryan, general manager, KLOK San Jose, Calif. (president, Advertising Assn. of the West), as major speaker in an AAW program. Felix Adams, vp, Radio Recorders (Hollywood Ad Club president), will be chairman.

Jan. 19—Ninth annual Sylvania awards, Hotel Plaza, N. Y.

Jan. 19—Radio & Television Executives Society timebuying-selling seminar. Carl Lindemann Jr., vice president in charge of daytime programs, NBC-TV, and Frank Minehan, vice president-director of media-chairman of plans board, SSC&B, discuss "What's The Difference In Daytime Audiences?" Hotel Lexington, New York, noon-2 p.m.

*Jan. 19-21—National Religious Broadcasters 17th annual convention, Mayflower Hotel, Washington.

Jan. 22-24—Advertising Assn. of West midwestern conference, Lafayette Hotel, Long Beach, Calif.

*Jan. 25—Retrial of former FCC Comr. Richard A. Mack and friend, Thurman A. Whiteside, on charges they conspired to throw grant of Miami ch. 10 to National Airlines. U. S. District Court, Washington.

Jan. 25-29—National Sales Executives-International St. Louis Field Sales Management Institute, The Chase-Park Plaza Hotel there.

Jan. 26—Radio & Television Executives Society timebuying-selling seminar. Performers Bob Elliott and Ray Goulding quip on the question of whether audiences are "Out-Sophisticating" the sponsors. Hotel Lexington, New York, noon-2 p.m.

Jan. 26—Academy of Television Arts & Sciences forum on international television, Beverly Hilton Hotel, Beverly Hills, Calif.

Jan. 26-28—Georgia Radio & Tv Institute, Athens. Co-sponsors: Georgia Assn. of Broadcasters, U. of Georgia's Henry W. Grady School of Journalism. Speaker: Sig Mickelson, CBS News president.

Jan. 27—Advertising Research Workshop, Assn. of National Advertisers, Hotel Sheraton-East, New York.

Jan. 28-30—South Carolina Broadcasters Assn. annual convention, Hotel Greenville, Greenville. Ken Beachboard of WFBC-TV there will be in charge of the tv sessions.

Jan. 29—Aircraft Club of Detroit, Statler Hotel. Speaker: Robert Hurlleigh, president, MBS.

Jan. 30—Oklahoma Broadcasters Assn. annual meet, Hotel Tulsa, Tulsa. FCC Comr. Robert E. Lee and Balaban stations' John Box slated to speak.

FEBRUARY 1960

Feb. 2—Radio & Television Executives Society timebuying-selling seminar. T. Rodney Shearer, vice president, A. C. Nielsen Co., and James W. Seiler, director-president of American Research Bureau, square off on ratings. Hotel Lexington, New York, noon-2 p.m.

Feb. 3-5—Institute of Radio Engineers' winter convention on military electronics, Ambassador Hotel, Los Angeles.

Feb. 4—Minnesota AP Broadcasters Assn., annual meeting, Minneapolis.

Feb. 5—Advertising Federation of America mid-winter conference, Statler-Hilton Hotel, Washington.

Feb. 6—Art Directors Club of Los Angeles. Presentation of awards for best advertising and editorial art of 1959 at Statler Hotel there. Prize-winners and other outstanding entries will be displayed for following month at California Museum of Science & Industry.

Feb. 7-9—Advertising Federation of America First District conference, Statler-Hilton Hotel, Boston.

Feb. 8—Academy of Television Arts & Sciences at New York, forum on tv for children and teenagers, CBS Studio 52.

Feb. 8—Minneapolis Sales Executives Club, Hotel Normandy. Speaker: Robert Hurlleigh, president, MBS.

Feb. 9—Radio & Television Executives Society timebuying-selling seminar. Ray L. Stone, associate media director, Maxon Inc., and Robert A. Wulfhorst, associate media director, Dancer-Fitzgerald-Sample, discuss the "Station Image Factor In Timebuying." Hotel Lexington, New York, noon-2 p.m.

Feb. 14-20—Advertising Federation of America's National Advertising Week (co-sponsored by Advertising Assn. of the West).



Lee A. Lahey
Robert E. Eastman
& Co., Inc.
New York Office

CALLS—CALLS—CALLS

Some men believe that a slump, like a cold, has to run its course. Here's an idea you might try to break it up faster.

The best thing for a slump is a goal. Don't shoot buckshot. That's primary. Aim for a specific target. It helps clear the air. Reanalyze what you really have to sell. Find one approach you believe in more than anything else.

Then go out and go to work. And I mean WORK. MAKE LOTS OF CALLS.

Too often, when business slows down, the tendency for the salesman is to slow down as well. Nothing's better for morale than to make those calls.

Baron Rothschild summed it all up better than anyone I know when he said. "There are no bad times—just good opportunities".

Lee

P.S. Speaking now of advertising sales calls, in Dallas, KBOX makes more sales calls per dollar than any other advertising medium. See your EAST/man for details.



robert e. eastman & co., inc.

representing major radio stations

WNEW • WIL • KLAC • KJR • KXL
KNEW • WRIT • CKLW • WHBQ • KXOL
KBOX • WING • WCOL • KDEO • WARM
KQEO • WPTR • WSBA • WAAB • WKLO
KLEO • WEEP • KTOK • WSAV • KSYD
KWKY • WAMS • KXLR • WZOK • KRIZ
• KHEY •

Our Sincere

★ Seattle
KIRO

Boise ★
KBOI

Fargo ★
WDAY



PETERS, GRIFFIN, WOODWARD, INC.
Pioneer Radio and Television Station Representatives

NEW YORK • CHICAGO • DETROIT • HOLLYWOOD • BOSTON
ATLANTA • DALLAS • FT. WORTH • SAN FRANCISCO

★ Denver
KHOW

"A deep bow of thanks to the radio stations who have selected us to represent them starting this year. Our promise to advertisers and agencies -- that we will give you the most timely, comprehensive, and the best data -- on these markets and stations, plus the others we proudly represent.

Robert H. Ticker

Vice President - Radio

Los Angeles

KPOP

San Diego

XEAK

Honolulu
KMBB-KHBC

San Antonio ★
KENS

Corpus Christi
KRY5 ★

Pioneer Station Representatives Since 1932

PETERS, GRIFFIN,

NEW YORK • CHICAGO • DETROIT • HOLLYWOOD

Thanks...

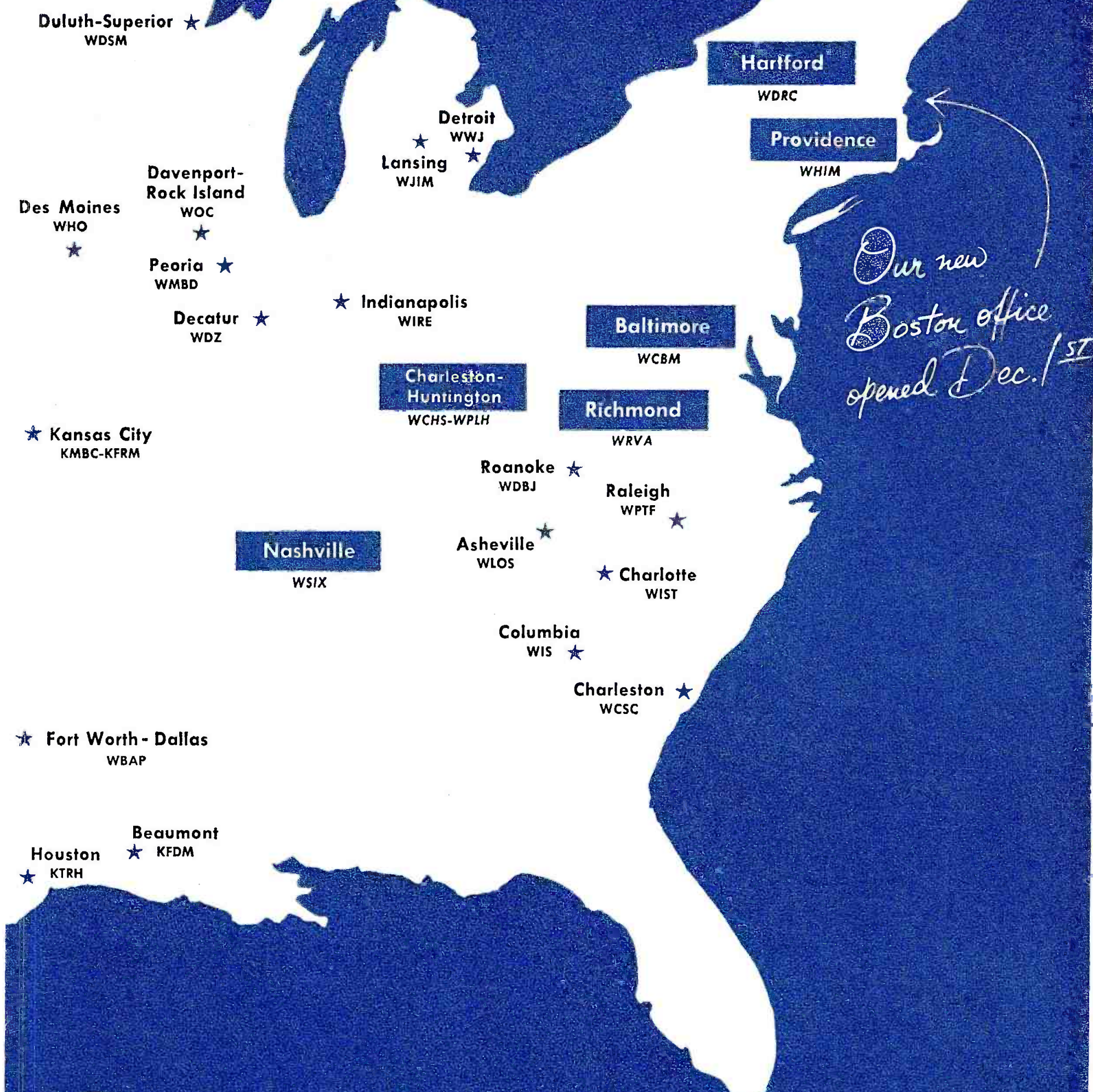

WOODWARD, INC.

• BOSTON • ATLANTA • DALLAS • FT. WORTH • SAN FRANCISCO

Don't bury your head

BUY NEGRO RADIO

An Ostrich with a buried head misses many things that are most obvious. If you haven't discovered Rounsville Radio's six Negro Markets you are overlooking an 824 million dollar consumer group. That's what Negroes in the Rounsville Radio area have ready to spend *AFTER* taxes! 80% of their money is spent on consumer items alone. Incomes are up 192% since World War II! To make sure you're getting your share of nearly one billion dollars, use Rounsville Radio! All six Rounsville Radio stations are Number-One Rated by *BOTH* Pulse and Hooper. Call Rounsville Radio in Atlanta, John E. Pearson, or Dora-Clayton in the Southeast today!



Personal Letter

An Advertiser's dream is a captive audience pre-conditioned to buy *his* product. The nearest thing to this is Rounsville Radio—100% programmed to the Negro audience. Negro performers tell your sales story to their Negro listeners, and believe me, they buy! A proper part of your budget must go to Rounsville Radio or you miss this market! We are one of the oldest and largest broadcasters in Negro Radio.

HAROLD F. WALKER
V.P. & Nat'l Sales Mgr.

FIRST U. S. NEGRO-PROGRAMMED CHAIN FIRST IN RATING IN SIX BIG MARKETS

WCIN 1,000 Watts (5,000 Watts soon)—Cincinnati's only all Negro-Programmed Station!

WLOU 5,000 Watts — Louisville's only all Negro-Programmed Station!

WMBM 5,000 Watts—Miami-Miami Beach's only full time Negro-Programmed Station!

WVOL 5,000 Watts — Nashville's only all Negro-Programmed Station!

WYLD 1,000 Watts—New Orleans' only full time Negro-Programmed Station!

WTMP 5,000 Watts—Tampa-St. Petersburg's only all Negro-Programmed Station!

BUY ONE OR ALL WITH GROUP DISCOUNTS!



ROUNSVILLE RADIO STATIONS

PEACHTREE AT MATHIESON, ATLANTA 5, GEORGIA

ROBERT W. ROUNSVILLE Owner-President HAROLD F. WALKER V.P. & Nat'l Sales Mgr.

JOHN E. PEARSON CO. Nat'l Rep. DORA-CLAYTON Southeastern Rep.

OPEN MIKE

Spotting the Jaguar

EDITOR:

My thanks for your excellent reporting of Jaguar's current radio spots [Nov. 30], which have been made available to Jaguar dealers and distributors. . . . We feel sure . . . your article will encourage station representatives to assist Jaguar dealers in radio scheduling.

Everett Taylor Martin
Vice president, public relations
Jaguar Cars Inc.
New York 22, N.Y.

How expert is the testimony?

EDITOR:

I read with mixed feelings the [Nov. 30] lead article, "Now casting: an FCC spectacular." I venture to predict that this set of hearings will go nowhere as this kind of hearing usually goes.

With the utmost respect for J. Edgar Hoover, James B. Conant, Norman Cousins, John J. McCloy and others of this select company, may I venture to ask the hitherto unasked question: "What the devil do these people know about radio?"

I wonder what significance can be attached to the fact that apparently those of us who do know something about non-rigged, non-payola, public service, public affairs, or just generally good radio are, as usual, unasked to appear?

I would sincerely propose that the first question asked be, "Do you listen to radio?" or, "Do you watch tv?"

Bert Cowlan,
General Manager
WBAI (FM) New York

Warning flares endorsed

EDITOR:

YOUR EDITORIAL THIS WEEK [DEC. 7] ONE OF FINEST IN 20 YEARS I'VE READ YOUR BOOK. IT'S NICE TO HAVE YOU IN THE BUSINESS.

ELDON CAMPBELL
V.P.-GENERAL MANAGER
WFBM-AM-TV INDIANAPOLIS

EDITOR:

Congratulations upon your editorials of Nov. 16 and Nov. 23. The two together constitute an eminently clear warning signal of the immediate dangers facing the industry and, at the same time, analyze the problem realistically and chart an intelligent course for the future. Broadcasting is very fortunate in having you in its corner for this continuing battle.

Oscar Elder
News Secretary
Office of Sen. Spessard Holland
(D-Fla.)
Bartow, Fla.

Dislikes Hurleigh's yardstick

EDITOR:

It was interesting to notice the divergent action taken by two network heads in regard to *Time* magazine's attack on television.

NBC Chairman Robert Sarnoff suggested that *Time* disaffiliate its stations from his network so that they might "open new horizons for tv, etc." This required real courage for a man in his position.

On the other hand Mutual's President Robert Hurleigh did broadcasting a great injury by giving the *Time* article lip service before the Sales Executive Club of Washington. In his own rantings about ratings he went on to reach the false conclusion that newspaper and magazine circulation figures are superior to radio and tv's ratings because they are based on subscriptions and newstand sales.

By these same standards, the total number of sets purchased should represent radio and tv's "circulation." However, the rating services ignore this figure, and deal only with the actual number of sets in use at any particular time. This would compare with actual readership, article by article, of newspapers and magazines. I find very few publications, bragging about their readership figures.

Charles A. Sprague,
General Manager,
WMAX Grand Rapids, Mich.

Too much negative attitude

EDITOR:

I think it is about time the broadcasting industry got its head out of the crying towel and started to speak up on the so-called tv quiz scandal and the payola crisis. I use the word "so-called" and "crisis" because it appears this is what the average citizen regards what they have heard and read.

The newspapers have played this to the hilt, which is natural for them. . . .

Just because one stalk of corn is found to contain a corn bore doesn't mean that the whole field is infested and should be left to rot. . . .

Vic Sterling
WANE-TV Fort Wayne, Ind.

BROADCASTING

SUBSCRIPTION PRICES: Annual subscription for 52 weekly issues \$7.00. Annual subscription including yearbook Number \$11.00. Add \$1.00 per year for Canadian and foreign postage. Subscriber's occupation required. Regular issues 35¢ per copy; Yearbook Number \$4.00 per copy.

SUBSCRIPTION ORDERS AND ADDRESS CHANGES: Send to BROADCASTING Circulation Dept., 1735 DeSales St., N.W., Washington 6, D.C. On changes, please include both old and new addresses.



Dear Santa,
Please thank our friends
in the television industry for
the wonderful reception
accorded us during our
first year. Give them our
sincerest Season's Greetings.
Albert L. Odeal
Harry Pertka
Boris Dayyan

**Tele
Features**
incorporated
New York: 15 West 44th St. • YUkon 6-4979
Hollywood: 6715 Hollywood Blvd. • HOLLYwood 5-6717

Contiguous Washington, D. C. trading areas now *at attractive*



Recent acquisition by the Evening Star Broadcasting Company, Inc. (WMAL and WMAL-TV, Washington, D.C.) of Stations WSVA and WSVA-TV permits a logical merger of time buying for the two markets.

Harrisonburg, located in the rich Shenandoah Valley 123 miles

What happens when you add WSVA-TV to WMAL-TV?

1. You gain measured coverage in a one-station area encompassing 100,000 television homes. Within WSVA-TV's Grade B contour are 41 counties in West Virginia, Virginia and Maryland. No *outside* station can achieve effective penetration of the Shenandoah Valley.
2. You buy at package-plan discount rate earned by announcements purchased on WMAL-TV. For example, purchase of WMAL-TV's 12-plan earns a weekly discount of 50% which applies to WSVA-TV purchases without limitation.

For details, check with H-R Television, Inc.

—Harrisonburg, Va. available to advertisers *combination rates.*

southwest of Washington and 120 miles northwest of Richmond, is a thriving city whose trading area, because of mountain ranges, is not effectively reached by outside stations.

Combination rates allow advertisers to reach Shenandoah Valley residents at very low cost.

What happens when you add WSVA Radio to WMAL Radio?



1. You gain effective coverage of approximately 189,000 radio homes. Because of WSVA's superior frequency (550 kc), its effective coverage area extends to some 35 counties in Virginia, West Virginia and Maryland.
2. You buy at combination rates. For a purchase of five or more announcements per week on each station concurrently, an advertiser receives bonus announcements equal in value to 20% weekly of cash expenditure on each station.

For details, check with H-R Representatives, Inc.



**So help me,
Smidley.**

If you pass up this Cascade buy again your days are numbered. Why Smidley, this Cascade four-station network carves out a market bigger'n Worcester in retail sales. It puts Indianapolis out of the running for E.B.I. and tops Oklahoma City and Toledo in food sales, Dayton and St. Paul in drugs. If you can't noodle the importance of this thing . . . we'll just find another boy for time buying.

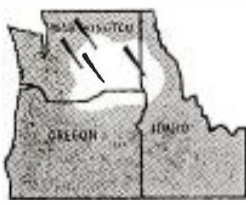
CASCADE TELEVISION

KIMA-TV YAKIMA, WASH.	KEPR-TV PASCO, RICHLAND, KENNEWICK, WASH.
KBAS-TV EPHRATA, MOSES LAKE, WASH.	KLEW-TV LEWISTON, IDA.

For Facts and Figures:

National Representatives:	Pacific Northwest:
GEORGE P. HOLLINGBERY Company	MOORE & ASSOCIATES

BROADCASTING PUBLICATIONS INC.

PRESIDENT.....Sol Taishoff
 VICE PRESIDENT.....Maury Long
 VICE PRESIDENT.....Edwin H. James
 SECRETARY.....H. H. Tash
 TREASURER.....B. T. Taishoff
 COMPTROLLER.....Irving C. Miller
 ASST. SEC.-TREAS.....Lawrence B. Taishoff

BROADCASTING*
 THE BUSINESS WEEKLY OF TELEVISION AND RADIO

Executive and publication headquarters:
 BROADCASTING • TELECASTING Bldg., 1735
 DeSales St., N.W., Washington, D.C. Tele-
 phone: Metropolitan 8-1022.

EDITOR AND PUBLISHER.....Sol Taishoff
 MANAGING EDITOR.....Edwin H. James
 SENIOR EDITORS: Rufus Crater (New York),
 J. Frank Beatty, Bruce Robertson (Holly-
 wood), Fred Fitzgerald, Earl B. Abrams,
 Lawrence Christopher.
 SPECIAL PROJECTS EDITOR..David Glickman
 ASSOCIATE EDITOR.....Harold Hopkins
 ASSISTANT EDITOR: Dawson Nail; STAFF
 WRITERS: George Darlington, Malcolm Oet-
 tinger, Jim Thomas, Leo Janos; EDITORIAL
 ASSISTANTS: Bob Forbes, Rita Larue, Pa-
 tricia Funk; SECRETARY TO THE PUBLISHER:
 Gladys L. Hall.

BUSINESS

V.P. & GENERAL MANAGER....Maury Long
 SALES MANAGER: Winfield Levi (New York)
 SOUTHERN SALES MANAGER.....Ed Sellers
 PRODUCTION MANAGER.....George L. Dant
 TRAFFIC MANAGER.....Harry Stevens
 CLASSIFIED ADVERTISING.....Doris Kelly
 ADVERTISING ASSISTANTS: Marilyn Bean,
 John Henner, Ada Michael.
 COMPTROLLER.....Irving C. Miller
 ASSISTANT AUDITOR.....Eunice Weston
 SECRETARY TO GEN. MGR....Eleanor Schadi

CIRCULATION & READER'S SERVICE

DIRECTOR OF PUBLICATIONS John P. Cosgrove
 SUBSCRIPTION MANAGER...Frank N. Gentile
 CIRCULATION ASSISTANTS: Charles Browne,
 Gerry Cleary, David Cusick, Paul Hagen,
 Christine Harageones, Marilyn Peizer.

BUREAUS

New York: 444 Madison Ave., Zone 22,
 Plaza 5-8354.

Editorial

SENIOR EDITOR.....Rufus Crater
 BUREAU NEWS MANAGER... Donald V. West
 ASSOCIATE EDITOR:.....David W. Berlyn
 N. Y. FEATURES EDITOR: Rocco Famighetti
 ASSISTANT EDITOR.....Jacqueline Eagle
 STAFF WRITERS: Richard Erickson, Valli
 Farhi, Janet Lantz.

Business

SALES MANAGER.....Winfield R. Levi
 SALES SERVICE MGR....Eleanor R. Manning
 EASTERN SALES MANAGER..Kenneth Cowan
 ADVERTISING ASSISTANT...Donna Trolinger

Chicago: 360 N. Michigan Ave., Zone 1,
 Central 6-4115.

MIDWEST NEWS EDITOR.....John Osbon
 MIDWEST SALES MGR.: Warren W. Middleton
 ASSISTANT.....Barbara Kolar

Hollywood: 6253 Hollywood Blvd., Zone 28,
 Hollywood 3-3148.

SENIOR EDITOR.....Bruce Robertson
 WESTERN SALES MANAGER.....Bill Merritt
 ASSISTANT.....Virginia Stricker

Toronto: 11 Burton Road, Zone 10, Hudson
 9-2694. CORRESPONDENT: James Montagnes.

BROADCASTING* Magazine was founded in 1931
 by Broadcasting Publications Inc., using the title:
 BROADCASTING*—The News Magazine of the
 Fifth Estate.
 Broadcast Advertising* was acquired in 1932,
 Broadcast Reporter in 1933 and Telecast* in 1953.

* Reg. U. S. Patent Office
 Copyright 1959 by Broadcasting Publications Inc.

BROADCASTING, December 14, 1959

ANOTHER WAY
RCA SERVES THE
BROADCASTING
INDUSTRY
THROUGH
ELECTRONICS

New
RCA-7513
gives you
BETTER
"PHOTOGRAPHIC"
QUALITY
in Color and
Black-White
TV



Registration is achieved more easily. Dark corners in the picture area are reduced. Glaring "halo effects" are eliminated. The signal current has good purity and low noise. These are some of the important advantages you can obtain with the new RCA-7513—the remarkable Image Orthicon that offers better "photographic" quality.

RCA-7513 precision construction includes accurate coaxial alignment of all sections of the tube and accurate interelectrode spacings. As a result, the three images produced within a three-image-orthicon type color camera can be practically identical in geometry. However, to take full advantage of the 7513's precision capabilities, the color camera should employ

deflecting yokes and focusing coils having precision construction and precision axial alignment with respect to each 7513.

A major design feature of the 7513...field mesh... assures that the scanning beam will strike the target perpendicularly at all points. This means improved corner resolution as well as reduced halo and edge effects. Moreover, the field-mesh defocuses the return beam, eliminating dynode spots from the picture.

Discover for yourself the new possibilities in color and black-white quality opened up by RCA-7513. Get in touch with your local RCA Distributor of broadcast tubes today for full details...or write RCA Commercial Engineering, Section L-13-02, Harrison, N. J.



RADIO CORPORATION OF AMERICA

Electron Tube Division

Harrison, N. J.

The SEATTLE results are in!!!

KOMO-TV AND ABC-TV

FIRST in popularity for Seattle-Tacoma and Western Washington!

The surveys agree on KOMO-TV and ABC-TV:

	American Research Bureau*	Nielsen Station Index*
KOMO-TV	41.3%	40.3%
Station B	34.5%	34.9%
Station C	18.8%	19.8%
Station D	4.8%	4.9%
Station E	.6%	.1%

Share of total homes reached

As a matter of fact, both Nielsen and ARB put us on top in total homes reached sign-on to sign-off Sunday through Saturday. For fascinating details and specific availabilities, ask your Katz man.

KOMO-TV 4 abc

Seattle, Washington

The Katz Represented Station

*Sources: share of total homes reached, Sun. thru Sat., 6 p. m. thru midnight, ARB Television Audience Report, 4 weeks ending Oct. 24, 1959. Nielsen Station Index, 4 weeks ending Oct. 18, 1959

MONDAY MEMO

from THOMAS M. MULLINS, president, Mullins/Earl Associates, Los Angeles.

Search for new radio advertisers . . .

Nose to the grindstone, shoulder to the wheel, eyes focused straight ahead on the job to be done. Those are the classic copybook components of the way to get the job at hand completed properly.

It often seems to me that broadcasters, particularly the operators of radio stations, have learned their lesson too well. They've done a fine job for their traditional advertisers, their regular customers; no argument about that. But they've failed to realize that the intense concentration recommended so wholeheartedly by the adage makers can actually result in a pretty limited point of view.

Broadcasters, not to be coy about it, seem more interested in going after business already active in radio, in trying to switch an account from "the other station" to their own doubtless superior facilities than in going after business that is new not only to them but to radio as well.

Wider View Needed • Even in the past decade, as tv has cut heavily into the kind of advertising that radio once considered particularly its own, it strikes me that there has been a singular lack of activity by radio broadcasters in searching out new fields for their services.

Let me illustrate with a pertinent, if personal, example. About three years ago, our agency got a new client, the Western Wood Excelsior Mfg. Co., whose business is selling excelsior, you know, the shavings of aspen trees grown on the slopes of the Rocky Mountains. For many years, this company had gone on pleasantly and profitably selling excelsior to fruit and vegetable packers, mattress manufacturers and even casket makers. But there was one item in the WWEM Co. line which the company president, Don B. Roesner, felt had a potential far beyond its current sales. This was the "Aspen-Pak" pad sold to cooler service people for replacement use in evaporative coolers.

So, for the first time in the company's history, it sought out an advertising agency for some professional help in developing a plan for marketing the cooler pads to the general public

through hardware and household appliance stores. Our initial research turned up the basic fact that evaporative cooler sales, and hence the sales of cooler replacement pads, are limited to particular parts of the country. The strongest potential markets were those with extremely hot and dry summer weather: Arizona, New Mexico, Southern California, West Texas, Oklahoma and Kansas.



Thomas M. Mullins was born in Cork City, Ireland immigrated with his family to Boston at the age of three and later moved on to New York, where he was studying marketing and television programming and production at New York U. when World War II took him out of the classroom and into the Air Corps as an information services officer. After the war, he spent three years with Irwin Vladmir & Co., New York agency, before moving cross-country to Los Angeles, where he worked as copywriter, tv-radio writer-producer and account executive for Atherton Advertising Agency, Noble Advertising Co. and Irwin-Los Angeles Advertising before joining forces with Warren Earl, former promotion-advertising manager of KCOP (TV) Hollywood, to form Mullins/Earl Assoc. in 1955.

Limited Budget Also Frozen • The advertising budget was limited; so too was the selling season—the three or at the most four summer months. This meant that the story of "Aspen-Pak" cooler pads had to be told rapidly and effectively over the Southwest. We proposed using radio as the basic medium, supplemented by strategic spots on tv.

This media plan accepted, we went ahead with the preparation of the radio commercials. Leaning heavily on the basic theme of the campaign; that changing evaporative cooler pads helps get the most out of the cooler, we produced a transcribed spot that opened with the sound of a baby crying, followed by the declaration: "Evaporative cooler pads need changing too." This voice and a second one then chased each other through the balance of the commercial, elaborating on the reasons why a replacement pad in a home or office cooler would provide more efficient cooling, more comfort for the cooler-owner during the hot summer months. The same copy approach was developed in the tv spots.

Hard Sell Sold Well • It was "hard sell," of course, and it probably was made doubly hard because this was the first time this company had ever used radio or tv to sell its products. It started in the early summer of 1956, when Western Wood Excelsior's cooler pad sales were less than 500,000 pads a year. In the summer just past, a continuation of this radio-tv promotion pushed sales past the two million unit mark.

The moral of this success story needs no embellishment. Here was an advertiser with an unusual problem calling for an unusual answer. Radio and television provided the answer so effectively that right now we are checking over the other items in the company's line to see if there isn't another "sleeper" hidden among the aspen shavings.

How about you, Mr. Broadcaster? Lift your eyes from the beaten path, your nose from the well-worn grindstone. Maybe you too will discover, to the left or right, a few "sleepers" of your own.

. . . not accounts from 'the other station'

"No, Adam, no problems . . .

just called to congratulate
you on your 15th anniversary"

It's hard to believe YoungPresentation is already 15 years of age.

But the calendar confirms it. This creative-minded kind of representation came into being December, 1944. Trusting station managements and receptive advertisers and agencies have brought us more than our share of success. To them, and to all the members of the Adam Young team who have worked so hard to please them, the Adam Young Companies say, "Thanks a million."



THE ADAM YOUNG COMPANIES

Adam Young Inc.

Young Television Corp.

Young Canadian Ltd.

NEW YORK
3 East 54th St.
New York 22, N.Y.
PL 1-4848

CHICAGO
Prudential Plaza
Chicago 1, Ill.
Michigan 2-6190

ST. LOUIS
915 Olive St.
St. Louis, Mo.
MAin 1-5020

LOS ANGELES
6331 Hollywood Blvd.
Los Angeles 28, Calif.
HOLlywood 2-2289

SAN FRANCISCO
Russ Bldg. (Rm. 1207)
San Francisco 4, Calif.
YUkon 6-6769

DETROIT
2940 Book Bldg.
Detroit 25, Mich.
WOodward 3-6919

ATLANTA
1182 W. Peachtree
Atlanta, Ga.
TRinity 3-2564

HAVE THE CRISES HURT TIME SALES?

- They haven't lessened advertiser-agency reliance on radio-tv
- Stations in major markets report business keeps climbing

The autumn avalanche of federal probes, headlines and gossip hasn't yet struck the broadcasting industry's most sensitive points—customers and audience.

Despite the unprecedented vigor and volume of payola and rigging charges, a major-market check by BROADCASTING shows:

- Advertisers and agencies haven't shown any loss of faith in radio and tv, judging by their business relations with networks, stations and representatives; there's no sign of cancellations.
- Audience reaction is negligible, almost nonexistent, if phone calls and mail at radio-tv stations are fair criteria.

Most important:

- December tv business is well ahead of last year and looks bright for early 1960, but
- Radio time sales are down at some stations for December, up at others; next year's prospects are generally good.

Station representatives, quick to feel agency-advertiser reaction, answered a question on late 1959-early 1960 spot business this way:

- Good or better, 17 votes.
- Worse, 11 votes.

The voting showed only two cases where spot tv is down for late 1959 and early 1960. Nine representatives found radio down in December and were uncertain about January compared to eight who described business as good or better than it was a year ago.

In one case an agency asked radio stations to sign a no-payola pledge (see Vaseline story page 30).

One business trend dominated comments of broadcast and rep officials who said business was down—the steel strike. The strike's impact spread into other industries, bringing an accumulation of lost pay envelopes and unemployment besides cancelled auto advertising due to lack of steel.

Reps Reaction Mixed • John Blair & Company—President John Blair announced radio spot reached an alltime high in 1959. Blair-TV—Billings for most stations comparable or better than a year ago; payola-quiz agitation not a factor since advertisers buy audience

and audience hasn't been affected. Blair Television Assoc.—Billings very good though seasonally slow as usual.

The Katz Agency—Billings not affected in radio or tv.

Peters, Griffin, Woodward—Business is very good; no scandal damage.

NBC Spot Sales—December radio and tv above same 1958 level; no payola-quiz problem; steel strike caused some auto business cancellations; January outlook "excellent."

Branham Co.—Not aware of any advertiser resistance; business about the same as a year ago.

Burn-Smith Co.—Business down from 1958 with December setting a record low for the month; any advertiser worried about quiz-payola charges would leave radio or tv only temporarily.

Radio-Tv Reps—Business off considerably due to low pre-Christmas business, not probes or headlines.

Avery-Knodel—No spot changes traceable to probes; advertisers recognize what's behind them; spot, the

"workhorse medium," down a little in radio, up in tv, especially in larger markets.

Television Advertising Representatives—Business is good, looks good for 1960; net impact of probes will be to make all broadcasters "more aware of their responsibilities."

Everett-McKinney—Billings up "considerably" in both radio and tv; no effect from probes or steel strike is apparent.

Headley-Reed Co.—Billings off in last quarter of 1959 but December projections are "quite good." Radio hit harder than tv, especially in secondary markets.

Weed Radio Corp. and Weed Television Corp.—December "not particularly good"; radio down, tv equal to last December; radio hit by steel strike due to advertiser caution during shutdowns.

Harrington, Righter & Parsons—No probe effects; regular December tv spot and holiday business are "fine."

Adam Young Inc. and Young Television Corp.—No impact yet but probes

Lestoil to give radio big try

Lestoil will be in radio for the first time starting Jan. 15.

That's the date Adell Chemical Co., one of television's classic success stories, begins a pilot radio spot campaign on WAKY Louisville using a minimum of 100 announcements per week for an indefinite period.

Adell Chemical has made broadcast history by buying mass tonnage of spot tv in fringe time periods on all tv stations in a given market. In many markets Lestoil (all-purpose liquid household detergent) placed its schedules before the product was available in the market thus producing forced distribution.

Lestoil advertising is placed through a house agency, Jackson Assoc., which like the manufacturer is in Holyoke, Mass. The radio testing will be measured on its own

merit as it was disclosed that Lestoil will pull out its tv and print money in the market.

The Lestoil test run in Louisville appears to be a media coup for John Blair & Co., the station's representative which consulted with Adell Chemical Co.

The Lestoil-maker told BROADCASTING last week that it has experimented with various media from time to time. In Chicago, for example, the one-time tv-only advertiser scheduled a 1,000-line per week contract for 52 weeks in *The Chicago Tribune*. The company said, however, that it had taken a "hiatus" after spending some \$160,000 on the *Tribune*, and it is now in tv in Chicago.

In its radio campaigning, Lestoil will use live announcements delivered by station personalities, recorded announcements and "scripts."

could lead to new federal controls, affecting all advertising. Radio dipping, tv up for year but radio should make strong comeback in 1960.

Paul H. Raymer Co.—Billings won't quite reach 1958 levels; payola-quiz effects not apparent but steel strike hurt; medium and smaller markets feel heavier advertiser investment in top markets.

Edward Petry & Co.—Radio Div. had increase in last quarter of 1958 though not up to expectations because of steel strike; first quarter of 1960 looks good; increase mostly in larger markets. Tv Div. slightly off from last December but 1959 billings exceed '58.

Robert E. Eastman & Co.—“Advertisers and agencies won't be taken in by newspaper publicity,” says Robert E. Eastman, who adds, “Payola represents a very, very tiny fraction of the industry.” One advertiser has inquired about payola. Business is in usual December dip; next year's spot radio should be good barring rail and steel strikes.

George P. Hollingbery Co.—Probes have no perceptible effect on billings; both radio and tv spot orders are ahead of last year.

Gil-Perna—No probe influence.

Continental Radio Sales—Ditto.

Venard, Rintoul & McConnell—No impact on billings except where its stations benefited when business was transferred from stations where disc jockeys were fired for payola reasons. Aside from payola, decline in rock 'n' roll record sales and new fall ratings mean “less time will be bought on rock 'n' roll programs.”

Forjoe & Co. and Forjoe-Tv Inc.—Tv prospects “tremendous”; current period not as “completely productive” for radio as in past years due to changed spending pattern and other factors but not to payola spotlight. Some payola-probe effect on radio is possible.

Station Representatives Assn.—Lawrence Webb, managing director, estimated spot radio and tv will surpass 1958 for year and fourth quarter. SRA predicts spot radio will reach \$185 million in 1959, up 6% over last year, and spot tv will go to \$385 million, nearly 12% up.

Tv in General • Television Bureau of Advertising expects 12% gain over 1958 with last quarter possibly higher; spot tv running close to capacity with IDs only type generally available; fourth-quarter spot may be 20% ahead of same 1958 period; network volume 9% ahead of 1958 for nine months and fourth quarter will surpass that margin. Total tv billings in 1959 should set record. No signs of advertising-agency reluctance because of probes.

Radio in General • Radio Advertising Bureau figures 1959 radio billings will

be 6-7% ahead of 1958 despite unusually bad first quarter this year. RAB doesn't say so but there's feeling network radio will again show a drop this year, though probes aren't a factor. Total radio billings in 1959 should set record.

Radio Networks • All four say there's no probe influence on sales. CBS Radio reports billings up; so does ABC, which says it signed 28 advertisers to \$3 million in new or renewal orders in last 30 days. NBC Radio billings off slightly in fourth quarter due to steel strike and the auto cancellations that developed from it; otherwise network billings might have been ahead of 1958. NBC signed \$4.25 million in new and re-

Payola jitters

Payola gave Vaseline (Cheesebrough-Pond's), an advertiser whose radio business is carried by 66 stations, a case of the jitters last week.

Vaseline through its agency—Norman & Kummel—asked for affidavits and got them from 44 stations by the middle of last week. An agency official said various representatives relayed the advertiser's request to stations that they signify under oath that their disc jockeys did not engage in payola and that tunes were selected through management committees.

An executive for a rep with a major lineup of Vaseline stations said his firm went along with the request and played middleman but that “Vaseline should have believed what our stations told them initially” (that is, integrity, no payola).

newal business in three-week period after announcing new program format. Mutual said quiz-payola excitement hasn't affected it at all.

Regional Record • Intermountain Network reports alltime record in national spot billings in October; first 10 months of 1959 31.4% over same 1958 period; October up 42.5% over same 1958 month.

Tv Network Gains • Healthy increases reported over last year. There's some thought that blue-chip advertisers (duPont, AT&T, etc.), extremely sensitive to public and governmental opinion, might be hesitant about long-range commitments until dust has settled. Some agencies say they sense storm signals in increasing reports that viewers may be getting disillusioned about commercials themselves because of Federal Trade Commission hints some

commercials may be misleading.

New York Tv • WPIX (TV) so far ahead of 1958 “it isn't even funny.” WABC-TV having excellent last quarter, bullish for early 1960. WNEW-TV having best year in history; December up; 1960 prospects good. WNTA-TV 100% above same 1958 period when station was deep in the red; it's still climbing out and sees hope in its more intellectual programming. WOR-TV shows increase over year ago and is “in good shape” for 1960. WRCA-TV feels quiz publicity is unpleasant but billings aren't hurt; December ahead of same 1958 month. WCBS-TV reports no scandal repercussions with billings exceeding last year's.

New York Radio • WRCA, adjusting for newspaper strike year ago, still is up 20% over early December in 1958; November was up 11% over same 1958 month; January will be even more above same 1959 period. WOR at an alltime high; January looks excellent; two-year growth amounts to 65%. WNEW running 7-8% ahead of last year's alltime high. WCBS “up to expectations”; December started sluggish but is picking up; soft spots due to steel strike. WINS running higher than last year but not as high as expected, mainly due to steel strike. WLIB is “bullish” as billings run 30% above 1958; steel strike not a factor; station is geared to Negro market. WQXR-AM-FM up 8% over December 1958. WMCA's current business is “excellent” and 1959 will be 20% over 1958; not yet optimistic about 1960. WMGM enjoying record billings, up 20%; last fiscal year was its best in 37-year history. WPAT (Paterson, N.J.) showing consistent 1959 gains, especially in recent months; many new national accounts added in last few weeks; 1959 gross up 26% over 1958; up 21% for last half of year; upswing expected to continue.

All's Well in Chicago • Increases reported by most radio and tv outlets. WGN-TV up 35% for first 11 months and 49% for November. WNBQ (TV) reports sizable rise. WBBM-TV believed to be over 1958 level. WBKB (TV) sales are higher. WGN's radio billings are up 31% for 11 months, and 42% for November; WGN Inc. 29.5% over same 11 months of 1958. WMAQ shows 11% rise for 11 months (local up 33%, spot down slightly). Good gains at WBBM for 11 months; December down. WCFL shows a 35-40% prospective increase for December, 33% for 11 months. WLS said to show gain. WIND billings up generally for 1959. Others reporting gains for year—WAAF, WAIT, WGES, WHFC, WSBC; all feeling seasonal December influence.

At WFOX Milwaukee, using stand-

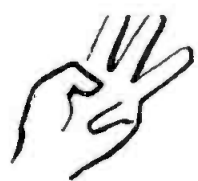

3 Points to remember about

WBBF

ROCHESTER, NEW YORK



- 1** *Prestige Ownership* – WBBF is affiliated with B. Forman Company, Rochester's distinguished department and specialty store. Maurice R. Forman, president of WBBF, is a leader in Rochester's Mid-town Redevelopment Plan, the success of which has gained nation-wide recognition.
- 2** *Audience Leadership* – Since Spring of 1958, WBBF has consistently had far more Rochester listeners than any other station. In the top 40 markets, only one station has a greater all-day share-of audience.
- 3** *New Representation* – Effective January 3, 1960, Station WBBF announces the appointment of

John Blair **and Company**
as exclusive national representative

ard music format, business was up 73% for November over last June; best fourth quarter in history.

Los Angeles Rosy • All stations report business the same or higher than at this time last year when they were emerging from the recession. Television—KABC-TV, same; KCOP up 30%; KHJ-TV better; KNXT better; KRCA, better; KTLA, better; KTTV, better. Radio—Gains shown at KHJ, KFAC, KFVB, KGFJ, KMPC, KPOL; same as year ago at KABC, KBIG, KFI, KLAC.

Happy D.C. Christmas • WRC-AM-TV showing big gains for national and local business in December and expects big increase in early 1960. WWDC far ahead for 11 months with "good healthy lead" for December. WOL business same as year ago; limited auto output is felt. WGAY (Silver Spring, Md.) sales good. WGMS "better than ever"; announcers told they're "free to accept payola for Bach, Brahms and Beethoven plays." WDON-WASH (FM) business is good. WTOP-AM-TV billings better; 1960 prospects are looking excellent. WMAL-AM-TV better than December 1958; first quarter in 1960 look fine. WTTG (TV) sales are better than year ago. Throughout the capital there is a general optimism about sales in 1960.

Dentists want strict control on dental ads

Stricter government control over "deceptive advertising practices" of dentifrice companies on television and in printed media was recommended last week by the American Dental Assn.

The association's recommendations were embodied in a talk by Dr. Paul H. Jeserich, ADA president, before the Greater New York Dental meeting last Wednesday (Dec. 9). Dr. Jeserich referred to the tv quiz revelations as providing "a stimulus" for upcoming investigations into tv programming and commercials by federal agencies and a self-examination of advertising practices by the advertising industry itself. He disclosed the following program, adopted by the association, to "correct the present unhappy situation":

- The enactment of legislation by Congress that would permit federal agencies to control "distorted advertising."
- The setting up of a code of fair practices for dentifrice through the cooperation of the Federal Trade Commission or the Food and Drug Administration with manufacturers of Health products.
- The Federal Trade Commission should be empowered to request scientific proof of advertised claims from dentifrice manufacturers.

SALES PITCHES Two experts present 'how to' demonstration

A session on "presentations" in radio and television brought two experts in the sales development field before the Radio & Television Executives Society in New York last week. For radio, Arthur H. McCoy, executive vice president, John Blair & Co., station representative, and for television, ABC-TV's Bert Briller, director of sales development, gave ample demonstration of how to deliver a skilled presentation.

Mr. McCoy urged agencies to be aware of radio's new sounds. To help them along, the Blair executive presented a series of sounds designed to create emotional impressions. He also had a proposal for agencies:

Radio, he said, ought to get its "own individual seat" at the agency's conference table and not be treated as an adjunct medium.

Tv has more to sell than circulation and cost efficiency, two things which Mr. Briller reminded the audience it has in abundance. His point was that tv combines the extra values of other media along with intangibles it can offer (sponsor identification, sales success, off-the-air impact, personality salesmen, dealer enthusiasm, merchandising, the "right" editorial framework and association with a network).

Mr. Briller emphasized that tv works with large packages, a typical half-hour weekly purchase on a network now totaling \$2.5 million—"that is more money than 3,330 of the nation's 3,500 advertising agencies billed in the full year 1958." The point here, he indi-



BLAIR'S MCCOY
Radio deserves own seat

cated, was that the tv stakes have become "high" and call for interplay of several factors. Hence the necessity for the rise of the presentation in tv—a means to get the "full story" across to the many people now involved in a single tv purchase. His stress was on communications: be simple, don't get tangled up in involved ideas and get to the point.

By means of a tape recorder, Mr. McCoy showed how sounds can be employed in dramatizing radio's story for the agency executive. The Blair firm, he said, has developed "sound seminars" for agency executives during which fundamentals of music, sound-effects and voice characterization are analyzed.

Agencies form co-op to exchange services

A new nation-wide organization of advertising agencies, devoted essentially to an interchange of marketing services and ideas, has been formed and is now seeking members in principal cities. Marketing Assoc. Inc. will be a separate corporation, jointly owned by member agencies. Instead of memberships, MAI will grant franchises for marketing areas to stockholder agencies. The franchise agencies will have the responsibility of providing market information and services within their own market to other MAI agencies.

MAI seeks agencies to be franchised in all major markets. Agencies must be billing \$500,000 or more and meet the organization's standards of marketing and creative services. One agency can request ideas, materials and artwork (with client permission) from an associated agency in another city and pays the agency supplying the materials through MAI, which collects a percentage to be applied to operating expenses, including experts in marketing services, a central research library, group purchasing services and lists of cooperating brokers and sales agencies in numerous industries. All franchise agencies are expected to provide requested services at the set fee.

At the first meeting Nov. 21 in Philadelphia, Howard Morris, president of Cavanaugh-Morris Adv., Pittsburgh, was elected treasurer *pro tem*. Harold Siegel, president of Siegel-Colgrove & Assoc., Louisville, was appointed chairman of the by-laws committee and marketing correspondent; Leonard Kanzer, partner in Marvin & Leonard Adv., Boston, was appointed chairman of the membership committee. MAI was organized at the suggestion of Raymond Rosenberg, president of Yardis Adv., Philadelphia. Its next meeting will be held Jan. 23-24 in that city, at which time officers will be elected. MAI expects to be fully operative by April.



**Tops in
action
add to the
big new picture
in
CHARLOTTE**

PETER GUNN
RIVERBOAT
77 SUNSET STRIP
THE MAN AND
THE CHALLENGE
PHILIP MARLOWE
TROUBLE SHOOTERS
BOURBON
STREET BEAT
ADVENTURES
IN PARADISE
THE UNTOUCHABLES
THE ALASKANS
THE LINE-UP
LOCK-UP
THIS MAN DAWSON

Adventure shows, mysteries—you name the big ones, WSOC-TV carries them in Charlotte. By being able to pick the best of both NBC and ABC, WSOC-TV comes up with program strength unmatched anywhere in the Carolinas. It is changing the viewing habits of America's 25th largest television market—fast! Buy WSOC-TV now . . . one of the great area stations of the nation.

WSOC-TV

CHARLOTTE 9—NBC and ABC. Represented by H-R

WSOC and WSOC-TV are associated with WSB and WSB-TV, Atlanta; WHIO and WHIO-TV, Dayton

SPOT TV'S 3RD QUARTER UP 18%

Automotive spending up 264%; 1959 increase 21.9% for 9 months

A standout year for spot television in 1959 appears assured.

For the third quarter, according to Television Bureau of Advertising's report today (Dec. 14), spot billed \$133,581,000 at the one-time rate. This represents an 18% increase in quarterly comparisons with last year.

Averaged with increases gained in the first and second quarters (of 25.7% and 22% respectively), spot's overall climb for nine months stands at 21.9%. This is nearly 5% over the estimated increase level in 1959 for spot made late in the spring by TvB President Norman E. Cash. On the basis of Mr. Cash's estimate, a 17% hike alone would bring in an additional \$86.9 million in spot gross expenditures (BROADCASTING, June 15).

To achieve this end, spot tv would need to bill about \$150 million in the fourth quarter, a figure that was exceeded in both the first and second quarters of 1959.

The TvB compilation is prepared for the bureau by N. C. Rorabaugh. These calculations show the third quarter 18% hike to be reflected in reporting by 342 stations compared to reporting in the third quarter 1958 of 317 stations of more than \$113.1 million.

When the 291 stations reporting in both years were compared, the increase in gross expenditure was computed at 13.8%.

In Summary • These were the high-points in national and regional advertiser investment in spot:

- Automotive alone was up 264% in the third quarter, from \$1.4 million in the 1958 like period to \$5.2 million.

- The gross spot investment of Procter & Gamble, tv's (and the country's) top national advertiser, was in the \$11.2 million bracket for the third quarter, only slightly behind the total P&G chalked up in the second quarter.

- American Snuff Co., Barcolene Co., International Shoe Co. and C. Schmidt & Sons were present in the top 100 spot spenders for the first time.

- Among the larger spenders in spot, these advertisers increased materially as compared to the same quarter 1958: American Home Products, Associated Products, Bristol-Myers, Carling Brewing, Drug Research, Max Factor, Ford Motor dealers, General Motors dealers, Gillette, Hertz, Kellogg, Lanolin Plus, Nestle, Pan-American World Airways, Ralston Purina, R.J. Reynolds Tobacco, and Wesson Oil & Snowdrift.

- In type of activity, spot announce-

ments continue to take most of the spot dollar (75.4%), programs much less (14.4%) and ID's the least share (14.4%). More than \$100.6 million went into announcements in the third quarter. Largest quarterly increase in the time of day was in nighttime (after Class A time periods).

The top 100 clients

THIRD QUARTER 1959
(Source: TvB-Rorabaugh)

RANK	Est. Expenditure
1.	Procter & Gamble Co. \$11,219,300
2.	Adell Chemical Co. 4,774,300
3.	General Foods Corp. 3,575,400
4.	Lever Brothers Co. 3,126,300
5.	Colgate-Palmolive Co. 3,106,600
6.	American Home Products Corp. 2,981,600
7.	Continental Baking Co. 2,625,200
8.	Warner-Lambert Co. 2,355,200
9.	Brown & Williamson Tob. Co. 2,327,500
10.	R. J. Reynolds Tob. Co. 2,223,400
11.	Bristol-Myers Co. 1,714,600
12.	Miles Lab. Inc. 1,629,900
13.	Kellogg Co. 1,620,400
14.	Philip Morris Inc. 1,371,300
15.	Gillette Co. 1,278,200
16.	International Latex Corp. 1,248,900
17.	Carter Products Inc. 1,210,100
18.	Texize Chemical Co. 1,175,900
19.	Lanolin Plus Inc. 1,031,000
20.	Ford Dealers 1,024,500
21.	Pabst Brewing Co. 986,800
22.	P. Lorillard & Co. 939,000
23.	General Motors Dealers 937,800
24.	Anheuser-Busch Inc. 905,300
25.	Drug Research Corp. 887,100
26.	Wesson Oil & Snow Drift 887,000
27.	Associated Products Inc. 827,100
28.	Coca-Cola Bottlers 826,100
29.	Pepsi-Cola Bottlers 823,900
30.	Corn Products Co. 772,200
31.	Sterling Drug Inc. 747,500
32.	Welch Grape Juice Inc. 738,200
33.	Robert Hall Clothes Inc. 733,200
34.	American Tob. Co. 706,900
35.	Avon Products Inc. 696,200
36.	General Mills Inc. 692,500
37.	Carling Brewing Inc. 679,500
38.	William Wrigley Jr. Co. 651,700
39.	Max Factor & Co. 651,700
40.	Ralston-Purina Co. 649,000
41.	Shell Oil Co. 645,700
42.	Esso Standard Oil Co. 637,200
43.	B. T. Babbitt Inc. 625,100
44.	Norwich Pharmacal Co. 593,000
45.	Sun Oil Co. 566,800
46.	Revlon Inc. 544,600
47.	Theo. Hamm Brewing Co. 544,000
48.	American Chic Co. 522,000
49.	U.S. Borax & Chemical Corp. 520,000
50.	Nestle Inc. 512,900
51.	Pharma-Craft Corp. 512,300
52.	Jacob Ruppert 509,200
53.	Andrew Jergens Co. 499,700
54.	Falstaff Brewing Corp. 488,000
55.	International Shoe Co. 487,300
56.	Pan-American World Airways 485,400
57.	Helena Rubinstein Inc. 480,900
58.	Food Mfgs. Inc. 479,500
59.	E. & J. Gallo Winery 461,600
60.	J. A. Folger & Co. 457,400
61.	Hertz Corp. 457,000
62.	Helene Curtis Industries Inc. 454,900
63.	Fels & Co. 440,700
64.	Liggett & Myers Tob. Inc. 437,400
65.	Standard Oil Co. (Indiana) 435,800
66.	Schlitz Brewing Co. 431,700
67.	Atlantic Refining Co. 409,700
68.	C. Schmidt & Sons Inc. 403,700
69.	Maybelline Co. 400,000
70.	Alberto-Culver Co. 396,000
71.	Armstrong Rubber Co. 392,700
72.	Pillsbury Co. 390,500

RANK	Est. Expenditure
73.	Wilson & Co. \$ 380,600
74.	P. Ballantine & Sons 380,200
75.	M. J. B. Co. 367,200
76.	Vic Tanny Enterprises Inc. 360,000
77.	Safeway Stores Inc. 354,700
78.	Piel Bros. 345,600
79.	S. C. Johnson & Son 343,800
80.	Paxton & Gallagher Co. 340,100
81.	Pacific Tel. & Tel. Co. 328,100
82.	Standard Oil Co. of Calif. 324,800
83.	Parker Pen Co. 321,900
84.	Phillips Petroleum Co. 315,800
85.	F. & M. Schaefer Brewing Co. 314,800
86.	Chrysler Dealers 312,400
87.	Kroger Co. 310,800
88.	Interstate Bakeries Corp. 308,400
89.	Burgermeister Brewing Corp. 308,000
90.	Ex-Lax Inc. 307,300
91.	Duncan Coffee Co. 306,100
92.	Rayco Mfg. Co. 303,000
93.	Dr. Pepper Bottlers 299,500
94.	Barcolene Co. 289,500
95.	Hills Bros. Coffee Inc. 286,300
96.	American Snuff Co. 285,900
97.	National Brewing Co. 285,300
98.	Jackson Brewing Co. 280,600
99.	Atlantis Sales Corp. 275,100
100.	Great Atlantic & Pacific Tea Co. 272,500

The kinds of business

NATIONAL AND REGIONAL
SPOT TELEVISION ADVERTISERS

AGRICULTURE	\$ 451,000
Feeds, meals	212,000
Miscellaneous	239,000
ALE, BEER & WINE	12,314,000
Beer & ale	11,597,000
Wine	717,000
AMUSEMENTS, ENTERTAINMENT	312,000
AUTOMOTIVE	5,233,000
Anti-freeze	36,000
Batteries	16,000
Cars	3,390,000
Tires & tubes	871,000
Trucks & trailers	40,000
Misc. accessories & supplies	880,000
BUILDING MATERIAL, EQUIPMENT	
FIXTURES, PAINTS	555,000
Fixtures, plumbing, supplies	126,000
Materials	163,000
Paints	181,000
Power tools	4,000
Miscellaneous	81,000
CLOTHING, FURNISHINGS, ACCESSORIES	3,295,000
Clothing	2,224,000
Footwear	838,000
Hosiery	147,000
Miscellaneous	86,000
CONFECTIONS & SOFT DRINKS	6,631,000
Confections	2,275,000
Soft drinks	4,356,000
CONSUMER SERVICES	3,825,000
Dry cleaning & laundries	6,000
Financial	695,000
Insurance	863,000
Medical & dental	45,000
Moving, hauling, storage	139,000
Public utilities	1,703,000
Religious, political, unions	201,000
Schools & colleges	44,000
Miscellaneous services	129,000
COSMETICS & TOILETRIES	14,196,000
Cosmetics	2,958,000
Deodorants	2,793,000
Depilatories	45,000
Hair tonics & shampoos	2,777,000
Hand & face creams, lotions	709,000
Home permanents & coloring	1,844,000
Perfumes, toilet waters, etc.	187,000
Razors, blades	283,000
Shaving creams, lotions, etc.	429,000
Toilet soaps	1,987,000
Miscellaneous	184,000

Continued

The Confidence Factor in radio

*New Pulse studies show
McClatchy stations KMJ and KFBK
lead in acceptance*

New Pulse qualitative studies in Sacramento and Fresno, California show the McClatchy stations, KFBK and KMJ, substantially ahead in public confidence and acceptance.

Briefly, respondents were asked which radio station:

1. gave most complete and accurate news
2. gave the greatest feeling of confidence in advertised products
3. gave the best programming variety

In each case, KFBK and KMJ ran substantially ahead of competition. In fact, in every instance, they topped the next two stations combined in listener favor.

Get what you want in your radio buy — listener confidence, ratings, coverage and economy — from KFBK and KMJ. Any Raymer man can give you details.



McClatchy Broadcasting Company

SACRAMENTO, CALIFORNIA

PAUL H. RAYMER CO., NATIONAL REPRESENTATIVE

Continued

DENTAL PRODUCTS	3,302,000
Dentifrices	2,229,000
Mouthwashes	864,000
Miscellaneous	209,000
DRUG PRODUCTS	10,100,000
Cold remedies	1,485,000
Headache remedies	2,240,000
Indigestion remedies	2,158,000
Laxatives	790,000
Vitamins	1,294,000
Weight aids	476,000
Miscellaneous drug products	1,331,000
Drug stores	326,000
FOOD & GROCERY PRODUCTS	30,218,000
Baked goods	5,830,000
Cereals	3,501,000
Coffee, tea & food drinks	6,809,000
Condiments, sauces, appetizers	1,565,000
Dairy products	1,199,000
Desserts	139,000
Dry foods (flour, mixes, rice, etc.)	2,671,000
Fruits & vegetables, juices	944,000
Macaroni, noodles, chili, etc.	533,000
Margarine, shortenings	1,016,000
Meat, poultry & fish	1,950,000
Soups	68,000
Miscellaneous foods	1,503,000
Miscellaneous frozen foods	226,000
Food stores	2,264,000
GARDEN SUPPLIES & EQUIPMENT	110,000

GASOLINE & LUBRICANTS	\$ 5,102,000
Gasoline & oil	4,488,000
Oil additives	285,000
Miscellaneous	29,000
HOTELS, RESORTS, RESTAURANTS	158,000
HOUSEHOLD CLEANERS, CLEANSERS, POLISHES, WAXES*	10,848,000
Cleaners, cleansers*	9,921,000
Floor & furniture polishes, waxes	549,000
Glass cleaners	75,000
Home dry cleaners	52,000
Shoe polish	209,000
Miscellaneous cleaners	42,000
HOUSEHOLD EQUIPMENT—APPLIANCES	987,000
HOUSEHOLD FURNISHINGS	806,000
Beds, mattresses, springs	486,000
Furniture & other furnishings	320,000
HOUSEHOLD LAUNDRY PRODUCTS	8,776,000
Bleaches, starches	1,311,000
Packaged soaps, detergents*	7,006,000
Miscellaneous	459,000
HOUSEHOLD PAPER PRODUCTS	780,000
Cleansing tissues	27,000
Food wraps	338,000
Napkins	1,000
Toilet tissue	152,000
Miscellaneous	262,000
HOUSEHOLD, GENERAL	1,291,000
Brooms, brushes, mops, etc.	50,000
China, glassware, crockery, etc.	205,000
Disinfectants, deodorizers	207,000
Fuels (heating, etc.)	90,000
Insecticides, rodenticides	689,000
Kitchen utensils	5,000
Miscellaneous	45,000

NOTIONS	\$ 65,000
PET PRODUCTS	1,020,000
PUBLICATIONS	218,000
SPORTING GOODS, BICYCLES, TOYS	547,000
Bicycles & supplies	3,000
Toys & games	457,000
Miscellaneous	87,000
STATIONERY, OFFICE EQUIPMENT	80,000
TELEVISION, RADIO, PHONOGRAPH, MUSICAL INSTRUMENTS	90,000
Radio & television sets	29,000
Records	21,000
Miscellaneous	40,000
TOBACCO PRODUCTS & SUPPLIES	8,398,000
Cigarettes	7,999,000
Cigars, pipe tobacco	368,000
Miscellaneous	31,000
TRANSPORTATION & TRAVEL	1,129,000
Air	924,000
Bus	45,000
Rail	157,000
Miscellaneous	3,000
WATCHES, JEWELRY, CAMERAS	817,000
Cameras, accessories, supplies	63,000
Clocks & watches	7,000
Jewelry	34,000
Pens & pencils	635,000
Miscellaneous	78,000
MISCELLANEOUS	1,927,000
Trading stamps	169,000
Miscellaneous products	952,000
Miscellaneous stores	806,000
TOTAL	\$133,581,000

*Starting with the 4th Quarter 1958 liquid cleaners (i.e. Lestoil) now included in subclass, "cleaners, cleansers."

Six figure spending on tv: why a local Ford dealer does it

Take it from Bill Strange—tv can sell cars.

Mr. Strange is sales manager of Adamson Ford Inc., one of five Ford dealers in the Birmingham, Ala., market area. Eighteen months ago his company was in last place among Ford dealers there, and was losing money. Then he started advertising on television. Today Adamson Ford is first in Ford sales, and profit for the year will hit \$140,000.

These are some details behind a tv success story Mr. Strange calls "almost unbelievable, but true."

Eighteen months ago Adamson spent \$2,500 in month for advertising, most of it in newspapers. Today its budget is \$15,000 a month, 95% in television (all on WBRC-TV), nothing in newspapers. This year's budget may go over \$200,000 on WBRC-TV. Agency for Adamson is T. O. White, Birmingham.

In June this year Adamson out-sold all Ford dealers in the South, and its profits for that month alone were \$25,000. It has maintained that sales leadership ever since.

In programming Adamson has relied principally on syndicated shows, with some spot buys and sponsorship of *Pro Football Highlights* on WBRC-TV. Its first and longest investment was in Ziv's *Sea Hunt* series. It's also sponsored *Highway Patrol*, *Dial 999*, *Bold Venture*, *Lockup* and *Mr. District Attorney*, also Ziv properties.

On *Sea Hunt*, as on all other

programs sponsored by Adamson, the commercials are delivered personally by Mr. Strange. This one, about 1960 Fords, is typical:

"Good evening. I'm Bill Strange, sales manager for Adamson Ford. It's no secret that cars are short. I know a lot of you have shopped around but can't find the model or style you want. Well, we can take care of most of you. Car allotments are based on sales and we have sold more cars than any other dealers in the area. In fact, we have sold more than twice as many cars as the second dealer which means we have twice the stock of any other dealer. We don't have as many cars as we'd like to have but as you can see [video shows slide of car lot] we have practically all models

in most colors and we can equip these cars the way you want them. We are certainly not going to hold back selling these cars.

"It looks like the steel workers will be going back to work next week so if we sell our entire stock of 150 1960 Fords we believe we will have more shortly. If you have looked for a car but couldn't find what you want come on down to Adamson Ford."

Explaining the customer response to his television advertising, Mr. Strange says: (1) Immediate sales results following the program either that night or within the next two days, and (2) there is a long-term lasting effect with purchasers referring to a commercial aired three or four months before.

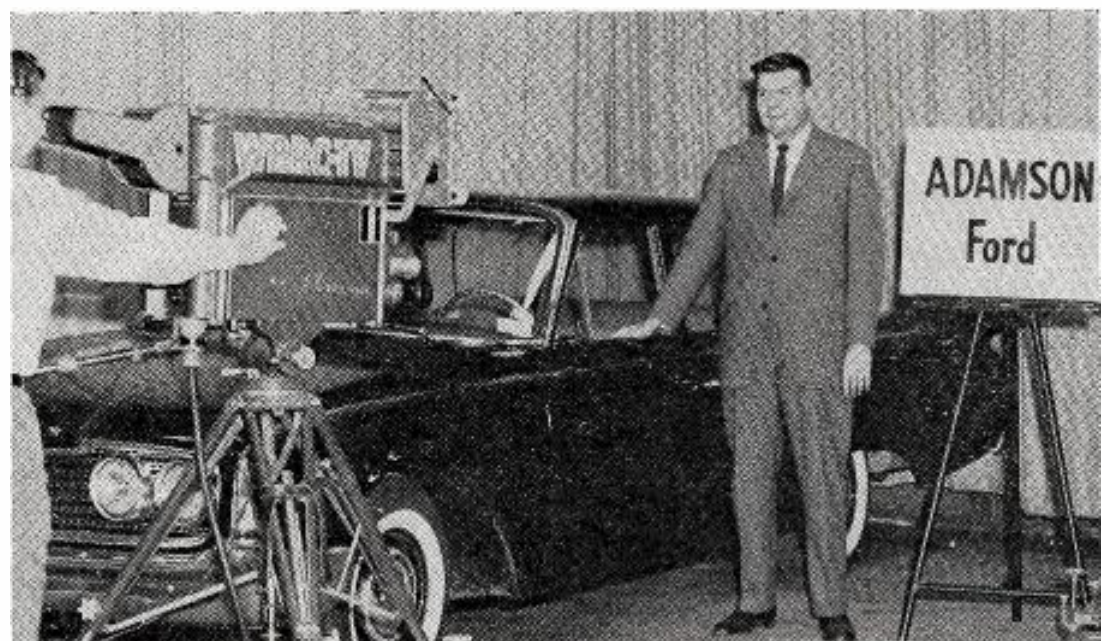

WHEN BILL STRANGE HAS A SALES MESSAGE, HE SAYS IT



YOU AIN'T HEARD NOTHIN' YET, FOLKS AL JOLSON

Nobody could sell a song like Jolson: His overnight success in the first talking movie, *The Jazz Singer*, had a million Americans repeating that film's first spoken words: "You ain't heard nothin' yet, Folks." Here was the pet of every music publisher in the business because above all, Al Jolson was a salesman! But YOU ain't heard nothin' until you've heard your own products and services sold in St. Louis by the cash-ringing salesmanship of Radio WIL. The sure delivery of WIL's dominant personalities delivers a buying audience unmatched in the Big River City because WIL is above all a salesman. No wonder WIL is first in Hooper, Trendex, Pulse and Nielsen!

WIL ST. LOUIS

WIL St. Louis THE BALABAN STATIONS

in tempo with the times

KBOX Dallas

John F. Box, Jr., Managing Director

WRIT Milwaukee

Sold Nationally by Robert E. Eastman

Same ad pattern set for 1960 elections

The two major political parties next year probably will stick to the television advertising patterns established for the last Presidential elections. They will take two or three half-hour programs per week from September to Election Day and will run five-minute commercials every other night on all three networks during that period. At least one network expects to spend \$150,000 to

\$200,000 in overhead to administer the advertising with concomitant schedule and program adjustments.

The preview was given in New York last week by William S. Hedges, vice president of NBC's new political broadcast unit, in a speech before the Assn. of Advertising Men & Women Dec. 8. Mr. Hedges told the group that he looks for more showmanship in political broadcasting for the coming election.

The network vice president filled in the group on 40 years of political broadcasting and the Sec. 315 equal

time provisions as amended by the last Congress. He also told the group he learned long ago to avoid setting any precedent of equal credit and insist on cash in advance from political sponsors. A Senator running for re-election some years ago asked for radio credit. Mr. Hedges won advance payment by explaining that the opponent might ask for equal treatment and that since the Senator could not acknowledge the other candidate a good risk, he might indirectly be responsible if he defaulted.

Sec. 315, as amended after the FCC's

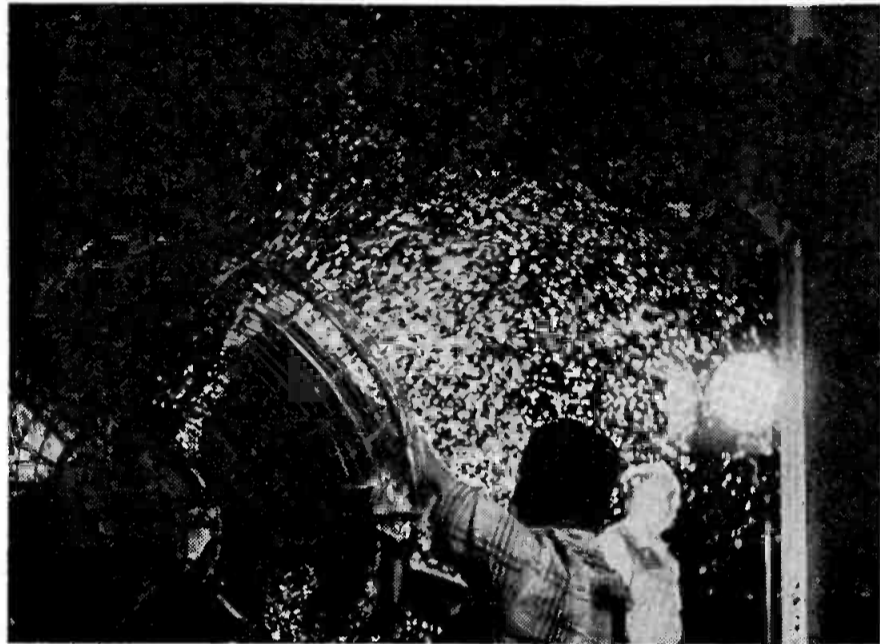

TV COMMERCIAL PREVIEW

Production sample • Stephen F. Whitman & Son of Philadelphia, founded in 1842, has been thinking about broadcast advertising for some time. Now the deliberation is over and Whitman's has a dozen video taped commercials to roll on two networks. Confectioner and agency, N. W. Ayer, found what they wanted for a one-two holiday blitz in *The Wizard of Oz* yesterday (Dec. 13, 6-8 p.m. EST) on CBS-TV and the *Liberty Bowl* football game in Philadelphia next Saturday (Dec. 19, 12:45 p.m.) on NBC-TV. (Benrus Watch Co. was co-sponsor yesterday and Gillette Co. Saturday.)

Whitman's *Oz* commercials, taped in color at CBS Television city in Hollywood, run the gamut from straight product presentation to pantomime to puppetry and ponytails. In the picture at left (above) technicians whip up a snowstorm for the entrance (center above) of carolers in a com-

mercial that uses only three spoken words, "It's Whitman's time," to open the scene. Another spot features a blonde youngster (left, below) who both dances and sings a gift-quandary theme with a supporting cast of puppets, Sportscaster Bud Palmer was seen once on the *Oz* show, providing a bridge to Saturday's game for which he does all commercials from a simulated press box. These were taped in monochrome at Elliott, Unger & Elliott studios in New York.

At right (below) agency producer Annette Bachner (she has since joined Benton & Bowles) and Ayer writer Hugh Best, who created the commercials, line up chocolates for the camera in another of four *Oz* spots, 90 seconds each (the sponsor will run eight 60-second commercials in the bowl game). Mr. Best and Mitch Leigh of Music Makers Inc., New York, collaborated on a Whitman's Sampler song running through the whole batch. Other credits: Tom Knitch, art director; John Walsh, storyboards; Michael Kane, director.

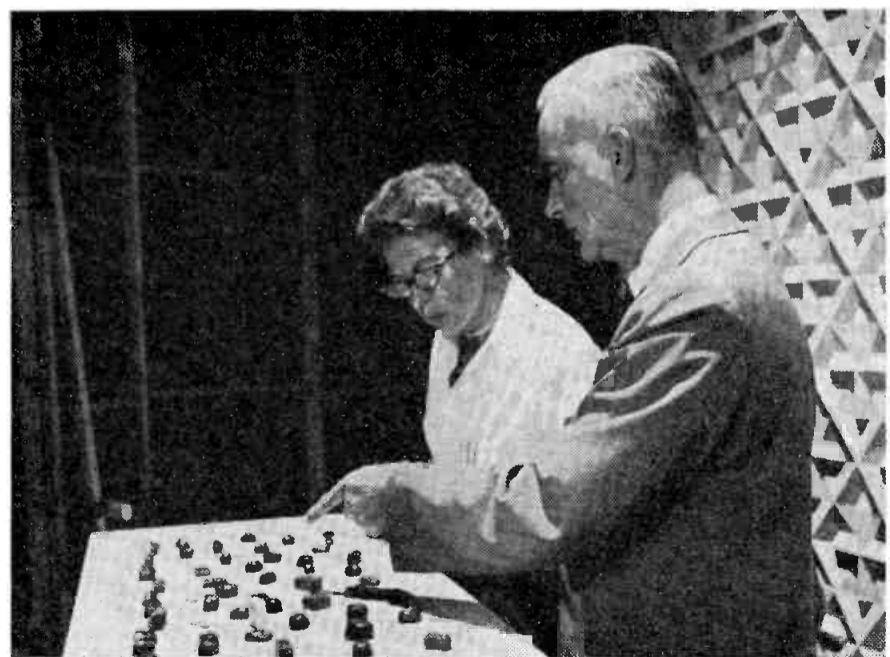

WNBQ'S
ALL-
TIME
SALES
RECORD
IN 1956...

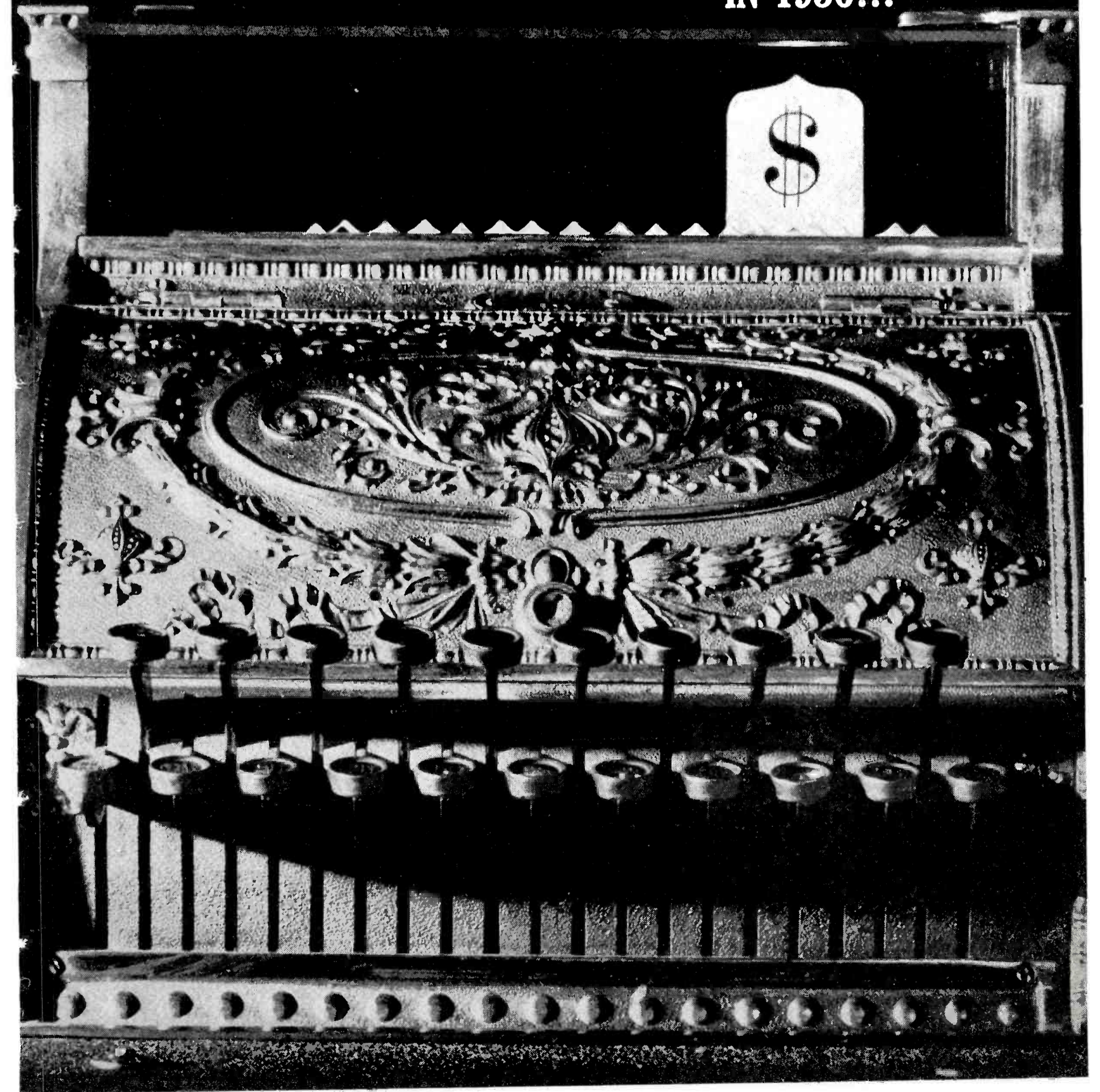

"Lar Daly Decision," now is workable, Mr. Hedges said in a question-answer session following his talk. To a question about ratings of political shows, he stated that in the heat of the campaign ratings go 'way up and some have scored higher than any other program in the same week'.

Chain store media ads may increase in 1960

Advertising budgets of variety chain stores may go up next year from 15 to 25%. Broadcasters can expect an increasing share of this business, even though the bulk of variety store advertising will remain in print. The forecast appears in the variety store edition of *Chain Store Age*.

Until three years ago television was virtually unknown in the field, but today tv is part of nearly all variety chains' advertising. "One chain, for example, can service 60 of its stores with one television station," the business paper states. Variety chains are among local radio customers and to a small degree are in network radio.

Big factors in the variety chain promotional picture next year will be the expanded use of consumer credit plans and a changing image "with value merchandising complemented by higher quality merchandising" in some departments, *Chain Store Age* says.

Miles Labs brewing headache for NCAA

Wade Advertising Agency of Chicago last week dangled a lucrative, long-term sports package before the Big 10—and sat back to await its "decision."

On behalf of its client, Miles Labs, the agency offered the Western Conference a three-year pact for tv rights to football, basketball and other athletic events starting coincident with the 1960-61 television season.

The decision is one, however, that for all practical purposes will be made by the National Collegiate Athletic Assn. of which the Big 10 is a member in good standing—at least at this time. The conference, a frequent critic of NCAA's controlled football tv policy, cannot make its own determination unless it decides to bolt the association or is dropped by NCAA.

Acting for Miles Wade seeks a proposed 26-week program of national telecasts. Coverage would include nine football games, 13 or more cage contests, a track meet and perhaps a swimming championship. The contract would call for an outlay of \$1 million per year for three years, plus option for renewal, with telecasts to be fed by a

network or specially-set hookup of stations. The \$1 million would be split equally among ten member schools and exceeds by \$100,000 the maximum ever received by the conference from NCAA football tv receipts.

Miles Labs, a heavy broadcast spender, already sponsors ABC-TV *Wednesday Night Fights* plus other network properties, and Wade has approached Lester Malitz, a New York sports tv promoter once identified with the Pabst fights. According to reliable estimates, Miles should shell out nearly \$10 million for time, talent and production costs over the three-year period if the package materializes.

Kenneth (Tug) Wilson, Big 10 commissioner, acknowledged receipt of the offer Tuesday and the conference's tv committee met Wednesday evening to discuss it. It was scheduled to report any suggestions or recommendations to the conference this past weekend.

• Business briefly

Time sales

Yule shoppers • CBS Radio announces the following purchases of pre-Christmas campaigns: Longines - Wittnauer Watch Co., N.Y. (Victor A. Bennett Inc., N.Y.), for co-sponsorship of 7-7:30 p.m. news programs; Shulton Inc., N.Y. (The Wesley Assoc. Inc., N.Y.), for two-week campaign for its men's toiletries; Yardley Co., N.Y. (N.W. Ayer & Son Inc., N.Y.), three-week saturation for men's gift products; Milton Bradley Co., Springfield, Mass. (Noyes & Co., Providence), month-long drive for its line of educational toys; Insurance Co. of North America, Philadelphia (N.W. Ayer & Son), will sponsor fifth annual *Sing with Bing* on Christmas Eve.

Women and children first • The Nestle Co., White Plains, N.Y., has started a five-week tv spot campaign in 31 markets for Nestle's Ever Ready cocoa, with filmed 20-second announcements aimed at women in daytime and children in kid shows. Agency: McCann-Erickson, N.Y.

Takes thirds • Colgate-Palmolive Co.,

N.Y., one-third sponsor of NBC-TV's *Laramie*, has renewed through 1959-60 season. Western series is seen Tuesdays, 7:30-8:30 p.m. EST. Agency: Ted Bates & Co., N.Y.

More beer • Kenyon & Eckhardt Inc., N.Y., already stocked with Pabst Brewing Co.'s (Chicago) Pabst Blue Ribbon and Blatz beers accounts, named to handle advertising for Pabst's Eastside beer account which moves to K&E from Young & Rubicam.

Oats and roses • The Quaker Oats Co., Chicago, through Lynn Baker Inc., N.Y., will sponsor ABC-TV's New Year's Day coverage of *Tournament of Roses Parade* from Pasadena, Calif. (Fri. 11:30-1:45 p.m. EST).

Takes half • Joseph Schlitz Brewing Co., Milwaukee, through J. Walter Thompson Co., Chicago, has signed for half-sponsorship of CBS-TV's new weekly series, *The Sunday Sports Spectacular*, which will be presented from Sunday, Jan. 3 through Sunday, April 10 (3-4:30 p.m. EST). Total of 13 specials will include coverage of sports not frequently seen by U.S. tv audiences, such as rodeos, polo, basketball games of the Harlem Globetrotters, sports car racing, spring training baseball, rugby, tennis, speedboat racing and others.

Agency appointments

• Richardson & Robbins Co. (food products), Dover, Del., appoints Kenyon & Eckhardt as agency, effective Feb. 1, 1960. Company is a recently-acquired subsidiary of the William Underwood Co., whose advertising is at K&E. Budget and media plans were not divulged.

• John H. Mathis, Park Ridge, Ill., appoints R. Jack Scott, Chicago, to handle advertising for its All-in-One Reducing Capsule, acquired by Mr. Mathis from State Pharmacal Co. Div. of Lanolin Plus Inc. He formerly was president of division. Radio-tv will be used in extensive advertising campaign for product.

• Halsam Products (wood and plastic toys), Chicago, has appointed Reach,



ARBITRON'S DAILY CHOICES

Listed below are the highest-ranking television network shows for each day of the week Dec. 2-8 as rated by the multi-city Arbitron instant ratings of American Research Bureau.

Date	Program and Time	Network	Rating
Wed., Dec. 2	Wagon Train (7:30 p.m.)	NBC-TV	32.1
Thurs., Dec. 3	Untouchables (10 p.m.)	ABC-TV	24.0
Fri., Dec. 4	77 Sunset Strip (9 p.m.)	ABC-TV	25.8
Sat., Dec. 5	Gunsmoke (10 p.m.)	CBS-TV	29.6
Sun., Dec. 6	Loretta Young (10 p.m.)	NBC-TV	32.6
Mon., Dec. 7	Danny Thomas (9 p.m.)	CBS-TV	29.9
Tues., Dec. 8	Star Time (9 p.m.)	NBC-TV	23.1

Copyright 1959 American Research Bureau

WNBQ's total sales for the first nine months of 1959 climbed 18% higher than the previous third-quarter record, set in 1956. Credit this healthy sales growth to advertiser confidence in WNBQ — confidence in the station's programming, audience and sales impact. And now, in the fourth quarter, this confidence continues to create new sales records. October total sales, for example, were 26% higher than any previous month in the station's history! Here is ample proof that your selling future in Chicago must include

WNBQ • NBC OWNED • CHANNEL 5 IN CHICAGO • SOLD BY NBC SPOT SALES

**SMASHED
IN '59**

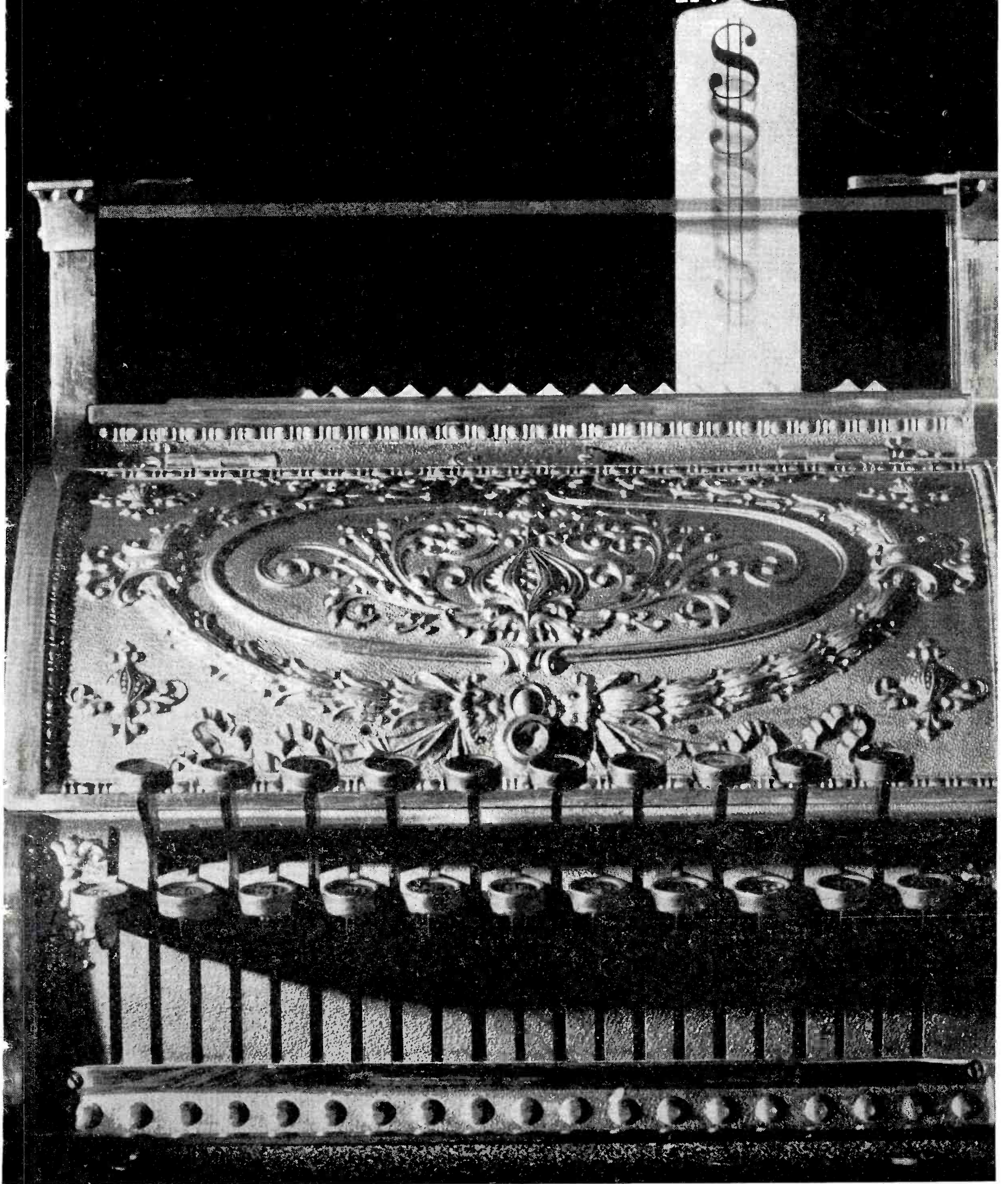

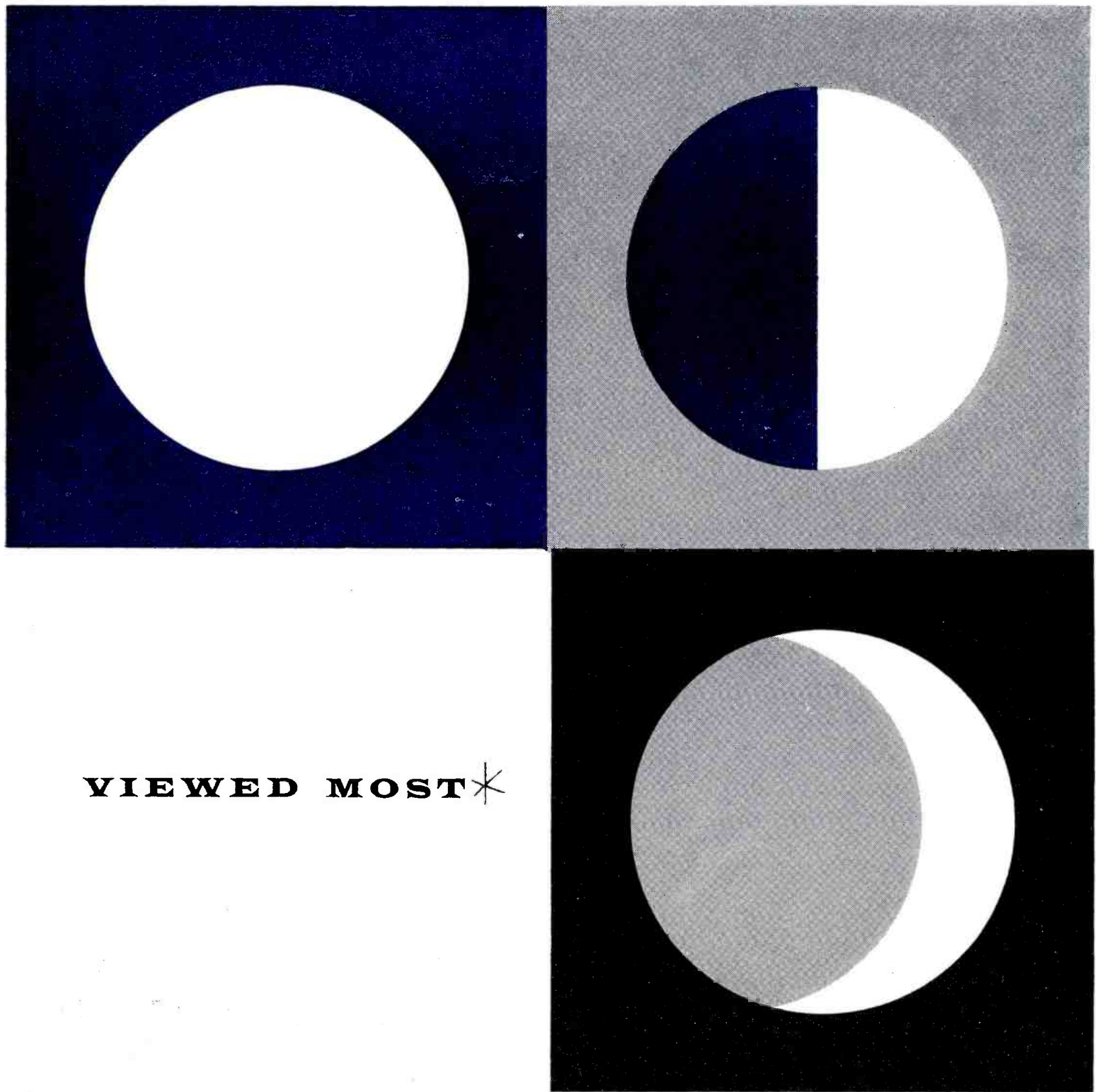

VIEWED MOST*

* The WGAL-TV audience is greater than the combined audience for all other stations in the Channel 8 area.

See Lancaster-Harrisburg-York surveys by ARB and Nielsen.

WGAL-TV

Channel 8 • Lancaster, Pa. • NBC and CBS

Representative: The MEEKER Company, Inc. • New York • Chicago • Los Angeles • San Francisco

McClinton & Pershall Inc., Chicago, for all advertising. With plans to use all major media, the account will be serviced jointly through the Chicago agency and its New York headquarters, Reach, McClinton & Co. Account supervisors: J. R. Pershall in Chicago; Bernard Lewy in New York.

• Creomulsion Co., Atlanta, has named Street & Finney Inc., N.Y., to handle special campaign in broadcast and print media.

• Houdaille Industries Inc., Buffalo, N.Y. appoints BBDO (Buffalo office) as its agency, effective Jan. 1. Corporate advertising campaign will begin in January. John H. Fogarty and J. Paul Meehan, named BBDO's account supervisor and account executive respectively on Houdaille. Firm handles industrial items including automotive components, machine tools and hydraulic mechanisms.

• Narragansett Brewing Co., Granston, R.I., appoints Doherty, Clifford, Steers & Shenfield, N.Y., as agency, effective Jan. 1, 1960, replacing Cunningham & Walsh, N.Y. Estimated budget of \$1.5 million will be used in spot radio and tv, magazines, newspapers and outdoor advertising in the New England area.

Also in advertising

Recht moves • Recht & Co., Beverly Hills, Calif., agency, has moved from the Hollywood Taft Bldg. to 177 S. Beverly Dr. Telephone: Bradshaw 2-8091.

Name change • Craig & Webster Adv., Lubbock, Tex., has changed name to Webster/Harris/Welborn. Agency owners: Rex Webster, Leon Harris and Howard Welborn.

New Orleans affiliates • Swigart & Evans Inc. and Perret & Kalman, New Orleans advertising agency and public relations firm, respectively, have affiliated. There is no change in ownership or management. The firms will continue to maintain separate offices and personnel.

Semi-annual roundup • The Katz Agency last week issued its semi-annual edition of "Spot Tv Advertising Summary," which is designed for rapid estimating of spot tv costs in as many as 242 markets. The summary is available to advertisers and agencies upon request. The present edition contains two new features, according to Dan Denenholz, director of research-promotion for the Katz Agency. These are, he said, compilations on six-plan and twelve-plan rates for daytime and late-night minutes and a section on daytime 20-second rates.

ARB

Tv report for October

Rank	Rating
1. Wagon Train	44.7
2. Gunsmoke	43.9
3. 77 Sunset Strip	38.2
4. Father Knows Best	34.7
5. Perry Como-Kraft Music Hall	34.7
6. Ed Sullivan	33.9
7. Have Gun, Will Travel	33.5
8. Perry Mason	31.8
9. G.E. Theatre	31.6
10. Real McCoys	31.5

Rank	No. viewers (000)
1. Wagon Train	48,620
2. Gunsmoke	41,790
3. Maverick	33,760
4. Ed Sullivan	33,732
5. Have Gun, Will Travel	32,690
6. 77 Sunset Strip	32,450
7. Real McCoys	32,430
8. Perry Mason	32,340
9. Father Knows Best	32,080
10. Perry Como-Kraft Music Hall	32,050

Copyright 1959 American Research Bureau

NIELSEN

Tv report for 2 weeks ending Nov. 8

TOTAL AUDIENCE‡

Rank	No. homes (000)
1. Wagon Train	20,292
2. Gunsmoke	17,845
3. Jack Benny Special	16,376
4. Perry Mason	15,219
5. Have Gun, Will Travel	14,952
6. Rawhide	14,552
7. Perry Como-Music Hall	14,552
8. Another Evening-Fred Astaire	14,552
9. Special Tonight	14,507
10. Ed Sullivan	14,507

Rank	% homes*
1. Wagon Train	46.2
2. Gunsmoke	40.8
3. Jack Benny Special	37.9
4. Perry Mason	35.1
5. Have Gun, Will Travel	34.2
6. 77 Sunset Strip	33.8
7. Rawhide	33.7
8. Perry Como-Music Hall	33.5
9. Special Tonight	33.5
10. Another Evening-Fred Astaire	33.4

AVERAGE AUDIENCE‡

Rank	No. homes (000)
1. Wagon Train	16,999
2. Gunsmoke	16,866
3. Have Gun, Will Travel	14,062
4. Jack Benny Special	13,306
5. Perry Mason	13,039
6. Father Knows Best	12,994
7. Danny Thomas Show	12,905
8. Wanted, Dead or Alive	12,861
9. Price Is Right-8:30 p.m.	12,327
10. 77 Sunset Strip	12,149

Rank	% homes*
1. Wagon Train	38.7
2. Gunsmoke	38.6
3. Have Gun, Will Travel	32.2
4. Jack Benny Special	30.8
5. Perry Mason	30.1
6. Father Knows Best	29.8
7. Danny Thomas Show	29.5
8. Wanted, Dead or Alive	29.5
9. Price Is Right-8:30 p.m.	28.8
10. 77 Sunset Strip	28.7

Copyright 1959 A. C. Nielsen Co.

† Homes reached by all or any part of the program, except for homes viewing only 1 to 5 minutes.

* Percented ratings are based on tv homes within reach of station facilities.

‡ Homes reached during the average minute.

VIDEODEX

Tv report for Nov. 1-7

Rank	% homes
1. Gunsmoke	30.9
2. Jack Benny Special	30.1
3. Another Evening-Fred Astaire	29.9
4. 77 Sunset Strip	29.0
5. Danny Thomas	28.8
6. Wagon Train	28.4
7. Father Knows Best	27.0
8. Alfred Hitchcock Presents	26.9
9. Red Skelton	26.7
10. Have Gun, Will Travel	26.6

Rank	No. homes* (000)
1. Gunsmoke	13,300
2. Jack Benny Special	12,700
3. Another Evening-Fred Astaire	12,600
4. 77 Sunset Strip	11,800
5. Danny Thomas	12,200
6. Wagon Train	12,100
7. Father Knows Best	11,400
8. Alfred Hitchcock Presents	11,300
9. Red Skelton	11,300
10. Have Gun, Will Travel	11,400

* Listed in sequence of rating level from first table.

Copyright 1959 Videodex Inc.

BACKGROUND: The following programs, in alphabetical order, appear in this week's BROADCASTING tv ratings roundup. Information is in following order: program name, network, number of stations, sponsor, agency, day and time.

Another Evening-Fred Astaire (NBC-187): Chrysler (Y&R), Wed., Nov. 4, 9-10 p.m.

Jack Benny Special (CBS-151): Benrus, Greyhound (both Grey), Sat., Nov. 7, 7:30-8:30 p.m.

Perry Como Kraft Music Hall (NBC-151): Kraft (JWT), Wed. 9-10 p.m.

Father Knows Best (CBS-170): Lever Bros., Scott Paper (both JWT), Mon. 8:30-9 p.m.

Gunsmoke (CBS-193): Liggett & Myers (DFS), Remington Rand (Y&R), Sat. 10-10:30 p.m.

Have Gun, Will Travel (CBS-164): Lever Bros. (JWT), American Home Products (Bates), Sat. 9:30-10 p.m.

Perry Mason (CBS-140): Colgate-Palmolive (Bates), Gulf Oil (Y&R), Sat. 7:30-8:30 p.m.

Price Is Right (NBC-159): Lever Bros. (OBM), Speidel (NCK), Wed. 8:30-9 p.m.

Rawhide (CBS-160): Lever (JWT), Philip Morris, Pream (both B&B), National Biscuit (M-E), Peter Paul (DFS), Vick (OBM), Fri. 7:30-8:30 p.m.

77 Sunset Strip (ABC-174): American Chicler, Carter Products, Whitehall (all Bates), R. J. Reynolds (Esty), Brylcreem (K&E), Fri. 9-10 p.m.

Special Tonight (CBS-179): General Mills, General Time (both BBDO), Sun., Oct. 27, 8:30-10 p.m.

Ed Sullivan Show (CBS-190): Colgate Palmolive (Bates), Eastman Kodak (JWT), Sun. 8-9 p.m.

Danny Thomas Show (CBS-200): General Foods (B&B), Mon. 9-9:30 p.m.

Wagon Train (NBC-184): Ford (JWT), R.J. Reynolds (Esty), National Biscuit Co. (M-E), Wed. 7:30-8:30 p.m.

Wanted, Dead or Alive (CBS-180): Brown & Williamson (Bates), Kimberly-Clark (FCB), Sat. 8:30-9 p.m.

G.E. Theatre (CBS-150): General Electric (Maxon), Sun. 9-9:30 p.m.

Alfred Hitchcock (CBS-182): Bristol-Myers (Y&R), Sun. 9:30-10 p.m.

Maverick (ABC-144): Kaiser, Drackett (both Y&R), Sun. 7:30-8:30 p.m.

Real McCoys (ABC-149): Procter & Gamble (Compton), Thur. 8:30-9 p.m.

Red Skelton (CBS-169): S.C. Johnson (FCB), Pet Milk (Gardner) Tue. 9:30-10 p.m.

A NEW NETWORK PRESIDENT AT CBS

Here's why Jim Aubrey, at 41, landed one of tv's biggest jobs

Jim Aubrey, who took over as president of the CBS-TV Network last week after the much-publicized departure of Louis G. Cowan (see page 46), is a tall man with a quiet voice, a relaxed manner, and, according to associates, an inner core of pure steel.

"I've never seen a man less satisfied with being anything less than No. 1 than Jim Aubrey is," says one who knows him. "He's a perfectionist."

"He makes up his mind and that's that," says another.

"He moves decisively—and unerringly," says a third.

James T. Aubrey Jr. doesn't do things half-way. When he was a salesman for CBS-owned KNXT (TV) Los Angeles, he decided to take up golf. Every morning he arose at 5 o'clock to practice, and in time he got his handicap down to 2 or 3. But the day he was made sales manager, he decided to give all his time to the job. He broke the golf habit so suddenly that he never returned to the course to pick up his clubs. A year later an associate found them rusting in Mr. Aubrey's abandoned locker.

By the time Mr. Aubrey became general manager of KNXT, he felt more secure in his work and decided to take occasional moments for his type of strenuous relaxation. This time he chose tennis. Day after day he went to the courts to practice, with the determination to beat Edmund C. Bunker, then sales manager of KNXT (and now CBS Washington vice president). Mr. Bunker was an expert on the courts.

At first the Bunker-Aubrey matches were one-sided, but gradually Mr. Aubrey's intensive training began to show. He was on the verge of achieving the triumph he had worked for when, in one especially violent match, he went after an impossible get—and broke a leg.

A Brilliant Enigma • In addition to "determined" and "decisive" there are other words that recur whenever Mr. Aubrey is being appraised by people who know him. One is "enigma"; it may not be the most apt, but it is a popular refuge for associates groping for a quick label. Another, almost universally applied, is "brilliant." That he possesses remarkable brainpower is not denied even by those who profess no love for him.

And there are such people, as is often

the case when a man reaches the peak in a hurry. Mr. Aubrey attained the CBS-TV Network presidency just six days short of his 41st birthday—a milestone which, incidentally, he reaches today (Dec. 14). No one can climb so high so fast without somebody feeling elbowed en route.

Those who profess to have been bruised use a slightly different lexicon in describing him. "Cold" and "unfeeling" are among their adjectives. Yet they, too, grant him an uncommonly sharp mind and quick ability, and their use of "unfeeling" may be "determination" or "decisiveness" in another context. Nor does anyone minimize his talent for being consummately charming and ingratiating.

Road to Success • The "enigma" label is usually attributed to a professed inability of the labelers to put a finger on any one contribution or series of accomplishments which led—or catapulted—Mr. Aubrey up the ladder. Mr. Aubrey



JAMES T. AUBREY JR.
Young man in a hurry

himself says he cannot easily single out any one reason for his success. To a great extent he says it involved "being lucky," including being in the right place at the right time.

Those who have worked with him, or watched him work, are more specific. They say, for instance, that he is conspicuously good at evaluating people—and "doesn't like stupid people." They contend that he wasn't particularly good as a salesman—but was great as a sales manager. "He knows how to run people," is their explanation.

"He's got the feel for the big job and doesn't get sand in his eyes about the little things that might get in the way," says one executive who has observed him closely for many years. He is also described as "intelligent" and "awfully tough . . . ideally suited for contemporary times."

Stanton Tribute • The biggest tribute and clearest insight into what got Mr. Aubrey his job came last week from CBS President Frank Stanton. In his letter accepting the resignation of Mr. Cowan, Dr. Stanton wrote that "in the first place, we must have strong and decisive leadership and a man with outstanding administrative skills as the chief operating executive of the CBS-TV Network—particularly in these times."

Mr. Aubrey defines his own concept of administration with some diffidence. Being a good administrator, he says, may mean having around you the best people available and letting them do their jobs: "Maybe the best way to be a good administrator is not to administer." Or, putting it another way: "If you put yourself in the position of having everything clear across your desk, you become a bottleneck."

The new president says he's convinced he has "the best people"—and has no intention of changing them. Nor does he expect, at least for the present, to replace himself in the job he held before last week: executive vice president of the network. If a replacement is made it will be done after careful thought.

In his personal working habits Mr. Aubrey is not a committee enthusiast, although much of his work is necessarily done with groups. The trouble with committees, he feels, is that they fall into a habit—"You get in the habit of meeting because it's the second Tuesday, rather than because there's work

How to make singing sell

One of our bright young people defines a good advertising jingle as "Music that goes in one ear and refuses to come out the other!"

Turning a solid sales idea into a haunting combination of words and music that runs round and round in the listener's head until a sale is made is more than a Tin Pan Alley art.

It calls for a unique breed of creative advertising person . . .

- . . . who knows when to be "square" and when to go, like, man, way out beyond Endsville
- . . . who knows how to use the new three-track stereo system for recording music-vocal tracks
- . . . who has discovered that mood music can come from a four-piece combo as well as a 36-piece orchestra, and much less expensively
- . . . who can put his ideas to composers, arrangers, musicians, vocalists, and recording engineers in their terms, and to sales managers in theirs.

We count ourselves fortunate in having attracted an unusual group of people who can make singing sell.



We work for the following companies: ALLSTATE INSURANCE COMPANIES • AMERICAN MINERAL SPIRITS Co. • ATCHISON, TOPEKA & SANTA FE RAILWAY Co. • BROWN SHOE COMPANY • CAMPBELL SOUP COMPANY • CHRYSLER CORPORATION • COMMONWEALTH EDISON COMPANY AND PUBLIC SERVICE COMPANY • THE CRACKER JACK Co. • THE ELECTRIC ASSOCIATION (Chicago) • GREEN GIANT COMPANY • HARRIS TRUST AND SAVINGS BANK • THE HOOVER COMPANY • KELLOGG COMPANY • THE KENDALL COMPANY • THE MAYTAG COMPANY • MOTOROLA INC. • PHILIP MORRIS INC. • CHAS. PFIZER & Co., INC. • THE PILLSBURY COMPANY • THE PROCTER & GAMBLE COMPANY • THE PURE OIL COMPANY • THE PURE FUEL OIL COMPANY • STAR-KIST FOODS, INC. • SUGAR INFORMATION, INC. • SWIFT & COMPANY • TEA COUNCIL OF THE U. S. A., INC.



LEO BURNETT CO., INC.

CHICAGO, Prudential Plaza • NEW YORK • DETROIT • HOLLYWOOD • TORONTO • MONTREAL

HOW THE EXPECTED HAPPENED UNEXPECTEDLY

The biggest top-level wrangle to be documented in the broadcasting business in recent years was brought out for all to see last week as CBS-TV Network President Louis G. Cowan resigned in an acid exchange with CBS President Frank Stanton.

Executive Vice President James T. Aubrey Jr. (see profile on facing page) was named to the network presidency before the dust had settled from the stir created by Dr. Stanton and Mr. Cowan in their exchange of letters (see texts below).

The resignation of Mr. Cowan and the elevation of Mr. Aubrey had been expected for some time (CLOSED CIRCUIT, Nov. 9), but the heat of the exchange last week was a surprise.

"You have made it impossible for me to continue," Mr. Cowan wrote to Dr. Stanton.

". . . As you yourself have said many times," Dr. Stanton replied, "administration is not your forte."

The letters showed Dr. Stanton and Mr. Cowan in agreement on one basic point: Dr. Stanton did not want Mr. Cowan to return to the CBS-TV presidency. They were at odds as to why. They also seemed to differ as

to how long the two men had been talking about it.

Mr. Cowan released his letter to newsmen at about the time it was delivered to Dr. Stanton on Tuesday (Dec. 8). Dr. Stanton's reply—which noted this procedure—was released an hour or two later. The appointment of Mr. Aubrey was announced Wednesday night. As executive vice president, he had been the chief operating officer of the network since Mr. Cowan was stricken and hospitalized by a thrombus in the left leg in October (BROADCASTING, Oct. 26).

Mr. Cowan, a former program packager whose credits include the radio *Quiz Kids* and tv's *\$64,000 Question*, which started the quiz craze a few years ago, joined CBS in 1955 as staff vice president in charge of creative services. He was elevated to president of the CBS-TV Network in March 1958 when CBS television operations were separated into a network division and a stations division (BROADCASTING, March 1958).

Mr. Cowan had been slated to testify in the House tv-quiz hearings shortly after he became ill. He has repeatedly denied knowledge of quiz rigging.

Texts of the Cowan and Stanton letters appear below.

Dear Frank:

Your recent actions have forced me to the conclusion that I must resign as president of the CBS Television Network.

Let me summarize briefly:

The record shows that my administration of the network has been successful. Both you and Mr. Paley have taken occasion to tell me so.

During recent weeks you have expressed, both publicly and privately, your complete confidence in me and in the fact that I had nothing to do with the rigging of quiz shows.

Nevertheless, in spite of my record and your confidence in my integrity, you have suggested repeatedly, directly and indirectly, that I should resign. Newspaper stories have referred regularly to my impending

resignation. And during these past two weeks you have asked me not to communicate with anyone at the office.

I find myself completely at a loss to understand your actions.

I have asked you explicitly whether the real reason you did not want me as president of the CBS Television Network is that, at this particular moment, you do not want a man who has had an association with quiz shows, even though his association was completely honest and honorable. But you have told me emphatically that this is not the reason for your desiring my resignation.

Instead you have suggested that my health may not be up to the grueling task ahead. But I have assured you, with the advice of my doctor, that

it is, that I am ready and able to return to fulltime work.

You have given a number of other reasons which I can scarcely accept as the real ones.

I have always thought that, as president of CBS Inc., you are entitled to have the man you want in charge of the network. Accordingly, during our recent discussions I have told you several times that you could have my resignation whenever you wanted it. I asked only that we issue a mutually agreed upon public statement.

But you have insisted that any public statement place primary responsibility for my resignation upon my health. I have insisted on greater accuracy: My health is now excellent. In consequence, we have been un-

to be done." It's also hard, he feels, to get decisions from committees.

No Memo Writer • Nor is he a great memo writer: "I try to miss no opportunity to keep my mouth shut and to keep the volume of paper work as low as possible." He discounts the need that many people seem to feel to write memos just to get their ideas "on the record."

He also feels that decisions cannot be shirked or postponed solely because they might be wrong. Being wrong, he feels, is a chance you have to accept.

Mr. Aubrey was born to and grew up in an advertising atmosphere. He is a son of the present chairman of the Aubrey, Finlay, Marley & Hodgson agency in Chicago, and he has had experience in sales, programming, and station and regional-network management. But he is especially glad now to have had the

station management background.

"Network management," he explains, "is just station management with a couple of digits added."

He is glad, too, to have had a chance to serve as vice president in charge of creative services for CBS Inc., the post which led both Mr. Aubrey and his predecessor into the network presidency. This job gave him an intimate awareness of all phases of CBS operations, at the same time affording him a chance to work closely with Board Chairman William S. Paley and President Frank Stanton.

Idea Bouncer • In the end-of-the-day bull sessions, or at other times when Messrs. Paley and Stanton "wanted to bounce ideas off somebody," Mr. Aubrey had an opportunity "to learn how they think," to find out first-hand what top management wanted to accomplish

and, in sum, to get "a perspective I couldn't have gotten anywhere else."

Mr. Aubrey held the creative services job from April 1958 until last June, when he was named tv network executive vice president. In this job his assignment was to ride herd on administrative detail and free President Cowan for more creative work. Since Mr. Cowan became ill in October, Mr. Aubrey has been handling in fact the duties to which he was officially named last week.

In the interim between his West Coast days and his return to CBS in 1958, he was programming and talent vice president for ABC-TV. When he took the ABC post in December 1956 he did so, he says, with considerable reluctance to leave CBS. But the move advanced him considerably farther than he felt he was entitled to expect so soon,



DR. STANTON

able to write a joint statement.

There is a limit to the amount of time that grown men can put in on such an effort. I see no point to further discussion.

So let us leave it at this: You have made it impossible for me to continue as president of the CBS Television Network.

Accordingly, I resign.

Under the terms of my contract I am required to give 30 days' notice of termination of my employment period as a senior executive of CBS Inc., and you may take this as such notice. If you desire the termination to be effective earlier, you may fix the date.

Sincerely yours,
/s/ Louis G. Cowan

Dear Lou:

I am very, very sorry that after our lengthy conversations over the past week, you felt it necessary to write me such a letter as the one delivered to me a few moments ago, which you immediately released to the press. It shocks me that you should attribute to me motives that have no basis in fact whatever.

It is true that I have urged you to give up your post as president of the CBS Television Network. The reasons for this feeling I have tried, in our private conversations, to make clear to you.

In the first place, we must have strong and decisive leadership and a man with outstanding administrative skills as the chief operating executive of the CBS Television Network—particularly in these times. Your talents and proven abilities are many indeed, but as you yourself have said many times, administration is not your forte.

I also expressed to you my concern over possible effects upon your health of assuming such new and strenuous burdens. You went to the hospital seven weeks ago with a thrombosis. Such an attack has often been a precursor to more serious illness, and none of us here has cared to accept the responsibility for any such possible aftermath. This concern was removed, however, when you told me that your doctor had certified that you are entirely fit again.

You told me in June of this year that you planned to give up your office at the end of this year, or June of 1960 at the latest. I had hoped that we might live with the situation until then, but when I initiated our



MR. COWAN

talks I told you that your lengthy absence in a fast-moving situation had led me to the conclusion that it would be most upsetting to the organization to have you return and then leave again within six months. This decision was importantly affected by the realization that the next six months may well be the most critical in the history of the CBS Television Network, as we engage in the basic reappraisal and planning which I announced Oct. 16 and which will require the most continuous attention and vigorous leadership.

At any rate, I accept your resignation. It is effective immediately.

Sincerely,
/s/ Frank Stanton

if he then remained at CBS.

View from the Outside • Moreover it gave him a chance "to see the other side of the coin"—to look at CBS as an outsider. The view from this vantage only increased his respect for the organization he had left, he says in a voice that implies no detraction from ABC.

At the rival network he helped develop ABC's programming concept of going after the younger rather than the older audience, and of doing so with action shows. He points out that he was involved in all programs initiated while he was there, including several that have given CBS-TV little cause to rejoice—among them *Maverick*, *77 Sunset Strip* and *The Real McCoys*.

Mr. Aubrey entered broadcasting as a salesman for KNX and KNXT in 1948 after three years in print media,

subsequently became sales manager of KNXT, general manager of KNXT and the CBS Television Pacific Network, and manager of CBS-TV network programs in Hollywood (see OUR RESPECTS, Feb. 13, 1956).

At CBS, he puts in close to 12 hours a day at the office, arriving about 8:30 and rarely getting away before 8 p.m. He drives to and from his home in suburban Bronxville, N.Y., but because his hours fall outside the peak traffic periods he can make the trip within 45 minutes and finds it relaxing.

Usually he takes "reading work" home at night, spends a lot of time watching television—he has a three-set arrangement which enables him to monitor all three networks at once—reads as much as he can in both fiction and non-fiction and, whenever possible, gets in some time as an amateur

photographer. He tries, too, to keep up with legitimate theatre, where he may be found on most Friday nights with his wife, actress Phyllis Thaxter, who except for occasional appearances has given up her career since the Aubreys moved East.

Intimates say that Mr. Aubrey has "a sort of yogi attitude toward health." He doesn't smoke, and drinks sparingly. He has returned to golf, at least in a modified way, and also swims and plays tennis in season. His weight is said to be 15 pounds less than it was when he played football and basketball at Princeton. "He abhors the idea of being anything but thin," says an old-time associate. Mr. Aubrey puts it this way: "I try to keep in reasonably good shape—I find I can't do my work if I don't. You might call it self-preservation."

FIGURES NEEDED NAB fm group wants better FCC reports

Fm broadcasters are disturbed by the lack of statistical information about the industry's operations and plan to do something about it. NAB's Fm Radio Committee, meeting in Washington Dec. 9, called on the association to find out if FCC financial reports could be broadened to show a better breakdown of am-fm station time sales.

The committee, headed by Ben Strouse, WWDC-FM Washington, voted to hold a special meeting of NAB's fm membership the afternoon of Sunday, April 3, opening day of the association's annual convention in Chicago. In past years the fm meeting has usually had to share interest with competing convention sessions.

A resolution was adopted encouraging the Assn. of Federal Communications Consulting Engineers to continue its efforts to obtain modernization of the FCC's technical rules for fm. During a luncheon conference, Kenneth Miller, FCC's Conelrad supervisor, said the Commission plans to push for fm emergency networks in every state. Florida and Massachusetts already have such hookups. Four others are about ready—New York, Illinois, Michigan and Pennsylvania.

Richard M. Allerton, NAB research manager, said fm radio set imports in 1958 were estimated at 78,000 units (auto sets not included). Were full data available, he said, imports might run about 90,000 sets.

Membership Up • Fm membership in NAB totals 451 of 664 operating stations, compared to 367 members a year ago, according to John F. Meagher, radio vice president.

C. Frederic Rabell, KITT-FM San Diego, Calif., committee member and president of the National Assn. of FM Broadcasters, said the new association plans to concentrate on sales promotion and hopes to be the Radio Advertising Bureau of fm, with a paid national director. NAFMB is in the black and gaining several members every week, he said.

A. Prose Walker, NAB engineering manager, reviewed the all-industry study of standards being conducted by the National Stereo Radio Committee. Douglas A. Anello, NAB chief counsel, reported on the FCC's 25-890 mc proceeding, simplexing and excise taxes in background music.

Attending besides Messrs. Strouse and Rabell were these committee members: N. L. Bentson, WLOL-FM Minneapolis; Everett L. Dillard, WASH (FM) Washington; Raymond S. Green,

Big board

The day after his elevation to president of CBS-TV Network (see page 46), James T. Aubrey Jr. was elected to the board of directors of CBS Inc. In this post, unlike the network presidency, he does not—strictly speaking, at any rate—succeed Louis G. Cowan. Company authorities pointed out that board members are elected by stockholders and that while the board had every right to elect Mr. Aubrey in the meantime, he must technically go up for election by the stockholders at their annual meeting next spring. By the same token, they said, Mr. Cowan, having been elected by the stockholders, will remain a board member until the stockholders' meeting unless he resigns in the meantime.

WFLN-FM Philadelphia; Michael R. Hanna, WHCU-FM Ithaca, N.Y.; Merrill Lindsay, WSOY-FM Decatur, Ill., and Richard Mason, WPTF-FM Raleigh, N. C.

New audience survey will use oscillator

A new radio-tv audience measuring device which utilizes electronic sampling methods has been announced by E. Roger Sherman Jr. of Sherman Tel-Analysis, Mansfield, Mass.

Tel-Analysis uses local oscillator counting which enables sampling to be undertaken in areas where other electronic sampling systems are not economically feasible, Mr. Sherman said. Being adaptable to fixed base or portable operation, the equipment requires no physical connection to sets in the sample. Instead, signals are received from local oscillators of am or tv sets operating within a quarter of a mile of the measuring unit.

According to Mr. Sherman, the entire sample can be "polled" electronically at intervals of two or three minutes, leaving the audience completely unaware that it has been sampled and eliminating possible bias or self-consciousness.

The local oscillator, a circuit found in all broadcast receivers, acts as a small radio transmitter. Sets tuned to a particular station radiate signals reflecting the station to which they are tuned. Clusters of oscillator signals are separated and counted individually by employing special equipment.

The head of the survey analysis bureau said that test surveys have been conducted since 1952 in several east coast cities.

MORE RAB FUNDS Fm advisory among expanded services

Bolstered by a record budget of \$1,125,000 for 1960, the Radio Advertising Bureau last week announced an expansion in services, covering the mailing of monthly information to fm stations; the institution of a monthly report to management service and the stepping up of presentations, speech writing and direct mail material to members.

These developments were reported during RAB's semi-annual meeting in New York, when the board approved the new budget. Officers named for the board for 1960 are: Allen M. Woodall, board chairman (WDAK Columbus, Ga.); Frank P. Fogarty, secretary, (WOW Omaha) and Alex Keese, treasurer (WFAA Dallas).

The new fm service, scheduled to begin no later than April 1, will be designed for all RAB members who are reducing or totally eliminating duplication of their am service by their fm transmitter and seeking revenue-producing techniques.

The monthly report to management service will be available to all members wishing to subscribe to it. It will provide reports on sales-related subjects.

The board also announced that the RAB sales clinics will be expanded from 43 in 1959 to 50 in 1960. The clinics begin April 20 and run through May 27.

Newly-appointed members of the board of directors for 1960 are: F. H. Brinkley, WENE Endicott, N.Y.; Dee Coe, WWCA Gary, Ind.; Robert B. Jones Jr., WFBR Baltimore, and Eugene Katz, the Katz Agency.

Tv owners continue buying radio sets

Radio sets continue to be bought at a record rate even in a community where virtually every family owns a tv set, according to a study released last week by the Radio Advertising Bureau.

The study, made for RAB by Fact Finders Assoc. Inc., was conducted in Littleton, Colo., a suburb of Denver, where 97.5% of the families surveyed owned at least one tv set. It showed that more than 65% of the families in this stronghold acquired new radio sets last year.

Called "Telurbia Revisited," the study is a follow-up to one made by RAB more than a year ago in Levittown-Wantagh, L.I. According to RAB President Kevin Sweeney, both studies indicated that people with tv sets continue to buy and acquire radios, and these new radios are located in room areas where competition from tv is "negligible, if non-existent".



again...

it's H-R RADIO!

WEBR BUFFALO

*joins the list of significant
major-market radio stations
to RING THE BELL, with*

H-R REPRESENTATIVES, INC.,
appointed exclusive national sales representative

RESPONSIBLE REPRESENTATION



cause:

The struggle against drug addiction. To explore one of the most serious problems facing the nation, the illegal sale and use of narcotics, KNXT's Public Affairs Department devoted months to the production of a hard-hitting film report on addiction. Finally, on Wednesday evening, November 18, 1959, between the hours of ten and eleven o'clock, KNXT presented "Hell Flower," an unflinching look at a tragic subject...



effect: Overwhelming!

A special ARB survey gave "Hell Flower" a 20.0 rating, *more* than the other network competition *combined*. Thousands of congratulatory wires, letters and phone calls were received (and they're still pouring in). *Daily Variety* praised "a job well done" . . . the *Los Angeles Times* called it "remarkable" . . . the *Los Angeles Examiner* cited "an excellent illustration of television's ability to fulfill its loftiest purpose." And a special Resolution of Commendation voted by the City Council of the City of Los Angeles saluted the program as "*an outstanding public service in the highest tradition of the broadcasting industry.*"

A landmark in Los Angeles community service programming, "Hell Flower" is one more example of a vital cause effectively served by Southern California's leading television station . . .

KNXT

CBS Owned
Channel 2, Los Angeles

now – for the first time – you can buy

McLENDON radio jingles...

and at a price less than you ever dreamed possible!

HERE'S THE ANSWER TO GREATER AUDIENCE RATINGS!

Now, at last, your station can super-charge its programming with the very same audience-building jingles that are used on the fabulously successful McLendon stations. These aren't just old jingles with your call letters dubbed in, either — they're individualized for your station's private use. Produced by radio people for radio people, these highly specialized jingles assure you of better quality at a lower price.

Package No. 1, now available for delivery, contains 15 different station IDs in the Spanish language. Ideal for Spanish language stations, this unique package can also be put to excellent use by "pop" music stations wherever there is a high concentration of Spanish-speaking residents, or even used with striking effectiveness as a curiosity and conversation-building device in areas where little or no Spanish is spoken.

Package No. 2, nearing completion, consists of 20 highly original and dramatically different jingles, the exact nature of which cannot be disclosed at this time. We guarantee that these jingles will hit your market like a bombshell. Try them and see!

Yes, I am interested. Please rush price list and detailed information with sample tapes of
 Package 1 Package 2, or Both to:

(NAME)

(TITLE)

(STATION)

(CITY)

(STATE)



McLENDON RADIO JINGLES

2008 Jackson Street, Dallas, Tex., Riverside 7-9311

B. R. McLENDON
Chairman of the Board

GORDON B. McLENDON
President

JAMES H. FOSTER
Executive Director

PETE PEDERSEN
Music Director

NAB musters 'ethics' task force

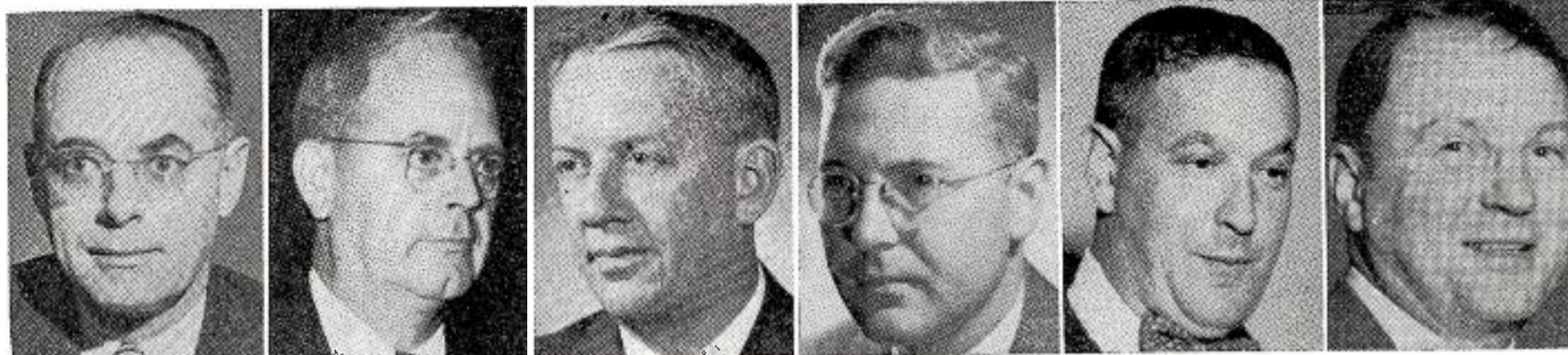

MR. SOWELL

MR. SHAFTO

MR. LINDSAY

MR. MARTIN

MR. KOPS

MR. MCCULLOUGH

NAB followed through last week on the crisis meeting held Dec. 4 by its Board of Directors by taking two steps:

- Formed a 12-man task force to handle 'ethical and legal issues facing radio and television,' and "to clean [broadcasting's] own house."

- Called a sudden meeting of the NAB Radio Standards of Good Practice Committee for Dec. 16.

President Harold E. Fellows, who was asked by the board to serve as chairman of the task force, said it has a broad directive—"to devote its attention and expertise to the immediate regulatory issues and problems faced by the industry."

The association's Tv Board had adopted several amendments to strengthen the code at its Dec. 4 session (BROADCASTING, Dec. 9). These

added specific language to protect the public from deceptive programming and advertising practices.

President Fellows, in appointing the task force members, said NAB welcomes the current FCC and Federal Trade Commission investigations and will cooperate wholeheartedly with federal agencies. He said the probes should bring out "the full story of broadcasting's tremendous service to the American public, which far transcends the misdeeds of a few individuals." He added that NAB is putting increased emphasis on its Standards of Good Practice, winding up with this observation, "Broadcasters are taking quick action against wrongdoing wherever they find it."

The six broadcaster members of the task force, all NAB directors,

are: F.C. Sowell, WLAC Nashville, Tenn.; G. Richard Shafto, WIS-TV Columbia, S.C.; Merrill Lindsay, WSOY Decatur, Ill.; Dwight W. Martin, WAFB-TV Baton Rouge, La.; Daniel W. Kops, WAVZ New Haven, Conn., and Clair R. McCullough, Steinman Stations.

Representing NAB are, besides Mr. Fellows: John F. Meagher, radio vice president; Thad H. Brown Jr., tv vice president; Douglas A. Anello, chief counsel; Vincent T. Wasilewski, government relations manager, and Howard H. Bell, assistant to the president.

NAB has cancelled its Jan. 24-29 board of directors meeting in Palm Springs, Calif., and all other scheduled committee meetings. This will give staff personnel time to concentrate on the regulatory crisis.



MR. FELLOWS

MR. MEAGHER

MR. BROWN

MR. ANELLO

MR. WASILEWSKI

MR. BELL

Code proposal critics hear Clipp's reply

Claims of NAB staff executives that previewing of tv commercials and programs might cost \$2 million or more were belittled last week by Roger W. Clipp, Triangle Stations, former chairman of the NAB Tv Code Review Board.

Writing to Niles Trammell, president-general manager of WCKT (TV) Miami, Fla., Mr. Clipp regretted that NAB's Tv Board had rejected his plan to introduce the preview concept (BROADCASTING, Dec. 7). He said NAB President Harold E. Fellows and G. Richard

Shafto, WIS-TV Columbia, S.C., and NAB's Tv Board chairman, "are begging the issue when they say it would cost \$2 million to effectuate my proposal and that previewing is contrary to self-regulation and tantamount to censorship."

Mr. Clipp contended, "if previewing is censorship, so is postviewing (monitoring) which has been a major activity of the Code Board for the last two years."

He said he felt an additional \$250,000 of the \$1¼ million annual membership dues of NAB can be allocated to tv code expansion "with very little effect on the NAB program of activities." Streamlining of the association or

dipping into their reserves, which he estimated at around \$300,000 to \$400,000, would handle financing.

Code activity "should now be NAB's most important effort—to correct those abuses of television which have made our industry the target of so many attacks," he said.

NAB Radio Board election begins

Twelve members of the NAB Radio Board will be elected under procedure set in motion last week by Everett E. Revercomb, association secretary-treasurer. Two board members are ineligible

for re-election, having completed the maximum of two consecutive two-year terms. They are Ben B. Sanders, KICD Spencer, Ia., and Robert L. Pratt, KGGF Coffeyville, Kan.

The elections, involve directors from even-numbered districts and at-large classifications whose terms expire in April. Those eligible to run for re-election are: Simon Goldman, WJTN Jamestown, N.Y.; Jack S. Younts, WEEB Southern Pines, N.C.; F.C. Sowell, WLAC Nashville, Tenn.; J.M. Higgins, WTHI Terre Haute, Ind.; George C. Hatch, KALL Salt Lake City, Utah; Robert J. McAndrews, KBIG Hollywood, Calif.; John H. DeWitt Jr., WSM Nashville, Tenn.; Frederick A. Knorr, WKMH Dearborn, Mich.; J. R. Livesay, WLBH Mattoon, Ill.; Merrill Lindsay, WSOY-FM Decatur, Ill.

Changing hands

ANNOUNCED • *The following sales of station interests were announced last week, subject to FCC approval:*

- WCOA Pensacola, Fla.: Sold by Denver Brannon to J. McCarthy Miller, associate, Paul H. Chapman & Co., Atlanta, for \$350,000. WCOA is 1370 kc with 5 kw. Broker: Paul H. Chapman & Co.
- WTRL Bradenton, Fla.: Sold by

Blue Skies Broadcasting Corp. and Lockwood P. (Dick) Doty to James I. Mitchell, executive vice president of KPIG Cedar Rapids, Iowa, and Jonathan M. Fletcher, president, Home Federal Savings & Loan, Des Moines, Iowa, for \$240,000. WTRL is 1490 kc with 250 w. Broker: Paul H. Chapman & Co.

- KJET Beaumont, Tex.: Sold by Walter L. Rubens and associates to Leon Walton and group for \$160,000. Mr. Walton also has an interest in KOPY Alice, Tex. Daytimer KJET, specializing in Negro programming, operates on 1380 kc with 1 kw. The sale was handled by Hamilton-Landis & Assoc.

- WBBQ-AM-FM Augusta, Ga.: 51% interest sold by Mr. and Mrs. Thurston Bennett to George G. Weiss for \$150,000. Mr. Weiss already owns 49% interest. WBBQ is 250 w on 1340 kc with MBS affiliation.

- WBLJ Dalton, Ga.: Sold by L.C. McCall to North Georgia Radio Inc. (Werner E. Worthsman and Brooks P. Smith, principals) for \$84,000. Broker: Blackburn & Co. WBLJ operates with 250 w on 1230 kc and is affiliated with MBS.

- KMRW Guthrie, Okla.: Sold by Farrell M. Brooks to James Porter

Clark, Fayetteville, Tenn., for \$56,000. Transaction was handled by Patt McDonald Co. KMRW operates on 1490 kc with 100 w.

- KCOM-FM Omaha, Neb.: Sold by Delta Broadcasting System Inc. to Don Burden for \$25,000. Mr. Burden's Star Stations are KOIL Omaha, KICN Denver and KISN Portland, Ore. KCOM-FM, on 96.1 mc with 3.4 kw power, will become KOIL-FM following consummation of the transaction.

- KROG Sonora, Calif.: Sold by John H. Robbins and wife, Charlotte A. Robbins, to Harlan L. Egan and Ralph P. Bowen, both engineers at NBC, Burbank, for \$25,000. KROG is 1450 kc with 250 w. Broker: Paul H. Chapman & Co.

- WMMM Westport, Conn.: Sold by group headed by Philip Langer to Donald Flamm for \$125,000. Mr. Flamm has interests in WPAT Paterson, N.J. and is former owner of WMCA New York.

APPROVED • *The following transfers of station interests were approved by the FCC last week (for other Commission activities see FOR THE RECORD, page 122).*

- KRAK-AM-FM Stockton, Calif.: Sold by Golden Valley Bcstg. Co. to Hercules Bcstg. Co., a group headed by Manning Slater and J. Kenneth Bradley, 35.7% each, for approximately \$550,000. Mr. Slater is station manager of WICC Bridgeport, Conn. Mr. Bradley is an attorney.

- KBOY-AM-FM Medford, Ore.: Sold to Kenneth R. and Isabel M. Card for \$220,000 plus agreement not to compete for 6 years. The Card family has no other broadcast interests.

Hurleigh issues call for 'facing facts'

The broadcasting industry can "lick the scandals" by "honest facing of fact," Robert F. Hurleigh, Mutual president, declared in a speech before the Advertising Club of Boston last Tuesday (Dec. 8).

Mr. Hurleigh said the tv quiz scandals swelled when the industry attempted to "sweep it all under the carpet—to scoff at the first reports, to deride the informers in the hope it would be smothered or forgotten." He observed:

"As a result the press jumped on a good story and played it for all it was worth."

He quoted copiously from a Nov. 30 editorial in BROADCASTING, urging the industry to police itself and added: "The industry must be positive and forthright in the years ahead—not defensive."

FLORIDA	\$235,000
Excellent technical facility, profitable, in a great growth market. Good real estate. Terms.	
MID-SOUTH	\$150,000
Fulltime facility in rich agricultural and shipping center. \$30,000 down, favorable terms.	
SOUTHWEST	\$125,000
This daytimer is located in one of the top Southern markets and programs for a large specialized audience. Outstanding physical assets. \$30,000 down and excellent terms.	
MIDWEST	\$125,000
Fulltime, single station market. Profitable operation. \$30,000 down puts you into this Minnesota market. Favorable terms on the balance.	
NEGOTIATIONS • FINANCING • APPRAISALS	
Blackburn & Company	
Incorporated	
RADIO - TV - NEWSPAPER BROKERS	
WASHINGTON, D. C. James W. Blackburn Jack V. Harvey Joseph M. Strick Washington Building STerling 3-4341	MIDWEST H. W. Cassill William B. Ryan 333 N. Michigan Ave. Chicago, Illinois Financial 6-6460
ATLANTA Clifford B. Marshall Stanley Whitaker Robert M. Baird Healey Building JACKSON 5-1576	WEST COAST Colin M. Selph Calif. Bank Bldg. 9441 Wilshire Blvd. Beverly Hills, Calif. CRestview 4-2770

SYLVANIA GOLD BRAND TUBES...

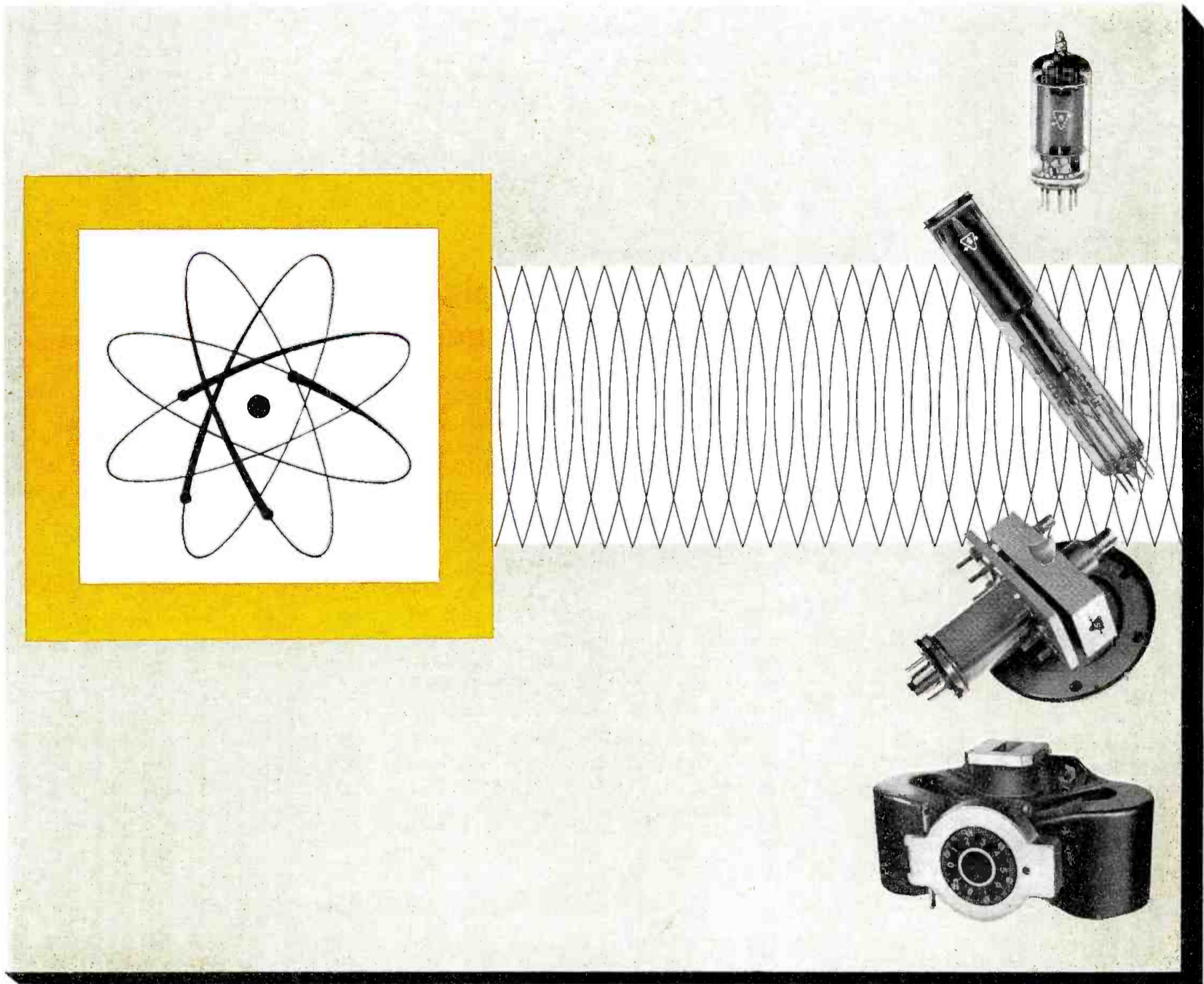

and the new standard everywhere in electronics

THE FAMOUS Gold Brand has long identified the premium dependability of Sylvania reliable receiving tubes for industrial applications. Now, in that same tradition of outstanding performance, Sylvania offers a full line of industrial tubes ranging from power triodes for transmitting service and industrial heating to vidicons and orthicons for TV.

Subject to rigorous testing programs, Sylvania industrial tubes meet extra critical quality control requirements in keeping with their high standard of reliable performance.

Whenever you need premium quality performance in the Gold Brand tradition, specify Sylvania industrial tubes.



Subsidiary of

GENERAL TELEPHONE & ELECTRONICS

SYLVANIA ELECTRIC PRODUCTS INC.
1740 Broadway, New York 19, N. Y.
In Canada: Sylvania Electric (Canada) Ltd.
P. O. Box 1190, Station "O", Montreal 9

CBS GOES ALONG Won't fight FCC order to drop rep business

It's now certain that CBS will be out of the business of representing affiliated tv stations by the end of 1961. The network has decided not to contest the FCC's order that it do so.

This decision runs contrary to that of NBC which is fighting the FCC's order. NBC officials last week reiterated that the network will pursue its battle with FCC over the order as spelled out in its petition filed with the Commission Dec. 1 (BROADCASTING Dec. 7).

Affiliated stations represented by CBS Television Spot Sales were informed of the stand over a period of three days (Dec. 2-4) by CBS Stations Div. President Merle S. Jones and Craig Lawrence, vice president in charge of CBS-TV's owned stations and spot sales.

Specifically the affiliates were told that CBS would not go to litigation but in the meantime hopes to continue to represent the stations until the order is effective. It was learned that CBS took its action on the basis of legal advice.

Stations affected by the FCC's order—including CBS and NBC represented affiliates—bill an estimated \$15 million a year in national spot.

Outlets Affected • CBS-TV's represented affiliates are WTOP-TV Washington; WJXT (TV) Jacksonville, Fla.; WBTW (TV) Charlotte; WBTW (TV) Florence, S.C.; KSL-TV Salt Lake City; KHOU-TV Houston and KOIN-TV Portland, Ore. KHOU-TV is leaving CBS-TV Spot Sales and joining H-R Television. This station's quitting has nothing to do with the FCC order, however, since it is part of Corinthian Stations which has appointed H-R Television exclusively for all its outlets.

There are two station components of CBS which are not subject to the FCC order. These are the owned tv stations which can continue to be represented and all the stations represented by CBS Radio Spot Sales. CBS Radio President Arthur Hull Hayes affirmed there would be no change in the radio spot sales representation in that the CBS-TV action was unrelated to the radio policy.

The affiliated stations had been well aware of the pending CBS decision. A meeting of the principals involved discussed this eventuality two weeks ago in Chicago. But first official word came on Dec. 2.

It is known that several station representative companies have solicited the

CBS-TV affiliates for their business. But none of the stations has yet indicated it is about to make a choice.

Early in October Mr. Jones had indicated that for the time being CBS was placing itself in opposition to the FCC order until an additional examination of the report and order could be made.

The stations affected reported they opposed the FCC order in principle but had to agree there was not much to be gained in a prolonged court battle.

L.A. begins campaign to improve tv image

A campaign designed to improve tv's image with the people who count, the civic, cultural, social and educational leaders who are the prime moulders of public opinion, will shortly be launched in Los Angeles as a joint venture of that city's seven tv stations. Initially, according to present tentative plans, the group will underwrite the publication of a combined log of their so-called public service programming, to be issued at least once a month and perhaps more frequently, for distribution to the community's top citizens. Eventually, it may embrace much more ambitious activities.

Agreement as to the need for such a joint public relations effort and decision as soon as possible was reached Dec. 4 at a meeting of top management of the

seven tv stations: James Riddell, KABC-TV; Kenyon Brown and Al Flanagan, KCOP (TV); John Reynolds, KHJ-TV; Clark George, KNXT (TV); Tom McCray, KRCA(TV); James Schulke, KTLA(TV); Dick Moore, KTTV(TV). Also present was Lou Hausman, director of Television Information Office.

The meeting was called by Mr. George, whose concern over the lack of public appreciation of the better things that tv has to offer was first stated publicly last spring. In accepting the Lee De Forest award of the National Assn. for Better Radio & Television (BROADCASTING, May 25), Mr. George urged that some of the energy expended in criticizing tv for its faults (which he admitted often deserved that criticism) be devoted instead to calling the public's attention to the many educational and cultural programs which the tv broadcasters feel would attract many more viewers if they only knew they were on the air.

MBS decision delayed

U.S. Referee Asa Herzog postponed until tomorrow (Dec. 15) a decision on Mutual's petition for reorganization under Chapter 11 of the U.S. Bankruptcy Act. A decision was delayed because final details had not been worked out on a settlement between the network and the City of New York over back taxes claimed by the city.

Self-criticism suggested

The three television networks were urged last week to carry programs on a regular basis that would criticize new tv productions and explain current developments in television and comment upon them.

The recommendation for tv critics' programming on the medium was made by Alfred Hollender, vice president and director of tv-radio for Grey Adv., New York, during an exclusive interview with BROADCASTING. Mr. Hollender asserted:

"Television prides itself on being the greatest mass communications medium of all. It is logical therefore that tv should use its own facilities to reach people constantly with what is happening in television."

He cautioned that tv should not utilize the proposed type of programming for "self-promotion." The first step, he said, would be for each of the networks to hire "one or more respected critics, who would be unbiased and have a free reign to say what they thought, with no punches pulled."

Though he does not have "the mechanics" of his proposal worked out, Mr. Hollender is certain that the networks could devise a suitable approach. He noted that Dave Garroway recently devoted a half-hour of the NBC-TV *Today* program to a discussion of current investigations into the broadcasting industry and similar developments could be, from time to time, incorporated into the tv criticism telecasts.

Mr. Hollender observed that today the general public relies largely on newspaper articles and columns for news and evaluations of tv programming. He conceded there are "some fair-minded, qualified critics," but many are former reporters with no training in the entertainment field. He said some critics "actually dislike television and have no feeling for the medium." And added: "A regular program of tv criticism on tv would give recognition to the medium's claim that it is the greatest means of mass communications."

WDSU-TV Wins National Award for Editorials

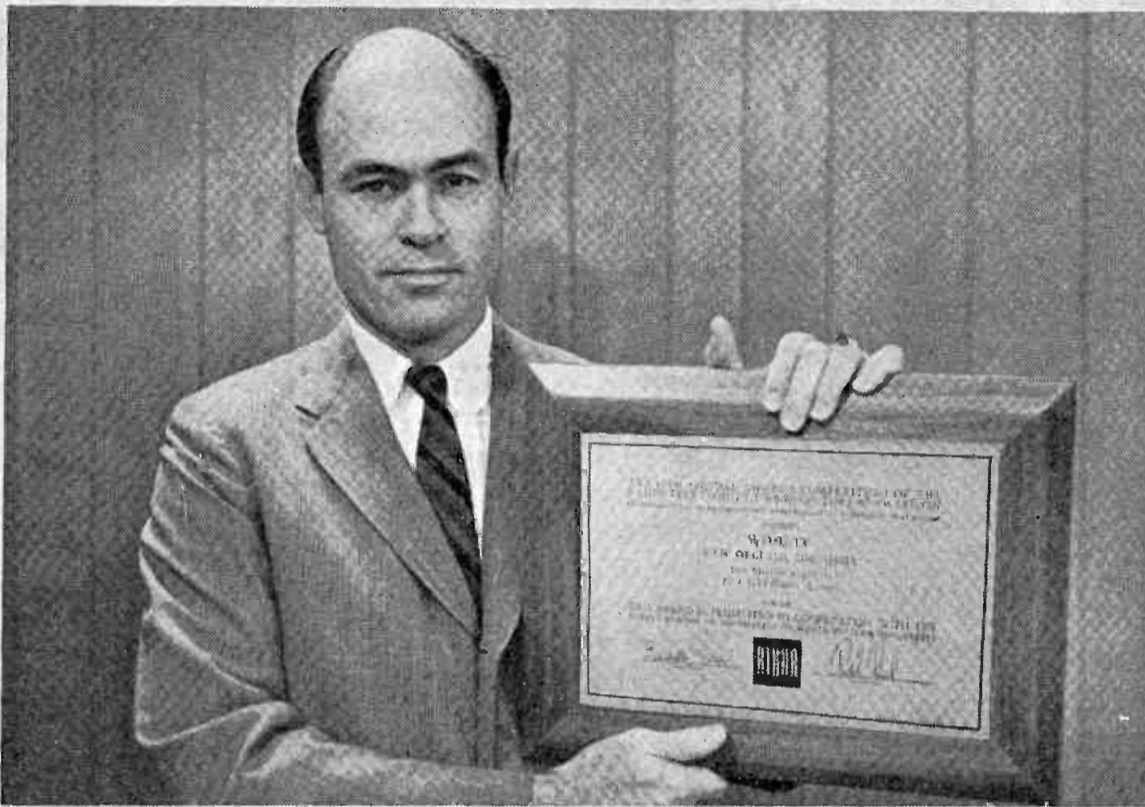

(WDSU-TV News Director Bill Monroe receiving RTNDA award)

Editorials cited for integrity, good taste, courage

NEW ORLEANS—Among all television stations in the United States, WDSU-TV was awarded First Prize by the Radio and Television News Directors Association for editorializing by a TV station. The opinion of the judges was stated as follows:

"Our first choice in the TV competition is WDSU-TV, New Orleans.

We were all enormously pleased by the editorials submitted. They were professional, they were important, they were concrete, they were done with good taste and integrity, and they indicated a basic courage on the part of station management."

WDSU-TV, according to station management, will continue to maintain an editorial policy dedicated to the progress and betterment of the area served.

In New Orleans

WDSU-TV

gives you the picture

Haffa files new suit to speed court action

A new \$10 million libel suit was filed in U. S. District Court Wednesday by Titus Haffa, Chicago industrialist, against CBS Inc., CBS-TV and four advertisers, charging defamation of character in two *Playhouse 90* presentations.

The new complaint is similar to that filed last September in Chicago Superior Court and seeks to obtain quicker legal action because of the lower court's "crowded calendar." It was submitted by attorneys Maxfield Weisbrod and William Unfanger.

As in the original brief, the suit charges Mr. Haffa was libeled and defamed on original and re-run showings of "Seven Against The Wall," depicting the 1929 St. Valentine's Day massacre in Chicago. Specifically, it claims that the telecasts of Dec. 11, 1958, and July 9, 1959, showed a newspaper headline, "Titus Haffa gets two years," but no other readable portion.

In the newest suit four advertisers (Procter & Gamble, Kimberly-Clark Corp., R. J. Reynolds Tobacco Co. and Renault Inc.) are named along with CBS Inc. and CBS-TV. Additionally, the four clients are being dismissed from the Superior Court suit. Omitted in the federal complaint were All-State Insurance Companies, American Gas Assn., Peoples Gas Light & Coke Co., Northern Illinois Gas Co. and North Shore Gas Co., all co-defendants in the initial litigation. (Renault and Reynolds were named in connection with only the July re-showing.)

The original legal action comprised a two-part suit, each seeking \$5 million in damages. All suits allege that the programs violated the Illinois Criminal Code on libel and that the headline was "not related to the events in the play, and because of the timing of the display the viewing public was given the erroneous impression that Haffa was involved in the gangland slayings" of seven mobsters. The incident alluded to in the headline involved charges that Mr. Haffa had violated the prohibition act that year.

Union rules delay KPOL's Mutual plans

Announcement made Dec. 8 by KPOL Los Angeles that it is joining MBS as the Los Angeles outlet was somewhat premature, although it probably will work out that way.

Fred Custer, station manager, who was in San Francisco when the announcement was made, said Dec. 10 that KPOL and Mutual can get together all right, but that there are still

union problems to be settled before an affiliation agreement can be signed. AFTRA, for instance, has a higher scale for announcers at network stations in Los Angeles than for independents, which if strictly interpreted might make the MBS affiliation too costly for the network and station.

However, KPOL's planned use of Mutual only as a news source, taking some of the network's newscasts and incorporating others into KPOL's own news programs, is appreciably different from the kind of affiliation on which the AFTRA scale is based. Both Mr. Custer and Claude McCue, AFTRA's western executive secretary, expressed the feeling that a mutually acceptable arrangement can be worked out.

TvAR researches 'audience dimensions'

"A 3-D project to provide detail, definition and depth to the existing body of information about audiences" is the way Larry H. Israel, general manager of Television Advertising Representatives Inc., describes his company's new continuing research studies called "Audience Dimensions."

The six-month-old rep firm for Westinghouse Broadcasting Co.'s five tv outlets held a dessert luncheon-news conference last week to announce the first of these reports, which deals with the "age of viewers." Planned mainly for agency and station presentations, the reports will henceforth be issued on a quarterly basis, with future studies to give information on viewing habits of career women, owners of pets, mothers of toddlers, men who shave, occupations of breadwinners, types of residence and levels of income as well as "viewer venturesomeness" (the willingness of viewers to try new products).

According to Bob Hoffman, director of marketing and research for TvAR, "Audience Dimensions" will fill a need for more information on audience composition, specifically for advertisers who up to now have been unable to get detailed information on a market-by-market basis "or which they have had to provide for themselves at considerable cost on a one-time schedule." Pulse Inc. conducts the field work for the project, and uses a minimum sample of 1,000 homes in each of the five Westinghouse tv markets: Boston, Baltimore, Pittsburgh, Cleveland and San Francisco. It is believed that the composite information will reflect the prevailing situation in other metropolitan areas in the U.S.

First Analysis • TvAR's current report on "age of viewers" points out that age is a key factor in shaping the needs, desires and buying habits of people for the majority of products and

services. Using the combined figures of the five markets, the report pins down these facts:

- "In the early evening (6-7:30 p.m.), 37% of the men and 39% of the women who watch tv are 18 to 34 years of age. In the late evening, these figures rise to 39% for men; 41% for women. In both time periods these younger adults comprise the largest segment of the adult audience."

- "Feature length movies, while popular among all age groups, have their greatest appeal to younger adults . . . regardless of when they are telecast. For example, 44% of the women watching daytime movies are in the 18-34 year bracket."

- "Advertisers may draw their own conclusion from the examination of the appeal of particular programs in specific markets, as exemplified on WJZ-TV Baltimore where *Romper Room* draws 69% of its "kid" audience from youngsters under 6 years of age and 31% among the 6-11 year olds. On the other hand, only 30% of the children watching the station's *Popeye* show are under 6 with the remaining 70% in the 6-11 age group."

KXLF-TV back on air one month after fire

One month after it had been knocked off the air by fire and its transmitter declared a total loss, (BROADCASTING, Nov. 16), ch. 4 KXLF-TV Butte, Mont., was back in operation Dec. 9, according to advices given the FCC.

Promptly after the \$150,000 fire at the transmitter, located atop the Continental Divide, on Nov. 9, E. B. Craney, owner-general manager, ordered a new RCA transmitter and essential related equipment, in the hope of getting the station back on the air before the end of the year. Working practically around the clock the station's engineering staff, aided by an RCA plant engineer, beat the deadline by 21 days. KXLF-TV feeds KXLJ-TV Helena and KFBB-TV Great Falls with film and network shows via microwave. During the emergency, the Helena and Great Falls stations were fed from Salt Lake City.

The new RCA transmitter (TT10AL) cost \$103,700, FCC was notified, and other essential equipment installed brought the cost to \$117,000, without labor and other charges.

• Media reports

NLRB order • WCKT (TV) Miami, Fla., has been ordered by National Labor Relations Board not to discourage membership in two IATSE locals or interfere with employes' rights to an election. Reinstatement of four em-



The Palace and the Stable

It was the seven hundred and fifty-third year since the founding of Rome.

Gaius Julius Caesar Octavianus Augustus was living in the palace of the Palatine Hill, busily engaged upon the task of ruling his empire.

In a little village of distant Syria, Mary, the wife of Joseph, the Carpenter, was tending her little boy, born in a stable of Bethlehem.

This is a strange world.

Before long, the palace and the stable were to meet in open combat.

And the stable was to emerge victorious.

— FROM "THE STORY OF MANKIND" BY HENDRIK WILLEM VAN LOON © HELEN C. VAN LOON

Young & Rubicam, Advertising

ployes to former or equivalent jobs was ordered along with repayment for loss of earnings resulting from discrimination. The employes, members of the news staff, were Cal Marlin, Charles Filer, Joseph Lipari and Jay Weand.

One for one • KTRE-TV Lufkin, Tex., has joined CBS-TV as an interconnected affiliate in the Extended Market Plan group, it was announced Dec. 8. At the same time, the EMP affiliation agreement with KUMV-TV Williston, N.D., was terminated by mutual agreement, the network said. KTRE-TV operates on ch. 9, and is owned and operated by Forest Capital Broadcasting Co., Lufkin.

Coordination • The program managers advisory committee of NBC Radio will discuss the coordination of the new network program structure (effective Jan. 4) with the program schedules of the affiliated stations at a meeting scheduled in New York Thursday (Dec. 17). Albert L. Capstaff, vice president of radio network programs, will preside at the meeting, which will be attended by executives of NBC Radio affiliates and of the NBC Radio network.

New network • Contemporary Radio Network, a group of radio stations which will exchange "contemporary" programming by tape, already has affiliates in Los Angeles, San Diego and Seattle, according to Dave Larsen, manager of KJAZ Berkeley, Calif., all jazz fm station which will be key station for the operation. Approximately 12 hours of weekly programming is already set, Mr. Larsen reports, and CRN plans to expand into Eastern markets during 1960.

Later start • KNDI Honolulu, which was to commence operation this month (BROADCASTING, Aug. 31), will go on the air Feb. 1. KNDI will be an all-woman operation.

At full strength • KALB-TV Alexandria, La. held a "full power day" celebration at its studios on Dec. 9. The station, which had been operating on 28.2 kw received approval of the FCC on Nov. 28 to increase to maximum power. FCC allows a maximum of 100 kw for ch. 5 stations.

KFJI to KAGO • KFJI Klamath Falls, Ore., has changed call to KAGO. Paul H. Raymer is named national representative. Art Moore & Assoc., Seattle, continues at northwest rep.

Rep name change • Ayers, Allen & Smith, San Francisco and Hollywood station representative, now is known as Robert R. Allen Co. Addresses: 233

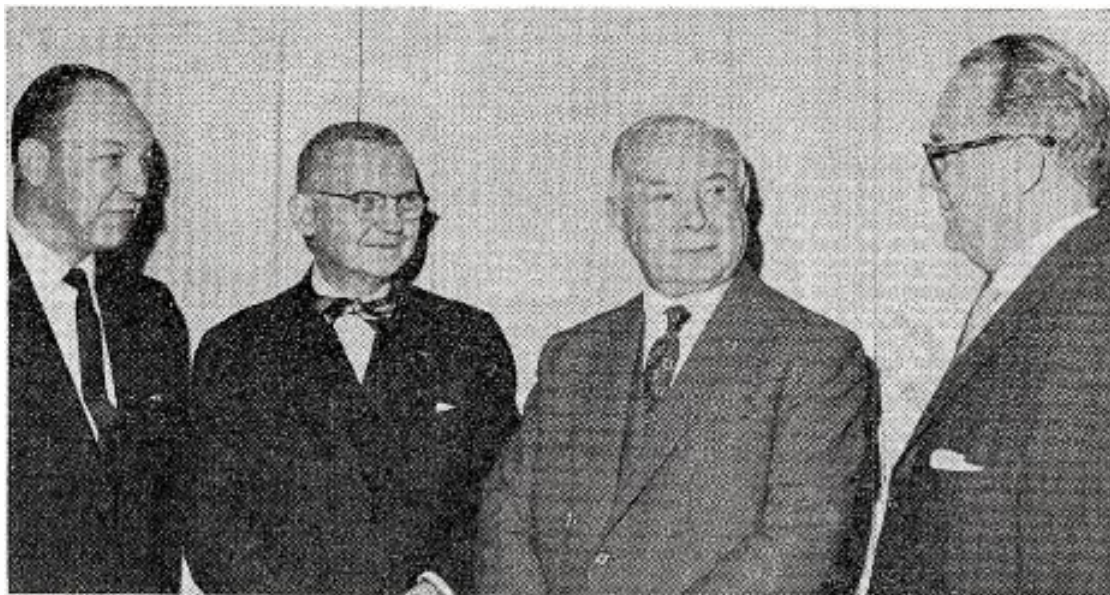

Policy talk • Brig. Gen. David Sarnoff, board chairman of RCA (second from right), discusses Medical Radio System, a service of NBC and RCA, with NBC executives and Dr. Chester S. Keefer (second from left), head of MRS' editorial advisory board, at the initial policy meeting of the editorial board Dec. 7 in New York. Dr. Keefer, executive director of Boston U. Medical Center, is president-elect of the American College of Physicians. Robert W. Sarnoff, NBC board chairman, is at left and Henry T. Sjogren, project manager of the Medical Radio System, is on the right. Chief areas of discussion by the board centered on selection of a qualified medical editor for MRS and exploration of policies designed to provide medical news and post-graduate materials to MRS subscribers. The new service expected to start next fall, is an fm network to deliver medical news to doctors' offices via multiplex fm. Subscribers will pay a fee of \$120 a year including equipment. NBC hopes to start the service in 16 markets (BROADCASTING, Nov. 9)

Sansome St., S.F.; 1546 N. Highland Ave., Hollywood.

Down the seaboard • The QXR Network has added WITH-FM Baltimore and WASH(FM) Washington bringing the affiliate total to 17 stations extending from Boston to Washington. WQXR New York is the key station.

WJPB-TV and WENS (TV) merger details • Details of the merger agreement worked out between WJPB-TV Inc. and Telecasting Inc. in their contest for ch. 5 Weston, W.Va. (BROADCASTING, Nov. 9) establishes a joint ownership of WJPB-TV, formerly on ch. 35 in Fairmont, W.Va., and officially the grantee of ch. 5 in Weston. Telecasting Inc., owner of the now defunct ch. 16 WENS (TV) Pittsburgh, is paying \$200,000 for this 50% interest. Corporate rearrangement of WJPB-TV Inc. brings Thomas P. Johnson, Pittsburgh attorney and vice president of the Pittsburgh Pirates and principal owner of Telecasting Inc., as chairman and treasurer of WJPB-TV Inc.; J. Patrick Beacom, principal owner of the erstwhile Fairmont uhf outlet who has interests in radio stations in Fairmont and New Martinsville, W.Va., and Butler, Pa., as president, and George Eby, of Harris Enterprises of Pittsburgh and an officer of Telecasting Inc. as secretary.

For Phillies followers • The Philadel-

phia Phillies announced that they will telecast 61 games next year, including all Saturday day games at home and complete Sunday doubleheaders at home. A total of 14 night games are also to be aired on WFIL-TV, with WFIL handling the am broadcasts. N. W. Ayer & Son Inc. announced that advertisers for the games will remain the same: Ballantine beer, Phillies cigars and Tastykake.

• Rep. appointments

• WITH Baltimore, WXEX-TV-WLEE Richmond, Va.: Adam Young Inc., N.Y., for Chicago, West Coast and Boston. Select Station Representatives, N.Y., continues to represent the stations in New York, Philadelphia and Washington and Clarke Brown Co., Dallas, continues as representative in the South. In reporting the Young appointment (BROADCASTING, Dec. 7) the area breakdown for each of the aforementioned firms was not clearly given.

• CFCL Timmins, Ont., and CFNB Fredericton, N.B., have appointed Paul Mulvihill & Co. Ltd., Toronto, Ont., as exclusive representative.

• WBAZ Kingston, N.Y.; WMBS Uniontown, Pa., and WAIX Galesburg, Ill.: Burn-Smith Co.

• WBBF Rochester, N.Y., appoints John Blair & Co. effective Jan. 3, 1960 as its national representative.

Your audience... seasonally

2 to 12 times a year

Nielsen Station Index reports audience measurements for each market, season to season, from 2 to 12 times a year depending upon the size and importance of the area. Right now NSI® issues over 750 different seasonal market reports a year . . . and by next spring it will be over 800!

To be sure that audience measurements are free of distortions caused by changes in programming, special promotions, and other atypical activities, Nielsen Station Index measures tv and radio audiences over broad time spans . . . 4 or 8 weeks. NSI reports *average conditions* . . . measurements on which marketing decisions can be based with confidence.

Number of homes reached . . . by station. NSI tells you both total and Metro (or Central) Area audiences for each station for each 15-minute period during the day.

Composition of the audience. NSI breaks down tv and radio audiences to show who are listening or viewing . . . men, women, teen-agers, children.

For television. NSI reports audience data for every competitive tv market in the U.S. These 146 market areas (231 cities) account for over 97 percent of all U.S. tv viewing.

For radio. NSI reports audience data for the top 34 markets in the U.S. These account for the bulk of radio listening, thanks to radio's reach.

Send for sample NSI Report. See for yourself the wealth of information NSI Reports put at your fingertips . . . it is the only way you will understand why leading agencies, advertisers, and stations consider NSI Reports a "must" for efficient operation.

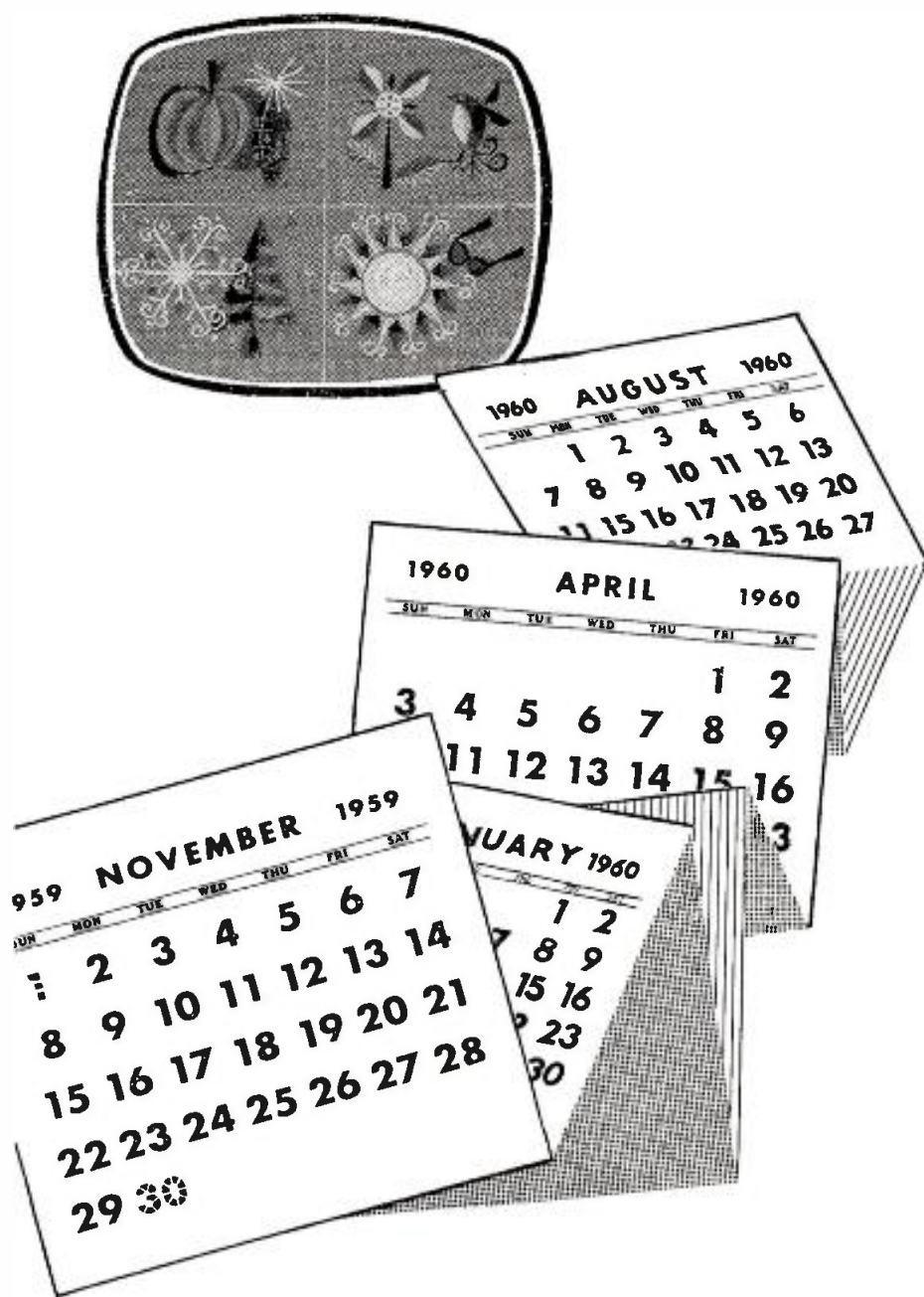

Nielsen Station Index

a service of A. C. Nielsen Company

2101 Howard Street, Chicago 45, Illinois • HOLLYCOURT 5-4400

CALL . . . WIRE . . . OR WRITE TODAY
FOR ALL THE FACTS

CHICAGO 1, ILLINOIS
360 N. Michigan Ave., FRANKLIN 2-3810

NEW YORK 22, NEW YORK
575 Lexington Ave., MURRAY HILL 8-1020

MENLO PARK, CALIFORNIA
70 Willow Road, DAVENPORT 5-0021

9740



man to man . . .

. . . in news broadcasting . . .

**you can
why settle**

get the **best**^{*}
for less?

**the Associated Press, of course.*



Three clubwomen • Clara S. Logan, National Assn. for Better Radio & Television, Mrs. Julian Whittlesey, National Council of Women, and Mrs. F.L. Bull, National Congress

of Parents and Teachers, (l to r) wait to testify before the FCC. The ladies were unanimously disturbed by lack of balanced programming. All asked the FCC to get tough.

FCC'S 'WE THE PEOPLE' SHOW

30 witnesses make 50 proposals before week's dust settles

After four days of hearings and testimony from over 30 witnesses, the FCC may not be any closer to solving the dilemma of radio and television but it has some 50 different proposals to consider.

Witnesses during the first week of the Commission's programming inquiry were verbose in their suggestions, recommendations and criticisms. Alternate praise and damnation bounced off the calloused ears of the five sitting commissioners. Hardly a phase of the broadcasting industry escaped mention, often with words that were highly critical but with a few phrases of com-

mendation now and then.

Ideas on what should be done to erase from the public's mind the bad taste of the tv quiz and payola scandals ran from exhuming the Blue Book (See page 66) to local hearings on each and every broadcast licensee renewal (approximately 1,800 yearly). Among recommendations repeated several times:

Public advisory committees in every way, shape and form; abolition of crime shows and westerns; network regulation; local, state, regional and national committees to hear complaints against stations; laws to require sta-

tions to devote prime time daily to public service and culture programs; more and better children's programs; federal aid for educational tv; pro-industry self-regulation and, on the other hand anti-industry self-regulation; divorcement of advertisers from control of programming content; regular FCC field hearings to hear complaints of John Q. Public; when warranted, revocation of licenses by FCC with close scrutiny at renewal time, and a requirement that a station make a public announcement when its license is up for renewal to give people a chance to comment.

The Speakers • Testimony came

Introducing the **ALL NEW** **GATES BT-5C 5000 Watt** **TELEVISION TRANSMITTER**

Under development for more than two years, the new Gates BT-5C is an entirely new 5 kilowatt VHF television transmitter designed for the most exacting color and monochrome transmission.

The new BT-5C is completely self-contained, including power supply and blowers, and requires total floor space of only 10 by 3 feet. Other highly rated features include separate high voltage power supplies for both aural and visual transmitter, and a new and improved video modulator with keyed clamping and automatic switch over to AC coupling with reduced carrier power in case of sync or program failure.

Visual transmitter is grid modulated in the 500 watt visual driver by a dynamic cathode load modulator circuit. Video modulator is equipped with RF bias failure alarm lamp, test meter and an abundance of front panel test jacks. The BT-5C uses proven 6076 tetrodes in final amplifier of both visual and aural transmitter.

FOR COLOR

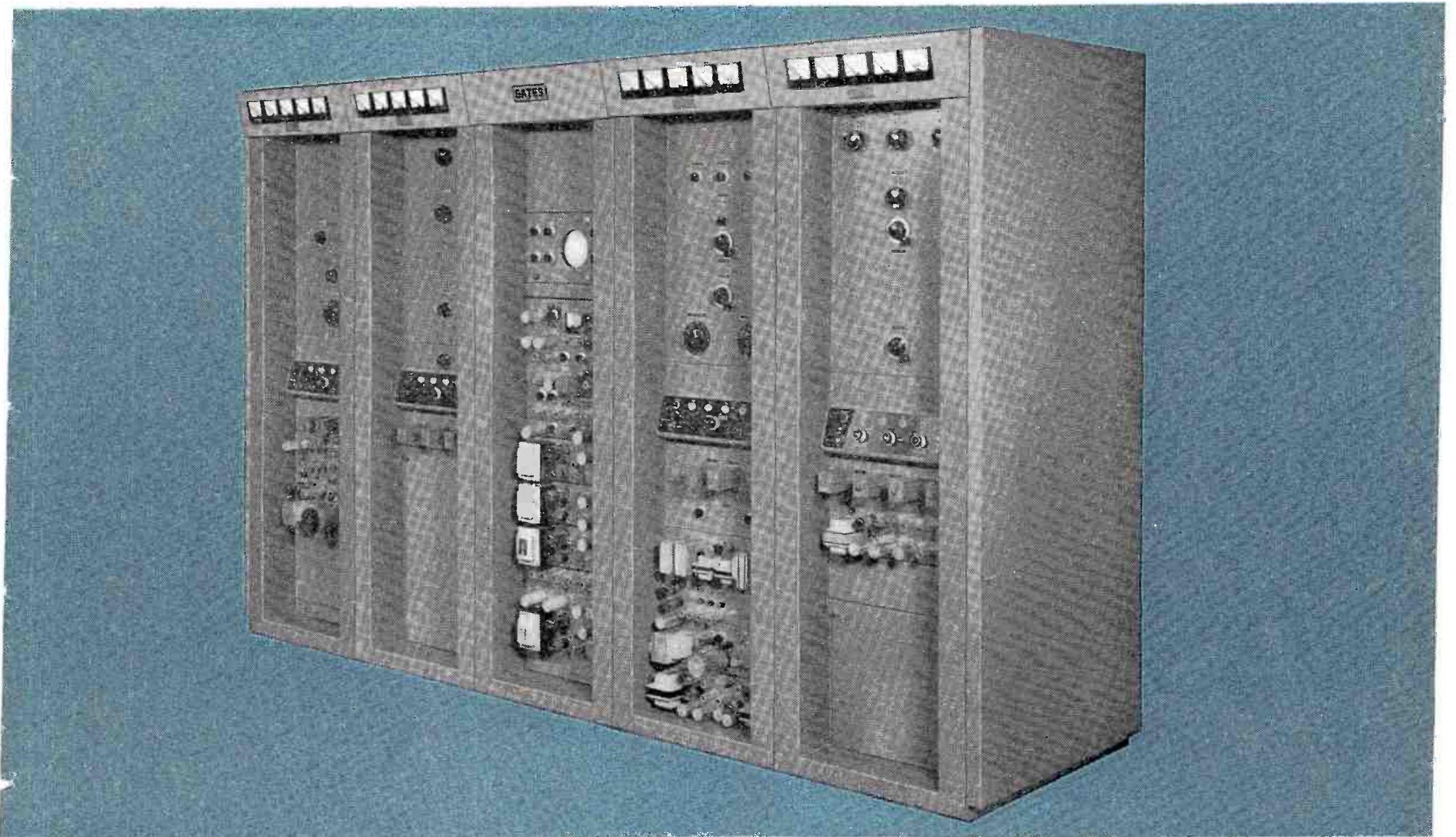

FOR BLACK AND WHITE



For detailed technical information on this exciting new television transmitter, write today for Bulletin 115-L—yours for the asking.

GATES

HARRIS
INTERTYPE
CORPORATION

GATES RADIO COMPANY

Subsidiary of Harris-Intertype Corporation

QUINCY, ILLINOIS

Offices in:
HOUSTON, WASHINGTON, D.C.

International division:
13 EAST 40th STREET, NEW YORK CITY

In Canada:
CANADIAN MARCONI COMPANY

WHAT THE BLUE BOOK WAS (OR IS)

There was talk of "bringing back the Blue Book" at the FCC hearing last week. This talk was certain to stir memories, many of them bitter.

Only 58 pages, with a pale blue cover, "Public Service Responsibility of Broadcast Licensees," issued by the FCC March 7, 1946, was greeted by broadcasters with roughly the same reaction accorded by the South to *Uncle Tom's Cabin*.

The Commission introduced it as a "proposed report," but added that it was "effective immediately." Justin Miller, then president of the NAB, referred to its sanctions as "illegal and unconstitutional."

In the month following its release, it was dismissed as "an impish attempt to throw a scare into broadcasters" and damned as "an attempt to cripple free speech." The American Civil Liberties Union stated that the Blue Book would bring "more freedom on the air, rather than less;" Republican National Committee Chairman B. Carroll Reece (R-Tenn.) said it had made radio "half slave, half free." Broadcasters charged the FCC with a violation of Sec. 326 of the Communications Act, which denies the Commission censorship authority.

The document which detonated this reaction was the result of an FCC staff study of programming practices. It began with case histories of five radio stations which had been granted their licenses on the basis of their proposed public service programming, which they then had failed to provide, turning instead to purely commercial programming.

Each of the five case histories was a morality play pointing out the FCC's concept of what constitutes public service programming. Each factor was taken up in a

subsequent section: live local programming, public issue presentations and avoidance of advertising excesses (such as what it called the "physiological commercial").

A large section was devoted to the importance of the sustaining program and charts of the proportion of commercial to sustaining programs were presented in heavy black (commercial) and white (sustaining). The sustaining program, the Blue Book stated, provides "program balance;" it allows for programs "inappropriate for sponsorship;" it caters to "significant minority tastes and interests." In addition, sustaining programs give greater opportunity for service to non-profit organizations and for program experimentation, the pamphlet said.

The last section consisted of the Commission's recommendations, including careful scrutiny of the programming history of license applicants and revocation of permits of those who fail to live up to their proposed schedules. These suggestions were to be implemented with programming schedule forms with elaborate categories of programs and commercials to be filled out by applicants. Random monitoring by the Commission of daily programming was suggested.

The programming study which gained notoriety as the Blue Book was proposed in 1945 by FCC Chairman James L. Fly. It was issued during the tenure of Chairman Paul A. Porter, now a communications attorney. Its authors were never officially revealed, but the names of Comrs. Clifford J. Durr, a Roosevelt appointee, and Charles R. Denny, now an RCA executive, were frequently linked with its philosophy. Prof. Charles Siepmann, who testified before the present Commission Thursday (see below), bore the brunt of the broadcasters' wrath.

from religious leaders, educators, farm leaders, civic clubs, women's clubs and etv groups. In many instances, they were questioned closely by the commissioners. Comr. Frederick Ford, for instance, liked the idea of local, regional and national committees to hear grievances.

The commissioners wanted to know when the saturation point is reached in crime shows, sex, westerns and other

types of "undesirable" programs. Chairman John Doerfer brought an admission from one witness that newsstands are dominated by this type of literature—in a higher percentage than tv programming.

In an opening statement, Comr. Doerfer stated: "We are determined to devote as much time as is necessary to this investigation. We must have suf-

ficient information to give thoughtful consideration to corrective measures within our powers or to propose legislation . . . This is an important moment in American history. These hearings may well determine the future course of our system of broadcasting."

Other commissioners present were Robert E. Lee, Robert Bartley and John Cross. Comrs. Rosel Hyde and T.A.M. Craven are in Geneva, Switzerland, for the International Telecommunications Conference.

The hearings continue today (Monday), tomorrow, Thursday and Friday in Room 7134, New Post Office Bldg. A resume of last week's testimony follows:

Prof. Charles Siepmann, New York U. • The infamous FCC Blue Book should be "recovered from the wastebasket and its provisions enforced . . ." the NYU professor who reportedly played at least an advisory role in drafting the 1946 programming manual, told the Commission.

The educator who is head of NYU's Dept. of Communications also made the following recommendations: divorcement of FCC appointments from politics, with choice based on "proven integrity, high intelligence and dis-



Commission braintrust • Working long hours in preparing last week's hearings and scheduling witnesses were (l to r) Ashbrook Bryant, James Tierney and Harold Cowgill of the FCC. Mr. Bryant, senior attorney on the Network Study Staff, introduced each witness and led off the questioning. Mr. Cowgill is chief of the Broadcast Bureau and Mr. Tierney is on the Network Staff.

The month after the Blue Book was issued, Mr. Siepmann released his own book, *Radio's Second Chance*, which expressed ideas and concepts identical with those in the FCC treatise and even cited one of the same station case histories. A former program director of the BBC, he was charged with trying to impose by force the British system of broadcasting on the United States. In the book he concluded that American radio was almost hopelessly commercialized and that its "second chance" and greatest hope lay in fm.

The Blue Book was at least in part inspired by what the Commission regarded as a lack of cooperative public service effort by stations during World War II. One example in the pamphlet cites a station's refusal to run a half-hour sustaining show devoted to the activities of the armed forces, preferring to run a record show with 11 spot commercials. Another complaint was that a commercial combined a patriotic appeal to keep healthy for national defense with the suggestion that X Headache Powder was the only way to do so.

While the controversy raged and Blue Book "suggestions" seemed about to be enforced, Comr. Durr, a strong proponent of the recommendations, stated that he would welcome a court test of their power. And in September 1946, it looked as though that test had come.

Washington columnists Drew Pearson and Col. Robert S. Allen, then co-authors of *Washington Merry-Go-Round* applied for the facilities occupied by WBAL Baltimore, one of the stations cited in the Blue Book. WBAL, owned by the Hearst Corp., was up for license renewal and the columnists claimed its record was one of "excessive commercialism." After hearing the case, however, the FCC renewed Hearst's license.

Despite the hue and cry, despite the hearings ordered

on programming grounds immediately after the Blue Book's publication, the FCC has never refused a station a license on programming grounds. The Blue Book is out of print and now something of a collector's item.

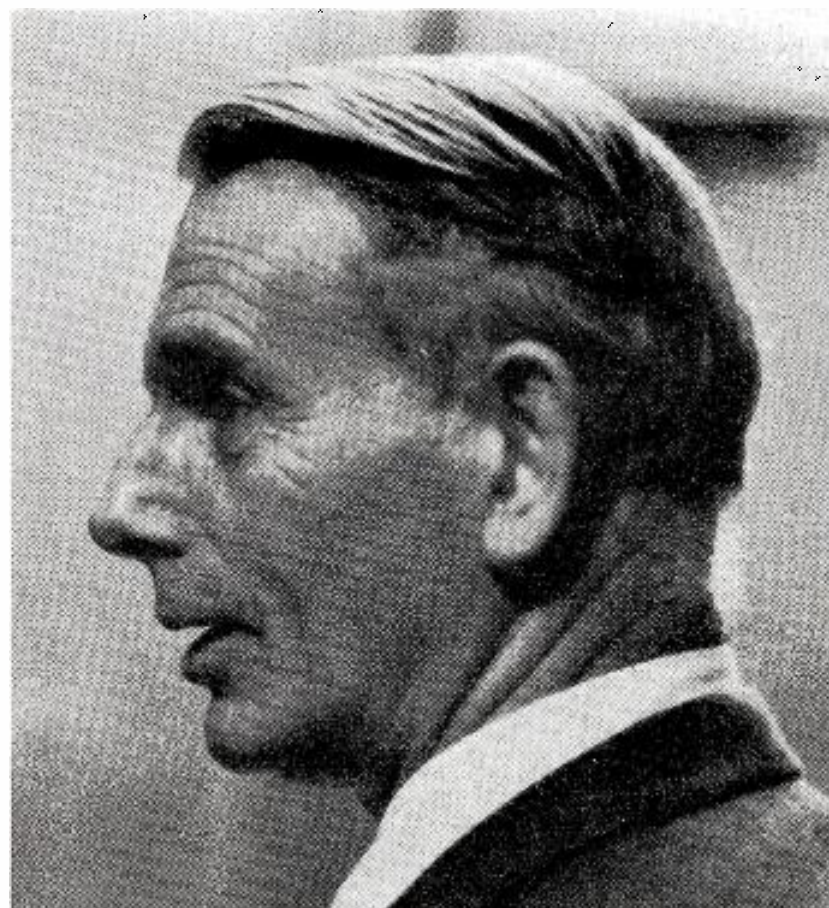

Visit to the grave • Prof. Charles Siepmann, now of New York U., urged the FCC last week to disinter the long-dead Blue Book. At the time the Blue Book was issued, there were reports he had a hand in its creation.

tinguished public service"; renewal hearings in localities served by the licensee; national advisory commission to sit with the Commission and to advise on matters relating to the public interest; mandate that each station devote a half-hour nightly for discussion of the arts, public issues; total divorce of advertising from program content with no more than three minutes per half hour devoted to commercials, and federal aid to etv.

Prof. Siepmann charged that the Commission's "record as guardian of the public interest has, in the judgment of many, been fitful, hesitant and, on occasion, down right pusillanimous. Stations, which later broke the promises of program service . . . have again and again had [their] licenses renewed. The provisions of the Blue Book . . . have been honored in the breach, not in observance. . . . Is the suggestion pertinent . . . that, instead of hearings at this late hour, the public might properly have looked for pronouncements by the FCC. . . ."

"Has the Commission no mind of its own?" he asked.

Of broadcasters, Prof. Siepmann said they are providing the "unseemingly spectacle . . . of men in high posts caught with their moral pants down

. . ." and now they loudly plead that no one, least of all the government, should "help them sew their suspender buttons on again."

Chmn. Doerfer questioned Prof. Siepmann very closely on several of his recommendations concerning advertising, programming quality, newspaper ownership and American-English tv comparisons. "I wonder if you are not advocating government control of broadcasting," the commissioner said.

"I have never spoken of governmental operation," the professor retorted. At another point, Prof. Siepmann said that, based on his limited personal observations, ITA programming in Britain is superior to that in the U.S. because it is free from advertiser control.

Comr. Doerfer cited his observation that a majority of the ITA programming consists of American re-runs and tried to get the witness to state how many hours he had observed British tv.

"You press me very hard, sir, as though you are suspicious," the witness replied. Prof. Siepmann, after being accused by Comr. Bartley of evading the question, said that he certainly would not allow an advertiser to purchase a program as such or to specify in what programs and at what time the adver-

tiser's commercials were to be delivered.

Prof. Gilbert Seldes, Pennsylvania U. • "Broadcasting is today a minority service. It will remain a minority service until a substantial portion of the public joins the broadcasters and the FCC in defining the public interest," the director of the Annenberg School of Communications told the Commission.

He charged that broadcasting oversatisfies a few interests to such an extent that other interests are choked off. The Commission should make it mandatory for stations to announce, six months before expiration, that their licenses were coming up for renewal, he said. This would educate the public, 99% of whom are not aware that a station needs a federal license, to the fact that they have a stake in broadcasting, Prof. Seldes stated.

Answering a question by Comr. Bartley, Prof. Seldes said that "with a great deal of reluctance" he would choose two commercial networks and one educational over three commercial networks. He charged that broadcasters have flunked the opportunity to do a good cultural job—which can be done only through a network of noncommercial stations. On the surface, however, it is perfectly ridiculous to require a station



Clear the air • James Wine, National Council of Churches of Christ called for clarification of FCC's role in licensing broadcasters.

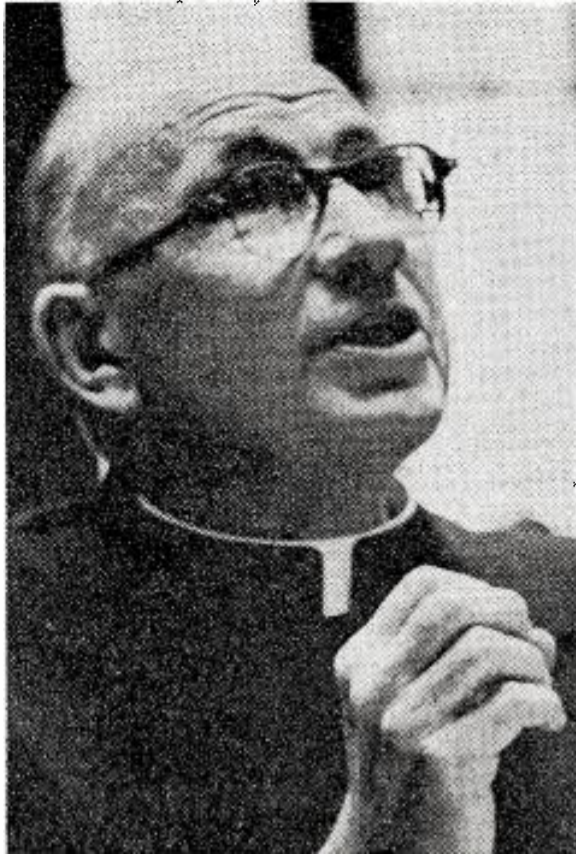

Positive thinker • Msgr. Celestin J. Steiner told the Commission that broadcasting's good outweighs its sins. He called for self-regulation.



Regulations adequate • Rabbi Bernard Mandelbaum told the FCC that existing regulations governing the tv industry were "adequate."

to broadcast sustaining shows, he said. Public service programming does not lose its value when a sponsor is signed, he pointed out.

Prof. William Y. Elliott, Harvard • Dr. Elliott maintained that the FCC has very little authority to do more than just assign frequencies and prevent downright pornography. He urged that sanctions be adopted to prevent the recent quiz show deceptions.

Compiler and editor of *Television's Impact on American Culture*, he was one of many witnesses who hit the alleged overabundance of crime shows and called for a study of their effect on children. He charged the number of cultural programs is declining "in spite of what appears to me to be rather rigged network statistics that suggest the contrary."

Prof. Elliott recommended legislation requiring stations and networks to devote at least one hour daily in prime time to cultural-type programming, for which he maintained there is a substantial audience. If such steps are not taken, he said, tv will "continue to follow a route . . . that is dangerous to the very basic moral fibre of the nation."

An alternative, he said, may be government-owned radio and tv. The industry does not have the capability to regulate itself, he charged. He also plumped for federal aid to etv, a citizens committee, and divorcement of programs from advertisers.

William F. Buckley Jr., 'National Review' • Mr. Buckley suggested that the fusion of "artistic ingenuity with individual enterprise" can best be accomplished with pay tv. The editor

called on the FCC to "permit those who are willing to bet on the existence of thousands of people hungry for . . . quality entertainment to place their bet." He conceded that the majority may not be willing to pay for their viewing but "let them prove themselves wrong; it is their money not ours, that they are staking."

Mr. Buckley insisted that he was not suggesting the elimination of regular tv. However, he said, "the . . . solution is to let the wretched individual choose for himself—which means granting channels to petitioners willing to give the consumer a choice." He asserted that the "vast majority" would probably choose to stay with free television but "would stand to benefit from the existence of a competitive system."

Comr. Cross pointedly told the witness that the present hearings were not a forum for pay tv and that the Commission has asked for toll tv applications but has received no takers.

Patrick M. Malin, American Civil Liberties Union • The executive director of ACLU called for increased government control over broadcasting. He urged the FCC to "energetically exercise" its powers to insure that broadcasters provide "maximum possible range and balance in subject matter and treatment" in its overall programming concepts.

Mr. Malin warned that "if we want the advantages of private radio-television, we must run some of the risks inherent in it. Government cannot do the whole job of seeing to it that the . . . industry satisfies everyone," he said. However, Mr. Malin suggested

that the government "can do part of that job and must begin immediately to do much more than it has been doing."

Suggesting specific areas of increased FCC authority, Mr. Malin said the Commission should make a firm policy commitment in using its existing power and responsibility to evaluate a station's over-all programming. He asked for an up-dating of the 1946 "Blue Book" and an improvement in the public service form to provide "skeletal guidance" for stations in applying the law's standards.

The Commission, Mr. Malin asserted, should hold public hearings to evaluate a station's overall programming before granting a licence renewal. He also suggested holding "interim hearings" during the life of a license if complaints "of responsible persons warrant it."

Licensing of networks should also be in the FCC domain, Mr. Malin said. The Commission should propose this to Congress and the communications law should be amended. This would allow the FCC "power to directly regulate . . . programming of networks . . ."

Prof. Paul Lazarsfeld, Columbia and Harvard • Prof. Lazarsfeld was one of many witnesses who pushed for a citizens committee to help improve radio-tv programming. He also advocated unilateral agreement among the networks on overall program policy and maintained that standards and guidelines can be established and enforced by the FCC.

He said that the industry could not just adopt a code tomorrow successfully; that it would take several years to prove if such a vehicle is satisfactory. On advisory committees, the former

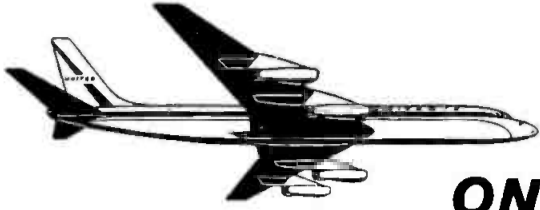

ONLY UNITED AIR LINES FLIES THE DC-8

BEST OF THE JETS COAST TO COAST Here's the way to let yourself go in style on the newest, roomiest, quietest of all the jets. It's United Air Lines magnificent new DC-8 Jet Mainliner®—acclaimed by pilots and passengers alike as *the best of the jets*. Coupled with this is United Air Lines famous *extra care* for the best of service from reservation to destination. Nonstop DC-8 flights between New York, Chicago and California. Plan to enjoy the best of service on the best of the jets. Fly United's new DC-8 jet soon. For reservations, call your nearest United Air Lines office or see your travel agent.

THE BEST OF THE JETS... PLUS UNITED'S EXTRA CARE

New Red Carpet® Room extends full width of plane, provides living room comfort for 8 passengers.





Wants advice • Miss Chloe Gifford, General Federation of Women's Clubs (r) and her legal counsel talk it over. Miss Gifford suggested FCC name advisory groups (like her's for instance) to study tv problems. She thought that advisory groups would be more practical than having FCC expand its activities.

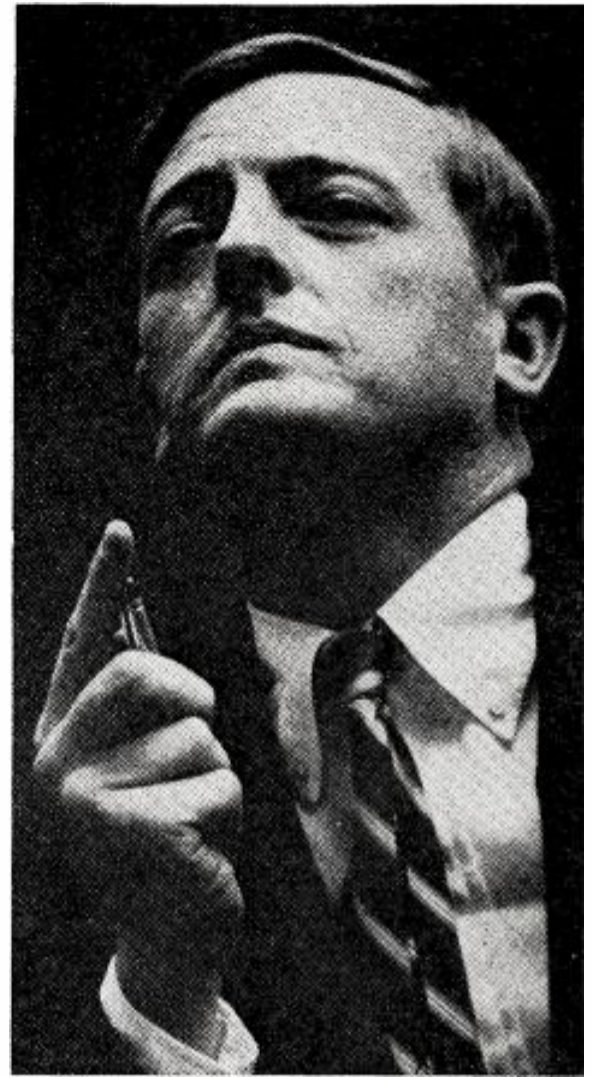

Pay to see • William F. Buckley Jr. of the *National Review*, pleaded the cause for pay tv to let the "wretched individual choose for himself."

CBS researcher said that so often they make their recommendations and nothing happens.

Comr. Bartley commented that the trouble with such groups is that they do not have to follow through on what they recommend and they so often make suggestions that cannot be attained.

While with CBS in the early 1940's, Prof. Lazarsfeld collaborated with Dr. Frank Stanton on a book titled, *Radio Research, 1941*. He said the book showed that 17 years ago it was common practice for music publishers to pay to have their songs plugged.

Monsignor John J. McClafferty, Catholic U. • Father McClafferty said that results of various psychological studies "led to the conclusions that television, pornography and movies play a distinct role in the creation of anti-social behavior in susceptible teenagers." He urged caution, however, in drawing conclusions that are general and vague. The FCC should investigate this area of tv impact, and "could arrange or contract for additional explorations," he said.

The priest placed great emphasis on the role of television in developing the nation's youth. He recommended that the industry concentrate on adherence and continued "perfection" of its self-regulation "based on the Television Code. . . . Industry self-discipline in

program planning and content seems to be the mature, responsible and democratic way of resolving the problem." The code, Msgr. McClafferty contended, "should have guiding influence not just for stations and networks but also for sponsors, advertising agencies and producing organizations."

Charles B. Shuman, American Farm Bureau Federation • (The president of the federation, unable to attend the Commission, had his statement filed for the record). Mr. Shuman told the hearing that his group was "disturbed" at the general decline in farm service broadcasting throughout the country. "In many instances where farm service programs have been retained," he said, "they have been squeezed into pre-dawn schedules. . . ." Mr. Shuman stated that most farm programs "have performed a vital service to the farmer—keeping him up to date with . . . market information and other news and facts important to his livelihood."

Martha Gable, American Assn. of University Women • "Since 1946 the demands on the communications media have changed as fundamentally as the technical means of meeting these requirements," Miss Gable stated.

"With mounting external and internal challenges to the nation, educational needs have become more pressing and the need for an informed public opinion more critical." She said that

the AAUW feels that, in light of these changes, the FCC "will wish to revise its statement of broadcasters' public service responsibilities."

Miss Gable suggested that "In undertaking such a reassessment, the Commission might benefit from the assistance of a broadly representative advisory council." She explained that the council could be charged with a periodic review of programming trends in the light of educational needs and broadcasting resources.

Walter B. Emery, Michigan State U. • ". . . In my opinion under the Communications Act of 1934 as it now reads, the FCC not only has the authority but the responsibility to concern itself with the program service of stations whatever may be the character of that service when those stations come up for license renewal," Mr. Emery said. The former FCC lawyer asserted that "as a legal matter, there can be no question about it," but added that "a lack of specificity in the statute itself has been troublesome. Sec. 326 of the Act prohibits the Commission from censorship. This has been interpreted by the Commission and the courts to mean that the FCC can't tell a station what particular programming it may not carry except where prohibited by statute (such as obscene and lottery programs)." Mr. Emery concludes, however, that this doesn't preclude

100
million
glass
bottles
annually
from
the market
on the
move...

TAMPA - ST. PETERSBURG

That's the number to be turned out from the eighth and newest plant—located in the fast-growing Tampa Bay area of Florida—of Thatcher Glass Manufacturing Company, Inc.!

Says J. W. Green, President of Thatcher, "This area was chosen, after months of study, for its (among other factors) proximity to a dynamic, progressive market."

Dominating this market on the move is WTVT, station on the move—first in total share of audience (48.6%, latest ARB) and first in top-rated shows!

CHECK THE TOP 50 SHOWS	}	ARB	Nielsen
		WTVT 37	WTVT 38
		Station B 9	Station B 10
		Station C 4	Station C 2

WTVT
STATION ON THE MOVE!



Channel 13

THE WKY TELEVISION SYSTEM, INC.
WKY-TV / WKY-RADIO Oklahoma City
Represented by the Katz Agency

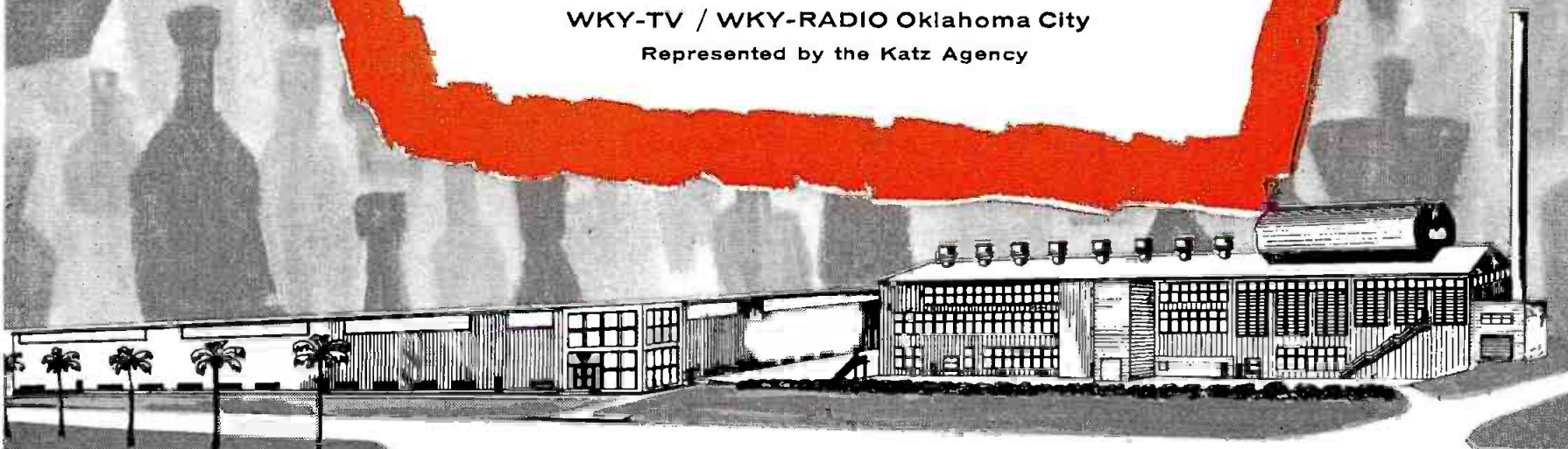

Tampa Industrial Park is location of \$3,500,000 Thatcher Glass Manufacturing Company plant.

**NAIL
DOWN THE
BEST
OF ALL THE
REST
OF MICHIGAN**

**W K N X
SAGINAW**

The number one Pulse rated station in the Saginaw - Bay City Area the 5th year in a row.

Outstate Michigan's most powerful station - serving a giant market of more than 1,000,000 radio listeners.

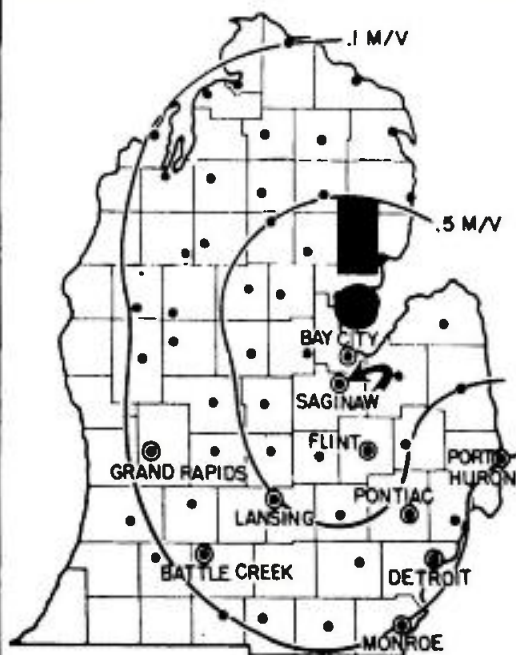

**W K N X
10,000 WATTS**

Lee gets ahead of the pack

FCC Comr. Robert E. Lee, in an interview with the *Chicago Daily American* last week, proposed some



MR. LEE

sweeping reforms of his own for radio-tv and the FCC. Some of the proposals, which the commissioner said were reported accurately, had not been stated publicly before. In essence, Comr. Lee recommends:

- A requirement that programs be labeled as to content.
- Issuance of credentials to radio-tv personalities, disc jockeys and entertainers and, if they do not live up to certain standards, their license to perform revoked.
- Sanctions short of license revocation to punish licensees for minor offenses.

• Conditional or probationary licenses for stations which have not lived up to promises, with revocation to follow if improvements are not made within a specified time.

• Licenses beyond the three year maximum for stations with spotless records.

• Adopt the Tv Code as part of the Commission rules with sanctions for violations.

• Direct regulation of networks. "I think I am getting pretty close to favoring doing directly what we now do indirectly," he said.

• Close inspection of sale applications, possibly with automatic hearings on all sales before the expiration of a station's original three-year license.

FCC review of the overall performance of a station at license renewal time.

Very Rev. Celestin J. Steiner, S. J., National Catholic Welfare Conference • Expressing confidence in the future of radio and tv, Rev. Steiner said that "the good already done is far greater than the shortcomings of the few." He said it would be unfair and misleading to ignore or underestimate the great good that has been accomplished by broadcasting.

"Moreover," the president of Detroit U. continued, "we would be as naive and/or insincere as those guilty of practices that are the concern of these hearings, if we were to take the position that the broadcasting industry alone is guilty of immoral practices, dishonesty [and] bad taste. . . ." He said the reprehensible practices disclosed are a revelation and an indictment of the state of this nation's morality and this should be our greatest concern.

Father Steiner stressed that direct supervision of program content by the licensee is imperative. Self-regulation is highly preferable to control by the government, he said, with an ideal situation one in which all stations subscribe to the industry's code. And, loss of the code approval should indicate to the FCC that some official sanction is needed against the offending station, even loss of license, Father Steiner said.

Rabbi Bernard Mandelbaum, Jewish Theological Seminary of America • "It would be most unfortunate if the result of all this turmoil was a series of new rules and watchdog committees for policing the airways," Rabbi Mandelbaum told the commissioners. He said existing rules of the FCC and self-imposed

regulations of the industry are adequate.

The public, the industry, Congress, the FCC and just about everyone must share the responsibility for the current situation, the rabbi stated. "The misleading aspect of all these inquiries is that some people act as if the chicanery which appeared on tv was created by tv," he said. "The mass media are 20th Century technological advances. Lying and cheating for money and fame are far older. . . ."

"Everyone pretends to know exactly what the industry should have done to avoid the recent difficulties and how it should behave now to prevent a recurrence."

Rabbi Mandelbaum recommended the establishment of an Institute on Values in the Mass Media, composed of leaders in education, philosophy and religion. Without legislative or investigative powers, its functions should be to study the ethical and moral implications of communications problems.

James Wine, National Council of Churches of Christ • "We do not share the belief that the law is not clear as to the responsibilities of the FCC and the licensee broadcasters," Mr. Wine said. "We believe that lack of will to enforce and weakness of will to obey the regulations are the primary sources of the difficulties in which the industry now finds itself."

He cited these practices of broadcasters as being "inimical to the public interest": programs featuring crime and violence during children viewing hours; using program star of children's programs for high-pressure, hucksterish commercials; use of half-truths and exaggerations; mediocrity in program

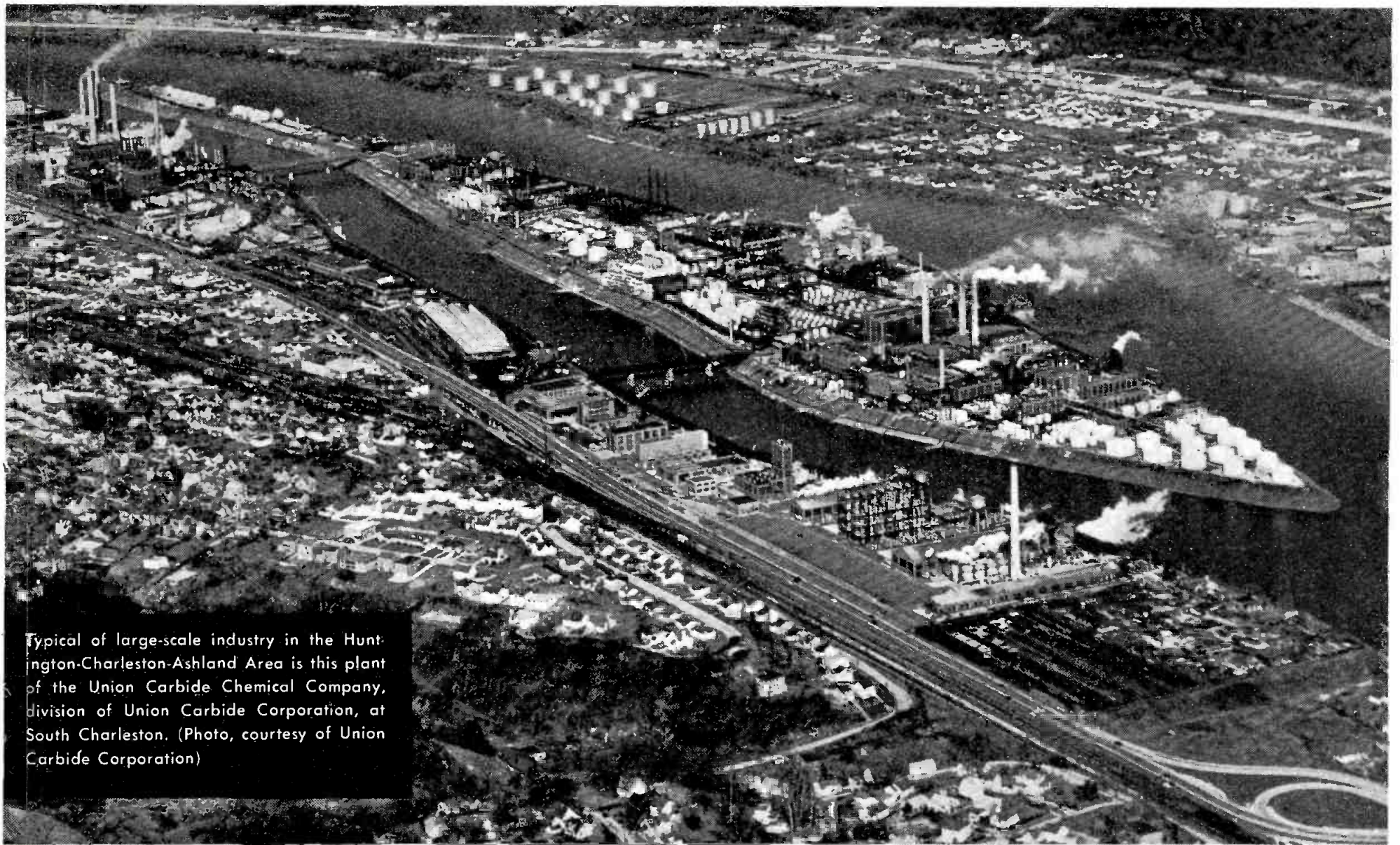

Typical of large-scale industry in the Huntington-Charleston-Ashland Area is this plant of the Union Carbide Chemical Company, division of Union Carbide Corporation, at South Charleston. (Photo, courtesy of Union Carbide Corporation)

WHTN-TV

No. 1 Selling-force in the Golden Ohio Valley,
America's Booming Industrial Empire

Call the roll of American industry—and you find most big names represented by tremendous plants in the Golden Ohio Valley—where high-level employment creates annual buying-power exceeding four-billion dollars.

It's a wide-spread market—5 key cities, 89 counties, with 591,020 TV homes—served best by the Valley's only full-power station, WHTN-TV. With top-rated CBS shows plus the alert local programming that distinguishes every Cowles operation, WHTN-TV gives this prosperous area its finest TV service—and puts a most powerful selling-force at your command. For specific data affecting your plans in this great market, call Blair Television Associates.

*Effective January 1, 1960
WHTN-TV announces
the appointment of*

BLAIR TELEVISION ASSOCIATES
as national representatives

NEW YORK • CHICAGO • BOSTON • DETROIT • JACKSONVILLE
ST. LOUIS • DALLAS • LOS ANGELES • SAN FRANCISCO • SEATTLE

WHTN-TV HUNTINGTON
CHARLESTON
WEST VIRGINIA



CHANNEL 13
A COWLES OPERATION • CBS BASIC

RCA Rack-Mounted

"Fits In" where

NO DOORS TO OPEN
NO PANELS TO SLIDE
NO GYMNASTICS IN SERVICING
The RCA TV Tape Recorder is
the ultimate in accessibility
and space-conserving design.



TV Tape Equipment

other designs "Stick Out"!

Any station can find rack room for the RCA TV Tape Recorder. Its rack-mounted design fits in anywhere. It adapts inconspicuously and unobtrusively . . . along one wall, across a corner . . . or into a mobile unit where all space is at a premium.

Without protruding doors or panels to open up and take up space, the RCA TV Tape Recorder is conveniently operated from the front and easily serviced from the rear. Your film room can become your tape room with a maximum of accessibility and a minimum of alteration. Your mobile unit can be used as a tape unit with all essential camera and control equipment included in it.

Any way you look at RCA TV Tape equipment, it's apparent that the "kind of space" the RCA Recorder requires keeps the "user cost" down to a minimum. Many regard this as the most important "plus" in a host of other fine features, including superb picture quality and operating simplicity. You'll find it well worth your while to consider carefully *all* the reasons why RCA TV Tape equipment is best for your requirements.

Don't settle for less than the best. See your RCA representative. Or write to RCA, Dept. BB-22, Building 15-1, Camden, N. J. In Canada: RCA VICTOR Company Limited, Montreal.

Why You Get The Best When You "TAPE IT RCA"

21 Outstanding RCA Features

1. Centralized control panel including metering of audio, video, control track and master erase heads.
2. Better than 36 db video signal-to-noise of wide bandwidth video.
3. Quadrature delay lines, record and playback.
4. Built-in picture monitor and oscilloscope with push-button selection of signals.
5. Continuously variable winding speed.
6. Foot-switch on reel brakes for easy tape threading.
7. Air lubricated tape guides.
8. Space-saving rack-mounted design.
9. Four channel video equalizer.
10. FM deviation meter.
11. Coarse and fine adjustment of control track phase with full 4-track range.
12. Simultaneous playback of program audio and control track during record.
13. Playback tape speed control for synchronization of two or more machines.
14. Tape footage indicator.
15. Complete cue channel facilities.
16. Calibrated control for measuring remaining video head life.
17. Automatic control of shoe positioning for protection against skewing in pictures.
18. Balanced shoe adjustment for protection against scallops in pictures.
19. Provisions for accurate tape splicing.
20. Master erase head.
21. Precision reel hubs for long bearing life.

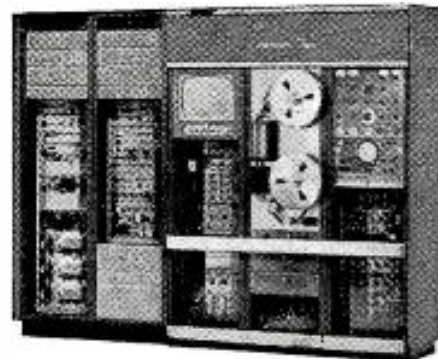

In-line arrangement—allows maximum accessibility for maintenance and operation.

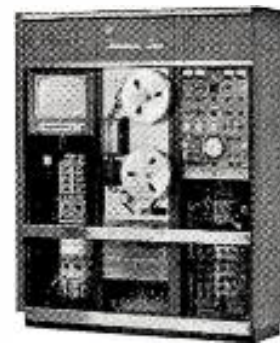

Corner arrangement—ideal for restricted areas. Assures excellent accessibility.



Mobile unit arrangement—accommodating cameras and tape equipment in one place.



Tmk(s)®

RADIO CORPORATION of AMERICA

BROADCAST AND TELEVISION EQUIPMENT • CAMDEN, N. J.

planning; superficial news reports; poor taste in commercials.

Mr. Wine recommended that a station be required to advertise the fact that its license is expiring, both over its own facilities and in newspapers, when it comes up for renewal. He also recommended (1) that the FCC hold local and regional hearings at regular intervals to hear complaints against licensees; (2) publication of FCC criteria and standards relating to maximum number of commercial announcements per week, percentage of commercial to sustaining time and amount of public service programming; (3) that stations be required to advise the public its facilities are available and (4) that stations be required to announce in prime time that they are using a public property, the spectrum.

Roy Battles, National Grange • Broadcasters carry an extra heavy responsibility to the public, in meeting challenges faced by the nation, Mr. Battles said. "In most cases, the broadcasting and tv industry has met these challenges fairly well," he said. "In some cases, it has failed." Because of these failures, the Grange spokesman recommended, the FCC should scrutinize "more carefully" the records of radio and tv stations in considering license renewals. "We believe the Com-

mission should not hesitate to refuse to renew licenses where stations are clearly failing to measure up."

He said farmers need and expect special additional services from radio and tv because of the very nature of agriculture. Mr. Battles cited regular and numerous weather reports and market information as examples and commended those stations who employ trained farm directors. He recommended that the Commission itself hire a farm expert.

The FCC now "has difficulty in differentiating between stations that give farm service programming and other special rural services a 'lick and a promise' and those who hire competent farm authorities and in general do a job for their rural audience," Mr. Battles said.

Clear channel service is the only way that farm population can receive nighttime signals, he stated. "We strongly urge the FCC to resist pressures for putting additional stations on the few clear channels left. . . . By such unwise action, thousands of rural listeners in remote areas would be deprived of any nighttime radio reception and thousands of other rural listeners of adequate service," the Grange spokesman stated.

He said that clear channel stations

should program with their far-flung nighttime audience in mind, instead of programming only for a local urban audience as many now do. Also he recommended that the FCC not reduce tv mileage separations. Such a move would be detrimental to farm viewers.

On the current radio-tv situation, Mr. Battles said the Grange believes present policies of the FCC are adequate. "We believe that radio and tv should be given a reasonable amount of time to rid their own houses of this latest blight on their character and prestige," he said.

Clara S. Logan, National Assn. for Better Radio & Tv • Quiz show disclosures "represent only a small and relatively unimportant part of the disregard for public interest which characterizes much of broadcast programs," the NAFBRAT president charged. In addition to quiz and payola exposés, Mrs. Logan told the commissioners that investigations also are needed into (1) the possibility of false statements in license renewal applications; (2) broadcast abuse in reporting news; (3) excessive and misleading advertising, and (4) "vast and ever-growing traffic in crime programming which [is] the largest single part of the broadcasting industry."

She suggested that a logical starting

We see by the papers' AN EDITORIAL

IT IS an interesting exercise to compare the actual testimony at the various proceedings involving broadcasting with the reports carried on the news wires or written by the Washington correspondent of some newspapers. As one who has been sitting in on the FCC hearings last week put it: "Any resemblance to the facts is purely accidental."

We won't go that far. But we do recognize that there's a lot of one-sided reporting, playing up the sensational and ignoring the meaningful.

For example, the readers of most newspapers certainly must have the notion that the opening day witnesses at the FCC hearings representing the clergy wanted the government to exercise stringent program controls. Actually, two of the three denominational witnesses advised hands-off programming lest there be censorship.

And at the Federal Trade Commission "conference" the preceding week with network and other broadcasting executives, the news reports shouted about a new crack-down on broadcasters. The fact was that nothing new developed as to radio-tv. But, so far as we're aware, no newspapers played the observation of Chairman Earl Kintner that the FTC has "continued to receive a large volume of complaints" against advertising in media other than broadcasting, or his comment that "the problem is not one common to the broadcast medium."

Many newspapers continue to display the tv and the payola stories above all else, including the President's historic trip abroad and other significant news. It's their prerogative. They can continue to rail and rant. It won't seriously affect tune-in. The public won't be fooled.

What is perhaps more disturbing is the fact the radio

and television stations utilizing the news association wires are getting the same stories that go to newspaper clients. Except in isolated instances where networks and stations do their own reporting, these shallow, one-sided reports, playing up the sensational, are getting on the air.

We do not charge the news associations or newspapers with dishonest reporting. The reports generally are factual, as far as they go. The harsh comments and the trenchant phrases get the reporters' ears. Softer spoken testimony, which finds little wrong with today's fare, and advocating extreme caution lest the Constitutional guarantees be infringed, is too often ignored. And, of course, there are those eager-beaver reporters who feel that broadcasting and newspapers are mortal enemies and who therefore slant their copy for the front office.

There was some blatant testimony at the FCC hearings last week. There will be more of it from the crack-pots and the lunatic fringe if they are given the forum of the proceedings. There also has been considerable thoughtful testimony from witnesses who do not want any bureaucrats in Washington deciding what the public may see or hear, but you wouldn't know it from the headlines or even from what you hear on the air.

The main thrust of the testimony so far has been that broadcasters should be allowed to clean up from within, in those isolated instances where improprieties and other abuses have crept in. There has been no sound proposal from any responsible quarter for new legislation or for imposing direct controls upon programming.

There can't be, because if it should happen, the First Amendment guaranteeing freedom of speech and of the press would be abridged.

total

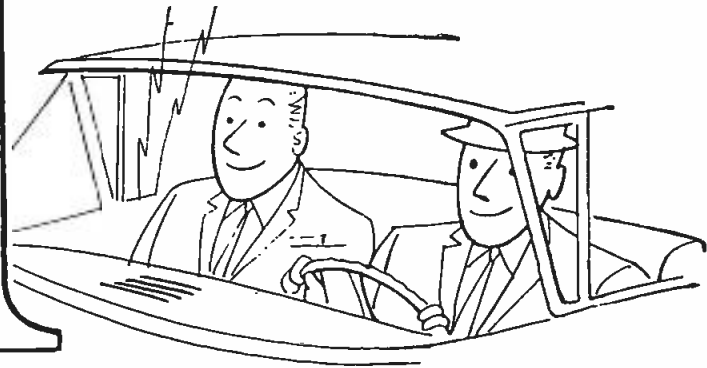

RADIO



There's good listening for everyone on WWJ!

No special group is favored.

No special group is left out.

At 9-5-0, housewives, breadwinners, teenagers, senior citizens all get their share of pleasure and information from WWJ's popular and classical music, complete and reliable news, sports, weather, drama and special features.

Advertisers, too, benefit from this broad gauge concept—find it perfectly planned for moving merchandise in the nation's Fifth Market.

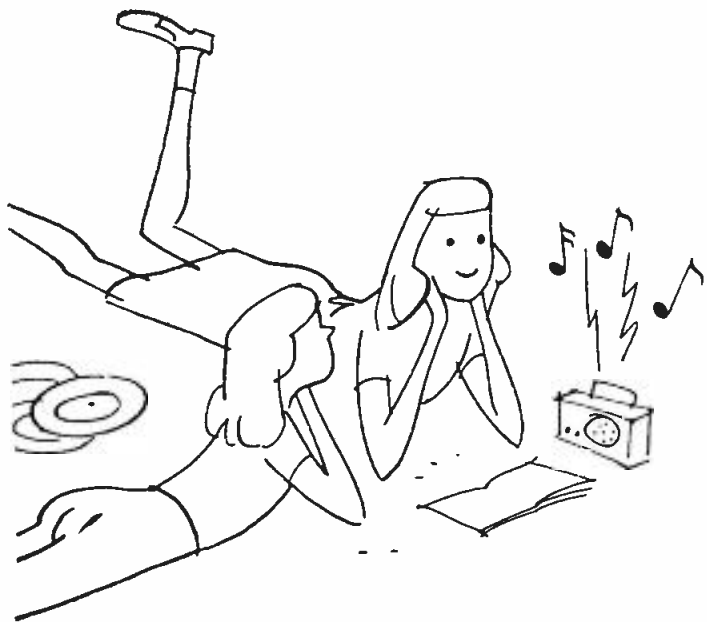
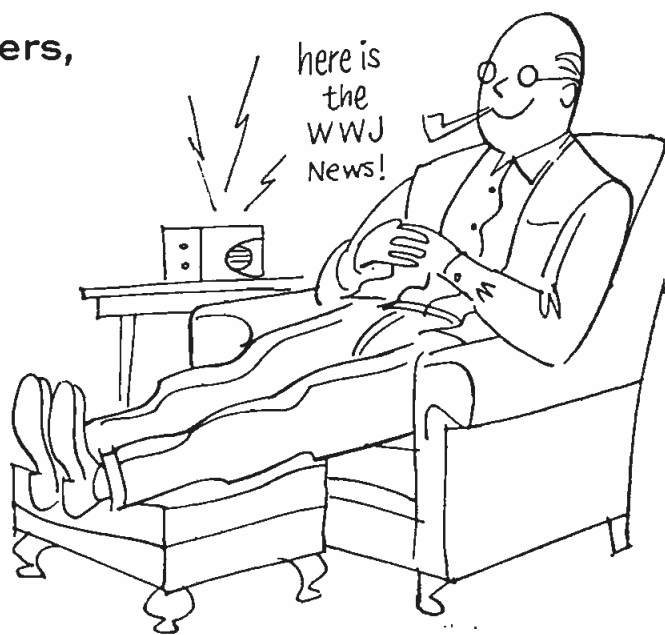

TOTAL RADIO for the TOTAL POPULATION

So good for sales! So try it!

WWJ AM and FM
RADIO
 Detroit's Basic Radio Station
 NBC Affiliate

NATIONAL REPRESENTATIVES: PETERS, GRIFFIN, WOODWARD, INC. OWNED AND OPERATED BY THE DETROIT NEWS



More control • Patrick Malin, American Civil Liberties Union, urged the FCC to increase government control over broadcasting. Regardless of the risks involved, he said FCC must exercise its powers to "do the job." Commission, he said, should hold public hearings before granting license renewals. FCC should also license networks.

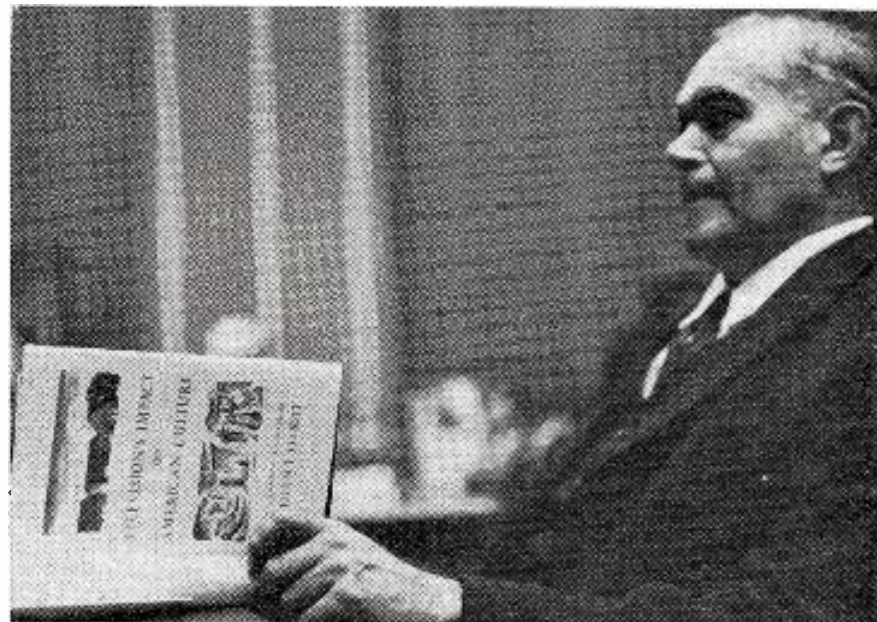

Culture guest • Prof. William Y. Elliott, Harvard U., lamented FCC's lack of authority, tv's lack of culture and the plethora of violence on the air. He called for law requiring daily prime time culture shows. An alternative, he said, would be government-owned radio and tv if the industry cannot regulate itself.

point would be a Commission examination of its own policy in approving station transfers "at huge profits to the licensee." The NAFBRAT spokesman was highly critical of the FCC's actions in this category. She maintained that a licensee has the "use" of the spectrum, but not the ownership thereof, and should not be permitted to sell intangibles.

She charged the networks have refused to heed the complaints of outstanding persons against crime and violence in programming. The two largest distributors of crime and violence in the history of the world, Mrs. Logan said, are ABC and NBC. She placed CBS in third place. She cited a long list of statistics purporting to show the overabundance of crime and violence in network schedules and asked the Commission to bring the networks to task.

NAB's tv code "represents an improper form of censorship and an improper delegation of responsibility by individual broadcasters," NAFBRAT charged in pointing out that current abuses "have flourished under the code's so-called administration."

Mrs. Logan also recommended a close scrutiny of a station's past performances at renewal time and that a licensee be given the opportunity and responsibility to exercise his own judgment in selecting programs.

Mrs. Julian Whittlesey National Council of Women • Mrs. Whittlesey recommended that at least one woman be appointed to the FCC. "As mothers, homemakers, teachers, social workers, professional and lay people, they have a right to be consulted on the one hand and a contribution to make on the other."

The NCW spokesman said that "all the fine codes and good intentions in

the world will not be effective unless there is a genuine understanding by the public as well as by the industry that tv is such a powerful instrument for good or evil, education or demoralization, that it can be lethal to our civilization."

She joined other witnesses in attacking "imbalance of programming" to many crime and western shows and urged that more shows expressing the values of the free way of life be scheduled. Mrs. Whittlesey also called for a complete re-evaluation of all programs where there exists the possibility of fraud; immediate cessation of all payola; less and improved commercials; less emphasis on ratings; more public affairs programs; elimination of all give-away shows, and less frequent and more complete news broadcasts.

The FCC itself, Mrs. Whittlesey said, should make an immediate study of possible and practical methods of licensing network programming; "be far more stringent in its renewal of station licenses"; review station programming at least once a year, and the Commission should be "greatly strengthened in personnel, staff and financing."

Dr. Eugene Hoffman, American Medical Assn. • "The American Medical Assn. would like to go on record as complimenting networks and local stations alike for ably and conscientiously devoting time and talent to the dissemination of health information to the general public," Dr. Hoffman told the FCC.

He outlined several years of close cooperation between AMA and the broadcasting industry providing medical information to the public. Broadcasting, he said, has been anxious that program material be factually correct and in good taste and has been most cooperative in revising scripts—some-

times at a tremendous cost.

AMA established a 12-man Physicians Advisory Committee on Tv, Radio & Motion Pictures, of which Dr. Hoffman is chairman, following many requests from the radio-tv industry for medical information to be aired. The committee also is called upon to comment on commercials advertising proprietary medicines, he said.

He said AMA supports NAB's announced plans to "clean its own house. As professional men, we are strong believers in the philosophy of self discipline, rather than government interference."

Victor H. Nyborg, Assn. of Better Business Bureaus • Mr. Nyborg's testimony dealt almost exclusively with cooperation between his bureau and the broadcasting industry to rid the airways of false, misleading, deceptive and offensive advertising.

He said BBB annually handles 2½ million contacts relating to advertising and selling in both air and print media. Of these, only about 25,000 cases require action, with only 3% referred to authorities after voluntary corrective procedures have failed. BBB has found that the vast majority of tv and radio stations attempt to carry only advertising which will merit confidence in the station and advertiser, he said.

In most instances, the association president said, broadcast media cooperate with BBB corrective procedures when advertising is found to be false or deceptive. "On the other hand, there is a minority in business and in the broadcasting field which uses or carries advertising which is dishonest and which, by willful design, is broadcast to mislead or defraud," he said.

BBB has had a close, harmonious relationship with the NAB Code Re-

In the Providence market WJAR-TV leads by almost 2 to 1* in weekday adult programming!

*NIELSEN FIGURES: From 7 A.M. to 6 P.M., Monday through Friday, there are 35 fifteen-minute segments of adult programming on both Providence stations. WJAR-TV leads on 22, the other station on 13 — a clear preference of almost 2 to 1! (Nielsen, August, 1959 Metro Ratings)

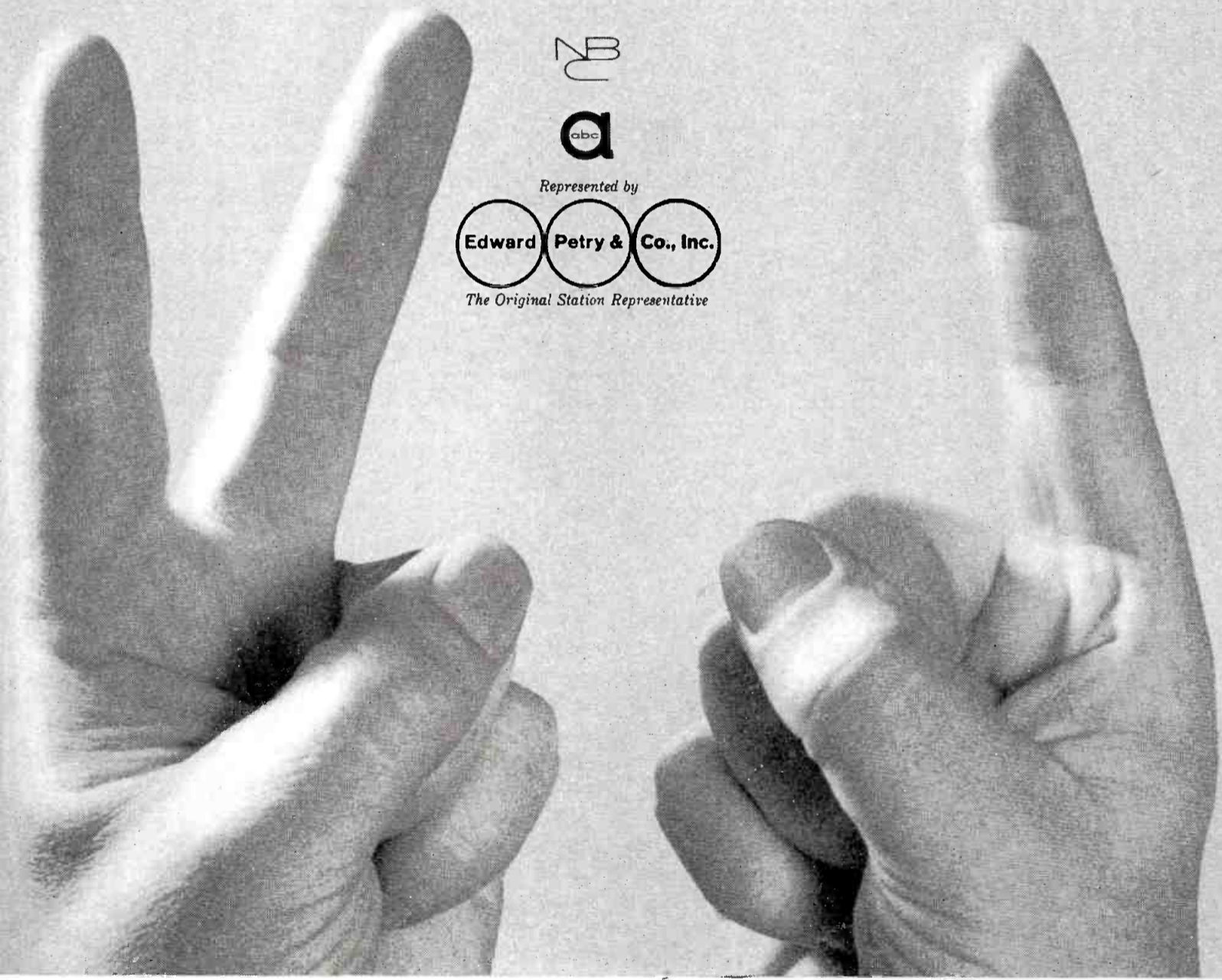

NB
abc
Represented by
Edward Petry & Co., Inc.
The Original Station Representative

Wmca 570 kc
 Wmca 570 kc
 Wmca 570 kc
 Wmca 570 kc
 Wmca 570 kc
 Wmca 570 kc
 Wmca 570 kc
 Wmca 570 kc
 Wmca 570 kc
 Wmca 570 kc
 Wmca 570 kc
 Wmca 570 kc
 Wmca 570 kc
 Wmca 570 kc
 Wmca 570 kc
 Wmca 570 kc

FIRST
ON
YOUR
DIAL



Wmca

THE VOICE OF NEW YORK

Call us collect at MUrray Hill 8-1500
Or contact AM Radio Sales.

view Board, he said. "On the whole, it can be said that there has been an improvement in recent years in local radio and tv advertising," he pointed out.

Angus McDonald, National Farmers Union • On the subject of remote communities receiving tv: "The consumers in the far distant towns and cities have no control whatsoever in the content and variety of the program," Mr. McDonald said. He observed that tv show producers-distributors have no interest in the remote communities, "they are only interested in the ring of the cash register. . . ."

"It is not clear to us who should bear the blame but probably the networks are more responsible than any other group," the Farmers Union man stated. "Just as community antenna tv has strangled locally-owned tv stations, so the networks have strangled good programs." He added that the networks, by requiring option time clauses, have forced affiliates to accept programs they didn't want. "Similarly," Mr. McDonald said, "local advertisers have been shut out by must-buy practices."

John White, National Educational Television & Radio Center • ". . . Who is to say what is in the public interest? In fact what is the 'public's interest?'" Mr. White asked. "Perhaps dilemma lies in our effort to define, measure and even legislate something that is an attitude or spirit of programming and operation rather than a commodity," he suggested. "If I'm correct how does one guarantee the public's rights?"

The answer to this, the NETRC spokesman thought, lies in the license renewal process. He said: "It can be assumed that the original license grant was made only after an opportunity for competitive hearings and only after the petitioner convinced this Commission and promised that he would serve the public's interests in specified ways.

Mr. White's suggestion: "Let us then at the license renewal period re-read those promises and shift the burden of proof from the FCC to those stations themselves." He said the Commission should substitute for the "almost automatic" license renewal the question: "Why should we renew your license and what have you done about the promises made by you at the time of the original license grant?"

Mr. White reminded that "we must not overlook the fact that the individual stations have a great deal of power in the selection . . . of programs."

Richard M. Saul, Educational Television Council, Philadelphia • "We believe that the answers to tv problems are to be found in greater public and community participation on an effective regional basis rather than greater federal regulation," the etv representative said in proposing the establish-

ment of noncommercial vhf stations in every U.S. city. The council submitted that such stations will bring about the public-community participation which will gradually develop changed public attitudes toward the medium.

These community stations "will provide the diversity of programming that, by making possible repeated exposure of the public to programs with a rising standard of meaningful content, offers the only effective means of sharpening the critical faculties of viewers and encouraging their demand for better programs on all channels," the etv council proposed.

The statement continued: "We therefore propose that the Commission abandon the allocations principles embodied in Sec. 309 of the Sixth Report & Order and embrace instead the regional concept of television service; and it place the prime—though by no means the only—responsibility for local service upon the noncommercial community stations. We do wish to express the hope . . . that the Commission will study the British system of commercial tv, and in particular, the divorcing under that system, of the advertiser from the program producer."

To a question from a commissioner about where the channels would come from for the suggested noncommercial community stations, Mr. Saul opined that maximum-station licensees who wished to buy a station in another area should be induced to surrender to the FCC the other license involved in the deal. This facility then could be turned over to the community. Comr. Robert E. Lee asked Mr. Saul if he thought Philadelphians would "stand for" one of their vhf stations being turned into etv. Mr. Saul didn't profess to know the answer but added that this system—surrendering a license to the FCC—could also be used to discourage trafficking in station licenses.

Miss Chloe Gifford, General Federation of Women's Clubs • Miss Gifford warned that the "moral fiber" of the nation is being degraded by many tv programs. She suggested that the Commission, rather than expand its activities, name advisory committees (drawn from groups such as hers) to meet with the FCC and licensees to study programming problems.

Ralph Steetle, Joint Council on Educational Tv • JCET used the hearings as a forum to appeal for more educational tv assignments in the vhf band. "The Commission has within its present capacities the responsibility and authority to bring about a better overall programming balance by reserving channels for noncommercial program broadcasting in those areas which are not now so served," Mr. Steetle said.

The failure of the FCC to make the

THE QUALITY TOUCH



That moment of a lifetime . . . that day of days when everything must be perfect . . . a reflection of love, beauty, happiness! It does, indeed, take the skill of one who possesses a quality touch to create such a masterpiece!

But quality is reflected in many forms—often times in an image created by combined skills. Such is the case in that all-important quality reflection which sets apart great radio and television stations today.

Represented by



Edward Petry & Co., Inc.

The Original Station Representative

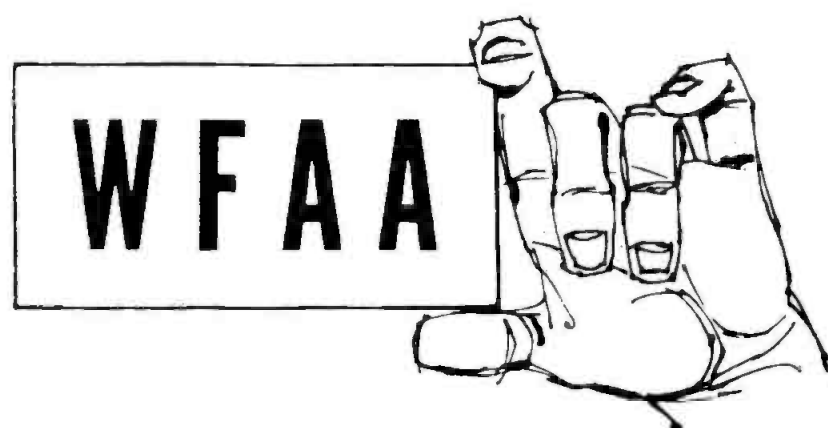

radio & television • dallas

Serving the greater DALLAS-FORT WORTH market

BROADCAST SERVICES OF THE DALLAS MORNING NEWS

YOU KCAN'T KCOVER TEXAS without KCEN-TV

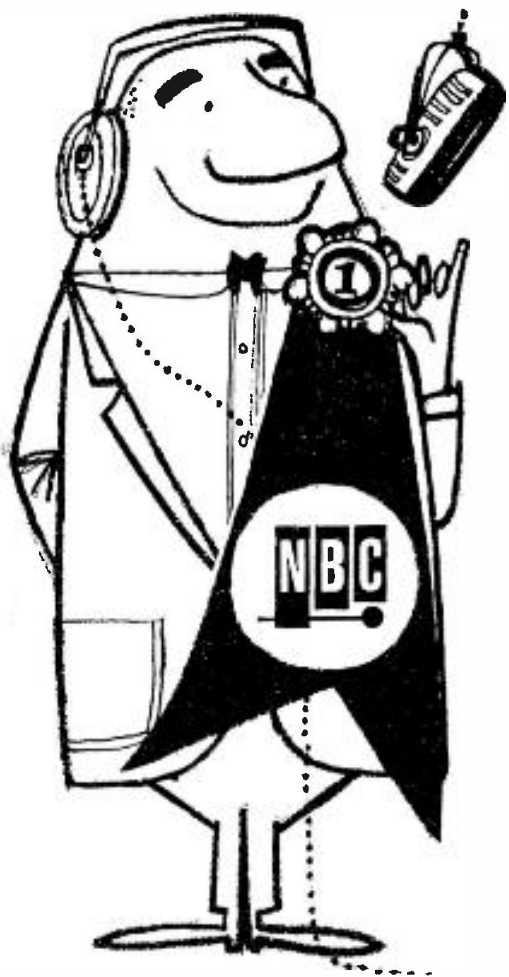

EXCLUSIVE!
we're the only NBC
outlet for miles
around Central Texas!



BLAIR TELEVISION ASSOCIATES
National Representatives

third vhf channel in a city available for education "would compel the conclusion that the Commission is more interested in making tv markets more commercially competitive than it is in providing the opportunity for a broadcast service dedicated to fulfilling the educational and cultural requirements of the community," he charged. Mr. Steetle said that the programs broadcast by the existing 45 educational tv stations "are a more significant reflection of what is good and worthwhile in American life than can be seen over most commercial tv stations."

JCET suggested that the FCC require broadcasters to state what steps they have taken to determine the needs of their respective communities in the areas of public affairs, education and discussions.

Mrs. F. L. Bull, National Congress of Parents & Teachers • PTA is "profoundly perturbed" by the daily tv programming fare offered for children, Mrs. Bull said. For every good children's show, the air abounds with countless, worthless cartoons that keep children occupied when they should be studying or engaged in constructive play, she said.

For every thought-provoking drama, there are 100 farces, she said. "So many programs," she continued, "seem to take the children on a voyage of violence. We'd like to see them taken on a voyage of discovery."

Self-regulation is not enough, Mrs. Bull stated, and the FCC must get tougher with licensees in spite of what the industry does. She advocated a continued evaluation of tv programs directed toward children.

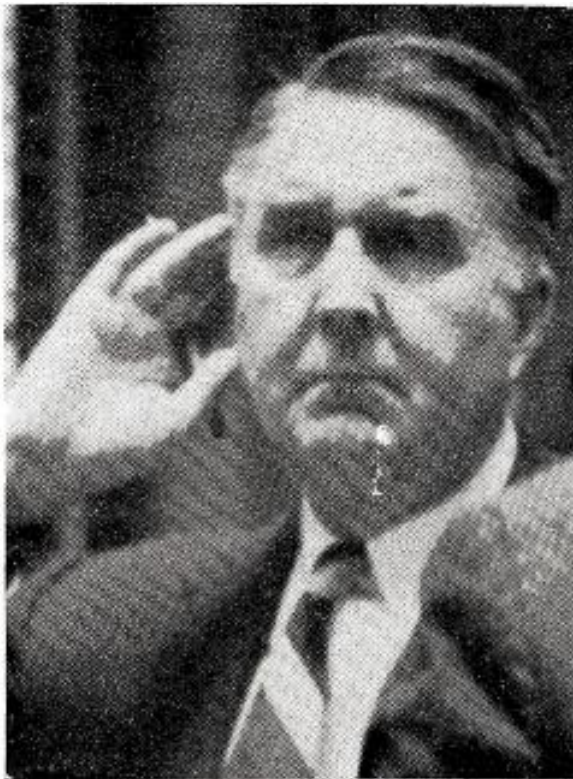

Catching every word • An interested observer at last week's Commission programming hearings was Beverly Coleman, No. 2 man on the staff of the House Legislation Oversight Subcommittee.

Mildred Edie Brady, Consumers Union of the U.S. Inc. • In a prepared statement read in her absence, the CU representative laid before the Commission a plan that would (1) set up an advisory consumers council to review all FCC licensing decisions, request additional data on a licensee's performance and publicize its findings; (2) make hearings mandatory in all license renewals; (3) hold hearings in the locale of the station involved; (4) require broadcasters to carry at a peak time each week a statement of the basis upon which it holds its channel; (5) charge a yearly license fee based on the station's signal strength and revenue. (The money would go to the Commission to defray the cost of added work involved in executing her suggested plan.)

Mrs. Edmund D. Campbell, Greater Washington Educational Television Assn. • Mrs. Campbell related how GWETA had found it impossible to get its *Time for Science* etv series accepted by a Washington network-affiliated station but had managed to have the series telecast by an area independent outlet. She did not direct her remarks toward the current programming problems.

Mack re-trial set

The re-trial of former FCC Comr. Richard A. Mack and his friend, Miami attorney Thurman A. Whiteside, on charges of conspiracy to throw the award of Miami ch. 10 to National Airline has been set for Jan. 25, 1960 in U.S. District Court in Washington. Appointment of the trial judge will be made after the first of year 1960 court term commences. The new trial date was made after the U.S. Supreme Court denied Dec. 7 a Whiteside petition for review of first trial judge's refusal to agree motion for acquittal. The defense were tried on the conspiracy charge before District Judge Burnita S. Matthews last spring-summer. This resulted in a hung jury.

McConnaughey warns of legislative danger

Former FCC Chairman George C. McConnaughey warned the Columbus (Ohio) Tv Executives Club Tuesday (Dec. 8) that there is a danger of "crippling legislation" being passed by Congress as a result of the quiz and payola scandals.

"And when I say crippling legislation, I mean something that will affect everybody, not only in the industry but the public as well," he said. Mr. McConnaughey suggested that the executives "start telling the story what broadcasting does from top to bottom."



*Pancake
make-up
...or pancake
mix...*

WHK has changed the sales complexion of Cleveland!

Whether you sell pancake make-up or pancake mix . . . take heed. Cleveland women have changed. (So have the men!)

Old habits (like listening and buying) have vanished as a 24% Pulse share-jump* gives WHK a virtual tie for first place.

Clevelanders don't slide past WHK as of yore. They stop for a big sample of our unique blend of service,

news and showmanship. And they stay tuned in such numbers, that WHK has vaulted to a shade under first—a development advertisers have been quick to perceive. Result? A drastic change in time-buying patterns. Let John Blair rejuvenate your Cleveland file, or call Jack Thayer, our new General Manager. (EXpress 1-5000.)

**Pulse, Mon.-Fri., Sept.-Oct., 1959; 6 a.m.-12 midnight*

The new sound and new sell of radio . . . in Cleveland

*Division of Metropolitan Broadcasting Corporation
WNEW-TV, WNEW-AM, NEW YORK
WTTG-TV, WASHINGTON
WHK, CLEVELAND*



CASE OF THE UNSENT LETTER

Key document in St. Louis ch. 2 case never sent; but 2 others suddenly appear

The St. Louis Ch. 2 case—third in the series involving purported *ex parte* contacts with FCC members—came to trial last week in Philadelphia amid new allegations of improprieties by KTVI-TV principals in the successful effort to move the vhf channel from Springfield Ill. to St. Louis.

With Harry Tenenbaum, KTVI-TV part-owner on the stand, FCC counsel developed that a key document had never been used, but two new documents were introduced for the record. These events occurred at a rehearing of the 1955-57 Ch. 2 rule making proceeding before FCC Examiner Horace Stern, 80-year-old retired Pennsylvania Supreme Court Justice, who also had handled the Miami Ch. 10 and the Boston Ch. 5 proceedings. The hearing will continue next week.

Details of Mr. Tenenbaum's successful campaign to persuade the FCC to move vhf ch. 2 from Springfield, Ill., to St. Louis and to have KTVI granted temporary permission to operate on the low-band channel were spread on the record in four days of testimony.

For virtually all of three days, Mr. Tenenbaum was on the stand.

Mr. Tenenbaum recounted his three year struggle to get the FCC to deintermix St. Louis. At one point, he acknowledged, he attempted to persuade the Commission to make St. Louis all uhf (except for the then-existing vhf station). It was in 1955 when ch. 20 WISC (TV) Springfield submitted a petition to move ch. 2 out of Springfield to St. Louis that Mr. Tenenbaum reversed his position and began plumping for this move.

Letter Never Sent • The hearings last week heard FCC Associate General Counsel E. W. Holtz report that a Feb. 20, 1957 letter allegedly written by Mr. Tenenbaum to individual commissioners before the final decision was issued to move ch. 2 had never been sent or received by the Commission.

This missive was a key exhibit in last year's House Legislative Oversight Committee hearings. Its presence was discovered in Mr. Tenenbaum's files.

This draft letter was never sent, it was stated. It had been written by John Hyatt, an executive of the D'Arcy Advertising Agency in St. Louis, with the intention of sending it to the FCC under the D'Arcy letterhead and with his signature as a rebuttal to the charge that Illinois residents would lose service by the move of ch. 2 to St. Louis. Mr.

Hyatt calculated that more Illinoisans would receive ch. 2 service from St. Louis than would from Springfield.

He testified that his superiors refused to permit him to send the letter over his name and that of D'Arcy. He, therefore, he said, dictated it for Mr. Tenenbaum's signature and sent it over to the KTVI president. It was this unsent letter that was found in Mr. Tenenbaum's files by the House investigators.

The FCC lawyers, however, produced two documents purporting to back up allegations of *ex parte* conduct by Mr. Tenenbaum.

Two Documents Found • One was a memorandum on the soundness of moving ch. 36 from St. Louis to Springfield and the other was a legal opinion on the propriety of granting KTVI special temporary authority to operate ch. 2 after it was moved into St. Louis. Both were dated prior to the final FCC decision to move ch. 2, issued in March 1957.

KTVI, which began operating on ch. 54 in Belleville, Ill., was operating on ch. 36 in St. Louis during the deintermixture proceedings before the FCC in 1955-57.

By moving ch. 36 out of St. Louis, it was implied, the Commission could find it easier to grant KTVI temporary authority to operate on ch. 2 there without the necessity of issuing show cause orders.

The ch. 2 St. Louis case was returned for rehearing by the U. S. Court of Appeals last May.

In it the court maintained that the facts brought out in the House Oversight Committee hearings (BROADCASTING, June 16, 1958) required a rehearing to determine whether any commissioner or any party should be disqualified because of *ex parte* contacts. The appeals court also accepted the House Committee's now discredited report that Mr. Tenenbaum had sent the Hyatt memorandum on Feb. 20, 1957, seven weeks after the cut-off date for filing reply comments.

The court asserted that the Commission could not permit violations of its own rules. It referred to the cut-off dates for comments and reply comments in the St. Louis-Springfield deintermixture and contended that the FCC cannot allow parties to make off-the-record contentions that it forbids them to make on the record.

Supreme Court Returns Case • The appeals court acted after the U. S. Su-

Doors were open

What was Harry Tenenbaum's procedure when he came to Washington to call on FCC commissioners? This is how he described the practice when he was on the witness stand last week during the rehearing in Philadelphia before Judge Stern:

"What I would do is get in a cab and have him take me there [the FCC], and there would be two or three entrances to the building, and I never knew quite which one I went to, so I knew they were on the sixth and seventh floor, so I would get off, and I would go see a commissioner's name, and I would walk in. And then I went from there to every commissioner's office until I had seen them all. If they were not there, I did not see them at that time. And that was true of every time I went."

preme Court returned the case to it for further action in referring to the allegations of improprieties dug up by the House Oversight Committee.

The basic legal case was the appeal by Sangamon Valley Television Corp. (with WTAX Springfield principals) from the FCC's action in moving ch. 2 out of Springfield. Sangamon Valley was one of two applicants for ch. 2 in Springfield. The other was WMAY Tv Inc. (WMAY Springfield). WMAY was given the ch. 2 grant, but was forbidden to construct pending the outcome of the deintermixture proceedings.

The first appeal was denied by the federal circuit court in Washington. It was when Sangamon asked the Supreme Court to review this that both the Solicitor General and the FCC called attention to the House findings.

Mr. Tenenbaum testified that in addition to seeing as many commissioners as he could almost every time he was in Washington during the deintermixture proceedings (which began with the Potter committee hearings in 1954), he also:

- Had lunch with then Chairman George C. McConaughy.

- Had Comr. Robert E. Lee as a dinner guest in St. Louis. Mr. Lee had gone to St. Louis to see uhf in action.

- Had then Comr. Edward M. Webster and Mrs. Webster as tea guests at his home in St. Louis. Comr. Webster was attending a U. S. Coast Guard meeting.

- Took Comr. Robert T. Bartley to the theatre in New York when Mr. Bart-

Mark this market

on your list!

CENTRAL and SOUTH ALABAMA

*...one of
Alabama's "Big Three"*

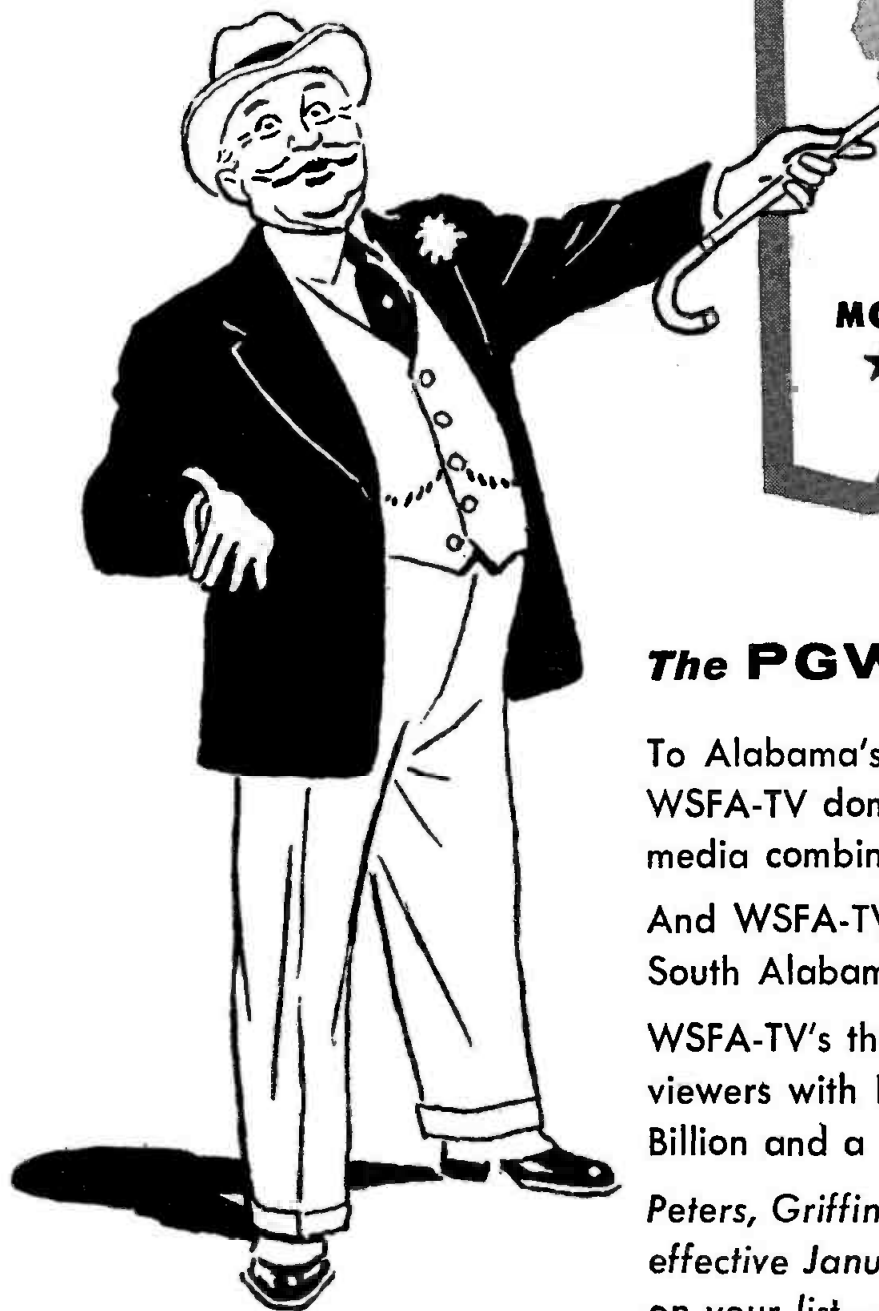

The PGW Colonel Invites Your Attention

To Alabama's second largest market...an area which WSEFA-TV dominates and an area no other medium or media combination can deliver!

And WSEFA-TV has the TOP 60 SHOWS in 25 Central and South Alabama counties in competition with 16 other stations.

WSEFA-TV's the "Hometown" station to more than a million viewers with Effective Buying Income reaching for a Billion and a quarter dollars.

Peters, Griffin, Woodward, Inc. will represent WSEFA-TV effective January 1, 1960 and urges you to mark this market on your list—and buy it now with WSEFA-TV!



A BLIND LADY donated trading stamps, housewives and working girls sent in more. As Mary Jo Tierney shows, above, nothing they might want themselves was more important than helping WTCN outfit a young Indian girl for nursing school.

"MARY JO SHOW" PROVES IT!

To Get RESULTS... Buy for RESPONSE on WTCN RADIO — Twin Cities

A WTCN radio listener first brought the problem to light. Another offered the solution.

When a student nurse needs help to continue her studies — especially a 17-year-old Indian girl from a virtually destitute family of 11 — depend on the response from WTCN listeners.

WTCN's Mary Jo Tierney passed the word along on her "For Women Only" show. "This girl needs many things," she said, "but especially a nurse's watch. We plan to get it for her with trading stamps. Mail your stamps to WTCN."

Did she get the stamps? Far more than enough. A single announcement on the air brought in half a million stamps. The young girl now has her nurse's watch, and more besides. Listeners mailed enough stamps to WTCN in the first few days to get her the watch plus a travel iron, a suitcase and a clock radio.

Twin Cities advertisers are accustomed to gratifying results like this on WTCN Radio. It's an awesome thing, however, to anyone not used to such audience loyalty and responsiveness. Try it yourself.

If you want results . . . buy for response. You get that on WTCN Radio in the Twin Cities.

WTCN

MINNEAPOLIS • ST. PAUL
RADIO AND TV

Affiliate American Broadcasting Network
Represented Nationally by the KATZ Agency

ley and other commissioners attended a New York Radio-Tv Executives Society conference there.

- Sent all commissioners turkeys for Christmas in 1955 and for Thanksgiving in 1956.

- Sent all commissioners' secretaries stockings for Christmas in 1955 and 1956.

- Had a social dinner with FCC Rules & Standards chief Hart S. Cowperthwaite.

- Saw and spoke to Sens. Stuart Symington (D-Mo.), Warren G. Magnuson (D-Wash.), John L. McClelland (D-Ark.), and J.W. Fulbright (D-Ark.) and then Sens. John W. Bricker (R-Ohio), and Charles E. Potter (R-Mich.). Mr. Tenenbaum explained he originally was from Arkansas.

Mr. Tenenbaum also explained that he hired attorney Robert F. Jones as his third lawyer in Washington because he discovered that his other two attorneys were not seeing eye-to-eye. Representing Mr. Tenenbaum's firm were Monroe Oppenheimer and William A. Roberts. Mr. Jones, former FCC commissioner and former Ohio Republican congressman, was retained at a \$55,000 fee, to confer with Mr. Oppenheimer and advise on FCC procedures, he said. Mr. Roberts, who received a \$25,000 fee, was not informed of the employment of Mr. Jones, Mr. Tenenbaum said, because he was a "high strung individual" who would "hit the roof" if he knew.

In addition to Mr. Oppenheimer, Isadore G. Alk is representing KTVI at the rehearing.

Mr. Tenenbaum contended that all his discussions with FCC commissioners were to persuade them to take some action on the St. Louis situation as well as the overall uhf problem. He alluded to the general understanding that it was no violation to discuss rulemaking proceedings with commissioners. He pointed out that when KTVI was in a hearing status with a second applicant for ch. 2 in St. Louis, he refrained from discussing the case with any commissioners.

After the FCC moved ch. 2 into St. Louis, a group under the name of Louisiana Purchase Co. filed in opposition to KTVI. Later a merger agreement was reached and the Louisiana Purchase stockholders received minority interest in Signal Hill. Signal Hill is now owned 33.66% each by Mr. Tenenbaum and Paul E. Peltason, Mr. Tenenbaum's partner in a St. Louis investment firm, 22.71% by the Newhouse radio-tv-newspaper interests and the remainder is owned by Louisiana Purchase.

Negotiations with GE and ABC • It was also brought out that Mr. Tenenbaum negotiated for the purchase of

ch. 2 equipment with General Electric Co. and with ABC for network affiliation in January 1957, two months before the final FCC decision.

It was also asserted that Mr. Tenenbaum spoke with Gordon Sherman, WMAY-TV Springfield, Ill., principal, about using KTVI's ch. 36 equipment and chances for affiliation with NBC.

Sangamon Valley attorneys indicated that they intended to make a fight to show that Mr. Tenenbaum misrepresented the financial losses of KTVI as a uhf outlet. Judge Stern took under advisement their request for profit and loss statements for the 1954-1957 years.

Oliver Keller, principal in the Sangamon Valley group, testified that he was not at first aware of Mr. Tenenbaum's activities in behalf of the ch. 2 move to St. Louis, and that when he did learn of it he instituted his own counter attack through his congressman and senators. He did not, he said, approach the FCC.

Mr. Keller acknowledged that he learned his group was not going to get the grant for Springfield ch. 2 from his attorney and that Comr. Lee is supposed to have reversed his vote in favor of Sangamon when informed that Sangamon was composed of a "bunch of New Dealers." Mr. Lee is a Republican.

Jones Testimony • Mr. Jones corroborated Mr. Tenenbaum's testimony in regard to his legal duties. He stated that he had seen no one in KTVI's behalf, either at the Commission or on Capitol Hill.

Mr. Jones also had been a key figure in the Miami ch. 10 rehearing. He had been hired by North Dade Video Inc. late in the original proceedings and acknowledged that he had spoken to several congressmen about the desirability of prohibiting airlines from engaging in broadcasting. National Airlines won that contest, but it also is in the hearing status.

Mr. Peltason corroborated most of Mr. Tenenbaum's testimony.

The FCC group is scheduled to place the following in the witness chair this week (beginning today):

Nelson Howath, mayor of Springfield; C. Arthur Weis, now of Detroit, but then of the *St. Louis Globe-Democrat* (which owned 23% of KWK-TV St. Louis) and Gordon Sherman, principal of WMAY-TV.

Other parties will have the opportunity to call their witnesses. In addition to KTVI and Sangamon Valley, these are WICS (TV) Springfield, American Broadcasting-Paramount Theatres Inc., and the Attorney General of Illinois. WMAY-TV surrendered its permit for ch. 36 in Springfield several weeks ago and has withdrawn from the case.

BROADCASTING, December 14, 1959

The most refreshing idea in radio



For its audience, a new, refreshing sound . . . the best in popular music and news features, intelligently packaged in KBIG's distinctive "FRESH AIR" programming. For its advertisers, *king-size coverage* of receptive listeners in 234 communities of all 8 Southern California counties . . . at 71% less average cost than other high-power stations.

The sales significance of "FRESH AIR" is demonstrated in a new 10 minute presentation. A call to your KBIG or Weed representative will bring it to your desk promptly!



KBIG Radio Catalina . . . 740 kc/10,000 watts

JOHN POOLE BROADCASTING COMPANY, INC.,

6540 Sunset Blvd., Los Angeles 28, Calif. • HOLLYWOOD 3-8205

NATIONAL REPRESENTATIVE: WEED RADIO CORP.

HARRIS HEDGES ON PAYOLA

Refuses to say that hearings will be held, issues memo on outside activities of staff

The House Legislative Oversight Subcommittee will not be ready to announce hearings on its "payola" investigation for "five or six weeks," Chairman Oren Harris (D-Ark.) said last Wednesday (Dec. 9).

The Arkansas congressman refused to say definitely that hearings would be held. But he left the implication that hearings are forthcoming by announcing that subcommittee staffers are carrying on interviews and investigations based on "mountains" of information supplied by sources all over the country.

Rep. Harris made his remarks after morning and afternoon sessions behind closed doors, where most of the day was spent questioning Boston industrialist Bernard Goldfine.

At the midday news conference, Rep. Harris admitted the departure of Richard N. Goodwin, 28-year-old attorney, from the subcommittee's staff. But he refused to say whether Mr. Goodwin, who is joining the staff of Sen. John F. Kennedy (D-Mass.), left at the subcommittee's request. Mr.

Goodwin became the subject of some controversy when an article under his byline appeared in *Life* magazine during last month's tv hearings by the House unit. The article described the subcommittee's and Mr. Goodwin's activities in collecting information on rigged network tv quiz shows.

'Our Function' • Rep. Harris emphasized that whatever the FCC and the Federal Trade Commission do about payola and free plug allegations in broadcasting will not disturb the congressional probe at all. "Our aim and function is to oversee these agencies under our jurisdiction and to carry out our responsibilities," he said. He added that these responsibilities are not "primarily" restricted to the misdeeds of disc jockeys.

Obviously in an indulgent mood, Rep. Harris explained that the Oversight Subcommittee got its name from the word "oversee" and said the group intends to do just that where the FCC and FTC are concerned.

The Arkansas Democrat wanted it known that the House group's activities are not directed at the broadcast industry itself. Many broadcasters throughout the country are innocent of payola activities, he said, and these broadcasters have nothing to fear. Asked whether the subcommittee has an open-and-shut case against anyone, he replied: "Not that I'm going to tell about."

Rep. Harris said the subcommittee will make an interim report to Congress in January. It also will discuss legislative recommendations based on its hearings held this year.

Voluntary Action • Mr. Goodwin, who said his resignation was effective Dec. 5 and that he has been away from the subcommittee's offices for a few days, told newsmen in the afternoon that his departure from the subcommittee was entirely voluntary and displayed a letter from Chairman Harris which expressed "regret" that he was leaving. He said he told Chief Counsel Robert W. Lishman during last month's hearings, before the *Life* article was published, that he planned to leave. Mr. Lishman confirmed that Mr. Goodwin had been considering leaving for some time and said no inference should be drawn that he was leaving at the subcommittee's suggestion.

Asked later if his letter to Mr. Goodwin expressing "regret" at his

departure reflected the sentiments of other subcommittee members, Rep. Harris said he hadn't consulted with other members. He added that as chairman he can take such action without asking other subcommittee members.

A subcommittee spokesman confirmed last week that Rep. Harris had circulated a memo (dated Nov. 27) among members on the subject of "outside activities for compensation." The memo said the work of the subcommittee involves "such a wide range of subjects" under jurisdiction of the parent House Commerce Committee that "it is deemed inadvisable and inappropriate for any staff member to be engaged in other and outside activities than the work assigned to him under the direction of the chairman." The memo continued:

"No member of the staff shall be permitted to prepare or assist in the preparation of written articles for publication or other means of communication whether for compensation or otherwise.

"No staff member shall become engaged in any other activity or employment outside of the committee without the express permission of the chairman."

Improper Activity • The Harris memo followed indications that several subcommittee members, both Democrats and Republicans, had questioned the propriety of Mr. Goodwin's placing the article in *Life* magazine (CLOSED CIRCUIT, Nov. 23). Rep. Harris also explained in an interview on KOTV (TV) Tulsa that he "did not understand that (the article) would be anything in connection with the committee."

Subcommittee members unhappy with the Goodwin article pointed out that they had agreed, following exposes given to newspapers by former Chief Counsel Bernard Schwartz last year before he was fired, that staffers would not be allowed to make outside comments, written or oral, about subcommittee activities.

Mr. Goodwin told newsmen he still is putting finishing touches on a report he is preparing for the subcommittee and that he had made a trip to Boston in connection with the payola phase of the House unit's probe before his resignation became effective. Mr. Goodwin, a native of Boston, said he feels his work for Sen. Kennedy, a fellow Bostonian, will be better for his career than staying with the House group. He said he is doing research and writing speeches for Sen. Kennedy, who is prominent among aspirants for the Democratic presidential nomination.

Discussing the resignation of Louis

TELEVISION MONITORS

To Fit Every Application



L59B/8" L59B/17"



Rack Mounting K59/21M

MIRATEL CONELRAD EQUIPMENT

Air Alert I	\$99.50
Air Alert II	\$46.50
Voice Operated Relay	\$125.00



1080 DIONNE ST.,
ST. PAUL, MINNESOTA

FULL SALE ON THE SEAWAY



WERC ERIE

A top-notch crew of performers and advertisers are signing up now for an exciting and profitable cruise on the good ship WERC... Adventure Radio in Erie. The St. Lawrence Seaway has made Erie an important world port. Erie is one of the top 100 markets... WERC carries the most local news... The Cleveland Indians... the Cleveland Browns... and a shipload of the most popular disc jockeys in the Erie area.

WERC ADVENTURE RADIO IN ERIE

In Erie, it's Adventure Radio WERE-owned WERC... both represented by Venard, Rintoul and McConnell, Inc.



NEGRO
Community Programming



SPANISH/PUERTO RICAN
Programming



of Whirl-Wind sales action

WWRL
NEW YORK DE 5-1600

*10:00AM-5:30PM

**5:30PM-10:00AM

Cowan as vice president in charge of CBS-TV, Mr. Goodwin said he had talked to Mr. Cowan during the subcommittee's investigation, feels Mr. Cowan is one of the "finest and most cultured" persons he has ever met and that the subcommittee found no evidence whatever to indicate that Mr. Cowan knew tv quiz shows on CBS-TV were rigged.

Guilty plea opens F.L. Jacobs trial

The trial of former Mutual President Alexander L. Guterma opened last Monday in Federal Court in New York. Mr. Guterma, along with the F. L. Jacobs Co., of which he was president and chairman, and Robert J. Everleigh, its vice president and treasurer, are being tried on charges of conspiring to defraud.

The government contended that it would prove that almost \$4 million in assets had "disappeared" from F. L. Jacobs while Mr. Guterma controlled the company. The prosecution further asserted that Jacobs during 1958 had failed to file required SEC reports in an attempt to avoid a "bubble burst." Defense counsel denied any conspiracy and claimed there were "legitimate reasons" why reports were not filed.

At outset of the trial, the F. L. Jacobs Co., now under new management, pleaded guilty to fraud.

Initial testimony came from Firman Hass, a Detroit partner of Ernst & Ernst, certified public accountant. He asserted that Mr. Guterma, over a period of time, stalled on supplying him with information. Mr. Hass testified that he still had not received enough data to certify the Jacobs 1958 annual report as accurate.

Big savings for fm seen in tax ruling

Fm operators furnishing background music to subscribers (via simplex or multiplex) stand to save "several hundred dollars" a year as a result of the U.S. Court of Claims decision Dec. 2 holding the 8% federal excise tax does not apply to broadcasts, Seymour Krieger, Washington attorney, said last week.

Mr. Krieger represented WGH-FM Newport News, Va., in successfully contesting an Internal Revenue Service ruling imposed in 1956 which held that background music broadcasting via fm is subject to excise taxes (BROADCASTING, Dec. 7). George Bunn, Washington attorney representing WFMF (FM) Chicago, joined Mr. Krieger in the tax test case.

John F. Meagher, NAB radio vice

president, last week called the tax decision a "signal victory for all fm broadcasters performing functional music services" and said it relieves them of "another unwarranted burden."

Mr. Krieger said no fm station was paying the tax until 1956, when a broadcaster asked IRS if the tax was required for broadcasting as it is for wired functional music services. IRS, looking for new sources of revenue, came through with its ruling in October, he said. He criticized IRS's "arbitrary" position that tax on wired services should apply also to broadcasts.

Fm broadcasters were forced into paying the tax, he said, when IRS threatened to collect the taxes from the stations' subscribers to the tune of \$30 to \$50 a year for each. Mr. Krieger made his estimate of tax savings to broadcasters based on the 80 to 100 broadcasters who provide functional music multiplied by an average number of customers for each.

The Justice Dept., which represented the government in the case, has not yet indicated whether it will appeal but has 90 days to do so. Mr. Krieger said he does not believe Justice will appeal because of the inherent difference between wired and broadcast functional music services.

KFWB editorials prompt FCC action

Editorializing on a controversial, statewide election by KFWB Los Angeles and four other California stations has caused some raised eyebrows at the FCC. The Commission last week set aside its Nov. 12 renewal of KFWB's license following complaints against the stations' editorials during the 1958 election.

The question up for voters' decision concerned a proposal to provide free transportation for students of parochial schools. It was not disclosed who made the complaints nor on what grounds. KFWB's application was placed in the pending file until final determination of the case.

Other stations involved, whose licenses are not up for renewal, include KNX Los Angeles, KOBV San Francisco, KMPC Los Angeles and KVON Napa.

• Government briefs

Fargo proposal • The FCC invited comment on the proposal of the Joint Council on Educational Television to revise the tv table of assignments by "dropping in" ch. 13 for noncommercial educational use at Fargo, N.D. The move would necessitate the deletion of the reservation now on ch. 34 (educa-

tional) in that city. This would also require an offset carrier change from plus to minus on ch. 13 in Minot, N.D., and North Dakota Bcstg. Co. was ordered to show cause why KXMC-TV Minot should not change accordingly.

Proposed shift • The FCC on Dec. 10 invited comment on its proposed rule-making which would shift ch. 11 from Marinette to Green Bay, Wis. WLUK-TV Marinette, petitioned for the change.

Denials in skyway • The FCC denied petitions for rehearing and reconsidera-

tion in the daytime skyway proceeding and also announced the accepted filing of opposition of Daytime Bcstrs. Assoc. Denied petitions include: CBS; NBC; Clear Channel Bcstg. Service; Crosley Bcstg. Corp., and Municipal Bcstg. System of New York.

Ask reconsideration • WTVY (TV) (ch. 9) Dothan, Ala., was granted a petition for reconsideration of a July 15 report and order in the Columbus, Ga., tv rulemaking decision which assigned WTVY ch. 4 instead of ch. 9 in Dothan. Comr. Lee abstained from voting while Comr. Bartley concurred.

Opposes ad tax rules • Rep. Overton Brooks (D-La.) last week charged that government refusal to exempt certain types of advertising from taxes as a business expense threatens freedom of speech and the press. He said recent tax rulings by Internal Revenue Service and the Federal Power Commission "have . . . set up the federal government as a censor of advertising, which is the life blood of our American economic system." The House Ways & Means Committee had held hearings the week before on whether certain advertising should be tax exempt.

INTERNATIONAL

Gross wins ITU vote; to be permanent head

Gerald C. Gross, of the U.S., acting secretary-general of the International Telecommunications Union, last Wednesday was elected permanent secretary-general of the world-wide organization controlling communications. He defeated the French candidate, Jean Rouviere, 51 votes to 35.

Mr. Gross' election came a fortnight prior to anticipated adjournment of

the International Telecommunications Conferences which have been underway in Geneva since Aug. 17. So far there have been no radical departures from existing allocations, particularly as to international broadcasting which would affect operations in the United States or its territories (BROADCASTING, Nov. 2, Dec. 7).

Last week the International Confer-



MR. GROSS

ence elected a 25-member administrative council to govern ITU operations. The terms of the new council members are for five years and the next council will be elected in 1965 by a Plenipotentiary Conference, probably to be held at Geneva headquarters.

Countries represented on the new council are Argentina, Brazil, Canada, Colombia, United States, Mexico, Spain, France, Italy, Germany, United Kingdom, Switzerland, Yugoslavia, Czechoslovakia, USSR, Ethiopia, Mo-

Norfolk, Nov. 30. Station WVEC-TV, the UHF station in the Norfolk-Hampton area which has been watched by UHF operators all over the nation because of its competitive battle against a VHF station, has been using every gimmick in the book including showmanship, good programming, public service, merchandising and promotion to prove that a hep UHF operation can turn the trick.

Variety
Wed., Dec. 1, 1954

The Nation's Most CELEBRATED UHF Station Becomes

A V STATION

WVEC-TV

Moved from UHF station channel 15 to VHF channel 13

"Nothing Succeeds Like Success." This can very well be the motto for fabulous WVEC TV. For six years a remarkably successful "U" station, WVEC TV this past month became a "V." Trendex shows that it's on its way to becoming "THE" Tidewater station. If it's Sales Action you desire . . . then make Virginia's new ACTION station a "Must."

Represented by Avery Knodel

ACTION PROGRAMS

MAXIMUM POWER

DUAL FACILITIES

NORFOLK, HAMPTON
NEWPORT NEWS
PORTSMOUTH
VIRGINIA BEACH

CHANNEL 13

rocco, United Arab Republic, Tunisia, Australia, China, India, Iran, Japan, Philippines.

Mr. Gross, a native of New York City, 56, and a former assistant chief engineer of the FCC, heads an organization of 260 in Geneva. He became acting secretary-general in 1958, following the death of Marco Andrada, of Argentine. Prior to joining the FCC, Mr. Gross had been a physicist at the Bureau of Standards. He became vice-director of ITU and head of its radio division in 1945.

ITU's 100 member organization on Dec. 10 elected Dr. Manohar Balaji Sarwate of India deputy secretary-general, succeeding Mr. Gross. Dr. Sarwate, 49, studied radio engineering at U. of Bombay and Liverpool. He was director of communications of the Civil Aviation Dept. of India and held other important communications posts in that government. He is India's representative on the administrative council of ITU and heads its delegation to the Geneva Radio Conference.

Dover's tv delayed

Dover, England, ch. 10 won't go on the air at Christmas (BROADCASTING, Oct. 5) after all. Special tests are nec-

essary to establish that the ch. 10 signal will not cause an unacceptable degree of interference in the service areas of existing tv stations on the Continent. The Dover station eventually will serve an area from the Medway towns to Beachy Head.

Food advertising code proposed in Canada

A code of ethics designed to guide food buyers and cut down misleading advertising was proposed in the report of the Royal Commission on Price Spreads of Food Products, released at Ottawa, Canada, on November 30. The report urged the Assn. of Canadian Advertisers, in cooperation with the food industry, to draw up and administer such a code.

The commission's report was released by its chairman, Dr. Andrew Stewart, who headed the commission during its investigations and since has been appointed chairman of the Canadian Board of Broadcast Governors.

The report pointed out that food products advertising increased almost 400% from 1949 to 1957, accounting for about 5% of the cost of food after it leaves the farm. This was estimated to be double the proportion accounted

for by advertising in 1949.

The report stated that the five-fold rise in advertising expenditures as food moves from farm to shopping basket was by far the greatest increase in all things added to the food marketing bill. The commission commented particularly on the growth of television advertising, tv accounting for the greatest part of the increase in total advertising spending.

• Abroad in brief

Madison 'Avenuesky' • The Soviet trade journal *Sovetskaya Torgovlya* announced last month that Russian tv advertising has spread from Moscow to provincial stations and has inaugurated a "new goods" program featuring products of interest to women. The journal said that "expert advice from specialists accompanied the demonstration." The chief planner for a provincial department store said that the telecasts "had rendered a good service. Demand for newly-introduced goods . . . literally increased the very next day."

Real Red network • The Russian government announced it has over 40 new tv and relay stations under construction in the Soviet Union besides the 68 existing stations and installations now in operation.

PROGRAMMING

SUING ASCAP SONGWRITERS JOLTED

Judge rules no standing to sue on performing rights issue

The \$150 million sting was taken out of the long-pending "songwriters' anti-trust suit" against BMI, the networks, NAB and a long line of broadcasters last week by a federal judge in New York.

Judge Edward Weinfeld of U.S. District Court held that the 33 songwriter-plaintiffs had no standing to sue for damages insofar as radio, television or other public performances of their approximately 7,000 songs were concerned. He held they could sue on their charges that BMI paid off, reimbursed or otherwise induced their publishers not to promote aggressively some 5,800 of the works, and also with respect to approximately 1,200 unpublished tunes.

Both sides hailed the decision as a great victory but counsel for the songwriters refused to say they would not appeal. BMI authorities, obviously jubilant over the decision, said they had no intention of appealing. If the songwriters appealed, however, they said they would consider filing a cross-appeal. Songwriters' counsel said they didn't yet know whether they would

appeal, but that none of the plaintiffs had suggested they do so. They said the decision established their right to sue for injunctive relief and for damages except on what they called the "limited issues" of performing rights.

BMI authorities countered that the "performing rights" issue represented at least 95% of the suit and that the decision effectively removed the element of damages because the only damages specified by the songwriters related to performance rights. Moreover, BMI contended that in order to support the charges left for trial the songwriters would have to prove that their own publishers, practically all of them ASCAP members not connected with BMI, had been induced by BMI to refrain from exploiting the music. Even if they could do this, BMI asserted, plaintiffs already have admitted in the law suit that they are unable to specify any damages arising out of this type of alleged interference.

In addition to \$150 million damages, the six-year-old suit, known as *Schwartz vs. BMI*, seeks the dissolution of BMI.

Whether this issue is left intact by Judge Weinfeld's decision was a question which brought varying answers even among broadcasters. The conservative opinion was that it is still in issue, but there were others who maintained that it no longer is.

The thrust of the charges, as summarized by Judge Weinfeld, is that the defendants conspired to dominate and control the market for the uses and exploitation of musical compositions, particularly the public performance rights, and ultimately to fix and reduce the price paid by broadcasters for the use of music on the air. The songwriters, all of them members of ASCAP, contended the defendants conspired against the use of their tunes, and in favor of BMI.

Judge Weinfeld ruled, however, that through their ASCAP membership the songwriters had "unequivocally" transferred their rights to ASCAP and that, under the law, it is ASCAP and not the members who would be hurt directly by any such conspiracy. Thus, he held, the plaintiffs have no legal standing

to sue for damages on the performance rights issue.

With respect to publishing and recording rights assigned to publishers and regarding some 1,200 songs as to which no publisher contracts are in effect, he ruled that the plaintiffs do have a right to go to trial. He made plain that in all phases of the ruling he was not passing on the merits of the various charges, but only on defendants' claims that plaintiffs had no standing to sue.

Offers being made in musicians fund row

American Federation of Musicians has made an offer to the musician members of AFM 47 in Hollywood who have gone to court to upset the AFM trust fund policies and divert all fund payments to the musicians doing the work involved. AFM has offered to turn over to them all impounded monies in connection with royalty fund payments for phonograph records and in connection with the release of theatrical motion pictures to television.

Henry Kaiser, AFM general counsel, told a special meeting of Local 47 that AFM is willing to release all the money (about \$1.9 million) impounded in the Anderson (phonograph record) case and to settle the as-yet-untried Atkinson (films released to tv) case for \$750,000. Noting that the litigation will be both lengthy and costly, he said that AFM "is trying to evolve the necessary formula for terminating the internal strife inevitably attending litigation."

Musicians Guild of America, rival musicians' union formed by leaders of the fight against the trust fund and other AFM policies, immediately questioned the good faith of the AFM offer. They point out that the offer to phonograph musicians is about 12% of their claims for \$15.5 million and the offer to motion picture musicians is about 9.5% of claims for \$7,945,000. MGA charges that this offer is made in an attempt to get recording musicians to vote for AFM in the mail balloting now in process to determine whether AFM or MGA will represent musicians in negotiations with more than a dozen recording companies.

First step in determining the acceptability of the AFM offer will undoubtedly be a meeting of attorneys representing both AFM and the plaintiff musicians. If the lawyers reach an agreement it would be submitted to the Defense Fund trustees, then to the actual plaintiffs (musicians who signed the complaints), then to the contributors to the Defense Fund to underwrite the expenses of the litigation and finally to all the musicians who would be affected by the settlement.

**LOOK
what
K-NUZ
is getting for
Christmas**

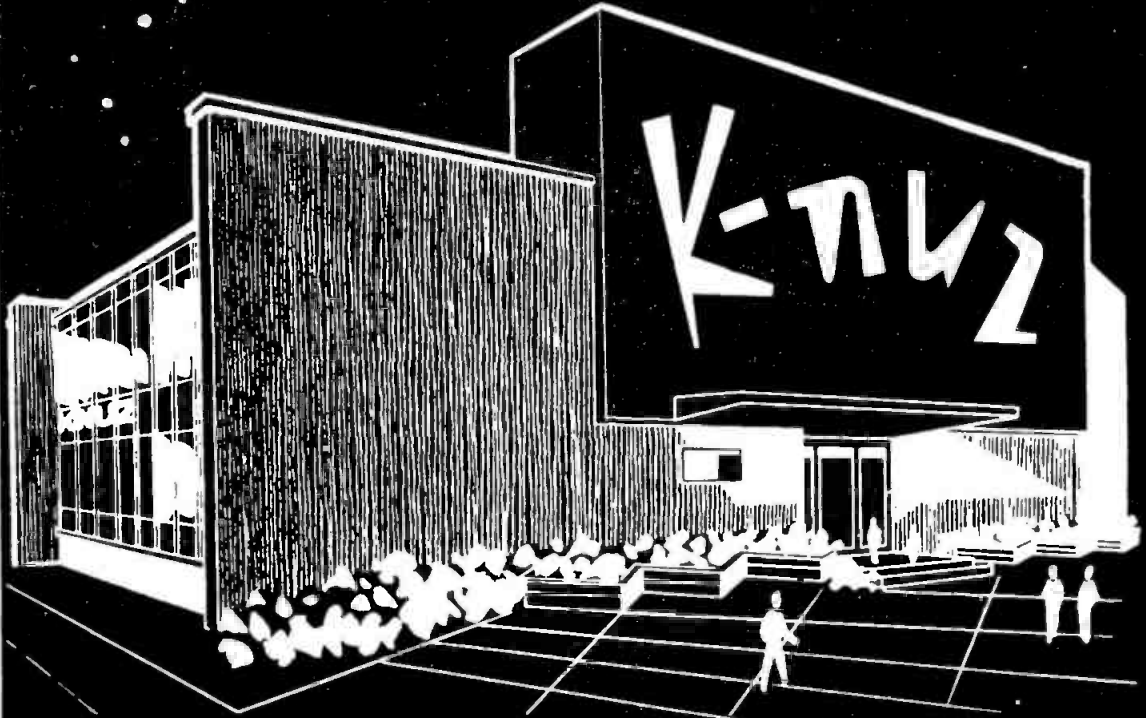

A brand-new home for Houston's Top-Rated
Radio Station... the Southwest's Newest,
Most Modern Radio Facilities!

MUSIC! NEWS! EQUIPMENT AND FACILITIES!
... KNUZ is the Pacesetter for Houston.

Kay-News
K-NUZ
Radio Center
Houston's 24-Hour
Music and News

National Reps.:
THE KATZ AGENCY, INC.

- NEW YORK
- CHICAGO
- DETROIT
- ATLANTA
- ST. LOUIS
- SAN FRANCISCO
- LOS ANGELES
- DALLAS

IN HOUSTON, CALL DAVE MORRIS
JACKSON 3-2581



Special Holiday Rates

**ONE YEAR SUBSCRIPTION
52 WEEKLY ISSUES—\$7.00**

EACH ADDITIONAL GIFT—\$6.00

Please send 52 issues of BROADCASTING as my gift to:

1
\$7.00

name		title/position	
company name			
street & number			
city	zone	state	

Sign gift card _____

occupation required

2
\$13.00

name		title/position	
company name			
street & number			
city	zone	state	

Sign gift card _____

occupation required

3
\$19.00

name		title/position	
company name			
street & number			
city	zone	state	

Sign gift card _____

occupation required

4
\$25.00

name		title/position	
company name			
street & number			
city	zone	state	

Sign gift card _____

occupation required

additional subscriptions may be listed separately at \$5.00

MAIL TODAY!

all orders will be checked, in the event of duplication you will be notified immediately

I enclose \$ please bill

name			
street & number			
city	zone	state	

● BROADCASTING Subscription Department • 1735 DeSales St., Washington 6, D. C.

DAYTIME SPECIALS NBC-TV unveils plan to improve programs

NBC-TV last week announced plans to improve daytime programming by applying the same formula it has developed over the past three years in prime evening time. The concept: hour-long specials aimed at exploiting daytime's maximum audience potential.

A colorfully illustrated brochure issued by the network for its "daylight specials plan" describes various programs currently in the works, or under consideration; research figures showing the strength of specials; the daytime audience potential, and the projected impact of daylight specials.

"In marked contrast to CBS-TV's *Woman* series," the brochure explains, "which is essentially documentary in approach, the full-hour programs offered in NBC-TV's daylight specials plan represent a wide diversity of entertaining and provocative program material, ranging from dramas with name stars through probing feature stories to musical and variety sequences."

NBC-TV also uses the CBS' *Woman* specials for its own audience projection purposes, calling it the only available Nielsen yardstick which reflects the impact of a daytime special opposite regular 3 to 5 p.m. programming. The *Woman* show of May 19, 1959, (3-4 p.m. NYT) registered a 39% increase in CBS average audience, NBC said. Normal NBC-TV audience level between 3 and 5 p.m. is listed at 2,904,000 homes per minute and 4,850,000 viewers per minute. At a 40% above normal level, these figures would change to 4,066,000 homes and 6,790,000 viewers (per minute).

NBC-TV special program ideas include a fashion show staged as a musical revue; a series of dramas about marriage; intimate glimpses into the lives of Hollywood stars; a roundup of best-selling musical talent; controversial explorations of pressing social problems, and special programs for children. Estimated net program prices range from \$30,000 to \$100,000.

Radio-tv, screen directors guilds merge

Merger of Screen Directors Guild of America and Radio & Television Directors Guild into a single union to be known as Directors Guild of America has been overwhelmingly approved by the members of both unions, culminating discussions begun four years ago. A total of 2,068 directors, assistant directors, associate directors, stage man-

agers and program assistants are involved, including RTDG's 518 New York members, 219 Hollywood members, 51 Detroit members, 50 Chicago members and 18 in Cleveland and Washington, D.C., as well as SDGA's 734 directors and 478 assistant directors in the U.S., Canada and Europe.

Frank Capra, now SDGA president, will serve as national president of DGA for the first two-year term, and Michael J. Kane, national president of RTDG will be national vice president of the new union. National DGA offices will be in Hollywood, at the present SDGA building, with Joseph C. Youngerman, national executive secretary of SDGA, assuming the same post for DGA. Newman H. Burnett, national executive secretary of RTDG, will be New York regional executive secretary of DGA.

The merger will bring under one organization contracts with ABC, CBS and NBC as well as with 361 film producing companies, of which 18 are in New York, 14 in states other than New York and California and eight outside the U.S.

Hope bit scissored

Bob Hope's controversial "Herman Payola" sketch seen on NBC-TV last Friday (Dec. 11) was changed before the final script was taped, a network spokesman said.

NBC-TV officials reviewed the script and suggested omission of some product references which were considered "excessive." The review procedure is a standard operating measure at NBC.

Mr. Hope, however, still claimed a moral victory, charging that plugs for the Edsel car, Blue Cross and the Diners Club, which were scissored, pertained to another segment of the show.

NBC-TV representatives maintain that the nature of the script was essentially unchanged.

The Friday special was sponsored by Buick through McCann-Erickson.

WOR news service

A total of 39 stations are now receiving WOR New York's voiced news service, it was announced last week by Robert J. Leder, vice president in charge of WOR-AM-TV New York. The operation went into effect on Nov. 30.

Stations signed for the service include the five other RKO General outlets—KHJ Los Angeles, KFRC San Francisco, CKLW Detroit, WNAC Boston and WGMS Washington—and the Yankee Network, covering 30 stations in addition to WNAC. Other new subscribers are KWK St. Louis, WBOF Virginia Beach, Va., and WAVI Dayton, Ohio. The service supplies international voiced news to clients.

Throughout the World

A famous name for QUALITY is

ROCHESTER'S

Taylor Instrument Cos.

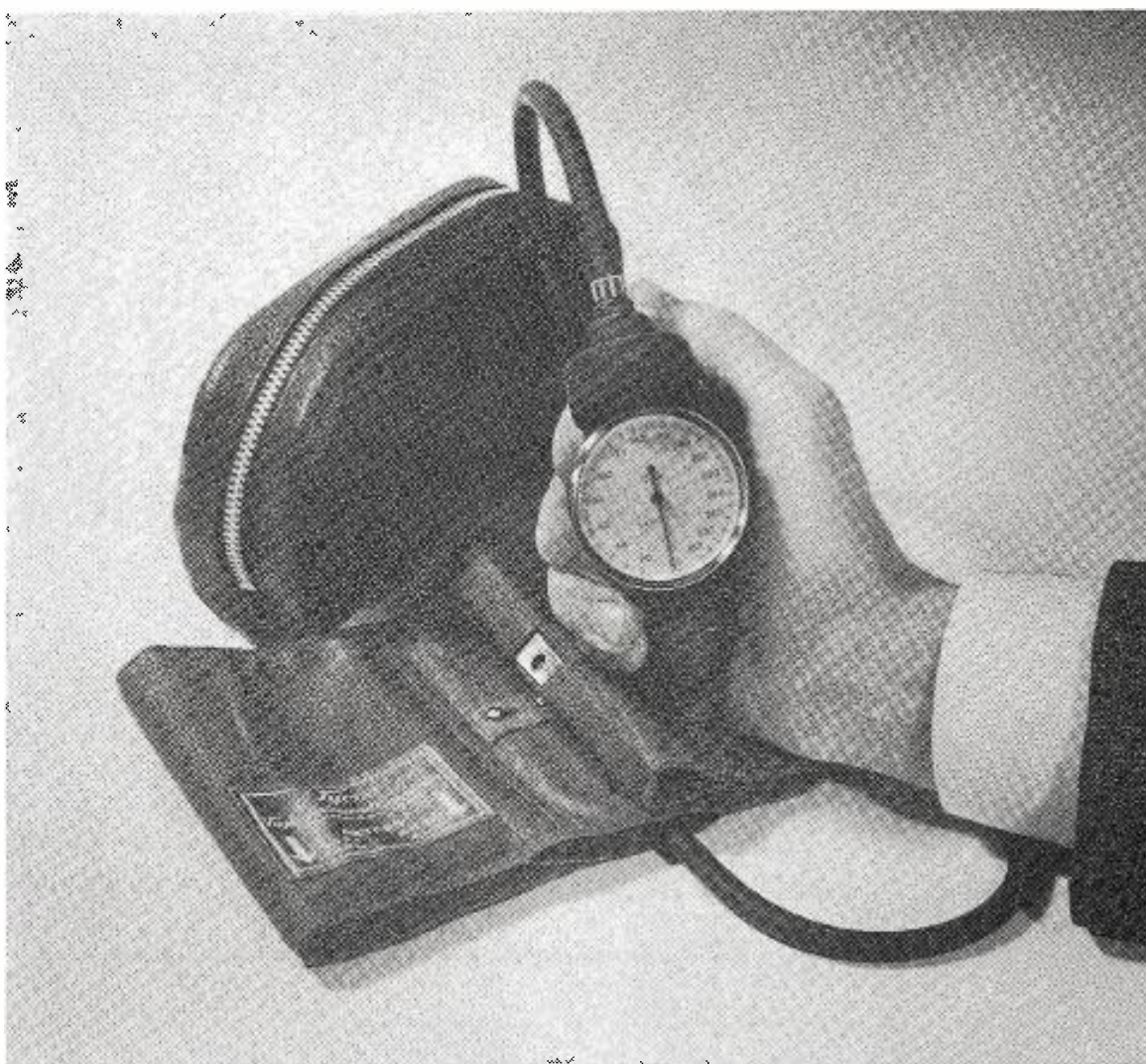

Pictured is the Tycos Aneroid Blood Pressure device, produced by Taylor Instrument Cos., and the leading diagnostic instrument of its kind since 1907.

In the vital ROCHESTER, N. Y. area

The QUALITY Radio Station is ...

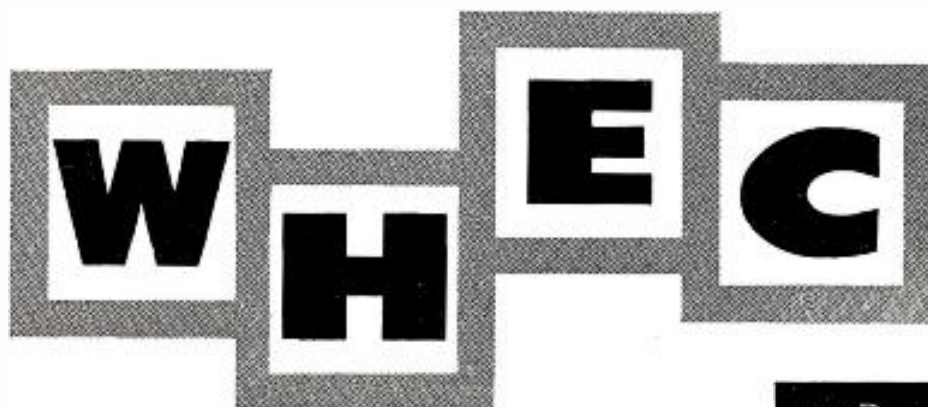

AM-TV
BASIC CBS ROCHESTER



REPRESENTATIVES: EVERETT MCKINNEY, INC.
NEW YORK • CHICAGO • LOS ANGELES • SAN FRANCISCO

"must" reading for advertisers and agencies...

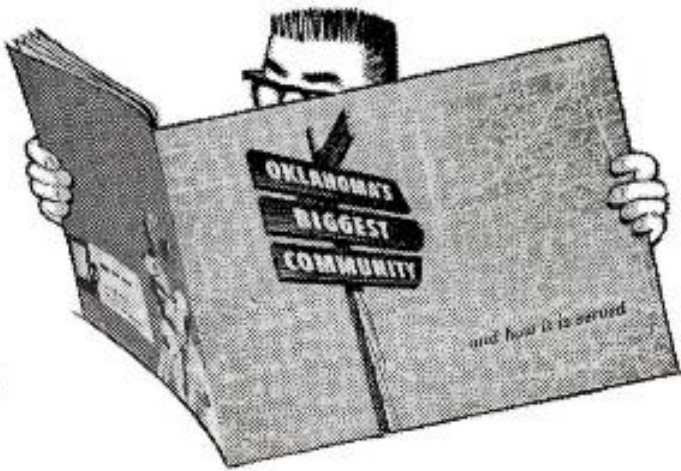

The KWTV Community—a 54-county area—is a community created and held together by SERVICE.

The variety, depth and quality of KWTV programming and promotion services are key factors in its leadership. Within the pages of this brochure, you will find reasons for—and evidence of—the remarkably keen communitywide interest which the KWTV brand of service generates.

Write for your copy . . . you'll find it a helpful tool in making market coverage decisions.

from

KWTV oklahoma city



*BUY the TOWER with
SALESpower in Oklahoma!*

Represented by



The Original Station Representative

570 WBAP



FORT WORTH • DALLAS

WITH THAT SOOTHING INGREDIENT . . .

NO-YAK

ASK YOUR COLONEL OR HERMAN CLARK FOR
THE ULTRA-REFINED 570 PACKAGE

WBAP AM-FM-TV

STUDIO & OFFICES
3900 BARNETT, FORT WORTH

DALLAS
1900 N. AKARD

Plan to block tv given theatre group

As a means of stopping the flow of post-1948 features to tv, J. Robert Hoff, national sales manager of Motion Picture Investors Inc., last week proposed that MPI purchase the top 10 attractions in the library of each film company and re-release them to theatres.

Mr. Hoff, whose company was formed about two years ago to interest theatre exhibitors to invest in motion picture production companies, offered his suggestion at the convention of National Allied in Miami Beach, Fla. National Allied is a trade association of medium- and small-sized theatre operators.

He indicated that MPI would require additional investors before the proposal could be implemented, adding that MPI has its sights on 4,000 to 5,000 investors. He reported that more than \$500,000 of MPI stock has been purchased since last September.

Mr. Hoff's proposal was offered as a substitute for one by Ben Marcus, general chairman of the convention, under which exhibitors would form a company for the purpose of buying the "blockbusters" in the post-48 libraries. Mr. Hoff remarked that MPI could perform the same function as a newly-organized company without the danger of legal complications. Mr. Marcus expressed approval of Mr. Hoff's proposal and the convention unanimously voted its endorsement.

As for the other films in the post-1948 libraries, Mr. Hoff suggested that they be released to tv on an "orderly" basis, should they be sold to tv. He recommended that a company specify in any television agreement that when a feature is shown on tv, the purchaser allot three minutes to promote the current product of the seller.

Astor Pictures sold to Franklin Bruder

Purchase of Astor Pictures Corp., New York, and its subsidiary, Atlantic Television Co., by New York industrialist Franklin F. Bruder was announced last week. The companies were bought from the estate of Robert Savini. Terms were not disclosed.

Atlantic has about 150 feature films in its library and one tv film series—*Uncommon Valor*. Mr. Bruder announced that Alfred H. Morton, formerly a vice president of NBC, will become president of Atlantic. The company will include Everett Crosby on its board, Mr. Bruder said. He will assist Atlantic in acquiring new products for television.

FIRST AGAIN!

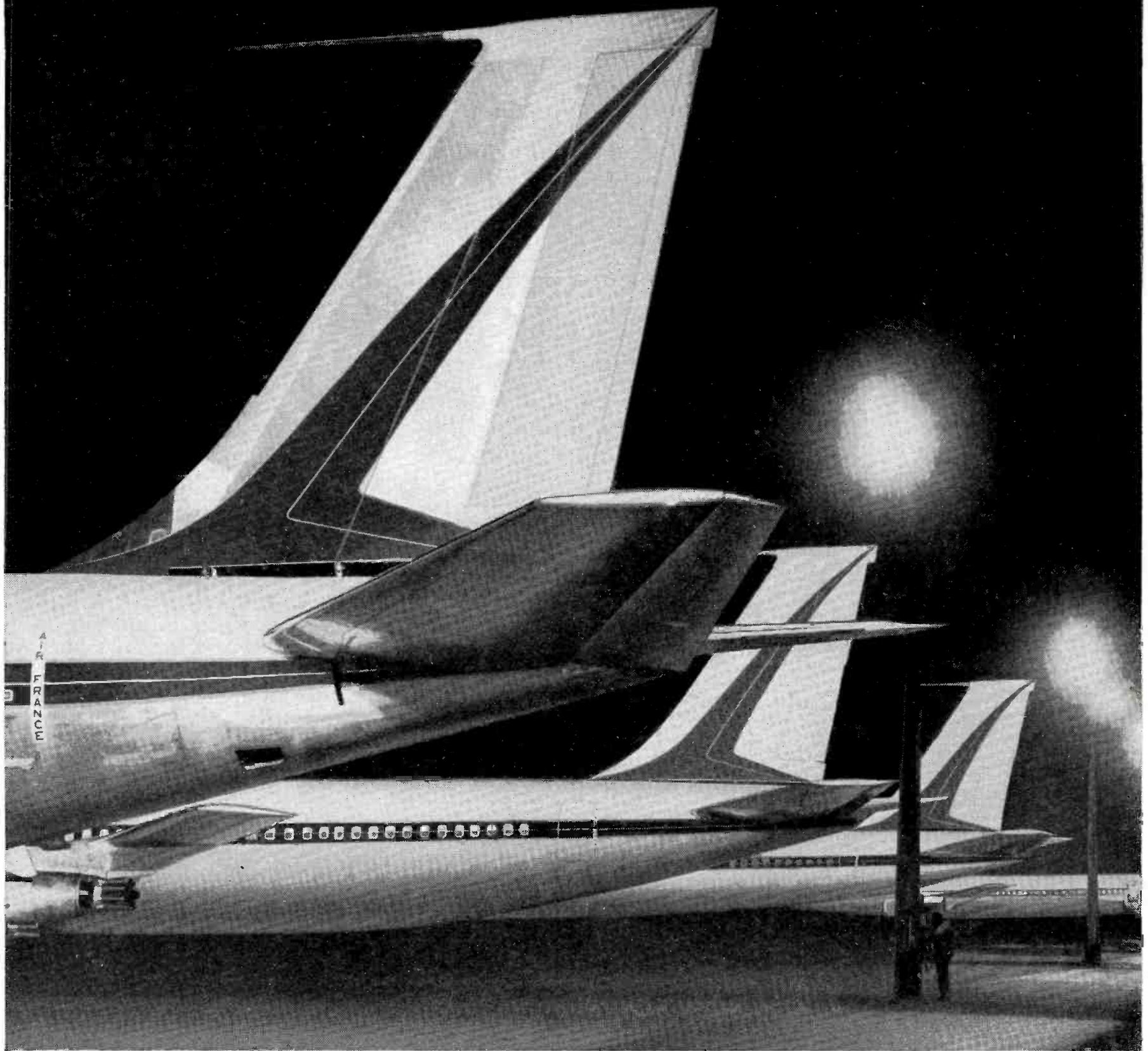

Air France—First European Airline to Fly Giant Boeing 707 Intercontinental Jets Across the Atlantic!

Here's another Air France "first" for the record! Soon Air France's Boeing 707 Intercontinental Jet will touch down at Orly Field after a 6½-hour non-stop flight from New York. This flight will mark the beginning of the world's first "jet-to-jet" service—Intercontinental jets non-stop daily to Paris, Caravelle jets from Paris to all Europe, Africa and the Middle East.

Air France is no stranger to the pages of aviation

history. As early as 40 years ago, Lucien Bossoutrot made the first international commercial flight between France and England. Similar historic first flights include the first crossing of the South Atlantic, the Andes, and the first scheduled Far East service.

The inauguration of transatlantic jet service demonstrates the forward steps that have helped make Air France the world's largest airline, with the world's most personal jet service.

AIR FRANCE JET

WORLD'S FASTEST JETLINER / WORLD'S LARGEST AIRLINE

WIS

gives you

More Adults!

Any time — ALL DAY — WIS reaches more adults in Metropolitan Columbia!*

WIS

gives you

High Ratings!

In the 56 quarter-hours from 6 am to 8 pm, WIS is FIRST RATED in 28!—in second place in the other 28! Even in second place, WIS delivers more adults than any of the other stations.*

WIS

gives you top

Personalities!

Mackie Quave (6-9 am) and Dave Wright (4-7 pm) are in SOLID FIRST PLACE* the entire length of their programs.

Get all the facts from the Metro Columbia, S. C. PULSE, Sept 1959. Call your PCW colonel

*Excluding station of specialized Audience.



G. Richard Shofto, Exec. Vice President
W. Frank Harden, Managing Director

COLORCASTING

Here are the next 10 days of network color shows (all times are EST).

NBC-TV

Dec. 14-18 (6:30-7 a.m.) Continental Classroom.

Dec. 14-18, 21-23 (11-11:30 a.m.) The Price Is Right, participating sponsorship.

Dec. 14-18, 21-23 (12:30-1 p.m.) It Could Be You, participating sponsorship.

Dec. 14, 21 (10-11 p.m.) Steve Allen Plymouth Show, Plymouth through N. W. Ayer.

Dec. 15, 22 (9-9:30 p.m.) Arthur Murray Party, P. Lorillard through Lennen & Newell and Sterling Drug through Norman Craig & Kummel.

Dec. 15 (9:30-10:30 p.m.) Lincoln-Mercury Startime, Ford through J. Walter Thompson.

Dec. 16, 23 (8:30-9 p.m.) The Price Is Right, Lever through Ogilvy Benson & Mather and Speidel through J. Walter Thompson.

Dec. 16, 23 (9-10 p.m.) Perry Como's Kraft Music Hall, Kraft through J. Walter Thompson.

Dec. 17 (9:30-10 p.m.) Ford Show, Ford through J. Walter Thompson.

Dec. 18 (8:30-9:30 p.m.) Bell Telephone Hour, AT&T through N. W. Ayer.

Dec. 19 (10-10:30 a.m.) Howdy Doody, Continental Baking through Ted Bates.

Dec. 19 (10:30-11 a.m.) Ruff and Reddy Show, Mars through Knox-Reeves and Borden through Benton & Bowles.

Dec. 19 (7:30-8:30 p.m.) Bonanza, RCA through Kenyon & Eckhardt.

Dec. 20 (9-10 p.m.) Dinah Shore Chevy Show, Chevrolet through Campbell-Ewald.

CBS-TV
Dec. 15 (9:30-10 p.m.) Red Skelton Show, S. C. Johnson & Sons through Foote, Cone & Belding.

NBC confirms, outlaws program fee kickbacks

NBC confirmed reports last week that a choral group had returned to the network half of the fees it earned for appearances on the *Today* program. James A. Stabile, NBC vice president in charge of Standards and Practices later issued a statement which said:

"The Clara Ward Singers made their last appearance on the *Today* program over a year ago. The NBC Dept. of Standards and Practices has been actively engaged in the study of this and similar incidents involving payments on behalf of artists for promotional appearances. Although this has been a common practice in the industry, we have reviewed the situation and have issued instructions for the termination of such practices on NBC."

The Clara Ward Singers, a Negro choral group, made four appearances on *Today* in 1957 and 1958. A spokesman for the group said that since the program could sustain only half the cost of paying the union-scale fee of \$173.50 to each performer for each appearance, the choral group agreed to the arrangement since it desired national tv exposure. He said one-half of the total salary

bill for each show, amounting to \$520 was returned to NBC.

A spokesman for the American Federation of Television and Radio Artists said its New York local was investigating the matter, since the union has banned the practices.

Spokesmen for ABC and CBS both said they knew of "no such practices" at their networks.

Prime time spy show cut for public affairs

The Saturday night counterspy series *Five Fingers* has lost its hold on NBC-TV and will be replaced starting Jan. 23, 1960 with a series that will cover much greater ground, that of public affairs. The 9:30-10:30 p.m. (EST) slot will draw on the network's news organization as well as its public affairs and special projects departments for in-depth reports on subjects ranging from alcoholism to meetings at the summit.

New Filmways studios opened in New York

Filmways Inc., New York, opened its million-dollar studios, billed as the largest film-videotape production center on the East Coast, last week. Two sound stages, each 100 feet square, were dedicated to actresses Lillian and Dorothy Gish.

Several hundred people, representing all phases of the film-advertising business attended the opening party Dec. 8. The plant they saw includes the studios with associated control and dressing rooms, commissary and offices, plus a five-story adjoining building housing props, electric shop, carpenter shop and scene dock.

Production of commercials, a large phase of Filmways business, has already begun at the new address, 127th St. and Second Ave.



Hometown girls • Martin Ransohoff, founder and president of Filmways Inc., presents a model of the plaque naming his firm's new soundstages for Lillian (1) and Dorothy Gish, recognizing "their contribution toward establishing the cinema as a major art."



How Good Housekeeping Can Help TV Believability

The current unfavorable publicity about TV, caused by the actions of a cynical few, has implications for all advertising that no thinking person can ignore.

We at Good Housekeeping feel that the maintenance of public confidence in *all* forms of advertising is as much our concern as publishing a good magazine.

And we have a specific, tested contribution to make to advertisers who are concerned with the credibility of their television commercials.

During the past year the Schwerin Research Corporation has conducted a study that evaluates the effect of including the Good Housekeeping Guaranty Seal in TV commercials.

Results show that the addition of the Good Housekeeping Guaranty Seal to the TV commercials of several major advertisers increased their effectiveness by 20% in one case, 27% in another, 39% in a third.

These facts prove once again the cumulative *faith* that has been built up in Good Housekeeping and its Guaranty Seal. Because we investigate every product and check every claim that is advertised in our pages 40,930,000 women* are influenced by our seal.

There are some products and some claims that may never earn our seal. But if you make a good product, and advertise it honestly if vigorously, let us show you the Schwerin results and discuss how the matchless confidence millions of customers have in Good Housekeeping can go to work for you now.

Call Good Housekeeping today.

*Crossley, S-D Surveys, Inc.

Good Housekeeping

MAGAZINE AND INSTITUTE

A HEARST MAGAZINE

BROADCASTING, December 14, 1959



**RCA
 THESAURUS
 TURNED
 THE TOWN
 UPSIDE
 DOWN!**



There's the look of success in Forest City, North Carolina, and new station WAGY wears it. RCA Thesaurus figures in this success story. WAGY manager, Don H. Lovelace, gives us this report:

"We're a new station in a two-station market . . . in first year sold 'SHOP AT THE STORE WITH THE MIKE ON THE DOOR,' adding \$13,000 to our gross . . . competitive radio is made easy with Thesaurus."

How are competitive conditions in your town? RCA Thesaurus may be just the thing for your station. Write for all the details today!

RCA THESAURUS

155 East 24th Street • New York 10, N. Y.
 Chicago, Nashville, Atlanta, Dallas, Hollywood

100 (PROGRAMMING)

VIDEOTAPE PROGRESS REPORT

Ampex man claims tape is replacing tv-film.

The tv tape recorder "will become the common storage machine for all tv program material and the prospects are that within five years the production of film for television will have been relegated to the status of a fringe operation," Bob Day, manager of sales development for Ampex Professional Products Co., predicted Dec. 8.

Mr. Day reviewed the progress of tape as a means of recording tv programs before the Los Angeles chapter of the Academy of Television Arts & Sciences during its monthly meeting. Taped program segments, fed to a dozen receivers around the room from the John Guedel-Jack Linkletter "On-the-Go" mobile Videotape cruiser parked outside, illustrated Mr. Day's remarks.

The program also featured a discussion of the provocative subject of whether tv tape will kill the television film industry by a panel whose moderator was the educator-performer Dr. Frank Baxter and whose members were Sheldon Leonard, producer-director, *The Danny Thomas Show*; Howard Meighan, president, Videotape Productions; James A. Schulke, vice president in charge of Paramount Television productions (KTLA [TV] Los Angeles); Ross Snyder, Ampex video products manager; Bud Stefan, Hollywood vice president, BBDO; Ralph Wells, technical test engineer, Screen Gems, and Bud Yorkin, producer-director, Tandem Productions.

Mr. Day reported that at the time of the last Ampex appearance before ATAS, in May 1958, there were 42 vtr machines in operation at the three tv networks and 33 individual stations. Today, he said, nearly 550 machines are in use in the U.S. and 10 foreign countries; more than 160 stations in this country have them; the networks together account for 73 machines, and 16 independent production companies have 32 recorders. (These producers plus the networks and some independent stations are producing at least 40 syndicated programs on tape.)

Compatible • Tape has achieved full interchangeability, black-and-white or color, Mr. Day stated. Copying techniques "give acceptable copies from far more tape generation than it will ever be necessary to utilize." Mobility has been provided by mobile cruisers, introduced early this year.

Problems remaining to be solved include electronic animation, which is being worked on and will be solved in a reasonable time, and editing, which unlike film is more than just splicing. The ideal solution, he said, "seems to be a method of feeding the output of two tv

recorders to a third machine and recording the output of either machine, as desired, with common electronic wipes, fades, dissolves between segments." Devices to do this job have been developed and field tested and a production version is expected next, Mr. Day stated.

Present economies of tape, which producers report at 25-50% under film costs, Mr. Day said, will be improved with new developments. By next summer, he stated, there should be at least 30% additional below-the-line economies in tape production.

Mr. Day's views were endorsed by Mr. Schulke, who declared: "We feel that there is nothing that can be done on film that can't be done as well on tape and less expensively." Mr. Leonard, however, said that as of today, if he wanted a quality program, he'd still use film. "With present techniques, we can get a higher professional polish with film" he declared. He added that ultimately, a blending of techniques will undoubtedly give tape a degree of perfection comparable to that of film. Mr. Wells agreed that at present tape does not give producers the same control over their product that they get from film, but he too expressed confidence in tape's future, noting that through a subsidiary, Elliot, Unger & Elliot, Screen Gems is already in the tape business and adding that the company has a series scheduled to be produced on tape during the coming year.

Proper Techniques • BBDO has been a leader in the use of tape commercials, with virtually all of its clients' nighttime network commercials now on tape, Mr. Stefan said. But even so the agency has more tv spots on film than on tape at this time. Mr. Yorkin advanced the view that many of tapes' problems came from people who tried to use it with film techniques, instead of following the proper pattern of live tv production.

Money may be a basic reason why more programs are not put on tape, Mr. Yorkin commented. "An advertising agency with \$3 million to spend on a tv program," he stated, "is not anxious to cut that billing down to \$1.5 million by putting the show on tape."

• Program notes

Rock-like convictions • Rock 'n' roll music produces strong convictions on radio listeners Ohio State U. reports. In a recent survey of listener tastes, researchers found that nearly 35% of a sample 1,992 adults aged 19 to 70 years said they would turn off their radios

BROADCASTING, December 14, 1959

THE *Fred. A. Palmer* CO.

SALES CONSULTANTS

POSTOFFICE — BOX 108, WORTHINGTON, OHIO

TELEPHONE — TUXEDO 5-7346

SALES CONSULTING
SALES TRAINING
RETAIL SALES CLINICS

SALES PROMOTIONS
SALES MEETINGS
SALES RESEARCH

GOOD MORNING, MR. BROADCASTER:

While speaking to a number of State Broadcasting Associations this year, many broadcasters asked me "When are you going to hold another SALES TRAINING SCHOOL?" My schedule has been so filled with Sales Consulting, conducting Industrial and Wholesale Sales Schools, and Retail Sales Clinics, that broadcasters were neglected this year.



More than 4000 Radio-TV salesmen have attended my two day Sales Training School during the past 15 years. It was this work that got me listed in Who's Who in Commerce and Industry.

I will personally conduct Sales Training Schools for broadcasters as follows:

Jan. 14-15	Charlotte, N.C.	Feb. 1-2	Phoenix, Arizona
Jan. 22-23	Columbus, Ohio	Feb. 4-5	Tampa, Florida
Jan. 25-26	Denver, Colorado	Feb. 11-12	Chicago, Illinois
Jan. 27-28	San Francisco, Calif.	Feb. 15-16	Dallas, Texas

Schools will be scheduled in other areas if enough inquiries are received. Individual station or Group Ownership Schools may be arranged. Each school is limited to 20 for personal attention. The fee is \$100.00 each; or \$250.00 for 3 or more from the same station. Only one station from a city is accepted.

Most financial writers and bank economists are predicting that 1960 will be one of our best years. More than eleven billion dollars will be spent on advertising. You have one of the best mediums for effective advertising. Three things are required to get your share: (1) Enough good salesmen (that's your job); (2) Good IDEAS to sell (that's our job); (3) A definite and proven method of telling about these ideas that will result in a sale (that's my job).

There is a shortage of good salesmen. Get the most from those you have. Send them to one of these Sales Schools for broadcast salesmen, conducted by a broadcast salesman. Wire, phone or Air Mail your reservation today.

Happy Holidays.....Good Health.....and a Prosperous New Year!

Fred A. Palmer

IN PROVIDENCE

WJAR is UP

In twenty-eight out of forty-nine daylight hours, 6:00 A.M. to 6:00 P.M., Monday through Friday (Pulse, March '59 vs. June '59) WJAR shows an increase.

WJAR is UP

Twelve out of twenty traffic periods rated 6:30 A.M. to 9:00 A.M., Monday through Friday (Pulse, March '59 vs. June '59) WJAR shows increases.

WJAR is UP

Thirty-eight of the forty-nine daylight hour segments, 6:00 A.M. to 6:00 P.M., Monday through Friday (Pulse, June '58 vs. June '59) WJAR shows increases.

WJAR is UP

In twenty-three of twenty-four traffic periods, 6:30-9:00 A.M., and 4:00-6:00 P.M., (Pulse, June '58 vs. June '59) WJAR shows increases.

**GET RESULTS!
BUY ADULTS!
BUY WJAR**

NBC NEWS,
SPORTS,
MONITOR



Sister station of WJAR-TV
Represented proudly by Edward Petry & Co.

if as much as a half hour of the frantic music was announced. Among other findings. Adults, ages 19 to 70, ranked their favorite tv show formats as (1) adult western drama; (2) prestige 60-minute drama; (3) play-by-play sports; (4) tv news; (5) jazz detective drama; (6) musicals with "sweet" music.

Olympic games • CBS Films Inc., New York, has acquired television rights to the 1960 Olympic Games for sale in all of South and Central America and Australia. Film sale rights were granted by the Olympics Committee, which is represented by Gardner Adv., St. Louis and New York. Each country will be offered at least 15 hours of programming, with special coverage to each about efforts of its participating athletes.

Nautical sounds • The 40,000-ton *U.S.S. Ticonderoga* became a floating stereophonic studio last month when audio engineers from Radio Recorders captured the authentic sounds of a week-long cruise to produce "Sounds of the Ti." The results will be edited and processed for release as an addition to the Standard Radio Hi-Fi and Super Sound Effects Library. G. Howard Hutchins, president of Radio Recorders, and Harry Bryant, vice president, directed the recording of naval sounds, from bugle calls to take-offs and landings of the Navy's new F3H Demon and FJ4 Fury jets, with added sessions on the hangar deck, flight deck control room, primary flight control room and the carrier's helicopter.

More 'Tombstone' sales • Ziv Television Programs reports that *Tombstone Territory* has been sold in 96 markets in the first 20 days of selling, with latest sales to Grant Furniture Co. and Welco Builders for WPTV (TV) West Palm Beach, Fla.; Riverside Bedding Co. and Sing Oil Co. for WALB-TV Albany, Ga., and Sheehon Buick Co. for WPST-TV Miami; KALB-TV Alexandria, La.; KPLC-TV Lake Charles, La.; KTEN (TV) Ada, Okla., and KMID-TV Midland, Tex.

Christmas buyers • United Artists Associated Inc., N.Y., has added 23 more markets for its Yule season films: "A Christmas Carol," "The Emperor's Nightingale," "Star in the Night" "Silent Night." The stations are: WKTU (TV) Utica, N.Y.; WESH-TV Daytona Beach, Fla.; KSLA-TV Shreveport, La.; KVKM (TV) Monohans, Tex.; WKBW-TV Buffalo, N.Y.; KOSA-TV Odessa, Tex.; KGBT-TV Harlingen, Tex.; KGHL-TV Billings, Mont.; KOLD-TV Tucson, Ariz.; WFMY-TV Greensboro, N.C.; WBAL-TV Baltimore; WCBI-TV

Columbus, Miss.; WSM-TV Nashville, Tenn.; WLOS-TV Asheville, N.C.; CKCK-TV Regina, Sask.; CFQC-TV Saskatoon, Sask.; CKX-TV Brandon, Manitoba; CFCJ-TV Port Arthur, Ont.; CHCA-TV Red Deer, Alberta; KENS-TV San Antonio, Tex.; KCMC-TV Texarkana, Tex.; WDAF-TV Kansas City, Mo., and KCMT-TV Alexandria, Minn.

New producer • Production and distribution of *Radio Press Conference*, weekly voiced Washington half-hour news show, has been taken over by News Assoc. Inc., Washington audio news service, it was announced last week. Heretofore it had been distributed by Radio Press International, New York. News Assoc., formed in 1958 with personnel from the old International News Service, has produced *Radio Press Conference* for RPI since inception of the program in mid-summer. Regular moderator has been I. Herbert Gordon, president of News Assoc. The weekly program, its name changed to *Radio News Conference*, has included top Washington government personalities.

Tragedy coverage • WLYC Williamsport, Pa. supplied stations throughout the country with on-the-spot reports of the disaster which occurred in its own backyard. Early on the scene of the crash of an Allegheny Airlines plane at the Williamsport airport on Dec. 1, the station gave beeper phone reports to stations in New York, Akron, Dayton, Philadelphia, Los Angeles, Cleveland among others.

New subscribers • Tel National, producer of jingles for use by local advertisers on radio stations, has announced six new station subscribers: KXRX San Jose, KWIP Merced, KSON San Diego, all California. KTLN Denver, Colo.; WDAF Kansas City and KSD St. Louis.

Series on blindness • WBBM-TV Chicago launched a three-part public affairs presentation on child blindness Dec. 6. Titled *Out of the Dark*, the weekly series deals with one child's success in living a normal life, efforts of people and institutions to meet the challenges posed by the problem, and cause, effect and prevention of blindness in children. The station's news and public affairs staffs devoted three months to production of the programs, shooting some 15,000 feet of film.

'Billy' goes tv • Sanrock productions, new tv program company, has completed filming the first episode of *The Legend of Billy the Kid*, planned as 39 half-hour series to be filmed in color. Jerry Schafer, executive produc-

SUCCESS OF "RADIANT RADIO KHJ", LOS ANGELES IS CREDITED IN GREAT PART TO FAST, EFFICIENT OPERATION OF MACKENZIE ELECTRONICS AUTOMATIC AUDIO FIVE-CHANNEL REPEATERS • Frequency 930 kilocycles, Los Angeles is "Radiant Radio KHJ" • And "Radiant Radio KHJ" features a new format...a format of fast, extra-fast news, music, and information put into effect when KHJ changed over from being a key network station to completely independent operation. The change was highly successful...made so by careful pre-planning, by careful rehearsal before format change, and by the use of newly-developed instant cuing, and instant-playing, tape machines manufactured by MacKenzie Electronics, Inc. • Mr. A. J. La Frano, vice-president and program director says...*"Our programming, now made up of much smaller segments than before, had to appeal to and hold our listeners. It had to be tight, bright, and fast. In the success we have had we owe a great deal to the program repeaters manufactured by MacKenzie Electronics. They prevent missed cues, fluffs, and retakes. They save us time and save us money, and have been of tremendous help in smoothing out our operation."*

"IT HAD

TO WORK!"

Says A. J. La Frano
Program Director,
KHJ-Los Angeles

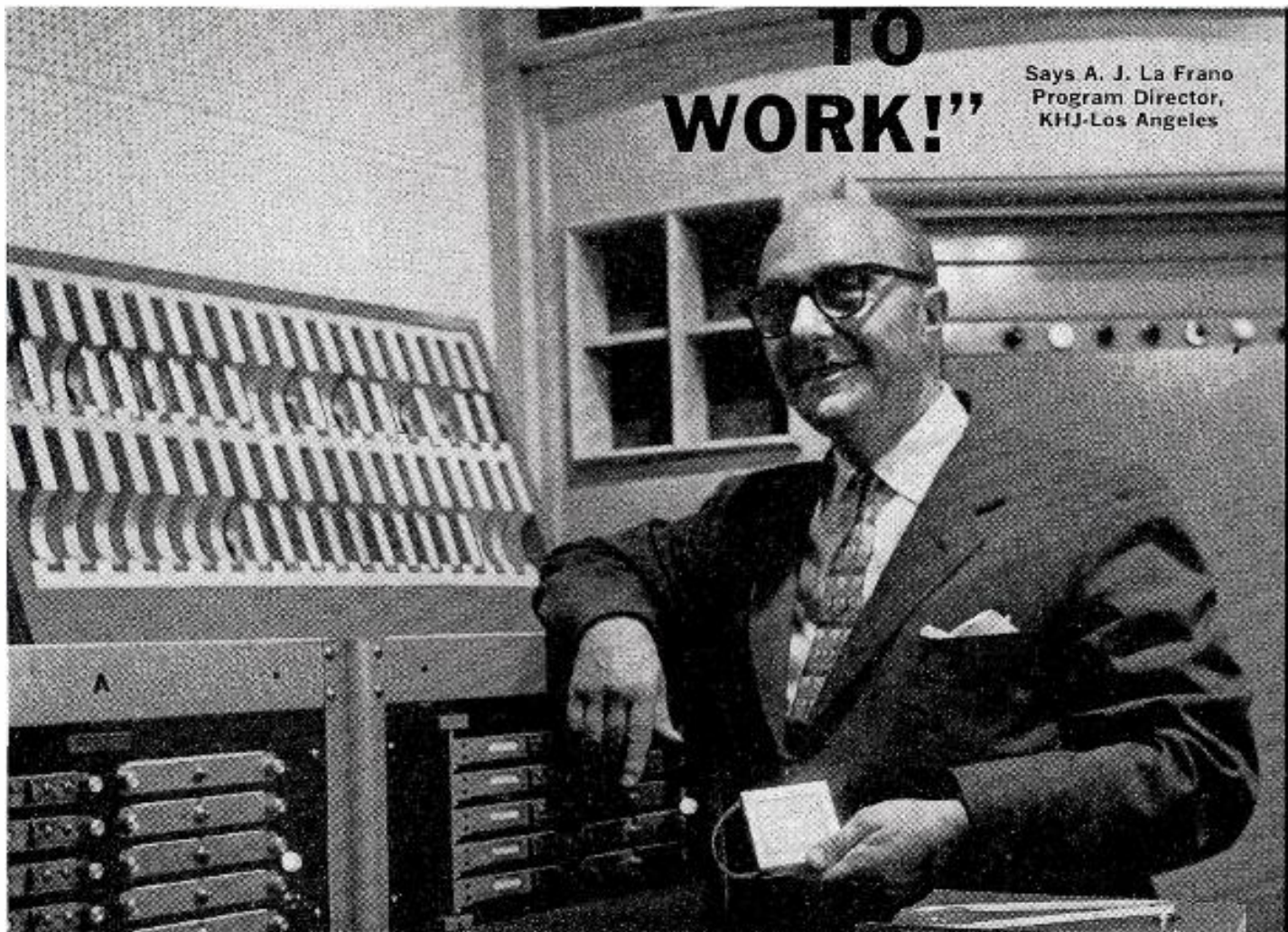

Mr. La Frano credits MacKenzie Automatic Audio Five-Channel Repeaters for success of new "Radiant Radio KHJ" format of news, music, and information...one of radio's smoothest, fastest moving continuous programming operations.

Model 5CPB Five-Channel Selective Program Repeater. Delivered as illustrated, mounted on a standard relay rack panel (8 3/4" high), complete with self contained power supply. Included with each machine are five magazines and accessories. Price \$1,250 F.O.B. Los Angeles. Leasing available. Demonstration upon request.

MACKENZIE 5CPB FIVE-CHANNEL SELECTIVE PROGRAM REPEATERS CAN ASSIST YOUR PROGRAMMING, TOO... SAVE YOU WORK...SAVE YOU MONEY • *The MacKenzie Five Channel Selective Program Repeater is designed for use by Radio Broadcasting...Television...Film and Sound Recording Studios...for playing of pre-recorded...spot announcements...station breaks...jingles...music bridges and other program material requiring precision cuing, with instantaneous...stop-start operation. The 5CPB is a complete special effects programming machine, housing 5 tapes, which will increase the flexibility and efficiency of your operations, with no more missed cues...program failures...re-takes...or fluffs. Fast, easy magazine changes provide hundreds of recordings at your fingertips. Tapes are quickly and easily prepared on standard recording equipment. Dubbing, cue-marking, loading, and splicing normally takes about five minutes. These machines save time and money.*

DO YOU NEED THESE FEATURES? • Instantaneous Cuing • Noiseless Operation • Rapid Magazine Changes (5 Seconds or Less, Each) • Easy Preparation of Tapes (5 Minutes or Less, Each) • Automatic Special Effects • Bright, Tight, Fast Operation
IF YOU DO, SEND COUPON TODAY!

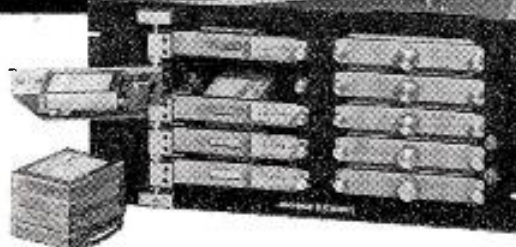

Gentlemen,

- Please send me literature describing Model 5CPB Repeaters.
- I am attaching my company calling card. Please send typical "Air Check" tape of KHJ Los Angeles operation.

Name _____

Company _____

Address _____

City _____ State _____

AUTOMATED AUDIO



MACKENZIE ELECTRONICS, INC.

145 WEST HAZEL ST./INGLEWOOD 3, CALIF./ OREGON 8-9335

Right on top in FRESNO

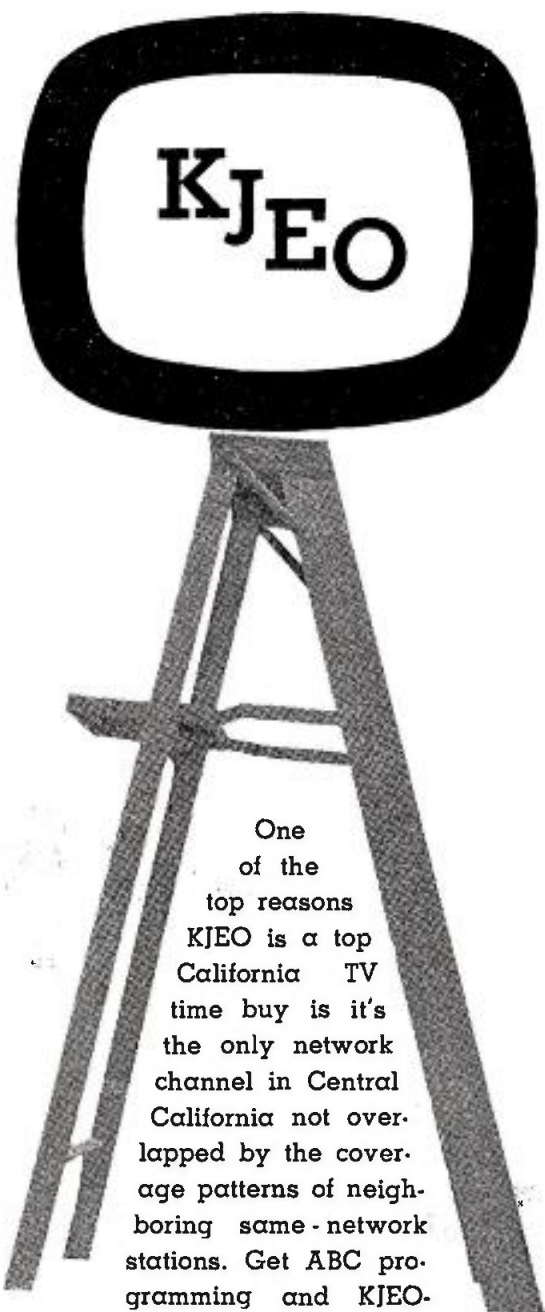

One of the top reasons KJEO is a top California TV time buy is it's the only network channel in Central California not overlapped by the coverage patterns of neighboring same-network stations. Get ABC programming and KJEO-TV's undiluted viewership in this million-plus population market.

Channel 47, No. 1 for the audience and the base cost in Central California audience.



J. E. O'Neill — President
Joe Drilling — Vice President and General Manager
W. O. Edholm — Commercial Manager
See your H-R representative **H-R**

er, also wrote the initial film, which was directed by Reg Parton. Mr. Schafer is vice president of Sanrock, which is headquartered at 4060 Buckingham Road, Los Angeles. Telephone is Axminster 5-3116. Other officers are: Isaac Avrin, president; William Bonney (who portrays Billy the Kid), secretary-treasurer; Sidney Schlafer, executive vice president.

First sales • Fremantle International Inc., N.Y., reports sales of its Spanish-

dubbed cartoon package *Cartoon Classics*, WKAQ-TV San Juan, P.R., for distribution in both Puerto Rico and Cuba, and to Zuriguel Asociados, Caracas, Venezuela, for tv stations throughout that country.

Screen Gem move • Screen Gems Inc. has moved its entire syndication production and sales division organization to new quarters located at Columbia Sunset Studios, 1422 Lyman Place, Los Angeles.

FATES & FORTUNES

Broadcast Advertising



MR. BARKER

• ROBERT C. BARKER, previously vp and account supervisor at Kenyon & Eckhardt and Ogilvy, Benson & Mather, both New York, to Compton Adv., that city, in similar capacity.

• NEIL H. McELROY, formerly Secretary of Defense, elected chairman of Procter & Gamble Co., succeeding R. R. DEUPREE who continues as honorary chairman. Mr. McElroy was president of P&G from 1948-1957 when he resigned to join Cabinet.

• GEORGE B. KOCH JR., advertising manager of B. F. Goodrich Chemical Co., division of B. F. Goodrich Co., Akron, Ohio, appointed to similar position with parent company for industrial and commercial products.

• WILLIAM J. JOST, previously with Owen & Chappell as vp and account executive and McCann-Erickson as merchandising executive; ALAN B. MILLER JR., previously account executive with Doherty, Clifford, Steers & Shenfield, and THOMAS S. QUINLAN all promoted to vps at Ted Bates, N.Y., where they have been serving as account executives. GORDON ENSIGN, Bates account executive, named assistant vp.



MR. GROMER

• FRANK J. GROMER JR., media manager at Foote, Cone & Belding, elected vp and named director of media for New York office. Mr. Gromer has been with FC&B for 12 years and has served in such capacities there as account research supervisor, director of account research and director of research.

• WILLIAM W. WOODBRIDGE, formerly

vp and account supervisor (Liggett & Myers) at Dancer-Fitzgerald-Sample, N.Y., to Guild, Bascom & Bonfigli, San Francisco, as assistant to president.

• ROBERT F. STEINHOFF, vp and member of account staff of Needham, Louis & Brorby, appointed manager of agency's New York office effective Jan. 1. He also has been member of NL&B training committee.



MR. WACHTER

• FREDERICK J. WACHTER, formerly vp and manager of Chicago office of Knox Reeves Adv., appointed vp and account supervisor at Needham, Louis & Brorby, that city. Mr. Wachter was previously executive vp of Erwin Wasey, Ruthrauff & Ryan, N.Y.

• A. MASON HARLOW, assistant to president of Burdick & Becker, N.Y., named vp and general manager.

• ANTHONY C. (DEL) DEPIERRO, vp and director of media Lennen & Newell, N.Y., resigns effective Jan. 1. He has been media director since 1952.

• M.J. WARNOCK, vp of Armstrong Cork Co., Lancaster, Pa., elected to board of directors, filling vacancy created by death of H.W. Prentice, Jr., board chairman and president.

• RALPH M. HAGEN, formerly vp, director and member of executive committee of Gallup & Robinson Inc., Princeton, N.J., advertising and pr firm, resigns effective Jan. 8. He moves to Hawaii to form own company engaging in research, marketing, advertising, sales and other professional services. New office located at Suite 573, 1015 Bishop St., Honolulu 13.

• JAMES R. FLEMING named president and chief executive officer of Mars Inc. (candy makers), Chicago, succeeding W.L. KRUPPENBACHER who continues as director and honorary board chairman. B.A. BOUCHARD, formerly vp in charge of sales, appointed executive vp

Does the public really want “public power”?

The promoters of federal government electricity like to say that “public power” is for all the people.

But the facts are—the majority doesn’t get it, never asked for it, and doesn’t want the federal government in the electric business.

A 1959 survey of public opinion shows that Americans prefer business rather than federal government ownership and operation of their electric utility. And they favor such companies over the government to meet future power requirements.

Nevertheless, the public is paying heavily for so-called “public power.” To date, about \$5,500,000,000 in tax money has gone into federal government power systems. And the “public power” pressure groups are pushing for another \$10,000,000,000.

“Public power” spending goes on in spite of the fact that it is quite unnecessary. The future power needs of the nation can be fully supplied by the hundreds of independent electric companies. They are able—and ready—to do the job, and *without* depending on taxes.

How have the “public power” promoters been able to get away with this spending for so long? Simply because most people don’t realize it is costing them money.

Informed Americans can call a halt to this unnecessary spending of tax money. Will you help spread the word?

America’s Independent Electric Light and Power Companies

Company names on request through this magazine





YOU'RE ONLY HALF-COVERED

**IN NEBRASKA
IF YOU DON'T USE
KOLN-TV!**

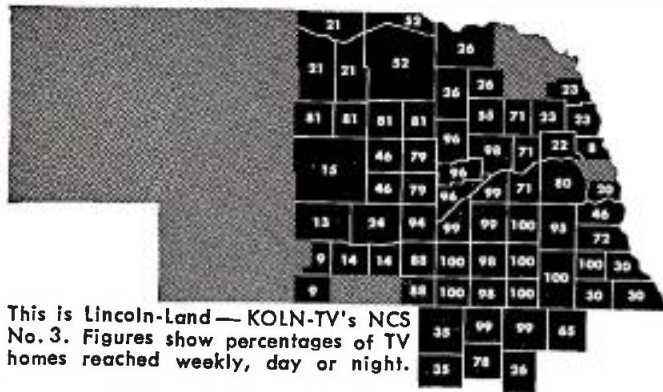

This is Lincoln-Land—KOLN-TV's NCS No. 3. Figures show percentages of TV homes reached weekly, day or night.

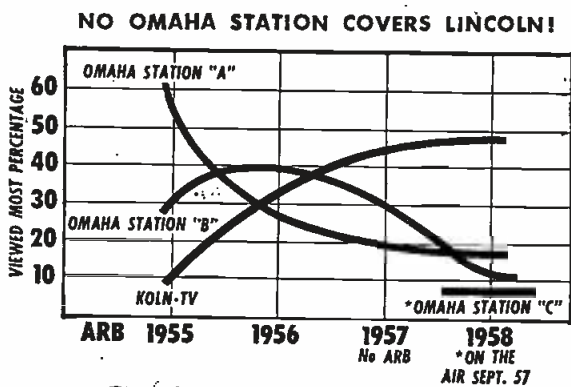

The Feltzer Stations

WKZO-TV — GRAND RAPIDS-KALAMAZOO
WKZO RADIO — KALAMAZOO-BATTLE CREEK
WJEF RADIO — GRAND RAPIDS
WJEF-FM — GRAND RAPIDS-KALAMAZOO
WWTV — CADILLAC, MICHIGAN
KOLN-TV — LINCOLN, NEBRASKA
Associated with
WMBD RADIO — PEORIA, ILLINOIS
WMBD-TV — PEORIA, ILLINOIS

Nebraska has two big television markets. They are both good markets, *but there's a big difference in the way they are covered!*

One market—in the extreme East—is well-served by *three* top TV stations, making it tough to reach a high percentage of the viewers economically.

The other—Lincoln-Land—is *really covered* by just *one* top TV station—KOLN-TV! And the area contains more than *HALF* the buying power of the entire state.

Ask Avery-Knodel for all the facts on KOLN-TV—the Official Basic CBS Outlet for South Central Nebraska and Northern Kansas.

following retirement of GEORGE B. HURLEY. NORMAN VANCE, JR., former president of The Callerman Co. (foods), Chicago, joins Mars as vp and director of marketing.

- CLAIR CALLIHAN JR., tv production supervisor at Earle Ludgin & Co., Chicago, to McCann-Erickson, that city, as radio-tv production supervisor.

- RAYMON M. WALL, account manager at Waldie & Briggs, Chicago, promoted to vp and account supervisor in agency's industrial division.

- GEORGE A. HUHNS, formerly copy supervisor at Fuller & Smith & Ross, Pittsburgh, to copy staff of N.W. Ayer & Son, Philadelphia. Other Ayer appointments: JOHN A.R. BIDUS. PETER HORST and FRANCES OSBORN, to copy department, Philadelphia office; WILLIAM J. ROACH to pr department in New York, and STANLEY T. POAG to service staff, Detroit.



MR. PASSMAN

- ROY PASSMAN appointed director of radio-tv department of J. M. Mathes, N.Y., succeeding RICHARD S. JACKSON, who resigns. Mr. Passman previously held similar position with Bryan Houston, N.Y., and prior to that was manager of NBC-TV network program administration.

and prior to that was manager of NBC-TV network program administration.

- EDMUND F. LINDNER, formerly copywriter at Ted Bates, N.Y., and DAVID H. GRAYSON, formerly copy staffer at Ogilvy, Benson & Mather, that city, to New York office of Benton & Bowles as copywriter and copy group head, respectively.

- THERRY L. McCORMICK, formerly sales manager of Reserve Beer Div., Peter Hand Brewing Co., Chicago, appointed advertising manager of parent company. He succeeds EDWARD BROOKS, who resigns.

- MERL BLOOM, formerly at Norman, Craig & Kummel, and THOMSON C. MCGOWAN, formerly at Lynn Baker Inc., to Reach, McClinton, N.Y., as radio-tv department staff member and project director-research, respectively.

- ARTHUR ZEVLIN, formerly pr coordinator for International Tel. & Tel. telephone and radio operating units in Latin America, joins pr staff of Doremus & Co., New York advertising and pr firm.

- ROBERT LEE, previously art director with Reach, McClinton & Co. and Cunningham & Walsh, to Joseph Katz Co., N.Y., in similar capacity.

- JOHN D. DAVIS, formerly with BBDO

BROADCASTING, December 14, 1959



KOLN-TV

CHANNEL 10 • 316,000 WATTS • 1000-FT. TOWER

COVERS LINCOLN-LAND — NEBRASKA'S OTHER BIG MARKET

Avery-Knodel, Inc., Exclusive National Representatives

BROADCASTING
THE BUSINESSWEEKLY OF TELEVISION AND RADIO
1735 DeSales St., N. W. Washington 6, D. C.

NEW SUBSCRIPTION ORDER

Please start my subscription immediately for—

52 weekly issues of BROADCASTING \$ 7.00

52 weekly issues and Yearbook Number 11.00

Payment attached Please Bill

name title/position

company name

address

city zone state

Send to home address — —

* Occupation Required



Above. Four sections of a BFA FM Antenna pole-mounted and interconnected by 3 1/8" coaxial transmission line.

Right. Single section of antenna, showing radiator details.

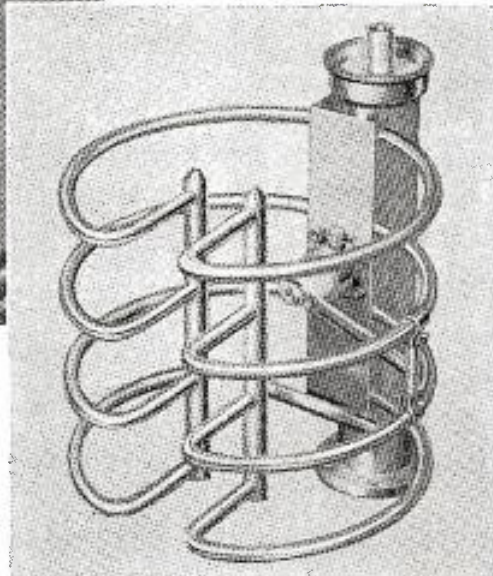

New High-Gain Broadband FM ANTENNAS

Ideal for Multiplexing

The new BFA series of FM Transmitting Antennas is designed for maintaining the high-fidelity sound normally associated with FM. Its broadband characteristics make it ideal for multiplexing. Featuring simplified design, it consists of four tubular stainless steel radiating rings attached to a supporting frame. The shunt-fed antenna sections are interconnected by 3 1/8-inch Universal Transmission Line. Thus, any number of sections can be stacked as shown. Sectionalized construction, low weight, and mechanical simplicity make installation quick and easy.

Reduced "Q" for Broadbanding—Necessary broadband for multiplexing is accomplished by stacking the four rings of a single section to reduce the "Q". A "Q" value of approximately 30 is easily achieved. Higher gains are obtained by discreet spacing of the sections.

Low VSWR—The new antennas will meet a VSWR specification of 1.2/1.0 or better when antenna is top-mounted. If side-mounted, a VSWR of 1.5/1.0 is achieved. Built-in input transformer permits field trimming, to obtain a VSWR of 1.1/1.0 or better.

Excellent Circularity—A horizontal circularity on the order of ± 1 db is normally obtained when the antenna is pole-mounted. When the antenna is side-mounted on a supporting tower, the circularity is normally better than ± 3 db. In those cases where close-in coverage is

desired, this antenna can be supplied with null fill.

Built-in De-icers—These new antennas are available with built-in de-icers which are installed at the factory. Under normal icing conditions the 250 watt heating unit should prove adequate, however, for severe icing conditions, the heater may be supplied with 220 volt AC to increase the heating capacity to 1000 watts for short periods of time. An optional item, Automatic Sleetmelter Control, MI-27369, is available, which will serve to operate the de-icers automatically under conditions necessitating their use.

Flexibility in Mounting—The antennas can be mounted in a variety of ways. Mounting hardware brackets and supports are supplied for both pole and side-mounting.

For complete information on the new BFA series of FM Antennas, call your RCA Broadcast Representative. Or write to RCA, Dept. BB-22, Building 15-1, Camden, N. J. In Canada: RCA VICTOR Company Limited, Montreal.



RADIO CORPORATION of AMERICA

BROADCAST AND TELEVISION EQUIPMENT

CAMDEN, N. J.

Tmk(s) ®

**WHICH TWIN CITIES?
Minneapolis - St. Paul? Kansas City - Kansas City?**



NO, THIS IS "KNOE-LAND"

(embracing industrial, progressive North Louisiana, South Arkansas, West Mississippi)

JUST LOOK AT THIS MARKET DATA

Population	1,520,100	Drug Sales	\$ 40,355,000
Households	423,600	Automotive Sales	\$ 299,539,000
Consumer Spendable Income	\$1,761,169,000	General Merchandise	\$ 148,789,000
Food Sales	\$ 300,486,000	Total Retail Sales	\$1,286,255,000

KNOE-TV AVERAGES 78.5% SHARE OF AUDIENCE

According to April 1959 ARB we average 78.5% share of audience from Sign On to Sign Off 7 days a week. During 361 weekly quarter hours it runs 80% to 100%, and for 278 weekly quarter hours 92% to 100%.

KNOE-TV

Channel 8
Monroe, Louisiana

CBS • ABC
A James A. Noe Station
Represented by
H-R Television, Inc.

Photo: Aerial View Prosperous Twin Cities of Monroe-West Monroe, Louisiana

**Beautiful Signals ...
HANDLED with CARE**

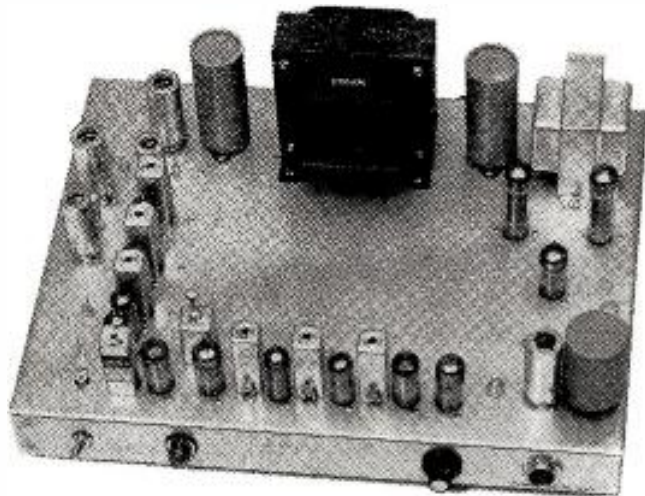

MCMARTIN MULTIPLEX RECEIVERS

Better sound sells FM on main carrier and subs. Better sales result with carefully engineered and reliable receiving equipment. At Continental rigid quality control and extreme manufacturing care guarantees you and your listeners the finest reception . . . whatever your requirements.

Lease (without down payment) and Lease Purchase Plans available.

Write or call

CONTINENTAL MANUFACTURING, INC.

1612 California Street - Omaha, Nebr.



and previously product manager at Simoniz Co., Chicago, to Tatham-Laird, that city, as account executive.

• MONTE GHERTLER, formerly with Lawrence C. Gumbinner and Grey Adv., to copy department of Doyle Dane Bernbach, N.Y.

• SID LINSKY joins Advertising Assoc. of Philadelphia as associate art director.

• HARRY MAGAFOS to Philip Lesley Co. (pr firm), Los Angeles office, as assistant account executive. He formerly was west coast radio and tv representative for YMCA of North America.

The Media



MR. DAY

• HAROLD DAY, director of daytime sales at ABC-TV, N.Y., elected vp in charge of daytime tv network sales. Mr. Day who previously served as manager, western division tv network sales, has been with

ABC since 1942.

• CHARLES B. WALSH, accountant with WBBM-TV Chicago, appointed executive assistant to H. LESLIE ATLASS, vp and general manager of CBS-owned station. He succeeds CARRINGTON W. DOEBLER, who resigned.



MR. MENKE

• DON MENKE, general sales manager of WFBM-TV Indianapolis, promoted to station manager. Mr. Menke previously was general manager of WEOA Evansville, Ind. in 1946, and prior to that, co-originator of *People Are Funny*.

• SYDNEY ASHE, assistant treasurer, Institute For Motivational Research, Croton-On-Hudson, N.Y., appointed vp and general manager. He joined Institute in 1957 as controller.

• GERALD HAUSER, formerly owner-manager of KAFP Petaluma, Calif., named station manager of KANS Kansas City, Mo. For past 1½ years he served as southwest manager of Community Club Awards.

• FRANK DOYLE, formerly air personality and sales executive with WMMB Melbourne, named general sales manager of WMEG Eau Gallie, both Florida. In addition, he continues as correspondent for Westinghouse Broadcasting Co. radio and tv stations in Florida area.

• OTIS SEGLER, station manager of



*Salesman
who KNOWS
he uses
trucks...*

Every salesman knows trucks deliver what he sells. He knows from personal experience. Without regular on-time delivery, sales would fade. In modern manufacturing and merchandising, limited inventory is common, fast replacement a "must." The salesman knows there isn't room for fumbling around . . . distribution is keyed to the clock . . . He uses trucks to keep everything in step . . . including his commissions.

AMERICAN TRUCKING INDUSTRY

American Trucking Associations, Inc., Washington 6, D. C.

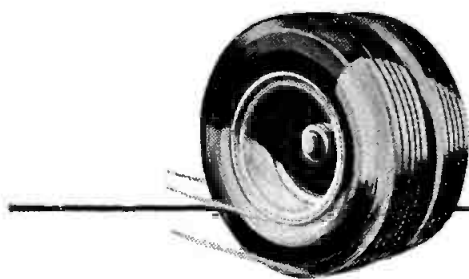

THE WHEELS THAT GO EVERYWHERE



WDEF-TV Chattanooga, and SUE JOHNSON, national sales secretary, assume additional responsibilities for national and regional sales, following resignation of national sales manager, RICHARD HOLLOWAY, who has joined WFMY-TV Greensboro, N.C.

- THEODORE M. WROBEL promoted to assistant sales manager for WBZ-TV Boston. He has been with sales department since 1957.

- JIM ROGERS, account executive with Paul H. Raymer Co., radio and tv rep., appointed to head new Chicago office.

- JOHN C. SCHULZ, formerly account executive with NBC, to The Pulse Inc., as director of midwest operations for Great Lakes activities, with Chicago headquarters.

- JOHN M. GRUBBS, formerly director of news and special events with WIBG Philadelphia, appointed program director of WJBK Detroit, both Storer Broadcasting Co. stations.

- JERRY WHITE appointed program director of WPEN Philadelphia. He was previously announcer with WNEW-AM-FM and WQXR-AM-FM, both New York, as well as ABC.

- DAN ALLAN, appointed station program director of WLOL-AM-FM Minneapolis-St. Paul, succeeding J. PETER BOYSEN who will devote his time ex-

clusively to air personality duties. ALLEN ROYSE, formerly account executive with Vance Pidgeon Adv., that city, joins WLOL sales staff, succeeding J. WARREN BURKE.



MR. DAY



MR. WELLINGTON

- DEL DAY and GIL WELLINGTON have formed Day-Wellington Inc., rep firm to handle regional and national radio and tv sales. Mr. Day formerly was west coast national sales manager for Midnight Sun Broadcasting Co., which operates KFAR-AM-TV Fairbanks, KENI-AM-TV Anchorage and KTKN Ketchikan, all Alaska. Mr. Wellington has been sales manager of KXA and KTIK, both Seattle, and previously was with Midnight Sun Broadcasting Co. for 14 years. New firm has offices at 424 Vance Bldg., Seattle. Telephone: Mutual 2-6535.

- SYD CASSYD, founding member of Academy of Television Arts and Sciences and president of that organization in 1950, joins U. of California Exten-

sion staff as special consultant in educational tv.

- GALEN FROMME, radio news editor, appointed news manager of WBAL-AM-TV Baltimore. MIKE MEISE named assistant news manager of WBAL-AM-TV. AL QUINN to WBAL-AM-TV as news specialist.

- RALPH P. McCASKY JR., formerly account executive with Young Television Corp., Chicago, to Peters, Griffin, Woodward, that city, as tv account executive.

- SHIRLEY DUNHAM named publicity manager of WKRC-TV Cincinnati. Previously she was with KSJO San Jose, Calif.

- H. L. (HANK) FOILES, formerly catcher for Pittsburgh Pirates, appointed promotion director of WVEC-TV Hampton-Norfolk, Va.

- JIM CURTIS, formerly with staff of WKBW-TV Buffalo, and JOHN R. SHARPE, night news editor for WEBR Buffalo, named production director and assistant director of promotion, respectively, of WEBR.

- WILLIAM SMALL, news director of WHAS-AM-TV Louisville and newly-elected president of Radio-Tv News Directors Assn. has announced chairmen of RTNDA committees for 1960: JAMES L. SNYDER, chief of Westing-

UPPER STRATA STRATEGY!

Friend of ours who always attends the sessions in the lecture halls, starts on the Fourth Floor with Production Items . . . and works his way down to Components on the First Floor. Says his feet tell him it's easier to come down than to go up! And he never misses a trick this way. Sounds like good engineering logic. Why don't you join him this year . . . and see if it doesn't work for you!

Will Copp

Show Manager

1959 IRE SHOW REGISTRATION:

60,052

.....and we're set to handle even more of you in 1960 looking for **NEW IDEAS in RADIO-ELECTRONICS!**



Yes, the IRE NATIONAL CONVENTION and RADIO ENGINEERING SHOW is growing bigger every year, and drawing more people—950 exhibitors representing 80% of the productive capacity of your industry—60,052 registrants last year! Yet, it's one of the most well planned, well executed gatherings you'll ever see!

There's room to move around, room to see all you want to see because the IRE takes over all 4 floors of the giant Coliseum in New York City to show what your huge, fast moving radio-electronics industry is coming up with. First and second floors for components; third for instruments and systems; and fourth for production items. Follow the engineers to the Coliseum for NEW IDEAS IN RADIO-ELECTRONICS, 1960!

The IRE NATIONAL CONVENTION
Waldorf-Astoria Hotel
and **The RADIO ENGINEERING SHOW**
Coliseum, New York City

MARCH 21, 22, 23, 24

The Institute of Radio Engineers
1 East 79th St., New York 21, N. Y.

now
you
can

Freeze TV Action!



NEW Hughes Storage Monitor

Tape advantages are well-known—superior “live-quality” picture reproduction, immediate playback and greatly reduced costs. One of the major difficulties to date has been development of efficient tape editing methods and techniques. Now, Hughes makes available to the industry a Storage Monitor for use as a key unit in the design of tape editing systems.

The new Hughes Storage Monitor operates like any standard TV monitor until you press the button. Immediately the Hughes 5" TONOTRON® Tube freezes the image, holding it until the monitor mode is restored.

Advantages to TV engineers include: High-Speed tape processing. Better program continuity and quality. Less tape wear during editing. Highest utilization of video recording equipment.

Pictures may be held for approximately ten minutes with a minimum of 5 half tones. Input may be from separate or composite video sources. Push-button controls permit local or remote operation.

Model 201 Storage Monitor is available in several mounting arrangements—portable or rack mounted, individually or in groups, for sequential frame study. This permits rapid selection of individual frames and desired action sequences.

For additional information write to: Hughes Products, Industrial Systems Division, International Airport Station, Los Angeles 45, California.

BROADCASTING, December 14, 1959

Now! A television monitor with a memory... capable of freezing any TV action.

Video Signal Positive Video or Positive Composite Video (sync. neg.) coaxial cable input, 1 volt p-p.
Separate Sync Inputs Negative sync, coaxial cable input.
Input Impedance 100 ohms each on Separate Sync Inputs, 1000 ohms on Video Input (with parallel terminal for 75 ohm matching termination).
Video Bandwidth Approximately 6 mc.
Vertical Scanning Frequency 60 cps. interlaced.
Horizontal Scanning Frequency 15,750 cps.
Picture Size 4 inch useable diameter.
Power Requirements 115 V 50/60 cps. 130 watts.
Dimensions (Model 201) 14" x 8-1/2" x 16-1/2" wt. approx. 40 lbs.
Mounting (Model 201-R) Standard 19" relay rack
Phosphor P-4 (Television black and white)

INDUSTRIAL SYSTEMS DIVISION

HUGHES PRODUCTS

© 1959, HUGHES AIRCRAFT COMPANY

Creating a new world with ELECTRONICS

SEMICONDUCTOR DEVICES • STORAGE TUBES AND DEVICES • MICROWAVE TUBES • VACUUM TUBES AND COMPONENTS • CRYSTAL FILTERS • MEMO-SCOPE® OSCILLOSCOPES • INDUSTRIAL CONTROL SYSTEMS

MEMO

to: *All Time Buyers*
from: *Milt Klein KEWB*

We didn't have time to get up a slick ad... but did you know that KEWB has gone from a big fat 0 to NUMBER TWO in the San Francisco-Oakland market in only 5 Months? Both Oct/Nov Hooper & Oct Pulse give us an average total audience share of 15%



KEWB BERMUDA BUILDING
2150 FRANKLIN • OAKLAND 12, CALIFORNIA
EXbrook 7-2891 Templebar 6-0910
ROBERT M. PURCELL, president
MILTON H. KLEIN, general manager
THE KATZ AGENCY, INC.
National Sales Representatives

A Service of Crowell-Collier
ROBERT M. PURCELL, Director

PERFECT TEST MARKET

Western Network Contains

- 51,000 TV homes
- Drug Sales Index 167
- Food Sales Index 145
- Auto Sales Index 176
- Retail Sales Index 143

(Source: NCS #3; Sales Mgt. 1959)

PERFECT TEST STATION KMSO-TV

MISSOULA, MONTANA

DELIVERS

- Captive Audience in 90% of the area
- Dominates the 10% remainder completely
- Low Cost/1,000 Homes

(Source: FCC Data; ARB '58-'59)

CBS—NBC—ABC



WREX-TV's officers • Officers elected by the directors of Greater Rockford Television Inc. (WREX-TV Rockford, Ill.) include (l to r) LOU CASTER, president; SWAN HILLMAN, treasurer; STANLEY H. GUYER, secretary and JOE M. BAISCH, vice president. Mr. Baisch, elected for his first term as a corporation officer, was also re-appointed general manager of WREX-TV. Messrs. Caster, Hillman and Guyer, stockholders in the station, were re-elected for their eighth consecutive terms. Mr. Caster is board chairman of American Bakers' Assn. and president of Rockford Colonial Baking Co. and KOCO-TV Enid-Oklahoma City. Mr. Hillman is president and general manager of Rockford Screw Products Co., and Mr. Guyer is a Rockford attorney.

house Broadcasting Corp.'s Washington news bureau, freedom of information; DICK JOHN, WKY-TV Oklahoma City, ethics and standards; DON F. JOHNSON, CHML Hamilton, Ont., and WALT BODINE, WDAF-AM-TV Kansas City, membership; CHARLES EDWARDS, Broadcast News Ltd., Toronto, publicity; DAN WOZNIAK, Michigan State U., career recruiting; ART SMITH, WHTN-TV Huntington, W.Va., convention sites; BOB FRANK, WOC Davenport, Iowa, wire policy; LEO WILMETTE, WLOS-AM-TV Asheville, N.C., techniques; JIM BENNETT, KLZ-AM-TV Denver, vocational film; HAROLD BAKER, WFGA-TV Jacksonville, Fla., constitution; TED KOOP, CBS Washington, protocol, and WALT WILCOX, Tulane U., research (surveys).

• DIXON L. HARPER, radio farm director of Aubrey, Finlay, Marley & Hodgson, Chicago, received National Assn. of Tv & Radio Farm Director's award for contributions toward promotion of farm broadcasting. JOE KELLY, WHDH-TV Boston, honored by American Farm Bureau Federation annual award for best job in communicating agricultural story to public; GEORGE MENARD, WBBM Chicago, given runner-up award. Presentations were during NATRFD annual convention in Chicago (BROADCASTING, Dec. 7).

• BILL (TURK) THOMPSON appointed program director and operations head of KWOW Pomona, Calif. He also continues as pr director and air personality.

• JOSEPH M. SEIFERTH, acting promo-

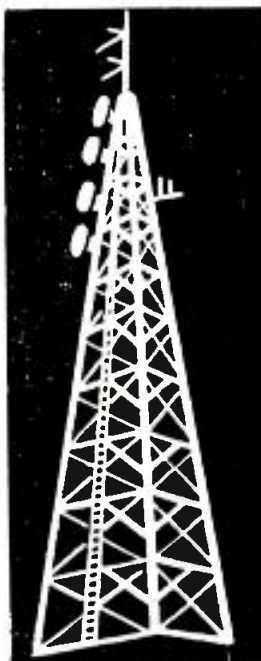

America's Leading Business Brokers

Interested in buying or selling Radio and TV Properties?

When your business is transacted through the David Jaret Corp., you are assured of reliability and expert service backed by over 36 years of reputable brokerage.

150 MONTAGUE STREET
BROOKLYN 1, N. Y.
ULster 2-5600

DAVID
JARET
CORP.

another Presto precision recording tool
to make your job easier.

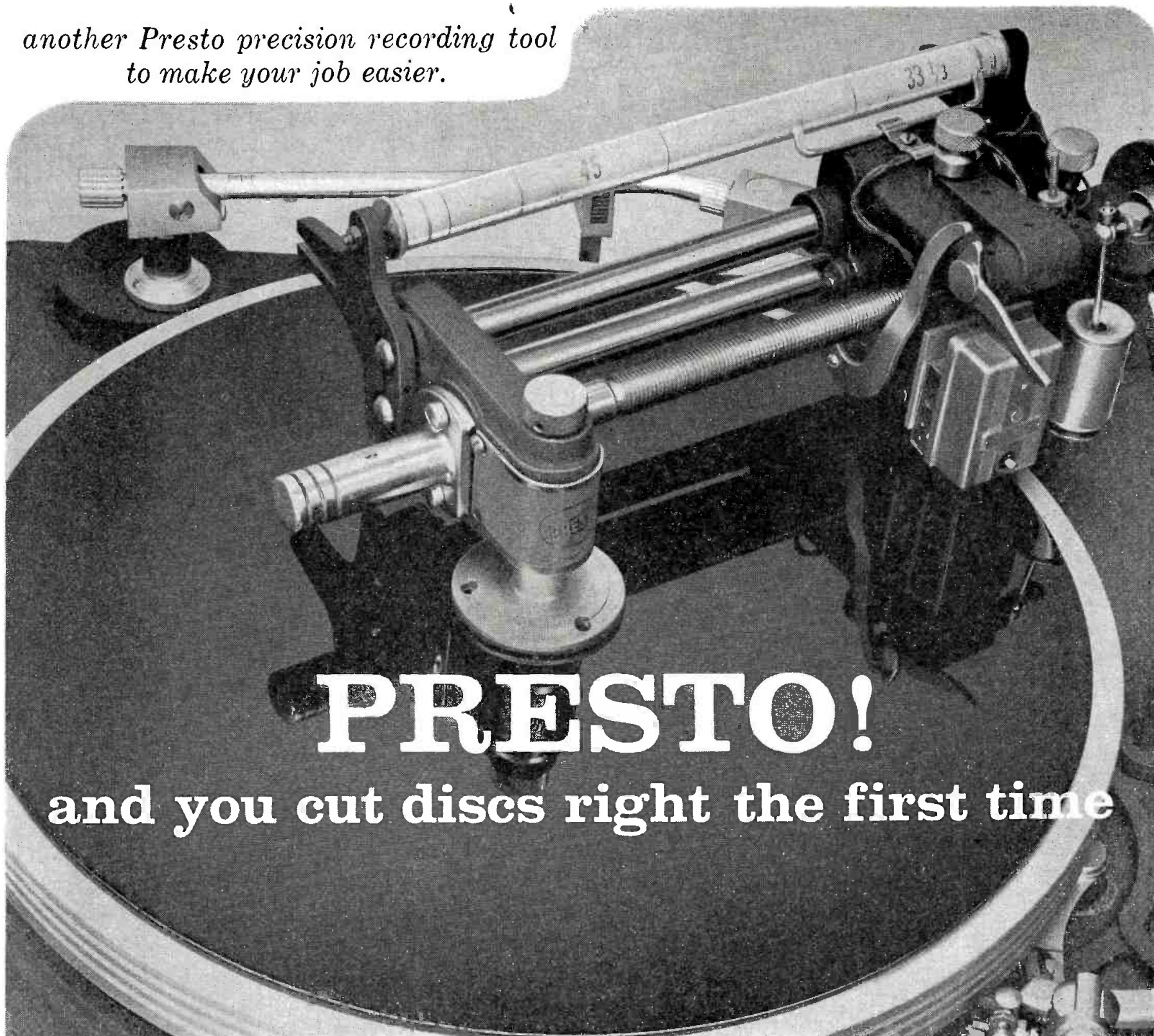

PRESTO!
and you cut discs right the first time

It may take two to tango, but it takes *three* to "take" that tango *properly* on a disc: Presto's 6-N Recorder, A-93 Amplifier and 1-D or S-1 System. Presto's use-proved recording instruments stand up under hard, daily service. And will for years to come. For proof, just ask anyone who's ever used a Presto (there are thousands of Presto units in use everywhere).

6-N 3-SPEED DISC RECORDER. 33½, 45 or 78 rpm. Ideal for work under all conditions—monophonic or stereo (with the new S-1 head). Stations and studios have found the 6-N to be the mechanism for instantaneous work (masters, too), delayed and local program recording.

A-93 DISC RECORDING AMPLIFIER. This power amplifier will last for...well, we've never heard of one that has been retired. Features: push-button control provides choice of equalization curves; provision for Presto radius equalizer Model 161A to compensate for changing diameter of disc; 30-watt output assures ample reserve for recording; meter monitors recording level and checks output tube currents.

1-D RECORDING HEAD. The best known recording head in the industry, more are in use today than all others *combined!* As long as there's monophonic recording, the 1-D will never

become obsolete. And if you send it in for reconditioning every few years or so, we'll *keep* it Presto-perfect. (Nominal charge.)

S-1 STEREO SYSTEM (45°-45° feedback cutting head and two 100-watt amplifiers). Stable from 30 to 20,000 c, without peaks, dips or break-up on high-frequency end. Costs *half* as much as comparable systems. An entirely new Presto-designed feedback-coupling technique permits recording at previously unattainable levels. Distortion is virtually unmeasurable and a unique suspension system provides superior cross-talk characteristics. "Studio-oriented" design permits quick change of stylus. The S-1 head fits all Presto disc-recording lathes (all others as well).

S-1 Cutting Head

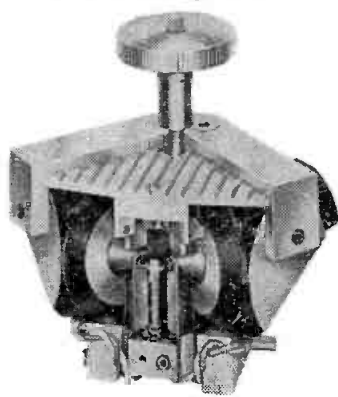

A-93 Disc
Recording Amplifier

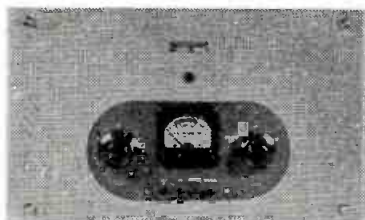

 **BOGEN-PRESTO**, Dept. B-129, Paramus, N. J.
 A Division of The Siegler Corporation.
 Rush data to me on the 6N, A-93, 1-D and S-1.
 Name _____
 Address _____
 City _____ Zone _____ State _____
PRESTO



**There is no comparison!
The fact is:**

WRVA-RADIO, Virginia's Largest Single Advertising Medium* Reaches More People At Less Cost Than Any Other Media In Virginia.

*** WRVA-RADIO'S Coverage of Virginia Includes:**

Retail Sales	54.2%
Food	49.2%
Automotive Sales	52.5%
Gasoline	54.5%
Drug	47.5%

WRVA-RADIO
RICHMOND, VIRGINIA

REPRESENTED BY
PETERS, GRIFFIN,
WOODWARD, INC.

CHECK and DOUBLE CHECK

✓ WTHI-TV offers the lowest cost per thousand of all Indiana TV stations!

✓

One hundred and eleven national and regional spot advertisers know that the Terre Haute market is not covered effectively by outside TV

WTHI-TV
CHANNEL 10 • CBS-ABC
TERRE HAUTE INDIANA
Represented Nationally by Bolling Co.

tion director of WDSU-TV New Orleans, appointed director of promotion and publicity.

• JOHN RUTLEDGE, president of WHOO Orlando, Fla., appointed chairman of Florida State Industrial Advisory Committee. He will be in charge of Broadcast Defense Network for Florida.

• EDWARD P. ANTOSYN promoted from engineering staff to chief engineer of KREM-AM-FM-TV Spokane, Wash., succeeding HOMER MEAD who resigned.

• ROBERT OSTIGUY joins sales staff of WSUN St. Petersburg, Fla.

• JAMES S. GESSNER, formerly time-buyer with J. Walter Thompson, N.Y., to radio sales staff of The Branham Co., that city.

• JACK HERBERT, formerly assistant pr manager for *McCall's Magazine*, to radio sales staff of H-R Representatives, N.Y.

• ROY McMILLAN named day news coordinator for WSB Atlanta. JACK SCOTT, formerly announcer with KFAB Omaha, to similar post with WSB. JIM AXEL, formerly with WCHK Canton, Ga., appointed night news editor for WSB.

• PAUL F. KAGAN, former air personality and sports director of WBRX radio, Berwick, Pa., appointed sports editor of *Endicott (N.Y.) Daily Bulletin*. He will also be in charge of sports affairs for WENE, that city.

• WILLIAM A. MARBURG joins New York office of Paul H. Chapman Co., media broker, as account executive.

• JAMES F. CHRISTIE, formerly district sales manager for Van Norman Machine Div., Detroit, joins sales staff of WXYZ, that city.

• JOE LAUGHLIN appointed assistant director of news and public affairs for WTVT (TV) Tampa, Fla., Previously he served as news director of WLAC-TV Nashville, Tenn.

• HERMAN LEVIN, formerly head of own food brokerage concern, and prior to that, division manager for Colgate Palmolive Co., to sales staff of WITH Baltimore.

• DAVE MACFEE, formerly air personality with WFGN Fitchburg, Mass., to WHIM Providence in similar capacity, succeeding KEN GARLAND, who joins WADO New York.

• JERRY DEXTER, air personality, transfers from KVI Seattle to KMPC Los Angeles. Both are Golden West Broadcasters stations.

• LEE MURRAY, women's director of WJRT (TV) Flint, Mich., to WJR Detroit in similar capacity. Mrs. Murray will also be hostess of two daily shows.

• BOB LEWIS, formerly air personality with WSET Glens Falls, to WIRY Plattsburgh, both New York, as air personality and newscaster.

• SHELDON A. SALTMAN, formerly director of advertising and sales promotion for Pilgrim Plastic Products, Boston, to WBZ-TV, that city, in advertising and sales promotion department.

• DON ADAMS, formerly announcer with KTIV (TV) Sioux City, to WOI-TV Des Moines, both Iowa, in similar capacity.

• BOB WELLS, formerly with KOCY and KWTW (TV) Oklahoma City, to WDAF-AM-TV Kansas City as air personality.

• PAUL ENGER, formerly with United Press International, to WCBS New York as news writer.

• JAY REYNOLDS, formerly with WGGH Marion, Iowa, to KIOA Des Moines as air personality.

• KEN WHITMORE, formerly news director and air personality with WLYN Lynn, Mass., joins WCSH Portland, Me., as announcer.

• MRS. DORIS ROYLE appointed copy

United Press International news produces!



One frame from WFAA-TV's film, "Disaster Dallas," shot entirely on Du Pont 931.

"Shooting fast, in the worst conditions,

WE CAN COUNT ON 931"

That's what Chief News Cameraman Marion Carlton, of Station WFAA-TV, Dallas, Texas, told us. "Du Pont Type 931 Rapid Reversal Film is the standard load in our cameras," says Mr. Carlton. "With 931, we know we can get usable TV footage indoors or out, in any light, without having to change film."

Mr. Carlton specially praises the wide latitude of Du Pont 931. "When we shot 'Disaster Dallas,' a news documentary of the tornadoes that hit Dallas in 1957," he explains, "we were out shooting during the worst of the storms. We didn't have much time to take meter readings—we just had to guess. We had our hands full just

hanging on and getting our shots. But the latitude of 931 helped give us a film that was cited as the outstanding news story of 1957."

Concludes Mr. Carlton: "Considering the high quality of the film and the fast and thoughtful service offered by Du Pont, it just makes good sense for us to continue to shoot most of our footage on Type 931."

Whatever your motion picture needs, you'll find there's a Du Pont film that's just right for you. For more information, get in touch with the nearest Du Pont Sales Office, or write Du Pont, 2432A Nemours Bldg., Wilmington 98, Del. In Canada: Du Pont of Canada Limited, Toronto.



Better Things for Better Living . . . through Chemistry

**WHERE
THERE'S
A FINE
TAPE
RECORDER...**



there's



note to **CONCERTONE** owners

To insure optimum recording quality with your excellent machine, the recommended tape is **irish** #211... and for uninterrupted recording, **irish** #602 gives 50% more playing time than standard tape on any given reel size.

Send for technical bulletin.

ORR INDUSTRIES INC.

Opelika, Alabama

CALIFORNIA—Very profitable well equipped 5 kw full-time station serving good income, growing area. \$315,000.00 total price includes valuable land and guaranteed receivables. \$115,000.00 down and balance on five year payout.

WEST TEXAS MAJOR MARKET—This is a 1000-watt daytimer with a price tag of \$115,000.00 with \$15,000.00 down and extremely liberal terms on the balance. It is in a major West Texas, fast growth market and capable of doubling the billings. It is now breaking even and has been on the air only a short time.

HAMILTON-LANDIS & ASSOCIATES, Inc.

BROKERS • RADIO AND TELEVISION STATIONS • NEWSPAPERS

WASHINGTON, D. C.	CHICAGO	DALLAS	SAN FRANCISCO
Ray V. Hamilton	Richard A. Shaheen	DeWitt 'Judge' Landis	John F. Hardesty
1737 DeSales St. N.W.	1714 Tribune Tower	1511 Bryan Street	111 Sutter Street
EXecutive 3-3456	DElaware 7-2754	RIverside 8-1175	EXbrook 2-5671

NATIONWIDE • NEGOTIATIONS • FINANCING • APPRAISALS

writer for WWLP (TV) Springfield, Mass. Formerly she held similar position with WHYN-AM-FM-TV, that city.

• DAN HYDRICK, general manager of WGH-AM-FM Newport News, Va. married STEVIE RICK in November.

Programming

• CHARLES W. GOIT, who joined Independent Television Corp., N.Y., last year in sales capacity, named director of national sales. Prior to his affiliation with ITC, Mr. Goit had been sales executive with



MR. GOIT

Ziv Television, Television Programs of America and *Look* magazine.

• PATRICK MURPHY appointed director of sales for Premier Film & Recording Corp., St. Louis. He was previously vp of Roland Reed Productions, Hollywood, and Pictures Inc., Detroit.

• JAMES MACRAE, previously vp of Grant Adv., Bogota, Colombia, and market analyst for Bell & Howell Co., Chicago, appointed creative marketing director for Wilding Inc., motion picture producer, that city.

• JOHN P. ROHRS, formerly sales manager of Walter Schwimmer Co., Chicago, to United Artists Television, that city, as central division manager. JOHN R. ALLEN named Chicago sales manager.

• PAUL HUME, music critic of *Washington Post & Times Herald*, signed for series of programs with WGMS-AM-FM Washington.

• PETE BASTIANSEN appointed creative director of story department of Animation Inc., tv commercial firm. He succeeds BOB CURTIS who resigned. Mr. Bastiansen previously was with art department of Campbell-Mithun, Minneapolis.

• ARTHUR FREED, MGM producer and songwriter, named to produce 32nd annual Academy Awards Presentation show (NBC-TV and Radio, April 4). He also produced 1952 show.

Equipment & Eng'ring

• THOMAS C. DEANE, retired vp of Bank of America, appointed to board of directors of Packard Bell Electronics, L.A.

• ROSS D. SIRAGUSA JR. promoted from tv sales manager to vp in charge of electronics division of Admiral Corp., Chicago. HARRIS HESKETH, formerly executive assistant to sales vp, appointed

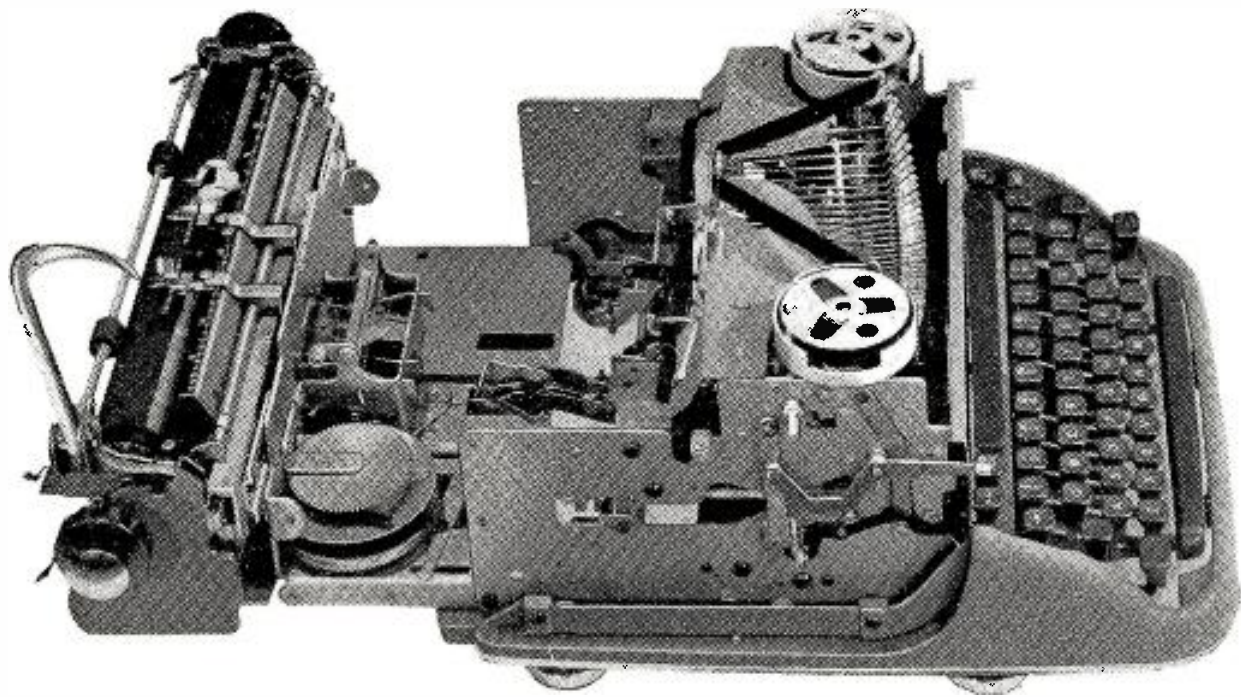

This is the **Remington Standard**[®] typewriter with **Fold-A-Matic** construction * It can be opened—to expose all operating parts—and closed like a book in less than three minutes * Because of **Fold-A-Matic** construction, the **Remington Standard** typewriter will never lose its accurate alignment and light, responsive touch * This jewel-like precision construction is found on no other manual typewriter * Call your local Remington Rand office for a demonstration.



Remington Rand DIVISION OF SPERRY RAND CORPORATION

Reduced



Miniaturized by the exigencies of rateholding, Mr. WSLSTV took it all with good grace. He said: "My model fee's the same no matter what size picture you use."

So's our market: 448,001 tv homes in our 58-county coverage area.

WSLS-TV • Channel 10 • NBC Television • Mail Address: Roanoke, Va. National Representatives: Blair Television Associates

Leadership

WSYR Delivers 85% More Radio Homes Than The No. 2 Station

In an area embracing 18 counties, 402,670 homes, 1.5 million people with a \$2.5 billion buying-power . . .

WSYR DELIVERS MORE HOMES THAN THE NEXT TWO STATIONS COMBINED



Top programming: Top facilities
Top personalities make the difference.

*All figures NCS No. 2, weekly coverage



Represented Nationally by
THE HENRY I. CRISTAL CO., INC.
NEW YORK • BOSTON • CHICAGO
DETROIT • SAN FRANCISCO



vp for company's branch distributing division. Both are newly-created positions.

- **RAYMOND G. JOHNSON**, controller and assistant treasurer of General Precision Labs, Pleasantville, N.Y., elected vp.

- **PHILIP J. KOEN** appointed director of planning for Hoffman Electronics Corp. Formerly he was management consultant with McKinsey & Co., L.A.

- **WILLIAM L. WRAY**, district manager-distributor sales, for Sylvania Electronic Tubes (division of Sylvania Electric Products) in Burlingame, Calif., named distributor sales manager for Southern California district, Los Angeles headquarters.

- **FRANK A. COMERCI**, formerly in charge of communications and acoustics section at New York naval shipyard in Brooklyn, to Audio Devices Inc., as senior project engineer at firm's Stamford, Conn., lab.

- **RUDOLPH J. NAPOLITAN**, formerly general sales manager of ARF Products Inc. and assistant general sales manager of Permoflux Corp., appointed general manager of National Electronics Conference, international forum held annually in Chicago.

- **WILLIAM ROBINSON** appointed chief engineer of paper and film capacitors, filters and pulse networks of Cornell-Dubilier Electric Corp., with headquarters at New Bedford, Mass.

- **MALCOLM O. CAMPBELL** named chief of Raytheon's new receiving tube parts and sub-assembly facility in Pawcatuck, Conn. He held similar post at Raytheon's Newton, Mass. plant.

- **WARREN DALBKE** promoted to mid-west regional manager, equipment sales of CBS Electronics. Previously he served as district manager.

- **E. P. (TED) ATCHERLEY** appointed Pacific region distributor sales manager for Sylvania Electronic Tubes effective Jan. 1, succeeding **WILLIAM G. (PAT) PATTERSON** who retires on that date. Mr. Patterson, with Sylvania since 1934, remains as consultant.

Government

- **CHARLES E. GRANDEY**, FTC director of bureau of consultation, to assistant general counsel for voluntary compliance. He joined FTC in 1935, was named assistant chief examiner in 1946, acting chief, bureau of anti-deceptive practices, Division of Investigation, in 1951, and was named consultation bureau director in 1954.

International

- **DOUGLAS SAUNDERS**, chairman of London office of J. Walter Thompson, will retire at year's end. He will be succeeded by **WILLIAM HINKLE**, London managing director for many years. **THOMAS SUTTON**, of JWT's Frankfurt office, will become managing director of what is described as Great Britain's largest agency.

- **DOUGLAS ANNETT**, Toronto investment dealer, named president of Trans-Video Productions Ltd., Toronto, with **GUY HERBERT**, retired vp of All-Canada Radio & Television Ltd., that city, named managing director. **JOE DUNKELMAN**, former president of Trans-Video Productions, joins Canadian Film Industries Ltd., Toronto.

- **DONALD HYDE**, previously executive with Gross-Krasne, Ltd., British subsidiary of Gross-Krasne Inc., opens own independent production organization in London.

- **MURRAY T. BROWN**, general manager of CFPL-AM-FM-TV London, Ont., to director of London Free Press Printing Co. stations' owner.

- **CHARLES E. S. CURMI**, formerly of *Quebec Le Soleil* newspaper advertising staff, Toronto, to sales staff of Interprovincial Broadcast Sales Ltd., that city.

- **FRANK C. MURRAY**, formerly of Stovin-Byles Ltd., Toronto, Ont., station representative firm, appointed manager of CJBQ Belleville, Ont. **J. H. MACDONALD** named assistant manager and advertising director of CJBQ.

- **MARILYN STONEHOUSE** named director of sales services of Robert Lawrence Productions (Canada) Ltd., Toronto.

- **JOHN FUNSTON**, formerly manager of CHNS Halifax, N.S., named assistant manager of CFCF Montreal.

Deaths

- **WALTER COMPTON**, 47, MBS Washington commentator, died Dec. 10 after long illness. He was originator and moderator of *Double or Nothing* quiz

HARVEY HAS AMPEX

Equipment and Parts
For Immediate Delivery



show in 1939; MBS commentator 1941-45; general manager of WAAM (TV) Baltimore (now WJZ-TV) 1946-47, and WTTG (TV) Washington 1947-53; consultant until 1957 when he rejoined MBS Washington news staff.

- BURL C. HAGADONE, 49, publisher of Coeur d'Alene (Idaho) Press, died Dec. 8 in that city following prolonged illness. Mr. Hagadone had been president of KNEW Spokane, Wash., and KVNI Coeur d'Alene and president and general manager of KJRL Pocatello, Idaho. He had disposed of his broadcast holdings by 1957.



MISS SCANLAN

- GERTRUDE SCANLAN, broadcast media liaison executive for 15 of BBDO's regional offices, died Dec. 6 at her Ridgefield Park, N.J., home. She joined BBDO in 1929 as head of stenographic department, became office manager eight years later, and head of radio talent in 1938. In 1941, Miss Scanlan began her long association with broadcast buying by being appointed manager of timebuying department. In 1943, her duties were changed to account executive and timebuyer, and this year she was named to liaison post.

• C. DAVIS TURNER, 57, president of The Chipola Corp. which operates WTOT Marianna, Fla., died following heart attack Dec. 2 in Marianna.

- MRS. JAMES P. DEEGAN, 65, president of WJPD Ishpeming, Mich., died Dec. 5 following long illness. She became president of station in 1954 upon death of her husband, station founder.

- ADELBERT ARTHUR MURPHY, 75, owner of CFQC-AM-TV Saskatoon, Sask., pioneer Canadian broadcaster, died following heart attack Dec. 2 at Saskatoon. Founder of CFQC in 1929 and CFQC-TV in 1954, he was past president of Western Assn. of Broadcasters and former vp of Canadian Assn. of Broadcasters.

- COL. WALTER P. BURN, U.S. Army, ret., 65, died of heart ailment in Middlebury, Vt., Dec. 4. He founded Walter P. Burn & Assoc., N.Y., in 1936, media research and promotion firm.

- JOHN ROBINSON BINNS, 75, honorary chairman of Hazeltine Corp., electronics research and engineering company, Little Neck, L.I., died last week in New York. He joined Hazeltine at its formation in 1924, was named treasurer in 1926 and director following year. Mr. Binns was elected chairman in 1952, and post of honorary chairman was created for him in 1957.

• JOHN ROBINSON BINNS, 75, honorary chairman of Hazeltine Corp., electronics research and engineering company, Little Neck, L.I., died last week in New York. He joined Hazeltine at its formation in 1924, was named treasurer in 1926 and director following year. Mr. Binns was elected chairman in 1952, and post of honorary chairman was created for him in 1957.



THE STANDARD THAT SAVES DOLLARS

Since its introduction, the Ampex 351 Series has been acknowledged as the *standard of excellence* in professional recorders for the broadcast industry. Broadcasters—and other users with highly critical recording requirements, such as recording studios and educational institutions—will find that the purchase of an Ampex 351 is further justified by these important facts:

The recognized precision and engineering skill which go into each Ampex 351 *guarantees* unsurpassed durability and reliability for a long, dependable life. As a result... *on a cost-per-operating-hour basis, Ampex is the most economical of any recorder made.*

PERFORMANCE SPECIFICATIONS

Note: As professional equipment, the Ampex 351 specifications listed are accurate measurements required by NAB standards and do not incorporate any exaggerated sales claims. These are the guaranteed minimum performance specifications the customer can expect in long-range operation.

Frequency Response:	15 ips ± 2 db 30 to 15,000 cps 7½ ips ± 4 db 30 to 15,000 cps ± 2 db 40 to 10,000 cps
Flutter and Wow:	15 ips—well below 0.15% RMS 7½ ips—well below 0.2% RMS
Timing Accuracy:	Within $\pm 0.2\%$ (± 3.6 sec. in a 30 min. recording)
Starting Time:	Full speed in less than 1/10 sec.
Stopping Time:	At 15 ips, tape moves less than 2" after pressing "Stop" button.
Models:	Half track, full track, 2 track stereo (separate erase to each track). Console, portable and rack mount.



FULL REMOTE CONTROL

The Ampex 351 Series can be operated in the relay-solenoid tape motion control unit for Start, Stop, Fast Forward, Rewind and Record modes from any remote location.

There are 185 Ampex dealers to serve you. Check the Recording Equipment listing in the yellow pages of metropolitan area directories, or write Dept. 304 for the name of your nearest dealer.

934 CHARTER STREET • REDWOOD CITY, CALIFORNIA
Offices and representatives in principal cities throughout the world.

AMPEX
CORPORATION
professional
products division



**RELIGIOUS
PUBLIC SERVICE
PROGRAMMING
FREE**

For Radio and TV Stations

Two 13-week, 15-minute series on "The Ten Commandments" and "The Lord's Prayer" . . . A public service for Radio and TV stations . . . Non-Denominational . . . Without emotional appeals and commercialism for the mature spiritual and cultural needs of all communities.



Write for Audition Print or Tape
THE BACK TO GOD HOUR
10858 S. Michigan Ave., Chicago 28, Ill.

HOWARD E. STARK

Brokers and Financial
Consultants

Television Stations
Radio Stations

50 East 58th Street
New York 22, N.Y. ELdorado 5-0405



**ADVERTISING IN
BUSINESS PAPERS
MEANS BUSINESS**

In the Radio-TV Publishing Field
only BROADCASTING is a
member of Audit Bureau of
Circulations and Associated
Business Publications

KABC-TV's toy campaign



More than 10,000 toys, filling seven six-ton trucks, were contributed to the Marine Corps Reserve "Toys for Tots" Christmastime campaign by more than 10,000 children and escorts who filled the Los Angeles Sports Arena Nov. 28 for an afternoon of fun presented by KABC-TV Los Angeles. The station picked up the tab for all expenses, including \$3,000 for Arena rental, plus performers' fees and other incidentals. Each child and each accompanying adult paid the admission price of a toy to get into the Arena to watch "Chucko's Christmas Show for Toys for Tots," with KABC-TV's "Chucko, the Clown," as ringmaster, master of ceremonies and one responsible for getting 34 separate acts on and off on schedule. Picture shows Chucko leaping with joy over the avalanche of toys filling the cartons and trucks, with a full platoon of Marines required to handle them. Event was described as the biggest in the 11 years of the Marine collection of toys for distribution to underprivileged children.

NBC promotion winners

The top five winners in the second annual NBC Promotion Managers Contest for affiliates' promotion of NBC-TV's fall evening schedule have been awarded an eight-day, expense-paid trip to Hollywood (Jan. 9-16), where they will meet stars of NBC-TV shows, watch rehearsals, filming and taping and learn details of network production, planning and programming. Trip winners are: Caley Augustine, WIIC-TV Pittsburgh; Jim Knight, WTRF-TV Wheeling, W. Va.; Charles Cash, WSM-TV Nashville, Tenn.; Henry F. Hines, WBAL-TV Baltimore, and Edna L. Seaman, WFBC-TV Greenville, S. C.

Other winners and their prizes:

John Hurlbut, WFBM-TV Indianapolis, RCA Victor color tv set; Kirt Harris, KPRC-TV Houston, hi-fi set;

Walter Purcell, WNDU-TV South Bend, Ind., tape recorder; Calo Mahlock, WKJG-TV Fort Wayne, Ind., RCA Sportable tv set; Mike Schaffer, WAVY-TV Norfolk, Va., RCA Sportable, and Arthur Garland, WRGB-TV Schenectady, N.Y., RCA Sportable.

South Florida campaigns

All last week timebuyers (total of about 400 by week's end) enjoyed the incongruous presence of a blustery early New York winter and a film about "Sun, Surf and Sales" in Miami. The film was presented by WTVJ (TV) Miami at the offices of its station representative (Peters, Griffin, Woodward). The study was of tv viewing habits of tourists in southern Florida. Along with scenes of sunbathers at beach and pool, timebuyers were fed fresh Florida orange juice, hot coffee and such data

as 66% of south Florida's estimated 5 million viewers watch tv while visiting there, about 66,500 tv sets are available to tourists alone and other marketing and station statistics along with a note that on the average the sun shines 359 days a year in south Florida.

Legal eagles

An experiment in legal education by radio has been started by KEX Portland, Ore., and the Multnomah Bar Assn.

Goal of the program, *You and the Law*, is "to make more people familiar with their basic legal rights; to acquaint them with general principles of the law, and to help them identify certain problems for what they are," according to Phillip J. Roth, president of the bar association.

Each week three lawyers, from among 80 volunteers, will answer listener's telephone questions. The panel of attorneys will then offer their opinions, without any advance preparation or rehearsal.

• Drumbeats

Brr-rr! • Bob Lake, news director of KOLO-TV Reno, and Bob Carroll, personality with that station, spent the frigid weekend of Nov. 20-22 on Donner Summit, clocking the number of vehicles passing there over a 52-hour period. The station was sponsoring a contest to see which listener could estimate most nearly the number; the contest was designed to prove that Reno attracted a spate of tourists even during non-holiday season. Guesses ranged from under 1,000 to hundreds of thousands. Messrs. Carroll and Lake reported through chattering teeth that the answer was 12,510, and the earliest postmarked of nine answers of 12,500 took the \$100 prize.

Timely arrival • Timothy Paul Jameson was born in Omaha the 10th day of the 11th month at 11:10 p.m. That was winning time in KFAB Omaha's annual 1110 Baby Contest. Master Jameson was presented with a check for one year's tuition at the college of his choice. The baby who placed time-wise was awarded a photograph album by the station. KFAB inaugurated the contest three years ago to publicize its 1110 frequency. The first year, the youngster of a rival station's engineer arrived at the fateful hour.

Jazz hit • A 45-rpm record now aired on Cleveland radio stations and available in area juke boxes cannot be purchased at any record store. "Everything

"FOTO-VIDEO—NOW THE BEST VIDEO MONITOR IN THE INDUSTRY," says

one of the Nation's electronic leaders about the completely new modularized Foto-Video product pictured below.

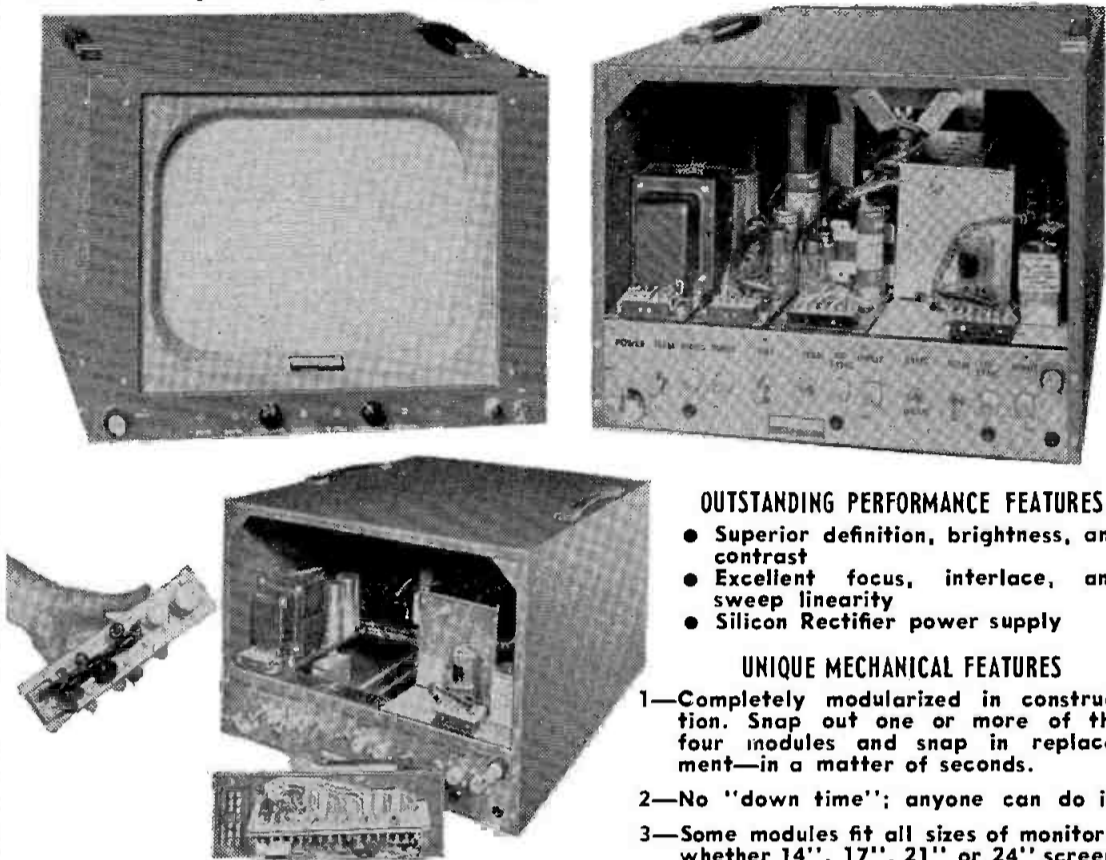

OUTSTANDING PERFORMANCE FEATURES

- Superior definition, brightness, and contrast
- Excellent focus, interlace, and sweep linearity
- Silicon Rectifier power supply

UNIQUE MECHANICAL FEATURES

- 1—Completely modularized in construction. Snap out one or more of the four modules and snap in replacement—in a matter of seconds.
- 2—No "down time"; anyone can do it.
- 3—Some modules fit all sizes of monitors, whether 14", 17", 21" or 24" screen.

Write or phone for complete details

FOTO-VIDEO®

LABORATORIES, INC.

ELECTRONICS • ENGINEERING AND MANUFACTURING

36 Commerce Road • Cedar Grove, N. J. • CEnter 9-6100

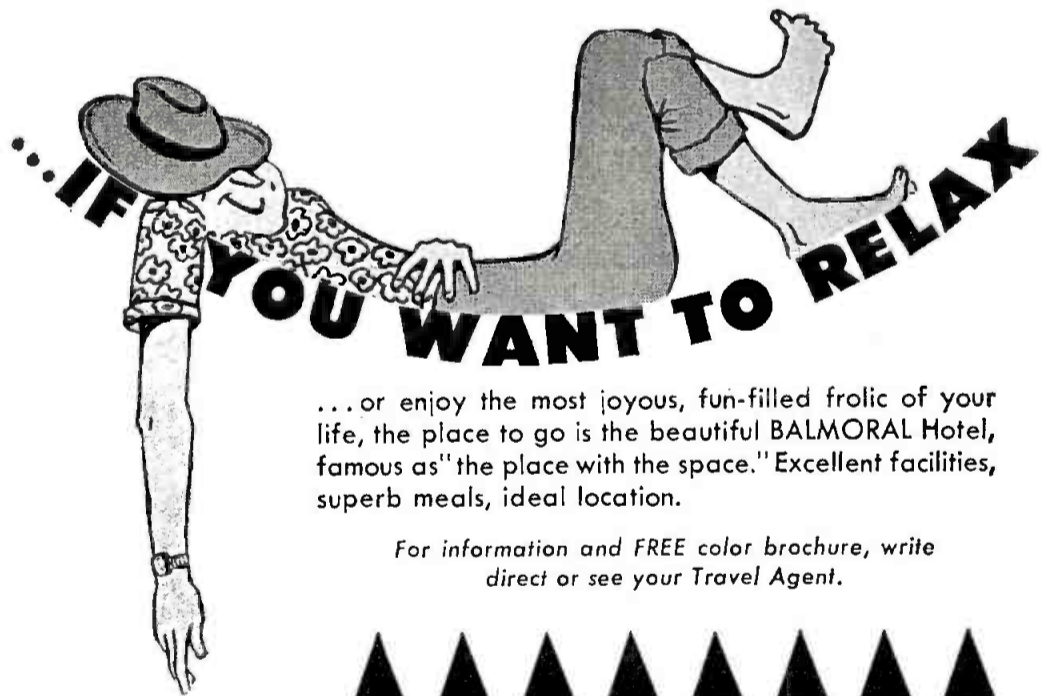

...or enjoy the most joyous, fun-filled frolic of your life, the place to go is the beautiful BALMORAL Hotel, famous as "the place with the space." Excellent facilities, superb meals, ideal location.

For information and FREE color brochure, write direct or see your Travel Agent.

Herbert Katz
Executive Director

Sherman Winn
Manager

BALMORAL

HOTEL • POOL
CABANA CLUB



SIX ACRES ON THE OCEAN
AT 98th STREET, BAL HARBOUR, MIAMI BEACH, FLA.

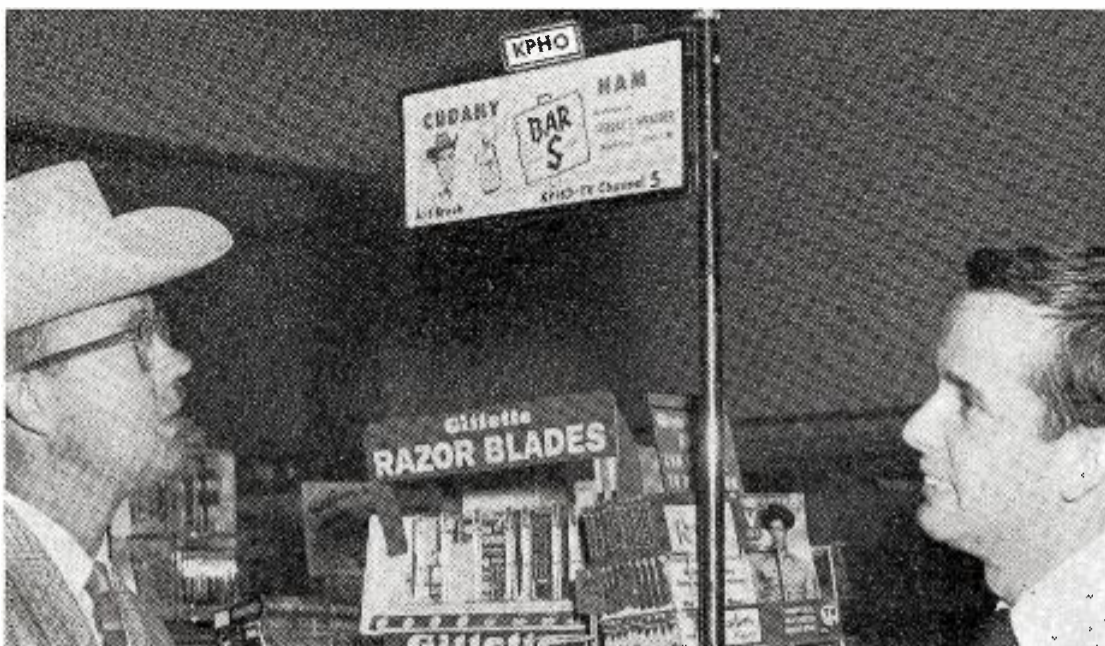

Check-out • Looking over the "Checkerlite" installation in a Phoenix supermarket are Ralph Blake (l.), sales manager of Cudahy Packing Co. in that city, and Steve Shannon, sales manager of KPHO-TV Phoenix. The station is said to be the first broadcasting outlet to use "Checkerlite" (an illuminated point-of-sales display) as a major merchandising service. KPHO-TV currently has 72 lights installed in nine different supermarkets and retains cards of a station sponsor in each location for 15 days (at no charge to the advertiser). KPHO-TV is negotiating to put additional "Checkerlites" in other markets in various parts of the state.

Goes" (on the Bright label) is a jazz rendition of the radio theme of the Manners Big Boy Restaurants in northern Ohio. It's also the theme song

of a jazz program the restaurant chain sponsors on KYW Cleveland. If there is a public demand for the record, it will be issued commercially.

Voices of Texas • Texas Christian U.'s Horned-Frog Band and the 60 singing cadets of Texas A&M College joined forces in a salute to the 31st year of the Texas state song as a highlight of WBAP-TV Fort Worth's "Color-burst Day." Circumstances have necessitated changing lyrics of the song which refer to the "biggest" state to the "boldest" state; this change was given its first airing on the WBAP-TV half-hour colorcast.

Payola for charity • WWDC Washington observed "Payola Week" and raised money for Variety Club Research Center at Children's Hospital, Washington. Ben Strouse, general manager, said "Listeners paid and we played a record, the listener's check being made out to the research center."

C-P-M • Advertising agencies and clients recently received a check for 73 cents from KOIL Omaha, Neb. The station explained that this is its audience cost per thousand adults.

Collecting Lincoln-heads • Asking for 12-cent contributions may not seem like much, but that's the way KDKA Pittsburgh raises funds for the local Children's Hospital. Last year, with its "Penny-A-Month" campaign, the station collected \$10,400 for the hospital.

FOR THE RECORD

Station Authorizations, Applications

As Compiled by BROADCASTING

December 2 through December 8. Includes data on new stations, changes in existing stations, ownership changes, hearing cases, rules & standards changes and routine roundup.

New Tv Station

APPLICATION

Salem, Ore.—Oregon Faculties Inc., vhf ch. 3 (60-66 mc); ERP 19.6 kw vis., 9.8 kw aur.; ant. height above average terrain 916

ft., above ground 166 ft. Estimated construction cost \$213,842, first year operating cost \$250,000 revenue \$250,000. P.O. address Box 2267, Salem, Ore. Studio location to be determined. Trans. location 7 miles southwest of Salem. Geographic coordinates 44° 51' 17" N. Lat., 123° 07' 08" W. Long. Trans.

Gates BT-5CL, ant. GE TY 50D. Legal counsel Dempsey and Koplovitz, Bowen Bldg., Washington, D.C. Consulting engineer, Grant S. Feikert, Corvallis, Ore. Applicant is Redwood Bcstg. Inc. (a California corp.). Redwood is licensee of KIEM-AM-TV and KRED-FM Eureka, Calif. Redwood also owns 50% of KAGI and KGPO-FM Grants Pass, Ore. (Principal of Redwood Bcstg. Inc. is William B. Smullin 78.6% and others). Ann. Dec. 3.

Existing Tv Stations

CALL LETTERS ASSIGNED

KVER-TV Clovis, N.M.—KICA Inc. Changed from KICA-TV.

ACTIONS BY FCC

KVOA-TV, KOLD-TV both Tucson, Ariz.—Granted applications of (1) KVOA-TV to increase vis. ERP from 5.37 kw to 35 kw, with aur. ERP 12.6 dbk (18 kw), change studio location, change trans. site. to about 18 miles northeast of city atop Mt. Bigelow in Coronado National Forest, change type trans. and ant. and increase ant. height from 30 ft. to 3,680 ft. and (2) KOLD-TV to move trans. to same location as KVOA-TV atop Mt. Bigelow, increase vis. ERP from 30 kw to

EDWIN TORNBURG & COMPANY, INC.

NEGOTIATORS FOR THE PURCHASE AND
SALE OF RADIO AND TELEVISION STATIONS
EVALUATIONS
FINANCIAL ADVISERS

NEW YORK

60 East 42nd Street
Murray Hill 7-4242

WEST COAST

860 Jewell Avenue
Pacific Grove, California
FRontier 2-7475

WASHINGTON

1625 Eye Street, N.W.
District 7-8531

Abbreviations:

DA—directional antenna. cp—construction permit. ERP—effective radiated power. vhf—very high frequency. uhf—ultra high frequency. ant.—antenna. aur.—aural. vis.—visual. kw—kilowatts. w—watts. mc—megacycles. D—day. N—night. LS—local sunset. mod.—modification. trans.—transmitter, unl.—unlimited hours. kc—kilocycles. SCA—subsidiary communications authorization. SSA—special service authorization. STA—special temporary authorization. SH—specified hours. *—educational. Ann. Announced.

18.8 dbk (75.9 kw), with aur. ERP 15.8 dbk (38 kw), install new trans., change type ant. and other equipment, and increase ant. height to 3,750 ft. By letter, denied petition by Tucson Television Inc. (KGUN-TV ch. 9), Tucson, to dismiss applications or designate them for hearing. Ann. Dec. 3.

New Am Stations

APPLICATIONS

Austell, Ga.—Great Southern Bcstg. Co., 1520 kc. 5 kw. D. P.O. address % David E. Fleagle, 2598 Sharondale Dr., NE., Atlanta, Ga. Estimated construction cost \$35,032, first year operating cost \$48,000, revenue \$55,000. Applicants are David E. Fleagle 75% and H.C. Tant 25%. Mr. Fleagle was formerly 50% owner of WDMF Buford, Ga. Mr. Tant is owner of radio tower. Ann. Dec. 3.

Hazlehurst, Ga.—Hazlehurst Radio, 1480 kc. 1 kw. D. P.O. address 1011 N. Ridge St., Tifton, Ga. Estimated construction cost \$13,100, first year operating cost \$38,000, revenue \$45,000. Applicant is William E. Sides who is station manager of WWGS Tifton, Ga. Ann. Dec. 2.

Opelousas, La.—Yam Bcstg. Inc., 1570 kc. 250 kw D. P.O. address Box 553, Ville Platte, La. Estimated construction cost \$13,381, first year operating cost \$20,000, revenue \$30,000. Principals include Robert Thompson 30%, John M. Pitre Jr. 20% and others. Mr. Thompson is doctor. Mr. Pitre Jr. is employe of KVPI Ville Platte. Ann. Dec. 2.

Joplin, Mo.—William B. Neal, 1560 kc. 250 w. D. P.O. address 1621 Main St., Joplin, Mo. Estimated construction cost \$5,500, first year operating cost \$30,000, revenue \$35,000. Applicant is in frozen produce business. Ann. Dec. 2.

Chadbourn, N.C.—William Norman Peal, 1590 kc. 500 w D. P.O. address Chadbourn, N.C. Estimated construction cost \$28,820, first year operating cost \$46,000, revenue \$52,000. Applicant is in furniture and appliance business. Ann. Dec. 2.

Havelock, N.C.—Radio Marine, 1330 kc. 1 kw. D. P.O. address Box 570, Southern Pines, N.C. Estimated construction cost \$9,354, first year operating cost \$28,700, revenue \$32,500. Applicant is Jack S. Younts who is majority owner of WEEB Southern curred. Ann. Dec. 3.

Existing Am Stations

ACTION BY FCC

KIMN Denver, Colo.—Issued order to show cause why am station license should not be revoked for certain program material broadcasts; ordered hearing at time to be later specified. Comr. Bartley concurred. Ann. Dec. 2.

APPLICATIONS

WNOG Naples, Fla.—Cp to change hours of operation to unli., using power of 500 w night and day, change ant.-trans. location install DA-N, operate trans. by remote control daytime and install new trans. (1270 kc). Ann. Dec. 7.

WPBC Minneapolis, Minn.—Cp to increase power to 5 kw, change hours of operation to unli., install DA-1 and new trans., change ant.-trans. location, change studio location and station location to Richfield, Minn. (980 kc). Ann. Dec. 2.

KPRK Livingston, Mont.—Cp to increase daytime power to 1 kw and install new trans. (1340 kc). Ann. Dec. 8.

WLOS-FM Asheville, N.C.—Cp to change frequency from 104.3 mc., ch. 282 to 99.9 mc., ch. 260, change ERP from 9.2 kw to 250 w, increase ant. height above average terrain to 2636 feet and install new trans.. Ann. Dec. 2.

CALL LETTERS ASSIGNED

KBZZ La Junta, Colo.—La Junta Bcstrs. Changed from KBNZ.

KKAN Phillipsburg, Kan.—North Central Bcstg. Inc.

KMIS Portageville, Mo.—New Madrid County Bcstg. Co.

KVER Clovis, N.M.—KICA Inc. Changed from KICA.

WCNF Weldon, N.C.—Twin City Bcstg. Co.

KGGG Forest Grove, Ore.—Triple G. Bcstg. Co. Changed from KRWC.

KAGO Klamath Falls, Ore.—KFJI Bcstrs. Changed from KFJI.

WEEZ Chester, Pa.—WDRF Inc. Changed from WDRF.

WOGA Chattanooga, Tenn.—Middle Georgia Bcstg. Co. Changed from WAGC.

KUKA San Antonio, Tex.—Leal Bcstg. Co. Changed from KEXX.

KSVN Ogden, Utah—KOPP Inc. Changed from KKOG.

KSXX Salt Lake City, Utah—William P. Fuller III.

WEET Richmond, Va.—Radio Richmond Inc. Changed from WLLY.

New Fm Stations

APPLICATIONS

Waukegan, Ill.—Edward C. Fritz Jr., 102.3 mc, 1 kw. P.O. address 2308 S. Highland, Berwyn, Ill. Estimated construction cost \$14,650, first year operating cost \$40,000 revenue \$50,000. Applicant is in record business. Ann. Dec. 8.

***Cincinnati, Ohio**—U. of Cincinnati, 90.9 mc 1.5 kw. P.O. address Cincinnati, Ohio (% Frank T. Purdy, dir. for development). Estimated construction cost \$27,491, first year operating cost \$37,370. Ann. Dec. 7.

Cleveland, Ohio—Taliesin Bcstg. Co., 95.7 mc 2.82 kw. P.O. address 6060 N. Ewing St., Indianapolis, Ind. Estimated construction cost \$10,061, first year operating cost \$22,500, revenue \$27,500. Principal is Mary W. Carpenter who is permittee of WDTM (FM) Detroit, Mich. Ann. Dec. 8.

CALL LETTERS ASSIGNED

WMLS-FM Sylacauga, Ala.—Marble City Bcstg. Inc.

KYEW (FM) Phoenix, Ariz.—Frank S. Barc Jr.

KOY-FM Phoenix, Ariz.—KOY Bcstg. Co.

KUPD-FM Tempe, Ariz.—Tri-State Bcstg. Inc.

WAJP (FM) Joliet, Ill.—Alfred and Mary Jane Pohlrs.

WSAB (FM) Mt. Carmel, Ill.—Albert A. Barnhard.

WQRS-FM Detroit, Mich.—Fine Arts Bcstrs. Inc.

WGYA (FM) Interlochen, Mich.—National Music Camp.

WOW-FM Omaha, Neb.—Meredith WOW Inc.

WFHA-FM Red Bank, N.J.—Frank H. Accorsi.

WRNW (FM) Mt. Kisco, N.Y.—Incorporated Meliphon.

WCUY (FM) Cleveland, Ohio—United Bcstg. Co. Changed from WJMO-FM.

KOGM-FM Tulsa, Okla.—Sound Unlimited Radio Enterprises.

WEEP-FM Pittsburgh, Pa.—Golden Triangle Bcstg. Inc.

KOST (FM) Dallas, Tex.—McClendon Corp.

WIAL-FM Eau Claire, Wis.—Bcstrs. Services Inc. Changed from WEAQ-FM.

Ownership Changes

ACTIONS BY FCC

KGST Fresno, Calif.—Granted assignment of license from Jeanne Bacher to Juan Mercado, consideration \$250,000. Ann. Dec. 3.

KOFY San Mateo, Calif.—Granted transfer of control to Tele-Broadcasters Inc.; consideration \$25,000. H. Scott Kilgore, transferee's principal stockholder, has controlling interests in KUDL Kansas City, Mo., KALI Pasadena, Calif., and WPOP Hartford, Conn. Ann. Dec. 3.

KILAUEA-Kau Community Tv Assn., Naalehu, Hawaii—Granted applications for two new tv translator stations on ch. 70 to serve Naalehu and Volcano Community and on ch. 74 to serve Naalehu and Pahala, both translating programs of KHBC-TV (ch. 9) Hilo. Ann. Dec. 3.

KCLN Clinton, Iowa—Granted transfer of control from Wm. E. Walker, et al., to Russell G. Salter, Robert O. Moran and Stanley B. Noyes; consideration \$95,600 for 80% interest now and \$15,000 for remaining 20% later. Mr. Salter owns WBEL South Beloit, Ill. Ann. Dec. 3.

KGAN Bastrop, La.—Granted assignment of licenses from George H. Goodwin and Willis G. Newcomer to same plus Nathan Bolton and A.R. McCleary, d/b under same name; newcomers to assume equal shares in liabilities of station not to exceed \$7,000 each conditioned that prior to consummation of this assignment, Nathan Bolton and A.R. McCleary dispose of their ownership interests in KTRY Bastrop, La., and that within three months from date of consummation of this assignment, they divest themselves of all their creditor interests in KTRY by assigning without recourse note and mortgage executed by Paul R. Schilling and presently held by them to person or persons who are not in privity with them through family or business relationship. Ann. Dec. 3.

KTRY Bastrop, La.—Granted assignment of licenses from Nathan Bolton and A.R. McCleary to Paul R. Schilling; consideration \$30,000. Ann. Dec. 3.

WBNY Buffalo, N.Y.—Granted assignment of license to WBNY Inc.; consideration

Equipping a Radio Station?

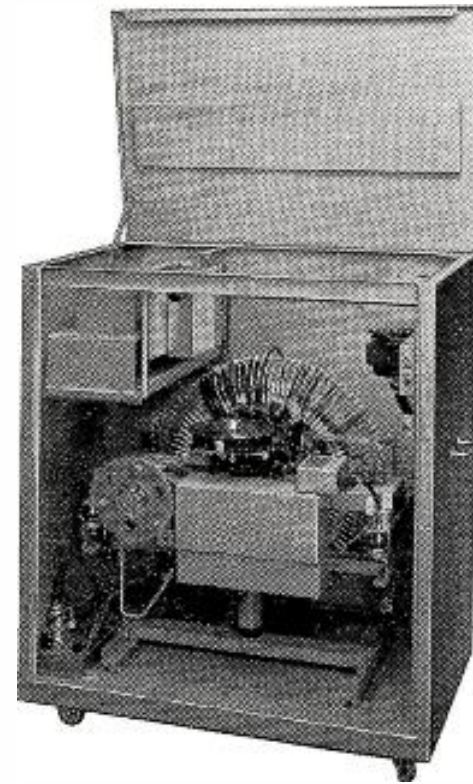

NEW RCA Automatic Turntable BQ-103

Assures Efficient, Simplified Handling of Recorded Program Material

This new automatic turntable offers an easy approach to semi-automated programming using 45 RPM records. All operations, such as selection, cue and playback have been fully automated. Operating "Fluffs" are minimized, and program flow is smoother for the listening audience. The BQ-103 Automatic Turntable is a basic building block for full automation.

For complete information write to RCA, Dept. BB-22, Building 15-1, Camden, N. J. In Canada: RCA VICTOR Company Limited, Montreal.

RADIO CORPORATION of AMERICA



Tmk(s) ®

\$535,000 plus \$75,000 for agreement not to compete for five years within 200 miles of Buffalo. Nathan Straus, assignee board chairman and other officers have interest in WMCA New York. Ann. Dec. 3.

WRRA Ithaca, WRRC Cherry Valley Township, WRRD De Ruyter Township, WRRE South Bristol Township, WRRL Weathersfield Township, all New York—is being advised that application for transfer of control from Cooperative Grange League Federation Exchange Inc. to Ivy Bcstg. Inc., indicates necessity of hearing. Chmn. Doerfer dissented. Ann. Dec. 3.

KVOW Littlefield, Tex.—Granted assignment of license to Grady F. Maples and R.B. McAlister, d/b as Maples-McAlister Bcstg. Co.; consideration \$71,250. Assignee operates KBYG Big Spring, and KUKO Post, both Texas. Comr. Lee dissented. Ann. Dec. 3.

KVIC Victoria, Tex.—Granted acquisition of positive control by J.G. Long by purchasing 10% additional stock for \$9,800 to give him 55.55½% interest. Ann. Dec. 3.

APPLICATIONS

KTEE Carmel, Calif.—Seeks assignment of license from Seaside Electronic Associates to Carmel Bcstg. Inc. for \$150,000. Purchaser is Sam S. Smith who is real estate developer. Ann. Dec. 8.

WTRL Bradenton, Fla.—Seeks assignment of license from Blue Skies Bcstg. Corp. to Fletcher-Mitchell Corp. for \$240,000. Purchasers are Jonathan M. Fletcher and James I. Mitchell, equal partners. Mr. Fletcher is 50% owner of KLIN Lincoln, Neb. as is Mr. Mitchell. Mr. Mitchell also has 16% interest in KPIG Cedar Rapids, Iowa. Ann. Dec. 2.

KCOG Centerville, Iowa—Seeks assignment of license from Centerville Bcstg. Co. to Hope Inc. for \$55,000. Applicants are L.W. Holland and Donald J. Porter 45% each and LeRoy Okerlund 10%. Mr. Holland is doctor. Mr. Porter is lawyer. Mr. Okerlund is former general manager of KIHQ Sioux Falls, S.D. Ann. Dec. 2.

WWTW (TV) Cadillac, Mich.—Seeks transfer of control from Fetzer Television Inc. to Fetzer Bcstg. Co. Merger into parent corporation; no financial considerations or ownership changes involved. Fetzer Bcstg. Co. is licensee of WKZO-AM-TV Kalamazoo and WJEF (FM) Grand Rapids, both Michigan. Ann. Dec. 8.

KATZ St. Louis, Mo.—Seeks assignment of license from Rollins Bcstg. Inc. to Laclede Radio Inc. for \$600,000 plus agreement not to compete for 5 years. Purchasers are Ralph N. Weil, 6.3%, Allen E. Wolin, 11.35% and others. Mr. Weil formerly had interests in WOV New York. Mr. Wolin is food manufacturer's representative. Ann. Dec. 7.

WIL St. Louis, Mo.—Seeks assignment of license from WIL a joint venture, to WIL a joint venture, to include Bon Family Corp. and Nan Family Corp. 2½% each for \$20,000 each. Ann. Dec. 3.

KXLO Lewistown, Mont.—Seeks assignment of license from Marlin T. Obie sole owner to Mr. Obie 51%, LeRoy L. Tappe 29% and David L. Sather 20%, for \$14,700 paid by Messrs. Tappe and Sather to Mr. Obie for their shares. Ann. Dec. 7.

KQAL-FM Omaha, Neb.—Seeks assignment of license of Jack L. Katz Enterprises Inc. from Jack L. Katz 90% and others to Mr. Katz 51%, Bill L. Dunbar 44% and Donald L. Stern 5%. Ann. Dec. 7.

WKAL Rome, N.Y.—Seeks transfer of control of Mid New York Bcstg. Corp. from Paul F. and Margaret E. Harron as tenants

SUMMARY OF COMMERCIAL BROADCASTING

Compiled by BROADCASTING through December 8

	ON AIR		CP	TOTAL APPLICATIONS
	Lic.	Cps.	Not on air	For new stations
AM	3,384	65	75	746
FM	607	62	157	121
TV	466 ¹	57	98	132

OPERATING TELEVISION STATIONS

Compiled by BROADCASTING through December 8

	VHF	UHF	TOTAL
Commercial	446	76	522
Non-commercial	33	10	43

COMMERCIAL STATION BOXSCORE

As reported by FCC through October 31, 1959

	AM	FM	TV
Licensed (all on air)	3,366	605	466 ¹
CPs on air (new stations)	62	51	55 ²
CPs not on air (new stations)	97	159	97
Total authorized stations	3,525	816	669
Applications for new stations (not in hearing)	487	77	59
Applications for new stations (in hearing)	240	28	67
Total applications for new stations	727	105	126
Applications for major changes (not in hearing)	627	28	29
Applications for major changes (in hearing)	167	6	17
Total applications for major changes	794	34	46
Licenses deleted	1	1	1
CPs deleted	0	0	1

¹ There are, in addition, ten tv stations which are no longer on the air, but retain their licenses.

² There are, in addition, 38 tv cp-holders which were on the air at one time but are no longer in operation and one which has not started operation.

by entirety 51.7% to same as tenants 40.89%, with difference being held by Mrs. Harron and by family trust. Ann. Dec. 2.

WKTW (TV) Utica, N.Y.—Seeks transfer of control of Mid New York Bcstg. Corp. from Paul F. and Margaret E. Harron as tenants by entirety 51.71% to same as tenants 40.89%, with difference being held by Mrs. Harron and by family trust. Ann. Dec. 2.

WHPB Belton, N.C.—Seeks transfer of control from Community Bcstg. Co. to Community Bcstg. Corp. Change to corporation. No ownership changes involved. Ann. Dec. 7.

WBBZ Ponca City, Okla.—Seeks involuntary transfer of control of Ponca City Publishing Co. from estate of Clyde E. Muchmore 50% deceased, to Gareth B. and Allan W. Muchmore 25% each, co-executors of estate. Ann. Dec. 3.

WRIB Providence, R.I.—Seeks transfer of control of R.I. Bcstg. Inc. from Harold C. and Ines C. Arcaro and others 20% to Irma Pace 50% and Frank and John Rao 25% each for \$55,000. Ann. Dec. 7.

WABV Abbeville, S.C.—Seeks transfer of control of Abbeville Bcstg. Inc. from J. A. Gallimore 55% and George W. Settles Jr. 45% to Mr. Settles 60% and Ruth Settles 40% for \$42,000. Ann. Dec. 3.

WGNS Murfreesboro, Tenn.—Seeks assignment of license from WGNS Inc. to Re-

gional Bcstg. Corp. for \$100,000. Principal purchaser is William R. Vogel 75.6% and others. Mr. Vogel has interests in KVOL Loveland, Colo. and WMMT McMinnville, Tenn. Ann. Dec. 3.

WMAK Nashville, Tenn.—Seeks assignment of license from Volunteer State Bcstg. Inc. to WCMI Radio Inc. for \$342,500. Purchasers are Frederic Gregg Jr. and Charles H. Wright 40% each and Charles F. King 20%. Mr. Gregg is sole owner of WCMI-AM-FM Ashland, Ky., and minority interest (33⅓%) in WOMP-AM-FM Bellaire, Ohio. Mr. Wright has 33⅓% interest in WOMP-AM-FM, as does Mr. King. Ann. Dec. 2.

KBOX Dallas, Tex.—Seeks assignment of license from KBOX a joint venture, to KBOX a joint venture, to include Elmer Balaban as 5% trustee under Tex Revocable Trust Agreement, for book value of stock. Ann. Dec. 3.

KULE Ephrata, Wash.—Seeks transfer of negative control of Coulee Bcstg. Corp. from John R. Speidel Jr., Donald R. Berry and Lloyd C. Hannah, all 33⅓% each to Messrs. Speidel Jr. and Berry, equal partners for total considerations of \$3,635, of which \$1,596 was paid to Mr. Hannah for his shares. Ann. Dec. 8.

Hearing Cases

INITIAL DECISIONS

Hearing Examiner Isadore A. Honig issued initial decision looking toward granting application of KVOS Inc., to increase daytime power of station KVOS Bellingham, Wash., from 1 kw to 5 kw, continuing operation on 790 kc, 1 kw-N, DA-N, and denying application of Richard L. DeHart for new am station to operate on 800 kc, 250 w-D in Mountlake Terrace, Wash. Ann. Dec. 14.

Hearing Examiner H. Gifford Irion issued initial decision looking toward granting application of Continental Bcstg. Corp. to change facilities of station WHOA San Juan, P.R. from 1400 kc, 250 w. unl. to 870 kc, 5 kw, DA unl. Ann. Dec. 8.

Hearing Examiner Forest L. McClenning issued initial decision looking toward granting application of Radio Americas Corp. to change facilities of WORA Mayaguez, P.R., from 1150 kc, 1 kw, unl. to 760 kc, 5 kw, unl. DA. Ann. Dec. 7.

OTHER ACTIONS

By memorandum opinion and order, Commission denied petition by Fox Valley Bcstg.

Your Ad Headquarters in Chicago

Executive House

71 E. WACKER DRIVE

Chicago's new hotel within walking distance of over 5 Billion Dollars in ad billing

Visit Executive House Dining Room & Cocktail Lounge

PROFESSIONAL CARDS

JANSKY & BAILEY INC.
Executive Offices ME. 8-5411
1735 DeSales St., N. W.
Offices and Laboratories
1339 Wisconsin Ave., N. W.
Washington, D. C. Federal 3-4800
Member AFCCE

JAMES C. McNARY
Consulting Engineer
National Press Bldg.,
Wash. 4, D. C.
Telephone District 7-1205
Member AFCCE

—Established 1926—
PAUL GODLEY CO.
Upper Montclair, N. J.
Pilgrim 6-3000
Laboratories, Great Notch, N. J.
Member AFCCE

GEORGE C DAVIS
CONSULTING ENGINEERS
RADIO & TELEVISION
501-514 Munsey Bldg.
Sterling 3-0111
Washington 4, D. C.
Member AFCCE

Commercial Radio Equip. Co.
Everett L. Dillard, Gen. Mgr.
INTERNATIONAL BLDG. DI. 7-1319
WASHINGTON, D. C.
P. O. BOX 7037 JACKSON 5302
KANSAS CITY, MO.
Member AFCCE

A. D. Ring & Associates
30 Years' Experience in Radio
Engineering
1710 H St., N.W. Republic 7-2347
WASHINGTON 6, D. C.
Member AFCCE

GAUTNEY & JONES
CONSULTING RADIO ENGINEERS
1052 Warner Bldg. National 8-7757
Washington 4, D. C.
Member AFCCE

Lohnes & Culver
Munsey Building District 7-8215
Washington 4, D. C.
Member AFCCE

RUSSELL P. MAY
711 14th St., N. W. Sheraton Bldg.
Washington 5, D.C. REpublic 7-3984
Member AFCCE

L. H. Carr & Associates
Consulting
Radio & Television
Engineers
Washington 6, D. C. Fort Evans
1000 Conn. Ave. Leesburg, Va.
Member AFCCE

KEAR & KENNEDY
1302 18th St., N. W. Hudson 3-9000
WASHINGTON 6, D. C.
Member AFCCE

A. EARL CULLUM, JR.
CONSULTING ENGINEERS
INWOOD POST OFFICE
DALLAS 9, TEXAS
Fleetwood 7-8447
Member AFCCE

GUY C. HUTCHESON
P. O. Box 32 CRestview 4-8721
1100 W. Abram
ARLINGTON, TEXAS

**SILLIMAN, MOFFET &
ROHRER**
1405 G St., N. W.
Republic 7-6646
Washington 5, D. C.
Member AFCCE

LYNNE C. SMEBY
CONSULTING ENGINEER
AM-FM-TV
7615 LYNN DRIVE
WASHINGTON 15, D. C.
OLiver 2-8520

GEO. P. ADAIR ENG. CO.
CONSULTING ENGINEERS
Radio-Television
Communications-Electronics
1610 Eye St., N. W.
Washington, D. C.
Executive 3-1230 Executive 3-5851
Member AFCCE

WALTER F. KEAN
CONSULTING RADIO ENGINEERS
Associates
George M. Sklam, Robert A. Jones
19 E. Quincy St. Hickory 7-2153
Riverside, Ill.
(A Chicago suburb)

WILLIAM E. BENNS, JR.
Consulting Radio Engineer
3802 Military Rd., N. W.
Wash., D. C.
Phone EMerson 2-8071
Box 2468, Birmingham, Ala.
Phone State 7-2601
Member AFCCE

HAMMETT & EDISON
CONSULTING RADIO ENGINEERS
Box 68, International Airport
San Francisco 28, California
Diamond 2-5208

JOHN B. HEFFELFINGER
8401 Cherry St. Hiland 4-7010
KANSAS CITY, MISSOURI

JULES COHEN
Consulting Electronic Engineer
617 Albee Bldg. Executive 3-4616
1426 G St., N. W.
Washington 5, D. C.
Member AFCCE

CARL E. SMITH
CONSULTING RADIO ENGINEERS
8200 Snowville Road
Brecksville, Ohio
(a Cleveland Suburb)
Tel: JACKSON 6-4386 P. O. Box 82
Member AFCCE

J. G. ROUNTREE
CONSULTING ENGINEER
P.O. Box 9044
Austin 17, Texas
GLendale 2-3073

VIR N. JAMES
SPECIALTY
DIRECTIONAL ANTENNAS
1316 S. Kearney Skyline 6-1603
Denver 22, Colorado

JOHN H. MULLANEY
Consulting Radio Engineers
2000 P St., N. W.
Washington 6, D. C.
Columbia 5-4666
Member AFCCE

A. E. Towne Assocs., Inc.
TELEVISION and RADIO
ENGINEERING CONSULTANTS
420 Taylor St.
San Francisco 2, Calif.
PR. 5-3100

PETE JOHNSON
Consulting am-fm-tv Engineers
Applications—Field Engineering
Suite 601 Kanawha Hotel Bldg.
Charleston, W. Va. Dickens 2-6281

MERL SAXON
CONSULTING RADIO ENGINEER
622 Hoskins Street
Lufkin, Texas
NEptune 4-4242 NEptune 4-9558

Service Directory

**CAMBRIDGE CRYSTALS
PRECISION FREQUENCY
MEASURING SERVICE**
SPECIALISTS FOR AM-FM-TV
445 Concord Ave.,
Cambridge 38, Mass.
Phone TRowbridge 6-2810

**CAPITOL RADIO
ENGINEERING INSTITUTE**
Accredited Technical Institute Curricula
3224 16th St., N. W.
Washington 10, D. C.
Practical Broadcast, TV Electronics
engineering, home study and residence
course. Write For Free Catalog, spec-
ify course.

**PRECISION FREQUENCY
MEASUREMENTS**
AM-FM-TV
**COMMERCIAL RADIO
MONITORING CO.**
P.O. Box 7037 Kansas City, Mo.
Phone JACKSON 3-5302

NUGENT SHARP
Consulting Radio Engineer
809-11 Warner Building
Washington 4, D.C.
DIstrict 7-4443

**FREQUENCY
MEASUREMENT**
AM-FM-TV
WLAK Electronics Service, Inc.
P.O. Box 1211, Lakeland, Florida
Mutual 2-3145 3-3819

contact
BROADCASTING MAGAZINE
1735 DeSales St. N.W.
Washington 6, D. C.
for availabilities

Co., Geneva, Ill., to enlarge issues in consolidated proceeding on am applications of Mid-America Bcstg. System Inc., Highland Park, Ill., et al. Ann. Dec. 3.

By memorandum opinion and order, Commission denied motion by Sangamon Valley Television Corp. for stay of proceeding on comparative applications of Wabash Valley Bcstg. Corp. and Illiana Telecasting Corp. for ch. 2 in Terre Haute, Ind., pending final action with respect to ultimate allocation of ch. 2 in Springfield-St. Louis remand proceeding. Ann. Dec. 3.

By memorandum opinion and order, Commission denied petition by Video Independent Theatres Inc., seeking (1) removal of stay of Dec. 18, 1957 grant of its application to move trans. of KVVIT (ch. 2), Santa Fe, from about 3 miles outside of Santa Fe to Sandia Crest, about 14 miles northeast of Albuquerque and 42 miles from Santa Fe, move main studio from present site of trans. to within Santa Fe, increase vis. ERP from 0.324 kw to 28.2 kw, with aur. ERP 14.4 kw, and make other equipment changes which was imposed pending hearing on protests by New Mexico Bcstg. Co. (KGGM-TV ch. 13) and Alvarado Television Inc. (KOAT-TV ch. 7) Albuquerque, (2) issuance of special temporary authorization to construct in accordance with that application, and (3) withhold action on pending application of Santa Fe Telecasting Co. for new station on ch. 11 in Santa Fe. Ann. Dec. 3.

By memorandum opinion and order, Commission denied motion by Mainline Bcstg. Co. to sever from consolidated hearing and to grant its application for new am station in Portage, Pa.; also denied its request for oral argument and waiver of rules. Comrs. Lee and Bartley dissented. Ann. Dec. 3.

Blue Island Community Bcstg. Co., Blue Island, Ill.; The News-Sun Bcstg. Co., Waukegan, Ill.; Hi-Fi Bcstg. Co., Chicago, Ill.; Elmwood Park Bcstg. Corp., Elmwood Park, Ill.; Suburban Bcstrs., Berwyn, Ill.; WXFM (FM) Elmwood Park, Ill.—Designated for consolidated hearing five mutually exclusive applications for new fm broadcast stations and application of WXFM (FM) for renewal of license; made WXFM party respondent with respect to possible interference from proposed stations; denied WXFM request for additional time to reply to Commission 309 (b) letter of Sept. 23. Ann. Dec. 3.

Commission granted applications by Salinas Valley Bcstg. Corp., KSBW-FM Salinas, Calif.; Gus S. Malpee, KFIL (FM) Santa Ana, Calif.; The Wooster Republican Printing Co. WWST-FM Wooster, Ohio; Herbert T. Graham, WMRT Lansing, Mich.; State-Wide Bcstg. Corp., WSEL Chicago, Ill., and John M. Norris, WGCB-FM Red Lion, Pa., for SCA to engage in functional (background) music operations on multiplex basis; conditions. Ann. Dec. 3.

KMAC, KISS (FM) San Antonio, Tex.—Designated for hearing applications for renewal of licenses. Ann. Dec. 3.

Routine Roundup

By notice of further proposed rule-making Commission proposed to amend its rules governing tv translator stations (part 4) to establish standards for licensing of new low power vhf tv translator stations. Comments are invited by Jan. 11, 1960.

Basic requirement would be accomplished, in part, by establishing conditions to guard against harmful interference by vhf translators to other radio communication services. Power output of vhf translators would be limited to 1 w. Those desiring greater power could ask to operate

on upper 14 uhf channels where, because interference possibilities are not so acute, translator power up to 100 w may be used.

While uhf translators must meet prescribed mileage separations from regular tv broadcast stations, no similar rule proposed for vhf translators. However, any vhf translator would be required to suspend operation if it causes interference to regular tv station, and licensees of vhf translators would be required to settle their own interference problems by mutual arrangement.

Type approved equipment would be required. Contemplated minimal operator requirements call only for observation and remote control and automatic cut-off device.

Rules would not permit use of so-called "co-channel" booster amplifiers (which transmit on same channel as tv stations they pick up). They are unstable and are capable of transmitting false and misleading signals when operated in vhf band.

Licensing and other operational requirements for vhf translators would, in general, be comparable to those of uhf translators. Applicants for vhf translator operation would use FCC form 346, same one used for uhf translators. Comr. Bartley dissented. Ann. Dec. 2.

Commission extended to March 31, 1960, period of grace for existing repeaters (boosters) which operate on vhf channels. Legislation relating to licensing of such installations is now pending before Congress. Comr. Bartley dissented. Ann. Dec. 2.

Commission announced that following letter requesting certain information is being sent to all am, fm and tv broadcast stations:

"Pursuant to the authority vested in the Commission under the Communications Act of 1934, as amended, you are requested to file with the Commission not later than January 4, 1960, verified and in triplicate, the following information:

"1. Since November 1, 1958, what matter, if any, has been broadcast by any of your stations for which service, money or any other valuable consideration has been directly or indirectly paid, or promised to, or charged, or accepted by your station or stations, or anyone in your employ, or independent contractor engaged by you in furnishing programs, from any person, which matter at the same time so broadcast has not been announced or otherwise indicated as paid for or furnished by such person?

"2. What internal controls and procedures have you established to provide you with information concerning the remuneration, other than that paid by you, that has been or may be received by individuals in connection with participation in the preparation and presentation of programs broadcast by your station?

"A separate verified statement shall be filed for each AM, FM and TV broadcast station." Ann. Dec. 3.

ACTIONS ON MOTIONS

By Commissioner Robert E. Lee

Granted petition by Southbay Bcstrs. for extension of time to Dec. 16 to file its opposition to petition by KFVB Bcstg. Corp., to enlarge issues in proceeding on Southbay's application for new am station in Chula Vista, Calif. Action Dec. 3.

Granted petition by Broadcast Bureau for extension of time to Dec. 8 to file petition for review of Nov. 17 order granting motion by Skokie Valley Bcstg. Co. for leave to amend its am application which is in consolidated

proceeding with am applications of Radio St. Croix Inc., New Richmond, Wis., et al. Action Dec. 3.

Granted petition by The Enterprise Co. for extension of time to Dec. 4 to file exceptions to initial decision in Beaumont, Tex., tv ch. 6 remand proceeding. Action Dec. 3.

Granted petition by Clearwater Bcstg. Corp. (WDCL) Tarpon Springs, Fla., to extent that it involves dismissal of its application of mod. of license; dismissed application with prejudice. Action Nov. 30.

Scheduled hearings on dates shown in following proceedings: Jan. 11, 1960: Wood Bcstg. Inc. (WOOD-TV) Grand Rapids, Mich., to change facilities; Feb. 4: Tri State Bcstg. Co. (WONW) Defiance, Ohio; Feb. 8: applications of Laramie Broadcasters for new am station in Laramie, Wyo., et al. Action Dec. 3.

Granted petition by Fort Wayne Bcstg. Co., Fort Wayne, Ind., for extension of time to Dec. 14 to file opposition to petition by South Bend Tribune (WSBT) South Bend, Ind., for leave to intervene in consolidated proceeding on am applications of Florence Bcstg. Inc., Brownsville, Tenn., et al. Action Dec. 3.

Scheduled oral argument for Dec. 8 at 9:30 a.m., on petition by Graves County Bcstg. Inc., to dismiss without prejudice its application for new am station in Providence, Ky., which is in consolidated proceeding with am application of Muhlenberg Bcstg. Co. (WNES) Central City, Ky. Action Dec. 3.

By Chief Hearing Examiner
James D. Cunningham

Scheduled for hearing on Jan. 13, 1960 am protest proceeding on applications of Old Belt Bcstg. Corp. (WJWS) South Hill, Va., and Patrick Henry Bcstg. Corp. (WHEE) Martinsville, Va. Action Dec. 2.

By Hearing Examiner J.D. Bond

Granted request by Irvanna Bcstg. Co. and John K. Rogers for extension of time from Dec. 7 to Dec. 21 to exchange drafts of engineering exhibits in proceeding on their applications for new am stations in Irvine, Ky., and Bristol, Tenn., et al. Action Dec. 3.

Granted petition by Broadcast Bureau for extension of time from Dec. 1 to Dec. 8 to file proposed findings and conclusions in proceeding on am application of Charlotte Radio & Television Corp. (WGIV) Charlotte, N.C. Action Dec. 3.

Granted petitions by Gertrude Baker, Poplar Bluff, KGMO Radio-Television Inc., (KGMO) Cape Girardeau, both Missouri, and Northwest Mississippi Bcstg. Co., Senatobia, and Star Group Bcstg. Co., Jackson, both Mississippi, for leave to amend their applications involving 1550 kc to reduce proposed operating power of each from 10 kw to 5 kw; applications are in consolidated proceeding on am applications of Cookeville Bcstg. Co., Cookeville, Tenn., et al. for appeal purposes, effective date of order is Dec. 2. Action Dec. 1.

By Hearing Examiner Basil P. Cooper

Received in evidence exhibits III-A and B by WPRA Inc. (WPRA) Guaynabo, P.R., and stipulation in proceeding on am applications of WPRA Inc. and Island Teleradio Service Inc., Charlotte Amalie, St. Thomas, V.I. and record closed. Action Dec. 3.

By Hearing Examiner Thomas H. Donahue

On petition by Robert Burdette & Assoc. Inc., West Covina, Calif., and with consent of all other parties, continued dates for filing proposed findings and replies scheduled for Dec. 1 and 10 to dates to be determined after hearing has been held on issue recently inserted into this proceeding by memorandum opinion and order, released Nov. 20 on am applications of Robert Burdette & Assoc. Inc., et al. Action Dec. 1; dismissed petition by Robert Burdette and Assoc. to reopen record. Action Dec. 2.

Issued memorandum opinion and order covering pre-hearing conference in proceeding on application of M.V.W. Radio Corp., for new am station in San Fernando, Calif., et al., formalizing certain rulings made; scheduled hearing for April 1, 1960. Action Dec. 1.

Granted petition by Broadcast Bureau insofar as it requests that application of Pan American Radio Corp. for new am station in Tucson, Ariz., be placed in pending file and retained in hearing status. Action Dec. 2.

Upon request by Island Teleradio Service Inc., and with concurrence of all other parties, scheduled hearing for Jan. 26, 1960 on Island's application and that of Supreme Bcstg. Inc. of Puerto Rico for new tv stations to operate on ch. 10 in Charlotte Amalie, St. Thomas, V.I. Action Dec. 3.

Continued on page 133

My experience of 25 years in management, ownership, and operation of radio and television stations is now available to you, if you are interested in the purchase or sale of broadcasting properties in the western states. Your inquiry, of course, will be treated in confidence.

Lincoln Dellar

LINCOLN DELLAR & COMPANY
SELECT RADIO AND TELEVISION PROPERTIES
MANAGEMENT CONSULTANTS • APPRAISALS • FINANCING
1470 EAST VALLEY ROAD, SANTA BARBARA, CALIF., WOODLAND 9-0770
EASTERN AFFILIATE — R. C. CRISLER & Co., Inc.

CLASSIFIED ADVERTISEMENTS

(Payable in advance. Checks and money orders only.) (FINAL DEADLINE—Monday preceding publication date.)

- SITUATIONS WANTED 20¢ per word—\$2.00 minimum • HELP WANTED 25¢ per word—\$2.00 minimum.
- DISPLAY ads \$20.00 per inch—STATIONS FOR SALE advertising require display space.
- All other classifications 30¢ per word—\$4.00 minimum.
- No charge for blind box number. Send replies to Broadcasting, 1735 DeSales St., N.W., Washington 6, D. C.

APPLICANTS: If transcriptions or bulk packages submitted, \$1.00 charge for mailing (Forward remittance separately, please). All transcriptions, photos, etc., sent to box numbers are sent at owner's risk. BROADCASTING expressly repudiates any liability or responsibility for their custody or return.

RADIO

Help Wanted—Management

5 kw network affiliated radio station in southwest seeks general manager. Send full resume, picture, including salary to Box 536R, BROADCASTING.

Virginia—new daytimer, competitive market, needs manager-salesman January 1st. Box 553R, BROADCASTING.

Can you announce? Can you sell and service? Can you program? Are you honest? Are you sincere in your efforts? Are you sober? Would you be happy in a small town with the opportunity to become assistant manager to our station? Do you think you are capable of making friends and holding them? Can you be available by January 1? If the above questions haven't scared you from answering this ad perhaps the next one will. Are you willing to work for a reasonable salary with opportunity of working into an assistant manager's position with higher salary? If you can answer all these questions "yes" then finish reading this ad, because we want you. We are a station of 1000 watts in western North Carolina. If you have limited experience you will not be ruled out, we are more interested in the person than his experience. Box 559R, BROADCASTING.

Sales

Northern Ohio medium market needs 2 men, building for top grosses, experienced men only. Box 308P, BROADCASTING.

\$125.00 weekly for salesmen. Also bonus and commission. Metropolitan market east coast. Opportunity unlimited. Box 865P, BROADCASTING.

\$100-\$150 weekly guarantee plus commission and bonus plan for aggressive self-starter salesman. Top station Washington, D.C. market. Box 867P, BROADCASTING.

Immediate opening for aggressive time salesman. Guarantee against 14% commission. Established accounts plus good prospect list makes this a \$750-\$900 per month position. Reply Box 484R, BROADCASTING.

Experienced salesman for top-rated radio property excellent market in New York state. Good salary plus commission. Station is member of group operation offering many extra benefits. Opportunity for advancement to right man. Send full details first letter. Appointment will be arranged. Box 506R, BROADCASTING.

Small market Oklahoma station wants aggressive salesman. Experience secondary. Will train the right man. Box 538R, BROADCASTING.

Virginia—new daytimer, competitive market, needs salesman-announcers January 1st. Box 554R, BROADCASTING.

FM sales executive opportunity. New Detroit station. Preferably under 35, with fine arts interests and 4 years radio sales. Forward detailed resume with three business references. All replies kept confidential. Box 556R, BROADCASTING.

California, KCHJ, Delano. Serves 1,300,000. Increasing sales staff.

Immediate opening for salesman and announcer or announcer-copywriter at new community station in family group. Good salary and working conditions. Excellent future with advancement for right man. Telephone Swan 3-4104. Plymouth, North Carolina or write WPNC.

Announcers

Modern number one format station in one of ten largest markets auditioning fast-paced, live-wire announcers. Key station leading chain offers big pay, big opportunity. Send tape to Box 864P, BROADCASTING.

Help Wanted—(Cont'd)

Announcers

1,000 watt station in southeast has opening for chief engineer-combination announcer. Good salary and excellent working conditions for right man. Send resume, references and tape to Box 176R, BROADCASTING.

If you're 30 or so, have several years solid commercial radio background, including news gathering and writing experience, here's your opportunity: combination deejay and newsman on evening shift till 10:30 p.m. at northeastern Illinois kilowatt. Format station emphasizing local news, sports and adult music—standard and pop tunes with strong melody. No top 40, no rock 'n' roll, no country and western, no rhythm and blues. Personal interview required. Free life, hospital, medical insurance, sick pay bonus, pension plan. List age, education, family status, references, experience in detail. Box 369R, BROADCASTING.

Announcer—first phone, no maintenance. All night show midwest metropolitan market. Box 390R, BROADCASTING.

Wanted: Mature, experienced announcer. Must be reliable and good worker. Attractive position. Write Box 426R, BROADCASTING.

Engineer-announcer for 1 kw daytime and fm station. Located in Ohio River Valley. Send full details. Box 529R, BROADCASTING.

Announcers 2. (1) some experience. (2) good training and background. Send only resumes. Box 531R, BROADCASTING.

Oklahoma station wants young, aggressive deejay immediately, over one year experience. Send tape, resume first letter. Box 537R, BROADCASTING.

Washington, D.C., indie has opening for experienced, modern disc jockey. Send tape et al. Box 539R, BROADCASTING.

1st phone announcer: Must be top air salesman. Start \$110.00. Central mid-west. No engineering. Box 567R, BROADCASTING.

New Jersey. Experienced announcer-newsman. Must be good. Excellent opportunity. Send complete information and tape. Box 571R, BROADCASTING.

Attention c&w dj's. I need two top-notch c&w dj's by the first of the year—morning and afternoon man. If you are tops . . . if you like friendly country radio . . . if you can and will sell for 15% commission . . . repeat . . . if you can and will sell . . . if you like the sound of \$125 per week . . . family insurance mostly paid . . . other benefits . . . and security, then write me air mail today. Please keep in mind that I am looking only for top-flight men, your air work and sales must be excellent and your habits and morals unquestionable. If you are one of the two men I want, you will be joining a mid-Atlantic group of six radio stations. Before I hire you, I will thoroughly check your credit and other references. Write today. Enclose your phone number, and if you sound good I will call you, then be prepared to send a tape. We are a country and farm station in Virginia's Shenandoah Valley with the advantages of non-pressing small town living. Box 575R, BROADCASTING.

Wanted, experienced announcer. Friendly style adult programming. Immediate opening. Box 576R, BROADCASTING.

Three city chain of modern radio stations expanding. Needs three disc jockies experienced in the new radio with accent on imagination and creative ability. Money good, need immediate. Send tape, photo and resume first letter to Box 584R, BROADCASTING.

Help Wanted—(Cont'd)

Announcers

Michigan 5 kw daytimer has opening for announcer. Excellent working conditions. First class ticket helpful, but not essential. Send tape and resume to WJBL, P.O. Box 808, Holland, Michigan.

Smooth, intelligent announcer with emphasis on enthusiasm who likes swinging operation wanted immediately. Will consider first class ticket holder as chief and announcer or a straight announcer. Contact Frank Haas, KAGE, Winona, Minnesota.

Announcer for top community service station, no top 40 dj's. Send full details and tape to KBRZ, Freeport, Texas.

KBUD, Athens, Texas, seeking experienced staff announcer. Salary open.

Announcer with first phone for night shift. You'll love KCOW Radio, Alliance, Nebraska. Permanency!

Expanding announcing staff. Excellent opportunity for beginner with potential. Resume, tape, first letter to Ralph L. Hooks, KDLA, De Ridder, Louisiana.

Combo-announcer with first ticket. No maintenance necessary. Adult format with emphasis on news. Send resume, tape and pix to G. C. Packard, KTRC, Box 1715, Santa Fe, N.M.

Wanted: Announcer with first ticket, no maintenance. Apply WAMD, Aberdeen, Md.

Thirteen year old station with top ratings appealing to family audience adding morning man and afternoon jockey. No formula or r&r; we beat them both. Our employees average 6 years service so we feel it reasonable to require that applicants have served in present job at least three years, but we will listen to well trained newcomer with exceptional talent. You will live in fine city and work with excellent equipment at station considered by audience and advertisers as No. 1. Everyone gets along famously together and we all work together to keep the station on top. Send resume, photo, tape, income requirement, and state whether you prefer morning or afternoon and why. Tapes returned. Ed Dunbar, Manager, WBBQ, Augusta, Ga.

Start 1960 right! In the job you've been wanting for so long—at WBYS. If you are a good, sensible announcer who likes good radio in a good community and can handle the morning shift, you'll like it here. Applicants with a first phone especially welcome. WBYS, Canton, Illinois.

Play-by-play all sports and news editor combination opening. No board. KCOW Radio, Alliance, Nebraska.

Eastern North Carolina station needs experienced announcer immediately. Good future for right man. Send full information to W.R. Ward, Mgr., WCPS, Tarboro, N.C.

Wanted: Air personality also newsman for five kw. Replace men moving to major markets. Up to \$150.00 if first phone. Must move tight production. Jim Duncan, WGGH, Marion, Illinois.

New modern sound, WIVY, Jacksonville, Florida. Need swingin' man at \$100.00 per week start. Send facts, tape, to Roger Roach, WIVY, Jacksonville, Florida.

We need a morning man that likes to combo. First class ticket, no maintenance. Adult programming on commercial station. Must be sharp announcer. Send tape and resume to WJBL, P.O. Box 808, Holland, Michigan.

WNCO is adding another announcer to its growing staff. Wonderful opportunity for the right man. Contact John Cigna, WNCO, Ashland, Ohio.

Help Wanted—(Cont'd)

Announcers

Experienced, sharp, mature staff announcer being sought by net affiliate with music-news format. Permanent position with an "UP" future. Send tape, experience, picture to Joe Butler, WKLZ, Box 663, Kalamazoo, Mich.

Wanted, experienced announcer for modern good music station in upstate New York. Send resume and tape to Radio Station WOKO, Albany, New York.

Wanted, experienced announcer with first phone. WSYB, Rutland, Vermont.

Announcers! Experienced? Opportunities in many markets. Send tapes, resumes to Paul Baron, Manager, Broadcast Department, Maude Lennox Personnel Agency, 630 Fifth Avenue, New York 20, N.Y.

Announcers losing jobs? Lack that professional sound? Audition tape not a polished . . . showcase? See New York School of Announcing display ad in Help Wanted column.

Technical

February 1st opening for combination engineer and announcer. Daytimer in northern New York. Box 132R, BROADCASTING.

Virginia—new daytimer needs engineer-announcers January 1st. Box 555R, BROADCASTING.

Chief engineer with announcing or sales ability for small market daytime station in western North Carolina. Salary open. Write Box 1114, Sylva, North Carolina.

First phone operator. Experienced. Make more money through sales. 20 hours operating. \$100 weekly against commission. Contact KCHJ, Delano, California.

Experienced engineer for studio maintenance. Must be familiar with DuMont equipment. Will send right man to Ampex Videotape school. Contact Chief Engineer, KOOL-TV, Phoenix, Arizona.

Help Wanted—(Cont'd)

Technical

5 kw fulltime DA-N midwest city 100,000 needs chief engineer. Contact KRES, St. Joseph, Missouri.

Wanted, combination engineer-announcer. Good salary according to proven record and good references. Permanent and good future. Write giving full history and details. Applications confidential. Baldwin Goodwin, Jr., General Manager, WKIZ, Box 1487, Key West, Florida.

Engineer-announcer. Immediate opening for capable first ticket engineer, experienced announcer, proficient air-salesman in ideal community. Two station chain with excellent opportunity for advancement. Must be willing to work. \$425.00 to start. Joe Haas, WLOI, La Porte, Indiana, 4144.

Our engineer drafted—need chief engineer that can announce. 35 miles from gulf coast. Good pay with benefits. Send tape and resume. WRJW, 5000 watts. Picayune, Miss.

Maintenance engineer — first-class license. Two years radio and/or tv station experience. Salary \$450 a month to start. Write University of Minnesota, Civil Service Department, Minneapolis.

Excellent opportunity for advancement for a transmitter engineer, WAMS. Your predecessor has been promoted within our organization. Maintenance experience helpful. Send photo and resume to Tim Crow, Rollins Broadcasting, P.O. Box 1389, Wilmington, Del.

Production-Programming, Others

Wanted: First class newsman. Must be hard worker, have car. Good future for right man. Send details to Box 427R, BROADCASTING.

Copy gal to write creative hard-sell copy for leading eastern music-news station. Good pay and working conditions. Enclose continuity samples, experience and snapshot. Box 622P, BROADCASTING.

Help Wanted—(Cont'd)

Production-Programming, Others

Copywriter and traffic assistant. Large metropolitan station. Top pay. Box 863P, BROADCASTING.

Needed immediately. Experienced, alert radio newsman for opening on fast-pace, top-flight news staff at number one station in major southwest market. Must be able to broadcast news as well as gather. Pays top salary. Replaces man promoted within organization. Send tapes and resume to Box 518R, BROADCASTING.

News editor-newscaster. Midwestern urban-rural community station. Experienced gathering local news. Community-minded. Excellent opportunity. Write all details including salary required. Box 551R, BROADCASTING.

Newsman. One of northern Ohio's top independent radio stations seeks a well schooled and experienced newsman who appreciates modern radio news and knows how to gather it. This man will deliver major newscasts throughout the day and must have a mature and authoritative delivery. Complete responsibility for the newsroom will be his. Can you handle it? Send a tape and resume to Dick Carr, WCUE, Akron 8, Ohio.

News Director—Must be aggressive, competitive, capable of heading two-man news staff, able to cover, write and deliver local news for a top 250 watt independent radio station in northern Ohio. Top fringe benefits—salary commensurate with experience and ability. Send resume, picture and tape to Program Director, WLEC, Sandusky, Ohio. Need approximately January 1, 1960. We will ask for personal interview.

Long established 4-A agency in southwest has immediate opening for experienced tv-radio copywriter/production supervisor. Must have thorough knowledge and experience in writing and production techniques for both mediums. Prefer college graduate. Agency background desirable but not mandatory. Excellent opportunity and growth potential for right man. Send complete resume, including previous salaries, and photo air mail to: Ward Hicks Advertising, 315 Gold Avenue, SW, Albuquerque, New Mexico.

RADIO

Situations Wanted—Management

Need rating and billing to prove station value? Can produce both — four station proven record available. Top 40 or better music. Trouble shooting my specialty, major and medium markets. 37—14 years sales and management. Challenge important, so is money. Currently major market. Box 522R, BROADCASTING.

Experienced manager now employed in metropolitan market southwest looking for job offering ownership possibilities. Box 533R, BROADCASTING.

California manager—18 years, excellent references—guarantee profits. Available immediately. Box 547R, BROADCASTING.

Young, experienced small market sales-manager wishes management opportunity. Married, veteran. Box 550R, BROADCASTING.

Experienced, mature, college man, with the know-how and drive to help your operation. I'm seeking a position of manager or program director in medium to small market. For best references or information write Box 564R, BROADCASTING.

Number 2 man to assist president or general manager in major market. 17 years experience on sales and management level all phases radio, television and agency. Stations 250 to 50,000 watts. Markets 10,000 to 2,000,000. One of best over-all records in the industry. With present employer 11 years in one of first five markets. Happily married, two children. Excellent references. Box 569R, BROADCASTING.

Wanted—Opportunity to make your station more successful in 1960. Veri Bratton, Management Consultant, 1205 LaPaloma Way, Colorado Springs. Will be in Chicago first week January. % W.O. Rice, Harris Trust & Savings.

Immediate openings at RCA for . . .

BROADCAST SYSTEMS ENGINEERS

Highly responsible positions are open to men who have experience in audio and TV equipment applications in broadcast studios. Salaries and opportunities for professional growth are both excellent.

As an RCA Broadcast Systems Engineer, you will work directly with such customers as radio and TV stations and recording studios. Acting in an advisory capacity, you can be the man who analyzes the customer's needs and designs the system which specifically answers his requirements.

You may work with TV installations (either black and white or color), AM-FM, Hi-Fi and stereo audio equipment, terminal equipment, mobile or closed circuit systems. Components include the latest and most exciting RCA products such as cameras, mikes, consoles, audio and video tape, loudspeakers, projectors, amplifiers, transmitters, multiplexers, etc.

FOR INTERVIEW WITH ENGINEERING MANAGEMENT

Send
resume
to

Mr. V. E. Broad
Box ZC-14M
Professional Employment
RCA,
Bldg. 10-1
Camden 2, New Jersey



RADIO CORPORATION OF AMERICA

Industrial Electronic Products

Situations Wanted—(Cont'd)**Sales**

Salesman-announcer, Radio-tv. 8 years experience, married, age 32. Southeast or southwest. Box 520R, BROADCASTING.

Experienced Colorado salesman available soon. Proven sales record. Family man. Excellent background, references. Box 548R, BROADCASTING.

Attention brokers! Agencies! Experienced young college graduate desires opening with media broker or advertising agency. Married, 26, child. Experience as radio time salesman, tv time salesman, tv sales manager. Currently managing radio station . . . all with same company. Box 560R, BROADCASTING.

Announcers

Sports announcer, seven years background play-by-play. Top references. Box 405R, BROADCASTING.

Honest, good music, morning man. Fifteen years. No screamer. Adult. Box 462R, BROADCASTING.

Experienced announcer, young, veteran, runs own board, seeks position with advancement possibilities, nights, travel anywhere. Box 463R, BROADCASTING.

Something different. Announcer-copywriter. Touch of Erin. Sales, promotion too. Box 515R, BROADCASTING.

Swinging disc jockey. Intelligent. Read good commercial. Can sell too. Box 516R, BROADCASTING.

West Coast: 2½ years experience radio, television. Versatile, adult music, classics, jazz, news, sports. College graduate. Veteran. Available February 1st. Box 523R, BROADCASTING.

Personality-dj. Bright, cheerful, experienced. Creative showman. References, tape available. Box 526R, BROADCASTING.

Announcer-salesman. "Tremendous". Personality, experienced. Runs own board—N.Y. college grad. Desires relocating in the Raleigh, N.C.-Washington, D.C. area. Impeccable taste in music. No r&r or c&w. Box 530R, BROADCASTING.

Versatile, good music and newsmen. Commercial specialist. Try me. Box 532R, BROADCASTING.

Five years radio staffing, news gathering and airing. Worked Boston's two top stations. Go anywhere with security and salary potential. Box 540R, BROADCASTING.

Radio personality-announcer, experienced from 250-10,000 watts, news background. No top-40 stations please. Prefer eastern market. Available February 1, 1960. Box 544R, BROADCASTING.

Full, rich background in listenable music with soft sell that works. Ready for step-up in February, 1960 within eastern market. No formula or top-40 outlets. News background and tv announcing. Six years experience from small to major markets. Box 545R, BROADCASTING.

DJ experienced, married, music and news. Vet, mature, available now. Box 549R, BROADCASTING.

Experienced young announcer wishes to relocate in upper midwest. Good commercial delivery. Handle sales and copywriting equally well. Box 562R, BROADCASTING.

Radio-tv announcer, college graduate, network calibre. Now in competitive market, desires position with potential in metropolitan area. Strong on news. Box 565R, BROADCASTING.

Experienced announcer, dj, program director, copywriter, scriptwriter and salesman. Also experienced in tv. Seeking opportunity to learn sportscasting and striving for a managerial position. Full details, tape and photo upon request. Box 566R, BROADCASTING.

Country music dj, available. Best references, reliable, sober, creative, knows programming, promotion. Box 568R, BROADCASTING.

Situations Wanted—(Cont'd)**Announcers**

Speak to me of five figures! Making bosses first in market is my business. Talk show or news director for radio and tv, or combination. 11 years experience in news. Will be in Rose Bowl New Year's Day, but can be on your station the following Monday. Box 583R, BROADCASTING.

Staff announcer—restricted license. Some air experience as emcee. Do best on news, commercials and disc shows. Box 183, Mendota, Illinois.

Announcer, dj. Green as the hills, personality as high as the sky. Limited show biz background. Top salesman, family, relocate, minimum salary. Age 34. 29536 W. Chicago, Livonia, Michigan.

Available—topnotch, experienced, stable, versatile announcer-newscaster. Desires aggressive station. Phone: Justice 3-0884, Norfolk, Virginia.

Newscaster, good music specialist, mature voice, excellent diction. Write continuity, sell. Personal audition for any major southern market. Tape available. Jerome Benjamin, 1181 Stewart Ave., S.W., Atlanta 10, Georgia.

Casey Clark, country and western dj and barndance promoter, available, January 1st. WNAX, Yankton, S.D. Phone North 5-2550.

Negro dj. Mature voice, professionally trained. Bob Lee, 6028 S. Drexel, Chicago. Dorchester 3-1958.

7 years radio, tv. C&W, dj, salesman, pop dj, "former entertainer Jubilee U.S.A." Looking for permanent, secure job. Will go look over good replies. Prefer south and Texas. Jack Reno, Box 51, Bloomfield, Iowa. Ph. 667.

Technical

Experienced engineer. No announcing. Available immediately. Radio or tv. Box 344R, BROADCASTING.

Chief engineer. 5 kw up, d.a. or multiple operation. 21 years experience technical, administration, construction and some tv. Want to settle in good western community. Box 534R, BROADCASTING.

Transmitter engineer. \$90/week. Separate transmitter within 12 miles low-rent, now near Richmond, Va. Immediate. Anywhere. Box 558R, BROADCASTING.

Start the year off right with a new engineer. Experienced chief engineer with mediocre announcing ability desires chief engineering position in 1 or 5 kw station with 20 hours of announcing, in Arkansas, Louisiana, Oklahoma, or Texas. Experienced in maintenance of Magnecord recorders. All inquiries will be promptly answered. Box 561R, BROADCASTING.

Employed mature adult, combo experience, at present chief engineer. Wish relocate in southwest steady as a rock. Will exchange tape etc., for reasonable offer. Box 579R, BROADCASTING.

Chief engineer 20 years experience am-fm directionals. Best references, permanent. Bill Alford, P.O. Box 902, Lakeland, Florida.

First class licensed engineer with announcing experience available. For details phone Palatka, Florida 5-3991.

Situations Wanted—(Cont'd)**Technical**

Radio-tv engineer-manager, registered engineer D.C. First phone, etc. Many years experience desires join D.C. consultant as associate or buy into partnership. Box 586R, BROADCASTING.

Production-Programming, Others

Sports director. Currently with tv and am station in large eastern market. Also staff work. Excellent play-by-play. College grad. 33 years old, married, two children. \$150-minimum. Box 431R, BROADCASTING.

News director-reporter. 3 years in midwest am-tv, B.S. Radio-tv journalism, 16mm and 35mm photographer, good am-tv delivery. High calibre, 25, married. Box 467R, BROADCASTING.

Program director, 12 years radio experience. Programmed for station that reached 60% rating in 4 station market. Age 31. Also top jock. Box 524R, BROADCASTING.

Copywriter. Start the new year right. Consider everything. Samples available. Box 525R, BROADCASTING.

Tired female gypsy wants to settle in medium sized town. In radio since 1949. Single, 34, veteran, college, radio and tv school graduate. Experienced chiefly in radio copy. Some: TV copy, tv news writing, radio traffic, women's show, concert hour. Can write copy fast if necessary. Typing fair. "Speed-writing" rusty. Box 543R, BROADCASTING.

Experienced newsmen-announcer, 24, B.A., recent vet. Gather, write, air. Copywriting. East coast preferred. \$4680 minimum. Bernie Shusman, 1013 E. Phil-Ellena St., Phila., Pa. LI 8-3903.

TELEVISION**Help Wanted—Management**

Wanted—General manager for network affiliated television station in sizable market. Only fully experienced executive with complete management background should apply, stating his detailed record and references (also picture) to Box 535R, BROADCASTING.

Sales

Young, aggressive television salesman needed immediately. Must have proven background. Position offers future with unlimited earnings. Apply only if you are not afraid to work and enjoy living in small community. We are a new station affiliated with CBS. Address all correspondence to Sales Manager, KBLR Radio-TV, Goodland, Kansas.

Salesman opportunity for good income and stable association in single station 3 network television market. If you are creative sales-wise and like selling you must do well in Wyoming's 1st market. Salary and commissions offer potentials worth investigating. Contact Bob Berger, KTWO-TV Casper, Wyoming.

Sacramento, California, nation's 48th market, \$1,000 night basic hourly rate. Corinthian station wants an aggressive, imaginative salesman who can keep pace in California's state capitol. Contact Mr. Jim Osborn, Sales Manager, KXTV, CBS Affiliate, Channel 10, 601 7th Avenue, Sacramento, California.

RESEARCH DIRECTOR

To organize and head research and statistical department for national film television production distribution company in Los Angeles area. Applicant must have had related education and experience in this field or with a top agency. Submit details of education experience and salary requirements to:

**P.O. Box 48458, Briggs Station
Los Angeles 48, California**

Help Wanted—(Cont'd)**Announcers**

Southwest radio and television station is seeking the best announcer available for our budget. Combination man as staff for adult musical format on radio and live commercials on television. Send full information, age, references, recent photo and starting salary requirements to: Clarke Brown Company, 1507 Southland Center, Dallas, Texas.

Technical

Supervisory engineer with 5 years tv experience as chief maintenance by Northwest University town of 40,000. Excellent living conditions, moderate 4 season climate. State references past experience and salary requirements to Box 519R, BROADCASTING.

One or more first class colored tv operators to work in Puerto Rico. Reply to Carl H. Butman, 892 Nat'l Press Bldg., Washington 4, D. C.

TV studio engineers for design, test, and field engineering. Rapidly expanding progressive company. All benefits, plus rapid advancement for qualified engineers. Foto-Video Laboratories, Inc. CE. 9-6100, Cedar Grove, New Jersey.

Top tv station in Puerto Rico needs maintenance personnel with first class license. Three years minimum experience. Forward resume and salary expected to: Telemundo, Engineering Department, Box 5096, Puerta De Tierra Sta., San Juan, Puerto Rico.

Production-Programming, Others

Film director to take over and reorganize film department mid-west tv station. Thorough knowledge of film operation essential. Film buying experience not necessary. Send full resume, salary requirements and date you are available for work to Box 492R, BROADCASTING.

Help Wanted—(Cont'd)**Production-Programming, Others**

Sacramento, California is booming! Are you ready to join the Gold Rush? Volume local business needs "sell" copy. Production experience is a plus. Samples? Salary? Experience? Contact Mr. Dean Borba, Program Manager, KXTV, CBS, Corinthian Station, 601 - 7th Avenue, Sacramento, California.

Continuity director to take charge of 3-person department. Must be experienced, creative writer with college background. Send samples, photo, all information first letter. Robert H. Kriehoff, WTOL-TV, Toledo, Ohio.

TELEVISION**Situations Wanted—Management**

General or sales manager: Formerly general sales manager, one of the first 25 tv markets. Station changed management. Offer 18 years management experience radio and television in programming and sales. Outstanding record and outstanding references. Box 578R, BROADCASTING.

Employment as general manager of television station or tv-radio combination. Known and respected in industry. Best references. Excellent record as a businessman, administrator, manager, sales. Your confidential reply respected. Box 580R, BROADCASTING.

Sales

Now available, executive-type salesman with 10 years radio and 5 years television experience in major markets. Commission earnings well above average. Married, sober, permanent with excellent references. Box 546R, BROADCASTING.

Technical

Experienced, uhf, new station installations, remotes, microwave, maintenance. 1st phone. Looking for advancement. Available January 1st. Interesting resume upon request. Box 323R, BROADCASTING.

Situations Wanted—(Cont'd)**Technical**

1st class tv engineer, 5 years am, 4 years color and b & w tv. All-around experience but heavy on maintenance. Presently engineer broadcast equipment manufacturing 2½ years. Desire California situation. Box 570R, BROADCASTING.

TV studio-transmitter engineer, 5 years experience, RCA graduate, 1st phone, 25, single, desires New York, New England position. Eugene Windsor, 113 Frederica Dr., Clearwater, Fla.

Production-Programming, Others

Producer-director-announcer, now in major market; ten years radio-tv-theatre, all phases, seeks better climate for family. Money secondary. Box 398R, BROADCASTING.

Director-producer. Currently jr. director midwest vhf. MS in radio and tv. Pleasant, hardworking, creative. Family man. Box 452R, BROADCASTING.

Have schooling and experience in cinematography, television, radio announcing, music, dramatics, journalism. Presently doing industrial motion picture. Desire relocate south. Age 27. Married. Box 521R, BROADCASTING.

Writer-producer-director. Practical experience, local, regional. Creative, versatile. Box 527R, BROADCASTING.

Top rated news director-caster wants to organize and run modern television news plant in competitive market. My know-how plus your money equals top rating. Box 542R, BROADCASTING.

Experienced, creative, producer-director. Family. All phases production. Excellent references. Box 557R, BROADCASTING.

FOR SALE

Radio broadcasting school east coast. State licensed, fully equipped, modern studios, leased in ideal location. Gross \$15,000 month, nets 20%. Needs experienced radio man to operate. Illness forces sales, \$32,500, terms. Box 572R, BROADCASTING.

Equipment

Used 150' Windcharger Tower type 150. \$550.00 fob. 200' U.S. Tower type S-20. \$950.00 fob. Box 517R, BROADCASTING.

Complete DuMont series 15000 uhf 5 kw television transmitter. Excellent condition. Priced very low for quick sale. Send for complete description. Box 541R, BROADCASTING.

Stereo equipment for sale. A Rondine deluxe 3-speed turntable—G.E. tone arm. G.E. "Golden Classic" cartridge. High quality G.E. transistor dual pre-amps and matching transformer for 600 ohm input. This complete unit only \$150. WDBJ-Radio, P.O. Box 150, Roanoke, Va.

Mole-Richardson 103 boom on brace triangular rolling stand. Best offer. You pay shipping. Call, wire, write, WENH-TV, Durham, N.H.

Channel (22) uhf RCA 1 kw transmitter TTU-1B complete with filterplexer, dummy load, frequency monitor General Radio, diode demodulator and FCC spare tubes. RCA antenna TFL-24-D with 1 degree electrical beam tilt. Placed in service in December 1953 and in continuous service up to March 4, 1959. Complete: \$11,500. WSIL-TV, Harrisburg, Ill. Channel (3).

Video monitors. Closed circuit and broadcast. See Foto-Video Laboratories ad today on Page 121.

Disc recorder, Presto 8D-G. Fairchild 539 lathe with head. Presto 92-B amplifier. T. H. Jones, 519 4th. Street, N.W., Rochester, Minnesota.

Miratel tv monitors demonstration units. New warranty 15-17" metal cabinets \$215.00 each. 8-17" veneer cabinets \$185.00 each. Complete line of new units available in 8", 14", 17", 21" and 24". Write: Miratel, Inc., 1082 Dionne St., St. Paul 13, Minn.

Microwave transmission line—Andrew 1½" Rigid 51.5 ohm, teflon insulated. Large quantity complete with connectors, ells, hardware, cables and dehydrating equipment. New. Unused. Bargain. Sierra-Western Electric Cable Company, 1401 Middle Harbor Road, Oakland 20, California.

PRESTIGE RADIO STATION FOR SALE

Powerful, fulltime, Independent in rich, major Southwestern city. Has averaged gross of about \$1,000 per day for several years with semi-classical music. Cash flow now approximately \$15,000 per month. Depreciation and other write-off factors in excess of \$400,000 make this an obvious self-liquidating, blue-chip buy.

Ailing owner will be in New York and/or Washington, D.C. from now to January 1st. I will NOT mail out P & L Statements, Balance Sheets, inventory lists, etc. These will be shown only to qualified principals during personal interview in East.

Minimum of \$300,000 cash down required (balance in secured paper) against \$800,000 purchase price or will sell for \$700,000 all cash. Will not dicker or waste time with go-between. Letters not telling all will be ignored.

Write, in confidence, to **OWNER**

Box 585R, BROADCASTING.

WANTED TO BUY

Stations

Want to retire? Let me buy in and manage with eventual ownership in view. Twenty years experience in radio and tv. Prefer midwest or New England 250 station. Other locations definitely considered. Box 188R, BROADCASTING.

Haskell Bloomberg, Station Broker, 208 Fairmount Street, Lowell, Massachusetts, Telephone Glenview 5-5823.

Wilt Gunzendorfer, station broker, has clients who want to buy stations. Write, wire 8630 W. Olympic, Los Angeles.

Equipment

Wanted. Used in good condition. One General Electric BT3-A or BT3-B 3 kw fm transmitter. Box 500R, BROADCASTING.

Used 250 watt transmitter in good operational condition. Also two used tape recorders of broadcast quality. Box 507R, BROADCASTING.

Wanted in mid-west, used 200 to 500 foot self-supporting or guyed tower capable of supporting multi-bay antenna for fm. Write Radio Station WAJC, Butler University, 1204 North Delaware Street, Indianapolis 2, Indiana.

STL microwave system, 900 mc band, good, used. Also assoc. equipment. Write James B. Holder, WHYL, Carlisle, Penna.

Need 900 feet 3 1/4" Styroflex transmission line. Call or write D.B. Ekberg, WLOL, Minneapolis, Minn.

3-5 kw fm transmitter with or without tape player and accessories. Also interested 250 w to 10 kw, am and fm. Submit details. Compass Electronics Supply, 75 Varick Street, New York 13.

Film line—16mm negative processor K jr. Write or call United Broadcasting Company, Shoreham Hotel, Washington, D.C.

INSTRUCTIONS

F.C.C. first phone license preparation by correspondence or in resident classes. Grantham Schools are located in Hollywood, Seattle, Kansas City, and Washington. Write for our free 40-page brochure. Grantham School of Electronics, 3123 Gillham Road, Kansas City 9, Missouri.

FCC first phone license in six weeks. Guaranteed instruction by master teacher. G.I. approved. Request brochure. Elkins Radio License School, 2603 Inwood Road, Dallas, Texas.

Since 1946. The original course for FCC 1st phone license, 5 to 6 weeks. Reservations required. Enrolling now for classes starting January 6, March 2, May 4, June 29, 1960. For information, references and reservations write William B. Ogden, Radio Operational Engineering School, 1150 West Olive Avenue, Burbank, California.

Be prepared. First phone in 6 weeks. Guaranteed instruction. Elkins Radio License School of Atlanta. 1139 Spring St., N.W., Atlanta, Georgia.

A review that places you in position to pass FCC exams. Very inexpensive. Free literature. "Electronics Unlimited", Box 10634, Jackson 9, Miss.

With pride we announce the opening of our new broadcasting school. Twelve weeks intensive, practical training in announcing, programming, etc. Brand new console, turntables, and the works. Reservations only. Elkins School of Broadcasting, 2603 Inwood Road, Dallas, 35, Texas.

MISCELLANEOUS

Production radio spots. No jingles. Free audition tape. M-J Productions, 2899 Templeton Road, Columbus, Ohio.

RADIO

Help Wanted—Sales

EXCELLENT FINANCIAL OPPORTUNITY

On 5kw CBS middle Atlantic area. Sales manager with executive ability to do personal selling and coordinate work of 3 salesmen on local, regional and national level. Salary. This is a permanent facility with long range plans.

Box 443R, BROADCASTING

SALES ENGINEER WEST COAST

The Company: Major midwest broadcast equipment manufacturer.

The Position: Sales engineer to travel and call on radio stations in California and Oregon, headquarters in Bay Area. Technical background essential.

Opportunities: Unlimited. Salary, expenses and incentive bonus system provides high earning potential for aggressive sales-minded individual. A permanent position with an excellent future.

Send complete resume to Box 502R, BROADCASTING.

IF

You have a proven radio sales record—

If you want the biggest earnings in your life—

If you want to sell the top station in the number #1 Mid-South market—

If you want to belong to the fastest growing group operation in the Nation—

If you have a hunk of paper, a picture, a story to tell us, and a 4¢ stamp—then send it to:

Box 577R,
BROADCASTING.

Help Wanted—(Cont'd)

Help Wanted—Announcers

UNUSUAL OPPORTUNITY

For extraordinary radio personalities. If you have the talent, intelligence and background required of top radio performers, there is a spot for you on the staff of one of the west coast's leading stations. Send tape, resume, photograph, salary desired, immediately to:

Box 574R, BROADCASTING

ANNOUNCERS

LACK THAT PROFESSIONAL SOUND? AUDITION TAPE NOT A POLISHED . . . SHOWCASE?

ADVANCED PROFESSIONAL coaching with NEW YORK BROADCASTERS. Our tapes are job getters. Ask to hear sample.

"Let us analyze present tape. NO CHARGE."

*** Call . . . MR. KEITH . . . SU 7-6938.

NEW YORK SCHOOL OF ANNOUNCING & SPEECH
160 West 73rd Street ***BY APPT. ONLY
New York 23, N.Y. SU 7-6938

RADIO

Situations Wanted—Announcers

TOPNOTCH ANNOUNCER AND RADIO PERSONALITY

A fluke situation makes available a pro with adult appeal who is completely versatile be it music, news, sports, commercials or production. Past 11 years NBC staff in Chicago with reputation for quality and integrity. Long list of credits, widely traveled, knowledgeable. Financially responsible—no taint of Payola. Solid permanent connection desired. Starting date need not be immediately. Prepared for in-person interview at my expense. Let's talk first. Chan, phone Diversey 8-0459 in Chicago at 2134 North Hudson.

STRENGTH NEEDED

to follow your morning man? We're husband and wife team with NY performing and arranging background plus two years as DJ's with chain which has gone formula. We feature music chosen by listening, not by charts or persuasion. Available January, will go anywhere responsible talent is wanted. While proving our effectiveness in your market, will accept short-term agreement with management option to renew. Phone or write Peggy and Tom Eldridge, Hollidaysburg, Pa., Owen 5-4882 or 3044.

MISCELLANEOUS

RADIO CONSULTANTS

Successful group ownership offers experience in

Management
Programming
Engineering

And all phases of money making operation of radio stations
Financing available if desired or needed.
Fee or percentage basis.
All replies confidential.

Box 581R, BROADCASTING

FOR SALE

Equipment

Standard Electronics 40kw hi-band vhf television transmitter type TH-644. Final amplifier consists of two units which may be operated independently with an output power of 20kw or a combined power of 40kw.

RCA type PT-2, 2kw high channel vhf transmitter. RCA type TF12AH antenna.

483' Blaw-Knox type H-40 self-supporting steel tower.

For further information on any of above items, phone or write:

Glenn G. Boundy
STORER BROADCASTING
COMPANY

1177 Kane Concourse
Miami Beach, Fla.
Tele: Union 6-0211

WANTED TO BUY

Stations

RADIO STATIONS
WANTED

Successful group ownership with excellent financial references interested in acquiring additional radio properties. All replies confidential.

Box 582R, BROADCASTING.

EMPLOYMENT SERVICE

RADIO — TV — ADV.

Top job placements in the dynamic south-east. Hundreds of job openings.

- Announcers
- Engineers
- Disk Jockeys
- Copywriters
- News Directors
- Salesmen

Free registration—Confidential

Professional Placement

458 Peachtree Arcade
Atlanta, Ga.

Sam Eckstein

JA 5-4841

STATIONS

FLORIDA

By owners, excellent growing market, all new equipment, excellent earning and growth record. Number one in market by all surveys since 1958. Financial references required. No Brokers.

Box 358R, BROADCASTING

Ariz.	Metro	5 KW	115M	Terms
Calif.	Metro	500 W	225M	Terms
Colo.	Medium	1 KW	300M	Terms
Nev.	Medium	1 KW	200M	Terms
N. Mex.	Medium	1 KW	265M	Terms
Okla.	Small	1 KW	60M	Terms
Oreg.	Metro	1 KW	175M	Terms
Wyo.	Small	250 W	60M	Terms

BUSINESS FINANCE SERVICE CORP.

MEDIA BROKERS

817 17th St. Denver, Colo.

DOUGLAS, ARIZONA

1,000 watt Daytime. New BTA-1R RCA transmitter. Absentee owner. \$45,000 cash or \$50,000 with 29% down. Good potential.

Box 563R, BROADCASTING

MONEY MAKING

Small town kilowatt daytimer in southeast resort area. Ideal for owner-operator. Good climate, hunting, fishing, boating. Netting average over \$1000 monthly on \$60,000 annual gross. Paying manager well under absentee ownership operation. \$75,000. 29% down.

Box 552R, BROADCASTING

Iowa	Single	1kw-D	125M	terms
La.	Single	250w	45M	terms
Minn.	Single	500w	85M	terms
Ala.	Single	1kw-D	35M	terms
Calif.	Single	250w-F	65M	terms
Minn.	Single	1kw-D	105M	terms
Ky.	Single	1kw-D	100M	terms
Ariz.	Small	1kw-D	65M	terms
Ala.	Medium	250w-F	160M	terms
N. Y.	Medium	1kw-D	150M	terms
La.	Medium	1kw	50M	terms
Gulf	Metro	1kw-D	100M	terms
Ga.	Metro	5kw	200M	terms
Fla.	Large	5kw	165M	terms
Ala.	Metro	1kw-D	175M	terms
N.E.	Major	1kw-D	325M	terms
Fla.	Major	250w	250M	terms

And Others

PAUL H.

CHAPMAN COMPANY

INCORPORATED

MEDIA BROKERS

Atlanta

Chicago

New York

San Francisco

Please address:

1182 W. Peachtree

Atlanta 9, Ga.

FOR SALE

I CAN HELP YOU
FIND A GOOD BUY

Verl Bratton,
Management Consultant
1205 LaPaloma Way,
Colorado Springs.

THE PIONEER FIRM OF TELEVISION AND RADIO MANAGEMENT CONSULTANTS

ESTABLISHED 1946

NEGOTIATIONS MANAGEMENT
APPRAISALS FINANCING

HOWARD S. FRAZIER, INC.

1736 Wisconsin Ave., N.W.
Washington 7, D. C.

GUNZENDORFER

THE OFFERING THIS WEEK—

A MERRY
CHRISTMAS
A HAPPY
NEW YEAR

WILT GUNZENDORFER
AND ASSOCIATES

Licensed Brokers—Consultants
8630 W. Olympic Los Angeles, Calif.

Texas regional, single market. Making money. \$79,500 \$19,500 down—South major regional day. \$300,000 25%—Southwest fulltime regional. Nice profits. Some real estate incl. at \$350,000 \$100,000 down. Bal. easy.—Texas fulltime, single. In black. Xmitter site, office bldg. incl. at \$48,000 \$16,500 down.—Southwest secondary, Regional day. Making money. \$143,000 29%—Southwest major, day. In black. \$225,000 29%—Top Midwest single under 20,000 pop. Good profits. \$125,000 29%. Contact PATT McDONALD, BOX 9266, AUSTIN, TEX. GL. 3-8080 or Jack Koste, 60 E. 42nd, NY 17, NY. MU. 2-4813.

NORMAN & NORMAN
INCORPORATED

Brokers — Consultants — Appraisers

RADIO-TELEVISION STATIONS

Nation-Wide Service

Experienced Broadcasters

Confidential Negotiations

Security Bldg. Davenport, Iowa

STATIONS FOR SALE

Ours is a personal service, designed to fit your finances, your qualifications and your needs.

If you are in the market for either an AM, FM or TV station anywhere in the country be sure to contact us at once.

JACK L. STOLL & ASSOCIATES

6381 Hollywood Blvd.

Los Angeles 28, Calif.

HOLLYWOOD 4-7279

Scheduled prehearing conference for Dec. 18 in consolidated proceeding on am applications of Cannon System Ltd. (KIEV) Glendale, Calif., et al. Action Dec. 3.

By Hearing Examiner Charles J. Frederick

Granted motion by Gospel Bcstg. Co. for extension of time from Dec. 1 to Dec. 31 to file findings of fact and conclusions of law and from Dec. 16 to Jan. 15, 1960 to file reply findings in proceeding for consent to assignment of licenses of KPAM and KPFM (FM) Portland, Ore. Action Nov. 30.

Granted petition by Broadcast Bureau for extension of time from Dec. 1 to Jan. 18, 1960 to file proposed findings and conclusions and from Jan. 4 to March 1, 1960 for reply findings, Dec. 1 to Jan. 18, 1960 to file motions to correct transcript of record and from Jan. 4 to March 1, 1960 to file statements in support of or in opposition to motions to correct transcript of record in proceeding on application of WHAS Inc. (WHAS-TV ch. 11), Louisville, Ky. Action Nov. 30.

By Hearing Examiner Millard F. French

On own motion, and with the consent of all parties, reopened record in Largo, Fla., tv ch. 10 proceeding, for limited purpose of further discussions and arguments as to filing of proposed findings and conclusions, and scheduled hearing for 2:30 p.m., Dec. 4. Action Dec. 4.

By Hearing Examiner Annie Neal Hunting

Continued hearing from Jan. 7 to Feb. 12, 1960, in proceeding on application of Tri-State Bcstg. Co. for new am station in Summerville, Ga. Action Dec. 3.

Continued hearing from Jan. 11 to Feb. 15, in proceeding on applications of James J. Williams and Charles E. Springer for new am stations in Williamsburg and Highland Springs, Va. Action Dec. 3.

Granted petition by United Bcstg. Co. (KVOG) Ogden, Utah, for continuance of dates designated for various procedural steps in proceeding on its am application, et al. Action Dec. 1.

Scheduled prehearing conference for Dec. 18 at 9:30 a.m., in proceeding on application of Ulster County Bcstg. Co., for new am station in Ellenville, N.Y. Action Nov. 30.

By Hearing Examiner H. Gifford Irion

Granted petition by Des Plaines-Arlington Bcstg. Co., for leave to amend its application for new am station on 1550 kc-D, in Des Plaines, Ill., to reduce its proposed power from 10 kw to 5 kw, change from nondirectional to directional operation, and reduce ant. height from 165 to 120 ft.; application is in consolidated proceeding with am applications of Radio St. Croix Inc., New Richmond, Wis., et al. Action Nov. 30.

By Hearing Examiner Forest L. McClenning

Granted petition by Coral Television Corp., South Miami, Fla., to extent that it requests leave to amend Sec. V of its application in Perrine-South Miami tv ch. 6 proceeding. Action Dec. 2.

Granted request by Garrett Bcstg. Corp. for continuance of date for exchange of exhibits to Jan. 18, 1960, and hearing from Jan. 18 to Feb. 23, 1960, in proceeding on its application for new am station in West Memphis, Ark., et al. Action Dec. 3.

By Hearing Examiner Elizabeth C. Smith

Scheduled prehearing conference for Dec. 22 in proceeding on applications of James E. Walley for new am station in Oroville, Calif., et al. Action Dec. 3.

Granted petition by Pattenon Brothers for extension of time to Nov. 30 to file

opposition to motion by George T. Herreich for addition of issue in proceeding on their applications for new tv stations to operate on ch. 8 in Jonesboro, Ark. Action Nov. 30.

Granted petition by South Minneapolis Bcstrs. for leave to amend its application for am facilities in Bloomington, Minn., to show new horizontal DA pattern; removed application as amended from hearing docket and returned it to processing line; denied request for oral argument. Action Nov. 30.

NARBA Notifications

List of changes, proposed changes, and corrections in assignments of U.S. standard broadcast stations modifying appendix containing assignments of U.S. standard broadcast stations, attached to recommendations of North American Regional Broadcasting Agreement meeting Jan. 30, 1941, as amended.

- 580 kc
KOBH Hot Springs, S.D.—0.5, ND D. III. (Now in operation with reduced power.)
- 740 kc
WBCI Williamsburg, Va.—0.5, ND D. II. (Now in operation with new station.)
- 1010 kc
WGUN Decatur, Ga.—(Change in call letters from WEAS.)
- 1250 kc
KUKA San Antonio, Tex.—(Change in call letters from KEXX.)
- 1340 kc
KSIL Silver City, N.M.—0.25 N, 1D ND unl. IV. (Now in operation with increased power.)
- 1380 kc
Greenville, Mich.—0.5, DA-D D. III. New.
- 1400 kc
KBZZ La Junita, Colo.—(Change in call letters from KBNZ.)
- 1440 kc
KDNT Denton, Tex.—0.5, N 5D DA-N unl. II-B (PO: 1440 kc, 0.5 N 1D, DA-N, unl. No change in nighttime operation.)

- 1490 kc
WCBQ Whitehall, Mich.—0.25 ND unl. IV. (Correction of error in NARBA change list which incorrectly listed call letters of this station as WBCQ.)
- KBOW Butte, Mont.—0.25 N-1D ND unl. IV. (PO: 1490 kc 0.25, unl. No change in nighttime operation.)
- 1580 kc
Aurora, Ill.—0.25 DA-D D. II. New.
- 1590 kc
WEEZ Chester, Pa.—(Change in call letters from WDRF.)
- Carnegie, Pa.—1 DA-D D. New.

License Renewals

Following stations were granted renewal of license: KBUZ Mesa, Ariz.; KBOI Boise, Idaho; KTOO Henderson, Nev.; KBUZ-FM Mesa, Ariz.; KAWT Douglas, Ariz., and KEYY Provo, Utah. Ann. Dec. 3.

Reports on sale

Volume 23 of Federal Communications Commission's decisions and reports is now on public sale at Superintendent of Documents, Government Printing Office, Washington 25, D. C., for \$3.00 a copy.

This 792-page volume comprises, in bound form, texts of major FCC docket decisions and important policy-making pronouncements heretofore sold by GPO in weekly printed pamphlets covering period July 12, 1957 to December 27, 1957, and includes syllabi index.

Commission does not make public distribution of either weekly pamphlets or bound volumes, both of which can be purchased from Government Printing Office.

INSTRUCTION

CHOOSE A CAREER IN RADIO-TV Announcing Producing Program Management

Thorough preparation for influential careers. Certificate courses in speech, diction, drama, writing. Closed circuit TV, film, control board operation. Free placement service. Men and women graduates in demand. 26th year. Write:

NATIONAL ACADEMY OF BROADCASTING
Dept. B, 3338 16th St., N.W., Wash., D.C.

THE NEMS-CLARKE

Video Jack Panels are designed to provide co-axial patching facilities for television installations or other applications where 70 ohm lines are used

• Jack panel components also available •

TYPE 924

Nominal impedance of jacks70 ohms
Size.....2 1/2" x 19" x 2 3/4"
Number of jacks..... 24
MountingRelay rack
Finish Light Umber Gray

TYPE 948

Nominal impedance of jacks 70 ohms
Size.....2 1/2" x 19" x 2 3/4"
Number of jacks..... 48
MountingRelay rack
Finish Light Umber Gray

LOOPING PLUG

PATCH CORDS
18" - 24" - 36"

NEMS-CLARKE COMPANY

A DIVISION OF VITRO CORPORATION OF AMERICA

919 JESUP-BLAIR DRIVE • SILVER SPRING MARYLAND • JUNIPER 5-1000

WHAT
STARTED
THE TELEVISION
REVOLUTION?

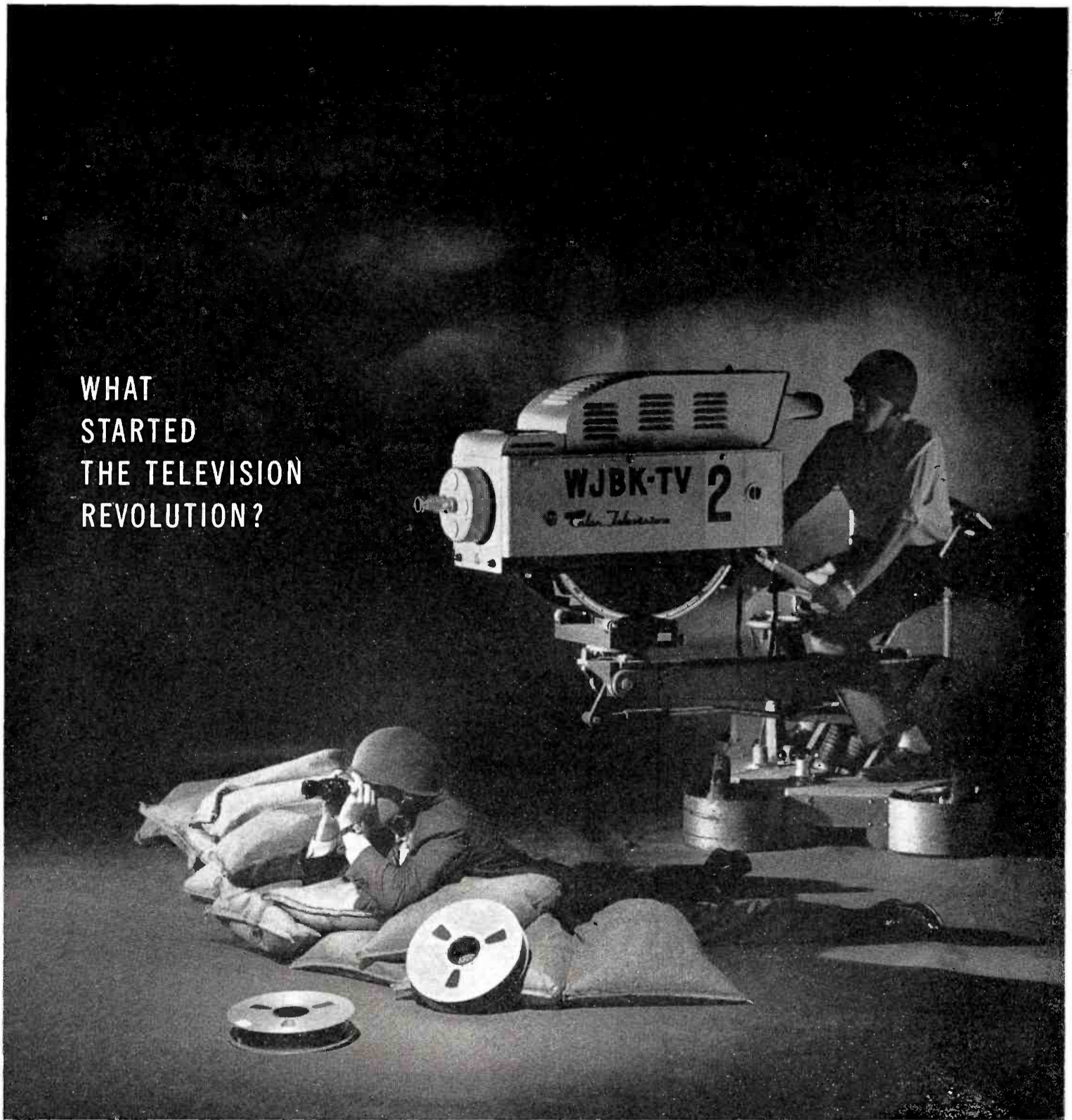

VIDEO TAPE MADE ONLY BY 3M

A lot of shooting in this revolution, but no casualties because "SCOTCH" BRAND Video Tape makes possible flawless "live" commercials and programs. Re-take and processing headaches are in exile. Production costs are under heavy attack.

And it's not over. The best producers agree that the uses and economies of video tape, pioneered by 3M research, are limited only by the imagination of the user.

Fast run-throughs and playbacks, more flexible schedules. The tape can be erased, re-used, spliced and edited.

Perfect video and audio are preserved on "SCOTCH" BRAND Video Tape which gives you "fluff-proof" commercials for half the cost. Maybe less.



MINNESOTA MINING AND MANUFACTURING COMPANY
... WHERE RESEARCH IS THE KEY TO TOMORROW



"SCOTCH" and the Plaid Design are Registered Trademarks of the 3M Co., St. Paul 6, Minn. Export: 99 Park Ave., New York. Canada: London, Ontario. © 1959 3M Co.

OUR RESPECTS TO . . .

John Peter Cowden

Just over a month ago John Peter Cowden quietly moved into an office on the 19th floor at 485 Madison Ave. in New York, charged by CBS-TV with the job of helping articulate the network's image—an image that had been tarnished along with the rest of the tv industry by 1959's quiz scandal and its aftermath. The formal announcement of his appointment as vice president of information services is likely to be the last public mention of his name for awhile. Jack Cowden is a man who puts himself behind the job, not in front of it.

Specifically, Mr. Cowden's responsibilities in CBS-TV's new "image" job extend over three areas: advertising-sales promotion, research and press information. The mark he makes will be through the activities of these departments rather than through projects emanating directly from his office. He comes to the job primarily through the advertising-sales promotion area (he was until last month vice president for advertising and sales promotion for the CBS Television Stations Div.), but has worked closely with the other two areas in his long career with the network.

Although Mr. Cowden's career in recent years has been in the wings rather than on stage, it was not always so. His professional experience with broadcasting dates to the age of 9 (in 1926) as a studio actor on the West Coast. Jack was "Joe Cornstastle" for five years in *Little Orphan Annie* on the old NBC Blue network, and also had roles in such series as *Death Valley Days*, *Memory Lane*, *One Man's Family* and *Pepper Young's Family*. This career before the microphones lasted until 1938, when he joined CBS in New York. With the exception of a year with KSFO San Francisco and two years out for World War II, he's been with CBS since that time.

Started in Promotion • That first association with CBS was as a copywriter in the promotion department of the owned & operated stations division, a job he held until March 1940. Then he went to KSFO as promotion manager, but returned to the network in station relations in 1941. In 1943 he was drafted.

Mr. Cowden served principally in Army public information capacities during the war, participating in the campaigns through New Caledonia, the Philippines and into Japan. His last duty was as Pacific editor of *Stars & Stripes*, headquartered in Tokyo. He

was discharged late in 1945 as a master sergeant.

Following the war Mr. Cowden returned to the CBS o&o division, and in 1949 became general manager of the network promotion department. Then, in 1951, the network separated its radio and television networks and Mr. Cowden became co-director of the tv network's advertising and sales promotion. In 1958, when the tv side split again into network and stations divisions, Mr. Cowden became vice president and sales promotion director on the stations side. He was named to his present post Nov. 10.

Tenacity • One aspect of Jack Cowden's personality threads through both his professional and personal life: the capacity to single out an objective and apply himself to obtaining it, with no diversion for frills or personal allowances. Take these examples:

His career as a child actor was motivated not just for the fun of it but because he needed the money—or more specifically, his family did. Jack's father died in an accident that year, and Jack (then 9; he was born in Santa Barbara, Calif., March 12, 1917) was the oldest of three children. A friend's father was an NBC executive, and through him he tried out for and got his first acting assignment. The career turned out successfully, enough so to put himself and his younger brother and sister through college.

College itself was for Jack Cowden a goal to be achieved, not something to play around with. He went through the U. of California (Berke-



CBS-TV's COWDEN
An old hand for a new job

ley) in 2½ years, graduating in 1938 with a major in economics.

When that was behind him he decided the next move should be to New York. Not having enough money for a ticket proved no handicap: he hopped freights (it took eight days).

Houses that Jack built • Or take the matter of housing his family in New York after the war. Houses were almost impossible to obtain, so Jack joined with four friends to build their own. They bought five acres in Westport, Conn., and after 2½ years had five houses. It wasn't an easy thing to do: the five would drive out from the city in all spare moments, sometimes ringing a house with their cars and working by headlights into the night. (He lived in this house until five years ago, when he sold it "at a tidy profit.")

In 1940 Mr. Cowden married Frances O'Keefe of Swampscott, Mass. They have four children: John Jr., 15 (now in prep school at Andover); Sally, 12; Peggy, 8, and Edward, 3. They also have three sheep, two rabbits, three cats and a dog. The family lives in Westport in an 1819-vintage home he purchased after giving up his hand-made model. They also have a summer place in New Hampshire.

Mr. Cowden has joined no organizations since he was a member of Phi Gamma Delta fraternity in college. He professes no sports interests, but if pressed for a hobby will name cabinet-making. Considering this includes anything from a shelf to a house, "hobby" may seem a mild name for it.

Rugged • Among Westport's commuters Mr. Cowden has a reputation as a rugged type. Until this year he made the run from his home to the station in an open jeep, rain or snow notwithstanding, and without benefit even of a topcoat. A bout with pneumonia last year put a stop to that, however, and the jeep has been retired for an Austin station wagon.

Mr. Cowden does not shrink from the problem any "image maker" faces in times like these; neither does he glamorize it. He is loath to say what personal part he will play in the job; he is quick to point out that the three areas which report to him are staffed with the talent and the tools needed to execute it. He is aware that the job of "articulating" CBS-TV policies is a delicate one, for in doing it the articulator may almost set them.

In his own mind Mr. Cowden has at least one thing going for him—the long association he's had with the CBS family since 1938, and a first-name familiarity with the people, policies and practices at the network. To management, at least another asset is Jack Cowden's own talent and his ability to get a job done.

Minds in conflict: Part II

IN EVERY communications organ which is financed by advertising there is a struggle for authority between the Advertising Mind and the Communications Mind. The nature of the organ is determined by the degree to which one mind or the other prevails.

To use extreme examples, as we did in this space last week, it could be said that a weekly shopping news is an illustration of what happens when the Advertising Mind acquires incontestable control and the *New York Times* an illustration of the consequences when the Communications Mind is boss.

In radio and television the struggle between the Advertising Mind and the Communications Mind is yet to be resolved. That is why some elements of broadcasting tend to take on the character of the shopping news and some the character of the *New York Times*. That is also the reason for conditions which invite the kind of criticism that has battered radio and television during the past couple of months.

What is the difference in the public's attitudes toward organs that are advertising-oriented and toward those that are communications-oriented?

If a shopping news fails, its disappearance may be noted, but not many people except the proprietor will feel a sense of personal loss.

If the *New York Times* today discharged its editorial department and tomorrow published nothing but ads, it would create a state of shock among its readers. If the *Times* elected to continue publishing without editorial content, it would soon be ignored.

These hypotheses are not advanced as an argument against the importance of advertising. If advertising were curtailed, the entire economy would face disaster. But advertising is one thing and communications another. A communications organ may carry advertising, but its success will be measured by the service it provides in addition to its advertising content and by the skill with which it fits its advertising content into its total package.

THE JOB of developing a communications organ and of fitting advertising into it cannot be done with maximum effectiveness if the Advertising Mind is in charge.

The advertiser (and his agency) has one objective, to attract maximum attention to his advertising. He is not interested in the other material appearing in the vehicle he is using—except to the extent that it has a direct effect upon him. There is nothing wrong with the fact that his interests are selfish. If he is to achieve his advertising's goals, he must be totally preoccupied with its preparation and placement.

Multiply the striving for individual attention by the number of advertisers using any communications organ and you have the formula for fragmented control, if the organ allows it to develop.

This formula is at work in a shopping news which has little character of its own and is nothing more than a collection of unrelated attempts to influence readers on behalf of individual products.

It is not at work in the *New York Times* or other true organs of communications. The *Times* has a recognizable identity. It is a package containing many elements, including advertising, but it is assembled with coordinated care by management which has much respect for all its parts but more respect for its whole. By this process it acquires a totality of character which has its own distinction.

The formula of fragmented control or modifications of

it are at work today in too many elements of broadcasting. Indeed in broadcasting the fragmentation is accentuated by still other influences.

People who have come to television or radio from the movies or other fields of entertainment think of broadcasting as an arm of show business. This attitude has been accepted by many advertisers. It is common for sponsors and their agencies to think that they are linking advertising with show business when they own a television or radio show.

To call broadcasting show business is to short-change it as much to call it a shopping news. Broadcasting networks and stations are communications organs. And they are communications organs that encompass far more functions than any others yet invented.

IT IS fully understandable that advertisers should wield a bigger stick in broadcast studios than in the editorial rooms of magazines and newspapers.

Advertising in a sense was created by publishing. It amounted to very little until newspapers and periodicals gave it circulation.

Advertising was already big business when radio and television came along. At the outset, radio and television needed advertising more than advertising needed them. Having no bargaining position whatever, radio and television sold pieces of themselves. With less reason they are still selling pieces.

The record shows that in the main advertisers have done well with the pieces they have owned. They have given the public finer entertainment than it ever knew before. It is their money that built, in a remarkably short time, a broadcast system that is the marvel of the age.

But this has not been charity. Advertisers have realized handsome returns from their investments in broadcasting. It has been good business for them to use radio and television. It will be better business for them as radio and television grow in size and character and influence. This growth will be accelerated at the same rate that the communications-minded among broadcasters seize control from their advertising-minded fellows.

THE publishing concept which keeps advertising and editorial content and placement in proper balance needs to be applied more widely than it is in radio and tv. The application of this concept must begin with top management.

The man at the peak of the organization chart must develop the ability to see his station or his network in its whole role as a communications organ. He must act as both guide and referee to his principal subordinates, the chiefs of the programming and sales departments. In some cases it may be desirable to add a third subordinate of equal stature, a man in charge of non-entertainment programming.

Between the programming and sales departments conflicts are inevitable. If capable executives are in charge, they will resolve most conflicts on their own. When they cannot, top management must be consulted. At that point the publishing concept succeeds or fails, depending on the attitude of the boss.

This internal arrangement, or others like it in principle, must be the first step in the gradual process by which broadcasters will claim both the authority and responsibility for their own communications organs. Unless the process is carried out, control will continue to be so decentralized among so many disparate interests that there is no answer to the question: who's in charge?

THE 12TH ANNUAL AWARDS COMPETITION OF THE
RADIO TELEVISION NEWS DIRECTORS ASSOCIATION
IN RECOGNITION OF DISTINGUISHED ACHIEVEMENT IN BROADCAST JOURNALISM

HONORS
WDAF

KANSAS CITY, MISSOURI
FOR NEWS REPORTING
BY A RADIO STATION

1-9-59

THIS AWARD IS PRESENTED IN COOPERATION WITH THE
MEDILL SCHOOL OF JOURNALISM OF NORTHWESTERN UNIVERSITY

Baskett Mosse
Award Patron



Ralph Reich
President RTNDA



**POLICY,
PERFORMANCE
... PLAQUE!**



Represented by Henry I. Christal Co., Inc.
A Subsidiary of National Theatres & Television, Inc.



You're in the Winner's Circle when you ride with Channel 9—

KMBC-TV is "a-1"  in **KANSAS CITY!**

The Consistent Winners on the Kansas City Television Track Are in the KMBC-ABC Stable of Fine Shows!

Put your advertising dollars on the favorite in the more than two billion dollar sales stake race in the Kansas City market!

The ABC-TV network is *Number One* in latest Nielsen 24-Market Report for 7:30-10:30 p.m. seven days a week! Average share of 30.6 is gain of 10% over year ago. Such great shows as "Maverick" . . . "Wyatt Earp" . . . "Cheyenne" . . . "Pat Boone" . . . "Dick Clark" . . . "77 Sunset Strip" . . . and many more, new, fresh and stronger than ever, are Kansas City favorites on KMBC-TV.

GREAT NEW SHOWS ADDED NOW . . .

. . . new hours and hours of pulling power—every night of the week—"The Untouchables" . . . "Bourbon Street Beat" . . . "The Detectives" . . . "Hawaiian Eye" . . . "The Rebel" . . . and more . . . more . . . more!

PLUS STATION-PRODUCED PROGRAMS THAT KANSAS CITY CHOOSES FIRST!

Channel 9's own locally matchless news-weather-sports coverage . . . "Impact" and "Shock" Theaters! . . . "The Big Show" (feature movie) every night. "Playboy's Penthouse" Fridays. Daytime winners, too! "Bowlin' with Molen" . . . "Whizzo's Wonderland" . . . and "Romper Room" . . . McCall Award-Winner Bea Johnson's "Happy Home"—plus fine syndicated films! Plus "Let's Go See", KMBC travel show with long time dominance of audience for hour and a half on Sunday mornings.

PLUS TALL TOWER — MAXIMUM POWER

Channel 9's high tower, top power reaches 34,142 more homes with Class A coverage than any other Kansas City TV station.



Plus "Videotape Headquarters"

KMBC-TV has finest Videotape recorders, two brand new AMPEX VR-1000B units! Use them to present commercials or shows—your top personalities, your best spots, around the clock and around the calendar. Check your commercials beforehand! Let KMBC-TV's "living image" Videotape recorders serve you.

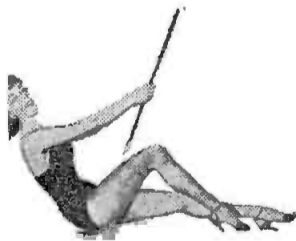

TAKE THE "WINSIDE" TRACK TO PROFIT on KMBC-KFRM Radio, too!

Soundest buy in the rich trade area—America's 17th market! Buy KMBC of Kansas City, get KFRM for the State of Kansas *free*—radio team that's 'way out ahead (latest Nielsen shows a near one-fourth share of total audience!). Twin transmitters of 10,000 watts power, blanket prosperous area of four million people. Top personalities, top programming and top coverage provide top impact for your sales message.

In Kansas City the Swing is to

KMBC-TV



Kansas City's Most Popular and Most Powerful TV Station

and in Radio the Swing Is to

KMBC of Kansas City — KFRM for the State of Kansas

with 10,000 Watts Power from Twin Transmitters

DON DAVIS, President
JOHN SCHILLING, Executive Vice Pres.
GEORGE HIGGINS, Vice Pres. & Sales
ED DENNIS, Vice President
MORI GREINER, Television Manager
DICK SMITH, Radio Manager



**PETERS, GRIFFIN
WOODWARD, INC.**
Exclusive National Representatives

