

19th ANNIVERSARY ISSUE

ANTIQUE RADIO CLASSIFIED



VOLUME 20

JUNE 2003

NUMBER 6

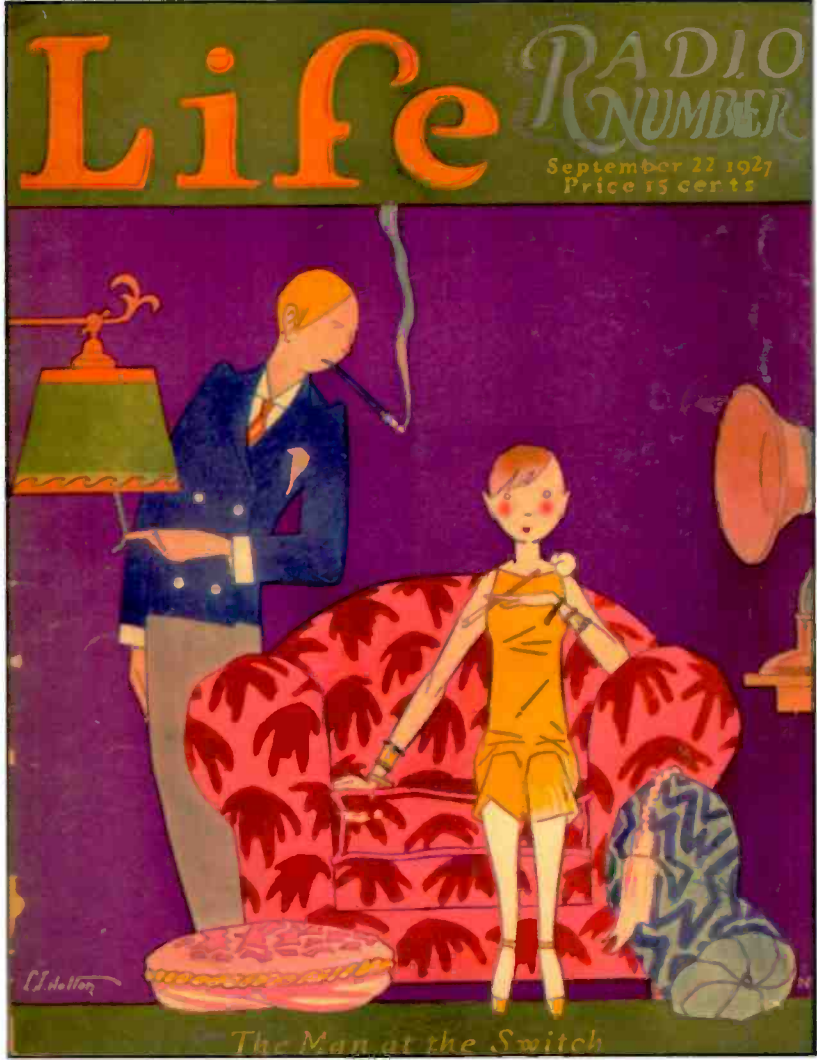

The Man at the Switch

A.R.C. — THE NATIONAL PUBLICATION FOR BUYERS AND SELLERS OF OLD RADIOS AND RELATED ITEMS — WWW.ANTIQUERADIO.COM

RADIO CRAZE

John Sakas P.O. Box 362 Walden NY 12586
Phone (845) 778-4064 ~ Cell (201) 410-0025

visit our web site at <http://www.radiocraze.com>

WANTED



AIR KING SKYSCRAPERS

PAYING **\$14,500.00+** for near mint condition red or blue
\$10,000.00+ for green, lavender or yellow
\$3000.00+ for black and **\$2000.00+** for white or brown
ALSO WANTED ANY COLOR-ANY CONDITION
COLLECTOR PAYING TOO MUCH, CALL ME LAST

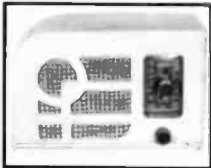

TOM THUMB CATALIN RADIOS WANTED

paying **\$6,750.00+** for mint cond red, green, orchid, blue
\$2500.00+ for any mint condition one
ALSO WANTED ANY COLOR-ANY CONDITION

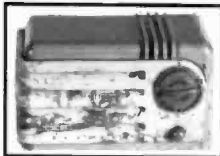

DETROLA PEE WEE & SUPER PEE WEE WANTED

paying **\$600.00+** for mint cond black, white
\$1,450.00+ for beattie, gray, salt & pepper
\$2000.00+ for red, blue **\$3500.00+** for green or lavender
ALSO WANTED ANY COLOR-ANY CONDITION

WANTED ANY CATALIN RADIO

ADDISON 2 MAROON & N & YELL W \$800.00, YELLOW & RED \$3,750.00
ARVIN 532 ANY COLOR \$2,500.00, BENDIX 526 GREEN & BLACK \$625.00
DeWALD A501, A502 BROWN \$375.00, YELL & RED \$1,200.00
EMERSON AU 190 & BT 245 YELL & BROWN \$1,300.00, GREEN \$2,500.00
DARK RED \$2,700.00, BLUE \$6,850.00, BRIGHT RED \$11,000.00
ESPEY MIDGET, YOU NAME THE PRICE I WILL PAY IT!
EMERSON BM258 YELLOW \$750, GREEN \$1,350, RED \$2,150, BLUE \$4,000
EMERSON 564 BLACK \$500.00, GREEN \$1,150.00, RED \$1,650.00
FADA L56, F55, 52, 5F50, 5F60, 136, 53X, YELLOW \$1,500.00, LT GREEN \$1,750.00
MAROON & YELLOW \$2,200.00, YELLOW & BLUE \$2,500.00, YELL & RED \$3,100.00
EMERALD GREEN & YELLOW \$7,000.00, BLUE & YELLOW \$7,000.00
FADA 115, 116 & 1000 ALL YELL & RED \$700.00, MAROON & YELL & RED \$950.00, YELLOW & RED \$1,150.00, PEA GREEN \$1,300.00, BLUE & YELLOW \$2,550.00
GAROD 6AUI MAROON \$675.00, YELLOW & RED 1,350.00, RED & YELLOW \$1,450.00
HALSON ANY COLOR \$1,500.00 TO \$5,000.00
MOTOROLA 50XC ALL YELLOW \$1,750, BROWN & TORT \$2,750.00, RED & YELLOW \$6,000.00, GREEN & YELLOW \$6,250.00
MOTOROLA 52 YELLOW & TORT \$1,500.00, MAROON & YELLOW \$1,850.00, GREEN & YELLOW \$2,900.00
SONORA KM ANY COLOR \$1,600.00
SENTINEL 284 WAVEY GRILL YELLOW \$700.00, SAND 950.00, RED 1,450.00, BLUE 6,500.00
SPARTON CLOISSONNE ANY COLOR \$3,500.00 TO \$5,500.00, EMERSON 520 \$500.00

always buying any catalin or pre-war colored bakelite radios
We will buy one piece or the entire collection.

"watch out there's a new guy in town"

WANTED

ADDISON 2 MAROON & YELLOW \$900.00, YELLOW & RED \$3,750.00
ARVIN 532 ANY COLOR \$2,500.00
BENDIX 526 GREEN & BLACK \$625.00
DeWALD A501, A502 BROWN \$375.00, YELLOW \$425.00, RED \$1,200.00
EMERSON AU 190 & BT 245 YELLOW \$1,300.00, GREEN \$2,500.00
DARK RED \$2,700.00, BLUE \$6,850.00, BRIGHT RED \$11,000.00
ESPEY MIDGET, YOU NAME THE PRICE I WILL PAY IT!
EMERSON BM258 YELLOW \$750, GREEN \$1,350, RED \$2,150, BLUE \$4,000
EMERSON 564 BLACK \$500.00, GREEN \$1,150.00, RED \$1,650.00
FADA L56, F55, 52, 5F50, 5F60, 136, 53X, YELLOW \$1,500.00, LT GREEN \$1,750.00
MAROON & YELLOW \$2,200.00, YELLOW & BLUE \$2,500.00, YELLOW & RED \$3,100.00
EMERALD GREEN & YELLOW \$7,000.00, BLUE & YELLOW \$7,000.00
FADA 115, 116 & 1000 ALL YELLOW \$700.00, MAROON & YELLOW \$950.00, YELLOW & RED \$1,150.00, PEA GREEN \$1,300.00, BLUE & YELLOW \$2,550.00
GAROD 6AUI MAROON \$675.00, YELLOW & RED 1,350.00, RED & YELLOW \$1,450.00
HALSON ANY COLOR \$1,500.00 TO \$5,000.00
MOTOROLA 50XC ALL YELLOW \$1,750, BROWN & TORT \$2,750.00, RED & YELLOW \$6,000.00, GREEN & YELLOW \$6,250.00
MOTOROLA 52 YELLOW & TORT \$1,500.00, MAROON & YELLOW \$1,850.00, GREEN & YELLOW \$2,900.00
SONORA KM ANY COLOR \$1,600.00
SENTINEL 284 WAVEY GRILL YELLOW \$700.00, SAND 950.00, RED 1,450.00, BLUE 6,500.00
SPARTON CLOISSONNE ANY COLOR \$3,500.00 TO \$5,500.00, EMERSON 520 \$500.00



CAN THE BEST GET BETTER?

REA created the first Riders CD-Series. Now we introduce "THE" CD that no radio restorer, repair-person or historian should miss! We proudly introduce the Radiotron-Cunningham Complete Perpetual Troubleshooters Manual published in 1933 by John Rider on a single high resolution CD-ROM

This CD runs with Windows on a PC. It holds 2,767 pages of very high resolution scanned schematic diagrams of all of the early radios from 1920 to 1933 when this publication was produced. This was the fore-runner to the famous 23 Volume series that John Rider produced of early radio schematics and that REA made easier by scanning and putting it on 6 CD-ROM's. This CD has the entire Radiotron-Cunningham publication with an accurate index and even a bonus of radio set information that can be used in identifying no-name or model number radio sets. This CD will show the most minute parts values as each page was scanned at 3 times the resolution of our original Riders CD-series. Early set restorers know about parts values whose value is unreadable. We also know of the site on the internet where one can find some "free" schematics that are worthless because you can't see the values. So we felt that with the new technology that is available that the time had come to perhaps make the best really get better. This CD is not a replacement to our database driven 6-CD set, but an addition to it to improve the quality of the images to get even the smallest unreadable characters magnified on the screen for easy reading!

A must CD - Only \$ 85 postpaid USA, \$ 95.00 export

Other CD-ROM Publications:

Sam's Photofact Sets 1-175 - 7 CD's, with Sets 1-25, 26-50, 51-75, 76-100, 101-125, 126-150 and 151-175. Only \$ 79 each CD-ROM (25 sets per CD)
All 7 Sam's CD's (1-175) - \$ 495.00

Radiophile Vol. 1 - \$ 85

Radiophile Vol. 2 - \$ 85

Radiophile Vol. 3 - \$ 85

Antique Radio Repair Vol. 1 - \$ 85

Antique Radio Repair Vol. 2 - \$ 85

R390-R390A/URR Technical CD - \$ 57

RCA Radiotron Handbook - \$ 67

RCA HB-3 Tube Manual - \$ 80

Zenith Trans-Oceanic - \$ 89

The Radio Boys - \$ 44

Amos 'N Andy - Vol. 1 - \$ 26

Sam's DialCord series - \$ 49

Collins Radio - Receivers - \$ 79

Collins Radio - Xmtrs/Amps - \$ 79

Collins Radio - Transceivers - \$ 79

Collins Radio - Accessories - \$ 79

Complete 4 CD Collins Set - \$ 279

RCA Service Notes - 4 CDs covering sets manufactured from 1923-1928, 1929-1932, 1933-1936 and 1937-1940. The most detail you will find on old sets \$ 79 each. **4-CD set - \$ 300.**

REA-Riders Complete Index - \$ 34

Record Changers - \$ 85

Military Radio V1 - (Compendium) \$ 57

Military Radio V2 - (Compendium) \$ 57

QST Series - 80 years of QST (1915-1994) in 11 sets of CD-Rom's @ \$ 39.95 per set or \$ 373 for all 11 sets

The *Hallicrafters* CD-ROM - \$ 89

Special Editions:

Collins R1051B technical manual - \$ 79

Collins ART-13 technical manual - \$ 39

Collins 618T technical manual - \$ 79

Collins 651S-1 technical manual - \$ 79

National R1490GRR17 technical manual - \$49.

Dept. of Commerce - 1929 Ham Call Book - \$ 29

SCHEMATIC DIAGRAM & MANUAL SERVICE

Over 500,000 schematics & 40,000 manuals and growing! Schematics and some manuals may be emailed instantly via the internet

Check the web - On-line antique radio flea market - Radios for sale - Antique radio museum - Zenith Trans-Oceanic museum - thousands of old catalogs, manuals, literature, information, how-to data, reference, auction price section and much-much more! Visit antique radios largest web address today!

RADIO ERA ARCHIVES

2043 Empire Central
 Dallas, Texas 75235
 Inquiries: 214-358-5195

Visit us on the Internet:
<http://www.radioera.com>

ANTIQUÉ RADIO CLASSIFIED

June 2003 • Volume 20 • Number 6

The National Publication for Buyers and Sellers of Old Radios and
Related Items — Published Monthly

www.antiqueradio.com

- 5 **Editor's Comments**
Beware the pitfalls of e-mail.
- 5 **On the Cover**
The man at the switch of *Life*.
- 6 **Life — 1927 "Radio Number"**
"Battle of the Centuries," etc.
- 8 **New England Antique Radio Club**
Revved up again.
- 10 **The Picnic Portables of the Late 1930s**
Marvel of the times.
- 13 **A 3-Tube AC-Powered "Regen"**
A beginner's dream set?
- 14 **Photo Review**
Home-brew code keyers, anyone?
- 16 **Estes Auction**
\$62,000 makes an OK day.
- 24 **Nye Estate Auction and Sale**
A collector's legacy.
- 25. **Radio Miscellanea**
Milton Bradley in the '20s.
- 28 **A.R.C. Rates and Policies**
Subscription display and classified ad rates and policies.

- 30 **Classified & Display Ads**
- 61 **Coming Radio Events**
- 63 **Mark Your Calendar**
- 68 **Business Card Ads**



ANTIQUÉ RADIO CLASSIFIED

Antique Radio Classified (ISSN:8750-7471) is published monthly, 12 times per year, by John V. Terrey, 498-A Cross Street, P.O. Box 2, Carlisle, MA 01741. Periodicals postage paid at Carlisle, MA, and additional mailing offices. Telephone: (866) 371-0512, 9:00 AM to 5:00 PM ET weekdays; machine answers phone at other times.

Annual subscription rates within the U.S. are \$39.49 by Periodicals mail and \$57.95 by First Class mail.

Annual foreign rates. By air: Canada - \$61.00; Mexico - \$67.00; Other foreign countries - \$105.00. Surface mail: Canada - \$51.00; Other foreign countries - \$58.00. (Surface delivery to countries other than Canada may take two or more months and cannot be guaranteed.)

Two-year subscriptions are twice these rates and receive an extra month. Sample issues are available free on request.

© Copyright 2003 by John V. Terrey.

If A.R.C. inadvertently has infringed on a copyright, A.R.C. will pay an appropriate usage fee when notified.

POSTMASTER: Send address changes to Antique Radio Classified, P.O. Box 2, Carlisle, MA 01741.
Printed in U.S.A.

PURPOSE. Antique Radio Classified is published for people involved in the radio collecting hobby. Its purpose is to stimulate growth of the hobby through the buying, selling and trading of radios and related items, and to provide a monthly forum for the interchange of ideas and information.

STAFF:

Publisher and Editor: John V. Terrey
Assistant Publisher: Cindie Bryan
Managing Editor: Dorothy Schecter
Office Manager: Pat Wedge
Advertising Manager: Cindie Bryan
Issue Coordinator: Pa. Wedge
Publishing & Editorial Staff: Ray Bintliff, Dave Crocker, Bobby Lyman
Founding Publisher/Editor: Gary B. Schneider
Contributing Writers & Consultants: Mike Adams, Richard L. Arnold, Richard Begbie, Ray Bintliff, Paul J. Bourbin, Norman Braithwaite, Dave Crocker, Dick Desjarlais, Alan Douglas, Richard Foster, Jim Kreuzer, Ron Ramirez, Gary Schneider, Daniel Schoo, Frank White, Ralph Williams, Walter Worth

CONTACTING ANTIQUÉ RADIO CLASSIFIED. All correspondence should be sent to:
A.R.C., P.O. Box 2, Carlisle, MA 01741.
Only UPS, FedEx, etc. items to street address: 498-A Cross Street.
Telephone: (866) 371-0512; Fax: (978) 371-7129
E-mail: ARC@antiqueradio.com
Web: www.antiqueradio.com

Please, no classified ads by telephone; thanks.

Your ads, renewals, letters, etc. can be handled faster and more efficiently if your name, address and SUB# are written on each.

Unfortunately, A.R.C. is not staffed to answer all letters with questions about antique radios or requests for advice. However, A.R.C. does solicit letters of interest to its readers and publishes them as space permits. (See "Publishing Rights" paragraph.)



EDITOR'S COMMENTS

Nineteen is a ripe old age for a small specialty magazine, and so we take pleasure in inviting you to share in our anniversary celebration. Though these are troubled times, we like to think we are a source of stability to the radio collecting community who can count on us as a source of information and camaraderie. We hope you'll stay with us for the big bang 20th anniversary in June 2004 and beyond.

Anniversaries always prompt retrospection and an assessment of how many changes have taken place. Without question, the biggest change has been the success of the Internet. But, most recently we've been struck by one of the negatives of that success — the proliferation of spam e-mail. Articles in publications like the *New York Times* and elsewhere have indicated that everyone remains at a loss as to what to do about this frustrating problem.

Our best answer at the moment is to urge you to observe the following suggestions in order to help us to differentiate your message from the more than 2,000 spam messages we receive daily:

First, make sure that your subject line is clear and descriptive, something that we can recognize as radio matter. A single word like "ad" or "help" could get by the weary reader. Be more detailed and explicit. Second, avoid attachments, unless there is no other way to communicate with us. If you must send attachments, let us know ahead of time. Third, watch for a confirmation of your ad and notify us if it doesn't arrive.

Finally, please send your e-mail only to ARC@antiqueradio.com. Any other address could be missed amidst the spam maze. Sometimes we long for the good old days of the straight U.S. Postal Service. Maybe that's why we appreciate the one-on-one contacts collectors still enjoy, such as radio meets.

In fact, radio meets are great treasure hunts. For example, recently at the New England Antique Radio Club meet in Nashua, N. H., the colorful cover on a 1927 magazine caught my eye, thanks to Frank Bequaert of Bequaert Old Books. It seemed the perfect cover for our anniversary issue, since the magazine had published from 1883 to 1936. A 50-plus record is one we'd like to match.

But, the cover was not the only lure. Even more exciting was the subtitle "Radio Number" and the back cover with a full page ad for an Atwater Kent Model E speaker. The cartoons and short, humorous articles related to radio made this a must purchase.

The subject matter of the cartoons is an interesting mix of past and present. Grebe is no longer around, but the Yankees and Detroit are, as is the "Battle of the Centuries" (read Sexes?). And how about headphones in use at the opera? It might be a challenge at one of today's meets to distinguish them from an Apple iPod MP3 player.

But, we're sure John Hagman, who reports on the latest NEARC meet in N. H., would be up to the challenge. John proves once again that one-day meets

continue to be successful.

The cartoons in the 1927 issue of *Life* also depict a life-style that seems ripe for the advent of the 1930s portable radios in Phil MacArthur's interesting article. These are the predecessors of the pocket transistor radio and the boombox. Summertime makes it easy to relate to the pleasure these sets brought to leisure hours on the beach or the front porch.

Doug Fox also takes us back to earlier forms of pleasure for radio hobbyists — homebrewing, which is a rarity today. In those good old days, Doug's 3-tube AC-powered regen was a good entry level set for a new enthusiast who could build a receiver from old parts.

Among the more striking items in *Photo Review* this month is an unusual pair of code keys, manufactured in the mid-1960s by Robert Enemark, a well-known shortwave radio collector. It would be interesting to know if there are any more of his keyers still out there.

Our intrepid reporter Ray Chase, who never saw an auction he wouldn't attend, reports on another Estes auction. Estes auctions generate a lot of excitement, and there are more scheduled, so watch for announcements in A.R.C. In this one, a number of items sold for over \$1,000, including Atwater Kent breadboards. The grand total was \$62,000.

Brian Belanger reports on the second part of the Rodger Nye estate auction. The third part is scheduled for June. These auctions serve a noble cause — support of the Radio-Television Museum in Bowie, Maryland. Nye was instrumental in launching an endowment fund for the museum. Such generous donors do much to preserve the history of radio.

Radio Miscellanea contains news, both good and sad. We're sorry to report the deaths of two avid radio/TV collectors — Danny Gustafson and Andy DuBois. They would have appreciated the support shown our avocation and A.R.C. by other letters on the page. Keep those letters coming.

A.R.C. Benefits. Be sure to take advantage of A.R.C. benefits: a toll-free number, (866) 371-0512; the Web: www.antiqueradio.com; Discover, Visa, American Express, and MasterCard accepted; books shipped free in the U. S. by book rate; and to current subscribers, a ten percent discount on all book orders.

Coming Radio Events. With summer coming on in full swing, events are multiplying. Be sure to get to at least one of the 44 meets and two auctions in June.

Happy Collecting!

John V. Terrey, Editor

ON THE COVER

The colorful cover of the September 22, 1927 early *Life* magazine with the subtitle "Radio Number" was too good to ignore for our anniversary issue cover. The caption "The Man at the Switch" suggests the male chauvinist temper of the times — times that some would say haven't fully changed. Cover: Copyright 1927 Life Pub. Co.

WITH THE COLLECTORS

Life — 1927 “Radio Number”

BY DOROTHY SCHECTER

The following article has an underlying message — when you go to a meet, don't hesitate to tell a dealer what you're looking for, if he doesn't already know your interests. When Frank Bequaert of Bequaert Old Books in Fitzwilliam, N.H., called out to me at a recent meet, “John, you'll like this,” he was absolutely right. Dealers like Frank know their stock better than you do and can lead you to finds that give the old thrill that motivates the search. (Editor)

Radio meets are wonderful discovery places. You just never know what will show up that sparks a memory or excites the imagination. This time at the April New England Antique Radio Club (NEARC) meet in Nashua, N.H., what caught the eye was an old *Life* magazine with the colorful cover, now on our cover. It has the provocative subtitle “Radio Number” and is dated September 22, 1927. How could the editor of a contemporary radio magazine resist?

Our research indicates that this early *Life* magazine was published by the Life Publishing Company in New York City from 1883 to 1936. Its connection, if any, to the later *Life* magazine we all know, is not clear. However, the year the early *Life* ceased publication — 1936 — was the year that Henry Luce and his colleagues at Time, Inc. in Chicago, Ill., created what Luce called the “picture magazine.” This *Life* ran weekly until 1972. From 1972 to 1978, it ran in semi-annual reports, but since then, it has been published monthly.

EMPHASIS ON HUMOR

The general tenor of this 1927 issue is humor, as demonstrated by the cartoons reproduced on these pages. We particularly like the solution for husbands who hate opera but are obliged to attend. Or how about the husband's response to his wife's inquiry about how he likes the soup she made from a recipe on the radio — “I can taste the static.” Or the drawing that captures



The Humane Society puts radio headsets in opera boxes for husbands who hate opera.

the sophistication of the 1920s era with the family elegantly dressed lounging around the set topped by a large speaker. The exception is Father with his big cigar who stands as if in charge, and the caption is “The Speaker of the House.”

Another cartoon is captioned, “The Battle of the Centuries.” The eight frames follow a marriage proposal scene in which the nervous Jack really doesn't have a chance of escaping this lady and her family members who are eavesdropping. The scene is “described” over a loudspeaker as if being broadcast to the world.

On another page, there is what can only be described as a “playlet” called “Freedom of the Air,” broadcasting the meeting of a few senators with some radio men who



The Triumph of a Grebe Testing Room Engineer. He discovers a Grebe Radio a fraction “off” in tone. (Three of eight frames)

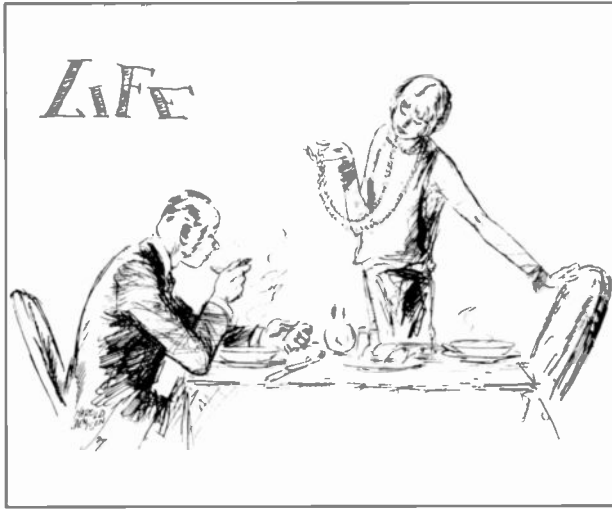

Bride: How do you like the soup, dear? I got the recipe over the radio.
Her Husband: I can taste the static.

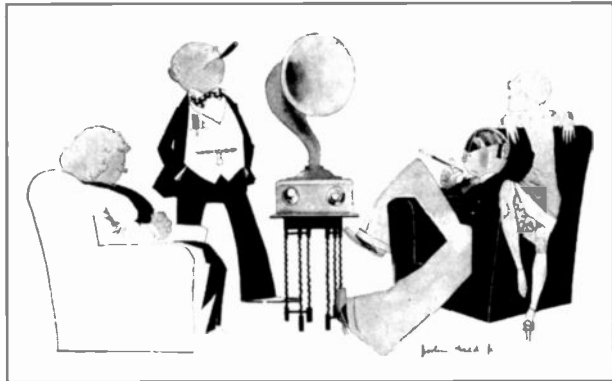

The Speaker of the House.

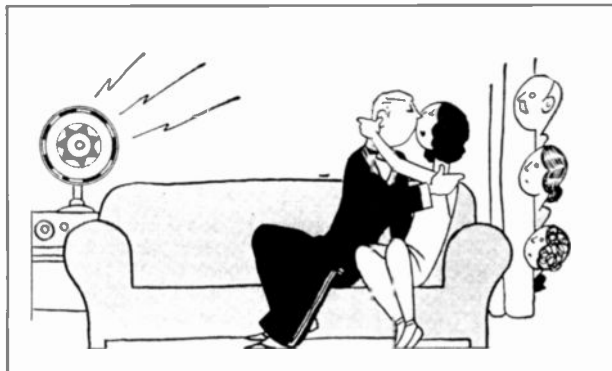

The Battle of the Centuries. ... "He closes in fast! ... He plants a hard right to the face... they clinch..."(Frame #4 of 8 frames.)

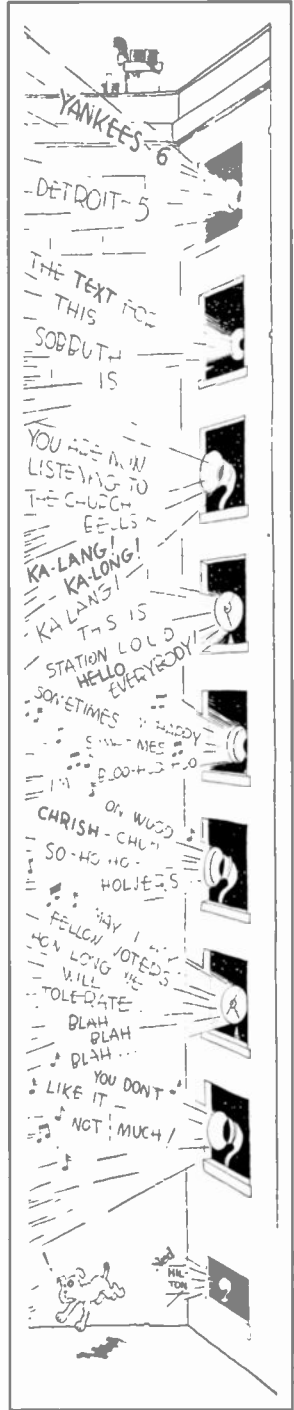

The Day of Rest.

(Continued on following page)

(Life Radio Number continued)

have asked for a hearing about wavelengths. Once the senators have heard wavelengths defined, they will be able to tell the radio men how many they can have. But, of course, the subject is never really addressed, as the senators get distracted by their complaints about song requests they had made that were ignored. The author of this piece is Marc Connolly, a noted playwright of the times.

ARTICLES AND ADVERTISING

Here and there, articles unrelated directly to radio are included. One is a drama review section by Robert Benchley, another well-known writer of the day. Another entitled "Is Your Town Safe?" is really an ad for the Metropolitan Life Insurance Company. The article is in the nature of a public service piece about accident prevention, but the insurance company urges you to send for two booklets on safety, one to keep and one to give to the mayor of your city.

On the other hand, advertising is the life-blood of any publication. Naturally, the ad department of any major radio manufacturer of the day would opt for the back cover of *Life's* 1927 "Radio Number." And Atwater Kent did just that with a full-page ad for a Model E speaker, touting its sensitivity "to the least tonal vibration." The price "with 9 feet of flexible cord" was \$30 (slightly higher west of the Rockies and in Canada). In addition, the ad lists 12 radio stations in cities across the country that carry the Atwater Kent Radio Artists Sunday evening summer shows. Who were those "artists"?

A full-page Grebe Radio ad features an 8-frame

cartoon following the "Triumph of a Grebe Testing Room Engineer" as "He discovers a Grebe Radio a fraction off in tone." The products featured are the Grebe Natural Speaker, selling at \$35, the Grebe Socket Power, at \$50, and the Grebe Synchronphase Seven, at \$135.

Life also ran an Alibi Contest weekly. The rationale for the contest was that alibi-making had become a "national pastime." After viewing the picture of the week, contestants would complete the sentence beginning with, "Well, you see, it's this way..." in 25 words or less. First prize was \$50 for the most ingenious conclusion.

For this issue, "Alibi Number Forty-one" was, of course, radio-related. In the picture, Father, who had always scorned radio, was caught tuning in. Three family members challenge him. Not having the next issue of *Life*, we can't know what the winning alibi was.

Perhaps Frank Bequaert will find the answer for us among his many treasures. Now that he knows how much we care, we're sure he'll be on the lookout. Meanwhile, we urge all of you to ask around — to "network" — for your radio interests. You too may find that gem you've been looking for all these years. As the *Life* motto goes, "Where there is *Life*, there's hope."

Illustrations: Copyright 1927, Life Pub. Co.

Reference:

The Library of Congress Online Catalog, <http://www.loc.gov/>

(Dorothy Schecter, c/o A.R.C., P.O. Box 2, Carlisle, MA 01741. Bequaert Old Books, P.O. Box 775, Fitzwilliam, NH 03447)

New England Antique Radio Club Spring 2003 Meet

BY JOHN HAGMAN

Thanks, again, to John Hagman for this personal report on another New England radio meet. (Editor)

As is my habit, I attended the NEARC meet on April 26, 2003 in Nashua, New Hampshire. This meet is again being run by Sue and Marty Bunis of guidebook fame, who founded it years ago. Joe Coco and his wife who chaired until recently did a good job of breathing life into a gathering which had recently appeared to be withering. But Marty Bunis boasted yesterday that the never too popular July meet will sell out — something that hasn't happened in years, if ever. It's great to have these enthusiastic legends of the hobby back in the saddle.

I stayed as usual at Motel 6, whose internet rate is just too good to resist. I could leave Vermont at 4 A.M., and avoid staying over, but that's just too taxing. It was already enough of an ordeal lugging two tables full of massive Hickok sweep generators and other heavy metal stuff from the van in the steady drizzle.

I arrived at 7:20 A.M. and about half the hall was set up. It was 8 A.M. before I had my two Airline consoles playing and my tables priced and arranged.

I was annoyed in the parking lot by a couple of swap jackals who don't feel it's a bargain unless they buy it out of the van. Actually I concluded they linger outside, buzzing around vans like gnats attacking arriving campers during the Very Early Admission period (\$15) until 8 A.M. when the admission price drops to five bucks.



This Radiola gets a close inspection from a potential buyer.

It's such a whirlwind getting everything all out and arranged, at least when you have literally half a ton of stuff to sell as I did. I should mention I bought out a collection in the fall that consisted of more than 100 pieces, mostly fixer uppers, parts sets, and lots of test equipment.

I sold a bunch of stuff right away, and about 8:30 found a second to enter my Supreme tube tester and Jackson 1" oscilloscope in the contest. In addition to "Big" and "Little Tubes," and "Painted Sets," there was a "Service Equipment" category. I had recapped the

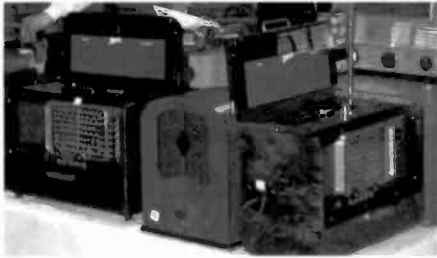

Examples of the "good stuff," including two nice portables.

Jackson, and had a transistor radio feeding it an audio signal so the screen wasn't just a flat line. The Supreme is a nice walnut paneled emissions tester in a leatherette case, from the fat-pin era. It was also working, with a Globe 27 fired up while on display. I mislabeled what button to push to test the tube, but someone fortunately corrected this for me. There was also a neat TV service console, and in the tube section, a giant transmitting tube all aglow nearby.

I got a chance to shop a bit around 9 A.M., and found a nice horn (for a lonely Magnavox driver base I have) for a mere \$20. I also had to pick up a couple of 6E5 eye tubes, which I buy at every meet, as these just aren't getting cheaper.

And I visited Joe Coco and picked up some capacitors. He has had some 8 and 16 mfd capacitors custom-made because he actually has a lot of customers who don't like to use 10 and 22 mfd replacements in a radio. Their reason is that the original engineer specified 8 or 16. It made me giggle — I had used a 100 mfd. at 400-volt capacitor recently to replace a 16/25 for an audio cathode bypass. His custom caps were very reasonable, though. I bought a bunch of the 16 mFd at 450 v for a dollar a piece.

There was also a bunch of rough low and middle end wood radios for sale fairly cheap, but as I have quite a few of these in the queue already, I managed to resist them. I did really want a very early Hickok tester (only two sockets) that looked like a work of art, but the fellow wanted \$500 for it which I thought a bit steep.

By 11 A.M., I had sold my Airline 1104 console, and about 500 pounds of stuff altogether. I probably erred selling a few items too cheap, but it's been a good deal of work sorting, cleaning, and lugging this stuff, so I was



A wide range of test equipment was in abundant supply.

still happy to see it go. Besides, I've bought enough stuff at swaps that was under priced by over burdened sellers. I see it as appropriate karmic payback. I do the same now that I have plenty too much to sell.

What remained at the end of the swap is the techy stuff that should sell well at Hosstraders hamfest the next weekend. So all in all, it was a great success.

Sometime before noon, I noted I'd won 2nd prize in the contest — the TV repair station got 1st. I also ended up selling the 1" scope to someone who had fallen in love with it. I have a 1" Hickok oscillograph still, so again I felt I should share the wealth.

Too many people started packing up at 11 A.M. for my taste, as usual. The Bunises had sent out cards to the general public advertising the show as lasting until noon, and I saw some people about that time to find the hall nearly empty. I didn't have my van reloaded until after 1 P.M., and noted with satisfaction my suspension travel had increased from two inches to well over four inches with the 500 pounds of sold items.



"I wonder if any of these work," might be the thought in this onlooker's head.

I thought of how far I've come as a collector in five years, to the point where I think in terms of pounds when selling — hundreds of pounds! I got a dollar a pound on average, not bad for a bunch of ancient test gear and a few battered radios.

Thanks to Sue and Marty for putting on another fine show. More of you should come to this one (that means you, Uncle Peter). I did have a chance to meet Sven, who took off pretty quickly probably thinking I looked busy. He should know I don't go to meets to make money, but to make friends and influence people.

I reserved a table for the July 26th NEARC show. See you there!

(John Hagman, "On the West Coast of New England," or 190 Park St., # 2, Burlington, VT 05401)

John Hagman is a Vermont "radio archeologist" with a talent (or weakness) for barn and basement dwelling radio orphans. His specialty is AC high-end wooden sets. 1930-1940. <http://home.att.net/~yanny>

The New England Antique Radio Club (NEARC) publishes "The Escutcheon" and holds swap and sell meets quarterly. Dues are \$14 a year. For membership information, write to Bob Andersen, P.O. Box 201, Spofford, NH 03462. bandersen@rfd.org

WITH THE COLLECTORS

The Picnic Portables of the Late 1930s

BY PHIL MACARTHUR

By including "picnic" in his title, Phil MacArthur conveys a real sense of the place portables have had in American life. We associate them with times of fun and relaxation in the days before the boombox and Walkman took over the scene. What a marvel of invention portables must have seemed in their day to everyone. (Editor)

In his 1991 work *The Portable Radio in American Life*, M.B. Schiffer leads us through fifteen years (1923-1938) worth of false starts for the portable radio. The real boom came only after the blossoming of high quality programming during the 1930s, the proliferation of high power stations, the development of Sylvania's low drain radio tubes (1A7, 1H5, 1N5, 1A5 etc.) in 1938, and the growing interest in the events unfolding in Europe in the late 1930s. From mid-1938 to the end of 1939, the number of models of true portable radios grew from perhaps a dozen to over 150.

The cabinet of choice for these portables was most often airplane or suitcase cloth of a striped tweed design. These radios were used at the beach, on roadside picnics, in boats, or at the camp so they had to be easily cleaned and had to survive the bumps and scrapes of every trip. Cloth-covered and sometimes leather-covered wood worked well, and many of these radios still look nice after 60 years.

My collection (I'm blaming Mr. Schiffer here) has about 40 of these gems, mostly of similar size (12" x 8" x 6") and weight (5 lbs, plus another 6-10 for batteries). There is a wonderful diversity of escutcheon design and dialwork, and I have included pictures of the extremes. Many of you will be able to guess the makers just these clues. The casework is quite varied,

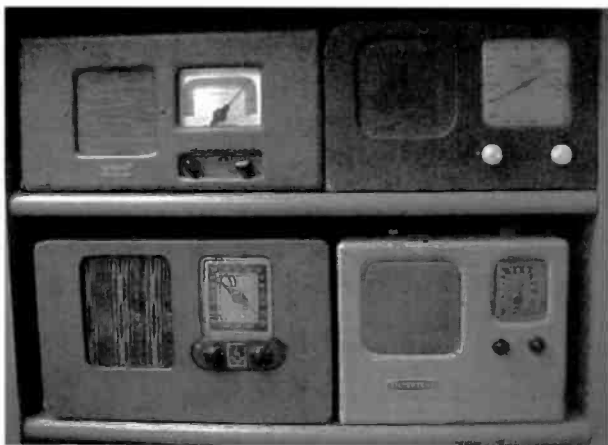

On the top row, left, is a Sky Chief and a Truetone Four 4BF. On the bottom row is an Emerson EA357 and a Silvertone 290.

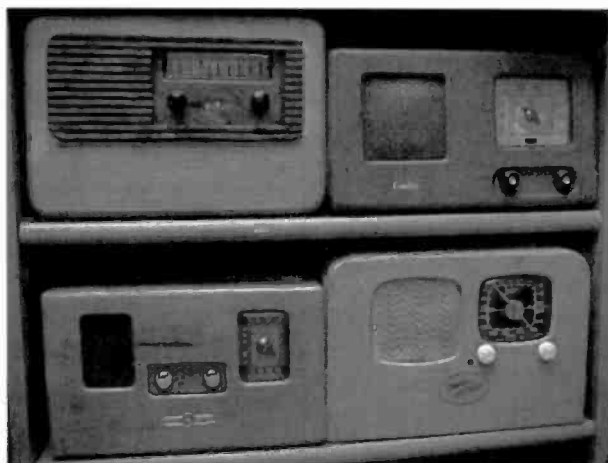

The top row, left, displays an Olympic 6A606 and a Grebe. On the bottom row are a GE and a Zenith 5G604.

with various colors and spacing of stripes overlaid on backgrounds of tweed in dozens of patterns. However, if the Catalins are at the extreme of

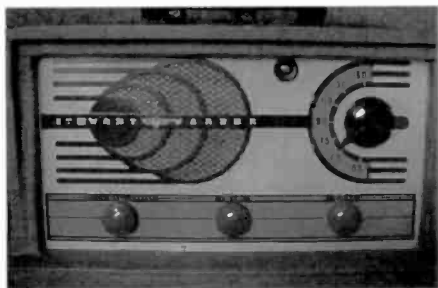

A tie in my "personal award" winning faces is the Stewart-Warner 9007A at the left, and the Stromberg-Carlson 1105 at the right.



Majestic's 7P420 receives the "best slogan" award for "Mighty Monarch of the Air."

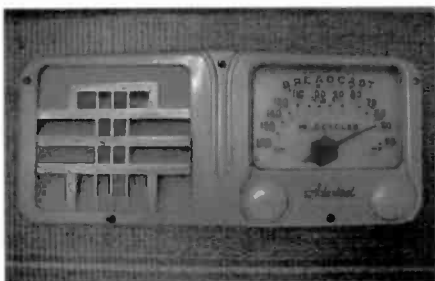

This Admiral P6 gets my award for the "fanciest face."



One of the "personal award" winners is the brass escutcheon on the Mantola L35XG6.

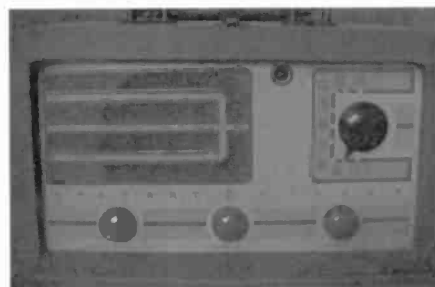

Shown in this photo is a 6-tube Stewart-Warner Model 9007F. This luggage-style portable was manufactured in 1946.

design impact and color, these picnic portables are the conservative country cousins.

Electronically, there is very little difference with a few exceptions. Several makers included a Wavemagnet antenna (Zenith's trademark) to improve reception in buildings and vehicles. Some included such touches as headphone jacks, a momentary contact dial lamp switch, a front panel battery/line switch, and a shortwave operation (most notably the Trans-Oceanic). Many includ-

ed the 1700 Kc police band, and most were "universal" sets, allowing three-way operation: battery and 115-volt AC or DC.

The only really different approach to universal operation I found in a Remler Scotty Model 93. Nine tubes are present providing two separate radios on one chassis — 35Z5, 35L6, 12A8, 12SK7, 12SQ7, and then 3Q5, 1N5, 1H5. 1A7 — all in a compact 11" x 10" x 7" case. What fun! I wonder if there are any similar examples out there.

My personal award winners are the following:
(Continued on following page)

(Picnic Portables, continued)

Best Slogan: Majestic, "Mighty Monarch of the Air." Most Serious Radio: Zenith Trans-Oceanic Clipper (duh!). Deco Face: a tie between the Stromberg-Carlson 1105 and the Stewart-Warner 9007A. Grille: the embroidered sailboat on the Zeniths of the period. Escutcheon: the all-brass Mantola L35XG6. Fancy Face: Admiral P6.

E-mail me with your entries. Heck, SELL me your entries. I realize the overall beauty contest would be taken by the Radiola 24, but that's another era, not to mention another article!

Reference:

Schiffer, Michael, Brian. *The Portable Radio in American Life*. Tucson and London: The University of Arizona Press, 1991.

(Phil MacArthur, 701 Spanish Main #71, Summerland Key, FL 33042)

Phil MacArthur, an engineer, teaches mathematics at the Florida Keys Community College in Key West. An antique radio collector since 1955, he enjoys hearing from other collectors at keywestmac@cs.com.

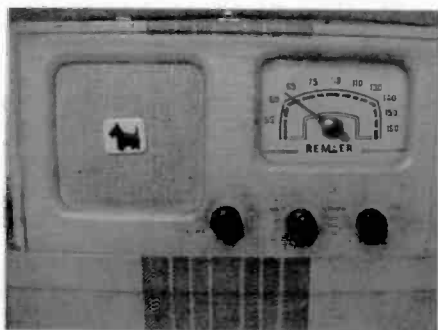

This is a Remler "Scottie" 93. Remler radios featured a Scottie dog on the front of their sets..



Here is the typical chassis of the "picnic portable" radios, this one for the Remler Scottie 93.



This photo shows approximately 20 of the "Picnic Portables" in my collection. On the top row, left to right is a Zenith 5G401, Admiral P6, Mantola R661, Firestone Roamer S-7426-7, Majestic 7P420. On the 4th row down, at far left is a G.E. Beamascope, which is similar to the one used by Western Electric as the platform for the very first transistor radio. Next to it is an unusual Zenith with the upside down Bakelite chassis (5419) in a tweed case. This chassis is more often seen in a varnished wooden case.



RESTORATION TOPICS

A 3-Tube AC-Powered "Regen"

BY DOUGLAS D. FOX

During the 1930s, the regenerative receiver was very popular with entry level radio builders. Usually, these sets were battery-operated. This 3-tuber is an AC/DC set with a floating ground. Like any AC/DC set, the usual safety precautions should be observed. The use of an isolation transformer is recommended. (Editor)

I acquired this interesting 3-tube AC powered regenerative radio about three years ago from another collector. The set uses two Type 37 triodes for the regenerative detector and audio amplifier. A third Type 37 is connected as a half-wave rectifier (grid and plate are tied together). A resistor line cord is used to drop the line voltage to about 119 VAC, and the heaters of the three tubes are connected in series.

The tuning circuit is very simple, employing a single gang tuning capacitor and a plug-in coil for the Broadcast Band (BC). The BC coil was the only coil supplied with the set. The radio uses a regenerative detector in which the volume control adjusts the amount of regenerative feedback.

There wasn't much to be done to restore the radio. After thoroughly cleaning the radio, I removed the front panel and repainted it a gloss black. The filter capacitors were replaced. After the set was reassembled and tested, it turned out to be a good performer on local Chicago metro stations, picking up several with enough volume to drive a high impedance magnetic cone speaker. The set has not been tested on shortwave, since no SW coils were available at the time of this writing.

I have no idea of the origin of the radio, but I do not think that it was home-brewed. Why? Because all holes, both in the chassis and front panel, are factory punched. It also seems that there was provision for more than one coil, since they are plug-in. There are no markings or any indication of a manufacturer any-

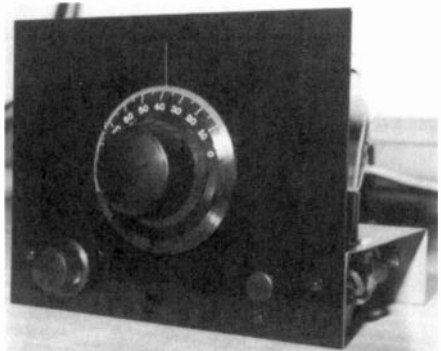

The front panel of the 3-tube regenerative radio.

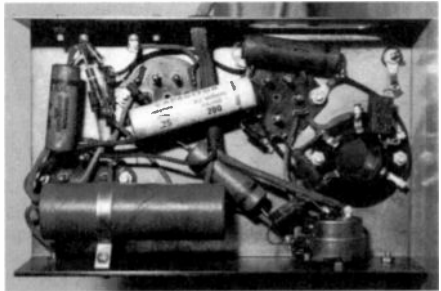

A view looking underneath the chassis of the 3-tube regenerative radio.

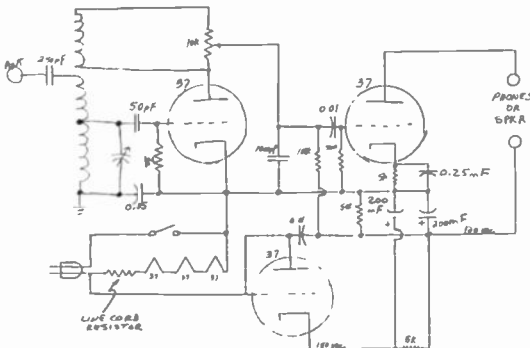

Schematic diagram for the 3-tube regenerative radio.

where on the set. Perhaps this was a training kit for a correspondence course? If anyone has information on this radio, please contact me directly. Thanks!

(Douglas D. Fox, 603 S. 12th Ave., St. Charles, IL 60174)

Doug Fox is an engineering technician for CX2 Technologies, Inc. in Burr Ridge Ill. He has had an interest in antique radios that goes back to his junior high school days. Among his collecting interests are battery radios from the 1920s, early AC sets, Philco cathedrals, Bakelite table radios, and early hi-fi gear.



PHOTO REVIEW



This column presents in pictorial form many of the more unusual radios, speakers, tubes, advertising, and other old radio-related items from our readers' collections. The photos are meant to help increase awareness of what's available in the radio collecting hobby. Send in any size photos from your collection. Photos must be sharp in detail, contain a single item, and preferably have a light-colored background. A short, descriptive paragraph **MUST** be included with each photo. Please note that receipt of photos is not acknowledged, publishing is not guaranteed, and photos are not returned.



CUTTING & WASHINGTON TELEDYNE – This 1925 receiver was manufactured in Minneapolis, Minn. It has a regenerative circuit using four Type 199 tubes. Inside are the original batteries. (*Ross Mason – Mason City, IA*)



AGA CRYSTAL SET – This 1926 crystal set was made in Sweden. It has variometer tuning inside its wooden case and jacks for two headphones. (*Erwin Macho – Vienna, Austria*)

MARCONI TYPE 22-B RECEIVER – This 2-tube receiver was manufactured for British naval use. Connected by buss wire on the left is the Type 229-B long-wave panel. Connected in the same way on the right is the Type 227-B amplifier. (*Jim Taylor – Bournemouth, England*)

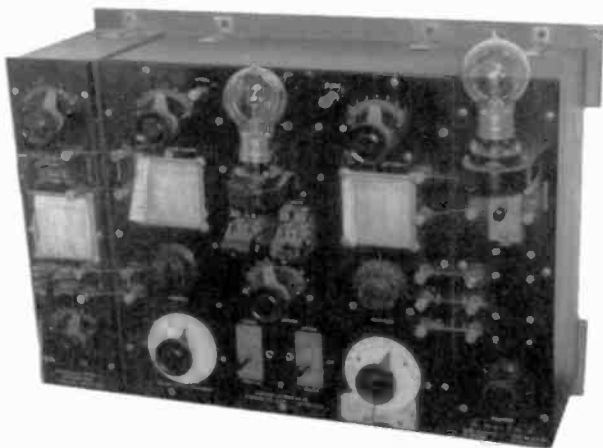
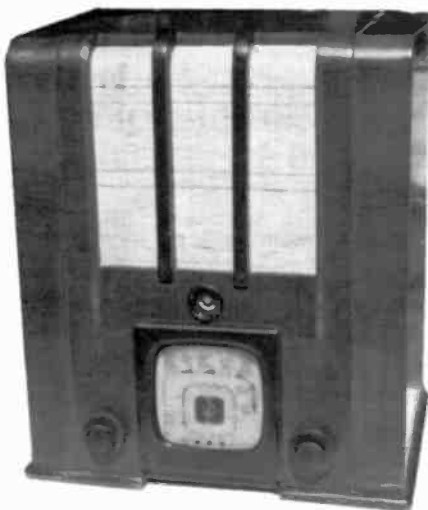

PHOTO REVIEW



ATWATER KENT MODEL 627 – This 1933 cathedral has a 7-tube superheterodyne chassis and features automatic volume control. It stands 19" tall and 15" wide. I found it with the dealer's operating instructions still attached behind the knobs. (*Dave Crocker – Mashpee, MA*)



PHILIPS MODEL 324N – This 7-tube, wooden cabinet tombstone was manufactured by the Philips Co. of Holland in the late 1930s. It tunes from 530 KHz to 22 mHz in three bands. It has an 8" PM speaker and uses Type EF3 as RF and IF amps, Type EK2 as converter, Type EBC3 as detector, Type EL4 for output, and Type AZ1 as a rectifier. The "magic eye" is a Type EM4. (*Carlos Queiroz – Buffalo, NY*)

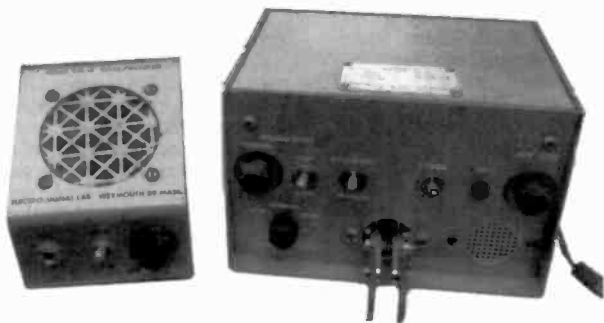

ENEMARK KM-1 AND EK-1 TRANSISTOR CODE KEYERS – I designed the two transistor code keyers shown in this photo in 1964-1965. Model KM-1 on the left has tone and hi-low volume controls. It keys transmitters using a large reed relay. Several dozen were sold to Hams through *QST* ads, but at \$19.95, the profit potential was minimal. The Automatic Keyer Model EK-1 on the right uses early integrated, dual-2 input nand-gates (Fairchild mL914), 2N2926s, and 1N276 diodes. It has a full speed range, adjustable make-break ratio, variable side-tone, dash memory, reed relay keying, and included a Brown Brothers, built-in paddle as shown. This prototype was priced out to sell at \$99.95, but the investment needed for its production was too high to be practical to compete with a Waters product. I have used this one-and-only keyer in my Ham station for years, and it still works very well! (*Robert E. Enemark – Duxbury, MA*)



AUCTION REPORT

Estes Auction Seville, Ohio – September 21, 2002

REPORTED BY RAY CHASE

Richard Estes Auctions of Seville, Ohio, seems to be the premier radio auction house, (they did the 3-day Muchow auction in Elgin, Illinois), so we decided to take a look at one of their specialty radio auctions held in Ohio. Advance advertising indicated that some very rare and historic items would be included, some from a collector in Hawaii. Upon arrival, we were somewhat dismayed to find an old barn behind a farmhouse as the auction site, and I mean a really old barn! Outside were about nine tables of "low-end radio stuff" — boxes of tubes, chassis, parts, etc. The forecast was for storms, and, although there were tarps about, I wondered how these goods would fare through the night.

Inside the barn was just as rustic as the outside; old church pews had been arranged in sloping tiers for seating and old carpets covered the dirt floor. However, the range and breadth of the radios was outstanding. No less than six Atwater Kent breadboards; Paragons, early DeForests, Grebes, hosts of really nice cathedrals, tombstones and consoles, about 20 microphones, about 25 crystal sets, over 50 speakers of all types, many good tubes, parts books and paper. Items were coming in Friday evening and even Saturday morning. In all, over 750 lots were auctioned, not counting the



Shown here are some of the items sold: a DeForest SP-500 selling at \$1,200, a Marconiphone 1 tube receiver at \$300, a Paragon Type VI at \$350, a DeForest/Crosley Model 51 at \$100, a Kodak "microphone" speaker at \$450, a black Neutrodyne, complete with tubes and caps, at \$350, and an RCA Radiola III-A, with tubes, at \$105.

"cheap stuff" outside.

On Saturday, a good crowd turned up. Although most of the license plates were from Ohio, buyers came from North Carolina, West Virginia, Louisiana, Pennsylvania, New Jersey and other states. The outside goods sale started at 8:30 A.M. They had suffered some water damage from a fierce storm that passed through during the night. Many lots sold for one or two dollars, and tubes were sold for almost millipennies each when one considers the size of the box lots and the sale price. Many of the buyers' pick-up truck beds quickly filled up.

At 10:15 A.M. inside the barn, Richard Estes started the sale of the good stuff, and he worked nonstop until 4:30 P.M. when he was relieved. The sale ended at 5:45 P.M. The auction moved right along at 100 lots per hour and each item was well described and displayed. Prices were generally fair and reasonable and there was no buyer's premium. Really good buys were occasionally to be had, especially if you stayed to the bitter end. There was good quality and quantity and no re-

A warning: Auction prices are not current values. Our selection of auction items is not necessarily complete. A listing such as this cannot adequately include the condition of cabinets, chassis, transformers, tubes, the operating status of the set, and the inclusion of incorrect, restored or replica components, etc. Auction prices are the result of the excitement of the auction process, the skill of the auctioneer and the specific interests of the participants. Nevertheless, auction prices serve as useful references and as another element in the value determining process. The possibility of error always exists, and if we are notified, corrections will be reported.

serves that sometimes keep items from being sold. The total realized from this sale was in the order of \$62,000, much better than all of the recent AWA auction sales. Estes has some interesting auctions coming up so it will pay to keep an eye on their schedule in A.R.C. ads.

Approximately 50 sales are not listed either because they were missed or were very low in value. Prices are rounded down to the dollar.

e=excellent, vg=very good, g=good, f=fair, p=poor, unk=unknown maker, WT=with tubes, NT=no tubes, N.I.B.=new in box, wk=working, nwk=not working, PB=push button, N.O.S.=new old stock

Adams Morgan Paragon 3A, in small cabinet with doors, vg.	\$2,000
Adams Morgan Paragon Type IV, WT (3)	350
Admiral Bakelite table radio/phone	12
Admiral portable, flip top, red plastic.	15
Aircastle tombstone, refinished, 3 knobs, nice 75	
Airline 62-103 semi-cathedral, 3 knobs, vg ..	150
Airline plastic, green	12
Airline, wood table, 1936, w/eye tube, vg	80
Atwater Kent 9 breadboard, WT	1,400
Atwater Kent 9 breadboard, (4445), w/tags, WT	1,200
Atwater Kent 10 breadboard, (4560), w/Atwater Kent horn & tubes, g	900
Atwater Kent 10 breadboard, WT	550
Atwater Kent 20 big box, NT	75
Atwater Kent 20 small box, NT	45
Atwater Kent 20 small box, NT, g	75
Atwater Kent 20, f	20
Atwater Kent 20, NT, (2), g	50, 110
Atwater Kent 30, NT, g	55
Atwater Kent 33, NT	55
Atwater Kent 33, NT, g	65
Atwater Kent 35, in desk cabinet, vg	85
Atwater Kent 35, NT, (2)	15, 15
Atwater Kent 36, NT, g	55
Atwater Kent 40, metal box	20
Atwater Kent 55, w/speaker stand, nice,	325
Atwater Kent 55, metal box, w/speaker	25
Atwater Kent 92 cathedral, 3 knobs, vg	625



This RCA Radiomarine AR 8503 long-wave regenerative receiver brought a high bid of \$145.

Atwater Kent 208 cathedral	500
Atwater Kent 217 cathedral, g	275
Atwater Kent 356 tombstone, 4 knobs, refinished, vg	300
Atwater Kent calendar print, p	5
Atwater Kent E cone speaker, f, (2)	15, 20
Atwater Kent E cone speaker, g	15
Atwater Kent F series dynamic speaker, (2).10, 50	
Atwater Kent Radiodyne breadboard, WT ..	1,500
American baby microphone, in box	5
American Electric Burns petal horn speaker, black, good driver, no chips	275
American Microphone suspension microphone on WE frame	25
American Microphone, wood ring suspension desk type	125
American Microphone, round suspension desk type, nice	125
American suspension desk microphone	55
American Telegraph Radio Electrical School Bakelite receiver	40
Antenna, loop, large diamond shaped, unk ...	75
Apex cathedral, no knobs, p	25
Argon simulated RCA microphone, on floor stand	10
Artif Baby Grand 3 dialer, NT	35
Astatic 67 desk microphone	7
Audiotone spice rack transistor radio	5

(Continued on following page)



Shown here is just a small assortment of the many tombstones and cathedrals of the 1930s that were offered for sale in this auction.

(Estes auction, continued)

Automatic 61332K table, wood, g	50
Automatic Electric headphones,	7
Baldwin Concert Grand horn speaker	60
Radio News magazines, batch	30
Beaver "Baby Grand" small crystal set, in box ..	350
Beitmans service book, 26-38	3
Benrus gold clock radio, very nice	35
Birnbach 61 2-dialer battery set, w/built-in speaker, WT	40
Bkonder-Tongue field strength meter	15
Bogen amp, WT 6L6 (2)	50
Transistor radios, some in boxes, (box lot) ...	30
British headphones	25
British Thompson Houston BTH wood box crystal set, vg	300
Brunswick 5KR with hood, p	4
Brunswick mantel speaker, (2), g	10, 20
Bulova 120 clock radio, white plastic gold trim ..	35
Bunnell telegraph box relay, vg	150
Bunnell telegraph relay, (2)	30, 35
Bunnell telegraph relay, vg	55

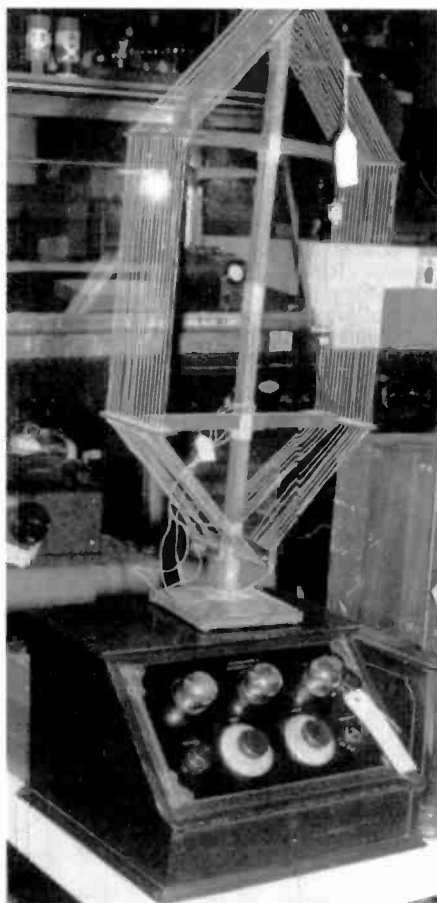

The large Matheson loop shown here sold for \$105; the Kennedy V, below, with tubes, sold for \$450.



This auction featured a large assortment of early and novelty microphones for sale.

Burn battery eliminator	30
Candlestick phone microphone, w/switch, unk ..	40
Case 5-tube 2-dialer, NT	40
Centennial, small	65
Charlie McCarthy Radio Party game, vg	85
Coca Cola cooler radio, w/clock-radio installed, f	200
Coca Cola cooler radio, modern, N.I.B.	25
Columbia wood table, 2 knobs	20
Continental button microphone, ring suspension on old stand	200
Crosley 20A wood table, 3 knobs, f	35
Crosley 51, WT, g	50
Crosley 51, NT	85
Crosley 52, WT	95
Crosley 66TA plastic, w/big dial, 4 knobs	25
Crosley 124 grandfather clock radio, wk, vg ..	300
Crosley 125 "Little Boy" console, nice	85
Crosley Musicone speaker, p	20
Crosley plastic "Trooper" & red Airline plastic. 45	
Crosley Pup, WT	325
Crosley Trirdyn, w/paper, NT	55
Crosley Trirdyn, NT, g	35
Crosley XJ, NT, g	200
Decca wood table disc phonograph, w/lid	10
DeForest (Canadian) Everyman crystal set, w/coil, g	700
DeForest 51 (Canadian Crosley), WT	100
DeForest D10, WT & loop, g	750
DeForest DT-600 Everyman crystal set, w/coil, complete	600
DeForest SP-500, NT	1,200
DeForest crystal detector for panel set	45
Delco wood table, 2 knobs, g	35
Detrola 571, black plastic, w/white knobs, grill bars bent	50
Detrola Pee Wee, wood case	75
Deutsch Tel. Works loop antenna, g	175
Dictogrand Dictograph "roll" speaker, g	225
Digital clock, w/light, small, looks like TV set ...	7
Dijou wood box crystal set, g	200
Ding Dong School record player	20
Edison cylinder records, (box)	40
Edison Home cylinder phono, complete	500
ElectroVoice 726 microphone, g	100
ElectroVoice V-1 ribbon microphone, on floor stand	175
Emerson brown & white Catalin, no back, g ..	150
Emerson, Treasure Chest, vg	300
Emud, German radio from the 50s, multiband ..	17



This Grebe CR-9 in good condition, with tubes, won a high bid of \$450, while the open type Atwater Kent 9 (4445), sold for \$1,200.

Erickson candlestick phone	225
Esterbrook, "Radio" fountain pen tips, metal box ...	5
Fada Neutrodyne 3-dialer kit radio, NT, g	25
Fada Neutrodyne 3-dialer, NT, g	40
Fada white urea cabinet, 4 knobs, no cracks, g	85
Fairbanks Morse large table, 4 knobs, PB, f	35
Fellowcryst wood box crystal set, g	300
Firestone wood table	10
French 3-tube battery radio, (European), tubes on top, vg	700
Freshman small cathedral, 2 knobs, g	95
Garod white plastic, minus 1 knob	10
GE 62 tombstone, 4 knobs, refinished, g	55
GE 145 portable, red plastic, vg	17
GE 401, red plastic, '50s	17
GE Deco Bakelite 7" table TV, vg	85
GE H51 large ornate console, w/doors, g	25
GE K64 cathedral, 4 knobs, g	150
GE transistor radio, w/leather case, (2) ..	10, 11
GE white plaskon, w/gold grill	20
GE white plastic, w/red knobs & pillow speaker	20
GE wood table, 4 knobs, PB, 2 grills	30
GEC telephone ear piece, old	25

General Clock grandfather clock radio, Simplex chassis, no speaker, g	135
German WWI field phone, in wood case, g ..	150
Grebe AC-6, on table speaker stand, green, f	17
Grebe CR-9, WT, g	450
Grebe CR-18, no coils, WT, g	1,900
Grebe MU-1, with chain, NT, g	125
Hallcrafters S-38, slide rule dial, gray	30
Hallcrafters SB-44 panadaptor	35
Hallcrafters TW-1000, g	65
Home brew, 2-dialers (2)	7, 10
Home brew, 3-dialers (4)	15, 15, 20, 40
Home-brew crystal set, on wood box, w/ ERLA detector	80
Home-brew crystal set, w/phones, g	35
Home-brew large crystal set tuner	40
Home-brew loose coupler crystal set, small, vg	155
Home-brew wood box crystal set, g	35
Headphones, (3) pairs	10
Heathkit SB-102, w/speaker, phones & paper	150
Hi-Q, Strauss stores boy's crystal set, in box	22
Hickock 600A suitcase tube tester w/paper, g	185
HMV (Canadian?) small wood table set	15
Howe crystal set	35
Jackson 6400 tube tester, wood case	105
Jackson Bell 240 small semi-cathedral	150
Jewett Super Speaker tall horn, g	60
Kadette small wood table, 2 knobs, slight damage	40
Kellogg candlestick phone	100
Kennedy V, WT (3 exposed), g	450
Knight Star Roamer receiver	15
Kodel 3 tube battery set, WT, minus 1 knob	300
Kodel Sr. speaker, looks like large desk mike	450
L'Tatro 46-50 tombstone, 3 knobs, refinished, g ..	45
Lafayette early CB radio	5
Lemco (Lee Electric Mfg. Co.), wood box crystal set	125
Lester piano radio, small repair in Bakelite, w/paper	125
Lifetime Radio Corp. D-42 microphone	10
Loop antenna, collapsible, unk but factory-made	50
Loose coupler, unk, vg	450
Lyric cathedral, 3 knobs, g	275

(Continued on following page)



This 1932 Emerson Model AC5 "Treasure Chest," in very good condition, sold for \$300.

(Estes Auction, continued)

Magnaphone driver & base for a horn speaker ...	30
Magnavox 6-transistor radio	5
Magnavox M-4 small horn speaker	150
Magnavox R-3 horn speaker, g	65
Majestic 35 mid-boy console, w/doors	30
Majestic WG-10 horn speaker, black, g	125
Mantel cone speaker, grill p, unk	55
Marble base detector, unk	55
Marconi (Canada) wavemeter, wood case ..	100
Marconi 2-piece receiver & amp home radio set, wood slope front, receiver, WT	600
Marconiphone 1-tube receiver, NT	300
Marconiphone low frequency amp, NT	150
Matheson large loop antenna	105
Meissner suitcase style recorder, player & radio, large	15
Melodyne 3-dialer, large, NT	35
Meridian (New York) crystal set, wood base	100
Meteor small plastic, w/2 white knobs	20
Meters, wood case lab style, (4)	17
Metrodyne 3-dialer, NT, no cabinet	35
Mickey Mouse red Catalin napkin holder	65
Microphone, suspension type on floor stand, brass ring, unk	115
Military, ARC-5 Command Set broadcast band receiver, w/AC supply	15
Military, BC-187 transmitter, needs paint, some mods, f	25
Military, BC-227 receiver, made by Cardwell, SN 1, WT 199s, factory new	1,600
Military, Japanese WW II field phone	250
Military, LS-3 metal case speaker, WW II	15
Military, RAC-7 receiver	10
Military, WW I Stromberg-Carlson buzzer tele- graph set, leather case	35
Milodyne (All Radio Corp.) box mantel speaker, g	30
Mingle MR-1 crystal set	115
Model EL ring suspension desk microphone	275
Monarch crystal set, Cleveland, OH, round shape, cute	175
Monarch small cathedral, 3 knobs, vg	65
Motorola 79X plastic, modern style	30



The Dictogrand Dictograph "roll" speaker, above, sold for \$225, while the RCA Radiola IV, complete with tubes and paperwork, went for \$700.

Motorola console, police desk, radio control, metal	10
Music Master horn speaker, wood bell	175
National 1-10 receiver, g	20
National small metal case speaker	40
Neodyne 3-dialer , in console cabinet w/speaker, WT	60
Neutrowound, black, metal, WT & caps	350
Novelty radio, Cabbage Patch, in box	5
Novelty radio, microphone style	5
Novelty, cannon radio, N.I.B.	7
Novelty, Coke vending machine, N.I.B.	5
Novelty, small keg radio	15
Novelty, two Nutcrackers	15
Packard Bell 45 small wood table, 4 knobs,g.	175
Parts, (6) Catalin knobs and handles	60
Parts, assorted knobs, box	30
Parts, sockets, caps, etc., flat	12
Parts, (± 20) meters, flat	20
Peerless cathedral speaker plus parts	12
Peerless oscillation brass blade fan, ± 14"	45
Philco 37-116, large, g	60
Philco 37-611 tombstone, 4 knobs, g	90
Philco 38-12 wood table, 2 knobs	50
Philco 40-130 wood table, 4 knobs, g	40
Philco 42-34 wood table, 2 knobs	30
Philco 90 cathedral, g	250
Philco 118 cathedral, vg	125
Philco 124 cathedral, p	25
Philco Jr. 80 cathedral, g	85
Philco Jr. cathedral, refinished, g	60
Philco Jr. cathedral, two-tone, g	55
Philco PT-95 table, wk, nice	35
Philco small wood intercom speaker	5
Philco T88 transistor radio, in box	12
Philco table, Deco, w/rounded end, 4 knobs, g	105
Philco table TV, 7-inch	100
Philco Transitone, Bakelite, 2 knobs	5
Philco Transitone, red plastic	15
Philips table, orange plastic, nice	25
Philmore crystal set, headphones, in box	5
Philmore crystal set, w/glass dome	25
Philmore Super crystal set, w/dome, in box ...	40
Phonograph arm, old electric type	15



Always in demand, this early Zenith Model 40A console, with phonograph and all original papers, brought a high bid of \$2,200.

Pilot midget cathedral, 3 knobs	175
Priess Straight Eight highboy, w/loop	25
Puretone (Pure Oil Co.), white plastic, 3 knobs, g	20
Quality, brown plastic, 2 knobs, vg	30
Radio Master 1954-55 book	4
Radio Tubes game, small pocket style,	15
Radioriet wood box crystal set, g	150
RCA "Ding-Dong School" phonograph	30
RCA "Golden Throat" advertising piece, w/1939 World's Fair motif, g	30
RCA 100 cathedral, 4 knobs, g	90
RCA 100 drum speakers, (2)	35
RCA 100A mantel speaker	12
RCA 106 floor model tapestry speaker, f	60
RCA metal case communications receiver, w/speaker	115
RCA Radiola 16, NT, no knobs	20
RCA Radiola 17, WT & hood	40
RCA Radiola 18, missing 1 tube, no hood, f	25
RCA Radiola 18, WT, refinished, no hood	25
RCA Radiola 26, WT & handle, complete, vg	375
RCA Radiola 60, refinished, g	70
RCA Radiola AR-812, NT	20
RCA Radiola Grand, poor restoration, NT	100
RCA Radiola Grand, WT, vg	500
RCA Radiola I, ER 753A, complete	800
RCA Radiola II, g	250
RCA Radiola III, WT	75
RCA Radiola III, NT, (2)	45, 60
RCA Radiola IIIA, w/WD11 adaptor	110
RCA Radiola IIIA, WT	105
RCA Radiola IV, complete w/paper & tubes	700
RCA Radiola Special, complete	2,000
RCA Radiola Special, no case	65
RCA Radiola, (Canadian), WT 3, g	150
RCA Regenoflex, top separated from case, NT, f	75
RCA UZ-1325 horn, f	45
RCA Victor 45 player, w/lid, Bakelite	35
RCA Victor 45 rpm changer	10
RCA 77DX floor stand microphone, g.	1,300
RCA Victor 110 cathedral, 4 knobs, g	95



This RCA multiband receiver, in a metal case, sold for \$115.

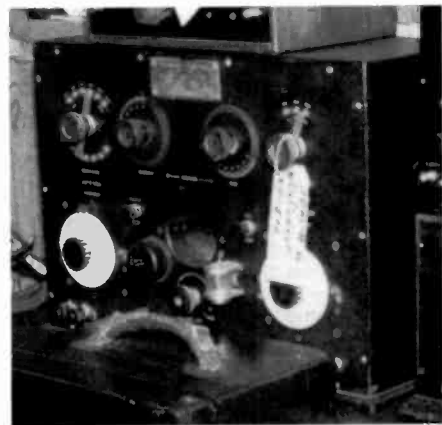

This early DeForest SP-500 receiver, with socket for exposed tube, was won with a bid of \$1,200.

RCA Victor 125 tombstone, 4 knobs, g	85
RCA Victor advertising piece, plastic, from the '60s or '70s	25
RCA Victor dealer framed certificate, 18" x 12"	20
RCA Victor Deco tube tester, wood case, g ...	30
RCA Victor flip-top portable	10
RCA Victor Jr. microphone, w/wrong stand	300
RCA manne DF multiband radio, metal case, g5	
RCA Victor plastic clock & sign "Replacement Parts"	15
RCA Victor portable solid-state receiver.	25
RCA Victor R-22S Repwood mantel radio, g 180	
RCA Victor R28 chest type, w/2 small doors, 3 knobs, vg	125
RCA Victor Radiola, plastic, 2 knobs	12.5
RCA Radiomarine AR 8503 long- wave regen receiver	145
RCA RC 24 tube manual	7
RCA Victor Service Notes (red books), '29 & '30, (2)	20
RCA Victor Service Notes, (red books), '38, '35, '39, (3), f	30
RCA Victor small wood table radio, 2 knobs, PB, nice	45
RCA tube manual	7
Regency MR-10 monitor radio	7
Remco crystal set complete, in box	15
Remler Infradyne amplifier, WT, vg	75
Rider, complete indexes, (11)	15
Rider Vol. V	5
Rider Vol. VI	9
Rider Vol. VI, N.I.B.	17
Rider Vol. IX	5
Rider Vol. XIV	5
Rio crystal set	45
Rola horn speaker	95
Sencore "Super Cracker" (tester ?)	12
Sentinel, Bakelite	15

(Continued on following page)

(Estes Auction, continued)

Sentinel, small plastic, 2 knobs	20
Sentinel, white plastic, 3 knobs	25
Shure 55 microphone, w/floor stand	80
Shure 55-B microphone	90
Shure carbon ring stand desk microphone, brass ring	175
Silvertone 6125 wood table, 4 knobs, PB & eye tube, vg	45
Silvertone 9000 brown plastic, 2 knobs	15
Silvertone tombstone, 1954, 4 knobs, g	55
Silvertone, red plastic, 3 knobs, f	7
Silvertone service & parts book, 1928-36	20
Silvertone small console, 3 knobs & big dial, nice	50
Silvertone wood table radio/phone	5
Silvertone wood table, 4 knobs, PB, f to g	35
Sonochorde cone speaker, cloth p, g	95
Sonora 3-dialer, NT, g	30
Sparton 400 peaked tombstone, 2 knobs, g ..	75
Sparton 400 tombstone, refinished, g	125
Sparton 517, cube style, wood, 3 knobs	150
Sparton ornate highboy	65
Speaker table, w/RCA speaker	50
Spltdorf single dial battery set, NT, f	40
Sterling large table, 3-dialer, NT	90
Stewart-Warner "book" radio, cover separated, g	65
Stewart-Warner shortwave converter, WT (2) blue, vg	90
Stewart-Warner, Deco, small, brown plastic, cracked	55
Stromberg-Carlson 28, AC, WT, f	55
Stromberg-Carlson 28 table, wood	25
Stromberg-Carlson 635B table, wood, g	15
Stromberg-Carlson cone speaker, needs cone	10
Stromberg-Carlson metal frame cone speaker, torn	10
Superior headphones, w/parts	7
Sylvania "Detector Tube" old advertising sign, 12"h x 40"w	125
Sylvania tube caddy	30
Telegraph omnigraph & key on large wood base w/label, unk	75
Telegraph practice set, key & buzzer on wood base, unk	25
Telegraph key & sounder on base, unk	25

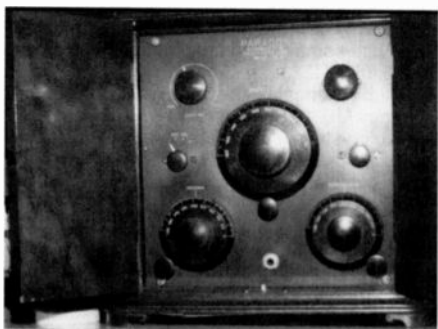

This 1924 Adams-Morgan Paragon Type 3A receiver, with front doors, in very good condition, sold for \$2,000.

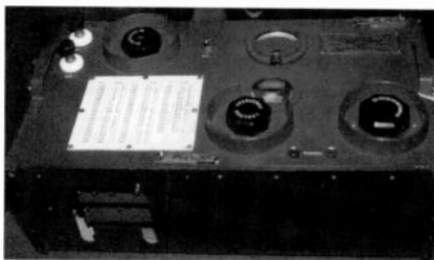

This Military Type BC0227A, manufactured by Cardwell, SN1, with Type 199 tubes, in factory new condition, sold for \$1,600.

Telegraph key & sounder on long wood base, unk	15
WE sounder	10
Temple cathedral, not original dial, wk, f+	105
Thermodyne Master Control, NT, f	15
Thompson horn speaker	105
TMC Wireless (British) wood crystal set, g ..	100
Tower Miestersinger horn speaker	75
Transistor radios, 3 flats	9
Transistor radios, 5 boxes	115
Truetone 911B large wood table, 4 knobs., PB, eye tube	55
Tube(s): 01-A, in box	55
Tube(s): 01-A, w/g fil, (5)	40
Tube(s): 01-A, (4) w/g fil, plus (3) duds	25
Tube(s): 01-A, (12) w/g fil, (20)	75
Tube(s): 01-A, g fil, (10)	55
Tube(s): 01-A, g fil, (3)	20
Tube(s): 01-A, g fil, (4)	25
Tube(s): 01-A, g fil, (5)	50
Tube(s): 01-A, (6), (2) BB, all g fil	115
Tube(s): 01-A, (6) g fil, (8)	50
Tube(s): 2A3, g	30
Tube(s): WE photocell, (3), plus (1) 351A & (1) 336	25
Tube(s): 5 flats, (3 sets)	20, 25, 60
Tube(s): 6L6, metal, (3), & 6A7 (2), all g, (2)	20
Tube(s): 6SN7, N.O.S., (6)	20
Tube(s): 6U5s, g fil, (7)	20
Tube(s): 24, some new, (18)	10
Tube(s): 26, in box, g fil, (16)	65
Tube(s): 27 & 31, each in box	25
Tube(s): 27 & 37 Arcturus blue, g fil	20
Tube(s): 40, N.I.B.	7
Tube(s): 45, (5), g fil, 71, (3), g fil, & (2) duds ..	50
Tube(s): 46 1B, (13)	50
Tube(s): 199, (8), and a 120, g fil	50
Tube(s): 250TH & one 100TH, g fil, (3)	50
Tube(s): Apollo globe 27 1B	20
Tube(s): Arcturus 27, g, & (2) display tubes ..	10
Tube(s): Arcturus 50, tests g	105
Tube(s): Arcturus 1828 & RA1, g fil	40
Tube(s): Arcturus AC26 & AC28, g fil	30
Tube(s): Foreign, (±12), in box	90
Tube(s): 51 blue & (2) DeForest 24A, g fil	7
Tube(s): box lots, (3)	22, 32, 80
Tube(s): Globe, (±25), half duds	45
Tube(s): CG type, "rainbow," in box	20
Tube(s): Champion 2A3, N.I.B.	50

Tube(s): DeForest DO1-A, in can, display only ...	15
Tube(s): DL-15, in can, g	65
Tube(s): DL-15, in can, g fil	55
Tube(s): DL-15, w/can, but no top, g fil	35
Tube(s): DL-15, w/can, no lid, g fil	30
Tube(s): DV-3, w/can, g fil	85
Tube(s): DV-5, g fil	35
Tube(s): GE 2A3, tests g	40
Tube(s): Globe 45, (2), & Globe 46, g fil	30
Tube(s): Globe style 50, g fil & emission	65
Tube(s): Kenrad 45, (2), N.I.B.	145
Tube(s): Mullard EL-33, in box, used, (2), g fil, .	20
Tube(s): 45, N.I.B. & WD-11 dud	40
Tube(s): Nuvistors, N.I.B., (8)	7
Tube(s): Raytheon 50, N.I.B., tests g	135
Tube(s): Raytheon 50, N.I.B.	90
Tube(s): Raytheon 50, used, checks OK, in box	75
Tube(s): RCA 01-A, N.I.B., (3)	55
Tube(s): RCA 203A carbon plate, g fil	25
Tube(s): Thermatron 01-A, N.I.B.	65
Tube(s): Transmitting, box	45
Tube(s): tubular audiotron, one fil g, unk	45
Tube(s): Tube caddies full of TV tubes, (2)	12
Tube(s): Universal WD-11, g fil, g	40
Tube(s): UV-199, (6), g fil.	75
Tube(s): UX-99, & a 120, (10), g fil.	60
Tube(s): Van Dyke 201, N.I.B., tested	35

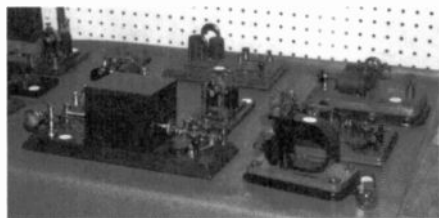

The early telegraph relay with a box , at left, sold for \$150, while the other miscellaneous relays brought prices of \$35 to \$55.

Tube(s): 12AU7, 12AT7, 12AX7, N.I.B., (11) .	20
Tube(s): VT-25, Hytron ST style, in box	25
Tube(s): VT-5, in box	25
Tube(s): VT-5, N.I.B., (2)	105, 125
Tube(s): WD-11, (2), one g fil	10
Tube(s): WD-11, N.I.B.	65
Tube(s): WE 35, in box, (2), g fil.	25
Tube(s): WE 101D, ST style, g fil.	25
Tube(s): WE 101F, g fil	70
Tube(s): WE 205D, Bakelite base, g fil	200
Tube(s): WE 259A, N.I.B., (2)	60
Tube(s): WE 264B & 310A, g fil	60
Tube(s): WE 300B, tests OK	100
Tube(s): WE 300B, weak emission	30
Tube(s): WE, used, (8)	85
Tube(s): WE, used, box	120
Tube(s): WW II German RL-12	10
Turtle radio from Japan, nice	30
Tuska 224, WT (1), wood box	275
Tuska Superdyme Jr., 3-dialer, WT (3)	75
TV Guide game, in box	4
Vanguard 888 transistor	20

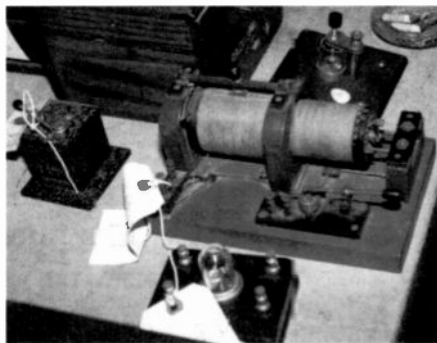

The Howe crystal set (left), sold for \$35; the homebrew, loose-coupled crystal set (right), for \$155; and the Philmore crystal set, (front), for \$25.

Victor Radio tapestry table, parts	40
Vogue picture record, (3)	30, 40, 40
Walson (New York) crystal set, wood box ...	100
Waterman Jr. 2" scope	30
WE 7A amplifier	500
WE 14" ccne speaker, paper p	30
WE candlestick phone	95
WE head set, (2)	10, 15
WE lineman's telephone, wood box, g	95
Webcor tape deck, wood case table model, w/ accessory drawer, unusual	12
Westinghouse "refrigerator" radio	45
Westinghouse Aeriola Jr., w/headphone, g ...	75
Westinghouse Aeriola Jr., WT, g	100
Westinghouse Aeriola Sr. 2-tube amp., NT ...	75
Westinghouse Aeriola Sr. 2-tube amp, WT ..	125
Westinghouse Aeriola Sr., WT	70
Westinghouse Aeriola Sr., WT, g	115
Westinghouse RC, g	175
Westinghouse RC, WT	200
Westinghouse WR-8 Columnaire, claimed wk.	95
Wirt drum speaker	10
Zenith "All Wave" portable, big dial, fabric covered, f	70
Zenith 5D027D wood table, g	20
Zenith 7S685 side-by-side radio/phono	25
Zenith 8S451 chairside, g	175
Zenith 10S464 console, g	125
Zenith 12S265 shutter dial console, g	425
Zenith 12S268 wide Deco console, shutter dial, spectacular! vg	300
Zenith 40A ornate large console, w/phono- graph, wk, all original paper, vg	2,200
Zenith 7000 TransOceanic, American version, g	145
Zenith gold pocket watch (not Zenith radio)	55
Zenith Royal 500 red transistor radio	40
Zenith, small green, AM/FM	7
Zenith TransOceanic, g	125
Zenith wood table radio/phono, g	10

(Ray Chase, 1350 Marlborough Ave., Plainfield, NJ 07060, Estes Auction, 7404 Ryan Rd., Medina, OH 44256; (330) 469-4992; estesauctions@aol.com)



AUCTION REPORT

Nye Estate Auction and Sale Davidson, Maryland — March 30, 2003

REPORTED BY BRIAN BELANGER

Rodger Nye of Columbia, Maryland, was an unusually enthusiastic radio collector. An FCC engineer prior to his retirement, he lived alone, and attending auctions, estate sales, and flea markets was his chief form of entertainment. After three decades of collecting, his home was filled with radios. In some cases, Rodger had two or three examples of the same radio, especially Philcos, which he dearly loved. There were dozens of pieces of test equipment — oscilloscopes, signal generators, tube testers, VOMs — and shelves filled to overflowing with parts and chassis.

Rodger was a major supporter of the Radio-Television Museum in Bowie, Maryland, operated by the Radio History Society. He made a generous contribution to launch an endowment fund for the museum and made two challenge grants soon after the museum was established. He provided the funds to purchase the impressive Philco neon sign that hangs just inside the entrance to the museum.

Rodger died last year after a long illness. He had willed his entire radio collection to the Radio History Society, along with a sum of money to be used for our building fund. In recognition of all that Rodger had done to encourage the museum, the Board of Directors voted to name the 1930s room "The Nye Room," as his favorite radio era was the 1930s. Several of his radios now grace that room, including a Philco grandfather clock radio of which he was particularly fond.

PREPARING FOR THE SALE

We rented a 26-foot truck and located suitable storage space. It took a large crew of hard working volunteers three days and five truckloads to transfer all of Rodger's radio items. Obviously we



David Willenborg and Don Ross admire an RCA console prior to the auction.

could not keep all of the collection. While there are many beautiful radios, including Catalins and cathedrals, that we are adding to the museum's permanent collection, there were hundreds of items that were duplicates or were not in good condition. We have been busy sorting through these items and deciding what to keep and what to auction.

Proceeds from auctions like these provide critical operating funds to pay for insurance, utilities, building rent, exhibit materials, and new acquisitions. At the same time, we are getting our excess radio items into the hands of collectors who will enjoy them.

We scheduled the first Nye estate auction in October, 2002, and held this, the second one on March 30, 2003. The third is scheduled for June

A warning: Auction prices are not current values. Our selection of auction items is not necessarily complete. A listing such as this cannot adequately include the condition of cabinets, chassis, transformers, tubes, the operating status of the set, and the inclusion of incorrect, restored or replica components, etc. Auction prices are the result of the excitement of the auction process, the skill of the auctioneer and the specific interests of the participants. Nevertheless, auction prices serve as useful references and as another element in the value determining process. The possibility of error always exists, and if we are notified, corrections will be reported.



An auction attendee carefully scrutinizes a Model 46-1201 Philco "Bing Crosby" radio/phonograph.

22. The auctions are held at the Davidsonville Family Recreation Center, Davidsonville, Maryland (between Annapolis, Maryland, and Washington, DC).

The weather was dreadful the day of the March auction — snow showers most of the day, which probably discouraged some from attending. Nevertheless, nearly 100 people showed up, from as far away as Florida. Prior to the start of the regular auction, we sold dozens of box lots and inexpensive single items that nearly covered the floor of the hall. At first, they were \$10 per box. When business began to slack off, we dropped the price to \$5, then \$2, and finally, \$1 per box. A few remaining boxes were given away free.

Auction prices were generally quite reasonable, and attendees commented that they were pleased that they had come. The auction moved along quickly, with 150 items crossing the auction block (not counting the box lots mentioned above) in roughly two hours.

The listing below is not complete, but rather provides examples of the wide variety of items sold and prices.

For more information on the Museum, future auctions, and tube sales, check our website: www.radiohistory.org

e=excellent, vg=very good, g=good, f=fair, p=poor, N.O.S.=new old stock, NT=no tubes

Admiral 69C19, black Bakelite, vg	\$22
Admiral 4203 B6 table, g	70
Airline 74BR-1812A table, vg	14
Airline WG 24 console, f	6
Ampex (Signal Corps) AN/TNH-2 tape recorder, g	20
Arvin 3586, f-g	1
Beitman <i>Most Often Needed</i> manuals (4), vg 16	
Bendix 0646A end table radio, f	20
Bendix 656A radio/phonograph, g	2
Capacitors, N.O.S. (box lot, 100s)	65
Champion spark plug novelty radio, g	50
Crosley 25AW tombstone, f-g	30
Crosley 46 FB table, f	21
Crosley 148 cathedral, f-g	90
Crosley 628B Bakelite table, (2), vg, e ...	60, 130
EICO 324 signal generator	7
EICO 368 FM sweep generator	2
Fisher FM 50B tuner, f-g	50

GE 218, Bakelite, vg	16
GE 402, Bakelite, vg	6
GE A-53 tombstone, g	75
GE JX 505, small table, g	10
GE L660 table, f	7
Gertsch FM6B VHF frequency meter, vg	10
Ghirardi, <i>Modern Radio Servicing</i> , g	16
Graybar 770 console, g	150
Grundig Majestic 7035, g	5
H.H. Scott Stereomaster, g	100
Hallcrafters S20R, f	30
Harmon Kardon Festival, AM/FM, g	20
Harmon Kardon T1040, AM/FM, f	18
Heathkit IB-2 impedance bridge, vg	13
Heathkit SG-8 signal generator, vg	18
Hickok 288XA signal generator, g	8
Hickok 533A tube tester, g	60
Hickok 536 tube tester, f-g	40
Hickok 615 sweep generator	6
Inter-Colonial 3-dial battery set, NT, f-g	30
Kay-Bar 75 table, Deco, f	60
Lafayette LC-4 capacitance/resistance tester, g ...	6
Landsdown whiskey bottle radio, f-g	150
Marantz 2015 stereo receiver, g	25
Meissner 9-1085, AM/SW, g	10
Military scope OS-57/USM 38, vg	10
Military TV-7U tube tester, g	80
Motorola HS 32 table	15
National NC66 communications receiver, f	5
Philco 37-11 console, f-g	35
Philco 37-610 console, f-g	30
Philco 37-611 console, f-g	40
Philco 40-130 table, vg	20
Philco 42-340 table, vg	12
Philco 46-1201 radio/phonograph, (2), f, vg	2, 40
Philco 46-1203 radio/phonograph, f	6
Philco 46-431, f-g	17

(Continued on following page)



This 1933 Philco Model 89 sold for only \$85.

(Nye Auction, continued)

Philco 60, f-g	70
Philco 89 console, vg	85
Philco service literature, 3" stack, 1940s, '50s. 3	
Radio-TV News magazines, 1950s, (box lot) ...	2
RCA 100A speaker, g	15
RCA 110 cathedral, vg	160
RCA 150 test oscillator, vg	8
RCA Radiola 33, p	15
RCA Victor 15K console, g	50
RCA Victor 16T4 table, vg	90
RCA Victor 18T table, f-g	10
RCA Victor 19K console, g	70
RCA Victor 26X3, vg	95
RCA Victor 28X, 8-tube table, g	22
RCA Victor 66X11, Bakelite, vg	17
RCA Victor 211 console, g	30
RCA Victor R14 console, f-g	60
RCA Victor "Radiola" 61-8 table, Bakelite, vg ..	6
RCA WR 69A sweep generator, e	31
RCA WR 99A marker generator, e	8
Rider, three service books, g	7
Sams Photofacts, #1 to #380, missing some, (5)	
boxes	60
Silvertone 36AC cathedral, g	105
Silvertone 101.506 table, Bakelite, f	15
Silvertone 110.403 radio/phono	34
Silvertone 7108 table farm radio, f	10
Silvertone 7226 table, f-g	8
Sonora RBU-175 table, g	16
Speakers, N.O.S., asst. sizes	12
Stewart-Warner 525 battery set, g	60
Stromberg-Carlson 1101-H, vg	24
Superior TV 50A genometer, vg	2
Transformers (audio, power), (2)	23, 5
Truetone D2616 table, ivory Bakelite, g	32
Tube sockets, N.O.S. (box lot, 100s)	85
Variac, heavy-duty, vg	18
Webcor Microcorder II tape recorder, vg	3
Westinghouse H125 "refrigerator radio," f-g ..	90
Westinghouse H161, AM/FM, g	4
Westinghouse WR 314 console, f-g	35
Wilcox-Gay reel-to-reel tape recorder, g	1
Zenith 5D150 console, g	125



A few of the many consoles and test equipment items in the auction.

Zenith 8S647 chairside, f-g	95
Zenith R-510 RZ1, red plastic, g	80
Zenith Trans-Oceanic, (2), f	10, 25

(Brian Belanger, 5730 Avery Park Dr., Rockville, MD 20855-1738; bcbelanger@aol.com)

In March 1999, Radio History Society President Ed Walker and the City of Bowie signed a long-term lease agreement for the Radio & Television Museum, located in a fully restored turn-of-the-century building at 2608 Mitchellville Rd., Bowie, MD 20716. Open Saturday/Sunday from 1:00 to 4:00 P.M. and weekdays by appointment. Admission is free; donations are accepted. Tel: (301) 390-1020; Web: www.radiohistory.org. For more information: Brian Belanger, Curator, at the above address.

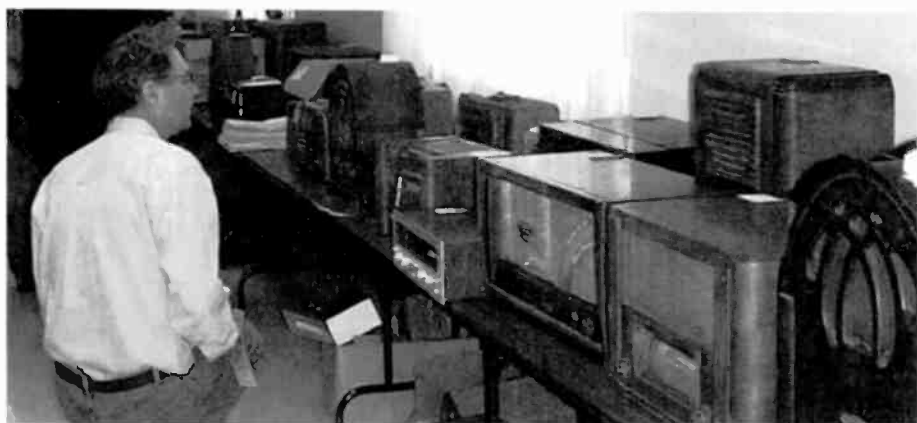

A potential buyer peruses the goodies to be auctioned during the preview time.



RADIO MISCELLANEA

"Radio Miscellanea" includes items of general interest selected from A.R.C.'s incoming correspondence. "In The Marketplace" items are based on information submitted by the businesses themselves. "From The Internet" items are obtained from internet newsgroups and other internet resources. Submitted items should be verified for accuracy; items may be edited by A.R.C. for publication, and publication is not guaranteed. See the masthead for more details.

Hooked on A.R.C. and Radio

Dear Editor:

I look forward to every issue of A.R.C. I guess you could say I'm hooked. I've been at this radio thing for about seven years, and it looks as though it's only getting better. I love making these relics from the past warm up and come to life again. Wow! I need to get a real life! Keep up the good work.

Bob Snively, Richmond, IN

Hams Should Find A.R.C.

Dear Editor:

Since TAP stopped circulation of *Amateur Radio Trader*, there should be an opportunity there for A.R.C. TAP thought that they could make a fortune with upgrading the publication. Apparently, they did not recognize that it was a specialty market that would not support such an approach. On the other hand, A.R.C. is not well known to many Hams and has few ads designed for the Ham radio community. An opportunity for you?

L.C. Cutright, Dallas, TX

Yes it is. In fact, A.R.C. advertises in several ham magazines which are among our best sources for new subscribers. (Editor)

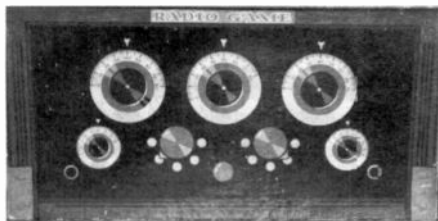

Radio Game

Dear Editor,

I found this "Radio Game" at a rural farm auction. It was made by Milton Bradley in the mid-1920s

First, you draw cards that have city names and that town's radio station call sign printed on them. The object of the game is to deliver messages to the cities on your cards. You then advance on a game board by chance to those towns to deliver your messages. The first player to deliver 11 messages to 11 towns is the winner.

The cards also list each station's frequency, not in kHz, but in meters..

Claude Chafin, Independence, MO

Great Articles

Dear Editor:

Keep up the good work! Your publication has great articles for the nontechnical historian like me.

Will De Vries, Dixfield, ME

Alton A. DuBois, Jr. — 1918-2003

Thanks to longtime subscriber Harry Goldman, who sent an obituary from the April 13, 2003, *Post Star* of Glens Falls, N.Y., we have learned of the passing of Alton A. (Andy) DuBois, Jr., on April 10, in Glens Falls. Andy was a frequent contributor to *Antique Radio Classified*, most recently of amusing vignettes about his life as a radio-TV serviceman before and after World War II. He was always eager to share some piece of radio information and often corresponded with our technical staff.

Andy was born on July 27, 1918, in Byram, Conn., and graduated from the Eastchester High School in 1939. His interest in radio began with a job after school working for an engineer for 10 cents an hour. In 1940, he enlisted in the U.S. Combat Engineers, but re-enlisted on December 5, 1941, and served in the 711 Railway Operating Battalion. He retired from the RCA Service Co. in 1981 after 32 years of service, and he became a founding member of an RCA Retirees Club.

We extend our sympathies to the DuBois family. Andy's contributions to A.R.C. will be missed. (Editor)

Danny Gustafson — 1942-2002

Many of you know Danny as a TV collector. I knew him as a good friend. Danny was a longtime member and past president of the Antique Radio Club of Illinois. He also was the owner and founder of Gustafson-Shields Advertising Agency in Chicago. His partners, employees, customers and friends were his family. His collecting passions were early television, almost anything RCA, and many other things, including vintage autos.

At a young age, he taught himself how to repair televisions, and by age sixteen, he sold and serviced Philco and RCA television sets. It was a great pleasure to him when he appeared on "The Today Show" during a celebration of TV's 50th anniversary and when his collections were featured in *Forbes Magazine*.

Danny loved nothing better than an evening with friends discussing politics or his latest find, or telling jokes. In fact, we had one of our recent dinners at our favorite Chinese restaurant before he passed away. He will be greatly missed.

Burby Janov, Des Plaines, IL

Article Kudos

Dear Editor:

I received the following brief note from John C. Capron, Lathrop, California, regarding my article "Radio Row — The Other Side":

"Thanks for the great article in A.R.C., the February 2003 issue."

Gene Katz, Mount Laurel, NJ

Even a response of a few words is most welcome. (Editor)



A.R.C. RATES & POLICIES

GUARANTEE. You may cancel your subscription at any time and receive a pro rata refund for issues not yet mailed. If errors to ads are made by A.R.C., upon request a free correction will be run in the next available issue.

PAYMENT. Please send in full payment with your order or ad. A.R.C. does not carry accounts; all subscriptions, ads, etc. must be prepaid (except for the 6 and 12 month display ads indicated below). Pay in U.S. funds. Checks drawn on a U.S. bank, money orders, VISA or MasterCard (\$10.00 min.) are preferred. Make check out to "A.R.C." Cash is OK for small amounts. Canadian payers may send a Canadian check but specify *U.S. funds*. Subscriptions will be prorated to amount sent if amount is incorrect.

FAX & E-MAIL PROCEDURES/PAYMENT. Subscriptions, book orders, classified ads, display ads, etc. are welcome by fax or e-mail. Deadlines are the same as for ads received by mail. Please calculate the amount due. Payment by VISA or MasterCard is preferred if your order is over \$10. If under \$10, or if you prefer to send a check or money order, state the amount being sent and that the payment is in the mail. **Do not** send another copy of your ad with your payment; simply indicate that it is a fax or e-mail payment. If you want confirmation of our receipt of your fax, call immediately after sending your fax.

CHANGE OF ADDRESS. Please notify us 4 weeks in advance of a change of address. Send both your new and old addresses, and include your SUB# and effective date of your new address. Temporary address changes can be made also.

SUBMISSION OF MATERIAL. Antique Radio Classified welcomes and solicits information that pertains or relates to radio history or collecting. This may include articles, book reviews, photos, information on upcoming radio events, meetings, antique radio organizations, radio auctions, sources of old radio and restoration supplies, and other related and interesting material. All material submitted should be carefully researched, typed and accompanied by good photos, if appropriate. Computer disks are appreciated. Writing guidelines are available upon request.

PUBLISHING RIGHTS. Unless other arrangements are made: (1) All received materials (ads, articles, letters, correspondence, e-mail, photos, artwork, etc.) become the property of A.R.C., may be edited, combined with other material, published, and will not be returned. (2) For all received materials, A.R.C. is granted publishing and reprint rights in all forms of media including the monthly printed magazine, internet, etc. (3) Publication is subject to approval by A.R.C. and to time and space constraints.

MAILING OF ISSUES. U.S. subscribers can receive A.R.C. by First Class or Periodicals mail (Periodicals is the way most magazines are mailed). The mailing of First Class copies is staggered with faraway copies mailed before local copies. Non-U.S. copies are mailed on the first day. Periodicals copies are mailed on the last day. Mailing dates change each month, but mailing is usually completed by the 27th of the month. First Class copies usually are received by the 5th of the month; copies by Periodicals mail, by the 10th.

ETHICS. No person involved in the production of A.R.C. is to act on any information in the magazine until the first delivery day after local copies are mailed.

DISCLAIMER. The publisher is not responsible for any buying and selling transactions incurred, or for any other use of the contents of this publication.

Antique Radio Classified subscription rates, frequency of publication, content, policies, size and ad details, and rates are subject to change at any time by A.R.C.

DISPLAY AND BUSINESS CARD ADS • DETAILS AND RATES

The deadline is the first of the month for display and business card ad artwork, payment and repeat requests.

Advertising is accepted only for early items related to radio, communication, etc. All items must be described fairly; reproductions, reprints and not-original items must be so identified. Advertisers must agree to respond promptly to inquiries and orders, to resolve problems promptly if the buyer is not satisfied, and to comply with a buyer's refund request on unaltered returned items.

Advertising must be prepaid, except as noted below; see "Payment" paragraph above for details. Late ads will be run only if space and time permit. **Originals must be the artwork size listed below.** Send all artwork on disk or ask us to typeset it for you. Do not send in artwork on art board or send negatives. Please call for instructions on how to send your electronic ad. If used, reverse type must be limited to 25% of the ad. If you want us to prepare your ad, include the one-time cost below for A.R.C. to make up the ad.

Add \$16.00 per photo for screening unless part of an existing electronic ad. **Do not cut or trim photos or glue photos to artwork; submit separately.**

If you are confused by these requirements and terms, please

contact A.R.C. before beginning to prepare your ad. We will be happy to advise you on your ad ideas, estimate how much the ad will cost, recommend an ad size, etc.

We assume that advertisers want all ads which are submitted to run without delay, therefore, we will run the ad and bill for any additional work required for the ad to meet these specifications. A late ad will run beginning with the next month "Tear sheets" will be sent only for 1/8-page or larger ads and only if requested when the ad is submitted.

First business card per advertiser is at lower rate.

The 3-month rates represent about an 11% discount, the 6-month rates 23%, the 12-month rates 30%. Placement requests, add 15% but call first. Clubs write for discount policy.

Page	ARTWORK SIZE (SEND IN THIS SIZE)		As Printed (size in magazine)		Cost for 1-month	Cost for 3-months	Cost for 6-months	Cost for 12-months	One Time to make up Ad
	H x W (inches)	H x W (inches)	H x W (inches)	H x W (inches)					
Full	7 3/4 x 4 3/4	7 3/4 x 4 3/4	7 3/4 x 4 3/4	7 3/4 x 4 3/4	\$289.00	\$769.00	\$1329.00*	\$2325.00**	\$69.00†
1/2 H	3 5/16 x 4 3/4	3 5/16 x 4 3/4	3 5/16 x 4 3/4	3 5/16 x 4 3/4	146.00	389.00	675.00*	1175.00**	37.00†
1/2 V	7 3/4 x 2 1/4	7 3/4 x 2 1/4	7 3/4 x 2 1/4	7 3/4 x 2 1/4	146.00	389.00	675.00*	1175.00**	37.00†
1/4	3 5/16 x 2 1/4	3 5/16 x 2 1/4	3 5/16 x 2 1/4	3 5/16 x 2 1/4	74.00	197.00	342.00	595.00	19.00†
1/8	1 5/8 x 2 1/4	1 5/8 x 2 1/4	1 5/8 x 2 1/4	1 5/8 x 2 1/4	38.00	101.00	177.00	305.00	9.00†
Business Card (1st)	2 x 3 3/4	2 x 3 3/4	1 1/4 x 2 3/8	1 1/4 x 2 3/8	not avail	53.00	90.00	159.00	7.00†
Business Card (2nd...)	2 x 3 3/4	2 x 3 3/4	1 1/4 x 2 3/8	1 1/4 x 2 3/8	not avail	68.00	118.00	205.00	7.00†

* Full & 1/2 page, 6-mos.; † 2 due with order; ‡ 2 due in 3 mos. ** Full & 1/2 page, 12-mos.; † 4 due with order; ‡ 4 due at 3, 6 & 9 mos. † For 6 and 12 month ads, no ad make-up charge if no change is made to ad for entire run.



A.R.C. RATES & POLICIES



CLASSIFIED ADS • DETAILS AND RATES

ONE FREE 20-WORD AD for subscribers in each issue; additional words are 29c each. See details below. Classified ads sent by mail, fax, e-mail or by any other method must be received (not just postmarked!) by Noon Eastern Time on the classified ad deadline date to guarantee inclusion in the current issue. Late ads are held for the following issue. Please enclose correct payment with all ads. Cash is OK for small amounts. (Canadian and other foreign advertisers, please see "Payment" on opposite page for methods.) "Free words" cannot be accumulated from month to month; free words must be requested when ad is submitted.

Faxed & e-mailed ads: Please see additional information on opposite page.

When including ads with other A.R.C. correspondence, write the ads on a separate piece of paper. Include SUB# with ad. Ads may be sent in advance; but, write each ad on a separate piece of paper and indicate the month (or successive two months) you want the ad to run.

To minimize our typing errors: Please write legibly. Use both capital and small letters. Do not use a slash between words. Carefully write the following numbers and letters (especially in model numbers) since some can look alike; for example 1, l and I (the number one, the capital l and the small L.) Also: 0, O, o, Q and D; r and n; 6, b and G; V, U, u, v and Y; A and R; 5, S and s; 2, Z and z. We try to correct spelling errors, so when using an uncommon word or manufacturer which we might mistake as a more common word or manufacturer, note it so that we do not "correct" it. Editor's annotations are in [brackets].

Advertising is accepted only for early items related to radio, communication, etc. All items must be described fairly; reproductions, reprints and not-original items must be so identified. Advertisers must agree to respond promptly to inquiries and orders, to resolve problems promptly if the buyer is not satisfied, and to comply with a buyer's refund request on unaltered returned items.

The publisher reserves the right to edit ads without notification to the advertiser and to reject ads for any reason. Names other than the advertiser will be edited out of ads. Ads with non-radio-related items will be returned or edited unless the non-radio-related items are for trade of radio-related items, or they are incidental to and appear at the end of an otherwise acceptable ad. The publisher is not responsible for errors due to illegibly written ads or for any other reason. See also Publishing Rights on opposite page.

Clubs: Since club activities receive free coverage on the *Coming Radio Events* pages, the free 20 words may not be used for club activity ads. A discount on display advertising is available for clubs.

CLASSIFIED AD DETAILS

Deadline: NOON ET— 10th of the month!

Classified ads must have a standard heading such as WANTED, FOR SALE, FOR TRADE, FOR SALE/TRADE, SERVICES, MESSAGE, HELP, AUCTION, MEET, FREE. This heading is the only bold or all-capitalized words allowed in the ad. Capitalize only manufacturer names, model names, etc. This standard ad format makes scanning the ads easier.

Before writing your ad, please look over the ads in a recent issue of A.R.C., and try to write your ad in the same style. Full name (or company name) and address is required in all classified ads; we will add it if you forget.

Classified Ad Rates per Month

Subscribers:

- First 20 words: FREE*
- 29c per word for extra words over 20 plus
- 10c per word for a shaded ad (count all words including free words).
- * Subscribers may take 20 free words on only one ad each month.

Non-Subscribers:

- 47c per word plus
- 10c per word for shaded ad.

Please do not forget to send in the extra 29c per word when your classified ad runs over the free 20 words; your payment will be appreciated, and it will help to keep A.R.C. healthy.

BOXED CLASSIFIED AD DETAILS

Deadline: 1st of the month!

Boxed classified ads can run unchanged for three months or more. No words are free. Ads may be shaded and may include bold and all-capitalized words freely. The ad need not begin with "For Sale," etc. Minimum run is 3 months, prepaid. Discount: 10% for 6 months; 20% for 12 months.

Boxed Classified Ad Rates per Month

Nonshaded ads:

- 40c per word for all words * none free, plus
- 10c per word for each bold word plus
- 10c per word for each all-caps word.

Shaded Ads (All words are bold at no charge):

- 50c per word for all words * plus
- 10c per word for each all-caps word.

Non-Subscribers:

- Add 20c per word to above costs.

*Three words can be bold-all-caps at no extra charge

PHOTO & DRAWING DETAILS

Deadline: 1st of the month

for all ads with drawings or photos!

Drawings and photos are encouraged as the response to your ad is much larger and the reader knows better what you want or are selling. Send in your drawing or photograph, and A.R.C. will reduce it or enlarge it as needed.

Photo and Drawing Rates per Month

\$23.00 per month for each photo or drawing

(If ad is canceled, this amount cannot always be refunded.)

CHANGES & CANCELLATIONS

Please check your ads carefully before sending them in. Once ads are received, it is not always possible to refund the amount sent, pull the ad or make changes.

IMPORTANT — COUNTING WORDS — IMPORTANT

The standard headings: WANTED, FOR SALE, etc., count as one word each time used in an ad. Name, address and (one) telephone number, count as 6 words, regardless of length. Ham call letters and business name can be included in the 6 words and do not count extra. Full name (or company name) and address is required in all classified ads. Each additional word, abbreviation, model number or number group, extra telephone numbers, fax, e-mail, etc. count as one word each. Hyphenated words count as two words.



FOR SALE: Technic Model SL-DL6 direct drive, automatic turntable system, 3 31/3 & 45 rpm. Technic Model SL-20 F.G. servo player system, manual included, minus head. Simpson Model 390 volt-amp-wattmeter, with box, cables, manual. Amprobe Test Master Model RS-1, volt/ammeter with Model A-40 triple purpose amprobe energizer A.C. amps 6-15-40-100 volts 150-600. Also, Amprobe Deca-tron Model A-50, includes cables, manuals, in handled leather box with lock. Sylvania Electronic Tube Technical Manual, 1959, 11th Edition. Jack Hagopian, 53 Hill Rd. # 211, Belmont, MA 02478

FOR SALE: (or WANTED): I have a horn for a Baldwin horn speaker. I need a base or will sell horn - \$47.50 + UPS. William Jelinek, 3985 Manor Loop, Rhineland, WI 54501. (715) 362-2909. E-mail: jelin@charter.net

FOR SALE: Tubes, N.O.S. & used. Buy separate or by lot. Send SASE. Call for appointment. Robert J. Stone, 721 Fisk St., Piqua, OH 45356-3729. (937) 773-2217

FOR SALE: Magnavox M20 Spkr, open - \$20. Grebe CR9 cabinet - \$75. B&K tester/rejuvenator, exc, w/ papers - \$30. Radiola 814 loop - \$70. Eagle radio, Portabloop - \$75. Electrola by American Specialty Co., w/tubes - \$95. GE, longrange, wood - \$30. Zenith T522R, Bake, plays - \$25. Majestic 152 tombstone cabinet - \$25. FADA 260G, Ivory - \$190. Marconi loose coupler, repro - \$90. Wall phone radio, works - \$35. Western Electric, IA loop, repro - \$95. All plus S&H. Wally Worth, 2 West Elm Ave, Wollaston, MA 02170. (617) 479-4512, please call before 8 pm

FOR SALE: Books: Tubes & Transistors Essential Char. or RCA Transmitting Tubes - \$5 plus shipping. Thomas Burnside, 4838 So. Westhaven Dr., Jackson, MS 39209-4711. (601) 922-2235

FOR SALE: Very large lot of parts for transmitters and receivers, tubes, coils, National dials. Stuart T. Carter II, W4NHC, 680 Fernwood Dr., Melbourne, FL 32904-1995. (321) 727-3015

FOR SALE: Untested Weston Instruments: Model 663 VOM, no leads; 432 wattmeter, 433 AC voltmeter, 433 AC ammeter. Lot for - \$100 plus shipping. Gabe, 485 Main, Glen Ellyn, IL 60137. (630) 469-4477, days

FOR SALE: Guild Town Crier, clean and working - \$125. Zenith H-500 T/O, very nice - \$125. Sonora bedlamp radio, WCV-246 - \$35. Tungar battery charger, cat. 277153 - \$35. Classic Radio & Television, 38 Western Ave., Fairfield, ME 04937. (207) 453-0044

FOR SALE: Philco 48-464 - \$40. Crosley 56TA-L - \$50. GE 60 - \$15. GE 515F - \$15. Paul Lisowski, 5603 E. 100 N, Knox, IN 46534. (574) 772-2021

FOR SALE: Parts, tubes, books. SASE with two stamps or e-mail for list. Wayne Letourneau, PO Box 62, Wannaska, MN 56761. E-mail: letourneau@wiktel.com

FORSALE: Philco 42-1011 radio-phone - \$40. Radiola 7-26, vg - \$300. Air King wire recorder-phonograph - \$50. Ned Connors, 14 Brook St., Barrington, RI 02806. (401) 433-2871. E-mail: nconnors@cox.net

FOR SALE: RCA tombstone T10-1. 10 tube (2) SW nicely restored - \$225. American Bosch 515 BC & SW cabinet refinished, plays good - \$125. Sparton 5218 PB & SW plays, looks good - \$100. James R. Lopaz, 5467 S. 975 E, Ogden, UT 84405. (801) 476-1470

.....
A.R.C. Advertising Policy
 Sellers and Buyers, Please Note!

 • Advertising is accepted only for early items
 • related to radio, communication, etc. All
 • items must be described fairly; reproduc-
 • tions, reprints and not-original items must be
 • so identified. Advertisers must agree to re-
 • spond promptly to inquiries and orders, to
 • resolve problems promptly if the buyer is not
 • satisfied, and to comply with a buyer's
 • refund request on unaltered returned items.
 •

FOR SALE: Zenith chairside 7-S-342, nice original, plays too! - \$350 P/U. Other chairside for sale, call. Claude Chafin, 4223 E. 42nd Way, Independence, MO 64055. (816) 478-4518. E-mail: n0fmo@sbcglobal.net

FOR SALE: While in Door County, Wisconsin, see my collection of antique and collectible radios, tape recorders, scanners, books, ham equipment, transistors, military uniforms and radios, electronic oddities. Must sell, running out of room. Please phone first. Cherry Lane Old Radios, John Enigl, Sr., 5425 Tart Cherry Lane, Egg Harbor, WI 54209. (920) 743-3672

FOR SALE: Micronta power supply, with probes - \$50. Weston DC amp meter, dual scale - \$12. Weston current transformer, 5 amps - \$9. Send LSASE for long list of radio related parts, equip., etc. Maureen Martin, 1407 Memory Ln., Lutz, FL 33549. (813) 949-1835

FOR SALE/TRADE: Numerous old manuals: Hickok, Superior, RCA, Lafayette, Allied Knight-Kit, Conar, Accurate, Simpson. A.J. Bernard, PO Box 690098, Orlando, FL 32869-0098. (407) 351-5536. E-mail: ni4q@juno.com

FOR SALE: (12,000) boxed tubes 50% new. (3,000) loose also. E-mail me for list. Dan Timmer, 3704 Alganssee, Grand Rapids, MI 49525. (616) 363-6927. E-mail: danerf@spectrum-sound.com

FOR SALE: Pre-60s working tube table radios and test equipment. Richard Bisoski, 2880 South Channel, Harsens Island, MI 48028. (810) 748-9421. E-mail: richb@i-is.net

WANTED: 4-pin ballast tube number 140R4. Jack Ghere, 1753 Community Beach Rd., Odin, IL 62870. (618) 532-5548

WANTED: Schematic for Precision Sound Calibrator Model CEL-177. J.R. Linden, PO Box 4927, Cave Creek, AZ 85327. E-mail: k7pur@arrl.net

WANTED: Sams Photofacts #103, 270, 272, 344, 625. Howard Hood, 5670 S.W. 44th St., Port Orchard, WA 98367. (360) 674-2179

WANTED: Junker Radiola IIIA for transformer salvage, or (2) Radiola III transformers that need not work. Joseph Mente, 20880 Thornwood Cir., Olympia Fields, IL 60461. (708) 747-8070. E-mail: k19ry@megsinet.net



WANTED: Air King Skyscraper radios, except for that unbearably ugly model with the third (tuning) eye at the top that bears better resemblance to a flounder than to the face of a building. Please write or call collect: Rain Buttignol, 214 State St., #7, Portsmouth, NH 03801. (603) 427-1384

WANTED: Tube hi-fi/commercial amps, preamps, tuners, compressors, tube testers, etc. Altec, Fisher, Scott, Marantz, Eico, McIntosh, Leak, Newer, Sonny Goldson, 520 Pocahontas Dr., Ft. Walton Beach, FL 32547. (850) 314-0321. Fax: 0284. E-mail: SonnySound@aol.com

WANTED: Sony service manuals for the following: SL-HF750, BMC-220, BMC-1000 Beta gear. Alan J. Kriss, 1872 Portsmouth Way, Union, NJ 07083. (908) 688-2092

WANTED: Fisher Model R-200-B receiver. Hallicrafters SX88 receiver. S-meter for Hallicrafters Skyrider 32. Power supply & spkr for National HRO-M receiver. Tony Molettiere, 105 Main St., Souderton, PA 18964. (215) 723-5917. Business: (215) 723-7459

WANTED: Western Electric radio and phonograph items. Igor Golio, 17 Addison Dr., Fairfield, NJ 07004. (973) 884-6468. E-mail: golio@lucent.com

ANTIQUE TUBES

We buy and sell Collector
and Pre-octal Tubes

See www.fathauer.com for listing
For catalog e-mail: tubes@qwest.net
or send request to:

George H. Fathauer & Assoc., LLC
688 W. First St., Ste. 4, Tempe, AZ 85281
Phone: 480.968.7686 Fax: 480.921.9957
Call toll free: 877.307.1414

WANTED: Schematic for Andrea TV K-127 or owners manual etc., junker. Thanks. Paul Recupero, 265 Union St., Portsmouth, RI 02871-2264. (401) 847-8589

WANTED: One plane readout Ind. Electronic Eng. Model No. 10-0011-00L. General Radio Numerik Ind. Type IN-0300. Also Wards Airliner radio. The only nos. I can see are L7551314 and on the wood is M601. Does anyone have the tubelayout? Charles E. Ingham, 94 Oswegatchie Rd., Waterford, CT 06385-1423. (860) 442-7449

Classified Ad Deadline Noon
June 10 for July 2003 Issue
July 10 for Aug. 2003 Issue
Boxed. Photo. & Display Ads - 1st

WANTED: Mackay marine 128AY schematic, manual. Harry A. Weber, 4845 W. 107th St., Oak Lawn, IL 60453-5252

WANTED: Plastic dial for Emerson Model 541 and/or 5-17. Joe Cali, 7072 Cinnamon Teal Way, El Dorado Hills, CA 95762. (530) 672-6185

WANTED: Philco 500 Series speaker. Any color, any condition. Round with metal base. Chris Farley, 4625 E. 2619th Rd., Sandwich, IL 60548. (815) 498-3459. E-mail: cfar@iglide.net

WANTED: Westinghouse WL787 tube, Acrosound transformers, Western Electric amplifiers. Ming Yang, 1995 University Ave., #119, Berkeley, CA 94704. (925) 376-4220. E-mail: wesys@aol.com

WANTED: Power transformer for Telefunken Concertino 9U. Ray L. Mayeux, 520 Gladstone Blvd., Shreveport, LA 71104. (318) 868-1202

A. G. Tannenbaum

Electronic Service Data
PO Box 386, Ambler, PA 19002
Phone: (215) 540-8055
Fax: (215) 540-8327

THE



FOR

Vintage Parts & Service Data
1920's - Present

Credit Cards Welcome

Browse our on-line catalog at
www.agtannenbaum.com

FOR SALE/TRADE: Antique radios, telegraph keys, old telephones & ham equipment. Please see my website www.interestingoldjunk.com. James J. McGrath, W2IOJ, 2 Centerville Ln., West Seneca, NY 14224-2124. (716) 675-0160. E-mail: w2ioj@interestingoldjunk.com

**HAVE YOU MOVED? ARE YOU MOVING?
PLEASE NOTIFY US A.S.A.P.**

SEND US YOUR...

OLD ADDRESS

NEW ADDRESS and

SUB #

MANY THANKS!!!!

FOR SALE: Radiola Model 33 w/tubes, square lid, no warp @9 - \$170. Hallicrafters Model SX71 w/spkr, plays @9 - \$265. Cunningham tube manual, 1934 C12, Blue Cover, 154 pp - \$35. Knight Kit blueprints for 30 watt deluxe amplifier, 4 double pages, 17 x 23 - \$15. Transistor, Panasonic Model RF 561, AM/FM, w/ pwr cord, top handle, upright, plays - \$30. Bernie Samek, 113 Old Palmer Rd., Brimfield, MA 01010. (413) 245-7174. Fax: 0441

FOR SALE: Large technical library. List by e-mail or SASE. Bill Carley, W3PCB, 7804 Moorland Ln., Bethesda, MD 20814. (301) 652-5836. E-mail: bill_carley@hotmail.com

FOR SALE: Minifon/Protona German miniature wire recorders, vintage mini-reel tape recorders. Jon Golden, PO Box 715, Carlisle, MA 01741. (978) 371-5557. E-mail: jon@make3dimages.com

FOR SALE: Outstanding Scott Allwave Deluxe, Wellington cabinet. Contact for details. Lansing, Rochester deliveries. Paul Farmer, Time Out of Mind Radio, PO Box 352, Washington, VA 22747-0352. (540) 987-8759. E-mail: oldradiotime@hotmail.com

FOR SALE: Munchie Tunes lunch box AM radio with headphones and thermos, N.I.B. - \$15 plus 3 lbs. Mark Anderson, 207 Fiddlers Elbow Rd., Greenwich, NY 12834-2206

FOR SALE: Antique radio schematics plus data still only - \$3 ppd. Joseph R. Forth, 119 Long Vue Acres Rd., Wheeling, WV 26003-1853. Fax: 227-3154. E-mail: wa2trt@ovis.net

FOR SALE: (6) PL253 coax connectors, used, cleaned, very good condition - \$5 ppd Conus. Ralph Michelson, KG8FA, 4538 Golfview Dr., Brighton, MI 48116. (810) 225-9825. E-mail: kg8fa@webtv.net

FOR SALE: KLH Model 20 radio-phono unit, 33 1/3-45-78 rpm, working, excellent condition, wood case, no speakers. Jack Hagopian, 53 Hill Rd. # 211, Belmont, MA 02478

FOR SALE: Riders manuals. Vol. I - XII. Also second copy of Vol. I A through H and complete index of Vol. 1 - XV - \$225. Andrew Toross, 425 Old Country Rd., Orange, CT 06477. (203) 795-4523

FOR SALE: Tube adaptors, 45 and 50 - \$16 and \$20 plus UPS. James Sinwell, 511 Newport Dr., Greensburg, PA 15601. (724) 834-0763

FOR SALE: Oneida Nu-color Picture Tube Restorer - \$8 plus. WANTED: Charlie McCarthy radio back pattern. Don Mier, 4009 N. Foxdale Ave., Covina, CA 91722. (626) 338-9225

FOR SALE: 350+ old radios, electronic items, thousands new, used tubes. All for one low price. W.O.W., PO Box 712, Libby, MT 59923

FOR SALE: Philco 51 - \$250, 84-B - \$150. Zenith D720-P, FM only - \$45. Scott 299-D stereo tube amp - \$225. Alva May, 6623 US Hwy 340, Shenandoah, VA 22849-3237. (540) 652-8638



New Jersey Antique Radio Club Antique Radio Indoor Swap Meet

Sunday, June 22, 8:30 AM - 1:00 PM*

North Centerville Vol. Fire Co., Hazlet, N.J.



The NJARC presents its Summer swap meet at the spacious North Centerville Fire Co. banquet hall in Hazlet, N.J. The first 30 reservations receive an 8-foot table at no extra cost. A \$3.00 buyer donation is suggested. *Vendor setup at 7:30 AM (no early admittance); the meet may extend beyond 1:00 PM.

DIRECTIONS: Garden State Parkway, North or South: Take exit 117 (towards Hazlet (Rt. 35)/Keyport/Aberdeen). Merge onto Route 36 and continue for about 1 mile. Turn right on Middle Road (County Route 516) and continue for about 1.5 miles. The Fire Co. banquet hall is on the right.

RESERVATIONS: Marv Beeferman, 2265 Emeraldal Park Drive, Forked River, NJ 08731 (609-693-9430). E-mail: mbeeferman@cs.com. Phil Vourtsis, 13 Cornell Place, Manalapan, NJ 07726. (732-446-2427). E-mail: pvourtsis@att.com.

RATES: NJARC members \$15/space; non-members \$20/space.

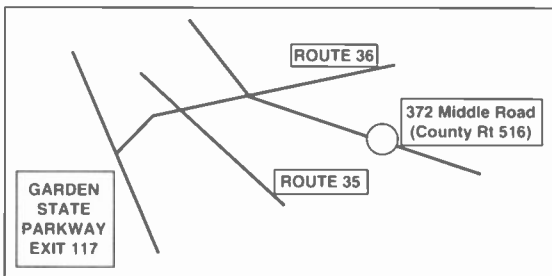

Estes Auctions



*Specializing in Vintage Radios
Complete Auction & Appraisal Service*

“The Robert Corbett Collection”

Vintage Radio Auction

Saturday, June 14, 2003 at 10 A.M. EDT

at the Expo Auction Center, 8157 Garman Rd.,

Burbank, Ohio, Exit 204 off Interstate 71

We have moved this collection to Ohio and the quality of the items in this sale would be hard to surpass. Some of the items are: Scott “Sweet Sixteen” in a Warrington cabinet, Atwater Kent breadboards Model 9 (2), Model 10 (2), Pennsylvania Wireless Receiver, Western Electric 4D, Western Electric 3A, Western Electric 2B tuner, Grebe RORN, Grebe CR-9, MU-1, large Music Master spruce horn speaker, Atwater Kent 82 cathedral, Haynes Tuner, Ken-Rad and other crystal sets, National 183D, NC 100K, HRO 60, Collins 75A4, 75A1, MS1C transceiver, R-389 URR, Collins transmitter 32V2, Kenwood TS-130, TS-700, Hallicrafters SX-42, Hammarlund R-274A, SP-600, HQ120, Drake R-8, BC-312, lots of TRF sets, horn speakers, many tombstones and cathedral radios, books, magazines, thousands of tubes. Our website will picture many of the items for sale. We hope to see you at the auction.

ESTES AUCTIONS

7404 Ryan Road

Medina, Ohio 44256

Richard Estes, K8LRY – Auctioneer

Bob Dobush – Tubes

Kim Graca – Tech Support

Alan Ferris – Set Up

Mark DeLauter – Set Up

Phone: (330) 769-4992

Fax: (330) 769-4116

E-mail: estesauctions@aol.com

Web: www.estesauctions.com

Call us to sell one radio or an entire collection.

Back Issues – \$2 Each – Full Calendar Years

A sampling of articles and topics is listed below. Topics may appear in more than one issue. Order by calendar year. (Single issues are \$5 each in the U.S.)

- 1984 A.R.C.'s First Year. The June Sample Copy plus September-December. First Kreuzer's Value Guide.* Heathcote's Collectors' Corner, Crocker's Crosley Review,* With The Collectors' and Meet Reports.*
(5 Issues, Photocopies, 16-20 pgs.) \$10
- 1985 First Photo Review,* Radio Novelties,* Collector Profile,* Telegraph Key Review,* Crystal Set Review* and Atwater Kent Breadboard Review.* Also Value Guide A-T, Penna Wireless, Marconi 106, WD-11. (Photocopies; 20-24 pgs.) \$24
- 1986 First Collecting British Crystal Sets.* Collectors' Corner, Value Guide S-Z, Horn Speaker Values, Speaker Review, Precision Ace, Quaker Oats Crystal Set, HQ-120X, First Issue Published by John Terrey. (Jan.-Sept. Photocopies; Oct.-Dec. reprints; 24-28 pgs.) \$24
- 1987 First full-cover covers. First Foster's Restoration Topics,* Vintage Television,* Philco 38-3, EHScott 48-Tube Set, Marconi Multiple Tuner, Vacuum Tube Value Guide, Freed Elsemann, Crosley Pup, Fada Bullet, Vitus, Sparton Mirrored Radios. (Jan.-Mar. reprints; Apr.-Dec. originals; 32-36 pgs.) \$24
- 1988 First Old Tyme Radio Services Directory,* Jim Fred's Repairing AC Radios,* Vintage Test Equipment,* Also DuMont Clifton TV, Mechanical TV, Aeniola Senior, A-K Model 20, Kennedy 20, Philco Predictas, Martian and Gem Crystal Sets. (40-60 pgs.) \$24
- 1989 Automatic Radio, Clapp-Eastham HR/HZ, Mechanical TV,* Western Electric 1920-1927, Radiola 44, Ace Radio Repair on June cover, Arvin & the Hopalong Radio, Magnavox TRF-5, A-K Crystal Set, A-K 9A, Philco Block Capacitors, Marconi 106D, Patterson PR-10, Oriole 7B. (52-68 pgs.) \$24
- 1990 First Radio Adventures.* Also California Earthquake, Transistor Radios, Cleaning Bakelite, EH Scott Telematic, Ekco Round Radios, Radiola Grand, Horn Speaker Survey, Atlantic Radio, GE 901 TV, Philco Block Capacitors, Tuska 224, RCA 816K, RCA Therenim. (68-92 pgs.)\$24
- 1991 First Collecting Foreign Sets.* Out-Of-Sight Radios, Philco 20, 90, Wilcox-Gay Recordio, A.R.C. Index '84-'90, Westinghouse RC-RA-DA-DR-RT-AR, Radio Stock Certificates, German Radios, Subminiature Tube Radios, Early Navy Radio Equipment, Gonset. (84-100 pgs. Index Issue Is 148 pgs.) \$24
- 1992 Vintage Microphones, Gonset, Early Navy Equipment, Superhets of the 20s,* The Neutrodyne, Telmaco, Atlantic Radio, Vintage Hi-Fi, Battery Eliminators, Radio Fans, A-K 35, RCA 648PTK TV, Repairing IF Transformers, Paragon RA-10/DA-2, A-K 21, 33, WLW, 1991 Index. (88-100 pgs.) \$24
- 1993 Arvin Metal Radios, Repairing RCA Catacombs, Philco Armchair Radios, Kenrad Crystal Set, Transistor Radios, A-K 52, Philco Cabinet Design,* Webster Electric Co., Klyelectron Electrostatic Speaker, Vintage Guitar Amp, Tower Cone Speakers, EH Scott Allwave, 1992 Index. (100-104 pgs.) \$24
- 1994 Radiola I, Radiola 60 series, Pot Metal, Fada Neutrodyne, Clinton Mfg. Co., Kardon Radios, Philco Cabinet Designers, Paico, SCR-609 & 610, Philco Survey, Permeability Tuning, Weston, Regency TR-1, Charles Herrold, Nipper, 1993 Index. (100-116 pgs.) \$24
- 1995 Zenith Trans-Oceanic, Steinway Capehart, Ken-Rad, Radio Shop J, Freshman Master Speaker, Broadcast Equipment, Philco Survey, Power Transformers, Tube Testers,* Radio Apparatus Co., L.E. Knott Apparatus Co., Ford Museum Auction in color, Ozarka, 1994 Index. (108-116 pgs.) \$24
- 1996 Communications Receivers, KDKA, Philco Designers, Radiola IV, WJZ, Art Deco Radios, Herrold Microphone, Tuning Battery Sets, Paul Godley & Paragon, Soldering, Webb Microphone Collection, Mirrored Glass Radios, Samson Electric Co., Russian Red Star, Echophone EC-1. (100-116 pgs.) \$24
- 1997 Thompson Minuet, Marconi Archive Auction Saga, Frank Krantz, Emerson Multivalve Radios, De Forest Detectors & Tuners, Remote Control Radios, Ekko Stamps, Freshman Polydyne, Vintage Audio Recorders, Selenium Rectifiers, DeForest Reflex Sets, Early Zenith. (100-116 pgs.) \$24
- 1998 Sears Commentator, 300B Tube, Replica Nameplates, Australian Radios, WMAZ, Espey, Nipper, Early Wireless, Rider's Volume 1, Pilot Radio, Browning-Drake, Army-Navy Numbering System, Cortlandt St. Radio Row,* Pooley Co., Transistor's Early History. (100-108 pgs.) \$24
- 1999 Reinzart Receiver, Cone Ship Speakers, The Internet, WebTV, Military Equipment,* Krantz Estate Auction, Atwater Kent Time Capsule, Atwater Kent Radiolodyne, RCA Radiolas for 1923/24, 15th Year Special Issue, Australian Pedal-Operated Radio, Early RCA TV, Battery Set Power Supplies. (100-108 pgs.) \$24
- 2000 Early Ham Radio, Rlder's Manuals, Meets & Auctions, Canadian Independent Telephone Company, Military Equipment,* Early Wireless, Wilcox-Gay, Grundig-Majestic, Recasting Metal Parts, Leutz, TV, Riga, Superhets, Loose Couplers, Musette, Nordmande, E.H. Scott, Victor. (84-100 pgs.) \$24
- 2001 Grebe, Philco, Home Brews, Airline, Loose Couplers,* Mignon, Radio Postcards, DeForest, RCA, Restoration & Repair,* Kolster, Meets & Auctions, Zenith, Million Dollar Muchow Auction, Crosley, Early Wireless, New York Radio Row,* Marconi. (84-100 pgs.) \$24

* These articles continued for one or more years and some continue today.

A.R.C., P.O. Box 2, Carlisle, MA 01741 – Toll Free: (866) 371-0512

Fax: (978) 371-7129 – E-mail: ARC@antiqueradio.com – Web: www.antiqueradio.com



Free shipping & handling on all U.S. orders (typical U.S. order will be received within 7 days, but allow 2-3 weeks), Mass. residents add 5% sales tax. Non-U.S. orders, write for shipping costs, or use credit card and specify air or surface (allow 2-3 months for surface shipping). Most orders shipped by next business day. If using credit card, include name on card, card number and expiration date. Send payment with order. Money back return policy. Subscribers, ask for discount when placing order. 10% off books; order must be mailed to address on file.



(#14Nov-02)

WANTED: Connecticut J-113 rheostat. Grebe 3" varicoupler knob, fits CR 3, CR 8, 50-0-50 cal. J.C. Woychowski, 81 Penn Ave., Niantic, CT 06357. E-mail: jc.woy@snet.net

WANTED: Gernsback, Gernsback, Gernsback, Gernsback Radio Service Volumes 3 & 5, Gernsback. Ye Olde Radio Shoppe, Noel S. Ilg, 228 Beck Rd., Avon Lake, OH 44012. (440) 933-5668. Fax: (440) 933-8864



WANTED: Symphony and Detrola Catalin radios. I am not a human being: I am a radio collector. God forbid! Pity me the lost soul that I am and fulfill my humble needs. Please write or call collect: Rain Buttignol, 214 State St., #7, Portsmouth, NH 03801. (603) 427-1384

RATE FOR ADDITIONAL WORDS:
29c per word
FIRST 20 WORDS FREE!
Cash OK for small amounts.

Your payment helps to keep A.R.C. healthy!

WANTED: Horn speakers, woofers, drivers, horns, crossovers, coaxial/triaxial. Altec, JBL, Electro-Voice, Jensen, Western Electric, Tannoy, etc. Sonny Goldson, 520 Pochontas Dr., Ft. Walton Beach, FL 32547. (850) 314-0321. Fax: 0284. E-mail: sonnysound@aol.com

WANTED: Altec 350A power amplifier. Will consider a trade for other Altec equipment. Thomas Rocheleau, PO Box 132, Franklin, MA 02038. (508) 528-3061 between 6-10 pm

WANTED: Drivers for Tower Castle cone. O'Neil oval ship speaker. Vitalitone ship speaker. Darrell Combs, 6587 Pacheco Way, Citrus Heights, CA 95610. (916) 969-0635

WANTED: Sparton 508 or 516, any condition. Bruce Phillips, 127 Bunker Hill, Stratham, NH 03885. (603) 772-7516. E-mail: radioorphanage@attbi.com

WANTED: Federal radios, 61, 59, 58, 57; Western Electric 4-B, D; Kennedy 110, 220; BBTT, 00A, 01A, BAK 00A; Lit for Federals, Tuska 225, Zenith 3-R, Radiodyne WG10; Magnavox horns; AC 2 amp; coil winder for Federal 226 AF's, Magnavox AC 2 AF's R3 field coils. Ward Kremer, 1179 Petunia Rd. Newport, TN 37821. Ph/Fax: (423) 625-1994. E-mail: witzend99@earthlink.net

WANTED: Service manual (or copy) for Racal-Dana 9008 modulation meter. J.R. Linden. K7PUR, PO Box 4927, Cave Creek, AZ 85327. E-mail: k7pur@arrl.net

WANTED: Many radios knobs, crystal sets, parts, 1920s radio books, other paper. Thanks. Evan Powell, 4717 Conquista Ave., Lakewood, CA 90713. (562) 429-3793. E-mail: overadio@bigvalley.net



RADIO DAZE



VINTAGE RADIO & ELECTRONICS
Components • Supplies • Sales • Service

Our charter is fundamental....

We want to become THE primary source for all your vintage electronic requirements - by offering YOU quality products backed by exceptional service.

We Continue To Expand Our Product Line Here Are Some Of Our Offerings:

• **CABINET RESTORATION** - Howard wood products, Mohawk lacquers & toners, Novus plastic polishes, Zenith almond sticks



• **CAPACITORS** - Electrolytic, film and silver mica
• **DIAL BELTS** - Generic dial belt replacement kit

• **DIAL LAMPS & FUSES** - wide selection
• **GLASS DIAL REPLACEMENTS** - We manufacture glass dial replacements - 60+ in stock - more each month!

• **RESISTORS** - Film, power, carbon composition
• **POTENTIOMETERS** - Single/dual, audio/linear
• **POWER CORD** - Cloth-covered with outer braid
• **POWER PLUGS** - Vintage style 2 prong plugs

GC ELECTRONICS

• **SUPPLIES & TOOLS** - Adhesives, lubricants, solvents, cleaners & electronic tools from GC

• **TRANSFORMERS** - We distribute the complete Hammond line of transformers & inductors



• **VACUUM TUBES** - We have a very large inventory of NOS and quality used tubes - Contact us with your needs today!

• **WIRE** - Cloth-covered solid & stranded wire

E.H. Scott.....
The Dean Of DX



**** NOW AVAILABLE FROM **
RADIO DAZE PRESS!**

E.H. Scott-The Dean Of DX
Expanded Second Edition

• Detailed History of Classic Radios
• 256 Pages w/Color Photos
• Schematic & Patent Illustrations

Check us out BEFORE you place your next vintage electronics order!

Great pricing every day and never a handling charge
** Ask for our free 2003 catalog **

Radio Daze buys vintage electronic items, vacuum tubes, parts, literature, & advertising plus complete collections and bulk/lot sales.



Visit Our On-Line Catalog At:
www.radiodaze.com



MAIN OFFICES & RETAIL STORE

7620 Omnitech Place, Victor, New York 14564

Tel: 585-742-2020 Fax: 800-456-6494

email: info@radiodaze.com

Radio Daze, LLC - A Limited Liability Company

FOR SALE: SW portables: Ross 3300 – \$35; (3) GE World Monitors – \$25 each; Sears multiband – \$25. Ed Kalpa, 4622 Melbourne Ave., Los Angeles, CA 90027. (323) 661-1221

FOR SALE: Tube and transistor radios, Free: Collectors Software. Hank Maurer, 101 Sunset Terr., Scotts Valley, CA 95066. (831) 438-0159, (evenings). E-mail: hmaurer@attglobal.net. Web: <http://pws.prserv.net/usinet.hmaurer/mywp.htm>

FOR SALE: Sparton 410 Junior, arched top w/finalis, good shape overall, untested – \$195. Walter Kiefner, 6233 51st. Ave. N.E., Seattle, WA 98115. (206) 526-1452. E-mail: wkusa@yahoo.com

SEND ALL A.R.C. MAIL TO
Antique Radio Classified
P.O. Box 2, Carlisle, MA 01741

FOR SALE: Coil wire, 22 AWG, cotton covered enameled, 100' for – \$5 ppd. Radio Boys list. Herman Gross, W9ITT, 1705 Gordon Dr., Kokomo, IN 46902. E-mail: w9itt@mindspring.com

FOR SALE: Full set of '73 magazine from Vol. 1, number 1 (early 60s) to December 2002. Great BA reading – \$300. Pickup only. Dave Metz, 1016 Ridgemont Dr., Staunton, VA 24401. (540) 886-0000 E-mail: dmetz@ntelos.net (preferable)

FOR SALE: Stock certificates of electronics companies. Technical books on radio, TV and electronics. Novelty items on Edison, Victor, RCA. Early tubes from WWI and after. Send LSASE w/2 stamps for each list. Phonograph needles and cartridges for all, no list. J.J. Papovich, 165 Trellis Ln., Sewell, NJ 08080. (856) 464-6741. E-mail: jjpapo@juno.com

FOR SALE: 1931 Howard cathedral/tombstone Model SG-B, Green Diamond, very good condition & plays well – \$275. Jim Ligouri, 7 Sycamore Ct., Atkinson, NH 03811. (603) 362-5712. E-mail: jligouri@aol.com

FOR SALE/TRADE: 2 cool Federal radios! First is a 59, very nice, orig. case, great face panel and lettering, all knobs nice, radio has been gone through, has all original AF's, RF, etc... This radio works great! The radio has the look. The lid is an exact repro, and so is lid instruction sheet. Next is a 110 in a very nice orig. case, also great face and lettering, knobs, also gone through, all orig., works great! This one has all orig. cabinet, also has the look. It does have exact repro lid instructions. Will sell or trade for other hi-end battery sets, AK breadboard, Western Electric, Kennedy, Tuska, Grebe, etc., or vintage mics, audio, what-have you! Same goes for the following horn speakers: Brandes Table Talker, Trimm, Home Speaker, AK Model L, needs driver. Have sleeve of four Mullard 5AR4's, N.I.B. Will trade for BBTT, 00A, 01A. **WANTED:** Federal Magnavox horns, AC 2 amp. Coil winder for Federal 226 AF's, Magnavox AC 2 AF's, R-3 field coils. Ward Kremer, 1179 Petunia Rd., Newport, TN 37821. Ph/ Fax: (423) 625-1994. E-mail: witzend99@earthlink.net

FOR SALE: Triumph 3" scope w/sweep; Electro #BJ 6/12V-12A bench supply – \$17.50 each + shpg. Henry Mohr, 1005 W. Wyoming, Allentown, PA 18103

FOR SALE: Zenith Royal 7000 w/man. – \$200. AK 12 breadboard, needs restoration – \$350. Bryan Tennyson, 6109 Oakland Park St., Meridian, MS 39307. (601) 482-3723

FOR SALE/TRADE: Outstanding Kadettes: first plastics, beelbed gothic & mahogany gothic. Consoles previous ad. Delivery July 11, 2003, Extravaganza. C.R. Nevins Museum of Radio, Ken Nevins, 406 Jipson St., Blissfield, MI 49228. (517) 486-3019, evenings please. E-mail: ken@kennevins.com



THE NEW ENGLAND MUSEUM OF WIRELESS AND STEAM, INC.

1300 Frenchtown Road, East Greenwich, Rhode Island 02818

Fax 401-884-0683 — Tel. 401-885-0545

<http://users.ids.net/~newsm> or e-mail: newsm@ids.net

HISTORIANS & COLLECTORS

RADIO STATIONS: PJ, W1NTE, W1MB & Fidelity Amateur Radio Club

YANKEE RADIO TUNE-UP

Saturday, August 2, 2003 — 8:00 A.M. – 3:00 P.M.

Admission \$10.00 — Free Parking

Bring something to auction at noon.

Antique Radio Flea Market & Tailgaters

WANTED: Chassis and speaker for U.S. Radio and TV Model 9 B, console radio, need not work but should be complete. Donald Dubias, 1375 Andrew St., Saginaw, MI 48603. (989) 799-5969

WANTED: Radio Mirror magazines, June 1934 and June 1935, Ruth Etting on covers. Glen Steinman, 7915 E. Michigan Ave., Jackson, MI 49201. (517) 522-4160

FREE – 20 WORD AD EACH MONTH
To get your free 20 words,
include your SUB# with your Ad.
Additional words are 29c each.
Read policy pages for details.
MANY THANKS!!!!

WANTED: Zenith 6 volt wind charger, loop antennas, horn and cone speakers, 20s battery sets. Joe Chambers, 6967 Kimberly Ln., Lithia Springs, GA 30122. (770) 819-0822

WANTED: The book, The Radio and TV Collectors Guide Book, Guy Biraud, Vol. 1 or Vols. 1 and 2. Earl Friedman, 27 NE 5th Ave., Hialeah, FL 33010-5014
Answering machine: (305) 884-2175

WANTED: Hallicrafters (2) small knobs, Model S-29, 39. Used also on S-41, 19R, 20R, 23, 24, 25. Robert Remes, 914 Hermosa Dr., Holbrook, AZ 86025. (928) 528-4223

WANTED: Sams Photofact television course TV-1. Please quote condition and price. Marion Clemens, KC8KCP, 10129 Lapeer Rd., Davison, MI 48423. (810) 653-2439

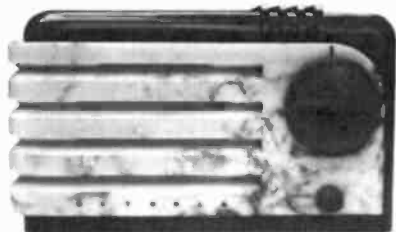

WANTED: More prewar plastics by Detrola, RCA, Kadette, Air King, et al. Take all my money before the relatives do. They are trying to hurry my already imminent demise. Please write or call collect: Rain Buttignol, 214 State St., #7, Portsmouth, NH 03801. (603) 427-1384

WANTED: Voice of Music parts, accessories, literature, dealer items. Gary Stork, 37530 E. Meadowhill, Northville, MI 48167. (248) 478-0990. E-mail from www.thevoiceofmusic.com

WANTED: Old guitars/guitar amplifiers, effects pedals. Vox, Fender, Supro, Silvertone, Gibson, Maestro, FuzzFace, etc. Sonny Goldson, 520 Pocahontas Dr., Ft. Walton Beach, FL 32547. (850) 314-0321. Fax: 0284. E-mail: sonny@sound@aol.com

WANTED: Coronado console radio wioth Gamble Skogmo chassis 807-B. Will consider cabinet or chassis alone. Have photos of this model if needed. Steve Danielson, 7630 Grand Oaks Cir., Lincoln, NE 68516. (402) 472-8693. E-mail: sdanielson1@unl.edu

audioXpress...

It just sounds better!



Subscribe to 12 great issues of hands-on audio...

BUILDING

RESTORING

MODIFYING

From vintage tubes to classic speaker designs to cutting-edge uses of today's technologies...

Find all this and more in the pages of each monthly issue of *audioXpress*.

SUBSCRIBE TODAY!

Only \$34.95 for 12 monthly issues of this great magazine.

That's \$54 off the cover price!

CANADA ADD \$12; OVERSEAS-1 YR. \$59.95

Call 1-888-924-9465 or e-mail to custserv@audioXpress.com

audioXpress, PO Box 876 Dept. ARC, Peterborough, NH 03458-0876

Phone: 603-924-9464 Fax: 603-924-9467
E-mail: custserv@audioXpress.com

VISIT OUR WEBSITE AT

www.audioXpress.com

FOR SALE: (66) used, assorted IF cans from old radios. Some Miller, Meissner, Merit coils boxed. (13) old style radio coils, various sizes. Ajjala Repair, 50 Fir Cir., Babbitt, MN 55706-1220

FOR SALE: Zenith 4G903 parts set – \$13.50. Philco 65, 87, RCA 29K, Silvertone 6093 consoles. Brian Kurrle, 2222 Nodleigh Ter., Jarrettsville, MD 21084. (410) 692-0450

One Month Free!

BONUS FOR EARLY RENEWALS

If you renew **before** the month shown on your mailing label (your expiration month), you will receive an extra month on your subscription: 13 months instead of 12! 26 months for an early 2-year renewal!

FOR SALE: Zenith MJ1035, AM/FM ST table model, vg – \$75. Zenith J402Y, AM, portable, vg – \$29. Zenith H500, vg, recapped – \$149. Bob Fuerderer, Holly Farm, 813 Rte. 12A, Surry, NH 03431. (603) 352-3005

FOR SALE: Freshman Masterpiece Model 5-F-4 – \$125. Zenith 1000 – \$140. Little Tattler headset, in original box – \$45. Sonora Brownie – \$55. Ernie Nagy, PO Box 822, Elk Rapids, MI 49629. (231) 264-9412. E-mail: elnagyl599@webtv.net

FOR SALE: Tube transistor radios. Check last month's A.R.C. LSASE list or e-mail. State preference. H.B. McMahan, 313 W. Shaw, Tyler, TX 75701-3029. (903) 593-5433. E-mail: hbmc2@juno.com

FOR SALE: Super dooper audio resistors. Vishay S102K series – \$2 ea. Many available. V. Vogt, 2311 Pimmit Dr., #114, Falls Church, VA 22043. E-mail: archaicaudio@webtv.net

FOR SALE: Television, How It Works, Rider 1948, 203 pp., softcover, g-vg – \$8 ppd. Henry C. Loos, 210 Ingraham Ln., New Hyde Park, NY 11040. (516) 354-1943. E-mail: hcloos@optonline.net

FOR SALE: Lifetime collection antique auction June 14 & 15, in Bradley SD. Many radios being sold June 14. Website: www.sdauctions.com. Loken, Bergh, Owen auction. Norman Sunne, HC 1, Box 50, Bradley, SD 57217. (605) 784-3216

FOR SALE: B&K Model 2800 digital multimeter with manual – \$15 + shipping. Martin Gottstine, 11136 79th St., Pleasant Prairie, WI 53158. (262) 948-0421. E-mail: M.I.Gottstine@worldnet.att.net

WANTED

MICROPHONES

BROADCASTING EQUIPMENT

Amplifiers, mixers, compressors, on-air lights, Mike flags, equalizers, Incentive, TV cameras, Disk, wire & tape recorders, 16 transcriptions, Turntables, arms, pickups, blank discs, speakers, Commercial home & theater audio. Interesting, early or elaborate radio & TV sets. Buy & sell



Robert Van Dyke, 2 Squires Ave., East Quogue NY 11942
631 728 9835 roberts.vandyke.com r.vandyke@optonline.net

FOR SALE: Sony Shortwave radio Model ICF2010, with manual, plus all accessories, brand new condition, has digital readout – \$200 plus UPS. Daniel Seidler, 10337 S. Keating Ave., Apt. 202, Oak Lawn, IL 60453-4752. (708) 424-2057

FOR SALE: F665 GE chairs – \$75. Universal 6B tombstone – \$80. Motorola 68F14 – \$45. Zenith G500, really clean – \$140. Sencore CG124 color gen. – \$10. Sencore SM158 aligner – \$10. Harmon Kardon C-12 amp – \$15. (2) Heathkit V7A meters – \$10. Zenith L569 chassis – \$25. Sparton RF amplifier chassis – \$10. Puritan 508 – \$85. RCA 100A speaker – \$60. Brandes phone – \$15. Music-Aire, Air King or ? – \$30. Automatic telephone tester – \$35. Kenwood KT5300 AM-FM tuner – \$35. Kenwood KA7300 amp. – \$35. JVC #1920 cassette – \$20. JVC #SEA20 equalizer. Crosley D speaker – \$45. Superior 82A tube tester – \$15. Old Westinghouse 12" fan with brass blades & guard – \$150. Hallicrafters BR40 – \$120. Ambotone 10 speaker – \$30. (50) 10" records, 78 rpm – \$25. Walt Wrabek, 10750 159 Ave., Menahga, MN 56464. (218) 564-4623

FOR SALE: Philco clock, grandfather clock radio, as seen in A Flick of the Switch p. 122. Original grille cloth, radio and clock do not work, but all parts are there, in position, cabinet has scratch on front – \$500. Carl Gorodetzky, 708 Sills Dr., Nashville, TN 37220. (615) 331-6446. E-mail: cgoro@comcast.net

FOR SALE: Grundig, King of the Satellits 650, like new, original box, literature – \$950. Panasonic RF-2200 – \$250. Gerald Silver, 10863 W. Clairmont Cir., Tamarac, FL 33321. (954) 720-1972.

FOR SALE: Westinghouse H-37177, 1953, plastic, brown, AM, FM, AC, DC, see Bunis – \$30 plus S/H. Leroy Neal, 603 Butterworth Ave., Dyersburg, TN 38024. (731) 285-5120, after 8 pm CDT.

FOR SALE: Wooden speaker out of 1923 Brunswick record player, 12 x 13 x 15, make offer. H.F. Brammell, 907 Waverly Way, Emporia, KS 66801. (620) 342-3074

FOR SALE: Arvin 722A – \$45. (16) collector tubes – \$55. Federal 1040TB – \$35. AMC children's phono – \$25. Tom Guastella, 1633 West 11th St., Brooklyn, NY 11223. (718) 256-8367

FOR SALE: High frequency Millimeter – \$50. Brunswick wooden speaker – \$125. Century Telephone Construction Company – \$300. Dubilier Cond. Co. transmitting condenser – \$40. Vibroplex key with black case – \$150. Type 558P amateur band frequency meter – \$175. Crosley Type V radio – \$250. RCA 100A – \$90. W.U. Tel Co., main line sounder – \$200. Type 358 general wavemeter – \$150. J.H. Bunnell sounder – \$500. Kellogg phone – \$75. Signal Corps radio receiving field telephone, dated June 20, 1918 – \$148. Signal Corps U.S. Army field induction telegraph dated 1918 – \$550. Tuner Type BC115 – \$500. Plus shipping. Larry Chambers, 5026 Suter Dr., Nashville, TN 37211. (615) 833-2448

FOR SALE: Panasonic mono r-r tape recorder, works – \$25 + postage. RCA tube manual, fair – \$7 + postage. Radiosale <http://members.aol.com/dmrradios/xstr.html>. Donald M. Maurer, 29 South 4th St., Lebanon, PA 17042. (717) 272-2481. E-mail: dmrradios@aol.com

EXTRAVAGANZA '03

Hosted by the Michigan Antique Radio Club

July 11 & 12, 2003

Holiday Inn South Convention Center
6820 S. Cedar Street, Lansing, MI 48911
(517) 694-8123

Come join us for our 18th annual convention

This year we are proud to honor a remarkable period of design. In 1925 the "Exposition Internationale des Arts Decoratifs Industriels et Modernes" held in Paris, would celebrate and define style for the next two decades. Radio design was profoundly influenced by the style and the result would be some of the most desirable sets. Come celebrate this remarkable era with us.

ART DECO

HIGHLIGHTS:



- **HUGE 2-DAY FLEA MARKET**
NOTE: FLEA MARKET OPENS FRIDAY!
- HOSPITALITY UNDER THE BIG TOP
- SATURDAY AUCTION WITH RICH ESTES
- EQUIPMENT CONTEST
- INFORMAL SOCIAL HOUR WITH LIVE ENTERTAINMENT
- ART DECO EXHIBIT
- 4 INFORMATIVE PROGRAMS
- DAILY PRIZE DRAWINGS

For information or registration contact: Don Colbert, 22400 Nowin, Dearborn, MI 48124. E-mail: donsradio@aol.com or check out our web page at www.antiqueradios.com/marc. Please be sure to include your name, address and a phone number where you can be reached.

EXTRAVAGANZA '03 Registration

Note: Everyone attending EXTRAVAGANZA must register! The monies collected from registration are a major source of revenue that helps pay for the event. Your cooperation is greatly appreciated.

Family Registration (All registrants must live at same address)		TOTAL
Current MARC member	\$15	\$
Non-MARC member	\$23	\$
Outdoor Flea Market sellers. Please note outdoor tables will require a \$10 ea., cash deposit at time of pick-up. The deposit will be returned when the table is returned.		
1st outside Flea Market space (\$25)		\$
Additional outside spaces <input type="text"/> # spaces x \$15 each		\$
8' table to rent <input type="text"/> # tables x \$15 each		\$
Under Tent Flea Market Sellers		
8' table with chairs <input type="text"/> # tables x \$30 each		\$
Make check out to MARC for this amount	TOTAL	\$

FOR SALE: 1928-1937 Philco Radio Service CD-ROM, over 140 models, 337 pp., any computer – \$35 postpaid! Mike Urban, 58 Nautical Ave., Milford, CT 06460. (800) 594-4359. Web: www.urban-antiqueradio.com

**PHONE NUMBER FOR
ANTIQUE RADIO CLASSIFIED
TOLL FREE (866) 371-0512
Best time to call is weekdays:
9 am to 5 pm Eastern Time
(Please no classified ads by phone.
Thanks!)**

FOR SALE: Vintage radio tubes, all tested and operating. Some four pin tubes. Send \$1 for price list. Stephen Perry, 314 E. Las Flores Ave., Arcadia, CA 91006. (626) 447-6381

FOR SALE: 1941 & 1942 Philco escutcheons, knobs and pushbuttons reproductions now available. Other various knobs and pushbuttons also available. Contact us for specific model numbers on escutcheons. Old Time Replications, 5744 Tobias Ave., Van Nuys, CA 91411. (818) 786-2500. E-mail: oldtimerep@aol.com. Web: <http://www.antiqueradioknobs.com>

FOR SALE: Channel Master TR6 early transistor radio, AM, original case – \$50. Levy, 8 Waterloo, Morris Plains, NJ 07950. (973) 285-0233

FOR SALE: Majestic Melody Cruiser Model 921, nice, plays – \$350. Kenneth Meyer, 502 Redwood Dr., Aviston, IL 62216. (618) 228-7522. E-mail: meyejk@papadocs.com

FOR SALE: FADA radio w/Bakelite case, asking – \$150 including shipping and handling. Gladys K Maloney, 620 State Route 35, Apt 317, Middletown, NJ 07748. (732) 275-9444

FOR SALE: (2) Zenith radios: N-825 and X-347W, excellent condition. Espey 511 receiver chassis 12 tube, 12" speaker on board, GE preamp with original schematic. Denton Lahner, 505 N. 10th St., Apt 801, Reading, PA 19604

FOR SALE: Tab book #778 Small Screen TV Servicing Manual. Tab book #532 How To Repair Solid-State Imports, audio & video. Sams Record Changer Manual #RC-10, 1956-1957. Sams Hi-Fi Stereo Servicing Guide by Robert Middleton. Sams Automobile Electronics Servicing Guide. Make offer & shipping. A-1 Radio & TV, 1402 Mather Ave., Utica, NY 13502. E-mail: liesthatbind1527@aol.com

FOR SALE: 1,200 plus transistor radios. I might have the one you're looking for. Doug Ferrero, 70173 Hillside Ct., Romeo, MI 48065. (586) 336-0120. E-mail: w8ynz@bignet.net

FOR SALE: ARC5 parts. Gloritone's first table Model 26P. Bill Coolahan, 1450 Miami Dr. NE, Cedar Rapids, IA 52402-2933. (319) 393-8075

FOR SALE: Setchell-Carlson, color, 21", round screen, unitized chassis, console, mahogany color. Pick up only. 1 box, 10 speakers & 10 meters. Ann Bichanich, Jay's, 15 W. Lake St., Chisholm, MN 55719

FOR SALE: GE J51 wood radio, nice cabinet, electronically restored, plays great – \$50 + postage. Jeff Ross, 170 Hwy 31, Flemington, NJ 08822. (908) 782-3121. E-mail: njradiodoctor@yahoo.com

FOR SALE: New Flashlight Reference & History Book, illustrates Eveready radios too – \$43 shipped. Brochure available. Bill Utley, PO Box 4095, Tustin, CA 92781. E-mail: flashlight1@cox.net

FOR SALE: RCA T62, very nice wood cabinet, works – \$65. F. Vaillancourt, PO Box 726, Woodstock, VT 05091-0726. (802) 457-3482

RADIO RESTORATION PARTS

Vacuum Tube Repair Wafers

These wafers are solid-state devices for quick and easy repair of early vacuum tubes. The wafer is installed by simply sliding it over the tube pins and reinserting the tube into its socket. If the filament is intact but there is little or no emission, the filament may be lit for best visual effect. However, the tube can be open filament.

No change in radio operating voltages is required. Any number of tubes may be repaired in a radio. If wafers are installed on all tubes, the B+ voltage typically may be reduced without sacrificing volume or sensitivity. Performance will vary between radio models. For best results, order one (1) "D" detector wafer for each radio. **\$10 each (3 or more, \$7.50 each)**



01A



WD11



UX199



UV199

Model # Also fits:

01A 00, 00A, 01, 201A, 301A, 12, 112, WD12, 40, 71, 171

WD11 –

UX199 20, 120, X120, UX120, 30, X130, UX130

UV199 –

Active Antenna

The active antenna allows antique radios designed for a long wire outdoor antenna to operate on an indoor whip antenna. Portable. Operates from a 9-volt battery. **\$34.95**

Call today!
501.407.0712

PTI
16302 Alexander Road
Alexander, AR 72002

tel: 501.407.0712 / fax: 501.407.0036
email: tburgess@powertechnology.com

Atwater Kent Breadboard Switch

This switch is a high-quality reproduction made in steel molds from the same type of material used by A.K. **\$50**

Prices include shipping. Orders shipped UPS or parcel post, prepaid in continental U.S. Allow 3 weeks for delivery. Arkansas residents add 5.375% sales tax.

Estes Auctions



*Specializing in Vintage Radios
Complete Auction & Appraisal Service*

Radio Auction

Saturday, July 26, 2003 at 10 A.M. EDT
at the Expo Auction Center, 8157 Garman Rd.,
Burbank, Ohio, Exit 204 off Interstate 71

We are conducting a sale from a private collector in Michigan. This will be a large auction that may require two sales. Some of the items are: "Protelgram" early projection TV, Tele-Tone w/ magnifier, Hallicrafters, early Zenith, Admiral, Emerson, Motorola TVs, tube guitar amps, tube type audio gear amps, tuners and preamps, early radios, TRF sets from the 1920s, horn speakers, military type transmitters & receivers, loads of table top radios, early Japanese and U.S.A. transistor radios, hundreds of tubes, tube testers, early recording and tape equipment, Trans-Oceanics, tube & transistor type, RCA commercial 20 watt FM xmtr, large amateur radio selection, Drake, National, Hammarlund, Hallicrafters, Ameco, RME, Gonset, EF Johnson & more. This will be an auction you will not want to miss. Make plans to be at this excellent sale.

ESTES AUCTIONS
7404 Ryan Road
Medina, Ohio 44256

Richard Estes, K8LRY – Auctioneer
Bob Dobush – Tubes
Kim Graca – Tech Support
Alan Ferris – Set Up
Mark DeLauter – Set Up

Phone: (330) 769-4992
Fax: (330) 769-4116
E-mail: estesauctions@aol.com
Web: www.estesauctions.com

Call us to sell one radio or an entire collection.

Order These Popular Books From Antique Radio Classified



Price
Guide

Collector's Guide to Antique Radios 5th Edition by John Slusser. 9,000+ sets from the 1920s to the 1950s. Updated prices. Many color photos, 264 pages. Available Now. — \$19.95



Price
Guide

The Collector's Guide to Transistor Radios 2nd Edition by Marty & Sue Bunis. This book will help you identify the most sought-after vintage transistor radios. Over 2,900 models, all with current prices. Includes radio club listing. 375 all new color photos, 320 pages. — \$16.95

Index to A.R.C., 1984-99. Sibley. Index to articles in *Antique Radio Classified*. \$15.00

Collectable Transistor TVs. Bunis. Identification and values for 150 transistor TVs from 29 manufacturers. B&W photos. 44 pgs. \$19.95

Classic Cones. Chidester. Pictorial reference & value guide for 1920s radio cone speakers. 100s of color photos. 200p. 122 pgs. \$25.95

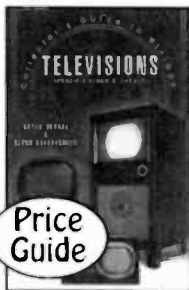

Price
Guide

Collector's Guide to Vintage Televisions by Bryan Durbal and Glenn Bubenheimer. Includes info. about the size of the screen, year of manufacture, cabinet composition, and current value for over 1,400 vintage TVs from 1945-1960 & transistor sets through 1980. 200+ full color photos, 176 pages. — \$15.95

Fixing Up Nice Old Radios by Ed Romney. Written by a retired radio instructor. Plastic binding. 300+ figures, 185 pages. — \$35.00

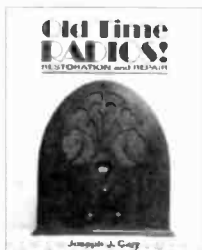
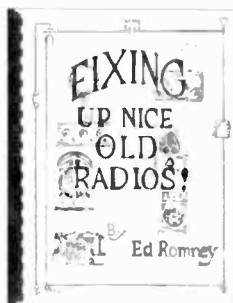

Old Time Radios Restoration and Repair by Joseph J. Carr. A self-paced training guide. History, theory and practical operation of antique and classic radios. 200 illustrations. 256 pages. — \$19.95

Everything stocked and shipped promptly — Radio is our middle name.

A.R.C., P.O. Box 2, Carlisle, MA 01741 – Toll Free: (866) 371-0512

Fax: (978) 371-7129 – E-mail: ARC@antiqueradio.com – Web: www.antiqueradio.com



Free shipping & handling on all U.S. orders (typical U.S. order will be received within 7 days, but allow 2-3 weeks). Mass. residents add 5% sales tax. Non-U.S. orders, write for shipping costs, or use credit card and specify air or surface (allow 2-3 months for surface shipping). Most orders shipped by next business day. If using credit card, include name on card, card number and expiration date. Send payment with order. Money back return policy. Subscribers, ask for discount when placing order: 10% off books; order must be mailed to address on file.



(#1-2-Dec-02)

Order These Popular Books From Antique Radio Classified

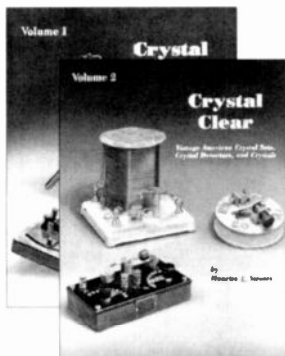

Crystal Clear Volume 1 and Crystal Clear Volume 2 by Sievers. *Comprehensive reference to crystal sets, crystal detectors, and crystals. Each volume contains different illustrations and information. Order by volume. — \$29.95*

Flick of the Switch by Morgan McMahon. *The classic photo reference guide for 1930s - 1950s radios. 1000+ photos of radios, 5" x 8", 263 pages. — \$11.95*



Hams! We now have 8 ham books. See our full page ad

The Collector's Vacuum Tube Handbook, Vol. 1, Millard. *Hard-to-find electrical data on 200+ tube types that pre-date the RMA standardized numbering system (1934). Basing diagrams, photos & brief developmental histories. 196 pgs. NEW \$25.95*
Tickling the Crystal, Sanders. *Comprehensive coverage of British crystal sets from the 1920s. 200+ B&W photos. 2001. 256 pgs. NEW \$64.95*



Guide to Old Radios, Pointers, Pictures, and Prices, 2nd Ed. by Johnson. *Introduction to radio collecting. Includes hundreds of photos and a price guide. 272 pages. — \$19.95*



Antique Radio Restoration Guide, 2nd Ed. by Johnson. *Beginner's introduction to troubleshooting and repairing AC table model radios. 145 pages. — \$14.95*



The Zenith Trans-Oceanic: The Royalty of Radios by Bryant and Cones. *Presents the fascinating story of the development and use of the Trans-Oceanic. Several photos, documents, ads, etc. 160 pages. — \$24.95*



Communications Receivers, 4th Ed. by Ray Moore. *Information on vacuum tube receivers by 66 manufacturers. 448 radios illustrated. 136 pages. — \$19.95*

Everything stocked and shipped promptly — Radio is our middle name.

A.R.C., P.O. Box 2, Carlisle, MA 01741 – Toll Free: (866) 371-0512
 Fax: (978) 371-7129 – E-mail: ARC@antiqueradio.com – Web: www.antiqueradio.com



Free shipping & handling on all U.S. orders (typical U.S. order will be received within 7 days, but allow 2-3 weeks). Mass. residents add 5% sales tax. Non-U.S. orders, write for shipping costs, or use credit card and specify air or surface (allow 2-3 months for surface shipping). Most orders shipped by next business day. If using credit card, include name on card, card number and expiration date. Send payment with order. Money back return policy. Subscribers, ask for discount when placing order: 10% off books, order must be mailed to address on file.



(#1-2-Dec-02)

NEW — NEW — NEW

E.H. Scott... The Dean of DX BY MARVIN HOBBS

2002 Second Edition – Expanded!

Additional Chapters

Color Photo Section – 24 pages

E.H. Scott... The Dean of DX, the definitive book on the E.H. Scott Company for over 15 years, has been revised and expanded by author Marvin Hobbs with the assistance of John Slusser of Radio Daze Press. This is a “must have” book for any E.H. Scott enthusiast. 8 1/2 x 11”, 240 pages.

\$29.95 – Softcover

E.H. Scott..... The Dean Of DX



A History
Of



Classic
Radios

By Marvin Hobbs • Scott Chief Engineer 1930 • 1947
Expanded Second Edition

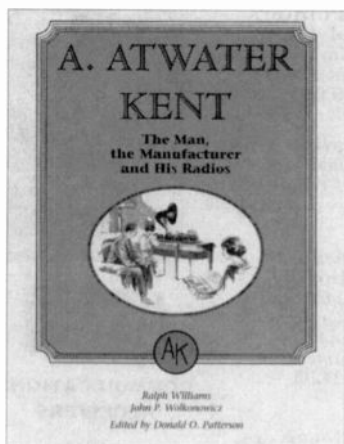

A. Atwater Kent The Man, the Manufacturer and His Radios BY RALPH WILLIAMS AND JOHN P WOLKONOWICZ

A compilation of the articles on Atwater Kent which were published in *Radio Age* by Ralph Williams in the 1970s. Covers 1920s Atwater Kent sets. Also included is John P. Wolkonowicz's 1976 article *WPI's Forgotten Millionaire*. This is a “must have” book for any Atwater Kent enthusiast. Donald O. Patterson, Editor. 8 1/2 x 11”, 108 pages.

\$25.95 – Softcover

**Everything stocked and shipped promptly — Radio is our middle name.
FREE SHIPPING — 10% Discount for Subscribers**

**A.R.C., P.O. Box 2, Carlisle, MA 01741 – Toll Free: (866) 371-0512
Fax: (978) 371-7129 – E-mail: ARC@antiqueradio.com – Web: www.antiqueradio.com**



Free shipping & handling on all U.S. orders (typical U.S. order will be received within 7 days, but allow 2-3 weeks). Mass. residents add 5% sales tax. Non-U.S. orders, write for shipping costs, or use credit card and specify air or surface (allow 2-3 months for surface shipping). Most orders shipped by next business day. If using credit card, include name on card, card number and expiration date. Send payment with order. Money back return policy.



Subscribers, ask for discount when placing order: 10% off books; order must be mailed to address on file.



(#33-Feb03)

WANTED: Knobs for Philips Model 431D and Mullard Model 69A. Thanks. Henry Tessier, 945 Commercial St., Weymouth, MA 02189. (781) 337-7279. E-mail: radiohenry@aol.com

— WANTED —
**PICTURES FOR PHOTO REVIEW OR
 TELEGRAPH REVIEW
 PHOTOS MUST BE SHARP IN DETAIL
 A SHORT DESCRIPTION IS A MUST!
 SEE PHOTO REVIEW PAGES FOR
 ADDITIONAL INFORMATION**

WANTED: 8C and 9A Western Electric amplifier needed for a working historical exhibit on film sound. Any condition OK. Will pay top dollar or trade for other interesting items. Nicholas Bergh, 6390 E. Los Santos Dr., Long Beach, CA 90815. (562) 212-0121. E-mail: nbergh@ucla.edu

WANTED: Airline 62-101 chassis & speaker, Radiola 20 cabinet, Philco 90 speaker, Philco 77 lower cabinet carving. Keith Park, 31 Barkwood Ln., Clifton Park, NY 12065. (518) 373-0417. E-mail: toptonch@nycap.rr.com

WANTED: Wavemagnet for Zenith 11S474, used in many different models, approx. 15" tall, has 4 or 5 leads leading to a small 4 or 5 pin plug. Needed to complete restoration of my beautiful console. Will Pay. Thanks for any help. Irv Sanders, 242 Hunter Ln., Harrisburg, PA 17112. (717) 469-2185. E-mail: sparkey34@juno.com

WANTED: 7JP4, 3KP4 picture tubes. Also round screen porthole TVs, microphones, tube CBs/accessories. Charles Zafonte, N1FRX, 364 Charette Hill Rd., Fort Kent, ME 04743. (207) 834-6273. E-mail: kwazydude@hotmail.com

WANTED: All info for Readers Digest CycloPhonic phono #C-5, instr., schem. H Jenkins, 92 Shawshen St., Tewksbury, MA 01876



WANTED: Motorola Catalins #s 50XC, 51X15, and 52, as complete or "parts" sets. I am a very serious collector seriously looking for serious stuff (leaving all kidding aside, of course)! Please write or call collect: Rain Buttignol, 214 State St., #7, Portsmouth, NH 03801. (603) 427-1384

WANTED: Examples of N.I.B. Gold Lion and Mullard 10M series tubes for display. Larry Daniel, 3112 Seton Hill Dr., Bellbrook, OH 45305. (937) 848-8892. E-mail: LDaniel102@aol.com

WANTED: Early military radio generator, hand or foot powered, 500 cycles AC. Tom Burgess, 9 Belle Meadow Ln., Little Rock, AR 72210. (501) 455-0773

WANTED: Book for Sigma AF/RF signal generator Model W-200. Gwen Cathcart, 410 Georgetown Dr., Kenner, LA 70065-4106

WANTED: Square brass escutcheon around tuner on Dumont TV Model RA-103D. Neil Dorfman, 7028 Clements, West Bloomfield, MI 48322. (248) 661-8770. E-mail: nbd@juno.com

CAPACITORS

ELECTROLYTICS



630 VOLT AXIAL LEADS

PRICE	VALUE	PRICE/25
.001-630	102K	\$6.00
.0022-630	202K	6.15
.0047-630	472K	6.25
.0068-630	682K	6.35
.01-630	103K	6.50
.022-630	223K	7.00
.033-630	333K	7.25
.047-630	473K	7.50
.1-630	104K	8.00
.22-630	224K	15.00
.47-630	474K	20.00
1.0-630	105K	26.00

160 VOLT AXIAL LEADS

PRICE	VALUE	PRICE/25
10-160	10	\$13.00
22-160	22	16.00
33-160	33	21.00
47-160	47	24.00

450 VOLT AXIAL LEADS

PRICE	VALUE	PRICE/25
10-450	10	\$18.75
22-450	22	28.00
47-450	47	45.00

PRICE	VALUE	PRICE/10
47-450-10	47	\$20.00
100-450-10	100	28.00

PILOT LAMPS

NUMBER	PACK	PRICE
41	(10 PK)	\$2.75
44	(10 PK)	2.75
47	(10 PK)	2.75
57	(10 PK)	4.50
81	(10 PK)	8.00

Phone: 1-708-352-0648

Fax: 1-708-352-0647

Email: radiobob1@aol.com

Visit: RADIOANTIQUES.COM

BOB'S ANTIQUE RADIOS & ELECTRONICS

111 East 29th St., LaGrange Park, IL 60526

TO ORDER PLEASE SEND CHECK, MONEY ORDER OR PAYPAL.
 THE PRICE INCLUDES SHIPPING COST WITHIN THE USA.

FOR SALE: Old TV Analyst – \$50 plus shipping. Lee Elkins, 3016 Jasmine Rd. NW, Carrollton, OH 44615

FOR SALE: Thinning my collection. Great selection, plastics, wood; cathedrals, tombstones, etc. for pictures send LSASE. Steve Casper, PO Box 1802, Benicia, CA 94510

Classified Ad Deadline Noon

June 10 for July 2003 Issue

July 10 for Aug. 2003 Issue

Boxed, Photo, & Display Ads - 1st

FOR SALE: UTC transformers; Types A-20, LS-33, LS-30, LS-667, some N.I.B. Top Shelf Audio & Video, 39 Boston St., Middleton, MA 01949. (978) 774-4041. E-mail: tk41c@aol.com

FOR SALE: Fisher 500C, no power tubes, missing knob – \$20 plus shipping. Jon D. Andreasen, PO Box 22, Newton, NJ 07860. (973) 579-6261, no calls after 8:30 pm Eastern! E-mail: rca12ax7a@yahoo.com

FOR SALE: Walkie-talkie collection, 210 pair and 82 singles in custom boxes. Marvin Hess, 204 Queensway Rd., Elma, NY 14059. (716) 674-1719

FOR SALE: Zenith T-O D7000Y parts set. FM/VHF works – \$100. Ed Kalpa, 4622 Melbourne Ave., Los Angeles, CA 90027. (323) 661-1221

FOR SALE: Drake SW4A shortwave receiver, MS4 speaker, ultra sensitive receiver, like new condition – \$250. Clyde Powell, 3822 Edwards Ter., Chattanooga, TN 37412. (423) 867-3200

FOR SALE: Majestic 1935 factory manual of all 122 receivers, speakers, tubes, parts – \$25 ppd. Charles Kirsten, Radio Relics, 1710 S. Mountain Ave., #E, Ontario, CA 91762. (909) 391-5856



BUY/SELL

TUBES

NEW & USED

SEND FOR OUR "WANT LIST"

OR

OUR FREE CATALOG

ELECTRON TUBE ENTERPRISES

P.O. BOX 652

SPRINGVALE, ME 04083

TEL: 207-490-5870

FAX: 207-490-2228

Visit or contact us via our web site at:

<http://members.aol.com/etetubes>

FOR SALE: Go to our website at GN4RADIO.COM for an extensive listing of items for sale! We have all of your reproduction Zenith restoration parts. Call for info. Crosley Widget. Zenith 15U269. Reproduction glass dial scale for the Zenith 12A57 and 12A58 – \$85. Dial glass for 1939 Zeniths. Two different repro plastic pointers for 1939 Zeniths – \$30 each. Back again: Zenith coffee mug, white with red logo – \$8 plus S/H \$5. NEW! Revised edition of our own Zenith Brochure Book to reference your radios with color cover, more pages and added models – \$28.95 plus \$5.95 shipping. Updated parts and supplies catalog, request free copy. E.H. Scotts for sale. See website. We have hundreds of Zeniths and other radios for sale. AC power cord for 7000 Trans-Oceanics – \$10 plus \$5 S/H. Most Trans-Oceanics available, call. Hard to find Rider's manual numbers in stock, call. We can and do ship consoles and we do it right. Satisfaction guaranteed, highest quality assured. We offer complete chassis restoration service on all radios. Visiting Minneapolis? Visit our store Great Northern Antiques at 5200 Bloomington Ave. just 3 miles from the airport. Owner's and service manuals for most Scott radios. We have over 100 different highest quality repro knobs. Trans-Oceanic knobs with inserts – \$15. We stock a large selection of quality repro grille cloth. We accept Visa, Discover, Mastercard, American Express and Paypal. Alan Jesperson, PO Box 17338, Minneapolis, MN 55417. (612) 727-2489, 11 am - 4:30 pm. Fax: (612) 821-4820, Tues-Fri, Sat 10-3. E-mail: mte612@aol.com

FOR SALE: Books, magazines, catalogs, entertainment, photos (instruction, radio). Make offer on each item. SASE (2) stamps. Call for appointment. Robert J. Stone, 721 Fisk St., Piqua, OH 45356-3729. (937) 773-2217

FOR SALE: Radiola III w/(2) WD-11s, exc cond. (2) Emersonette radios; 1 black & 1 maroon. Electro-Voice mike #264. 8" RCA BW TV 1950s, working, metal cabinet on tripod, looks great – \$70. (2) Flot-A-Tone guitar amp in maroon & ivory leatherette cabinet, working, looks great, uses (2) 6L6s. S38C Hallicrafters & S38E, exc cond. 63TA Crosley table model, has red, white & blue stripes & 4 gold stars on huge dial, all orig. w/back. McIntosh 250 amp. Bill Kalcik, 1533 River Rd., Wisconsin Dells, WI 53965. (608) 253-9855, after 9pm CST

FOR SALE: N.O.S. TV tubes – \$2 ea. plus ship, N.O.S. 1/2 W & 1 W resistors – 10c ea. Gordon Van Allen, 5822 Knollwood Dr., Ashtabula, OH 44004-7534. Ph./fax: (440) 998-0723

EUROPEAN RADIOS (VINTAGE)

RADIOS! Grundig, Telefunken, Phillips, Nordemende, Blaupunkt, also English, French, Yugoslavian, Polish and Russian radios, etc. All radios are subject to prior sale! For a complete list, please send SASE or visit our Web Page: Rgbent.com

Call 732-607-0299 • Fax 732-679-8524

E-mail: RGBENT@AOL.COM

R.G.B. Enterprises, Dept. 77

P.O. Box 5367, Old Bridge, N.J. 08857, U.S.A.

Estes Auctions



*Specializing in Vintage Radios
Complete Auction & Appraisal Service*

“The Donald Rosbach Collection” Vintage Radio Collection

Saturday, September 20, 2003 at 10 A.M. EDT
at the Expo Auction Center, 8157 Garman Rd.,
Burbank, Ohio, Exit 204 off Interstate 71

Estes Auctions is pleased to offer the collection of Donald Rosbach of Canton, Ohio for auction. Don collected early radios and crystal sets as well as amateur radio receivers. Everything in his collection is in pristine condition. He also has a nice assortment of tubes and other items. In the following weeks we will be taking photos of Don's collection for our website. There are several nice Federal radios in his collection. We will have flyers at the summer meets in Michigan, Elgin & Rochester. Also watch A.R.C. for our announcement on a super auction from New York State that may be combined with the Rosbach auction.

ESTES AUCTIONS
7404 Ryan Road
Medina, Ohio 44256

Richard Estes, K8LRY – Auctioneer

Bob Dobush – Tubes

Kim Graca – Tech Support

Alan Ferris – Set Up

Mark DeLauter – Set Up

Phone: (330) 769-4992

Fax: (330) 769-4116

E-mail: estesauctions@aol.com

Web: www.estesauctions.com

Call us to sell one radio or an entire collection.

FOR SALE: Visiting NH? Check out the Radio/Technology Books in our shop. Visit www.beqbooks.com for details or call. Bequaert Old Books, PO Box 775, Fitzwilliam, NH 03447. (603) 585-3448. E-mail: info@beqbooks.com

FOR SALE: Transistor novelty radios N.I.B. – \$17 S&H included. Detailed list. Clarence Kell, 202 S. State, Danville, IL 61832

FOR SALE: Sundial Wire supplies new cloth-covered wire, custom manufactured to replicate vintage electrical wire. Many styles, colors, gauges. Plugs also. Safe and authentic. Sundial Wire, PO Box 1182, Easthampton, MA 01027. Fax: (413) 582-6908. Full service web site: <http://www.sundialwire.com>. E-mail: custserv@sundialwire.com

FOR SALE: Repro spherical Audions as seen in May OTB. Czech-made standard base tennis ball tube with bright filament. Limited quantity – \$100 ea. postpaid. Spec sheet included. Dick Parks, 2620 Lake Ridge Ct., Oakton, VA 22124. (703) 242-8268. E-mail: dparks@erols.com

FOR SALE: (3) Air King, black; (2) white; (1) green, metal flaked, see Sideli p. 7 Model 52. (3) Sparton Cloisonne p. 123. Many Fada models and other Catalins & novelty radios. Alex Kertesz, 7860 Montecito Pl., Delray Beach, FL 33446. (216) 831-4199. (561) 495-1017

FOR SALE: Sony earth-orbiter – \$295. Trans-Oceanics: RD7000 chassis 500 MDR 70. excellent – \$495; 7000Y1, excellent – \$425; 3000-1, vg – \$195; 8G005 complete. excellent – \$395; H-500 mint – \$495; 600L tan leather – \$795; royal 990 SW – \$95. Ted Demski, 5806 225 Pl. SW, Mountlake Terrace, WA 98043. Ph./fax: (425) 778-7100. Ph.: (425) 345-1670

FOR SALE: Collection of 28 old radios and 1,000 old tubes. Selling entire collection. Don J. Scher, 3705 57th Ave., Vero Beach, FL 32966. (772) 562-5149

FOR SALE: New Flashlight Reference & History Book – illustrates Eveready radios too – \$43 shipped. Brochure available. Bill Utley, PO Box 4095, Tustin, CA 92781. E-mail: flashlight1@cox.net

CLASSIFIED AD NOTICE

Please check your ads carefully before sending them in. Once ads are received, it is not always possible to refund the amount sent, pull the ad or make changes.

FOR SALE: Crystal Radio Kits, complete with face panel, base board, variable capacitor, prewound coil and many parts for old style radio, remit – \$22.50. Carl & Grace Ent., 5636 Romeyn, Detroit, MI 48209

FOR SALE: Crosley 56TX, recapped, excellent cond. – \$59. 9-122W recapped, excellent cond. – \$45. Philco 20, plays – \$180. Tubes: 12AX7, new in box – \$15. 12BH7A, new – \$17. 6V6, used, tested – \$5. 80, used, tested – \$10. 27, used, tested – \$5. Tube caddy – \$16. Box of 70. 5963 (12AU7A), tested a couple of them, the rest unknown, offer? Other tubes, inquire. All plus shipping. Andy Shackelford, 702 Brandywine Blvd., Wilmington, DE 19809. (302) 764-7502. E-mail: andrwhac@aol.com

FOR SALE: Heath Model AJ-15 solid-state FM stereo tuner, unused for 20 years, all original, with manual – \$65 or Best Offer. Max Strange, 11710 Wayneridge Ct., Fulton, MD 20759. (301) 725-3858

FOR SALE: Rider's Perpetual Troubleshooting Radio Manuals, numbers 1 thru 19, with index, very good condition, set – \$3,000. Zeke Lakeman, 111 Mabry Way, San Rafael, CA 94903. (415) 479-1095

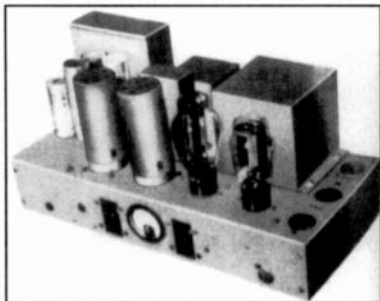
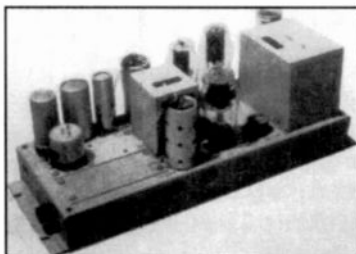
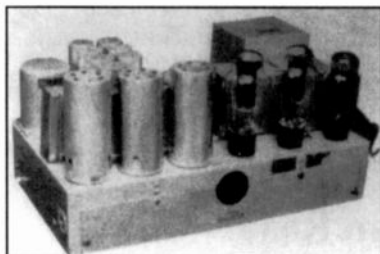

Always wanted Western Electric theatre amps, speakers, horns, drivers and tubes. Also seeking vintage tube equipment by Marantz, McIntosh and Tannoy. Thank you.

Chong Ong
10717 Ames Street
Fairfax, VA 22032
Tel. (703) 273-3866
E-mail: cong@cox.net

WANTED: JVC FR-6600JW shoulder belt assembly V31156-00A. Richard Dzick, 37079 Tamarack Dr., Sterling Heights, MI 48310. (586) 268-4671. E-mail: rwdzick@tm.net

WANTED: Anything by David Grimes: radios, advertising, ephemera, stories, literature, references. Please contact: Mike Grimes, K5MLG, 3805 Appomattox Cir., Plano TX 75023. (972) 867-6373. E-mail: grimesm@flash.net

**FAX NUMBER FOR
ANTIQUÉ RADIO CLASSIFIED
(978) 371-7129 – 24 hours a day
Ads – Subscriptions – Book Orders
See policy pages for details**

WANTED: Uher tape recorder, series 4000, 4200 and 4400, need not be working. Ray Barnes, 38 Woodmere Rd., Framingham, MA 01701. (508) 877-5232. E-mail: raybar13@juno.com

WANTED: Sony transistor radios, paying \$5,000 for Model TR-55 or TR-5. \$1,000 - \$2,000 for TR-66 or TR-62. David Mednick, 10 Doe Dr., Wesley Hills, NY 10901-2302. (845) 354-5041. E-mail: davemd@optonline.net. Web: <http://mednick.homestead.com/Mednick.html>

WANTED: First AFT transformer for Atwater Kent 20 set 4640 part no. 8060? Norman Reiss, 360 South St. West, Deer Park, WI 54007. (715) 269-5473

WANTED: Collections for The Southern Appalachian Radio Museum, a place your equipment can be seen. Visit us in Asheville, NC and at www.saradiomuseum.org. Clint Gorman, 240 Governors View Rd., Asheville, NC 28805. (828) 299-1276. E-mail: cgorman@bellsouth.net

WANTED: Back cover for Hallicrafters TW-25. Brian Ulrich, 371 High St., Souderton, PA 18964. E-mail: nyoldradiostuff@yahoo.com



WANTED: Fada Catalin radios. Help! My entire collection spontaneously combusted during an interview with the "Enquirer." Replenish and repent ye sinners. Please write or call collect: Rain Buttignol, 214 State St., #7, Portsmouth, NH 03801. (603) 427-1384

WANTED: 1 inch oscilloscopes using one inch CRT's. Please contact: Allan H. Weiner, 97 High St., Kennebunk, ME 04043. (207) 985-7547

WANTED: Collector looking for large collections of ham, shortwave radios, also tube hi-fi gear, parts. NY tri-state area. Juan Remus, 2 Springbriar Ln., Kings Park, NY 11754. (631) 544-6004

WANTED: Manual for EMC Model 208. 1.65-4.1 MHz coil for Knight Ocean Hopper. Doug Fox, 603 S. 12th Ave., St. Charles, IL 60174. (630) 584-5915. E-mail: dfoxradio@aol.com

WANTED: Record changer for a console Zenith Allegra Model No. SR915P with Cobra arm. Also, restorable Philco cathedral Model 16B. Jack D. Campbell, 1804 Crestview, Danville, IL 61832. (217) 446-0229

**ELECTRIC
RADIO**



Now in our 14th year, the popular monthly Electric Radio Magazine is published for those who are interested in AM and CW operating, vintage ham and military radio equipment, the history of radio communications, and shortwave listening. ER has the largest vintage-only ham classified section available. \$2 for a sample copy.

ER, PO Box 582, Pine CO, 80470-0582
720-924-0171 or ER@OfficeOnWeb.net
WWW.ERMAG.com



**Philco knobs,
pushbuttons,
and escutcheons!**



Quality marbled repros. **For 1941 models:** Escutcheon \$29.95. Knobs, set of four \$20. Pushbuttons, set of eight \$16 your choice opaque brown or non-marbled translucent wine red. **For 1942 models:** Escutcheon with gold trim as per original \$32.95. Knobs, set of four \$20. Pushbuttons, set of nine \$31.50. Money order gets immediate shipment. Add \$5 s&h. Calif. residents add 8.25% sales tax. Old Time Replications, 5744 Tobias Avenue, Van Nuys, CA 91411. Phone (818) 786-2500. Email oldtimerep@aol.com

1941 models 41-250, 255, 256, 280, 285, 287, 290, 296, 610
1942 models 42-355, 42-355T, 42-380, 42-380X, 42-390, 42-390X

FOR SALE: Heathkit signal tracer, T-4, probe, no manual – \$25. PACO capacitor checker C-20 – \$25 + shipping. Stephen L. Bonino, 107 Georgetown Rd., Glassboro, NJ 08028. (856) 881-0244. E-mail: sibon@erols.com

FOR SALE: Gernsback's Radio-Craft and Short Wave Craft magazines from 1930s. Free list. Bob Ryan, 1000 S. Gilbert St., Apt. 132, Hemet, CA 92543-7065

FOR SALE: Coronado B3 – \$45+. Emerson CS 268 – \$45+. Fujiya R-R – \$25+. GE 321 – \$55+. GE 115W – \$50+. Grunow 580 – \$175+. Robert Rossi, 10936 Melbourne St., Allen Park, MI 48101. (313) 386-8321

FOR SALE: RCA Fieldcoil speakers, 12", #8203058, vg – \$45. Heavy 12" for 15K – \$40. Jay Myers, 1010 Graybar Ln, Nashville, TN 37204. (615) 297-5886. E-mail: jlmyers3@highstream.net

FOR SALE: RCA DX77 ribbon microphone, great condition, no stand – \$850. C. Kirk, One Center Court, Ste. 200, Portland, OR 97227. (503) 797-9871

FOR SALE: Westinghouse WR-10 chassis WT – \$65. Kolster K-130 chassis NT – \$55. Silver-Marshall Model 30 NT – \$45. RCA 13K chassis WT – \$125. Philco 650 or 655 chassis and speaker WT – \$125. Glenn Novak, 6789 West 700 South, Union Mills, IN 46382. (219) 767-2367

FOR SALE: Tubes S1 each. 1B3, 0D3, 6SK7, 12AT7, 12AU7, 12BL6, 12SQ7, 12SK7, others. Thanks. James Wright, 4307 Hwy. 166N, Maynard, AR 72444. (870) 647-2913

FOR SALE: EICO 4-track stereo/mono tape recorder #2400, classis kit assembled with instruction assembly book, looks fine, asking – \$75 + UPS. Phil Guinan, 106 Page Rd., Litchfield, NH 03052. (603) 889-6213. E-mail: Philip1924@aol.com

FOR SALE: Nipper shakers, no stoppers – \$40. KWK/WEMP lighter – \$38. Grinnell radio/TV ashtray – \$15. Jacob, 2276 Holloway Ave., Maplewood, MN 55109. (651) 777-6791

**E-MAIL ADDRESS FOR
ANTIQUE RADIO CLASSIFIED
ARC@antiqueradio.com
Ads – Subscriptions – Book Orders
See policy pages for details**

FOR SALE: Plastic dial covers, any size, any shape – \$14. Glass dial covers. 2" to 8 7/8" x 1/16" incr. – \$14. Electrolytic capacitors, new, 7/8" dia. x 3" or 3 1/4" long, shiny red or blue cover, brown hot glue end seal with printed inscription the long way down the length, a metal mounting strap with a hole for mounting, exactly like the ones so popular in the 40s, 50s & 60s, 33uF-47uF 160 volts – \$4, 33uF-47uF 160 volts, 47uF/100 – \$5, 33uF-47uF 94 uF/100 volts, for AC/DC battery sets – \$5, 22uF-22uF 450 volts, for AC sets – \$5.50. The following are 1" IN dia. X 3 3/4" long, black: 33uF-33uF 450 volts – \$6; 47uF-47uF 450 volts – \$7. All postage paid, cash, money order, check. Bill Turner, WA0AB1, 1117 Pike St., Saint Charles, MO 63301. (636) 949-2210. E-mail: dialcover@webtv.net

FOR SALE: Superior TV-11 tube tester, tests all tubes 4-pin to 8-pin sub min and condensers, like new. Ken Flockhart, 425 South 18th St., Fort Dodge, IA 50501-5159. (515) 573-5477

FOR SALE: Supreme Model 85 tube tester; (2) Zenith 12CBP4 picture tubes, new in original cartons; Atwater Kent Model 35; Stewart-Warner Model 300 with 4 original Stewart-Warner tubes; Riders manuals 2 to 15. Telmer Olson, W0YPT, 304 W. Iowa St., PO Box 267, Monona, IA 52159. (563) 539-2315

S.A.R.S. SUMMER SWAP MEET ATLANTA, GEORGIA

JUNE 13 & 14, 2003

FRIDAY "NO HOST" DINNER

7:00 PM AT A LOCAL RESTAURANT

SATURDAY FLEA MARKET FROM

8:00 AM UNTIL 12:00 PM

(No Early Sales)

**Fairfield Inn – Alpharetta
(same as last year)**

**11385 Haynes Bridge Road
(Exit 9, Ga. Hwy. 400)**

**Special Fairfield Inn Rate for Attendees
Call: (770) 663-4000**

Vendors (unlimited space) – \$10.00

This is an outdoor, tailgate meet.

Info: Gordon Hunter (770) 475-0713

THE TUBE SHOP

"Your one stop for new old-stock tubes"



Box 11283

Norfolk, VA 23517

Phone: 757-624-6622

Fax: 757-624-3735

E-mail: tubeshop@cox.net

On the Web at:

www.thetubeshop.com

Looking for a Price Guide?

- Classic Cones, Chidester.** *Pictorial reference & value guide for 1920s radio cone speakers. 100s of color photos. 122 pgs.* **\$25.95**
- Collectable Transistor TVs, Bunis.** *Identification and values for 150 transistor tvs from 29 manufacturers. B&W photos. 44 pgs.* **\$19.95**
- Collector's Guide to Antique Radios, 5th Edition, Slusser.** *This price guide covers the 1920s to the 1950s. Over 9,000 models. Color photos. Updated pricing. 264 pgs.* **\$19.95**
- The Collector's Guide to Novelty Radios, Bunis & Breed.** *The source for novelty transistor radios in all shapes & sizes. Radios are described in detail with current prices. 600+ color photos. 224 pgs.* **\$18.95**
- The Collector's Guide to Novelty Radios, Book II, Bunis & Breed.** *All new 2nd volume. New radios are described with current prices. 600+ all new color photos. 208 pgs.* **\$19.95**
- The Collector's Guide to Transistor Radios, 2nd Ed., Bunis** *Identifies the most sought-after vintage transistor radios. Over 2,900 models. 375 all new color photos, with current prices. 320 pgs.* **\$16.95**
- The Collector's Guide to Vintage Televisions, Durbal & Bubenheimer.** *Includes information about the size of the screen, year of manufacture, cabinet composition, and current value for over 1,400 vintage TVs made from 1945-1960 and transistor sets through 1980. 290+ color photos. 176 pgs.* **\$15.95**
- The Complete Price Guide to Antique Radios: Pre-War Consoles, Stein.** *Identifies, grades, values & pictures 3,500 models. Tube & band count information & variations. Resource section. 240 pgs.* **\$29.95**
- The Complete Price Guide to Antique Radios: Sears Silvertone Catalogs 1930-1942, Stein.** *1,000+ radios. Original advertising, options, specs & pricing. Full model cross reference matrix with tube & band counts, variations, cabinet materials & colors. 240 pgs.* **\$34.95**
- Genuine Plastic Radios of the Mid-Century, Jupp & Piña.** *Overview of plastic table radios with ads, vintage black & white photos. 439 color photos. 208 pgs. Hardcover.* **\$39.95**
- Ham Price Guide, 2nd, Eugene Ripper.** *Prices for over 3,800 transceivers, receivers, tuners, transmitters, amplifiers, antennas, test equipment, books, tubes and catalogs. Small print. 81 pgs. Softcover.* **\$10.95**
- Machine Age to Jet Age, Stein.** *3 volumes. Pictorial reference & price guides. Virtually no overlap.*
Vol. 1: 2,500 radios, black & white photos. 239 pgs. Revised for 2003. **NEW \$29.95**
Vol. 2: 2,700 radios, black & white photos, 16 pg. color insert. 372 pgs. **\$28.95**
Vol. 3: 3,000 radios, black & white photos, tube and band count information. 256 pgs. **\$29.95**
- Radios by Hallicrafters, 2nd Ed., Dachs.** *The most definitive book on the company. Over 1,000 photos (some color) on everything they made. Additional coverage & updated pricing. An invaluable tool for anyone interested in Hallicrafters. 225 pgs.* **\$29.95**
- The Talking Machine, Fabrizio and Paul.** *Contains over 550 photos of internal and external horn phonographs. The text and value guide, complemented with lots of visuals, make this book a must in your library. 256 pgs. Hardcover Only.* **\$69.95**
- Transistor Radios: 1954-1968, Smith.** *Over 1,000 transistor radios identified by manufacturer, marketing organization, type, and style. Color photos and price guide. 160 pgs.* **\$29.95**
- Zenith The Early Years, 1919-1935, Bryant & Cones.** *Explains the Zenith story. Discover never published photos, documents and info. 300 photos & illustrations. 120 color. 224 pgs.* **\$29.95**
- Zenith Transistor Radios, Evolution of a Classic, Smith.** *A complete listing of all transistor radio models created by Zenith from 1955-65. Color photos and price guide. 160 pgs.* **\$29.95**

Everything stocked and shipped promptly — Radio is our middle name.

A.R.C., P.O. Box 2, Carlisle, MA 01741 – Toll Free: (866) 371-0512

Fax: (978) 371-7129 – E-mail: ARC@antiqueradio.com – Web: www.antiqueradio.com



Free shipping & handling on all U.S. orders (typical U.S. order will be received within 7 days, but allow 2-3 weeks). Mass. residents add 5% sales tax. Non-U.S. orders, write for shipping costs, or use credit card and specify air or surface (allow 2-3 months for surface shipping). Most orders shipped by next business day, if using credit card, include name on card, card number and expiration date. Send payment with order. Money back return policy. Subscribers, ask for discount when placing order: 10% off books; order must be mailed to address on file.



(#20-Dec-02)

FOR SALE: Precision B-12 0-400V 7-tube power supply/adj bias - \$75. George Cortelyou, 1409 Madison St. NE, Albuquerque, NM 87110. (505) 255-3347. E-mail: georgebc3@webtv.net

FOR SALE: Precision E-200C and E-200 signal generators - \$35 ea. Knight R-55 receiver - \$45. Angelo Pallotta, 1367 D'Angelo Dr., N. Tonawanda, NY 14120. (716) 695-0329 E-mail: rthursby@wzrd.com

FOR SALE: Vacuum tubes! Our tube inventory just keeps growing and growing! Call/fax/e-mail for our free tube catalog. Pick up one at the Rochester Hamfest and MAARC 2003! Radio Daze, LLC, 7620 Omnitech Pl., Victor, NY 14564. (585) 742-2020. Fax: (800) 456-6494. E-mail: info@radiodaze.com. Web: www.radiodaze.com

FOR SALE: GE Superadio II - \$65. GE Superadio III - \$30. Rich Stamer, 331 Virginia Ave., Collingswood, NJ 08108. (856) 869-0238. E-mail: soundremedy@aol.com

FOR SALE: Isolation transformer - \$25; Variac - \$35; Hammarlund Super Pro - \$175; Navy low frequency receiver - \$150; 1926 Fada R65 nice - \$175; BK oscilloscope #1470 - \$75. Ernest Odeneal, K5QJF, 2710 Lee, Greenville, TX 75401. (903) 455-2113/5788. E-mail: odeneal@geusnet.com

FOR SALE: Grid caps, part of tube, N.O.S., 1/4 in. diameter, 5 for - \$1 + 37c postage. Ernest Bigler, 292 Cleveland Ave., Macon, GA 31204. (478) 746-6616. E-mail: leroybigler@cox.net

FOR SALE: Radios 20, 30, 40, 50, 60. Cathedrals, tombstones, don't work, work, new repair, chairsides (pick up only), Trans-Oceanics. Also horns, speakers, transistors, novelty. Send one SASE for each list. Call for appointment. Robert J. Stone, 721 Fisk St., Piqua, OH 45356-3729. (937) 773-2217

FOR SALE: Vibroplex Presentation w/case, new - \$265; 1919 Blue Racer - \$325; Autronic paddle - \$125. Richard Prester, 131 Ridge Rd., West Milford, NJ 07480. (973) 728-2454. E-mail: rprester@warwick.net

FOR SALE: Radio collection for sale, 1920s to 1950. E-mail for photos to radiatorich1@yahoo.com. Richard Bednarick, 28 Steele Ave., Lincoln Park, NJ 07035. (973) 694-6374, eves.

FOR SALE: Silver-Marshall Silver 30. Tubes, radios, tube & transistor, books, more. Lists 18 pgs LSASE. WANTED: Chassis, Kennedy 21, 30, 32, King 80, AK 33, 35. Bill Horn, 13110 Marsh Rd., Bealeton, VA 22712. E-mail: wehcoll@earthlink.net

FOR SALE: WW2 manual TM-11-619 for Radio Set SCR-619, 76 pages - \$10. More via e-mail. Ellsworth O Johnson, 364 S. Coeur Dalene St., Spokane, WA 99204-1063. (509) 838-2161. E-mail: eojohnsonww2@attbi.com

FOR SALE: WE ringer 315H in oak box - \$90. Small one tube Radiette radio - \$100. Edgar A. Guest book, A Heap O'Livin, 1918 - \$45. Emerson 50s vintage plastic, new filters, good cosmetics - \$35. All plus shipping. Harry M. Books, Jr., W3PSU, 699 Red Mill Rd., Eters, PA 17319. (717) 938-6694. E-mail: w3psu@webtv.net

FOR SALE: Novelty radios. Rolls Royce Phantom II, porcelain limited edition Cologne, 1946 jukebox - \$24.95 each. All play with original boxes & info sheets. New, Collector's Guide to Novelty Radios, Bunis - \$12.95. All plus shipping. E-mail photos available. Robert P. Morrison, 10238 117th Ln., Live Oak, FL 32060-6716. (386) 362-1521. E-mail: rmorrison@suannevalley.net

FOR SALE: Radiola III parts, literature and information for SASE. James Fred, 5355 S 275 W, Cutler, IN 46920. (765) 268-2214

YOUR ONE STOP SOURCE FOR:

**NOS TUBES
CURRENT PRODUCTION TUBES
RADIO GRILL CLOTH
TRANSFORMERS
REFINISHING PRODUCTS
CAPACITORS & RESISTORS
BOOKS, SCHEMATICS
TOOLS & METERS
AND A WHOLE LOT MORE!**



6221 S. MAPLE AVE
TEMPE, AZ 85283

WE ALSO BUY TUBES!
CONTACT US FOR OUR CURRENT BID LIST

WWW.TUBESANDMORE.COM

PHONE: 480.820.5411
FAX: 480.820.4043
OR 800.706.0780

FOR SALE: Pilot FM tuner Model T601 - \$35 plus shipping. Mark Hewitt, 6659 Tipperary Trl., Roscoe, IL 61073. (815) 623-8729

FOR SALE: Silvertone, Worlds Fair Model 1708, fair - \$50. Crosley, New Buddy Model 54, poor - \$25. Paul Cowlishaw, 1424 25th St., Ogden, UT 84401. (801) 393-8703

FOR SALE: Philco 40-217 including remote, nice cabinet, owner's manual, works some, will not ship - \$350. Gabe, 485 Main, Glen Ellyn, IL 60137. (630) 469-4477, days

FOR SALE: Japan Electronics Buyers Guide, 1969, over 500 page book with pictures of thousands of vintage Japanese products and parts - \$30. Hewlett-Packard 200CD oscillator, 5 Hz to 600 kHz - \$65. Heathkit AG-9A audio generator, 10 Hz to 100 kHz - \$45. Sencore VA62 universal video analyzer, with 2 accessories, the NT64 NTSC pattern generator and the VC63 VCR test accessory - \$225. Beckman 300 digital VM - \$25. Beckman LP-25 logic probe - \$15. Allen B. Dumont 5-inch scope Model 304A, works good - \$45. Sams Photofact folders, about 3,000 available, buy the entire lot or individually, call for model lookup, only - \$1 (min. 5) ea. Phono needles: about 1,000 N.O.S., call for needle number look up. Lafayette Star Fire VI, 6 band multiband portable radio, ca. 1960s, resembles Zenith Trans-Oceanics - \$35. Fisher X-101B amp - \$200. Webster-Chicago Model 100-601 phono, ca. 1951 - \$45. Hewlett-Packard 1600A logic state analyzer, 5" CRT, with 4 data probes, manual - \$200. Mystery Grab Bag Special: Hundreds of pounds of parts. Mostly new, some in original packaging: jacks, plugs, wires, cables, needles, lamps, controls, pots, relays, switches, misc. hardware, and more. A generous 5 pound box (no 2 alike) for \$10 ea. plus LPS. All prices plus UPS. Bob Lynn, 26 E. Orchard St., Someville, NJ 08876. (908) 685-9070

FOR SALE: Sams Transistor Radio Manuals 1-123 (5 missing), various electronic literature/tubes. Fred Greenleaf, 214 Barden Dr., DeLand, FL 32720. E-mail: CRDream@msn.com

FOR SALE: Radio/television/electronics course. National schools, 137 booklets - \$15 + shipping. J.R. Monego, 12729 Ithaca Ave., Hudson, FL 34667. E-mail: radiow2ofb@aol.com

FOR SALE: DB-20, very good, inspection sticker intact 11-'39 - \$125. **WANTED:** Exhibition head for Victor Talking Machine or will sell machine, as is - \$500. Harry Moore, W5BXV, 102 Louise Ln., Athens, TX 75751. (903) 675-1878

FOR SALE: Electronic Servicing & Technology, 1982 1 missing, 1983 all, 1984 1 missing 1986 all, 1987 all, 1988 all, 1989 all, 1990 2 missing, 1991 5 missing, 1992 3 missing. Best offer plus UPS. Ajiala Repair, 50 Fir Cir., Babbitt, MN 55706-1220

FOR SALE: Crosley 555 painted case, complete, Zenith 9H079 chassis and cobra swing-out changer, 6D612 case broken, displays fine, Silvertone 4419, no bezel, Motorola 61K2 console, chassis fits 6T-22 table set, will part out, Riders 11, 12 & 14, nice shape, Melco Supreme, original, complete, Radiola 17 & 100A speakers, Nordemende Sterling Turandot, nice, clean, plays great, Philco 37-630, 37-650, 38-116, inquire, Philco radio/flashlight, Setchell Carlson 427, Crosley 66-TW. Much more, send want lists. Wilbur Gilroy, PO Box 459, Lake Winola, PA 18625. (570) 378-2508. E-mail: radiowilbur@aol.com

FOR SALE: Instruments, test equipment, parts, tools, military. Make offer on one or all. SASE. Call for appointment. Robert J. Stone, 721 Fisk St., Piqua, OH 45356-3729. (937) 773-2217

Visit the A.R.C. Web Site!

The URL to access the A.R.C. Web site is:
www.antiqueradio.com

Our site includes highlights from current and recent issues:

- Editor's Comments
- Image of the Cover
- Featured Articles
- Radio Miscellanea
- Classified Ads

- Plus:
- Book Reviews
 - Coming Radio Events
 - Radio Club Listing
 - List of Books For Sale
 - Subscription Information
 - Links to Related Web Sites

While visiting our site, you may send e-mail and orders for books, videos and subscriptions.

Let us know what you think about A.R.C. on the Web!

Join the
AWA

ANTIQUE WIRELESS ASSOCIATION

THE ORIGINAL AND LARGEST HISTORICAL RADIO-COLLECTOR GROUP

- Publishes *Old Timer's Bulletin* with:
 - Battery and AC receiver restoration
 - Vacuum-tube history and collecting
 - Old-time amateur-radio contests
 - Communications receivers
 - Free want-sell-swap ads
 - Early television
 - Horn loudspeakers
 - Reviews of current books
 - Keys and land-line telegraphy
 - News of U. S. and foreign clubs
 - Information on public radio museums.
- Maintains unique radio-TV museum.
- Produces the annual Rochester meet.
- Co-sponsors local meets.
- Publishes the annual *AWA Review*.

US membership is only \$20 per year (\$25 per year elsewhere). Write to:

Antique Wireless Association, Inc.
Box E, Breesport, NY 14816
<http://www.antiquewireless.org>



Classic Cones

By Buford and Jane Chidester

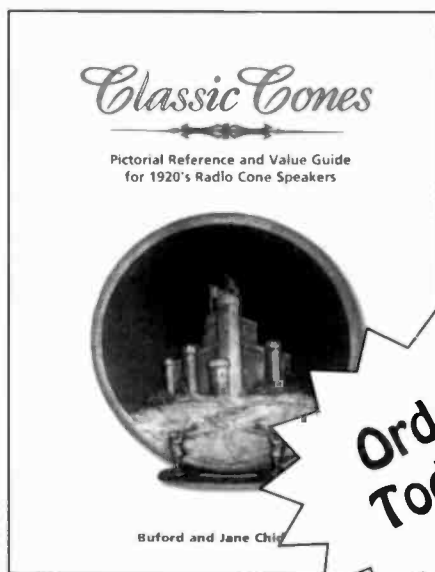

Pictorial Reference & Value Guide for 1920's Radio Cone Speakers

**Hundreds of Full Color Photographs
Original Advertising
Alphabetical Index of Mfrs.**

122 pages

\$25.95 – Softcover

Everything stocked and shipped promptly — Radio is our middle name.

A.R.C., P.O. Box 2, Carlisle, MA 01741 – Toll Free: (866) 371-0512

Fax: (978) 371-7129 – E-mail: ARC@antiqueradio.com – Web: www.antiqueradio.com



Free shipping & handling on all U.S. orders (typical U.S. order will be received within 7 days, but allow 2-3 weeks). Mass. residents add 5% sales tax. Non-U.S. orders, write for shipping costs, or use credit card and specify air or surface (allow 2-3 months for surface shipping). Most orders shipped by next business day. If using credit card, include name on card, card number and expiration date. Send payment with order. Money back return policy. Subscribers, ask for discount when placing order. 10% off books; order must be mailed to address on file.



(#32-Nov-02)

WANTED: Harvey-Wells SM-1 station monitor, schematic, manual; TBS-50-B only and TS-90 xmtrs. Kelly, W8GFG, 9010 Marquette, St. John, IN 46373. (219) 365-4730

HAS YOUR SUBSCRIPTION

EXPIRED?

It has if your mailing label reads
"EXP=JUN03" or earlier.

Renew now!

**BONUS: Renew before
your "EXP" month and receive
13 issues per year instead of 12!**

Renewal rates are:

\$39.49 for Periodicals Mailing

\$57.95 for First-Class Mailing

(Two-year renewals are twice above rates.)

WANTED: Magician wants small electronic device to see through paper, cardboard. Wm. Hendricks, PO Box 165, Alton, IL 62002

WANTED: Anything Fairchild or Langevin. Richard Robinson, PO Box 1425, Wallingford, CT 06492. (203) 949-0871. E-mail: richmix@erols.com

WANTED: Probe Model 00189 for Simpson multimeter Model 313-3. Carl Walczewski, 29 Woodhaven Dr., New Britain, CT 06053. (860) 224-0617



WANTED: Emerson Catalin radios. Nobody pays more than I. What an arrogant and inaccurate thing to say. I mean, like there isn't anyone wealthy enough, dumb enough, desperate enough – or any combination of the three – to pay even a dollar more than I would pay. I mean, c'mon, who am I trying to kid! Please write or call collect: Rain Buttignol, 214 State St., #7, Portsmouth, NH 03801. (603) 427-1384

Kentucky June 20 & 21

Cincinnati Antique Radio Society

Radiatorama

Florence, KY

Signature Inn

(859) 371-0081

Fri. Sign-in • Sat. Meet • Dawn

Info: Bob White (513) 385-8291

croslley@fuse.net

WANTED: Original 8-inch electro-dynamic speaker for a GE Model A-70 tombstone radio. Gregg Humanic, 540 Wicklow Ln., Monroe, OH 45050. (513) 539-8926

WANTED: Hallicrafter S2CR manual & external S meter. Joe Whisnant, 1233 Newcastle Way, Maryville, TN 37803. (865) 977-9024

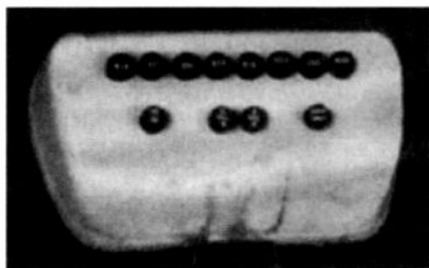

WANTED: Capehart remote controls, original catalogs and related items. Bill G. Davis, 800 Rosemount Rd., Oakland, CA 94610-1311. (510) 839-8309. E-mail: Billgd@aol.com

WANTED: E.H. Scott! E.H. Scott! E.H. Scott! Interested in Scott battery and AC sets, military, accessories, advertising, and literature. Check with us before selling your items, we are very serious Scott collectors. Radio Daze, LLC, 7620 Omnitech Pl., Victor, NY 14564. (585) 742-2020. Fax: (800) 456-6494. Web: www.ehscott.com

WANTED: Altec 350A power amplifier. Will consider a trade for other Altec equipment. Thomas Rocheleau, PO Box 132, Franklin, MA 02038 (508) 528-3061, between 6-10 pm

A.R.C. BACK ISSUES

April '87 to current issue: Originals available
32 to 100 pages each.

Oct. '86 to Mar. '87: Reprints available
Reprinted from original artwork; 28 to 32 pgs. ea.
Quality & appearance same as an original copy.

June '84 to Sept. '86: Photocopies available
Not original quality, useful for info.; 16 to 28 pages each.

Publication of *Antique Radio Classified* began in 1984 which had only five issues: June, Sept., Oct., Nov., & Dec. 1984, 1985 through current year have had 12 issues each.

**\$5.00 each – Postpaid to
U.S., Canada and Mexico.**

Orders of 6 issues or more may take a 10% discount. Orders for a full calendar year may take a 60% discount (\$2.00/each). Foreign orders other than Canada and Mexico: \$8.00 each by air.

A.R.C. UNCUT, UNFOLDED COVERS

June '91 to present - 9 1/2" x 12 1/2" - \$9.95 each
Postpaid to U.S., Canada, & Mexico

A.R.C., P.O. Box 2, Carlisle MA 01741

E-mail: ARC@antiqueradio.com

Or Call Toll Free (866) 371-0512

Visa, Mastercard, American Express, Discover
Mass. residents, please add 5% sales tax

Collecting International Radios

Tickling the Crystal: Domestic British Crystal Sets of the 1920s

by Ian L. Sanders

Comprehensive coverage of British crystal sets. Twelve chapters on history, circuits, aerials, headphones, etc. Chapter thirteen contains photos, detailed description, original price, etc. of hundreds of sets. Seven appendices. Index. B&W photos. 8 1/2" x 12", 256 pages. Hardcover.

NEW — \$64.95



Audio! Audio! by Jonathan Hill. *A comprehensive directory of classic audio amplifiers and control units. Details of over 850 models from nearly 150 British manufacturers from the 1940s to the 1970s. 8 1/4" x 12", 95 pages. Softcover — \$19.95*



Radio! Radio! 3rd Edition by Jonathan Hill. *Comprehensive coverage of British radios from the 1920s to the 1970s. Includes a directory of nearly 3,000 different transistor models made in Britain or imported between 1956 and 1972. 8 1/2" x 12", 320 pages. Hardcover. — \$64.95*



Old Radio Sets by Jonathan Hill. *The development of the radio in Britain from the late Victorian era until the late 60s. 60 photos. 6" x 8", 32 pages. Softcover. — \$4.95*

Everything stocked and shipped promptly — Radio is our middle name.

A.R.C., P.O. Box 2, Carlisle, MA 01741 — Toll Free: (866) 371-0512

Fax: (978) 371-7129 — E-mail: ARC@antiqueradio.com — Web: www.antiqueradio.com



Free shipping & handling on all U.S. orders (typical U.S. order will be received within 7 days, but allow 2-3 weeks). Mass. residents add 5% sales tax. Non-U.S. orders, write for shipping costs, or use credit card and specify air or surface (allow 2-3 months for surface shipping). Most orders shipped by next business day. If using credit card, include name on card, card number and expiration date. Send payment with order. Money back return policy. Subscribers, ask for discount when placing order: 10% off books; order must be mailed to address on file.



(#31-Mar-03)

WANTED: One or two twist-on baffles for Western Electric 633-A saltshaker microphones. Dan Wood, Box 42172, RPO Ferry Rd., Winnipeg, Manitoba, Canada R3J 3X7. (204) 831-5393

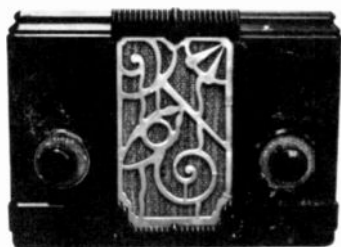

WANTED: Early (prewar II) plastic radios. I collect these objects of beauty to enhance my otherwise dull and uneventful life to which I am forever bound by my sad-but-true unworthiness and shortcomings: physical, emotional, and intellectual. Please write or call collect: Rain Buttignol, 214 State St., #7, Portsmouth, NH 03801. (603) 427-1384

WANTED: Hallicrafters S-29 Sky Traveler, Heathkit TO-1 test osc., Heathkit AV3 AC VTVM, Sencore op. manual for SS137, 1AQ5 tubes. John M. Andrews, 2975 S. 600 East, Salt Lake City, UT 84106. Ph./fax: (801) 467-4522

WANTED: Power supply unit for 1948 Zenith 28F20 TV or two 95-1109 transformers. Gil Kenner, 5314 Leavells Crossing Dr., Fredericksburg, VA 22403. (540) 898-5275. E-mail: fchips@adelphia.net

WANTED: References to articles concerned with the use of ham radio on U.S. railroads. Louis L. D'Antuono, 8802 Ridge Blvd., Brooklyn, NY 11209. (718) 748-9612

WANTED: Crystal sets, collection now at 505 pieces, seeking more. Erwin Macho, Ambrosweg 17/A/8, A-1230 Vienna/Austria. E-mail: detektor1@gmx.at

WANTED: Arvin 417 & 467 any shape. See Stein 1, p. 38. Patrick Franzis, 235 Millville Ave., Naugatuck, CT 06770-3848. (203) 723-8976. E-mail: old_radios@yahoo.com

WANTED: Braemar style console cabinet for an E.H. Scott Phantom. I prefer a nice original finish example but will consider one needing refinishing if priced accordingly. Thank you. Bob Snively, 516 S 16th St., Richmond, IN 47374. (765) 935-3746. E-mail: totallytubular@aol.com

ELECTRON TUBES: Over 1 Million Tubes in Stock. Buy & Sell. Daily Electronics, 10914 NE 39th St. #B-6, Vancouver, WA 98682. 800-346-6667. 360-896-8856. 360-896-5476, fax

PHONO NEEDLES & CARTRIDGES (magnetic/ceramic). Over 500 cartridges and 5,000 needles. J. J. Papovich, 165 Trellis Ln., Sewell, NJ 08080. (856) 464-6741

BOXED CLASSIFIED ADS WORK! This is a boxed classified ad. These ads can be run more than two months. See the A.R.C. Rates & Policies pages for details. Boxed ad deadline: the 1st of the month.

WANTED: Pre-1925 Zenith and Chicago Radio Laboratories. I pay top dollar. Scott Morton, 3011 Hudson, Erie, PA 16508. E-mail: mrzenith@aol.com

— **WANTED** —
CLUB CONTACT INFORMATION. A.R.C. IS UPDATING ITS CLUB LIST. PLEASE SEND US NAME OF CONTACT PERSON, ADDRESS, DUES, RATES, ETC.

WANTED: One decenter and glass for the Pla Pal Pokeradio c. 1934. Joseph DiCaro, 4155 Lastrada Hts., Mississauga, Ontario, Canada L5C 3V1. (905) 848-7759. E-mail: decoradio@primus.ca



WANTED: Heathkit Model O-1 oscilloscope in any condition. This was introduced in 1947. Also interested in instruction sheets or schematics for the Model O-1. Top dollar paid. Thanks. Erich Brueschke, 319 N. Lincoln St., Hinsdale, IL 60521. (630) 325-9259. E-mail: eeb44@hotmail.com

WANTED: The books Flying Sub and Whispering Isles by Snell. Robert Stapleford, 1800 S.W. Randolph Ave., Topeka, KS 66604-3158. (785) 234-4628

WANTED: COLLINS RADIO Company Catalogs, promotional literature, manuals 1933-1983. Jim Stitzinger 23800 Via Irena, Valencia, CA 91355. 1-661-259-2011

WANTED: Broadcast-type MICROPHONES. Early carbon, condenser, ribbons, etc. Cash or trade. James Steele, P.O. Box 6*0, Kingsland, GA 31548-0620. (912) 729-2242. E-mail: JSteele@k-bay106.com. Microphone collectors Internet site: <http://www.k-bay106.com/mics.htm>.

VICTROLA REPAIR SERVICE: Windup phonograph repairs, parts, springs, needles via U.P.S. Rod Lauman, 206 Cliff St., St. Johnsbury, VT 05819. (800) 239-4188, eves.

WANTED: Vintage Electronic Music Synthesizers and modules by the following manufacturers, especially the listed models. Aires Modular, System III. ARP 2500. Buchia Modular. 100, 400. E-mu Modular. EML Electrocomp 100, 101, 200. EMS Synthi A, Synthi AKS, VCS3. Korg Modular PS-3100, PS-3200, PS-3300. Moog Theramin, Modular, Series 15, 35, 55. Oberheim SEM modules, 2-, 4- & 8-Voice Systems. Paia Modular 2700, 4700. Roland Modular Systems 100, 700. Serge Modulators, System 79. Syntcn Modular System. Call and surprise me; make my day! John V. Terrey, 498 Cross St., Carlisle, MA 01741. (978) 369-9770. Fax: (978) 371-7129

Collector's Guide To Antique Radios 5th Edition

By John Slusser & the staff of Radio Daze

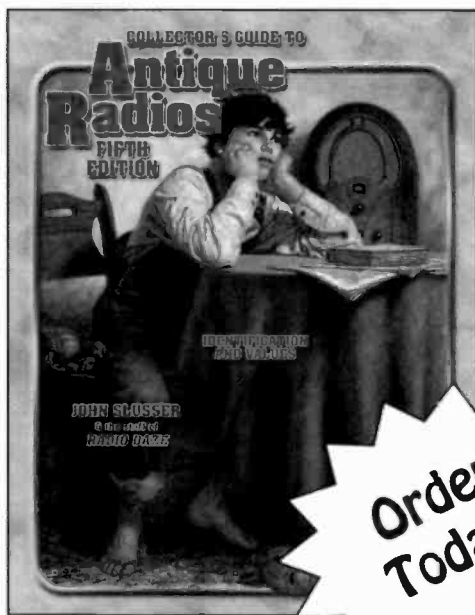

**Order
Today!**

**9,000+ sets from the '20s - '50s
Color Photographs**

Updated prices

\$19.95 - Softcover

Everything stocked and shipped promptly — Radio is our middle name.

A.R.C., P.O. Box 2, Carlisle, MA 01741 – Toll Free: (866) 371-0512

Fax: (978) 371-7129 – E-mail: ARC@antiqueradio.com – Web: www.antiqueradio.com



Free shipping & handling on all U.S. orders (typical U.S. order will be received within 7 days, but allow 2-3 weeks). Mass. residents add 5% sales tax. Non-U.S. orders, write for shipping costs, or use credit card and specify air or surface (allow 2-3 months for surface shipping). Most orders shipped by next business day. If using credit card, include name on card, card number and expiration date. Send payment with order. Money back return policy. Subscribers, ask for discount when placing order. 10% off books; order must be mailed to address on file.



(#25-Dec-02)

WANTED: Quantities of N.O.S. tubes: pre-octal, transmitting, special purpose, unusual or odd William Berson, PO Box 1223, Weston, CT 06883. Fax: (203) 226-3306. E-mail: William@webtubes.com

WANTED: Your N.O.S. vacuum tubes. We are always buying tubes in quantity, send us your list we will promptly quote. Radio Daze, LLC, 7620 Omnitech Pl., Victor, NY 14564, (585) 742-2020. Fax: (800) 456-6494. E-mail: info@radiodaze.com

WANTED: Philco 500 Series speaker. Any color, any condition. Round with metal base. Chris Farley, 4625 E. 2619th Rd., Sandwich, IL 60548. (815) 498-3459. E-mail: cfar@iglide.net

WANTED: Tubes, tube testers, and Western Electric tubes from estates, shops or collectors. Send me a list or give me a call. Jeff Arndt, 908 6th St., Kewaunee, WI 54216-1718. (920) 323-6789

WANTED: 6L6GC - RCA, TungSol, GE, 6V6GT - RCA, Raytheon; 12AX7/12AT7 - Telefunken, Raytheon; 6CA7, 6550, EL-37, KT-66; Astron caps; Jensen speakers; guitars, amps, revert, echo, effects. Mac Lora, 70 Slayton Ave., Montpelier, VT 05602. (802) 223-4620

WANTED: Output transformer for Crosley Model 124 radio. Sams Photofacts: 850-7 Sears Model 6049 radio; 1422-6 RCA stereo VST 113F; 2144-2 Zenith Y2512E TV; 2212-1 RCA TV GTR 2033L, chassis CTC-121D. Paul M. Williams, 2364 Beaver Valley Pike, New Providence, PA 17560-9622. (717) 786-3803

WANTED: Zenith Stratosphere or cabinet, any condition. Will trade from vast supply of fine radios or buy. Will pick up. Alan Jespersion, PO Box 17338, Minneapolis, MN 55417. (612) 727-2489, 11 am - 4:30 pm. Fax: (612) 821-4820, Tues-Fri, Sat 10-3. E-mail: mte612@aol.com. Go to our website at GN4RADIO.COM

WANTED: Stromberg-Carlson radio cabinets and knobs for Models 125-H, 130-U and 225H, or I will buy these radios not working. Arnie Sanchez, 9615 Rockhurst, Houston, TX 77080. (713) 939-9221

WANTED: Stromberg-Carlson #10 or similar S/C exposed cone tripod stand speaker. David D. Kaiser, 375 Yarmouth Rd., Rochester, NY 14610. (585) 654-6604. E-mail: ddk375@frontiernet.net

HAS YOUR SUBSCRIPTION

EXPIRED?

It has if your mailing label reads
"EXP=JUN03" or earlier.
Renew now!

**BONUS: Renew before
your "EXP" month and receive
13 issues per year instead of 12!**

Renewal rates are:
\$39.49 for Periodicals Mailing
\$57.95 for First-Class Mailing
(Two-year renewals are twice above rates.)

WANTED: Early military radio generator, hand or foot powered, 500 cycles AC. Tom Burgess, 9 Belle Meadow Ln., Little Rock, AR 72210. (501) 455-0773

WANTED: Metal band surrounding the horn and neck of a Music Master horn speaker. James Fisher, RR 1 Box 861, Port Royal, PA 17082. (717) 527-2224. E-mail: yrless@tricity.net

WANTED: Chassis photos and dimensions for single band Pure Oil Station with two knobs. Dennis Smith, KN8H, Box 113, Trenton, MI 48183. (734) 675-5847

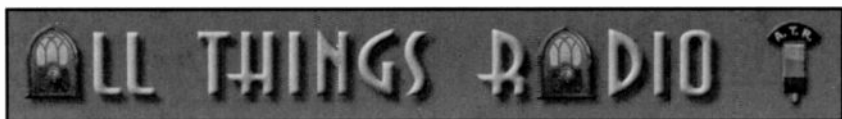

<http://www.allthingsradio.com>

Your One-Stop Online Source For ALL Of Your Radio Needs

- Restored Antique Radios
- Unrestored Antique Radios
- Parts Sets
- Replicas
- Tubes (NOS & Tested Used)
- Electronic Components
- Wood Refinishing Supplies
- Plastic Restoration Supplies
- Reproduction Knobs
- Reproduction Dial Scales
- Reproduction Grille Cloth
- Vintage Test Equipment
- Shop Tools
- Radio Restoration Services
- Technical Data Research Services
- Radio Books (New & Vintage)
- Radio-Related Gift Items
- Radio Clothing
- Memorabilia
- Old Time Radio Lending Library
- Easy-To-Navigate Web Site
- New Items Added Daily

Competitive Pricing & Excellent Customer Service!
Your Satisfaction is 100% Guaranteed

P.O. Box 371708 • El Paso, Texas 79937 • 915-838-8177 (Voice)

AUCTION: My collection of 30s & 40s radios, over 150 professionally restored & refinished. 16 small tombstones; 7 small cathedrals; 23 metal Arvins, all colors; 6 Catalins; many names like Air Pal, Rhythm Baby, U5A, Phantom Baby, Ferrodyne, Buddy Boy, wood Bluebird, 40 Series Jewel plus other Art Deco radios from the 30s. If you're a collector of 30s & 40s radios, you won't be disappointed! Also, there will be over 2,500 new & used tubes, over 1,000 knobs of all kinds plus tons of new & used parts transformers, speakers, coils, capacitors, hardware, dial glasses, escutcheons, hand tools, power tools, many old 78 records, some 1 sided & 2 Vogue picture records. Auction date: 7/26/03, conducted by Oberman Auctions. Complete listing will be available mid-June. Joe Svihel, 17227 Co. Rd. 54, Avon, MN 56310. (320) 356-7601

FOR TRADE: My restored GE-81/RCA 143 tombstone for your Philco 90 cathedral. A. Bruno, 24 Butternut Dr., New City, NY 10956. (845) 354-8899

HELP: Westinghouse H-188 dial. Chassis or cabinet Bendix 526. GE Model G75 dial bezel. Larry Porter, 4115 Beam Rd., Crestline, OH 44827. (419) 683-2540

HELP: I need a dial escutcheon for a Silvertone Model 4667. Other models that might fit are 4677, 4651, 4614, 4675. Thanks. Charles Poplin, 3518 Courland Dr., Durham, NC 27707. E-mail: Popawapado@wmconnect.com

MESSAGE: Canadian wanting sweep generator, call, write. **FOR SALE:** 1952 Pontiac radio - \$35. Jim Gauldin, 134 Hawthorne Dr., Danville, VA 24541. (434) 791-2286. E-mail: jimgauldins@earthlink.net

MESSAGE: Send now for the World's Premier 78 rpm & Cylinder Record Auction Catalog. Nauck's Vintage Records, 6323 Inway Dr., Spring, TX 77389. E-mail: nauck@78rpm.com

SERVICES: Quality radio schematics. Rider/Sams 1920-70-\$4ppd. Give make/model. Richard A. Lerche, 1561 Bluebell Ct., Livermore, CA 94551. (925) 447-9365. E-mail: lerche@attbi.com

SERVICES: Can't wait months for a quality antique radio restoration? Then call me. I'll restore your radio promptly and for a reasonable price. I bring 15 years of experience and a passion for perfection to the process. Send me your wretched radios yearning to be fixed! Mike Simos, 100 Commonwealth Ave., Merrick, NY 11566. (516) 223-1470. E-mail: mike_simos@yahoo.com

SERVICES: Tubes, parts, supplies and literature. Your source for all your radio needs! Antique Electronic Supply, 6221 S. Maple Ave., Tempe, AZ 85283. (480) 820-5411. Web: www.tubesandmore.com

SERVICES: All American Five-Tube, table radio, restoration special - \$49.99. 6-Tube - \$59.99. Call for details. Dave's Antique Radio and TV Restorations, 10068 Carousel Center, Syracuse, NY 13290. (315) 457-5099. Web: http://www.borg.com/~dave2

SERVICES: Hickok factory authorized contact person, offering affordable, professional service, calibration and technical assistance. **FOR SALE:** #1= New replacement meters for Hickok, 533A, 600A, 800, 800A, 539A, B and C, 6000, 6000A, for - \$134.50 each. #2= Custom, master-crafted, furniture quality, solid wood carrying cases, your choice of finishes, all new hardware, for Hickok & military tube testers - \$150 to \$195. #3= Battery eliminator, all new affordable, compact, high quality battery eliminator power supply, a total of 15 separate voltages available at any one time. Kit with all components including PC, board with solder mast, new PC, board mount power transformer, screw output terminals, full layout and instructions, easy to assemble and use, kit only - \$87.50 or built and tested \$119.50. Will ship flat rate with insurance for - \$15 U.S.A. only. Will power most very old battery radios, farm sets, & portables. Ideal for test bench. #3= Easy to learn. Service by Signal Substitution. You can cut your old radio trouble shooting time by as much as 90%. Fix the dogs you could not fix before. Bring 'em Back Alive. Eliminate troubles an entire stage at a time. Stop unnecessary voltage & resistance measurements. Service and align radios properly like the pros by using this 100 page copy of Service by Signal Substitution originally published by Precision Instruments engineers for their E 200 signal generator. Hundreds of pleased users. For only - \$15 including S/H. #4= Get started now with, refurbished tube testers, signal generators, V.T.V.M., condensertesters, etc. #5= Manuals, manuals, manuals, for Hickok, Eico, Heath and Military and other major makes of test equipment. Manuals and tube charts backed by professional technical assistance if needed. #6= Socket savers, limited quantity 7, 9, pin min. and octal socket savers. As always, satisfaction guaranteed. **WANTED:** N.O.S. 5, 6, 7 pin ring mount phenolic tube sockets, also 9/10 pin miniature. Reward, wanted dead or alive, complete, repairable Hickok, Military and other major makes of radio test equipment. **MESSAGE:** Service that satisfies for over 59 years. Wendell E. Hall, 3 Mockingbird Cir., Jeffersonville, IN 47130. (812) 282-9709. Fax toll free (612) 435-4167. E-mail: hickok@bellsouth.net. Web: www.wendellhall.net

THANKS!

*Thanks for suggesting
A.R.C. to your friends.*

*Did you know that nearly 20% of
our new subscriptions come from
referrals from subscribers?*

So spread the word about A.R.C.!

*Give the center coupon to a
collector, or ask us to send a
friend a free sample copy.*

*Help A.R.C. and
radio collecting grow!*



NEW YORK - Jun. 1

**GREATER NEW YORK VINTAGE
WIRELESS ASSOCIATION - SWAP MEET**
Lake Ronkonkoma, NY - 367 Hawkins Ave.
8 am - Noon

Info: Chris Lieppert - (631) 471-9526
Chris Bacon - (516) 437-7106

CALIFORNIA - Jun. 7

**CALIFORNIA HISTORICAL RADIO SOC.
SWAP MEET**
San Rafael, CA - Erik's Downtown Drive-In
Corner of Second & Lindaro
8 am

Info: CHRS Hotline - (415) 821-9800
www.californiahistoricalradio.com

OHIO - Jun. 3

**ANTIQUE RADIO COLLECTORS OF OHIO
MEETING**

Dayton, OH - 2929 Hazelwood Ave.
7 pm

Info: Karl Koogler - (937) 294-8960 - karlkrad@gemair.com

CONNECTICUT - Jun. 7

**VINTAGE RADIO & COMMUNICATIONS
MUSEUM OF CT - SWAP MEET**

Windsor, CT - 33 Mechanic St.
6 am

Info: John Ellsworth - (860) 673-0518
radioctr@aol.com
www.nationalcommunicationmuseum.org

ONTARIO - Jun. 4

**OTTAWA VINTAGE RADIO CLUB
MEETING**

Ottawa, Ont. - The Ottawa Citizen
Conference Room, 1101 Baxter Rd.
Flea Market: 7 pm - Meeting: 8 pm

Info: OVRC - (613) 832-3097
www.ovrc.org

ONTARIO - Jun. 7

**LONDON VINTAGE RADIO CLUB
MEETING**

London, Ont - 417 Wing, 2155 Crumlin Rd.
12:30 pm

Info: Dave Cantelon (416) 502-9128
justradios@yahoo.com

ARKANSAS - Jun. 5

**ANTIQUE RADIO COLLECTORS CLUB
OF FORT SMITH - MEETING**

Fort Smith, AR - St. Luke Lutheran Church
Waldron Road, at Free Ferry

7:30 pm
Info: Paul Tucker - (479) 782-8178

WASHINGTON - Jun. 7

**RADIO ENTHUSIASTS OF PUGET SOUND
MEETING**

Seattle, WA - Queen Anne Library
400 W. Garfield

2 pm
Info: REPS - (206) 488-9518 - www.repsonline.org

MARYLAND - Jun. 6-8

**MID-ATLANTIC ANTIQUE RADIO CLUB
RADIOACTIVITY 2003**

Beltsville, MD - Sheraton College Park Hotel
4095 Powder Mill Rd

I-95, exit 29B, left at first stop light
Flea Market: Fri. - Sun.

Auctions: Fri. & Sun.

Seminars, Old Equip. Contest, Banquet

This years theme: Philco

Info: Lynne Bushong (301) 206-5353
www.maarc.org

ILLINOIS - Jun. 8

**ANTIQUE RADIO CLUB OF ILLINOIS
COMBINED SWAP MEET**

WITH 6 METER CLUB
Wheaton, IL - DuPage County Fairgrounds
2015 manchester Rd.

Gates open: 7 am - Buildings open: 8 am
Donation Auction: 11 am

Info: ARCI PO Box 1139, LaGrange Park, IL
60526 - www.antique-radios.org
clubinfo@antique-radios.org

**Attend a radio event near you,
learn, meet others in the hobby.**

SUBMISSION DEADLINE: 5th OF MONTH

NEW MEXICO - Jun. 8

NEW MEXICO RADIO COLLECTORS CLUB MEET

Albuquerque, NM - Anna Kaseman Hospital
8300 Constitution Ave. (W. of Wyoming)

1:30 pm: Tailgate Swap Meet

2 pm: Program, Show & Tell and Auction

Info: Chuck Burch - (505) 286-9674

ChuckBurch@aol.com - <http://members.aol.com/NMRCC>

TEXAS - Jun. 10

HOUSTON VINTAGE RADIO ASSOC. MEETING

Houston, TX - Bayland Park Community Center
6400 Bissonnet, just west of Hillcroft Ave.

6:30 pm

Info: Bill Werzner (713) 721-2242

www.clarc.org/HVRA

GEORGIA - Jun. 9

SOUTHEASTERN ANTIQUE RADIO SOC. MEETING WITH SHOW & TELL

Norcross, GA - Picadilly Cafeteria
3400 Holcomb Bridge Road

6:30 pm

Info: Gordon Hunter - (770) 475-0713

VIRGINIA - Jun. 11

TIDEWATER ANTIQUE RADIO ASSOC. MEETING

7 pm

Norfolk, VA - Dale's Train Station
5880 Poplar Hall Drive

Info: Vic Johnston - (757) 825-0757, eves.

Scott Balderston - (757) 549-0449, eves.

MISSOURI - Jun. 10

ANTIQUERADIO COLL. & HIST. OF GREATER ST. LOUIS - MEETING

Kirkwood, MO - Kirkwood Community Center
111 S. Geyer Rd., Room 201-A

7:30 pm: Meeting, Show & Tell, Swap Table

Info: Joe Tauser - (636) 677-4973 - joetauser@cs.com

ARKANSAS - Jun. 12

ARKANSAS ANTIQUE RADIO CLUB MEETING - 7 pm

Call for Location and Directions

Info: Tom Burgess - (501) 455-0773

N. CAROLINA - Jun. 10

EAST CAROLINA ANTIQUE RADIO CLUB MEETING - 7 pm

Greenville, NC - Sheppard Memorial Library
Meeting Room A, 530 Evans St.

Info: Bill Engstrom - (252) 355-8732

Herman Schnur - (252) 752-2264

NEVADA - Jun. 12

NEVADAN ENTHUSIASTS FOR ANTIQUERADIOS - MEETING

Las Vegas, NV - Henderson Police
Substation, 300 Green Valley Pkwy.

7 pm

Info: Cort & Eileen Ancman

(702) 312-7110

www.u2.lvcm.com/radio/near/

OHIO - Jun. 10

SOC. OF THE PRESERVATION OF ANTIQUE RADIO KNOWLEDGE - MEETING

Kettering, OH - Party Room at
Cassano's Pizza, 1700 E. Stroop Rd.

7:30 pm

Info: John Pansing - (937) 299-0210

sparkinc@juno.com

www.antiqueradios.com/spark

NEW JERSEY - Jun. 13

NEW JERSEY ANTIQUE RADIO CLUB MEETING

Call for location & directions

7 pm

Info: Marv Beeferman - (609) 693-9430

Phil Vourtsis - (732) 446-2427

GEORGIA - Jun. 13-14

SOUTHEASTERN ANTIQUE RADIO SOCIETY SUMMER SWAP MEET

Alpharetta, GA - Fairfield Inn
11385 Haynes Bridge Rd.

8 am - 12 Noon

Gordon Hunter - (770) 475-0713

PENNSYLVANIA - Jun. 10

DELAWARE VALLEY HIST. RADIO CLUB MEETING - SWAP MEET - AUCTION

Telford, PA - Telford Community Bldg.
Hamilton & Hamlin

7:30 pm

Info: Delaware Valley Historic Radio Club

PO Box 5053, New Britain, PA 18901

<http://pw2.netcom.com/~firstake/dvhrcc.htm>

Always Updating Club List

*Please send A.R.C. the name, address, etc.
of your club's contact person.*

MARK YOUR CALENDAR

Jun. 1 - NY, Lake Ronkonkoma - GNYVWA Swap
Jun. 3 - OH, Dayton - ARCO Meeting
Jun. 4 - Ontario, Ottawa - OVRC Meeting
Jun. 5 - AR, Fort Smith - ARCCFS Meeting
Jun. 6-8 - MD, Beltsville - MAARC RadioActivity 2003
Jun. 7 - CT, Windsor - VRMC Swap Meet
Jun. 7 - CA, San Rafael - CHR5 Swap Meet
Jun. 7 - Ontario, London - LVRC Meeting
Jun. 7 - WA, Seattle - REPS Meeting
Jun. 8 - IL, Wheaton - ARCV 6 Meter Club Swap Meet
Jun. 8 - NM, Albuquerque - NMRCC Meet
Jun. 9 - GA, Norcross - SARS Meeting
Jun. 10 - MO, Kirkwood - ARCH Meeting
Jun. 10 - NC, Greenville - ECARC Meeting
Jun. 10 - OH, Kettering - SPARK Meeting
Jun. 10 - PA, Telford - DVHRC Mtng, Swap & Auction
Jun. 10 - TX, Houston - HVRA Meeting
Jun. 11 - VA, Norfolk - TARA Meeting
Jun. 12 - AR, "Call" - AARC Meeting
Jun. 12 - NV, Las Vegas - NEAR Meeting
Jun. 13 - NJ, "Call" - NJARC Meeting
Jun. 13-14 - GA, Alpharetta - SARS Summer Swap
Jun. 14 - OH, Burbank - Estes Auction
Jun. 14 - OK, Oklahoma City - OKVRC Meeting
Jun. 14 - OR, Oregon City - NVRS Meeting & Swap
Jun. 14 - PA, Pittsburgh - PARS Meeting
Jun. 14 - SD, Bradley - Loken, Bergh & Owen Auction
Jun. 15 - TN, Memphis - MARC Meeting
Jun. 15 - TX, Schertz - TARC Meeting
Jun. 15 - WA, Seattle - PSARA Meeting
Jun. 16 - FL, Jacksonville - JARS Meeting
Jun. 17 - CA, "Call" - CHR5-Sac. Meeting
Jun. 18 - OH, Cincinnati - CARS Meeting
Jun. 18 - OH, Columbus - COARA Meeting
Jun. 19 - OK, Tulsa - OKVRC-GCC Meeting
Jun. 20 - NY, Highland Falls - HARPS Meeting
Jun. 20-21 - KY, Florence - CARS Radiorama
Jun. 21 - CA, Merced - CHR5 Swap Meet
Jun. 21 - TX, Irving - VRPS Meeting
Jun. 22 - MD, Davidsonville - RSHRTM Auction
Jun. 22 - NJ, Hazlet - NJARC Swap Meet
Jun. 22 - NY, Schenectady - SARC Meeting
Jun. 22 - WS, Hubertus - WARC Swap Meet
Jun. 23 - AL, Birmingham - AHRS Meeting
Jun. 24 - OH, Kettering - SPARK Meeting
Jul. 1 - OH, Dayton - ARCO Meeting
Jul. 3 - AR, Fort Smith - ARCCFS Meeting
Jul. 5 - CA, San Francisco - CHR5 Swap & Gen. Mtg.
Jul. 5 - WA, Seattle - REPS Meeting
Jul. 6 - NY, Lake Ronkonkoma - GNYVWA Swap
Jul. 8 - MO, Kirkwood - ARCH Meeting
Jul. 8 - NC, Greenville - ECARC Meeting
Jul. 8 - PA, Telford - DVHRC Mtng, Swap & Auction
Jul. 8 - TX, Houston - HVRA Meeting
Jul. 9 - VA, Norfolk - TARA Meeting
Jul. 10 - AR, "Call" - AARC Meeting
Jul. 11 - NJ, "Call" - NJARC Meeting
Jul. 11-12 - MI, Lansing - MARC Extravaganza '03
Jul. 12 - OK, Oklahoma City - OKVRC Meeting
Jul. 13 - CO, Denver - CRC Meeting
Jul. 13 - NM, Albuquerque - NMRCC Meet
Jul. 14 - GA, Norcross - SARS Meeting
Jul. 15 - CA, "Call" - CHR5-Sac. Meeting

MARK YOUR CALENDAR

(Continued from bottom left column)

Jul. 16 - OH, Cincinnati - CARS Meeting
Jul. 16 - OH, Columbus - COARA Meeting
Jul. 18-19 - WV, Huntington - MRT Show & Auction
Jul. 19 - OK, Tulsa - OKVRC-GCC Meeting
Jul. 19 - TX, Kyle - TARC Meeting
Jul. 19 - TX, Irving - VRPS Swap
Jul. 20 - MD, Burtonsville - MAARC Meeting
Jul. 20 - WA, Seattle - PSARA Meeting
Jul. 20 - WS, Hubertus - WARC Swap Meet
Jul. 21 - FL, Jacksonville - JARS Meeting
Jul. 26 - NH, Nashua - NEARC Swap Meet
Jul. 26 - MN, Cold Spring - Oberman Auction
Jul. 26 - NC - CCAWA Summer Swap Meet
Jul. 27 - KS, Kansas City - MAARC Swap Meet
Aug. 2 - RI, East Greenwich - Yankee Tune-up
Aug. 7-9 - IL, Elgin - ARCI Radiofest XXII
Aug. 9 - NY, Amherst - NFWA/AWA Meet
Aug. 20-23 - NY, Rochester - AWA Annual Convention
Nov. 7-9 - TX, Mesquite - VRPS/AWA Convention '03

See expanded listing for many of these events

OHIO - Jun. 14

ESTES AUCTIONS
VINTAGE RADIO AUCTION
Burbank, OH - Expo Auction Center
8157 Garman Rd.. I-71, Exit 204
10 am

Info: (330) 769-4992 - Fax: (330) 769-4116
estesauctions@aol.com - www.estesauctions.com

OKLAHOMA - Jun. 14

OKLAHOMA VINTAGE RADIO COLLECTORS
MEETING
Oklahoma City, OK - Hometown Buffet
3900 N.W. 63rd St.
6 pm: Dinner - 7 pm Meeting
Info: Frank Karner - (405) 769-4656
fkarn@cox.net
<http://members.cox.net/okvrc/>

OREGON - Jun. 14

NORTHWEST VINTAGE RADIO SOCIETY
MEETING & TAILGATE SWAP
Oregon City, OR - Abernethy Grange Hall
15745 S. Harley Ave.
8:30 am: Swap - 10 am: Meeting
Info: Ed Charman - (503) 654-7387
<http://nwwrs.org>

NOTE: The "Coming Radio Events" pages are tabulated from the best information available to A.R.C. However, changes, cancellations and errors do occur. To avoid disappointment, verify place, date and time especially for events which are new to you.

PENNSYLVANIA – Jun. 14**PITTSBURGH ANTIQUE RADIO SOC.
MEETING**Pittsburgh, PA – Brentwood Presbyterian
Church, 3725 Brownsville Rd

10 am - 3 pm

Info: Ted Depto (814) 674-8834

TENNESSEE – Jun. 15**MEMPHIS ANTIQUE RADIO CLUB
MEETING**Memphis, TN - St. Timothy United
Methodist Church, 4105 St. Elmo Ave.

2 pm

Info: Ray Eaton (731) 989-7089, reaton@fhu.edu

TEXAS – Jun. 15**TEXAS ANTIQUE RADIO CLUB
MEETING**

Schertz, TX - VFW Hall

2 pm

Info: Ed Engelken – EdEngel@gvtc.com
(830) 899-3864 – www.gvtc.com/~edengel/TARC.htm**WASHINGTON – Jun. 15****PUGET SOUND ANTIQUE RADIO ASSN.
MEETING**Seattle, WA - Shoreline Museum
N. 175th & Linden Ave.10 am - 12 pm Tailgate Swap
12 pm - Meeting, Program, Show & Tell

Info: Pete Peterson - (425) 747-1323

FLORIDA – Jun. 16**JACKSONVILLE ANTIQUE RADIO SOCIETY
MEETING**Jacksonville, FL - Countryside Village Mobile
Home Park Clubhouse, 10960 Beach Blvd

7:30 pm

Info: Sean Olin - (904) 386- 8332
radiofan@bellsouth.nethttp://community-2.webtv.net/jarsclub/
JACKSONVILLEANTIQU**CALIFORNIA – Jun. 17****CALIF. HISTORICAL RADIO SOCIETY
SACRAMENTO CHAPTER – MEETING**

Call CHRS Hotline for location

7 pm

Info: CHRS Hotline – (415) 821-9800
www.californiahistoricalradio.com**OHIO – Jun. 18****CENTRAL OHIO ANTIQUE RADIO ASSOC.
MEETING**Columbus, OH – DeVry Institute of Tech.
1350 Alum Creek Rd., I-70 Exit 103B

7:30 pm

Info: Barry Gould – (614) 777-8534
Chuck Davis – (614) 792-6237

http://members.tripod.com/~COARA/index.htm

OHIO – Jun. 18**CINCINNATI ANTIQUE RADIO SOCIETY
MEETING**Cincinnati, OH – Scarlet Oaks Career
Development Center, Entry 1

7:30 pm

Info: Tina Haucke – (513) 247-9406

OKLAHOMA – Jun. 19**OKVRC GREEN COUNTRY CHAPTER
MEETING**

Tulsa, OK - Nathan Hale Library

7 pm

Info: Curt Lutz - (918) 251-4915
OldeRadios@cs.com

http://members.cox.net/okvrc/

NEW YORK – Jun. 20**HUDSON VALLEY ANTIQUE RADIO
AND PHONO. SOCIETY – MEETING**

Highland Falls, NY – Art Kingsley Residence

7-9 pm (Call to confirm details)

Info: Peter DeAngelo – (914) 496-5130
harpnsy.tripod.com**KENTUCKY – Jun. 20-21****CINCINNATI ANTIQUE RADIO SOCIETY
RADIORAMA**

Florence, KY – Signature Inn (859) 371-0081

Fri. Sign In – Sat. Meet starts at dawn

Info: Bob White (513) 385-8291
crosley@fuse.net**CALIFORNIA – Jun. 21****CALIFORNIA HISTORICAL RADIO SOC.
SWAP MEET**Merced, CA - Cliff's Radio Warehouse
Corner of 13th and "X"

9 am

Info: CHRS Hotline: (415) 821-9800
www.CaliforniaHistoricalRadio.com**MENTION A.R.C. WHEN CONTACTING CLUBS!****Does your Club have a Web Site?
Send it to: ARC@antiqueradio.com**

TEXAS - Jun. 21

VINTAGE RADIO & PHONOGRAPH SOC. MEETING

Irving, TX - Senter East Bldg
Swapmeet: 1 pm - Meeting: 3 pm
Info: George Potter (972) 353-4862

MARYLAND - Jun. 22

THE RADIO HISTORY &
RADIO-TELEVISION MUSEUM
NYE ESTATE AUCTION - PART 3
Davidsonville, MD - Family Recreation Center
3789 Queen Anne's Bridge Rd

Preview: 11:30 am - 1 pm
Auction: 1 pm

Info: Brian Belanger (301) 258-0708
bcbelanger@aol.com

NEW JERSEY - Jun. 22

NEW JERSEY ANTIQUE RADIO CLUB SWAP MEET

Hazlet, NJ - North Centerville Vol. Fire Co.
372 Middle Rd.
Garden State Parkway Exit 117, to Rte 36,
to Middle Rd (County Rte. 516)

8:30 am - 1 pm

Info: Marv Beeferman (609) 693-9430
Phil Vourtsis (732) 446-2427

NEW YORK - Jun. 22

SCHENECTADY ANTIQUE RADIO CLUB MEETING

Schenectady, NY - Schenectady Museum &
Planetarium, Knott Terrace

1:30 pm

Info: David Ellers - (518) 237-2665
<http://dadellers.tripod.com/sarc>

WISCONSIN - Jun. 22

WISCONSIN ANTIQUE RADIO CLUB SWAP MEET

Hubertus, WS - Richfield Chalet 1271 HWY 175

8 am - 11 am

Info: Bill Engaas (414) 328-0223

ALABAMA - Jun. 23

Alabama Historical Radio Society MEETING

Birmingham, AL - Homewood Public Library
1721 Oxmoor Rd.

7 pm

Info: Ron Westbrook - (205) 833-8035
www.ahrs.org

OHIO - Jun. 24

SOC. FOR PRESERVATION OF ANTIQUE RADIO KNOWLEDGE - MEETING

Kettering, OH - Party Room at Cassano's
Pizza, 1700 E. Stroop Rd.

7:30 pm

Info: John Pansing - (937) 299-0210
sparkinc@juno.com - www.antiqueradios.com/spark

OHIO - Jul. 1

ANTIQUERADIO COLLECTORS OF OHIO MEETING

Dayton, OH - 2929 Hazelwood Ave.
Waldron Road, at Free Ferry

7 pm

Info: Karl Koogler - (937) 294-8960
karlkrad@genmair.com

ARKANSAS - Jul. 3

ANTIQUERADIO COLLECTORS CLUB OF FORT SMITH - MEETING

Fort Smith, AR - St. Luke Lutheran Church
Waldron Road, at Free Ferry

7:30 pm

Info: Paul Tucker - (479) 782-8178

CALIFORNIA - Jul. 5

CALIFORNIA HISTORICAL RADIO SOC. SWAP MEET & GENERAL MEETING

San Francisco, CA - St. Anne Church of the
Sunset - Corner of Funston (13th Ave.)
& Irving

8 am

General meeting after the Swap -
everyone is invited

Info: CHRIS Hotline - (415) 821-9800
www.californiahistoricalradio.com

WASHINGTON - Jul. 5

RADIO ENTHUSIASTS OF PUGET SOUND MEETING

Seattle, WA - Queen Anne Library, 400 W. Garfield

2 pm

Info: REPS - (206) 488-9518
www.repsonline.org

SUBMISSION DEADLINE: 5th OF MONTH

Although non-members are
welcome at all events, joining
may be required at some.
Admission is charged at some.

NEW YORK - Jul. 6

**GREATER NEW YORK VINTAGE
WIRELESS ASSOC. - SWAP MEET**

Lake Ronkonkoma, NY - 367 Hawkins Ave.
8 am-Noon

Info: Chris Lieppert - (631) 471-9526
Chris Bacon - (516) 437-7106

ARKANSAS - Jul. 10

**ARKANSAS ANTIQUE RADIO CLUB
MEETING**

Call for Location and Directions
7 pm

Info: Tom Burgess - (501) 455-0773

PENNSYLVANIA - Jul. 8

**DELAWARE VALLEY HIST. RADIO CLUB
MEETING - SWAP MEET - AUCTION**

Telford, PA - Telford Community Bldg.
Hamilton & Hamlin
7:30 pm

Info: Delaware Valley Historic Radio Club
PO Box 5053, New Britain, PA 18901
<http://pw2.netcom.com/~firstake/dvhrc.htm>

NEW JERSEY - Jul. 11

**NEW JERSEY ANTIQUE RADIO CLUB
MEETING**

Call for location and directions.
7 pm

Info: Marv Beeferman - (609) 693-9430
Phil Vourtsis - (732) 446-2427 - www.njarc.org

MISSOURI - Jul. 8

**ANTIQUE RADIO COLL. & HIST. OF
GREATER ST. LOUIS - MEETING**

Kirkwood, MO - Kirkwood Community Center
111 S. Geyer Rd., Room 201-A

7:30 pm: Meeting, Show & Tell, Swap Table

Info: Joe Tauser - (636) 677-4973 - joetauser@cs.com

MICHIGAN - Jul. 11-12

**MICHIGAN ANTIQUE RADIO CLUB
EXTRAVAGANZA '03**

Flea Market, Auction, Contest, Art Deco Exhibit
Programs, Prize drawings

Lansing, MI - Holiday Inn South Conv. Center
6820 S. Cedar St

Flea Market opens Friday
Auction - Saturday

Info: Don Colbert - donsradio@aol.com
www.antiqueradios.com/marc

N. CAROLINA - Jul. 8

**EAST CAROLINA ANTIQUE RADIO CLUB
MEETING**

Greenville, NC - Sheppard Memorial Library
Meeting Room A, 530 Evans St.

7 pm

Info: Bill Engstrom - (252) 355-8732
Herman Schnur - (252) 752-2264

OKLAHOMA - Jul. 12

**OKLA. VINTAGE RADIO COLLECTORS
MEETING**

Oklahoma City, OK - Hometown Buffet
3900 N.W. 63rd St.

6 pm: Dinner - 7 pm: Meeting

Info: Frank Karner - fkarner@cox.net
(405) 769-4656 - <http://members.cox.net/okvrcl/>

TEXAS - Jul. 8

**HOUSTON VINTAGE RADIO ASSOC.
MEETING**

Houston, TX - Bayland Park Community Center
6400 Bissonnet, just west of Hillcroft Ave.

6:30 pm

Info: Bill Werzner (713) 721-2242
www.clarc.org/HVRA

COLORADO - Jul. 13

**COLORADO RADIO COLLECTORS
MEETING**

Denver, CO - Museum of the Americas
863 Santa Fe Ave.

1 pm

Info: Larry Weide - (303) 758-8382

VIRGINIA - Jul. 9

**TIDEWATER ANTIQUE RADIO ASSOC.
MEETING**

Norfolk, VA - Dale's Train Station
5880 Poplar Hall Drive

7 pm

Info: Vic Johnston - (757) 825-0757, eves.
Scott Balderston - (757) 549-0449, eves.

NEW MEXICO - Jul. 13

**NEW MEXICO RADIO COLLECTORS CLUB
MEET**

Albuquerque, NM - Anna Kaseman Hospital
8300 Constitution Ave. (W. of Wyoming)

1:30 pm: Tailgate Swap Meet

2 pm: Program, Show & Tell and Auction

Info: Chuck Burch - (505) 286-9674
ChuckBurch@aol.com - <http://members.aol.com/NMRRCC>

GEORGIA - Jul. 14

SOUTHEASTERN ANTIQUE RADIO SOC.
MEETING WITH SHOW & TELL

Norcross, GA - Picadilly Cafeteria
3400 Holcomb Bridge Road

6:30 pm

Info: Gordon Hunter - (770) 475-0713

TEXAS - Jul. 19

TEXAS ANTIQUE RADIO CLUB
MEETING

Kyle, TX - Railroad BBQ
10 am

Info: Ed Engelken - EdEngel@gvtc.com
(830) 899-3864 - www.gvtc.com/~edengel/TARC.htm

CALIFORNIA - Jul. 15

CALIFORNIA HISTORICAL RADIO SOCIETY
SACRAMENTO CHAPTER - MEETING

Call CHRS Hotline for location
7 pm

Info: CHRS Hotline - (415) 821-9800
www.californiahistoricalradio.com

TEXAS - Jul. 19

VINTAGE RADIO & PHONOGRAPH SOC.
REPAIR WORKSHOP

Irving, TX - Senter East Bldg
8 am - Noon

Info: George Potter (972) 353-4862

OHIO - Jul. 16

CINCINNATI ANTIQUE RADIO SOCIETY
MEETING

Cincinnati, OH - Scarlet Oaks Career
Development Center, Entry 1

7:30 pm

Info: Tina Haucke (513) 247-9406

WISCONSIN - Jul. 20

WISCONSIN ANTIQUE RADIO CLUB
SWAP MEET

Hubertus, WI - 5917 S. Howell
South of the airport

8 am - 3 pm

Info: Bill Engaas (414) 328-0223

OHIO - Jul. 16

CENTRAL OHIO ANTIQUE RADIO ASSOC.
MEETING

Columbus, OH - DeVry Institute of Tech.
1350 Alum Creek Rd., I-70 Exit 103B

7:30 pm

Info: Barry Gould - (614) 777-8534
Chuck Davis - (614) 792-6237
<http://members.tripod.com/~COARA/index.htm>

FLORIDA - Jul. 21

JACKSONVILLE ANTIQUE RADIO SOCIETY
MEETING

Jacksonville, FL - Countryside Village Mobile
Home Park Clubhouse, 10960 Beach Blvd.

7:30 pm

Info: Sean Olin - (904) 386-8332 - radiofan@bellsouth.net
<http://community-2.webtv.net/jarsclub/JACKSONVILLEANTIQUE>

W. VIRGINIA - Jul. 18-19

MUSEUM OF RADIO & TECHNOLOGY
SUMMER HEAT

TRADER SHOW & AUCTION

Huntington, WV - 1640 Florence Ave.

Friday program starts at 1 pm

Saturdays program at 8 am

Info: Lloyd McIntyre lmcin79627@aol.com

NEW HAMPSHIRE - Jul. 26

NEW ENGLAND ANTIQUE RADIO CLUB
SWAP MEET

Nashua, NH - St. Stanislaus Hall
Rt. 3 (Everett Turnpike) Exit 6
East on Rt. 130/Broad St. to Blue Hill Ave.

8 am - 12 Noon

Info: Marty Bunis (603) 938-5051
m_bunis@conknet.com

N. CAROLINA - Jul. 26

CAROLINA CHAPTER-AWA
SUMMER SWAP MEET

Valdese, NC - Mcgalliard Falls Park
Off I-40, East of Morganton

Info: Ron Lawrence - (704) 289-1166
www.cc-awa.org

OKLAHOMA - Jul. 19

OKVRC GREEN COUNTRY CHAPTER
SUMMER SIZZLER SWAPMEET & SHOW

Sapulpa/Kellyville, OK - Creek County
Fairgrounds

8 am

Info: Curt Lutz - (918) 251-4915 - OldeRadios@cs.com
<http://members.cox.net/okvrc/>

Publicize Your Event
Submit your listing to A.R.C.
arc@antiqueradio.com or fax: (978) 371-7129
Or mail to: PO Box 2, Carlisle, MA 01741

RHODE ISLAND - Aug. 2

YANKEE TUNE-UP
ANTIQUÉ FLEA MARKET & AUCTION
East Greenwich RI - NE Wireless & Steam
Museum, 1300 Frenchtown Rd.
8 am - 3 pm Auction at Noon

Info: (401) 885-0545 <http://users.ids.net/~newsm>

KANSAS - Jul. 27

MID AMERICA ANTIQUE RADIO CLUB
SWAP MEET

Leawood, KS - Leawood Park
9am - 12 Noon

Info: Bob Lutz lutzeeel@hotmail.com

ILLINOIS - Aug. 7-9

ANTIQUÉ RADIO CLUB OF ILLINOIS
RADIOFEST XXII

Elgin, IL - Best Western
345 River Rd. (847) 695-5000

Thursday: Swap Meet starts at 5 pm
See website for updated information
Contest and displays focused on Chicago radios
Info: ARCI PO Box 1139, LaGrange Park, IL
60526 - www.antique-radios.org
clubinfo@antique-radios.org

NEW YORK - Aug. 9

NIAGRA FRONTIER WIRELESS ASSN.
JOINT MEET WITH AWA
FLEA MARKET, AUCTION, CONTEST
Amherst, NY - Amherst Museum

Flea Market: 8 am - Noon
Auction: 11 am

Info: Larry Babcock (716) 741-3082
Gary Parzy (716) 668-2943

NEW YORK - Aug. 20-23

ANTIQUÉ WIRELESS ASSOCIATION
ANNUAL CONFERENCE

Rochester, NY - RIT Conference Center
Easy access from the New York State Thruway

More info listed as it becomes available
Info: www.antiquewireless.org

**Submission Deadline for
Jul. issue is Jun. 5
Aug. issue is Jul. 5**

BUSINESS CARD ADS - \$53.00 FOR 3 MONTHS

IT IS
YOUR BUSINESS CARD
TIME!

\$53 for 3 months - \$90 for 6 months
Can't have one? Send me \$7
and we will buy one for you.

Richard E. Desjarlais
(978) 486-9018
dicksradiodays@webtv.net

Antique Radios
Bought and Sold

DICK'S RADIO DAYS



P.O. Box 629, Littleton
Massachusetts 01460

Don't Trash - Get Cash!

Member AWA NEARC



<http://www.radioswapmeet.com>

Antique and Vintage
Electronics Market

Come Join the Fun!

Browse the Tables
or Buy a Table

Listings are always FREE!!!

Just.
Radios



Capacitors & Schematics for Tube Radios

David and Babylyn Cantelon
42 Clematis Rd., North York
Ontario, Canada M2J 4X2

www.justradios.com
justradios@yahoo.com
(416) 502-9128

TUBES !

Antique • Collectable • Transmitting
Audio • Special Purpose

www.WEBTUBES.COM

PO Box 1223 Weston, CT 06883

ANTIQUÉ RADIOS



WANTED

DAVE CROCKER

35 Santuit Pond Rd. #4B
Mashpee, MA 02649

(508) 477-1578

BUSINESS CARD ADS - \$53.00 FOR 3 MONTHS

Free Estimates
Hrs : 9 AM - 5 PM EST
Tues - Sat

Tel/Fax (860) 928-2428
E-mail bob@oldradiodoc.com
www.olderadiodoc.com



ANTIQUA RADIO RESTORATION & REPAIR

1920 - 1960's

Buy & Sell

Reasonable Rates, Tubes, Professional
Overhauls, Cabinet Refinishing, Service
For All Antique Car, Table & Console
Radios, Communication Receivers &
Tube Amplifiers



BOB ESLINGER

20 Gary School Road
Pomfret Center, CT 06259

ANTIQUA RADIO REPAIR

Repair - Restore - Buy & Sell
Schematic Service
Radios \$3.00, TVs \$5.00

DAMASKE ELECTRONICS

574-W16834 Janesville Road
Muskego, WI 53150
Phone: (262) 679-0838

ARBE-III

Universal Battery Eliminator

\$149.95 + S/H

Antique Radios Inc, PO Box 6352

Jackson, Michigan 49204

Web: www.arbeiii.com

Email: arbeiii@yahoo.com

Phone (517) 787-2985 Evenings

FOR SALE: Just released, Flyer 200A.

For details send 2-stamp LSASE
for 20-page flyer to:

Old Tyme Radio Company
2445 Lyttonville Road, Suite 317
Silver Spring, MD 20910

Fax/phone (301) 587-5280
Fax anytime, phone 10 am-10 pm local time
E-mail: oldtymradio@juno.com

TOM'S ANTIQUE RADIO & TV

- Repairs and Restorations
- All pre-1960 models
- 45 years experience



Thomas Romano
(508) 865-6293

8 Howe Lane, Millbury, MA 01527



Erstwhile Radio Brings You

Oldtime Radio Broadcasts on Cassettes

\$7.00 + Shows Available - Purchase By The Hour

(catalog is Only \$2.00 (P&H) - Send To:

Erstwhile Radio
P.O. Box 2284
Peabody, MA 01960-7284

Your Ticket To The Golden Age of Radio

Antique Radio Grille Cloth

John Okolowicz, NY3SR

624 Cedar Hill Rd.

Ambley, PA 19002

\$3 for samples

www.Grillecloth.com

Tel 1-256-881-3436

E-mail midsouth7702@aol.com

www.members.aol.com/midsouth7702



MID-SOUTH

ANTIQUA RADIO REPAIR
ALL WORK IS GUARANTEED

7702 Shadow Bend Drive
Huntsville, AL 35802



Modern Radio Laboratories®

Since 1942

www.modernradiolabs.com

Crystal Set and One Tube Radio Instructions. Exclusive source,
printing and publishing of all MRL Handbooks & literature by
Elmer G. Osterhoudt. Tested instructions and plans

MODERN RADIO LABS

P.O. Box 14902-T

Minneapolis, MN 55414-0902

Catalog \$2.00 ppd.



ESTES AUCTIONS

*Specializing in Vintage Radios
& Radio Appraisal Service*
www.estesauctions.com

7404 Ryan Road
Medina, Ohio 44256

Phone: (330) 769-4992
Fax: (330) 769-4116

E-mail: estes.auctions@aol.com

WANTED

PRI 1901
ELECTRICITY

MEDICAL X-RAY

TELEGRAPHY & TELEPHONE

PRI 1925

RADIO-WIRELESS

PRI 1940

TELEVISION

BOOKS • TUBES • ARTICLES
MAGAZINES • AUTOGRAPHS
CATALOGS • EPIHEMERA



NEW WIRELESS PIONEERS

1541 BRONSON RD

GRAND ISLAND, NY 14072

(716) 773-4999 • Fax (716) 773-5757

E-mail wireless@pcc.net

www.marconi-wireless.com

WANTED

Federal 56, 60 (Tuner), Amp for Xtal Set; Amrad 2752,
2777, 2766, 3290, 3670, 2531 Crystal Set; Adams
Morgan RA-6; CR-11, CR-17, CR-19, RORC,
RORD (w/external rheostats), RORG, RORL, RORJ;
Breadboards: 3925, 3955, Model 9 w/tuners, 4340
Radiodyne; Cutting & Washington 8A, 8B, 9A, 11, 12

John Terrey, 498 Cross St., Carlisle, MA 01741
(978) 369-9770 - johnterrey@aol.com

BUSINESS CARD ADS - \$53.00 FOR 3 MONTHS

BETA-TEK

ANTIQUE RADIO SERVICE

- Quality Radio Repair & Restoration ● Prompt Service
- Free Estimates ● Radios Bought & Sold
- Custom Battery Eliminators

RAY BINTLIFF, W1RY
2 Powder Horn Lane
Acton, MA 01720-2014
978-263-7435
w1ry@msn.com



Great Northern Antiques



Vintage Radios
Buy • Sell • Repair
Advertising • Antiques • Collectibles

Alan Jesperson
5200 Bloomington Ave. S.
Minneapolis, MN 55417
Tel: (612) 727-2489
Fax: (612) 821-4820
Email: Alan@gn4radios.com
Web: www.gn4radios.com



Vintage Electronics

Our Specialty - Phono
Cartridges/Needles
Center Post/Idlers • 45 Adaptors
Phono / Tape Idlers - Rebuild

Ed Crockett
128 Buccaneer Drive
Hattiesburg, MS 39402
e-mail: phoned@aol.com

Phone (601) 264-4755
Phone Monday-Friday
8am - 5pm CST Only
Fax (601) 264-0226
Fax Anytime

RADIO BOOKS WANTED

Always buying: **Books, Magazines and Manuals**
Single items or collections. Call us toll free: 888-447-5037
We have a large selection of books on radio and related
technology for sale. Call us about our shop and catalogs or
visit our web site: <http://www.beqbooks.com>

BEQUAERT OLD BOOKS
P.O. BOX 775, FITZWILLIAM NH 03447
(603)-585-3448 info@beqbooks.com

ANTIQUE ELECTRONIC RESTORATION

35 Years Experience
Radios - Juke Boxes - Vintage TV's
Repair - Buy - Sell
Complete Restorations • Auto and Home • Prompt Service

COOPERS'S RADIO SERVICE

425 Court Street
Rockwell City, Iowa 50579

LARRY COOPER
712-297-7232



Old Time Replications

"TURN TO US WHEN YOU NEED KNOBS"
KNOBS • PUSHBUTTONS • ESCUTCHEONS
PLASTIC GRILLS

LARRY BORDONARO

5744 TOBIAS AVE., VAN NUYS, CA 91411
PHONE (818) 786-2500 • FAX (818) 909-0241
E-MAIL: oldtimerep@aol.com
www.antiqueradioknobs.com



If you buy, sell or like Jukeboxes, you need
**ALWAYS JUKIN' - THE MONTHLY JUKEBOX
MAGAZINE!!** Subscribers in 25 countries,
ALWAYS JUKIN' LEADS THE WAY: Articles,
photos, show reports, ads, new products,
price guides, restoration tips, repairs -
everything you need to know about **JUKEBOXES**
- the fastest appreciating collectible in the world!!
Fun & a great investment.

Sample Copy \$3.53 per year

ALWAYS JUKIN', 404 E. Howell St. #100-AR
Seattle, WA 98122, (206) 652-4005
Fax (206) 652-4007
Master/Visa OK



STEINMETZ ELECTRONICS

7519 MAPLEWOOD AVENUE
HAMMOND, INDIANA 46324
YES! "WE'RE STILL HERE"

TUBES - ANTIQUE
SCHEMATICS
SASE FOR LISTS

(219) 931-9316



WAVES L.L.C.

ANTIQUES
EARLY RADIOS
&
PHONOGRAPHS
BOUGHT • SOLD
RENTALS • REPAIRS

110 MON-SAT
CLOSED SUNDAYS

201-461-7121
e-mail: c1wave@aol.com
www.rubyfane.com/shops/wavesradios

251 W 30TH ST. NY, NY 10001 212 273-0616
PROPRIETORS Bruce and Charlotte Mager

RADIOS & STRANGE MISCELLANEA
IF YOU VISIT THE BRIMFIELD FLEA MARKET...
STOP BY FIRST!

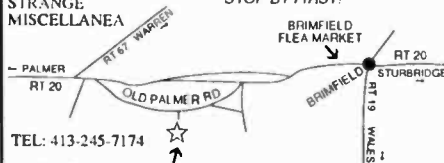

TEL: 413-245-7174

COUNTRY ROAD BARN - BERNIE SAMEK
OLD PALMER ROAD, BRIMFIELD, MASS.

Fine Quality Reproductions - Addison to Zenith - SASE for List

DECALS & DIAL SCALES

Rock-Sea Enterprises
PMB 241
323-110 E. Matilija St.
Ojai, CA 93023

Mike Tobin
(805) 646-7362
dials@juno.com
<http://members.aol.com/RockSeaEnt>

OCEAN STATE ELECTRONICS

Components, kits, test equipment, books, tools, and supplies.
Many hard to find items like variable capacitors, coil forms,
vernier dials and drives, magnet wire, toroids, and more.

Visit our 120 page catalog on-line at
www.oselectronics.com
or write for our FREE 120 page paper
catalog. Visa, MC, & Amex accepted.



800-866-6626

Ocean State Electronics
PO Box 1458
Westerly, RI 02891

Books About Television

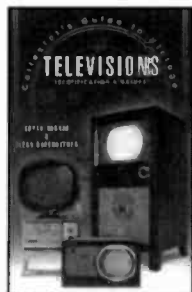

Collector's Guide to Vintage Televisions, Durbal & Bubenheimer. *Includes information about the size of the screen, year of manufacture, cabinet composition, and current value for over 1,400 vintage TVs made from 1945-1960 and transistor sets through 1980. 200+ color photos. 176 pages. — \$15.95*



Classic TVs, 2nd Printing, Wood. *140+ televisions, from prewar to the 1950s. Revised price guide. Color photos, B&W reproductions of catalogs and advertisements 86 pages. — \$18.95*



The Mechanics of Television, Yanczer. *A brief history of television, beginning in 1847. Explanation of mechanical TV, details for a working system. Photos, charts, and diagrams. 170 pages — \$24.95*

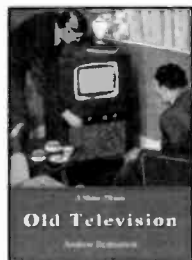

Old Television, Emmerson. *The development and history of television from the Baird Televisor until the introduction of color television to Britain in 1969. 50 photos. 32 pages. — \$4.95*



Collectable Transistor TVs, Bunis. *Identification, description, and value ranges for 150 transistor televisions from 29 manufacturers. 150+ B&W photos. 44 pages. — NEW \$19.95*

Everything stocked and shipped promptly — Radio is our middle name.

A.R.C., P.O. Box 2, Carlisle, MA 01741 — Toll Free: (866) 371-0512

Fax: (978) 371-7129 — E-mail: ARC@antiqueradio.com — Web: www.antiqueradio.com



Free shipping & handling on all U.S. orders (typical U.S. order will be received within 7 days, but allow 2-3 weeks). Mass. residents add 5% sales tax. Non U.S. orders, write for shipping costs, or use credit card and specify air or surface (allow 2-3 months for surface shipping). Most orders shipped by next business day. If using credit card, include name on card, card number and expiration date. Send payment with order. Money back return policy. Subscribers, ask for discount when placing order: 10% off books; order must be mailed to address on file.



(#28-Nov02)

Amateur Radio Books



COMMUNICATIONS RECEIVERS

4th EDITION



Communications Receivers 4th Edition by Raymond S. Moore. *A comprehensive guide to 750, 1932 to 1981, vacuum tube receivers by 66 manufacturers. Three pages of military receivers. 448 radios pictured! Sharper, clearer photographs. 8 1/2" x 11", 136 pages. Softcover. — \$19.95*

Radios by Hallicrafters, 2nd Ed. by Chuck Dachis. *This book includes over a thousand photographs (b/w & color) of radio receivers, transmitters, electronics accessories and advertising material. Technical descriptions are provided for every known Hallicrafters model, including dates of production, model numbers, accompanying pieces and original prices. This 2nd edition includes additional coverage of receivers and updated pricing. 8 1/2" x 11", 225 pages. Softcover. — \$29.95*

A Pictorial History of Collins Amateur Radio Equipment by Jay Miller. *The most complete story of Collins. Told in hundreds of photos & in the words of the men who made it happen. NEW. — \$39.95*

Shortwave Receivers Past & Present Communications Receivers 1942-1997, 3rd Edition by Fred Osterman. *This book is designed for the radio collector, the informed receiver buyer or anyone interested in the history and development of shortwave radios. Over 770 receivers from 98 manufacturers. 8 1/2" x 11", 473 pages. Softcover. — \$24.95*

Ham Price Guide, 2nd by Eugene Rippen. *Prices for over 3,800 transceivers, receivers, tuners, transmitters, amplifiers, antennas, test equipment, books, tubes and catalogs. Mass print. 8 1/2" x 11", 81 pages. Softcover. — \$10.95*

Tube Type Transmitter Guide by Eugene Rippen. *Provides a wealth of information on transmitters and transceivers. Includes ancillary items such as linear amplifiers, converters, modulators and VFOs. Over 500 illustrations. 8 1/2" x 11", 145 pages. Softcover. — \$17.95*

Transmitters, Exciters & Power Amplifiers 1930-1980 by Ray Moore. *Pictorial and descriptive guide to amateur high frequency transmitters and amplifiers manufactured in the U.S.A. Over 500 photos. 8 1/2" x 11", 144 pages. Softcover. — \$21.95*

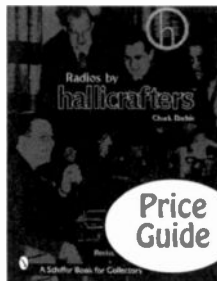

Price Guide

Ham Price Guide 2nd



Price Guide

TRANSMITTERS EXCITERS & POWER AMPLIFIERS 1930-1980

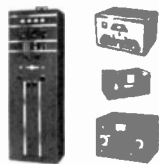

Tube Type Transmitter Guide



MANUFACTURED
From 1930 and 1980
using all or mostly tubes

By Eugene Rippen

A SOUND SOURCE PUBLICATION

\$ 17.95

Everything stocked and shipped promptly — Radio is our middle name.

A.R.C., P.O. Box 2, Carlisle, MA 01741 – Toll Free: (866) 371-0512
Fax: (978) 371-7129 – E-mail: ARC@antiqueradio.com – Web: www.antiqueradio.com



Free shipping & handling on all U.S. orders (typical U.S. order will be received within 7 days, but allow 2-3 weeks). Mass. residents add 5% sales tax. Non-U.S. orders, write for shipping costs, or use credit card and specify air or surface (allow 2-3 months for surface shipping). Most orders shipped by next business day. If using credit card, include name on card, card number and expiration date. Send payment with order. Money back return policy. Subscribers, ask for discount when placing order. 10% off books; order must be mailed to address on file.



(#8-May-03)

Restoration & Repair

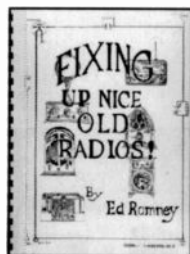

Fixing Up Nice Old Radios, Romney. Written by a retired radio instructor, this book covers Ohm's law, through battery sets, superhets and communications receivers. 300+ figures, 185 pgs. — \$35.00



Old-Time Radios! Restoration and Repair, Carr. How to repair vacuum-tube and transistor radios. A self-paced training guide. 200 illustrations, 256 pgs. — \$19.95

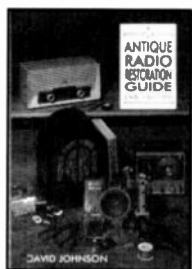

Antique Radio Restoration Guide, 2nd Ed., Johnson. Beginner's introduction to troubleshooting and repairing AC table model radios. 1992. 145 pgs. — \$14.95

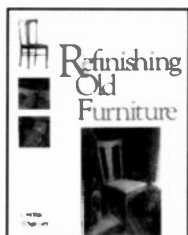

Refinishing Old Furniture, Wagoner. Written by a furniture restoration instructor. A step-by-step guide to furniture (or radio) restoration, from removal of finishes right up to the final polish. 178 pgs — \$14.95

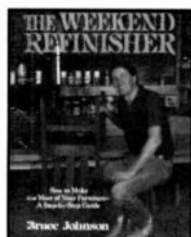

The Weekend Refinisher, Johnson. A complete guide to stains and finishes and tips for setting up your own workshop. A handy furniture "first aid" kit for quick repairs. Illustrated. 296 pgs. — \$12.00

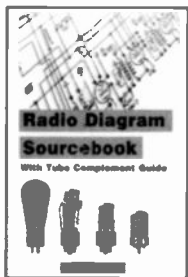

Radio Diagram Sourcebook, Gray. Valuable tool for identifying radios. Tubes used, replacement dial lamps, and I.F. frequency. Reprint of Sylvania's tube complement guide is included listing almost 10,000 radios. 290 pgs. — \$18.95

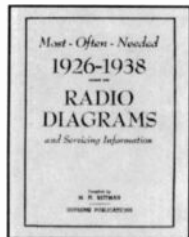

Most Often Needed 1926-38 Radio Diagrams and Servicing Information (reprint). 600+ diagrams for mostly AC radios from '26-'38. 240 pgs. — \$18.50

Back Issue Special #1, A.R.C. The 10 issues containing: "All You Need To Know About Repairing AC Radios," the 9-part series by Jim Fred and Richard Foster. — \$19.00

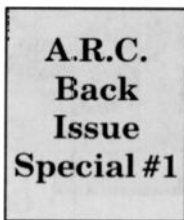

Everything stocked and shipped promptly — Radio is our middle name.

A.R.C., P.O. Box 2, Carlisle, MA 01741 – Toll Free: (866) 371-0512

Fax: (978) 371-7129 – E-mail: APC@antiqueradio.com – Web: www.antiqueradio.com



Free shipping & handling on all U.S. orders (typical U.S. order will be received within 7 days, but allow 2-3 weeks). Mass. residents add 5% sales tax. Non-U.S. orders, write for shipping costs, or use credit card and specify air or surface (allow 2-3 months for surface shipping). Most orders shipped by next business day. If using credit card, include name on card, card number and expiration date. Send payment with order. Money back return policy. Subscribers, ask for discount when placing order: 10% off books; order must be mailed to address on file.



(#24-Nov02)

Books for the Collector

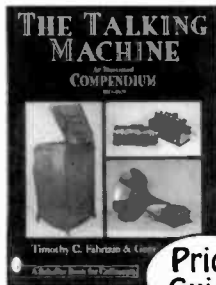

The Talking Machine, An Illustrated Compendium, 1877-1929 by Timothy Fabrizio and George Paul. *Contains over 550 beautiful photos of external & internal horn phonographs. The authoritative text & value guide, complemented with a wealth of visuals, make this book a must in your library. 8 1/2" x 11", 256 pages. Hardcover. — \$69.95*

Price Guide

Tube Testers and Classic Electronic Test Gear by Alan Douglas. *Overview of pre-1970 radio test equipment. Discusses tube testing and use of testers. Compares emission, dynamic & mutual conductance testers. Tabulates and pictures testers from 23 different manufacturers. Over 300 photos & illustrations. 8 1/2" x 11", 163 pages. Softcover. — \$25.95*



Zenith Radio: The Early Years 1919-1935 by John Bryant and Harold Cones. *The first of a planned 3-book series explains the Zenith story. Never published photos, documents, and information. 300 photos and illustrations, 120 in color. 8 1/2" x 11", 224 pages. Softcover. — \$29.95*

Price Guide

Genuine Plastic Radios of the Mid-Century by Ken Jupp and Leslie Piña. *Illustrates mid-century table radios made of plastic as examples of industrial design and pop-culture. Vintage B&W photos and advertisements. 439 color photos. 8 1/4" x 11 1/4", 208 pages. Hardcover. — \$39.95*

Price Guide

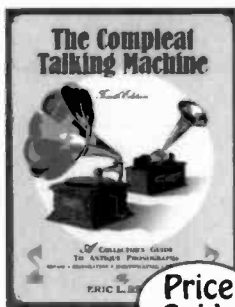
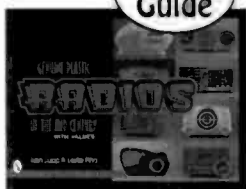

The Compleat Talking Machine, 4th Ed. by Eric L. Reiss. *A guide to antique phonographs. Revised price guide. Covers construction, cleaning and repairing of parts and cabinets. Over 700 pictures. 249 pages. — \$29.95 NEW*

Price Guide

Radio Tubes and Boxes of the 1920s, by George A. Fathauer. *A pictorial presentation of radio tubes of the 20s, including packaging and advertising. 400+ color photos and illustrations. 105 pages. — \$26.95*

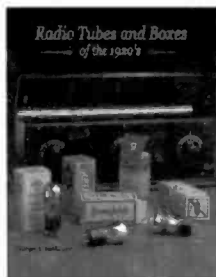

Everything stocked and shipped promptly — Radio is our middle name.

A.R.C., P.O. Box 2, Carlisle, MA 01741 – Toll Free: (866) 371-0512
 Fax: (978) 371-7129 – E-mail: ARC@antiqueradio.com – Web: www.antiqueradio.com



Free shipping & handling on all U.S. orders (typical U.S. order will be received within 7 days, but allow 2-3 weeks). Mass. residents add 5% sales tax. Non-U.S. orders, write for shipping costs, or use credit card and specify air or surface (allow 2-3 months for surface shipping). Most orders shipped by next business day. If using credit card, include name on card, card number and expiration date. Send payment with order. Money back return policy. Subscribers, ask for discount when placing order: 10% off books; order must be mailed to address on file.



(#9-May-03)

Books About Tubes

The Collector's Vacuum Tube Handbook



Volume 1
The Non-RMA Standardized Bases and Tubes

Robert I. Millard

The Collector's Vacuum Tube Handbook, Vol. 1, Millard. *Hard-to-find electrical data on 200+ tube types that pre-date the RMA standardized numbering system (1934). Basing diagrams, photos & brief developmental histories. 196 pgs. NEW — \$25.95*

Tube Lore, Sibley. *Trends in tube design, receiving and audio tubes, special-purpose and transmitting tubes, military types, tips on testing, repairing, adapting various tubes, auction prices from six major sales. 186 pgs. — \$19.95*

Tube Lore

A REFERENCE FOR TUBE AND COLLECTORS



70 Years of Radio Tubes and Valves

Special Edition

A Guide for
Fluoresce Experimenters,
Historians and Collectors

by Edna W. Stokes



70 Years of Radio Tubes and Valves, 2nd Ed., Stokes. *The thermionic vacuum tube story from 1883 through 1960. New chapter on audio application tubes, more photos, magazine ads and a new index by tube number. 264 pgs. — \$29.95*

Radio Tubes and Boxes of the 1920s, Fathauer. *A pictorial presentation of radio tubes of the 20s, including packaging and advertising. Over 400 color photos and illustrations. 105 pgs. — \$26.95*

Radio Tubes and Boxes of the 1920's



75 Years of Western Electric Tube Manufacturing, Magers. *A log book history. 750+ WE tubes. Illustrated. 133 pgs. — \$16.95*

Saga of the Vacuum Tube, Tyne. *The development of vacuum tubes — 1880 to 1930. From Edison, Thomson and Fleming to DeForest, Philips, Siemens and many more. 100+ tube photos. 495 pgs. — \$18.95*

SAGA OF THE VACUUM TUBE

by Gerald E. J. Tyne



Everything stocked and shipped promptly — Radio is our middle name.

A.R.C., P.O. Box 2, Carlisle, MA 01741 — Toll Free: (866) 371-0512

Fax: (978) 371-7129 — E-mail: ARC@antiqueradio.com — Web: www.antiqueradio.com



Free shipping & handling on all U.S. orders (typical U.S. order will be received within 7 days, but allow 2-3 weeks).

Mass. residents add 5% sales tax. Non-U.S. orders, write for shipping costs, or use credit card and specify air or surface (allow 2-3 months for surface shipping). Most orders shipped by next business day. If using credit card, include name on card, card number and expiration date. Send payment with order. Money back return policy.

Subscribers ask for discount when placing order: 10% off books; order must be mailed to address on file.



(#18-May-03)

Transistor Radio Books



Price
Guide

The Collector's Guide to Transistor Radios 2nd Edition by Marty & Sue Bunis. *This book will help you identify the most sought-after vintage transistor radios. Over 2,900 models listed, all with current prices. Includes radio club listing. 375 all new color photos. 5 1/2" x 8 1/2". 320 pgs. 1996. Softcover. —\$16.95*

Transistor Radios: 1954-1968 by Norman Smith. *Over 1,000 transistor radios identified by manufacturer, marketing organization, type, and style. 460+ color photographs and price guide. 8 1/2" x 11". 160 pgs. Softcover — \$29.95*



Price
Guide



Price
Guide

Collector's Guide to Novelty Radios by Marty Bunis & Robert Breed. *This book is the source for novelty transistor radios in all shapes and sizes. Radios are described in detail with current prices. Over 600 color photographs. 8 1/2" x 11". 224 pgs. Softcover — \$18.95*

Collector's Guide to Novelty Radios, Book II by Marty Bunis & Robert Breed. *All new second volume takes up where the first book left off. New radios are described with current prices. Over 600 all new color photographs. 8 1/2" x 11". 208 pgs. Softcover — \$19.95*



Price
Guide

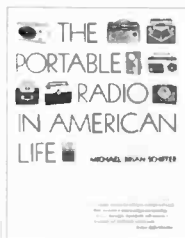

Zenith Transistor Radios, Evolution of a Classic by Norman Smith. *A complete listing of all transistor radio models created by Zenith during the Magic Years from 1955-65. 200+ color photographs and price guide. 8 1/2" x 11". 160 pgs. Softcover — \$29.95*

The Portable Radio in American Life by Michael Schiffer. *Approximately 50 pages on transistor radios, beginning with the Regency TR-1 through to the later sets made overseas. 450 photographs, 193 transistor radios pictured. 8 1/2" x 11". 259 pgs. Softcover — \$26.95*



Price
Guide

Everything stocked and shipped promptly — Radio is our middle name.

A.R.C., P.O. Box 2, Carlisle, MA 01741 – Toll Free: (866) 371-0512
Fax: (978) 371-7129 – E-mail: ARC@antiqueradio.com – Web: www.antiqueradio.com



Free shipping & handling on all U.S. orders (typical U.S. order will be received within 7 days, but allow 2-3 weeks). Mass. residents add 5% sales tax. Non-U.S. orders, write for shipping costs, or use credit card and specify air or surface (allow 2-3 months for surface shipping). Most orders shipped by next business day. If using credit card, include name on card, card number and expiration date. Send payment with order. Money back return policy. Subscribers, ask for discount when placing order: 10% off books; order must be mailed to address on file.



(#6-Dec-02)

Price Guides from Radiomania Books By Mark V. Stein

The Machine Age to Jet Age Series



The continuing series of vintage radio pictorial reference and price guides. Each volume is a supplement to the others with virtually no overlap among the three. Over 7,000 vintage tabletop radios are individually described and valued.

Volume 1: 2,500 radios. Black and white photos. Updated with 2003 market values. Includes master index for all three volumes. 239 pages. \$29.95

Volume 2: 2,700 radios. Black and white photos. 16 page color insert. Updated with 2001 market values and hundreds of variations not previously included. 372 pages. \$28.95

Volume 3: 3,000 radios. Tube and band-count information. Black and white photos. Includes 2001 market values. 256 pages. \$29.95

The Complete Price Guide to Antique Radios Series



Pre-War Consoles

Identification, grading, and current market values for 3,500 models focusing on the period from 1930 through the end of pre-war production in 1942. Tube and band-count information and variations. Expanded resource section. B&W photos. 240 pages. \$29.95



Sears Silvertone Catalogs 1930-1942

Current market values for 1,000+ radios. Original advertising, options, specs and pricing. Historical preface. Manufacturer source code table. Full model cross reference with tube and band counts, variations, cabinet materials and colors. B&W photos. 240 pages. \$34.95

Everything stocked and shipped promptly — Radio is our middle name.

A.R.C., P.O. Box 2, Carlisle, MA 01741 – Toll Free: (866) 371-0512

Fax: (978) 371-7129 – E-mail: ARC@antiqueradio.com – Web: www.antiqueradio.com



Free shipping & handling on all U.S. orders (typical U.S. order will be received within 7 days, but allow 2-3 weeks).

Mass. residents add 5% sales tax. Non-U.S. orders, write for shipping costs, or use credit card and specify air or surface (allow 2-3 months for surface shipping). Most orders shipped by next business day. If using credit card, include name on card, card number and expiration date. Send payment with order. Money back return policy.

Subscribers, ask for discount when placing order: 10% off books; order must be mailed to address on file.



(#30-Dec-02)

Radios by Hallicrafters, 2nd Ed.

By Chuck Dachis

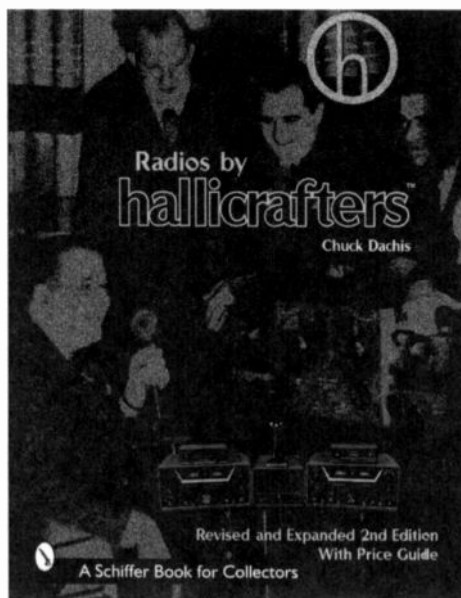

Over 1,000 Photos
Additional Coverage of Receivers
6 Additional Pages of Special Purpose
and Prototype Items
Updated Pricing

\$29.95 - Softcover

Everything stocked and shipped promptly — Radio is our middle name.

A.R.C., P.O. Box 2, Carlisle, MA 01741 – Toll Free: (866) 371-0512
Fax: (978) 371-7129 – E-mail: ARC@antiqueradio.com – Web: www.antiqueradio.com



Free shipping & handling on all U.S. orders (typical U.S. order will be received within 7 days, but allow 2-3 weeks).

Mass. residents add 5% sales tax. Non-U.S. orders, write for shipping costs, or use credit card and specify air or surface (allow 2-3 months for surface shipping). Most orders shipped by next business day. If using credit card, include name on card, card number and expiration date. Send payment with order. Money back return policy.

Subscribers, ask for discount when placing order. 10% off books, order must be mailed to address on file.



(#16-Nov-02)

Tube Testers and Classic Electronic Test Gear

By Alan Douglas



**Overview of Pre-1970 Radio Test Equipment.
Over 300 Photos & Illustrations.
Discusses Tube Testing & Use of Testers.
Compares Emission, Dynamic &
Mutual Conductance Testers.
Tabulates & Pictures Testers from
23 Different Manufacturers.
\$25.95 - Softcover**

Everything stocked and shipped promptly — Radio is our middle name.

A.R.C., P.O. Box 2, Carlisle, MA 01741 – Toll Free: (866) 371-0512

Fax: (978) 371-7129 – E-mail: ARC@antiqueradio.com – Web: www.antiqueradio.com



Free shipping & handling on all U.S. orders (typical U.S. order will be received within 7 days, but allow 2-3 weeks). Mass. residents add 5% sales tax. Non-U.S. orders, write for shipping costs, or use credit card and specify air or surface (allow 2-3 months for surface shipping). Most orders shipped by next business day. If using credit card, include name on card, card number and expiration date. Send payment with order. Money back return policy. Subscribers, ask for discount when placing order: 10% off books; order must be mailed to address on file.



(#23-Nov-02)

COLLECTOR BOOKS AVAILABLE FROM A.R.C.

BOOKS MARKED WITH "C" ARE THE MOST POPULAR AND ARE ESPECIALLY RECOMMENDED FOR NEW COLLECTORS!

- Antique Radio Restoration Guide, 2nd Ed., Johnson, Beginner's intro to trouble-shooting & repairing AC table radios. 145 pgs. \$14.95
 The AWA Review, Vols. 1-5 on CD-ROM: Complete text of volumes 1, 2, 3, 4 and 5 of the AWA Review. Selections AWA & its mission -
 Alator Kent, Delcrest, RCA-GE, Western Electric. \$19.95
- The AWA Review, Order by volume Vol. 6: Hawaiian Wireless, UK Television, SCR RC RC Dr., NYC Wireless Vol. 7: Poldin
 transmitters, Navy equipment, Av. transmitters Vol. 8: Keys, Federal Co., KLS-Federal, Mackay-Storv, National Elec. Supply Co.
 Navy Elec. Div. Each \$10.00
- Vol. 9: Marconi, The International Contest for Radio Magnetron Storv 1, Loewenstein Ham Licensing Vol. 10: Alator Kent
 Race for Radiotelephone Radio Central 5th Anniv., The Heintz & Kaufman Storv, Collins Radio Co. Vol. 11: Scott Radio Products
 National shipping collectors Vol. 13: Northern Electric Co., Marconi Radio Direction Finding Radio Station WBI, Lark Radio
 Stations. Each \$20.00
 Vol. 14: Spark Keys, Canadian Marconi, Bakelite Radios. \$27.50
 Vol. 15: Marconi Wireless Telegraph Apparatus in RMS Titanic, America's Broadcasting System, First Commercial Light Socket
 operated radio receivers with AC tubes from Rogers Ltd., Toronto, Canada. Cumulative table of contents for all volumes of the
 AWA Review. NEW \$24.95
- A. Atwater Kent, The Man, the Manufacturer and His Radios. Patterson, Editor. Compilation of articles by Ralph Williams and
 John P. Wolkonowicz on Alator Kent sets from the 1920s. 108 pgs. NEW \$25.95
- The Antique Radio Boys and the Garrulous Grebe, Dwyer. Adventure story written in the style of the '20s & '30s. 51 pgs. \$4.95
 The Auto Radio, Matteson. Info. photos & ads of the auto radio through the 1950s. 316 pgs. (hardcover) \$34.95
- Audio! Audio! I, Hill. A comprehensive directory of classic audio amplifiers and control units. Details of over 850 models from nearly
 150 British manufacturers from the 1940s to the 1970s. Signed and numbered. 95 pgs. \$19.95
- Behind the Iron Panel, Rutland. Receives radio circuits and radio history. 145 descriptions. 25 pgs. 158 pgs. \$18.95
 Broadcasting's Forgotten Father, (Videotape, VHS). The Charles Herrold story. \$29.95
- Classic Cones, Childster. Pictorial reference & value guide for 1920s radio cone speakers. 100+ of color photos. 2001. 122 pgs. \$25.95
 Classic TVs, 2nd Printing, Wood. Pictorial to 1950s. Revised price guide. 140+ color photos, repro. of catalogs & ads. 86 pgs. \$18.95
 Collectable Transistor TVs, Burns, ID & values for 150 transistor TVs from 29 manufacturers. REW photos. 44 pgs. \$19.95
- Collector's Guide to Antique Radios, 5th Edition, Slusser. This price guide covers the 1920s to the 1950s. Over 9,000 model-
 color photos. Updated pricing. 264 pgs. \$19.95
- The Collector's Guide to Novelty Radios, Burns & Breed. Descriptions with prices. 600+ color photos. 1994. 224 pgs. \$18.95
 The Collector's Guide to Novelty Radios, II, Burns & Breed. New radios & prices. 600+ color photos. 1998. 208 pgs. \$19.95
- The Collector's Guide to Transistor Radios, 2nd I., Burns. Identifies the most sought-after, antique transistor radios.
 Includes club listing. Over 2,900 models. 375 all new color photos, with current prices. 1996. 320 pgs. \$16.95
- The Collector's Guide to Vintage Televisions, Durbal & Bubenheimer. Includes information about the size of the screen
 year of manufacture, cabinet, and current value for over 1,400 vintage TVs. 200+ color photos. 1999. 176 pgs. \$17.95
- The Collector's Vacuum Tube Handbook, Vol. 1, Millard. Hard-to-find electrical data on 200+ tube types that pre-date the RMA
 standardized numbering system (1934). Basic diagrams, photos & brief developmental histories. 196 pgs. \$25.95
- Communication Receivers, 4th Ed., Moore. Information on 750 1932 to 1981, vacuum tube receivers by 66 manufacturers.
 448 radios illustrated. 3 pages of military receivers. 136 pgs. \$19.95
- The Compleat Talking Machine, 4th Ed., Reiss. A guide to antique phonographs. Updated and revised price guide. Covers construction,
 cleaning and repairing of parts and cabinets. Over 700 pictures. 249 pgs. NEW \$29.95
- The Complete Price Guide to Antique Radios: Pre-War Consoles, Stein. Identifies, grades, values & pictures 3,500 models.
 Tube & band count information & variations. Resource section. 240 pgs. \$29.95
- The Complete Price Guide to Antique Radios: Sears Silvertone Catalogs 1930-1942, Stein. 1,000+ radios. Original advertising
 options, specs & pricing. Full model cross reference matrix with tube & band counts, variations. 240 pgs. \$34.95
- Crystal Clear - Vintage American Crystal Sets, Crystal Detectors and Crystals, Sievers.
 Vol. 1 - Comprehensive reference with 750 illustrations. 570 crystal sets, 341 detectors, 207 crystals. 282 pgs. \$29.95
 Vol. 2 - 479 All new & different illustrations, more crystal sets, detectors and crystals identified. 252 pgs. \$29.95
- Crystal Radio: History, Fundamentals, and Design, Kinzie. Plus crystals for detectors. 121 pgs. \$11.95
 Crystal Set Projects: 15 Radio Projects You Can Build, The Xtal Set Society. 160 pgs. \$14.95
- E.H. Scott Radio Collectors Guide, 1925-1946, Clark. The reference for collectors of Scott radios, cabinets and accessories.
 Lists original prices of cabinets and accessories. Over 200 photos with descriptions. 88 pgs. \$29.95
- E.H. Scott The Dean of DX, 2nd Ed, Hobbs. Expanded, new edition of the definitive book on E.H. Scott. Additional chapters plus
 a 24 page color photo section. 240 pgs. NEW \$29.95
- 1940 L.H. Scott Catalog, King. Quality reproduction of the custom built receivers. Includes radio & cabinet illustrations. \$12.95
 Evolution of the Audio Recorder, Van Praag. Comprehensive guide to the audio recorder. 1997. 518 pgs. \$39.95
- Evolution of the Radio, L-W Books. Radios pictured and priced, plus reproductions of catalog pages and ads.
 Vol. 1 - Light hundred + radios. 1991. 227 pgs., 118 pgs. in color. \$22.95
- Fixing Up Nice Old Radios, Romney. Written by a retired radio instructor, this book covers: Ohm's Law, through battery sets, superhets
 and communications receivers. 1990. 300+ figures, 185 pgs. \$35.00
- Flick of the Switch, McMahon. The classic photo reference guide for 30s - 30s radios. 1000+ photos. 263 pgs. \$11.95
- Genuine Plastic Radios of the Mid-Century, Iupp & Peña. Overview of plastic table radios with advertisements, vintage black & white
 photos. 439 color photos. 208 pgs. (hardcover) \$39.95
- Guide to Old Radios - Pointers, Pictures & Prices, 2nd Ed., Johnson. Introduction to radio collecting. Includes hundreds of photos
 and a price guide. 1995. 272 pgs. \$19.95
- Ham Price Guide, 2nd, Rippen. Prices for over 3,800 transceivers, receivers, tuners, transmitters, amplifiers, antennas and test equipment.
 Additional prices for books, tubes and catalogs. 1999. 81 pgs. \$10.95
- Healthkit, A Guide to the Amateur Radio Products, 2nd Ed., Penson. Updated and expanded documentation of Healthkit's amateur
 radio products and a history of the company. 328 pgs. NEW \$25.95
- Index to A.R.C., 1984-99, Sibley. Index to articles in Antique Radio Classified from 1984 through 1999. 76 pages. \$15.00
- I. A. Radio Manufacturing, Paul. Radio makers in I.A. from 1922-42. Leophone, Cathilan & others.
 Supplement No. 1, 1993. 48 pgs. \$6.75
 Supplement No. 2, 1999. 54 pgs. \$10.90
- Machine Age to Jet Age, Stein. 3 volumes. Pictorial reference & price guides. Virtually no overlap between volumes.
 Vol. 1: 2,500 radios, REW photos. 239 pgs. Updated for 2003 values. Includes master index for all three volumes. \$29.95
 Vol. 2: 2,700 radios, REW photos, color insert. 372 pgs. Updated for 2001 values & 100+ of variations not previously included. \$28.95
 Vol. 3: 3,000 radios, REW photos, tube and band count information. 256 pgs. \$29.95
- The Magnetic Cone Speaker Notebook, Paul. 250+ cone speakers from 120+ companies. Photocopy. 1995. 58 pgs. \$11.90
 The Mechanics of TV, Sanchez. Explanation of mechanical TV details for a working system. 170 pgs. \$24.95
- Most Often Needed 1926-38 Radio Diagrams and Servicing Information (reprint). 600+ diagrams for mostly AC radios
 from '26-'38. 240 pgs. \$18.50
- Old Radio Sets, Hill. The development of the radio in Britain from the late Victorian era until the late 60s. 60 photos. 32 pgs. \$4.95
 Old Telephones, Emmerson. The development of the telephone in Britain from 1878 thru the 80s. 50 photos. 32 pgs. \$4.95
 Old Television, Emmerson. The development of the television in Britain until the late 60s. 50 photos. 32 pgs. \$4.95

-  **Old-Time Radios! Restoration and Repair.** Carr. How to repair vacuum-tube and transistor radios. A self-paced training guide
200 illustrations, 256 pgs. \$19.95
- The Old Timer's Bulletin.** AWA. Back issue library on 2 CD-ROMs. Vol. 1: Jan. 1960-Mar. 1985, searchable index. Vol. 2: Jun. 1985-
Nov. 1996, searchable index. \$49.95 each; two volume set \$89.95
- Philco Condensers and More.** Bintliff. Detailed service data for Philco Bakelite block condensers, metal-cased condensers and tone controls.
Pictorial guides show electrical connections and capacitor values. 300+ illustrations. 68 pgs. \$14.95
- Philco Radio: 1928-1942.** Ramirez. A reference book on Philco. Shows receivers and company history year-by-year. 464 color photos,
364 black & white photos and drawings. 1993. 160 pgs. \$29.95
- A Pictorial History of Collins Amateur Radio Equipment.** Miller. The most complete story of Collins. Told in hundreds of photos and
in the words of the men who made it happen. 1999. 175 pgs. \$39.95
- Portable Radio In American Life.** Schifter. Traces the development of the portable radio and how it affected American culture and society.
450 photos and drawings. 259 pgs. \$26.95
- RCA Radiolas, Radiotrons, and Accessories** (reprint). Twenty-page booklet summarizing RCA's 192b product line. \$4.50
- The Radio Collector's Foto-Finder.** Bintliff. An alphabetical index to illustrations in the first four editions of the "Collector's Guide to
Antique Radios." 1997. 48 pgs. \$12.95
- Radio Diagram Sourcebook.** Gray. Valuable tool for identifying radios. Tubes used, replacement dual lamps, and I.F. frequency. Reprint of
Sylvania's tube complement guide is included listing almost 10,000 radios. 290 pgs. \$8.95
- Radio Horn Speaker Notebook.** Rev. H. Paul. The companion to the Encyclopedia. Over 450 horn picture ads are shown, over 325
manufacturers are identified. Photocopy. New Issue. 1995. 72 pgs. \$6.90
- Radio Manufacturers of the 1920's.** Douglas. 3 volumes
Vol. 1: A-C Dayton thru Ferguson. 225 pgs. \$24.95
Vol. 2: Freed-Eisemann thru Priess. 266 pgs. Vol. 3: RCA thru Zenith. 292 pgs. \$29.95 each
- Radio Tubes and Boxes of the 1920s.** Fathauer. A pictorial presentation of radio tubes of the 20s, including packaging and advertising.
400+ color photos and illustrations. 1999. 105 pgs. \$26.95
- Radio/Radio!** 3rd Ed., Hill. Comprehensive coverage of British radios from the 1920s-70s. This expanded edition includes the previous
versions plus 75 new pages and 50 new illustrations. New transistor radio section. (hardcover only) \$64.95
- Radios by Hallcrafters, 2nd Ed., Dachs.** The most definitive book on the company. Over 1,000 photos (some color) on everything
they made. Additional coverage & updated pricing. An invaluable tool for anyone interested in Hallcrafters. 225 pgs. \$29.95
- Rasco Radio Parts.** (reprint). Catalog No. 18 summarizing 1928's product line. 144 pgs. \$9.95
- Refinishing Old Furniture.** Wagoner. Written by a furniture restoration instructor. A step-by-step guide to furniture (or radio) restoration,
from removal of fin-ishes right up to the final polish. 178 pgs. \$4.95
- Saga of the Vacuum Tube.** Tyne. The development of vacuum tubes - 1880 to 1930. From Edison, Thomson and Fleming to de Forest,
Philips, Siemens and many more. 100+ tube photos, 495 pgs. \$8.95
- Scott Quaranta Service Notes.** DuBois. Service notes, schematics, diagrams. \$5.00
- Shortwave Receivers Past & Present, Communications Receivers 1942-1997.** 3rd Ed., Osterman. For the radio collector, the informed
receiver buyer or anyone interested in the history of shortwave radios. 700+ receivers listed. 473 pgs. \$24.95
- S. Gernsback Radio Encyclopedia** (reprint). 1927 classic encyclopedia on radio. From "A" battery to Zirconium, with 1000s of entries in
between. 100s of illustrations. 175 pgs. \$9.95
- 70 Years of Radio Tubes and Valves.** 2nd Ed., Stokes. The thermionic vacuum tube story from 1883 through 1960. New chapter on audio
application tubes, more photos, magazine ads and a new index by tube number. 264 pgs. \$29.95
- 75 Years of WE Tube Manufacturing.** Magers. A log book history 750+ WE tubes. Illustrated. 133 pgs. \$16.95
- The Talking Machine.** Fabrizio and Paul. Over 550 photos of horn phonographs. 256 pgs. (hardcover only) \$69.95
- Tickling the Crystal.** Sanders. Comprehensive coverage of British crystal sets from the 1920s. 200+ B&W photos. 2001. 256 pgs. \$64.95
- Transistor Radios: 1954-1968.** Smith. Over 1,000 transistor radios identified by manufacturer, marketing organization, type and style.
Color photos and price guide. 1998. 160 pgs. \$29.95
- Transmitters, Exciters and Power Amplifiers 1930 - 1980.** Moore. Pictorial and descriptive guide to amateur high frequency
transmitters and amplifiers manufactured in the U.S.A. Over 500 photos. 144 pgs. \$21.95
- Tube Lore.** Sibley. Trends in tube design, receiving and audio tubes, special-purpose and transmitting tubes, military types, tips on testing,
repairing, adapting various tubes, auction prices from six major sales. 186 pgs. \$9.95
- Tube Testers and Classic Electronic Test Gear.** Douglas. Overview of pre-1970 radio test equipment. Discusses tube testing & use
of testers. Compares emission, dynamic & mutual conductance testers. Tabulates & pictures testers from 23 manufacturers. Over 300
photos & illustrations. 163 pgs. \$25.95
- Tube Type Transmitters.** Rippen. Provides a wealth of info on transmitters and transceivers. Includes an diary items such as linear
amplifiers, converters, modulators and VFOs. Over 500 illustrations. 145 pgs. \$7.95
- The Voice of the Crystal.** Friedrichs. How to build working radio receiver components from scratch. Illustrated. 184 pgs. \$4.95
- The Weekend Refinisher.** Johnson. A complete guide to stains and finishes and tips for setting up your own workshop. A handy
furniture "first aid" kit for quick repairs. Illustrated. 296 pgs. \$12.00
- Wireless Communication in the U.S., Mayes.** Early development of American radio operating companies. Alternators, coherers,
stock promotions, unpublished letters, etc. 160 illustrations, 240 pgs. \$29.95
- The Xtal Set Society Newsletter.** Order by volume.
Vol. 1 & 2: 7/91 to 5/93. Field strength meter, FM xtal set, Xtal sets & circuits, the lead pencil detector, the universal xtal set, etc. \$4.95
Vol. 3: The Crystal Set Handbook: Formulas for coil inductance, procedure for measuring coil capacitance, circuit matching theory, etc. \$11.95
Vol. 4: 1/94 to 11/94 - Measuring Coil Capacitance, home-brew headphones and curve tracers, etc. \$0.95
Vol. 5: AM Receiver Design, Marconi Type 107, Radio Outfit in a Headset, etc. \$10.95
Vol. 6&7-Crystal Set Building and More: Projects and info about crystal radios, mostly dealing with design and elec. issues, etc. \$15.95
Vol. 8-Crystal Set Loopers, a 3 Tube and More: Shortwave looper, AM/SW 3 tube, antenna tuner/AM trap, etc. \$15.95
Vol. 9, 10 & 11 - Crystal Radio Bonanza: Biggest, best crystal radio book ever. Over 20 complete projects, detailed instructions,
technical questions & answers, magazine reprints, photos, graphics & more. NEW \$19.95
- Zenith The Early Years, 1919-1935.** Bryant and Cones. The 1st of a planned 3-book series. Explains the Zenith story. Discover never
published photos, documents and info. 300 photos and illustrations, 120 in color. 224 pgs. \$29.95
- Zenith Radio Corporation** (reprint). The instructions for installation and operation for Models 39-39A Models 392-392A, and Electric
Zenith Receivers. 3 schematics, 3 photos. 16 pgs. \$4.50
- The Zenith Trans-Oceanic: The Royalty of Radios.** Bryant and Cones. Presents the fascinating story of the development and use of
the Trans-Oceanic. Several photos, documents, ads, etc. 160 pgs. \$24.95
- Zenith Transistor Radios.** Evolution of a Classic, Smith. A complete listing of all transistor radio models created by Zenith during
the "Magic Years" from 1955-65. Color photos and price guide. 1998. 160 pgs. \$29.95

A.R.C., P.O. Box 2, Carlisle, MA 01741 - Toll Free: (866) 371-0512

Fax: (978) 371-7129 - E-mail: ARC@antiqueradio.com - Web: www.antiqueradio.com



Free shipping & handling on all U.S. orders (typical U.S. order will be received within 7 days, but allow 2-3 weeks).
Mass. residents add 5% sales tax. Non-U.S. orders, write for shipping costs, or use credit card and specify air
or surface (allow 2-3 months for surface shipping). Most orders shipped by next business day. If using credit card,
include name on card, card number and expiration date. Send payment with order. Money back return policy.
Subscribers, ask for discount when placing order: 10% off books; order must be mailed to address on file.



www.catalinradio.com

Steven D. Turner 5443 Schultz Dr. Sylvania, OH 43560

Phone (419) 283-8203 - Fax (419) 824-2472

*****WANTED*****WANTED*****WANTED*****

CATALIN RADIOS

\$\$\$ Cash paid for any Catalin Radio in any condition!!! \$\$\$

MAKE	MODEL	COLOR	PRICE
Addison	2	Maroon & Yellow Yellow & Red	\$ 900 3,750
Addison	5	Black & Red Yellow & Maroon Black & Yellow Red & Yellow	1,250 1,250 1,000 1,250
Arvin	532	Yellow Maroon	2,500 2,750
Dewald	561	Any Color	500+
Detroit		Any Color	6,000+
Bendix	526C	Green & Black	625
DeWald	A501 & A502	Brown Yellow Red	375 425 1,200
Emerson	AU190 & BT 245	Yellow Green or Brown Dark Red Blue Bright Red	1,300 2,500 2,700 6,850 12,000
Emerson	BM258	Yellow Green Red Blue	1,000 1,350 2,250 4,000
Emerson	564	Black Green Red	500 1,150 1,650
Emerson	AX-235	Yellow & Black Red & White Dk Red & White Blue & White Black & Orange	900 2,000 2,750 5,000 6,000
Espey	Name	Your	Price
Fada	115, 116 & 1000	All Yellow Maroon & yellow Yellow & red Pea Green Blue & Yellow	700 950 1,150 1,400 2,650
Fada	L56	Yellow Light Green Maroon & Yellow Yellow & Blue Yellow & Red Emerald Gr/Yellow Blue & Yellow	1,500 2,500 2,200 3,000 3,500 7,000 7,000

MAKE	MODEL	COLOR	PRICE
Fada	F55 & 52	Yellow Light Green Maroon & Yellow Yellow & Blue Yellow & Red Emerald Gr/Yellow Blue & Yellow	1,000 1,500 1,500 2,000 3,000 4,000 4,000
Fada	5F50 & 5F60	Yellow Light Green Yellow & Blue Yellow & Red Emerald Gr/Yellow	1,000 1,000 2,500 3,000 4,000
Fada	700	Yellow Maroon Onyx Blue	750 1,000 1,200 2,000
Halsen		Yellow Green Red	2,500 3,500 5,000
Motorola	50XC	All Yellow Brown & Tortoise Red & Yellow Green & Yellow	2,000 2,750 6,000 6,250
Motorola	52	Yellow & Tortoise Maroon & Yellow Green & Yellow	1,500 1,850 3,000
Sonora	KM	Any Color	1,600
Kadette	Clockette	Yellow Green Red Blue & Clear	2,000 3,500 6,000 8,000
Sentinel	284 Wavy Grill	Yellow Sand Red Blue	600 800 1,250 6,500
Spartan	Clois'anne'	Yellow Front Blue Front Red Front Brown Front	3,500 4,000 6,000 4,000
Symphony	Name	Your	Price
Tom Thumb	All Colors Needed Name Your Price!		

Above prices are for undamaged, original examples.
Prices paid for damaged or parts sets available on request.

Call or email me: Steve@catalinradio.com

**Prices subject to change without notice!

Classified Ads On-Line at www.antiqueradio.com

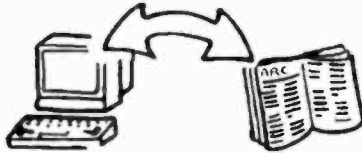

★ Classified Ads are On-Line! ★

Check the "Latest Web Site News" on the A.R.C. Web Site for the Release Date of the Next Month's Ads.

Now including photo classified ads!

Previous month's ads available free to all.

Updated Each Month

The Cover, On The Cover, Editor's Page
One or More Feature Articles (Web Editions)
Book Reviews, Radio Miscellanea
Coming Radio Events & Mark Your Calendar
Radio Club Listing (over 80 clubs, worldwide)
Links to Over 200 Related Web Sites

Archives on the A.R.C. Web Site

Nearly Four Years of Web Editions of A.R.C.

The A.R.C. Web Store

Subscribe and Renew
Order From Over 90 Books and Videos
Request a Free Sample Copy

Also on the A.R.C. Web Site

Frequently Asked Questions (FAQ) about A.R.C.
E-mail A.R.C. With Your Ads and Comments

A.R.C., P.O. Box 2, Carlisle, MA 01741. Tel: (978) 371-0512
Fax: (978) 371-7129 – E-mail: arc@antiqueradio.com – Web: www.antiqueradio.com

(#15-Nov-02)

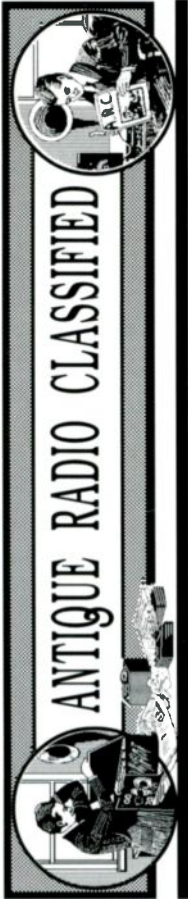

PERIODICALS

A.R.C., P.O. Box 2, CARLISLE, MA 01741
ADDRESS SERVICE REQUESTED

G-6N SUB#=27-777 [3630]
EXP=SEP05
JOE W MCCLUGHAN
PO BOX 310465
NEW BRAUNFELS TX 78131-0465

AADC 018
34
35



WWW.ANTIQUERADIO.COM

CLASSIFIED AD
DEADLINE JUNE 10th
Noon Eastern Time