



ANTIQUE RADIO CLASSIFIED



VOLUME 13

MAY 1996

NUMBER 5

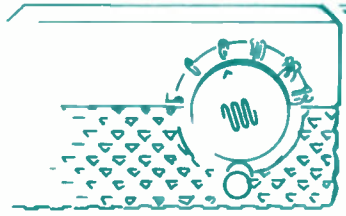
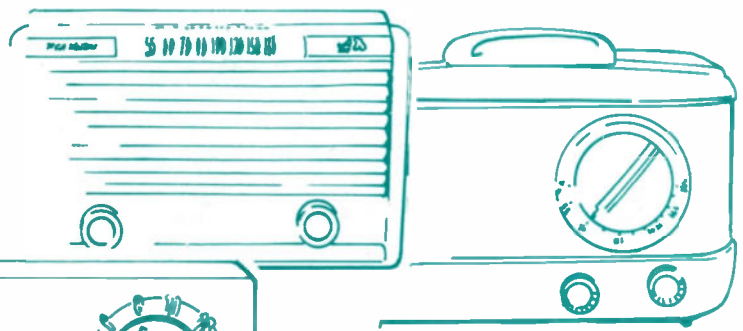

How To Fix Those Old AC-DC Sets

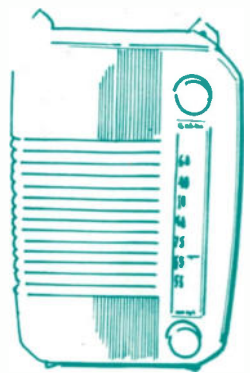
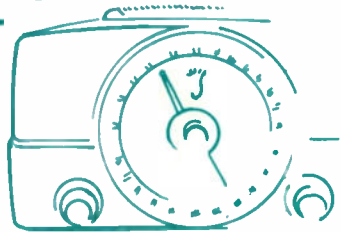
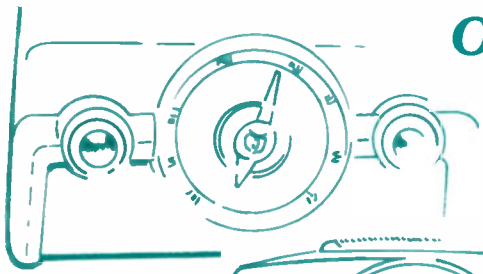

A.R.C. — THE NATIONAL PUBLICATION FOR BUYERS AND SELLERS OF OLD RADIOS AND RELATED ITEMS — PUBLISHED MONTHLY

ANTIQUE RADIO CLASSIFIED

Antique Radio Classified (ISSN:8750-7471) is published monthly, 12 times per year, by John V. Terrey, One River Road, P.O. Box 2, Carlisle, MA 01741. Second-class postage paid at Carlisle, MA, and additional mailing offices. Telephone: (508) 371-0512, 8:30 AM to 6:00 PM ET weekdays; machine answers phone at other times.

Annual subscription rates within the U.S. are \$36.95 by Second Class mail and \$53.95 by First Class mail.

Annual foreign rates. By air: Canada - \$58.00; Mexico - \$64.00; Other foreign countries - \$100.00. Surface mail: Canada - \$47.00; Other foreign countries - \$52.00. (Surface delivery to countries other than Canada may take two or more months and cannot be guaranteed.)

Two-year subscriptions are twice these rates and receive an extra month. Sample issues are available free on request.

© Copyright 1996 by John V. Terrey.

POSTMASTER: Send address changes to Antique Radio Classified, P.O. Box 2, Carlisle, MA 01741.

Printed in U.S.A.

STAFF:

Publisher and Editor: John V. Terrey
Production Manager: Scott J. Young
Office Manager: Lisa A. Friedrichs
Advertising Manager: Cindie P. Bryan
Managing Editor: Dorothy Schecter
Radio Events Editor: Chris Frederickson
Publishing & Editorial Staff: Ray Bintliff, Dave Crocker, Dick Desjardis, Bobby Lyman, Jean Meldonian
Founding Publisher/Editor: Gary B. Schneider
Contributing Writers: Mike Adams, Richard L. Arnold, Ray Bintliff, Ron Boucher, Paul J. Bourbin, Norman S. Braithwaite, Dave Crocker, Alan S. Douglas, Richard C. Foster, Fred Geer, Jim Kreuzer, Ron Ramirez, Henry Rogers, Ian L. Sanders, Gary B. Schneider, Daniel Schoo, Dwane Stevens, Frank R. White, Ralph Williams

PURPOSE. *Antique Radio Classified* is published for people involved in the radio collecting hobby. Its purpose is to stimulate growth of the hobby through the buying, selling and trading of radios and related items, and to provide a monthly forum for the interchange of ideas and information.

CONTACTING ANTIQUE RADIO CLASSIFIED. All correspondence should be sent to:

A.R.C., P.O. Box 2, Carlisle, MA 01741.

Only UPS, Federal, etc. items to street address: One River Road, Telephone: (508) 371-0512; Fax: (508) 371-7129

E-mail: ARCMagzine@aol.com — Web: www.antiqueradio.com
 Please, no classified ads by telephone; thanks.

Your ads, renewals, letters, etc. can be handled faster and more efficiently if your name, address and SUB# are written on each.

Unfortunately, A.R.C. is not staffed to answer letters with questions about antique radios or requests for advice. However, A.R.C. does solicit letters of interest to its readers and publishes them as space permits. A.R.C. assumes that permission is given to edit and to publish all correspondence and articles received unless otherwise indicated.

GUARANTEE. You may cancel your subscription at any time and receive a pro rata refund for issues not yet mailed. If errors to ads are made by A.R.C., upon request a free correction will be run in the next available issue.

PAYMENT. Please send in full payment with your order or ad. A.R.C. does not carry accounts; all subscriptions, ads, etc. must be prepaid (except for the 6 and 12 month display ads indicated below). Pay in U.S. funds. Checks drawn on a U.S. bank, money orders, VISA or MasterCard (\$10.00 min.) are preferred. Make check out to "A.R.C." U.S. stamps or cash are OK for small amounts. Canadian payers may send a Canadian check but specify U.S. funds. Subscriptions will be prorated to amount sent if amount is incorrect.

FAX & E-MAIL PROCEDURES/PAYMENT. Subscriptions, book orders, classified ads, display ads, etc. are welcome by fax or e-mail. Deadlines are the same as for ads received by mail. Please calculate the amount due. Payment by VISA or MasterCard is preferred if your order is over \$10. If under \$10, or if you prefer to send a check or money order, state the amount being sent and that the payment is in the mail. Do not send another copy of your ad with your payment; simply indicate that it is a fax or e-mail payment. If you want confirmation of our receipt of your fax, call immediately after sending your fax.

CHANGE OF ADDRESS. Please notify us 4 weeks in advance of a change of address. Send both your new and old addresses, and include your SUB# and effective date of your new address. Temporary address changes can be made also.

SUBMISSION OF MATERIAL. *Antique Radio Classified* welcomes and solicits information that pertains or relates to radio history or collecting. This may include articles, book reviews, photos, information on upcoming radio events, meetings, antique radio organizations, radio auctions, sources of old radio and restoration supplies, and other related and interesting material. All material submitted should be carefully researched, typed and accompanied by good photos, if appropriate. Computer disks are appreciated. Writing guidelines are available upon request. Unless prior arrangements are made, all submitted materials may be edited, become the property of *Antique Radio Classified* and will not be returned. Publication is subject to approval by A.R.C. and to time and space constraints.

MAILING OF ISSUES. U.S. subscribers can receive A.R.C. by First or Second Class mail (Second Class is the way most magazines are mailed). The mailing of First Class copies is staggered over one to four days with faraway copies mailed before local copies. Non-U.S. copies are mailed on the first day. Second Class copies are mailed on the last day. Mailing dates change each month, but mailing is usually completed by the 27th of the month. First Class copies usually are received by the 5th of the month; copies by Second Class mail, by the 10th.

ETHICS. No person involved in the production of A.R.C. is to act on any information in the magazine until the first delivery day after local copies are mailed.

DISCLAIMER. The publisher is not responsible for any buying and selling transactions incurred, or for any other use of the contents of this publication.

Antique Radio Classified subscription rates, frequency of publication, content, policies, size and ad details, and rates are subject to change at any time by A.R.C.

DISPLAY AND BUSINESS CARD ADS - DETAILS AND RATES

The deadline is the first of the month for display and business card ad artwork, payment and repeat requests.

Advertising is accepted only for early items related to radio, communication, etc. All items must be described fairly; reproductions, reprints and not-original items must be so identified. Advertisers must agree to respond promptly to inquiries and orders, to resolve problems promptly if the buyer is not satisfied, and to comply with a buyer's refund request on unaltered returned items.

Advertising must be prepaid, except as noted below; see "Payment" paragraph above for details. Late ads will be run only if space and time permit. Since artwork is reduced to 63% in the printing process, originals must be the artwork size listed below. Do not send in artwork on art board or send negatives. Ads should be typeset or typed neatly with a carbon ribbon, black ink (not pencil) on white. If used, reverse type must be limited to 25% of the ad. If you want us to prepare your ad, include the one-time cost below for A.R.C. to make up the ad.

Photos should be at an 85-line screen; otherwise, add \$14.00 per photo for screening. Do not cut or trim photos or glue photos to artwork; submit separately.

If you are confused by these requirements and terms, please

contact A.R.C. before beginning to prepare your ad. We will be happy to advise you on your ad ideas, estimate how much the ad will cost, recommend an ad size, etc.

We assume that advertisers want all ads which are submitted to run without delay; therefore, we will run the ad and bill for any additional work required for the ad to meet these specifications. A late ad will run beginning with the next month. "Tear sheets" will be sent only for 1/8-page or larger ads and only if requested when the ad is submitted.

First business card per advertiser is at lower rate.

The 3-month rates represent about an 11% discount, the 6-month rates 23%, the 12-month rates 30%. Placement requests: add 15% but call first. Clubs: write for discount policy.

| Page | ARTWORK SIZE (SEND IN THIS SIZE) | | As Printed (size in magazine) | | Cost for 1-month | Cost for 3-months | Cost for 6-months | Cost for 12-months | One Time to make up Ad |
|------------------------|-------------------------------------|----------------|----------------------------------|----------------|---------------------|----------------------|----------------------|-----------------------|------------------------------|
| | H x W (inches) | H x W (inches) | H x W (inches) | H x W (inches) | | | | | |
| Full | 12 7/16 x 7 1/2 | 7 3/4 x 4 3/4 | 3 5/16 x 4 3/4 | 7 3/4 x 4 3/4 | \$249.00 | \$664.00 | \$1149.00* | \$1999.00** | \$69.00† |
| 1/2 H | 5 1/4 x 7 1/2 | 3 7/8 x 4 3/4 | 3 5/16 x 4 3/4 | 3 7/8 x 4 3/4 | 126.00 | 336.00 | 582.00 | 1013.00** | 35.00† |
| 1/2 V | 12 7/16 x 3 9/16 | 7 3/4 x 2 1/4 | 3 5/16 x 2 1/4 | 7 3/4 x 2 1/4 | 126.00 | 336.00 | 582.00 | 1013.00** | 35.00† |
| 1/4 | 5 1/4 x 3 9/16 | 3 5/8 x 2 1/4 | 3 5/16 x 2 1/4 | 3 5/8 x 2 1/4 | 64.00 | 170.00 | 295.00 | 514.00 | 18.00† |
| 1/8 | 2 5/8 x 3 9/16 | 1 5/8 x 2 1/4 | 1 5/8 x 2 1/4 | 1 5/8 x 2 1/4 | 33.00 | 88.00 | 152.00 | 265.00 | 8.50† |
| Business Card (1st) | 2 x 3 3/4 | 1 1/4 x 2 3/8 | 1 1/4 x 2 3/8 | 1 1/4 x 2 3/8 | not avail. | 45.00 | 78.00 | 136.00 | 6.50† |
| Business Card (2nd...) | 2 x 3 3/4 | 1 1/4 x 2 3/8 | 1 1/4 x 2 3/8 | 1 1/4 x 2 3/8 | not avail. | 59.00 | 102.00 | 177.00 | 6.50† |

* Full page, 6-mos.: 1/2 due with order; 1/2 due in 3 mos. ** Full & 1/2 page, 12-mos.: 1/2 due with order; 1/2 due at 3, 6 & 9 mos.

† For 6 and 12 month ads, no ad make-up charge if no change is made to ad for entire run.



EDITOR'S COMMENTS

What was that we said last month about the hope of spring in the air here in New England? Well, two snowstorms in one April week, making an all-time-record accumulation, somewhat dampened that hope. Perhaps that's why our lead article features an indoor repair project, although everyone knows that repair projects are always in season.

This article by Donald Teale is a reprint from a 1963 magazine contributed by Paul Williams. For AC/DC radios of that era, it is as useful today as it was then.

Richard Arnold tells us about his RCA Model T10-1 oversized tombstone, a 10-tube set which covers the shortwave bands as well as the usual broadcast band. Quality sound must have been a goal of RCA with this set since it has an 8-inch speaker and 8.5 watts of "undistorted power."

Mac Lackey provides us with a glimpse of radio's past in his article on WJZ Newark, which can trace its history to 1909 and the experimental broadcasts of Dr. A. Frederick Collins. By 1922, Westinghouse had begun experimenting with radio as entertainment on WJZ by playing records on a Diamond Disc phonograph provided by Edison himself.

This month Paul Bourbin writes about the Navy OQ-3, the military version of the Weston Model 788 tube tester. Paul is remembered for a number of test equipment articles for A.R.C. in the past, and has been joined recently by Alan Douglas in adding to our knowledge about tube testers.

Reports on radio meets, auctions and club spotlights add up to four this month. The Greater Boston Antique Radio Collectors (GBARC) held its 27th meet here in Massachusetts in February. (Yes, it sometimes takes us this long to get a report together for A.R.C.) As host of the largest event in New England, GBARC welcomed over 900 browsing attendees and provided for 90 flea market tables.

At the other end of the record book was a gathering at the Crested Butte, Colorado, ski resort. Here the attendance was six with one vendor. (Quantity is not always what counts!) This first annual event has a way to grow, so all of you radio-skiers out there, let A.R.C. know if you are interested in attending the second annual "Meet on the Mount." Small or large, expect a success.

Richard Estes held another major radio auction with sales exceeding \$34,000. We print his report along with a number of photos. With 153 bidders, Richard's events are not to be missed by any avid collector. Top bids were brought by a Majestic Charlie McCarthy radio at \$925 and a Zenith 15U-269 console at \$600.

And speaking of major auctions — a new advertiser to A.R.C., Auction Team Köln, of Köln, Germany, announces a "Classic Radio & TV Sets" auction on June 8, 1996. See pages 112 and 113. If Germany is not on your June itinerary, absentee bids will be accepted.

The Arizona Antique Radio Club is featured on our *Club Spotlight* page. This club has grown to over 150

members since it was formed in 1983. Although based in the Phoenix area, it draws collectors from the entire southwestern region.

Photo Review shows a number of AC sets from early TRFs to a 1950s plastic model. An interesting breadboard-style crystal set by Electronic Age Mfrs. (EAM) of Brooklyn, N. Y., is shown also.

A *Radio Miscellanea* letter identifies the man and woman listening to their Radiola IV on our April cover. Although we suspected that the couple were celebrities, we decided to leave it up to our readers to do the sleuthing for us. Also included are follow-ups on Nipper, a Deluxe Midget radio, and KDKA. And, a subscriber from almost the end of Alaska's Aleutian Islands writes in appreciation of A.R.C. — and, thank heavens, *not* to complain about his 3-week plus delivery time!

Chuck Dachis' long-awaited book, *Radios by Handcrafters*, is reviewed this month by A.R.C. staff member Ray Bintliff. Published by Schiffer, the publisher of the Philco and Zenith books, this book is a "must buy," according to Bintliff. It joins the fine books by Moore (*Communications Receivers, 3rd ed.*) and Penson (*Heathkit: A Guide to Amateur Radio Products*) in filling the information needs of collectors of ham equipment.

Additional books for the ham collector are *The Pocket Guide to Collins Amateur Radio Equipment, 1946-1980* by Jay Miller; two new books on ham transmitters — *Transmitters, Exciters, and Power Amplifiers, 1930-1980* by Ray Moore, and *Tube Type Transmitter Guide* by Eugene Rippen. Also available is Rippen's *Ham Price Guide*. A.R.C. now carries all of these books.

Coming Radio Events. This month there are 55 events for the collector with multiday events in Indiana, Texas, Michigan, Ohio, Minnesota, and Alberta. The next event for A.R.C. is the Dayton, Ohio, Hamvention on May 17-19. Attracting 35,000 hams, this is the largest ham event in the U. S. Although mainly for radio amateurs, this event is attended by many radio collectors, as both buyers and sellers in the outdoor flea market.

A.R.C. will be at Booth 207, with New Wireless Pioneers next door at 206. Our booths are a "must stop" for all Hamvention radio collectors. Dayton-area A.R.C. subscribers Dianna and Lew Lewis, Alan Parlin, and Tom Steele help me out at this event, so stop by and say "hi" to us all.

Happy Collecting.

John V. Terrey, Editor

ON THE COVER

Our cover this month is a stylized line drawing by A.R.C. staff member and collector/artist Dave Crocker. They are from top right, counterclockwise: an Emerson 543, ca. 1947; an RCA 35X, ca. 1942; a Motorola 5R1, ca. 1951; a Crosley 10-138, ca. 1950; a Zenith H-725, ca. 1951; and a Westinghouse H-210, ca. 1949. Dave's talent and extensive radio knowledge are a great resource for A.R.C.

From the Pages of... *Electronic Technician*

Service AC-DC Radios at a Profit, By Donald Teal

CONTRIBUTED BY PAUL WILLIAMS

This article is adapted from "Electronic Technician," December 1963, pages 48-52. It was so helpful to Paul Williams, who happened to find the article just as he was repairing an AC/DC set, that he offered to share his find with A.R.C.'s readers. A.R.C., in turn, made a copyright search, found no restrictions, and decided to reprint the article in its entirety, along with its many helpful tables. Since this is a reprint, certain spellings and syntax that are no longer standard remain unchanged. (Editor)

(Warning: One side of the AC line is usually connected to the chassis in an AC/DC radio. Use an isolation transformer to prevent shock!)

What's your reaction when a customer brings

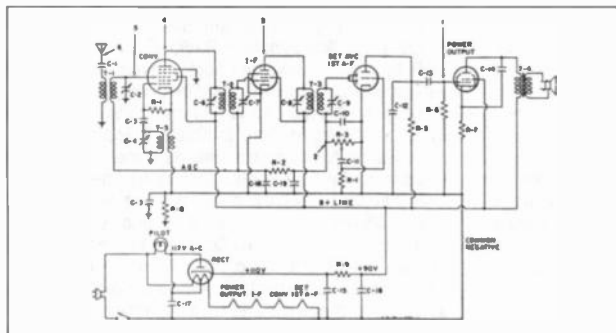

Figure 2. Schematic of typical ac-dc receiver.

in one of those little ac-dc table radios? Some shops take the easy way out — they just refuse the job. Others silently cuss them as nonprofit headaches, taking them just to keep the customers happy but farming them out to an electronically inclined neighborhood teenager or moonlighter who will work for a buck an hour plus parts.

The technician who's on the ball and really knows what he's doing, however, welcomes the little five-tuber as a profitable addition to his business. He can do so, however, only because he: (1) took the trouble to learn how they work, (2) adopted a thorough troubleshooting procedure, and (3) made it a policy to accept every ac-dc repair job he could get until he became as familiar with table-radio idiosyncrasies as he is with those TV sets.

HOW DOES IT ACT?

The first step in any ac-dc radio troubleshooting

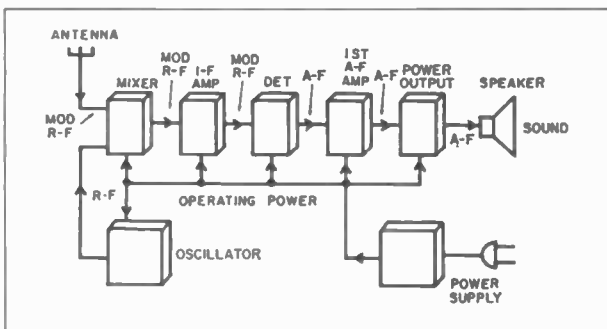

Figure 1. Block diagram of typical ac-dc receiver.

procedure is to find out what the problem is. When the customer brings in a set for repair, he knows more about the problem than you do. So the first thing to do is ask him how it acts. Although he may initially say only that "It doesn't work right," careful

questioning on your part may translate his original answer into "It starts out all right, but after about ten minutes, it starts sounding fuzzy, and before long, I can't stand to listen to it."

After you have learned as much as you can from the customer, thank him for the business and then put the receiver on the shelf until he has left.

The next step in determining the problem is to check all the tubes. Some technicians check the tubes while the customer is still in the shop because they feel that he will be happier if, five minutes after he walks in with a dud, he can walk out with the set playing again. In many cases, it would be all right to do this, but not all tube failures are

Table 1 Types of complaints

- Dead Receiver
- Distortion
- Excessive Hum
- Interference from other stations
- Intermittent operation
- Noise
- Oscillation "birdies"
- Repairs needed too frequently
- Weak, poor performance

caused by old age, and putting in a new tube might be only a temporary cure. In addition, you might be out of the particular tube needed, you might have an embarrassing time just getting the case open, and you will certainly lose the opportunity to impress the customer by giving the alignment its first touch-up in years or discovering unsafe conditions in the line cord, switch or other circuitry.

After the customer has left, pull the tubes and check them. If a bad tube is found, check the circuitry associated with it before plugging in a new one and turning on the set, to make sure that the failure was not caused by a defective component. If you find no circuit faults, plug in the tubes again (along with the new one) and turn on the set. If it does not operate properly, remove all the tubes and replace them with a set

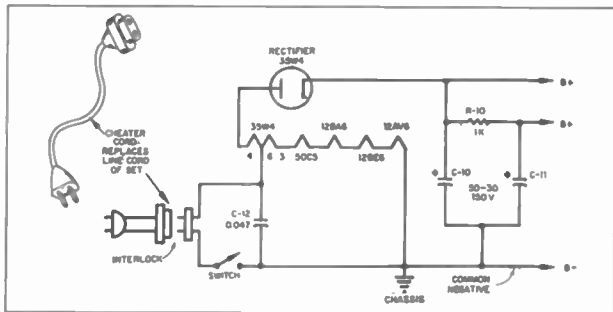

Figure 3. Power supply and filament schematic for ac-dc radio.

of tubes you know are good (bad tubes don't always show up even on the best tube testers). Again turn on the set. If it plays properly, you know that one of the tubes is bad but was not detected by the tube tester. If the problem still remains, however, the next step is to isolate it analytically to a single stage.

TROUBLESHOOTING TECHNIQUES

The block diagram of a typical ac-dc radio is shown in Figure 1, and a complete schematic appears in Figure 2. Most ac-dc radio problems fall into one or more of the categories listed in Table 1, and their most common causes are listed according to category in Tables 2 through 8.

If the set is not completely dead, Tables 3 through 8 should give you some idea as to which

(Continued on following page)

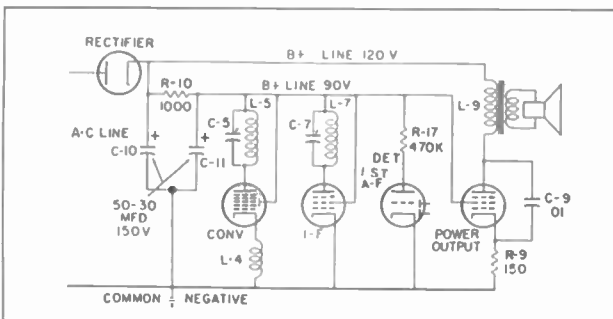

Figure 4. B+ distribution circuits for typical table model radio.

Table 2 Causes of dead receivers

- Burned out fuse
- Defective ballast tube
- Defective selenium rectifier
- Defective switches
- Defective tubes
- Defective volume control
- IF transformers grossly misaligned
- Open coil
- Open heater voltage-dropping resistor
- Open or shorted antenna
- Open or shorted coupling capacitors
- Open or shorted transformers
- Open resistors
- Open speaker voice coil
- Shorted B+
- Shorted filter capacitors
- Shorted filter choke
- Shorted line filter capacitor
- Shorted variable capacitors
- Touchy oscillator stage

Table 3 Causes of weak reception

- Bent tuning or trimmer capacitors
- Broken ferrite-rod antenna
- Corroded IF cans
- Defective antenna
- Defective antenna, RF or IF transformer
- Defective input filter capacitor
- Defective self-bias resistors
- Defective tubes
- Defective volume control
- Floating grid circuit in output stage
- Leaky coupling capacitors
- Leaky screen bypass capacitors
- Moisture in tuned circuits
- Open avc bypass capacitor
- Open audio tube cathode bypass capacitor
- Open coupling capacitors
- Open plate bypass capacitor
- Poorly or incorrectly seated tubes
- Receiver misaligned
- Weak batteries

(Service AC-DC Radios, continued)

stage is affected and what the trouble is. The quickest way to find the cause of a dead set, however, is to follow a fairly standardized troubleshooting procedure.

The value of a good signal generator and signal tracer cannot be stressed too highly. Instead of using a signal generator, some technicians touch the tube grids with one lead of a 0.01 μf capacitor while holding onto the other lead. If the stages are operating properly, touching audio grids may cause hum output, while touching IF and RF grids may create loud "pops" and scratching noises in the speaker. If no signal generator is available,

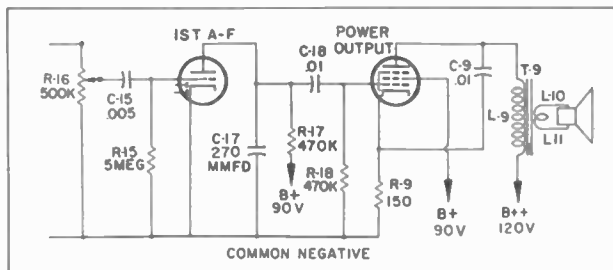

Figure 5. Schematic of standard ac-dc radio audio circuitry.

accidental electrocution, and because it would otherwise be necessary to turn off the set every time a test lead is connected to or disconnected from ground, most technicians use an isolation transformer between the power line and the radio.

ISOLATING THE TROUBLE

To begin the troubleshooting procedure, check the power and filament supply. A typical power and filament supply is shown in Figure 3. Turn the set on and make sure that all the tubes light. If any of the tubes are the metal variety, you won't be able to see the filaments, but after a minute's operation, a metal tube with good filaments will be warm or hot to the touch. If the tubes do not heat up

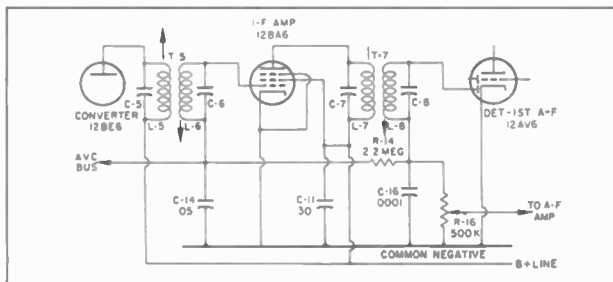

Figure 6. IF, detector and AVC stage circuits.

you can do nothing else, but this procedure is very unreliable.

Worse yet, it is not "quantitative"; that is, while it creates some noise, you can't tell how much noise was caused by how much input — the input level will depend on the temperature, humidity, location and a host of other unknown variables. Most important, this method precludes the use of a signal tracer or signal injector.

When working on an operating ac-dc radio, remember that circuit ground is actually one side of the 117-v power line. Because of the danger of

Table 4 Causes of excess hum

- Cathode-to-heater leakage
- Corroded contacts
- Defective rectifier tube
- Defective volume control
- Leakage between capacitors in a multiple can
- Open cathode bypass capacitor
- Open decoupling filter capacitor
- Open filter capacitors
- Open grid circuit
- Open line filter capacitor
- Oscillating stage
- Overbiased tube
- Poor lead dress
- Poor shield grounding

Table 5 Causes of squealing and motorboating

- Corroded or poor connections
- Defective antenna, RF or IF transformer
- Defective supply filter capacitor
- Gassy tubes
- Improperly grounded tuning capacitors
- Low bias
- Microphonic tube
- Open agc filter capacitor
- Open bypass capacitor
- Open detector RF bypass capacitor
- Open grid circuit
- Open plate decoupling capacitor
- Open screen bypass capacitor
- Open screen voltage-dropping resistor
- Poor grounding
- Poor lead dress
- Poor rubber mounts
- Poor shielding
- Poor wiper contact in tuning capacitors
- Weak batteries

but you know that they are good, check for a broken line cord, defective switch, cold-solder joint, broken printed circuit wiring or defective tube socket. Also double-check to make sure that you put the tubes back in the correct sockets.

Some tubes are "blinkers" or intermittents. If you can't see the filament, a blinker can be found by connecting either a neon lamp or an AC voltmeter across the filament pins of each tube during one complete on-and-off blink cycle. When the tube is "on," the neon lamp will not light and the AC voltmeter will read just the filament voltage appropriate for the tube. When the filament blinks open, however, the full 117-v line voltage will appear across it. The neon lamp then will light (make sure it is designed for 117-v operation), or the voltmeter will read 117-v.

Next listen for hum in the loudspeaker, or, better yet, gently place your fingertips on the speaker cone (your hearing may not be "20-20" at 60 cps). Although you should expect a small amount of hum in a properly operating ac-dc set, if it is excessive, you will feel strong excursions of the speaker cone.

With a multimeter, test the power supply B+ (see Figure 4). It should be between 100 and 125 vdc at the cathode of the rectifier and about 10-v less at the positive terminal of the second filter capacitor. If the rectifier is OK but the B+ is low, look for a shorted or very leaky filter capacitor or a short in the B+ distribution wiring. If the B+ is high (around 140- to 150-v), look for an open in the B+ line, especially in the power amplifier wiring. If the filament and

power supply circuits check out OK, the audio circuits should be checked next.

Approximately half the circuitry of an ac-dc receiver precedes the audio volume control. To determine which half of the receiver the trouble is in, turn the volume control to maximum gain and touch the hot end of the volume pot with one lead from your multimeter. (Don't connect the other test lead to anything — just pull it out of the meter or let it lay on the bench.) If you hear a loud 60-cps hum from the speaker, the trouble probably is in the stages which precede the volume pot. If you don't hear the hum, the trouble is somewhere in the audio stages.

CHECKING THE AUDIO STAGES

To check the output transformer and speaker, unplug the radio line cord and set your ohmmeter to the X1 or X10 scale. Then connect the ohmmeter leads across the primary of the output transformer. A schematic of typical ac-dc radio audio circuitry is shown in Figure 5. If the transformer and speaker are OK, you will hear a "pop" when the leads are disconnected.

If the speaker and output transformer seem OK, turn the set back on again and connect the 400-cps output of the signal generator to the control grid of the power amplifier tube. A 1.5-v input to the grid should result in loud 400-cps output from the speaker. If the output is too loud, it may be distorted; on the other hand, distortion might result from a faulty stage or speaker. Therefore, reduce the output level of the signal generator until the speaker output is not uncomfortable when your ear is about a foot away from it.

If the audio is still distorted, check the operating voltages of the stage. If they seem correct, disconnect the speaker and substitute a speaker known to be good. If the audio is still distorted, the trouble is in the power amplifier circuitry or tube. If the audio from the substitute speaker is not distorted, a new speaker probably is needed.

The next stage to check is the power amplifier
(Continued on following page)

Table 6
Causes of noise

- Bad battery connectors*
- Bad stators and rotors of tuning capacitors*
- Break in antenna lead-in*
- Conductance between tube pins*
- Corroded solder joints*
- Corroded windings in RF, IF and AF coils and transformers*
- Cracked printed circuit board*
- Cracked resistors*
- Defective line filter capacitor*
- Defective or dirty volume and tone controls*
- Defective switches*
- Defective tubes*
- Dirt in speaker*
- Dirty wiper contacts on tuning capacitors*
- Dusty tuning capacitors*
- Intermittent shorting of wires inside receiver*
- Leaky capacitors*
- Loose loudspeaker spider*
- Loose parts in receiver*
- Loose pilot light*
- Loose voice-coil wires*
- Torn loudspeaker cone*
- Tubes seated improperly in sockets*

Table 7
Causes of intermittent operation

- Cracked printed circuit board*
- Defective solder joints*
- Defective switches*
- Defective tubes*
- Defective volume controls*
- Dirty tuning capacitor wipers*
- Faulty taps in wire-wound resistors*
- Intermittent shorts inside receiver*
- Intermittently open fixed capacitor*
- Intermittently open resistors*
- Intermittently open coils*
- Intermittently shorted variable capacitors*
- Leaky coupling and filter capacitors*
- Loose tube and wire shields*
- Resistors changed in value*
- Shorted coils*
- Weak batteries*

(Service AC-DC Radios, continued)

is OK is the first audio amplifier. Connect the 400-cps output of the signal generator to the hot end of the volume pot. With the pot set to maximum gain, a 30-mv audio signal should provide loud 400-cps audio at the speaker. If there is no output from the speaker, the trouble is somewhere in the circuitry of the first audio amplifier. Some of the voltages which should be found at various audio-circuit points are as follows:

| | |
|-------------------|-------------|
| First amp cathode | 0 v |
| First amp grid | -0.5 v |
| First amp plate | 50 to 70 v |
| Pwr amp grid | 0 v |
| Pwr amp screen | 80 to 90v |
| Pwr amp plate | 110 to 125v |

If the trouble is not found in the audio stages, it probably is in the IF amplifier, mixer, local oscillator, RF amplifier (if the set has one) or antenna circuitry.

CHECKING THE IF AND RF STAGES

To troubleshoot the IF amplifier, connect the 400-cps-modulated 455-kc output of the signal generator to the plate of the IF amplifier. (See Figure 6 for typical IF, detector and AVC circuitry.) It may be necessary to rock the frequency of the signal generator up to 50 kc either side of 455 kc if the IF cans are not tuned to exactly 455 kc. A 0.1-v input signal should produce a strong 400-cps output from the speaker. Strong speaker output indicates that the second IF can and the detector stage are OK.

Next connect the modulated signal generator output to the grid of the IF amplifier tube. A 3.5-mv input signal should result in loud 400-cps output from the speaker, the lack of which indicates that the IF amplifier or its associated circuit-

Table 8
Causes of distortion

- Cathode-heater leakage*
- Changed value resistors*
- Defective controls*
- Defective filter capacitor*
- Incorrect tube bias*
- Leaky agc filter capacitor*
- Leaky coupling capacitors*
- Misalignment*
- Open grid circuit*
- Oscillating stage*
- Shorted cathode bypass capacitor*
- Shorted coupling capacitor*
- Shorted detector stage RF bypass capacitor*
- Shorted filter capacitor in agc line*
- Shorted turns in transformer*
- Voice coil rubbing or dirty*
- Warped or torn loudspeaker cone*
- Weak batteries*

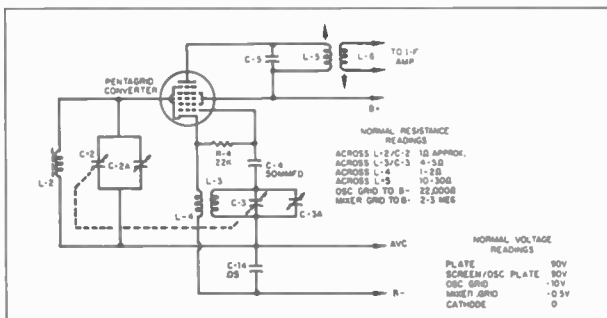

Figure 7. Schematic of ac-dc table radio converter stage.

ry is defective.

To check the first IF can, connect the modulated 445-kc, 3.5-mv signal generator output to the plate of the converter tube. If a strong 400-cps output from the speaker is heard, the trouble probably is in the stages which precede the IF section. Some of the voltages normally present in the IF and detector circuits are as follows:

| | |
|---------------------|-------|
| Diode plates | -0.5v |
| IF amp cathode | 0v |
| IF amp control grid | -0.5v |
| IF screen grid | 85v |
| IF plate | 85v |

The converter stage is checked in two steps. First, short out the local oscillator tuning capacitor in order to stop the oscillations. (An ac-dc radio converter schematic is shown in Figure 7.) Connect the modulated 445-kc signal generator output to the mixer grid. A 50- μ v input signal should produce a loud 400-cps output from the speaker. If it does not, the trouble probably will be found in the converter circuitry not associated with the local oscillator.

If speaker output was obtained in the previous step, remove the short from the local oscillator tuning capacitor, set the signal generator frequency to 600 kc, and connect the output leads to the converter RF input grid. Attempt to tune in the 600-kc signal. A 50- μ v input signal should produce loud 400-cps speaker output. If the 400-cps audio is not heard, check the voltage at grid No. 1. If the local oscillator is oscillating properly, grid No. 1 should measure approximately -10v.

If the converter and other stages are operating properly, the next step is to check the RF amplifier (if the set has one). Leave the signal generator and receiver tuned to 600 kc and connect the signal generator to the plate of the RF amplifier. With an input level of 50 μ v, listen for loud 400-cps output from the speaker. This checks the RF coupling circuitry. If the output is heard, connect the modulated 600-kc signal to the RF amplifier grid. A 10- μ v input signal should produce the loud 400-cps speaker output. If the RF and other stages are operating properly and the set is still dead, the trouble probably is in the antenna circuitry.

This completes the troubleshooting procedure for ac-dc sets. If it is followed closely and intelligently, it will help you a long way toward ac-dc repair jobs that are easier, quicker and profitable.

(Paul M. Williams, 2364 Beaver Valley Pike, New Providence, PA 11560-9622)

WITH THE COLLECTORS

The RCA Model T10-1

BY RICHARD ARNOLD

The RCA Model T10-1, shown in Figure 1, is a 10-tube, 3-band, superheterodyne that covers the frequency range of 540-18,000 Kc. This 1935 table model tunes the domestic, foreign, police, and amateur bands and employs an airplane dial.

A very large tombstone model measuring 19 inches tall, 16.5 inches wide and 13.5 inches deep, the Model T10-1 takes up a lot of space. Still, for so much radio, the price was only \$69.95.

The tube complement consists of the following metal tubes: one 5Z3 as a full wave rectifier, two 6F6 push-pull power output tubes, two 6C5 audio amplifiers, one 6J7 oscillator, one 6H6 second detector and AVC, two 6K7s — one as

RF amplifier and one as IF amplifier — and one 6L7 as a first detector.

The radio uses an 8-inch electrodynamic speaker and delivers 8.5 watts of "undistorted power."

The five knobs include a combination low frequency tone control and power switch, a treble tone control, a volume control, a tuning knob, and a range selector. The range selector has three positions with red, green and white band indicators. Red is the standard broadcast band (540-1,800 Kc), white is shortwave (1,800-6,000 Kc), and green is amateur, police, weather and aircraft (6,000-18,000 Kc).

The tuning drive ratio is variable by means of a push-pull clutch arrangement. A tuning ratio of 10:1 or 50:1 may be selected. The tuning dial also includes a vernier pointer for logging and fine tuning of stations.

Some versions of this set used a universal transformer capable of operation on a wide range of line voltage.

These sets seem to be somewhat scarce, at least around here in Oklahoma. I have not seen any for sale at any auction, nor have I seen any on display in any contest. I am looking for a copy of an ad on this radio. Does anyone have one?

References:

Radio News, November 1934..
RCA Service Notes for 1935.
RCA Victor Service Data, Vol. 1, 1923-1937

(Richard Arnold, Box 275, Lone Grove, OK 73443)

Richard Arnold, a frequent contributor to A.R.C., has been collecting radios since 1985. His interest is primarily in cathedrals and 1920s battery sets, and his collection ranges from crystal sets to a 1928 American Bosch in a Pooley cabinet. His prize is the 1932 Jackson Bell Peter Pan featured in the June 1991 A.R.C.



Figure 1. The cabinet of this RCA Model T10-1 oversized tombstone is in excellent condition, and the grille cloth appears to be original.

VINTAGE BROADCASTING

WJZ and the Newark Connection

BY MAC LACKEY

Research in the Newark Public Library enabled Mac Lackey to share with us more information on early radio broadcast history. The intriguing topic of radio "firsts" seems never-ending. See "The Story of Charles Herrold" in A.R.C. of October 1994; the KDKA toppled tower article of March 1996; and the article "More on Call Letters" of April 1996. (Editor)

On October 1, 1921, the switch was thrown for the first time on the new WJZ Westinghouse transmitter in the "shack" of the Newark station, shown in Figure 1. This event spelled another very important chapter in the history of radio broadcasting in New Jersey.

THE BEGINNING

A *Newark Sunday Call* headline for October 11, 1931, stated, "Original Radio Station in City 23 Years Ago — Clinton Street Plant Used in 1908 by Dr. Collins." The story told of Dr. A. Frederick Collins, president of Collins Wireless Telephone Company, who had moved his electrical laboratory, previously located in Philadelphia, to Newark. There he erected an arc transmission station where he began his experiments with the electric arc. He soon outgrew the first location on Pine Street and moved to the top floor of an office building located at 54 Clinton Street.

It was during experiments with an oscillating arc as a means of generating high frequency waves that experimental broadcasts were made

from his station in Newark to his receiving station in Philadelphia. Collins and his assistants talked by radio to the receiving station daily. He soon established a receiving station in the L.S. Plaut and Co. building on Broad Street in Newark from which thousands of citizens heard broadcasts of music and voices.

A *Newark Star* headline of April 15, 1936, recalled, "Radio Field Started in Newark in July 1908 — New Jersey Governor and Municipal Heads Made Speeches by Broadcast during June 1909."

Collins was awarded a gold medal by the Alaskan/Yukon Pacific Exposition in 1909 for the development of the world's first radiophone station. But the public was skeptical, and when Collins offered to sell stock in his company, he met with no success. Dejected, he left Newark.

A few months later, Dr. Lee de Forest came to Newark where he established a laboratory and radiophone station on Boyden Place near the Lackawanna Train Station. DeForest, like Collins, used an arc for transmitting voice and music, and interest in this process grew. He left Newark a year after his arrival, moving to High Bridge, New York, where his experiments continued, and his real mark on radio would soon be made.

ENTER WESTINGHOUSE

Westinghouse Electric & Manufacturing Co. gained much expertise from the manufacture of radiophone equipment used in France by aviators during World War I. Westinghouse was the

parent of KDKA in Pittsburgh, licensed October 27, 1920. Then on June 1, 1921, the company was granted a license to operate WJZ, a radio broadcast station in Newark, N. J.

The site for the transmitter was a hastily constructed wooden shack on the roof of the Westinghouse factory located at the intersection of Plane and Orange Streets in Newark.

Up on the roof, the 500-watt, 360-meter transmitter was enclosed in metal screening and glass with a blower to cool its five tubes. A switch panel was located on the right side of the transmitter to select the announcer's mike, the first floor studio mikes, or the Edison phonograph pickup.

Near the transmitter to the right of the announcer's position



Figure 1. This interior view of the transmitter "shack" of radio station WJZ Newark is an original photo that Lackey acquired with a phonograph collection he purchased about 20 years ago.

was a Westinghouse medium wave receiver used for receiving time and weather information from the Naval Observatory for rebroadcast.

By November, a studio had been created in an old cloak room and part of the infirmary. Live professional entertainers were first broadcast from that studio on November 8.

The new studio was designed for live concert work. Located on the first floor, it was convenient to artists, and a grand piano and other musical instruments were part of the studio equipment. The walls were draped with heavy carpets to deaden echoes and eliminate outside noise. A variety of microphones was available for use by various groups of entertainers.

AUDIENCE RESPONSE

WJZ helped set the stage for entertainment for an entire nation. Westinghouse's WJZ engineers began testing on October 1, 1921, by playing records on an Edison Diamond Disc phonograph presented to the station by Thomas Edison in person. The testing engineers asked for listeners to write the station. The young man who picked up the daily mail called in requesting a truck to pick up the huge amount of mail that had come in.

After its first day of broadcasting, WJZ received reports that the signals had been received as far east as Stockbridge, Mass., as far west as Easton, Ohio, and as far south as North Carolina.

On October 5, 1921, the station broadcast the World Series game between the Yankees and the Giants to listeners who adjusted their crystal sets to receive the signals from the new station, the first on the Atlantic seaboard.

More interest was aroused when WJZ began to broadcast the first children's stories; "The Man in the Moon" aired first on October 9, 1921. These shows brought in thousands of letters, and within just a few short months, over 45,000 stars were hung out bearing names of "good" children.

WJZ decided to broadcast big college games, starting with the play-by-play of the Princeton-

Yale game on November 13, 1921. The week before, the station had broadcast the election results of the November 8 municipal elections.

Mostly because of the programming, the WJZ audience grew in just months to over a million listeners, and Newark grew in importance, not only as a pioneer in radio broadcasting, but also as a manufacturing center.

By the spring of 1923, WJZ had moved across the river to New York City where it was located on the 6th floor of the Aeolian Hall on 42nd Street. By 1925, the station was part of the NBC network operating at 660 Kc and 1000 watts of power.

Oh, by the way, Newark had an operating television station by 1930 with regularly scheduled programming.

References:

"Description of the Radiophone Broadcasting Station WJZ of the Westinghouse Electric & Mfg. Company located at Newark, N. J." Westinghouse document, August 2, 1927.

Newark News, April 14, 1936; October 11, 1951.

Newark Star, April 15, 1936.

Newark Star Ledger, October 1946.

Newark Sunday Call, May 21, 1922; October 11, 1931; March 29, 1936; April 15, 1936; October 5, 1941; September 1946.

(*Mac Lackey, Mac Lackey's Automated Musical Instruments, P.O. Box 1571, Statesville, NC 28687-1571*)

Mac Lackey grew up in a family-owned radio-television business. As an antiques dealer, he specializes in buying and selling collections of phonographs and similar items. He began collecting radios in the 1950s, concentrating primarily on Atwater Kent, Capehart, Philco, Scott, and Zenith sets, literature and memorabilia. An avid historian, he has written historical features for "The Charlotte Observer" and currently is writing three history books.

Gridley's Radio Shop — May 1940

By Ron Boucher

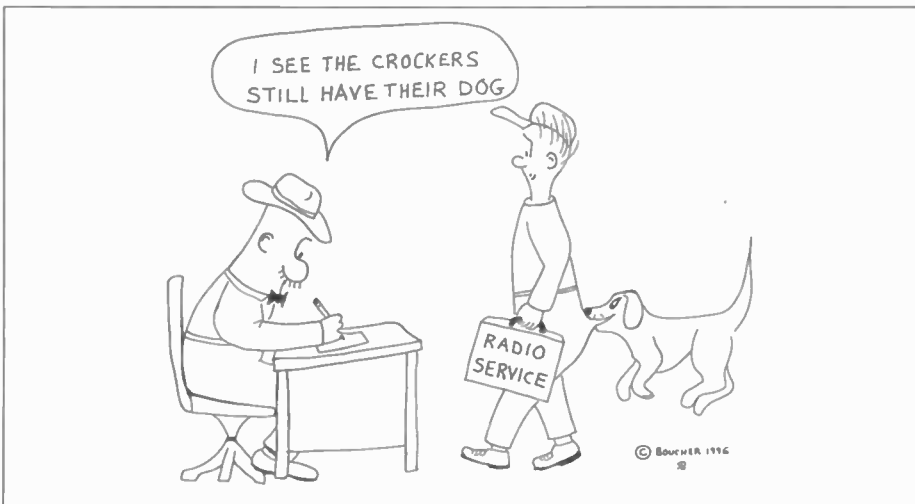
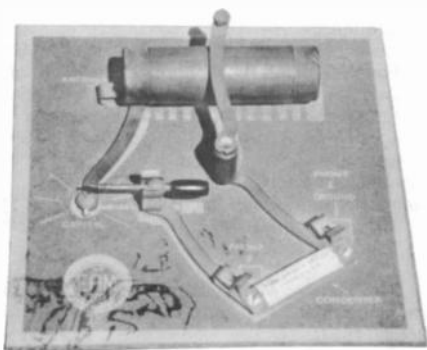



PHOTO REVIEW



This column presents in pictorial form many of the more unusual radios, speakers, tubes, advertising, and other old radio-related items from our readers' collections. The photos are meant to help increase awareness of what's available in the radio collecting hobby. Send in any size photos from your collection. Photos must be sharp in detail, contain a single item, and preferably have a light-colored background. A short, descriptive paragraph **MUST** be included with each photo. Please note that receipt of photos is not acknowledged, publishing is not guaranteed, and photos are not returned.



EAM TOY CO. CRYSTAL SET – This quaint little "breadboard" style crystal radio is mounted on a masonite board with yellow painted trim and component positions. The hardware is constructed of brass. (*David Petrozello – Johnson City, NY*)



VICTOR RADIO CORP. MODEL OPERETTA – This small cathedral radio has a red "V" over the name "Operetta" below the dial. The tube lineup is Types 24, 47, 51, and 80. (*Mike Nail – Mt. Prospect, IL*)



ARMRAD Type AC – This cathedral set is a very basic 5-tube TRF with Types 80, 47, 24, and (2) 35/51. It may have been made in New York, N. Y. Perhaps the name "Armrad" is a spinoff of Armstrong. (*Geoff and Wendy Shearer – Albuquerque, NM*)

PHOTO REVIEW



RCA VICTOR MODEL 6-BY-4 – The radio of this late 1950s portable radio-phono combination can be operated with the lid closed in a flat or upright position. The phono plays 45s only, with record storage on a foam rubber peg under the lid. The plastic case is ivory, with pink knobs, tonearm and speaker grille. Note the folded handle in front of the speaker grille in open view. (Robert Bailey – Jacksonville, FL)

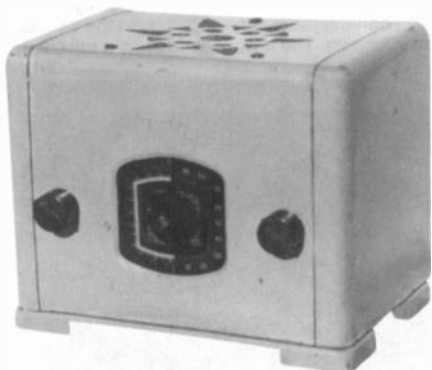
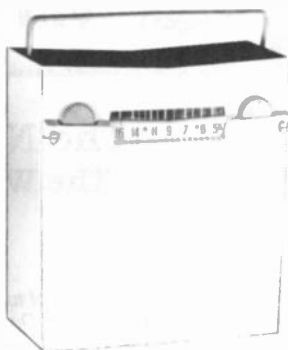

CLINTON MODEL UNKNOWN – This green painted metal cabinet was made by James Metal Products Co., Inc., of Chicago, Illinois. The tube complement includes Types 25Z5, 6C6, 6D6, 43, and a ballast. Anyone recognize this set? (Geoff and Wendy Shearer – Albuquerque, NM)

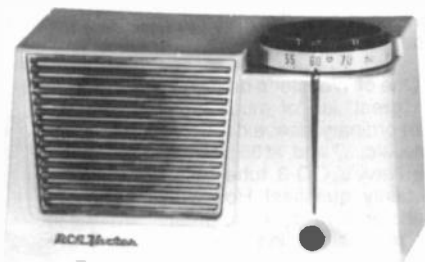

RCA VICTOR MODEL 4X-552 – The plastic cabinet of this 1955 AM radio is ivory with a gold tone metal speaker grille and dial pointer. This radio has a 5-tube AC-DC chassis. (Robert Bailey – Jacksonville, FL)

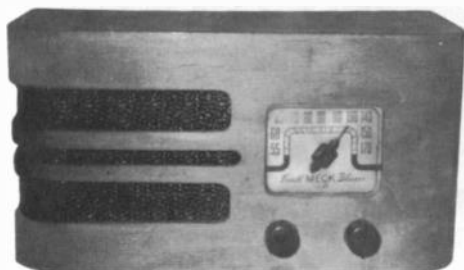

MECK TRAIL BLAZER MODEL RC-5C5-DLW9 – Made by John Meck Industries of Plymouth, Indiana, this AC/DC radio, ca. 1946, measures 5½" x 11" x 6". I have been unable to find much information on this manufacturer. Can anyone help? (Bob Perry – Painted Post, NY)



RCA MODEL 94X2 – This 4-tube TRF, ca. 1938, has preset tuning only. The wooden cabinet measures 8½" x 8½" x 6". The "La Siesta" design is original. Has anyone else run across one of these sets? (Geoff and Wendy Shearer – Albuquerque, NM)



VINTAGE TEST EQUIPMENT

The Navy OQ-3 Tube Tester The World's Greatest Portable?

BY PAUL JOSEPH BOURBIN

Several military models of tube testers were described in Part 2 of Alan Douglas' series on vintage tube testers (A.R.C., October 1995). In the following article, Paul Bourbin adds to our knowledge of these old testers with a description of an interesting military version of a Weston tube tester. (Editor)

One of Webster's definitions for "great" is: "of much more than ordinary size, extent, volume, etc....," and, at 35 pounds, the Navy's OQ-3 tube tester certainly qualifies! However, Webster also defines "great" as: "much higher in some quality or degree; much above the ordinary or average..."; this definition also applies. Anything made for the military had to be accurate, reliable and durable. Cost and convenience were secondary.

The OQ-3 tube tester (Weston Model 788), shown in Figure 1, is an extremely well made piece of equipment with a solid oak cabinet, all metal faceplates and three very fine meters with special scales for this unit. Due to the weight of the tester, the leather carrying strap extends around to the sides of the cabinet. In addition to the storage compartment located at the top of the tester, the front panel is divided into three sections.

PANEL SECTIONS

The top section contains sockets for 4-, 5-, 6-, and 7-pin tubes as well as sockets for octals, loktals, 7- and 9-pin miniature tubes, acorn tubes and a special socket for the Western Electric 215A tube. Also included on this panel are nine banana jacks corresponding to the pin positions on the socket. These are connected

by jumpers from the middle section.

The middle section contains all of the electronics, the meters, switches and controls, and the power supply for the tester. It also has the neon bulb for the short test, a jeweled pilot light and twelve banana jacks corresponding to the various tube elements. The lower section has a roll chart.

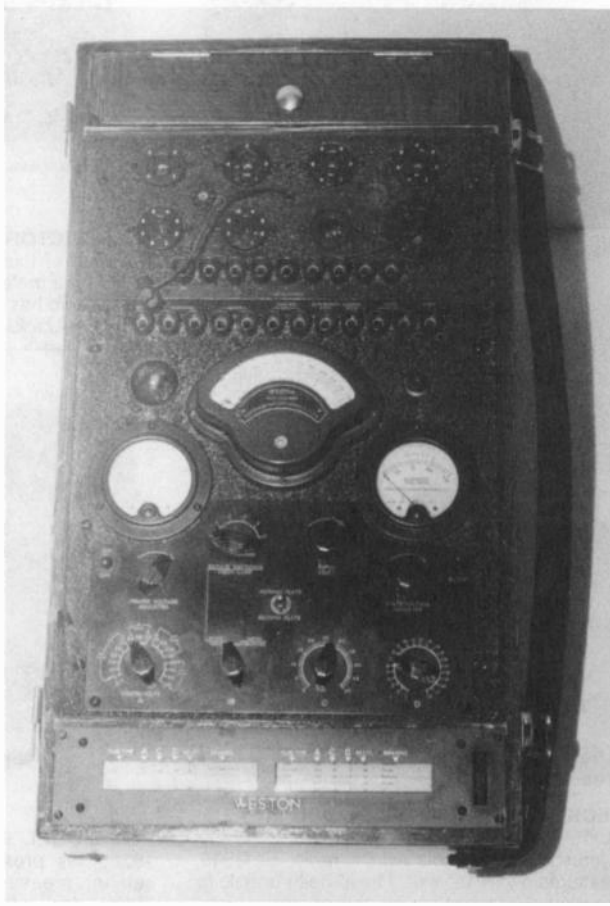

Figure 1. The "great" in size and quality Navy OQ-3 tube tester with (count 'em) 21 banana jacks!

The cabinet lid has a holder for the manual (yet they still seem always to be lost!). Interestingly, the manual is marked "restricted," meaning that Navy personnel were not to talk about its contents to anyone outside of the service. One wonders how national security could be compromised by someone finding out how a tube tester works!

OPERATION

The OQ-3 tube tester is a mutual conductance unit that measures a change in plate current brought about by a change in grid voltage. When the test is done under controlled conditions, one can ascertain whether or not the tube is operating within manufacturer's specifications. For tubes for which this test is not possible, such as diodes and rectifiers, an emission test is used.

Unlike most tube testers used by civilians, this tester measures proportional mutual conductance in terms of a percent above or below normal listed value of the tube as specified by the manufacturer. The scale on the fan-shaped meter reads for 0-130% of normal listed value, with 100% being the accepted value for a new tube.

Whether or not a tube should be kept or discarded is based upon the percentage of this value remaining in the tube. This is quite different from most tube testers that have an "English" reading scale: "Bad" (or "replace"), "?", "Good," or a direct reading in micromhos.

Another interesting feature is that of the heater controls. To obtain as accurate a reading as possible, heater voltage must be exact. A meter is provided to show the filament voltage, and the scale is automatically shunted to the proper scale for the voltage needed. A potentiometer allows the operator to make the fine adjustments to the heater voltage so it can be exact.

In the same way, the Plate Voltage Adjuster switch, which sets all of the other voltages in the tester, is referenced by the Element Voltage potentiometer to 100 on the Element Voltage meter. Note that the value of 100 on the Element Voltage meter is merely a reference point; correct voltages for the tube being tested are switched to the tube's pins by the plate voltage adjusted switch.

The reason for all of these adjustments is that consistent, reliable and repeatable results are possible without variations introduced by the power supply. This makes for a tube tester with accuracy a cut above the norm.

THE DOWN AND UP SIDES

Unfortunately, improved reliability and accuracy do not come without a price. The downside is that the OQ-3 is not the most convenient tester to use. It is also not one to be used when one is in a hurry. In addition to setting the switches, the operator must use jumper cables for each element to each pin. Unless he knows the pin connections for the tube being tested, he must look up the tube base diagram in the manual. Such information is not on the roll chart.

For each tube, the heater and element voltages, as well as the meter reset potentiometer, must be adjusted. This can be time consuming. Since the tester is built to military specifications and contains two separate power supplies, the unit is quite heavy. Also, one has to keep track of all the jumper cords.

Remember, the OQ-3 was used by the Navy, and was more than likely exposed to damp and/or corrosive atmospheres. When purchasing the OQ-3, or similar Navy equipment, it is a good idea to remove the center section of the panel and examine the components. I have seen testers where everything under the panel is heavily corroded even though the panel and case look pretty good. Test all of the switches and pots to make sure that they turn easily. Frozen ones are often corroded beyond repair.

Be careful carrying the OQ-3 by its leather strap. While it is substantial, dried out leather can lose its strength. While we are thinking about the strap, be sure to use some saddle soap and neatsfoot oil to preserve the leather.

In spite of the above drawbacks, the OQ-3 is a very fine instrument. It is a World War II veteran that is a beautiful, accurate and reliable instrument, as good as any available to the servicemen and better than most. In addition to testing most commercial tubes, it will handle some other tubes that most commercial tube testers can not. It is a worthy and useful addition to any collection of vintage test equipment.

My article on the Supreme 385 tube tester and set analyzer in the August 1988 A.R.C. will give the restoration information you will need to get your unit going. Please feel free to contact me anytime about vintage test equipment.

© 1995 by Paul Joseph Bourbin. All rights reserved.

(Paul Joseph Bourbin, 25 Greenview Ct., San Francisco, CA 94131)

References:

- Bourbin, Paul Joseph. "The Supreme 385 Automatic Tube Tester and Set Analyzer." Carlisle, Ma.: *Antique Radio Classified*, August 1988, p. 4.
- "Instructions Model OQ-1 Vacuum Tube Testing Equipment." Newark, N. J.: Weston Electrical Instruments Corp., for Navy Department, Bureau of Ships, March 1942.
- Webster's Dictionary of The English Language, Unabridged, Encyclopaedic Edition.* New York: Publishers International Press, 1979.

Paul Bourbin's interest in test equipment started with finding an old Supreme tube tester in a secondhand store long before he knew that other collectors were out there. His collection spans the time from wireless to the transistor radio and consists largely of radios that he has saved from the junk heap and brought back to life. Past president and chairman of the board of the California Historical Radio Society, Paul writes for various old radio publications.

MEET REPORT

GBARC's Radio XXVII — February 25, 1996 Westford, Massachusetts — Attendance: 922

CONTRIBUTED BY JOHN V. TERREY

On Sunday, February 25, 1996, the Greater Boston Antique Radio Collectors (GBARC) held its annual show at the Westford Regency Inn in Westford, Massachusetts, a full-service, 193-room hotel with 3 restaurants and over 500 parking spaces. Located just off Interstate I-495, the 20,000 square feet of conference space (we use about half) allows for an inside show which has become the largest in New England, with 90 tables sold and 650 paid attendees. Family members swelled the ranks, as 922 name tags were handed out. Although a one-day show, the 28 hotel rooms reserved for attendees were sold out early.

Radio XXVII is managed by A.R.C., and its staff once again did an excellent job (if we do say so ourselves) of preplanning and organization at the site. A convenience to exhibitors was the



Max Mager, helping out his parents Bruce and Charlotte of Waves, is selling this Clapp-Eastham R.Z. which has a curious, but correct, knob spanning the two split panels.



Occasionally, cylinders and other phonograph items are found at meets.

option to reserve tables by telephone and to use a credit card for preregistration. This year, for the first time, exhibitors could deliver their goods to their tables before the general public entered the hall, resulting in less congestion than in the past. The tightness of the space between aisles was a bit of a problem, but we hope to remedy that next year by using adjacent rooms.

Those who visited your editor's collection at his home after the meet were very positive in their response. Unfortunately, parking is limited, the driveway long, and it was a typical mud-season day. Perhaps next year we can make it easier for more people to view this collection of over 600 early wireless and radio items.

In all, the atmosphere was very upbeat. Almost



These Catalin radios including Addisons, Emersons, DeWalds and Fadas were on display at Bruce Phillips' table.



Richard Foster with his Philco "Deluxe" restoration project.

everyone seemed to be delighted to be there, and several said that this was one of the most successful shows they had attended.

The Greater Boston Antique Radio Collectors is not a club, and it has no dues or newsletter. It is

just a group of collectors who get together once or twice a year. For information, write GBARC, c/o A.R.C., P.O. Box 2, Carlisle, MA 01741.

(John V. Terrey, c/o A.R.C., P.O. Box 2, Carlisle, MA 01741)

First Annual Vintage Radio Meet on the Mount Crested Butte, Colorado — Attendance: 6

CONTRIBUTED BY JOHN V. TERREY

The Crested Butte, Colorado, ski area was the scene of the first annual Vintage Radio Meet on the Mount on March 2-3, 1996. No, this is not a joke — the radio "crowd" has begun to gather annually at this mountain resort, a world-class ski area in a quaint historic mining town.

Over the years, your editor has been taking an annual ski vacation to visit his daughter, a Crested Butte resident. Then, a few years ago, Florida collector Robert Uiterwyk moved there and started a cable television station. Last year, we two "radioniks" were joined by collector/skier Craig Smith, also from Florida. And this year A.R.C.'s founding editor Gary Schneider and Jim Kreuzer of "Jim & Gary's Great Adventure" fame, (see A.R.C., June 1994), came also. Gary and Jim were on another of their cross-country radio treks. And so, the first annual Radio Meet on the Mount was underway.

First things first, of course — the "meet" began with a steak dinner on Saturday night at the Wooden Nickel, Crested Butte's oldest bar. After breakfast at Brad's Place, another local favorite, business became serious with a tailgate flea market next to the Center for the Arts. Several radios and crystal sets exchanged hands at a furious pace. And yes, several of the collectors then skied the slopes of Mount Crested Butte!

The unanimous decision was that this is an example of how much fun collectors can have if they make the effort to get together and combine



With Mount Crested Butte in the background, a small, but enthusiastic tailgate flea market was held.

seemingly unrelated activities.

Although the date has not been chosen, the second annual Vintage Radio Meet on the Mount will happen. All of you radio collectors/skiers out there, here is a chance to blend two of your passions — radio collecting and skiing — with a family vacation. Come join us on the mount! Please express your interest to Radio Skiers, c/o A.R.C., P.O. Box 2, Carlisle, MA 01741.

(John V. Terrey, c/o A.R.C., P.O. Box 2, Carlisle, MA 01741)

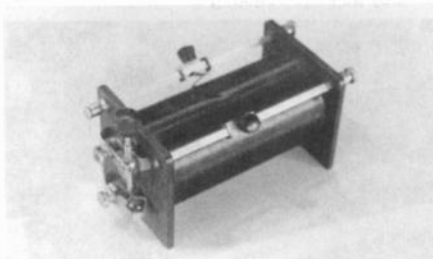

This crystal set looks like the one made by Star Mfg. Co., but it is marked "Pennsylvania Jr., Ham-burg Bros., Pittsburgh, PA."



Meet attendees caught at breakfast (left to right) — Jim Kreuzer, John Terrey, Gary Schneider, Robert and Beth Uiterwyk and Craig Smith.



AUCTION REPORT

Estes Vintage Radio Auction Medina, Ohio — February 17, 1996

REPORTED BY RICHARD ESTES

Estes Auctions conducted its winter radio auction on February 17, 1996, at the Seville Antique Auction Barn, Medina, Ohio, with sales amounting to over \$34,000. A total of 153 bidders had travelled from 11 states to this auction. Absentee bids were taken from California, Canada, and Japan.

Items in this sale included a large collection from Pennsylvania of many battery sets and wood case table radios. Along with this collection, a collection from Ohio provided quite a variety. Highlights included a Zenith Model 15U-169 console going for \$600, a Majestic Charlie McCarthy radio for \$925, a Radiola 28 with antenna and speaker for \$300, and a Crosley Pup for \$325.

Tubes bid well throughout the sale. Bob Dobush handled the myriad of tubes, checking filaments and emissions; these were noted before a tube was sold. Kim Graca and Bob Ready handled the offering of radios and related items. In addition, many box lots of tubes and parts sold in the \$10 to \$50 range. Many wood and Bakelite radios from \$5 to \$75 crossed the block.

John Estes assisted auctioneer Rich Estes with auctioneering duties. The next Estes Radio Auction will be the annual odds and ends sale on May 11, 1966, at 10 A.M., at the Seville Antique Auction Barn. Call or write to consign your equipment.

e=excellent, vg=very good, g=good, f=fair, p=poor, filg=filament good, NT=no tubes, WT=with tubes, BB=brass-based



A sailing ship radio (not a Majestic Melody Cruiser), plus a medley of transistor and novelty radios.

| | |
|--|-------|
| Air King table, g | \$110 |
| American Bosch 46, g | 30 |
| American Bosch radio books, g | 18 |
| Arborphone 26, g | 105 |
| ARC-5 command set, g | 20 |
| Arvin 6 transistor in case, red, g | 45 |
| Atwater Kent 20, g | 85 |
| Atwater Kent cone speaker, small, g | 30 |
| Audiola cathedral, g | 50 |
| Belmont 60-111, g | 95 |
| Bendix 110 table, g | 40 |
| Boss battery set, g | 30 |
| Candlestick phone, g | 95 |
| Clinton wood case, g | 50 |
| Coca Cola bottle radios, (2), g | 40 |
| Columbia key wind cylinder player, g | 200 |
| Coronado Bakelite, 1947, g | 33 |
| Crosley 14-B cathedral, g | 40 |
| Crosley 50 in oak case, g | 95 |



An illustration of the quantity of wooden table model tombstones and cathedrals at the auction.

A warning: Auction prices are not current values. A listing such as this cannot adequately include the condition of cabinets, chassis, transformers, tubes, the operating status of the set, and the inclusion of incorrect, restored or replica components, etc. Auction prices are the result of the excitement of the auction process, the skill of the auctioneer and the specific interests of the participants. Nevertheless, auction prices serve as useful references and as another element in the value determining process. The possibility of error always exists, and if we are notified, corrections will be reported.



This Crosley Model 51 portable is unusual because of the oak cabinet with its folding lid.

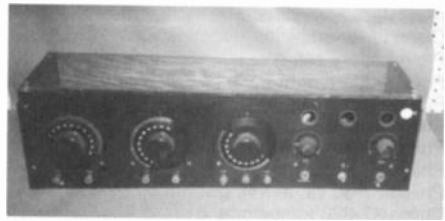

This Fada Model 160 battery set cabinet has been refitted with a glass lid to permit easy viewing of the chassis.

| | |
|--------------------------------------|-------|
| Crosley 51, g | 85 |
| Crosley 124, g | 85 |
| Crosley 148 cathedral, g | 125 |
| Crosley 169 cathedral, g | 115 |
| Crosley 206-FA, g | 80 |
| Crosley 515 tombstone, g | 90 |
| Crosley 635 tombstone, p | 35 |
| Crosley Art Deco radio, wood case, g | 100 |
| Crosley clock-radio, chartreuse, g | 80 |
| Crosley cone speaker, metal case, g | 30 |
| Crosley Fiver, wood case, g | 25 |
| Crosley military receiver, g | 95 |
| Crosley mini tombstone, g | 50 |
| Crosley Pup, g | 325 |
| Crosley salt/pepper shakers, g | 53 |
| Detrola 436, g | 45 |
| Detrola Midget, g | 125 |
| Diamond phono needles, (61), g | 23 |
| Dictogrand radio speaker, g | 200 |
| Edison cylinders, (5), g | 4 ea. |
| Emerson 64-1B, g | 23 |
| Erla 5 battery set, g | 40 |
| Excel 6 transistor radio, g | 10 |

| | |
|--|-----|
| Fada 160 battery set, g | 40 |
| Fada 790, g | 45 |
| Fada battery set w/glass top, transformers g. | 85 |
| Farnsworth table, g | 20 |
| Federal E, g | 65 |
| Federal radio plastic table, g | 65 |
| Ford car radio 133, g | 25 |
| Freed-Eisemann 40 battery set, g | 30 |
| Freshman Masterpiece battery set, g | 85 |
| Freshman Masterpiece, white, g | 55 |
| GE F-74, g | 85 |
| GE H-531 table, 1939, g | 60 |
| General Radio Corp. Variac, g | 23 |
| Globe 10 transistor radio | 18 |
| Globe transistor radio, g | 65 |
| Grebe Synchrophase, works, g | 200 |
| Grunow 510 w/chrome grille, g | 120 |
| Grunow Teledial table radio, g | 30 |
| Guild Country Belle phone/radio, g | 70 |
| H.O. train set, w/Crosley car, g | 40 |
| Hallicrafters Sky Champion S20R, p | 40 |
| Hallicrafters Skyrider, e | 50 |
| Hallicrafters Skyrider, p | 30 |
| Hallicrafters TV, small, g | 85 |
| Harmonson radio, cracked | 135 |
| Heathkit signal generator, g | 10 |
| Hickock 6000 tube tester, g | 75 |
| Home brew crystal set | 30 |
| Home brew loose coupler | 80 |
| Home brew parts set | 25 |
| Home brew, w/Little Spitfire headphones in own box | 40 |
| Howard 118 console, works, g | 65 |
| Kadette table, g | 85 |
| Light bulb w/ceramic base, g | 60 |
| Magnavox battery set, g | 45 |
| Magnavox driver base, g | 35 |
| Majestic 20, 1933, g | 75 |
| Majestic 50, w/stand, g | 120 |
| Majestic Charlie McCarthy, g | 925 |
| Majestic Model 20 cathedral, f | 75 |
| Mark Twain radio, g | 28 |
| Melco battery set, g | 50 |
| Metrodyne battery set, e | 70 |
| Microphone, 1300 Kc, cracked | 70 |
| Military command set 8C-457, g | 45 |
| Military command set BC-457, (2), g | 50 |
| Military command set BC-459, (2), g | 48 |
| Military radio BC-342N, g | 50 |
| Miraco Ultra 5, g | 45 |
| Miratone table, g | 65 |
| Music Master base, g | 50 |
| National power supply, g | 15 |
| National SW-54, g | 30 |
| Norden-Hauck paper advertisement, g | 50 |



This Majestic Charlie McCarthy brought the top price of \$925.

(Continued on following page)

(Estes Auction, continued)

| | |
|--|--------|
| Olson tuner-amplifier, g | 10 |
| Penn battery set, g | 65 |
| Pepsi dispenser radio, g | 100 |
| Philco 14 console, g | 75 |
| Philco 15X, g | 35 |
| Philco 20 cathedral, f | 85 |
| Philco 37 tombstone, g | 40 |
| Philco 37-60 cathedral, g | 80 |
| Philco 37-620 tombstone, g | 55 |
| Philco 38-4, g | 80 |
| Philco 39-116 w/remote, g | 110 |
| Philco 39-45 console, g | 50 |
| Philco 60 cathedral, g | 95 |
| Philco 60 console, g | 55 |
| Philco 70 cathedral, rough | 100 |
| Philco 71 cathedral, g | 125 |
| Philco 90 cathedral, f | 200 |
| Philco 91 cathedral, f | 140 |
| Philco 118 console, g | 70 |
| Philco 141 | 40 |
| Philco 1623 speaker, g | 50 |
| Philco Jr. cathedral, g | 90 |
| Philco Jr. cathedral, works, g | 125 |
| Philco power supply, g | 23 |
| Public 6 transistor radio, g | 8 |
| Puritan 4-B, table, g | 45 |
| Sailing ship radio (not Majestic Melody Cruiser), g .. | 185 |
| Radio News book, g | 5 |
| Radiola 16 w/case, g | 50 |
| Radiola 16, WT, g | 75 |
| Radiola 18, WT, works, g | 85 |
| Radiola 28 w/antenna and speaker, g | 300 |
| Radiola 28 w/o antenna, rough | 70 |
| Radiola base, w/horn, g | 65 |
| Radiola drum speaker, g | 38 |
| Radiola horn speaker, g | 75 |
| Radiola III, g | 75 |
| Radiola III, NT, g | 75 |
| Radiola loop antenna, g | 35 |
| RCA 86-T6, works, g | 70 |
| RCA radio batteries clock advertisement, g | 90 |
| RCA Radiola IIIA, NT, g | 95 |
| Read-Rite tube tester, g | 25 |
| Revere Jr. cathedral, g | 100 |
| RFL 9 in-line battery set, g | 100 |
| Rider Troubleshooters, Vol. 6, 10, g | 25 ea. |
| Rogers 26 tombstone, g | 105 |
| Scott News, (2), g | 13 |
| Selznick battery set, g | 60 |
| Sentinel 7" suitcase TV, g | 50 |
| Signal Corps tube tester, g | 45 |
| Signal Electric Mfg. battery set, g | 35 |



This large tombstone set of Canadian manufacture is a Rogers Model 26.

| | |
|--|---------|
| Spark plug radio, g | 65 |
| Station WSLR 1350 clock, g | 215 |
| Stewart-Warner 300 battery set, g | 38 |
| Stewart-Warner leatherette table, g | 10 |
| Super hom speaker | 90 |
| Thorola horn speaker, g | 75 |
| Toshiba transistor 8, g | 50 |
| Trav-Ler radio, g | 85 |
| Triplet volt-ohmmeter, new | 65 |
| Truetone Western Auto, w/red grille, g | 10 |
| Tube tester, military, g | 160 |
| Tube(s): 26, (12), fil g, g | 15 |
| Tube(s): 205F, (6) used, (2) new, g | 70 |
| Tube(s): 281, ST 45, (11), g | 80 |
| Tube(s): 861, g | 38 |
| Tube(s): Arcturus 71A, blue, fil g, | 20 |
| Tube(s): dud, (30), g | 15 |
| Tube(s): UV199, BB, fil g | 20 |
| Tube(s): UV200, BB, fil g | 20 |
| Tube(s): UV201, fil g | 20 |
| Tube(s): WD11, (2), fil g | 35, 40 |
| Tube(s): WE 300B, (2), used, g | 250 ea. |
| Tuska battery set, g | 85 |
| Utah drum speaker, g | 25 |
| Viking Model 94, g | 25 |
| Wall phone w/o Magneto, g | 65 |
| Westclox transistor radio, g | 20 |
| Westinghouse radio unit, rough | 125 |
| Zenith 5S-29 tombstone, g | 170 |
| Zenith 7S-557 console, g | 80 |
| Zenith 8A-02 console, WT, g | 175 |
| Zenith 12S-568 console, g | 190 |
| Zenith 15U-269 console, w/knobs, WT, g | 600 |
| Zenith Solar radio, g | 85 |
| Zenith tombstone, g | 180 |
| Zenith Trans-Oceanic, brown, g | 175 |



Battery sets and speakers, including the Magnavox set.

(Richard Estes, Seville Antique Auction Barn, 7404 Ryan Rd., Medina, OH 44256)

CLUB SPOTLIGHT

Arizona Antique Radio Club AARC

The Arizona Antique Radio Club (AARC) got its start when George H. Fathauer and Ed Sharpe, who had each been talking to collectors about starting a club, brought their groups together in Phoenix on March 8, 1983. George Fathauer had just created the company which later became Antique Electronic Supply. Ed Sharpe had become interested in radio through one of radio collecting's first authors, Morgan McMahon (*Flick of the Switch*), with whom he had grown up as a neighbor in Rolling Hills, California. Thirty members enrolled in AARC that day; of the thirty, twelve remain members today.

AARC now has over 150 members. The club's purpose is primarily for the association and mutual assistance of radio devotees and collectors in Arizona. However, it is open to all persons interested in radio and television history, preservation, restoration and collecting.

Most members reside in the Phoenix area. Others are from Tucson and smaller Arizona communities, as well as neighboring states. Since most Arizona residents moved to the state after cleaning out basements and attics while still "back East," radio collectors have had to rely on each other more than usual to find material to develop their collections.

AARC publishes the *Arizona Antique Radio Club News*, a 40-page well-illustrated quarterly. For 12 years, this publication has been entertaining and informing readers with articles of historical, technical, stylistic and collecting interest. The quarterly also offers stories based on the past experiences of several members who had careers in radio, the military, and related communications fields. Club announcements, meeting reviews and free classified ads may also be found in this publication.

Due to the legendary summer heat in the Southwest, club activities take place between October and May. Many winter-only residents of Arizona can thus join two radio clubs and enjoy the peak seasons of both.

The club meetings usually feature a visit to a member's collection or a program on restoration or other topics of interest. The annual Arizona Radio Roundup brings together a large number of radios on a specific theme. The theme for the first Great Arizona Radio Roundup held in January of 1995 — multi-purpose radios — brought out a wide variety of sets, from an Air King Sky-scraper to a unique display of 1950s Motorola clock radios.

The first club swap meet was held in May of 1983 when the temperature was a record 112 degrees. Since then, the club has wisely held its two swap meets in the cooler months of November and March. The November meet, held annually at Antique Electronic Supply in Tempe, includes an auction.

Several AARC members have written well-known books on antique radio and collection. A few members with large world-class collections have been very generous in making their collections available to the club for meeting sites and displays.

Arizona Antique Radio Club AARC

Dues: \$18.00 per year (\$20 for families)

Publication: *Arizona Antique Radio Club News*, published quarterly

Membership year: Jan. 1 to Dec. 31

Officers:

President: Dennis Craft

Vice-President: Steve Smith

Secretary: Michael Ging

Treasurer: Debbie Krol

Editor: Bill Lettow

For membership information:

Arizona Antique Radio Club

2025 E. LaJolla Dr.,

Tempe, AZ 85282-5910



Arizona Antique Radio Club News



BOOK REVIEW

Radios by Hallicrafters, By Chuck Dachis

REVIEWED BY RAY BINTLIFF, K1YDG

If you have heard of Hallicrafters, then you must know of Chuck Dachis, "The Hallicrafter Collector." As a collector, Dachis began concentrating on Hallicrafters equipment in 1974, and he is widely known as an authority on the Hallicrafters Company and its products. *Radios by Hallicrafters* is truly an authoritative work.

WHAT IS COVERED?

As you might expect, the line of Hallicrafters communications receivers and ham gear is well documented. But also covered are Hallicrafters products as diverse as Citizen's Band (CB) transceivers, low-end Short Wave Listening (SWL) receivers, consumer electronics, military radios, TV sets and knock-offs of the Zenith Trans-Oceanic-style radios.

One chapter is devoted to the H and Z series of Silver-Marshall radios from 1933 and 1934. The Hallicrafters and Silver-Marshall relationship has been described in other publications, but Dachis reminds us of this connection. Another chapter dealing with radio restoration offers a number of basic, very practical guidelines for restoring old radios.

Logically, the book begins with a short chapter devoted to the history of Hallicrafters and containing some interesting old photographs of buildings, products and personnel. Various versions of the Hallicrafters logo are also illustrated. A price guide is included in the book's index.

THE SKY BUDDY AND ITS OFFSPRING

It is amazing just how many hams and SWLs remember the Sky Buddy as their first commercially-built radio. A separate chapter is devoted to this series of affordable beginner's radios. The original Model 5-T Sky Buddy is illustrated and described along with the follow-up models — the S-19 and the S-19R.

Although not known as a Sky Buddy, the S-38 can trace its lineage to the Sky Buddy line. The

various versions of the S-38 along with the Model S-120 are described in detail. Also included is the late and unlamented S-119, the Sky Buddy II. This chapter of the book is written at a level that will be comfortable for the novice collector.

THE S AND SX SERIES

Many readers will find the "real meat" in this chapter of the book. Starting with the Model S-1 Skyrider dating from 1933, the book illustrates and describes the S and SX series radios up to the Model S-240 of 1967. The chapter ends with a photograph and description of a mock-up of a concept radio designated a Model SX-1000A.

With a few exceptions, the material in this chapter is presented in model number and chronological order. The quality of the illustrations is outstanding. Remarkably, most of the radios shown are from Dachis' collection. Photographs of radios from other collections are credited.

The descriptions are detailed and informative. For example, we learn that the Model S-1 was a TRF regenerative set that tuned from 1.5 MHz to 22 MHz. Coverage of the broadcast band began with the Model S-5, a super-het. The descriptions

follow a similar format and include the model number, name (when one was given), the period of production, and original list price. The descriptions are augmented by sidebars that alert the readers to schematic errors and differences in production runs.

So read the book and drool over the offerings from Hallicrafters, especially those early beauties. For those readers who lust for the high-end stuff, the DD-1 dual diversity receiver is covered in great detail.

TRANSMITTERS AND TRANSCEIVERS

The coverage of these products spans the period from 1937 to 1977, and includes an impressive array of exciters, transmitters and trans-

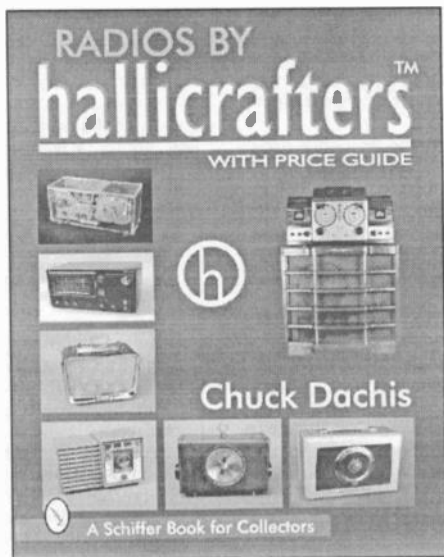

ceivers. Some features found in the early models are unique. For example, the Model HT-1 covered the 40-, 20- and 10-meter ham bands and automatically switched antenna connectors when a band change was made. Not bad for 1937! Some transmitters were real heavyweights — the Model HT-4 weighed in at 390 pounds. The book contains a great deal of interesting information on these old rigs.

ACCESSORIES

Like the other major manufacturers of ham gear, Hallicrafters produced a wide range of accessories — keyers, VFOs, antenna tuners, external S-meters, speakers, etc. These units are also well documented with a separate chapter devoted to speakers. The coverage of Hallicrafters speakers should be especially useful to collectors, since this is a relatively undocumented area of radio collecting.

CITIZENS BAND

Perhaps of limited interest is Citizens Band equipment. However, the book does not overlook Hallicrafters production of this equipment during the period from 1959 to 1967. Did you know that Hallicrafters built CB radios for Sears?

TEST EQUIPMENT

Another unknown, or possibly just forgotten fact is that Hallicrafters sold test equipment in wired or kit form during the mid-1960s. The equipment resembled Heathkit products and included such items as an RC bridge, a decade box, an oscilloscope, and a VTVM. These and other items are documented in this book.

CONSUMER ELECTRONICS

Hallicrafters also produced radios for the consumer market. These radios and radio-phonographs ranged from small clock radios and portables to large consoles. Hallicrafters' answer to the Zenith Trans-Oceanic radios was its Worldwide portable. The color photographs of the Worldwide models, beautifully reproduced in this book, should be of interest to the collector of portable radios. Other colorful table radios are also illustrated.

TELEVISION

Like many other manufacturers, Hallicrafters joined the TV manufacturing frenzy of the late 1940s and produced TV sets until 1956. The book's coverage of TV sets begins with a 7-inch set — Model T-54 — and a 16" x 22" rear projection set, both from 1947. The T-54 was sold under a number of brand names, including Sears and Montgomery Ward. The photographs and descriptions of other TV sets span a total of nineteen pages.

MISCELLANEOUS UNITS

The equipment shown under the title "Miscellaneous Units of Various Models Series" is a curious mixture that includes a hi-fi amplifier, some garden variety radios with and without clocks, military radios, aircraft gear and, surprisingly enough, a nifty looking 1936 Model H8PA called the "Sky Master." Coverage of some hand-held transceivers, some home entertainment sets and a collec-

tion of specialty devices round out this chapter.

Another chapter covers miscellaneous ham gear, consisting of paired receivers and transmitters such as the S-53 and HT-17 from 1948.

For nostalgia buffs, the book contains some excellent color photographs of employee incentives (remember tie clips?), promotional items, signs and dealer displays. There are also black and white reproductions of advertisements, catalog covers and related ephemera.

INDEX AND PRICE GUIDE

The scope of *Radios by Hallicrafters* is impressive. If Hallicrafters ever built the equipment, it is most likely covered in this book. Because the chapters are arranged by model series, all communications receivers, for example, are not to be found in a single chapter. But no problem — the index is arranged in model number order and the page number of a particular piece of gear can be found with ease.

The index also contains an estimated range of values for most models. It is understandable that it is not possible to determine the value of equipment that is seldom sold or is extremely rare. Also a range of values for a particular model seems more practical than a single figure. Dachis explains his rationale and ground rules for his value system, and his approach seems reasonable.

OVERVIEW

The production quality of the book is excellent. A publisher's note reads: "During production, this wonderful book grew well beyond its original scope with information and photographs. Because of this, combined with the tremendous increase in paper prices and increased cost of color printing, the publisher has printed many photographs in black and white instead of color as originally planned."

Even so, more than 60 pages appear in color. And the quality of the black and white illustrations are of such high quality that color is hardly missed. Besides, with so much black crackle paint you needs color?

Some typos and misspellings appear. The most glaring errors appear in the "List of Technical Abbreviations" box in the preface. But these minor flaws are insignificant when the book is viewed as a whole.

Reviewers will frequently describe a book as a "must" and the term may be over used, but in this case, *Radios by Hallicrafters* easily falls into the "must buy" category. It is a trip down memory lane, a buyer's guide, and an introduction to radio restoration all wrapped up in one impressive book. It reflects the more than twenty years of effort that Chuck Dachis has invested in gathering data about Hallicrafters.

Radios by Hallicrafters is published by Schiffer Publishing Limited, 77 Lower Valley Road, Atglen, PA 19310. Priced at \$29.95, this softbound book is printed in an 8½" x 11" format and contains 224 pages. Copies may be ordered from the publisher, A.R.C., and other A.R.C. advertisers. Be sure to check with the suppliers for ordering and shipping information.

(Ray Bintliff, 2 Powder Horn Ln., Acton, MA 01720)



RADIO MISCELLANEA

"Antique Radio Classified" invites its readers to contribute letters and information for inclusion in "Radio Miscellanea" and elsewhere in the magazine. The topic should be of general interest and sent to A.R.C., P.O. Box 2, Carlisle, MA 01741. All material submitted should be verified for accuracy and may be edited for publication, which is not guaranteed. See the masthead for more details.

April Cover — N.Y. Governor

Dear Editor:

Being an amateur historian, as well as an avid collector of antique radios, I was delighted with your April cover photo, which included not only a marvelous radio, but also an unidentified great American, whom I instantly recognized. This distinguished gentleman, shown with his wife, but without his trademark brown derby hat, once served the people of New York as an assemblyman, sheriff of New York City, and 4-term governor.

No stranger to radio, he was often heard addressing his constituents over the new medium by prefacing his comments with, "Ladies and gentlemen of the *raahdio* audience..." (speaking with his characteristic Lower East Side accent). The "Happy Warrior" (as FDR called him) was even nominated by the Democrats in 1928 as their candidate for President. Although unsuccessful, he remained a beloved figure in American politics for many years thereafter. Oh yes, his name — Alfred E. Smith.

Mark Cowart, Jacksonville, FL

Thanks also to George Barnes, Framingham, Ma., David Carson, Long Lake, N.Y., and Sydney Thomas, Stillwater, N.Y., for making this same identification. (Editor)

Deluxe Midget Radio — Two IDs

Dear Editor:

I noticed a familiar radio in the *Photo Review* section, September 1995, p. 12. Readers should check A.R.C., August 1991, p. 20, for a full page on the Deluxe Manufacturing Co. I obtained my Deluxe Model 45 in 1990. Found at an estate sale for \$10, it had been sold in places like Walgreens for around \$9.95. The name "Elenor Plath" is punched into the wooden back with a sharp tool. It was basically a cheap radio — the cheapest capacitors that they could get (Ariston) were used. They have all been replaced.

The cabinet, which was in very poor shape, has been repaired with 5 coats of hand-rubbed tung oil. The line cord is a special resistance cord (heater cord) often used on small table radios of this vintage. It is warm to the touch. These cords are no longer available and must be treated with care. Do not pull the plug out of the wall by the cord!

All the carbon resistors had changed in value and have been replaced. The Types 12Z3, 6C6, and 6D6 tubes checked OK, but the Type 43 tube was shorted and was replaced. The missing antenna (30 feet of flexible wire to be laid on the floor) was replaced.

Harold Isenring, Colgate, WI

Dear Editor:

The Deluxe Model Unknown, shown on page 12 in the *Photo Review* section of the September 1995 A.R.C., is a Model TC-30, manufactured by Transformer Corporation of America, ca. 1934. I have an identical set, and glued to the bottom of the cabinet is a schematic provided by the manufacturer — same as the one in Rider's 5-6.

Floyd A. Mills, Madison, GA

Nipper Returns to Baltimore

Dear Editor:

The April *Photo Review* shows a large Nipper and phonograph sitting in Merrifield, Va. This is outdated news. Since I was born and raised in Baltimore, I am very familiar with the latest Nipper story.

In the early 1950s, D & H Distributors (RCA) installed this large logo on a platform atop its building on Russell St., two blocks south of Oriole Baseball Park at Camden Yards. It sat there until 1976 when D & H relocated.

A fellow I know named Jim Wells purchased the logo for \$1 and had it moved to his front yard (not a "playground") on Lee Highway in Merrifield. Jim was a collector of automatic musical machines of all kinds, antique cars, circus equipment, and a train! About a year and a half ago, he auctioned off about 95 percent of this stuff but kept Nipper. Now in his eighties, he finally decided to move to Florida, and he put Nipper up for grabs.

The city of Baltimore always regretted the fact that Nipper had been moved and somehow raised the \$25,000 Jim wanted for it. Nipper was returned to Baltimore and was pictured in the *Baltimore Sun* going down Howard St. in a parade. It now belongs to the Baltimore City Life Museum, which will find a suitable place for it. A good guess is that it might be returned to the top of the old D & H building.

Barry Cheslock, Arlington, VA

Just in from William Schultz, Fairfield, Pa. — a Maryland newspaper article which says that the 1,700-pound fiberglass Nipper will sit atop the museum's 4-story exhibition center. On the fourth floor itself is "Nipper's Neighborhood" where children can play at living in an atmosphere of bygone decades. As William says, "You can't keep a good dog down!" (Editor)

A.R.C. Invaluable in Alaska

Dear Editor:

I work at a site near the end of Alaska's Aleutian Islands, and mail is hit or miss, mostly just late. Although your magazine rarely will arrive before three weeks of any given month have passed, I find it invaluable. Thanks and keep up the great effort.

Fred Ringwald, Sheyma, AK

More on KDKA

Dear Editor:

I appreciated the article on KDKA (February 1996). I was born and raised within 3-4 miles of the tower, which was quite impressive. It's been some time, but I thought it was designed and built with an unusual feature — the tower was positioned on top of a glass ball.

W.F. Horn, Bealeton, VA



CLASSIFIED ADVERTISEMENTS



WANTED: American Bosch Model 505; perfect glass dial for restoration. Will consider chassis or complete radio. Clyde Watson, 8311 Via de Sereno, Scottsdale, AZ 85258. (602) 948-6466

WANTED: Atwater Kent Models 137, 155, 246, 356, 708, 755, 825, 854. Dennis Craft, 10513 E. Clinton, Scottsdale, AZ 85259. (602) 860-8951, after 5 pm MST

WANTED: Juvenile books Ocean Wireless Boys and the Lost Loner and Radio Pals Marooned. Robert Stapleford, 1800 S.W. Randolph Ave., Topeka, KS 66604

WANTED: Wooden cabinet for UST Clearsonic Series Radio Model 2L-2001 or maybe 7L-2001 (can't quite make out the first number or letter), made by United States Television Mfg. Corp., New York, New York. John Phipps, 1412 Navaho Trl., St. Charles, MO 63304

WANTED: Cabinet and dial knobs for a Hallicrafters SX100 or SX99 or SX96. Will consider a junk radio for these parts. H.I. Stark, K9UBL, 3215 S. Meridian St., Indianapolis, IN 46217. (317) 788-1210

WANTED: Japanese transistors, pocket or coat-pocket size, need not work. Call or write: Bob Davidson, 310 Main St., Concord, MA 01742. (508) 369-2007

WANTED: Book titled Elements of Radio Servicing by Marcus & Levy. Ron L. Stollings, PO Box 331, Eldon, MO 65026-0331. (573) 392-3924, evenings

WANTED: General Electric World Monitor BC/SW receiver. Giles Crabtree, Box 110, Lewisburg, PA 17837. (717) 523-6551

WANTED: Genuine wood/metal horn, motor board (top wooden case), and reproducer for Victor III talking machine. Ryo Kobayashi, 2-4-6, Miyanodal, Sakura, Chiba, 285 Japan. Tel/fax: 81-43-461-2297

WANTED: Eveready radios, speakers, old flashlights, flashlight catalogs, related items. Subscribe Flashlight Newsletter - \$12 year. Bill Utley, PO Box 4095, Tustin, CA 92681. (714) 730-1252

WANTED: Any info on early wireless-sets builder using single-wing Audion regen. circuit during 1910-1912 period: Paul E. Wallace, boss of the Wallace & Co., located 59 5th Ave., New York City. Looking for: pictures, circuitry diagrams, books, articles, catalogs of Wallace products. Also buying: RJ4-type porcelain rheostats, Murdock var. condensers, types: 360, 366, 367, 368, pre-1920 detectors (zincite, bornite, carborundum) and loose couplers, switch-lever knobs, pointer knobs w/center hole-fitting. Please no junk-stuff. Offers. Call/write anytime to: Guy Kueng, PO Box 8, CH-1211, Geneva-28, Switzerland. Ph./Fax: 01-41-22-796-5848

WANTED: Good Paragon audio transformers. Will pay \$50 ea. Need two for DA-2. Ernie Hite, 2625 Colecreek Ln., Rock Hill, SC 29732. (803) 366-9998

WANTED: Philco 89 cathedral chassis, speaker, and escutcheon. Thanks! Mark S. Cowart, N4FBL, PO Box 550766, Jacksonville, FL 32255-0766. (904) 724-1364

WANTED: Philco 46-1209 chassis. Will consider purchasing entire set if needed. Will pay top dollar and shipping. Scott Starr, 2845 Page Pl., Montgomery, AL 36116. (334) 281-0960

WANTED: Loctals, 14C5, 7C5, 7Y4, 7A7, 7B6, 7B8 and others. Fred Cranshaw, 1624 Bitter Ck., Garland, TX 75040. (214) 494-4917

WANTED: Clock for Philco Model 70 grandfather radio. Guido Montella, 2714 Charleston Dr., Plant City, FL 33565. (813) 752-7174

.....
● **A.R.C. Advertising Policy** ●
● **Sellers and Buyers, Please Note!** ●
● Advertising is accepted only for early items ●
● related to radio, communication, etc. All ●
● items must be described fairly; reproduc- ●
● tions, reprints and not-original items must be ●
● so identified. Advertisers must agree to re- ●
● spond promptly to inquiries and orders, to ●
● resolve problems promptly if the buyer is not ●
● satisfied, and to comply with a buyer's ●
● refund request on unaltered returned items. ●
●

WANTED: Late 1940's plywood radios. Ultradyne #L-43, Tele-Tone #117, Val-keen #572 (see Bunis 3). Pay up to \$100 in very good condition. Also want Radio Nurse plastic speakers, and Stephans speaker cabinet. Steven Cabella, 500 Red Hill Ave., San Anselmo, CA 94960. (415) 461-6810

WANTED: Original tube-type CB radio operating/owners manuals & CB call books, old tube-type CB radios. Warren Belles, 1421 E. Royal Palm Rd., Phoenix, AZ 85020. (602) 943-4135

WANTED: Suggested circuits and parts to build small electrostatic display TV from late 1940's. Dave Dameron, KG6BP, 819 Boundary Pl., Manhattan Beach, CA 90266-6621. (310) 318-5311

WANTED: Squires Sanders SS-1R, SS-1V, SS-1T; Coliins 55G-1, 55S-1, 62S-1, 75S-3C, 32S-3A, 75A-4, KWM-1, Millen 90673, Miller AT2500, Hickok 539C, 580 700. Hank Kolesnik, WD5JFR, 4161 Oak Rd., Tulsa, OK 74105. (800) 364-4265

WANTED: A couple of Big Box Model 20 Atwater Kent radios, any condition as long as complete. Please quote price. Paul Thompson, 315 Larkspur Dr., Santa Maria, CA 93455. (805) 934-2778

WANTED: RCA Broadcast News from '30s-'50s, duplicates to trade. Also want: Western Electric magazines, Pickups and Oscillator and broadcast equipment catalogs and transmitter brochures of '30s-'50s. Sam Thompson, W6HDU, 1031 San Antonio Ave., Alameda, CA 94501. (510) 521-1429

WANTED: 8" x 12" speakers with green cones, gold frames. Crosley hi-fi phono, El Dorado TV. John May, 205 Wren, Scotia, NY 12302. (518) 377-9522

FOR SALE: Yaesu SP901P speaker, phone patch, excellent condition - \$100 OBO. Jim Shoemaker, RR#1, Box 118A, Prescott, KS 66767. (913) 471-4644

FOR SALE: Kadette Topper, Coronado 43-8190, cabinets broken - \$60 ea. **WANTED:** Silvertone 4763 escutcheon & pointer. Tim Dugan, 415 N. White Oak, Marshfield, MO 65706. (417) 859-5710, 5-9 pm

FOR SALE: Arvin Model 444, white, good condition, looks like it may have been repainted - \$40 plus shipping. Jim Montague, 1907 South Stanley Ln., Spokane, WA 99212. (509) 535-9576

FOR SALE: Four Command transmitters, 4.0 to 9.3, nice - \$30-\$50. GE S22 - \$175. G. Stevens, PO Box 704, Longmont, CO 80502-0704. (303) 776-9036. E-mail: syww90a@prodigy.com

FOR SALE: Heathkit Seneca transmitter VHF-1, never used, brand new and looks it - \$200 + shipping. Fred Hegel, 1901 Frank Pl., South Daytona, FL 32119. (904) 760-7632

FOR SALE: Zenith Golden Triangle - \$100. Zenith console 6R087 - \$90. John Golden, 245 DiMarco Dr., Philadelphia, PA 19154. (215) 632-0955

FOR SALE: BC-348Q - \$150. Eddystone Model 940 - \$300. TCS-14 xmtr & rec. - \$300. Heathkit HW-12 & PS-23 - \$75. Heathkit SB-301 & SB-401 \$200. OBO. Manuals for all, shipping extra. Kenneth Hunt, 872 Sudden Valley, Bellingham, WA 98226-4824

FOR SALE: Moving. List, LSASE. MRL 2-stage xtal set - \$50. Enlarged Radiola III diagram with all values - \$3. David P. Smith, Box 81, Olney, IL 62450. (618) 392-6601

FOR SALE: Send large SASE for list of over (100) reasonably priced old radio books. Don Johnston, 3621 East/700 North, Windfall, IN 46076-9344. (317) 945-7735

FOR SALE: Western Electric: (1) 713C horn driver, mint - \$2,750; (1) KS-12025 horn, mint - \$1,500; TA-7381A line preamp, exc - \$2,800/pair. Harald Gruber, Oeder Weg 48, 60318 Frankfurt/Main, Germany. Voice/fax: 0049-69-5969649

FOR SALE: RCP Flyback transformer tester, Simpson TV Field Strength Meter, Mod 80 (standard) signal generator, Hickock Mod 288X sig. gen., Millen grid dip meter (4 coils), General Radio output power meter 583A, 100-160MHz field strength meter, General Radio Wavemeter 55-400 MHz, Sel Son CRT substituter, Supreme Publications Most Often Needed TV Servicing Info, 1949 thru 1959, 14 volumes. Contact me for prices. **WANTED:** 45 rpm RCA record player. Bob Brandt, 571 N. Wisconsin St., Porterville, CA 93257. (209) 784-8685

FOR SALE: Freshman Masterpiece, 1924, (Douglas, p. 24), poor cabinet - \$50. Grebe MU-1, vg, but no cabinet - \$150. Zeniths: K725, black - \$40; K725, green - \$40; H511 - \$40. Philco 60 cathedral, poor cabinet - \$50. RCA 66BX Globetrotter - \$40. Supreme Model 567, great display, mint - \$45. Grommes Little Jewel amp - \$55. Nice Wagner-Nichol's home record cutter/player, plus blanks, microphone, and multi-color store display - \$55. 1956 Edmund Scientific Wilmhurst Electrostatic machine - \$40. VE-PO-AD hand-held mechanical pocket calculator - Offer. Jim Watson, PO Box 41, Coarsegold, CA 93614. Phone/Fax: (209) 683-7260

FOR SALE: Rare radio tubes from 1910s thru mid 1920s. Early wireless equipment such as triple, couple detectors. Various detectors. Large DeForest tuning condenser, spark coils and gaps. Morse register? brass with beveled glass, and etc. Will sell for Best Offer per item. SASE for illustrated list. Herman Fothe, 5292 Tiffany Ann, West Palm Beach, FL 33417. (407) 688-2794

RADIO AUCTION

Saturday, May 11, 1996

Auction: 10 A.M. — Preview: 9 A.M.

Estes Auctions will conduct its yearly odds and ends radio sale at
The Seville Antique Auction Barn, 8240 Wooster Pike Rd., Medina, Ohio 44256.

This will be a sale of all types of radios, parts, tubes, ham gear, military, novelty, transistor, test equipment, books, magazines, speakers, headphones. You won't need a big bank roll for this one, but you will have fun and just might find the elusive treasure you've been seeking.

**To consign or for information,
call, fax or write:**

Estes Auctions
Phones: (330) 769-4992, or
(330) 769-3987

Fax: (330) 769-4116
7404 Ryan Rd., Medina, OH 44256



ESTES AUCTIONS
Service That Sells

We look forward to seeing you at the summer meets. Richard Estes, Auctioneer

WANTED: IF coils, top tuned dual padder, 260 Kc & 455 Kc. Fred Cranshaw, 1624 Bitter Ck., Garland, TX 75040. (214) 494-4917

WANTED: Zenith automatic tuning unit for Chassis 5907 in Models 9S307, 9S324, 9S344, 9S367, 9S369. Also Zenith speaker for Model 12U158 console. Jim Agostino, 827 Holly Pl., West Covina, CA 91790. (818) 960-7123

WANTED: For cash or trade, 1950's semiconductor components, especially transistors. Send for wants list. Andrew Wylie, 21 Brancaster Ln., Purley, Surrey, CR8 1HJ, England

WANTED: UTC S14, S15 transformer, many U.S.A. made transformer but old only. Kouji Matsuo, 6-2, Tsurumi-cho, Beppu-shi, Oita, 874, Japan. Fax: 81-977-23-9579

WANTED: Finials (3) for Philco #80 Colonial clock radio. Frank Connors, 16 Windsong, Bedford, NH 03110. (603) 472-9772

WANTED: Phonograph-related items: Top dollar paid immediately for Vogue picture records, Edison, Columbia, and any wax cylinder records, toy phonographs, needle tins and cutters, Nipper, record dusters, puzzles, fans, calendars, pocket advertising mirrors, dealer lapel pins, phonograph toys, posters, broadsides, original dealer advertising items from Edison, Victor and Columbia. Thanks. Bernie Seiberg, 714 Moredon Rd., Meadowbrook, PA 19046-1907. (215) 886-6124

WANTED: Grundig 4192 table radio, working or not. Ed Kalpa, 4622 Melbourne Ave., Los Angeles, CA 90027. (213) 661-1221

WANTED: Presto 85E amplifier, Western Electric 394/47A microphones, RCA 4AP1 (4A type) microphones, and other 1930's recording equipment. Trent Ruane, 111 N. Grant, #1, San Mateo, CA 94401-1953. (415) 340-8371

WANTED: Top \$ paid for early European wireless apparatus. Try me! Francois J. Humery, 16, Hameau des Marronniers, F-77185 Lognes, France. Phone: 00-33160052836. Fax: 00-33160843700

WANTED: Info on RCA's Radiomarine HF Communications Coast Stations. Also, RCA, McKay marine HF equip. Jim Krajovic, 546 Sheridan Ave., Pittsburgh, PA 15206

WANTED: Top prices paid for scarcer pre-1926 items. Horn speakers, crystal sets, detectors, tubes, wireless, battery sets, or what have you? Ed Bell, 5311 Wooddale Rd., Raleigh, NC 27606. Fax/phone: (919) 851-1517

WANTED: First transistor radios at any company like Regency TR-1, GE 678, Philco T-7, etc; Japanese-made tube portable radios, like Koyo, Crown, Excel, Grobal, etc; anything V-1, V-2 and Von Braun related. Takashi Doi, 1-21-4, Minamidai, Seyaku, Yokohama, Japan. Fax: 011-8145-301-8069

WANTED: Type UX171A. John Butrovich, PO Box 660, Orange Grove, TX 78372

WANTED: Meter historian searching for Instruments, The Instrument Maker, and other meter magazines from 1940s. Chris Cross, Box 94, McConnell, IL 61050

WANTED: Heathkit GR-78 SWL receiver in clean, working condition (or kit). Hal Knight, KA9JDG, 7 South Deer Park Dr., Dorsey, IL 62021. (618) 585-4486

ORDER TODAY!

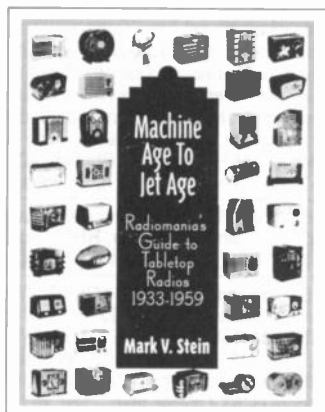

**OVER 250 PAGES
1,400 RADIOS**

Most not in any other reference
**EACH RADIO INDIVIDUALLY PICTURED,
IDENTIFIED AND VALUED**

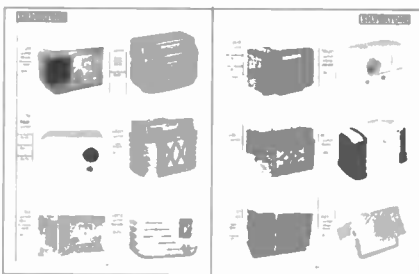

Special For
ARC Reader!

~~\$24.95~~ List Price
Now \$21.95!

Only When Purchased From Radiomania Directly
All ARC Orders Autographed by Author

Add \$1.75 Shipping U.S.A., \$3.50 Canada, \$5.00 All Other Countries

Send Check or Money Order Payable to:

Radiomania
2109 Carterdale Road, Baltimore, MD 21209

Maryland Residents add 5% Sales Tax. Allow 2-4 Weeks for domestic orders.



Radiomania™

FOR SALE: Compactron adapters, set of (2) adapters which allow 9-pin and 12-pin Compactron sweep tubes to be tested on TV-7 type tube testers. These lists popular tubes such as 6JB6, 6JE6, 6JF6, 6JM6, 6JS6, 6JU6, 6JZ6 6KD6, 6KM6, 6KN6, 6LB6, 6LF6, 6LQ6, 6LR6, 6LX6, 6ME6, 6MJ6, 12BJ6, 20LF6, 21JS6, 23JS6, 24JE6, 27LF6, 30KD6, 40KD6, 8950, 7868 be tested on TV-7 testers which do not have Compactron sockets. Tube test setup and test data are supplied for the TV-7 tester series only. This includes switch settings and bias values as well as minimum and as new test values. (2) adapters as well as tube test information and pin-out conversion data are supplied. Please send \$25 to: Daniel Nelson, 1025 E. Desert Ln., Phoenix, AZ 85040. (602) 243-7421, evenings. E-mail: djn@indirect.com

FOR SALE: Yaesu FRG7700 HF receiver, new condition - \$450 OBO. Jim Shoemaker, RR#1, Box 118A, Prescott, KS 66767. (913) 471-4644

FOR SALE: Simpson 260 VOM - \$50. HP1741A 100 MHz dual-trace storage scope - \$375. Heathkit, with manuals: IB-5281 RCL bridge - \$42; IM-5248 IM distortion analyzer/ACVM - \$58; IM-4100 50 MHz frequency counter - \$50. Millen 90651 grid dipper, 1.7-30 MHz, vg - \$98. Sencore LC53 Z meter, as-is - \$88. Much more, list SASE. Kirk Ellis, KK4YP, 203 Edgebrook Dr., Pikeville, NC 27863. (919) 242-6000, evenings

FOR SALE: Beautifully engraved, illustrated Marconi Wireless 1910's stock certificates, great for framing!, only - \$25. Ken Prag, PO Box 14817, San Francisco, CA 94114. (415) 566-6400

FOR SALE: Used tested tubes: X201A - \$10; 227 - \$7; 226 - \$9; 224 - \$7; 280 - \$22; 6L6G - \$9; p6V6GT - \$5. Many more, send LSASE for list. Dean Toombs, 5001 E. Fanfol Dr., Scottsdale, AZ 85253. (602) 483-2970

FOR SALE: Abbotwares horse & rider in excellent original condition. SASE. Neil O'Donnell, 1809 Sampson St., Butte, MT 59701. (406) 491-1809

URGENT

A Collector Is Looking For

WESTERN ELECTRIC

Horn: 23A / 15A / 16A / 22A

Driver: 550 / 555W / 594E / 596EF / 15942

Amp: 120 / 124 / 8182 / 1086

Amp: 41 / 42 / 46 / 46C / 48

Woofer: 4194 / 4191 / 4181 / 4151A / 5153 / 41942

Speaker: 753 / 757A

...and Other Western Electric Items

Also Looking For Heavy Quality Range Finder Cameras; Leica, Canon, Nikon, Zeiss.

The Best Price To Be Paid

For Details, Call (212) 921-2862

Or Send List Of Items & Prices;

Fax (212) 997-5404

*Ask For Sam Huh

FOR SALE: Sams dial cord drives DC1 - \$15; DC2, DC3, DC4, DC5, DC6 and DC8 - \$10 ea. J.J. Papovich, 53 Magnolia Ave., Pitman, NJ 08071

FOR SALE: Over (5,000) tubes, many N.I.B. Tony Jones, 3728 Baxter Ave., Nashville, TN 37216. (615) 227-8136

FOR SALE: 1996 is clean-out time. Listed and unlisted items. LSASE for details. Old collectors tubes, light bulbs, old 1930 up test eqpt., amps, radio parts N.O.S., old orig. boxes, old books, catalogs. Want to clean out dual garage, attic, house, basement. All pickups cash and carry, phone first. Radios, tuners, plus more. Selling all unwanted items. F. Krantz, 100 Osage Ave., Somerdale, NJ 08083-1136. (609) 783-0400, 10 am to 8 pm EST

FOR SALE: Radios, 30's thru 50's, SASE for list. Sam Giansante, 4255 West Ave. Rd., Elba, NY 14058

FOR SALE: Met.-Vic. Cosmos 5-tube VS6 oak Jacobean lowboy, rare - \$2,800. Brit. Navy B11 receiver, 1930, 5-tube, plug-in coils, h/book - \$580 plus UPS. (3) WWII German naval flags, trade for Colonial Globe, Walton, rare Catalins. Jim Taylor, G4ERU, No.5, Luther Rd., Winton, Bournemouth, BH9 1LH, United Kingdom. Tel./Fax: 01202-510400

FOR SALE/TRADE: Kadette Clockette, Blue Glass bottom cracked through. WANTED: New Kadette (silver, wood, F.O.S., p. 100) or other interesting Kadette. Nevins Museum of Radio, Ken Nevins, 406 Jopson St., Blissfield, MI 49228. (517) 486-3019, evenings please

FOR SALE: Dynaco ST 400 - \$275. Fada bullet and Belmont repros - \$40 ea. Franklin LaBarbara, 13 Lauriston St., Providence, RI 02906. (401) 751-1215

FOR SALE: Newly acquired! (45) early transistor & novelty radios - \$5-\$25 ea. Guild phone radio - \$65. Motorola Tandem, Hallicrafters Skyrider DDD-1, mint - \$600. Clock radio 5105 - \$30. AM/FM & 5-band CR-44 - \$70. GE red Catalin L-516, mint - \$1,200. Zenith Flashmatic flashlite, N.I.B. - \$45. Ancient Motorola car radio, complete - \$55. Jeff VanAssche, 103 West Silvermeadow, Midwest City, OK 73110. (405) 732-5747

FOR SALE: A number of Midwest chassis 16 and 18 tubes set, National S3, Radiola Model 20, Atwater Kent battery set. Joseph Harter, Box 274, Bloomfield, NY 14469. (716) 657-5396

FOR SALE/TRADE: Scientific instruments: Early!! Eliott, Faraday, Crookes, Firth. Sell/trade for telegraph keys. SASE for list. Thomas Perera, K2DCY, 11 Squire Hill Rd., North Caldwell, NJ 07006

TUBES BOUGHT & SOLD

**Industrial • Power • Receiving
Special Purpose • CRT's**

— Vast Inventory —

Contact: Donna - Sales Mgr.

(201) 751-2591 / (800) 526-1275

Fax → (201) 481-1524

United Electronics Co. Est. 1935

**Tube Manufacturing Equipment For Sale
Assorted Tube Bases For Sale**

WANTED: Zenith Trans-Oceanics, need parts for 7000 and 3000 and 3000-1, doors, cabinets, battery boxes and so on. Jim Montague, 1907 South Stanley Ln., Spokane, WA 99212. (509) 535-9576

WANTED: Crosley 59 chassis for 124 Oracle grandfather clockradio. Barry Kasindorf, 1 Heights Rd., Franklin, MA 02038. (508) 528-0026. E-mail: bkasindorf@bix.com

WANTED: Schematic for Precision/PACO B-12 regulated power supply or clone. FOR TRADE: Zenith sailboat 6G601L, front cover missing, for (4) UX-201-A's, balloon. U ship. Mark A. Anderson, RD#1, Box 58A, Greenwich, NY 12834. (518) 692-2593

WANTED: Highest prices paid for Western Electric tubes new or used. Also wanted 2A3, 10, 45, 50, KT-66, KT-88, 6550 (ST) and Altec equipment. Singerhouse Sound, PO Box 268, New Richmond, WI 54017. Phone/fax: (715) 246-3899

WANTED: 6-meter solid-state mobile transceiver, SSB or FM. Tad Drogoski, N3JZQ, 507 Coal Valley Rd., Jefferson Boro, PA 15025-3703. (412) 466-5950

WANTED: Round tube shields ST size. Edmund DeCann, Box 543, Osakis, MN 56360. (320) 859-4282

WANTED: TV horiz. sweep glow-bar varistor. Workman Type FRT2. Weber, 4845 W. 107th St., Oak Lawn, IL 60453-5252

WANTED: DeForest interpanel receiver, grid leak/capacitor unit for Unit MP-100. John B. Drew, 28 Babcock Rd., North Stonington, CT 06359

WANTED: WWII U.S. VT fuse for anti-aircraft gun bullet. I need only electrical circuit and schematic. Taskashi Doi, 1-21-4, Minamidai, Seyaku, Yokohama, Japan. Fax: 011-8145-301-8069

WANTED: Zenith Trans-Oceanics radios, transistorized, working or not. Ray Morrow, 1430 Montego Dr., San Jose, CA 95120. (408) 268-5727

WANTED: WWII Japanese and German radio of any kind; British Type 38 radio set; TBY-7, BC-222; anything German airships related. Takashi Doi, 1-21-4, Minamidai, Seyaku, Yokohama, Japan. Fax: 011-8145-301-8069

WANTED: Allied Radio, Knight-kits, shortwave/schematics. Space Spanner/Ocean Hopper, working or not, kits. G.S. Fowler, 140 1/2 Eastern Ave., Worcester, MA 01605. (508) 756-6503

WANTED: RCA table model 9INT1 radio, (Baby Boom #4, p. 307), Sams PF, 399-11), circa 1958. Paul Campbell, 107 Edgewood Dr., Conneaut, OH 44030

WANTED: Chassis and speaker for Atwater Kent 82 cathedral. Will pay your price. Ron Stoner, 5341 High St., Lincoln, NE 68506. (402) 489-9259

WANTED: Base with driver for Model L AK horn speaker. Bill Schultz, 7213 Donet Ct. NE, Rio Rancho, NM 87124. (505) 294-5302

WANTED: Eico HF-85 preamplifier. Bryan Walker, 19400 T.R. 77, Coschocton, OH 43812-9449. (614) 327-3431

WANTED: Lamp hood for Radiola Model #17. Stan Thompson, 43 Cozy Corner, Avenel, NJ 07001-1122. (908) 636-3630

WANTED: WE 25B amp with 205D tubes. Aritoshi Ogata, 3-1-56-503, Nagatoishi, Kurume, Fukuoka, Japan. Fax: 81-942-32-6958

WANTED: Beta video player, perfect functioning, cosmetics unimportant - \$80 + UPS. Charles Graham, 4 Fieldwood Dr., Bedford Hills, NY 10507. (914) 666-4523

WANTED: All parts for 7000, 3000, and 3000-1 Zenith Trans-Oceanic radios. Need cases, handles, fronts and backs and so on. Jim Montague, 1907 South Stanley Ln., Spokane, WA 99212. (509) 535-9576

A. G. Tannenbaum

Electronic Service Data

PO Box 386, Ambler, PA 19002

Phone: (215) 540-8055

Fax: (215) 540-8327

THE



FOR

Vintage Parts &
Service Data
1920's - Present

Free Catalog

Credit Cards Welcome

RADIO ★ GRILLE ★ CLOTH

Now **34** patterns & color combinations
are available to suit most radio needs!
55¢ LSASE for samples

More Good News!
Even More Variety!

- 1) **Three** new patterns: one for Crosley Repwoods, one for 100A speaker, and a great new console pattern.
- 2) Selling off my remaining stock of green Philco V cloth, Now only \$15 for a full 1 1/2 square yard piece. Enough for up to 10 sets.
- 3) Still offering sampler packages of 5 or 10 pieces of cloth for \$20 and \$38, postpaid. See prior issues of A.R.C. for details, or call.

MICHAEL KATZ
3987 DALEVIEW AVENUE
SEAFORD, NY 11783
(516) 781-6202 (EVENINGS)

FOR SALE: Electrolytic capacitors, 1 3/8" cans, 10 for -\$20 (my choice) plus S&H. J.J. Papovich, 53 Magnolia Ave., Pitman, NJ 08071. (609) 582-8279

FOR SALE: Lafayette 1 1/2" vernier dials, calibrated 0 to 10, fits 1/4" shaft, N.I.B. - \$5 ppd. Joseph D'Airo, 424 Higbie Ln., West Islip, NY 11795

FOR SALE: Citizens Radio Call Books Vol. 7, 8, 9, 10, 11 and 12 from 1926-1931. Les Rayner, 5512 N. 71st Pl., Scottsdale, AZ 85253

FOR SALE/TRADE: RCA 12" speaker #050824 (RL70E-2) w/output transformer, fits 810K, 9K/10K & others, excellent - \$60. Jay Myers, 1019 Graybar Ln., Nashville, TN 37204-3213. (615) 297-5886

FOR SALE: Books: radio, electronics, manuals, magazines, now 16 pages. Free for SASE (52¢). Chuck Vaccaro, 708 Booth Ln., #M2, Ambler, PA 19002. (215) 646-3641

FOR SALE: Transistor novelties: Old World globe - \$55; Jaguar - \$100; Galleon 8 ship - \$60; Inkwell - \$75. SASE for list of many others. Rod Galloway, 2220 Woodbury Rd., Melbourne, FL 32935. (407) 254-0280

FOR SALE: Catalin, Crosley 58TC, burgundy with black swirl, no cracks, no crazing, beautiful condition! Clyde Powell, 3822 Edwards Ter., Chattanooga, TN 37412. (423) 867-5022

FOR SALE: Real nice NRI signal tracer with RF oscillator built-in, excellent for servicing older radios, RF and audio inputs - \$85 plus \$20 shipping. Send large SASE for radio book and magazine list. Maurer Television, 29 So. 4th St., Lebanon, PA 17042. (717) 272-2481

FOR SALE/TRADE: Philco 40-180 chassis - \$50; will trade for Emerson R-156 chassis. Philco 40-180 working speaker - \$40; will trade for Crosley 124 working speaker. Dave Stott, 29 Willow Bee Ln., Middletown, CT 06457. (203) 344-0697

Antique Radio & TV's

50-year-old collection

Dates: May 20 to 27, 1996

TV's Black & Whites (120)

Radios • Console Radios

Tabletop Radios • Phonographs

Table Players • Picture Tubes

Scopes & Test Equipment

Schematics • Tubes New & Used

CB's & Accessories

2500 New 78 rpm Records/box lots

Assortment of 45's & 33 LP's

Many other items relating to electronics. Everything must be sold, or it goes to the dump.

Grann's Then and Now

143 E. Michigan Ave, Paw Paw, MI 49079
(17 miles west of Kalamazoo, MI off of I-94)

616-657-4259 for more info

Mailing Address: 31087 56th Ave.

FOR SALE: Zenith B-600 with papers. Send SASE to: Robert J. Stone, 721 Fisk St., Piqua, OH 45356-3729. (513) 773-2217

FOR SALE: Rider's: 6, 7, 8, 10, 12, 13, 14, 15. Radio Theory and Operating, Mary Texanna Loomis, hardcover, 1927, 886 pages. RCA Receiving Tube Manual RC-29. RC Receiving Tube Manuals, (2) RC-19. Sams Tube Substitution Handbooks; (2) Vol. 3; (1) Vol. 10; (1) Vol. 11; (1) Vol. 16; (1) Vol. 20 Basic Radio, Hoag, 1942, hardbound, 377 pages: The Radio Decade hardbound RCA 1930; Sams 1988 Annual Index Photofacts, 2 copies; Cleveland Institute Electronics Lessons booklets, (34). Console radios: GE J-805 very good, 1940. Crosley airplane dial Mod 726. Philco Mod 37-650, round dial face, shadow meter. Airline Mod 048R-730A. Rauland-Borg ATR 6 & 12Vdc power supply Mod ELIF 10/6 amp. (Equipment). Heath VTVM, electric Mod IM-10. Electro-Voice mike Mod 428A, desk, mid 50's. Harmonic generator Mod TE-143, transistorized. Heathkit RF sig. gen. no lead, mod?. Knight RF gen. mod?. Radio City Products multimeter Mod 410, elec. Precision Mod 10-12 tube tester. Triplett tube tester Mod 3413 roll chart, extra charts. RCA Mod WR49B sig. gen. Heathkit tube checker Mod IT-17 roll chart. B&K transistorized tube tester Mod 747 mutual conductance. Heathkit cap. tester Mod CT-1, elec. Standard UHF converter Mod B-51. Shure desk mike Mod S-36, 60's, NRI professional sig. tracer Mod. 33. Precision Electronics sig. tracer Mod 201A. AM-FM receiver Mod H-155A, 12 tube, mid 50's, very good. 1934 RCA Mod 262 airplane dial, 10 tube, very nice. Midwest Mod 18-36, plays great. Grundig-Majestic Mod 8058 AM-FM, (2) SW bands, 45 rpm player, W. Germany, beautiful pecan wood. Motorola Mod 82A w/clock on dial, works good, cabinet fair. Table radios: Harman Kardon The Theme AM-FM receiver Mod A-310, early '60's top-of-the-line, brushed copper, black face trim, lighted edge dial, yellow/white tuning meter, excellent. Good parts set, Magnavox AM/SW receiver amp, speaker, out of console, 12 tube, works great, make your own cabinet. Sorry, Scott Phantom is sold. I have a Philharmonic in Warrington cabinet, fair chrome, plays, Beam of Light dial, ca. 1937. Many thanks to all. Richard R. Bruning, 1901 U.S. Hwy. 150N, Apt. B, Galesburg, IL 61401. (309) 344-1968

FOR SALE: Radios, misc., SASE list. (15) pre-1926 screw binding posts - \$15 + UPS. Tom Tetzlaff, 23 Nelson Dr., Silver Bay, MN 55614. (No phone)

FOR SALE: Zenith 6503Y - \$30. Zenith A515L, excellent - \$20. Emerson 544 - \$35. All play good. Arthur Kreitner, 2013 East Belle Ave., Belleville, IL 62221. (618) 233-5610



Greenbaum Radio Refinishing

Call Joe Greenbaum

Professional Radio
Refinishing Using
Hand Rubbed
Lacquers

Monday - Saturday
6 a.m. - 4 p.m. est.

410-276-4420

The Mid-Atlantic Antique Radio Club

RADIO ACTIVITY 96

Celebrating

THE POST WAR DECADE

1946 - 1956

June 13-15 Timonium MD

*Super Location
Minutes to Baltimore's
Inner Harbor*

Holiday Inn
Timonium Plaza
2004 Greenspring Drive
Timonium, MD 21093
(410) 252-7373

Mention MAARC for
Special Rate

Featuring

GIANT TRADER'S MART

BANQUET - AWARDS

SEMINARS - PRESENTATIONS

GRAND AUCTION - PRIZES

GREAT FAMILY ACTIVITIES

OLD EQUIPMENT CONTEST

You Don't Want to Miss
the
RADIO REPAIR CLINIC
featuring
**Electronic Restoration
and
Wood Cabinet Repair**

For a
Detailed Brochure
With a Full Schedule,
Old Equipment Contest
Categories and More,
Call or Write MAARC
(Info Below)

Trader's Mart: Starts Thursday at 6:00 p.m., All day Friday, and Saturday a.m.
Old Equipment Contest: Entries Accepted Till Noon on Friday
Banquet with Guest Speaker: Friday Evening, Please Reserve Early
Auction: Saturday at Noon - Daily Program of Presentations

**MAILED REGISTRATIONS MUST BE RECEIVED BY JUNE 3rd
AFTER 6/3, REGISTER IN HOTEL LOBBY AT CONFERENCE**

Send Name and Address with Registration
Information to: Steve Snyderman
4147 Lenox Drive
Fairfax, VA 22032
(703) 978-3086

Registration \$ 8.00 (\$6.00 if by mail)
Trader's Space 15.00 First
Add'l Spaces 10.00 Each
Banquet 22.00 Per Person
(Specify Fish or Chicken)

FOR SALE: 1924 BC115 Signal Corp. tuner, nice original. Bing Pygmy phone phonograph, needs restoration. Radio Lamp Company of Chicago radio, excellent. Bendix Catalin green & black. Sentinel 284 Catalin pale yellow. Pal Radio Company, Palcone Liberty speaker. Excellent all original and working. Please make fair offers. Bill Skaggs, 36 Stanton Hall, Destrahan, LA 70047. (504) 785-1054, days only

FOR SALE: Copies of manuals for Eico, PACO, Precision, Simpson, Triplett and other test equipment. Send two-stamp large envelope for lists. Have KT-66 and National Union 350B's and transmitting tubes, write your needs. Clayton Mundine, 6112 S. Flores St., San Antonio, TX 78214

FOR SALE: Telefunken Allegro 1962 FM stereo, blond, impeccable condition. Herman Weber, 119 Saturn Rd., Etobicoke, Ontario, Canada M9C 2S8. (416) 963-4900 evs. or leave message

FOR SALE: Tube checker TV-7D/U - \$80. Gen. URM 25D - \$75. Rohde & Schwarz selective voltmeter 10Kc to 30MHz - \$200. Fluke 8060A - \$75. Eico P.S. Mod 1030 - \$100. Drake TR-4 & MS-4 - \$300. Most with manuals, shipping extra. All OBO. Kenneth Hunt, WL7MV, 872 Sudden Valley, Bellingham, WA 98226. (360) 734-9572, or (360) 671-0882

FOR SALE: Lots of new investment quality radios for sale! Including Zenith 10-S-30, Zenith Half-Barrel chair-side, Fada 12-tube tombstone, Crosley Coloradios, chrome grilles, Bakelites, tombstones, tabletops. Our apologies to those who ordered a catalog from the last ad. We appreciate your patience. Also, check out our photo catalog website at: http://www.sscsi.com/machine_age/radiomania. Our new photo catalog picturing approx. (200) radios will be available by the time of this printing. Send \$1 or (3) 32¢ stamps (not SASE!) to: Radiomania, 2109 Carterdale Rd., Baltimore, MD 21209

So, what's in this new Friends of Radio Antiquity DIRECTORY ?

- √ The list of antique radio * collectors, indexed by country & state, which includes details of what they like to collect.
- √ The list of dealers and services and stores dealing in antique radios * by location, including details of their speciality.
- √ The list of museums by location that proudly display items we love to see and study!
- √ The list of clubs - worldwide, with particulars on the organization.
- √ The list of publications of particular interest to all of us.
- √ Advertisements, business card file, etc.
- √ New expanded forms, for your entry in next year's directory.

Published in May - pre-publication special price of \$12.95 + 2.50 U.S. postage. (after May 1st, price is \$14.95 + postage). Please support this, it's going to be great for the hobby!

Xtal Publishing
P.O. Box 253
Sandy, UT 84091-0253
801-571-5453

*By antique radio collectors - we mean all related aspects and interests in the field of early electronics, etc!

FOR SALE: National NC-109 in good working condition - \$135. Philco portable Model 41-185 (1941), has AM & one shortwave band - \$45. Call: Sheldon Kane, 360 Rhinecliff Dr., Rochester, NY 14618. (716) 442-6338

FOR SALE: Bert Wilson, Wireless Operator, Duffield, 1913 - \$30. Sprague TV Capacitor Manual, 1954 - \$5. Rich Yoch, 22410 Bartlett Dr., Rocky River, OH 44116. (216) 331-9206

FOR SALE: Parts for Grebe Synchrophase MU1. Chassis for Radiola 30A. George Johnson, 1147 1/2 Camino San Acacio, Santa Fe, NM 87501. (505) 989-4492. E-mail: johnson@santafe.edu

FOR SALE: Mechanical filters: F455J-15 - \$165; F455FA-21 - \$55; LSB for PRC-47 - \$50. Joseph Pinner, KC5IJD, 201 Ruthwood Dr., Lafayette, LA 70503. (318) 981-7766. E-mail: kc5ijd@aol.com

**FAX NUMBER FOR
ANTIQUE RADIO CLASSIFIED
(508) 371-7129 - 24 hours a day
Ads - Subscriptions - Book Orders
See inside front cover for details**

FOR SALE: Crosley Trirdyn - \$125. American Radynola - \$125. Stewart-Warner Model 300 - \$125. Stewart-Warner Model 325 - \$100. Aeriola Sr. - \$140. Kodel Logodyne - \$120. Aeromaster, rare, unlisted set - \$175. Bryant made by Bryant Radio Co. of Palo Alto, Calif., very rare - \$250. 1-tube well-made home-built with good and very rare Electrad diode tube and, of course, the equally rare Electrad socket - \$80 or BO. Audio control box similar to DeForest RJ-5 but no maker's name, possibly Wallace, with DeForest Spherical Audion with one good filament - BO. Tyrman 50 mid-20's portable in black leatherette, extremely rare Los Angeles made set, a fancy good-looking radio - \$400. Leilani, small 1950's guitar amp, iridescent case, gorgeous - \$300. Marconi 1920's Type 55 portable with (5) Marconi valves - BO. Electro-Import Bulldog spark coil - \$450. Electro-Import loose coupler - \$350. Repru Crosley Pup bottom covers, no label - \$50. Buyer pays shipping. Dennis Branch, 1238 W. Ivyton St., Lancaster, CA 95453. (805) 723-1569

FOR SALE: 20's battery sets; Gilfillan GN-1 - \$450. Crosley 50 - \$125. Crosley Trirdyn 3R3 - \$150. Radiola III w/balanced amp - \$275. Eria S-50 - \$150. Sonny Clutter, 14407 N.E. Fremont St., Portland, OR 97230. (503) 254-9296

FOR SALE: Collins station; 75S1, 32S1, 516F-2, 312-B4, manuals, original cartons, wiring jumpers, and extra tubes, excellent - \$750 PU or plus S&H. James Cole, 240 Gillespie Dr., Abingdon, VA 24210. (540) 628-2835

Vintage Radio Repair

23 years experience!
- TRUST YOUR PHILCO TO NO ONE ELSE -
(yes, we also repair AK, RCA, Zenith, etc.)
**NOW OFFERING A FOUR YEAR
LIMITED WARRANTY!**

Call, E-mail, or send SASE for details

RON RAMIREZ ENTERPRISES

811 Maple St.
Providence, KY 42450
(502) 867-5440
E-mail address:
Mr.Philco@genie.com

PHILCO
BALANCED UNIT RADIO

WANTED: JVC turntables Model Nos. QL-A2, QL-F4, JL-F45 and JL-F44Z, working or not, any condition. Bryan H. Opalko, 1542 Charlotte Cir., Naperville, IL 60564. (708) 820-8336

WANTED: Fada 652 butterscotch, Majestic 651, Addison A2A, Bendix 526C, Fada 1000 butterscotch. Don Moody, 1600-M Glenwood Ave., Raleigh, NC 27608. (919) 821-3530

WANTED: Hallicrafters S-29, S-39 or S-72. Bill Gustavson, 1819 Green Tree Ln., Duncanville, TX 75137. (214) 939-4510, 8am-5pm CSTM-F, or leave message

WANTED: Chassis and speaker for Philco 90. Knobs for Sparton 930 or 931. Bill McChesney, 10313 St. Andrews Dr., Oakdale, CA 95361. (209) 848-1197

WANTED: Hammond clocks, skyscraper day/date, etc. Also any info, manuals, service data, etc. Ritchie Fiegler, PO Box 18247, Fountain Hills, AZ 85268. (602) 837-2918

WANTED: Colorful plastic, Kadette, Detrola, Catalin, Plaskon, beetle, transistors, etc. Bob Masterson, Box 172, Valley Cottage, NY 10989. (914) 353-3151

WANTED: Meissner signal shifter. Robert Braza, N1PRS, 23 Harvard St., Pawtucket, RI 02860. (401) 723-1603

WANTED: Western Electric Type 274A/B tubes, N.I.B. - \$160; good used - \$90. H. Kato, c/o Mr. T. Kato, 6866 Chelsea Rd., McLean, VA 22101

WANTED: Knobs for Zenith TV, G2420 Mayflower (F.O.S., p. 196). Joe Quinn, 30511 Manhasset Dr., Bay Village, OH 44140. (216) 835-8420

WANTED: Rider's Vol. VIII, have VI for possible trade-up. Farm radios 6Vdc/110 VAC, 32Vdc. Charles W. Rhodes, 10105 Howell Dr., Upper Marlboro, MD 20772. (301) 574-0214



WANTED: Emerson Catalin radios. Nobody pays more than I. What an arrogant and inaccurate thing to say. I mean, like there isn't anyone wealthy enough, dumb enough, desperate enough - or any combination of the three - to pay even a dollar more than I would pay. I mean, c'mon, who am I trying to kid! Please write or call collect: Rain Butignoll, 214 State St, #7, Portsmouth, NH 03801. (603) 427-1384

WANTED: I pay the following for Western Electric: 274A or 274B with lettering engraved or molded in base (not yellow print), used - \$150. 274A balloon or globe shape, used - \$200. 310A wire mesh plate, new - \$30. 205F, new - \$120. 248A, new - \$60. All WE tubes wanted new or used. Tube sockets 100M or 100L - \$50 ea. Tube book, any volume - \$75. Also buying transformers and amplifiers, call for my offer on any Western Electric items you have. Tim Metz, 221 Wheatland, Fairview, OK 73737. (405) 227-2456

WANTED: Radiola 21 and Radiola VIIIB junker cabinet. William Boyd, 74 Atsion Ct., Medford, NJ 08055. (609) 722-2369

WANTED: Elephant-shape transistor radio, BC-611 Motorola walkie-talkie; Radio Boys-Voice, Iceberg, Snowbound, Pacific Rescue. Dale B. Allen, 606 Third St., Herndon, VA 22070. (703) 904-9895. E-mail: dallen@melpar.esys.com



WANTED: Amplion and Burns horns, drivers and parts in any condition. Jim Peters, 983 Chapel Ct. South, Glen Ellyn, IL 60137. (708) 790-9699

WANTED: Service sheets, schematics for any German Grundig, Telefunken, Siemens, etc. tube radios. Geoff Fors, WB6NVH, Box 342, Monterey, CA 93942. (408) 373-7636

WANTED: Hickok TV10, 6000A, 539C. Record cutting lathes, amplifiers, limiters, (Fairchild, Westrex, Gotham, McIntosh, Marantz, Gates, Collins), Kim Gutzke, 7134 15th Ave. S, Minneapolis, MN 55423. (612) 869-4963. Fax: 798-4169

WANTED: Manuals for Simpson 260 Series 6, RFL Gaussmeter Model 505. Gary Ledbetter, 7321 Granalta Cir., Frederick, MD 21702. (301) 473-4563

WANTED: Payphones, (3) slots, Gray/Western Electric, separate transmitter and receiver. Stanley Schreier, 350 Hendrickson Ave., Lynbrook, NY 11563. (516) 887-4966. Fax: (516) 887-4780

WANTED: Detrola Models between 105 and 133 inclusive. Also Detrola console radio/phonographs. Scott Flaughner, 41100 Plymouth Rd., Plymouth, MI 48170. (313) 451-4221. E-mail: FlaughSM@po5.pl.unisys.com

WANTED: Separate standing Philco speaker (working or not) for 1928 Philco metal cabinet 500 Series radio. Also want old open (bad) audio transformers from 1920's battery sets. Chester Johnson, PO Box 883, Cedar Park, TX 78630

WANTED: BC-611, BC-342-N, and Philco 70 with original finish. Michael Harrington, PO Box 7619, Little Rock, AR 72217

WANTED: GN-44 generator (hand cranked) for WWII field set, BC-474 restoration project. Also need the small O.D. filter box FL-10 and any of the unique connectors. Could use a junker set for parts too. Please call or write if you have this radio, or anything that goes with it. Henry Engstrom, KD6KWH, PO Box 5846, Santa Rosa, CA 95402. (707) 544-5179

WANTED: Hi-fi, auditorium, theatre sound equipment. Corner speakers, coaxial/triaxial speakers. Altec, Western Electric, Lansing, Electro-Voice, Jensen, Stephens, IPC, Ampex, horns, drivers, parts & tubes. Sonny Goldson, 1413 Magnolia Ln., Midwest City, OK 73110. (405) 737-3312, fax 3355

FOR SALE: AK 20 big box - \$85. Crosley 10-135, paint chips - \$65. Crosley 51 - \$100. Crosley 725 - \$90. Delco 1106, painted - \$100. GE A-53 - \$100. Michigan MRC-12 - \$225. **WANTED:** Crosley Ace V/Crosley 51 lid; Echophone/meteor cabinet; Magnavox AC-3 cabinet; RCA Radiola V crystal detector. Don Sturzenbecher, 26990 S. Marion Rd., Sioux Falls, SD 57108. (605) 368-2135

FOR SALE: Many novelty, transistor radios made in Japan from the 1960's, most radios new in box. Free list SASE. Bill Hyde, 34 Cerrado Loop, Santa Fe, NM 87505. (505) 466-6613

FOR SALE: Sparton #136 chassis, complete - \$125. Philco 40-150, working - \$75. Lafayette HE-80, weak - \$60. U-ship. Bob Bakinowski, 1524 Saint Tropic, Tucson, AZ 85713. (520) 624-8029

FOR SALE: Zenith H724Z, brown plastic, plays good - \$20. Zenith C724P, butterscotch plastic, plays - \$20. RCA portable 8BX6, aluminum, clean, plays - \$20. All plus UPS. Ferdinand Estree, 660 Fineview, Kalamazoo, MI 49004. (616) 344-0231

FOR SALE: Retiring, selling collection. All sets are in mint condition & are working with tubes, & all sets are TRF DC of early 1920's & some are rare. Will send photo. Kemper K-5-2, mint - \$300. Supreme xtal reflex, mint, rare. Haynes Griffin, mint, 1923 with manual - \$250. Freed-Eisemann, mint NR7 - \$250. Cosmopolitan 5, mint - \$250. Shamrock, mint 6 tube - \$400. Freshman Masterpiece, mint - \$250. Victory, mint, 5 tube - \$250. Airline 15, excellent condition - \$225. Ramway, mint - \$250. Aeriola Canadian Westinghouse, mint - \$300. USA Westinghouse Aeriola, mint - \$250. Radiola III, mint - \$250. RCA. Floyd Bocox, Box 1657, San Pedro, CA 90733. (310) 831-9336

FOR SALE: Atwater Kent Model F4A speaker, Model 30 radio, and Atwater Kent advertising lamp. For info call or write to: Robert J. Stone, 721 Fisk St., Piqua, OH 45356-3729. (513) 773-2217

FOR SALE: By widow of 1930's radio technician, approx. (35) console radios plus a small number of table radios. Untested, un-inventoried. Zenith, Philco, Silver-tone, etc. (1) E.H. Scott chassis & speaker. Prefer lot sale but will piecemeal if necessary. J.S. Kay, 5 Fiske St., Worcester, MA 01602-2922. (508) 755-4880, 5:30-7:30 pm, weekdays

FOR SALE: Philco 40-180 console - \$55. B&K CRT rejuvenator - \$19; 826, 4X150, 4CX250 tubes. Ham and old audio equipment. List LSASE. Tim Martin, PO Box 342, New Lebanon, NY 12125. (518) 794-7435, evs., weekends only please

FOR SALE: Paper items. RCA RC30 Tube Manual - \$15. Have GE, Sylvania tube manuals. Basic Electronics, Marcus - \$9. Radio Data Book, 1,148 pages - \$10. Mix of (70) booklets NRI and DeVry TV and Radio, all - \$20. Hawkins Elect. Guide, (5) copies, all - \$15. The Resistor Manual, Daven, 1925, 45 pages on resistance amps - \$9. Treatise on Testing Units For Service Men, Rider, 1927 - \$7.50. Copies of High Fidelity, 100 Years of Talking Machine, RCA 1938 Service Lecture and 1936 High Fidelity Recording, all three - \$10. Coyne Electric Radio Book, 1,212 pages - \$10. Radio paper by the bundle. Hom speaker 6", 18+ pounds, all - \$60. Stromberg-Carlson, 3/4" - \$8.50. Westinghouse, 1 1/4" - \$15. Magnavox Sets-Amps Changers, 1 1/2" - \$15. TV Yokes Transformers, 1 3/4" - \$8. Wilcox-Gay, Lear - \$8. Capehart Farnsworth mix - \$8. Grunow - \$9.50. Sets made by Belmont Radio for others, 1 1/2" - \$22.50. Truetone (Belmont), 1 1/2" - \$18. (100) QSL cards - \$10. RCA Amps Sound for Film Projectors Hi-fi Photophone, 1 1/2" - \$25. Howard Sams Parts Buyer's Book - \$15. VIB catalog - \$6. GE TV Early 800 Lne, 2" - \$22. Admiral Early TV, 3/4" - \$9.50. Philco 47-48-49, 1 1/2" - \$15; 47-48, 1 1/4" - \$12. Philco Record Players, 3/4" - \$12. Philco Howard Sams 46-53, 1" - \$15. Crosley Service Manual 1932 to '39, 2 1/2" - \$30. Also have other Motorola, RCA changers books. Batt. tester Micronta - \$10. Home-brew crystal radio, 5" x 5 1/2" x 5 1/2", (2) ID tap SWs wire loose-rewind - \$35. Zenith Trans-Oceanic 6A40, plays - \$85. Emerson Model 149 brown Bakelite, needs repairs - \$35. Dynamic mic PM-7 50KΩ desk model - \$30. Each have 2. Stromberg Carlson 5-tube AC chassis, plays, no speaker - \$35. Jensen 9" speaker, metal case - \$18, have two. 1000's of unlisted tubes, test eqpt. N.O.S.-used parts. Write wants SASE. ARRL Special Defense Edition Radio Amateurs Handbook, 1942 - \$20; 1952 Handbook - \$15. Elements of Radio Servicing, Marcus, hardcover - \$10. Following on pick up only cash-carry. Ampex reel-to-reel stereo recorder amp. Catalog 910 and Ampex speakers built-in amps, all 3 units - \$190. RCA Selectavision video disc player - \$75. Kellogg 507 batt. radio, less tubes - \$175. Edison office voice machine & stand - \$125. Meissner dual speed record maker, player, radio portable - \$150. Philco Model 65 - \$75. 512 - \$75. U.S. Navy RAK-8 15 to 600 Kc rec. and power unit - \$95. Philco TV 10" 1001 - \$125. Have some lab quality test eqpt., list - SASE. Lots of parts, tubes, small sets, test eqpt. for sale, write wants. Some on pick up and cash. Selling out. All plus shipping. Min. orders - \$8. F. Krantz, 100 Osage Ave., Somerdale, NJ 08083-1136. (609) 783-0400

FOR SALE: New tubes 5691 and 5692 red base - \$32 ppd. Crosley Bullseye - \$95. John Lyle, 1161 S.W. Muivane, Topeka, KS 66604-1456. (913) 232-0128

FIRST ISSUE FREE

SEND FOR OUR NEW QUARTERLY
FLYER - APRIL 1996 ISSUE

TEST EQUIPMENT - ELECTRONICS - PARTS

Boca Electro Magnetic Lab
21218-10 St. Andrews Blvd.
Boca Raton, FL 33433
(407) 750-8911

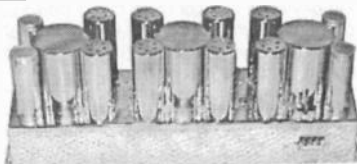

WANTED: Chrome-plated amplifier, 8 to 10 tubes with Jones plug on the side in any condition. If you have this amp or know of its possible location, please contact me. John T. Meredith, 2462 Stantonsburg Rd., Suite 152, Greenville, NC 27834. (919) 551-1882

OLD RADIO AUCTION

FRIDAY, MAY 17, at 10:00 a.m.

Held at **WHALEN AUCTION BUILDING, NEAPOLIS, OH**
20 miles SW of Toledo, OH or 7 miles W of Waterville, OH
Exit 3A, Ohio Turnpike

CONSOLES: Zenith 5-J-255, 5808, 9-5-262; General Electric K-62, Majestic 70B; Majestic High Boy model 90; Philco 46-1209, 42-358, 87, 49-1602, 112; Silvertone 1993; Stromberg Carlson 1120-PL radio & phono; Atwater Kent 325E, 89; Spartan model 18; Silver Marshal Radio model 30; U.S. Radio model 31; American Bosch A-2 6056.

CATHEDRAL: Philco 70, 80; Majestic 20; Emerson; Legionnaire.

WOOD TABLE MODELS: Philco 40-135, 41-250, 48,42-321, 40-125; Air Castle 629; Detrola 571; Spartan 121; RCA 348-A, 28X5, 96T; Sonora; Parmak; Majestic 50 case only; Travler 5170; Westinghouse; Coronado WG618, MSE622; Wards 62-345; Westinghouse WR-12X16; Stromberg Carlson 925-H; Airline 8A23.

Approximately 100 TABLE RADIOS, many Bakelite transistor radios, including Zenith 500 Royal.

TOMBSTONE: Philco 620, US9A, American Bosch 430, RCA 5T.

Old BATTERY SETS: Kolster table; American Bosch Cruiser 66; Stewart Warner 300; RCA Radiola 18; Pfanstiehl A-18455; Atwater Kent 20;

RADIO PHONO: Admiral 5D32, 7RT41-N; Zenith 5C02.

OTHERS: Stromberg Carlson Duncan Phyfe drop leaf style; Zenith Transoceanic;

ACCESSORIES: Tube Tester Hickok 533 w/manual works; Tube Tester Tung-Sol TS78; Tube Tester Hickok 534B w/manual needs service; other tube testers w/manual; other test equipment; spare speakers & others such as RCA 100-A, 4 horn speakers; chests full of parts; 3 tube caddies full of old tubes in boxes; over 1,000 tubes such as 504G, 7868, 76, UX200, 01A, WD11, BH, 81, 245, 75, UX201A, 34, CX301A, 6AU5, 6R7G, 7A7, 6U7, 79, 6B8G, 39/44, 280, 50, many globe type and much more.

JOHN'S NOTE: Lunch available. Plenty of parking. Heated & air conditioned building. Plan to come and spend the day.

PREVIEW: Thursday evening May 16, from 7:00 - 9:00 p.m. Open day of sale at 8:30 a.m.

TERMS: Cash or check with proper ID. No buyer's premium. Selling to the highest bidder. Call for any further information.

offered by

John A. Whalen Realty & Auction Service

P O Box 550, Neapolis, OH 43547

Auctioneers: John & Jason Whalen,

Huner, Murry & Keim

(419) 875-6317 875-6603 fax 875-6333

JOHN A.
WHALEN

Whalen Realty & Auction

Information deemed reliable but not guaranteed

FOR SALE: More tube testers: Weston Model 981 mutual conductance - \$75. B&K solid-state tube checker Model 747 - \$125. B&K Model 667 - \$45. All with setup charts. Add \$20 shipping each. Maurer Television 29 So. 4th St., Lebanon, PA 17042. (717) 272-2481

FOR SALE: Hitachi TH-621 salvage parts set - \$20. Donald Sochurek, W191 S17500 Richdorf Dr., Muskego, WI 53150. (414) 679-0212

FOR SALE: Zenith 12S370, vgc - \$650 or Best Offer. Zenith 9S262, vgc - Make Offer. Zenith 760 console, vgc - \$225. Jeffrey Weber, 8507 Mohr Ln., Fogelsville, PA 18051. (610) 285-2421

FOR SALE: Kadette chassis Mod 649, unworking - \$25. Zenith chassis Mod 5S327 tombstone, chassis working - \$50. C D R Roter control TR4 - \$25. Philco UHF converter Mod 78-1594, nice - \$45. Hallicrafters TW1000 Worldwide, works - \$75. B&K tube tester Mod 667 - \$30. B&K CRT tester Mod 445 - \$40. Books & magazines: Rider, National Union Radio Service Manual, Vol. VI - \$35. Practical Amplifier Diagrams - \$15. Rider Tube Substitution Guidebook - \$12. RCA Tech. Series RC 22 Tube Manual - \$8. Radio Amateurs Handbook by F. Collins, 12th rev. edition 1970 - \$12. ARRL Radio Amateurs Handbook, 1968 - \$10. Radio News, March, Aug. 1947 - \$3.50 ea. Radio-Craft Feb. 1944 - \$5. Popular Electronics 1957 to 1974 - \$2 ea. All + S&H. For 19-page list send \$1, stamps OK. Ben Martin, 18334 Pepper St., Castro Valley, CA 94546. (510) 582-6804

FOR SALE: 441-T Hopalong Cassidy, red, exc condition - \$550. Glenn Piar, 4040 Allard Rd., Medina, OH 44256. (330) 239-1857

FOR SALE: Tubes: Good assortment of (100) different new 7- and 9-pin miniature tubes in original boxes, mostly TV types - \$25 ppd, in U.S. only. Herb Ratner, 3542 Westminister Ct., Holiday, FL 34691. (813) 937-7452

FOR SALE/TRADE: Zenith X-334 - \$20. Zenith 5D-0272 - \$20. Philco portable 52-643 - \$20. Emerson 514 - \$25. Philco 52-530 - \$30. Hallicrafters portable TW-201 - \$25. Prices do not include UPS. Will trade for original set of knobs for any of these radios: Grunow 450, Grunow 460, Crosley 124, Crosley 515. Dave Stott, 29 Willow Bee Ln., Middletown, CT 06457. (203) 344-0697

FOR SALE: Fada 115 1941 Catalin. Fada 1000 1946 Catalin. Send SASE to: Robert J. Stone, 721 Fisk St., Piqua, OH 45356-3729. (513) 773-2217

FOR SALE: RCA Aeriola Sr., nice - \$150. RCA 128 tombstone, nice - \$250. Philco Predicta parts. Picture tube 21" - \$75. Mask 21" - \$50. Brass parts for Tandem - \$30. Tony DeMara, 40231 Day, Clinton Township, MI 48038. (810) 263-0325

FOR SALE: 6DS4 and 6CW4 nuvistors. These small metal tubes, less than 3/4" from pins to top, were from an era when tubes were competing with transistors, new-in-the-box - \$9 ea. J. Arndt, 1215 Division St., Manitowoc, WI 54220-5734. (414) 684-8830, answering machine on 24 hrs. a day

FOR SALE/TRADE/WANTED: ICOM IC745, Kenwood TS-520, Argonaut 509 transceivers. Misc. ham equip. Interested in tube audio, audio transformers. SASE. Chip Schmidt, 2024 Hilton Dr., Cedar Falls, IA 50613. (319) 277-8504, eves. 8-10 pm CST or weekends

FOR SALE: Heathkit W5-M amp, WA-P2 preamp, FM-3 Turner, all work - \$400 for all. Panasonic RS 1000S reel-to-reel professional auto reverse solenoid operated deck with manual - \$200. Malcolm Canon, 449 East Ventura Dr., Birmingham, AL 35235. (205) 836-7657

FOR SALE: New release: Send 2-stamp LSASE for Olde Tyme Radio's latest flyer, No. 196 to: Olde Tyme Radio Company, 2445 Lyttonville Rd., Suite 317, Silver Spring, MD 20910. Phone/fax: (301) 587-5280

AUCTION NOTICE



NORTHLAND ANTIQUE RADIO CLUB

Radio Daze '96 — Friday May 31, 1996 — 7:30 pm
Golden Valley, Minnesota



- AK Models 20, 20c, 52, L, E3
- AC Dayton XL5
- Radio News Crystal Set
- Freed-Eisemann FE15, NR9
- Tecla Crystal Set
- Howe Crystal Set
- Westinghouse Aeriola Sr.
- Tri-City W-1
- Day-Fan 7
- Crosley 50, 51, 51SD, XJ
- Trego, Northland, Splitdorf

— And Many Other Items! —

Limited consignment space available.
Contact: Don Hauff, Auction Chairman
(612) 933-9070



WANTED: Antique and novelty tube and transistor radios. We buy complete collections or quality individual pieces. Also radio-related vacuum tubes, parts, literature, magazines, advertising and test equipment. Call or send list. Radio Daze, John & Kathy Slusser, PO Box 144, Mendon, NY 14506. (716) 624-9755

WANTED: 1938 RCA-Victor armchair control, remote control. Also, anything RCA, same year. Paul Connolly, 4178 N. Longvalley Rd., Hernando, FL 34442. (352) 726-8505

WANTED: Heathkits: Model CC-1 cathode ray tube checker and Model T-3 signal tracer. Thanks. Daniel Racovaz, 1237 Albion Rd., Rexdale, Ontario, Canada M9V 1A9. (416) 743-7052

WANTED: Sweep generator suitable for use on AM radios like a Supreme Model 582, as seen in Jan. '96 A.R.C. page 4. Also any catalogs, sales brochures, etc. on Hewlett-Packard test equipment made in the 40s, 50s, and 60s. Doug Burskey, 732 Pulver-List Rd., Mansfield, OH 44905. (419) 522-5669

WANTED: Old books, telegraph, wireless, radio, television, Edison, Marconi, DeForest, Fessenden, Tesla. Jerry Simkin, 10 Avalon Ln., Matawan, NJ 07747

WANTED: For General Electric table model J-62, 2-band oscillator coil. Matt Lutkus, 3296 West 102nd Cir., Westminster, CO 80030

WANTED: Manuals for Heathkit IG-102 & AG-10 signal generators, and Superior Inst. Co. TV-II tube tester. Copies OK. Tim Dray, 2741 Colfax Ave. So., Minneapolis, MN 55408. (612) 872-2492

WANTED: I understand that there was a publication or supplement in the 1930s or 1940s which cross-referenced manufacturers with their aliases (i.e. Company D for Detrola and the like). I will pay for a copy of such a cross reference. Your help is greatly appreciated! Mark V. Stein, 2109 Carterdale Rd., Baltimore, MD 21209. (410) 466-2814. E-mail: Radioman@cais.com

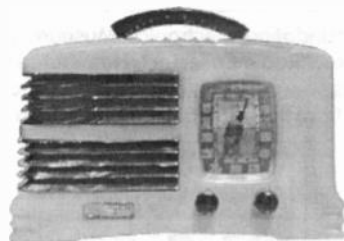

WANTED: Symphony and Detrola Catalin radios. I am not a human being: I am a radio collector. God forbid! Pity me the lost soul that I am and fulfill my humble needs. Please write or call collect: Rain Buttignol, 214 State St, #7, Portsmouth, NH 03801. (603) 427-1384

WANTED: HA101X, HA137, HA104 UTC transformers, have LS58 and LS6L1 for swap. Also looking for Western Electric tubes, etc. Many trades available. Michael Payne, 803 S. Taylor, Akin, TX 77511. (713) 331-9217. Fax: (713) 585-2727. E-mail: we300b@aol.com

WANTED: Tube manual, RCA Number RC-30. Steve Dimedio, 2077 Dutton Mill Rd., Newtown Square, PA 19073. (610) 644-8713, leave message. E-mail: sdimedio@camden.ge.com

WANTED: Mitchell brand appliances. Also Who's Who in Hollywood/Radio/TV magazines and Pilot TV ads/literature. Lee Mitchell, The Mitchell Collector, 175 E. Delaware, 8209, Chicago, IL 60611. (800) 869-7869

WANTED: Manual and advertisements for Philco 60MB Baby Grand tombstone. Western Coil WC5 manual. Gary Carter, WA4IAM, 1405 Sherwood Dr., Reidsville, NC 27320. (910) 349-1991

WANTED: Heathkit catalogs before 1956, 1958 through 1965; certain Heathkit items, SP-99, HN-31, etc. Phil Cranston, KB5ZAV, 1016 Avondale St., Jackson, MS 39216

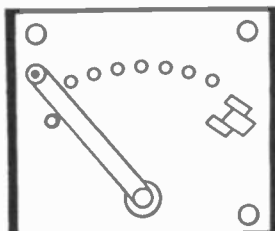

WANTED: Early electric Motor-Starter or Motor-Starting rheostat. Tim James, 17365 S.E. Walta Vista Dr., Oak Grove, OR 97267. (503) 653-0407

WANTED: Fairchild SMI, 232 cartridges, Lansing 801 driver, Collins 51J1-4 radio and 270G1. Vincent Gallo, 532 LaGuardia Pl., #600, New York, NY 10012. (212) 274-0432

WANTED: Sell J.D.'s Radiowear at your next meet. Dealer prices, return your excess, no risk. For information, write or call John at: J.D.'s Radiowear, 1161 S.W. Mulvane, Topeka, KS 66604-1456. (913) 232-0128

WANTED: Schematic and any available information to help restore a Victor Electrola/Radiola Model VE7-26X. Dave Stott, 29 Willow Bee Ln., Middletown, CT 06457. (203) 344-0697

WANTED: Hallicrafters R46 or R46A speakers. Daniel Seidler, 3721 W. 80 St., Chicago, IL 60652. (312) 284-8221

WANTED: 1 1/2" long carbon tuner slug with 1 1/8" wire attached for a Collins 51J-4 or equivalent. Roger Quickel, 5511 S. Ridge W, Geneva, OH 44041. (216) 466-6808

WANTED: Reel-to-reel albums. Also reel-to-reel locks. Mike Downing, KM6BN, 4331 Hayes Pl., Las Vegas, NV 89107. (702) 870-8299. E-mail: downing@lvvwd.com

WANTED: The book, Raytheon Transistor Applications, Volume II, published in 1957. Michael Burke, PO Box 439, Westminster, MA 01473. (508) 874-0908

WANTED: Antique medical devices especially violet rays, scientific, small table fans and radios. Richard Cane, 1333 N.W. 127th Dr., Sunrise, FL 33323. (954) 846-7116

WANTED: Zaney-Gill organ pipe cathedral. Johnny Johnson, 7075 W. 32nd Ave., Wheat Ridge, CO 80033. (303) 274-5474

WANTED: Thor No. 460 coupling unit criteria 1927, Thordarson audios 2:1, 3:1, and R-200. Jewel panel meters pattern #55 and #135, KARAS Micrometer dials. John T. Meredith, 2462 Stantonsburg Rd., Suite 152, Greenville, NC 27834. (919) 551-1882

FOR SALE: Lot of (18) transistor radios - \$100. B&K 747 tube checker - \$200. Hammarlund and Motorola 6 meter transceivers - \$50 ea. Tape-A-Thon reel-to-reel tape transport - \$40. Knight Model KA55 stereo amp - \$50. Heathkit Model A1 mono amp - \$50. All items plus shipping. Call or write: Gil Jungert, 3061 Wellington Ave., Grand Junction, CO 81504. (970) 434-5000

FOR SALE: Moving shop sale, lost lease. Partial liquidation. Antique radios & TVs, audio. Pick up only. Vaughn Rudisill, 11 East Marie St., Hicksville, NY 11801. (516) 822-4501

FOR SALE: Electro-Voice SP12B speaker. **WANTED:** Amps; Craftsman C2; Dyna MK2; Heath AA81 & other EL34's. Rob Taylor, PO Box 10503, Bradenton, FL 34282. (941) 751-1072

FOR SALE: RAK-6 receiver & power supply, 15 to 600 Kc, TRF, operational - \$75 pick up only. Ray Harland, 2602 Mary Ln., Escondido, CA 92025. (619) 746-4584

FOR SALE: Several hundred ST shape tubes. Mostly from the 1930s. All have tested good or better on TV7D/U tester. SASE for list. Herman Fothe, 5292 Tiffany Ave., West Palm Beach, FL 33417. (407) 688-2794

FOR SALE: GE/Western Union tube AC dispatch receiver, Model 4ER18A3 - \$85 plus shipping. Walt Kiefner, 6233 51st Ave. NE, Seattle, WA 98115. (206) 526-1452

FOR SALE: Hammarlund HQ110, HQ170, trade for National General coverage rcvr. Hoover Noonan, Rt. 1, Box 187, Pineland, SC 29934. (803) 726-5762

FOR SALE: Books. U.S. Army Radio School, Coyne, (3) books - \$35. Cathode Ray Tube at Work, Rider - \$15. Radio Operators License Guide - \$5. Mathematics For Radiomen - \$15. Automatic Frequency Controls Systems, Rider - \$15. Frequency Modulation, Rider - \$10. Transistor Manual, GE - \$5. Robert J. Stone, 721 Fisk St., Piqua, OH 45356-3729. (513) 773-2217

FOR SALE: 1954 Radio Station toy by Remco with box - \$50. Gold transistor paperweight from Bell Laboratories - \$45. Triplett volt-ohm-mil-ammeter in wood case - \$35. WWII transmitting tube Eimac 450TL - \$45. Majestic radio poster - \$65. Books: The Radio Reading Course 1924 - \$12.50; Vacuum Tube Voltmeters, Rider, 1941 - \$8.50. Don Wagnon, 1221 Camino Real, Fairview, TX 75069. (214) 562-0621

FOR SALE: Spartan Model 400 Jr., 1930 upright table radio, arched top finials, all original, excellent condition, complete, works - \$375. Tom Fino, 245 Bainbridge Ave., Thornwood, NY 10594. (914) 769-7603, afternoons

FOR SALE/TRADE: (100) 12AX7 tubes N.I.B. - \$500. (100) 12AU7 tubes N.I.B. - \$300. All U.S.A. made. Michael Payne, 803 S. Taylor, Alvin, TX 77511. (713) 331-9217. Fax: (713) 585-2727. E-mail: we300b@aol.com

FOR SALE: Zenith Trans-Oceanic 3000-1, no battery box - \$95. Sony 6F-21WA FM & AM 9 transistor portable - \$20. Sanyo RP-8880 9-band SW receiver - \$125. Uniden Bearcat BC 560XLT scanner - \$45. Zenith 6 band Continental - \$20. Scharp AM, FM, CB, WB, portable - \$45. All plus shipping. Jerry Silver, 10863 W. Clairmont Cir., Tamarac, FL 33321. (954) 720-1972

FOR SALE: Ham Price Guide introductory - \$9.95. (3,000) items ham gear identified and described. Over (6,000) real, dated prices for over (2,500) items. Boat anchors through HT's, linears, tuners, mics, power supplies, antennas and more. Use also to decipher cryptic ad descriptions - \$9.95 includes U.S. postage, \$11.50 to Canada, \$14.95 other. Also, Tube Type Transmitter Guide, 1922 to 1970, (550) pictured items, (104) manufacturers - \$17.95 U.S., \$19.95 Canada, \$27.95 other. Californians add sales tax. Sound Values, PO Box 9, Dept. C, Auburn, CA 95604

The "Radio Collector" Video

Writer-producer Mike Adams and the Perham Foundation Electronics Museum are pleased to present the original, best-selling PBS series, "Radio Collector". Nominated for an Emmy, Best Information Series, "Radio Collector" is now available complete and uncut. All five half hour shows have been newly duplicated from the original broadcast masters.

Order the Popular VHS
Videotape "Radio Collector"
Directly From
the Perham Foundation!



Writer-producer Mike Adams

You'll meet dozens of collectors and experts, see hundreds of radios made between 1900 and 1960, plus you'll learn about radio restoration!

Send \$29.95 plus \$3.00 S&H to:
Perham Foundation,
101 First Street, Suite 394,
Los Altos, CA 94022

For more information,
call us at 408-734-4453
Proceeds support construction
of our new museum!

Radio Restoration Parts

Vacuum Tube Repair Wafers

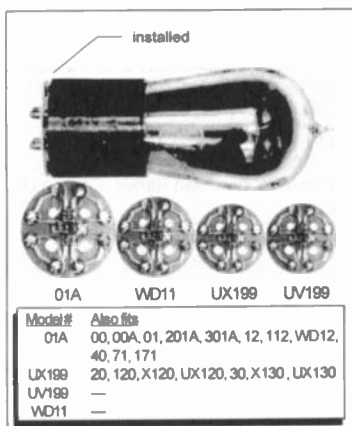

These tube repair wafers are solid-state devices for quick and easy repair of early vacuum tubes. The wafer is installed by simply sliding it over the tube pins and reinserting the tube into its socket. If the filament is intact, but there is little or no emission, the filament may be lit for best visual effect. However, the tube can be open filament.

No change in radio operating voltages is required. Any number of tubes may be repaired in a radio. If wafers are installed on all tubes, the B+ voltage may usually be reduced without sacrificing volume or sensitivity. Performance will vary between radio models.

\$10.00/each (\$7.50/ea. 3 or more)

New Atwater Kent Breadboard Switch

Exact replacement for Models:

9 • 9C • 10 • 10A • 10B • 10C • 12

and all additional models with board mounted switch.

Newly manufactured under high pressure heat from the same type brown thermoset resin used in the original. Beryllium copper spring contacts are used for long, trouble-free life. Custom built knurl is used to exactly reproduce the original.

\$50.00/each

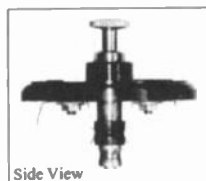

Side View

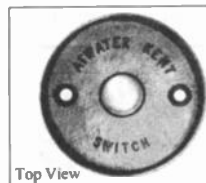

Top View

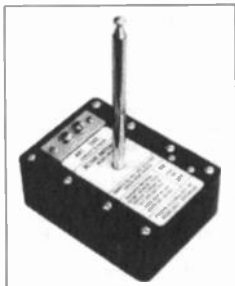

Active Antenna

Allows antique radios which were designed for a long wire outdoor antenna to operate on a 42" indoor whip antenna. Portable, operates from a 9 volt battery.

Only \$34.95

Order from: PTI, 7925 Mabelvale Cutoff, Mabelvale, AR 72103

Orders shipped UPS, prepaid in continental U.S. Please allow 3 weeks for delivery.

Arkansas residents add 5.5% sales tax.



To Order: Call (501) 568-1995

FOR SALE: Transformer 1500 VCT, 300 mA, (2) 7.5v, 3A, (1) 5V3A - \$25 plus UPS. Jack Shaymow, Vintique Electronics, 522C Tilford, Deerfield Beach, FL 33442. (954) 427-1222

FOR SALE: (2) Zenith Trans-Oceanic 3000-1, good - \$100; excellent - \$175; 1000 as-is - \$55. Bearcat 210XL, excellent - \$85. Newcomb phono/PA, plays 16" records, excellent - \$175. Sony 500U micro TV, works - \$50. Sony TR-911 SW - \$45. Add shipping. Ted Demski, 5806-225 Pl. SW, Mountlake Terrace, WA 98043. Phone/fax: (206) 778-7100

FOR SALE: Recordio Wilcox-Gay Coronet console similar to Model 7D44, (Bunis 3), but with left-lift up lid for phone, right lift-up lid for recorder, lower left and right doors, center front tilt out dial, 14 tubes, works - \$95. Pick up only. Dick Desjarlais, Box 629, Littleton, MA 01460. (508) 486-9018

FOR SALE: Radio Amateur Call Book U.S.A., 1978-1980 - \$15 ea. QST in binders, mint condition, 1968 to 1975 - \$15 per year. Plus shipping via UPS. F. Krantz, 100 Osage Ave., Somerdale, NJ 08083-1136

FOR SALE: WE N.I.B. 247-A, 259-A, 274-A, 274-B, 301-A; RCA N.I.B. 2A3, 6A3, 802, 837, 843, 845, etc. Some used also. LSASE for list. Jim Robinson, K1ZJW, 46 Branch St., Scituate, MA 02066

FOR SALE: Variac Type W10, 0-140V, 10A; Powerstat 0-140V, 10A box mounted with meter - \$25 ea.; 1N1190 rectifiers 40 A 600V - \$4 ea. Carl Hackenson, 31 Hixson Farm Rd., Sharon, MA 02067. (617) 784-8834

FOR SALE: Plastic reproduction dial covers for AK 145, Belmont 6D111, DeWald S61, Emerson AM 169, 375, 400, 520; Fada 1000, General Television 534, Hallcrafters S-38, National 240D, Northern Electric B-5000, Zenith 8G005, and hundreds of others or will make yours - \$15 ppd. Doyle Roberts, HC63, Box 236-1, Clinton, AR 72031. (501) 745-6690

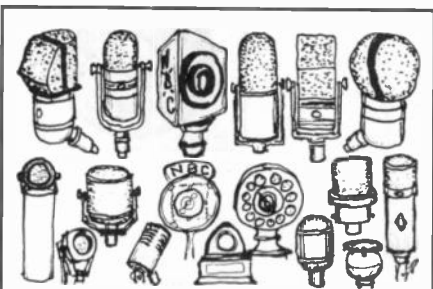

WANTED

FOR MY BROADCASTING MUSEUM

Microphones, stands, call letter plates. Tube amplifiers, mixers, compressors, Hi-Fi equipment. Speakers, on-air lights, equalizers. Disk, wire & tape recorders. Blank recording disks. Catalogs, magazines, manuals. 16" transcriptions, turntables, arms, pickups. Early TV cameras & receivers. Elaborate console, deco, plastic, mirror, novelty & wireless radios. Jukeboxes & parts. Acoustic phonographs.

We are looking for all makes of equipment, and especially *Western Electric*, *Telefunken*, *Neuharn* and *RCA*. The museum contains various duplicates and items surplus to our needs, and many of these articles are available for sale or trade. The collection is located in my Victorian seaside inn, The Caffrey House, situated on a bay next to the ocean, in the Southampton resort area of Long Island. A trade of equipment for a stay at the hotel is always encouraged.

Robert Van Dyke, 2 Squires Ave., East Quogue NY 11942
516-728-9835

FOR SALE: Grunow Model 500 - \$175. Used tubes: (5) 42 - \$5 ea.; (10) 26 ST - \$3.50 ea.; (5) 6L6 - \$3 ea.; (2) 6L6G - \$5 ea.; (20) 6V6GT - \$2 ea.; (4) 5U4G - \$3.50 ea. Plus UPS. George Jones, 1943 Palm Dr., Fernandina Beach, FL 32034. (904) 261-6533

FOR SALE: National FB7A with (6) extra coil forms and pair of (40) meter coils - \$525. Japanese 1-tube field xmitter, #95 Type 5 Model 32, good top leather flaps and ties - \$550. Garod Catalin 6AU1 Commander, yellow with red trim - \$1,100. Tim Rasset, 4109 38th Ave., Mandan, ND 58554. (701) 663-6620

FOR SALE: 1937 Stromberg-Carlson Art Deco mirror top coffee table radio Model 231F - \$500. Brian Morelli, 1932 Las Gallinas Ave., San Rafael, CA 94903. (415) 472-2866

FOR SALE: Rider's Radio Abridged Vol. 1-5, TV Vol. 1 - \$40 ea. plus shipping. Rich Jendrucko, 458 Hillvale Turn East, Knoxville, TN 37919. (423) 523-7323

FOR SALE: Choice radios, most all have been re-capped and are in excellent playing condition. Cathedrals: Apex 8A - \$200, Apex 7 - \$150, Clirbron 40 - \$200, Zenith L - \$300, Lyric S-6 - \$400, Gibranson rare - \$500, Echophone 80 - \$350, Philco 20 - \$375, Philco 118 - \$400, Philco 89 - \$150, Philco 89 - \$150, Philco 19 - \$300, Philco 80 or Junior - \$150, Philco 60 - \$200, Philco 70 - \$400, Philco 71 - \$450, Philco 91 - \$650, Philco 16 - \$550, Philco 43 - \$600, Atwater Kent 90 - \$500, AK 84 - \$450, AK 82 - \$300, AK 627 - \$650, AK 165 - \$300, AK 708 - \$550, AK 217 - \$350, AK 246 - \$350, AK 558D - \$650, AK 735 - \$450, RCA 100 - \$350. Tombstones: AK 856 - \$250, AK 337 - \$400, AK 854 - \$225, Zenith 807 - \$250, General Electric A-63 - \$175, Philco 610 - \$175, RCA T-8-14 - \$350. Consoles you haul away, all play well: Sparton 930 - \$75, AK 70 - \$75, Hoffman 8002A radio combo - \$50. Larry Dreyfuss, 11088 Crescent Dr., Nevada City, CA 95959-3447. (916) 273-0927

Frankenstein's Radio Laboratory

4010 Fairmont Parkway, Suite 285

Pasadena, Texas 77504

(713) 998-0130 or 24 hour fax# (713) 998-2207

PREMOVING SALE / STOCK UP

We are relocating to Florida this summer.

| VALUE | VOLTS | MANUF. | LEADS | SALE PRICE |
|-------|-------|------------------|--------|------------|
| 2.2uf | 450v | Rubycon | axial | \$.50 |
| 4uf | 150v | (N.O.S.) Sprague | axial | .30 |
| 4.7uf | 450v | ICC | axial | .55 |
| 10uf | 450v | Xicon | axial | .75 |
| 22uf | 160v | Rubycon | axial | .60 |
| 22uf | 450v | Xicon | axial | 1.20 |
| 33uf | 160v | Rubycon | axial | .90 |
| 47uf | 160v | Xicon | axial | 1.20 |
| 47uf | 450v | Xicon | axial | 2.00 |
| 50uf | 150 | CDE | axial | 1.30 |
| .001 | 600 | Sprague 715P | radial | .35 |
| .0022 | 600 | Sprague 715P | radial | .35 |
| .0047 | 600 | Sprague 715P | radial | .35 |
| .01 | 600 | Sprague 715P | radial | .45 |
| .022 | 600 | Sprague 715P | radial | .50 |
| .047 | 400 | C/MC | axial | .40 |
| .047 | 600 | Sprague 715P | radial | .55 |
| .1 | 600 | Sprague 715P | radial | .85 |
| .1 | 630 | Xicon | radial | .50 |
| .22 | 600 | Sprague 715P | radial | 1.30 |
| .22 | 630 | Xicon | radial | .60 |
| .33 | 630 | Xicon | radial | .70 |
| .47 | 630 | Xicon | radial | 1.25 |

Shipping to anywhere in the U.S.A. is a flat rate of \$ 4.00

WANTED: Amplion horn speakers, working S-C table radios. J. Finkelstein, 205 Alapocas Dr., Wilmington, DE 19803

WANTED: Chassis & speaker for Philco Model 80 Jr. Stephen Schaub, PO Box 1258, Peoria, IL 61654

WANTED: Copy of the Journal of the British Institute of Radio Engineers, VIII, 1948. John A. Benyo, 25 Schley St., Garfield, NJ 07026

WANTED: All microphones, cheapies OK, guitars, guitar amps effects, tubes, catalogues. Alex Pepiak, 330 Third Ave., Bellmawr, NJ 08031. (609) 933-0374. E-mail: alpep@aol.com

WANTED: Radio Shack magazines: 1970, 1972, 1974, 1978 & 1980. Thanks! Marty Dzik, 412 Gregory St., Schererville, IN 46375. (219) 322-4104. E-mail: marty_dzik@calunet.com

WANTED: Motorola 9R cylindrical console. Tom Kleinschmidt, 506 N. Maple St., Prospect Heights, IL 60070-1321. (847) 255-8128

WANTED: Hallicrafters SX-115 receiver. James Olson, 3442 N. Cook Rd., Powder Springs, GA 30073. (770) 429-8189. E-mail: jolson@intergate.net

WANTED: Spark transmitters and loose coupler type crystal receivers; anything prewar Japanese steamships related, like N.Y.K. Takashi Doi, 1-21-4, Minamidai, Seyaku, Yokohama, Japan. Fax: 011-8145-301-8069

WANTED: I will pay to rent or buy outright your advertising brochures ca. 1930-1960 to be used in my next book. I also need issues of Radio Retailing and Radio Today from the same period. Again, I will pay for the privilege of scanning your materials and will return them to you promptly, safely and intact. This reference will be only as good as you help make it. Please help! Contact: Mark V. Stein, 2109 Carterdale Rd., Baltimore, MD 21209. (410) 466-2814. E-mail: Radioman@cais.com

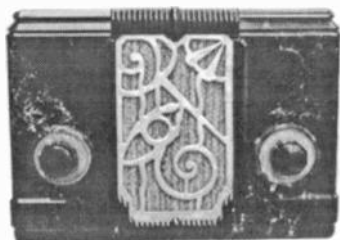

WANTED: Early (prewar II) plastic radios. I collect these objects of beauty to enhance my otherwise dull and uneventful life to which I am forever bound by by sad-but true unworthiness and shortcomings: physical, emotional, and intellectual. Please write or call collect: Rain Buttignol, 214 State St, #7, Portsmouth, NH 03801. (603) 427-1384

WANTED: Eico catalogs, amateur radios, and CBs. Tom Bonomo, 81 Lakewood Cir., San Mateo, CA 94402. (415) 578-1897

WANTED: Crystal sets, collection now at 367 pieces; seeking more. Erwin Macho, Ambrosweg 17/A/8, A-1230 Vienna, Austria

WANTED: Allied Radio catalog from late 30s to early 40s. Socket for WD11 tube. Jack Ghere, 1753 Community Beach Rd., Odin, IL 62870. (618) 532-5548

WANTED: Heathkit receiver SB-301 or SB-303 in good or better condition. Jorge Liacer, 215 Pomona Ave., El Cerrito, CA 94530. (510) 528-0354

WANTED: Admiral collectors, I am looking for sales literature from the 1956/57 line of Admiral TV's. In particular for a model known as the Granada, prefer buying the actual literature but will consider copies. Also looking for the TV in mahogany finish but will consider blonde, working or not. Al Tobia, 5692 Abington Dr., Newark, CA 94560



WANTED: Zenith 500/600 Series radios or any Zenith/Intercean radio with the escutcheon illustrated manufactured 1932/1933. I'll pay at least \$300 for any restorable set I can add to my collection. Will be at Elgin. Martin Blankinship, PO Box 157, Lecompton, KS 66050. (913) 887-6560

WANTED: Need Aeriola Jr. detector, Radiola 5 detector, Bowman Airphone dial, Crosley binding post tops, Federal DX 58 cabinet. Merrill Bancroft, 169 S. Row Rd., Townsend, MA 01469. (508) 597-6623

WANTED: Navy ship's receivers: RAL/RAK type radios, manuals, power supplies. Parts & lists. Send quotations: Ross Marshall, Plutonium Films Prod. Inc., 8055 Lankershim Blvd. #2, N. Hollywood, CA 91605. (818) 504-4135. E-mail: ross@pacifcnet.net

WANTED: Crosley 124 chassis, knobs, escutcheon for 124 Playtime grandfather clock radio. Barry Kasindorf, 1 Heights Rd., Franklin, MA 02038. (508) 528-0026. E-mail: bkasindorf@bix.com

WANTED: Lists of radio stations pre-1980, including World Radio Handbook, Broadcasting Yearbook, Whites Radio Log (including photocopies). Ralph Marson, 8070 Busch, Centerline, MI 48015. (810) 754-3808

WANTED: Restoring Grebe MU-1. Need tone control switch assy., dual resistance element volume control assy. and tuning chain with attachment parts. All items to be in good condition. Jim Briscoe, 6972 Crestview Ln., Hillsboro, OH 45133. (513) 393-9624

WANTED: Correct original electrodynamic speaker for Hammarlund SP-110, 1937 model, preferably in black wrinkle finish cabinet, original power supply to radio wiring harness and any literature about this radio, especially any pictures of the bottom view of the chassis wiring. Interested in a dead unit for parts. Also wanted, an original cabinet and front panel for a National NC-183. Will consider a parts or dead unit if cabinet is good. Jim Garrett, PO Box 442032, Houston TX 77244. (713) 589-2444

WANTED: Cabinet for 1938 Silvertone midget Model 3051, walnut plastic, or Model 3251, beetle plastic. Matt Limpert, 4519 Saint Joe. Center Rd., Fort Wayne, IN 46835. (219) 485-6352

FOR SALE: DeForest spherical Audion, double wing, 1 good filament, cloudy glass, air?, good leads, with porcelain display socket - \$450. Craig Smith, 1935 1st Ave. South, St. Petersburg, FL 33712. (813) 822-7592, days

FOR SALE: Very good horn only for Radiola speaker Model UZ1325 - \$30 plus. Elwood Hunt, 308 Georgetown Rd., Carneys Point, NJ 08069. (609) 299-5259

FOR SALE: Heathkit IT-17 tube tester with manual & supplement, excellent - \$50. Eico 625 tube tester, very good - \$40 + shipping on both. Mike Piskunoff, 6132 Bellevue Dr., NE, North Olmsted, OH 44070. (216) 777-3498. E-mail: jukebox1@ix.netcom.com

FOR SALE: Manuals: Most Often Needed TV Service '47 thru '58 with index, 14 vol., '46, '47, '48 Zenith auto radio service manuals. 1941 Motorola Auto Radio Dealer display book, incl. 4 factory service booklets. Sams TSM 97. Circa 1934 Howard Models D and F service manual. RCA Tube Manual RC 18. Army, Navy, Air Force electronic books S&H extra. William L. Clark, 15476 Wellington Pl. Dr., Basehor, KS 66007. (913) 724-1203

FOR SALE: N.I.B. Allied receivers, Models A-2515A five-band AM/CW/SSB 150 khz to 30 MHz and A-2589 VHF-FM 30 to 50 and 152 to 174 MHz - BO. Allan Haasken, 8422 Berea Dr., Vienna, VA 22180. (703) 560-4869

FOR SALE: Stromberg-Carlson tombstone Type 60 - \$165. Tuska 225 double panel, warped lid, wrong knob - \$480. DeForest D10 no coils, wrong loop - \$450. Western coil WC10 - \$375. Ross Mason, 715 S. Penn, Mason City, IA 50401. (515) 423-4687

FOR SALE: Rare book, From Semaphore to Satellite, 1965, 100 year history of the International Telecommunications Union - \$65 postpaid. Jim Sandberg, 1138 Rustic Rd., Escondido, CA 92025. (619) 745-6940

FOR SALE: David Grimes 4DL, 1924, excellent - \$250. **WANTED:** Regency TR1. 5+ page radio/early TV sale list - \$1. Don M. Maurer, 29 South 4th St., Lebanon, PA 17042. (717) 272-2481

FOR SALE: Two Remler Scottie radios, both with minor problems - \$80 ea. Emerson 520 Catalin - \$620. Arvin 444 metal set - \$35. Arvin 540 metal set, green - \$60. A few transistors, send SASE for list. Bob Furtado, 23 Garden Rd., Alameda, CA 94502. (510) 521-3084

FOR SALE: Battery stuff: Two Pilot tuning dials w/ knobs, scaled 0-100. Silver-Marshall No. 255 audio transformer for use between detector and 1st audio tubes, SM256 audio Trans-O, use between 1st and sec. audio tubes; SM 258 push-pull output choke, Apollo audio transformer, Pilot No. 391 audio trans. Pilot No. 394 audio transformer, Senator No. 2257 push-pull input trans. (By Silver-Marshall). All above test good. These test bad: Supreme audio trans, Jefferson audio, and Fada audio; display only. N.O.S. tube socket adapters, 4 pin to 6 pin, etc. 15" Magnavox spkr, needs reconed. Richard R. Bruning, 1901 U.S. Hwy. 150N, Apt. B, Galesburg, IL 61401. (309) 344-1968

FOR SALE: 1929 RCA Theremin - Best Offer received by June 1, 1996. Fred Geer, 6042 Brookridge Rd., Jacksonville, FL 32210. (904) 771-7828

FOR SALE: Crosley plastic table radio Model E-15-CE, lime green, real nice - \$200. Crosley book radio Model JM-8-GN hybrid - \$325. Zippo pocket lighter, circa 1940s - \$100. Bill Constantine, PO Box 493, Glens Falls, NY 12801. (518) 792-7065

FOR SALE: Electrola Borgia II cabinet, 1925 xint - \$400. Books by Terman, etc. + ship. Agreed? Renee May, 1242 N. El Cetro Ave., Los Angeles, CA 90038

FOR SALE: Tubes, radio, TV, 40's thru 50's, SASE for list. Lee C. Dickinson, 401-3 Talcottville Rd., Vernon, CT 06066

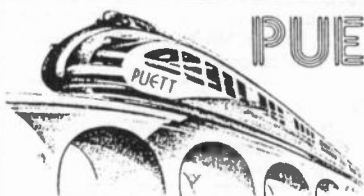

PUETT ELECTRONICS

P.O. BOX 28572 DALLAS TX 75228

NEW CATALOG 77



CATALOG 77/PLL-2 (56-PAGES) ----- \$5.00 POSTPAID

YOU RECEIVE A \$6.00 DISCOUNT COUPON WITH THIS CATALOG!

MORE THAN 1,500 DIFFERENT ANTIQUE RADIO PUBLICATIONS FROM 1902 TO THE 1960'S OFFERED, REPRINTED BOTH SIDES OF THE PAGE AND BOUND!

WE OFFER BOOKS, INSTRUMENT MANUALS, SERVICE DATA, SALES BROCHURES, ATWATER KENT, RCA, CROSLY, ZENITH, ETC. FACTORY SERVICE MANUALS, SCOTT, MC MURDO SILVER, STROMBERG CARLSON, CAPEHART, FISHER CLASSIC RADIO LITERATURE, DIRECTORY OF ANTIQUE RADIO SERVICES, SCHEMATIC DIAGRAMS, OLD TIME RADIO PROGRAMS ON CASSETTES, TUBES, TUNING DIALS, KNOBS, 30-SERVICES & DISCOUNTS WITH THE PUETT ELECTRONICS ANTIQUE RADIO CLUB AND MUCH MORE - ORDER YOUR CATALOG TODAY!

OUR NEW BOOK "THE WORLDS LARGEST RADIOS" IS NOW AVAILABLE, PHOTOS, SCHEMATICS, BY J.W.F. PUETT - \$14.95 PLUS \$2.00 HANDLING. INCLUDES SCOTT, MC MURDO SILVER, PHILCO, RCA, ZENITH, LINCOLN, FREED EISEMANN, FISHER, MEISSNER, MAGNAVOX, CROSLY + MANY MORE!

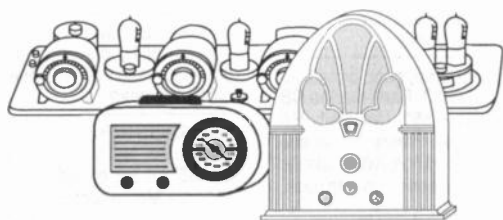

Come visit

ANTIQUE RADIO CLASSIFIED

at the 45th

Dayton Hamvention

May 17-19, 1996

at the HARA Arena, Dayton, Ohio

Exhibit Hours: Friday Noon - 6 pm

Saturday 8 am - 5 pm

Sunday 8 am - 2 pm

Browse through our books...

Renew your subscription...

Become a subscriber...

Chat with your Editor.

**Now - 7 books
available on
Ham
Equipment**

We are at Booth #207

**Also visit New Wireless Pioneers at
Booth #206 and look over their old books,
magazines, and catalogs.**

**Last year's show drew over
35,000 attendees!**



For Info: A.R.C., P.O. Box 2, Carlisle, MA 01741

or Call: (508) 371-0512 Fax: (508) 371-7129



FOR SALE: Spring clearance \$20 each. Zenith 5D011ZY, Motorola 10P 28D, Emerson 541, Bendix 526. Philco 49-505. Zenith L520G - \$15 ea. GE 122, Regency MR33, Motorola 5C. Bob Masterson, Box 172, Valley Cottage, NY 10989. (914) 353-3151

FOR SALE: Spectra tube guitar amp, good condition, made by Dean Markley - \$150 OBO. Early marine CB N.O.S. Dolphone by Unimetrics - \$50. University PA horns N.O.S. Type 8A - \$15 ea. Prewar Japanese tombstone Hermes, nice original condition, AWA Bakelite tombstone (like Air King), very nice condition with back. **WANTED:** Pilot radios, any model, any condition, tubes & literature. Bill Moore, 3049 Box Canyon Rd., Huntsville, AL 35803. (205) 880-1207

FOR SALE: Philco 39-19 PCS (Ramirez, p. 114) chair-side, original finish in excellent condition - \$70 shipable. General Electric clock 7H80 butterscotch Catalin, working - \$50. True-Time tellers windup clock in black Catalin and Plaskon case, works - \$40. Philco 600 surround wood cabinet, works, nice original finish - \$70. Regency RC600 UHF converter, mint - \$20. Westinghouse WR-205 tombstone, electronically redone 8-tube monster, nice 2-tone original finish - \$90. All plus S/H F.O.B. Swarthmore. Sam Mannino, PO Box 233, Swarthmore, PA 19081. (610) 353-6747

FOR SALE: Tubes, schematics, service notes, Riders, Sams Photofact Folders and Transistor Books, etc. for early radios. LSASE for price list. Sam Faust, PO Box 94, Changewater, NJ 07831

FOR SALE/TRADE: Sony U-matic VCR, professional 3/4" Model VO-2610 with about (20) cassettes, exc - \$140. Pick up only (heavy). John Walch, 381 Co. Rt. #17, Bernards Bay, NY 13028. (315) 675-8135

FOR SALE: Crys Tech Report No. 3 on crystals and crystal detectors. Includes historical background, compares early day and modern materials, plus applications. Discusses crystal properties, with details on how to make your own and how to use them. Also describes detector stands then and now, and how to build them. Order Report No. 3 for - \$4.75 ppd, from: Crys Tech, c/o P.A. Kinzie, PO Box 6805, Kingman, AZ 86402

FOR SALE: (25) old panel meters from 1920-40's - \$25 plus UPS. Also have knobs, S-meter, power transformer for SX-28 and HV transformer for Globe King 500. Ron Franzen, 4307 Wild Ivy Ct., Arlington, TX 76016. (817) 451-5282

FOR SALE: Pathé cathedral - \$495. Dynaco 400-watt #416 - \$450. Antique 25c slot machine - \$1,300. List LSASE. Richard Bednarck, 28 Steele Ave., Lincoln Park, NJ 07035. (201) 694-6374

REPLACEMENT DRIVERS FOR ATWATER KENT HORNS

Driver w/housing for Model M & Pooley horns (this assembly replaces all pot metal) \$65.75 + \$4.75 s&h

Driver w/repair ring for Models G, H, & L (repair ring replaces threads in base) \$59.85 + \$4.75 s&h

All drivers above include diaphragm, gaskets, spacer, and spring. All parts are also sold separately. Send SASE for price list.

M. Harold Ezzone, 4861 Park Drive
West Des Moines, IA 50265 — (515) 221-9447

FOR SALE: Sterling R403 vacuum tube reactivator - \$25 plus. Elwood Hunt, 308 Georgetown Rd., Carneys Point, NJ 08069. (609) 299-5259

FOR SALE: Silvertone 7002, beetle plastic (Machine Age, p. 181), cracked but still nice - \$225. David Mednick, 1450 Palisade Ave., #5H, Fort Lee, NJ 07024. (201) 461-3082

FOR SALE: B&K counter Model 1827 w/manual - \$50. EMC tube tester - \$20. OS-8 oscilloscope - \$45. LSASE for list of radios, etc. Stan Lopes, KB6LGV, 1201-74 Monument Blvd., Concord, CA 94520. (510) 825-6865. E-mail: splopes@aol.com

FOR SALE: Loose coupler, in good condition - \$150. Buyer pays shipping and handling. Jim Barrows, 15121 41st Ave. SE, Bothell, WA 98012-6113. (206) 337-4880

FOR SALE/TRADE: Old Crow, Silvertones, Model-1, Model 8003, both - \$100. Paul Steingel, 2153 10th West, Seattle, WA 98119-2844. (206) 284-8412

FOR SALE: Unique lighted counter sign "Auto Radio Service" with built-in tube, vibrator tester, mint, with original box - \$175. Fisher 500-C tube-type FM receiver - \$215. Plus shipping. List of others - LSASE. Ernie Nagy, PO Box 822, Elk Rapids, MI 49629. (616) 264-9412

FOR SALE: Does anybody need Allied 69, Lafayette 69-72-73 catalogues. Florian Rogowski, 25103 Cunningham, Warren, MI 48091

FOR SALE: Triplett 3423 mutual conductance tube tester, portable case, serviced, working fine - \$85 + UPS. Alan J. Kriss, 1872 Portsmouth Way, Union, NJ 07083. (908) 688-2092

FOR SALE: Repairable, missing parts - \$5 ea.: Precision 612 tube tester, E200C signal generator, Heath QF-1, IM-28 VTVM, Plus UPS. Jim Clifford, KE4DSP, 108 Bayfield Dr., Brandon, FL 33511. (813) 654-7531

FOR SALE: Catalogs, books, manuals. Test equipment. Send for list. H.N. Felder, 7517 Granada Dr., Bethesda, MD 20817

FOR SALE: Zenith R-7000-2 Trans-Oceanic, nearly mint - \$300. Royal 3000-1, excellent - \$150. Dan Merz, 312 Sierra St., Richland, WA 99352. (509) 375-1334

FOR SALE: Thinning out my collection of antique, transistor and novelty radios. LSASE gets my list. Hank Trabold, 2058 Nakiska Ct., Toms River, NJ 08755. (908) 244-2345. E-mail: trabold@exit109.com

FOR SALE: Projection bulbs, N.O.S., prices - \$7-\$12. Call for availability. Bob Putnak, 1507 4th St., Monongahela, PA 15063. (412) 258-6236

TUBES WANTED

HIGHEST PRICES PAID \$\$\$

101D, F.205D, F. Tennis Ball. 300B, 274B, 211, 845, KT66, KT77, KT88, EL34, PX25, 280, 250, 102F, Telefunken, Bugle Boy, Mullard, ECC81, 82, 83, 801S, 802S, 803S.

— AUDIO EQUIPMENT WANTED —

Fisher, Scott, Dynaco, McIntosh, Marantz, JBL, Altec 604, B, C, D, E, 515, B, C, 288, B, C. UTC trans.; Black Beauty, A&B Resistor, etc...

FULL RANGE ELECTRON TUBE SHOP

Jonathan Woo Yik Fan
Flat B, 37/F, Block 5, Greenfield Garden
Tsing Yi, NT, Hong Kong
Tel: (852) 24349466 - Fax: (852) 24344963

WANTED: Tube hi-fi amps, preamps, speaker, etc. McIntosh, Altec, Marantz, Fisher, Scott, Leak, Quad, Lansing, Jensen, JBL, Electro-Voice, Western Electric, etc. Also tubes: KT-66, KT-77, KT-88, EL-37, WE 300A, 300B, 350, 274, 275, 845, 211, etc. Sonny Goldson, 1413 Magnolia Ln., Midwest City, OK 73110. (405) 737-3312, fax 3355

WANTED: FM converter that allows old 41-50 FM band radios to tune modern 88-108 FM. One unmarked unit used three Western Electric 717A's but all considered. Charles Combs, 508 E. Daniel, Albany, MO 64402. Phone/fax: (816) 726-3038

WANTED: N.O.S. volume controls. Larry Daniel, 706 Pearson Rd., Wright-Patterson AFB, OH 45433. (513) 754-1567

WANTED: Info on small Sonora cathedral, 15 inches high, early 1930s, model unknown. I have cabinet, need chassis. Chuck Regen, 2724 N. 27th St., Sheboygan, WI 53083

WANTED: Chassis and speaker for Philco 118 or junker with same. Dave Gonshor, 7121 S. Jellison St., Littleton, CO 80123. (303) 979-9511. E-mail: david.v.gonshor@den.mmc.com

WANTED: Philcos 87 and 116 chassis. Variac or variable transformer. Carlos Martinez, #21 Colonel Irizarry St., Cayey, PR 00736. (787) 263-2741



WANTED: Fada Catalin radios. Help! My entire collection spontaneously combusted during an interview with the "Enquirer." Replenish and repent ye sinners. Please write or call collect: Rain Buttignol, 214 State St, #7, Portsmouth, NH 03801. (603) 427-1384

WANTED: ARC 5 equipment, R25 1.5-3Mc rcvr, T17, T18 trans. Pete Hamersma, WB2JWU, 87 Philip Ave., Elmwood Park, NJ 07407

WANTED: TV-7 tube tester military type or Hickok. Must be complete and working. John T. Meredith, 2462 Stantonburg Rd., Suite 152, Greenville, NC 27834. (919) 551-1882

WANTED: Emerson BA-199 Bakelite, no cracks w/ back. Karen McCoy, 8104 N.W. 114th St., Oklahoma City, OK 73162. (405) 722-0595. E-mail: kcmccoyok@aol.com

WANTED: Ozarka 95. Will pay top cash. Also early electric, battery water-powered fans. Rick Padron, 1005 E. Idlewild Ave., Tampa, FL 33604. (800) 320-3267

WANTED: Wooden sets with metal grilles or trim. Jay Malkin, 1250 Galapago, #206, Denver, CO 80204. (303) 623-6451

WANTED: Knob for the bandswitch on a National NC-300. Harold Sullivan, 15300 Prairie Rd., Andover, MN 55304. (612) 434-3003

WANTED: NFL football helmet radios. I am looking only for: New York Jets, New York Giants, Phila. Eagles, Seattle Seahawks, and San Diego Chargers. I'll treat you right and pay for the call. Scottie McElroy, KC5MTM, 2309 Driftwood, A1007, Mesquite, TX 75150. (214) 279-6138

WANTED: ARC R-11, R-23, R-148, BC-453, any condition; 85kHz IF transformers; unused 5AP1 CRTs, magnal sockets. Bruno R. Ruchalski, PO Box 2153, Clifton, NJ 07015

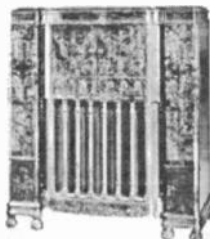

WANTED: This Stromberg-Carlson Model 74, any parts of same, or any information as to one's existence for research and/or collection. Finders fee. Also Models 734, 744, (early AC); #2 console neutrodyne, 2A horn, 240S, 145SP, 160P, consoles. Other S-C's sought, inquire. Will pick up. Always want S-C paper, ephemera. John M. England Jr., PO Box 59136, Schaumburg, IL 60159. (708) 823-5287

WANTED: Manuals, etc. for auto testing equipment. Acroset VA-3 and Fidelity coil & condenser. David Edyvean, 2508 Campbell Ave., Schenectady, NY 12306

WANTED: Workman Electronics FRT2 universal glow-bar disc varistors. Allied Knight KG-687 manual. Harry Weber, 4845 W. 107th St., Oak Lawn, IL 60453-5252

WANTED: Book: Joy of QRP by Adrian Weiss, Milliwatt. Patrick Franzis, 235 Milville Ave., Naugatuck, CT 06770. (203) 723-8976. E-mail: franzis@gdc.com

WANTED: (1) box #223 mini lamps. Also wanted Science Fair bell/buzzer code kit. Tom Farkas, 14847 Fremont Ave., Seattle, WA 98133. (206) 363-7980

One Month Free!

BONUS FOR EARLY RENEWALS

If you renew before the month shown on your mailing label (your expiration month), you will receive an extra month on your subscription: 13 months instead of 12! 26 months for an early 2-year renewal!

WANTED: Dial diagram and original type string for Majestic 70B. Schematic for Pioneer SX950 receiver. Ray Barnes, 38 Woodmere Rd., Framingham, MA 01701

WANTED: Zenith 9S324. Also any good 1938-1941 Zenith 8-inch electrodynamic speakers (with output transformer mounted). Almost any part number will do. Armand Cote, 6 Sycamore Ct., Atkinson, NH 03811-2727. (603) 362-8715

FOR SALE: Beautiful Emerson Ingrahams—\$75. Bulova 672—\$55. Philco 37-602—\$50. Motorola 53H, grey, repainted—\$50. 53H black—\$75. Crosley 56TD, crack—\$60. Junk lot (10) radios—\$75. Working video camera—\$125. Bob Masterson, Box 172, Valley Cottage, NY 10989. (914) 353-3151

FOR SALE: Keuffel & Esser collectibles, books, ham stuff, callbooks, catalogs, textbooks, manuals, literature. SASE list. Bill Tucker, W4FXE, 1965 S. Ocean Dr., Apt. 15-G, Hallandale, FL 33009. (954) 456-1349

FOR SALE: Hardy Boys, The Shortwave Mystery, 1945—\$15. Bearcat 800 XLT—\$200. Mike Brillhart, 12551 Maiden Creek Rd., Abingdon, VA 24210. (540) 944-4387

FOR SALE: Airlite 62-316, table, wood, off center oval dial, tuning eye, left cloth grille, w/Deco cutouts, 3 knobs. Delco R-1246 console R/P 1948, mahogany, upper slide rule dial, and grille, center phono storage, 4 knobs, BC, AC. Philco 37-630, console, 1937, wood, recessed front, upper round dial, lower cloth grille, w/3 vert. bars, 4 knobs, BC, SW, AC. Philco 48-1262, console 1948, two-tone wood, slanted slide rule dial, 4 knobs, lower tilt-out phono, BC, AC/DC. RCA 8BX6, Globe Trotter, portable, 1948, aluminum and plastic, upper front slide rule dial, lower horizontal grille bars, thumb wheel knobs, handle, BC, AC/DC/battery (B274). Zenith B513Y table, 1957, plastic, lower right dial, large front oval grille w/vert. bars and center crest, BC, AC. Charles E. Austin, 630 East 10th Ave., Hutchinson, KS 67501-6325. (316) 662-6858

FOR SALE: Hallicrafters SX-99, nice—\$125. SASE for large list of equipment/parts/publications. Chase Hearn, 104 Glenwood Dr., Williamsburg, VA 23185. (804) 229-7236

FOR SALE: Fairchild oscilloscope camera Model F-286 (Polaroid), complete in case—\$50 plus UPS. Jack A. Freeman, 2512 Sunnycrest Dr., Reidsville, NC 27320

Introducing

Exciting New

ZENITH Grille Cloths

Authentic reproductions based on original patterns using original materials

- Zenith 'block,' 'swirl' and 'leaf' patterns for those shutterdial consoles, Walton tombstones, and Deco sets are available NOW!
- New brown 'big waves' generic pattern - just right for all those consoles. See it to believe.
- More Philco patterns - new "weathered look" series now available.
- 20 additional patterns for GE, RCA, Emerson, Stromberg are also available.
- Satisfaction or money back guarantee.
- Free installation instructions with every order.

Now on the World-Wide Web at <http://www.libertynet.org/~grcloth/>

Send a \$5^g LSASE for samples to:

John Okolowicz, N3VSR
624 Cedar Hill Rd.
Ambler, PA 19002

E-mail: 70313.2564@compuserve.com

FOR SALE: Vintage 1926 Cunningham CX-299 detailed tube information supplied with original tube purchase, collector interest, Xeroxed, 10 paragraphs long, diagrams—\$1 + LSASE. C. Hill, 6934 Orion Ave., Van Nuys, CA 91406

FOR SALE: Bulova-Comet 620, ivory, vg to excellent—\$100. Top Flight, boys blue and white—\$60. Coronet, B&W—\$40. Tamatone, N.I.B.—\$60. Angel, white—\$50. Angel, black—\$50. Septre, white—\$60. Holiday Deluxe, boys, white—\$60. WANTED: 2 transistor radios! Gary Willoughby, 5930 W. Jefferson Blvd., Los Angeles, CA 90016. (310) 559-0706. Fax: (310) 836-6518

FOR SALE: Philco 80 cathedral—\$90. Fada 252 wood Temple—\$150. GE A53 tombstone—\$75. WANTED: Amperite SR-80 microphone. Dennis Schrank, 3129 S. Quincy Ave., Milwaukee, WI 53207. (414) 744-3374. Fax: (414) 744-8780

FOR SALE: Vassos 1939 RCA 96X-1, exc—\$225. Truetone metal Deco set, woodgrain finish, chrome accents—\$125. Standardyne B-5 w/O1-A's—\$90. King-Hinner neutrodial w/O1-A's—\$100. Radiola 111A, no tubes, (1) bad tube socket, otherwise very good—\$130. Several excellent Arvin, Silvertone, Kent, Temple metal sets, (2-tube Arvin!)—\$65 to \$175. AK E speaker—\$70. Several unknown horn parts, cail. Tubes (balloon, ST) tested good on Precision 10-12: O1-A—\$9; 45—\$20; 26, 71A—\$6; 24A, 27, 80—\$3. Many other tubes, knobs, parts, call (no list). All items plus shipping. Paul Ernst, 238 Meadow Ln., Webster, NY 14580. (716) 787-9879

FOR SALE: British tube hi-fi: Leak Stereo 20 amplifier, fully restored—\$1,000. 1 pair of Quad II amplifiers, fully restored—\$1,200. Rogers HG88II integrated stereo amplifier, fair condition—\$400. Croft V stereo amplifier, mint condition in box—\$1,000. (500) N.O.S. tubes assorted—\$300. All items plus shipping. Michael Wharton, 1122 Hiland Ave., Coraopolis, PA 15108. (412) 262-2580

300+ STALLHOLDERS

will be exhibiting at the 5th annual

National Vintage Communications Fair

NEC, BIRMINGHAM • UK

• Sunday 5th May 1996 •

10.30am - 5pm

Britain's premier event for buying

VINTAGE
RADIO,
EARLY
TVS, and
GRAMS



etc. etc.

For further details/bookings:

NVCF, 2-4 Brook St, Bampton, Devon, ENGLAND

Telephone: (01398) 331532

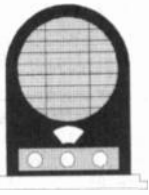

*Society for Preservation of Antique Radio Knowledge
Presents:*

RadioRama 96

A Show, Swap Meet, and Gathering for Antique Radio Enthusiasts.

Cincinnati, Ohio - June 21 & 22, 1996

Host Hotel:

Signature Inn
Turfway Road
Florence, KY 41042
(606) 371-0081

Exit 182 off I-75

10 minutes south of Cincinnati

2nd exit south of I-275

Room Rates: \$49.95

Within walking distance of many restaurants

Thursday:

Hospitality Session 6:00 - 9:00 PM

Friday:

Swap Meet starts at dawn

Open Exhibition 10:00 AM - 5:00 PM "Fantastic Plastics"

Seminar: 7:00 PM "ABC's of Plastic Radios" by B.A. Richard

Saturday:

Swap Meet starts at dawn

General Admission: \$5.00 per family (All at one address)

Vendor Fee: \$15.00 per space
which includes 2 general admissions.

FOR SALE: LSASE for list of new/used receiving tubes; octal, loctal, miniature, some older. Sell or trade for old or unusual tubes or related material for my collection. John H. Walker, Jr., 16112 W. 125th St., Olathe, KS 66062. (913) 782-6455

FOR SALE: Grundig SO-290U/S, Variac 230V-2KVA Hallicrafters S-47, kilowatt amplifier tubes-components, cables galore! Francis H. Yonker, W2IBH, 1229 Inverary Pl., State College, PA 16801. (814) 867-1400

FOR SALE: Trav-Ler 1925 portable, 199 tubes, (V.R., p. 136) - \$220 plus UPS. Dale Parsons, 5312 Koontz Dr., Cross Lanes, WV 25313. (304) 776-2180

FREE - 20 WORD AD EACH MONTH
To get your free 20 words,
include your SUB# with your Ad.
Additional words are 25¢ each.
Read inside back cover for details.
MANY THANKS!!!!

FOR SALE: Arvin metal midget - \$75. Standard Micro Ruby SR-H436 - \$115. Norman M. Landis, 1315 Marbendale Ct., St. Louis, MO 63122-6932. (314) 821-7933

FOR SALE: Ham magazines 1955 to 1980. QST. Sams PF Reporter. Sams PF Index. Ham Radio Horizons. Radio Electronics. Electronics Technician. Electronics World. For the price of UPS. ARRL 1943, 57, 63, 66, 68, 80, ARRL SSB 58. All for \$35. Bill Coolahan, 1450 Miami Dr., NE, Cedar Rapids, IA 52402-2933. (319) 393-8075

FOR SALE: Ancient radio test instruments. General Radio, Jewell, Westinghouse. Wood cases. For list contact: Bill Leggott, Box 501, Bowmanville, Ontario, Canada L1C 3Z2

FOR SALE: N.I.B. Sylvania/RCA 6EU7 tubes - \$8 ea. **WANTED:** Transformer for Zenith 6A20. Bill Jewell, 6828 Trinity Landing N, Fort Worth, TX 76132. (817) 294-9061

FOR SALE/TRADE: 1925 battery set, Murdock Mod 26, exc shape, includes tubes - \$150. Paul Fulton, 711 Jacquelyn Rd., Westwood, NJ 07675. (201) 664-5260

FOR SALE: Philco 57, small Deco wooden set, nice - \$60. R. Burick, 274 14th St., #1, Ambridge, PA 15003. (412) 266-4516

FOR SALE: Sony Micro trans. Mod 1R-81, white, untried - \$40. Silverstone tombstone Mod 1955, BC/SW, works - \$75. + shipping. Raymond Humphreys, 904 Jackson St., Macon, MO 63552. (816) 385-2821

FOR SALE: Transistors: Red Channel Master 6515 - \$35; Sony TR-4100 - \$25; Zenith 3000-1 service manual - \$7; R-600 Trans-Oceanic - \$75. Matthew Hinson, 1663 Bridge St., Merrick, NY 11566. (516) 379-3601

FOR SALE: Speakers! Speakers! Speakers! Check these out: Rola Recreator horn, clean and working - \$165. Saal Symphony Grand, gold/red, beautiful - \$200. RCA Type FH, hard to find, nice - \$275. RC UZ-1320, the rare one, immaculate - \$200. B.S.C. Co. nickel-plated headphone type, rare - \$250. Tower miniature celluloid midget, clean - \$150. Bosch Ambortone Jr. cone speaker, nice, works - \$90. Crosley Musicone Ultra, the small one, mint, with original dealer tag - \$125. RCA Radiola 103 "tapestry," very, very nice - \$150. Jewett Superspeaker horn, clean & original - \$185. Pausin Octacone, excellent condition, nice looker - \$65. DeForest LS-400 cone spkr, extremely rare - \$185. Ramo small horn spkr, N.Y., cute little horn - \$150. Tower ship speakers, all three sizes - \$200, \$150 and \$125. Manhattan Elect. Co. Symphonic horn (see AWA for Feb. 96, p. 10), unique piece - \$550. Dave Crocker, 6 Raymond St., Sandwich, MA 02563. (508) 888-6236, before 9 pm

FOR SALE: Instruction manual for 1942 Jefferson-Travis marine radiotelephone Model 101. Doug Wright, 1343 Hoffman Ln., New Braunfels, TX, 78132. (210) 625-5577, after 5 pm

New Wireless Pioneers Books, Magazines, Literature Bought and Sold

New Wireless Pioneers buys and sells books, catalogs, magazines and other literature from the 1800's to 1950 that deal with early radio, wireless and electricity. A selection from our list of specialties:

Pre-1900 Electricity
Pre-1925 Radio or Wireless
Pre-1950 Computers

Pre-1900 Telegraphy
Pre-1940 Television
Early X-Ray

Magazines, Catalogs, Autographs or Ephemera related to the above topics. Also: Pre-1920 Wireless and Telegraph Apparatus - Radio-Related Novelties and Advertising - Early Vacuum Tubes and Electrical Devices.

Some items available in other technical subject areas also.

Several catalogs featuring items for sale are published each year.

New Wireless Pioneers - Jim & Felicia Kreuzer

P.O. Box 398, Elma, NY 14059

(716) 681-3186

WANTED: Old guitars, guitar amplifiers, microphones, compressors, effects pedals, etc. Fender, Gibson, Vox, Pultec, Altec, Gretsch, RCA, Rickenbacker, Martin, etc. Sonny Goldson, 1413 Magnolia Ln., Midwest City, OK 73110. (405) 737-3312, fax 3355

WANTED: Industrial/special purpose tube manuals or pamphlets. Also any odd or unusual tube types. Will pay \$100 for Eimac 500T tube. John H. Walker, Jr., 16112 W. 125th St., Olathe, KS 66062. (913) 782-6455

WANTED: RCA AVR5A, AR60, Western Electric, National AGS, anything marked Bureau Air Commerce. James Treherne, 11909 Chapel Rd., Clifton, VA 22024. (703) 830-6272. E-mail: treherne@erols.com

WANTED: Regency TR1 any color, uncracked and complete. Will pick up within 150 miles N.Y.C. Eugene Ladisky, 175 West 76th St., New York, NY 10023. (212) 496-9827

WANTED: FM tuner chassis and two knobs for Stromberg-Carlson 535-M console. Rick Taylor, 4201 Shady Oak Dr., Ooltewah, TN 37363. (423) 855-0174

WANTED: Eveready radios, speakers, old flashlights, flashlight catalogs, related items. Subscribe Flashlight Newsletter - \$12 year. Bill Utley, PO Box 4095, Tustin, CA 92681. (714) 730-1252

WANTED: Working Zenith chassis Number 1206 and speaker for 12S370. One mahogany AR02 speaker. Gary Williams, 3449 Lancaster-Kirkersville Rd., Lancaster, OH 43130. (614) 756-7340

WANTED: Motorola tortoise knobs, record holder from an Edison Diamond Disc player. Thanks. Peter Jaber, 281 McDowell, Asheville, NC 28803. (704) 277-2060

WANTED: Geiger counters, dosimeters and chargers, test samples, civil defense info. Also want Trans-Oceanic military version. Jack McCreary, 7783 Wildcreek Trl., Huntsville, AL 35802. (205) 882-0037

WANTED: Chassis: US Radio AC 27, Motorola 52. Cabinet: Pfanstiel 75, Radiola IV. Horn only: Radiola UZ1325, FH, Burns fiber. Pilot 199 tube sockets. Richard B. Jehlik, 14441 North River Rd., Omaha, NE 68112. (402) 457-4604, after 7 pm CDT

WANTED: Plugs or chords with military TRS 1/4" plugs. Same as Switchcraft 482 stereo plugs. I can send a Xerox. Also want recording and broadcast equipment, mics, etc. Jim Kollens, 29 W. Commercial, Addison, IL 60101. (708) 628-0810, days; (708) 691-8890, evenings

WANTED: 1939 and 1933 World's Fair radios. Lamar Heath, 2160 Old Salem Rd., Conyers, GA 30208. (770) 922-4328

WANTED: Fisher 800B or 800C AM/FM stereo receiver with cabinet, unmodified. Tod Prowell, Obsolete Technologies, 413 N. York Rd., Mechanicsburg, PA 17055-6016. (717) 697-5227

WANTED: Speaker for RCA table Model 128, 1250 ohms, speaker for Zenith Model 6S229 and wooden knobs for same. Jim Martin, 5826 E. Lakeside Dr., Hanahan, SC 29406. (803) 554-5644

WANTED: Electron tubes, ball bearings, Collins radio parts and equipment, aircraft parts & instruments, helicopter parts, lamps, synchros. Hy Ness Company, 709B Delair Rd., Cranbury, NJ 08512. (609) 395-1116. Fax: (609) 395-1117

WANTED: Manual/schematic for WWII entertainment radios, REO, REP, REH. Also looking for photos, history, etc. on Morale radios. Henry Engstrom, KD6KWH, PO Box 5846, Santa Rosa, CA 95402. (707) 544-5179

WANTED: Audio tuner to receive television sound through car radio or information on them. James W. Walcher, 1311 Janet Dr., Wilmington, IL 60481. (815) 476-9184

WANTED/TRADE: Telegraph keys and bugs. SASE for list of swap items. Dave Pennes, WA3LKN, 4607-C Santa Cruz Dr., Indianapolis, IN 46268-5354. (317) 471-9605



WANTED: Air King Skyscraper radios, except for that unbearably ugly model with the third (tuning) eye at the top that bears better resemblance to a founder than to the face of a building. Please write or call collect: Rain Buttignol, 214 State St, #7, Portsmouth, NH 03801. (603) 427-1384

WANTED: April 1983 edition of the CQ magazine. Jim Schliestett, W4IMQ, PO Box 93, Cedartown, GA 30125. (770) 748-5968

WANTED: WE antique telephones. Please fax with price and condition. Aritoshi Ogata, 3-1-56-503 Nagatoishi, Kurume, Fukuoka, Japan. Fax: 81-942-32-6958

WANTED: Grebe CR13, Paragon DA-2, Paragon detector, pre-1940 Collins, transmitters. FOR SALE/TRADE: Paragon RA10, Drake R4C. Stu Mount, K2OA, 35 Grand, Highland, NY 12528. (914) 691-7957

WANTED: Fisher FM-200B tuner. Stancor 10P transmitter. National HRO 5A1 receiver, UTC LS-57 output transformer. FOR SALE: Stromberg-Carlson Model AU-58B 6L6 audio amp. Thanks! Tom Smith, N5AMA, 13034 Elmington Dr., Cypress, TX 77429-2062. (713) 376-3436, evenings

WANTED: Band switch for GE Model A63 or junk chassis. Also audio output transformer for GM 120, 130, 140 or junk chassis. Bill Johnson, 4906 River St., Sears, MI 49679. (616) 734-2635

WANTED: Beitman Most Often Needed Radio Diagrams, 1943-1944-1945-1949, most of 1950s. Will buy or trade my volumes 1926-38, 1940-1941-1942. Also hunting Gernsback Official Radio Service Manuals; I have Volumes 1 and 4. Send large SASE for new radio book list. Maurer TV, 29 So. 4th St., Lebanon, PA 17042. (717) 272-2481

WANTED: Hallicrafters TW-55 portable, top cash for excellent condition. Dr. Wolfgang Hornik, Seestr. 37, D-82229 Seefeld, Germany. Phone: 011-49-8152-76318

WANTED: A Philco wireless record player. Knox Lee, 630 Shadowbrook Dr., Columbia, SC 29210. (803) 772-6593

FOR SALE: Auto Radio Service manuals 1937-1954: Delco, Motorola, Philco, Sylvania, United Motors, Zenith, 1946 Chevy radio - \$200. Bill Coolahan, 1450 Miami Dr., NE, Cedar Rapids, IA 52402-2933. (319) 393-8075

FOR SALE: 1959 HiFidelity magazines, (12) issues - \$120. H.H. Scott, full line brochure, 1960's - \$50. Pioneer receiver SX-838 blue dial - \$150 or trade. Send large SASE. Ernest Naaz, 242 E. 89th St., Apt. C, New York, NY 10128. (212) 289-7681

FOR SALE: (6) inverters, 12v to 110v 150-watt, plugs into car lighter, two outlets, N.I.B. - \$85 ppd. Richard Brill, PO Box 5367, Old Bridge, NJ 08857. (908) 679-8026

FOR SALE: N.O.S. tubes, all military stock, volume discount available: 6EU7 - \$9. 6EV5 - \$5. 6BU8 - \$3. 6F5 - \$2.50. 6GF5 - \$1.50. 1LH4 - \$1.50. 6F4 - \$4. 5719 - \$4. **WANTED:** Hickok 539-C adapter 1050-164. SASE for complete tube list. Kirk Cline, 1818 Walker Ave., Greensboro, NC 27403-1760. Phone/fax: (910) 379-7197

FOR SALE: Reel-to-reel video recorder Sony #AV 3650 with (20) tapes - BO. Garrard turntable RC 98/4L - \$20. Webcor N.O.S. replacement turntable, 90 volt - \$12. Box of TV knobs - \$15. Hammond power transformer N.O.S. #AO-27118-001 - \$18. RCA power line meter WV-120A - \$26. Radio Amateurs Handbooks 1971, 1977 - \$28/both. Tested tubes 4 for \$10: 24A, 26, 27, 41, 43, 56, 58, 75, 76, 80; 3 for \$10: 35/51, 42, 57, 71A, 84. RCA R28P wood radio - \$95. RCA 95+5 wood radio - \$50. Shure 55S mic with preamp and boom arm - \$200. Kevin and Kathy Moe, 616 Lockrem St., Ottawa, IL 61350. (815) 433-4598

FOR SALE: T368E, Valiant, SP600's, also trade LED calculators for transistor radios & vice versa. SASE. Joe Pfeifer, KB7ZZG, PO Box 253, Sandy, UT 84091-0253. (801) 571-5453

"Send in 2 boxtops. . ."



Not really. But you *can* be the first on your block to get a **RADIO BOYS** T-shirt. Authentic 1920's illustration in bright blue and black on white, 100% cotton tee. Order today - makes a great gift!

M(38 - 40), L(42 - 44), XL(46 - 48).
\$16.95 ea plus \$3.00 s&h in U.S.A. (Add \$1.00 for each additional shirt.) N.Y. Residents include \$1.18 sales tax/shirt.

Send check or money order payable to
W Sacks to.

P.O. Box 1459
Olivebridge N.Y. 12461-0459

Please include phone # with order.

FOR SALE: Rider's Manuals 1-20 except 19 and 1-5 abridged and indexes; some volumes are rare National Union (green covers). LSASE pricing. Dennis Hoffman, KW9G, 3519 Hoffman Rd., Chippewa Falls, WI 54729. (715) 831-1855, evenings. E-mail: hoffman @edp.net

FOR SALE: Crosley clock radio JC6BK - \$35. Eico tube tester Model 666 - \$55. Plus UPS. Ed Povraznik, 9606 Biddulph Rd., Brooklyn, OH 44144. (216) 661-0032

FOR SALE/TRADE: Hallicrafters Sky Buddy S19R - \$100. Collins 75A3 w/speaker - \$400. Turner 258 desk mic - \$25. Astatic D104 desk mic - \$30. Emerson 569 w/o cord - \$45. Brunswick 1923 phonograph Model 101 - \$150 plus UPS. Trade in your mini keychain license plates made by Disabled American Veterans for \$2 ea. off any radio. John Williams, Jr., PO Box 1545, Scarborough, ME 04070-1545. (207) 775-4212

FOR SALE: Rich Estes will be the auctioneer for our auction at Extravaganza '96, which we have moved to Friday night instead of Saturday afternoon. This change should improve auction attendance and increase the quality and quantity of merchandise offered at the same time. For further information or for a convention brochure, write to: Michigan Antique Radio Club, Extravaganza '96, Suite 100, 3520 Okemos Rd., #6, Okemos, MI 48864

FOR SALE: Novelties: Globe, Pl. 47 - \$50. Tropicana orange, M.I.B. - \$20. Polaroid film, M.I.B. - \$20. Wrist-watch with 30' strap, Pl. 493 - \$50. Piano, Franklin, ivory color with bench, Pl. 427 - \$75. Jukebox, Windsor, Pl. 411 (Wurlitzer 1015), M.I.B. - \$50. Jukebox AM/FM cassette, Pl. 414 (Rockola 1426), M.I.B. - \$60. Gramy-Phone, Pl. 419, NBC - \$15. Knight helmet, Pl. 507 - \$35. Rolls Royce HK, Pl. 10, M.I.B. - \$20. Rolls Royce, pewter, Pl. 8 - \$20. Snorks, Pl. 229, M.I.B. - \$25. Mork from Ork, Pl. 123 - \$25. Smurf head, Pl. 158, M.I.B. - \$15. Snoopy outline, Pl. 152 - \$30. Pound Puppy, Pl. 130 - \$10. Mickey Mouse, Pl. 116 - \$12. Care Bears, Pl. 78 - \$12. My Little Pony, Pl. 124 - \$15. Mickey Mouse, Pl. 109, NBC - \$10. Medallion, Pl. 516, Get Well Soon - \$15. Shipping - \$5 ea. order. Thanks! Joe Matuska, 2523 Sunset Blvd., Steubenville, OH 43952. (614) 264-7806

FOR SALE: Thorens TD-160 turntable - \$135. JVC JT-V77 analog tuner - \$70. Empire Royal Grenadier speakers, mint - \$500. EICO HF-61 preamp - \$65. Heathkit GR-21 w/manual - \$50. Zenith 6D116 - \$65. Kodol Senior - \$70. Fisher 800C - \$75. RCA tube manuals - \$12 ea. RCA Victor cart. tape recorder - \$45. Telefunken Hymnus AM/FM/SW/phono console, mint, pickup only - \$375. Shipping extra. Joel Camicia, 1811 N.E. 58th Ave., Portland, OR 97213-4103. (503) 287-7832

WANTED

WESTERN ELECTRIC

TUBES, SPEAKERS, HORNS & AMPS

TUBES: Telefunken, Genalex, RCA, Radiotron, etc. General Electric, Amperex, JAN, Sylvania, GEC, National Union

McIntosh, Marantz, Dynaco, Jensen, Linn, Levinson, Fisher, Leak, Tannoy, Altec, EV, Thorens, EMT, JBL... Amps, Spkrs., Turntables

MAURY CORB

12325 Ashcroft, Houston, TX 77035

Tel: (713) 728-4343

Fax: (713) 723-1301

The Radio Collector's Directory and Price Guide, 1921-1965, 2nd Ed.

by Robert E. Grinder

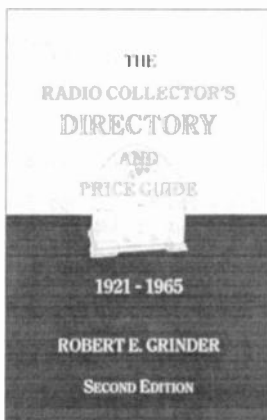

20,000+ Models Listed

U.S. models manufactured from 1921-1965.

Listing includes:

*Model Name,
Year of Production,
Type of Power,
Cabinet Style, and
Current Market Value Range.*

Rewritten Chapters On:

*Early Broadcasting,
Radio Broadcasting Regulation,
Advances Made in Receivers,
The Evolution of Radio Cabinet Styles.*

\$26.95 - Softcover

U.S. Orders - Enclose \$3.00 per order for packing & book-rate shipping if total order is under \$35.00. If using VISA or MasterCard, include name on card, card number and expiration date. Send payment with order. Mass. residents please add 5% sales tax. Money back return policy. Most orders shipped the same day received, but allow 2-4 weeks to receive order. Foreign orders - write for shipping costs, or use credit card and specify air or surface (allow 2-3 months for surface shipping).



**Send Order To: A.R.C., P.O. Box 2, Carlisle, MA 01741
or Call: (508) 371-0512 Fax: (508) 371-7129**



FOR SALE: Sams TV Photofacts 50-1230, 200 lbs. - \$25, U haul. Biddle 72-311J calibrator/precision pot., like new w/manual - \$60. Magne recorder F35B tapedeck - \$15. Wilcox-Gay Recordio - \$20. Magnetophon 208 tapedeck - \$20. Olson tape recorder - \$20. Bogen MT-125B amp - \$20. Crown D60 stereo amp - \$70. V. good cond. All above you ship. **WANTED:** Logo for Columbia 360 phono, 1953. Someone to repair 3M 2790 cass. duplicator. To trade a dual trace medical o-scope toward repair of a Tektronix scope. Escutcheon for Ozarka cathedral, can't find Mod #. Harold D. Wright, R.R. 1, Box 259, Chancellor, AL 36316-9749. (334) 347-0393

FOR SALE: Crosley 148 cathedral - \$175. Zenith chairside 7S342 - \$100. Zenith console 10S464 for parts - \$80. Admiral console Tilt Top Tuner - \$135. Vance Rayburn, 2718 Homestead Rd., Madison, WI 53711. (608) 274-3002

FOR SALE: Hallicrafters: S41W - \$145; WR600 - \$55; SX71 - \$225; SX101 MKIII - \$225; National NC+125 - \$175; RME VHF 12A - \$45. Free lists, manuals/equipment, call/write. Richard Prester, 131 Ridge Rd., West Milford, NJ 07480. (201) 728-2454

FOR SALE: Operation manual for Heathkit IO-4530 10 MHz scope. Original, not copy. R.J. Eastwick, N2AWC, 224 Chestnut St., Haddonfield, NJ 08033. (609) 429-2477

FOR SALE: Pilot Neutrograd Midget condenser, N.I.B. - \$15. Jefferson Star audio transformer, 1-5 - \$15. Panasonic R-70 Blue Ball radio - \$15. 3-piece Barbie and Smurf radios - \$55 ea. Operadio drum speaker - \$75. Capitol cone speaker, 21" diameter, stain and small hole - \$100. RCA 100 speaker for internal parts - \$20. Crosley 11-114, beige, hairline - \$35. Crosley S-38, restorable, plays, NT - \$40. Setchell-Carlson, small white, frog-eye - \$60. Emerson 587 - \$30. Emerson EC-301 - \$50. Crosley E-15-WE, white (2) - \$30 ea. Crosley 11-122U, lime - \$70. Philco chassis 39-5505 - \$25. Admiral chassis #6C71-10A1 - \$45. Vista transistor globe radio - \$145. Zenith wave-magnet - \$15. Zenith black dial face #26-122, 6 3/4" - \$15. 1950's Model Fun magazines - \$6 ea. Stewart-Warner ad brochures, clock-shaped - \$10 ea. Motorola 52R, green plastic - \$20. Silvertone 12" drum speaker - \$45. RCA Lever-matic, 50's clock radio - \$25. Zenith G-511-W, white plastic - \$25. Bulova 1230, transistor clock radio - \$15. Kitco 7-TR, plastic transistor clock radio - \$150. Radiola 111 box only with decal - \$25. Lewol green paper radio, warped of course - \$55. Crosley 10-136E mint black - \$80. Zenith H-511-Y mint black, hums. Offers? Sure! Thanks. Del Tysdal, Rt. 1, Box 157, Glyndon, MN 56547. (218) 287-2562

I am not a dealer, but a serious collector and historian interested in all aspects of E. H. Scott.

Please contact me first if you are selling your E. H. Scott Radio, Select-**E-H** tone Coils, World's Record Superhet, or Scott Transfor-mer Co. items.



Always interested in any E. H. Scott stock certificates, literature, and military sets.

John T. Meredith
2462 Statonsburg Rd., Suite 152
Greenville, NC 27834 - (919) 551-1882

FOR SALE: Audio mint: Mark III. Stereo 70. Pair 12" Jensen. Pair 10" horns. Astatic 788 recording microphone. Electric Voice 664 and 625. Turner 77, BDX, BDD, C-3, TR-2, Flexarms, mounting flanges, desk stands, Sidekick 100, 101, chromium screens. Bill Coolahan, 1450 Miami Dr., NE, Cedar Rapids, IA 52402-2933. (319) 393-8075

FOR SALE/TRADE/HELP: AK Model 60C (chassis) & schematic. Zenith ZE7 power supply for Models #15E, 16E, 16EP. Heathkit amp, TI xtmr heats. Lafayette Comstat25A transceiver. RCA Radiola Model 86; radio/phonograph/mike/all there, no tubes., cab. exc cond. **WANTED:** Practice key & sounder. Op. manual for Bell Howell Mod 34 oscilloscope. A-B batt pack Z985 for Trans-Oceanic Mod G-500/chas. 5G40. Prefer to trade. I'm a novice. Sydney Thomas, Box 383, Stillwater, NY 12170. (518) 664-3489

FOR SALE: (1) 6B4G good used - \$12 ppd. Supreme Radio Analyzer Model 491. (4) v. good used 6L6GC - \$50 ppd. S-85 Hallicrafters - \$85. Pete Putra, 1429 Lawndale Ave., Racine, WI 53403. (414) 632-2543

FOR SALE: Radio books 1907-1950, manuals, catalogues, tube manuals, television literature. Many old radios. List - SASE. Bill Rolf, 30131 Center Ridge, Westlake, OH 44145

FOR SALE: Pepsi bottle radio - \$500. Philco 51 cathedral - \$230. Radio lamp - \$175. Zenith 4T26 Deco tombstone - \$85. Jim Peters, 983 Chapel Ct. South, Glen Ellyn, IL 60137. (708) 790-9699

FOR SALE: Midwest 18-36 chassis only with 12" PM speaker, restored, exc, working - \$150 + UPS. Phil Guinan, 106 Page Rd., Litchfield, NH 03052. (603) 889-6213

FOR SALE: Catalins. AMC peaktop, (3) stress lines, real nice - \$1,250. Sentinel 284, sand colored - \$1,000. Fada 652, open grille, pea green, (2) hairlines - \$500. White 845 Fada, repro knobs, hairlines on bottom - \$225. Motorola Pixie, nice - \$125. All plus UPS. Vernon Shatwell, Rt. 5, Box 195, Sapulpa, OK 74066. (918) 224-4551, after 7 pm ET

FOR SALE: Radiola 60 - \$125. Tombstones: AK 337 - \$210. Crosley 61 - \$130. GE A-53 - \$115. GE A-70 - \$150. Grunow 750 - \$125. Philco 39-70 - \$60. RCA 118 - \$125. Zenith 5R135 - \$125. Zenith 5S228 - \$175. Plus shipping. Edward G. Janssen, Jr., 730 Quail Cir., Lewisville, TX 75067. (214) 436-4722

FOR SALE: Supreme tube tester Mod 599-A, excellent condition - \$60 ppd. **WANTED:** Seeburg teardrop speaker. Don Rathbun, 27851 Bruno St., Hayward, CA 94544. (510) 783-1841

WANTED

**Unbuilt Heathkits,
Knight-kits, Eico Kits**

— Top Prices Paid —

Arnold L. Chase
9 Rushleigh Road
W. Hartford, CT 06117
(860) 521-5280

WANTED: Schematics, instructions for Sherwood S-5000 amp and S-3000 II FM tuner. Copies OK. Jack Casey, 9905 Whitworth Way, Ellicott City, MD 21042. (410) 461-1141

WANTED: Battery cover for Belmont Boulevard or poor condition set. I'll pay top dollar. Bob Wood, 3610 N. 12th Ave., Pensacola, FL 32503. (904) 432-3782

WANTED: Viking Ranger restorable or parts rig. Reasonable HQ170. Ron Merrell, 10701 W. 54th St., Shawnee, KS 66203. Fax (913) 268-0461

WANTED: Voice of Music (VM) cassette recorders. Also VM parts, literature, demo records. Gary Stork, 37530 E. Meadowhill, Northville, MI 48167. (810) 478-0990

WANTED: Paragon DA-2 cabinet, good condition. Charles A. Days, PO Box 80205, S. Dartmouth, MA 02748-0205

WANTED: Knobs tube Zenith Trans-Oceanic Model G500 or 8G005Y. Frank Schoen, Box 2370, Winnipeg, Manitoba, Canada R3C 4A6. (204) 888-6120

WANTED: Bendix radios, ads, signs, etc. Radios need not work. Aaron Mall, 903 Dropleaf Ct., Baltimore, MD 21208. (410) 486-8813

WANTED: For Philco 118X, upper front trim pieces. Thomas Bisel, 2266 Halyard Ct., St. Louis, MO 63129. (314) 846-0025

WANTED: Catalin radio parts, paying \$20 or more per knob. Need a Garod Peaktop chassis. Ray Carroll, 158 Oakwood Dr., Wayne NJ 07470. (201) 696-1149

WANTED: Weston: 519 set tester, 526 tube tester, data sheet for underside of 533 tube tester (copy OK). General Radio: 213 tuning fork oscillator, 361A (or B) vacuum tube bridge, 465 mutual conductance meter, pre-1932 catalogs & brochures. Lane Upton, 11284 Clinton Bar Rd., Pine Grove, CA 95665. (209) 223-4638

WANTED: Westinghouse WL-461, Taylor 833, DeForest 430 through 440 tubes, duds OK. John H. Walker, Jr., 16112 W. 125th St., Olathe, KS 66062. (913) 782-6455

WANTED: Rider's 23, copy OK. Also, dial face for Philco PT-49. Byron Bernor, 2479 W. Sierra, Acton, CA 93510. (805) 269-5459

WANTED: Zenith Model 5S228 and 7S261 in excellent condition. Larry Boshier, PO Box 193, Palo Pinto, TX 76484. (817) 325-5333

RATE FOR ADDITIONAL WORDS:

25¢ per word

FIRST 20 WORDS FREE!

Cash or stamps OK for small amounts.

Your payment helps to keep A.R.C. healthy!

WANTED: 1950's LP: Religious music, has birds singing with orchestra. Jim Farago, 4017 42nd Ave., S, Minneapolis, MN 55406-3528

WANTED: TV-7 tube tester military type or Hickok. Must be complete and working. John T. Meredith, 2462 Stantonsburg Rd., Suite 152, Greenville, NC 27834. (919) 551-1882

WANTED: Majestic 15B chassis. R.V. Eastham, KA4RBH, Rt.5, Box 427, Hendersonville, NC 28792

WANTED: Emerson Catalin cabinet for Patriot/Aristocrat. Prefer white, blue or red. No cracks. Bob Zuch, 5601 DeSoto Ave., Woodland Hills, CA 91365. (818) 700-0980, or work (818) 719-2608

WANTED: Internal speaker for Super Zenith IX or description of same. Also center rheostat and knob for Super VII or IX. Ken Martin, 12667 Eckard Way, Auburn, CA 95603. (916) 885-0243

WANTED: Table radios wanted: Bakelites and colorful plastic sets, red, maroon, etc. Send price/description: John Lopez, 825 Lees Dr., Las Cruces, NM 88001-3960

**NORTHLAND
ANTIQUÉ
RADIO
CLUB**



AND

**PAVEK
Museum of
Broadcasting**

Proudly Announce

RADIO DAZE '96 Sponsored by AWA

Friday, May 31st and Saturday, June 1st, 1996

- SPECIAL** — Old Radio Auction
FEATURES: — A visit to the Pavek Museum of Broadcasting
— Video presentation of NARC members' radio collections

NARC

P.O. Box 18362 • Minneapolis, MN 55418

☎ Joe Gruber: 612-489-5552 ☎

Best Western - Golden Valley Inn

4820 HWY 55 • Golden Valley, MN

☎ 612-588-0511 ☎

SWAP MEET/AUCTION/PROGRAMS/CONTEST/LUNCHEON

FOR SALE: Sams, below #1000, as low as \$1 each. Must sell, overstocked, send SASE for list. John E. Kendall, PO Box 436, Fallston, MD 21047

FOR SALE: Norelco L3X95T transistor with broadcast and SW, battery cover missing - \$15 plus 6 lbs. John Uscinowski, RR#1, Box 379, Greenwich, NY 12834-9519

FOR SALE: New book on collecting Sinclair products - \$25 including post & packing, airmail. Enrico Tedeschi, 54 Easthill Dr., Brighton, United Kingdom BN41 2FD. Tel/fax: (+0044 1273) 410749

FOR SALE: Riders Television Manual #2 - \$25 plus UPS. WANTED: Zenith 8S359 osc. assy. Ted Stewart, 2157 Braemar Rd., Oakland, CA 94602. (510) 531-7042. Fax: (510) 531-7072

FOR SALE: Atwater Kent 145 rough, but restorable - \$75. WANTED: Aeriola Jr. and Radiola I. Phil Boydston, 640-18 Tete Lours, Mandeville, LA 70471. (504) 845-0867

FOR SALE: Boys radios: Acme, vvg - \$55; Angel, vg, black - \$45; Coronet, blue N.I.B. - \$65; Coronet, black, N.I.B. - \$65; Nuvox, red, reverse plastic, exc cond. - \$75; Sceptre, horizontal, red, vvg - \$55; Sceptre, horizontal, white, vvg - \$55; Tama-Tone, N.I.B., black - \$60; Valiant, red, vg - \$35; Windsor, blue, exc cond., box - \$60; Windsor, red, exc cond., box - \$60. Transistor radios: Channel Master Micrette with presentation box - \$45; Holiday 11P601, exc cond., works - \$45; Marvel 6YR-65, exc cond. salmon color - \$45; Motorola X11R, red, vvg - \$35; Russian micro radio, N.I.B. - \$40. Tube radios: Continental M-500, Art Deco style, CD marks, exc cond. - \$75; GE P-800A, magnifying dial, exc cond., CD marks, works - \$45; Harpers GK-301, 4-tube radio, CD marks, Japanese, vvg - \$55; Olympic 447, exc cond., works - \$150. Postage is extra. Kay Botzum, RD2, Box 419, Morgantown, PA 19543. (610) 286-0047. Fax: (610) 286-5315

Visit the A.R.C. Web Site!

The URL to access the A.R.C. Web site is:
<http://www.antiqueradio.com/>

Our site includes highlights from current and recent issues:

- Editor's Comments
- Image of the Cover
- Feature Article
- Radio Miscellanea

- Plus:
- Photo Reviews
 - Book Reviews
 - Coming Radio Events
 - Complete Club Listing
 - List of Books For Sale
 - Subscription Information

While visiting our site, you may send e-mail and orders for books, videos and subscriptions.

Let us know what you think about A.R.C. on the Web!

FOR SALE: Must sell extra small radios and tube tuners. SASE for list. Will trade for tubes. Charles D. Blair, 815 N. 5th St., Cambridge, OH 43725. (614) 432-4453

FOR SALE: Tubes, N.I.B.: GE 8072 - \$65; (4) RCA 6LQ6's - \$120; pr. SYL 6JS6A's - \$45. N.O.S.: 4-125A - \$65; 6550 - \$15; 6AS7G - \$8; 1631 - \$6; pr. RK28A, similar 803 - \$20; 8122 - \$100; pr. 6KD6 - \$40; 6L6's in several varieties - Write! TS175 freqmeter - \$30. Connecticut Telephone & Electric nice toy 'phone set, 1920's - \$100. Collins phone patch - \$25. Other stuff, meters, tubes, variable capacitors, misc. manuals, parts, etc. List SASE. George H. Goldstone, W8AP, 1010 Burnham, Bloomfield Hills, MI 48304. (810) 647-3399

FOR SALE: BC-348Q - \$150. Eddystone Model 940 - \$300. TCS-14 xmtr & rec. - \$300. Heathkit HW-12 & PS-23 - \$75. Heathkit SB-301 & SB-401 - \$200. OBO. Manuals for all, shipping extra. Kenneth Hunt, 872 Sudden Valley, Bellingham, WA 98226-4824 (360) 734-9572 or (360) 671-0882

FOR SALE: Rider's TV Manuals, Volumes 1-24 - \$200 for set. Mark S. Rauber, PO Box 1077, Minden, NV 89423. (702) 782-3596

FOR SALE: Trans-Oceanic, cloth-covered, rough, works - \$40. KLH Model 20 AM/FM rec. changer & spkr - \$100. Roger Ruddick, 33 Emily Ln., Ft. Myers Beach, FL 33931. (941) 463-8887

FOR SALE: Tubes tubes tubes. Carefully selected radio and TV tubes. All N.O.S. gems by RCA/Syl. Few output tubes. Might have some by the time you read this. SASE for wants. C. Ong, 3806 Lake Blvd., Annandale, VA 22003. (703) 573-2288, lv. msg. Fax: (703) 280-0317. E-mail: ongkt88@pop.erols.com

FOR SALE: Capacitor tester, signal generator, and signal tracer. Twenty each plus shipping. Dan Olson, E. 4913 Sumac Dr., Spokane, WA 99223. (509) 448-8828

E. H. Scott Historical Society

The primary source
concerning the radios
and history of E. H. Scott

- Quarterly Bulletin: Scott News
- Service Manuals
- Reproduction Parts and Service
- Scott Video
- E. H. Scott the Dean by Marvin Hobbs

For more information write:
E. H. Scott Historical Society
3712 N. Broadway #4450
Chicago, Illinois 60613

*"Your One-Stop Spot
For All Things Scott"*

EXTRAVAGANZA '96

Hosted by the Michigan Antique Radio Club

July 12-14, 1996

Holiday Inn South Convention Center
6820 S. Cedar Street, Lansing, MI 48911
(517) 694-8123



Come join us and celebrate our 11th anniversary!

MARC's TOP 10 REASONS WHY YOU SHOULD ATTEND EXTRAVAGANZA '96

1. Flea Market...we have nearly 400 contiguous spaces available for sellers, come help us fill them up!
2. Our meet runs Friday-Sunday as advertised...we STARTED the trend of not allowing early selling (you can really get here Friday morning and not miss anything) and in addition, you don't have to take a whole week off from work to attend our convention!
3. Rich Estes, who conducted the recent Henry Ford Museum Auction, will be the auctioneer for our Friday evening auction!
4. Low costs...we have reduced our family registration to \$12 this year (\$15 last year) and again will offer our flea market spaces after the first one for ONLY \$10 each!
5. The theme of our meet will be Grebe...and we will have Alfred Grebe Jr. as our keynote speaker at our Social Hour Saturday evening!
6. We will have an outstanding Grebe exhibit in support of the theme of our convention, in which we encourage you to participate!
7. For the first time, we will be offering selling spaces UNDER our unique Big-Top tent in the center of our flea market!
8. Last year we had attendees in from 29 states, Canada and Australia. If you can only attend one major antique radio show this year, EXTRAVAGANZA '96 should be your choice!
9. You know that large multiband Fada tombstone (22" tall) that everyone is looking for (see photo A.R.C. Jan. 1996 issue, page 61)...we are raffling off an excellent example of this radio at EXTRAVAGANZA '96!
10. HOSPITALITY...we treat you right, just ask anyone who has ever attended an EXTRAVAGANZA convention. We want you here...and bring your family too. We encourage you to attend EXTRAVAGANZA '96 to see and experience for yourself what your friends have been telling you!

EXTRAVAGANZA '96 Registration

Note: Everyone attending EXTRAVAGANZA must register! Additionally, you must be a current MARC member or join MARC at this time in order to participate in the auction or equipment contest and/or to sell in the flea market.

| REGISTRATION | TOTAL |
|--|-----------------|
| Family registration _____ → | \$ 12 |
| MARC membership (if not currently MARC member) | |
| Balance of 1996 (\$6) _____ → | \$ |
| Flea Market sellers | |
| 1st outside Flea Market space (\$20) _____ → | \$ |
| Additional outside spaces <input type="text"/> # spaces x \$10 each _____ → | \$ |
| 8' table inside (under tent)* <input type="text"/> # tables x \$20 each _____ → | \$ |
| <small>*Includes 8' table, one chair & one parking space in the designated non-selling area of our flea market</small> | |
| Make check out to MARC for this amount | TOTAL \$ |

To mail check or to request a convention brochure, write: EXTRAVAGANZA '96, Suite 100, 3520 Okemos Rd. #6, Okemos, MI 48864. For additional information contact: Jim Clark @ (517) 349-7187 or fax (517) 349-4059, or check out our MARC Homepage on the WWW at <http://sojourn.com/~micharc/web/index.html>

FOR SALE/TRADE: 1908 DeForest spherical Audion detector tube w/twin wires and original decals - \$1,350. Plus the actual DeForest brass tube socket w/twin wires leads - \$150. Also Conn. Telephone and Telegraph J-117 brass and glass tube, 1923 - \$450. Cunningham C-376 ballast tube, new - \$350. Larry Drago, 383 Lincoln Dr., Cheshire, CT 06410. (203) 272-6030

FOR SALE: At Kokomo meet, nice collection transistors, (20+) novelties, assorted tubes (new, used); Crosley Trirayn Super Special, exc with original headset. Other assorted clean radios. Jim Hauskins, 1403 W. Miller St., Bloomington, IL 61701. (309) 828-6879, days 3-4 pm, weekends 5-9 pm

FOR SALE: Red Lion desk panel w/Atwater Kent Model E speaker - \$85. Plus shipping. Don Mier, 4009 N. Foxdale Ave., Covina, CA 91722. (818) 338-9225

FOR SALE: RCA 8X681 - \$35. Hallicrafters 5R10A - \$30. Old Parr Whiskey transistor - \$35. UPS extra. Scott Olson, 2631 Cobblestone Ct., Fargo, ND 58103. (701) 293-9238

FOR SALE: Workrite George Walker multi-unit set (1-tube) with coil, (see Douglas 3, p. 245) - \$200. Bill Moss Settle, 120 Clarksdale Cir., Glasgow, KY 42141. (502) 651-6525

FOR SALE: Timex magnetic disc recorder Model 40-1, 1943 - \$20. Zenith 6D-315, rough - \$50. Mikes: EV 644 - \$100. Shure 9B22-A bullet - \$150. Shure CR-80H - \$65. Bill Cherensky, 6 Kate Ln., Metuchen, NJ 08840. (908) 549-2165

FOR SALE: Loctals 7V, must buy all (25) - \$75. Simpson manuals - \$5 ea. Plus shipping. Dewey Shaffer, RD 2, Box 104-B, New Paris, PA 15554. (814) 839-4728

FOR SALE: (2) Zenith Royal 500's (E & D w/case). Pete Hittle, 5415 Bushnell Ave., Sioux City, IA 51106-3834. (712) 276-2316

FOR SALE: Majestic #174, chrome-front tombstone w/ timer and auto tune. Robert Lutz, 9041 Gillette St., Lenexa, KS 66215. (913) 894-1327

FOR SALE: Used: 245's - \$45; 45 (ST)'s - \$20; 253A, 277A, 258B. New: (\$2 ea./min.10) 12AH7GT, 1N5G, 6SJ7. + shipping. Wayne Ferriman, 597 Grierson St., Oshawa, Ontario, Canada L1G 5J3. (905) 576-0548

FOR SALE: Crosley 51 two-tube battery set, fair condition, tubes good - \$85 plus UPS. John Schehrer, 508 Gray, Joplin, MO 64801. (417) 781-4028

HAS YOUR SUBSCRIPTION

EXPIRED?

It has if your mailing label reads "EXP= MAY96" or earlier. Renew now!

BONUS: Renew before your "EXP" month and receive 13 issues per year instead of 12!

Renewal rates are:

\$36.95 for Second-Class Mailing

\$53.95 for First-Class Mailing

(Two-year renewals are twice above rates.)

FOR SALE: Crystal set: Germanium rocket radio in box, works great, some wire marks - \$65. Harry Blesy, N9CQX, 9S740 Clarendon Hills Rd., Hinsdale, IL 60521. (708) 789-1793

FOR SALE: 275+ antique radios, 1000's old and interesting electronics; huge photolist - \$1.50 + SASE (55¢). Radio Ranch, 10745 255th Ave. NE, Belgrade, MN 56312

FOR SALE: HP 435B - \$900. HP 5342A - \$3,000. Tannoy Orbitus 12" coax - \$1,800. Audiocyclopedia - \$100. V. Vogt, 330 S.W. 43rd St., #247, Renton, WA 98055. (206) 382-382-5571

FOR SALE/TRADE: McMurdo-Silver Mod #15-17 chrome-plated receiver chassis w/poor chrome but has excellent parts - \$350. Also, Masterpiece III parts set - \$250. Larry Drago, 383 Lincoln Dr., Cheshire, CT 06410. (203) 272-6030

FOR SALE: Siemens 469-UP, 3-band Deco Bakelite - \$300. Geophone Osram Music Magnet 4 - \$500. Japanese Realistic 12A4 w/Futaba tubes - \$150. + UPS. Chuck Bray, 1322 Ivy Rd., Bremerton, WA 98310. (360) 373-1013

• OLD TIME RADIO BROADCASTS ON CASSETTES

- Many of your old time radio favorites are available on quality cassettes at a reasonable cost. You select the shows you want and purchase them by the hour. Fast, friendly service too. Send for our catalog listing over 5,400 shows arranged by show category & title, many including original broadcast dates.

Only \$2.00 (P & H). Send request to:

• ERSTWHILE RADIO — P.O. BOX 2284 • PEABODY, MA 01960



WANTED!

Microphones—all types:
Telefunken, Neumann, AKG, RCA, Sony, etc.

Also buying recording studio equipment, tube compressors, EQ's: Pultec, Lang, Teletonix, Urei, Fairchild, RCA, etc.

818.784.7611 • Fax 818.784.7564

Moving Hands Studios - Los Angeles, CA

WANTED: Fairchild SM1 and 232 cartridges, Fairchild 412-4 table, Lansing 801 drivers, iconic system. Vincent Gallo, 532 LaGuardia Pl., #600, New York, NY 10012. (212) 274-0432

WANTED: Ready-made coils for Rx's and Tx's (Hammarlund plug-in type or similar and ceramic). Ken Seymour, KATOSM, 9115 S.W. 176th Ave., Beaverton, OR 97007. (503) 306-7439, days/eves. E-mail: ken.seymour@attws.com

WANTED: Majestic 90 or 100 power chassis and cable. Thank you. Art Eberhardt, Box 209, Loomis, NE 68958. (308) 876-2240

WANTED: No. 6 dry cells with early colorful labels in excellent condition. Tom Burgess, 9 Belle Meadow Ln., Little Rock, AR 72210. (501) 455-0773

WANTED: Amplion horn speakers, working S-C table radios. J. Finkelstein, 205 Alapocas Dr., Wilmington, DE 19803

WANTED: Eico 460 oscilloscope manual and probes, knobs for Arvin 444, Philco 16 tombstone. Ed Martin, 485 Benwood Hill Rd., Benwood, WV 26031-1301

WANTED: Battery box for the Zenith Trans-Oceanic 3000-1, with or without cover. Gerald Silver, 10863 W. Clairmont Cir., Tamarac, FL 33321. (954) 720-1972

WANTED: Zenith Trans-Oceanic 3000-1, must be in mint or near mint condition, and working properly. Gerald Silver, 10863 W. Clairmont Cir., Tamarac, FL 33321. (954) 720-1972

WANTED: Copy of manuals for Sencore TF-151 transistor analyzer and HP-654A osc. Also B&K 283 DVM. Harry Pewowaruk, 1535 No. 8th Ave., St. Cloud, MN 56303. (320) 252-9910. E-mail: PewowarukH@aol.com

WANTED: Battery door for Global GR-900. Will buy junker with door. Paul Sommer, 16415 Viberg Rd., Leo, IN 46765. (219) 627-2838

WANTED: Information on Guild Radio Co. and listing of the Types Country Belle, Spice Chest, etc. Bob J. Moretz, KI4EC, PO Box 2278, Lenoir, NC 28645. (704) 758-1995

WANTED: Western Electric speakers/amps/trans/tubes, Brook, Altec amps/speakers, UTC amps/trans, large EV/Jensen/JBL speakers. Mike Somers, 2432 W. Fargo, Chicago, IL 60645. (312) 338-0153

WANTED: Schematic for Electronic Measurement Corporation Model 106 VTVM. Copy OK. Robert A. Decker, 3001 W. Mandalay Ln., Phoenix, AZ 85023-4870

WANTED: Wavemagnet for T600L Trans-Oceanic, dial pointer for Emerson EC301. Ivory volume knob for Continental 1600. Flyback transformer for Philco Predicta 10L43 chassis. Chassis for Zenith 10S464. Eric A. Miller, PO Box 778, Linn, MO 65051. (573) 897-4121

WANTED: Chassis for DeForest D6 radio. Please call or write: James R. Lopaz, 5467 So. 975 E, Ogden, UT 84405. (801) 476-1470

WANTED: Following "800" Series tubes: 825 (RCA), 827R, 839, 848, 853, 854, 855, 856, 859, 870, 875, 881, 887, 888, 891, 895, 896, 897, 898, 899. John H. Walker, Jr., 16112 W. 125th St., Olathe, KS 66062. (913) 782-6455

WANTED: Atwater Kent console. Can pick up 300 mile radius of Chicago or Lansing, Golden Valley or Elgin shows. Bruce Haacker, 65 So. Collins St., So. Elgin, IL 60177. (847) 741-5831, after 4 pm weekends

WANTED: Copy of handbook for Hickok Model 156 "indicating Tracometer." Howard T. Douglas, 701 N. Camino Del Codorniz, Tucson, AZ 85748. (520) 298-6450

WANTED: Wood radio made by Par Mak Radio Co. of Kansas City, 1939-40. Please!! Mid-America Antique Radio Store, 233 S. Tulane, Liberal, KS 67901

TUBES • PARTS • SUPPLIES YOUR COMPLETE SOURCE FOR...

TUBES:

Over 3500 receiving, transmitting, audio and industrial types in stock, including many foreign and early types.

TRANSFORMERS:

Hard to find power, filament and output transformers as well as filter chokes for tube equipment. We feature HAMMOND performance transformers as well as many new old stock transformers.

CAPACITORS:

High voltage electrolytic and mylar capacitors, multi-section capacitors and more for tube circuits.

PARTS:

Resistors, tube sockets, potentiometers, knobs, dial belt lamps, diodes, speakers, wire, phonograph needles and cartridges and much more.

LITERATURE:

Extensive selection of literature and books on antique radios, tubes, circuits diagrams, communication gear and hi-fi equipment. Some items not available elsewhere!

SUPPLIES:

Grill cloth, cabinet restoration supplies, batteries, chemicals, tools, test meters, gifts and kits.



CALL OR FAX FOR OUR NEW 40 PAGE CATALOG!

ANTIQUE ELECTRONIC SUPPLY™

LIMITED PARTNERSHIP

8221 S. MAPLE AVE. • TEMPE, AZ 85283 • (602) 820-5411 • FAX (602) 820-4643 or (800) 706-8789

Order These Popular Books From Antique Radio Classified



Price
Guide

The Collector's Guide to Antique Radios 3rd Edition by Marty & Sue Bunis. *8,500+ Battery & AC sets from the '20s to the '60s. Updated prices. Over 650 all new photos, 278 pages. 1994. — \$18.95*

The Collector's Guide to Transistor Radios 2nd Edition by Marty & Sue Bunis. *This book will help you identify the most sought-after vintage transistor radios. Over 2,900 models, all with current prices. Includes radio club listing. 375 all new color photos, 320 pages. 1996. — \$16.95*



Price
Guide

NEW! Compleat Talking Machine, 2nd Edition

by Eric L. Reiss. A guide to antique phonographs. Revised and expanded. Covers construction, cleaning, and repairing of parts and cabinets, 70 more pages and 200 new pictures. Complete identification guide with photos. Over 700 pictures. 252 pages. Softcover. Available Today! \$29.95

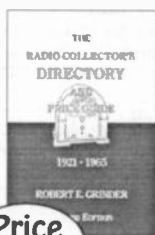

Price
Guide

The Radio Collector's Directory and Price Guide, 1921-1965, 2nd Ed. by Robert Grinder. *Over 20,000 radios by manufacturer, model number, year, etc. with prices. Radio history, cabinet style chapters. No photos, 264 pages. — \$26.95*

Transistor Radios, A Collector's Encyclopedia and Price Guide by Robert Lane and David Lane. *Identification guide to over 2,500 transistor and novelty radios. History and key to collecting chapters, 170 pages. — \$19.95*

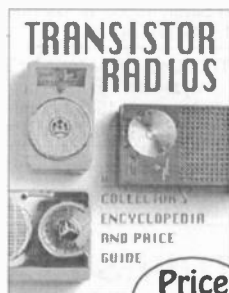

Price
Guide

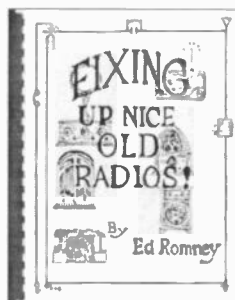

Fixing Up Nice Old Radios by Ed Romney. *Written by a retired radio instructor. Plastic binding. 300+ figures, 185 pages. — \$19.00*

Old Time Radios Restoration and Repair by Joseph J. Carr. *A self-paced training guide. History, theory and practical operation of antique and classic radios. 200 illustrations, 256 pages. — \$18.95*



U.S. Orders - Enclose \$3.00 per order for packing & book-rate shipping if total order is under \$35.00. If using VISA or MasterCard, include name on card, card number and expiration date. Send payment with order. Mass. residents please add 5% sales tax. Money back return policy. Most orders shipped the same day received, but allow 2-4 weeks to receive order. Foreign orders - write for shipping costs, or use credit card and specify air or surface (allow 2-3 months for surface shipping).



Send Order To: A.R.C., P.O. Box 2, Carlisle, MA 01741
or Call: (508) 371-0512

Fax: (508) 371-7129



(May-96)

Order These Popular Books From Antique Radio Classified



Crystal Clear Volume 1 and Crystal Clear Volume 2 by Sievers. *Comprehensive reference to crystal sets, crystal detectors, and crystals. Each volume contains different illustrations and information. Order by volume. — \$29.95*

Flick of the Switch by Morgan McMahon. *The classic photo reference guide for 1930s - 1950s radios. 1000+ photos of radios, 5" x 8", 263 pages. — \$11.95*



New Book — Audio! Audio!

by Jonathan Hill. A comprehensive directory of classic audio amplifiers and control units. Details of over 850 models from nearly 150 British manufacturers from the 1940s through the 1970s. Signed and numbered by the author. Softcover. 95 pages. **Available Today! \$19.95**



Guide to Old Radios, Pointers Pictures, and Prices, 2nd Ed. by Johnson. *Introduction to radio collecting. Includes hundreds of photos and a price guide. 272 pages. Available late October. — \$19.95*



Antique Radios Restoration and Repair, by Johnson. *Beginner's introduction to troubleshooting and repairing AC table model radios. 145 pages. — \$14.95*

Price
Guide



The Zenith Trans-Oceanic: The Royalty of Radios by Bryant and Cones. *Presents the fascinating story of the development and use of the Trans-Oceanic. Several photos, documents, ads, etc. 160 pages. — \$24.95*

Communications Receivers, 3rd Ed. by Ray Moore. *Information on vacuum tube receivers by 66 manufacturers. 402 radios illustrated, 115 pages. — \$19.95*

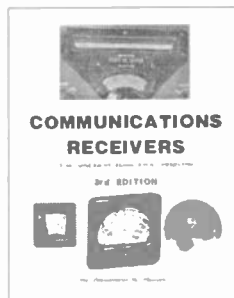

U.S. Orders - Enclose \$3.00 per order for packing & book-rate shipping if total order is under \$35.00. If using VISA or MasterCard, include name on card, card number and expiration date. Send payment with order. Mass. residents please add 5% sales tax. Money back return policy. Most orders shipped the same day received, but allow 2-4 weeks to receive order. Foreign orders - write for shipping costs, or use credit card and specify air or surface (allow 2-3 months for surface shipping).



Send Order To: A.R.C., P.O. Box 2, Carlisle, MA 01741
or Call: (508) 371-0512

Fax: (508) 371-7129



(May-96)

FOR SALE/TRADE: Addison Catalin Mod 5 in ebony black w/butterscotch marbling, vertical bars and knobs, beautiful flawless condition, (see Collins 1, p. 56) - \$2,000; or will trade for Western Electric amplifiers. Larry Drago, 383 Lincoln Dr., Cheshire, CT 06410. (203) 272-6030

FOR SALE: Philco 37-60 cathedral missing condensers - \$45. Wood tables: Zenith 6S321, bad cabinet - \$30. Airline 64WG 1804, nice - \$25. Air Chief 378 S 7428 - \$15. Tables - \$10 ea.: Zenith J723, GE T155, Panasonic RE710. RCA 6C5 clock radio, turquoise, new - \$25. Cromwell portable record cutter, player - \$40. Transistor, Spirit of '76, GE 72753 with box and instructions - \$35. 2-tube home brew, what's it worth? Thanks to those folks who have responded to my ads. Guy Forstrom, PO Box 159, Quinnesec, MI 49876. (906) 774-8116

FOR SALE: McIntosh C28 preamplifier and MQ101 equalizer, Marantz 250 power amplifier and 115B tuner. JBL SA660 integrated amplifier - Best Offer. Contact: Steve Pompe, 59 Shirecreek Ct., St. Charles, MO 63303

FOR SALE: Genuine ticker tape, 7" wide rolls with 2" hub or 9" wide rolls with 1" hub - \$10 ea. ppd. The following plus UPS shipping collect: Harman Kardon A300 amp, no case - \$35. Pilot TV37U - \$275. Zenith Trans-Oceanic, brown, A600 - \$125. Teletype Model 3282 stock ticker refurbished by Teletype in 1962 and never used original shipping box, no print head - \$150. 3KP1 CRT N.O.S. - \$25. 7JP4 used - \$50. Riders 8, 11 - \$20 ea. Gary Haberman, 29 Woodway Rd., Plainview, NY 11803. (516) 931-5214, eves.

FOR SALE: Beitmans 1926-1938 - \$12. 1939, 1940, 1941, 1942, vg to mint - \$10 ea. plus UPS. Philco 1940 home-auto radios by Philco - \$20 plus UPS. Marion J. Chelkowski, W5DBN, 1103 Kayton Ave., San Antonio, TX 78210. (210) 533-1876

NEW HI QUALITY

CAPACITORS

Volt 630 Axial Leads

| Value (UF) | *Price/25 |
|------------|-----------|
| .001 | \$ 6.00 |
| .0047 | \$ 6.25 |
| .01 | \$ 6.50 |
| .022 | \$ 7.00 |
| .033 | \$ 7.25 |
| .047 | \$ 7.50 |
| .1 | \$ 8.00 |
| .22 | \$ 15.00 |

ELECTROLYTICS

Volt 160 Axial Leads

| Value (UF) | *Price/25 |
|------------|-----------|
| 22 | \$16.00 |
| 33 | \$21.00 |
| 47 | \$24.00 |

Volt 450 Axial Leads

| Value (UF) | *Price/25 |
|------------|-----------|
| 22 | \$28.00 |

To order, call or write:

BOB'S ANTIQUE RADIOS

111 East 29th St., LaGrange Park, IL 60526

Telephone: (708) 352-0648

Fax: (708) 352-0647

*** Satisfaction Guaranteed ***

*Sold in 25 piece lots only.

Shipping & Handling

Ask about super bulk rates.

included in price.

- Whole Sale -

FOR SALE: Amplifiers Strom Communications APH1030 pair 7355 output - \$40. Preamplifier Viking RA61 tubed 12AX7/pair 12AU7/6X4/6E5 - \$25. Amplifier stereo Lafayette LA375 - \$20. Hallicrafters receiver S40, needs alignment - \$50. Heath HD-20 100kc calibrator - \$8. Tube testers GE YTW1 with rollchart - \$25. Lafayette portable with manual copy - \$15. Books: ARRL Handbooks 1968 - \$10; 1971 - \$8; 1974 - \$8. Radiotron Designers Handbook fourth edition - \$55. ITT Reference Data for Radio Engineers, with d/c - \$20. Handbook Practical Electronics References, Buchbaum, with d/c - \$20. Mathematics for Electricians, Kuehn, 1949 - \$8. Joe Monego, W2OFB, 6419 Nashua Dr., Port Richey, FL 34668. (813) 847-0279. E-mail: Radiow2ofb@aol.com

FOR SALE: Spectacular dark lacquer Federal oriental table radio Mod 1050-T w/multicolor handpainted scenery on all surfaces and brass hidden red front pulls; radio pulls out from cabinet, a simply beautiful and elegant piece, (E.O.R. 2, p. 93) - \$475. Larry Drago, 383 Lincoln Dr., Cheshire, CT 06410. (203) 272-6030

FOR SALE: Heathkit, EICO and PACO VTVMs - \$15 to \$25 + shpg. Some manual copies available at - \$4 ea. James Fred, R1, Box 41, Cutler, IN 46920. (317) 268-2214

FOR SALE: My remaining Sams Photofacts by the set, cheaper by the dozen. Bill Olson, Route 1, Filer, ID 83328. (208) 326-4962

FOR SALE: Panel for Standard Super/Worc[?] w/2 condensers & rheo (flat) 7X26 - \$60. Wide-band decade amp Type 500 AR in wood case, antenna - \$50. Challenger amp Mod HF10G, @9 - \$60. AK 35 a/o chassis, surface rust, unit @9 - \$45. Day-Fan 5 1KN01 a/o N/D, @9 - \$80. Fresh/Masterpiece 6TU lift-top #8831, no front panel, @9 - \$50. Eico sig. gen. M324 w/cords a/o - \$40. Catalog M/W 1949-50 electronic equipment catalog, @10, 62 pgs. - \$40. Pamphlet RCA radios scripts, The Lost Train, @9, 20 pgs. - \$25. Plus P&S. Bernie Samsk, 113 Old Palmer Rd., Palmer, MA 01069. (413) 245-7174

FOR SALE: Swan 700CX Special, clean but sick, 230XC PS, works - \$150. Tempo VHF one (2) meter, sick - \$25. Heathkit HW32, 20M SSB transceiver no/PS - \$25. HW12 80M SSB, no/PS - \$25. 10-17 oscilloscope, works - \$55. Airline 62-288, no cracks - \$145. All plus ship. Doyle Roberts, HC63, Box 236-1, Clinton, AR 72031. (501) 745-6690

FOR SALE: (5) Airline gold 01-A's - \$300. Abbotwares with two jockeys riding race horses, one tail missing - \$200 + UPS. Don Howland, W. 4621 Shawnee, Spokane, WA 99208. (509) 466-0939

Virginia City Radio Museum

109 So. "F" St.

Wireless and Radio Apparatus from 1915 through the 1950's - Antique Radios, Speakers, Vacuum Tubes, Microphones, Telegraph Keys, Photographs, Ham Equipment & Vintage Ham Radio Station

We also repair and restore antique radios

*Henry & Sharon Rogers - P.O. Box 511
Virginia City, NV 89440 Tel: 702-847-9047*

The Collector's Guide To Antique Radios - 3rd Edition

By Marty & Sue Bunis

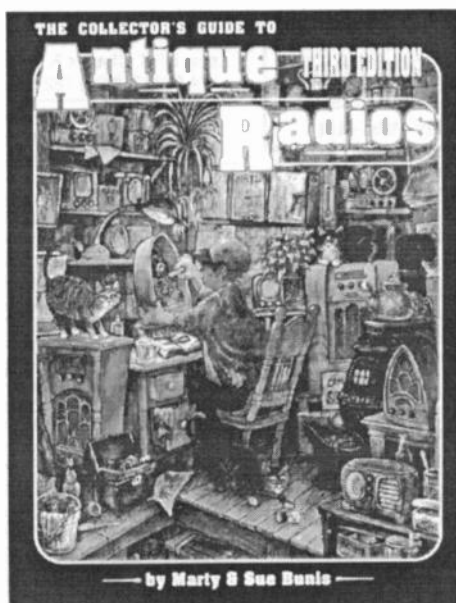

8,500+ Battery & AC sets from the '20s - '60s
Expanded listing of radios from the '60s
Over 650 all new color photographs
Updated prices
\$18.95 - Softcover

There are no transistor radios listed in the third edition. You will find them in *The Collector's Guide to Transistor Radios* available from A.R.C. for \$16.95.

U.S. Orders - Enclose \$3.00 per order for packing & book-rate shipping if total order is under \$35.00. If using VISA or MasterCard, include name on card, card number and expiration date. Send payment with order. Mass. residents please add 5% sales tax. Money back return policy. Most orders shipped the same day received, but allow 2-4 weeks to receive order. Foreign orders - write for shipping costs, or use credit card and specify air or surface (allow 2-3 months for surface shipping).



Send Order To: A.R.C., P.O. Box 2, Carlisle, MA 01741
or Call: (508) 371-0512 Fax: (508) 371-7129



(May-96)

FOR SALE/TRADE: Circa 1955 McIntosh 50W-2 power amp w/power supply - \$750. McIntosh 1956 Mod 20W-2 power amplifier - \$600. McIntosh C 4 preamplifiers - \$350/pair. McIntosh Mod 1700 tube/SS receiver - \$675. McIntosh MC-30 parts set with excellent chrome chassis and decals, (output transformer missing) - \$200. Call: Larry Drago, 383 Lincoln Dr., Cheshire, CT 06410. (203) 272-6030

FOR SALE/TRADE: 1929 Neutrodyne Radiotrope in ornate highboy cabinet - \$55. Radiola 33 in a Radiola 106 loudspeaker tapestry cabinet - \$65. John Koop, 48 Wheelbarrow Ln., Wantagh, NY 11793. (516) 731-6711 pm

Classified Ad Deadline Noon

May 10 for Jun. 1996 Issue

Jun. 10 for Jul. 1996 Issue

Boxed, Photo, & Display Ads - 1st

FOR SALE: QST 1958-59 complete, misc. 1955 to 1960, (36) in all - \$40. Electronics Illustrated (14) issues, late 50's to mid-60's - \$20. Meissner 1943 How to Build Manual, cover has some wear, contents fine - \$12. Glen Woody, PO Box 44, Mountain View, AR 72560. (501) 269-8522

FOR SALE: Zenith Trans-Oceanics 1000 - \$120; 3000-1 - \$120. Sony transistor T.R. 84 - \$45. Jim Montague, 1907 South Stanley Ln., Spokane, WA 99212. (509) 535-9576

FOR SALE: Taking offers on the following: Zenith 7G605 Trans-Oceanic chassis and speaker; JVC video capsule, has minor problems, great parts set; Harman Kardon tube-type AM/FM tuner Model T-12; Toshiba 6TP-515 baseball transistor with box and all accessories, hairline; Air Chief crystal set, kit, assembled but appears complete. Eric Hayes, 1248 Denver Ct., Naperville, IL 60540. (708) 357-4569

FOR SALE: Moving. Long picture-list, LSASE. Radiola III/III-A info pack, LSASE. Both, two stamps. David P. Smith, Box 81, Olney, IL 62450. (618) 392-6601

FOR SALE: Zenith lunch box transistor radio chassis 7AT44Z1; Star-Lite 5M-A2 plastic tube radio; HP 400D VTM, 1000pF, 3000V vacuum variable; PK-88 with HX-1000 computer, Heath 2M amp HA-201A - Best Offer or Trade for 900MHz scanner. Bud Machado, AA6HL, 4110 Crestview Dr., Pittsburg, CA 94565. (510) 439-7143

FOR SALE: Bosch Recreator in original box, unit vgc box fair cond. - \$100. Darrell Combs, 6587 Pacheco Way, Citrus Heights, CA 95610. (916) 969-0635

10 BAND MINIATURE SHORTWAVE RADIOS!

Listen to the entire world! This unusual shortwave radio, 7 x 1 1/4 x 3 1/2 inches, is one of the smallest and most sensitive radios ever built. It has AM/FM/MV and 7 short-wave bands; you can listen to the entire world! It uses only two AA batteries or 3-volt adapter (not included). The cost including shipping and insurance is only \$35.00 per set N.I.B. Quantities are limited! If you purchase 2 or more, 10% discount will apply!

Call 908-679-8026, Fax 908-679-2485.

Mail your check or money order to:

R.G.B. Enterprises

P.O. Box 5367, Old Bridge, N.J. 08857, U.S.A.

FOR SALE: Hallicrafters S-40 - \$70. RCA 9-Y-7 (table r/p) - \$25. Bendix 0526A (works, poor case) - \$25. Bogen amps MX30A & M330A, Zenith chassis 7S258, Zenith escutcheons: 61, 6S254, 7S258. AK 35 - \$40. Jackson tube tester G485 (have 2) - \$70 both. Ship speaker (unusual) - BO. Tubes new and used. Send wants. Wilbur Gilroy, 129 Belmont Ave., Clarks Green, PA 18411. (717) 586-7356

FOR SALE: Transistors: Bulova 290 - \$50. Universal PTR-62B - \$25. Sharp BP-117 - \$20. Sharp FX-18004-A - \$40. Sanyo RP-1250 - \$20. Panasonic RF-513 - \$20. Panasonic R-8 - \$20. GE P-2710C/KT-2 - \$20. Tube units: Silvertone tombstone #1919 - \$150. Airline #177 - \$130. Arvin #540T - \$70. RCA 83T - \$45. RCA cathedral #4T - \$125. Airline #62-185 - \$150. All items plus UPS. Charles R. Boller, 3108 N.W. 91st, Seattle, WA 98117. (206) 782-8318

FOR SALE: RCA micro-synchronous console radio, good condition, with all tubes (not tested) - \$50. Chris Barnett, 1361 W. Wood St., Decatur, IL 62522. (217) 428-1639

FOR SALE: Hallicrafters S-40 - \$70. RCA 9-Y-7 (table R/P) - \$25. Bendix 0526A, works, poor case - \$25. Bogen amps MX30A & M330A. Zenith chassis 7S258. Zenith escutcheons: 61, 6S254, 7S258. AK 35 - \$40. Jackson tube tester G485, have 2 - \$70/both. Ship speaker, unusual - BO. Tubes new and used. Send wants. Wilbur Gilroy, 129 Belmont Ave., Clarks Green, PA 18411. (717) 586-7356

FOR SALE/TRADE: Scott 99-D mono amplifier - \$150. Scott Model 296 100-watt amplifier - \$350. Scott Mod 330-C dual AM/FM stereo tuner - \$250. Scott Mod 311-D stereo tuner - \$175. Scott Mod 350-B stereo receiver - \$325. Scott Mod 335 wide band multiplex adapter - \$225. Scott Mod LM-35 wide band adapter kit - \$200. Scott 355 stereo preamplifier - \$375. Scott Mod 208 stereo 80-watt power amplifier - \$300. Larry Drago, 383 Lincoln Dr., Cheshire, CT 06410. (203) 272-6030

FOR SALE: 50%-off sale on radios, all table models: Bendix, 110, needs filter - \$25. Crosley 9-122W, plays - \$23. Crosley, wood, 56TV-0, plays - \$20. Emerson 567A, plays - \$30. GE 115, plays - \$25. GE YRB-82-1, plays - \$23. Philco 52-942, static - \$23. RCA, wood, 56X5, plays - \$25. Stromberg-Carlson, 1101, plays, needs dial cord - \$25. George Stagakis, c/o George's Radio & TV Repair, 1714A 41st St., North Bergen, NJ 07047. Phone/fax: (201) 867-9136

FOR SALE: Large tabletop Zenith AM/FM tube radios: G725 Bakelite, B835A wood - \$25 ea. + UPS. Onerio "Lou" Sabetto, 1717 Burgess Rd., Cleveland, OH 44112. (216) 481-1036

VACUUM TUBES

20's - 50's N.O.S. & USED

Reasonable Prices - Free List

ANTIQUE TRIODE

BOX A2, FARNHAM, N.Y. 14061

Fax/Phone (716) 549-5379

WANTED: Quality crystal sets and detectors from 1920's and earlier. Not trying to see how many I can get, just want a few nice ones. Ed Bell, 5311 Wooddale Rd., Raleigh, NC 27606. Fax/phone: (919) 851-1517

WANTED: Atwater Kent 337 cabinet and speaker. Philco 70 cabinet & speaker. Walter Curry, 10035 Country View Rd., La Mesa, CA 91941. (619) 461-9327

WANTED: Philco 70 with original finish and brass escutcheon. Michael Harrington, PO Box 7619, Little Rock, AR 72227

WANTED: Hallicrafters HT-6 transmitter. Winston Burt, 185N. Poland Rd., Conway, MA 01341. (413) 369-4469

WANTED: Balloon-shape only, 80/280/380/480 tubes, used - \$13; N.O.S. - \$15. 210 wire mesh or large (ST) 210 - \$15. Used: WE 217A tennis ball (BB) - \$50. WE: 205-D/E/F - \$100; tube must test good. George Stagakis, c/o George's Radio & TV Repair, 1714A 41st St., North Bergen, NJ 07047. Phone/fax: (201) 867-9136

WANTED: SW-3 Model 1, 6- and 2-volt versions. Pre-1950 commercial ham gear. Dean Showalter, WA6PJR, 72 Buckboard Rd., Tijeras, NM 87059. (505) 286-1370

WANTED: Power supply for Radiola 60 110V AC. Wayne Martin, 701 N. Dale, Perryville, MO 63775. (573) 547-4292

WANTED: Emerson 888 Vanguards in turquoise, white, gray. Also other 888's. Excellent condition only. R. Matzko, 3 Coloma Ct., Sterling, VA 20164. (703) 406-2713

WANTED: Hammarlund or Bruno 4-pin plug-in coils. Dick Lowe, Box 296, Santa Clara, CA 95052-0296. (408) 984-1555

WANTED: Patterson PR-16 cabinet, Hallicrafters T-54 TV. FOR TRADE: Edison Blue Amberol Cylinder catalog, 1st edition. Don Merz, N3RHT, 47 Hazel Dr., Mt. Lebanon, PA 15228. (412) 234-8819

WANTED: Chassis and speaker for Model #80B or one that will fit cabinet. Butch Grieves, 2313 W. Summit Pl., Chandler, AZ 85224. (602) 820-1644



WANTED: Zenith 250 cathedral. I'll pay \$500 for a restorable set. Martin Blankinship, PO Box 157, Lecompton, KS 66050. (913) 887-6560

WANTED: McIntosh audio equipment, tube amps, preamps, all mint tuners, whole systems; Altec 604B speaker w/crossover, 333 amp. Thorens 124. Garrard 301 turntables. Scott 310 tuners. Walt Fleming, 182 Plain Hill Rd., Norwich, CT 06360. (860) 889-1957, 9 pm best

WANTED: Berlant Concertone 2020 or broadcast recorder tape reel clamps; Brandes Table Talker horn, 3 1/4 inch magnetic tape reels. Robert Perlstein, 17 Vine St., Medford, MA 02155. (707) 934-9206. E-mail: 75347.2001@compuserve.com

WANTED: Heathkit vibrator tester VT-1, 1954, and a Heathkit AC power supply Model HP-23 transformer. F. Brewster, RR2, Box 201C, Baxter Springs, KS 66713. (316) 856-3220

WANTED: Schematic or operating instructions for a Hallicrafters SX-9. Leland Smith, 10 Hawthorn Dr., Harrison, AR 72601

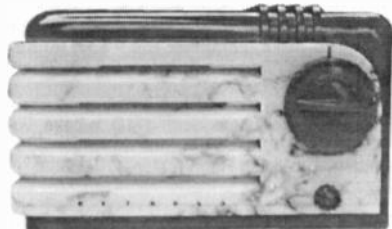

WANTED: More prewar plastics by Detrola, RCA, Kadette, Air King, et al. Take all my money before the relatives do. They are trying to hurry my already imminent demise. Please write or call collect: Rain Buttignol, 314 State St, #7, Portsmouth, NH 03801. (603) 427-1384

WANTED: To buy or borrow: Crosley shield for Buddy Boy to cast reproductions. Don Patterson, 636 Cambridge Rd., Augusta, GA 30909. (706) 738-7227

WANTED: No one offers more for my preferred items, i.e. up to: \$2,400 on Marantz 7, \$3,000 Consolettes, \$3,500 Twos, \$2,000 Threes, \$1,600 8b, \$3,000 MacIntosh MI200AB, \$1,400 Fisher SA1000, \$1,200 F/Lincoln, \$1,200 Scott 4310, 4100, 4120, \$1,000 Regency HF1000, \$8,000 Patrician, \$2,000 Jensen Imperial, \$1,800 Tannoy red, \$2,000 Hadley amp, \$6,000 WE 1086, \$1,800 S.C. 475RF system, \$500K Monks r.c., \$1,000 R.E.L., \$800 Altec 1570A, \$1,600 Laguna, Capistrano, \$700 Ionovac, \$60 2A3, \$45 EL37, \$60 m. base EL34, \$35 8045, \$55 8005. Also: KT66, 77, 88, 7591, 845, 811, 211, 6LF6, 50, 12AX7 Mullard, Black Cats, U.T.C., Acro, Partridge xfms, transcription arms. Tube x'overs, Ampex 352, Altec 340, 350, 260, 287, A.R.-LST, LST2, AR1, Lansing, Klangfilm Eurodyn, Klipschorn, Tannoy, Trichannel, Vitavox, Beveridge, Brociner, Brook, Cotter, Dynavector, Dyna MKIII, EICO, Fairchild, Futterman, Garrard 301, Grommes, Harvard Lab, Heath, H.K., KLH8, Leak, Ohm A, Pilot, Quad, R.C., RCA amps, spkrs, mikes, T.T., Thorens pro, S.C. ASP 422, Sequerra FM1, Sinclair TV, SME 3012, Sony (et al) Elcaset machines, Transcriptor T.T., WE equip., Win cart., Hill Plasmatronics. Trading fairly 25 yrs. Messages returned on wanted items. Be specific. Ed Schneck, 1401 Ocean Ave., Brooklyn, NY 11230. (718) 377-7282, M-F, 3-6 pm

WANTED: Western Electric 753, also info on WE amps and speakers. Frank Cooney, 30 Columbia Ave., Cranford, NJ 07016. (908) 272-0676

WANTED: Radio News: May 1937; January and September 1942; January 1944; June 1945. A.J. Bernard, PO Box 690098, Orlando, FL 32869-0098. (407) 351-5536

WANTED: 12Vdc dynamotor power supply. Col-2188LA for TCS-12 or TCS-13 receivers. Call, write, leave message. Mr. & Mrs. C.R. Filer, Jr., 1163 Hawksbill Ln., Sugarloaf Key, FL 33042-3159. (305) 745-1801

FOR SALE: N.I.B. Gavin UHF TV converters - \$5 plus ship. **WANTED:** Solid-state vibrator schematic. Sanford Mathis, 29390 Somerset Rd., Paola, KS 66071. (913) 294-2669

FOR SALE: Pepsi Cola cooler radio PCR-5 - \$450. RCA 5T - \$100. Zenith 6S229 - \$130. Crosley 5-50, with original paperwork - \$100. Mark Rotsch, 311 McClure Ave., Alton, IL 62002. (618) 463-3758

FOR SALE: Hallicrafters S-53A, exc - \$60. National T-55 pocket transistor, turquoise, exc - \$30. Ed Kalpa, 4622 Melbourne Ave., Los Angeles, CA 90027. (213) 661-1221

FOR SALE: Mono tuners: Scott 311D, w/case, vg+ - \$60; Brooks ST10, excellent, not working - \$35. Al Wirtenberg, 15 Wilson Rd., Weston, CT 06883. (203) 544-9270

FOR SALE: Aeriola Jr., vg paper and dial plate, works - \$475. Two-stage audio amp, uses UV-199s, kit, vg, NT - \$50. Magnavox R3 horn with 18-inch bell, vg, works - \$250. Radiola 27, excellent, works NT - \$500. Pilot 3-inch TV, Model 37, original, works, vg - \$300. Spark coil by KW in Cleveland, good coils, g - \$25. Air King shortwave adapter, works well, vvg - \$50. Cornell-Dublier capacitor bridge, Type BN in box, works - \$30. Radiola IIIA, vvg, original, good transformers, no rust or corrosion - \$155. Arrow crystal set, vg; with antenna, headphone and instructions - \$125. Midget crystal set, Bakelite, headphone, vvg - \$150. Philmore pocket radio, crystal set in box, vvg - \$160. Handie Walky, 1 tube, in box with instructions and headset, vg - \$75. Leave message on answering machine. Will return calls after April 27th in order that they were received. Richard A. Botzum, RD 2, Box 419, Morgantown, PA 19543. (610) 286-0047. Fax: (610) 286-5315

FOR SALE: Majestic 71B console 1928, exc+ condition with orig. instruction book - \$250. Dictaphone 2-piece set & 100 blank recording belts, exc - \$50. Delivery to Extravaganza. Phil Brunais, 14185 Pleasanton Hwy., Bear Lake, MI 49614. (616) 864-3143

FOR SALE: Airline (Belmont) 93BR509A - \$75. Travler 5049 - \$45. EV 630 mic with stand - \$60. Philmore mini mic - \$25. **WANTED:** Outside horn phonographs. Doug Koehn, 315 S. 14th, Quincy, IL 62301. (217) 228-1257. E-mail: dkoehn@harris.com

FOR SALE: Meissner 1938 Products Catalogue - \$7. Heathkit TC-2 tube checker - \$25. Three 833 transmitting tubes - \$12 ea. Two Dynakits Mark IV audio amplifiers, work good - \$95 ea. National SSB transceiver Mod 200 - \$95. Philco Transitone - \$30. Radiola 61-10 - \$25. Crosley Showbox - \$50. Kellogg Type 401 tube - \$10. **WANTED:** Two 10 1/2" relay rack panels, relay rack cabinet with 24-30" panel space. Fenton Wood, 109 Shoreline Dr., S.H., Malakoff, TX 75148. (903) 489-0204

FOR SALE: Transistor radios. Zenith 500H, black - \$35. Emerson 888 Explorer, ebony - \$35. GE P-800A - \$20. Philco T-70-124, white - \$20. Buy all - \$90. Robert Parke, 504 Essex St., Gloucester City, NJ 08030-1015. (609) 742-8221

FOR SALE: Axial lead electrolytics. Fresh new Nichicon miniature 10 mFd. at 450 Vdc - 98¢ ea./10 or more. Includes P&H. Many other types in stock. Write, phone or fax for free flyer. D.H. Distributors, PO Box 48623, Wichita, KS 67201. Voice/fax: (316) 684-0050

FOR SALE: Large music/PA amps. (3) Schulmerich Mod 6-123A mono blocks - \$70 ea. and (4) Mod 6-118B dual mono amps. All have massive transformers, normal speaker taps, 6L6G outputs. Untested. Schulmerich chime unit with paper roll player. Charles D. Blair, 815 N. 5th St., Cambridge, OH 43725. (614) 432-4453, 9-5

FOR SALE: Zenith Model 33. Zenith 10" speaker. 1939 Hallicrafters Sky Buddy. Zenith 5F-166, 7S-434 parts. Bill Coolahan, 1450 Miami Dr., NE, Cedar Rapids, IA 52402-2933. (319) 831-8075

FOR SALE: Scott Stereomaster 200B amp, 333B tuner, pair - \$300. Frequency meter Signal Corps BC221-T - \$75. Jim Smith, 1228 S. 40th Dr., Yuma, AZ 85364. (520) 329-0384. Fax: (520) 782-6252

FOR SALE: Grundig Satellite 5000 and 6000, super condition - \$95 ea. Harald Herp, 6615 Michele Ct., Huntingtown, MD 20639. (301) 855-7071

**HAVE YOU MOVED? ARE YOU MOVING?
PLEASE NOTIFY US A.S.A.P.
SEND US YOUR...
OLD ADDRESS
NEW ADDRESS and
SUB #
MANY THANKS!!!!**

FOR SALE: Airline 62-230 and 62-240 farm radio 1920-30? Standard AM FM SW transistor, Catalin?, 5R JB08FA, Japanese. F.H. Montgomery, 505 Congress, #910, Havre De Grace, MD 21078. (410) 939-2099

FOR SALE: Radiola VI complete and original, good condition, good audios, w/original advertising leaflet - \$1,800 OBO. Radiola Special, no cover, otherwise vg - \$525. Aeriola Sr. amp, near mint condition, good transformers, NT - \$285. Steve Wallace, 3707 Pricetown Rd., Fleetwood, PA 19522. (610) 944-7230

FOR SALE: Used once, Heathkit Model CO-2600, 12" solid-state deluxe ignition analyzer with accessories - \$475 plus shipping. John Nosbaum, 2743 Wilmette Ave., Wilmette, IL 60091-2273. (847) 256-0547

FOR SALE: N.O.S. tubes, 5V4G & 5U4GB - \$6 ea.; 6CS6 - \$3.50; 6F5G - \$6; 6K5G - \$6; 7F7, 7N7, 12AT7, 12AY7, 50L6 - \$2 ea. The following \$1 ea.: 6AC7, 6AF4A, 6AG7, 6AL5, 6AK5, 6AK6, 6AM8, 6AQ5, 6AT6, 6AT8, 6AU6, 6AV6, 6BA6, 6BA7, 6BJ6, 6BK7B, 6C5, 6CB6, 6F5, 6G6G, 6H6, 6J5, 6J6, 6K5GT, 6SA7, 6SJ7, 6SL7, 6SS7, 6B7, 6U6GT, 6V6GT, 6X4, 6X5, 7A4, 7A5, 7A6, 7A7, 7B6, 7B8, 7C7, 7E7, 7W7, 7X7, 14Q7, 14E7, 35C5, 50B5, 50C5, 35W4, 35L6, 4523, 117Z6. Also have tubes left from my ad p. 85 in April A.R.C. Joe Svihel, 17227 Co. Rd. 54, Avon, MN 56310. (612) 356-7601

FOR SALE: Tube audio. Amplifiers: Bell 2315 - \$50; Eico ST40 - \$95; Heath EA2 - \$25. Tuners: Fisher FM100 - \$75; FM50B - \$35; Pilot AF821U - \$75; Eico ST97 - \$45; HFT92 - \$40; HFT90 - \$15; Heath FM3A - \$25; Knight KG50, with real nice wood case - \$60; Sherwood S20000II - \$40, S3000 - \$25; Dyna FM3, factory wired - \$90; Bogen RR550 AM/FM receiver - \$45. All + S&H. John E. Kendall, PO Box 436, Fallston, MD 21047. (410) 483-3884

FOR SALE: 1939 Zenith 6S-321 - \$195. Old Western Electric telephones, working - \$40-\$115. Shipping extra. Steven DiMattia, PO Box 4480, Pocatello, ID 83205-4480. (208) 233-7491

WANTED: 6KD6s; new/used CBS, Telefunken, Rogers, Amprex ECC88, E88CC, E188CC; RCA red 5692. Robert Koerner, NY11, 8910N Camino de la Tierra, Tucson, AZ 85742. (520) 742-6130

WANTED: Brach Key & Knife Switch for 1917 Brach Supply Co. U.S. Army Signal Corps Induction Telegraph like the one sold at the Rochester AWA. Any leads appreciated. David Bart, 8512 N. Kedvale, Skokie, IL 60076. (847) 676-0612, home; (312) 676-0612, work

WANTED: National Model NC-2-40D with matching speaker, Hallicrafters Model S-29 Sky Traveler, Hallicrafters Model S-33 Sky Trainer, Hallicrafters Model S-39 Sky Ranger, Model All-Star, Model All-Star Jr. Len Bourquin, 67 Stafford Ave., Newington, CT 06111. (860) 666-9771

WANTED: Broadcast and recording equipment. Microphones, compressors, reverbs, mic pre's, military style 1/4"-plug cables, literature. Jim Kollens, 29 W. Commercial, Addison, IL 60101. (708) 628-0810, days. (708) 691-8890, evenings

WANTED: Belmont bullseye, small prewar Bakelite, no cracks w/back, (see Stein, p. 46). Karen McCoy, 8104 N.W. 114th, Oklahoma City, OK 73162. (405) 722-0595. E-mail: kcmccoyok@aol.com

WANTED: Mics wanted: Tumer BX/CX, BD/CD, VT-73. Astatic JT-30, W80, T-3. EV 605. Shure 707A, 708, 545. Call/fax if you have others. Tom Ellis, Box 140093, Dallas, TX 75214. (214) 328-3225. Fax: (214) 328-4217

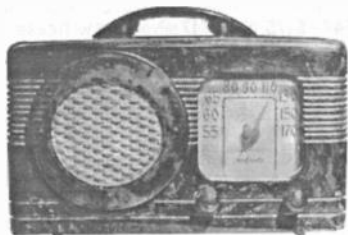

WANTED: Motorola Catalins #'s 50XC, 51X15, and 52, as complete or "parts" sets. I am a very serious collector seriously looking for serious stuff (leaving all kidding aside, of course)! Please write or call collect: Rain Buttignol, 214 State St, #7, Portsmouth, NH 03801. (603) 427-1384

WANTED: WE early transmitting tubes: 212D, 212E, 211D, 211E. Minoru Muraoka, 2-18-30-503 Kikuna, Kohoku-ku, Yokohama, Kanagawa 222, Japan. Fax: 81-45-401-1499

WANTED: Chapman's Radio Boys To The Rescue. Collins Signal magazines. 75A3/2 parts source. Brian Roberts, K9VKY, 3068 Evergreen Rd., Pittsburgh, PA 15237. (412) 931-4646

WANTED: Nov. 1920 Radio News and RTTY magazines. Tom Kleinschmidt, 506 N. Maple St., Prospect Heights, IL 60070-1321. (847) 255-8128

WANTED: Zenith #8S467 console, must be in good condition or restorable. Zenith Newport #12H670 console. Zenith table Model 9S234, 9S-323, Zenith Trans-Oceanic T600. Reed & Company, 4438 S. Santa Fe Pl., Tulsa, OK 74107. (918) 446-4276

WANTED: National SW-54; Hallicrafters S-38, 40, 52, 72, 77, TW1000, 2000; Zenith Trans-Oceanics; radio should be original and exc condition; anything prewar Pan American related. Takashi Doi, 1-21-4, Minamidai, Seyaku, Yokohama, Japan. Fax: 011-8145-301-8069

WANTED: National HRO-60 with coil/speaker rack. This unit sat on a desktop. James Olson, 3442N. Cook Rd., Powder Springs, GA 30073. (770) 429-8189. E-mail: jolson@intergate.net

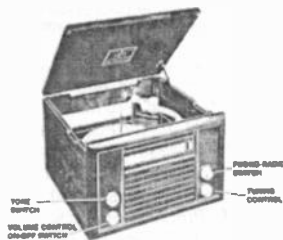

WANTED: GE 303 or 304 table radio/phonograph as pictured. Terry A. Kovalchik, R.D. #1, Box 291, Bradley Rd., Dillonvale, OH 43917. (614) 733-7226

WANTED: Schematic to MECK TV chassis number 9033A, built in 1952. Will reimburse costs. Ken Wasulko, 502 W. 12th St., Mishawaka, IN 46544. (219) 259-8444

WANTED: American Mohawk Seneca schematic, tube layout, battery hookup info and a floor cabinet in any shape or will buy the whole thing. M. Endicott, 18 N. Walnut Ln., Schaumburg, IL 60194. E-mail: mendicot@ais.net

**PHONE NUMBER FOR
ANTIQUA RADIO CLASSIFIED
(508) 371-0512**

**Best time to call is weekdays:
8:30 am to 6 pm Eastern Time
(Please no classified ads by phone. Thanks!)**

WANTED: Instruction manuals for Heathkit test eqpt. Sig. tracer Model IT 5283. Audio generator Model 1G5282. RF oscillator Model 5280. John Blake, 4147 Rose, Western Springs, IL 60558. (708) 246-2992

WANTED: Good warm loving home for Snow White and her seven friends (Emerson Q-236). Adoption papers available. Frank D. Atwood, 117 E. Main St., Merrimac, MA 01860. (508) 346-8100

WANTED: Manual or copy for Mosley CM-1 ham radio receiver. Boca Electro Magnetic Lab, 21218-10 St. Andrews Blvd., Boca Raton, FL 33433. (407) 750-8911

WANTED: (2) Kurz Kash vernier dials. Conrad R. Hilpert, KL7JKE, 1300 W. Aluminum St., Butte, MT 59701. (406) 782-0328

WANTED: 12 tube Zeniths, mint or parts sets. Mark Hewitt, 6659 Tipperary Trl., Roscoe, IL 61073. (815) 623-8729

WANTED: NRI or similar radio repair course. Also Triplett 67 or 68 tube charts. Dan A. Unruh, 458 W. Main, Monmouth, OR 97361. (503) 606-0264

WANTED: Motorola 56T1 transistor radio for parts or working radio. Joe Schlosser, 5300 Knollwood Dr., Raleigh, NC 27609. E-mail: 10337.422@compuserve.com

FOR SALE: Marantz Model 2252B solid-state receiver, new in box - \$220. Marantz Model 6350Q turntable, new in box - \$100. Gerald Kitchens, 116 E. South, Orea, IL 62554. (217) 468-2540

FOR SALE: Philco 89, complete but cabinet rough - \$40. WANTED: Hallicrafters 500Ω speaker. Steve Hansman, 855 Arundel Dr. N, Arnold, MD 21012. (410) 974-0561

FOR SALE: Zenith Royal 16 w/instructions, floral grille - \$30. WANTED: LED-type pocket calculators. Larry Gilbert, 2602 Amapola Dr., Davis, CA 95616. (916) 758-5025

FOR SALE: Magnavox Junior, orig. - \$165. Grundig 2035, plays - \$75. National 1-10 no PS, nice with orig. book - \$175. National 1-10A no PS, nice with orig. book - \$175. Philco RP-2 wireless record player, nice, works - \$175. Philco 60, 1 veneer chip on front, plays - \$150. Philco 60, refinished, plays - \$150. Knight R-100, nice, plays - \$125. Precision 660 tube tester, works, with books - \$40. RCA 56X, nice, plays - \$35. Hammarlund HQ129-X, nice with orig. speaker, book, plays - \$175. RCA 3-BX-671 Strato-World, nice, plays - \$150. Hallicrafters S-120, nice, plays - \$50. Hallicrafters S-200, nice, plays - \$50. Hallicrafters SW-500, nice, plays - \$50. Hallicrafters SX-130, nice, plays - \$125. RCA BP-10, nice - \$65. Zenith 7000-1, plays - \$250. Zenith 3000, plays - \$100. Zenith 1000, plays - \$100. Zenith Royal 500, chassis 7ZT4021, nice, plays, with leather case - \$100. Zenith R25Y1, nice, plays - \$25. Bulova 280 Series, nice, plays - \$35. Bulova 290P, has scratches, plays, with leather case - \$50. Waltham SR-H105L, nice, plays - \$35. Viscount 602, clear front panel, has chips - \$75. Realtone TR-1057, nice, plays, with leather case - \$20. Toshiba 10TL-429F, nice, plays - \$50. GE P-808E, nice, plays - \$20. WANTED: RCA AR-812 parts set, tube caddy in good condition. Shipping extra, open to offers. Ed Wilmar, 593 W. 15th Pl., Chicago Heights, IL 60411. (708) 747-6423

BUY • SELL • TRADE

CATALIN RADIOS

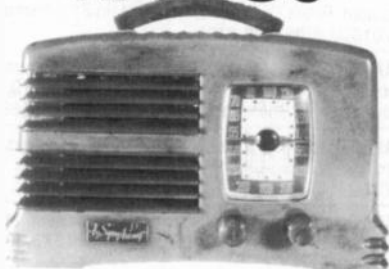

I'll buy single pieces or
whole collections. Top prices paid.

RADIOART

Jim Meehan
P.O. Box 102 • Centerbrook, CT 06409
(203) 526-1762

FOR SALE: Westinghouse Aeriola Sr. - \$195. Mengel crystal radio - \$275. Federal Jr. - \$295. Emerson 540 - \$150. Radiola II - \$395. Black Neutrowound - \$650. Ware 3 exposed tubes - \$275. Radiola bal. amp - \$225. Zenith Royal 7000 - \$295. 7G605 - \$295. Jackson Bell 82 - \$350. Swan - \$550. AK 165 - \$350. Crosley widge - \$695. Stewart-Warner dancing girls floor model - \$595. Danish Modern Philco Predicta - \$1,200. RCA oriental radio - \$195. Radiola 103 speaker - \$195. Radiola UZ1325 - \$175. Stewart-Warner etched glass radio advertisement - \$375. AK etched glass - \$395. Emerson wood left side bullseye - \$175. RCA La Siesta - \$795. RCA 1939 World's Fair - \$1,600. San Francisco Expo - \$895. Catalins maroon Fada bullet - \$850. Red & yellow wavy grille Sentinel - \$795. Brown & yellow swirl DeWald harp - \$675. Fada 652 yellow & red with yellow insert grille, some hairlines - \$695. Transistors N.I.B. Champion 2 transistor radio - \$75. Orange Sony 620 N.I.B. - \$195. NEC NT-61 - \$195. Pink Zenith Royal 500, hairlines - \$250. Zephyr ZR740, blue - \$175. Red TR1 - \$495, black - \$395, grey - \$275. Standard SRG433 N.I.B. - \$75. Blue Futura Medallion Model 888 - \$250. Perfect Emerson 888 white Vanguard - \$175. Futura 2 trans. earphone only - \$75. Crown TR-666 - \$175. Toshiba 6TP-31 - \$495. Windsor Superior Deluxe 2 tran. boys radio - \$45. Kent 6 tran. - \$35. Tiny Tim crystal radio - \$65. Clairtone earphone only - \$25. White refrigerator radio H126 Westinghouse - \$95. Black U.S.A. Emerson - \$295. Baseball trophy radio - \$795. Micronic Ruby red SRG640 - \$95. Mint Grebe Synchrophase - \$250. Pilot TV 373" screen - \$350. Jackson Bell 84 Peter Pan - \$850. Crosley red 11-115U - \$195, white - \$150. Red Privatear sub mini tube radio - \$475. Emerson maroon & gold 747 - \$175, black 747 silver front with case - \$195, black 856 hybrid - \$150. Beige Motorola Pixie - \$195. Pee-Wee pocket radio - \$195. Pakette - \$175. Monarch pocket radio N.I.B. - \$150. Blue & white space satellite - \$195. New with mailer Charlie McCarthy game - \$125. Little Wonder microphone N.I.B. - \$45. Sylvania Thunderbird - \$550. Tuska 225 - \$425. Western Electric crystal radio - \$795. Commerce crystal radio - \$850. Bowman crystal radio - \$1,800. Ken-Rad crystal radio - \$350. Spellman Electric Co. New York crystal radio - \$295. Spartan Bluebird - \$2,995. Spartan 558, 4 knob blue mirror - \$2,995, peach 558 - \$3,395. N.I.B. Radiola 103 - \$495. Small Shure Elvis mike - \$175. 1920 spring type mike - \$450. RCA 77 mike - \$995. Blue Turner deco mike - \$250. Altac - \$595. Electro-Voice, looks like RCA 44 - \$450. Many Arvin metal radios. Call: Vintage Radio Co., 87 Sandra Dr., Parsippany, NJ 07054. Voice or fax: (201) 316-8424

FOR SALE: Popular Electronics and others (1956 to 1980) - \$12-\$18 per year. SASE list. Dave Minchella, KE2GE, 80 Campfire Rd. N, Henrietta, NY 14467

FOR SALE: Floor model Edison Diamond Disc phonograph Model S-19 - \$450. Jeffrey Williams, 201 E. 62nd St., Apt 8C, New York NY 10021. (212) 754-5865

FOR SALE: Magnavox T(RF)-6 tabletop, original and complete with tubes, mahogany drop-front cabinet - \$125. Curt Brohard, 1417 Court St., Alameda, CA 94501. (510) 521-4299

FOR SALE: Bits of Wireless History by Jack Gray, 1969, limited edition reprint 1994 - \$18. Gray History of Wireless Museum, 404 Ross Ave., Hamilton, OH 45013. (513) 867-0079. E-mail w8gfa@aol.com

WANTED: Speaker panel for National RAC-2 receiver, complete or parts. Please advise. Richard Norton, 9 Endo Blvd., Garden City, NY 11530. (718) 225-7412. Fax: (718) 279-9011

WANTED: SABA 200/10T table radio. Phil Holahan, PO Box 392, Grafton, MA 01519. (508) 839-3765. E-mail: holahan@mtpc.org

WANTED: Nice condition National CN-400. I have excellent condition GPR-90 receiver for trade. Niel Wiegand, WA5VLZ, 12105 Mustang Chase, Austin, TX 78727. (512) 219-8548

WANTED: Schematic and additional information for Grundig 2028. Louis D'Antuono, 8802 Ridge Blvd., Brooklyn, NY 11209. (718) 748-9612, after 6 pm

WANTED: Chassis for GE radio Model H77. A.J. Long, 11830 Heath Rd., Chesterland, OH 44026. (216) 729-8451

WANTED: KLH 8 and accessories. Philco 48-230, 48-460-1, 49-501, 49-503, 49-506, 50-526, 51-532, 51-930, 52-548, 53-561, 53-563, 53-566, E818, TP-7, T-1000. Motorola 53H1, 53X1, 5X11U, 72XM21. Acrosound, Fairchild, Fisher, Hadley, Karg, REL, etc., tube hi-fi equipment, accessories, sales literature. 1950's-1960's hi-fi books, plus Allied, Lafayette, Heathkit, etc., catalogs. Paul Creasy, 6216 Worlington Rd., Bloomfield Township, MI 48301. (810) 737-0429. E-mail: 74664.1153@compuserve.com

WANTED: Vacuum tubes, write for bid list showing prices I pay. Antique Triode, 653 Commercial St., Farnham, NY 14061. Phone/Fax (716) 549-5379

WANTED: Philco PT6 complete or chassis. Sam Sewell, Jr., 4238 So. 164th, Tukwila, WA 98188. (206) 243-1023

WANTED: All Catalin and Plaskon radios in any condition. Jean-Claude Reboul, 7010 S.W. 48 Ln., Miami, FL 33155. (305) 662-1986

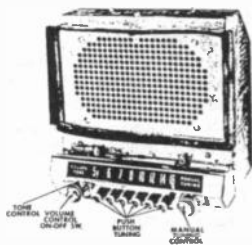

WANTED: 1951 Studebaker radios (S-5127, S-5124, S-5123) in decent condition. Also need parts (chrome bezels, knobs, pots, parts etc). Roy Yost, R.P. Obsolete, 30 Clinton St., Redwood City, CA 94062. (415) 369-0890

WANTED: Cleervue Hollywood television hand-wired Zenith 500 knobs. Lee White, 86 Spruce St., Framingham, MA 01701. (508) 788-0359

WANTED: International Kadette Bakelite radios, rare horn speakers, and tube-operated bicycle radios. Greg Farmer, 71 Rice Creek Way, Fridley, MN 55432. (612) 571-6062

WANTED: Navy Modulator CAY-50064 for TBM. Tall skinny thing, six meters on top, handset. William Donzelli, 304 S. Chester, Park Ridge, IL 60068. (847) 825-2630. E-mail: integrat@usr.com

WANTED: Unbuilt radio or amplifier kits. Jim Williams, 6622 Shalestone Ct., Clifton, VA 22024. (703) 631-0071

WANTED: RCA 100 cathedral; Philco 512, 514 or 515 w/matching speaker; AK 46 w/matching speaker; Columbia Grafonola with record ejector; Victrolas; Garrard 301. Richard Rubin, 227 Riverside Dr., Apt. 5-A, New York, NY 10025. (212) 864-8416. E-mail: wireless@panix.com



WANTED: Any McMurdo Silver radio or any Scott radio that sits on speaker cabinet. Don Hauff, Box 16351, Minneapolis, MN 55416. (800) 769-9980. E-mail: McMurdoDon@aol.com

WANTED: Antique radio and television collectors to attend Radiofest 1996. See page 37 of the January A.R.C. for a pre-registration blank. Watch for our two-page ad in July. Jeff Aulik, 1708 Parkview Ave., Rockford, IL 61107. (815) 399-1902

WANTED: Kudelski/Nagra Model IV-SD or -S recorder. Radios: Telefunken T12 with Arcotrons, RCA 65BR9, unusual shaped table radios such as Philco 49-501 boomerang radio. TV's: Philco Predictas, Hallicrafters 505 (doghouse), Sony 8-301W & FD-20A. Tubes: 6D5, Acrotion 201 & 301. FOR SALE: Japanese WWII tubes: UZ135, UY133A & KX250, all N.I.B. - \$20 ea. Also CRTs BG75A, 3", test good - \$40 & SSF120G, 5", N.O.S. - \$50, postage extra. Noriyoshi Tezuka, 1-11-2-403 Hiroo, Shibuyaku, Tokyo 150, Japan. Fax: 011-813-3440-8396

WANTED: Paragon Amplifying Transformer Model 80 (open-frame audio). Will pay good bucks! Thanks! Rick Ammon, 1249 Solstice Ln., Fort Collins, CO 80525-1239. (970) 221-4001

WANTED: Correct AM/FM radio for 1963 Chev. Impala. Face is 1 1/2" x 3 1/2" w/AM/FM switch on top. Carl Limmer, 21769 Meridian, Grosse Ile, MI 48138. (313) 676-1125

WANTED: 1930 Midwest Radio/MIRACO screen grid A-C chassis, speaker, knobs and promotional literature. Mark Gutekunst, 2600 Martin Rd., Willow Grove, PA 19090. (215) 657-8958

WANTED: Telefunken and Bugle Boy 12AX7, 6DJ8, EL34; WE 211, 212; Globe 50; KT77; Heath W6 amps. John Birk, 458 E. 600, N, Orem, UT 84057. (801) 224-4809

WANTED: Sonora Candid, Zenith 4K600, Majestic 130, Emerson 645 and other early personal portables. Tony Parjus, 816 Richard Ln., Gretna, LA 70056. (504) 393-0099

WANTED: Pocket-size tape or wire recorders with 2" or smaller reels. Thank you. Guy Doss, 736 Las Padres Blvd., Santa Clara, CA 95050. (408) 241-2437

FOR SALE/TRADE: New valves from flowing production: KT88, EL34, E34L, EL84, 6L6GC, ECC83, and ceramic sockets. Price list from: Robert Losonci, Fleischgasse 34, A-1130 Wien, Austria. Fax: Austria Wien +43 1 876 788 329

FOR SALE: Knobs, National Co. N.I.B., gray/black-\$5 ea. Hickock 209A w/book, very clean-\$75 ppd. Kelly Nichols, RD 1, Box 103K, Greenwood, DE 19950. (302) 349-5059

FOR SALE: Knight R-55A communications receiver - \$55 + shipping. Allen Jochem, 2205 Broadway, Quincy, IL 62301. (217) 223-6751

FOR SALE: Manufacturing specifications from Western Electric and Western Union Telegraph. Send \$1 and SASE for list and details. Tom Pencak, 29822 102nd St., Trevor, WI 53179. (414) 889-4633

FOR SALE: Currier Royal-\$75. USL Contact 23-\$75. S-38E-\$40. Harvey-Wells TBS-50D-\$90. Dynakit 70 amp-\$140. John Malley, 19 Claremont Ave., Enfield, CT 06082. (860) 745-0733

FOR SALE: Price slashed: 103 old radio programs on reel tapes. SASE for info. Ron Russell, 1927 Laxalt Way, Elko, NV 89801. (702) 738-7474. E-mail: russellron@aol.com

FOR SALE: Swan 350D amateur transceiver, rare digital display version of 350, original box, manual-\$350 OBO. RCA WA-504B sine/square wave audio generator-\$50. Dan Langston, 820 Harrington Dr., Milledgeville, GA 31061. (912) 452-1015

FOR SALE: Zenith transistor radio Model 500H oval grille, black w/gold front-\$95. Toshiba transistor baseball radio Model 6TP-515, exc in box, missing bat stand-\$95. Philco Safari TV, missing visor, no side knobs-\$85. Zenith Royal M hearing aid w/box-\$75. Bill Constantine, PO Box 493, Glens Falls, NY 12801. (518) 792-7065



Vacuum tubes for Audio
are back...
and they sound better
than ever!

Glass Audio

brings together yesterday's tubes
and today's improved components,
making smooth sound possible
from your audio again.

Ask for your first FREE
issue, without obligation!

Glass Audio

PO Box 176, Dept. ARC6
Peterborough, NH 03458-0176 USA
FAX (603) 924-9467

FOR SALE: Command receiver set with rack FT220-A, BC453, BC454, BC455, connectors, hand cranks, dynamotors, and BC450 remote control-\$500; AN-N6 gun camera-\$60; LS166/U speaker, no connector-\$20; TU-8-B, TU-10-B tuning unit-\$30 ea. National NC-60-\$45; NC-66-\$100; NC188-\$100. Knight R-55 receiver, excellent-\$165. Dynaco MKIII-\$250. Dynaco mono preamp-\$50. Dynaco stereo control-\$50. Marantz 240 solid-state U.S.A.-\$450; 3250-\$250; 1180DC-\$225. Sony 2R-21, excellent-\$45. Mini Vox watch radio, box-\$75. Teachers Highland cream-\$90. RCA 8-BX-7L-\$35. Maquire 561 DW, inductive tuning-\$55. Brush BK-401 sound mirror-\$90. Tom Murray, 3177 Latta Rd., #409, Rochester, NY 14612. Voice/fax: (716) 723-1672

IF YOUR EXPIRATION DATE IS MAY OR BEFORE, RENEW TODAY! EARLY RENEWALS RECEIVE AN EXTRA ISSUE!

FOR SALE: Arvin 440T, plays-\$46. Grunow 941 console-\$175. Emerson BA199, parts-\$40. Philco 20, 89 chassis and speakers-\$90 ea. Truetone D2210 Deco metal-\$169. Wilcox-Gay A-27 Deco-\$195. Zeniths: 1936 6S2 console-\$250; 12S550 chairside-\$295. Transistors: Channel Master 5606, red, plays-\$34. Regency TR-1, gray, back cracked, needs help-\$200. Sunoco, plays-\$27. Zenith, black handwired-\$100. Bill Timoszyk, 35283 Leon, Livonia, MI 48150. (313) 421-2076

FOR SALE: RF signal generators: HP8640B/323 0.450 to 512+ MHz with LED frequency counter display, AM FM CW pulse modes, vg, with case-\$320. Logimetrics 0.05 to 80 MHz, AM CW frequency counter display, crystal phase lock to 10 Hz runs well-\$150. HP606A 0.05-65 MHz-\$115. HP-606B-\$150. URM-25D 0.01-50 MHz AM, CW, output attenuators, RF outputs, as is-\$40. HP freq. counter to 500 MHz, 9 digit LED display high stability time base-\$165. HP-200CD audio generator-\$40. Power Design power supply 0-50v 1/2A-\$40. Tek 7000 scope series plug-in extender-\$150. KrohnHite wide-band tube amp, 50 watts out, DC-500 kHz, massive, commercial grade, working-\$220. Antique light bulbs, clear glass, with tip, good filament-\$35; no tip-\$20; dud-\$5. Temple console, 1929, pickup only-\$75. N.I.B. WE-205F-\$110. N.I.B. RCA 2A3-\$50. All plus UPS. Stan Krumme, KO6YB, 16432 Lakemont Ln., Huntington Beach, CA 92647. (714) 841-5866

FOR SALE: Philco 38-12-\$45. Stromberg-Carlson 641-A-\$100. Teletone TV-149 7" set, needs knobs-\$85. Federal Jr. crystal set-\$325. RCA 1-MBT-6 Strato-World-\$100. Sony TR-650-\$25. Sony TR-810-\$25. Audio Engineering magazines. Technical books. Call. Jon Steinhauer, 1205 E. Broadway, F-15, Hewlett, NY 11557. (516) 295-3147

FOR SALE: Philco 84 cathedral cabinet-\$40. WANTED: Atwater Kent 206 chassis, knobs; 708 restorable. Curt Schreiber, 3923 East Latoka St., Springfield, MO 65809. (417) 887-5184, collect. E-mail: Curradio@aol.com

FOR SALE: Many old radios. Batt., AC, AC/DC, transistor. Most need restoring. SASE for list. John Webb, W6RCW, 12736 Erin Dr., Auburn, CA 95603. (916) 885-9556

FOR SALE: Vacuum tubes. N.O.S. and used. Send two-stamp SASE for List #4. Neal Simpson, 27-1 Queen Rd., Lambertville, NJ 08530. (609) 397-3346

WANTED: A Precision EV-10A VTVM parts set and complete set of leads for same. Rene van Gaalen, 218 Sandpiper, Portland, TX 78374. (512) 643-1589

WANTED: Manual (copy OK) for Superior Instruments Co. transistor radio tester Model 88. Thanks. Steve Beale, 4694 Chickasaw Rd., Memphis, TN 38117. (901) 685-0209

WANTED: Rider's Radio Volume 1. Ray Sanders, 342 S. Third St., Cottage Grove, OR 97424

WANTED: Coke cooler or Pepsi 1949 radio mini cathedrals (dead or alive), microphone tube radios, baseball trophy. Early transistors. Sam Bates, 6144 Fair Ave., N. Hollywood, CA 91606. (818) 985-9912

WANTED: 1950's pinball machine, not working OK. Lags for Philco Predicta TV, speaker for Philco 70. Someone to unstick tuner on Grundig Satellite 6001. Ross "Doc" Ellis, 206 Gregg Dr., Battle Creek, MI 49017. (616) 962-1514

WANTED: Fisher AM-FM receiver Model #RS-913A. Matt Kachmarchi, RD2, Box 150, Cherry Tree, PA 15724. (814) 948-7526

WANTED: Rider's books 16 thru 25, operating manual for Eico 950 resistance capacitance comparator. FOR SALE/TRADE: Rider's #11, good condition - \$25. Loads of mini tubes 7 & 9 pin. Also large tubes of same type, radio & TV mixed, with tube caddy. Must pick up, too much to ship. Jerry Reed, 4438 S. Santa Fe Pl., Tulsa, OK 74107. (918) 446-4276

WANTED: Schematic/info. for Nova-Tech Air-O-Ear receiver Model 711-AN. Need 1940's RCA TV decal set reproductions. Dave Abramson, 1649 Yellow Springs Rd., Chester Springs, PA 19425. (610) 827-9757

WANTED: Zenith 12U158 dial glass, pointer & knobs. Airline 62-101 chassis, door knob Ambosch 48. Keith Park, 795 Grooms Rd., Rexford, NY 12148. (518) 373-0417

WANTED: Schematic and technical data for a Weston 682 tube tester. Ray Glass, 1500 Centre St., Boston, MA 02131. (617) 323-5241. E-mail: rglass@lynx.dac.neu.edu.

WANTED: Scott AW-23 power transformer or whole amplifier. McMurdo Silver Masterpiece III speaker (Jensen?). David C. Poland, 6546 Upper Lake Cir., Westerville, OH 43082. (614) 890-5422

WANTED: Desperately need RCA AP-936 power amp for Victor VE-10-69 Electrola. Will pay generously. Jeff Lendaro, 1107 Logan St., Noblesville, IN 46060-2346. (317) 773-3969. E-mail: lendaroj@indy.tce.com

WANTED: Atwater Kent 255, 312, 318, 412, 710 or cabinets, speakers, chassis for same. Jeff Aulik, 1708 Parkview Ave., Rockford, IL 61107. (815) 399-1902

WANTED: Nice condition working Philco Model 90 cathedral. C.P. Moriarty, 4928 North 105 St., Omaha, NE 68134. (402) 493-1474 or (402) 636-3055. E-mail: cmoriarty@oppd.gov

WANTED: Crosley 11-105U chartreuse Bullseye radio in vg/excellent condition, working condition not important. Kenneth Schroyer, 101 Timber Ridge Rd., State College, 16801. (814) 237-1258

WANTED: Original working loudspeaker for Philco 20, 21, 70 or 90. George B. Shields, Jr., 108 Jacques Ln., Somerset NJ 08873. (908) 297-0363. Fax: (908) 297-2007

WANTED: Capacitance tester and inductance tester, 4-pin staggered tube socket. Noel S. Ilg, 228 Beck Rd., Avon Lake, OH 44012. (216) 933-5668. Fax: (216) 933-8864

WANTED: Zenith G663, G665, G882. Stan Sarch, 1105 Middleton St., Madison, WI 53717-1078. (800) 831-2266. Fax: (608) 831-7581

"Do you know me?"

I started the world's first broadcasting station. I'm Charles Herrold, and between 1912 and 1917 I was sending music and news to an audience in San Jose, California, on a regular schedule. But while I may have been first, most people forgot all about me. Now there's hope; my story is told in this exciting new videotape from the creator of the award-winning PBS series "Radio Collector." It's available from the Perham Foundation. Don't leave home without it!"



"Broadcasting's Forgotten Father: The Charles Herrold Story"

VHS-Hi-Fi, close-captioned, \$29.95 plus \$3.50 S&H.

Order directly from the Perham Foundation,
101 First St., Suite 394, Los Altos, CA 94022.

Or call 1-800-771-KTEH and use your credit card.

All profits go to support the preservation of electronics history.

FOR SALE: Airline 54BR-1503, Deco, bullet knobs - \$55. Emerson 502 Catalin, crack - \$95. RCA 8X541 - \$30. RCA 66 BX - \$30. RCA 6BX8 - \$20. Mirror Tone midget - \$50. Truetone D2102A - \$20. Truetone D1012, Deco - \$125. Truetone D941, Deco - \$175. Silvertone 6002, black - \$75. Stromberg-Carlson 1500, Deco - \$80. Westinghouse H-147 - \$30. Wilcox-Gay Recordette - \$45. Sony 5-303W transistorized micro TV - \$125. IBM tube tester - \$25. Weston 771 tube tester, 1930's - \$35. Transistors: Candle PTR-85C, N.I.B. - \$125. Candle PTR-100 - \$50. Channel Master 6503 - \$25. Channel Master 6518 - \$20. Emerson 888, red - \$100. Emerson 888, aqua - \$80. Emerson 888 Vanguard - \$80. Emerson 911 - \$40. GE P800A - \$35. GE P711A - \$25. GE P807J - \$15. GE P808J - \$15. Hitachi TH666 - \$85. Arvin 60R63, red - \$40. Philco T7-126 - \$75. Zenith Royal 500D - \$65. RCA 4RH11 - \$25. Hoffman OP-708 - \$20. Motorola 8X26S - \$30. Motorola 6X31R, coral - \$45. NEC NT-6M11 - \$25. Penney's (Toshiba) 6TP-555 - \$60. RCA 3RH22G - \$25. RCA 4RH16 - \$25. Sharp BX-384, red - \$50. Sharp TR-203, purple box, papers, etc. - \$50. Sony EFM-117L - \$50. Sony TR-84, green - \$35. Toshiba 6P-15, blue - \$50. Truetone DC3901 - \$45. Windsor boys radio, red - \$50. Zenith Royal 20, N.I.B. - \$60. Zenith Royal 500B, maroon - \$50. Novelties: Avon SSS, Amoco Pump, GE cube, Cheeseburger, Panasonic R-8, Panasonic ball, Polaroid 600, Delco battery - \$15 ea. TSM's: 20, 24, 25, 26, 28, 29, 59 - \$10 ea. Russ Abrams, 2330 Villaret Dr., Huntsville, AL 35803. (205) 883-7322

FOR SALE/TRADE: Midwest Miraco Mod MA-4, (see Douglas, p. 176, bottom left corner) - \$400. Crosley Ace Mod #3-D w/3 WD-12 tubes - \$300. Larry Drago, 383 Lincoln Dr., Cheshire, CT 06410. (203) 272-6030

FOR SALE: Signal Corp TT-1F/TXC-1 tube-type fax transceivers, less power supply, recond. - \$25. N.I.B. tubes: 5V4GA, 5U4GB, 6082WB - \$5; 83, 7587, nuvistor - \$9.50; 3RP1 - \$21; 4D32 - \$35. Lowell Thomas, AA6ZD, PO Box 15026, Fresno, CA 93702. (209) 227-1605

The Olde Tyme Radio Services Directory is now available. Find the services and parts needed to restore that old radio or t.v., also included are clubs and publications all categorized and sorted by state for easy look-up. Over 225 suppliers listed, and always adding more each year. Send \$4.00ppd. Andrew Mooradian, 5 Priscilla Lane, Winchester, MA 01890

CRYSTAL SETS: The Xtal Set Society Newsletter Volume 5 now available in paperback, \$9.95 plus \$2.50 shipping. Design of Unpowered AM Receivers, Radio Outfit in a Headset, The Matching Secret, and more. Join the Society and receive 6 newsletters, \$9.95. The Xtal Set Society, PO Box 3026, St. Louis MO 63130. (314) 725-1172

WANTED: Collins Radio Company Catalogs, promotional literature, manuals 1933-1983. Jim Stitzinger, 23800 Via Irana, Valencia, CA 91355. 1-805-259-2011

WANTED: 18" Jensen speaker w/carrying handle and pedestal circa 1935, 36. Bo Broock, 4858 Willow Lane, Orchard Lake, Mich. 48324. (810) 681-7133, eves.

FOR SALE/TRADE: Heath DX-100-B transmitter - \$300. Large size Amplion AR-19 - \$950. Mid-size Amplion #19 horn speaker - \$800. Collins 75A-3 w/2 mechanical filters - \$500. Erla cathedral w/clock in grille, casket style, cabinet design, unbelievably beautiful - \$475. Call Larry Drago, 383 Lincoln Dr., Cheshire, CT 06410. (203) 272-6030

FOR SALE: Hammarlund Hi-Q 6 complete chassis but missing corner of faceplate; Erla #02298 - \$75. Stewart-Warner Model 801 w/owners man. - \$75. Westrad 80, AC, (2)45's, 8 tubes - \$100. Case 20's AC set - \$75. Buckingham 7-tube AC set from 20's; (8) home brews WT - \$30 up; Hallicrafters SX-104, CRX-5, World Wide; Grundig 4066, exc - \$100. Farrand Concert Senior speaker, exc - \$150. **WANTED:** AK speaker for Model 808, Part #34500, torn cone OK. Thanks to all the dealers/visitors who helped make the March show a success. See you in October! Ray Lamont, 70 Litchfield Rd., Unionville, CT 06085. (860) 675-6327

FOR SALE/TRADE: Conn. Tel. & Tel. spark coil - \$70. Philmore Tiny Tim rcvr 1-tube, rare - \$260. Edison battery oil bottle, never used - \$40. Edison com. coin, 1947 - \$25. Graham Bell plate hand-painted in Germany - \$50. Telephone signs. Dictograph horn, gold - \$310. Radiodyne WC 15JR - \$400. Tuska 300 - \$400. AK parts variocoupler, variometer, 2-tube amp & repro crystal det. Pepsi dispenser radio, missing strap & shelf - \$75. Stutz Bearcat - \$70. Radio Rex - \$150. Bob Fuschetto, 1758 Michael Dr., Whitehall, PA 18052. (610) 435-8944, call between 7 & 9 pm

FOR SALE: Heathkits: HW12, Mohican, HR10, HX30. Military: BC-659-J xcvr, RT-18/ARC-1 xcvr complete with 29 tubes & dynamotor, Western Electric I-166 calibrator, ARC5 rcvrs, dynamotors: DA1E, DMFX, LD1D, 3412-12. S-band signal generator. Chassis: AK Type-H and 85 superhets w/faceplate and knobs. **WANTED:** Philco 84 chassis and knobs, junker OK. Andrew R. Mitz, WA3LTJ, 4207 Ambler Dr., Kensington, MD 20895. (301) 897-5531. E-mail: arm@helix.nih.gov

FOR SALE: Transistor radios, send SASE for list. Jim Martes, 15400 E. 2nd St., S, Independence, MO 64050-2295

FOR SALE: Riders Radio Manuals I thru XXII, with indexes - \$1,000. Beitman R1, 3, 4, 5, 5, 17, 19 - \$75. Jim Keller, 1505 Kendal Dr., San Bernardino, CA 92407. (909) 887-6900

WANTED: Radio Callbooks 1900 thru 1927. Bob Arrowsmith, W4JNN, PO Box 166, Annandale, VA 22003. Collect (703) 560-7161

WANTED: Fairbanks Morse console Model 9C or 12B preferred. Charles E. Patterson, 2621 Sweetwater Rd. SP#33, National City, CA 91950. (619) 475-7141

REPLACEMENT GRILLE CLOTH for Radiola 103 speakers, excellent silk-screen copy of the original tapestry - \$32 + \$3.00 S.H. Phil Guinan, 106 Page Rd., Litchfield, NH 03052. (603) 889-6213

WANTED: Premium Prices Paid. Chassis for Zenith Model 563. Need all electronics for this model in restorable condition. Larry Wilson, 310 75th Avenue No., Myrtle Beach, SC 29572. Phone/Fax (803) 449-5839

WANTED: Manuals and charts for tube testers Superior Model TD-55 and Mercury Model 1101. Many thanks. C. Ong, 3806 Lake Blvd., Annandale, VA 22003

WANTED: Altec 1568 amp; broadcast microphones; tube limiters, EQ, mixers; Klipsch Heresey; Altec speakers. Mike States, Box 81485, Fairbanks, AK 99708. Ph/fax: (907) 456-3419

WANTED: Still looking for a restorable set or chassis only for GE K-63. Junius Bailey, W5FTW, 1002 Reeves St., Abilene, TX 79602. (915) 673-0986

WANTED: Service literature for Ampro, Bell & Howell, Victor, Kodak, and RCA 16mm sound projectors. Sams Set #53. Riders Volume XX. **FOR SALE:** RCA 45-EY-2 tabletop 45 rpm record player, sounds great, imperfect - \$30. Doug Hershberger, 101 Columbia Dr., Williams-ville, NY 14221. (716) 632-2662

WANTED: Heathkit Q multiplier Model GD-125. George M. Bonanno, WA2KPE, 34 Charles St., Clifton, NJ 07013. (201) 746-5953

WANTED: Phono books: Look for the Dog, 2nd. The Edison Disc Phonographs. The Edison Cylinder Phonograph Companion. Ken Sperr, HC 74, Box 725, Hackensack, MN 56452. (218) 682-2512

WANTED: Amrad 2634 junker or parts set (must have rheostats). Amrad 3366. J.C. Woychowski, 17 Hope St., Niantic, CT 06357. (860) 739-6579

WANTED: Speaker for Crosley cathedral Model 148, cabinet for Philco 84B. Leon Bitters, 4209 Logtown Rd., Lena, WI 54139. (414) 834-3707

WANTED: Crosley Fivers, any condition. Steve Casper, 444 Heather Ct., Benica, CA 94510. (707) 745-3310

WANTED: Signal meter and Bakelite escutcheon for Hallicrafters SX25. Mark Shoup, 27 Dogwood Dr., Newton, NJ 07860. (201) 383-6417

WANTED: Navy transmitters: TBW, TCE or any accessories. Modulator for TBM Type CAY-50065. Steve Finelli, 38 Stonecroft Dr., Easton, PA 18045. (610) 252-8211

Victrola Repair Service: Windup phonograph repairs, parts, springs, needles via U.P.S. Rod Lauman, 19 Cliff St., St. Johnsbury, VT 05819. (800) 239-4188, eves.

WANTED, ANY CONDITION: RBY, Hallicrafters S-35, PR-1, Collins 478R-1, Squires-Sanders SS-1V panadaptors; also schematics, manuals, ads, articles, technical data on them. John A. Benyo, 25 Schley Street, Garfield, NJ 07026

SPEAKER PARTS: Adhesives, Cone, Dust Caps, Gaskets, Voice Coils (Round and Edgewound) Spiders and Terminals. Refoam Kits - \$14-\$18 for speakers. Cat. avail. \$10.00 (Refund.) 800 order line Visa/MC/Am.Ex. Speaker Parts Co., PO Box 14731, Fremont, CA 94539. 510-490-5842/510-490-1961 **FAX**

WANTED: BRUNSWICK UPRIGHT PHONOGRAPH w/curved sides in oak or walnut, v. good or better cond. I'll pay your price for the right one! Call or write: Bo Broock, 4858 Willow Lane, Orchard Lake, Mich. 48324. (810) 681-7133, eves.

WANTED: Zenith 1207, 12A3 or 12A4 chassis for parts. Must have good 85-209 bandswitch. Detrola chairside. Detrola TV. Dennis Smith, KN8H, Box 113, Trenton, MI 48183. (313) 675-5847

WANTED: Speaker grille or good cabinet with good grille for AK 165. Good grille cloth for AK 84. Front of Philco 20 or good cabinet. Bill Moss Settle, 120 Clarksdale Cir., Glasgow, KY 42141. (502) 651-6525

WANTED: Speaker for Majestic Model 20. Knobs for Silvertone Model 6438B. Dial for RCA Little Nipper Model 9TX23. Gilbert Simpson, 18 Beechwood Dr., Ansonia, CT 06401

WANTED: Dual gang 5-25pF tuning capacitor. CRT socket 11-pin magnal for 5BP4, 5BP1. James S. Fisher, 344 Harrison Ave., Manville, NJ 08835. (908) 725-7476

WANTED: Cabinets for: Montgomery Ward 62-197, Thompson S-70, Kennedy 281, DeForest F-5, Grebe MU-1, Crosley 51, 555 & D-25MN, Zenith 5R-317, Echophone 3, GE G-66 and Silvertone 4500A. Larry Porter, 4115 Beam Rd., Crestline, OH 44827. (419) 683-2540

WANTED: 12" speaker for Stromberg-Carlson Model 520-L glass dial, 12" speaker round antenna for General Electric Model J-805, 14" speaker for General Electric Model L-915 or L-916. Leon Gann, 1134 E. 50 Pl. N, Tulsa, OK 74126. (918) 425-3590

SOLID-STATE VIBRATORS for automobile radios 1932-58. Exact duplicates of originals in metal cans. Synchronous, Non-sync, European. Dealer inquiry invited. Free catalog. Visa, MasterCard, Discover. Antique Automobile Radio Inc., 700 Tampa Road, Palm Harbor, FL 34683. (800) WE FIX AM 933-4926, or Fax (813) 789-0283

PHONO NEEDLES & CARTRIDGES: (Ceramic & magnetic) What do you need? Send SASE. J.J. Papovich, 53 Magnolia Ave., Pitman, NJ 08093. (609) 582-8279

ANTIQUE RADIO RESTORATION Satisfaction - Guaranteed. Ray Sanders, 342 South Third, Cottage Grove, OR 97424. 541-942-0866



WANTED: RCA hi-fi/stereo console Model SHF-1 (pictured) or similar RCA consoles/home entertainment centers, late 50's-early 60's (especially blond Danish moderne look). RCA Product Catalogs, RCA Engineer, RCA Electronics Age, from 1956-1962. Any help appreciated. John McLawhorn, 112 Walnut St., Cary, NC 27511. (919) 467-8018

RADIO SCHEMATICS PLUS DATA STILL \$3.00 EACH. TV \$4.00, POSTPAID USA. JOSEPH R. FORTH, 321 LONG VUE ACRES, WHEELING, WV. 26003. (304) 277-3154. E-mail: Schematic1@aol.com

FOR SALE/TRADE: The following Hallicrafters: SX40A - \$200; S-20 - \$175; Super Skyrider - \$400; SX-17 - \$475; SX 120 - \$150; SX 130 - \$200; SX-62A - \$450; early Skybuddy - \$350. All above receivers are in museum-quality condition w/early serial numbers. Call: Larry Drago, 383 Lincoln Dr., Cheshire, CT 06410. (203) 272-6030

FOR SALE: Tektronix 535A dual trace scope, with plug-in modules A, B, D, E, H, manual, fresh tubes, good working order - \$350 OBO. Large tube caddies: (2) RCA, (1) Tung-Sol - \$45 ea. (1) small RCA - \$40. 1965 Radio Master - \$25. Engineering manual, GE 5 star and special purpose tubes - \$35. Radiotron Designers 3rd Edition - \$15. Hickok 6000 tube tester, rough but works - \$40. Compact (2/3 size of TV7) transconductance tube tester SECO Model 107C - \$40. TV2 tube tester - \$295. RCA RC-30 excellent - \$35. RC20 - \$15. Rider books: Servicing by Signal Tracing - \$20; Servicing Superheterodynes - \$15; both excellent. (25) RCA 6L6GC (BP) used, tested on 539 and in circuit - \$10 ea. or \$200 for all. (12) Sylvania 6L6GC, used, tested same - \$7 ea. or \$60 for all. Mullard EL37 tested same, (2) used - \$25 ea. (2) N.O.S. - \$50 ea. All plus shipping. **WANTED:** Radiotron Designer 4th edition, European tube manual. Doug Haugen, 15330 18th Ave. N, Plymouth, MN 55447. (612) 473-6949, call after 8 pm Central

FOR SALE: RCA WV-87B meter with manual - \$50. H.P. 400D with manual - \$40. Joseph R. Forth, 321 Long Vue Acres, Wheeling, WV 26003. (304) 277-3154

FOR SALE: Capehart 406P, 27 tube - \$600. Phil Jackson, 601 Becky Ln., Ozark, MO 65721. (417) 581-4932

FOR SALE: Philco 18 cathedral and its factory-built cabinet - \$450. National NC190. Hallicrafters SX62. Steve Lange, 1351 N. 58 St., Milwaukee, WI 53208. (414) 259-1031

WANTED: Broadcast-type MICROPHONES. Early carbon, condenser, ribbon, dynamic, etc. Cash or trade. James Steele, PO Box 620, Kingsland, GA 31548-0620. (912) 729-2242

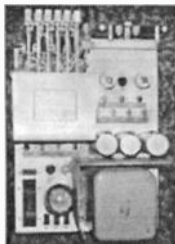

WANTED: Parts for a 1961 Columbia Masterworks, Model 1066. The parts needed: pot transformer number #507-1 and a push-button slide type made by Oak Inc. switch number #69589-130. Call or write. Kurt A. Wieseman, 25735 Lorain Rd., #117, North Olmsted, OH 44070. (216) 777-6038, call after 7:30 pm

WANTED: BRUNSWICK UPRIGHT PHONOGRAPH w/curved sides in oak or walnut, v. good or better cond. I'll pay your price for the right one! Call or write: Bo Broock, 4858 Willow Ln., Orchard Lake, MI 48324. (810) 681-7133, eves.

FOR SALE: Radios, transistors, hi-fi equipment, Rockola parts, Gumball; DeWald harp, yellow-hairline on bottom - \$375. Garod peak top case/handle/grille, yellow - \$300. Kadette Jewel, brown - \$395. Detroit Super Peewee, brown - \$395. Emerson 109 (Collins, p. 30) - \$275. Bendix 526 - \$575. Crosley bulls-eye 11-102U; Philco flying wedge 49-506 - \$95. Silver, wood, (Stein, p. 249) - \$250. Emerson 888 Vanguard, red - \$125; turquoise - \$125. Zenith 500, pink, small chip - \$350. Set Philco 90 knobs - \$30. Fada 1000, yellow knobs, set - \$125. Fada L56, yellow knobs, set - \$175. Fada 652 yellow bezel - \$65. Futterman H3 stereo/mono power amp output transformerless (OTL), 50 watts, 22-tube - \$1,500. H.H. Scott equalizer/preamp 121, rough - \$175. Marantz 3300 - \$250. Marantz 8B transformer cover-painted - \$75. Altec N-1000-B network for 604 speaker, Rockola 1422; title board - \$150. Push-button assembly - \$225. Set color cylinders - \$200. Master gumball (large casting), rare 1¢/5¢ - \$325. All items electronically unrestored. **WANTED:** Deco radios, parts, hi-fi equipment, speakers. Ross Litrenta, 1 Wilton Rd., Eastchester, NY 10709. (914) 337-7176

FOR SALE: The mysterious black box that was used by projectionists in theatres call the Wright-Decoster multi-test speaker with universal output transformer, field coil and voice coil transformer for exact testing of theatre equipment - \$450. Call: Larry Drago, 383 Lincoln Dr., Cheshire, CT 06410. (203) 272-6030

FOR SALE: Blue Patriot line crack, Little Miracle in big trouble, white Patriot part set, perfect red Commander/wrap, onyx Fada 711, (2) open grille Temples, yellow bullet, also Silvertone candy canes brown, beetle, 4500 Election, GE H-600, brown Midget Traveler, Crosley Musical Chef, brown D25MN, wood General Television, Viz parts set. Also transistors: Tom Thumb 528, Toshiba Lace in trouble, mint 285-B Traveler, white Royal 500, black 250, hi-fiver, turquoise Explorer, boys radios, new/box NTR-120 petite, T-O 3000-1. Also green Catalin clock hairline, Stewart-Wamer dancing girls speaker, bronze Tiffany desk set, Chase Deco cat doorstop. While they last, small quantity enamel Reddy Kilowatt pins, mint on cards. Ted Chronister, 7073 Carlisle Pike, #26, Carlisle, PA 17013. (717) 766-6436

VINTAGE MANUALS AVAILABLE for amateur, audio, and radio-related equipment. Quality is always our number one customer priority. Satisfaction guaranteed. Send two 32¢ stamps for catalog. Pete Markavage, THE MANUAL MAN, 27 Walling St., Sayreville, NJ 08872-1818. (908) 238-8964

WANTED: 1930 to 1942 Police Radio communication equipment. Any 6 VDC mobile communication equipment. Raymond Miller, 953 N. 1st St., Albemarle, NC 28001. (704) 982-0228

WANTED: Zenith consoles: 15-U-246, 15-U-270, 15-U-272; table model: 9-S-232. Bo Broock, 4858 Willow Lane, Orchard Lake, Mich. 48324. (810) 681-7133, eves.

MILLEN ORIGINAL PARTS, manuals, equipment. New and used. Bought and sold. James Millen Electronic Equipment Mfg., PO Box 4215, Andover, MA 01810-0814. (508) 975-2711. Fax at (508) 474-8949

WANTED: Heath AA191 small amp with constr. manual. I will pay handsomely! Name your price! Try me! Desperate! Bill Miller, 3410 Hunnicutt Ln., Sacramento, CA 95821. (916) 489-1703

WANTED: RCA QU-516 or V-225 w/turntable, Philco 41-620, owners manual for 41-608. Donald Cochrane, 858-I Antoinette Ln., S. San Francisco, CA 94080. (415) 875-1725

WANTED: Good Stancor 10-P transmitter, original speaker for Radiola Model 26, cabinet for Federal 59, good AK 2-tube TA audio unit, drum dial for Crosley 5-50 radio, plastic dial for National FB-7. Pat Stewart, W7GVC, 1404 Ruth Ave., Walla Walla, WA 99362-3558

WANTED: N.O.S. output tubes: 6CA7/EL34; KT66; KT88; 6550; 7591, 7199, 6V6; 6B4G, etc. Must be in original boxes. C. Ong, 3806 Lake Blvd., Annandale, VA 22003. (703) 573-2288, lv. msg. Fax: (703) 280-0317. E-mail: ongkt88@pop.erols.com

WANTED: Amphenol black molded tube sockets, ring spring mount, need octal and 4-pin sockets, will pay—\$1 ea. James Fred, R1, Box 41, Cutler, IN 46920

WANTED: Please help! Need large knob for Radiola II (or IV) 1 5/8" dia. plus pointer. Has GE logo. Also need for Radiola IIIA. Also always looking for S-C stuff. Ted Babcock, 163 Long Island Dr., Moneta, VA 24121. (540) 721-1222

BOXED CLASSIFIED ADS WORK! This is a boxed classified ad. These ads can be run more than two months. See the inside back cover for details. Boxed ad deadline: the 1st of the month.



WANTED: Tube Hi-Fi components & commercial amplifiers by Marantz, McIntosh, Tannoy, Acrosound, Brook, Brociner, Fairchild, Hadley and others. Also want Western Electric theater amplifiers, speakers, tubes, & microphones. Richard Sharisky, PO Box 521, Belmont, MA 02178. Phone (617) 484-5784. Fax (617) 489-6592

WANTED: Vintage Electronic Music Synthesizers and modules by the following manufacturers, especially the listed models. Alres Modular, System III. ARP 2500. Buchla Modular, 100, 400. E-mu Modular. EML Electrocomp 100, 101, 200. EMS Synthi A, Synthi AKS, VCS3. Korg Modular PS-3100, PS-3200, PS-3300. Moog Theramin, Modular, Series 15, 35, 55. Oberheim SEM modules, 2-, 4- & 8-Voice Systems. Paia Modular 2700, 4700. Roland Modular Systems 100, 700. Serge Modulars, System 79. Synton Modular System. Call and surprise me; make my day! John V. Terrey, 498 Cross St., Carlisle, MA 01741. (508) 369-9770. Fax: (508) 371-7129.

WANTED: Working horn drivers wanted. Rob Loeser, 390 Beech St., South Hempstead, NY 11550. (516) 483-0463

WANTED: Ohmite Little Devil resistor cabinets, Bakelite only, preferably empty. B.K. Reaveau, PO Box 73032, Las Vegas, NV 89170-3032

WANTED: Philco PT 87, Minerva W-117, old Jensen 12" speaker w/80 rect. Ichiro Yamada, 10-21 Chiyoda-dai-cho, Kawachi Nagano-shi, Osaka, Japan 586. Phone/fax: 011-81-721-4695 mid./eve. local. E-mail: yamadnr1@osk.threewebnet.or.jp

WANTED: Escutcheon for RCA Model 9X14 (RC350) or 9X4. Art Martinez, 3254 E. Forge Ave., Mesa, AZ 85204. (602) 830-2501

WANTED: Complete Morris, or similar, coil winder. Bill Olson, Route 1, Filer, ID 83328. (208) 326-4962

WANTED: Unusual brand 01-A's for display collection and old 01-A boxes. Hal Kravig, 2615 Juneway Dr., Memphis, TN 38134. (901) 388-2857. Fax: (901) 388-5102

WANTED: Early Crosley such as crystal set, audion detector unit, Vili portable, XX, pre-1923 Aca., any with overhang lid. Ed Bell, 5311 Wooddale Rd., Raleigh, NC 27606. Fax/phone: (919) 851-1517

ELECTRON TUBES: Over 1 Million Tubes in Stock. Buy & Sell. Daily Electronics, 10914 NE 39th St. #B-6, Vancouver, WA 98682. 800-346-6667. 360-896-8856. 360-896-5476, fax

WANTED: Hallicrafters Models S-2, S-33, S-35, SX-112, EP-132, HT-2, HT-3, HT-8, HT-12, HT-14, console speaker R-8, RCA Model AVR-11, AR-88, Philco 38-690, Midwest 20-38 chassis & speaker. Chuck Dachis, The Hallicrafter Collector, 4500 Russell Dr., Austin, TX 78745. (512) 443-5027

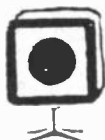

Wanted. The following radios and speakers, your price based on condition. TELE-TONES #117 and #117A. Wood with round speaker holes. late 40's. STEPHANS Tru-Sonic, cube floor speakers. 1957-61. SILENT-NURSE plastic table speaker. 1950's. Steven Cabella, 500 Red Hill Ave., San Anselmo, CA 94904. Phone 415-461-6810

WANTED: WE European etc. tubes, transformers, SP, parts, hi-fi amp, jazz LP. Kouji Matsuo, 6-2, Tsurumi-cho, Beppu-shi, Oita, 874, Japan. Fax: 81-977-23-9579

WANTED: Electro-Voice (pair) Georgian 600, Patricia 600; pair IMF monitors; Tannoy dual concentrics; Altec 820's; large Jim Lansing; McIntosh 2205 amp; bi-directional record tape recorder, 10 1/2"; Ampex 600 speaker amp (russet); wire cartridges for RCA wire recorder. Bo Brook, 4858 Willow Lane, Orchard Lake, Mich. 48324. (810) 681-7133, eves.

FOR SALE: 12 E.H. Scott consoles for sale, including a beautiful original 20-tube Phantom in a Braemar. Call for info. We accept Visa and MasterCard. Alan Jespersen, PO Box 17338, Minneapolis, MN 55417. (612) 727-2489, 8 am to 8 pm 7 days. Fax only (612) 727-1908

FOR SALE: Emerson 550 - \$50. Crosley #161 - \$85. Radiola 16 - \$75. Dave Working, 418 North Shore Rd., Lake Oswego, OR 97034. Ph/Fax: (503) 699-9864

FOR SALE: SASE for electronic book list and/or novelty transistor radio list. Limited supply of good, used audio tubes: 250 - \$150 ea. OBO; 245 - \$40 ea.; 247 - \$25 ea. Audio Cyclopeda by Tremain - \$90 OBO. Radio's 100 Men of Science by Dunlap - \$10. GE L-663 radio with curved Ingraham cabinet, AM and SW to 18 Mc - \$100. Lafayette Explor-Air Mark Five SW radio, five bands, excellent, working - \$45. Sonora WJU 252 painted Bakelite radio, vg, looks like small toaster, (Stein, p. 185) - \$100. All shipping extra. Bob Warren, Church St., PO Box 279, Waverly, PA 18471. (717) 587-2405

FOR SALE: Telefunken Gavotte 5253WK, AM, FM, SW1, SW2 - \$120. Grundig Majestic 85/USA AM-FM - \$30. Philco Transitone PT-30, AM - \$45. Lang 406 AM - \$35. Zenith 7L05 AM-FM - \$50. All in very good condition. Shipping extra. Simon Sarkissian, 930 Montgomery Ave., Apt. 407, Rosemont, PA 19010. (610) 525-7675, after 7 pm

FOR SALE: GE JM-3 thirties Bakelite phono - \$45. Zenith H-500 Trans-Oceanic w/cracked dial - \$35. Crosley F-5 MY Musical Chef style - \$20. Fada 192-A Nucleotette - \$75. Tandberg TD-20A stereo reel w/ damaged reel table - \$45. Astatic CT-1 early UHF converter - \$20. Raytheon CK6476A neat early display tubes, new (AES - \$651) - \$5. Semi-pro U.S.-made three input tube mic mixer - \$55. Turner 22X microphone - \$55. Motorola 45P1 Pixie - \$145. Motorola 7X24S transistor - \$225. Always glad to trade for transistor radios! Send LSASE for long list of goodies! Jon Hall, WB4MMV, 39 Spring Oaks Ln., Ruckersville, VA 22968. (804) 985-3827, 8:30-10:30 pm. Fax: (804) 984-3299. E-mail: jon@halls.com

FOR SALE: Scott 299 integrated amp - \$75. Scott 310E tuner - \$300. Pilotuner AF 821 V, Gray A50 mono amp with preamp - \$250. Dyna FM-3 - \$45. RCA 3BX671 portable shortwave, very good condition - \$100. Junkers: Stewart-Warner R180A, Bendix 526A, Motorola 65T22, Zenith H-500 - Offers. Larry Kays, 6 Old Ivy Dr., Harwich, MA 02645. (508) 430-0462

FOR SALE: Sterling Deluxe, black and chrome - \$350. GE 114W white, (Bunis 1, p. 75) - \$45. Grantline 606-A, white, (Collins, p. 83) - \$150. Zenith R510-R (Bunis 3, p. 274) - \$40. Emerson 652-B (Bunis 1, p. 61) - \$35. Philco 49-902 (Bunis 1, p. 116) - \$35. Stewart-Warner Air Pal, black w/white knobs, (Collins, p. 78) - \$135. Bendix 55P3U (Bunis 1, p. 35) - \$45. All radios are in very good or excellent condition. Call evenings before 9:30 pm Eastern Time. Mark Chamberlain, 9735 Oxford St., Naples, FL 33942. (941) 591-4835

FOR SALE: Radiola III n/tube - \$125. Radiola IIIA n/tubes - \$165. Music Master horn, sm. bell, sm. crack - \$185. We have lots of other stuff for sale and/or trade, let us know what you're looking for. We buy collections and accumulations of radios and windup phonographs. Contact us: Waves, 32 E. 13 St., New York, NY 10003. Hrs. 12-6 Tues.-Fri., 12-5 Sat., closed Sun. & Mon. (212) 989-9284 (during business hrs.) 24-hr. fax: (201) 461-7121. E-mail: c1wave@aol.com

FOR SALE: Book entitled Jim Clark's E.H. Scott Radio Collectors Guide, 1925-1946 - \$32.95 mailed. Jim Clark, 3520 Okemos Rd., #6, Okemos, MI 48864. (517) 349-2249

FOR SALE: Ameco TX62, 286 meter transmitter - \$45. Crosley 627, wood, Fiver, plays - \$70. Philco 16RX sound cabinet for chairside (Ramirez, p. 46) - \$85. Silvertone 1908 tombstone, plays - \$115. Zenith Trans-Oceanic, plays: R600 & H500 - \$85 ea. Casio TV2000 pocket color TV, AC/DC, plays - \$75. Motorola VT711M-A tabletop TV - \$100. Hallicrafters: S-38B, black, plays - \$50. S38D, grey, plays - \$35. S38E, grey, plays - \$45. Bell 2200C integrated amplifier, (2) ea. 5881's - \$85. Dukane 1E460 PA amplifier (2) ea. 5881's rack mount, untested - \$45. Chicago DeVry PA amplifier, (3) ea. #45 tubes, w/case and speaker, untested - \$95. Altec A319B amplifier, (2) ea. 6V6 - \$40. JBL 075 high frequency unit w/bracket - \$70. University 312 Series 200, 3-way speaker - \$75. University 4401 horn w/mid T driver - \$35. Weston Model 1, mil-ammeter, 1901 - \$50. Electro-Voice V2 ribbon broadcast microphone - \$250 BO. Rider's: Volume 1, fair - \$30; Volume 1-5 abridged - \$30; Volume 3 - \$25; Volume 4 - \$20; Volumes 6, 7, 15 - \$15 ea. Volumes 8, 9, 10, 11, 12, 12, 13, 14 - \$13 ea. Volumes 16, 17 - \$18 ea. Sams: AR Series 25-290 - \$1.25 ea. TSM Series 25-100 - \$2.50 ea. TSM Series 101-159 - \$1.50 ea. TR Series 25-212 - \$1.25 ea. Shipping extra. Many other new items. Three lists available. (1) Pocket transistors, table radios, sound equipment, microphones, test equipment and more. (2) 15,000+ transmitting/receiving tubes and projector bulbs. (3) Books, catalogs, magazines and manuals. Send SASE. Ray Nowak, 30513 Ednil Dr., Bay Village, OH 44140. (216) 871-8303

FOR SALE: Zenith Royal 500 transistor radio, maroon, includes original operating manual, excellent cond., asking - \$145. Dahlberg 10¢ coin-op radio w/pillow sprk & mounting bracket, excellent cond., all new capacitors, only - 99¢! Dumont RA103 Chatham TV, tabletop, wood trapezoid-shaped cabinet, also has built-in radio w/tuning eye, pick up only - \$75. RCA portable 45 rpm player (plays thru old radios, home stereo?, etc.) - \$45. Motorola portable 53LC2, has subminiature tubes - \$25. Crosley 9-101, looks fine, slight warp on bottom left dial scale - \$39. RCA Victor X551, vg cond., complete - \$35. Original wood box for Tower speaker w/original lettering, etc. - \$30. Joseph L. Gambaccini, 192 Division Ave., Shelton, CT 06484. (203) 924-0271

FOR SALE/TRADE: Rider's Perpetual Trouble Shooter's 9 & 11 - \$15 ea. Heathkit 10-17 oscilloscope, excellent, works - \$35. Plus shipping. WANTED: Need Rider's 17-21. Paul Geraghty, 1245 Lyon Ave., Waterloo, IA 50702. (319) 233-3520

FOR SALE: Two HK245 transmitting tubes N.I.B. - \$50. Wayne Abare, 335 Meadowood Ln., W. Melbourne, FL 32904. (407) 727-8559, after 5:30 pm weekdays

FOR SALE: Philco 38-690 - \$700. Zenith 10-S-130 - \$600. Atwater Kent 84 cathedral, excellent original, works - \$325. Atwater Kent 3975 breadboard components - \$625. Audiophone Model J horn, excellent - \$195. RCA 1325 horn - \$85. RCA 1325 base, good driver - \$35. AK E-3 speaker - \$40. Dictogrand horn - \$150. Freshman Masterpiece with built-in speaker and drop front, excellent and working - \$195. Victoreen 14-tube console - \$1,100. McMurdo Silver Masterpiece II, excellent chrome - \$1,100. Edison Home - \$495. Victor V, excellent - \$3,500. Victor M - \$1,450. 4-minute cylinder records - \$3.75 ea. John Hayes, 27 Highland Dr., Henniker, NH 03242. (603) 428-3053, or fax only (603) 428-8315

WANTED: Set of knobs (4) for 1947-48 Admiral 10-inch television Model 20X-122. Jeff Hoskins, 824 E. Madison Ave., Stuart, FL 34996. (407) 283-2291, after 7 pm

WANTED: Zenith, black dial console in any condition. Pre-1942. Can pick up at Elgin. Scott Headley, 567 Traverse Dr., Costa Mesa, CA 92626. (714) 662-3497

WANTED: Western Electric loudspeaking telephone. Welcome, any models and condition. Jun Mizuno, 933 Portswood Cir., San Jose, CA 95120. (408) 268-4016

WANTED: Still offering \$750-\$1,000+ for Regency TR-1 transistor radios in pearlescent colored cabinets. Bill Burkett, PO Box 2488, Sun City, AZ 85372. (800) 507-7234

WANTED: 1957 Allied Radio catalog, any 50's Newark Electronics catalogs. Joe Esdale, 1769 Eastwood Ave., Highland Park, IL 60035. (847) 831-2544

WANTED: Philco 116X console, attending Elgin & Rochester **FOR SALE:** Rider's 1-5 abridged - \$40. Paul Froehlich, 4152 Hwy. J, Cross Plains, WI 53528. (608) 798-4905. E-mail: pa.froehlich@hosp.wisc.edu

— **WANTED** —

PICTURES FOR PHOTO REVIEW OR TELEGRAPH REVIEW PHOTOS MUST BE SHARP IN DETAIL A SHORT DESCRIPTION IS A MUST! SEE PHOTO REVIEW PAGES FOR ADDITIONAL INFORMATION

WANTED: Art Deco, streamline or moderne style radios. Also sets with metal or chrome grilles. Adam Schoolsky, 15149 S.W. Cabernet Dr., Tigard, OR 97224. (503) 579-1080. E-mail: Adam@ArtDeco.com or www.ArtDeco.com/~adams

WANTED: Western Electric tubes, parts and data-sheet: 101, 102, 104, 205, 211, 212, 216, 242, 252, 262, 271, 274, 275, 276, 284, 300, 310, 339, 347, 348, 349, 350, VT1, VT2, VT25A, VT52. Also Western Electric: amp, spkr, socket, xfmr, wire. Others: KT88, 77, 66, RCA 50/250/350/245/345, VT-62/801, 845, European tubes. Will pay top \$\$\$ Jun Mizuno, 933 Portswood Cir., San Jose, CA 95120. (408) 268-4016

WANTED: Western Electric 12A horn. Will pay up to \$10,000/pair. Jun Mizuno, 933 Portswood Cir., San Jose, CA 95120. (408) 268-4016



WANTED: This Lewol radio with metal trim & other sets with metal grilles or trim. Jay Malkin, 1250 Galapago, #206, Denver, CO 80204. (303) 623-6451

WANTED: Zenith Trans-Oceanics, all models, any condition tube and transistor. Zenith military Trans-Oceanics #R520/URR and #R520A/URR. All Zenith wood table models manufactured between 1935 and 1942. Frank J. Manzano, 82 Monhegon Ave., Oakland, NJ 07436. (201) 337-5263

WANTED: RCA 3 1/4" R/R tape recorder Model #YJS-15G manufactured ca. 1967. Slanted front panel, lift-off lid, AC/batt. (4) piano-type keys, vu meter, pea-soup green. Bret F. Johnson, 13495 102nd Ter. N, Largo, FL 34644. (813) 595-9287

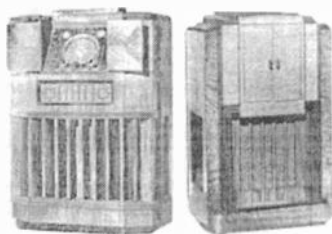

WANTED: E.H. Scott Laureate Grande or E.H. Scott Westerly Grande. Not looking for a bargain, just a nice original. Eddie Burris, 2837 Winterbrook Dr., Lawrence, KS 66047. (913) 841-4174. E-mail: burris@cstp.umkc.edu

WANTED: Low frequency coils for Millen 90651 grid-dip meter. Ernest Bigler, 292 Cleveland Ave., Macon, GA 31204. (912) 746-6616

WANTED: N.O.S. tubes: 7025, 6CA7, 6L6GC, 5881, 6V6GT, 6BQ5, GZ34, 7591, 6550. Jensen 10" & 12" Alnico speakers, old harmonicas, all makes and models. John McGrath, 29 Ripley Rd., Belmont, MA 02178. (617) 484-0515. Fax: (617) 492-7921

WANTED: Pay dearly for schematic diagram for Jackson 650 capacitor chkr. Gary Formica, 823 91st St., Niagara Falls, NY 14304. (716) 283-2274. E-mail: radio@ns.moran.com

WANTED: Crystal sets, germanium diode radios, related parts, incompletes. (120) pieces now and growing. The Crystal Radio Guy, Galen Feight, 3104 S.E. 20th, Portland, OR 97202. (503) 231-9708

WANTED: Restorable Zenith 11S474 console. Can pick up at Elgin. Scott Headley, 567 Traverse Dr., Costa Mesa, CA 92626. (714) 662-3497

WANTED: Rider's Radio Manuals, any Volumes 18-23. Jeff Hoskins, 824 E. Madison Ave., Stuart, FL 34996. (407) 283-2291, after 7 pm

WANTED: RCA 44 microphone. Have a rebuilt 77DX and others to trade. Brad Jones, 4801 Crofton Springs Ct., Greensboro, NC 27407. (910) 547-1919, please call before 8 pm, afternoons best

WANTED: Zenith Stratosphere and other high tube count radios. Also Zenith and other pre-1950 advertising. We will buy or trade. Alan Jespersion, PO Box 17338, Minneapolis, MN 55417. (612) 727-2489

WANTED: Amplifier, EICO HF-60. Speakers: EV Georgian, corner utility cabinet; Heathkit Legato, Jensen Imperial. RCA tube manuals: RC-13, 27, and R-10. Pat Smith, 136 S. Dutoit St., Dayton, OH 45402. (513) 224-4333

WANTED: I'm hunting the very earliest transistor types: I mean the components not radios! I pay cash, or can trade. Contact me if you have anything interesting, or to see my wants list. Dr. Andrew Wylie, 21 Brancaster Ln., Purley, Surrey CR8 1HJ, England. E-mail: 100546.2477@compuserve.com

FOR SALE/TRADE: I have located a 1955 Vorbamatix reverb auto system, N.O.S., in the original box, complete with manuals, warranty cards, oval rear speaker, under dash control head and Motorola amplifier. This was the hottest auto accessory in the late 50's that made AM car radio sound like a stereo echo chamber - \$295. Call: Larry Drago, 383 Lincoln Dr., Cheshire, CT 06410. (203) 272-6030

FOR SALE/TRADE: Shure CR20SLE bullet mike w/ grip-to-talk, teardrop base - BO or trade for Sennheiser ME-40. Jay Myers, 1010 Graybar Ln., Nashville, TN 37204-3213. (615) 297-5886

FOR SALE: Browning FM Multi-Plex receiver Model BLR-15, needs work - \$275 shipped. Glenn Hendrix, PO Box 144, Ardmore, OK 73402. (405) 657-3327

FOR SALE: Oscilloscope, Tektronix Model 535 dual trace, works - \$275. Oscilloscope Heathkit Model 0-11 5-inch 5 MHz, works - \$125. Typewriter, Sears Electric w/spell-check Model 2 - \$15. Harry L. Brown, 4861 Tom Fall Rd., Baxter, TN 38544. (703) 243-0435

FOR SALE: Peter Pan record player, 1951 by Electronic Creations Co., gooseneck - \$100. Crosley Model 11-109U, mint - \$125. All plus UPS. Stephen L. Bonino, 107 Georgetown Rd., Glassboro, NJ 02028. (609) 881-0244

FOR SALE: Tubes: (5) 5U4G new bulk packed - \$5; (4) 6L6C, N.I.B. National Russian - \$6; (22) 2050A GE/RCA - \$5; (4) 12AU7 National - \$3; (4) 5751 National - \$4; (7) 12AV7 National/GE - \$3; (5) 6Y6 National - \$4; (3) 83 GE - \$4. All each, N.I.B., U.S.A. Heathkit electronic switch Model 10-4101 - \$20. Gibson/Hawk guitar amp Model GA25RVT - \$150. (2) Budweiser clocks with Clydesdale horses - \$110 ea. GE wood radio, metal grille, & Teledial Model 540-16?? - \$35. Shipping extra. SASE for books, tubes. Serge Casagrande, 1318 Norwick Dr., Lutz, FL 33549. (813) 949-6729. E-mail: scasagra@ix.netcom.com

FOR SALE: Emerson Model DB301 - \$45. Motorola Model 62CNI - \$45. Plus shipping. Don Sickels, Box 174, Forestville, WI 54213. (414) 856-6651

FOR SALE: General Radio Company Type 1650-A RLC bridge, completely checked out; includes new batteries, test leads and manual - \$180 plus shipping. Ross Wollrab, 229 N. Oakcrest Ave., Decatur, IL 62522. (217) 428-7385

FOR SALE: Knight KG-635 scope, exc condition, both manuals, no probes - \$50. Plus ship. Bill Gansen, 7513 So. Westnedge, Portage, MI 49002-5108. (616) 327-7285

FOR SALE: Western Electric speaker amp Model #100F, cabinet refinished but untested - \$160. Novelty radio, stuffed tiger 16" tall, M.I.J., very unique, exc - \$38. All plus shipping. Bill Cramer, PO Box 1075, Bella Vista, CA 96008. (916) 275-1167

FOR SALE/TRADE: Northern Electric lt. blue rainbow radio, (see Collins 2) - \$325. Maroon Crosley 56-TD Duette - \$250. Echophone 5-3 cathedral w/front thumb dial - \$395. Call: Larry Drago, 383 Lincoln Dr., Cheshire, CT 06410. (203) 272-6030

FOR SALE: Silvertone Model 7165 depression era, 1935, 4-tube AC/DC receiver, wood cabinet, excellent condition and working, new filter caps - \$55 ppd, U.S. 48. SASE for photo. Ralph Michelson, KG8FA, 4538 Golfview Dr., Brighton, MI 48116. (810) 229-8339

FOR SALE: Instruction booklet, Majestic Models 71, 72, excellent - \$15 ppd. Early radio parts supply company catalogs, Rasco; Catalogs #10 1923, #11 1924, excellent, original - \$20 ea. ppd. Official Zenith service books; schematics for many models - 1940, 1941, 1942. Also various loose Zenith service schematics mostly 1947, couple 1937 - \$10 ea. ppd. First buyer gets loose stuff free. Ron Kudasik, 2235 Tanya Dr., Chambersburg, PA 17201. (717) 267-9468, 3-11 pm EST



The California Historical Radio Society

- ✓ *Eight meets per year all over Northern California*
- ✓ *Two or more Journals per year featuring original historical and technical articles*
- ✓ *Join now and get a valuable collection of restoration articles from 20 years of CHRS!*
- ✓ *A mere \$15 per year!*

For more information, or to join...

write to: PO Box 31659
San Francisco CA 94131
or Call 415-978-9100

Catalins Wanted



Fada • Emerson • Motorola
Addison • Air King • Arvin • Detrola
Crosley • Symphony • Tom Thumb
I buy all makes and models.

Michael Lawlor
P.O. Box 179 • Santa Barbara, CA 93102
(805) 682-2336

FOR SALE/TRADE: Philco 40-150 - \$100. Stromberg-Carlson 500H - \$40. Philco 40-130T, have two - \$65 & \$80. Philco 42-350 - \$140. Stromberg-Carlson 1100H - \$45. Zenith 5S-320 - \$150. Philco 610 tombstone - \$125. Stromberg-Carlson 500J - \$35. AK 33 with globe tubes - \$140. Philco 91 console - \$140. Prices do not include UPS, sorry can't safely ship the console, pick up only. Will trade for Westinghouse WR-14 cathedral. Dave Stott, 29 Willow Bee Ln., Middletown, CT 06457. (203) 344-0697

FOR SALE: Simpson Therm-O-Meter electronic thermometers in Bakelite cases, complete with probes, Model 389 covers -50 to +200°F; Model 388 covers -50 to +1,000°F, but not working, both for - \$30. Joseph D'Airo, 424 Higbie Ln., West Islip, NY 11795

One Month Free!

BONUS FOR EARLY RENEWALS

If you renew before the month shown on your mailing label (your expiration month), you will receive an extra month on your subscription: 13 months instead of 12! 26 months for an early 2-year renewal!

FOR SALE: Beautiful Guild Country Belle, Model 556, telephone style radio from 1956 - \$55 + shipping. Herb Parsons, 5 Surrey Ln., Peabody, MA 01960. (508) 535-1009

FOR SALE: Used tested tubes: X201-A - \$10; 227 - \$7; 226 - \$9; 224 - \$7; 280 - \$22; 6L6G - \$9; 6V6GT - \$5. Many more, send LSASE for list. Dean Toombs, 5001 E. Fanfol Dr., Scottsdale, AZ 85253. (602) 483-2970

FOR SALE: Coyne radio-TV books, hardcover, excellent, 1956, 7 books - \$65. Also: Mallory Service Encyclopedia, 1949 - \$15. Del Tysdal, 812 Broadway, Fargo, ND 58102. (218) 287-2562

FOR SALE: Coca Cola cooler radio, plastic letter transfers, limited number - \$25/sst. Jerry Simpson, 17665/1 2 Sierra Hwy., Canyon Country, CA 91351. (805) 251-7829

FOR SALE: Tubes 1/3 of AES price, send SASE for list to: Tubes, 555 Seminole Woods Blvd., Geneva, FL 32732

FOR SALE: Radios & related - SASE for list. WANT-ED: Radio catalogs and any other catalogs, pre-1940. Steve Blank, 407 Hamilton Ave., Linwood, NJ 08221. (609) 926-9277

FOR SALE: HRO dial mechanism, includes (4) tuning condensers, dial & gears in good shape - \$75, please include UPS. Marion Chelkowski, W5DBN, 1103 Kayton, San Antonio, TX 78210. (210) 533-1876

FOR SALE: Rider Basic Transistors, 1961 - \$15. Rider Basic Electricity, 4 vol., first edition set, 1954 - \$25. Book, Radio Boys at Ocean Point - \$20. Postcard CBS TV City, Hollywood, 1950's, mint - \$4.50. WLS Family Album Centennial Edition, 1941 - \$20. Don McNeill Breakfast Club 20 Years of Memory Lane, 1953 - \$20. War Department technical books; Frequency Meter Sets, 1944 - \$15; International Morse Code, 1945 - \$18; Radio Sets SCR 399A, 499A, 1945 - \$20; recipe book Radio Roundup, WLPO, La Salle, Ill., 1955 - \$17. Postage extra. R.C. Moore, 452 West Park Ave., Aurora, IL 60506. (708) 264-0488

FOR SALE: (2) wood decorated boxes with a total of (25) 78 rpm records in Japanese. Call or write to: Robert J. Stone, 721 Fisk St., Piqua, OH 45356-3729. (513) 773-2217

FOR SALE: Portables: Zenith 6A40 - \$90; Zenith Royal 94 - \$100; Zenith Royal 3000 - \$125; Admiral 6P32 - \$40; Lafayette JS118 - \$30; Motorola 5A7A - \$40; Philco 46-350 - \$40; RCA BX57 - \$30. Plus S&H. J.J. Papovich, 53 Magnolia Ave., Pitman, NJ 08071. (609) 582-8279

FOR SALE: (1) Tom-Tom radio model, real nice, all original, clean - \$150 + S/H. Also Crosley Cat. 124, works, nice, clean - \$385 + S/H. Carlos Gimenez, 15091 Shamrock Dr., Fort Myers, FL 33912. (941) 482-0198

FOR SALE: New 1996 50-page WWII military radio catalog, 100's of items - \$2 U.S., \$5 foreign. Sam Hevener, W8KBF, The Signal Corps, 3583 Everett Rd., Richfield, OH 44286-9723. (216) 659-3244

FOR SALE: Sams Photofacts, sets from 1 to 600's - \$600. Have radio/TV repair books/red books Stancor, Halldorson, Zenith, GE, troubleshooting books. Steven Lombardi, 1620 Wilmot Ln., Anaheim, CA 92802. (714) 638-1487

FOR SALE: Radios, audio, ham, medical, catalogs, handbooks, calculators. List \$1 and SASE. Joseph Bedlowies, PO Box 139, Stratford, CT 06497

FOR SALE: (20) different earphone drivers for horn speakers - inquire. (22) tubes including a WD-11, 45's, 01-A, 47's, dud 99, 2A3, 171A, etc. - \$150 value at 25% discount. Los Angeles horn speaker called "Chanson" Labs - SASE. Floyd A. Paul, 1545 Raymond Ave., Glendale, CA 91201. (818) 242-8961

FOR SALE: RCA TV Model 8-T-243 chassis KC5-28-1, good working condition - \$250. Call or drop a card: Frank Waskiewicz, 143 Carl's Path, Deer Park, Long Island, NY 11729. (516) 667-2269

FOR SALE: Detrola A-501 harp butterscotch, (2) top angle cracks - \$275. WWII gun camera - \$50. William Harder, 911 W. Northrup St., Lansing, MI 48911-3640. (517) 882-2303

FOR SALE: Emerson China chest radios, same as shown in 2/96 A.R.C. Photo Review - \$350/BO. Martin S. Doctor, 49 Indian Rock Rd., Nashua, NH 03063. (603) 881-4895

FOR SALE: BC-221 frequency meter with calibration book and manual - \$70. Bob Rolffness, 2327 Malaga Rd., Moses Lake, WA 98837. (509) 765-4721. E-mail: rsrolfne@atnet.net

FOR SALE: DeForest loop antenna for D-7, D-10, D-12, D-14, D-17. Quality reproduction. Fully assembled, original type wire, special sale, regularly \$135, now - \$114.50. Plus \$15 shipping or can deliver to some meets. Very limited quantity. Buy now or be sorry later! Ed Bell, 5311 Woodsdale Rd., Raleigh, NC 27606. Fax/phone: (919) 851-1517

FOR SALE: Western Union standard radio-telegraph signal set, instructions & miniature telegraph blank, in original box (toy) - \$35. 1960 Newark Industrial Electronics 1500-page catalog, Parts & Equipment For the Radio, Television & Electronic Industry - \$35. Beige old 3-slot coin phone - \$160. Cliff Sullivan, 4902 W. Monte Cristo, Glendale, AZ 85306. (602) 978-3551

FOR SALE: New photo list, spring cleaning sale, good for reference - \$1+ LSASE 2 stamps. Bob Masterson, Box 172, Valley Cottage, NY 10989. (914) 353-3151

FOR SALE: Two books, Collector's Guide to Transistor Radios (Bunis) and Made in Japan (Handy), both together - \$18 ppd. Ken Greenberg, 4858 Lee, Skokie, IL 60077. (847) 679-8641

FOR SALE: Red Channel Master, Model 6506, working and in original box - \$30 price includes UPS. Call or write: Ron Marley, 172 Brandi Way, Winchester, TN 37398. (615) 967-7219

FOR SALE: Transistors: Magnavox AM-5 - \$60. Toshiba 8TM-294 - \$50. Plus shipping, both very nice. Ralph Kemper, 297 27 3/8 Rd., Grand Junction, CO 81503. (970) 243-2576

FOR SALE: Harder Model L-2 Toroidal coil winding machine with accessories and books, working condition unknown - \$350. Mark Miner, 11430 Tuscarora Ln., Clermont, FL 34711. (352) 394-6596

FOR SALE: Hallicrafters S-120 - \$55. HK TA3000X - \$165. Airline 1696A table radio - \$30. Plus more. SASE or call for list. Roger Ruddick, 33 Emily Ln., Ft. Myers Beach, FL 33931. (941) 463-8887

FOR SALE: HQ-160 - \$300. SX42 - \$250. NC-88 - \$200. NC-33 - \$175. Trans-Oceanic 3000 - \$200. Wayne E. White, 5267 Arcadia Ct., Las Vegas, NV 89118. (702) 871-0754

FOR SALE: Check pages 66, 91, April A.R.C., much left. LSASE for list of more. Michael Crain, 3 Hillside Ave., Harveys Lake, PA 18618-9782. (717) 639-2794

FOR SALE: List 1: Tubes, Parts, Radios - Tube/Transistor/Novelty. List 2: Books, Semiconductors, Resistors, Meters, Parts. W.F. Horn, 13110 Marsh Rd., Bealeton, VA 22712. (540) 439-9781

FOR SALE: Wood case Utah electrodynamic speaker #A100 - \$75. Globe good emission UX-201A's - \$12. Box of Aeriola Senior parts - \$60. Philco 20 parts chassis - \$25. Fada Bakelite #1001 - \$60. Philco slant-front #39-25 - \$100. Philco 37-93, (see E.O.R. 2) - \$140. + UPS. Jim O'Neill, 170 Devon Rd., Delaware, OH 43015. (614) 363-3682, evenings

FOR SALE: ECG, Nap and other ICs and transistors. Some obsolete numbers available. Ray Schmidt, 607 1 Ave. SW, Austin, MN 55912. (507) 433-0069, (507) 433-3250

FOR SALE: Telegraph key collector's illustrated quarterly journal, free subscriber ads - \$10/yr. U.S.A. Sample - \$2. TVC, Box 88-A, Maynard, MA 01754

FOR SALE: Beautiful Abbotwades horse with rider, plus more. Send a SASE to: Neil O'Donnell, 1809 Sampson St., Butte, MT 59701. (406) 491-1809

FOR SALE: Wilcox-Gay Recordette, works, fair condition - \$25 plus shipping. Lance Walker, 7116 Reedy Creek Rd., Charlotte, NC 28215. (704) 568-5379

FOR SALE: RCA 45X1 - \$60. Emerson 520 - \$145; 520, crack - \$75; 569 - \$45. Arvin 951T - \$35. Westinghouse H322T5 - \$50; H188 oriental - \$95. Melrose 571 - \$40. Guild Spice Chest - \$50. Guild phone radio - \$45. Atwater Kent 20 - \$65. Fada 1000 repro - \$50. Fada mantle piece - \$85. Clarion 400 - \$85. New photo list \$1+ LSASE 2 stamps. Bob Masterson, Box 172, Valley Cottage, NY 10989. (914) 353-3151

FOR SALE: Knight R/C tester, RF generator, condenser substitution box, resistance substitution box, all vg condition, no manuals - \$60 plus. Antique Philco signal generator - \$25 plus. Elwood Hunt, 308 Georgetown Rd., Carneys Point, NJ 08069. (609) 299-5259

FOR SALE: Heathkit AJ-30 AM/FM tuner and companion AC-11 multiplex adapter, both in working condition, tuner manual included - \$75 includes shipping within con. U.S. Dale B. Allen, 606 Third St., Herndon, VA 22070. (703) 904-9895. E-mail: dallen@melpar.esys.com

FOR SALE: Philco PT2 - \$18. Crosley 13AE - \$18. RCA 9X641 - \$20. GE clock/radio #50 - \$15. Philco 53-958, wood - \$20. GE P790 transistor - \$10. Toshiba 6P15 - \$15. Precision EV10S multimeter, wood case - \$20. Eico electronic VOM - \$10. Home-brew 5-tube TRF w/tubes, vg - \$75. Eveready Model 3, no PS - \$40. DeForest D10 loop repro., excellent - \$150. Stewart-Warner Varsity, cracked case - \$50. All plus UPS. Please call before 9 pm. Walter Worth, 2 West Elm Ave., Wollaston, MA 02170. (617) 479-4512

FOR SALE: Colorful Crosleys - \$65-\$125. Continental 1600NL, ivory - \$125. Long SASE, giant list. Ripley, Box 9374, North St. Paul, MN 55109. (612) 777-6791

FOR SALE: Sams Auto Radio books, Volumes 8 to 228, total (103) - \$75 plus shipping. Steve Whited, 3637 West 71st St., Indianapolis, IN 46268. (317) 298-9967

**E-MAIL ADDRESS FOR
ANTIQUÉ RADIO CLASSIFIED
ARCMagzine@aol.com
Ads - Subscriptions - Book Orders
See inside front cover for details**

FOR SALE: Browning Model RJ-42 (chrome chassis) & Sherwood Model S-3000 tuners, both for - \$50. Jim Ligouri, 7 Sycamore Ct., Atkinson, NH 03811. (603) 362-5712

FOR SALE: ITC Julia German 10-band portable - \$125. Fisher R-200 tube stereo tuner - \$100. Lafayette LA 235 integrated amp - \$75. RCA old hi-fi integrated amp - \$40. Pioneer old tube receiver, two tuning eyes, SM-G-204 - \$80. Heathkit W-9 amp - \$80. New in box Heathkit VHF-UHF GR 1132 scanner unbuild - \$80. Jensen 12" Alnico 5 P12S speakers - \$50. Bell 2521 tuner amp - \$50. Ampeg Gemini II guitar amp - \$125. Heathkit shortwave GR 64 - \$30. Thorens TD165 turntable - \$50. Philips turntable - \$40. Dynaco PAT-5 - \$40. PS audio 4.5 preamp - \$200. Espey AM-FM hi-fi - \$60. Hickock 534 tester N.W. - \$25. Stromberg-Carlson coaxial 12" hi-fi speaker - \$40. All plus shipping. Frank DeFilippi, 62 Second Ave., Massapequa Park, NY 11762. (516) 798-6577

FOR SALE/TRADE: Mercury Super 10 with tubes and cabinet, in working condition. WANTED: Westinghouse DR resistance coupled detector-amp. Tod Prowell, Obsolete Technologies, 413 N. York Rd., Mechanicsburg, PA 17055-6016. (717) 697-5227

FOR SALE: RCA RC-23 Receiving Tube Manuals, 1964, 608 pages, good+ condition - \$16 ppd. Rainy Day Books, PO Box 775, Fitzwilliam, NH 03447-0775. (603) 585-3448

FOR SALE: Carbon microphone elements, new, GTE Type, 2 1/16 wide, 1" deep - \$3 or \$7/3 ppd. West-Tech Services, PO Box 1415, Sebring, FL 33871. (941) 471-0922

FOR SALE: N.O.S. tubes at reasonable prices. Large SASE for newest list. **WANTED:** 7027A's. Charles D. Blair, 815 N. 5th St., Cambridge, OH 43725. (614) 432-4453

FOR SALE: Radiola 60 with 103 tapestry speaker or speaker table - \$250. Philco 40-190, refinished and nice and works great - \$200. Pick-up only. Don Willard, 36 Mayfair Rd., Meriden, CT 06450. (203) 639-1306, days

FOR SALE: Transistors RCA RZG101J - \$10. Deltone 613 - \$10. Clock radio, model number unknown - \$20. James S. Looney, Rt. 1, Box 54, Grundy, VA 24614. (540) 531-8677, after 7 pm

FOR SALE: RCA 5T - \$75. **WANTED:** Chassis for AK 944, chassis for Philco 49-505, manual for Minerva Tropic Master. Ted Depto, The Philco Collector, 818 5th Ave., Patton, PA 16668. (814) 674-8834

FOR SALE: Philco chassis for 46-1213 - \$35. Electro-Voice #664 microphone - \$40. Jensen tweeter horn - \$15. Zenith chassis for Majestic 8B07D - \$25. Victor #VV-IV phonograph - \$225. Philco #38 cathedral - \$125. Majestic #9P6 power supply - \$15. Sony #TC-18 cassette recorder - \$15. Zenith #8A02 chassis WT - \$40. Philco #60 cathedral - \$65. Philco #20 cathedral - \$75. RCA #4502 record player - \$10. Emerson #640 portable radio - \$35. (100) Sams #1843 to 2165 - \$15. Brunswick 2-way reproducer - \$50. **WANTED:** Crosley #48 chassis. Walt Wrabek, Rt. 4, Box 370, Menasha, MN 56464. (218) 564-4623

FOR SALE: UFO's are real! I have one, a GE P2775 UFO radio. Ever see one listed in any A.R.C. ad? This one N.I.B. - \$85. Also Philmore Little Wonder crystal radio, pink, N.I.B. - Make Offer or Trade. **WANTED:** Pushbutton assembly for Zenith 6J322, 6J357, 6S361 or buy your junk chassis with good pb's. Also for sale: Music Master Model 60, restorable, no tubes or battery cable - \$65 + ship. Still need good dial for Sparton Jr. Model 410. Willard Smith, 1802 13th St., Bedford, IN 47421. (812) 275-5760, call evens.

FOR SALE: Everything necessary to repair antique radios. Riders 1-20, 156 tubes, parts and test equipment to be sold as a lot. Send #10 SASE and \$1 for 6-page computer printed list. Michael Franzen, 3618 Effie St., Los Angeles, CA 90026

FOR SALE: Fisher 50R tuner w/box, not tested - \$60. Eico HF-20 vg overall, not tested - \$60. Scott 222C w/ case, works, fair cosmetics - \$60. All + ship. **FOR TRADE:** Altec 803B or 416A for the other. Chuck Steika, 24 Frederick St., Johnson City, NY 13790. (607) 797-9573

FOR SALE: Fisher 400, excellent, with papers; 1984 L.A. Olympics promotional autographed picture record disc; parting out Graetz Super 160W; Majestic 5B01 black-silver Bakelite. Charles Harper, 2000 Jackstown Rd., Paris, KY 40361. (502) 769-0404

FOR SALE: McElroy collection, Vibroplex bug collection. Mail auction. SASE and \$1 for pictures, rules. Gene Greneker, 184 Lake Somerset Dr., Marietta, GA 30064. (770) 422-2979

FOR SALE/TRADE: Atwater Kent kit breadboard w/ good parts - \$675. Many other AK parts - call. Philmore crystal radio w/original box - \$100. Crosley 51 portable - \$125. Transcontinental ZR-4, 3 tube - \$325. Wizard condenser microphone - \$40. Spencer pocket crystal radio - \$145. Tuska 224 w/paper & tube - \$450. Westinghouse AR tuner - \$900. Crosley 3 w/tubes & phones - \$145. WD-11 tubes, new in box - \$50. List available: Jerry Finamore, 1374 Stafore Dr., Bethlehem, PA 18017-1633

FOR SALE: RCA 3BX671 Strato-World tan leather, excellent, works great - \$150. Zenith 7G605 Bomber, works - \$230. Add shipping. Ted Demski, 5806-225 Pl. SW, Mountlake Terrace, WA 98043. Phone/fax: (206) 778-7100

FOR SALE: 500C receiver - \$150. Realistic 40A tube integrated amp - \$85. Hallicrafters S-38B - \$75. Bernard Bank, 303 Devoe Ave., Yonkers, NY 10705. (914) 476-5933

FOR SALE: Old phonograph turntables recovered in bright green, dark maroon, or dark brown felt - \$20 plus \$5.50 shipping. Doyle Roberts, HC63 Box 236-1, Clinton, AR 72031. (501) 745-6690

FOR SALE: Tektronix Type 422 solid-state portable oscilloscope, 15 Mc dual channel, tested and calibrated, with manual - \$150 plus shipping. Larry Hescocock, 549 Silverleaf Dr., Oroville, CA 95966. (916) 589-5612

FOR SALE: RCA 1923 Radiola AC 2-tube amplifier (repaired hairline crack in panel), with (2) dud WD11's - \$170; w/o WD-11's - \$140. ERLA 1925 Model S-11 3-tube radio in working condition, w/o tubes - \$125. All items plus shipping. Ken Higgins, 9331 Southport Dr., Richmond, VA 23235-4933. (804) 272-1825

FOR SALE: Beautiful Capehart Chippendale with pre-war turnover changer, offers til 6-1-96. W. Coast delivery negotiable. N. Hill, 9530 Cross St., Missoula, MT 59802-9510. (406) 258-6388

FOR SALE: Micros. Juliette. Ross. Zenith. Roxy. **WANTED:** ED: Zenith, small R-to-R's, Geloos stuff. Stewart Struzer, 3210 Dow St., Pompano, FL 33062. (305) 834-4946

ARBE-III — Universal Battery Eliminator

\$149.95 Shipped USA

Contact:

Antique Radios Inc.

Box 6352, Jackson, MI 49204

(517) 787-2985 or

Fax (517) 782-7422





VISIONETTE
MECHANICAL TELEVISION
24 LINES
AUTHENTIC OPERATION
SCANNING DISK CAMERAS AND RECEIVERS
EASY TO BUILD KITS OR READY TO GO
AVAILABLE NOW!
A collection is incomplete
without the **VISIONETTE**
FOR INFORMATION, CALL OR WRITE
PETER YANCZER, 836 BRICKEN
St. Louis, MO 63122
Ph. 1-314-822-1748 or a SASE

FOR SALE/TRADE: The following tube-type audio items: EICO HE-60 power amps - \$1,100/pair; EICO MX99 stereo multiplex adapter - \$100; EICO HF-85 stereo preamplifier - \$175; EICO HF-90 stereo tuner - \$150; Rek-O-Kut 2-speed professional 12" stereo turntable - \$150; Knight 60-watt chrome-plated tube amplifier Mod 83 - \$500; Fisher 500-C w/space expander and reverb tank - \$350; Fisher X200 amplifier - \$325; Webster Electric PA music amplifier, Mod TP 14, 12 watts - \$75; Ampeg guitar amp Mod R-15-N chrome-plated with black cage, powerful - \$350; Newcomb KX25 professional mixer amplifier w/overload and volume light beam indicators - \$275. Call: Larry Drago, 383 Lincoln Dr., Cheshire, CT 06410. (203) 272-6030

**NOTICE TO ALL
CLASSIFIED ADVERTISERS!
OUR CLASSIFIED AD DEADLINE IS
12:00 NOON
ON THE 10th OF EACH MONTH**

FOR SALE: N.O.S., 304TL, Elmac tube - \$75. Used tubes: 6K7GT, 6V6, 12AX7 - \$1.50 ea. All cleaned boxed and tested good, minimum order - \$25. Plus S/H. \$100 order gets \$10 worth of free tubes plus free S/H. George Stagakis, c/o George's Radio & TV Repair, 1714A 41st St., North Bergen, NJ 07047. Phone/fax: (201) 867-9136

FOR SALE: Amberola 50, Delco tabletop, wax cyl. Mike Nail, 305N Pine, Mt. Prospect, IL 60056. (847) 398-1879

FOR SALE: Nice 1924 Atwater Kent Model 10 breadboard, No. 4340 - \$1,100. Many test instruments. Admiral 7M12 transistor - \$45. Plus UPS. John Enigl, K9HJL, 5425 Cherry Ln., Egg Harbor, WI 54209. (414) 743-3672

FOR SALE: Heath LCR bridge - \$35. Waveforms AC VTVM .001v-300v 10Hz-2MHz - \$25. RCA WV77E VTVM - \$20. Heath scope dual trace adapter - \$15. Clegg FM27 2m xcvr - \$50. Robert Perlestein, 17 Vine St., Medford, MA 02155. (207) 934-9206. E-mail: 75347.2001@compuserve.com

FOR SALE: Philco 70B - \$350. Philco 39-7 - \$55. Silvertone #528 wood, 1936 - \$65. Grundig 4070 AM/FM/SW - \$125. Ernest Odoneal, 2710 Lee, Greenville, TX 75401. (903) 455-2113 or 5788

FOR SALE: Novelty transistor radios. Many new in box. Send SASE for list. Arnold Hornstein, 21 Goldenhill Ct., Baltimore, MD 21228. (410) 744-0919

FOR SALE: Ampex 440 tapedeck 2, 4 channel heads and electronics - \$500 or Offer. Joe Brady, Box 8, Star Rt., Huntingdon, PA 16652. (814) 643-0603

FOR SALE: Early Sony portable 5" B&W TV, #5-303W, vg. Realistic DX-150 HF receiver, exc. Crystal scanners: Bearcat IV, Realistic Pro-77A, several Regency, Panasonic RF973 AM/FM ST. portable w/spacer feature, exc. 1954 Amateur Call Book, exc. Audel's Eng's & Mech's. Guide #8, 1921, exc. WANTED: Monitoradio DRS-1 external speaker. Zenith Royal 94, 97, 7000, and R7000. Gary Richardson, PO Box 712708, San Diego, CA 92171. (619) 670-7590

FOR SALE: Atwater Kent radio, no cabinet, with speaker, all the tubes, Model 55C, looks good - \$60. Rider Radio Manual #14 - \$15. All items plus shipping. Call or write: Thomas Burnside, 4838 S. Westhaven Dr., Jackson, MS 39209-4711. (601) 922-2235

FOR SALE: Tube-type AC table radios: Zenith C724L AM/FM, M512W AM, H722 FM - \$15 ea. GE 235 AM/FM, Sentinel 315A AM/FM - \$10 ea. Also power, input, output transformers and filter chokes salvaged from jukeboxes using 45, 2A3 and 6L6 tubes in P.P. All above + UPS. Onerio "Lou" Sabetto, 1717 Burgess Rd., Cleveland, OH 44112. (216) 481-1036

FOR SALE: "Well bust my buttons and call me Buster," we finally have a new catalog. Crystal set instructions radio parts, supplies, MRL Handbooks published by us. Catalog - \$2. Modern Radio Labs, PO Box 14902, Minneapolis, MN 55414-0902

FOR SALE/TRADE: Detrola Super Pee-Wee, all beetle plastic; Fada 1000 Bullet, all yellow with insert grille; Motorola S-grille, red and black; yellow Emerson tombstone AU-190, black Air-King with Egyptian insert; Kadette Clockette in tomato red with original box; Garod Commander in yellow and red; large pistachio and maroon Addison, and brown Bakelite Lackner Nassau clock with neon. Jean-Claude Rebourg, 7010 S.W. 48 Ln., Miami, FL 33155. (305) 662-1986

FOR SALE: Dr. Edward Weston's finest instrument giant-size laboratory standard, mahogany case - \$235. Old technical book list. Western Union relays. Write for list. Henry Weiland, 8946 W. Grantosa Dr., Milwaukee, WI 53225. (414) 463-4681

FOR SALE: Wood table models: Philco 40-120, ivory - \$45. Detrola 495, small Deco - \$40. RCA 55X - \$35. Silvertone 2541, battery - \$30. Silvertone 6356, battery - \$40. Zenith 6G601ML, alligator - \$55. Crosley 52TF - \$35. Plastic sets: Philco, CR, 52-545 - \$25. Zenith L721 - \$30. Sparton 5G1, Canadian, turquoise - \$40. Astatic antenna booster, Deco - \$50. Classic Radio & Television, 541 Riverside Dr., Box 61, Augusta, ME 04330. (207) 623-2059

FOR SALE: Addison 5A, Catalin black/butterscotch, exc. will trade for maroon Bullet and cash. Northern Electric Bullseye Midge, hairline - \$75. Lifco Deluxe, same as Midge Bullseye, white, exc - \$120. Tan Zenith Royal 500, exc - \$200. Wilco Deluxe Boomerang Dial ST-7 R.P.P. - \$70. Belvoice, like Nipco, jet grille, exc - \$65. RCA 8BT-8FE pink/white - \$75. WANTED: Will trade these radios for minor damaged Catalin radios and parts. Mike Herman, #2-1731 Rockland Ave., Victoria, British Columbia, Canada V8S 1W6. (604) 595-2829

FOR SALE/TRADE: Hammarlund Mod 180 - \$450. 1935 McMurdo Silver Mod 5-C communication receiver - \$450. The original National HRO w/large metal dial and doghouse power supply - \$575. Hallicrafters original Sky Buddy - \$325. 1938 National 1938 HRO Sr. prototype communication receiver and special design power supply, speaker and manual - \$600. FR-7 w/3 sets of coils - \$450. Call: Larry Drago, 383 Lincoln Dr., Cheshire, CT 06410. (203) 272-6030

FOR SALE: (2) Lux audio power amps, Model MB3045. Tube compliment, (2) ea. 8045, (2) ea. 6240G, ECC82, ECC83, S.S. rect. beautifully constructed - Offers please. Dennis Lariviere, PO Box 1446, Lake Worth, FL 33460. (407) 585-2979

FOR SALE: 1959 HiFidelity magazines, (12) issues - \$120. H.H. Scott, Full Line brochure, 1960's - \$50. Pioneer receiver SX-838, blue dial - \$150 or trade. Send large SASE. Ernest Naaz, 242 E. 89th St., Apt. C, New York, NY 10128. (212) 289-7681

FOR SALE: 15" audio speakers: (1) Altec (604B); (1) (604C); (1) Altec (418B); (1) Altec multicell Diacone 603-B; two Bozak two-way coaxial speakers Mod 207A; (1) Bozak 209 mid-range speaker; two 15" Stromberg-Carlson Slim-line chrome-plated speakers. Call for prices. Larry Drago, 383 Lincoln Dr., Cheshire, CT 06410. (203) 272-6030

FOR SALE: Catalin repo glass dials: Addison No. 5, Sentinel 284, Fada 652, Bullet 1000 and 115. Gregg Jewett, 1905 First St., Sandusky OH 44870. (419) 625-2319

FOR SALE: Sonora RBU-176 - \$40. Temple metal radio, re-painted with homemade handle - \$20. Arvin 341-T, metal, re-painted knobs - \$30. Silvertone metal 6002, like Arvin with louvers, original - \$40. Motorola 68X120, brown and tan - \$200. Guild mantle clock AM/FM - \$80. **WANTED:** Transistor General Electric 678, aqua. Add \$5 to cover shipping. All radios untested. Jim Martes, 15400 E. 2nd St., S, Independence, MO 64050. (816) 836-0668

FOR SALE: 1940 Zenith robot dial 12S568, nice cond. - \$350. Emerson 888 Atlas, black, w/case, plays - \$65. 1957 Motorola 6P34S - \$20. Airline 62-288 Miracle, plays - \$60. North American Super Midget 7 transistor radio/phono - \$50. Zenith hearing aid - \$35. 1962 Admiral portable TV Model T-930, metal case, plastic front, nice cond., plays excellent - \$30. Philco TV booster Model T.B.3 - \$25. Al and Tina Varga, PO Box 203, Casco, WI 54205. (414) 837-2363

FOR SALE: Last of the kits! Grommes 20W amp, Eico signal gen. - BO on ea. Nice PAT-4 & FM-5 - \$85 pr. N.I.B. Garrard RC88/4 & Ampex 2070 reel to reel. W/Elec. intercom for Bell, desk set, wood cab. - \$50. (2) RCA EY-3's - \$35 ea., or (2) - \$60. **WANTED:** Zenith 6S27 chassis, Heath MX-1 mpx adapter. Thanks! Michael L. Hagan, 428 Sharron Dr., Waco, TX 76712. (817) 776-4760

FOR SALE: E.H. Scott radios in rare desirable cabinets. Allwave 12 in Napier cabinet - Best Offer over \$3,000. Phantom AM/FM Deluxe in Louis XV cabinet - Best Offer over \$4,000. Both radios in original, excellent condition. Serious inquiries only, photos available for \$5. Will accept bids through May 20th. Scott Vala, 16585 Hascall, Omaha, NE 68130. Phone/fax: (402) 330-7186

FOR SALE: Crystal set instructions, radio parts, supplies. MRL Handbooks. Catalog - \$2. Modern Radio Labs, PO Box 14902, Minneapolis, MN 55414-0902

FOR SALE/TRADE: Rare 6-tube Hanscom Superunit superhetrodyne battery set, made in Woonsocket, R.I., in early 1920's, a must for Rhode Island collectors. Call: Larry Drago, 383 Lincoln Dr., Cheshire, CT 06410. (203) 272-6030

FOR SALE: JVC RC-828 powerful shortwave multiband AM/FM Biphonic stereo super large, hi-sensitivity portable with stereo cassette recorder - \$200. Nordemende Traveler 4, mint - \$325. Harman Kardon TP 7000-X 70W stereo, 17-tube tuner/amplifier - \$200. French Interfon Super, automatic search, rare - \$200. Large selection, magnificent European receivers in Telefunken, Saba, Emud, Grundig, Philips (Holland), Nordemende. **WANTED:** Buyers worldwide, interested in acquiring fine European tube-style radios. Reasonable prices. Also wanted schematic/manual for Simpson 1000 tube checker. Electro Technics, 75 Breakwater Shores Dr., Hyannis, MA 02601, U.S.A. (508) 771-5955

FOR SALE: The following National communications receivers: HRO M - \$350; NC 100A - \$395; NC-300 w/ converter box, speaker and manual - \$450; National 183 - \$200; National R.A.S. #2 military communication receiver w/speaker, power supply, 7-coil set - \$425. NC-2-40 - \$325; NC-200 - \$350; NC 105(?) - \$300; NC 46 - \$340. Larry Drago, 383 Lincoln Dr., Cheshire, CT 06410. (203) 272-6030



*Craig L. Graybar
Furniture Works Ltd.*

(414) 258-2390

**SPECIALISTS IN RESTORING,
REPAIRING AND REPRODUCING
CLASSIC STYLED ANTIQUE TV,
RADIO & PHONOGRAPH CABINETS**

Send us your plans or your project
via UPS for immediate price quotes



**1535 S. 84th St.
West Allis, WI 53214**



"We Turn Ideas Into Heirlooms"

Join the
AWA

ANTIQUE WIRELESS ASSOCIATION
THE ORIGINAL AND LARGEST HISTORICAL RADIO-COLLECTOR GROUP

- Publishes *Old Timer's Bulletin* with:
 - Battery and AC receiver restoration
 - Vacuum-tube history and collecting
 - Old-time amateur-radio contests
 - Communications receivers
 - Free want-sell-swap ads
 - Early television
 - Horn loudspeakers
 - Reviews of current books
 - Keys and land-line telegraphy
 - News of U. S. and foreign clubs
 - Information on public radio museums.
- Maintains unique radio-TV museum.
- Produces the annual Rochester meet.
- Co-sponsors local meets.
- Publishes the annual **AWA Review**.

Membership is only \$15 per year (\$27 for two years, \$18 per year for overseas). Mail check to:

**Antique Wireless Association, Inc.
Box E, Breesport, NY 14816**



FOR SALE: Radio schematics - \$2.75. Zenith, Philco, Crosley service manuals, Rider's Radio Index 1 thru 23, all Xerox copies. Reproduction Philco cathedral cabinets parts. Rider's Radio Manuals 6 thru 15. All plus S&H. **WANTED:** Philco cathedral cabinets, any condition. Dick Oliver, 28604 Schwalm Dr., Elkhart, IN 46517. (219) 522-4516, evenings

FOR SALE: Peerless electrodynamic cathedral speaker - \$70. Elvis silver novelty - \$60. Zenith Trans-Oceanic 1000 - \$95. Don Reinsma, 610 Nix Rd., Pensacola, FL 32506. (904) 455-7721

FOR SALE: La Siesta handpainted wood radio, RCA 40X53 - \$500. Siwertone 3621 - \$100. Mark Gilbert, N5MG, Box 88, Old Greenwich, CT 06870. (203) 625-8374

FOR SALE: Neon lamp NE-48/B9A - \$2. 2130 pF 1% 500V dip mica cap. - \$1. Star-Tronics, Box 98102, Las Vegas, NV 89193. (702) 795-7151

FOR SALE/TRADE: Atwater Kent Mod 66 console, decent cabinet, electronically complete - \$350. Call: Larry Drago, 383 Lincoln Dr., Cheshire, CT 06410. (203) 272-6030

FOR SALE: Fada 659 Catalin Temple with shortwave, butterscotch, cab. perfect, working - \$550. AK L horn sprk - \$160. 1948 Bing Crosby Jr. jukebox - \$275. Zenith 6S258, black dial, chassis only, complete, U/T - \$75. AK 975 twin sprk chassis only, complete, U/T - \$75. **WANTED:** Crank-up phonos, parts, horns, reproducers, etc. Also AK 206 chassis & Zenith 12S471 escutcheon. Thanks. J.L. Acciavatti, PO Box 321, Southborough, MA 01772

FOR SALE/TRADE: Lost storage, sacrifice: Wurlitzer/Seeberg jukeboxes. Scott, Capehart, Midwest consoles. Broadcasting, recording, audio. Robert Van Dyke, 2 Squires Ave., East Quogue, NY 11942. (516) 728-9835

A.R.C. BACK ISSUES

April '87 to current issue: Originals available
32 to 100 pages each.

Oct. '86 to Mar. '87: Reprints available
Reprinted from original artwork; 28 to 32 pgs. ea. Quality & appearance same as an original copy.

June '84 to Sept. '86: Photocopies available
Not original quality, useful for info.; 16 to 28 pages each. Publication of *Antique Radio Classified* began in 1984 which had only five issues: June, Sept., Oct., Nov. & Dec. 1984. 1985 through current year have had 12 issues each.

**\$4.00 each - Postpaid to
U.S., Canada and Mexico.**

Orders of 6 issues or more may take a 10% discount. Orders for a full calendar year may take a 50% discount. Foreign orders other than Canada and Mexico: \$6.00 each by air. Mass. residents, please add 5% sales tax.

A.R.C. UNFOLDED COVERS

June 1991 to the present
9.25" x 12.5" - \$9.95 each

Postpaid to U.S., Canada, & Mexico
Mass. residents, please add 5% sales tax.

Send Order To:

**A.R.C., P.O. Box 2, Carlisle MA 01741
Or Call (508) 371-0512**



FOR SALE/TRADE: Before you read this ad take a look at the Majestic Mod 300-A console radio on p. 127 of E.O.R. 2, and I believe you will agree as I, that it is one of the most beautiful radios ever made. I have just acquired this set complete with stained-glass side panels, carved organ pipe designs on grille and in great working condition. You can own this rare radio for - \$995, and I can ship it anywhere in the world. Call me: Larry Drago, 383 Lincoln Dr., Cheshire, CT 06410. (203) 272-6030

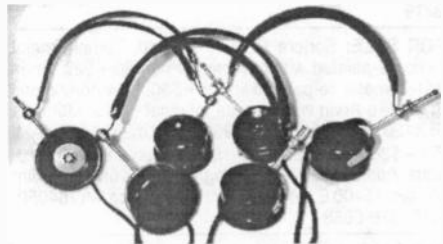

FOR SALE: Headsets w/improvised cases containing N.O.S. elements from highest quality sound-powered telephone equipment. Listening tests indicate 200% advantage over next best balanced armature elements (recent military surplus) & 400% advantage over Baldwin's best! Headset w/matching transformer - \$100. Rewound to eliminate transformer - \$200. John Stanley, 6156 Summit Ave., Brown Summit, NC 27214

FOR SALE: RCA Model 4-X-643, lots of grille, no cracks, works - \$25. GE Model P-808E, P-806A, both good - \$10 ea. Sony Model 2R-27, complete in box, all accessories - \$25. Tempest Model KM-617 micro transistor, new in box - \$25. RCA Model 1-RJ-19 transistor, good - \$10. Sony Model 4R51 transistor - \$12. Panasonic Model R-1040, green - \$7. Truetone 10 transistor radio - \$5. Box for NEC Model NT-625 transistor, black, to complete someone's package - \$15. Valiant Model TR-880 transistor, leather case - \$10. Monacor AM/FM 9-transistor radio, antenna tip broken - \$5. GE Model P17110C transistor, works - \$7. Emerson Model 31P56, big G-clef logo, ear plug case, plug on handle - \$20. All plus shipping. Tom Bates, 1928 N. Braeswood, #11, Houston, TX 77030

FOR SALE: Novelty radios, all N.I.B.: Crayola - \$30. Harley Davidson tank - \$50. Harley Davidson Jr. Rider - \$22. Power Rangers coin, pendant, set of six - \$55. Playhouse, B&B 613 - \$20. FS Superlube, B&B 28 - \$25. Mickey Mouse large head, looks like the Mickey lunch box but larger - \$55. Transformer, B241 - \$30. Tony the Tiger, B317 - \$25. Labatts beer can - \$22. Also have Knight helmet with face B509A, exc cond. - \$75. Standing Knight, replacement sword, exc cond. - \$45. Mini Coke cooler, N.I.B. - \$40. Add shipping. Jerry Emily, 1053 W. Outer 21 Rd., Arnold, MD 63010. (314) 296-7179

FOR SALE: DuKane mic-amp Mod 1A385A - \$65. Zenith T-O 3000, U.S.A., @ 10 - \$175. David Roche, 10 Hospital Rd., Monson, MA 01057. (413) 289-1037

FOR SALE: Grundig table model 4570 U/ST w/operating manual and schematic - \$95 + postage. Nils Hardin, PO Box 1094, Summertand, CA 93067. (805) 963-0116

FOR SALE: Little Fliver crystal set - \$130. Altec 1589B mixer-amp - \$90. Bulbs, BEH - \$7. Wm. Harder, 911 W. Northrup St., Lansing, MI 48911-3640. (517) 882-2303

FOR SALE: Radio/broadcasting books, mags, ephemera; British valve data, ads, etc. Send for list. Roger Hart, 4533 Harvard Ave., Montreal, Quebec, Canada H4A 2X3. (514) 483-3857

FOR SALE: Knight-kit collection over 30+ pieces. Radios, shortwave, ham, CB, tube amps, tuners. SASE for list. David Koesche, 61 S. Barrington Rd., Barrington, IL 60010. (847) 382-7997

FOR SALE: Kennedy Model XV Type 430 radio, excellent condition with all five 01-A tubes - \$425 + UPS. Henry Engstrom, PO Box 5846, Santa Rosa, CA 95402. (707) 544-5179

FOR SALE: Aeriola Senior, fair condition, works - \$125. RCA 103 tapestry speaker, looks & works good - \$125. LSASE for picture list of additional radios and miscellaneous. Tim Healy, 18 Abby Ln., Syosset, NY 11791. (516) 496-7206

FOR SALE: Rare catalogs, Electro-Importing, Nat. Radio, Try-Mo. (?) duck, Manhattan Electric, F.D. Pitts, DeForest and many others. Please no phone calls. Les Rayner, 5512 N. 71st Pl., Scottsdale, AZ 85253

FOR SALE: 1939 Majestic Model 3BC90B, refinished, plays, unique, (Blast, p. 242) - \$125. Spencer Doggett, 61333 North Ridge Trl., Washington, MI 48094. (810) 651-3811

FOR SALE: Rider Radio 1-23 - \$525; 9-13, 15, 16 - \$20 ea. Rider TV 11 Vol. 10-26 - \$130. (90) issues Radio News, 1946-55 - \$80. Walter Sanders, 15 Todd Dr., Terre Haute, IN 47803. (812) 877-2643

FOR SALE: Zenith 12H094 12-tube black dial - \$135. Silvertone metal - \$100. Jim Berg, 4261 Wilcox Rd., Box A, Northport, WA 99157. (509) 732-4047

FOR SALE: Four (4) 575A tubes - \$45 ea. plus shipping. Marv Glassman, 19300 Romar St., Northridge, CA 91324. (818) 993-4560. Fax: (818) 886-0355

FOR SALE: David Grimes Baby Grand Duplex - \$200. Stromberg-Carlson 5A floor model speaker, works - \$250. Guild Buccaneer Chest - \$140. **WANTED:** Tapestry grille cloth for Philco 95 console, Wunderlich tubes, duds OK. Gerald Kitchens, 116 E. South, Orea-na, IL 62554. (217) 468-2540

CLASSIFIED AD NOTICE
Please check your ads carefully before sending them in. Once ads are received, it is not always possible to refund the amount sent, pull the ad or make changes.

FOR SALE: PARSEC antenna booster/discriminator frequency, gain controls AM/FM N.I.B. - \$59. Heathkit tube tester, Model #TT-1, manuals - \$55. Fisher-Price PXL-2000 camcorder for kids, uses standard C-90 audio cassette for 10-in. picture, untested, looks good, rare find - \$69. **WANTED:** I still am desperately looking for a 1967 RCA 3 1/4" R/R tape recorder Model YJS-15G, green with piano keys, slanted perforated grille, recording meter, barrel-type volume control, recessed chrome handle, lift-up see-thru lid, AC/DC. There must be one out there somewhere! Thanks. Bret F. Johnson, 13495 102nd Ter. N, Largo, FL 34644. Ph/fax: (813) 595-9287

FOR SALE: 1938 18-tube 18-36 Midwest console, nice, can deliver to Kokomo, In., meet - \$225. Fred Schultz, 1246 Lincolnway S, Ligonier, IN 46767. (219) 894-3779, fax after 5 pm

FOR SALE: Escutcheon's Philco 77, 89 RCA-R9, Emerson, Majestic, United Motors, Coronado - \$20 ea. ppd. Steven Thompson, 504 Cardell Cir., Mableton, GA 30059. (770) 819-1743

FOR SALE: Axial electrolytics: (22) mFd.450v - \$1; (30) mFd. 450v - \$1.25; (33) mFd.450v short leads 1/2" - 75c; (100) mFd.450v - \$3 plus shipping. Apex Jr., Steve Slater, 3045 Orange Ave., La Crescenta, CA 91214. (818) 248-0416

NEW AND USED TUBES WANTED

We urgently need the following tubes. All tubes must be well known brands such as GE, RCA, Sylvania, Tung-Sol, Phillips, etc. of US or W. Europe manufacture. New tubes must be in their original boxes. All tubes are subject to inspection. Ship by UPS (ground); we'll mail a check to you upon receipt and testing at prices shown plus your shipping charges. Call or fax for buying procedures and complete bid list. Call before sending more than 10 pieces of one type of tube.

NEW TUBES

| | | | | | | | | | |
|-------------|--------|----------|--------|------------|--------|----------|---------|------------|---------|
| 01A | \$9.00 | 6F6G | \$5.20 | 12BH7A | \$5.10 | 274B(WE) | \$85.00 | 6146B/298A | \$12.00 |
| 1L6 | 8.50 | 6G5/6U5 | 8.00 | 12DN7/7247 | 9.00 | 275A(WE) | 85.00 | 6267/EF86 | 6.00 |
| 2A3 | 24.00 | 6K5G | 5.00 | 20LF6 | 16.00 | 300B(WE) | 250.00 | 6550/A | 12.00 |
| 2B6 | 6.00 | 6KD6 | 15.00 | 26LX6 | 6.00 | 350B(WE) | 100.00 | 6550 (ST) | 34.00 |
| 5R4GY/AB | 3.40 | 6L6GC | 8.40 | 35LR6 | 6.00 | 623 | 35.00 | 7189/A | 5.30 |
| 5U4G | 6.70 | 6LB6 | 7.50 | 45 | 30.00 | 808 | 16.00 | 7591A | 20.00 |
| 5V4G | 4.70 | 6LF66MH6 | 18.60 | 50 | 110.00 | 805/331A | 32.00 | 8005 | 50.00 |
| 5Y3G | 3.80 | 6V6 | 6.00 | 71A | 8.20 | 845 | 80.00 | 8068 | 20.00 |
| 6BK4C/6EL4A | 8.00 | 6V6G | 6.50 | 80(ST) | 5.60 | 864 | 5.00 | 8908 | 27.50 |
| 6CA7/EL34 | 11.00 | 10 | 25.00 | 211(VT-4C) | 35.00 | 5691 | 15.00 | 8950 | 25.00 |
| 6F5G | 5.80 | 12A | 11.00 | 274A(WE) | 110.00 | 5692 | 18.00 | M-2057 | 32.00 |

USED TUBES

| | | | | | | | | | |
|-----------|--------|-----------|---------|------------|--------|------------|---------|-------|---------|
| 01A | \$5.00 | 10 | \$16.00 | 171A | \$7.00 | 245 | \$23.00 | 845 | \$31.00 |
| 2A3 | 12.00 | 12A | 7.00 | 183483 | 9.30 | 246 | 11.00 | 7591 | 8.60 |
| 5AR4/GZ34 | 6.00 | 20LF6 | 7.30 | 210 | 20.00 | 247 | 8.00 | 8417 | 8.50 |
| 6B4G | 6.50 | 42(GLOBE) | 8.00 | 211(VT-4C) | 14.50 | 250 | 65.00 | 8950 | 12.30 |
| 6LF6/6MH6 | 9.20 | 45(VT-52) | 25.00 | 230 | 6.20 | 280 | 12.00 | V201A | 6.50 |
| 6V6G | 2.10 | 45 | 11.00 | 237 | 8.50 | 282 | 8.00 | WD-11 | 35.00 |
| | | 50 | 60.00 | 240 | 8.50 | 401-CARDON | 9.60 | WD-12 | 24.00 |

ANTIQUE ELECTRONIC SUPPLY™

LIMITED PARTNERSHIP

6221 S. MAPLE AVE. • TEMPE, AZ 85283 • (602) 820-5411 • FAX (602) 820-4643 or (800) 706-6789

FOR SALE: Zenith Trans-Oceanics. All are complete, original and 100% cosmetically restored following restoration procedures outlined in Zenith Trans-Oceanics book by Bryant & Cones: 7G605 bomber grille - \$325. 8G005YT - \$175; G500 made only one year - \$185; H500 - \$185; B600 - \$205; Y600 - \$205; T600 - \$210; B600L tan - \$250. Zenith full color repro ads circa 1940's-1950's - \$7 ea. Philco #46-1203 radio + record player (Bunis 3, p. 164) - \$95. Hammarlund HQ129X receiver - \$250, or trade for Zenith wood table model radio with 7, 8 or 9 tube chassis. Zenith Trans-Oceanic Royal D 7000Y, with tuneable weather channel - \$265. Frank J. Manziano, 82 Monhegon Ave., Oakland, NJ 07436. (201) 337-5263



FOR SALE: Transistor Radio Photo Guides. Each guide packed with photos of all known collectible models of each brand. With model numbers and notes. Global/Zephyr, Standard, Realtone, Toshiba, and Sony are \$7 each including postage. Regency booklet - \$10. Eric Wrobbel, 20802 Exhibit Ct., Woodland Hills, CA 91367. (818) 884-2282

FOR SALE: Zenith Trans-Oceanic - \$65. Mike radio - \$90. Sentinel Midget - \$35. Monitor Midget - \$40. 1930's amp and speaker, 2A5 outputs - \$70. Plus assorted microphones. Need RCA 44 microphone. Rebuilt 77DX and others to trade. Brad Jones, 4801 Crofton Springs Ct., Greensboro, NC 27407. (910) 547-1919, call before 8 pm

FOR SALE: Mouse Music, novelty computer mouse FM radio with auto scan tuning, N.I.B., only four left, cute and play great - \$28 ea., includes S&H. Jeff Hoskins, 824 E. Madison Ave., Stuart, FL 34996. (407) 283-2291

FOR SALE: Needles, Pfanstiehl & other brands, over (1,500) N.O.S. Call or write your requirements with model or cartridge numbers. Bob Lynn, 26 E. Orchard St., Somerville, NJ 08876. (908) 685-9070

FOR SALE: Tubes: (4) matched pairs 6CA7/EL34, Amperex made in Great Britain; (2) 2A3's RCA; (1) SP-2A3 RCA; (2) 6B4G Raytheon; (1) 6A3 Raytheon. Preamp (2) EICO HF-85 - \$100 ea. Amplifier (1) EICO ST-40 - \$150. Pat Smith, 136 S. Dutoit St., Dayton, OH 45402. (513) 224-4333

FOR SALE: Grundig Micro Boy with spkr box, near mint - \$250. Ballantine's, vg, in near mint box - \$110. Little John radio advrt. G.H. Wood, exc in box - \$50. All plus shipping. Clement Richard, 340 Benjamin Suite, Laval, Quebec, Canada H7M 1Y3. (514) 629-7395

FOR SALE: Philmore (2) tube AC-DC radio kit catalog #7001-B, new in original box - \$35. Joe Kelly, 537 Stafford Ave., Erie, PA 16508. (814) 459-3910

FOR SALE: GE TV 9T002. Zenith AM FM H845 Delco transistors DS-501. Louis L. Veltre, 643A Sherwood Ct., Lakehurst, NJ 08733-4207. (901) 657-7592

FOR SALE: Zenith T-shirts and sweats, call. Fada EOC cathedral; 18-tube round white dial Midwest console - \$450. RCA 813K; RCA 40x55 - \$45; cute wooden Grantline radio phono table Model 465/7; 1931 Philco advertising, 8" x 6" paper-maché Philco escutcheon with a double-sided slide-in price card for the 9- and 11-tube consoles - \$145. Charlie McCarthy - \$850. Mitchell Lumitone lamp radio, gold base, excellent condition, no cloth shade - \$165. N.O.S.: Sonora RDV 209, wood - \$60. GE 202 Bakelite - \$40. GE 103 wood - \$35. Rider's Manuals: 8-14 - \$15 ea. Call for current availability on other numbers. We have available all type Trans-Oceanics except 7G605 and military, electrically restored, if requested, and guaranteed. 150+ General Cement dial belts - \$12, \$4.50 shipping. TV Rider's, in the original boxes, missing #17 - \$7.50 ea. (4) Transistor Rider's - \$20 ea. For your radio book library: we have 10 of the small Rider instructional books with the dust jackets - \$15 ea., call. Also Rider's Phonograph manual w/dust jacket - \$20. We have for sale many console radios not advertised: Stromberg, Philco, RCA, Airline and many others, call. Zenith consoles: 22H 1942 AM-FM 22-tube radio/phono; 15S373A; 15S372; 15U269; 12S569; 12S471; 12U159; 10S153; 10S155; 10S156; 10S157; 10S160; 9S54; 9S262; 9S367; 8S154, 8S463 (5808); 8S359; 7S366; 7S363; 7S260; 7S258; 410 and many others. Zenith chairside: 12S245; 6S147; 8S451; 7S343; 6S241 bar radio; 6S239. If you are looking for a set not listed, please call for more info. We can and do ship consoles anywhere and we do it right. Zenith table models: 5S29; 5S127; 7D226; 6S322; 6S330; 9S30A, export; 7S323; 6V27; 6S27, 6S128; 6S222; 7S432; 807; 809 chrome front, L cathedral and many others, call. We can deliver to the Kokomo, Lansing, Elgin and Rochester meets. All radios unrestored electrically unless noted. Shipping extra unless noted. Satisfaction guaranteed, highest quality possible assured. Send for our free catalog showing restoration and shop supplies, owner's manual reprints, grille cloth, etc. When in Minneapolis, be sure to visit our retail location Great Northern Antiques, 5159 Bloomington Ave., just five minutes from the airport. We accept Visa and MasterCard. Alan Jespersion/Mike Emery, PO Box 17338, Minneapolis, MN 55417. (612) 727-2489 or fax only (612) 727-1908, ans. mach. after 4 rings. 8 am to 8 pm 7 days

FOR SALE: Philco 66, nice - \$100. Philco 84, dial plastic broken, wear around knobs - \$65. JAX small cathedral, cabinet needs restoration - \$60. GE S22 tapestry front - \$155. Emerson in Ingraham cabinet - \$80. RCA 7BX9H portable - \$25. Universal mini cathedral toaster style, needs knobs & dial plates & refinished - \$75. Detrola toaster style, fair condition - \$50. GE J-80 cathedral, needs complete restoration - \$85. Magnavox R3B speaker, needs restored - \$90. RCA 103 speaker, tapestry good, base warped - \$145. RCA 103 with no tapestry - \$100. Fada 192A Neurolette, nice - \$90. Bristol 1-tube amp - \$175. 6LX6 GE, N.I.B. tubes, (5) \$20 ea.; 01-A's, various makes, styles, good filaments - \$8 ea. Joseph A. Szabat, 1019 Hilland Ave., Coraopolis, PA 15108. (412) 264-7498

FOR SALE: AK 9; AK 10; Mercury Super 10; Northern Electric R-4, etc. Transistors: Sony TR-63 yellow; TR-86; TR-610 (yellow, N.I.B.); TR-6, etc. Marconi bust. Marconi 1912 silver momento of 1912 London conference, in box. Marconi lighted sign. A.R. Nolf, 539 Kastelic Pl., Burlington, Ontario, Canada L7N 3S9. E-mail: u9329988@muss.cis.McMaster.ca

FOR SALE: Eddystone Type 958, vg, works, built like a Rolls-Royce and priced to sell - \$850 + shipping. Clement Richard, 340 Benjamin Suite, Laval, Quebec, Canada H7M 1Y3. (514) 629-7395

FOR SALE: Universal dial belt kit, 6' of belt material, glue and instructions - \$8.50 ppd. To reference most Zenith models from 1920 to 1946 we offer our 60-page 11x17 Zenith Brochure Book with pictures and specs on most models - \$28.95 ppd. Laser reprint 1937 Zenith total line catalog - \$21 ppd. Our 1936 Zenith poster reproduction shows the complete 1936 lineup plus all three Stratospheres - \$20 ppd. Zenith T-shirts and sweats, call for info. Visa and MasterCard accepted. Alan Jespersion, PO Box 17338, Minneapolis, MN 55417. (612) 727-2489

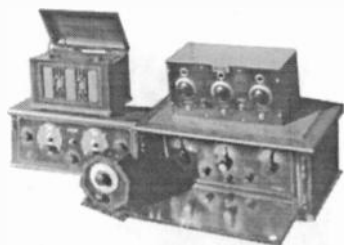

FOR SALE: Atwater Kent Model 555 "chest" radio, in fine working condition - \$435. A-C Dayton XL-25, has all correct tags and cards, in excellent condition, with tubes - \$250. Boston Scale and Machine Type 100 detector-amplifier, panel repaired but nice and correct - \$675. David Grimes Type 4DL (inverse-duplex) in Mediterranean cabinet with pull-down front - \$375. Also (not shown) Heliphone crystal set, in wooden book-type box, unique - \$350. DeForest Type D-10, in rare leatherette cabinet, has four DeForest DV-2 tubes, original antenna, nice - \$1,050. Ozarka 1-tube receiver in octagon leatherette case, very unusual style and tuning - \$350. Atwater Kent Type 4066 breadboard, very early type very seldom offered for sale, check this one out - \$1,850. Atwater Kent Model 21, 199 type tubes, looks like Model 20 compact, lots of brass - \$425. Radiola 103 tapestry speaker, very nice and working - \$125. Crosley small Musicone, excellent and works - \$85. Manhattan Symphonic horn speaker, very unique (see AWA Old Timer's Bulletin, Feb. '96, p. 10) - \$550. Dave Crocker, 6 Raymond St., Sandwich, MA 02563. (508) 888-6236, before 9 pm please

FOR SALE: Thinning my collection of tubes. All N.O.S. except as noted. (2) matched pair Genalex KT88 - \$700. (1) slightly used matched pair - \$175. (6) RCA 8005 round plate with full shiny ceramic bases, sold as set for - \$750. RCA 2A3, N.O.S. in red/black RCA boxes - \$100 ea. (8) GE VT4C 211 - \$100 ea. Pair Mullard EL 34 in Mullard IEC boxes - \$150. (4) GE #45 with loose bases as purchased - \$140. Dozens of 6B4G JAN by Ken Rad, Sylvania. Will match pairs, or \$40 ea. (3) Telefunken 12AX7 smooth plate in mint N.O.S. Telefunken boxes - \$120. (1) Cetron 845W - \$175. Visa, MC, Discover and money orders accepted. Call: Carlton Carver, 303 Magnolia Dr., Washington, NC 27889. (919) 946-2358, eves. EST after 7 pm

FOR SALE/TRADE: Zenith 6S254 - \$150. Hugo Gernsback's Science Fiction Plus magazine, only published one year, 1953, complete exc condition. Bob Suslovich, Box 9053, McLean, VA 22102-0053. (703) 841-5889

FOR SALE: Anyone out there want an instant world-class antique and speaker collection that includes over (40) E.H. Scott, Scott Transformer Co. and World's Record radios and many other related items? Would prefer one buyer; if not, will then sell items individually. Jim Clark, 3520 Okemos Rd., #6, Okemos, MI 48864. (517) 349-2249. Fax: (517) 349-7186. E-mail: HGGW75A@prodigy.com

FOR SALE: Sencore TC 154 tube tester - \$35. EICO 625 tube tester - \$45. Hickok #546 tube tester with manual - \$375. Picture tube brighteners for 1950's vintage B&W TVs - \$5 ea. Fisher 49T tuner & 49A amp - \$100/pr. RCA 8-BT-10K portable transistor AM radio, 1956 - \$35. RCA 6-B-5-B portable tube-type AM radio, 1955 - \$35. Zenith H724 AM/FM table radio, 1951 - \$35. University 8" trumpet speaker #1B-8, N.I.B. - \$20. Radiola 42 - \$75. H.H. Scott 296 dual laboratory amp - \$500 Remington Model 5 portable typewriter - \$35. Garrard RC88/4 record changer - \$75. Scott LT-112 stereo transistor FM tuner - \$45. Stromberg-Carlson 17CM2, 17-inch B&W console TV - \$75. All prices plus UPS. Bob Lynn, 26 E. Orchard St., Somerville, NJ 08876. (908) 685-9070

FOR SALE: Antique radio schematics & service information. 1936-1941 RCC for most models in addition to 1931-1933 information. If model is unavailable, money will be refunded. Also available is the entire collection on CD-ROM for \$150 U.S. Inquire for complete listing of models. Send e-mail to dgmarusz@agt.net or send \$10 U.S. plus \$3 postage and handling, money order or check, with make and model to: Ideas In Action - East Division, 25 Brittany #410, T.M.R., Quebec, Canada H3P 1A2. (514) 735-7625

FOR SALE: Ampex 600 recorder, very good - \$50. Elco Lindstrom violet ray quack medical device - \$30. Goldak TR-2 two unit metal locator, case, phones, data - \$25 + UPS. Mervyn Ellsworth, 2309 N. 25 St., Boise, ID 83702. (208) 345-6878

Wanted

(Top Prices Paid)

1. Western Electric Tubes, Amps, Drivers, Horns, Speakers, Parts, etc.
2. Tube-type amps from Marantz, McIntosh, ARC, Quad, Leak, Dynaco, Fisher, etc.
3. Telefunken audio tubes & KT-66/77/88, etc.

Also Wanted... Vintage watches from Patek Philippe, Vacheron Constantin & Audemars Piguet

David Yo — Audio City USA
PO Box 80371
San Marino, CA 91118-8371
Telephone: (818) 441-3942

FOR SALE: Tubes N.I.O.B. at 1/2 price. Send LSASE 55¢ postage for list. J.J. Papovich, 53 Magnolia Ave., Pitman, NJ 08071

FOR SALE: All-American Lyric Mohawk Service Manual, ca. 1930 - \$26. Walter Ashe, 1949 Catalog - \$16. Gary A. Micaneck, 226 Henry Ave., Manchester, MO 63011. (314) 227-7046

HAS YOUR SUBSCRIPTION

EXPIRED?

**It has if your mailing label reads
"EXP=MAY96" or earlier.
Renew now!**

**BONUS: Renew before
your "EXP" month and receive
13 issues per year instead of 12!**

Renewal rates are:

\$36.95 for Second-Class Mailing

\$53.95 for First-Class Mailing

(Two-year renewals are twice above rates.)

FOR SALE: Crystal radio kits, complete with face panel and baseboard, 365 variable capacitor, large prewound coil, and many other parts for an old style crystal radio, remit - \$19.50 plus \$3 shipping. Car & Grace Ent., 5636 Romeyn, Detroit, MI 48209

FOR SALE: Motorola service monitor, VHF, with deviation scope, looks-operates good, - \$1,000 OBO. Jim Shoemaker, RR#1, Box 118A, Prescott, KS 66767. (913) 471-4644

FOR SALE: Buy my Zenith 6D411 N.O.S. case for \$45 or sell me complete radio with damaged case for like amount. Clyde Watson, 8311 Via de Sereno, Scottsdale, AZ 85258. (602) 948-6466

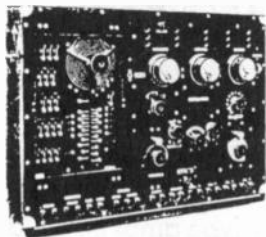

FOR SALE: World War I Western Electric Type CW-936. This was the first commercially produced radio telephone and telegraph transmitter and receiver. This version was taken from a U.S. Navy sub-chaser and looks absolutely gorgeous! Best offers over \$5,000. This would be an impressive addition to your collection. Hurry, before it goes overseas. Dave Crocker, 6 Raymond St., Sandwich, MA 02563. (508) 888-6236, before 9 pm please

FOR SALE: Tubes, tubes, tubes. Brand new list of thousands of tubes for sale. Almost anything you could need new or used. Cheapest prices anywhere. Satisfaction guaranteed. Send LSASE for full list. Bruce Phillips (Tubes), 127 Bunker Hill Ave., Stratham, NH 03885

FOR SALE: Thousands of tested tubes w/warranty! Send for new list with improved discounts and monthly specials. Both xmit and rec tubes. I have acquired many common tubes recently. Buy those spare tubes for your tube radio, audio, ham and electronics. Most tubes are used at about 33% of new, many are about \$1. I have bunches of octal, older, 7- and 9-pin tubes. All tubes are tested on TV-7D/U tester and then boxed. I give a 30-day warranty. Send wants or SASE with two stamps for list. Daniel Nelson, 1025 E. Desert Ln., Phoenix, AZ 85040. (602) 243-7421, evenings. E-mail: djn@indirect.com

FOR SALE: Used tubes: 1U4, 1U5, 3V4, 5U4GB, 6CG7/6FQ7, 6EU7, etc. Offers plus shipping. Gregory Sheppard, KA3DBG, 4402 Jupiter St., Rockville, MD 20853-3255. (301) 946-6460



FOR SALE: Schematic & parts list for deluxe crystal set, switchable to transistorized detector/amplifier configuration powered by free AC from ground. Novel age circuit permits fixed-threshold noise clipping & prevents overloading of limited power supply - \$25. John Stanley, 6156 Summit Ave., Brown Summit, NC 27214

FOR SALE: Hallicrafters owners need Receiver Saver 200 to extend tube life. SASE brings brochure. Jeff Kincaid, WA6BIL, 5529 West 140th St., Hawthorne, CA 90250

FOR SALE: Antique Weston Photronic cell, output .75 volt in bright indoor light - \$45 ppd. Parker Heinemann, W1YG, 87 Cove Rd., Lyme, CT 06371. (203) 434-7783

FOR SALE: Triplett 3434A TV-FM sweep-marker gen., untested - \$25+. Robert Rossi, 10936 Melbourne St., Allen Park, MI 48101. (313) 386-8321

FOR SALE: Guild Grafonola Model 785, complete with legs, plays well - \$150. Scott Starr, 2845 Page Pl., Montgomery, AL 36116. (334) 281-0960

FOR SALE: RCA Strato-World - \$125. RCA T-80 - \$75. Chelsea Super 5 - \$85. Modern Radio Servicing, 1st Ed. - \$45. Separate lists for literature and radios. Dave Sutherland, PO Box 201, Spofford, NH 03462. (603) 363-4459

FOR SALE: Micros: Ross, Juliette, Zenith. WANTED: Mini reel-to-reels, Geloso products. Stewart Struzer, 3210 Dow St., Pompano, FL 33062. (305) 834-4946

FOR SALE: Oscilloscope, Tektronix Model 535 dual trace, works - \$275. Oscilloscope Heathkit Model 0-11 5-inch 5MHz, works - \$125. Typewriter, Sears Electric w/spell-check Model 2 - \$15. Harry L. Brown, 4861 Tom Fall Rd., Baxter, TN 38544

FOR SALE: Fisher Spacexander reverb. vintage tube CB's. List - LSASE. Crosley 124 cathedral, restored - Best Offer. Charles Zafonte, N1FRX, RR3, Box 2075, Fort Kent, ME 04743. (207) 834-6273

FOR SALE: Motorola 5P31A portable - \$30. Tan Zenith Royal 500, one chip, Chassis Z7T40Z1 - \$150. Suzanne Wyatt, 4403 Boyd Rd., Dearborn, MO 64439. (816) 992-8811

FOR SALE: Car radios: Edsel, Hudson DB-42. WANTED: Grunow 901/902 chassis with oscillator coil. Restorable AK 84. Philco chassis. Ben Mast, 3253 O St., NW, Washington, DC 20007. (202) 338-7145

FOR SALE: Mylar capacitors: .0033 ufd 600v AX, .0047 ufd 600v AX, .01 ufd 600V radial, .047 ufd 600v radial, .056 ufd 400v AX, .0022 ufd 600v axial, all - \$5/50. Electrolytics: 22 ufd 450v axial - \$5/4; 33 ufd 450v axial - \$6/4; 47 ufd 450v axial - \$7/4; 47 ufd 160v axial - \$5/10. Add UPS. Flyer available. Santech Electronics, PO Box 187, Tappan, NY 10983. (914) 359-1130

FOR SALE: Chassis & parts: Zenith 517, plays - \$80; Majestic 200; Philco 37-610, 37-635, 37-630; RCA 34X; Crosley 66CA; DeWald 521; GE HP 561. Some cabinet parts. Wilbur Gilroy, 129 Belmont Ave., Clarks Green, PA 18411. (717) 586-7356

FOR SALE: Nordemende Carman - \$75. GE World Monitor multiband leather - \$95. Realistic DX100 - \$55. Hallicrafters 5R41 - \$50; 5R10A - \$50. Charles Voigt, 94 Cleveland St., Norfolk, MA 02056. (508) 528-7928

FOR SALE: Vibroplexes: Blue Racer #57351, Lightning #135602, some wear, not deluxe - serious offers. Claude Chafin, NØFMO, 4223 E. 42nd Way, Independence, MO 64055. (816) 478-4518

FOR SALE: Dynaco FM-3 - \$60, FM-5 - \$50; both exc. Radio books: Elements of Radio - \$10; Practical Radio Communication - \$10; Radio Troubleshooters Handbook - \$20; Sidney Gernsback Radio Encyclopedia, autographed - \$75; Centralab Volume Control Guide, 1939 - \$7; Cornell-Dublier Capacitor Manual, 1939 - \$7; Sams DC-1 - \$15; DC-2 - \$10, DC-3 - \$5, DC-4 - \$10. Emerson #555 with case, good - \$40. Rick Yerke, PO Box 392, Moscow, PA 18444. (717) 842-4857

FOR SALE: Automobile radio vibrators. Free catalog. See our boxed classified ad. Dan Schulz, Antique Automobile Radio, Inc., 700 Tampa Rd., Palm Harbor, FL 34683. (800) 933-4926. Fax: (813) 789-0283

FOR SALE: GM Little General cathedral, refinished - \$65. Automatic 613X - \$65. Trav-Ler 5015 - \$45. Philco 38-624, professionally restored - \$125. Inghams: Emerson 779 - \$35. Emerson TV - \$75, pickup. Transistors: Pair hearing aids - \$30. Stuffed poodle/radio - \$40. Philips LZX97T - \$50. WANTED: Atwater Kent 206 chassis, Regency TR1, Crosley D25MN. Don M. Maurer, 29 South 4th St., Lebanon, PA 17042. (717) 272-2481



WANTED

Amrad 3670 as shown, any condition. Also a Type E crystal set, 3500-2 and other pre-1926 Amrad sets & parts.

Andrew Mooradian, 5 Priscilla Lane
Winchester, Massachusetts 01890
tel. 617-729-1873 after 7 pm

FOR SALE: RCA 45 players: 9-Y-510 - \$45 (r/p), 45-J-2 - \$40; another similar to #2: brown case, red platter, black/gold spindle, gold tonearm - \$45; box for 7EY2HH - \$30. Del Tysdal, Route 1, Box 157, Glyndon, MN 56547. (218) 287-2562

FOR SALE: Brass escutcheons for Radiola 18, RCA R-7, RCA R-5, Philco 511 or 514, Philco 89B plastic - \$10 ea. plus. Radiola 33 escutcheon, volume control, switch, dial - \$15 plus. Elwood Hunt, 308 Georgetown Rd., Carneys Point, NJ 08069. (609) 299-5259

FOR SALE: Rare Heathkits, isn't that an oxymoron?; 1940's HT-4 aircraft transmitter and HBR-5 receiver - \$250/pr. (21) Heath catalogs 1954-1980 - \$100/all or call. Craig Smith, 1935 1st Ave. South, St. Petersburg, FL 33712. (813) 822-7592, days

FOR SALE: B&K Model 830 auto range capacitance meter; measures from 0.1 pf to 1999 µf, w/book, led display and leads, still in B&K line, needs repairs, new \$110, special - \$50. CD capacitor bridge, Model BN measures .00001 µf to 50 µf - \$30 + shipping. J.J. Papovich, 53 Magnolia Ave., Pitman, NJ 08071. (609) 582-8279

FOR SALE: RCA Service Data Consumers Electronics Books, 1967 to 1978. Sams Photofacts 1709. Ann Bichanich (Jay's), 15 1/2 W. Lake St., Chisholm, MN 55719. (218) 254-4421

FOR SALE: Meissner Model 8C FM tuner, wood, untested - \$15 plus UPS. Henry Boersma, 6253 Dolores Dr., Oak Forest, IL 60452. (708) 687-9444

FOR SALE: Radio Masters Catalog 1952-53, excellent condition - \$60 postpaid. Hitachi dual trace scope V202F - \$290. Leader audio generator LAG-54 - \$55. A few tube testers left for checking antique numbers. Also NRI signal tracer, works perfect - \$75. All plus shipping. Maurer TV, 29 So. 4th St., Lebanon, PA 17042. (717) 272-2481

NOW AVAILABLE CATALOG #5

88 PAGES - \$4.50 PPD

(Foreign - \$8.00, Canada - \$5.00)

(Check or cash/stamps OK)

Over 9,800 Separate Listings

Magazines 2,825 entries
Books 325 entries
Literature 1,483 entries
Transformers 1,555 entries
Parts/Tubes/Misc. 3,624 entries

Play Things Of Past
9511 Sunrise Blvd., #J23
Cleveland, Ohio 44133
216-251-3714 (Store)

FOR SALE: Marlboro cigarettes transistor radio, (Bunis/Breed Novelty Radios, Plate 160, p. 67) - \$85. Gerald Schneider, 3101 Blueford Rd., Kensington, MD 20895-2726. (301) 929-8593

FOR SALE: Hallicrafters SX24 - \$125. Much MRL crystal set and 1-tube data, (Osterhoudt) - \$45. William Ernst, 16300 Campbell Rd., Comins, MI 48619. (517) 848-5002

FOR SALE: Emerson AH wooden table radio - \$50. Timex-Sinclair 1000, 16K Rampak - \$25. Stan Jennings, PO Box 185, Washington Depot, CT 06794. (860) 868-2046

FOR SALE: The following N.I.B. novelty radios: Snooker table - \$25; Pepsi radio - \$25; green apple - \$13; cellular phone radio - \$15. Camus liquor bottle radio, last one - \$25. All plus UPS. Norm Hertz, 4904 Amboy Rd., Staten Island, NY 10312. (718) 967-1025

FOR SALE: Brunswick Model PR-6 Panatrop and Radiola console, AC instruction manuals, bound record albums - \$600. Grunow Model 2-A remote control tuner, will trade for unit for Philco 39-116, many others; send SASE for list: Charles Chapman, 1357 N. Broad Creek Ln., Stafford, MO 65757. (417) 736-2772

FOR SALE: Heathkit GD1B grid dipper, nice, works, complete - \$50 and shipping. Jack Campellone, KD4HAD, PO Box 232, Genoa, OH 43430. (419) 855-4420

FOR SALE: Hundreds of motion lamps (1920's-present), electric animated clocks, transistor/novelty radios. Restoration available. Sam Samuelian, 2305 W. Deerfield Dr., Media, PA 19063. (610) 566-7248. Fax: (610) 566-7285

FOR SALE: Throw away those faucet washers, use exact fit rubber grommets for your Philco 20, 70, 90 tuning condenser mounts - \$5/set, \$8 for two, \$23 for three ppd. DeForest D-12 chassis, det. missing - \$100 plus UPS. Motorola 7" leatherette TV, recapped - \$175 plus UPS. Motor not call before Apr. 29, will be in hospital. Don Patterson, 636 Cambridge Rd., Augusta, GA 30909. (706) 738-7227

FOR SALE: Sherewood S3000 III FM tuner, Panasonic R72 transistor radio. Glen Richie, W4JGO, 643 Diamond Rd., Salem, VA 24153. (540) 389-3356

FOR SALE: N.O.S. tubes: 6KD6 - \$20 ea. 6JS6 - \$20 ea. 6LB6 - \$10 ea. + shipping. These are Realistic brand GE and Sylvania tubes. Steve Harrell, 1179 Boylston St., #30, Boston, MA 02215. (617) 247-0672

FOR SALE: Sams Auto Radio AR19 to 273 - \$200. Transistor Radio TSM 24 to 137 - \$100. Tape recorder TR110 to 173 - \$50. Hi-fi MHF, 18 various volumes - \$30. Some TV Rider's. Some National Union manuals. RCA Service Data Redbooks 1943/1946, 1949, 1950, 1951 & 1952 - \$25. Sams CB 4 to 10 + 96 - \$10. J. Gary Cameron, 824 Andrews St., Southington, CT 06489. (860) 276-9200

FOR SALE: Philco G speaker - \$25. Kor Minipops 35 synthesizer, as is - \$45. Grundig 2540, AM, FM, SW - \$45. Music Master Ware chassis, panel - \$45. 6JB6-US - \$35/pr. WANTED: Zenith 1936-40, tubes, any quantity. Thanks! R. Dobush, Arcurus, 3554 W. 105, Cleveland, OH 44111. Ph./fax: (216) 647-3908

FOR SALE: Benton Harbor lunchboxes. Heathkit transceivers HW-29A, HW-30, good condition, with manuals - \$75 ea., \$135 both. George Wright, 4181 Enders Way, Doylestown, PA 18901. (215) 997-4144

HELP: Have Scott 800B but receiver and PS don't match. Need schematics, alignment instructions, advice. Need record changer for above. Also looking for Zenith 8S154 schematic. Richard Torment, 6863 Buffman Rd., Seville, OH 44273. (216) 887-5535. E-mail: dickt@telxon.com

HELP: Schematic and/or manuals needed for WE 61C sig. gen., Eico #322 sig. gen., Hickok 670 scope, Eico #145 sig. tracer and Knight tube tester, 1962 era. John Theisen, 917 Broadway, Valley Springs, SD 57068. (605) 336-3650, days; (605) 757-6775, evenings

HELP: Need remote control for RCA color TV, Model #211CDR835. TV chassis #CTC10. I also collect RCA radios, TVs, promo, advertisement, etc. Please call or write with info. Jeff Strutin, 1 2nd Ave., Central Islip, NY 11722. (516) 582-2569

MESSAGE: Do you collect antique phonographs or 78 rpm records? Then check out our website at <http://www.78rpm.com/> for a listing of vintage record and phonograph collector publications, plus the world's premier vintage 78 rpm & cylinder phonograph record auction. Kurt Nauck, 6323 Inway, Spring, TX 77389

FOR TRADE: Attention Zenith collectors. I have a working, completely original, Zenith black dial console Model 7S-558, I'll trade it for a 12-tube Grunow Teledial console in similar condition. Sorry no shipping. Dave Stott, 29 Willow Bee Ln., Middletown, CT 06457. (203) 344-0697

FOR TRADE: Hoffman solar transistor radio, Heathkit AR1302 stereo unbuilt in box, McElroy photo tube auto keyer and Amrad spark transmitter from 1918. Michael Payne, 803 S. Taylor, Alvin, TX 77511. (713) 331-9217. Fax: (713) 585-2727. E-mail: we300b@aol.com

SERVICES: Repair/replacement of meters before 1940. WANTED: Early (1900) power meters as is. Ye Olde Meter Cellar, Leonard W. Cartwright, 879 Russet Dr., Sunnyvale, CA 94087. (408) 739-6025

OLD TECH BOOKS & THINGS



*Early
Technical
Books &
Apparatus*

**Announcing - Catalog No. 1
Available Soon*
Write For Free Copy.**

We Specialize In:

Wireless - Radio - Television - Telegraph
Telephone - Electricity - Computers - Slide Rules
Electro-Medical - Calculators - Typewriters
Atomic Energy - Astronomy - Skiing

We Buy & Sell:

Books - Juveniles - Catalogs - Magazines
Manuals - Ephemera - Novelties - Apparatus
Anything Related!

Send us a list of your general & specific wants.

OLD TECH - BOOKS & THINGS

John V. Terrey, Proprietor
P.O. Box 803, Carlisle, MA 01741 U.S.A.

**Still delayed, but eventually I will get it finished!*

SERVICES: Your Hickok contact person, specializing in repair & calibration of Hickok, military and other major brands of test equipment (service that satisfies). **FOR SALE:** Test your Cardmatic calibration cell - \$5 w/S&H. New Cardmatic calibration cell - \$45 w/S&H. New 4-, 5-, 6-, 7-pin test adapters for Hickok 6000 Series tube testers w/obsolete tube test date - \$65 w/S&H. New 7-pin min. & 8-pin octal socket savers - \$10 w/S&H. Obsolete & foreign tube test data, technical & operators manuals, at reasonable prices. Affordable, reconditioned & calibrated electronic test equipment in stock. **WANTED:** Clean & complete radio test equipment, need no work, manuals a plus. **MESSAGE:** Computerized tube test data for Hickok & military tube testers. Now under construction. Please contact me if interested. Let's keep the filaments lit. Thanks. Wendell E. Hall, 3 Mocking Bird Cir., Jeffersonville, IN 47130. (812) 282-9709

SERVICES: Antique Radio Restoration & Repair is now on the WWW. Please come visit at <http://www.neca.com/~radiodoc>. Thanks. Bob Eslinger, 20 Gary School Rd., Pomfret, CT 06259

SERVICES: Repair of TV-7 tubes testers w/calibration: I will fix and then verify calibration of your TV-7 tube tester for \$45 plus all shipping or return it no charge. Daniel Nelson, 1025 E. Desert Ln., Phoenix, AZ 85040. (602) 243-7421, evenings. E-mail: djn@indirect.com

SERVICES: 3-year guarantee. Radio overhaul. Enjoy original performance, everyday. Professional shortwave specialist. Free: Brochure, estimates, send SASE. Captain Larry Rau's Occidental Radio Workshop, Box 1139, Occidental, CA 95465. (707) 874-1000

SERVICES: Repair/replacement of meters before 1935. **WANTED:** Old meters/galvos before 1910 as is okay. Ye Olde Meter Cellar, Leonard W. Cartwright, 479 Russet Dr., Sunnysvale, CA 94087. (408) 739-6025

SERVICES: Passing thru central Ohio? Clear your bench of headaches. Bring me: abused, basket cases, fire damaged, tough dogs, amps, radios, TVs, fans, phones, speakers, clocks, signs. Get instant service while you watch and wait. Enjoy historical sentimental items with a story behind them. Free quote, am lending my Zenith, RCA, Sams Service Files 1945 to 1985. Can trade my services and parts for museum quality "guttered" highboys and grandfather cabinets. Visit: Jim Brown, 7708 Main St., West Rushville, OH 43163. (614) 536-7322

SERVICES: Rider Radio Schematics, 1930 thru 1950's. Includes alignment data. Send \$3 with make, model and SASE to: George M. Bonanno, WA2KPE, 34 Charles St., Clifton, NJ 07013. (201) 746-5953

SERVICES: Schematics 1920's thru 1950's, mailed or faxed - \$3 radios; \$4 TVs ppd. Robert Schrantz, 610 E. Juanita Ave., San Dimas, CA 91773. Phone/fax: (909) 394-1194

SERVICES: Precision machining from your sample or drawing. Brass, aluminum, steel, plastics, etc. Jim Dill, Box 5044, Greeley, CO 80631

SERVICES: Schematics and service info 1920 thru 1950's. Send SASE, \$2.50, make & model to: Steve Rosenfeld, PO Box 387, Ocean Gate, NJ 08740. (908) 269-2022, days

SERVICES: Buying original manuals for amateur, audio and radio-related equipment. Send list, prices. Pete Markavage, 27 Walling St., Sayreville, NJ 08872-1818. (908) 238-8964

HELP: Need diagram for Lorenz German Bakelite radio. Odd TVs wanted, Bendix, Videodyne, others. Glenn Bubenheimer, 27851 Terrence, Livonia, MI 48154. (313) 421-5574

HELP: Need RCA working chassis 40 x 50, RC 436 chassis. Louis Filo, Jr., 3070 Schoenersville Rd., Bethlehem, PA 18017. (610) 866-0385, after 6 pm

HELP: Can anybody recommend an expert repair person on Zenith Trans-Oceanics? Gerald Silver, 10863 W. Clairmont Cir., Tamarac, FL 33321. (954) 720-1972

HELP: Need field telephone Kellogg Mod 1914. Please write to: Orlandino Iginio, Via Lessing, IO - 00137 Roma (Italy)

HELP: Need following for Philco 37-60 cathedral: dial plate, knobs, speaker screws. Tony Herzog, 402 Walnut St., Ridgway, PA 15053. (814) 772-5256

HELP: Need programming instructions for old Regency WHAMMO-TEN scanner. Joseph Mente, KF9RY, 916 Olive Rd., Homewood, IL 60430

HELP: Information wanted on reproducing the black crinkle and crystalline finishes found on metal cabinets of communication equipment of the 1930s and 1940s. John T. Meredith, 2462 Stantonsburg Rd., Suite 152, Greenville, NC 27834. (919) 551-1882

HELP: Need junker Zenith Model 563 with chassis, dial, tuner. Larry Wilson, 310 75th Ave. No., Myrtle Beach, SC 29572. Phone/fax: (803) 449-5839. E-mail: Blueboy131@aol.com

HELP: Need schematic and construction manual for Precise Model 300B oscilloscope. Pat Riffey, 147 Fairground Rd., Woodstock, VA 22664. (540) 459-3933

HELP: Need owners manual and servicing information for Rek-O-Kut N-33H turntable. Doug Fox, 603 S. 12th Ave., St. Charles, IL 60174. (708) 584-5915

HELP: Please any additional info on a Stromberg-Carlson 10-A, already have schematic. Thanks. David Clare, 33 Rock Hill Rd., Old Bridge, NJ 08857. (908) 727-4713

MESSAGE: Radio and early electronic yard sale. Tubes from the 20's to 60's, many N.I.B. Over (100) table & floor models, lowboys and restorables. Communication receivers, transmitters, early RR Telegraphia & insulators. Parts & chassis for restoration &/or stripping. Lab & electronic test equipment. May 18-19, 1996, at 9 am sharp. Jim Koehler, 242 Guy Lombardo Ave., Freeport, NY 11520. (516) 623-0035

MESSAGE: We have four outstanding programs lined up for Extravaganza '96! They include: Mark Oppat with his popular Repair Hint's and Kinks session; Doug Houston on cabinet restoration; Jerry O'Reilly, reputed to have the largest Heathkit collection in the world, will talk about collecting Heathkit products; and Professor John Reinicke will present a clinic on introduction to transistor radio repair. For further information or for a convention brochure write to: Michigan Antique Radio Club, Extravaganza '96, Suite 100, 3520 Okemos Rd., #6, Okemos, MI 48864

MESSAGE: Will the person with the possible AK165 chassis please contact me again? Thanks. Steven L. VanderLinden, KC6YRB, 4435 Greenfield Way Dr., Winston-Salem, NC 27103. (910) 766-2065

MESSAGE: Still here, still buying collections, thanks to everyone who responded last month! Phil Harris, The Radio Nuts, 45 Windsor on the Marsh, Savannah, GA 31419. (912) 925-1512

MESSAGE: Thanks to everyone regarding my request for a code key with leg clamp. Don Niess, Jr., 133 N. 17th St., Wheeling, WV 26003. (304) 277-2629

MESSAGE: Thanks to the many people who have responded to my "Wanted scarcer pre-1926" ads. Even if I don't want it, I'm always glad to help appraise. Ed Bell, 5311 Woodsdale Rd., Raleigh, NC 27606. Fax/phone: (919) 851-1517

MESSAGE: Visit the new Internet Web site at <http://cpu.net/classicradio>. Merrill Mabbs, 709 Pluma Dr., Rapid City, SD 57702. (605) 342-4090. E-mail: mmabbs@cpu.net

MESSAGE: Talk to me again at Dayton. Look for the WWII uniform with corporal stripes. Sam Hevener, W8KBF, The Signal Corps, 3583 Everett Rd., Richfield, OH 44286-9723. (216) 659-3244

MESSAGE: Thanks to everyone who responded to my ads for knobs for the Scott Special. Your help is appreciated. John Meredith, 2462 Stantonsburg Rd., Suite 152, Greenville, NC 27834. (919) 551-1882

MESSAGE: Alfred Grebe Jr. will be the keynote speaker at our informal social hour at Extravaganza '96. He is looking forward to sharing the Grebe story with all of us. With Grebe as the theme of our convention, we will also be putting on an extensive exhibit of Grebe items. Please contact Grebe Exhibit Coordinator Fred Schultz at (219) 894-3779 if you have something Grebe you would be willing to display. For further information or for a convention brochure, write to: Michigan Antique Radio Club, Extravaganza '96, Suite 100, 3520 Okemos Rd., #6, Okemos, MI 48864

FOR TRADE: Over (100) pieces radios over 20 years old, trade off for motorcycles Harley Davidson: Victor 8BX5, Zenith 720, Granco FM610U, Unelco 1914, Westminster 1438, Zenith A510F, Victor RGD24Y, Zenith K725, Zenith L727, Motorola BT16BH, Magnavox 080, General Electric, Zenith, Zenith M723, Admiral 5F31A, Topp RCV400, KLH 21, Zenith M723, Bendix 0526A, Truetone D2216B, RCA Victor, Roco compas, Beacon 2182, Motorola 5H11U, Motorola 5T25MC1, Motorola 54A16117, Zenith S58040, Panasonic 782, Westinghouse Gay 46077, audio oscillator 201B, Silvertone, DC NOOL detector, Lampsmiths 484, Packard Bell 5R1, RCA RZC 225X, Lloyd's, Lafayette 25B, Heathkit Daystrom, Zenith S52224, Emerson 31T10, General Electric C435A, Radiola 76ZX12, Hallicrafters S20R, Hallicrafters S53A, Hallicrafters S38B, Hallicrafters SX62-A, Echophone, General Electric 419, RCA RZD 943WK, Silvertone 5009, Zenith 6G601M6B03, General Electric C490A, Air Wave 14BR525A, Zenith S56957, Solidstate, Zenith S62676, Philco, Zenith S54567, Policalarm PR31, General Electric, Philco 46350, General Electric 552, Erlene, RCA Victor 94BP4, Admiral, Panasonic RE710, Majestic B, General Electric, Motorola 24D634/98, Braun RT20 Braun RC8AU, Braun, Braun signal gen., Heathkit LG1, + (40) pieces radios no mark. Jaroslav Loucky, PO Box 393 Hinkley, CA 92347

FOR TRADE: My Stromberg-Carlson 535M or Majestic 130A for your Zenith console. A. Bruno, 24 Butternut Dr., New City, NY 10956. (914) 354-8899

FOR TRADE: Beautiful Radiola 26 w/instructions, for high end transistor(s). Darryl Rehr, 2591 Military Ave., Los Angeles, CA 90064. (310) 477-5229

FOR TRADE: Military ARC-5 transmitters for ARC-5 receivers bcdast band and above. **WANTED:** Parts for HQ170A and Zenith 7H820 receivers. James E. Inglett, N5WUT, Rt. 1, Box 248A, Midway, AR 72651

FOR TRADE: NC 240D/spkr, HQ 180X/spkr. **WANTED:** Squire Sanders stuff, Collins 4:1 vernier dial. Fred Watson, KB8NRF, 581 W. Summit St., McClure, OH 43534. (419) 748-8798

FOR TRADE: Lots of Rider manuals up to Volume 19 for your AK 735/206 or Philco 90 cathedral or Zenith console. A. Bruno, 24 Butternut Dr., New City, NY 10956. (914) 354-8899

FOR TRADE: Two Amrad variocouplers No. 2416, in the original boxes. One has tickler winding; other does not. Tod Prowell, Obsolete Technologies, 413 N. York Rd., Mechanicsburg, PA 17055-6016. (717) 697-5227

FOR TRADE: Book: Elements of Astronomy, by Norman Lockyer, 310 pages, printed 1870, Appleton Co., for a usable ham transceiver. Joseph Wood, 6511 Chester, Hodgkins, IL 60525

FOR TRADE: 75A-1 and 32V-2, speaker and manuals for a 32S-3 RE or 75A-4. **FOR SALE:** AM transmitter, circa late 30's used for airport tower communications made into ham band transmitter. Has (2) 100th's for modulator and 4-400 final, works! Power supply and externals original. Willing to part out or sell complete. Many interesting parts. Pick up only! Make Offer. John Poland, AE4EN, 2859 Scotts Hill Loop Rd., Wilmington, NC 28405. (910) 686-4236, before 2 pm

FOR TRADE: German WWII 1-tube transmitter. German WWII field phone. Other type items available. Michael Payne, 803 S. Taylor, Alvin, TX 77511. (713) 331-9217. Fax: (713) 585-2727. E-mail: we300b@aol.com

THANKS!

*Thanks for suggesting
A.R.C. to your friends.*

*Did you know that nearly 20% of
our new subscriptions come from
referrals from subscribers?*

So spread the word about A.R.C.!

*Give the center coupon to a
collector, or ask us to send a
friend a free sample copy.*

*Help A.R.C. and
radio collecting grow!*



VIRGINIA - May 1

**TIDEWATER ANTIQUE RADIO ASSN.
MEETING**

7 pm - Call for location & directions
Info: Phil Stroud, 2328 Springfield Ave.
Norfolk, VA 23523 - (804) 481-2561, pms

ARKANSAS - May 2

**ANTIQUe RADIO COLLECTORS CLUB
OF FORT SMITH - CLUB MEETING**

Fort Smith, AR - St. Luke Lutheran Church
Waldron Road, at Free Ferry - 7:30 pm
Info: Paul Tucker, 4700 N. "N" Street
Fort Smith, AR 72904 - (501) 782-8178

INDIANA - May 3-4

**INDIANA HISTORICAL RADIO SOCIETY
ANTIQUe WIRELESS ASSOCIATION
25th SPRING FLING RADIO FESTIVAL**

Kokomo, IN - Ramada Inn: (317) 459-8001

May 3: All Day - Flea Market

8 am-Noon - Seminars

Noon - Ladies' Luncheon

1-4 pm - Contest

1-2 pm - Enter Items

2-4 pm - Judging

7 pm - Banquet

May 4: All Day - Flea Market

8-9:30 am - Auction Check-in

9:30-11 am - Donation Auction

11 am-? - Consignment Auction

Info: Bob O'Friel - (317) 849-4028

NEW YORK - May 4

**ANTIQUe WIRELESS ASSOCIATION
NEW YORK SPRING MEET**

Bloomfield, NY - Routes 5 & 20
Annex and American Legion Hall

8 am-12 noon - Flea Market

10:30 am - Annex Auction

12 noon - Buffet Luncheon (reserve ahead)

1 pm - Members' Auction

AWA Museum open right after auction

Info: Bruce Kelley, 59 Main Street
Bloomfield, NY 14469 - (716) 657-7489

Submission Deadline - 5th of month.

TEXAS - May 3-5

**HOUSTON VINTAGE RADIO ASSN./
AWA - CONVENTION '96**

Houston, TX - Ramada Hotel, Astrodome
2100 So. Braeswood - (713) 797-9000

May 3: 12 am-6 pm - Auction Check-in

2-3 pm - Technical Presentation

7-10 pm - Contest Check-in

6-11 pm - Auction

May 4: 8-9 am - Final Contest Check-in

8-11:30 am - Auction Check-in

9-10 - Technical Session

12 am-5 pm - Auction

7-9:30 pm - Awards Banquet, w/Tom Bacon

May 5: 8 am-Noon - Flea Market

Info: David Moore - (713) 485-1705

ALBERTA - May 4-5

**CANADIAN VINTAGE RADIO SOCIETY
ALBERTA CHAPTER - SWAP MEET/SALE**

Red Deer, Alberta - Westerner Agriplex

May 4: 9 am-5 pm; May 5: 10 am-3 pm

Info: Rick Williams - (403) 449-5413

CALIFORNIA - May 4

**CALIF. HISTORICAL RADIO SOCIETY
SWAP MEET**

Los Altos Hills, CA - Foothill College
Exit Magdalena off 280 Freeway - 8 am

Info: (415) 978-9100

OREGON - May 4

**NORTHWEST VINTAGE RADIO SOCIETY
SPRING SHOW AND SALE**

Portland, OR - Multnomah Art Center
7688 S.W. Capitol Hwy. - 9 am-Noon

Info: Myron White - (503) 629-5513, or
E-mail: myron@ncube.com

WASHINGTON - May 4

**RADIO ENTHUSIASTS OF PUGET SOUND
MEETING**

Seattle, WA - Queen Anne Library
400 W. Garfield - 2 pm

Info: REPS, 9936 NE 197th Street
Bothell, WA 98011 - (206) 488-9518

ENGLAND - May 5

5th NATIONAL VINTAGE COMMUNICATIONS FAIR

Nec, Birmingham, United Kingdom
10:30 am-5 pm

Info: NVCF, 2-4 Brook St., Bampton
Devon, England - Tel.: (01398) 331532

NEW YORK - May 5

GREATER NEW YORK VINTAGE WIRELESS ASSN. - SWAP MEET

Lake Ronkonkoma, NY - 367 Hawkins Ave.
N. of L.I. Expressway, lg. white house
9-12 am

Info: Chris Lieppert - (516) 471-9526, or
Chris Bacon - (516) 821-7618

OHIO - May 5

BUCKEYE ANTIQUE RADIO & PHONO CLUB MEETING

Brunswick, OH - Brunswick Library
3649 Center Rd., Rt. 303
1-4:30 pm

Info: Rich Bradley - (216) 842-5937

WASHINGTON - May 5

VINTAGE AUDIO LISTENERS AND VALVE ENTHUSIASTS - MEETING

Poulsbo, WA - Classic Radio
1127 N.W. Bright Star Ln.
10 am-2 pm

Info: Dan Schmalte - (360) 697-1936

ONTARIO - May 8

OTTAWA VINTAGE RADIO CLUB MEETING

Ottawa, Ontario - Ottawa Citizen
Conference Room, 1101 Baxter Road
7 pm

Info: Tom Devey, 810 Edgeworth Ave.
Ottawa, Ontario K2B 5L5 - (613) 828-5152

ARKANSAS - May 9

ARKANSAS ANTIQUE RADIO CLUB MEETING

Little Rock, AR - Call for location
7 pm

Info: Tom Burgess - (501) 455-0773

**MENTION A.R.C.
WHEN CONTACTING CLUBS!**

NEW JERSEY - May 10

NEW JERSEY ANTIQUE RADIO CLUB MEETING

Freehold, NJ - Grace Lutheran Church
West Main St. & Park Ave. (old Rt. 33)

7:30-9:30 pm - Meeting & Swap

Info: Don Cruse - (908) 542-2848
Tony or Kathleen Flanagan - (908) 462-6638

ALABAMA - May 11

SOUTHERN VINTAGE WIRELESS ASSN. SPRING MEET

Decatur, AL - 9th St. Methodist Church
7 am-12:30 pm

Info: Jim Makar - (205) 233-8357

CALIFORNIA - May 11

PERHAM FOUNDATION Foothill FLEA MARKET

Los Altos, CA - Foothill College
Parking Lot A
6 am-2 pm

Info: Perham Foundation - (408) 734-4453

FLORIDA - May 11

FLORIDA ANTIQUE WIRELESS GROUP SPRING MEETING

Orlando, FL - VFW Hall
4444 Edgewater Drive

9 am-1 pm - Spring Meet
1 pm-close - Special Estate Auction

Info: Dennis - (407) 895-0146, days
Paul - (407) 365-9305, eves.

NEW JERSEY - May 11

ANTIQUE WIRELESS ASSOCIATION NORTHERN NEW JERSEY MEET

Schooley's Mountain, NJ - The Inn at
Schooley's Mountain, on Rt. 517

8 am - Traders Market
12:30 pm - Lunch

Info: Lauren Peckham, Box E,
Breesport, NY 14816 - (607) 739-5443

OHIO - May 11

ESTES RADIO AUCTION

Medina, OH - Seville Antique Auction Barn
8240 Wooster Pike Road - see display ad

9 am - Preview
10 am - Auction

Info: Estes Auctions - (330) 769-4992

MARK YOUR CALENDAR

May 1 - VA, TBA - TARA Meeting §
 May 2 - AR, Fort Smith - ARCCFS Meeting §
 May 3-4 - IN, Kokomo - IHRS Radio Festival*
 May 3-5 - TX, Houston - HVRA Convention*
 May 4-5 - Alberta, Red Deer - CVRS/AL Meet*
 May 4 - CA, Los Altos Hills - CHRSS Swap Meet*
 May 4 - NY, Bloomfield - AWA Spring Meet*
 May 4 - OR, Portland - NWVRS Show/Sale*
 May 4 - WA, Seattle - REPS Meeting §
 May 5 - England, Birmingham - NVCF Meet*
 May 5 - NY, Lake Ronkonkoma - GNYVWA §
 May 5 - OH, Brunswick - BARPC Meeting*
 May 5 - WA, Poulsbo - VALVE Meeting §
 May 8 - Ontario, Ottawa - OVRC Meeting §
 May 9 - AR, Little Rock - AARC Meeting §
 May 10 - NJ, Freehold - NJARC Meeting §
 May 11 - AL, Decatur - SVWA Meet*
 May 11 - CA, Los Altos - Perham Flea Market*
 May 11 - DC, Washington - RHS Dinner*
 May 11 - FL, Orlando - FAWG Meeting/Auction*
 May 11 - NJ, Schooley's Mtn. - AWA/NJ Meet*
 May 11 - OH, Medina - Estes Radio Auction*
 May 11 - OK, Okla. City - OKVRC Meeting §
 May 11 - OR, Portland - NWVRS Meeting §
 May 12 - CO, Denver - CRC Meeting*
 May 12 - MS, Meridian - MHR&BS Meeting §
 May 13 - GA, Norcross - SARS Meeting §
 May 13 - IL, Belleville - BAARC Meeting §
 May 14 - MO, St. Louis - ARCH Meeting §
 May 14 - OH, Kettering - ARCO Meeting §
 May 14 - PA, Souderton - DVHRC Meeting §
 May 14 - TX, Houston - HVRA Meeting §
 May 15 - OH, Cincinnati - SPARK Meeting §
 May 15 - OH, Columbus - SPARK Meeting §
 May 16 - NY, Goshen - HARPS Meeting §
 May 17-19 - OH, Dayton - 1996 Hamvention*
 May 17 - OH, Neapolis - Old Radio Auction*
 May 18 - AZ, Scottsdale - AARC Auction/Meeting*
 May 18 - CA, San Luis Obispo - Joint Meet*
 May 18 - PA, Williamsport - CPRCC Swap Meet*
 May 18 - TX, Irving - VRPS Swap Meet §
 May 18 - WV, Huntington - Museum Class*
 May 19 - NM, Albuquerque - NMRCC Meeting §
 May 19 - MO, St. Louis - ARCH Picnic/Swap Meet*
 May 19 - VA, Sterling - MAARC Meeting §
 May 19 - WA, Seattle - PSARA Meeting §
 May 20-27 - MI, Paw Paw - Antique Radio Sale*
 May 21 - CA, N. Highlands - SHRS Meeting §
 May 24 - WV, Huntington - Museum Class*
 May 25 - CA, Valencia - SCARF Meet*
 May 25 - NC, Raleigh - VRUS Meet*
 May 25 - Ontario, London - LVRC Meeting*
 May 26 - Manitoba, Winnipeg - CVRS/MB Sale*
 May 28 - OH, Kettering - SPARK Meeting §
 May 31-Jun. 1 - MN, Golden Valley - Radio Daze '96*
 Jun. 8 - CA, Marin County - CHRSS Meet*
 Jun. 8 - Germany, Köln - Radio Auction*
 Jun. 8 - RI, E. Greenwich - Yankee Tune-up*
 Jun. 8 - TN, Memphis - MARC Swap Meet*
 Jun. 9 - MO, Joplin - FSARC Swap Meet*
 Jun. 11 - CA, Redding - CHRSS-NVC Meeting*
 †Jun. 13-15 - MD, Timonium - RadioActivity*
 Jun. 15 - CA, Canoga Park - SCARS Swap Meet*
 Jun. 15 - Quebec, Knowlton - QSVRC Meet*
 Jun. 21-22 - OH, Cincinnati - SPARK Radiorama*
 Jun. 22 - AL, Birmingham - ALHRS Meeting §
 Jun. 27-29 - WA, Seattle - REPS Showcase IV*
 Jun. 29 - Ontario, London - LVRC Meeting §
 Jul. 6 - CA, San Francisco - CHRSS Meet §
 Jul. 12-14 - MI, Lansing - Extravaganza '96*
 Jul. 20 - NH, Nashua - NEARC Swap Meet §
 Jul. 27 - KY, Louisville - MSARC Swap Meet §
 Jul. 27 - WV, Huntington - Show/Auction §
 Aug. 3 - CA, Los Altos Hills - CHRSS Swap Meet §
 Aug. 3 - IN, Forest Park - IHRS Summer Meet §
 Aug. 10 - NY, Amherst - NFWA Summer Meet §
 Aug. 16 - OH, Dayton - ARCO Swap Meet §

(Continued at top of next column)

MARK YOUR CALENDAR

(Continued from bottom left column)

Aug. 17 - CA, Canoga Park - SCARS Meeting §
 Aug. 17 - TX, Irving - VRPS Swap Meet §
 Aug. 28-31 - IL, Elgin - ARCI Radiofest 1996 §
 Sep. 4-7 - NY, Rochester - AWA Conference §
 Sep. 14 - CA, Fairfield - CHRSS Picnic & Meet §
 Sep. 14 - Ontario, Guelph - LVRC Flea Market §
 Oct. 5 - CA, Redding - CHRSS/NVC Meet §
 Oct. 5 - KY, Lexington - MSARC Swap Meet §
 Oct. 12 - NY, Highland Falls - HARPS Meet §
 Oct. 12 - OR, Portland - NWVRS Show/Sale §
 Oct. 19 - CA, San Diego - SCARS Meeting §
 Oct. 19-20 - OH, Brunswick - BARPC Show §
 Oct. 19 - WV, Huntington - Show/Auction §
 Oct. 26 - NH, Nashua - NEARC Swap Meet §
 Nov. 2 - CA, Los Altos Hills - CHRSS Swap Meet †
 Nov. 15-16 - CA, Los Angeles - SCARS Meet §

* See expanded listing this month. § Monthly Meeting
† Date changed from original announcement

OKLAHOMA - May 11

OKLA. VINTAGE RADIO COLLECTORS MEETING

Oklahoma City, OK - Spencer's Barbeque
63rd and North May Avenue

6 pm - Dinner

7 pm - Meeting: Your Ugliest Radio

Info: Mike Lapuzza - (405) 745-3394, after 7 pm
OKVRC, PO Box 332, Wheatland, OK 73097

OREGON - May 11

NORTHWEST VINTAGE RADIO SOCIETY MEETING

Portland, OR - NW Vintage Radio Museum
7675 SW Capitol Hwy.

10 am - Meeting

Info: Ed Charman, PO Box 82379
Portland, OR 97282-0379 - (503) 654-7387

WASHINGTON, DC - May 11

RADIO HISTORY SOCIETY GRAND RADIO DINNER

Washington, DC - Marvin Center, 3rd floor
George Washington U., 21st & I St. NW

6-7 pm - Social hour

7 pm - Grand buffet dinner, followed by nostalgic, side-splitting radio of old

Info: Steve Snyderman - (703) 978-3086

COLORADO - May 12

COLORADO RADIO COLLECTORS MEETING

Denver, CO - SouthWest Bank Bldg.
1380 So. Federal Ave., Community Room

1 pm - Meeting,

followed by Swap Meet in parking area

Info: Rick Ammon - (970) 221-4001

MISSISSIPPI - May 12

**MISSISSIPPI HISTORICAL RADIO &
BROADCASTING SOCIETY
MEETING**

Meridian, MS - 2412 C Street
3 pm

Info: Randy Guttery, 2412 C. Street
Meridian, MS 39301 - (601) 693-5958

TEXAS - May 14

**HOUSTON ANTIQUE RADIO ASSN.
MEETING**

Houston, TX - Tides II Motel
Lal Lal Restaurant, Holcombe & Main St.
7-10 pm

Info: David Moore - (713) 485-1705

GEORGIA - May 13

**SOUTHEASTERN ANTIQUE RADIO SOCIETY
MEETING**

Norcross, GA - Picadilly Cafeteria
3400 Holcomb Bridge Road

6 pm - Mini-Meet

6:30 pm - Meeting

Info: Charles Milton - (770) 922-6507, or
SARS, PO Box 500025 - Atlanta, GA 31150

OHIO - May 15

**SOCIETY FOR PRES. OF ANTIQUE RADIO
KNOWLEDGE/CINCINNATI CHAPTER
MEETING**

Cincinnati, OH - Richards Radio & TV
4041 Edwards Rd., I-71, Exit 6

7:30 pm

Info: Tim Kaiser, PO Box 81
Newport, KY 41071 - (606) 441-2548

ILLINOIS - May 13

**BELLEVILLE AREA ANTIQUE RADIO CLUB
MEETING**

Belleville, IL - Belleville Area College
7 pm

Info: Karl Stegman, 4 Cresthaven Drive
Belleville, IL 62221 - (618) 234-7992

OHIO - May 15

**SOCIETY FOR PRES. OF ANTIQUE RADIO
KNOWLEDGE/COLUMBUS CPT. - MEETING**

Columbus, OH - DeVry Institute of Tech.
1350 Alum Creek Road, I-70 Exit 103B

7:30 pm

Info: Sharon/Ken Fullerton - (614) 237-2621

MISSOURI - May 14

**ANTIQUA RADIO COLLECTORS & HISTORIANS
OF GREATER ST. LOUIS - MEETING**

St. Louis, MO - Kirkwood Community Center
111 S. Geyer Rd., Room 201-A

7 pm

Info: Scott Teichmann - (314) 256-6263

NEW YORK - May 16

**HUDSON VALLEY ANTIQUE RADIO AND
PHONO. SOCIETY/AWA - MEETING**

Goshen, NY - Cataract Firehouse, Main St.
7-9 pm

Info: John & Linda Gramm, Box 1, Campbell
Hall, NY 10916 - (914) 427-2602, 6-9 pm

OHIO - May 14

**ANTIQUA RADIO COLLECTORS OF OHIO
MEETING**

Kettering, OH - National City Bank Basement
4100 Far Hills Ave., at Stroop Rd.

7:30 pm - Parking Lot Swap Meet

Info: Ed App - (513) 865-0982
ARCO, PO Box 292292, Kettering, OH 45429

OHIO - May 17-19

45th DAYTON HAMVENTION

Dayton, OH - Hara Arena

Exhibit Hours:

May 17: noon-6 pm

May 18: 8 am-5 pm

May 19: 8 am-2 pm

A.R.C. at Booth #207

New Wireless Pioneers at Booth #206

Info: Dayton Hamvention, PO Box 964

Dayton, OH 45401 - (513) 276-6930

PENNSYLVANIA - May 14

**DELAWARE VALLEY HISTORIC RADIO CLUB
MEETING - SWAP MEET - AUCTION**

Souderton, PA - 113 Main St.,
N. Penn Amusements Bldg.

7:30 pm

Info: DVHRC, PO Box 41031, Philadelphia,
PA 19127-0031 - Mike Koste - (215) 646-6488

OHIO - May 17

OLD RADIO AUCTION

Neapolis, OH - Whalen Auction Building

10 am - See display ad in this issue

Info: Whalen Realty & Auction Service
PO Box 550, Neapolis, OH 43547 - (419) 875-6317

ARIZONA - May 18

ARIZONA ANTIQUE RADIO CLUB AUCTION/MEETING

Scottsdale, AZ - Villa de Fuente Club House
5512 N. 71st Place
2 pm
Info: Les Rayner - (602) 947-1375

NEW MEXICO - May 19

NEW MEXICO RADIO COLLECTORS CLUB MEETING

Albuquerque, NM - Sierra Vista Bible
Church, 7509 Paseo Del Norte
1:30 pm - Advertising Items
Info: Bill Schultz, 7213 Donet Ct. NE
Rio Rancho, NM 87124 - (505) 294-5302

CALIFORNIA - May 18

CALIF. HISTORICAL RADIO SOCIETY/ SO. CALIF. ANTIQUE RADIO SOCIETY JOINT SWAP MEET

San Luis Obispo, CA - 2880 So. Broad St.
8-11 am, followed by
Open House at Bob's TV, 2300 Broad St.
Info: Dan Steele - (805) 543-2946

VIRGINIA - May 19

MID-ATLANTIC ANTIQUE RADIO CLUB MEETING

Sterling, VA - Sterling Community Center
120 Enterprise St.
1:30 pm
Info: Community Center - (703) 430-9480

PENNSYLVANIA - May 18

CENTRAL PA. RADIO COLLECTORS CLUB - 3rd SWAP MEET

Williamsport, PA - Trinity Episcopal Church
844 W. Fourth St., Maynard St. Exit
8 am - ?
Info: Frank Hagenbuch - (717) 326-0932
Mike Heffner - (717) 546-2907

WASHINGTON - May 19

PUGET SOUND ANTIQUE RADIO ASSN. MEETING

N. Seattle, WA - Shoreline Museum
749 No. 175th St. & Linden Ave.
9 am - Swap Meet
12 noon - Meeting
Info: Al Atworth, PO Box 125
Snohomish, WA 98291-0125 - (360) 568-2698

TEXAS - May 18

VINTAGE RADIO & PHONO. SOCIETY SWAP MEET

Irving, TX - Garden & Arts Building
8 am-12 noon
Info: George Potter - (214) 315-2553

MICHIGAN - May 20-27

ANTIQUE RADIO SALE

Paw Paw, MI - Grann's Then and Now
143 E. Michigan Ave., off I-94
Info: (616) 657-4259

W. VIRGINIA - May 18, 24

MUSEUM OF RADIO & TECHNOLOGY RADIO REPAIR/RESTORE CLASSES

Huntington, WV - 1640 Florence Ave.
May 18: 10-12 am - Basic Electronics
and Radio Repair
May 24: 7:30 pm - Cabinet Restoration
Info: Museum - (304) 453-2915

CALIFORNIA - May 21

SACRAMENTO HISTORICAL RADIO SOCIETY - MEETING

N. Highlands, CA - SMUD Foothill Service
Center, Room D, 5026 Don Julio, 1 mi. W. of I-80
7-9 pm
Info: SHRS, PO Box 162612, Sacramento
CA 95816, or Don Steger - (916) 929-8274

MISSOURI - May 19

ANTIQUEN RADIO COLLECTORS & HISTORIANS OF GREATER ST. LOUIS - PICNIC/SWAP MEET

St. Louis, MO - St. Ann Park
9 am
Info: Scott Teichmann - (314) 256-6263

CALIFORNIA - May 25

SOUTHERN CALIFORNIA ANTIQUEN RADIO FEST

Valencia, CA - Valencia Travel Village
27946 Highway 126 - (805) 257-3333
6 am-12 noon
Info: Byron Bernor - (805) 269-5459

Non-members welcomed at all meets! - Admission charged at some meets.

N. CAROLINA - May 25

**VINTAGE RADIO UNIQUE SOCIETY
"OLDE RADIO CONGREGATION"
TRADE FAIR/PICNIC/SHOW**

Raleigh, NC - State Fairgrounds
I-40 Exit 290, East to Youth Ctr. Rd.
Gate 6 - L.R. Harrill Center

9 am-3 pm - Inside/Outside Trade
11:30 am-Noon - Special Presentation:
"Fessenden's Works in North Carolina"
Authority Speaker Michael Everette
Noon-1 pm - Picnic (pack your basket)
2-5 pm - Open House (& Barn!):
Ed Bell's Radio Collection

Info: Jerryl Sears, 312 Auburndale St.
Winston-Salem, NC 27104 - (910) 765-4302

CALIFORNIA - Jun. 8

**CALIF. HISTORICAL RADIO SOCIETY
MEET**

Marin County, CA - Location TBA
8 am

Info: CHRS Hotline - (415) 978-9100

GERMANY - Jun. 8

ANTIQUÉ RADIO AUCTION

Köln, Germany - Auction Team Köln
Bonner Str. 528-530

Refer to display ad in this issue.

Info: Uwe Breker, PO Box 50 11 19, D-50971
Köln, Germany - Tel.: +49221/38 70 49

ONTARIO - May 25

**LONDON VINTAGE RADIO CLUB
MEETING**

London, Ontario - Jaycee Building
317 Adelaide St. South
1 pm

Info: Don Hatch, 14 Kingspark Cres., London
Ontario, Canada N6H 4C4 - (519) 472-6167

MANITOBA - May 26

**CANADIAN VINTAGE RADIO SOCIETY
MANITOBA SPRING FLEA MARKET**

Winnipeg, MB - 541 Portage Avenue
CBC Parking Lot
10 am

Info: Bob Murray - (204) 885-3045

OHIO - May 28

**SOCIETY FOR PRESERVATION OF
ANTIQUÉ RADIO KNOWLEDGE - MEETING**

Kettering, OH - Cassano's Pizza
1680 E. Stroop Rd.

7:30 pm

Info: Harold Parshall - (513) 865-5900, days
(513) 268-2909, eves. until 9 pm

MINNESOTA - May 31-Jun. 1

**NORTHLAND ANTIQUÉ RADIO CLUB
PAVEK MUSEUM OF BROADCASTING
RADIO DAZE '96**

Golden Valley, MN - Best Western
4820 Hwy 55 - (612) 588-0511

May 31: 7:30 pm - Auction
Auction Info: Don Hauff - (612) 933-9070

Info: Joe Gruber - (612) 489-5552
NARC, PO Box 18362
Minneapolis, MN 55418

RHODE ISLAND - Jun. 8

**N.E. WIRELESS & STEAM MUSEUM
YANKEE TUNE-UP**

East Greenwich, RI - Frenchtown Road
8 am-3 pm

Antique Radio Sale and Swap
Tables in Tent Available

Tailgaters Welcome - Silent Auction

Special Field Events Station K1NQG of
Fidelity Amateur Radio Club

Coffee, Tea & Allie's Famous Donuts in AM

Info: Fax (401) 884-0683 - Phone (401) 884-1710

TENNESSEE - Jun. 8

**MEMPHIS ANTIQUÉ RADIO CLUB
2rd ANNUAL SWAP MEET**

Memphis TN - St. Timothy United
Mehodist Church, 4105 St. Elmo Ave.

7 am-1 pm

12 noon - Informal Auction

Info: Bob Miskell - (901) 386-1893

MISSOURI - Jun. 9

**FOUR STATES ANTIQUÉ RADIO CLUB
SWAP MEET**

Joplin, MO - Tyler Hall, 2002 Tyler

8:30 am-12:30 pm

Info: Stephen Phipps, 1702 S. McKinley Ave.
Joplin, MO 64801-3773 - (417) 659-8140

CALIFORNIA - Jun. 11

**CALIF. HISTORICAL RADIO SOCIETY
NORTH VALLEY CHAPTER - MEETING**

Redding, CA - 7 pm

Info: Chris Galantine, 15853 Ontario Place
Redding, CA 96001-9785 - (916) 244-2337

MARYLAND - Jun. 13-15

MID-ATLANTIC ANTIQUE RADIO CLUB RADIOACTIVITY '96

Timonium, MD - Holiday Inn
Timonium Plaza - (410) 252-7373
The Postwar Decade: 1946-1956

Jun. 13: 6 pm - Trader's Mart Opens
8 pm - First Seminar

Jun. 14: All day - Trader's Mart
Fri. pm - Banquet with Guest Speaker

Jun. 15: Sat. am - Traders' Mart
Noon - Auction

Old Equipment Contest: Entries accepted
till Noon on Friday

Radio Repair Clinic - Family Activities
Info: Steve Snyderman, 4147 Lenox Dr.
Fairfax, VA 22032 - (703) 978-3086

CALIFORNIA - Jun. 15

SOUTHERN CALIF. ANTIQUE RADIO SOCIETY - SWAP MEET

Canoga Park, CA - 8130 Remmet Ave.
7-10 am

Super 8 Motel, Topanga Canyon Blvd.
(818) 883-8888 - (no SCARS deals)
Info: Jim Webb - (818) 769-6738

QUEBEC - Jun. 15

QUEBEC SOCIETY FOR VINTAGE RADIO COLLECTORS - MEETING

Knowlton, Quebec - Odd Fellows Hall
Rt. 104, Knowlton Rd.

Flea Market/Swap Meet - Radio Show
132 Lakeside St. - Crystal Radio Festival
Noon - Free BBQ

Info: Orn Arnason - (514) 243-6934, or
QSVRC-Radiophile Quebec,
c/o Micheal Morin, 799 St. Etienne St.
Granby, Quebec, Canada J2G 9N8

A free* listing on these pages is available for each coming radio event. Sponsors should provide description of event, date, time, place, directions, & information/contact person. Since listings are on a "space available" basis, no guarantee of listing is made.

Submission Deadline - 5th of month.

*Club/museum/non-profit events are listed free; other events are obtained from advertisements placed elsewhere in A.R.C.

Although non-members are welcome at all events, joining may be required at some. Admission is charged at some events.

OHIO - Jun. 21-22

SOCIETY FOR PRESERVATION OF ANTIQUÉ RADIO KNOWLEDGE RADIORAMA '96

Cincinnati, OH - Signature Inn, Turfway Rd.
(606) 371-0081 - Exit 182 off I-75

Jun. 21: Dawn - Swap Meet starts
10 am-5 pm - Open Exhibition
"Fantastic Plastics"
7 pm - Seminar

Jun. 22: Dawn - Swap Meet starts
Info: Richard Arter, 307A Junemarie Dr.
Lebanon, OH 45036 - (513) 258-8300, days

WASH. - Jun. 27-29

RADIO ENTHUSIASTS OF PUGET SOUND - RADIO SHOWCASE IV

"Twisting the Dial in 1946"

Seattle, WA - Overlake Hospital
Conference Center-Bellevue

Thurs. event at Museum of History & Industry

Hotel: West Coast Bellevue - (206) 455-9444

Info: REPS Radio Showcase
9936 N.E. 197th St., Bothell, WA 98011

MICHIGAN - Jul. 12-14

MICHIGAN ANTIQUE RADIO CLUB 11th EXTRAVAGANZA '96

Lansing, MI - Holiday Inn South
Convention Center, 6820 South Cedar St.
Off I-96 at Exit 104 (Holt/Cedar St.)
(517) 694-8123

Grebe Theme

Open-air Flea Market - Auctions
Contest - Programs

Guest Speaker: Alfred Grebe Jr.
Women's Luncheon

Info: Extravaganza '96, Suite 100
3520 Okemos Rd., #6, Okemos, MI 48864

CONNECTICUT

NEW MUSEUM VINTAGE RADIO & COMMUNICATIONS MUSEUM OF CONNECTICUT

East Hartford, CT - 1173 Main Street

Open Thursdays & Fridays: 10 am-2 pm

Open Saturdays: 11 am-4 pm

Open Sundays: 1-4 pm

Info: John Ellsworth - (860) 675-9916
Chris Watts - (203) 757-3191

Attend a club event near you, learn, meet others in the hobby, and perhaps find an item or two for your collection!

BUSINESS CARD ADS - \$45.00 FOR 3 MONTHS

784-9417

784-9417

**COSMOS
TV**
• Low Prices
• TV Repair
Free Estimates
784-9417

• Quality Used TV's
• Antique Radio Repair
• Buy, Sell, Trade
5919 15th Ave. N.W.
Seattle, WA 98107

WANTED: Tube Hi-Fi Components & Commercial Amplifiers of the 1950's & 1960's

**Marantz, McIntosh, Scott, Fisher, Brook
Acrosound, Brociner, Western Electric
Fairchild, Altec, Tannoy, JBL**

Richard Sharisky (617) 484-5784, phone
P.O. Box 521 (617) 489-6592, fax
Belmont, MA 02178

Free Estimates
Hrs. - 10 AM - 7 PM EST.
Tues - Sat

Tel./Fax (860) 928-2628
E-Mail: cbradloc@aol.com



**ANTIQUE RADIO
RESTORATION & REPAIR**

1920 - 1960's



Buy & Sell

Reasonable Rates, Tubes, Professional
Overhauls, Cabinet Refinishing, Service
For All Antique Car, Table & Console
Radios, Communication Receivers &
Tube Amplifiers.

20 Gary School Road
Pomfret Center, CT 06259

BOB ESLINGER

TUBES TUBES TUBES

New Old Stock

1/3 Of AES Price

SASE For List

Tubes, 555 Seminole Woods Blvd
Geneva, FL 32732

ANTIQUE RADIO RESTORATION

Since 1936 Repair - Buy - Sell
Complete Restorations • Prompt Service

COOPER'S RADIO SERVICE

425 Court Street
Rockwell City, Iowa 50579



LARRY COOPER
712-297-7232

Antique Radio Hardware

- Knobs, handles, pendants, pulls, etc.
- Original dies for hundreds of different patterns dating back to 1920
- Specializing in solid brass hardware

Will cater to your needs - Even single piece orders
Send \$3 for catalog (refunded from 1st order)

GUY FREDERICK - (616) 456-9378
1121 Powers NW, Grand Rapids, MI 49504

Old Time Replications

"TURN TO US WHEN YOU NEED KNOBS"
KNOBS • PUSHBUTTONS • ESCUTCHEONS
PLASTIC GRILLS • HANDLES

LARRY BORDONARO

5744 TOBIAS AVE. VAN NUYS, CA 91411
PHONE (818) 786-2500 • FAX (818) 909-0241

WANTED ! JAPANESE MILITARY RADIOS

any kind of WW-2 radios & aircraft instruments

Takashi Doi



FAX : 011-8145-301-8069
1-21-4, Minamidai, Seyaku, Yokohama, Japan



HARD TO FIND BATTERIES

that really run your antique radios!!
1 1/2 to 135 volts of various sizes &
shapes! Also available: new & used panel
meters; VTVM & multimeters; JAN
16mm projectors, UHER reel-to-reel
recorders and more! Wanted: Meters &
reel-to-reel recorders.

S&G ELECTRONICS 618 S 62nd St, Phila, PA 19143
Phone 215-474-7663 - Fax# 215-726-9761

BETA-TEK

ANTIQUE RADIO SERVICE

- Repair of Radios, Communications
Receivers & Test Equipment
- Power Supplies for Battery Sets



RAY BINTLIFF
2 Powder Horn Lane
Acton, MA 01720
508 283-7435



TEL: (214) 276-5458
FAX: (214) 272-1831

THE RADIO MAN

Buy-Sell-Trade
Antique Radios • Tubes • Parts

DICK MORGAN
RES: (214) 564-6464

P.O. BOX 461485
GARLAND, TX 75046-1485

20 Years
Experience Telephone/Fax
1-615-456-2529

Specializing in Antique Speaker Repair

- Very large stock of vintage parts
- Can repair most any cone-type speaker
- Field coils rewound • Fast turn-around
- Reasonable prices

Work
Guaranteed

Hank Brazeal
103 N. Lake Point Ct.
Crossville, TN 38555

BUSINESS CARD ADS - \$45.00 FOR 3 MONTHS

Carbon Resistors • Capacitors • Vacuum Tubes

ALLTRONICS

Electronic Component Supply

2300 Zanker Road • San Jose, CA 95131

Voice (408) 943-9773 • Fax (408) 943-9776

BBS (408) 943-0622 • 24 Hrs. • N-8-1

Call or Fax for Catalog

50 years

CHUCKS

of service!

**Any Tube Radio Repaired and
Guaranteed to work good.**

\$25 plus parts & UPS

CHUCKS

167 LYNN DRIVE - PO Box 598

NEW HAVEN, WV 25265 - Ph (304) 882-2220

78 RPM Cartridges Repaired



Dead cartridges rebuilt right. New crystals etc., as needed. Allow 3-4 weeks. Most crystal and "horseshoe" magnet types \$34.50
100 hr. sapphire setscrew needles (list \$2.50 ea.) . . . 4/\$5.50



Joe Smolski
835-A Pleasant Street
Framingham, MA 01701

Inquiries: (508) 879-2778, evenings and weekends. Prices include return postage. Please include payment with order.

PHILCO PREDICTAS WANTED:



BUY • SELL • TRADE • RENT • RESTORE

DAVID WEDDINGTON
(615) 890-7498

2702 Albany Ct.
Murfreesboro, TN 37129

ELECTRON TUBE ENTERPRISES

BOX 8311 11 LINDEN LN

ESSEX, VT. 05451

BUY TEL: 802-879-1844 **SELL**

FAX: 802-879-7764

INTERNET: ETETUBES @ AOL.COM

WRITE FOR FREE 1996 CATALOG

(Lowest prices for new & used tubes)

INSTRUMENTS



Jim & Rhoda
Morris

Radio, Telegraph,
Historical Instruments,
& Books For Sale
Catalogs
& Lists
Available

Antiques of Science & Technology

A of ST Box 1852 Wakefield MA 01880 U.S.A.
Tel 617 245 2897 Fax 617 245 3572

COMMNAV BQIP
RADIO SETS
NAVAL AIR FIELD
U S FOREIGN

CHARLES DEBCCA KAJGON
501 MYSTIC VALLEY PKWY
MEDFORD, MASS 02155
PHONE: 617-386-9354



MILITARY ELECTRONICS

BUY WANTED TRADE

"The Early Sound Man"

Mr. John P. Andolina, Jr.

Antique Phonographs



28 Glen Oaks Dr.
Rochester, NY 14624
(716) 247-3056
Reasonable prices

Collect • Repair • Restore
Edison, Victor, Columbia
Cylinder • Disc Records
Phonograph Advertising
Quality Repairs Since 1973



AWA
Member

REPRODUCERS rebulk



THE FINISHING TOUCH



Judd E. Hinman Restorations

SHOW WINNING FINISHES

— AUTO INTERIOR WOOD —

- RADIOS
- MECHANICAL
- 78 RPM JUKEBOXES
- ELECTRONICS



203-274-0705

203-268-6680



182 JUDD FARM ROAD

WATERTOWN, CONN. 06795



All Tube Equipment Repaired



"The Fisher Doctor"

Al Pugliese
718-948-7489

**27 Daleham Street
Staten Island N.Y. 10308**

VINTAGE FISHER PRODUCTS

Bought • Sold • Traded • Repaired

SUNSHINE SOUNDS

WANTED:



Hi Fi TUBE & COMMERCIAL AMPS

McIntosh, Marantz, Dynaco, Heath,
Altec, Scott, RCA, Fisher, Craftsman,
Grommes, Fender, Ampex, W.E. Vox,
Brook, Acro, Pultec, Fairchild

SPEAKERS & HORNS

Altec, Jensen, RCA,
E.V., Western Electric,
JBL, Tannoy

Phone: 405-737-3312 or Fax: 405-737-3355
Sonny - 1413 Magnolia Ln., Midwest City, OK 73110



WAVES

ANTIQUES, EARLY RADIOS &
PHONOGRAPHS

BOUGHT • SOLD • REPAIRED

OPEN 12 - 6, SAT. 12 - 5

CLOSED SUN. & MON.

Phone: 212 989-9284

32 EAST 13TH ST., NEW YORK, N.Y. 10003

Fax: 201 461-7121 / E-Mail: C1Wave@aol.com

PROPRIETORS Bruce and Charlotte Mager

BUSINESS CARD ADS - \$45.00 FOR 3 MONTHS

SPY EQUIPMENT WANTED!

- Code Machines
- Secret Radios
- Clandestine Weapons
- Secret Cameras
- OSS, SOE, CIA, KGB!
- Buy or Trade!

Keith Melton
P.O. Box 5755 Bossier City, LA 71171
(318) 747-9616 Days: FAX (318) 747-9010



If you buy, sell or like jukeboxes you need **ALWAYS JUKIN™-THE MONTHLY JUKEBOX MAGAZINE!!** Subscribers in 25 countries, **ALWAYS JUKIN LEADS THE WAY:** Articles, photos, show reports, ads, new products, price guides, restoration tips, repairs—everything you need to know about **JUKE-BOXES**—the fastest appreciating collectible in the world!!! Fun & a great investment. Sample copy, \$3. \$33 per year. **ALWAYS JUKIN, 221 YESLER WAY AR, SEATTLE, WA. 98104. (206) 233-6460. MasterCard ok.**



HAROLD C. BRAMSTEDT
C & N ELECTRONICS
6104 Egg Lake Road North
Hugo, MN 55038

612-429-9397
800-421-9397
Fax 612-429-0292



- Buy
- Sell
- Transmuting & Industrial Tubes

The RCA Shop

Carlton Carver
PROPRIETOR-RCA COLLECTOR

1645 W. 5th St.
Washington, NC
27889
(919) 975-2677

Quality electronic restoration of your mid-thirties RCA radios including all Magic Brain receivers. Oscilloscope sine wave tuning for maximum performance as per RCA service literature.

30 years experience 

Jackson Speaker Service
Expert Antique Loudspeaker Repairs (Cone Types) And Rebuilding A Speciality. Speaker Parts And Repair Service On Virtually Any Speaker Made Including Stereo, P.A., And Antique Auto Speakers. 217 Crestbrook Dr. Owner
Jackson Mich 49203 Ron McGee
Ph.-(517)789-6400, Ans. 4th ring
Wk-days 10:am-7pm Wk-Ends 9-5pm



Get your ZENITH Transoceanics working again... on batteries! It only takes 6, maybe 7 "D" cells. You need the PORTA-POWER, CVA-9 converter. It works on others sets too.

You can get everything you need directly from me at the new low price of \$84.50 plus \$4 shipping. Over 200 sold! Peter Yanczer
TESLA ELECTRONICS (314) 822-1748
835 BRICKEN, ST. LOUIS, MO 63122

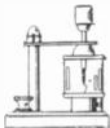

CRYSTAL SETS

PARTS - PLANS - KITS - BOOKS
CATALOG \$1.00

Largest source of Vintage and New Variable Air Condensers, Variometers, Vario-Couplers, Tap Switches, Tap Points, Galena and Germanium Detectors, Detector Stands, Cat Whiskers, Terminals, Sliders, Headsets, Dial Knobs, Coil Forms, Magnetic Wire, etc.

MIKCO
P O Box 2288
Hollywood, FL 33022
(305) 925-3670
B A Turke, Ph D E E

USED TEST EQUIPMENT

Bought & Sold * NOS & Used Parts

HP - TEK - GR - Measurements Corp. - Heath - EICO

Boca Electro Magnetic Lab

21218-10 St. Andrews Blvd.
Boca Raton, FL 33433
(407) 750-8911

Buy Sell Trade

(510) 490-5842 Fax (510) 490-1961

Speakerworld®

Expert Speaker Refoaming and Reconing

2000 Warm Springs Ct. #6
Fremont, CA 94539

Visa/MC

Vintage Radio

Bob's Radio & TV

2300 Broad St
San Luis Obispo
California 93401
(805) 543-2946

- ◆ Repairs
- ◆ Restorations
- ◆ Specializing in all tube type car and home radios
- ◆ FM additions

Full warranty on work performed, walk-ins welcome, stop by and see our antique radio museum

CAPACITORS - TUBES RADIO SERVICE ITEMS
Thousands in Jam-packed illustrated 24-page catalog No. 49

INFORMATIVE INTERESTING FUN-TO-READ

Send \$3 U.S./Canada \$5 overseas (U.S. funds) for a Heavy-Paper limited edition copy NOW!

DON DIERS 4276 North 50 St. Dept. AB8
Milwaukee, WI 53216-1313

Phono Needles/Stylel
1500 Types
Magnetic - Ceramic -
Crystal Cartridges



Rebuild Astatic and All Types of Crystal Ceramic Cartridges



West-Tech Services

648 N. Ridgewood Dr. #11
P.O. Box 1415
Sebring, FL 33871

Rebuild Obsolete Idlers
New Idlers and Belts
Fabricate 78 RPM Needles

STEVE KARPIAK C.E.T.
Phone (941) 471-0622

BUSINESS CARD ADS - \$45.00 FOR 3 MONTHS

WRIGHT'S ELECTRONIC SERVICE THE RADIO DOCTOR

"You Don't Have To Worry When It's Done Wright"

1920-1960's RADIOS-PHONOS-CAR RADIOS-TUBE AMPS

CHASSIS REPAIRS FROM SIMPLE TO COMPLETE REFURBISHMENT
MOST REPAIRS FROM \$25 MOST REFURBS \$50 TO \$100

WRIGHT'S ELECTRONIC SERVICE
(206) 859-3592

P.O. BOX 8252
FEDERAL WAY, WA 98003

TV • VCR • RADIO • TUBES & ANTIQUE ELECTRONICS



Loubriel Repair Service

Joseph Loubriel
Technician

Office 901-387-6665
Fax 901-387-8701
Home 914-351-5868

92 East Quackenbush
Dumont, NJ 07698

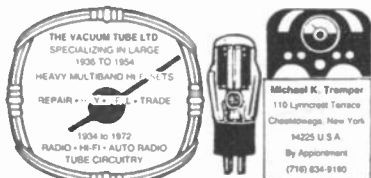

MAGNAVOX STROMBERG-CARLSON MIDWEST HOWARD

FRANK'S RADIO SHOP National Schools 1952 graduate

Repair & Restore of tube radios and
SW communication receivers

Frank Martinho

3511 Rowley Dr. San Jose, Ca. 95132
Ph (408) 946-0240 - Fax (408) 942-9786

5,000,000 Vacuum Tubes In Stock Industrial & Receiving Types

Electronics Emporium Inc.
107 Trumbull Street
Elizabeth, NJ 07206

Buying & Selling, Call For Prices & Delivery

800 - OLD TUBE
(653 - 8823)

Ph: 908-351-0100

Fax: 908-351-8600



ANTIQUE RADIO RESTORATIONS

109 S. Oak St., O'Fallon, IL 62269
618-632-7423

Electronic Consultant

Dial Reproductions

Hickok Tube Testers, Service & Calibration

Life Member I.E.E.E.
AWA, ARCA, MAARC

Clinton Blais, P.E.

* GRUNDIG • SABA • TELEFONEN • NORDMEIDE • PHILIPS • SIEMENS •
- SPECIALIZING IN REPAIR OF EUROPEAN RADIO SETS -

The Bavarian Radio Works

Russ A. Hochstrasser
(617) 447-4299



162 BELLAH ST.
WETMAN, MA 02382

LOGANS TV-RADIO

SINCE 1952

BUY • SELL • TRADE

100's of N.O.S. PARTS, TUBES IN STOCK.
PARTIAL OR TOTAL RESTORATION AVAILABLE.

412-837-5580

REAR 526 MT. PLEASANT ST., GREENSBURG, PA 15601

WANTED PRE 1900 ELECTRICITY

MEDICAL • X-RAY
TELEGRAPHY • TELEPHONE

PRE 1925
RADIO • WIRELESS
PRE 1940
TELEVISION

BOOKS • TUBES • ARTIFACTS
MAGAZINES • AUTOGRAPHS
CATALOGS • EPHEMERA



NEW WIRELESS
PIONEERS

P.O. BOX 598
ELMA, NY 14059
716-681-3186

WHAT... You have CATALINS?

I'll Pay Top \$'s — Any Models

Please Send a Photo and Price To:

Kunihiko Suzuki

2173 Takao, Fukuroi-Shizuoka, Japan 437
(Fax) 81 538 43 3188

RADIO BOOKS FOR SALE

Large selection of books on Radio and Related Technology

Call or write for our List of Catalogs.

Always buying, single items or collections.

RAINY DAY BOOKS

P.O. BOX 775, FITZWILLIAM NH 03447
(603)-585-3448

** WANTED **

Masco, Newcomb PA Systems
Turner, Shure, Astatic Mics
Jensen 8", 10" speakers,
any condition.

* Gary (203) 777-7426 *

BUSINESS CARD ADS - \$45.00 FOR 3 MONTHS

VINTAGE RADIO SERVICES

Ken Hubbard
KA9WRN

Repair of
Vacuum Tube
Equipment

P.O. Box 792
Beloit, WI 53512-0792
(608) 362-1896
6 pm Evenings

Home-Auto

REPAIRS • BUY • SELL • TRADE
PRE '65 AC SETS & CAR RADIOS

FRED'S OLD RADIO EMPORIUM
1612 WEST 7TH AVENUE
CORSIANA, TEXAS 75110

F.L. GORDON, PROPRIETOR
BUSINESS (903) 874-5185 HOME (903) 874-7147



ESTES AUCTIONS

Specializing in Vintage Radios

7404 Ryan Rd
Medina, Ohio 44256

Bus. Phone 216-769-4992
Fax 216-769-4116
Res. Phone 216-769-3987

RADIOS & STRANGE MISCELLANEA IF YOU VISIT THE BRIMFIELD FLEA MARKET... STOP BY FIRST!

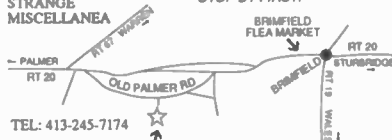

TEL: 413-245-7174
COUNTRY ROAD BARN - BERNIE SAMEK
OLD PALMER ROAD, BRIMFIELD, MASS.



K4GIT

RADIO ELECTRIC SUPPLY

We Specialize In Receiving and Special Purpose Tubes

Send For Price List

Dorothy and Don Gies
Owners

Box 2790 RR#2
Melrose, FL 32666
352-475-1950
Phone or Fax

We have been supplying quality electronic parts to satisfied customers for 25 years.
Call or write for our monthly flyers.

Phone/Fax (702) 795-7151

STAR-TRONICS

P.O. Box 98102
Las Vegas, NV 89193-8102

Are You Looking For Antique Radios, Parts, Tubes, Schematics and Restoration Services?

For Free Flyer, a 2-Stamp LSASE is required to insure a response to your request. Send to:

Olde Tyme Radio Company
2445 Lyttonville Road, Suite 317
Silver Spring, MD 20910

Wish to contact us by phone or fax?

Our number is (301) 587-5280.

Please call 10 am to 10 pm (Local Time)

Antique Radios



David & Nancy Snow

P.O. Box 6352
Jackson, MI 49204
(517) 787-2985

We Buy, Sell, Repair

ARBE - III Battery Eliminators

1920-1970
SCHEMATICS + PAGES OF INFO
\$5.00 POSTPAID

MANUAL PRICES - SASE
RADIO/TV/HAM/MISC.

"IF I DON'T HAVE IT, YOU
PROBABLY DON'T NEED IT."

ALTON H. BOWMAN - 4172 EAST AVENUE
CANANDAIGUA, NY 14424-9564

ANTIQUÉ RADIO REPAIR

Repair - Restore - Buy & Sell

Schematic Service

Radios \$2.⁵⁰, TVs \$4.⁵⁰

DAMASKE ELECTRONICS

574-W16834 Janesville Road

Muskego, WI 53150

Phone: (414) 679-0838



New/Old Stock Parts
Reproduction Items
Books & Refinishing Supplies

\$2.00 for 20 page catalog.
Refundable with first order.

Vintage Tv & Radio

3498 West 105 St. Cleveland, OH 44111
216-871-8712



"The Home of Mr. Happy Amp"

PR NOVELTY

VACUUM TUBE SPECIALISTS
Amplifier Rebuilding Service
Surplus Parts Brokerage
(New Old Stock and Used)

Paul Jorobinski Audio Technician
Robin Richards General Manager

P.O. Box 148 • Milwaukee • WI 53201
414 964 3392
414 960 8812

Radios

of the Baby Boom Era

Six Volumes — 2000 pages — From Sams' Archives
 1946 to 1960 — 274 Brands — 3494 Illustrations (B&W)
 6769 Models — Catalin, Bakelite, Wood, Transistor Radios & More



All Volumes Available!

| Vol. | Brands | Included |
|------|--------|-----------------------------|
| 1 | 56 | Admiral to Clearsonic |
| 2 | 54 | Co-op to Geloso |
| 3 | 58 | GE to Monitoradio |
| 4 | 36 | Motorola to RCA Victor |
| 5 | 35 | Realtone to Stratovox |
| 6 | 35 | Stromberg-Carlson to Zenith |

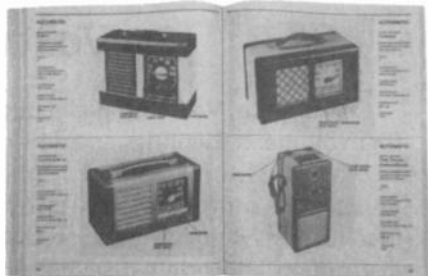

1/2 Page for each illustrated radio including:

- Large illustration of the radio including knob functions
- Short description of the radio
- Number of tubes
- Power supply type (AC, Battery, etc.)
- Tuning range
- Manufacturer
- Sams Photofact Set number & year Photofact published.

ALSO

- Index by model number listing tubes in radio
- List of similar radio models indexed to pictured radio
- List of manufacturers and suppliers indicating their brand names
- Basic trouble-shooting hints

Each Volume: \$16.95 – Softcover
8 1/2" x 11" – Approx. 328 pages

U.S. Orders - Enclose \$3.00 per order for packing & book-rate shipping if total order is under \$35.00. If using VISA or MasterCard, include name on card, card number and expiration date. Send payment with order. Mass. residents please add 5% sales tax. Money back return policy. Most orders shipped the same day received, but allow 2-4 weeks to receive order. Foreign orders - write for shipping costs, or use credit card and specify air or surface (allow 2-3 months for surface shipping).



Send Order To: A.R.C., P.O. Box 2, Carlisle, MA 01741
or Call: (508) 371-0512 Fax: (508) 371-7129



(Jan-98)

CRYSTAL CLEAR

By Maurice L. Sievers

Volume 1

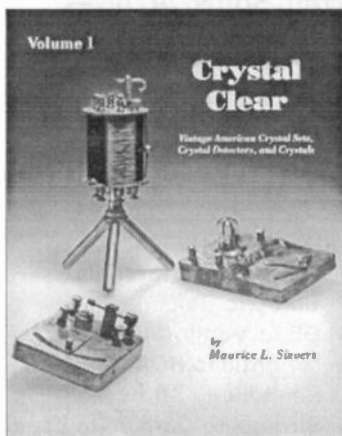

750 Illustrations – 570 Crystal Sets
341 Detectors – 207 Crystals
Perfect for the beginning collector!
Useful for the experienced too!

Crystal Clear is the most comprehensive reference for collectors, historians and anyone interested in early radio. In addition to the many excellent photos and reproductions of ads, *Crystal Clear* includes lists showing all sets by manufacturer, set name, selling price and date of manufacture. 8 1/2" x 11", 282 pages.

\$29.95 – Softcover

Volume 2

Crystal Clear, Vol. 2 supplements the first volume. It identifies an additional 172 crystal radio sets, 91 crystal detectors and 26 crystals by manufacturer, model, year produced, description and original selling price. Further research on many of the crystal sets covered in Volume 1. Detailed history on the Philmore Manufacturing Company and the Western Manufacturing Company. 8 1/2" x 11", 252 pages.

\$29.95 – Softcover



U.S. Orders - Enclose \$3.00 per order for packing & book-rate shipping if total order is under \$35.00. If using VISA or MasterCard, include name on card, card number and expiration date. Send payment with order. Mass. residents please add 5% sales tax. Money back return policy. Most orders shipped the same day received, but allow 2-4 weeks to receive order. Foreign orders – write for shipping costs, or use credit card and specify air or surface (allow 2-3 months for surface shipping).



Send Order To: A.R.C., P.O. Box 2, Carlisle, MA 01741
or Call: (508) 371-0512 Fax: (508) 371-7129



(May-96)

Amateur Radio Books

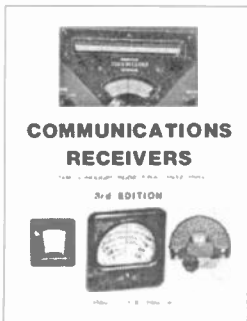

Communications Receivers 3rd Edition by Raymond S. Moore. A comprehensive guide to 700 vacuum tube communications receivers from 1932 to 1981. In addition to Collins, Hallicrafters, Hammarlund and National, 66 other manufacturers from Allied to Tobe are included. New section on military receivers. The description of each set includes years, band coverage, type, filters, tubes, a photo in many cases, and other info. 402 radios pictured! Sharper, clearer photographs. 8 1/4" x 11", 115 pages.

\$19.95 - Softcover

Heathkit, A Guide to the Amateur Radio Products by Chuck Penson. Documentation of ALL Heathkit's amateur products. An extensive illustrated history of the company. Over 200 sharp photos of receivers, transmitters, transceivers, amplifiers, accessories, and more. Most products are pictured with a full-page description. 8 1/4" x 11", 256 pages.

\$24.95 - Softcover



NEW

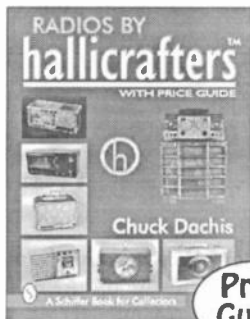

Radios by Hallicrafters by Chuck Dachis. This book includes over a thousand photographs (b/w & color) of radio receivers, transmitters, speakers, early television sets, electronics accessories and advertising material. Technical descriptions are provided for every known Hallicrafters model, including dates of production, model numbers, accompanying pieces and original prices. A current price guide is included. 8 1/4" x 11", 225 pages.

\$29.95 - Softcover

**Price
Guide**

NEW

U.S. Orders - Enclose \$3.00 per order for packing & book-rate shipping if total order is under \$35.00. If using VISA or MasterCard, include name on card, card number and expiration date. Send payment with order. Mass. residents please add 5% sales tax. Money back return policy. Most orders shipped the same day received, but allow 2-4 weeks to receive order. Foreign orders - write for shipping costs, or use credit card and specify air or surface (allow 2-3 months for surface shipping).



Send Order To: A.R.C., P.O. Box 2, Carlisle, MA 01741
or Call: (508) 371-0512 Fax: (508) 371-7129



(May-96)

Radio Manufacturers of the 1920's

BY ALAN DOUGLAS



"The definitive book on American broadcast receivers of the 1920s"

Volume 1: A-C Dayton - Adams Morgan - Air-Way - All-American Mohawk - American Bosch - Amrad - Amrad S-Tube - Apex - Atwater Kent - Bremer Tully - Browning-Drake - Clapp-Eastham - Crosley - Cutting & Washington - Day-Fan - DeForest - Eagle - ERLA - FADA - Federal - Ferguson. 225 Pages.

Volume 1: \$24.95 (softcover only)

Volume 2: Freed-Eisemann - Eisemann - Freshman - Garod - Gilfillan - Grebe - Howard - Jones (Lester/Melco) - Jones (Jos.) - Kellogg - Kennedy - King - Kodel - Kolster - Leutz - Magnavox - Majestic - Marti - Metro - Klitzen/Michigan - Midwest - Mu-Rad - Murdock - Music Master - Neutrowound - Operadio - Ozarka - Pfanstiehl - Philco - Pilot - Priess. 266 Pages.

Volume 2: \$29.95 (softcover only)

Volume 3: RCA - Scott - Silver-Marshall - Slagle - Sleeper - Sonora - Sparton - Splittorf - Steinite - Stewart-Warner - Stromberg-Carlson - Thermiodyne - R.E. Thompson - Thorola - Tri-City - C. D. Tuska - Ware - Western Coil - Western Electric - Workrite - Zenith. 292 Pages.

Volume 3: \$29.95 (hardcover: \$39.95)

U.S. Orders - Enclose \$3.00 per order for packing & book-rate shipping if total order is under \$35.00. If using VISA or MasterCard, include name on card, card number and expiration date. Send payment with order. Mass. residents please add 5% sales tax. Money back return policy. Most orders shipped the same day received, but allow 2-4 weeks to receive order. Foreign orders - write for shipping costs, or use credit card and specify air or surface (allow 2-3 months for surface shipping).



**Send Order To: A.R.C., P.O. Box 2, Carlisle, MA 01741
or Call: (508) 371-0512**

Fax: (508) 371-7129



Books on Radio History



Empire of the Air by Tom Lewis. *A biographical history of radio focusing on Lee de Forest, Edwin H. Armstrong and David Sarnoff. 1991. Illustrated. 421 pages.*

\$13.00 - Softcover
\$24.95 - Video

Hertz: The Beginning of Microwaves by John H. Bryant. *Photos and descriptions of Hertz's apparatus and experiments. A book prepared for the IEEE Hertz Centennial exhibit. 50 pages.*

\$15.00 - Softcover



Heinrich Hertz

THE BEGINNING OF MICROWAVES



Wireless Communication in the United States by Thorn L. Mayes. *Early development of American radio operating companies. Alternators, coherers, stock promotions, unpublished letters, etc. 160 illustrations. 240 pages.*

\$29.95 - Softcover

Inventing American Broadcasting by Susan J. Douglas. *A careful weaving of technology, social forces, and business decision making from the days of Marconi to broadcasting in the 1920s. 1987. 363 pages.*

\$14.95 - Softcover



Syntony and Spark by Hugh G. J. Aiken. *Subtitled "The Origins of Radio." Describes the development of radio from Maxwell's work in the 1860s through the contributions of Hertz, Lodge and Marconi. Reprint. 1976. 347 pages.*

\$16.95 - Softcover

U.S. Orders - Enclose \$3.00 per order for packing & book-rate shipping if total order is under \$35.00. If using VISA or MasterCard, include name on card, card number and expiration date. Send payment with order. Mass. residents please add 5% sales tax. Money back return policy. Most orders shipped the same day received, but allow 2-4 weeks to receive order. Foreign orders - write for shipping costs, or use credit card and specify air or surface (allow 2-3 months for surface shipping).



Send Order To: A.R.C., P.O. Box 2, Carlisle, MA 01741
or Call: (508) 371-0512

Fax: (508) 371-7129



(Jan-96)

Books with Great Photographs



Radio Art by Robert Hawes. *This outstanding book is an illustrated history of radio that celebrates the technical and stylistic progress of the radio. Although focusing primarily on British sets, this book also contains the following American sets: Addison, Airline, Atwater Kent, Bendix, Colonial, Country Belle, Dahlberg, E.H. Scott, Emerson, Fada, General Electric, Grunow, Majestic, Motorola, Philco, RCA, Sperton, Westinghouse, & Zenith. 250 photos, 150 in color. 9 1/4" x 12". 128 pages.*

Hardcover only: \$9.95 — New Low Price

Radio! Radio! 2nd Edition by Jonathan Hill. *Comprehensive coverage of British radios from the 1920s to the 1960s. Illustrated chapter on the history of wireless. Descriptive information on each radio pictured. Over 900 photographs. 8 1/2" x 12". 244 pages.*

**Hardcover only: \$44.95
Individually Signed & Numbered**



Radios Redux by Philip Collins. *Subtitled "Listening in Style," this book showcases the sleek lines and luscious colors of over 80 gleaming sets from the collection of Philip Collins. 121 color photographs. 10" x 8 3/4". 120 pages.*

Hardcover: \$29.95. Softcover: \$17.95

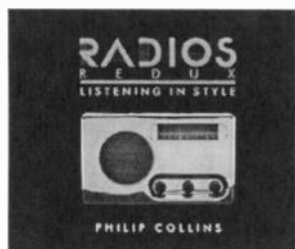

Radios: The Golden Age by Philip Collins. *Collins' first book of the colorful Catalin and Bakelite radios from the late 1930s to the early 1940s. Over 100 color photographs. 10" x 8 3/4". 128 pages.*

Hardcover: \$29.95. Softcover: \$17.95



U.S. Orders - Enclose \$3.00 per order for packing & book-rate shipping if total order is under \$35.00. If using VISA or MasterCard, include name on card, card number and expiration date. Send payment with order. Mass. residents please add 5% sales tax. Money back return policy. Most orders shipped the same day received, but allow 2-4 weeks to receive order. Foreign orders - write for shipping costs, or use credit card and specify air or surface (allow 2-3 months for surface shipping).



**Send Order To: A.R.C., P.O. Box 2, Carlisle, MA 01741
or Call: (508) 371-0512**

Fax: (508) 371-7129



(Jan-96)

Transistor Radio Books



Price Guide

The Collector's Guide to Transistor Radios 2nd Edition by Marty & Sue Bunis. *This book will help you identify the most sought-after vintage transistor radios. Over 2,900 models listed, all with current prices. Includes radio club listing. 375 all new color photos. 5 1/2" x 8 1/2". 320 pgs. 1996.*

NEW

\$16.95 - Softcover
(1st edition still available for \$15.95)

Made In Japan by Roger Handy. *A stunning book on the development and growth of the transistor radio featuring over 175 transistor radios in full color. 10" x 9 9/16". 108 pgs.*

\$16.95 - Softcover



The Portable Radio in American Life by Michael Schiffer. *Approximately 50 pages on transistor radios, beginning with the Regency TR-1 through to the later sets made overseas. 450 photographs, 193 transistor radios pictured. 8 1/2" x 11". 259 pgs.*

\$24.95 - Softcover
\$45.00 - Hardcover

Collector's Guide to Novelty Radios by Marty Bunis & Robert Breed. *This book is the source for novelty transistor radios in all shapes and sizes. Radios are described in detail with current prices. Over 600 all new color photographs. 8 1/4" x 11". 224 pgs.*

\$18.95 - Softcover



Price Guide



Price Guide

Transistor Radios, A Collector's Encyclopedia and Price Guide by David Lane & Robert Lane. *Identification & price guide to over 2,500 transistor and novelty radios. History & key to collecting chapters. 8 1/4" x 11". 170 pgs.*

\$19.95 - Softcover

U.S. Orders - Enclose \$3.00 per order for packing & book-rate shipping if total order is under \$35.00. If using VISA or MasterCard, include name on card, card number and expiration date. Send payment with order. Mass. residents please add 5% sales tax. Money back return policy. Most orders shipped the same day received, but allow 2-4 weeks to receive order. Foreign orders - write for shipping costs, or use credit card and specify air or surface (allow 2-3 months for surface shipping).



Send Order To: A.R.C., P.O. Box 2, Carlisle, MA 01741
or Call: (508) 371-0512

Fax: (508) 371-7129



COLLECTOR BOOKS AVAILABLE FROM A.R.C.

- BOOKS MARKED WITH "NEW" ARE THE MOST POPULAR AND ARE ESPECIALLY RECOMMENDED FOR NEW COLLECTORS!**
- Antique Radio Restoration Guide, 2nd Ed., Johnson.** *Beginner's introduction to troubleshooting and repairing AC table model radios.* 1992. 145 pgs. \$14.95
- The AWA Review.** Collections of articles. Vol. 6: *Hawaiian Wireless, U.K. TV, SCR-RC-BC Dir., NYC Wireless, etc.* Vol. 7: *Poldhu xmitters, Navy Equipment, Arc xmitters, etc.* Vol. 8: *Keys, Federal Co., KFS-Federal-Mackay Store, Nat'l Electrical Supply Co., Navy Electronics Dir., etc.* Vol. 6-8, ea. \$10.00
Vol. 9: *Marconi, The Int'l Contest for Radar, The Magnetron Story, F. Louvenstein, Ham Licensing.* Vol. 9 \$17.00
- The Antique Radio Boys and the Garrulous Grebe, Dryer.** *Thrilling adventure story written in the traditions of the '20s and '30s. 5 1/2" by 8 1/2".* 51 pgs. \$4.95
- The Auto Radio: A Romantic Genealogy, Matteson.** *Info, photos & ads from the early days of the auto radio through the 1950s.* 316 pgs. (hardcover) \$34.95
- Behind the Front Panel, Rutland.** *Reviews radio circuits and radio history. Easy descriptions.* 25 pics. 158 pgs. \$18.95
- Blast from the Past, A Pictorial History of Radio's First 75 Years, Rhoades.** *The performers, programs, & technology that made radio a part of everyday life. 100s of never-before-published photos.* (hardcover) NEW \$39.95
- Broadcasting's Forgotten Father: The Charles Herold Storey, Adams.** (Videotape, VHS). *One-hour documentary on this amazing inventor. Featuring his family, students, and photos to document his work.* \$29.95
- Classic TVs, Wood.** *Prewar to 1950s, with price guide. 140+ color photos, plus repros of catalogs & ads.* 86 pgs. \$16.95
- The Collector's Guide to Antique Radios, 3rd Ed., Bunis.** *This guide covers radios from 1920s to 1960s. Over 8,500 prices and over 650 all new color photos are included.* 1994. 278 pgs. \$18.95
- The Collector's Guide to Novelty Radios, Bunis & Breed.** *The source for novelty transistor radios. Full descriptions with current prices. Over 600 color photos.* 1994. 224 pgs. \$18.95
- The Collector's Guide to Transistor Radios, 2nd Ed., Bunis.** *Identifies the most sought-after vintage transistor radios. Includes club listing. Over 2,900 models, 375 all new color photos, with current prices.* 1996. 320 pgs. NEW \$16.95
- Communication Receivers, 3rd Ed., Moore.** *Information on 738, 1932 to 1981, vacuum tube receivers by 66 manufacturers. 402 radios illustrated. New section: 3 pages of military receivers.* 125 pgs. \$19.95
- The Complex Talking Machine, Reiss.** *A guide to restoration of antique phonographs.* 183 pgs. \$19.95
- Crystal Clear - Vintage American Crystal Sets, Crystal Detectors and Crystals, Sievers.**
Vol. 1 - *Comprehensive reference with 750 illustrations, 570 crystal sets, 341 detectors, 207 crystals.* 282 pgs. \$29.95
Vol. 2 - *479 All new & different illustrations, more crystal sets, detectors and crystals identified.* 252 pgs. \$29.95
- E.H. Scott Radio Collectors Guide, 1925-1946, Clark.** *The reference for collectors of Scott radios, cabinets and accessories. Lists original prices of cabinets and accessories. Over 200 photos with descriptions.* 88 pgs. \$29.95
- Early Radio, In Marconi's Footsteps, Jensen.** *Realistic description of Marconi's work and his surroundings. Early construction projects with diagrams. Color and B&W photographs.* 170 pgs. (hardcover only) \$39.95
- Empire of the Air, Burns.** (Videotape, VHS). *2-hour video based on Lewis' book.* \$24.95
- Empire of the Air, Lewis.** *Biographical radio history on De Forest, Armstrong and Sarnoff.* 1991. 421 pgs. \$13.00
- Evolution of the Radio, L-W Books.** *Radios pictured and priced, plus reproductions of catalog pages and ads.*
Vol. 1 - *Eight-hundred + radios.* 1991. 227 pgs., 118 pgs. in color. \$22.95
Vol. 2 - *Totally different from volume one with new photos, etc.* 1993. 654 color photos. 226 pgs. \$24.95
- Firco Radio Equipment, John Firth & Co., Inc. (reprint).** *Twenty-six-page booklet of the Firth Co.* \$4.95
- Fixing Up Nice Old Radios, Romney.** *Written by a retired radio instructor, this book covers Ohm's law, through battery sets, superhets and communications receivers.* 1990. 300+ figures, 185 pgs. \$25.00
- Flick of the Switch, McMahon.** *The classic photo reference guide for '30s - '50s radios. 1000+ photos.* 263 pgs. \$11.95
- Great Radio Personalities (reprint).** *B&W pics of the golden days of radio - Abbott & Costello, etc.* 128 pgs. \$11.95
- Guide to Old Radios - Pointers, Pictures & Prices, 2nd Ed., Johnson.** *Introduction to radio collecting. Includes hundreds of photos and a price guide.* 1995. 272 pgs. \$19.95
- Hake's Guide to TV Collectibles.** *Price guide and photos for 1600 TV shows, comic books, etc.* 1990. 185 pgs. \$14.95
- Heathkit, A Guide to the Amateur Radio Products, Penson.** *Documentation of all Heathkit's amateur radio products, a complete history of the company, 200+ sharp photos.* 256 pgs. NEW \$24.95
- Hertz: The Beginning of Microwaves, Bryant.** *Photos and descriptions of Hertz's apparatus and experiments. A book prepared for the IEEE Hertz Centennial exhibit.* 50 pgs. \$15.00
- Inventing American Broadcasting, Douglas.** *A careful weaving of technology, social forces, and business decision making from the days of Marconi to broadcasting in the 1920s.* 1987. 363 pgs. \$14.95
- Los Angeles Radio Manufacturing, Paul.** *History of radio manufacturers in the L.A. area from 1922 to 1942. Features Echophone, Giffillan, Jackson Bell & 9 others.* 88 pgs. \$10.50
- Supplement No. 1, Paul.** *Coverage of additional manufacturers, people and sets.* 1993. 48 pgs. \$6.75
- Made in Japan, Handy.** *A stunning book on the rise of the transistor radio. 175+ radios in color.* 1993. 108 pgs. \$16.95
- The Mechanics of Television, Yanczer.** *History and explanation of mechanical television, plus construction details for a working system.* 1987. 5 1/2" by 7 1/2", 170 pgs. \$24.95
- Most Often Needed 1926-38 Radio Diagrams and Servicing Information (reprint).** *600+ diagrams for mostly AC radios from '26-'38.* 240 pgs. \$11.95
- Novelty Radios, Breed.** *500+ transistor novelty radios in full color with current prices.* 1990. 217 pgs. \$24.95
1994 Price Update - *Novelty Radios, Breed and Bunis.* 14 pgs. \$4.95
- Official Radio Service Manual (reprint).** *100s of pre-1930 circuits & notes.* 356 pgs. \$24.95
- Old Gramophones, Bergonzi.** *The development of phonographs and gramophones.* 64 photos 32 pgs. NEW \$4.95
- Old Radio Sets, Hill.** *The development of the radio from the late Victorian era until the late 60s.* 60 photos 32 pgs. NEW \$4.95
- Old-Time Radios! Restoration and Repair, Carr.** *How to repair vacuum-tube and transistor radios. A self-paced training guide. 200 illustrations.* 256 pgs. \$18.95
- Philco Radio: 1928-1942, Ramirez.** *A reference book on Philco. Shows receivers and company history year-by-year. 464 color photos, 364 black & white photos and drawings.* 1993. 160 pgs. \$29.95
- Portable Radio In American Life, Schiffer.** *Traces the development of the portable radio and how it affected American culture and society. 450 photos and drawings.* 259 pgs. (hardcover) \$45.00
- Poster's Radio & Television Price Guide, 1920 - 1990, 2nd Ed.** *875+ TV's, 650 transistor radios and 2,200 other radios listed. 600 sets illustrated, 75 in color.* 1993. 7" x 10". 264 pgs. \$17.95
- Price Guide to Plastic Collectibles, McNulty.** *Describes types of plastics, etc. (Radio is 8 of 207 pgs.)* \$17.95
- RCA Radiolas, Radiotrons, and Accessories (reprint).** *Twenty-page booklet summarizing RCA's 1926 product line including the Radiola III, 20, 25, 26, 28, etc.* \$4.50
- Radio Art, Hawes.** *A chronological, illustrated history of the technical and stylistic progress of the radio. Mostly British, but American sets are featured as well.* 250 photos, 150 in color, 128 pgs. (hardcover only) Low Price \$9.95
- Radio Art Postcard Deck.** *30 full-color photographs from Hawes' book.* \$7.50

COLLECTOR BOOKS AVAILABLE FROM A.R.C.

BOOKS MARKED WITH "R" ARE THE MOST POPULAR AND ARE ESPECIALLY RECOMMENDED FOR NEW COLLECTORS!

- Radio Collector. (Videotape, VHS).** *The five-part Emmy-nominated PBS series combined on one 130-minute videotape. Meet collectors, see collections, attend swap meets, learn about radio restoration.* \$29.95
- The Radio Collector's Directory and Price Guide, 1921-1965, 2nd Ed.,** Grinder. *Directory of over 20,000 radios by manufacturer, model number, year, etc., with prices. Radio history, cabinet styles, vacuum tube development chapters. Over 1,200 trade names listed. Thoroughly revised and expanded. 500 pgs.* \$26.95
- Radio Collector's Guide, McMahon.** *Listing of 9,000+ radios made by some 1200 companies from 1921 to 1932. Gives manufacturer, year, model name and other info. No photos, 264 pgs.* \$11.95
- The Radio Collector's Guide to Philco Bakelite Block Condensers, 2nd Ed.,** Bintliff. *A detailed description of Philco Bakelite block condensers with illustrations and parts lists. 1995. 57 pgs.* \$9.95
- Radio Craft - 50 Years of Radio** (reprint). March 1938 issue of *Radio Craft* magazine. *Numerous articles on the development of radio, then 50-years old, and on early radio pioneers. 144 pgs.* \$15.95
- Radio Equip. & Supplies, (reprint).** 1922 radio catalog, accessories, etc. RCA, Clapp-Eastham, etc. 168 pgs. \$19.95
- Radios-The Golden Age, Collins.** *Full-color book on the colorful Catalin and Bakelite radios from the late 1930s to the early 1940s. 128 pgs.* (hardcover \$29.95) \$17.95
- Radio Horn Speaker Encyclopedia, Paul.** *Listing of horn speakers for over 320 manufacturers for the 1920s. Expanded information on ten manufacturers. Over 145 photos, 80 pgs.* \$14.90
- Radio Horn Speaker Notebook, Rev. H. Paul.** *The companion to the Encyclopedia. Over 450 horn picture ads are shown, over 325 manufacturers are identified. Photocopy. New Index. 1995. 72 pgs.* \$15.90
- Radios Manufacturers of the 1920's, Douglas.** *Three comprehensive volumes.*
- Vol. 1 covers A-C Dayton thru Ferguson.** 225 pgs. (softcover only) \$24.95
- Vol. 2 covers Freed-Eisemann thru Priess.** 266 pgs. (softcover only) \$29.95
- Vol. 3 covers RCA thru Zenith.** 292 pgs. (hardcover: \$39.95) \$29.95
- Radio Poster, Sonoran Publishing.** *Color 20" x 26". A radio timeline. 20 radios from the Pup to transistors. NEW 10.95*
- Radio! Radio!, 2nd Ed., Hill.** *Revised easy-to-read subject index, separate A-Z directory listing of 1,000+ British radio models with clearer photographs than first edition. 978 photos, 244 pgs.* (hardcover only) \$44.95
- Radio Redux, Collins.** *Subtitled "Listening in Style." This book showcases the sleek lines and luscious colors of over 80 gleaming sets from the collection of Philip Collins. 120 pgs.* (hardcover: \$29.95) \$17.95
- Radio/TV Finder, Okolowicz.** *Reference to nearly 7,000 radio and TV pics found in 24 books. No photos, 110 pgs.* \$13.95
- Radio & T.V. Collector's Guide Book, Biraud.** *The "Vintage Radio" illustrated guide to European sets from early wireless to the 1930s (a few later). Text is in both French and English. Vol. 1: History & Manufacturers A to P. 256 pgs. Vol. 2: P to Z & T.V., Speakers, Tubes, Loops, Parts & Novelties. 256 pgs.* (Per Volume) \$49.95
- Radios by Hallicrafters, Dachis.** *The most definitive book on the company. Over 600 photos (some color) on everything they made. An invaluable tool for anyone interested in Hallicrafters. 220 pgs.* (Available in Now) NEW \$29.95
- Radios of the Baby Boom Era.** *Pictures and info from Sams Photofacts. 3,494 radios illustrated plus 3,275 additional radios listed. 274 brands. 1946 thru 1960. Six volumes, 300+ pages per volume. Order by volume:*
- Vol. 1: Admiral - Clearsonic. Vol 2: Co-op - Geloso. Vol 3: GE - Montitoradio. Vol 4: Motorola - RCA. Vol 5: Realtime - Stratovox. Vol 6: Stromberg-Carlson - Zenith.** (Per Volume) \$16.95
- Refinishing Old Furniture, Wagoner.** *Written by a furniture restoration instructor. A step-by-step guide to furniture (or radio) restoration, from removal of finishes right up to the final polish. 178 pgs.* \$14.95
- Saga of the Vacuum Tube, Tyne.** *The development of vacuum tubes - 1880 to 1930. From Edison, Thomson and Fleming to de Forest, Philips, Siemens and many more. 100+ tube photos, 495 pgs.* \$18.95
- Sound & Vision Yearbook 1995/96.** *An annual directory of radio & TV collectors, primarily European* \$6.95
- Syntax and Spark, Aiken** (reprint). Subtitled "The Origins of Radio." *Describes the development of radio from Maxwell's work in the 1860s through the contributions of Hertz, Lodge and Marconi. 1976. 347 pgs.* \$16.95
- S. Gernsback Radio Encyclopedia** (reprint). 1927 classic encyclopedia on radio. From "A" Battery to Zirconium, with 1000s of entries in between. 100s of illustrations, 175 pgs. \$9.95
- 70 Years of Radio Tubes and Valves, Stokes.** *The story of the radio tube from the laboratory to the commercial market. 247 pgs.* \$25.95
- 75 Years of WE Tube Manufacturing, Magers.** *A log book history 750+ WE tubes. Illustrated. 133 pgs.* \$16.95
- Tomart's Price Guide to Radio Premium and Cereal Box Collectibles, Tumbusch.** *Includes comic character, pulp hero, TV and other premiums. 1991, 3,000+ illustrations, 176 pgs.* \$22.95
- Transistor Radios, A Collector's Encyclopedia and Price Guide, Lane.** *Identification guide to over 2,500 transistor and novelty radios. History and key to collecting chapters. 1994. 170 pgs.* \$19.95
- Vintage Radio, McMahon.** *The classic photo reference guide for collectors of radios prior to 1930. Crystal sets, battery sets, tubes, horns, parts, etc. Over 1000 pictures, 263 pgs.* (Temporarily Out-Of-Print) \$44.95
- The Weekend Refinisher, Johnson.** *A complete guide to stains and finishes and tips for setting up your own workshop. A handy furniture "first aid" kit for quick repairs. Illustrated. 296 pgs.* \$10.00
- Westinghouse Catalog** (reprint). 1920s catalog of the RA-DA and other early Westinghouse equip. 8 pgs. \$4.00
- Wireless Communication in the U.S., Mayes.** *Early development of American radio operating companies. Alternators, coherers, stock promotions, unpublished letters, etc. 160 illustrations, 240 pgs.* \$29.95
- The Xtal Set Society Newsletter, Anderson.** *Complete set of the Society's newsletter. Order by volume. Vol. 1: 7/91 to 5/92 - Field Strength Meter, FM Xtal Set, Xtal Sets & Wireless, & more. Vol. 2: 7/92 to 5/93 - The Lead Pencil Detector, The Universal Xtal Set, etc. Vol. 4: 1/94 to 11/94 - Measuring Coil Capacitance, home-brew headphones and curve tracers, etc. Vol. 5: AM Receiver Design, Marconi Type 107, Radio Outfit in a Headset, & more.* (Per Vol.) \$9.95
- The Xtal Set Handbook, Anderson.** *Formulas for coil inductance, a procedure for measuring coil capacitance, circuit matching theory, & more. Also included is Vol. 3 of the Xtal Set Society Newsletter.* \$10.95
- Zenith Radio Corporation** (reprint). *The instructions for installation and operation for Models 39-39A Models 392-392A, and Electric Zenith Receivers. 3 schematics, 3 photos, 7 1/2" by 5", 16 pgs.* \$4.50
- The Zenith Trans-Oceanic: The Royalty of Radios, Bryant and Cones.** *Presents the fascinating story of the development and use of the Trans-Oceanic. Several photos, documents, ads, etc. 160 pgs.* \$24.95

U.S. Orders - Enclose \$3.00 per order for packing & book-rate shipping if total order is under \$35.00. If using VISA or MasterCard, include name on card, card number and expiration date. Send payment with order. Mass. residents please add 5% sales tax. Money back return policy. Most orders shipped the same day received, but allow 2-4 weeks to receive order. Foreign orders - write for shipping costs, or use credit card and specify air or surface (allow 2-3 months for surface shipping).



Send Order To: A.R.C., P.O. Box 2, Carlisle, MA 01741

or Call: (508) 371-0512

Fax: (508) 371-7129



World's leading
Specialty Auction
"Classic Radio & TV sets"

8 June 1996

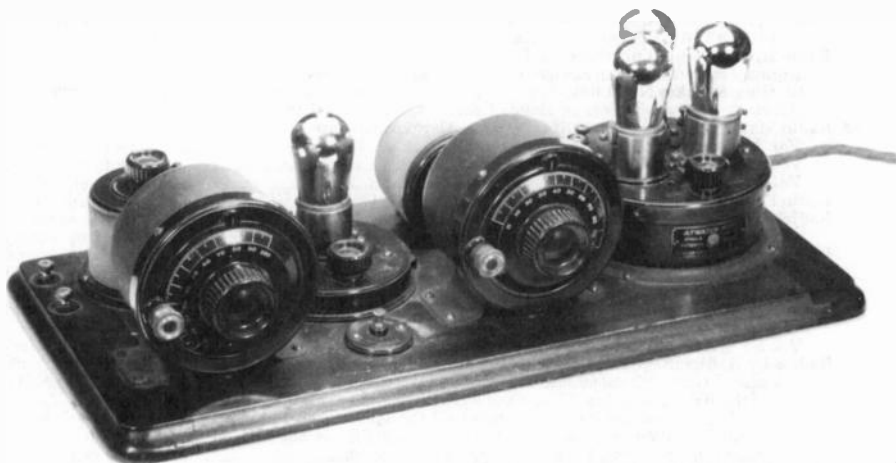

Giant offering of early historical collector's items including:

Early TV sets: Marconi 703 (1937), HMV 900 (1936), HMV 904 (1938), Cossor 1210 (1939) * **Radio sets:** Atwater Kent 9C, 10, 10C, 20, etc * Federal 57, 59, 61 * Kennedy 220, 281 * Paragon 2, RA10, RD5 * Radiola Grand, V * Westinghouse Radiola RA, AC * Isaria T8 * Körting Ultramar, Transmare * Lumophon RN3 * Mende E45 * Sachsenwerk RDN, RE1, WV * Schuchardt 2R * Seibt EA530, EA337A * Siemens Rfe22 * Telefunken 9, ESC, T10, T12, T1000 Arcofar * Ericsson Wien Typ LA 320W * Loewe OE333 * **Accessories:** Speaker, valves/tubes, headsets, antennas, spools ... and much, much more!

AND: Part 1 of the famous 350 item collection of the late Gerhard Ebeling, Braunschweig/ Germany, the well known long time editor of the German historic radio magazine "Funkgeschichte". (Part 2 follows on November 30, '96)

Fully illustrated catalogue against prepayment only (Eurocheque, cash, major credit cards) of DM 43.- (Overseas: USA, Japan, etc: DM 55.-/approx. \$ 36.- incl. airmail and realized price list * Annual subscription: DM 75.- (Overseas: DM 95.-/ approx. \$ 63.-)

AUCTION TEAM KÖLN

Breker – The Specialists

P.O. Box 50 11 19, D-50971 Koeln, Germany * Tel.: +49221/38 70 49 * Fax: +49221/ 37 48 78
Bonner Str. 528-530, D-50968 Koeln, Germany

Our international representatives:

USA: Jane Herz, Tel. (941) 925-0385/Fax: (941) 925-0487

England: Robin Kahan, Tel./Fax (01935) 851 203 * **France:** M. Pichon, Tel./Fax 37.31.92.43

Japan: Murakami Taizo, Tel./Fax (06) 845-8628



HMV 904 (1938)

HMV 900 (1936)



Federal 61 (1923)



Crosley 48 (1931)



Westinghouse RA/DA (1921)



Kennedy 281/521 (1921)



Radiola Grand (1923)

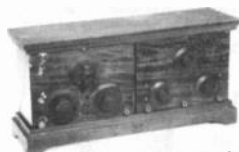

Radiola V (1923)



Detector OTB, London



"The Crosley Pup" (1925)



The Radio Shop (1924)



HF Coupler (1916!)



Cossar 1210 (1939)

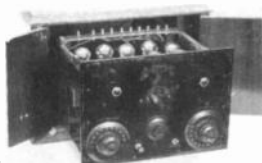

Federal 141 (1925)



Paragon RA10/DA2 (1920-22)



RCA: Aeriola SR (1922)



Federal 57 (1922)



De Forest D-12 (1924)



Westinghouse RA/DA (1922)



Kennedy 521



Crosley 54 (1931)



Sachsenwerk WV (1927)

Marconi 703 (1937)



Atwater Kent 10C (1924)



Schneider/Opel Type K (1925)



ZENITH "Lazy Bones" Dealer Display!



FORSALE: 1950 Lazy Bones Remote Control display. Good for a museum or major display, when set-up it's 4-1/2' high by 7-1/2' wide, and shows a Porthole TV with rotating photos behind the screen, and a man in an easy chair with his dog. The area above the TV is soiled but it's restorable. With boxed LAZY BONES unit. A one-of-a-kind! \$295 (Picked-up or a crate can be built)

FORSALE: Zenith Porthole TV similar to the one illustrated in the display. Nice, complete, as found condition...\$185

FOR SALE:

Philco 50-701

Very scarce Philco 7" black bakelite TV which is a copy of their wooden 702 series; a very heavy set with unusual 1B3 high voltage supply for the 7JP4. It has the original back. These are really hard to find! Priced at only...\$245



FOR SALE: Admiral 10"

Bakelite Console. This was the largest piece of bakelite molded in 1948-a 10" TV that is only 32" high! No cracks or breaks. As found with original chassis...\$270

Empty bakelite cabinet-\$225

With modern color TV-\$385



FOR SALE: Philco

48-1001. This 1948 Philco TV has a 10" picture tube and 8 channel tuner. Exc wooden television, complete with knobs, back, chassis, etc. Priced at....\$180



FOR SALE: FISHIBA. No, not a Toshiba, this black plastic "TV set" is actually a fish tank which is styled to resemble a 1970s television! Think how many stares you'll get with this filled up...\$58

FOR SALE: RCA

Phono Model 7-EY-1JF. Sure you've seen the brown bakelite RCA's, but this is a nice 1950's vacuum tube phono in grey plastic with a pink front, and a brass button with the Nipper logo and "his MASTER'S VOICE"...\$59



FOR SALE: Zenith

Trans-Oceanic A600. Working 7-band portable 6A40, nice condition but the dial string has come off. Includes flip-down chart, operating guide, schematic, 1956 foreign calls, plus 8 page gold and black printed dealer brochure. Working \$91



FOR SALE: Radio Information. Back issues: Great for reference; maybe you'll even find the review of my Radio/TV Price Guides!

- >>>A.R.C. 1987-1990, 19 assorted issues...\$24
- >>>A.R.C. 1991...all 12 issues...\$16
- >>>A.R.C. 1992...all 12 issues...\$15
- >>>A.R.C. 1993...all 12 issues...\$15
- >>>A.R.C. 1994...all 12 issues...\$14
- >>>AWA's "The Old Timer's Bulletin". 1992 through 1995, 16 various issues...\$18
- >>>Radio Age Apr '91-Nov '93, all 32 issues...\$25
- >>>Mid-Atlantic ARC, 1991-'93, 25 issues...\$15
- >>>New Jersey and New England, 15 iss...\$8

Lots of illustrated articles...unbelievable ads!



Now you can you find the date of manufacture of nearly any radio or TV from 1946-1970!

This 1970's Sam's Photofax Index includes a printed sheet which helps you date your sets-\$12

CLASSIFIED ADVERTISING POLICY

ONE FREE 20-WORD AD for subscribers in each issue; additional words are 25¢ each. See details below. Classified ads sent by mail, fax or by any other method must be received (not just postmarked) by Noon Eastern Time on the classified ad deadline date to guarantee inclusion in the current issue. Late ads are held for the following issue. Please enclose correct payment with all ads. Stamps or cash are OK for small amounts. (Canadian and other foreign advertisers, please see "Payment" on page 2 for methods.) *Free words* cannot be accumulated from month to month; free words must be requested when ad is submitted.

Faxed & e-mailed ads: Please see additional information on the inside front cover.

When including ads with other A.R.C. correspondence, write the ads on a separate piece of paper. Include SUB# with ad. Ads may be sent in advance; but, write each ad on a separate piece of paper and indicate the month (or successive two months) you want the ad to run.

To minimize our typing errors: Please write legibly. Use both capital and small letters. Do not use a dash between words. Carefully write the following numbers and letters (especially in model numbers) since some can look alike; for example 1, I and l (the number one, the capital i and the small l). Also: 0, O, o, Q and D; r and n; 6, b and G; V, U, u, v and Y; A and R; 5, S and s; 2, Z and z. We try to correct spelling errors, so when using an uncommon word or manufacturer which we might mistake as a more common word or manufacturer, note it so that we do not "correct" it. Editor's annotations are in [brackets].

Advertising is accepted only for early items related to radio, communication, etc. All items must be described fairly; reproductions, reprints and not-original items must be so identified. Advertisers must agree to respond promptly to inquiries and orders, to resolve problems promptly if the buyer is not satisfied, and to comply with a buyer's refund request on unaltered returned items.

The publisher reserves the right to edit ads without notification to the advertiser and to reject ads for any reason. Names other than the advertiser will be edited out of ads. Ads with non-radio-related items will be returned or edited unless the non-radio-related items are for trade of radio-related items, or they are incidental to and appear at the end of an otherwise acceptable ad. The publisher is not responsible for errors due to illegibly written ads or for any other reason.

Clubs: Since club activities receive free coverage on the *Coming Radio Events* pages, the free 20 words may not be used for club activity ads. See inside front cover for additional information.

CLASSIFIED AD DETAILS

Deadline: NOON ET— 10th of the month!

Classified ads must have a standard heading such as WANTED, FOR SALE, FOR TRADE, FOR SALE/TRADE, SERVICES, MESSAGE, HELP, AUCTION, MEET, etc. This heading is the only bold or all-capitalized words allowed in the ad. Capitalize only manufacturer names, model names, etc. This standard ad format makes scanning the ads easier.

Before writing your ad, please look over the ads in a recent issue of A.R.C., and try to write your ad in the same style. Full name (or company name) and address is required in all classified ads; we will add it if you forget.

To encourage varied content of the ads, the same classified ad may be run only once per issue and for only two consecutive months. (To run an ad longer, use a boxed classified or display ad.)

Classified Ad Rates per Month

Subscribers:

First 20 words: **FREE***

25¢ per word for extra words over 20 plus

10¢ per word for a shaded ad (count all words including free words).

* Subscribers may take 20 free words on only **one** ad each month.

Non-Subscribers:

41¢ per word plus

10¢ per word for shaded ad.

Please do not forget to send in the extra 25¢ per word when your classified ad runs over the free 20 words; your payment will be appreciated, and it will help to keep A.R.C. healthy.

BOXED CLASSIFIED AD DETAILS

Deadline: 1st of the month!

Boxed classified ads can run unchanged for three months or more. No words are free. Ads may be shaded and may include bold and all-capitalized words freely. The ad need not begin with "For Sale," etc. Minimum run is 3 months, prepaid. Discount: 10% for 6 months; 20% for 12 months.

Boxed Classified Ad Rates per Month

Nonshaded ads:

36¢ per word for all words,* none free, plus

10¢ per word for each bold word plus

10¢ per word for each all-caps word.

Shaded Ads (All words are bold at no charge):

45¢ per word for all words* plus

10¢ per word for each all-caps word.

Non-Subscribers:

Add 20¢ per word to above costs.

*Three words can be bold-all-caps at no extra charge.

PHOTO & DRAWING DETAILS

Deadline: 1st of the month

for all ads with drawings or photos!

Drawings and photos are encouraged as the response to your ad is much larger and the reader knows better what you want or are selling. Send in your drawing or photograph, and A.R.C. will reduce it or enlarge it as needed.

Photo and Drawing Rates per Month

\$20.00 per month for each photo or drawing

(if ad is canceled, this amount cannot always be refunded.)

CHANGES & CANCELLATIONS

Please check your ads carefully before sending them in. Once ads are received, it is not always possible to refund the amount sent, pull the ad or make changes.

IMPORTANT — COUNTING WORDS — IMPORTANT

The standard headings: WANTED, FOR SALE, etc., count as one word each time used in an ad. Name, address and (one) telephone number, count as 6 words, regardless of length. Ham call letters and business name can be included in the 6 words and do not count extra. Full name (or company name) and address is required in all classified ads. Each additional word, abbreviation, model number or number group, extra telephone numbers, fax, e-mail, etc. count as one word each. Hyphenated words count as two words.

SECOND CLASS

ANTIQUE RADIO CLASSIFIED



A.R.C., P.O. Box 2, CARLISLE, MA 01741

RETURN POSTAGE GUARANTEED

G-56 SUB# 22-17477 EXP=DEC96
FRED KILMER
59 ALDA DR NY 12603
POUGHKEEPSIE

**CLASSIFIED AD
DEADLINE MAY 10th
Noon Eastern Time**