

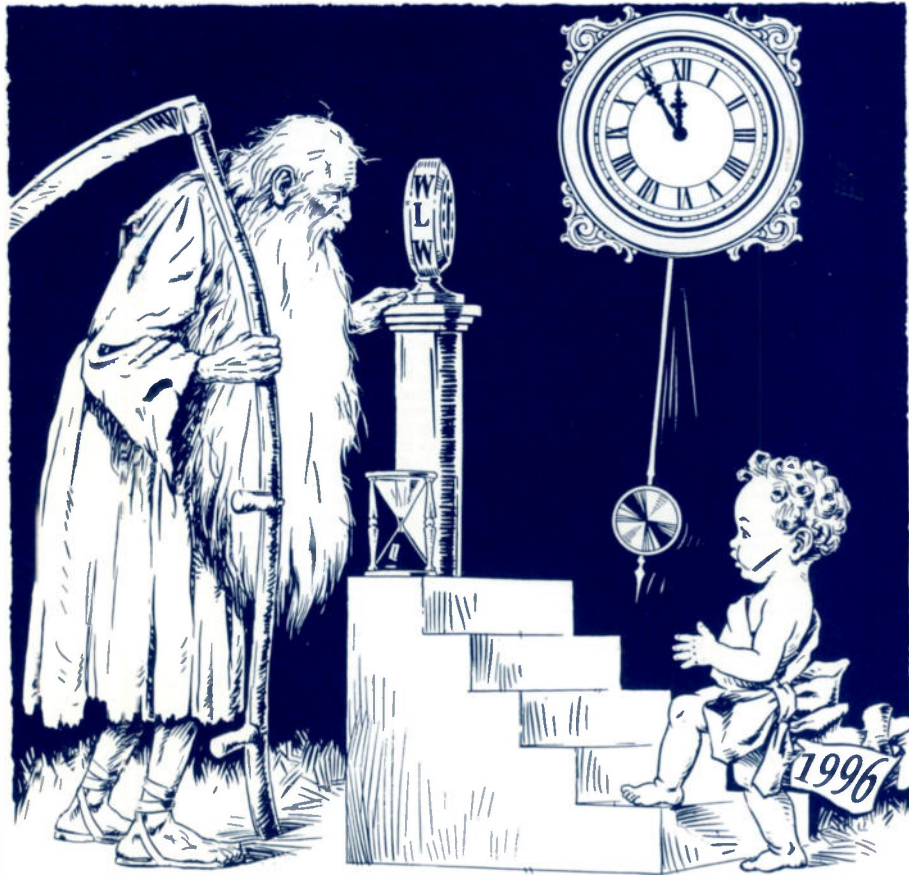

VOLUME 13

JANUARY 1996

NUMBER 1



1995 Signing Off - 1996 Will Be On
In Five Minutes - Please Stand By

A.R.C. — THE NATIONAL PUBLICATION FOR BUYERS AND SELLERS
OF OLD RADIOS AND RELATED ITEMS — PUBLISHED MONTHLY

ANTIQUE RADIO CLASSIFIED

Antique Radio Classified (ISSN:8750-7471) is published monthly, 12 times per year, by John V. Terrey, One River Road, P.O. Box 2, Carlisle, MA 01741. Second-class postage paid at Carlisle, MA, and additional mailing offices. Telephone: (508) 371-0512, 8:30 AM to 6:00 PM ET weekdays; machine answers phone at other times.

Annual subscription rates within the U.S. are \$36.95 by Second Class mail and \$53.95 by First Class mail.

Annual foreign rates. By air: Canada - \$58.00; Mexico - \$64.00; Other foreign countries - \$100.00. Surface mail: Canada - \$47.00; Other foreign countries - \$52.00. (Surface delivery to countries other than Canada may take two or more months and cannot be guaranteed.)

Two-year subscriptions are twice these rates and receive an extra month. Sample issues are available free on request.

© Copyright 1995 by John V. Terrey.

POSTMASTER: Send address changes to Antique Radio Classified, P.O. Box 2, Carlisle, MA 01741. Printed in U.S.A.

STAFF:

Publisher and Editor: John V. Terrey
Production Manager: Scott J. Young
Office Manager: Lisa A. Friedrichs
Advertising Manager: Cindie P. Bryan
Managing Editor: Dorothy Schecter
Radio Events Editor: Chris Frederickson
Publishing & Editorial Staff: Ray Bintliff, Dave Crocker, Dick Desjarlais, Bobby Lyman, Jean Meldonian
Founding Publisher/Editor: Gary B. Schneider
Contributing Writers: Mike Adams, Richard L. Arnold, Ray Bintliff, Ron Boucher, Paul J. Bourbin, Norman S. Braithwaite, Dave Crocker, Alan S. Douglas, Richard C. Foster, Fred Geer, Jim Kreuzer, Ron Ramirez, Henry Rogers, Ian L. Sanders, Gary B. Schneider, Daniel Schoo, Dwane Stevens, Frank R. White, Ralph Williams

PURPOSE. Antique Radio Classified is published for people involved in the radio collecting hobby. Its purpose is to stimulate growth of the hobby through the buying, selling and trading of radios and related items, and to provide a monthly forum for the interchange of ideas and information.

CONTACTING ANTIQUE RADIO CLASSIFIED. All correspondence should be sent to:

A.R.C., P.O. Box 2, Carlisle, MA 01741.

Only UPS, Federal, etc. items to street address: One River Road.

Telephone: (508) 371-0512; Fax: (508) 371-7129

E-mail: ARCMagazine@aol.com — Web: www.antiqueradio.com

Please, no classified ads by telephone; thanks.

Your ads, renewals, letters, etc. can be handled faster and more efficiently if your name, address and SUB# are written on each.

Unfortunately, A.R.C. is not staffed to answer letters with questions about antique radios or requests for advice. However, A.R.C. does solicit letters of interest to its readers and publishes them as space permits. A.R.C. assumes that permission is given to edit and to publish all correspondence and articles received unless otherwise indicated.

DISPLAY AND BUSINESS CARD ADS — DETAILS AND RATES

The deadline is the first of the month for display and business card ad artwork, payment and repeat requests.

Advertising is accepted only for early items related to radio, communication, etc. All items must be described fairly; reproductions, reprints and non-original items must be so identified. Advertisers must agree to respond promptly to inquiries and orders, to resolve problems promptly if the buyer is not satisfied, and to comply with a buyer's refund request on unaltered returned items.

Advertising must be prepaid, except as noted below; see "Payment" paragraph above for details. Late ads will be run only if space and time permit. Since artwork is reduced to 63% in the printing process, originals must be the artwork size listed below. Do not send in artwork on art board or send negatives. Ads should be typeset or typed neatly with a carbon ribbon, black ink (not pencil) on white. If used, reverse type must be limited to 25% of the ad. If you want us to prepare your ad, include the one-time cost below for A.R.C. to make up the ad.

Photos should be at an 85-line screen; otherwise, add \$14.00 per photo for screening. Do not cut or trim photos or glue photos to artwork; submit separately.

If you are confused by these requirements and terms, please

Page	ARTWORK SIZE (SEND IN THIS SIZE)		As Printed (size in magazine)	
	H x W (inches)		H x W (inches)	
Full	12 7/16 x 7 1/2		7 3/4 x 4 3/4	
1/2 H	5 1/4 x 7 1/2		3 5/16 x 4 3/4	
1/2 V	12 7/16 x 3 9/16		7 3/4 x 2 1/4	
1/4	5 1/4 x 3 9/16		3 5/16 x 2 1/4	
1/8	2 5/8 x 3 9/16		1 5/8 x 2 1/4	
Business Card (1st)	2 x 3 3/4		1 1/4 x 2 3/8	
Business Card (2nd...)	2 x 3 3/4		1 1/4 x 2 3/8	

* Full page, 6-mos.; 1/2 due with order; 1/2 due in 3 mos. ** Full & 1/2 page, 12-mos.; 1/2 due with order; 1/2 due at 3, 6 & 9 mos.

† For 6 and 12 month ads, no ad make-up charge if no change is made to ad for entire run.

GUARANTEE. You may cancel your subscription at any time and receive a pro rata refund for issues not yet mailed. If errors to ads are made by A.R.C., upon request a free correction will be run in the next available issue.

PAYMENT. Please send in full payment with your order or ad. A.R.C. does not carry accounts; all subscriptions, ads, etc. must be prepaid (except for the 6 and 12 month display ads indicated below). Pay in U.S. funds. Checks drawn on a U.S. bank, money orders, VISA or MasterCard (\$10.00 min.) are preferred. Make check out to "A.R.C." U.S. stamps or cash are OK for small amounts. Canadian payers may send a Canadian check but specify U.S. funds. Subscriptions will be prorated to amount sent if amount is incorrect.

FAX & E-MAIL PROCEDURES/PAYMENT. Subscriptions, book orders, classified ads, display ads, etc. are welcome by fax or e-mail. Deadlines are the same as for ads received by mail. Please calculate the amount due. Payment by VISA or MasterCard is preferred if your order is over \$10. If under \$10, or if you prefer to send a check or money order, state the amount being sent and that the payment is in the mail. Do not send another copy of your ad with your payment; simply indicate that it is a fax or e-mail payment. If you want confirmation of our receipt of your fax, call immediately after sending your fax.

CHANGE OF ADDRESS. Please notify us 4 weeks in advance of a change of address. Send both your new and old addresses, and include your SUB# and effective date of your new address. Temporary address changes can be made also.

SUBMISSION OF MATERIAL. Antique Radio Classified welcomes and solicits information that pertains or relates to radio history or collecting. This may include articles, book reviews, photos, information on upcoming radio events, meetings, antique radio organizations, radio auctions, sources of old radio and restoration supplies, and other related and interesting material. All material submitted should be carefully researched, typed and accompanied by good photos, if appropriate. Computer disks are appreciated. Writing guidelines are available upon request. Unless prior arrangements are made, all submitted materials may be edited, become the property of Antique Radio Classified and will not be returned. Publication is subject to approval by A.R.C. and to time and space constraints.

MAILING OF ISSUES. U.S. subscribers can receive A.R.C. by First or Second Class mail (Second Class is the way most magazines are mailed). The mailing of First Class copies is staggered over one to four days with faraway copies mailed before local copies. Non-U.S. copies are mailed on the first day. Second Class copies are mailed on the last day. Mailing dates change each month, but mailing is usually completed by the 26th of the month. First Class copies usually are received by the 5th of the month; copies by Second Class mail, by the 10th.

ETHICS. No person involved in the production of A.R.C. is to act on any information in the magazine until the first delivery day after local copies are mailed.

DISCLAIMER. The publisher is not responsible for any buying and selling transactions incurred, or for any other use of the contents of this publication.

Antique Radio Classified subscription rates, frequency of publication, content, policies, size and ad details, and rates are subject to change at any time by A.R.C.

contact A.R.C. before beginning to prepare your ad. We will be happy to advise you on your ad ideas, estimate how much the ad will cost, recommend an ad size, etc.

We assume that advertisers want all ads which are submitted to run without delay; therefore, we will run the ad and bill for any additional work required for the ad to meet these specifications. A late ad will run beginning with the next month. "Tear sheets" will be sent only for 1/8-page or larger ads and only if requested when the ad is submitted.

First business card per advertiser is at lower rate.

The 3-month rates represent about an 11% discount, the 6-month rates 23%, the 12-month rates 30%. Placement requests: add 15% but call first. Clubs: write for discount policy.

Cost for	Cost for	Cost for	Cost for	One Time
1-month	3-months	6-months	12-months	to make
\$249.00	\$664.00	\$1149.00*	\$1999.00**	\$69.00†
126.00	336.00	582.00	1013.00**	35.00†
126.00	336.00	582.00	1013.00**	35.00†
64.00	170.00	295.00	514.00	18.00†
33.00	88.00	152.00	265.00	8.50†
not avail.	45.00	78.00	136.00	6.50†
not avail.	59.00	102.00	177.00	6.50†



EDITOR'S COMMENTS

As we ring in the New Year here at A.R.C., we are still basking a bit in the glow of the applause for the December 1995 issue, our first to include full-color article photos. At 116 pages, it also was one of our largest issues. This month, collectors must be concentrating on holiday shopping, as we have received fewer ads than usual. The result is a slightly scaled down January issue, but one we know you'll find quality-filled.

The Supreme Instrument Company is the topic of our lead article by Dale B. Allen. Unlike so many of the early radio manufacturers, Supreme is still in business — as a subsidiary of Hickok. A Supreme signal generator led Dale to Greenwood, Mississippi, and an interesting history of the firm. Dale also helped us to shed light on the correct spelling of "Hickok."

Richard Arnold continues to provide us with short reports on a variety of sets. In this issue, he describes the RCA Model 121, a "midget radio," and explains a bit about the midget radio market.

We present this month our last installment on the Henry Ford Museum Auction, along with commentaries from two collectors — Ludwell Sibley and Richard Foster. Richard suggests that a comprehensive catalog should have been a requirement for a sale of this significance. Although belated, such a project is being considered jointly by A.R.C. and Jim Kreuzer.

This final report includes a listing of many of the vacuum tube prices. Some lots not reported were such a mixture that their prices were meaningless.

Photo Review this month features two unique horn speakers — a Burns horn with a Radio Cabinet Co. Orchestron bell and the Payne Co. "Oracle" speaker/lamp combination. *Radio Miscellanea* highlights the problems in shipping radios.

Engineer and collector Blake Dietz presents a comprehensive discourse on "getters" in vacuum tubes. This may be more than you need or want to know, but

his presentation is both concise and understandable.

We always welcome a touch of levity. Ron Boucher's Gridley Shop cartoon provides just that.

Although auctions and reports seem to saturate the collector calendar, and sometimes the pages of A.R.C., two more are reported this month. About 170 items were sold at the Colorado Radio Collectors' fourth annual auction in September, while more than 300 lots in the October Finkel auction totaled over \$30,000.

A.R.C. on the Web. Monthly, we are posting radio event information, selections from our printed version, links to other "sites," and our marketplace of books and videos. Our URL is "<http://www.antiquradio.com/>".

Advertising rate increase. All classified and display advertisers should review the inside front and rear covers for our 1996 rates. The change with the broadest impact is the increase to 25¢ per word for words over the subscriber's free 20 words. These increases make it possible for A.R.C. to continue to provide a quality forum for all in the radio collecting community.

Coming Radio Events. Included in the three dozen U.S. events listed for January 1996 on our *Coming Radio Events* pages is the two-day Mega Auction in Houston, Texas. This is the big January event. However, I will risk being a little parochial and give the two events in our neighborhood special mention.

The quarterly New England Antique Radio Club Swap Meet is on January 20 in Nashua, New Hampshire, northwest of Boston. The Greater Boston Antique Radio Collectors' (GBARC) Radio XXVII will be held on February 25 at the Westford Regency Hotel, off I-495, in Westford, Mass., also northwest of Boston. Last year, this event drew over 600 attendees and 90 seller tables. A visit to your editor's collection is a feature of this event. A.R.C. runs Radio XXVII for GBARC, so we issue a special invitation to our readers to make the trip.

Happy New Year from all the A.R.C. staff.

John V. Terrey, Editor

ON THE COVER

Our cover for the New Year's issue gives us the opportunity to reflect, not only on the past year, but also on a decade of progress. How can that be? Well, in a nostalgic moment, your editor remembered an early A.R.C. cover that portrayed a New Year's theme. As luck would have it, that issue happened to be the January 1986 issue, taken from a 1927 ad for WLW (see A.R.C., November 1992). We decided to update the '86 cover and to examine how far we have come in ten years.

A first reaction as we leafed through this decade-old issue was a sense of stability and continuity. Many of the same advertisers and contributors still appear in current issues. Ads for Radiofest and Radio XV (now approaching XXVII since there were two in some years) reminded us that today's multiple radio events have strong roots.

A second reaction was to realize how much A.R.C. has changed in the past decade. First, in size — the 1986 issue has 24 pages, whereas we now publish 100-plus pages regularly. Second, in quality — our efforts to

improve the quality of writing, photos, layout, and service to the radio collecting community have paid off in a big increase in interest in A.R.C. The number of subscribers has risen seven-fold — from just over 1,000 in January 1986 to over 8,000 in January 1996.

Have radio prices changed? Looking over the prices in the 1986 classified ads is an amusing exercise. An Atwater Kent breadboard is for sale at \$350. Today, that item would bring about three times that amount. On the other hand, a Crosley 51, offered at \$100, would sell at about the same price today.

Improvements mean subscription rate increases, and ours have increased about two and a half times in ten years. But, A.R.C. has quadrupled in size, and keeping pace with costs has been a constant challenge.

The January 1986 A.R.C. was our 18th issue, while this January 1996 issue is Number 138. In all, reflecting on the New Year's issue of a decade ago has given us a sense of pride in our progress and a renewed incentive to improve with each passing year.

WITH THE COLLECTORS

The Supreme Instrument Company

BY DALE B. ALLEN

On a recent trip to Los Angeles, I spotted an elegant example of late 1930s radio test equipment — a Supreme Model 582 signal generator, shown in Figure 1. What first caught my eye was the natural finish, tongue-and-groove wood cabinet and the etched front panel. I decided that the generator would be useful in restoring antique radios, since one of the main features is a built-in sweep generator for all of the standard IF frequencies.

I purchased the signal generator, knowing I would need the manual and schematic to get it up and running. After an unsuccessful search through the A.R.C. ads, I decided to call "information" in the town named on the front panel — Greenwood, Mississippi. Much to my surprise, Supreme is still operating in Greenwood, only 16 blocks from its original location. Figure 2 shows Supreme's humble beginnings in the 1920s, while Figure 3 pictures the Supreme plant as it looks today.

The company is now known as the Supreme Electronics Corporation, and it is a subsidiary of the Hickok Electrical Instrument Company of Cleveland, Ohio. Yes, this is the same Hickok of tube tester fame, which was founded in 1910 and which acquired Supreme in 1956.

Upon making the connection, I explained to customer service that I needed a copy of the Model 582 manual and schematic. I was referred to a "long-term employee" who perhaps would be able to locate the information.



Figure 1. A Supreme Model 582 signal generator in a natural finish, tongue-and-groove wood cabinet with an etched front panel.

There are 27 employees still working at Supreme who have 25 or more years of service. But, Ms. Janie Cain beats them all — she celebrated her 60th year with Supreme in September of 1994. At 84 years young, Ms. Cain has no plans to retire. Of course, Ms. Cain found the manual for me, and after talking to her, I decided there was a story about Supreme that should be shared with other collectors.

SUPREME HISTORY

Supreme was founded in 1926 in Greenwood, Mississippi, by a Mr. Williams, who began producing radio set analyzers for radio servicemen. Greenwood was and still is a small agricultural community with relatively few industrial jobs. However, Supreme has the distinction of being the first industry in Greenwood to employ female workers.

By 1929, Supreme had an Engineering Department, and its product line had grown to include volt-ohmmeters (VOMs), multiband signal generators, and vacuum tube testers. Around 1930, the company developed financial troubles and was taken over by B.F. Dulweber of the Kratzer Cured Lumber Company. Mr. Dulweber's son was made president of Supreme when he graduated from college in 1932. By the time Ms. Cain joined the company in 1934, Supreme already led the field in the production of test equip-



Figure 2. Supreme's humble first location was in a garage near Main and Henry Streets in Greenwood, Mississippi.

ment for servicing radios.

According to Ms. Cain, the company survived the Depression because people could not afford new radios and needed to have their old radios repaired. This, in turn, created a need for affordable test equipment, which Supreme excelled in building.

Ms. Cain started working at Supreme because the telephone company wouldn't hire married women. She says, "It's still a great place to work. What company today would let three people in their 80s keep working?" The starting pay in 1934 was 25 cents per hour, and paid holidays and vacations were non-existent. At this time, Supreme had approximately 50 employees (Ms. Cain remembers 47 of them by name).

From 1932 to 1941, Supreme employed 150 to 200 persons, including 17 graduate engineers. One of them was Grady Perkins who became Chief Engineer in 1937. During this period, Supreme products were assembled only while school was in session, and the summers were devoted to the design of new products. Workers were recalled in September for another nine months.

The years 1942 to 1945 marked a period of steady expansion for Supreme. The company did not employ the production-line concept until the needs of World War II dictated a change in production processes. Prior to this time, one person was responsible for an instrument from start to finish and sometimes even signed it, as an artist would. My Model 582 was signed by a former coworker of Ms. Cain's whom she fondly remembers.

When I complimented her on the Model 582 construction, she replied, "Southern women know how to build things right." Inside the beautiful wooden case is a chrome-plated box which pro-



Figure 3. Supreme as it looks today on Carrollton Avenue in Greenwood, Mississippi.

vides an overall shield for the generator. The chassis is also chrome-plated, and the wire harnesses are laced, military style.

By 1942, Supreme was helping the U.S. Government specify the test equipment necessary for troop support. Due to the acute shortage of panel meters, the company enlisted outside design assistance from Washington, D.C., and began producing in excess of 1500 meters per day to meet both the needs of Supreme and other equipment suppliers.

Supreme People

Other former Supreme employees:

1955	Frank Christopher, Meter Production Manager.
1928-1972	Clarence Greeley, Engineer.
1930-1937(?)	Floyd Faucett, Engineer.
1936-1964	Harper Johnson, Engineer.
1950	Clyd Farrell, Head Bookkeeper.
1970	Charles Cooper, Purchasing.
1935-1937	H. H. Shotwell.

Supreme 30-year employees:

M.L. Parkerson
Hazel Wheeler
Ruth Williams
Jackie James
Betty Lambert
Faye Cutts
Evelyn Long, retired, after over 40 years
Jamie Cain, 60 years as of Sept. 1994



Figure 4. A Supreme Model 542 pocket voltmeter produced at a rate of 200 per day during World War II.

During this period, Mr. Perkins redesigned the horseshoe magnet, used in all meters, to a bar magnet, thus saving much time and material. This basic design is still in production at Supreme and was copied by most of the competition.

Supreme operated on three shifts to help meet wartime needs and produced four types of test equipment for early radar systems. Ms. Cain re-

(Continued on following page)

(Supreme Instrument Company, continued)

calls one of these instruments as a Model 542 pocket volt-ohmmeter, shown in Figure 4, which was produced at the rate of 200 per day during the war. She moved to the Calibration Department in 1942 to test the Model 542 and is still there today as a Technician III.

In 1947, as Supreme introduced its first 3½-inch oscilloscope, Grady Perkins purchased Supreme and managed it until the company was acquired by Hickok in 1956. Mr. Perkins continued as a consultant through 1965 and still lives in Greenwood, Mississippi, today.

Acknowledgement:

A special thank you to Ms. Janie H. Cain who inspired this article and provided numerous per-

sonal memories of the Supreme Instrument Company.

Reference:

"History of Supreme & Hickok," internal company document.

(Dale B. Allen, 606 Third Street, Herndon, VA 22070)

Dale Allen has been interested in radio since building his first Philmore crystal set, ca. 1948. An electrical engineer, he has designed several surveillance receivers during his career. He collects and restores radios (post-1930), TVs (pre-1950), wire recorders, and test equipment, and is an active member of the Mid-Atlantic Antique Radio Club.

"Hickock" or "Hickok"?

Dale Allen's mention of the fact that the Supreme Co. was acquired by the Hickok Electrical Instrument Co. in 1956 renewed our interest in the spelling of the latter company's name. As far back as A.R.C.'s November 1990 issue, page 19, regarding an article on the Hickok 155 radio traceometer, we asked the perennial question — "Is it 'Hickock' or 'Hickok'?" Our answer then was that it appeared to be both, since early catalogs showed instruments manufactured by "Hickock," while later catalogs show test equipment by "Hickok." We hoped that readers would enlighten us on the subject.

Until now, there has been no response. But, we asked Dale Allen to do some additional research on the Supreme-Hickok history, and the following is his reply:

"The Hickok Electrical Instrument Company was founded in 1910 by R.D. Hickok, Sr., in Atlanta, Georgia, to produce panel meters for switchboards. (Note that the spelling of the family name without the second "c" is the correct one.) The company moved to Cleveland, Ohio, in 1913, to be closer to materials and markets and is still there today. Hickok produced the first commer-

cial tube tester in 1920 and began producing aircraft instruments in 1936. Hickok later became a major supplier to the war effort, and after the war, remained a strong competitor of Supreme until acquiring that company in 1956. In 1995, the company name was changed to Hickok, Inc."

Following up on this information, A.R.C. began to do some further research. Our suspicion that the discrepancies in spelling were merely catalog typos was confirmed by close examination of the ads from the 1939 Lafayette Catalog #76, page 75, and the 1940 Lafayette Catalog #78, page 93, both pictured here. For example, the 1939 caption, "Hickock No. 18 Oscillator," clearly misspells the name, because under magnification "Hickok" may be seen pictured on the instrument itself.

The 1940 Lafayette Catalog #78 shows an ad on page 93 in which the caption has the correct spelling; however, the index reads "Hickock." Those of us in the publishing business know well the pitfalls of proofreading. Here is a good example of how an error can be perpetuated ad infinitum.

Another mystery of radio history appears to be solved, unless someone out there has more to add. (Editor)

HICKOCK No. 18 Oscillator

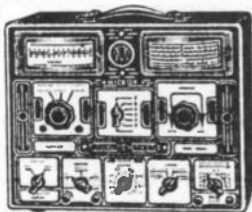

Covers 100 kc. to 30 mc. in 6 ranges. Accuracy better than 1/4%. Two a.f. oscillators 0-400 cps., fixed, 100-10,000 cps. variable. Direct reading scale. Frequency modulated output (30 kc. sweep) available over entire range.

Three db ranges: -10 to +6, +6 to +22, +22 to +38. Output ratio-control provides step attenuation of r.f. and a.f. output. For 110 volts, 50/60 cycles a.c. 13x10x7". Shpg. wt. 21 lbs. **K21635** --- **\$52.92**
Your Cost.....

— HICKOK —

Model 180 Signal Generator



Covers 100 KC. to 30 mc. in 6 ranges. Accuracy better than 1/4%. Two A.F. oscillators 0-400 cps., fixed, 100-10,000 cps. variable. Direct reading scale. Frequency modulated output (30 KC.

sweep). Amplitude modulated RF. Unmodulated RF, and AF are all available. Output meter, ranges: -10 to +6, +6 to +22, +22 to +38. Output controlled by attenuator, continuously variable from 0 to 1.0 volt. Wired for crystal control (no crystal included). Crystal may be obtained later and installed without returning instrument to factory. For 110 volts, 50-60 cycles A.C. Size: 13x10x7". Shpg. wt. 21 lbs. **K21635** --- **\$55.86**
Your Cost.....

WITH THE COLLECTORS

Midget Radios and the RCA Model 121

BY RICHARD ARNOLD

One of the first magazine advertisements in 1930 on the new "midget" radios reads in part, "Only 17.5 inches high and 16 inches wide, with reception limited only by the suitability of your location." The radio industry invented the name "midget" for these radios, but years later they came to be called "cathedrals" or "tombstones."

This style of radio came into being on the West Coast in 1929, and by 1931 had spread across the nation. These radios were usually TRF (tuned radio frequency) sets that used the new screen-grid tubes. The cabinets of tombstone or cathedral design occasionally used moulded wood.

The power, tone and overall general performance left a lot to be desired. However, the weight of these sets (about 25 pounds) and the

price (averaging \$50) were well below that of the heavy and relatively high-priced consoles of the period (\$100 plus).

RCA had a pretty good clamp on the superheterodyne market and patents, and it wasn't until 1928-1929 that they really started to lift these restrictions. As a result, most manufacturers began producing superhet radios in the early 1930s. In 1933, there were 3,800,000 radio sets sold at an average unit price of \$61. In 1929, the average unit price of a radio sold was \$136. The midget radio market faltered for a while in 1931-1932, but then made a strong comeback for a few more years.

THE RCA MODEL 121

In 1933, RCA came out with the beautiful cathedral cabinet design of the Model 121, shown in Figure 1. This AC "midget" measures 17 inches high by 14 inches wide. The set has a broadcast band of 540-1500 Kc and a shortwave band of 5400-15.350 Kc.

The six tubes used are Types 58 (RF amplifier), 2A7 (oscillator and 1st detector), 58 (IF amp), 2B7 (detector/1st AF), 2A5 (audio) and 80 (rectifier). The radio has four controls — volume, tone, tuning (with a fine tuning feature to assist in tuning in the shortwave band), and a small knob on the right that pulls out to receive shortwave reception.

References:

Paul, Floyd A. *Los Angeles Radio Manufacturers*. Glendale, Ca.: Floyd A. Paul, 1994.
Radio Today, Jan. 1939, p. 12.

(Richard Arnold, PO Box 275,
Lone Grove, OK 73443)

Since 1985, Richard Arnold's collecting interest has been primarily in cathedrals and 1920s battery sets. His collection of over 60 radios ranges from crystal sets to a 1928 American Bosch desk radio in a Pooley cabinet. His prize is the 1932 Jackson Bell Peter Pan featured in the June 1991 A.R.C.



Figure 1. The RCA Model 121 midget has a beautiful cathedral cabinet design.



FORD MUSEUM AUCTION

The Henry Ford Museum Radio Auction Part 3 — Report and Reflections

COMPILED FROM INFORMATION FROM JOHN V. TERREY, LARRY BABCOCK, RICHARD ESTES, LUDWELL A. SIBLEY, WILL JENSBY, JIM KREUZER, AND AUGUST LINK

The following is the third part of our extensive report on the Ford Auction. The December issue included a detailed list of the non-vacuum tube items, as well as the reflections of two collectors who attended. Here we present the vacuum tube sales listing and two additional collectors' responses to this extraordinary event. (Editor)

The Henry Ford Museum Radio Auction was held on October 7 and 8, 1995, in Dearborn, Michigan, where about a thousand lots drew \$590,693. Auctioneer Richard Estes of Medina, Ohio, was assisted by Jim Clark and other members of the Michigan Antique Radio Club, and Bob Dobush, who got the tubes into logical order and did emission testing of the more interesting ones.

The sale was held in a large tent on the museum grounds and ran from 10 A.M. to 5 P.M. the first day, and 10 A.M. to 3:30 P.M. the second day.

Last month's report included the extensive listing of radio sets and other non-vacuum tube items, as well as the personal reflections of your editor and Larry Babcock. This month, we add those of Ludwell Sibley and Richard Foster, a collector who was unable to attend. Each reports from his own perspective. We also continue our photo report of the event, including several broadcast-era and obscure items.

The highlight of the tubes auctioned was an unmarked tube, thought to be a DeForest CF-340 Oscillon, which sold for \$2,100. Two DeForest spherical Audions joined the Oscillon as high-priced items. They sold at \$800 and \$1,400, similar prices to those for spherical Audions at the annual AWA tube auction.

Western Electric VT-1 tubes, all good and sold in various combinations, brought from \$37 to \$222 each. Prices for VT-1s at the AWA auctions have

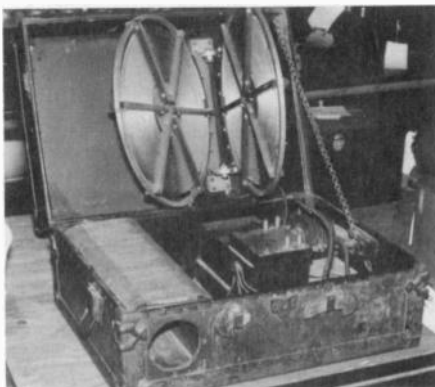

One of the pack sets in the auction, which sold for \$4,500 to \$9,000 without the receivers. (Terrey photo)

been from \$42 to \$75 each. WE-216A tubes, which went for \$110 each, have sold for \$35 to \$110 each at AWA auctions.

Popular battery set tubes sold for at least twice their commonly seen prices — 199s sold at \$25 to \$75 each and 201As at \$55 to \$73 each. WD-11s soared to \$100 to \$125 each!

Condition, as with many of the radios sold, seemed unimportant for some rare tubes, with a Sodian D-21 selling for \$80 and a Welsh WT-501 Peanut selling for \$50, even though they both had open filaments.

Again, we thank the contributors for their cooperation. Without their input, A.R.C. would not be able to achieve the degree of accuracy that we want to offer our readers.

Now that the Ford Auction is part of radio history, perhaps some of you have been thinking about it and would like to share reflections or comments with the antique radio community. If so, let's hear from you, even if you did not attend.

The tube listing follows. All amounts ending in ".50" are rounded off to the dollar.

As with all auctions, please note the "warning box" on page 18.

Notes and abbreviations:

e=excellent, vg=very good, g=good (regarding tubes, refers only to filament), f=fair, unk=unknown, BB=brass based, TT=tipped, N.I.B.=new in box.

Vacuum Tubes:

01-A, (22) g.....	\$180
6A6, 2B7, etc., (19).....	5
45, (10), (5) g.....	95

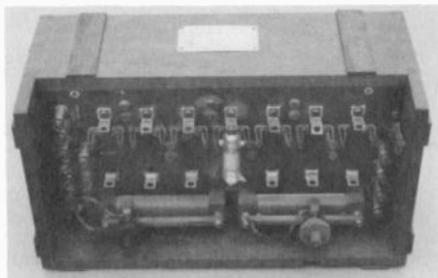

A British Marconi Type 55 amplifier using seven V24 tubes, one of which can be seen in the center. (McElroy photo)

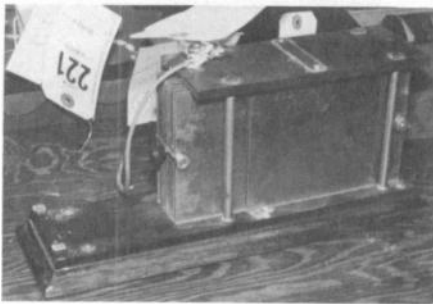

A Murdock variable capacitor using sliding rectangular plates. (Terrey photo)

200A etc., (5), g	50
201A, BB, TT, (7), (4), g	295
226, (18)	20
865, 866A, 203, RX-21, (8)	15
Arcturus 127 blue, g	27
Arcturus blue RA-1, g	90
Arcturus blue Wunderlich detector, 6-volt, g	105
Arcturus blue, (5), g	65
Audiotron, open	35
BH and (2) others	25
Box lot, big-pin, w/(6) 01-A	90
Box lot, (8), WD-11 and WX-12, g; (6) open	130
Brightson blue, (2), g	125, 140
British HL2, g	10
British tubular triode, g	25
CG-1162, g	50
CG-886, g	100
Cunningham C-12, BB, TT	100
Cunningham C-301, BB, TT, g	40
CX-331, pair, g	10
Daven MU-20, g	35
Daven MU-series, g	75
DeForest 401A, in '30s box	30
DeForest 410, (2), (1) g	25
DeForest 426(?), N.I.B., (2), g	140
DeForest 426, N.I.B., (2)	95
DeForest CF-340 Oscillon or unbased "H", 8", unmarked, g	2,100
DeForest DV-2, (3)	110
DeForest DV-3 (similar), unmarked, (3)	100
DeForest DV-3, (3), g	65
DeForest DV-3, in can, (2), g	175, 250
DeForest DV-3A, new in can	175
DeForest Singer rectifier, UV-202 size, g	310
DeForest single-wing spherical Audion, both fils g, short leads	1,400

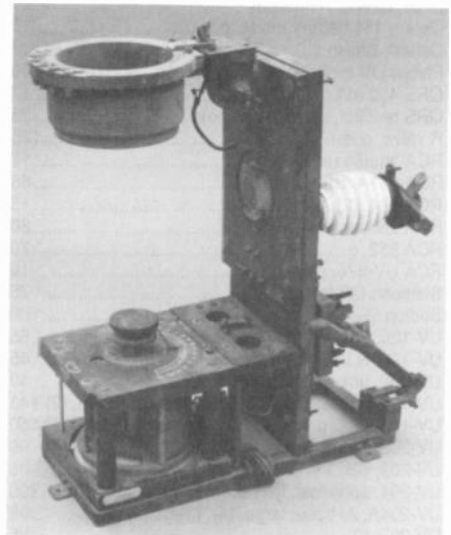

A Telefunken Type E-5 crystal receiver, ca. 1914, missing the detector and other parts. (McElroy photo)

DeForest single-wing spherical Audion, both fils g, glass repaired, degree of vacuum unk	800
DeForest tubular Audion, g	900
Eimac 75T, 250T, 1005(?), 872	17
Eimac 750T, dud	45
Eimac 2000T, dud	85
Eimac klystron, gold-plated demo version	25
FG-105, UV-852, Eimac 150T, one other	50
French transmitting, like SIF (Tyne, p. 397), g	400
GE 50, N.I.B., g	95
GE Cooper-Hewitt rectifier, small, dud	50
GE WW I, 210-size, glass broken	300
GE-1, BB, TT, g	55
Gecovalve, MS-4, g	27
Kellogg 401, g	25
Moorhead "A", g	90
Musselman 5EA, g	10
Myers RAC in socket, g	60
Myers RAC, open	65
Myers RAC-3, fil g	60
Myers RAC-3, in UV adapter, g	70
NS-4 amplifier, BB, TT, g	25
O. T. transmitting valve, BB, TT, g	155

(Continued on following page.)

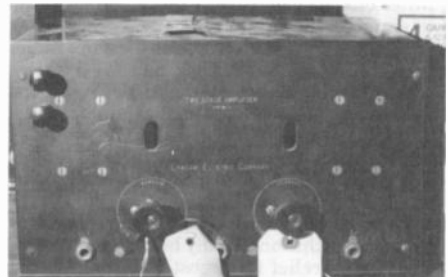

These early units from obscure manufacturers brought surprisingly high prices. The Home Manufacturing Company of Jersey City 3-tube detector and 2-step amplifier at left sold for \$750; the Lawsam Electric Company RA-7 2-stage amplifier, at right, for \$350. (Terrey photos)

(Ford Auction, continued)

Osram 414 battery triode, g	10
Osram, British	2
Philips DV triode, g	130
QRS 400 mA rectifier	17
QRS rectifier, untested, in box	35
R valve, open	125
RCA "studio rectifier"	10
RCA 201A, BB, TT, g	55
RCA 211, (2)	15
RCA 250, emission g	80
RCA 852, g	70
RCA UV-876, g	10
Siemens GR transmitting	75
Sodium D-21, open	80
UV-120, (4), g	65
UV-120, N.I.B., (2), g	45
UV-196, unk	40
UV-199 in box, (6), g	(2), 60; (2) 75; (2) 145
UV-199, (20), g	(4), 55; (4), 110; (6), 145; (6) 150
UV-202, (2), g	15, 90
UV-202, BB, TT, g	85
UV-204, spherical, less base and top cap, g	300
UV-204A, Al base, large, (4), (3) g	35
UV-207, (2)	85
UV-218, large, g	30
UV-851, fil g	80

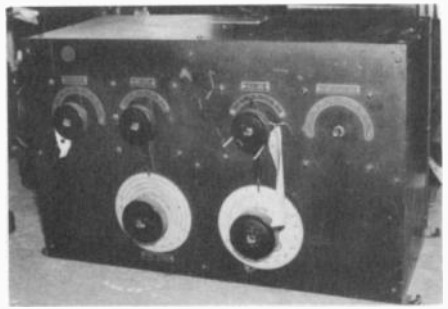

One of the dozen or more components from an RCA transatlantic commercial station, ca. 1928. (Terrey photo)

UV-857 and FG-195(?), unk	115
UV-858, water-cooled, transmitting	25
Van Horne 3BP (similar to 199), g	12
VT-1, (4), g	(2), 75; (2), 425
VT-1, N.I.B., g	125
VT-2, g	95
WD-11, g	100
WD-11, N.I.B., g	125
WE 101D, (3), g	(1), 55; (2) 135

The Henry Ford Museum Auction

BY LUDWELL SIBLEY

Have you ever attended a radio auction where the average sale price was \$600? That's how the Henry Ford Museum de-accession sale went on October 7-8, 1995. The lowest item went for only one dollar, but about 100 lots went for over \$1,000 each. Still, raw dollars are hardly the whole story.

What this sale was about is a unique group of early wireless gear, much of it Marconi equipment of 1910-1920, but with other extraordinary makers' names — Newton & Wright (British), Wireless Improvement Co., NESCO, DeForest, Kilbourne & Clark, and Hammond — represented. There was a veritable scrapyard of parts for big spark transmitters of World War I vintage. There was also a whole supply depot of World War I military sets and subunits: Army SCR-49, -59, and -68; Navy SE-68, -143, -1000D, -1071, -1419, -1420, -1690, and -1950.

Attracted by these rarified goodies, heavy-hitter bidders came from France and Sweden, to join many from the U. S.

There were some irritations — the lot numbers in the printed catalog had to be abandoned for the actual sale, and the handlers insisted on bellowing, "Yeaaw!" on spotting bids. But overall, the sale went well and the accuracy of bid records, etc., was very good. In addition, a commercial packing service was available in the checkout tent.

Every auction has its own "texture" or character. After this one, many bidders expressed a feeling of relief that most of the rare stuff was being kept in the United States (despite the British, German, and French origins of many of the treasures). One active French

buyer was fun to watch. As the bidding on one item went "\$18,000, \$19,000, \$20,000..." he calmly held his bid card in the air with one hand while eating French fries with the other!

There was a special draw to a lot of the material. Much of it was clearly identified as having originated in the RCA-George Clark collection of the late 1920s or the somewhat later McMurdo Silver collection. Even simple parts attain a special appeal when attached to a red 1931 tag reading "National Radio Museum Warehouse/G.H. Clark, Curator," or "National Broadcasting Co., Inc./Radio City Museum/Joseph D'Agostino, Curator." (Clark was a sort of official historian at RCA; D'Agostino was a special assistant to David Sarnoff.) However, despite the price pressure, alert bidders got some bargains, particularly in the area of vacuum tubes.

The equipment was not necessarily in prime shape; much of it was as pulled out of an RCA or other lab generations ago, with small parts missing (the rheostats always go first) and grimed-up in years of storage. Material that had been restored for display often reflected the museum's apparent penchant for shiny-bright, rather than authentic restorations.

(Ludwell Sibley, 44 E. Main St., Flemington, NJ 08822)

Ludwell Sibley is an electrical engineer and the editor of the Delaware Valley Historic Radio Club "Oscillator." He is primarily a collector of radio-related literature, but regarding equipment, he says, "I like it all." A true auction buff, he is an invaluable contributor to A.R.C. auction reports.

WE 101F, (2), g	55, 85
WE 102A, g	25
WE 102E, (2), g	50, 55
WE 202A, glass broken in tip area	205
WE 205B, (2), g emission	125
WE 205D, emission g	65
WE 208A, g	115
WE 211A, g	25
WE 211E, g	50
WE 212A, (7)	180
WE 212E, CG-886, (2), others	225
WE 215A, (2)	20; g, 30
WE 215A, w/sockets, (2), g	125
WE 216A, (2), emission g	225
WE 228A, water-cooled, unk	40
WE 232A, condition unknown but looks new	70
WE 270A, g	80
WE 355A, dud	13
WE tennis-ball, (13), and VT-1, (3), duds	300
WE VT-1, (3), g	(2), 100; (1) 85
WE VT-11, BB, TT, g	50
WE VT-2, g	35
Welsh WT-501 Peanut, open	50
WX-12, g	15

Contributors:

Larry Babcock, 8095 Centre Ln., East Amherst, NY 14051. Richard Estes, 8240 Wooster Pike Rd., Medina, OH 44256. Will Jensby, 645 Giannini Dr., Santa Clara, CA 95051. Jim Kreuzer, P.O. Box 398, Elma, NY 14059. August Link, 2215 Faraday NE, Ste. A, Carlsbad, CA 92008. Rob McElroy, 1045 Delaware Ave., Buffalo, NY 14209. Ludwell Sibley, 44 E. Main St., Flemington, NJ 08822. John V. Terrey, c/o A.R.C., Box 2, Carlisle, MA 01741.



Santa in the guise of your editor, John Terrey, caught with one of his purchases — a 6-tube, Magnavox AC-3 Model B amplifier. Unfortunately, the six Type VT-2 tubes are missing. (McElroy photo)

A Response to the Ford Auction

BY RICHARD FOSTER

The report in the November 1995 A.R.C. of the October auction at the Henry Ford Museum is extraordinary. That sale was an important event of historic proportions, and I'm sure that I speak for others who were unable to attend when I say that I feel that I missed out on something big. This excellent first report gives a real feeling for the event.

The importance of the event leads me to a couple of comments. First, it was rather frustrating not to be able to bid as an absentee. This cut out a number of people who wanted to bid but couldn't. It is common practice to bid by telephone or fax all over the world, and I've done it plenty of times myself. I have friends in France who wanted to bid but could not attend.

Second, the catalog was a big disappointment. Personally, \$20 for a first-class glossy catalog of the sale of the century would not have put me off. Being unable to attend means that I would like to have some record of this sale (as good as your reporting is), if the museum can find time to do the research on the important pieces.

I find it regrettable that the museum didn't do it ahead of time and that there was no clear description of the items in the catalog, not even a number key to the few photos

shown. As a collector, I want a real catalog of these once-in-a-lifetime pieces. How often will things from the George Clark collection come up for sale? There was no way to participate, even vicariously.

Third, a sale of this character deserves a better presentation as a matter of principle. This was a unique and historic event in this hobby, deserving better commemoration than it got. It is good to know that the sale was well organized and conducted in a professional manner and that the prices went way beyond expectations. However, I hope that future sales will be better documented and that better catalogs will be available for such important collections in order to round out the libraries of collectors worldwide.

(Richard Foster, 12 Shawmut Ave., Cohasset, MA 01778)

Richard Foster, a professional woodworker, specializes in the restoration of antique radios. He has published many articles in A.R.C. and elsewhere and has given workshops on rebuilding and refinishing wooden radio cabinets, including repairing the electronic components. He is also frequently called upon for his widely known expertise in Philco receivers.



PHOTO REVIEW



This column presents in pictorial form many of the more unusual radios, speakers, tubes, advertising, and other old radio-related items from our readers' collections. The photos are meant to help increase awareness of what's available in the radio collecting hobby. Send in any size photos from your collection. Photos must be sharp in detail, contain a single item, and preferably have a light-colored background. A short, descriptive paragraph **MUST** be included with each photo. Please note that receipt of photos is not acknowledged, publishing is not guaranteed, and photos are not returned.



RCA MODEL 54B5 – This portable battery radio measures $6\frac{1}{8}'' \times 4\frac{3}{8}'' \times 3''$. It has a $\frac{1}{4}''$ -thick swirled plastic front and gold-finished metal sides. It uses a $1\frac{1}{2}$ -volt and a $67\frac{1}{2}$ -volt battery and has a built-in loop antenna. (Greg Farmer – Fridley, MN)

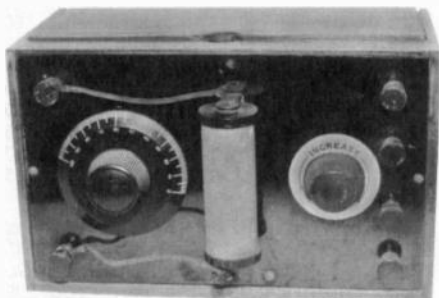

MIRACO MODEL UNKNOWN – This 1-tube radio was made by the Midwest Radio Corporation of Cincinnati, Ohio, in about 1923. An unusual feature is the front-mounted loading coil. Originally, there was a decal on the front panel with the MIRACO logo. (Greg Farmer – Fridley, MN)



ZENITH MODEL 8-S-462 – This handsome bookcase set has AM plus 2 shortwave bands and a tube complement of (2) 25Z6, (1) 6K7, (1) 6A8, (1) 25AC5, (1) 6AF5, (1) 6Q7, and (1, loktal base) 7G7/1232. The square grille and two drawers curve outward, while the dial portion is flat and has 5 push buttons. (Robert W. Tappan – Arlington, VA)

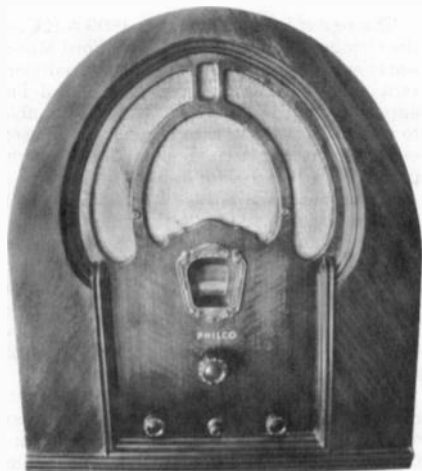

PHILCO MODEL 43 – This 1932 8-tube superheterodyne cathedral radio has three shortwave bands in addition to the standard broadcast band. It is an excellent performing radio on all bands. (Bill Harris – Roanoke, TX)

PHOTO REVIEW

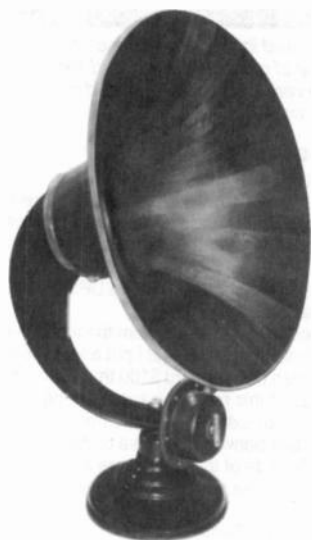

RADIO CABINET CO. ORCHESTRION – This Burns horn speaker has a very unusual wooden bell. The bell is obviously made by Radio Cabinet Co. (Orchestrion). I have located two others like this. Are there more? (Ed Bell – Raleigh, NC)



PHILCO MODEL 19 – This 6-tube superheterodyne cathedral radio made in 1933, has one shortwave band and employs Philco's "Shadow Graph" tuning indicator. (Bill Harris – Roanoke, TX)



"THE ORACLE" – This unusual horn speaker/lamp was made by the Payne Co. in New York City. The driver is in the lamp base with the throat of the horn inside the lamp column. There is a sound diffuser near the top. "The Oracle" is embossed on the lamp finial, on a brass tag on the lamp, and on the speaker driver. (Greg Farmer – Fridley, MN)



RADIO MISCELLANEA

"Antique Radio Classified" invites its readers to contribute letters and information for inclusion in "Radio Miscellanea" and elsewhere in the magazine. The topic should be of general interest and sent to A.R.C., P.O. Box 2, Carlisle, MA 01741. All material submitted should be verified for accuracy and may be edited for publication, which is not guaranteed. See the masthead for more details.

Jack Gray Collection at Crosley

Dear Editor:

An article in the *Dayton Daily News* (July 17, 1995) told about the Gray History of Wireless Museum in Cincinnati, Ohio, which your readers might like to know about. This is the collection of the late Jack Gray, the former transmitter supervisor for the Voice of America near Mason, Ohio. It is a huge collection, largely of the 1920s-1930s and consisting of some of the first radio receivers, microphones, crystal sets, loudspeakers, telegraph keys, amplifiers and other components. It includes radios built by Crosley, Kodell, Doron, and Day-Fan, a late 1940s television set with a 3-inch picture tube, wire recorders, and "On the Air" signs.

This collection is on display at the Crosley Telecommunications Center, which was designed with wide hallways to house the collection after Gray's death in 1970. Part of the collection is displayed on the first floor, also occupied by WCET-TV. The rest of it fills three dozen glass cases along hallways of the second floor, which houses WGUC-FM, the University of Cincinnati station.

The Crosley Center is across the street from the Music Hall on the northern fringe of downtown Cincinnati. The Gray Museum has no income or operating budget, so advertising is not possible. Thus, it remains one of radio's best held secrets.

Robert Stone, Piqua, OH



Ad Success Story

Dear Editor:

After many years of looking, I was called by a gentleman in response to my ad in A.R.C. for an E.H. Scott Special Communications receiver. We were able to come to terms on the receiver. I am very grateful to A.R.C. If it weren't for my ad, I would never have been contacted. Thanks, A.R.C.!

John Meredith, Greenville, NC

John and his Scott are shown above. (Editor)

UPS Saga Goes On

Dear Editor:

I shipped a Stiedaboter table model to a collector in Lynchburg, Virginia, and shortly thereafter received a letter from him stating that the radio had been badly damaged. The UPS claims adjuster said it wasn't properly packed, and if I had taken it to a UPS terminal, they wouldn't have accepted it.

However, I had shipped it from the local drugstore, and they even suggested that I put a little more insurance on it than the standard \$100 that every shipment gets. I shipped this radio in a super-strong cardboard box, plus lots of extra sheets of cardboard cut to the size of the box between the case of the radio and the box itself. In spite of this, they were able to break the front down until the speaker was resting on top of the tubes.

Roger Warren, Baltimore, MD

Dear Editor:

This is a quick blurb to remind people once again to pack their treasures properly prior to shipping with UPS. I received yesterday yet another broken piece through UPS, even though the item was double boxed. The item was a telegraph key and sounder box mounted on a board. The sounder was mounted on a swivel arm which was clearly broken by an obvious drop.

This unit came from Purcell, Oklahoma, and had been in use at the telegraph office at the train station. The original operator had handed this down to his kin, and I was able to acquire it through an antique dealer in town.

As these items arrive broken, my heart sinks in dismay. Please folks, these items need to be packed to sustain a fall of 4-6 feet. This is not conjecture — this comes from actually watching the UPS operation.

Geoff Shearer, Albuquerque, NM

The article "Let the Packager Beware!" from our November 1990 issue is reprinted on the next page. (Editor)

Helpful Magazine

Dear Editor:

Thanks for a great magazine. It has brought me much help in locating all the radios and information that I have needed.

Alan Deplae, Roseville, MI

Timely Sanding Article

Dear Editor:

I found Joe Greenbaum's article on sanding in the September A.R.C., page 15, very interesting and also very timely. I am hoping to start a cabinet restoration soon and his article will be right by my workbench. If I can muster up the patience that he says will be required, then I should have a magnificent piece of history when finished.

Sam Wrenn, Arlington, TX

LET THE PACKAGER BEWARE!

A Package Dropped 30 Inches Is Not Considered Mishandled!

What do the U.S. Postal Service, United Parcel Service (UPS) and Federal Express say about packaging?

The U.S. Postal Service guidelines are perhaps the most convenient to obtain. Ask at your local post office to look through their "Domestic Mail Manual" (they call it the DMM) and read the thirteen-page section detailing the important aspects of packaging. (These are sections 121.1 to 121.766 in the "Preparation for Mailing" section.)

All three carriers reference the National Safe Transit Association (NSTA) test standards which establish the minimum packaging required to withstand the transportation environment. Warning: the phrase "transportation environment" is a quaint euphemism for some allowable rough treatment of

your prized possessions or purchases!

Federal Express, for example, performs NSTA industry-standard drop, vibration and impact tests to simulate the transportation environment. Their pass/fail test on packaging includes ten drops of a package on various corners and edges from a height no greater than thirty inches (for packages under 100 lbs.) as well as a certain period of vibration.

This means that Federal Express, along with the industry in general, allows the dropping of your packaged Grebe Synchrophase, Scott All-Wave chassis, or Addison Catalin radio from a height of up to 2 1/2 feet! It is imperative that you do all your packaging with this kind of rough handling in mind. (Editor)

UPS Guidelines for Good Packaging

At UPS our objective is to get every package safely to its designation. You can help us achieve this goal by properly packing and labeling your shipments. The outer carton, the packaging material, the closure and the address label are four key elements in a properly prepared package. By following the simple suggestions below, you help ensure that your UPS-shipped merchandise arrives in good condition.

THE CARTON

A corrugated carton is the ideal way to ship most items and provides the best protection for your package contents. We recommend that you select a carton with a minimum 200-pound test rating as described on the carton manufacturer's seal printed on the bottom of the carton. Always use cartons in good, rigid condition with all flaps intact. Cartons that have punctures, tears, rips or corner damage should not be used. Make sure the carton is large enough to allow room for adequate cushioning material on all sides of the product.

THE CUSHIONING

A minimum of two inches of packing material should completely surround each item in the shipment. Crumpled Kraft paper makes a good, inexpensive cushioning material, as does bubble-wrap. (Caution: "foam peanut" cushioning material can settle or shift position in a carton during transit, thereby reducing its effectiveness as a cushioning material.)

Begin by packing several inches of the cushioning material you have chosen in the bottom of the carton. Next, wrap individual items separately and place them toward the center of the carton at least two inches apart. Finally, stuff cushioning material firmly

around, over and between the items.

Use enough cushioning material so that the contents cannot move easily when you shake the carton. Several inches of cushioning material all the way around your merchandise should do it. But remember, the further you keep fragile articles away from the corners and sides of the container, the less chance there is of damage. Extremely delicate items should be double-boxed for added protection. Carefully pack the delicate items in the first container with cushioning, and then place the sealed package in a second cushioned container.

THE CLOSURE

Proper closure of a package is as important as adequate cushioning. To close a carton securely, use a heavy-duty tape designed for shipping, at least two inches in width. Pressure sensitive plastic tape and water activated paper tape, with or without fiber reinforcement, are all acceptable closures.

The "Six Strip Method" for package sealing provides maximum protection against cartons popping open. First, tape the bottom center seam, leaving a two-inch overlap on each end. Next, seal both bottom edge seams. Pack the contents, using the cushioning guidelines above. Now tape the center seam and both edge seams of the box top, exactly as you taped the bottom.

Never use masking or cellophane tapes. These tapes do not provide the strength necessary for proper package sealing. In addition, avoid using string or cord on your package. These can catch on automatic sorting equipment. Finally, don't paper wrap your package. If the paper tears, your address label may become separated from the package.

(Supplied by United Parcel Service)



VINTAGE VACUUM TUBES

Vacuum Tubes and "Getters"

BY BLAKE M. DIETZE

"What every radio collector wants to know about getters but is afraid to ask" could easily be the subtitle of this enlightening article. (Editor)

Most radio collectors at one time or another have taken the time to ponder the hearts of their old tube radios — the tube. Have you ever wondered how that pretty silver or gold spot on the inside of the glass envelope got there? I've been told many fables concerning those marks.

One collector told me that the silvering of the inside of the glass hid the tube makers' secrets from the general public. Another told me that this "flash" was a product of very high voltage testing during quality control, prior to release of the tube. Others just stated, "That's the getter; it gets the air out." Here is the straight scoop on the "getter."

Residual gases must be evacuated from all vacuum tubes. The presence of any gas, especially oxygen, and water vapor will cause erratic behavior and, more often than not, premature failure. The ionization of these gases will impair the emission of

electrons within the tube envelope. When vacuum tubes are designed to operate with a specific gas present in the envelope, they are always evacuated prior to being filled with the gas.

Even though fairly good vacuum pumps were available in the 1920s and 1930s, residual gas and water vapor still posed a problem. These gases and vapors would remain even in a near vacuum, particularly in the glass and metal components. The accepted method of removing the gasses was to employ a "getter."

The getter is a material which is capable of readily absorbing any residual gas and vapors. Some of the materials used to produce getters in tube manufacture include the following: cerium, aluminum, magnesium, barium, and phosphorus. Red phosphorus was used in many early Type O1-A tubes, which are easily recognized by the reddish tone on their glass envelopes. Early tube manufacturers used an absorbing material "paint-

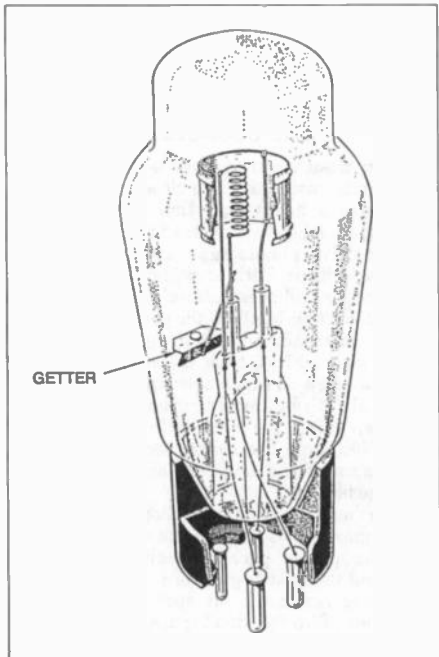

Figure 1. The getter is shown here inside the glass envelope of a standard-shaped vacuum tube. (Photo from "How to Repair Old-Time Radios," p. 16.)

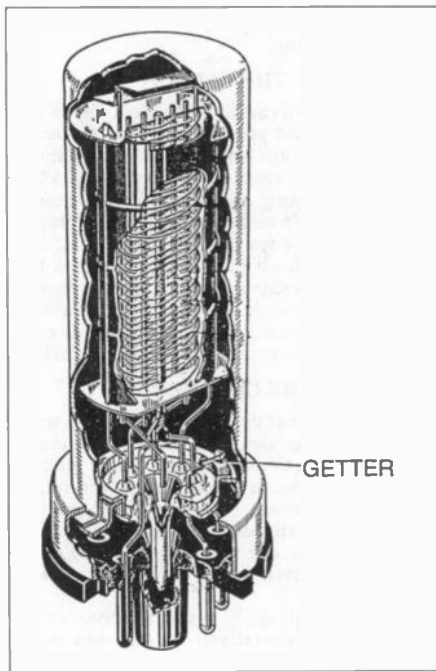

Figure 2. In this metal tube, the getter "ribbon" is connected between the ground pin of the octal base and the metal shell of the tube. (Photo from "How to Repair Old-Time Radios," p. 24.)

ed" on the glass stem of the tube. A powder-like compound near the base of the tube is usually visible on tubes like the WD-11 or WX-12, which are examples of tubes employing this "passive" getter technique.

Later research found that the best getters were of "active" design and made of the same material as the emitting element (filament). Barium compounds were widely used as the getter in receiving tubes because the cathodes were generally oxide-coated. Unfortunately, pure barium is not protected from the air by its own oxide coating and, therefore, is somewhat volatile. As an alternative, compounds which break down or produce barium when activated were used.

The most popular method of employing the getter was the "flashing" technique. After assembly of the tube was completed, flashing was performed by focusing a high frequency electric field on the getter through the glass. This flashing process left its indelible mark in the form of a mirrored coating on the inside of the glass envelope. Figure 1 shows a typical getter.

Metal tubes of the mid- and late-1930s posed a bit of a problem for the accepted method of activating the getter. Because of the tubes' metal structure, the electric field could not penetrate the envelope. To get around this problem, the method employed was to use a tantalum ribbon which was folded or rolled and filled with a barium compound called berylliate, as shown in Figure 2. The ribbon was connected between the ground pin of the octal base and the metal shell of the tube. After production, an electrical current was passed through the ribbon, causing the ribbon to

heat up the berylliate, which reacted under heat to release the barium getter.

One interesting note is that the getter itself may impair the operation of the vacuum tube, so care has to be taken not to allow the getter material to condense on the internal components of the tube. This led tube manufacturers to place getters in troughs or cups and flash toward the glass envelope where they would not cause any trouble. Very early tubes, up to and including the Type 01-A, used thoriated elements (thorium dissolves in tungsten) and a nondirected getter — the reason why the flashing covers most of the glass envelope.

References:

- Eastman, Austin V. *Fundamentals of Vacuum Tubes*. 2nd ed. New York: McGraw-Hill, 1941.
- Hallmark, Clayton L. *How to Repair Old-Time Radios*. Blue Ridge Summit, Pa.: Tab Books, 1979.
- The Radio Amateur's Handbook*, 53rd ed. Newington, Conn.: American Radio Relay League, 1976.
- Radiotron Designers Handbook* 4th ed. Harrison, N.J.: Radio Corporation of America, 1953.

(Blake M. Dietze, 3201 Augusta Dr., Flower Mound, TX 75028)

Blake Dietze, an electrical engineer, holds a General Class Commercial Radiotelephone license. A licensed radio amateur since 1974, he has been a radio collector for 22 years with a special interest in pre-1930 radios and literature. Of the 60 radios he owns, about 35 are Zenith "black dials."

Gridley's Radio Shop — June 1939

By Ron Boucher





AUCTION REPORT

Colorado Radio Collectors — Denver, Colo. 4th Annual Auction — September 10, 1995

REPORTED BY DICK HAGRMAN

The Colorado Radio Collectors (CRC) held their 4th Annual Auction at a meeting on September 10, 1995, at CRC's old meeting location — the SouthWest Bank Building parking lot, Denver, Colorado. As the hammer went down for the final item, 171 lots had gone for a total of over \$4,300. While the lot count went up this year, the average dollar per lot value went down. CRC gained about \$500 from items donated for the auction and in commissions.

Ace Type V table	\$80	Hoffman table	10
AEG wooden table	30	Home-brew battery set	30
Air King 4603 table	10	HP voltmeter	5
Airline 54BR-1506 table	11	Jerrold sweep generator	9
Airline 62-256 table	30	Knight AM tuner	3
Airline 62-313 console	90	Knight amplifier	3
Airline 84BR 1508 table	32	Kolster 6D	50
Airline table, (2)	30, 35	Kolster K48 lowboy	14
Airline table, wooden	45	Londale table	6
Airline WG-24 table	40	Lyric table	8
Airline, green plastic	8	Magnavox 32NF chairside	42
Airline, red	4	Majestic 30 table	17
Arvin 622A table	21	Majestic 50 table	45
Arvin 664 table	15	Majestic 4706 table	11
Arvin table, bronze	32	Majestic table	20
Arvin transistor radio	2	Mitchell clock radio	40
Arvin, table, gold	25	Mohawk Pyrrmonic speaker	35
Atwater Kent 30 table	65	Motorola 5C table clock radio	5
Atwater Kent 55 console	85	Motorola 65X14BA table	3
Atwater Kent tombstone	115	Newcomb phonograph	9
Automatic 613X table, wooden	30	Noma plastic clock radio	11
Brunswick 5KR table, wooden	50	Packard Bell wooden	25
Capehart	11	Peerless speaker	27
Coronado plastic	7	Philco 20	65
Cromwell table	7	Philco 37-60 cathedral	90
Crosley 11-106U table	25	Philco 37-610 tombstone	65
Crosley 125 cathedral	60	Philco 37-62 table	35
Crosley clock radio	60	Philco 38-12 table	30
Crosley console	5	Philco 40-140 table, wooden	40
Crosley Dynacoil speaker	34	Philco 40-180 console	20
Crosley table	12	Philco 46-350 portable, (2)	5, 6
Crosley table, wooden	6	Philco 48-250 plastic	10
Emerson 541 table, wooden	5	Philco 49-500 table	16
Emud multiband radio	20	Philco 49-506 wooden	17
Espy 581	20	Philco 50 cathedral	77
GE 430 table	9	Philco 60 cathedral	65
GE E7L tombstone	65	QST 1946-47	19
GE H51 console	85	Radiola antenna	35
GE J62 table, wooden	90	RCA 9Y510 table	5
Giffillan GN5 battery set	40	RCA 9X561 table	15
Gould scope	65		
Grantline	4		
Grunow tombstone	30		

A warning: Auction prices are not current values. A listing such as this cannot adequately include the condition of cabinets, chassis, transformers, tubes, the operating status of the set, and the inclusion of incorrect, restored or replica components, etc. Auction prices are the result of the excitement of the auction process, the skill of the auctioneer and the specific interests of the participants. Nevertheless, auction prices serve as useful references and as another element in the value determining process. The possibility of error always exists, and if we are notified, corrections will be reported.

RCA 75X11 table	5
RCA 75X15 table	17
RCA 106 speaker	40
RCA Radiola 17 table	50
RCA Radiola 100A speaker	20
RCA Radiola console	50
RCA Strato-World, (2)	13, 30
RCA T64 table	47
RCA table battery set	26
RCA Y552	10
Regency DR-155A highboy	3
Revere 400 portable	25
Roberts tapedeck	5
Sentinel 1948	30
Silvertone 4308	30
Silvertone chrome	37
Silvertone magazine rack	105
Silvertone plastic	20
Silvertone table	17
Silvertone tombstone, wooden table, (2)	50
Smokerette radio	130
Sonora RBO176	15
Sparton 517 tombstone	75
Supertone tombstone	40
Symplex Midget table	40
Telechron	17
Telefunken Adagio	25

Variac 5A with meters	35
Variometers, (2)	14
Westinghouse WR23 tombstone	65
Workrite battery set	40
Zenith 5D610 table	18
Zenith 6G601 portable	12
Zenith 8C01 table, wooden	7
Zenith 8S661 console	50
Zenith 10S464 console, (2)	30, 75
Zenith 10S567 console	125
Zenith G615 plastic	15
Zenith H725Z1 table	5
Zenith tombstone	70

(Dick Hagman, 3429 W. Berry Pl., Littleton, CO 80123)

The Colorado Radio Collectors (CRC) participate in "The Flash!!," a bimonthly journal published by the Mountains 'N' Plains Radio Collector's Assn. for CRC and the Nebraska Antique Radio Collectors Club. Dues are \$12. The CRC hold bimonthly meetings/swap meets, an April show and swap meet, a July family picnic, and a September auction. For information, contact Larry Weide, 5270 E. Nassau Cir., Englewood, CO 80110.

Finkel Auction Kulpsville, Pennsylvania — October 1, 1995

REPORTED BY PAT AND MIKE KOSTE AND LUDWELL SIBLEY

Longtime collector and Delaware Valley Historic Radio Club (DVHRC) member Arnold Finkel recently retired from the hobby and put his extensive collection of colorful, high-style radios up for auction. On Sunday, October 1, 1995, Hamilton Auction Co., under the experienced gavel of Arnold himself, offered over 300 quality lots to an enthusiastic crowd of 60 bidders at the Holiday Inn in Kulpsville, Pennsylvania.



The display tables were filled with quality wood, plastic and Catalin table sets, as well as desirable transistor and novelty radios.

With the help of DVHRC members Pete Grave, Lewis Newhard, Don Rector, and Ned Berger, Arnold managed to move the entire inventory in a little more than three hours. This auction did not bog down in a multitude of paper, box lots and bulky consoles. Instead, Finkel's offerings were limited to wood, plastic and Catalin display-ready table sets, as well as a table full of desirable transistors and novelty radios. It was quite an unusual experience to be in the same room with so many truly classy pieces.

The auction totaled more than \$30,000. Among the highlights were the following: a fine Sparton Bluebird selling at \$1,900, a brown Majestic Charlie McCarthy for \$900, a model unknown blue-mirrored Troy radio for \$1,250, and a lovely Emerson "Mae West" for \$1,050. A blue-mirrored Sparton Model 557 went for \$900, a very fine maple Emerson "Stradivarius" for \$525, and a

very early Pilot 3" TV complete with carrying case for \$300. There were numerous Catalins, including a Fada L56 in maroon and butterscotch, for \$1,800. The high-bid item of the day was a rare black Silvertone 6110 rocket-shaped radio, which sold for a rather disappointing \$2,150.

The following list omits many of the more common radios. Conditions are not specifically noted, but all were good to excellent.

Air King A-450 midget, brown Bakelite	\$60
Airline 62-337 movie-dial farm set	60
Airline 93WG604A, w/tuning eye, brown Bakelite	95
Arvin 444A midget, metal, white	40
Arvin 540T metal, green	25
Arvin 540T metal, red	75
Belmont 5D111, white	130
Belmont 6D111, white	120

(Continued on following page)

(Finkel Auction, continued)

Bulova 620 Comet, transistor radio, aqua	110
Bulova 620 Comet, transistor radio, ivory	100
Colonial 653 tombstone, wood	180
Crestline 6T-220 bullseye, transistor radio, red	60
Crosley 11-100U, center bullseye, white	130
Crosley 11-101U, center bullseye, blue	300
Crosley 11-102U, center bullseye, green	200
Crosley 11-114U, left bullseye, cream	100
Crosley 11-114U, left bullseye, white	120
Crosley 11-116U, left bullseye, grey	140
Crosley 11-119U, left bullseye, blue metallic	220
Crosley D25CE dashboard, lime green	60
Crosley Musical Chef, white w/red, w/timer	35
Crosley Super Sextette, coppertone	55
Delco R1231A, ribbon candy, brown Bakelite	90
Dumont RA-346, oriental clock, red	90
Emerson 106, oval wood, Ingraham cabinet	130
Emerson 157, black and white, gold grille	330
Emerson 400 Aristocrat, green Catalin	875
Emerson 517 Moderne, red w/gold grille	210
Emerson 520, brown swirl Catalin, white grille	100
Emerson 540 Emersonette, red	140
Emerson 540 Emersonette, white Plaskon	160
Emerson 570 Memento	105
Emerson 615, wood, (Ingraham cabinet?)	60
Emerson 744 plastic, 2-tone green	180
Emerson 744, grey and red plastic	300
Emerson 888 Atlas, transistor radio, black	85
Emerson 888 Explorer, transistor radio, green, rare	225
Emerson 888 Pioneer, transistor radio, w/case, turquoise	55
Emerson 999, transistor radio, black	140
Emerson AX-212, wood bullseye, Ingraham cabinet	250
Emerson AX-217, midget, wood	75
Emerson BD-197 "Mae West"	1,050
Emerson DQ-351, wood, Ingraham cabinet	130
Emerson "Stradivarius," maple	525
Fada 450W, brown Bakelite	160
Fada 740, white	50
Fada 845, white marbled plastic	145
Fada 1000, Bullet, butterscotch	425
Fada L56, Catalin, maroon and butterscotch	1,850
Firestone S-7403-4, wood, (Ingraham cabinet?)	175
GE H-500, big thumbwheel, white	110
Global GR-11, transistor radio, blue	70
Guild Spice Chest	75
Hitachi TH-666, transistor radio, w/case, white	60
Majestic 5LA5, brown Bakelite	55
Majestic 370(?), mini-cathedral, wood	165
Majestic Charlie McCarthy, brown Bakelite	900
Motorola 7X24S, transistor radio, tan/brown, chrome jet	180
Musicaire, yellow plastic w/orange knobs	35
Northern Electric Rainbow, light green	160
Panasonic R-103, transistor radio, w/case, black	50
Philco 49-501 small boomerang, brown	235
Philco 49-901, w/large roller knob, white plastic	80
Philco 52-548, ivory plastic	70
Pilot TV-37 3" TV, w/carrying case	300
RCA 96T4, wood w/chrome bars	30
Setchell-Carlson 416, frog eyes, red and white	125
Setchell-Carlson 416, frog eyes, white	60
Setchell-Carlson 416, maroon and white	70
Silvertone 6610 Rocket, black plastic	2,150
Silvertone Candy Cane, Beetle plastic	120

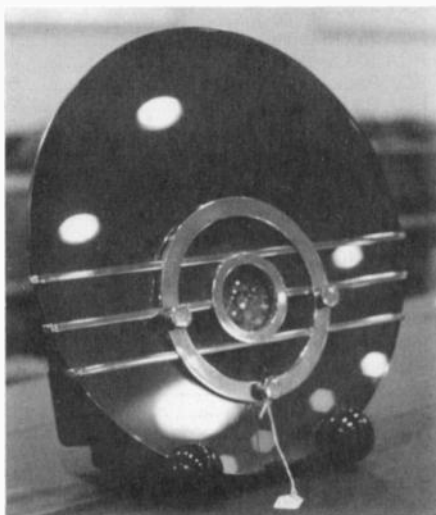

This fine Sparton Bluebird sold for \$1,900.

Sonora WAU243, white plastic	190
Sparton 557, blue mirror	900
Sparton Bluebird, blue mirror	1,900
Sparton, wood-grained metal, w/chrome trim	160
Spica ST-500, transistor radio, bright blue	45
Spica T-500, transistor radio, w/case, box, paper, grey	75
Sterling Deluxe, blue, w/chrome wraparound trim	170
Sterling Deluxe, white plastic, w/chrome wraparound	100
Sterling LS4 Japanese minitube portable, white plastic, w/chrome	65
Stewart-Warner 9001E dropleaf table radio, w/push buttons	60
Stewart-Warner 9182, black and red	75
Stewart-Warner R-3044A, birdseye maple, aqua trim	310
Stromberg-Carlson 1500H, white	50
Tarleton, transistor radio, w/case and antenna, white	40
Telitone, unusual translucent green swirl	80
Toshiba 8TM-294, transistor radio, w/case, box and paper, tan w/blue sparkle grille	75
Troy, blue mirror	1,250
Truetone D2017 boomerang, brown	90
Truetone Stratoscope, Beetle plastic	400
Webcor B308, transistor radio, blue and white	90
Zenith 6D2615, brown	75
Zenith 6D311 Deco, brown Bakelite	150
Zenith 6D510, white w/tan handle	55
Zenith H-511, green	20
Zenith Royal 500 Deluxe, long distance, transistor radio, maroon	55
Zenith Royal 500H, transistor radio, black	80
Zenith Royal 1000 Trans-Oceanic	50

Photos courtesy of Arnold Finkel.

(Pat and Mike Koste, 57 Tennis Ave., Ambler, PA 19002; Ludwell Sibley, 44 E. Main St., Flemington, NJ 08822)
(Hamilton Auctions, 3425 Iron Bridge Rd., Allentown, PA 18104)



CLASSIFIED ADVERTISEMENTS



WANTED: Any stock market ticker tape machine. Rick Hardin, 1750 Coleman Rd., Anniston, AL 36207. (205) 835-0900, day. Fax: (205) 835-0992. (205) 237-2008, night

WANTED: National coil forms XR-13, plugs PB-5, socket XB-5. Millen 44000 coils, plugs, socket. Wayne Steiner, NØTE, 1212 17th Rd. NW, New Strawn, KS 66839. (316) 364-5353

WANTED: Portables. Collector paying book (Bunis) prices for the following: Automatic Tom Thumb portable, jewelry box-style radios with flip-up lids (e.g.: Emerson 508), Westinghouse Little Jewel refrigerators, or any other unique portables. Vgc or better to \$100. I also collect Kodak Brownie cameras and radios that look like cameras. Send description to: Don Bridge, 194 Kempton Dr., Berea, OH 44017. E-mail: 71420.2635@compuserve.com

WANTED: Fisher K-10 Spacexander spring reverb. unit. RCA, or other, Theremin. **FOR SALE:** Tube CB's. LSASE - list. Zafonte, RFD 1, Box 75, Fort Kent, ME 04743. (207) 834-6273

WANTED: Schematic for Devry 5-inch scope Kit 1G09. Also week/fair #45 tubes. Wilbert Kimple, 3015 Kelsey Creek Rd., Spartanburg, SC 29302. (803) 585-6465

WANTED: Top cover, bottom cover, power supply cord for Hammarlund Super Pro BC-779. J.M. Roseman, W9UD, 2716 West 3rd. St., Coal Valley, IL 61240. (309) 799-7447

WANTED: Cash or will trade radios for old elec. fans with brass blade and guard. Dave Friedlund, 36006 S.W. Bald Peak Rd., Hillsboro, OR 97123. (503) 628-1439. E-mail: Davef@Teleport.com

WANTED: Any make of American or Japanese transistor radios, working or not. Doug Ferrero, WB8YNZ, 70173 Hillside Ct., Romeo, MI 48065. (810) 336-0120

WANTED: Phonograph-related items: Top dollar paid immediately for Vogue picture records, Edison, Columbia, and any wax cylinder records, toy phonographs, needle tins and cutters, Nipper, record dusters, puzzles, fans, calendars, pocket advertising mirrors, dealer lapel pins, phonograph toys, posters, broadsides, original dealer advertising items from Edison, Victor, and Columbia. Thanks. Bernie Seiberg, 714 Moredon Rd., Meadowbrook, PA 19046-1907. (215) 886-6124

WANTED: Old telegraph keys and bugs. SASE for my list of duplicates for trade. Neal McEwen, K5RW, 612 Stillmeadow, Richardson, TX 75081. E-mail: nmcewen@metronet.com

WANTED: Delco Auto Radio (service handbooks), not schematics. Books contain: circuit explanation, troubleshooting hints, tuner servicing info. All years needed. Also looking for same for Bendix, Motorola, Philco. Fred Cranshaw, 1624 Bitter Ck., Garland, TX 75040. (214) 494-4917

WANTED: Speaker and chassis, good condition, for RCA 140 tombstone. Thanks! Mark Cowart, N4FBL, PO Box 550766, Jacksonville, FL 32255-0766. (904) 724-1364

WANTED: Schematic, brochure, anything on Capehart-Farnsworth combination model B1003-M. Thanks for help! Dan A. Unruh, 458 West Main, Monmouth, OR 97361

WANTED: Old or unusual light bulbs, glow lights, clear glass Tungar bulbs, Tungar battery charger. Richard Bock, 1001 Meadow Ln., Fortuna, CA 95540

.....

• A.R.C. Advertising Policy •

• Sellers and Buyers, Please Note! •

• Advertising is accepted only for early items •

• related to radio, communication, etc. All •

• items must be described fairly; reproduc- •

• tions, reprints and not-original items must •

• be so identified. Advertisers must agree to •

• respond promptly to inquiries and orders, to •

• resolve problems promptly if the buyer is not •

• satisfied, and to comply with a buyer's •

• refund request on unaltered returned items. •

.....

WANTED: Chassis Crosley Buddy Boy, any condition. Wanted for my jukeboxes N.O.S. or used tubes: 5U4G, 6L6G, 6SW7, 6SL7, 7199, 6973, 6EU7, 6AN8, 6AU6, EL34, 6J5. Please write or fax to: Geert Olieu, Buurtweg 707, 8930 Menen, Belgium, Europe. Fax: 1132 5651 3971

WANTED: World Radio Handbook, Broadcasting Yearbook, other radio station lists, before 1980. Ralph Marson, 8070 Busch, Centerline, MI 48015. (810) 754-3808

WANTED: Completing collection service bulletins: Crosley, RCA, Philco, etc. Let's compare and help ourselves. Gary A. Micaneck, 226 Henry Ave., Manchester, MO 63011. (314) 227-7046

WANTED: Clean late Collins S-Line. Frank Czajka, A19T, 8968 W. Forest Home Ave., #4, Greenfield, WI 53228. (414) 259-9395

WANTED: Up to \$1,000 paid for certain 78 rpm records! Send \$2 + LSASE for our illustrated want-list with actual prices paid. Nauck's Vintage Records, 6323 Inway Dr., Spring, TX 77389-3643

WANTED: Martian Big 4 crystal radio. All cash or trades. Dave Thomson, 3521 S.W. Gale Ave., Portland, OR 97201. (503) 228-7022

WANTED: Vacuum tube amplifiers, Fender, Gibson, McIntosh, Marantz, Dynaco, Silvertone, etc. Peter DeGregorio, 85 Burroughs Rd., Fairfield, CT 06430-3504. (203) 331-9155

WANTED: Atwater Kent radio models 135Z, 215Z, 305Z, and 565Z. Dennis Craft, 10513 E. Clinton, Scottsdale, AZ 85259. (602) 860-8951, after 5 pm MST

FOR SALE: New price guide, free shipping! The Collector's Guide to Transistor Radios, 2nd Edition, by Marty & Sue Bunis, will be released in February. This beautiful new book with over 370 all-new full color photos, 2,500 model numbers and up-to-date pricing will help you identify today's hottest vintage transistor radios - only \$16.95 ppd (Canada, add \$1; foreign, write for shipping costs). Order your autographed copy today, and we'll hold your charge or check until the book is shipped! Payment by check, money order, Visa, or MasterCard. Marty & Sue Bunis, 32 West Main St., Bradford, NH 03221. (603) 938-5051, before 8 pm EST. Fax: (603) 938-2430, anytime

FREE - 20 WORD AD EACH MONTH
To get your free 20 words,
include your SUB# with your Ad.
Additional words are 25¢ each.
Read inside back cover for details.
MANY THANKS!!!!

FOR SALE: Winter clearance, Happy Holidays! \$20 ea., 3/\$50, as is, most vg: Motorola 5L Regency MR33, Emerson 691, Philco 50-522, RCA X551, Silvertone 2038, Westinghouse 438T5, Telechom 8H59, Grundig 80U, Meissner tuner, RCA PX1, Zenith J733, Bulova 100, tape deck Sony TGU 20. Amplifiers: Lafayette LA350, Heathkit AA161. Bob Masterson, Box 172, Valley Cottage, NY 10989. (914) 353-3151

FOR SALE: Satchell-Carlson, Model #ER331, clean, works, ebony color - \$35 + UPS or trade. Rob Loeser, 390 Beech St., South Hempstead, NY 11550. (516) 483-0463

FOR SALE: Motorola radio frequency amp 1953, rated 50W in 250W out, w/manuals, N.O.S. 6GH8 (135) EL84 (17). Hewlett Packard 3476A bench digital multimeter. **WANTED:** Rough MC60's working, reasonable. Dave Barth, 8320 Bevan St., San Gabriel, CA 91775. (818) 286-6503

FOR SALE: Granco 704 6-tube A-C tabletop AM-FM radio, 12"x6"x5" - \$10 + UPS. Onerio L. Sabetto, 1717 Burgess Rd., Cleveland, OH 44112-1103. (216) 481-1036

FOR SALE: RCA radios: X4HE turquoise/white - \$30; 3X521 - \$25; 3RC76 AM/FM - \$35; RFC11B AM/FM - \$15. GE AM radios: #476 white - \$25; #400 - \$15; T1060 - \$10. Zenith clock radios: F728 pink - \$20; G516V white AM/FM - \$25. Sony AN10 indoor AM/FM, active antenna, N.I.B. - \$40. Hallicrafters 5R13 - \$30. Harman Kardon T1040 AM/FM tuner - \$30. Precision ES500A oscilloscope - \$15. Heathkit SG8 signal generator, untested - \$10. Eico 625 tube tester, untested - \$15. All items plus UPS. Jon D. Andreasen, PO Box 22, Newton, NJ 07860. (201) 579-6261, 6-9 pm Eastern except Sunday

FOR SALE/TRADE: Altec 1567A tube mixers, recapped exc - \$800/pair. Others: good T-O parts - \$3 to \$75. Altec 1592 SS mixer with 1599 AB, aux. mixers, all exc. Good variety input modules, phono 1579, mic 4722 line 15095. Transistor 1588. 351 50W SS amp - make reasonable offer. (3) Gates 5767 StaLevel tube compressors: recapped - \$375; as is - \$225. Zen. Royal 3000, vg, recapped - \$100. Zen. 755, vg - \$50; 705, vg - \$35. Mic for sale/trade 74 Jr. umber, vg - \$350. BK 5B exc - \$475. Some cool vintage tape recorders: Pentron, Ekotape, etc. - Offers! LSASE for new list, 1/96. **WANTED:** Western Electric 640A/1095 mic amp combo. WE 630 Eight Ball, Altec M-21-B Coke bottle yoke for 639B. Always looking for RCA & other signs, clocks, banners, thermometers, etc. Pair cabs. for 15" speakers. Collins 26-U. Ward Kremer, 301 S.W. 16 St., Ft. Lauderdale, FL 33315. (305) 524-5652, ph/fax

FOR SALE/TRADE: 1938 Zenith 15U269 in excellent condition, pick up only - \$1,400. **FOR TRADE:** 1937 Zenith 10S130 in excellent condition for Zenith 9S232 in same condition. Arnie Sanchez, 9615 Rockhurst, Houston, TX 77080. (713) 939-9221, after 5 pm

TUBES • PARTS • SUPPLIES

YOUR COMPLETE SOURCE FOR...

TUBES:

Over 3500 receiving, transmitting, audio and industrial types in stock, including many foreign and early types.

TRANSFORMERS:

Hard to find power, filament and output transformers as well as filter chokes for tube equipment. We feature HAMMOND performance transformers as well as many new old stock transformers.

CAPACITORS:

High voltage electrolytic and mylar capacitors, multi-section capacitors and more for tube circuits.

PARTS:

Resistors, tube sockets, potentiometers, knobs, dial belt lamps, diodes, speakers, wire, phonograph needles and cartridges and much more.

LITERATURE:

Extensive selection of literature and books on antique radios, tubes, circuits diagrams, communication gear and hi-fi equipment. Some items not available elsewhere!

SUPPLIES:

Grill cloth, cabinet restoration supplies, batteries, chemicals, tools, test meters, gifts and kits.



CALL OR FAX FOR OUR NEW 40 PAGE CATALOG!

ANTIQUE ELECTRONIC SUPPLY™
 LIMITED PARTNERSHIP

8221 S. MAPLE AVE. • TEMPE, AZ 85283 • (602) 820-5411 • FAX (602) 820-4643 or (800) 706-6789

MARCH 22 & 23 1996, Fri. & Sat.

Charlotte, NC

20th Annual

Spring Meet in the Carolinas

Friday Evening
Equipment Auction

GIANT
Flea Market

Friday afternoon
Barbeque Dinner

World Famous
Guest Speakers

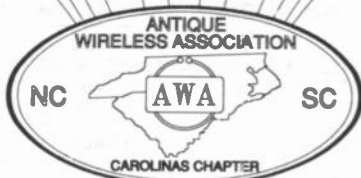

Here we grow again!

Due to the overwhelming growth of this meet we are forced to move to a larger more modern World Class Hotel. We hope you approve.

The Sheraton Airport Plaza Hotel

Located on I-85 at exit 33, Billy Graham Parkway

***** VERY IMPORTANT *****

Rooms are limited, make your reservations before MARCH 1st.

Special AWA room rates are only good thru February 28th.

Call 1-800-325-3535 for reservations.

There will be NO BUYING, SELLING, TRADING, or DISPLAYING of Merchandise before 8 AM on Friday! **ENFORCED!!**

REGISTRATION

	In Advance	At the door
Meet Registration*.....	\$ 5.00	\$10.00
Vendor Pass**.....	\$10.00	\$20.00
Ladies Activity***.....	\$15.00 per person	N/A
BBQ Dinner***.....	\$ 9.00 per person	N/A

* EACH PERSON MUST REGISTER (SPOUSES FREE)

** EACH VENDOR VEHICLE MUST HAVE A VENDOR PASS TO ENTER FLEA MARKET

*** REGISTRATION MUST BE RECEIVED NO LATER THAN MARCH 15

To send Registration or to request a flyer write to:

CC-AWA

POBox 11358

Charlotte, NC 28220-1358

Ron Lawrence, 704/289-1166 or Stephen Brown, 704/847-1301

88A85-11-20-85- KC4XP

FOR SALE/TRADE: McIntosh MC240, fresh American tubes, manuals - \$1,600. C-8 mono preamp, Telefunkens, walnut cabinet - \$200. Dynaco ST-70 and early PAS 2 - \$500. (2) Dynaco Mark III's, KT-88's with (2) PAM's and unitized D.S.C. integrated preamp, manuals, cables - \$1,000. Peter DeGregorio, 85 Burroughs Rd., Fairfield, CT 06430-3504. (203) 331-9155

FOR SALE: Tube replacement guides for radios 1938 to 1947, over (5,400) sets listed, copy - \$20. Dial restringing guides, copies; DC1, 1938-1947 - \$20; DC2, DC3, DC4, DC6 & DC8 ea. - \$10. ARRL Handbooks 1945 - \$25. 1961 - \$15, 1963 - \$15. Philco 1952 tube manual, copy - \$15. RCA 1961 tube manual - \$10. RCA 1973 and GE 1964 transistor manuals - \$10 ea. GE 1977 SCR manual - \$10. RCA solid-state servicing 1973 - \$10. Plus postage. Over (500) books, and over (5,000) tubes for each list - send 64¢ LSASE. J.J. Papovich, 52 Magnolia Ave., Pitman, NJ 08071. (609) 582-8279

FOR SALE: Steinite Seville highboy - \$395. Mahogany Brunswick Ultona phonograph - \$350. TV-2/U tester - \$150. All OBO. Richard Rubin, 227 Riverside Dr., Apt. 5-A, New York, NY 10025. (212) 864-8416

FOR SALE: Scott 310-D tuner, 335 multiplex adapter and 299 amplifier, working - \$150, plus shipping. Thomas Peters, PO Box 3925, McAllen, TX 78502

FOR SALE: RCA tombstone Model 128 - \$275 plus shipping. Robert J. Stone, 721 Fisk St., Piqua, OH 45356-3729. (513) 773-2217

FOR SALE: RCA ACR-136 - \$20 plus 30 lbs. RCA 97T with 6U5 - \$12 plus 13 lbs. Both need help. John Uscinowski, RR#1, Box 379, Greenwich, NY 12834-9519

FOR SALE: New in box Tucker car radio. **WANTED:** GM Little General 250. Greg Bogel, 312 Peg Run Rd., Cherry Tree, PA 15724. (814) 743-9028

FOR SALE: E.H. Scott SLRM Navy WWII receiver. **WANTED:** Stancor 10P transmitter. National HRO 5A1 receiver, UTC LS-57 output transformer. Thanks! Tom Smith, N5AMA, 13034 Elmington Dr., Cypress, TX 77429-2062. (713) 376-3436, evenings

FOR SALE: Ekco table radio, Model U83, made in England, AC/DC, nice cabinet and dial, needs repair, 1 knob on side has small piece of Bakelite missing - \$90 plus shipping. Jerry L. Everhart, 278 Wildlife Rd, Lexington, NC 27292. (704) 243-2171, days

FOR SALE: New-old radio and transmitting tubes. Send LSASE for free list. Gerald Scott, N7WVY, PO Box 2731, Elko, NV 89803. (702) 738-7734

FOR SALE: Model AR 1264 Theremin with console speaker, tapestry front, electronics in excellent condition, cabinet fair - Make Offer. B. A. Weeks, M.D., 435 Haiku Rd., Haiku, Maui, HI 96708

FOR SALE: Radios, parts, literature, books. 4-page list LSASE. **WANTED:** Homebrew amateur radio gear. Dave Dameron, KG6BP, 819 Boundary Pl., Manhattan Beach, CA 90266-6621. (310) 318-5311

FOR SALE: 11" x 17" professional copy of instructions for DeForest Interpanel, includes schematics, four blue-printed pages and cover - \$17.50 ppd. U.S. Ed Bell, 5311 Woodsdale Rd., Raleigh, NC 27606. Fax/phone: (919) 851-1517

FOR SALE: Westinghouse H122 radio phono - \$30. Masco PA amplifier M25N w/preamp - \$30. Amperite microphone Model RAH - \$15. HP 122A dual channel oscilloscope - \$30. Gonset civil defense 2 meter communicator - \$30. Radiola speaker 100A - \$30. Webster Chicago wire recorders, (2) - \$30. Stromberg-Carlson 636A - \$150. Philco 95 - \$100. Victor 52 - \$100. Fisher 400 receiver - \$40. Timex-Sinclair computer T1000 - \$10. Stan Jennings, PO Box 185, Washington Depot, CT 06794. (860) 868-2046

FOR SALE: Most Dynaco tube-type booklets, good to mint, and - \$15-\$20 ea. Rudy G. Purcell, 4473 W. 136th St., Cleveland, OH 44135. (216) 251-6511

FOR SALE: Altec A7500-8's Klipsch, Lascala's Shure V15 III + IV carts, Watkins WEIA's. **WANTED:** Allied Cat. 60-67, Dynaco PAS2, 3X, MK6, PAS 3 transformer, Sony VR6 headphones, VTL mono amps 50, 100, Optimus 3400. Russell Coco, 5505 Loranger Dr., Baton Rouge, LA 70809. (504) 292-7501

FOR SALE: Knight Model KN110 tuner restorable condition - \$15. Heathkit Model G-5 signal generator - \$5. Nathan Neth, 17833 S. Harlem Ave., Tinley Park, IL 60477. (708) 532-3411

Are You Into Tubes?



Then You Need

VACUUM TUBE VALLEY

Now Available

A New High Quality Publication devoted to the Best in Modern and Vintage Vacuum Tube Electronics.

Hi-Fi Amps, Guitar Amps, Tubes, Tuners, Speakers, and More!

4 Issues - 1 Yr.
\$25 US or \$35 Foreign
No Credit Cards

Vacuum Tube Valley
1095 E. Duane Ave. #106
Sunnyvale, CA 94086

ELECTROSTATIC SPEAKERS

~ KITS ~ PARTS ~ TRADE SECRETS ~

Enjoy building and listening to this hi-tech 1/Bin thin marvel. Easy low cost kits produce the ultimate in sound quality! Catalog/start-up manual - \$5.00

~ DAVID LUCAS ~

DEPT. ARC

924 HULTON RD. OAKMONT, PA 15139

WANTED: All types of telegraph items - will buy whole collection. Rick Hardin, 1750 Coleman Rd., Anniston, AL 36207. (205) 835-0900, day. Fax: (205) 835-0992. (205) 237-2008, night

WANTED: Jensen Concert, special design and Alnico 5 loudspeakers. Peter DeGregorio, 85 Burroughs Rd., Fairfield, CT 06430-3504. (203) 331-9155

WANTED: Old tube guitar amplifiers, and guitars, working or not! Fender, Gibson, Vox, Gretsch, etc. Steve Harrell, 1179 Boyston St., #30, Boston, MA 02215. (617) 247-0672. Fax: (617) 730-8449

WANTED: Radiola 18 P/S or transformer only. Also unusual 01-A tubes for display collection. Hal Kravig, 2615 Juneway Dr., Memphis, TN 38134. (901) 388-2857. Fax: 388-5102

WANTED: RCA UX 859 tube, looks like a UX 199. Jim Cross, 3246 Floridale Ln., Cincinnati, OH 45239-6203. (513) 385-3855

WANTED: Japanese transistors, pocket-size or coat-pocket size, need not work. Call or write: Bob Davidson, 310 Main St., Concord, MA 01742. (508) 369-2007

WANTED: Parts set & front cover for Sony CRF-150 portable SW radio. Ed Kalpa, 4622 Melbourne Ave., Los Angeles, CA 90027. (213) 661-1221

WANTED: Anything and everything having to do with Presto lathes. Also, Western Electric microphones and any other prewar recording equipment. Trent Ruane, 111 N. Grant #1, San Mateo, CA 94401-1953. (415) 340-8371. E-mail: trent@aimnet.com

WANTED: Philco console 640X in restorable condition. Call: Burl F. Updyke, RR#3, Hunlock Creek, PA 18621. (717) 477-3688, days. (717) 477-3856, eves. til 9 pm

WANTED: Diagram for transmitter Type T6-3 No. 1. Hammond Radio Signaling System. Pay your price! Gerard Faassen, Heideweg 1, 5953 Reuver, Holland

WANTED: Philco 46-1209 chassis. Will consider purchasing entire set if needed. Will pay top dollar and shipping. Scott Starr, 2845 Page Pl., Montgomery, AL 36116. (334) 281-0960

WANTED: Thorens automatic record changer model "concert" CD.40 goes to a Scott 800B; also need info on German Neutrofona radio. Butch Grieves, 2313 W. Summit Pl., Chandler, AZ 85224. (602) 273-1688

WANTED: National Union Radio Service Manual Volume 5. Tube tester power transformer (16 taps, 0 through 130 volts), MIRACO AC-9 radio. Mark Gutekunst, 2600 Martin Rd., Willow Grove, PA 19090. (215) 657-8552

WANTED: Parts for old telephones. John Phipps, 1412 Navaho Trl., St. Charles, MO 63304

WANTED: McIntosh 15W1 or 50W1 amplifier, 1954 Realist amplifier by Radio Shack, Newcomb, Pedersen and Meissner audio components. Jack Smith, 288 Winter St., N. Andover, MA 01845. (508) 686-7250

WANTED: Oscillator coil for Philco Model 71, Part Number 04186. W.F. Cobb, 943C Ave. Majorca, Laguna Hills, CA 92653. (714) 581-9350

WANTED: Eveready radios, speakers, old flashlights, flashlight catalogs, related items. Subscribe Flashlight Newsletter - \$12 year. Bill Utley, PO Box 4095, Tustin, CA 92681. (714) 730-1252

ORDER TODAY!

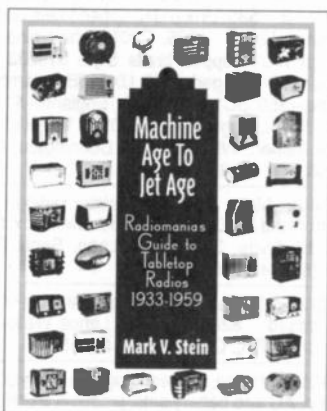

OVER 250 PAGES
1,400 RADIOS
Most not in any other reference
**EACH RADIO INDIVIDUALLY PICTURED,
IDENTIFIED AND VALUED**

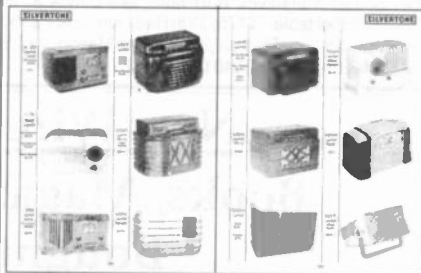

**Special For
ARC Readers!**

\$24.95 List Price
Now \$21.95!

**Only When Purchased From Radiomania Directly
All ARC Orders Autographed by Author**

Add \$1.75 Shipping U.S.A., \$3.50 Canada, \$5.00 All Other Countries

Send Check or Money Order Payable to:

Radiomania
2109 Carterdale Road, Baltimore, MD 21209

Maryland Residents add 5% Sales Tax. Allow 2-4 Weeks for domestic orders.



Radiomania™

FOR SALE: Tubes: Used unless stated otherwise: DeForest Audion 26 - \$7. C301 tipped brass - \$25. Audiotron 201A tipped brass - \$25. DeForest DV5 Isolontite base tipped - \$35; same, dud - \$20. C300 tipped brass - \$30. WE 101D tipped - \$50. DeForest DV2 Isolontite base tipped - \$35; same, dud - \$20. UX199 N.I.B. - \$35. Ureco U12 tipped brass dud - \$25. Perryman PA201A - \$25. C301A short pins - \$20. Radiotron WD11 tipped brass Style 319533 - \$50. Radiotron WD11 tipped - \$40. UX216B Rectron N.I.B., flap gone - \$50. SC1/1200 N.I.B., England - \$15 OBO. G55/1K N.I.B., England - \$15 OBO. WE VT1 - \$50. Eugene Rippen, WB6SZS, 105 Donnington, Auburn, CA 95603. (916) 885-6147

FOR SALE: Many novelty, transistor radios made in Japan from the 1960's. Most radios new in box. Free list SASE. Bill Hyde, 34 Cerrado Loop, Santa Fe, NM 87505. (505) 466-6613

FOR SALE: Soldering gun Weller #8200PK, never used, cased - \$28 plus UPS. Lance Walker, 7116 Reedy Creek Rd., Charlotte, NC 28215

FOR SALE: Moving, still reducing size of my collection including: AC and battery sets, plastic & Bakelite, tube portables, television, advertising and misc. For large picture list, send \$1 to cover postage and cost. Sonny Clutter, 14407 N.E. Fremont St., Portland, OR 97230. (503) 254-9296

FOR SALE: Transistors: Zenith Royal 16 - \$20. Real-tone TR-1088 - \$25. Tables: Zenith J723 AM-FM clock radio - \$20. Majestic 5A410, (Bunis 3, p. 130) - \$50. Tombstone: GE Model E-61 - \$100. Plus shipping. Guy Forstrom, PO Box 159, Quinnesec, MI 49876. (906) 774-8116

FOR SALE: Magnavox R3B horn, like new - \$175. AK's: 55 in Kiel table - \$175; 33 in Red Lion desk - \$150; 48 or 49 - \$50 ea. Plus shipping. Ross Mason, 715 S. Penn, Mason City, IA 50401. (515) 423-4687

FOR SALE: Gramy-Movno novelty radios (Breed's white book, Plate 419): #1. Works but tarnished, horn has been repaired - \$5. #2. Works but tarnished - \$10. #3. Mint condition with box, but I can't get the stations to come in - \$10. Include \$5 shipping each. Marcie Tichenor, 19794 E. Oxford Dr., Aurora, CO 80013

FOR SALE: Airline 93BR715A - \$30. Airline GSL1564 - \$25. Airline 74W61510A - \$30. Admiral Y3523 - \$15. Admiral 5S32 - \$25. Admiral 4L28A - \$25. Crosley 56TC - \$35. Dunlop 500 - \$50. Emerson SIMAX217 - \$35. Emerson SIM519 - \$30. Emerson 456 - \$45. Emerson 523? - \$35. Emerson SIMFL715 - \$35. Emerson 343 - \$50. Emerson 920 - \$25. Emerson 659 - \$55. Fada PL22 - \$50. GE T165A - \$20. GE Art Deco - \$35. GE 408 - \$20. GE E52 - \$65. GE T256A - \$25. GE 123 - \$15. Grunow 660 - \$175. Howard 225 - \$100. Jewel 5030 - \$50. Meteor 7001 - \$35. Motorola 7XM21 - \$40. National Union 571 - \$15. Philco PT3 - \$25. Philco C716 - \$15. Philco 51631 - \$35. Philco 53954 - \$70. Philco 50621 - \$35. Philco 51930 - \$40. RCA 4X641 - \$35. RCA 2X62 - \$40. RCA 96T - \$70. RCA 66X2 - \$40. RCA 9X571 - \$60. RCA 6BX63 - \$40. RCA 8X52 - \$55. Silvertone 8215 - \$35. Silvertone 4532 - \$85. Silvertone 2421 - \$50. Silvertone ? - \$25. Silvertone 25 - \$20. Sentinel 118BT - \$15. Sylvania BT3-1W - \$30. Truetone D117 - \$55. Truetone D2919 - \$15. Zenith 4K035 - \$45. Zenith H509 - \$25. Zenith H723 - \$30. Zenith M723 - \$20. Zenith X519 - \$20. S/H extra. Bud Santoro, 3715 Bower Rd., Roanoke, VA 24018. (703) 774-9153

FOR SALE: Philco 16B, cathedral - Best Offer. WANTED: Atwater Kent 337 for parts. Bud Machado, AA6HL, 4110 Crestview Dr., Pittsburg, CA 94565. (510) 439-7143

FOR SALE/TRADE: SX101, SX101A, RBK-15, HT32, HT37, RMG 45. WANTED: Ten-Tec? Ray Williams, 4521 Whitfield Ln., Saint Louis, MO 63134. (314) 428-1963

New Wireless Pioneers Books, Magazines, Literature Bought and Sold

New Wireless Pioneers buys and sells books, catalogs, magazines and other literature from the 1800's to 1950 that deal with early radio, wireless and electricity. A selection from our list of specialties:

Pre-1900 Electricity
Pre-1925 Radio or Wireless
Pre-1950 Computers

Pre-1900 Telegraphy
Pre-1940 Television
Early X-Ray

Magazines, Catalogs, Autographs or Ephemera related to the above topics. Also: Pre-1920 Wireless and Telegraph Apparatus - Radio-Related Novelties and Advertising - Early Vacuum Tubes and Electrical Devices.

Some items available in other technical subject areas also.

Several catalogs featuring items for sale are published each year.

New Wireless Pioneers - Jim & Felicia Kreuzer

P.O. Box 398, Elma, NY 14059

(716) 681-3186

WANTED: E.F. Johnson, Collins, Drake, Hammarlund, National. You may have the specific models I'm looking for. Also buying parts units. Dee Almquist, PO Box 371, Crimora, VA 24431. (540) 949-8300, leave msg.

WANTED: TRS-80 Model 4 TRSDOS Version 6 word processing program. Matt Kachmarchi, RD2, Box 150, Cherry Tree, PA 15724. (814) 948-7526

WANTED: Early TV's: RCA 6T530, 630TS, 621TS, Pilot TV 37. Jimmy Weaver, 1007 E. Bridges, Wynne, AR 72396. (501) 238-8328

WANTED: Zenith transistorized Trans-Oceanics, working or not. Ray Morrow, 1430 Montego Dr., San Jose, CA 95120. (408) 268-5727

WANTED: Original owners' manual for RCA Senior Voltomyst Model WV-98A. Don Mier, 4009 N. Foxdale Ave., Covina, CA 91722. (818) 338-9225

WANTED: My-own brand radio information and/or picture. Tombstone, small. Model #N/A. Made in Chicago. Paul Garbarczyk, 7805 S. McVicker, Burbank, IL 60459. (708) 599-8823

WANTED: Aviola 502-612 table radio. Spartan 109 chassis or audio input transformer for same. Dan Schwartzman, 712 13th Ave., Bethlehem, PA 18018-3401. (610) 882-0859

WANTED: Radiola 17 canopy for escutcheon (lamp-hood) and good compatible speaker, prefer Model 100. David Clare, 33 Rock Hill Rd., Old Bridge, NJ 08857

WANTED: Crosley Model 50 in nice condition. Martin Lamonde, 265 Du Pont, Apt. 101, Quebec (Quebec), Canada G1K 6L8

WANTED: Crosley Buddy Boy. Super Buddy. Show Buddy. Widget. Australian collector will pay good prices for one or all of above. Please write. R. Mardell, 2 MacDonald St., Vaucluse, Sydney, Australia 2030. Phone: 337 1662. Fax: 388 7038

WANTED: Hitachi TH-666, ivory. Looking for excellent example, complete with leather case and any accessories. Scott Starr, 2845 Page Pl., Montgomery, AL 36116-3142. (334) 281-0960

WANTED: Philco cathedral farm radio, Model 37-34. 5 tubes. Frank Cass, 20813 Albany, Warren, MI 48091. (810) 754-3387

WANTED: BC-611 Signal Corps walkie-talkie, Crosley 167 cathedral cabinet (restorable). Bill Jewell, 6828 Trinity Landing N, Fort Worth, TX 76132. (817) 294-9061

WANTED: Hallicrafters SX-96, SX-99 or SX-100 with speakers/manuals/price. Tony Wentkiewicz, 4107 County Rd., 138, Barnum, MN 55707. (218) 389-6907

WANTED: Old microphones. General PA types, like EV 605, Astatic JT-30, T-3, Shure 707A, 520, etc. Bullet shapes and others. Thanks! Dennis Gruenling, 26 Dupont Ave., Piscataway, NJ 08854. (908) 752-5737

WANTED: Service manual and information about parts source for Tandberg Model 3041X R to R tape recorder. Ray Barnes, 38 Woodmere Rd., Framingham, MA 01701

WANTED: National NC-100X and NC-100XA receivers. Also, National catalogs, brochures, manuals and ephemera. Wayne Childress, KC7KUE, 1903 Jerome Pl., #3, Helena, MT 59601. (406) 443-7255

WANTED: Radiola RS 2-tube radio, vg condition, expensive OK. Gary Gordon, 21112 Bank Mill Rd., Saratoga, CA 95070. (415) 857-4958. Fax: (408) 741-0715

WANTED: Zenith Trans-Oceanics 7000 American and 3000-1, need not be working. Also need front top lid for 3000-1 or junker with top front lid. Jim Montague, 1907 South Stanley Ln., Spokane, WA 99212. (509) 535-9576

A. G. Tannenbaum

Electronic Service Data

PO Box 386, Ambler, PA 19002

Phone: (215) 540-8055

Fax: (215) 540-8327

THE



FOR

Vintage Parts &
Service Data
1920's - Present

Free Catalog

Credit Cards Welcome

RADIO ★ GRILLE ★ CLOTH

Now **34** patterns & color combinations
are available to suit most radio needs!
55¢ LSASE for samples

More Good News! Even More Variety!

- 1) Three new patterns: one for Crosley Repwoods, one for 100A speaker, and a great new console pattern.
- 2) Selling off my remaining stock of green Philco V cloth, Now only \$15 for a full 1 1/2 square yard piece. Enough for up to 10 sets.
- 3) Still offering sampler packages of 5 or 10 pieces of cloth for \$20 and \$38, postpaid. See prior issues of A.R.C. for details, or call.

MICHAEL KATZ
3987 DALEVIEW AVENUE
SEAFORD, NY 11783
(516) 781-6202 (EVENINGS)

FOR SALE: Grundig Satellit-700 - \$295. ICOM IC-R1 world band hand-held, boxed - \$350. Sony 3-band ICF-5500W, does not work - \$25. Panasonic antenna coupler - \$25. All plus shipping. Gerald Silver, 10863 W. Clairmont Cir., Tamarac, FL 33321. (305) 720-1972

FOR SALE: Raytomic B-50-B Geiger counter, like-new condition with accessories/less batteries - Best Offer. Henry Galbraith, 1214 South Alvord, Evansville, IN 47714. (812) 476-7601

FOR SALE: Rare Cheney console, windup phono in mahogany, Hepplewhite cabinet (1920), nickel-plated parts, gold distributors logo, instructions, inc. several 78 records vgc, can deliver to Nashua. Also: several unique instruments, some very old from Harvard Univ. labs. SASE for list. Robert Enemark, W1EC, PO Box 1607, Duxbury, MA 02331. (617) 934-5043

FOR SALE: Philco 18 cathedral - \$275. AK breadboard original - \$825. Bristol Single Control Inverce Duplex - \$2,950. E.H. Scott Phantom FM Upper - \$200. Charles Vesser, 1929 Plumb Branch Rd., Knoxville, TN 37932. (423) 690-9217

FOR SALE: E.H. Scott console, 12-tube, early Warrington cabinet - \$425. Transistors: London HT6101? - \$25. Hi-Sonic red/chrome - \$20. Coronet Boys radio with box - \$15. Magnavox AM80 - \$15. Lloyd TR-6L - \$15. Maco T-18? - \$10. Shipping extra. Scott Olson, 2631 Cobblestone Ct., Fargo, ND 58103. (701) 293-9238

FOR SALE: Photoflash capacitors, small size, low leakage, 160 µfd, 330 volt - \$8/50; \$15/100 plus postage. Gordon Wilson, 11108 50 Ave., Edmonton, Alberta, Canada T6H 0H9. (403) 434-6257

FOR SALE: Philco Model H3410 Predicta Princess television, 1960, working, nice shapel, pick up only - \$450. Gerald Schneider, 3101 Blueford Rd., Kensington, MD 20895-2726. (301) 929-8593

FOR SALE/TRADE: KT-66's Emittron, pair N.I.B. - BO. Argonne AR-57, capsule microphone, N.I.B. - \$75. Altec 416 microphone w/base - \$75. Metrotone GB-8" bixial speaker, new - \$80. Electrola 12" coax's, pair - \$50. Peter DeGregorio, 85 Burroughs Rd., Fairfield, CT 06430-3504

FOR SALE: Nordemende Sterling Parsifal radio. 6BQ5 push-pull output, excellent condition - \$225. Al Pugliese, 27 Daleham St., Staten Island, NY 10308. (718) 948-7489, eves.

FOR SALE: B&K 1450B oscilloscope with original box & manual, very good shape - \$150. Eico VTVM - \$50. VT25 tubes - \$40 ea. Shipping extra. Rick Parrish, 1260 Marilyn Dr., Cape Gir, MO 63701. (314) 334-1726

FOR SALE/TRADE: Bell & Howell 16mm sound projector (specialist autoloader), exc condition - \$50 + UPS. Paul Fulton, 711 Jacquelyn Rd., Westwood, NJ 07675. (201) 664-5260

FOR SALE: Magnacord PT6-A tape deck - \$20. Solar capacitor analyzer Type CA - \$20. Plus shipping. Al Manieri, 384 Bates St., Phillipsburg, NJ 08865. (908) 454-3699

FOR SALE: Stromberg-Carlson AR-425 amp and preamp - \$225. McIntosh preamp C-29 - \$575. Fisher 200B tuner - \$175. Scott 130 preamp - \$225. Garrard 301 turntable - \$475. Thorens TD-124 - \$275. Raul Gil, 180 Union Ave., Belleville, NJ 07109. (201) 751-5959

FOR SALE: Dynamic mutual conductance tube tester 1-177B, nice condition - \$75. F. Brewster, RR2 Box 201C, Baxter Springs, KS 66713. (316) 856-3220

FOR SALE: Selling out dual garage, attic, house, basement, full of radios, speakers, parts, tubes, N.O.S. and pullouts. Test, eqpt., amps, tuners, service data, books, magazines. Cash and carry. No lists. Phone first. F. Krantz, 100 Osage Ave., Somerdale, NJ 08083-1136. (609) 783-0400, 10 am-8 pm EST

The "Radio Collector" Video

Writer-producer Mike Adams and the Perham Foundation Electronics Museum are pleased to present the original, best-selling PBS series, "Radio Collector". Nominated for an Emmy, Best Information Series, "Radio Collector" is now available complete and uncut. All five half hour shows have been newly duplicated from the original broadcast masters.

Order the Popular VHS
Videotape "Radio Collector"
Directly From
the Perham Foundation!



Writer-producer Mike Adams

You'll meet dozens of collectors and experts, see hundreds of radios made between 1900 and 1960, plus you'll learn about radio restoration!

Send \$29.95 plus \$3.00 S&H to:

Perham Foundation,
101 First Street, Suite 394,
Los Altos, CA 94022

For more information,
call us at 408-734-4453
Proceeds support construction
of our new museum!

CLASSIC RADIO BOOK REPRINTS

Official 1934 Shortwave Radio Manual edited by Hugo Gernsback

A master collection of heavily illustrated articles from *Short Wave Craft* magazine followed by page after page of schematics, coil diagrams and data on many commercially built shortwave sets of the era: SW-58, SW-5 "Thrill Box", deForest KR-1 and many, many more. A new chapter describes experiments in building regenerative receivers with transistors. One great book! 8 1/2 x 11 softcover 260 pages
No. 4643 \$15.95

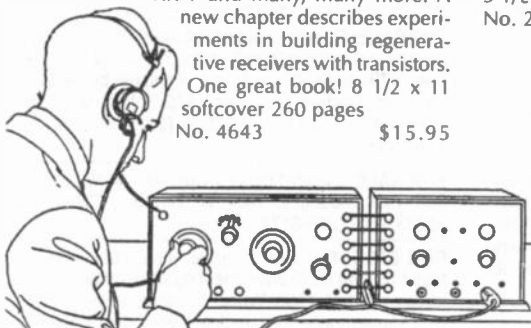

Experimental Television by A. Frederick Collins

Build a complete 1932 television system using Nipkow scanning disks! With 185 illustrations Collins will show you how to use photo tubes, synchronous motors, photocells to capture the image to be transmitted. Rare book.
5 1/2 x 8 1/2 softcover 313 pages
No. 20790 \$14.95

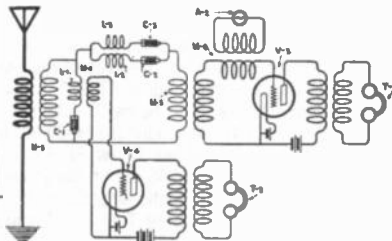

Wireless Experimenter's Manual by Elmer E Bucher

Bucher showed 1920 enthusiasts how to build equipment and operate it. From spark gap transmitters to continuous wave transmitters and radio telephone transmitters. You get great construction how-to on winding power transformers, coil winding machines, oscillation transformers, high-voltage condensers, rotary spark gaps, making a key, building receivers with variometers, and home made crystal detectors. Great classic book. Countless incredible drawings. Get a copy. 5 1/2 x 8 1/2 softcover 350 pages
No. 20854 \$13.95

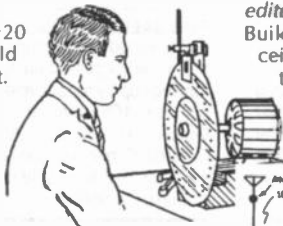

How to Build Your Radio Receiver edited by Banning & Cockaday

Build a 1924 NBS crystal set, a Haynes DC receiver, a two-stage AF amplifier, a four-circuit tuner, a TRF receiver, a brand "new" regenerative superhet, and others. Heavily illustrated how-to. 8 1/2 x 11 softcover 104 pages
No. 20951 \$8.95

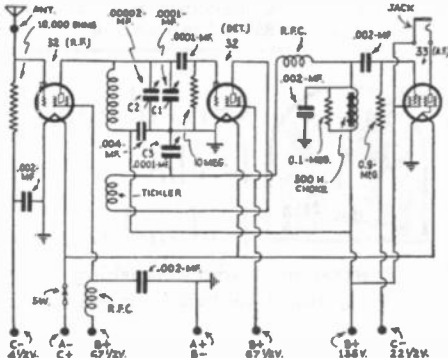

Vacuum Tubes in Wireless Communication by Elmer Bucher

Another classic Bucher book. This one from 1919. Covers all the two, three and four element oscillation valves, plus unusual varieties such as the Dynatron, Pliodynatron, the Kenotron or Pliotron. Reveals more than 140 early circuits: Weagant Beat receiver, Espenschied's Duplex Wireless Telephone system, regenerative cascade systems and more. Good stuff. Get one.
5 1/2 x 8 1/2 softcover 208 pages
No. 20412 \$12.95

TO ORDER send titles of the books, check, money order, Visa or Mastercard numbers, along with shipping & handling charge of \$1.00 for the first book and 50¢ for each additional. Or WRITE for your personal copy of our COMPLETE CATALOG listing many other old-time radio, electronic and electricity books. All books guaranteed highest quality. Fast service. Fair dealing. Order today!

LINDSAY PUBLICATIONS INC

PO Box 538-WH1, Bradley IL 60915-0538

FOR SALE: Tube tester, NRI professional Triplett Model 67 - \$45. Delco ribbon front R1231A, excellent working except fine crack left rear - \$50. Larry Kellough, PO Box 849, Canton, CT 06019-0849. (203) 693-8269

FOR SALE: Transistors: Spiket ST-607, sky blue, horizontal; Global GR-711, red, r.p., stand. (M.I.J., p. 35); Channel Master 6509 pocket, red, stand; Marvel 6YR-15A, blue, r.p., (M.I.J., p. 49); Admiral Y2229, blue, U.S. mfr.; Motorola X14B, aqua, round grille, stand, U.S. mfr.; Mitsubishi 6X870 blue/white, r.p., stand; Trav-Ler TR-600, black, r/p., (M.I.J., p. 60); Danube, round grille, black, stand; Realtone TR-1088 Comet, black, stand, (M.I.J., cover); Pearl Tone, early, pink/white, horizontal; Airline 1130B, blue/white, r.p., horizontal; Zephyr, ZR620, r.p., (M.I.J., p. 43); Realtone TR 8611, white, stand; Champion 2 trs. Boy's Radio, red/white, (similar to Acme, M.I.J. p. 108); Windsor 2 trs., red; Arvin 6R16, green, U.S. mfr.; Suntone DeLuxe, cream/white; Motorola X11R, red, U.S. mfr.; Jaguar 6T 250, black, r.p.; Sorrento Hi-Fi Deluxe, pink; Spica ST-600, red, horizontal, (M.I.J., p. 64); Westinghouse H652P6, green, horizontal, U.S. mfr. Mini tubes: Crown PR-530, cream, (R.T.G.A., p. 105); Olson RA-355, cream. Geiger counter: Universal Atomics, yellow plastic, large CD maring, very cool. Scott Hagerman, 3 Deer Trail Rd., Decatur, IL 62521. (217) 692-2373

FOR SALE: Transformers new, primary 120v, secondary 540VCT-275MA, three 6.3V2A, one 6.3V1A, one 5V2A - \$12 plus UPS. Jack Shaymow, Vintage Electronics, 52C Tilford, Deerfield Beach, FL 33442. (954) 427-1222

FOR SALE: 1964 Gertsch Model FM3AM freq. meter, good cond. - \$50. Clough Brengle old battery-operated signal generator, good cond. - \$30. Military freq. meter BC906D in original wood case, exc cond. - \$40. Taffet Radio & Television Co. audio osc. Model T5382 D/U, fair - \$40. John Be Lille, 302 Herndon St., Park Forest, IL 60466. (708) 747-1850, before 6 pm Central



**Greenbaum
Radio
Refinishing**

**Professional Radio Refinishing
Using Hand-Rubbed Lacquers**

From Cleanup/Touchup to Full Refinishing
Veneer Repair
Faux Graining
Glazing/Shadowing
Reasonable Prices
Satisfaction Guaranteed!

Call Joe Greenbaum
Weekdays 5pm-10pm est
Weekends 10am -10pm est
(410) 752-2438

FOR SALE: (8) UX 199, N.I.B. sealed matched 1922. WANTED: WWII aircraft radar H2S. Bert Belanger, 863 Boulevard St. Anne, Pte. Au Pere, Quebec, Canada G5M 1J1. (418) 723-9689. Fax: (418) 721-3015

FOR SALE: Grebe AC6 Synchrophase, clean, with good tubes, tuning mechanism coupling broken - \$150. Grebe MU-1, chain drive, clean, with good tubes, lower right wood damaged - \$200. Crosley Ace, plus 2-tube amp, no tubes, (1) book capacitor and knob missing, parts sets, dirty - \$50/all. Federal panel with 3-tube sockets - \$25. All items shipping extra. Shipping to MPLS. \$10 on any or all. Everett Hoard, Box 218, Lehr, ND 58460. Phone/fax: (701) 378-2341

FOR SALE: Silvertone red #2204 transistor radio - \$25. Japanese giant wristwatch radio, N.O.S. - \$75. Emerson 707B, early 50's, maroon, w/original box - \$135. Old chart of radio frequencies - \$25. Bob Burleson, 228 Monroe St., Hoboken, NJ 07030. (201) 795-9565, before 10 pm

FOR SALE: Leuth Trans-Oceanic Model No. H500 - \$95. Rick Mountjoy, 1350 W. Straford, Gilbert, AZ 85233. (602) 926-8174

FOR SALE: Our new 12-page photo catalog is out, featuring over (250) investment quality vintage tabletop radios ca. 1930-1959! Wood, Bakelite, metal, plastics, tombstones, cathedrals, midgets, you name it. Send \$1 or (3) 32¢ stamps to: Radiomania, 2109 Carterdale Rd., Baltimore, MD 21209. (410) 466-2814

FOR SALE: New Guide For Old Transmitters, 1922 to 1970; includes transmitters, transceivers, linears and more; 146 pages including 4 great indexes in which you can look up by model, make, year or final tube type; 500 pictures, 105 manufacturers, Tube Type Transmitter Guide, only - \$17.95 including U.S. postage. Add \$2 for Canada. Other countries add proper postage, 21 ounces. Calif. residents add tax. Sound Values, PO Box 9, Auburn, CA 95604



**AUCTION
AUCTION
AUCTION**

Southern California
Antique Radio Society (SCARS)
announces its

ANNUAL AUCTION
with a professional auctioneer

FEBRUARY 17, 1996
St. Andrews Lutheran Church, 15520 Sherman Way,
Van Nuys, California 91406

Partial list of pledged items:
Kennedy XV, Detroitla Chrome (exc), Coke Cooler, SV
Magic Dial, Majestic Chrome Front, AK 944, Musette
horn spkr, Gemsback Vols 1-3, W.E. VT-1, New 301As
in cartons, six good UV99s, good 200 & 201s
Westinghouse RC (mix), Radiola 26 (exc), 1940s TV,
Glorystone 26, Kennedy Coronet, Jackson-Bell 84 Peter
Pan (exc), Hickocks 533 & 539. Riders Manuals
complete 23 vol. set.

See February SCARS Gazette for details.
Info & pledges, call Kosh (213) 465 9919
Fax 213 465 2956
or Richard Gray (619) 977 6033

MEMBERS ONLY AT THE AUCTION
(Join SCARS at the door)

WANTED: RCA Model 6T10 wood set with chrome base. Johnny Johnson, 7075 W. 32nd Ave., Wheat Ridge, CO 80033. (303) 274-5474

WANTED: (2) butterscotch knobs for Fada 1000 bullet. Print for RCA 16Z chanalyst. Lee J. Rossiter, 3797 Edison St., NW, Uniontown, OH 44685. (216) 699-4037

WANTED: Cariole 5" TV Model 462 40 20010. Also Conar Model 311 resistor capacitor tester. Matt Kachmar-chi, RD 2, Box 150, Cherry Tree, PA 15724. (814) 948-7526

WANTED: Scott 830 Mpx stereo generator and manual. Bill Crawford, Cushman Rd., Patterson, NY 12563. (914) 878-4653, or e-mail: BCrawf2974@aol.com

WANTED: External speaker for Hammarlund HQ180. Must be in excellent condition. Clyde Hixson, 3907 Columbia St., Des Moines, IA 50313. (515) 243-7930

WANTED: Wooden sets with chrome grilles or trim. Jay Malkin, 1250 Galapago, #206, Denver, CO 80204. (303) 623-6451. E-mail: klaaslaw@aol.com



WANTED: Motorola Catalins #'s 50XC, 51X15, and 52, as complete or "parts" sets. I am a very serious collector seriously looking for serious stuff (leaving all kidding aside, of course)! Please write or call collect: Rain Buttignol, 214 State St, #7, Portsmouth, NH 03801. (603) 427-1384

WANTED: Working meter for Hickok Micromho tube tester Model 6000A. Gus McKenzie, 3701 Taiga Dr., Anchorage, AK 99516

WANTED: Pay \$1,000 for any wood telephone with crank in front door. Stanley Schreier, 350 Hendrickson Ave., Lynbrook, NY 11563. (516) 887-4966. Fax: (516) 887-4780

WANTED: Power transformer or complete power supply for Kolster Model 6K. Cris Van Houten, 728 Keup Rd., Cedarburg, WI 53012. (414) 377-5873. (414) 358-5855, work

WANTED: Mics: EV605, 619, 638, 641, 719. Shure 707A, 440, 545. Turner BX, CX, VT-73. Working or not. Send your list of others for sale. Tom Ellis, Box 140093, Dallas, TX 75214. (214) 328-3225. Fax: (214) 328-4217

WANTED: Surplus conversion Manual #3, blue one; 1939 ARRL Handbook; R-23/BC-453 ARC receiver; ARC T-17 1.3-2.1 Mc transmitter, there has to be some out there somewhere. FOR SALE: Heath SB-101 transceiver, HP-23A power supply, SB-600 speaker & all manuals, no mic. - \$150 + UPS. Wayne LeTourneau, Box 62, Wannaska, MN 56761. (218) 425-7826

WANTED: Philco Model No. 40-180 (console). Original in good-excellent condition. J.M. Syken, 6 Burns St., Forest Hills, NY 11375. (718) 261-9614

WANTED: Cabinet for Zenith 10S130, 10S147, 10S153, 10S155, 10S156 or 10S160. Also AK 89. Mark S. Rauber, PO Box 1077, Minden, NV 89423. (702) 782-3596

WANTED: (300) 9-pin miniature sockets; (100) octal sockets. Chassis mount, no shields, must be clean, N.O.S. Will buy or trade, lots of vintage transistor radios, tubes from 20's to 60's sweep, transmitting, audio books, Radiotron Designers Handbook, etc. Dan Steele, 2300 Broad St., San Luis Obispo, CA 93401. (805) 543-2946



WANTED: I will pay top dollar for the pictured Midwest wood tabletop in any restorable condition. Also seeking other Midwest tabletop radios ca. 1933-40. Call or write: Mark V. Stein, 2109 Carterdale Rd., Baltimore, MD 21209. (410) 466-2814. Fax: (410) 466-0815

WANTED: Junked Zenith Royal-500 owl-eye radio with good speaker. Also good Silvertone 3051 cabinet. Matt Limpert, 4519 S. Joe Ctr. Rd., Fort Wayne, IN 46835. (219) 485-6352

WANTED: Chassis for big Addison, wood or Catalin version. Will pay reasonable price for junker or chassis only. Don't need dial glass or knobs. Mark V. Stein, 2109 Carterdale Rd., Baltimore, MD 21209. (410) 466-2814

WANTED: Info on Telicon radio Model 12-F mfg. by Telicon Corp., New York City, N.Y. Have owned since new, gift in 1941. William J. Toensing, 13226 Mystic Mine Rd., Nevada City, CA 95959. (916) 477-1128



WANTED: Large multiband Lafayette cathedrals & tombstones such as the one pictured. Have cash or trades and can pay finders fee. Thanking everyone in advance. Bill Moore, 3049 Box Canyon Rd., Huntsville, AL 35803. (205) 880-1207

WANTED: RCA or GE 211s or 845. Call: Bill Phillips, 327 Colonial Ave., Trenton, NJ 08610. (609) 888-4524

WANTED: Electron tubes, ball bearings, Collins radio parts and equipment, aircraft parts & instruments, helicopter parts, lamps, synchros. Hy Ness Company, 709B Delair Rd., Cranbury, NJ 08512. (609) 395-1116. Fax: (609) 395-1117

FOR SALE: Telefunken Jubilate AM/FM/SW - \$65. Grundig Satellite 650 - \$750 firm. Call: Nisar Ahmad, 34 Saccheri Ct., Staten Island, NY 10308. (718) 966-9018, after 7 pm EST

FOR SALE: Kadette Jewell 48 chassis good, cabinet broke - \$50. Hallicrafters SX11 Skyraider and SP44 Panoramic adapter, excellent rust free unaltered condition, repro manuals - \$450 for pair. RCA 8-BT-10K plug-in transistors - \$35. GE S-42 lowboy Junior w/2 Globe 45s, good condition, hums - \$100. Airline 62-316 chrome chassis w/speaker - \$55. Airline console, drum dial, eye tube, refinished lacquer cabinet, works - \$70. Magnavox AM-81, N.I.B. - \$40. Dictaphone 103800, mint w/mic and case - \$40. Transette 3-in. R-to-R, Japanese - \$25. Revere T-100 R-to-R, 1951, w/mic, 5-in. reels - \$50. Sony Model 111 R-to-R w/case, 1965 - \$65. Muntz car cart player, predecessor to 8 track, all chrome, rare - \$70. Singer TV6U basket case w/UHF tuner and case - \$40. Sony 5-303W and 307w, untested - \$50 both. RCA 8-TR-29, 1950, untested - \$75. Admiral TV, 20X1, 1950 Bakelite case, clean, 1950 - \$75. Heathkit FMO-1, clean - \$20. Standard sig. gen., 78B, no rust, untested, 30S - \$20. BC221M with books - \$25. Approx. 120 various panel meters, all types, sold as lot, SASE for list - \$225. Commodore computer, 2 KBD's, 2 drives, printer, NEC monitor programs, misc. - \$200 for lot. Trade for brass steam gauges or cash. Mark Parthe, 213 S. Charles, Saginaw, MI 48602. (517) 793-9103. E-mail: meparthe@alpha.delta.edu

FOR SALE: Koestler #10 amp/field coil, buy or sell 1. WANTED: Open-reel tapes; Lafayette KT-550 amp. Richard E. Brown, PO Box 686, Farmington, CT 06034. (860) 677-4828

FOR SALE: QST collection 1922-1976 in ARRL binders - \$1,000; 826, 4-400, 4CX250B transmitting tubes, many books and magazines - inquire. Dynaco, Scott, Fisher, Heath audio equipment. (6) page list - LSASE. Tim Martin, WB2VVQ, Shaker Heights, Rt. 49, Pittsfield, MA 01201. (413) 499-7482, call evens., weekends only please

FOR SALE: Radiola One (ER753A) crystal radio - \$950. Bendix 526C Catalin - \$600. Both mint! James Kroegel, 856 Old Farm Rd., Columbus, OH 43213. (614) 864-8327

FOR SALE: World's most popular WWII military communications merchant, over (1,300) past customers worldwide, huge inventory, earn our free "historic military communications award," completely revised 50-page catalog out January 15th - \$2 U.S.; \$5 foreign. Sam Hevener, W8KBF, The Signal Corps, 3583 Everett Rd., Richfield, OH 44286. (216) 659-3244



WANTED

Amrad 3670 as shown, any condition. Also a Type E crystal set, 3500-2 and other pre-1926 Amrad sets & parts.

Andrew Mooradian, 5 Priscilla Lane
Winchester, Massachusetts 01890
tel. 617-729-1873 after 7 pm

FOR SALE: Museum quality Radiola 28 highboy console and matching 104 loudspeaker/AC console; Aeriola Jr.; Aeriola Sr.; ATTP Tom Thumb portable; Crosley Pup; Stewart-Wamer miniature 5-tube tombstone; Zenith 6D326 child's console; xtal sets; and numerous radios and radio items. Send SASE for detailed list, description and prices. WANTED: Tom Thumb portable bike radio; Fada 711 chassis. Dan Clayton, 12441 Coconut Creek Ct., Fort Myers, FL 33908. (941) 466-6644



FOR SALE: Spherical Audion working replicas, single wing type, ca. 1907, 3 1/2-volt filament - \$350 ea. Price includes candelabra base and shipping. Ca. residents add 7% sales tax. Science Resources, 1260 Liberty Way, Suite B, Vista, CA 92083. (619) 727-6933

FOR SALE: AK 9 breadboard, gc - \$800 firm. UPS paid. T. Hartley, 3106 Russell, Parma, OH 44134. (216) 661-5232

FOR SALE: B&W SSB receiver adapter Model 370 - \$40. R-444/APR 4Y, (2) receivers, (4) plug-in units, 30-4000 MH, works - \$150. PS-225 dynamotor with shock mount - \$25. R-27/ARC5. 19-55 MH - \$30. C760 B/A Seeburg control box with cables - \$15. The above unchecked unless noted. WANTED: To complete my HRO collection: Japanese, German or Australian HRO's, and speaker/coil unit for HRO 50/60. John Orahood, N5SPQ, 5819 Miller Valley, Houston, TX 77066. (713) 440-5598

FOR SALE: Rider Radio Manuals, no ends. SASE for list. Mark Anderson, RD#1, Box 58A, Greenwich, NY 12834. (518) 692-2593

FOR SALE: Sencore color generator 141, new radio & TV tubes, field strength meter 134, F.S. Ann Bichanich (Jay's), 15 1/2 W. Lake St., Chisholm, MN 55719. (218) 254-4421

FOR SALE: Junker chassis, BC-342, SP400, SP210 - Offers. Clarion 422 - \$125. Series string Christmas lights. G. Stevens, PO Box 704, Longmont, CO 80502-0704. (303) 776-9036

FOR SALE: Radios, audio, transmitters, books, tubes, parts, manuals. List - \$1 and SASE. Joseph Bedlovies, PO Box 139, Stratford, CT 06497

FOR SALE: RF generators: N.I.B. Heathkit IG-1275, LINLOG sweep 3Hz-3MHz, partially assembled - \$89; HP606A, 50kHz-65MHz, manual - \$95; HP8614A 800-2400MHz, manual - \$245; RCA WR-99 19-260MHz - \$38; TV7D/U tube tester - \$100. VTVM's: RCA WV-98C, manual, HV probe - \$48; HP400L, manual - \$25; HP412A - \$25; Fluke 8375A 5 1/2 digit DMM - \$25; Heath ET-3400A microprocessor trainer - \$78. Millen 90651 grid dip meter - \$98. More, list - LSASE. Kirk Ellis, KK4YP, 203 Edgebrook Dr., Pikeville, NC 27863. (919) 242-6000, evenings

RADIO XXVII

★ SAME-GIANT ★ ★ OUR 27th ★
LOCATION GET-TOGETHER

An Indoor Old Radio Flea Market

6500 square feet — 90+ Tables Available

Last year attendance was over 600!

Sunday, February 25, 1996 — 8:00 A.M. till 1:00 P.M.

Registration begins for all at 7:30 A.M. in inside heated foyer.

\$4.00 admission (spouse & children free) — Sellers see below.

Westford Regency Inn — Regency Room — Westford, Mass.

(I-495 at Exit 32 — directions below)

Coffee, Donuts, Sandwiches, Soup, etc., will be available.

The Westford Regency Inn and Conference Center is a 193-room hotel with 3 restaurants and over 500 parking spaces. With over 20,000 square feet of conference space, we have room to expand our future radio meets!

Also, visit John Terrey's Collection of Early Radio & Wireless

5 mi. from meet. 1:00 P.M. - 3:00 P.M. Sign up at meet.

Pre-registration & Information: Lisa Friedrichs at: A.R.C., P.O. Box 2, Carlisle, MA 01741 — (508) 371-0512.

Sellers: \$4.00 per person for admission plus \$15 per 8' table (for either 30" or 36" wide). Table sizes and location assigned on a first come-first serve basis. Early registration is recommended in order to obtain space in the main hall. Adjacent rooms will be used for overflow. Four table limit per seller. Sellers may register at the door or may pre-register by mailing payment to: Radio XXVII, c/o A.R.C., P.O. Box 2, Carlisle, MA 01741. (Make check/MO to A.R.C.; Visa or MasterCard OK, too.) If paying by credit card, sellers may pre-register by calling (508) 371-0512 or faxing (508) 371-7129. **New Policy:** After reporting to the registration desk, sellers may enter the hall to deposit goods at their table and then must return to the foyer until the doors open for everyone at 8 A.M. Last year's sellers may reserve the same location as last year if we receive their paid registration by 2/1/96. **Cancellation Policy:** Table fee will be refunded only if requested and the table is resold. If a table is not occupied by 9 A.M., a table may be cancelled and resold.

Overnight stay: Westford Regency Inn at 1-800-543-7801 (In Mass.: 1-800-543-7802.) Mention Radio XXVII for special rates. Bring your family to enjoy indoor pool, health club, racquetball courts, three restaurants, bar, etc. Night skiing at Nashoba Valley Ski Area, only 2 miles away!

Directions: From I-495, take Exit 32. Follow sign to Rt. 110. At stop light, turn right onto Rt. 110-West for .4 miles. The Westford Regency is on the right. Use doors on right (north) side of Inn. Ramps at both show entrances!

Sponsored by:

The Greater Boston Antique Radio Collectors

Not a club, no dues, no newsletter... just a great group of collectors!

Thanks to Antique Radio Classified for organizing this meet.

FOR SALE: (11) New 12AX7 tubes, half RCA, half military, for - \$45 plus \$5 postage. Maurer TV, 29 S. 4th St., Lebanon, PA 17042. (717) 272-2481

FOR SALE: RCA tombstone Model 128, 1934 - \$275 plus shipping. Robert J. Stone, 721 Fisk St., Piqua, OH 45356-3729. (513) 773-2217

FOR SALE: Reproduction Fada Bullet 1000 dial face - \$25. John Reid, 6 Queensway, Merrimack, NH 03054. (603) 886-9670

FOR SALE: Emerson 1933 model, 157 chassis & back cover & knobs, fits in Model 409-416 Mickey Mouse, etc. - \$60. Also USA chassis working. T. Romano, 8 Howe Ln., Millbury, MA 01527. (508) 865-6293

FOR SALE: The Vail Correspondent, telegraph collector's illustrated quarterly, free ads - \$10 /yr. U.S.A. Sample - \$2. TVC, Box 88-A, Maynard, MA 01754

FOR SALE: Automobile radio vibrators. Free catalog. See our boxed classified ad. Dan Schulz, Antique Automobile Radio, Inc., 700 Tampa Rd., Palm Harbor, FL 34683. (800) 933-4926. Fax: (813) 789-0283

FOR SALE: TV's: RCA 9T246, same as 9T256 (Poster V2, p. 166), exc condition; Emerson AC/DC portable, fair condition - \$100/\$50 or Best Offer. Phil Brunais, 14185 Pleasanton Hwy., Bear Lake, MI 49614

FOR SALE: Dictogrand speaker, refinished and in good condition - \$125. Buyer pays shipping and handling. Jim Barrows, 15121 41st Ave., SE, Bothell, WA 98012-6113. (206) 337-4880

FOR SALE: Original rosette and other Philco knobs. Many other old radio knobs, no trash. Elwood Hunt, 308 Georgetown Rd., Carneys Point, NJ 08069. (609) 299-5259

FOR SALE: Heathkit IM-28 VOM, works, have two, for - \$15 and \$10 plus UPS. Jim Clifford, KE4DSP, 108 Bayfield Dr., Brandon, FL 33511. (813) 654-7531

FOR SALE: Catalin radio, green louvered Emerson tombstone, knockout color and dramatic marbleization, minor flaw - Best Offer over \$1,000. John Reid, 6 Queensway, Merrimack, NH 03054. (603) 886-9670

FOR SALE: Silvertone red #2204 transistor radio - \$25. Japanese giant wristwatch radio, N.O.S. - \$75. Emerson 707B, early '50's, maroon, w/original box - \$135. Old chart of radio frequencies - \$25. Bob Burleson, 228 Monroe St., Hoboken, NJ 07030. (201) 795-9565, before 10 pm

FOR SALE: Radios, misc., SASE list. Avionics tube radios: NARCO VHT-3/Superhomer works, Omnigator MKII nw, Omnigator MKIII nw, & NARCO Model V12 MP-2A modulator-power unit vibrator type, no manuals - \$35 for the lot + UPS. Tom Tetzlaff, 23 Nelson Dr., Silver Bay, MN 55614. No phone

FOR SALE: B&K transistor radio analyst, w/box, instructions - \$175. (25) A.R.C.s, 1989 - \$25. RCA 29K2 console, awesome! - \$125. Sony radios. Mini tape recorders, transistor radios, lists - \$1 ea. **WANTED:** Zenith Royal 500, Regency TR1. Don M. Maurer, 29 South 4th St., Lebanon, PA 17042. (717) 272-2481

FOR SALE: Sprague capacitor resistor analyzer Model TO-3, no manual - \$20 + UPS. John Martin, 111 Bancroft, Rochester, NY 14616. (716) 663-4182

FOR SALE: Sony TR-66 transistor, yellow & red, not mint but still a beauty and very rare. S. Volpin, 178 Cecil St, Sarnia, Ontario, Canada N7J 6W5. (519) 336-8787

FOR SALE: Zenith Trans-Oceanic 1000, good - \$65. Toshiba 7TP-352M, excellent, w/case - \$95. Add UPS. Walt Kieffer, 6233 51st Ave. NE, Seattle, WA 98115. (206) 526-1452

FOR SALE: Magazines, (25) issues of International Shortwave Club from 1930, 31, 32, all for - \$15. Harry Blesy, N9CQX, 9S740 Clarendon Hills Rd., Hinsdale, IL 60521. (708) 789-1793

"Do you know me?"

I started the world's first broadcasting station. I'm Charles Herrold, and between 1912 and 1917 I was sending music and news to an audience in San Jose, California, on a regular schedule. But while I may have been first, most people forgot all about me. Now there's hope; my story is told in this exciting new videotape from the creator of the award-winning PBS series 'Radio Collector.' It's available from the Perham Foundation. Don't leave home without it!"



"Broadcasting's Forgotten Father: The Charles Herrold Story"

VHS-Hi-Fi, close-captioned, \$29.95 plus \$3.50 S&H.

Order directly from the Perham Foundation,
101 First St., Suite 394, Los Altos, CA 94022.

Or call 1-800-771-KTEH and use your credit card.

All profits go to support the preservation of electronics history.

WANTED: Telescopic antenna for a Zenith transistor Trans-Oceanic radio, Model 3000-1. Hank Trabold, 2058 Nakiska Ct., Toms River, NJ 08755. (908) 244-2345

WANTED: Need copy of schematic/manual for Senecore TF-17, TF-30, TF-151 transistor testers. Also Conar 22 1 tube tester. Harry Pewowaruk, 1535 No. 8th Ave., St. Cloud, MN 56301. (612) 252-9910. E-mail: PewowarukH@aol.com

WANTED: 1931-1936 Atwater Kent ads and sales literature. High quality copies preferred. Jeff Aulik, 1708 Parkview Ave., Rockford, IL 61107. (815) 399-1902

WANTED: Vacuum Tube Application Notes, Ham Tips, and other related tube publications from RCA and other manufacturers. Ken Seymour, KA7OSM, 9115 S.W. 176th Ave., Beaverton, OR 97007. (503) 306-7439, days/eves.

WANTED: Collins 51S1 receiver. James Okubo, W6OU, 529 Kevin Way, Placentia, CA 92670. (714) 528-5652

WANTED: Meters for RT-834/GRC-106, AM-3349/GRC-106 & MD-522A/GRC, part of AN/GRC-142-C Hut. Edward J. White, WA3BZT, 809 Seymour Rd., Bear, DE 19701-1121. (302) 322-1313

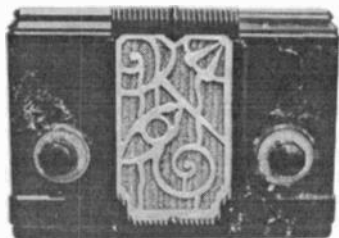

WANTED: Early (prewar II) plastic radios. I collect these objects of beauty to enhance my otherwise dull and uneventful life to which I am forever bound by by sad-but true unworthiness and shortcomings: physical, emotional, and intellectual. Please write or call collect: Rain Buttignol, 214 State St, #7, Portsmouth, NH 03801. (603) 427-1384

WANTED: Hallicrafters HT-9 transmitter and spare parts. Robert Braza, N1PRS, 23 Harvard St., Pawtucket, RI 02860. (401) 723-1603

WANTED: Transformers: Amertran 678, 151CB. UTC 52462, 52463, HA135. WE 247B, 264C, 127D, 159B. Lary Rubins, 2614 Old Stone Mill Dr., Cranbury, NJ 08512. (609) 426-9744

WANTED: Working vintage broadcast equipment, mikes, mixers, etc. J. Finkelstein, 205 Alapocas Dr., Wilmington, DE 19803

WANTED: Any strange or unusual tubes out there? Let me know what you have. Duds, too! Sam W. Wrenn, 2314 Seminole Dr., #1207, Arlington, TX 76010

WANTED: Heathkit HO-10 ham monitor oscilloscope. Must be good mechanical condition and working. Ralph Michelson, KG8FA, 4538 Golfview Dr., Brighton, MI 48116. (810) 229-8339

WANTED: T22/ARC-5 Navy aircraft transmitter, RE/2-ARC-5 antenna relay. P. Hamersma, 87 Philip Ave., Elmwood Park, NJ 07407

WANTED: Info on Philco Junior Scope, Model 7019. Larry Daniel, 706 Pearson Rd., Wright Patterson AFB, OH 45433. (513) 754-1567

WANTED: Belmont 6D111, brown, no cracks or parts missing, exc cond. electronically & looking good. Tom Elmhorst, 9605 Arvilla Ct. NE, Albuquerque, NM 87111



WANTED: Grigsby-Grunow artifacts from 1921-1934: Majestic advertising, paper & anything related to the Grigsby-Grunow Co. of Chicago. Contact: Chip Taylor, PO Box 20132, Bradenton, FL 32403. (941) 745-2893. Fax: (941) 741-4947

WANTED: Antique medical devices especially violet rays, scientific, small table fans and radios. Richard Cane, 1333 N.W. 127th Dr., Sunrise, FL 33323. (305) 846-7116

WANTED: Hallicrafters: SX-122, SX-62B, SX-117, SX-71. National NC-400, NC-190. Must be in mint or near mint. **FOR SALE:** Grundig Satellit 700, like new - \$295. Sanyo RP-8880 multiband, mint - \$150. GE Superadio II, boxed - \$75. ICOM IC-R1 hand-held worldwide receiver, boxed - \$350. All plus shipping. Gerald Silver, 10863 W. Clairmont Cir., Tamarac, FL 33321. (305) 720-1972

WANTED: Coils & dial scale E & F for the National HRO-60. Please help, will pay your price. Richard J. LaMark, N2TXL, 6822 Tuckahoe Rd., Williamson, NY 14589-9589. (315) 589-2552

WANTED: Side knob for Airline (Wells Gardner) 62-352 and radio drama transcription discs. Merrill Mabbs, 709 Pluma Dr., Rapid City, SD 57702. (605) 342-4090. E-mail: Radio@aol.com



WANTED: Seminole transistor radio Model #1020. It's the leather model from 1964. Also, I'm looking for a record player/radio combination made by Audio Industries Model #355 (see picture). John Theisen, 917 Broadway, Valley Springs, SD 57068. (605) 336-3650, days, or (605) 757-6775, evenings

WANTED: Theremin. Mint tube CB's. **FOR SALE:** Fisher K10 Spacexpander. Collins R390, R390A, R391 manuals. Vintage CB's: LSASE - list. C. Zafonte, RFD 1, Box 75, Ft. Kent, ME 04743. (207) 834-6273

FOR SALE: Used test equipment. **FOR SALE/TRADE:** Assorted tubes. Some with good filaments, some duds. LSASE for lists. Please specify which list. Sam W. Wrenn, 2314 Seminole Dr., #1207, Arlington, TX 76010

FOR SALE: Phonograph restorers, we sell high new/rebuilt cartridges, obsolete idlers resurfaced, 78 needles. West-Tech, PO Box 1415, Sebring, FL 33871. (941) 471-0922

FOR SALE: Junking Silvertone radio R1171. Also RCA TV KCS47. Richard Korb, 43 River St., Holden, MA 01520. (508) 829-2063

FOR SALE: Zenith radios - call or write for list. Robert J. Stone, 721 Fisk St., Piqua, OH 45356-3729. (513) 773-2217

FOR SALE: Arvin 950T2 - \$35. Emerson 883B - \$35. Farnsworth ET-065 - \$75. Philco 42PT91 - \$40. Temple G-513, white Plaskon - \$40. Plus UPS. Michael LaPuzza, 2015 E. Willow Crk., Mustang, OK 73064. (405) 745-3394, after 6 pm

FOR SALE: Acme PA-1 single stage amp 1924-27 - \$25. Knott early multi-tap resistance box - \$25. Pair Stromberg inter-office telephones - \$45. Chet Wisner, 1014 Main, Dalton, MA 01226

FOR SALE: Lyric 546T, ivory - \$45. Zenith 6-D-520, doesn't play - \$30. RCA 1-X53, green - \$30. Arthur Kreitner, 2013 East Belle Ave., Belleville, IL 62221. (618) 233-5610

FOR SALE: Warner Electric pole changer - \$50. Heathkit SW HR-10B - \$35. Realistic 4-channel synthesizer - \$15. Weston VOM, wood box - \$15. Field strength meter, N.I.B. - \$10. Admiral 5X21 Bakelite - \$10. Radio Handbook, Radio Manual, Aligning Philco, Cathode Ray Books; all - \$10 ea. Plus others. 809 tube N.I.B. - \$20. All plus S&H. Please call before 9 pm. Wally Worth, 2W. Elm Ave., Wollaston, MA 02170. (617) 479-4512

FOR SALE: Plastic dial covers for AK145, 337, Belmont 6D111, Emerson AM169, AU 190, BM258, 375, 400, 520, U5A, Fada 1000, Hallcrafters S-38, Zenith 6G005, 8G005, 6D525, 6D311, and many others or yours with old cover and/or drawing - \$14.50 ea. ppd. Doyle Roberts, HC 63, Box 236-1, Clinton, AR 72031. (501) 745-6690

FOR SALE: (6) pieces, modulator, radio transmitter, MD 203GR - \$25 ea. + shipping. Gerald Cromer, K4NHN, 1014 Summerland Dr., Cayce, SC 29033

FOR SALE: Rider's Radio X, Amateur Handbooks 1959, 1967 - \$15 ea. ppd. Sanford Mathis, 29390 Somerset Rd., Paola, KS 66071. (913) 294-2669

**PHONE NUMBER FOR
ANTIQUE RADIO CLASSIFIED
(508) 371-0512**

**Best time to call is weekdays:
8:30 am to 6 pm Eastern Time
(Please no classified ads by phone. Thanks!)**

FOR SALE: Early Fada radio orange neon edge lite sign, works & clean - \$800. Western Union clock, metal case, 20", clean & works - \$165. Early Craw Foot gravity cell, glass case, N.O.S. electrodes - \$125. Electrical Review, bound ex Stanford Library, years 1885 to 1889, ten volumes, very clean - \$600. Handbook Technical Instruction for Wireless Telegraphs, Hawhead - \$40. Wireless Telegraphy & Telephony, Eides - \$55. Radio Amateur Handbook, 1927 - \$45. Robisons Manual of Radio, Telephone & Telegraph - \$25. Above items plus shipping, OBO, and available for trade. **FOR TRADE:** Bi-polar open-frame motors complete, working: C&C Models 1A, rare, and 1D, C&W Type 1/8 K, Union switch & signal with covered glass commutator, Roth - DC to AC converter (very early telephone ring?), no name - cast brass end bells, plus smaller units - K&D etc. Key-20 Century pump handle, clean with cable. Trade for old meters/galvos, scientific instruments before 1900. SASE, color photos - \$1. Machine answer after 4th ring. Ye Olde Meter Cellar, Leonard W. Cartwright, 879 Russet Dr., Sunnyvale, CA 94087. (408) 739-6025

FOR SALE: Chinese heavy chrome keys, N.O.S. - \$65 ea. ppd. Sony book, Genryu Sony challenges 1946-1986 - \$25 ppd. Intl. Postal/MO please. **WANTED:** 6D5, not 6D5G/6D5MG, Sony TR8. Japanese Mt & Sub-Mt tube portables. Japanese tr. radios using oval-shaped tr. Solar radios Hallcrafters 505 (doghouse TV). European-made tube & tr. hybrid radios. Japanese WW2 sets. WW2 German peoples radios. Noriyoshi Tezuka, 1-11-2-403 Hiroo, Shibuyaku, Tokyo 150, Japan. Fax: 011-813-3440-8396

**TUBES WANTED
HIGHEST PRICES PAID \$\$\$**

101D, F.205D, F. Tennis Ball, 300B, 274B, 211, 845, KT66, KT77, KT88, EL34, PX25, 280, 250, 102F, Telefunken, Bugle Boy, Mullard, ECC81, 82, 83, 801S, 802S, 803S.

AUDIO EQUIPMENT WANTED
Fisher, Scott, Dynaco, McIntosh, Marantz, JBL, Altec 604, B, C, D, E, 515, B, C, 288, B, C. UTC trans.; Black Beauty, A&B Resistor, etc...

FULL RANGE ELECTRON TUBE SHOP

Jonathan Woo Yik Fan
Flat B, 37/F, Block 5, Greenfield Garden
Tsing Yi, NT, Hong Kong
Tel: (852) 24349466 - Fax: (852) 24344963

OLD TECH *Early*
BOOKS *Technical*
& **THINGS** *Books & Apparatus*

**Announcing - Catalog No. 1
Available Soon*
Write For Free Copy.**

We Specialize In:

Wireless - Radio - Television - Telegraph
Telephone - Electricity - Computers - Slide Rules
Electro-Medical - Calculators - Typewriters
Atomic Energy - Astronomy - Skiing

We Buy & Sell:

Books - Juveniles - Catalogs - Magazines
Manuals - Ephemera - Novelties - Apparatus
Anything Related!

Send us a list of your general & specific wants.

OLD TECH - BOOKS & THINGS

John V. Terrey, Proprietor
P.O. Box 803, Carlisle, MA 01741 U.S.A.

**Still delayed, but eventually I will get it finished!*

The Antique Radio Club of Illinois'

RADIOFEST '96

August 28th, 29th, 30th and 31st

Holiday Inn Holidome and Convention Center
 345 River Road, Elgin, IL 60123
 Phone (708) 695-5000, (847) 695-5000 After 1/20/1996

Room reservations are now being accepted in blocks of three or four consecutive days only. One or two day reservations will be accepted after June 25th, as permitted by remaining hotel space.

ARCI is also pleased to offer an "Early Reservation Discount Package" to those persons reserving the first 160 rooms for Wed., Thurs. and Fri. nights, August 28th, 29th and 30th, at the special 1-4 person rate of \$72 + 9½% tax per room per night. In order to be eligible for the Discount Package, room reservations must be made directly with the Holiday Inn, must include the above three nights, and the person making the reservations must identify him/herself as being with the Antique Radio Group. All parking lot assignments will be made by ARCI on a first registered, first served basis. Pre-registration is necessary to help insure a seller's space.

NO OPEN SELLING IN PARKING LOT BEFORE WEDNESDAY MORNING

SINGLE ROOM EARLY DISCOUNT PACKAGE

Registration \$8. One paved seller's space \$15. Auction bid card \$2. Trip to Muchow Museum \$5. Banquet \$20. This \$55 value \$ 35 _____
 One extra selling space \$ 30 _____
 Second extra selling space \$ 40 _____

DOUBLE ROOM EARLY DISCOUNT PACKAGE

Registration \$8 or \$16 non-family. One paved seller's space \$15. Auction bid card \$2 or \$4 non-family. Trip to Muchow Museum \$10. Two banquet tickets \$40.
 This up to \$85 value \$ 60 _____
 One extra selling space \$ 30 _____
 Second extra selling space \$ 40 _____

NON-DISCOUNT PACKAGE RATES

Awards banquet \$ 20 _____
 Holiday Inn Guests:
 Seller's fee (one blacktop space) \$ 15 _____
 One extra selling space \$ 30 _____
 Second extra selling space \$ 40 _____
 Selling space on grass-car or pickup \$ 30 _____
 Selling space on grass-van or lg. truck \$ 40 _____
 Vendors Not Staying At Holiday Inn:
 Seller's fee (one blacktop space) \$ 30 _____
 One extra selling space \$ 40 _____
 Second extra selling space \$ 50 _____
 Selling space on grass-car or pickup \$ 40 _____
 Selling space on grass-van or lg. truck \$ 50 _____

NAME _____ PHONE _____
 ADDRESS _____
 CITY _____ STATE _____ ZIP _____

Make check payable to ARCI and send to:
 Carolyn Knipfel, Rt. 3, 200 Langham, Morton, IL 61550.
 Your reservation packet will be held at the door.

For further information contact:
 Jeff Aulik, 1708 Parkview Ave., Rockford, IL 61107.
 (815) 399-1902 evenings or weekends.

FOR SALE: Coin boxes for old radios, 25¢ for 2 hours, external mount 6"x8"x3", all metal - \$20. Del Tysdal, 812 Broadway, #4, Fargo, ND 58102. (218) 287-2562

FOR SALE: Early Philco 90, push-pull 45's - \$425. Atwater Kent 567, restored - \$550. Philco 37-60, re-capped - \$75. **WANTED:** General Electric GM-125 and HM-136. Has anybody ever seen these FM models? Also want HM-80, HM-85, JFM-165 and Musaphonic 80. Jeff Lendaro, 1107 Logan St., Noblesville, IN 46060-2346. (317) 773-3969. E-mail: lendaroj@indy.tce.com

FOR SALE: Electro-Voice 644 shotgun mikes - \$275 for both. Sylvania tube manual, 1959 - \$25. Bill Cheren-sky, 6 Kate Ln., Metuchen, NJ 08840. (908) 549-2165

FOR SALE: Sams DC-1 - \$15; #2 - \$10; #4 - \$10. Rider's 6 to 15, Radio - \$15 ea. Rick Yerke, PO Box 392, Moscow, PA 18444. (717) 842-4857

FOR SALE: Hallicrafters SX99 - 495. Heathkit 2 meter - \$30. (10) tube radios - \$10 ea. Fred Hegel, 1901 Frank Pl., South Daytona, FL 32119. (904) 760-7632

FOR SALE: Radio News, Radio TV News 1928-1989, complete - \$999. You ship. D.C. Payne, 4201 E. Coolidge St., Phoenix, AZ 85018

FOR SALE: Stromberg-Carlson mahogany Chinese AM-FM phono 12" TV console. Denton Lahner, 116 N. 4th St., Reading, PA 19601

FOR SALE: Radio books, manuals, magazines, catalogues, tube manuals. Scanning disc and early television literature. Large list - SASE. Seven wooden and Bakelite radios - \$150/all. Bill Rolf, 30131 Center Ridge, West-lake, OH 44145. (216) 871-4547

FOR SALE: HK, Award Series A500 amp, vg, works - \$200. RCA BP10 1941 port., works/batteries - \$60. Crosley 51 (late), both tags, good condition, NT - \$135. UPS extra. J.C. Woychowski, 17 Hope St., Niantic, CT 06357. (203) 739-6579



The California Historical Radio Society

- ✓ *Eight meets per year all over Northern California*
- ✓ *Two or more Journals per year featuring original historical and technical articles*
- ✓ *Join now and get our 75-page collection of restoration articles from 20 years of CHRS!*
- ✓ *A mere \$15 per year!*

For more information, or to join...

write to: PO Box 31659
San Francisco CA 94131
or Call 415-978-9100

FOR SALE: Allied, Lafayette catalogs. Radios Master, tube manuals. Rider's Vol. 14 - \$12. Gerald E. Perkins, RFD #2, Box 34, Milo, ME 04463-9605. (207) 943-5204

FOR SALE: Trans-Oceanic owners need Receiver Saver 200 to extend tube life. SASE brings brochure. Jeff Kincaid, WA6BIL, 5529 W. 140th St., Hawthorne, CA 90250

FOR SALE: Hickok 532 tube tester with supplement tube charts and operating instructions - \$60. Don Rathbun, 27851 Bruno St., Hayward, CA 94544. (510) 783-1841, mornings

FOR SALE: 1949 Coke cooler radio, cabinet broken, back damaged, plays, photos available - \$200. Charles Combs, 508 E. Daniel, Albany, MO 64402. (816) 726-3038



FOR SALE: Radios, hi-fi equipment, parts. International Kadette, black, no back - \$100. General Television, brown/black trim - \$75. Emerson Miracle 6, brown - \$250. General Electric Beetle H-600U - \$300. Emerson Aristocrat, brown handle - \$55. Fada 652, yellow bezel - \$100. Harman Kardon Citation I with case - \$300 or Best Offer. Altec speaker 515 - Best Offer. Altec Dividing Network N501-8A - \$45. Stancor transformer HF-22 - \$50. Pig nose amplifier - \$55. All items unrestored electrically. **WANTED:** Deco radios & objects, hi-fi and theater equipment, parts, Kadettes, Detrolas, Fadas, Air King, others, Lacner clocks. Tube hi-fi components including mono-blocks, 15" speakers, power tubes, Western Electric early equipment. Ross Litrenta, 1 Wilton Rd., Eastchester, NY 10709. (914) 337-7176

FOR SALE: U.S. Radio cathedral - \$175. Hewlett Packard #417 VHF detector, four bands, 10 to 500 MHz, mint - \$125. Grunow #500 (Bunis), 1933 table, nice - \$250. Ernest Odeneal, K5QJF, 2710 Lee, Greenville, TX 75401. (903) 455-2113 or 5788

FOR SALE: (2) 2A3 single plate boxed Sylvania - \$55 ea. Ditto 6A3, (2) at - \$40 ea. Tung-Sol, both types, new boxed. AK Model 60 chassis, works, vg. Marion J. Chelkowski, W5DBN, 1103 Kayton Ave., San Antonio, TX 78210. (210) 533-1876

FOR SALE: Firestone R313 chassis, knobs, speaker, escutcheons, tubes - \$12. Rider's 19 - \$25. Jim Gauldin, 134 Hawthorne Dr., Danville, VA 24541. (804) 791-2286

FOR SALE: Streamline Stromberg-Carlson 1101 - \$42.50. GE E-81 roll dial tombstone - \$97.50. John Lyle, 1161 S.W. Mulvane, Topeka, KS 66604-1456. (913) 232-0128

FOR SALE: Transistors. Radios. Realtone TR-1166-2, Realtone 1069, Jade 143, all three for - \$30. Gary Nitkin, 102 Long Highway, Little Compton, RI 02837. (401) 635-2816

WANTED: Western Electric tubes. Paying the following for new in original box: VT 52 - \$80; 101D - \$30; 104D - \$50; 205F - \$90; 231D, 239A, 262B - \$40; 274B - \$150; 301A - \$100; 310A/B - \$12; 311A/B - \$10; 348A - \$35; 404A - \$8; 422A - \$40. Most all others wanted, new or used. Tim Metz, 221 Wheatland, Fairview, OK 73737. (405) 227-2456

WANTED: Old Jensen speakers 8", 10", 12", & 15" Alnico Concert Series. N.O.S. audio tubes, 5881/6L6GC, 12AX7/7025, 5AR4/GZ34, 7027, 6550, 7591, 6BQ5, 6CA7. Old harmonicas, all makes & models. John McGrath, 29 Ripley Rd., Belmont, MA 02178. (617) 484-0515. Fax: (617) 492-7921

WANTED: Hallicrafters PM-23 speaker. Need (3) knobs (brown), volume, tone and band selector for Airline 04BR-729A wooden table; Sams AR Manuals #1-21. Bill Regan, 4566 O'Dell Pl., Jamesville, NY 13078. (315) 492-2817

WANTED: Mayola radio. Trivet for Guild teakettle. Henry Field KFNH seed catalogues. Front crest for Crosley 58 Buddy Boy. Bakelite cabinet for Coronado Jewel. Ken Armstrong, Box 216, Storm Lake, IA 50588. (712) 732-3012

WANTED: Kennedy Model 281 chassis (early battery set) and an I.P.-501 cabinet, a large wood case. Gary B. Schneider, 9511 Sunrise Blvd., #J-23, North Royalton, OH 44133. (216) 251-3714



WANTED: I will pay top dollar for the above pictured Grebe or Garod wood tabletop radio in any restorable condition. Also seeking other unusual wood Deco radios. Call or write: Mark V. Stein, 2109 Carterdale Rd., Baltimore, MD 21209. (410) 466-2814. Fax: (410) 466-0815

WANTED: Volume knob for Stromberg-Carlson 345M. 1960s Heathkit catalogs. 250K potentiometer/SPST switch. Doug Fox, 603 S. 12th Ave., St. Charles, IL 60174. (708) 584-5915

WANTED: Still collecting early WWII radar equipment and manuals. What have you? Allan H. Weiner, 97 High St., Kennebunk, ME 04043. (207) 985-7547

WANTED: Collins 75A2/75A3 parts source. Signal magazines. Chapman's Radio Boys To The Rescue. Brian Roberts, 3068 Evergreen Rd., Pittsburgh, PA 15237. (412) 931-4646

WANTED: GN-1 or GN-2 generator for SCR-68 Western Electric. Pat Stewart, W7GVC, 1404 Ruth Ave., Walla Walla, WA 99362-3558

WANTED: Good split-second dial, shutters and grille cloth for Zenith Robot Dial 12S265. Mark W. Hilliard, N3NBL, 921 South Edward St., Allentown, PA 18103-4657. (610) 432-8089

WANTED: Complete General Electric HM-225 9" TV. Have cabinet and good tube, looking for junker HM-225 or HM-226 to make good set. Jeff Lendaro, 1107 Logan St., Noblesville, IN 46060-2346. (317) 773-3969. E-mail: lendaroj@indy.tce.com

WANTED: Amrad cartridge condensers (look like small cartridge fuses with aluminum pointed ends). Amrad potentiometer (large porcelain 3"-3/4 round, has 3/16" shaft), paying top \$. J.C. Woychowski, 17 Hope St., Niantic, CT 06357. (203) 739-6579

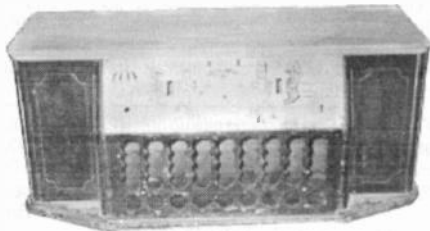

WANTED: Chassis for this United Lan-Sing mid-20's battery radio any condition. Mike Bennett, 1151 S. Farm Road 115, Springfield, MO 65802. (417) 864-4178

WANTED: Western Electric speakers/amps/trans/tubes, Brook, Altec amps/speakers, UTC amps/trans, large EV/Jensen/JBL speakers. Mike Somers, 2432 W. Fargo, Chicago, IL 60645. (312) 338-0153

WANTED: Large Zenith black dial radios. Mark Hewitt, 6659 Tipperary Trl., Roscoe, IL 61073. (815) 623-8729

WANTED: Bendix radios, ads, signs, etc. Radios need not work. Aaron Mall, 903 Dropleaf Ct., Baltimore, MD 21208. (410) 486-8813

WANTED: Cathedrals & t-stones, parts, fair to basket cases. Pat Wilson, 101 Mooney, Oglesby, TX 76561. (817) 470-2101, evenings

WANTED: Atwater Kent cathedrals Models: 228, 387, 80, 90 and 567. Robert Alexander, 7314 E. Berridge Ln., Scottsdale, AZ 85250-5506. (602) 948-9332

WANTED: Off/on key for Thompson radio, Majestic tube No. 2Z2/G84. Jack Ghery, 1753 Community Beach Rd., Odin, IL 62870. (618) 532-5548

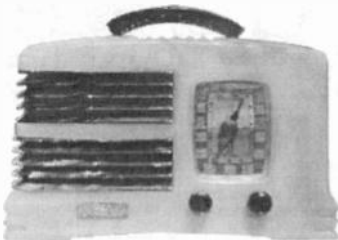

WANTED: Symphony and Detrola Catalin radios. I am not a human being: I am a radio collector. God forbid! Pity me the lost soul that I am and fulfill my humble needs. Please write or call collect: Rain Buttignol, 214 State St, #7, Portsmouth, NH 03801. (603) 427-1384

WANTED: Light bulb, Osram 4 volt, 4 C.P. double contact bayonet base with evacuation tip on side, about 1x1 inch. Phil MacArthur, FKCC, 5901 College Rd., Key West, FL 33040. (305) 296-9081, ext. 219

FOR SALE: Sams, below #1000, as low as - 50¢ ea. Must sell, overstocked. Send SASE for list. John E. Kendall, PO Box 436, Fallston, MD 21047

FOR SALE: Parts-used, original for vintage radio, audio & test equipment. Electrical parts, case parts (wood or plastic) and cosmetic parts available. Send brand name & model number of the piece of equipment along with a description of the needed part(s): VE Parts, PO Box 436, Fallston, MD 21047. Fax: (410) 877-1697. E-mail: vintel@aol.com

FOR SALE: Photocopies of following Hickok manuals: 188X, 288X, 288XA RF generators; 539, 539A, 539B, 539C tube testers; 870 transistor tester - \$7 ea. ppd. Alan J. Kriss, 1872 Portsmouth Way, Union, NJ 07083. (908) 688-2092

FOR SALE: The following pickup only: (2) Zenith tombstones Models 807 and 5S127 - \$175 ea. 1938 Hammarlund HQ-120X Special Edition, all black - \$175. **WANTED:** Freshman Masterpiece 3 dialer with tubes, not the window version. Tom Wagner, 45 Windsor Rd., Hamden, CT 06517. (203) 248-1659

FOR SALE: Zenith 19-AG-379 10" EM speaker w/ xformer. Pair old 4" cone speakers. Panel meters incl. AC ammeter, tubes. Few parts left. Lists. Ron Champagne, Box 778, Blandford, MA 01008-0778. (413) 848-2806

FOR SALE: National NC173 - \$90. Philco Moon-dial 46-420 - \$45. RCA tombstone - \$80. Teac A1250. **WANTED:** German portables. Charles Voigt, 94 Cleveland St., Norfolk, MA 02056. (508) 528-7928

FOR SALE: Hammarlund HQ170A - \$175. National NC 2-40D with speaker - \$175. HRO 60 and 50T1 - \$200 ea. Hallicrafters S-72R - \$75. Realistic DX-160 and Eico 711 - \$20 ea. Still need Predicta emblem, help! Tom Cangiaco, 1028 Thomson Ave., Roselle, NJ 07203. (908) 289-5000, ext. 5734

FOR SALE: RCA Radiotron advertising doll - \$700. Addison 2A, scarce brown with maroon trim - \$700. Bob Wood, 3612 N. 12th Ave., Pensacola, FL 32503. (904) 432-3782

FOR SALE: Drake TR4C transceiver, MS4 power supply with manual - \$275. **WANTED:** Bogen DB20 amplifier, must be good. Dave Kolseth, 2103 Scotland Dr., Clearwater, FL 34623. (813) 734-1301

FOR SALE: Hallicrafters S36A-RBK15 with manual, excellent cosmetically and working, asking - \$275 + UPS 85 lbs. Phil Guinan, 106 Page Rd., Litchfield, NH 03052. (603) 889-6213

FOR SALE: Airline console Model 04BR-730A, Crosley console, Mod 726, Philco Mod 37-650. Equipment: Heathkit counter, Mod IM4100, Heathkit audio generator, Heathkit visual-aural signal tracer, Heathkit signal tracer, Heathkit transistor tester, Knight RF generator, Century antenna line tester Model ALT-1. Ranger signal generator Model 557, McGraw-Edison crystal calibrator Model 111 U.S. Army AC-DC calibrator Model TS-375 A/U Most Often Needed TV Servicing magazines; 1948 thru 1956, many Sams TSM's. **WANTED:** Dial pointers for Scott Philharmonic. Richard R. Bruning, 1901 U.S. Hiway 150 No., Apt. B, Galesburg, IL 61401. (309) 344-1968

FOR SALE: (2) pr. Langevin AM-50 amps - \$150/pr. Pr. JBL 404 amps - \$175/pr. Hickock TN-118 Cardmatic tube testers - \$200. RCA 3BX-671 shortwave, mint - \$135. Zenith tombstone 4B - \$100. Emerson 811 - \$35. Happy New Year. Sonny Goldson, 1413 Magnolia Ln., Midwest City, OK 73110. (405) 737-3312. Fax: (405) 737-3355

FOR SALE: N.O.S. Tucker car radio, no tuning head; Spartan 500 chassis; EV SP12 speaker - \$75 ea. OBO. 10- and 12-inch recording blanks - Best Offer. Norman S. Braithwaite, PO Box 992443, Redding CA 96099. (916) 246-4209, evs.

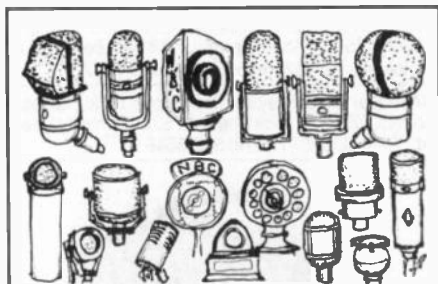

WANTED

FOR MY BROADCASTING MUSEUM

Microphones, stands, call letter plates. Tube amplifiers, mixers, compressors, Hi-Fi equipment. Speakers, on-air lights, equalizers. Disk, wire & tape recorders. Blank recording disks. Catalogs, magazines, manuals. 16" transcriptions, turntables, arms, pickups. Early TV cameras & receivers. Elaborate console, deco, plastic, mirror, novelty & wireless radios. Jukeboxes & parts. Acoustic photographs.

We are looking for all makes of equipment, and especially *Western Electric*, *Telefunken*, *Neumann* and *RCA*. The museum contains various duplicates and items surplus to our needs, and many of these articles are available for sale or trade. The collection is located in my Victorian seaside inn, the *Caffrey House*, situated on a bay next to the ocean, in the Southampton resort area of Long Island. A trade of equipment for a stay at the hotel is always encouraged.

Robert Van Dyke, 2 Squires Ave., East Quogue NY 11942
516-728-9835

Frankenstein's Radio Laboratory

4010 Fairmont Parkway, Suite 285

Pasadena, Texas 77504

(713)998-0130

ELECTROLYTICS, AXIAL LEADS	EACH	20+
2.2mf 450v Rubycon	\$.65	\$.60
4mf 150v (N.O.S.) Sprague	.30	.25
4.7mf 450v ICC	.70	.65
10mf 450v Xicon	1.00	.95
22mf 160v Rubycon	.75	.70
22mf 450v Xicon	1.30	1.25
33mf 160v Rubycon	1.08	1.03
47mf 160v Xicon	1.30	1.20
47mf 450v Xicon	2.25	2.00
50mf 150 CDE	1.30	1.15
VALUE VOLTS MANUF	LEADS	EACH 20+
.001 600 Sprague 715P	radial	\$.42 \$3.7
.0022 600 Sprague 715P	radial	.42 .37
.0047 600 Sprague 715P	radial	.42 .37
.01 600 Sprague 715P	radial	.54 .49
.022 600 Sprague 715P	radial	.65 .60
.047 400 CMC	axial	.40 .35
.047 600 Sprague 715P	radial	.73 .68
.1 600 Sprague 715P	radial	1.00 .90
.1 630 Xicon	radial	.65 .60
.22 600 Sprague 715P	radial	1.50 1.35
.22 630 Xicon	radial	.75 .70
.33 630 Xicon	radial	.85 .80
.47 630 Xicon	radial	1.95

Shipping to anywhere in the U.S.A. is a flat rate of \$ 4.00
Buying your surplus components, transformers & tubes.

Radio Restoration Parts

Vacuum Tube Repair Wafers

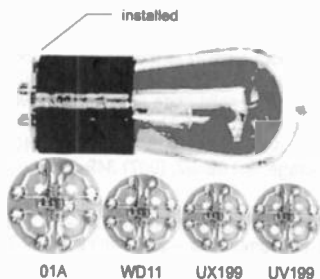

These tube repair wafers are solid-state devices for quick and easy repair of early vacuum tubes. The wafer is installed by simply sliding it over the tube pins and reinserting the tube into its socket. If the filament is intact, but there is little or no emission, the filament may be lit for best visual effect. However, the tube can be open filament.

No change in radio operating voltages is required. Any number of tubes may be repaired in a radio. If wafers are installed on all tubes, the B+ voltage may usually be reduced without sacrificing volume or sensitivity. Performance will vary with radio model.

\$10.00/each (\$7.50/ea. 3 or more)

Model #	Also fits
01A	00, 00A, 01, 201A, 301A, 12, 112, WD12, 40, 71, 171
UX199	20, 120, X120, UX120, 30, X130, UX130
UV199	—
WD11	—

1920's styled Universal Loop Antenna

Features solid hardwood construction, available in oak or mahogany, with solid brass hardware. Tuning control is built into the base or can be tuned from the radio.

Applications as:

1. A loop for early battery radios.
2. A signal & selectivity booster for transistor & tube sets.
3. A loop for radios designed for long wire antenna.

The loop is rotatable for strongest signal or best interference rejection. A small auxiliary loop is supplied for radio to Universal Loop coupling; when used to couple to a radio with a ferrite antenna/loop no electrical connection to the radio is required.

Ready to use: \$79.95 (specify oak or mahogany)

Kit: \$49.95 (unfinished oak or mahogany, specify)

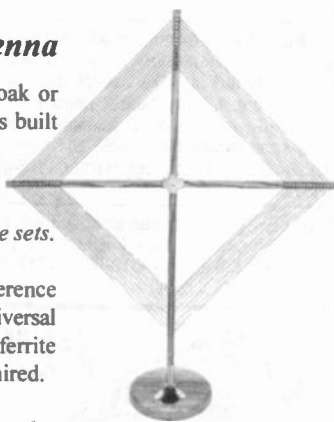

Size: 28" wide x 35" tall

Active Antenna

Allows antique radios that were designed for a long wire outdoor antenna to operate on a 42" indoor whip antenna. Portable, operates from a 9 volt battery.

Only \$34.95



Also: New Atwater Kent Breadboard Switch

Thermoset plastic, same as AK - new mfg. \$50.00/ea

Order from: PTI, 7925 Mabelvale Cutoff, Mabelvale, AR 72103

Orders shipped UPS, prepaid in continental U.S. Please allow 3 weeks for delivery.

Arkansas residents add 6% sales tax.

To Order: Call (501) 568-1995



FOR SALE: Grundig AM/FM? SW #846 - \$125. English Pye #R45 AM/SW - \$75. Heathcode Practice - \$15. Heath VTVM or transistor tester - \$20 ea. Ernest Odeneal, K5QJF, 2710 Lee, Greenville, TX 75401. (903) 455-2113 or 5788

FOR SALE/TRADE: For sale or swap: Tubes: N.I.B. & used 1B3GT - \$2; ZAP1A - \$7; 2BP1 - \$12; 6AR6WA - \$4; V45 - \$12; VT266 - \$5; 7554 - \$12; VT136 - \$3; 6ZY5G - \$2; 27, 35, 55, 57, 77, 78, 79, 89 - \$4 ea.; many others send wants. Books: RCA Tube Handbook H B-3 - \$25. Basic Radio Course, Gernsback - \$7. Basic Electronics, Rider 170-3 Vol. 3, covers video amps, tuned circuits, and two-stage amps - \$4. Send \$1 for long list of many other radio, electronic books & magazines. Flybacks: For Philco, Admiral, Sylvania, RCA, Dumont - \$5 to \$25. Large Gen. Elect. TV tube caddy - \$25. Small caddy - \$15. EMC Mod 801 in circuit cap. tester - \$20. Heathkit Mod IT22 cap. tester - \$15. EICO Mod 368 TV FM sweep gen. marker, w/man. - \$30. Precision Mod 667 tube tester - \$20. BK Mod 445 CRT TV tube tester, regenerator - \$35. Test-O-Matic tube tester & chart - \$30. CDR antenna rotor TR4 - \$15. **WANTED:** Cabinets for: Philco 60B, Jackson Bell cath. Sunburst, Majestic Gothic cath. Mod 194, a Philco Mod 40-180 chassis. Ben Martin, 18334 Pepper St., Castro Valley, CA 94546. (510) 582-6804

FOR SALE: Greatly expanded selection of antique and collectible radios, transistors, amateur receivers, televisions, novelty radios, mikes, earphones, telephones, hi-fi equipment. Military radios, uniforms and equipment. Antique radio, medical, scientific, aircraft books. For list, send two-stamp LSASE to: John Enigl, Sr., K9HJL, 5425 Cherry Ln., Egg Harbor, WI 54209. (414) 743-3672

FOR SALE: 1950's German slot machine; Philco butterfly - BO for one or both. Michael Crain, 3 Hillside Ave., Harveys Lake, PA 18618-9782. (717) 639-2794. E-mail: mcrain@aol.com

FOR SALE: Realistic 40/A amp & TM/8C tuner - \$115 ea. Bogen DB130 mono amp & R660 mono tuner - \$295/pair. Knight KG 250 amp & KG50 tuner - \$225/pair. Heathkit AA151 amp & AJ12 tuner - \$295/pair. Sherwood 5500 amp & 3000II tuner - \$375/pair. Scott 99D mono amp - \$175. Heathkit AJ31 mono tuner - \$95. Knight KN734 amp - \$185. Pilot 602 receiver - \$195. Pilot AM-FM mono tuner/preamp - \$175. Sansui 1000 receivers, (2) - \$225 ea. Heathkit A9B & A9C amps - \$195/both. Eico 2715 mono tuner - \$150. Scott LT10 mono tuner - \$150. Eico HFT90 tuners, (2) - \$95 ea. McIntosh 5100 solid-state amp - \$275. All prices plus shipping. All equipment has been refurbished and is in good working condition. (907) Rhea, 2407 Lore Rd., Anchorage, AK 99507. (907) 349-5519, machine after 4th

FOR SALE: Two Hickoks Model 532 - \$35 & \$75. Airline 62-177 tombstone - \$65. Airline 14BR-736B - \$55. Decca P-907 45 rpm player/built-in amp - \$45. Grundig EN3 tiny hand-held reel-to-reel tape recorder - \$70. Philco 46-420 - \$35. Philco 48-482 - \$40. Raytheon TV M-1750K, works well - \$50. Tiny tube RCA TV, Model 8-PT-7032, works well - \$50. 1928 Steinite 261 radio - \$60. Stromberg-Carlson 1101 - \$20. Large Temple drum speaker - \$30. Early Japanese Transcorder TR-300 - \$30. Wilcox-Gay Recordette Sr. - \$35. All items must meet your approval or your money back! Send a SASE to: Neil O'Donnell, 1809 Sampson St., Butte, MT 59701. (406) 491-1809

FOR SALE: Philcos 1st T7 - \$80. Zephyr ZR 930, black - \$130. Mr. Peanut M.I.B. - \$75. **WANTED:** Raytheon T150, T100. Toshiba 6TP-309, 6TP-304. Sony TR63, red, yellow. Harald Herp, 6615 Michele Ct., Huntingtown, MD 20639. (301) 855-7071

FOR SALE: Book, Radio Manufacturers of the 1920's, Vol. 3 - \$10. Hallicrafters SX101 - \$200. National NC173 - \$150. Vance Rayburn, 2718 Homestead Rd., Madison, WI 53711. (608) 274-3002

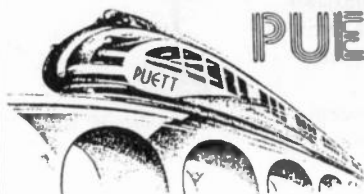

PUETT ELECTRONICS

P.O. BOX 28572 DALLAS TX 75228

NEW CATALOG 77

**GET THIS
WORLD'S
GREATEST
RADIO
CATALOG**

CATALOG 77/PLL-2 (56-PAGES) ----- \$5.00 POSTPAID

YOU RECEIVE A \$6.00 DISCOUNT COUPON WITH THIS CATALOG!

MORE THAN 1,500 DIFFERENT ANTIQUE RADIO PUBLICATIONS FROM 1902 TO THE 1960'S OFFERED, REPRINTED BOTH SIDES OF THE PAGE AND BOUND!

WE OFFER BOOKS, INSTRUMENT MANUALS, SERVICE DATA, SALES BROCHURES, ATWATER KENT, RCA, CROSLY, ZENITH, ETC. FACTORY SERVICE MANUALS, SCOTT, MC MURDO SILVER, STROMBERG CARLSON, CAPEHART, FISHER CLASSIC RADIO LITERATURE, DIRECTORY OF ANTIQUE RADIO SERVICES, SCHEMATIC DIAGRAMS, OLD TIME RADIO PROGRAMS ON CASSETTES, TUBES, TUNING DIALS, KNOBS, 30-SERVICES & DISCOUNTS WITH THE PUETT ELECTRONICS ANTIQUE RADIO CLUB AND MUCH MORE - ORDER YOUR CATALOG TODAY!

OUR NEW BOOK "THE WORLDS LARGEST RADIOS" IS NOW AVAILABLE, PHOTOS, SCHEMATICS, BY J.W.F. PUETT - \$14.95 PLUS \$2.00 HANDLING. INCLUDES SCOTT, MC MURDO SILVER, PHILCO, RCA, ZENITH, LINCOLN, FRED EISEMANN, FISHER, MEISSNER, MAGNAVOX, CROSLY + MANY MORE!

WANTED: Used Western Electric tubes. Paying 262A - \$45. Tennis ball used 101D - \$120; 101F - \$100; 104D - \$120; 205D - \$160. All others wanted. Tim Metz, 221 Wheatland, Fairview, OK 73737. (405) 227-2456

WANTED: Early Victrolas, fancy Victrolas, Electrolas and Victors with Radiolas. Buy or trade. Jeff Lendaro, 1107 Logan St., Noblesville, IN 46060-2346. (317) 773-3969. E-mail: lendaroj@indy.tce.com

WANTED: Base/horn driver for Herald horn (diamond shaped). Paying \$100 to \$200, depending on condition. J.C. Woychowski, 17 Hope St., Niantic, CT 06357. (203) 739-6579

WANTED: AK 465Q, 735, 24, 74, 20 big box. Heathkit DX100, Comanche MR-1. George Folse, KB5WWO, 630 Dolhonde St., Gretna, LA 70053. (504) 362-9228, T/F

WANTED: Rider's Radio Manual #23, or rent yours for two weeks, your rules. Joseph R. Forth, 321 Long Vue Acres, Wheeling, WV 26003. (304) 277-3154

WANTED: Original dial for AK 80, 82, 83, 84 or similar set. Rick Taylor, 4201 Shady Oak Dr., Ooltewah, TN 37363. (423) 855-0174

WANTED: Help me restore my Zenith 7000-1. Need metal insert in handle or complete handle, 1 front knob, manual and AC line cord. Thanks and a Merry Christmas and Happy New Year. Gerald Cromer, K4NHN, 1014 Summerland Dr., Cayce, SC 29033

WANTED: Rectifier IN2389 octal base for AMI T11 juke amp. H. Hoopes, 10 Bassett Ave., Mine Hill, NJ 07803. (201) 361-7309, eves.

WANTED: Navy speech amplifier units: 50055, 50064 & 50254 for TBL transmitter. Modulator units: CRV-50193 & CAY-50065 for TBK & TBM transmitters, any condition. Steve Finelli, 37 Stonecroft Dr., Easton, PA 18045. (610) 252-8211

WANTED: Tektronix 570 curve tracer, tube equipment, record cutting machines, Neumann, Westrex, Scully, McIntosh, Marantz, etc. Kim Gutzke, 7134 15th Ave. S, Minneapolis, MN 55423. (612) 869-4963. Fax: (612) 798-4169

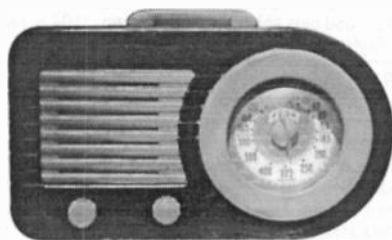

WANTED: Fada Catalin radios. Help! My entire collection spontaneously combusted during an interview with the "Enquirer." Replenish and repent ye sinners. Please write or call collect: Rain Buttignol, 214 State St, #7, Portsmouth, NH 03801. (603) 427-1384

WANTED: Operators/service manual for H.P. 3211A sweep oscillator, copy OK. State price. Thank you. Paul Rosen, 30 Cherrystone Dr., Willowdale, Ontario, Canada M2H 1S1. (416) 493-6962, eves. (800) 387-0233, days EST

WANTED: Tube hi-fi amplifiers, preamplifiers, tuners, etc. McIntosh, Altec, Dynaco, Marantz, Fisher, Scott, Craftsman, Heath, Leak, Quad, Pilot, etc. Also tubes: KT-66, KT-77, KT-88, Western Electric 300A&B, 350B, 274, 275, 6550, 5AR4, EL-34, EL-37, 211, 845, etc. Happy New Year. Sonny Goldson, 1413 Magnolia Ln., Midwest City, OK 73110. (405) 737-3312. Fax: (405) 737-3355

WANTED: Philco transformer #32-7226. Junker chassis or trade Model 70 pwr trans. Chuck Schwark, 7454 Campbell, Chicago, IL 60645. (312) 274-7034. E-mail: caschwarz@aol.com



WANTED: I will pay top dollar for the pictured DeWald tombstone radio in any restorable condition. Also seeking other unusual wood Deco radios. Call or write: Mark V. Stein, 2109 Carterdale Rd., Baltimore, MD 21209. (410) 466-2814. Fax: (410) 466-0815

WANTED: Navy equipment, any condition. Huge transmitters a plus. I can pick up. William Donzelli, 304 South Chester, Park Ridge, IL 60068. (708) 825-2630. E-mail: integrat@usr.com

**E-MAIL ADDRESS FOR
ANTIQUE RADIO CLASSIFIED
ARCMagazine@aol.com
Ads - Subscriptions - Book Orders
See inside front cover for details**

WANTED: Dial glass and dial face for Zenith 5S237 or good Zenith 5521 chassis with glass. Hal Kravig, 2615 Juneway Dr., Memphis, TN 38134. (901) 388-2857. Fax: (901) 388-5102

WANTED: Western Electric 9A transmitter, 1A tuning unit, 2A power rectifier, 251A tube, manuals. James Treherne, 11909 Chapel Rd., Clifton, VA 22024. (703) 830-6272

WANTED: Zenith Model 970 console. Have only the cabinet. Need radio chassis and speakers. Chuck Menard, WB9IFE, 232N. Brashares Dr., Addison, IL 60101. (708) 543-4699

WANTED: Crystal sets, parts, stands, detectors, condensers, headsets, dial knobs, terminals, wire. B. Turke, PO Box 2288, Hollywood, FL 33022. (305) 925-3670

WANTED: Voice of Music (VM) radios, tape recorders, parts, advertising, etc. What have you? Gary Stork, 37530 E. Meadowhill, Northville, MI 48167. (810) 478-0990

WANTED: Tuning shaft and knob for Fada Neutrodyne 6. Also need knobs for Philco 37-11. Denis Meany, 81 Madison St., Blue Point, NY 11715. (516) 363-0512

WANTED: Command set receiver BC453 and BC455, fair condition only. Michael Durand, 21 Le Grande Ave., Tarrytown, NY 10591. (914) 631-0493

FOR SALE: Grebe Synchrophase AC7 in exc working condition, all pot metal tuning cond. plates replaced with aluminum end plates, beautiful orig. finish cabinet - \$375. Radiodyne Jr. WC-14 - \$250. Splitdorf 3 dialer, NT - \$40. Cutting & Washington 11A refinished cabinet, beautiful set w/tubes - \$795. Radiola 20, nice orig. cond., NT - \$150. Magnavox Model T, NT - \$45. Bremer-Tully Counterphase 6 w/parts booklet, NT or cabinet - \$25. Philco 42-350 broken dial - \$45. Joe Svihel, 17227 Co. Rd. 54, Avon, MN 56310. (612) 356-7601

FOR SALE: Cabinets, Stewart-Warner R-1401A, Kennedy cathedral. Reproduction parts for Philco 70 cabinet: bottom moulding - \$15; year arch - \$14; front panel - \$40; bottom board - \$18. Plus S&H. Dick Oliver, 28604 Schwalm Dr., Elkhart, IN 46517. (219) 522-4516

FOR SALE: RCA ashtray, military style, has picture of airplane, ship, submarine on it - \$30. Buddy Cartee, 205 Mason Rd., Chesnee, SC 29323. (864) 578-3532

CLASSIFIED AD NOTICE

Please check your ads carefully before sending them in. Once ads are received, it is not always possible to refund the amount sent, pull the ad or make changes.

FOR SALE: Horns; DeForest LS300 - \$275. Thompson (gold bell) - \$250. UX250 - Offer. Floyd A. Paul, 1545 Raymond Ave., Glendale, CA 91201. (818) 242-8961

FOR SALE: Brunswick Panatop console with bound record volumes, owner's manual, AC - \$600. RCA Aeolian console, AC, \$650 new in 1927, works - \$1,000. GE Model 675 transistor, black, with battery - \$75. Military R-174/JRR receiver, multi-band, AC or battery, works, excellent condition - \$95. Many others, send SASE for list: Charles Chapman, 1357 N. Broad Creek Ln., Strafford, MO 65757. (417) 736-2772

FOR SALE/TRADE: Philco 89-19 console, vg - \$150. American Bosch 5A, vg - \$75. Radiola 33 - \$55. Bob Fuerderer, Holly Farm, 813 Rt. 12A, Surry, NH 03431. (603) 352-3005

FOR SALE: Zenith 7-S-529, excellent condition - \$95 plus UPS. Gary Harmon, 10704 Callanish Park Dr., Austin, TX 78750. (512) 219-0499. Fax: (512) 219-0699

FOR SALE: 85-piece collection. Going back to college! Includes SAMs books, radios, books, miscellany. Send \$1 for list. Thanks. Bill Fairbanks, 11024 Royal Palm Blvd., Coral Springs, FL 33065. (305) 341-2722

FOR SALE: Brach induction telegraph (picture, November A.R.C., p. 20). Mail auction, pictures via SASE. Gene Greneker, 184 Lake Somerset Dr., Marietta, GA 30064. (770) 422-2979

FOR SALE: Precision 612 tube tester, ca. 1950, not GM type, blonde wood case, fair+ - \$25. Al Wirtenberg, 15 Wilson Rd., Weston, CT 06883. (203) 544-9270

FOR SALE: (4) Altec 1592-B mixer - \$100 ea. (3) Altec 1593-B power amplifiers - \$85 ea. (1) Altec 2454-A FM/AM tuner - \$50. Plus shipping. Joe Esdale, 1769 Eastwood Ave., Highland Park, IL 60035. (708) 831-2544

FOR SALE: Radio Rider Manual #13 or 14 - \$16 ea. plus UPS. Phone or write: Thomas Burnside, 4838 S. Westhaven Dr., Jackson, MS 39209-4711. (601) 922-2235

FOR SALE: Zenith R-1000D T-O's, (1) original, (1) missing front door - \$50 ea. Realistic DX-150 SW rcvr, vg working cond. - \$75 OBO. Monacor (Japanese) 4-band portable (AM, FM, AIR, SW) AC/DC, ca. 1960's, works well - \$25 OBO. Regency/Monitoradio DR-200 tube 2-band rcvr, (30-50Mc & 152-174Mc), exc cond. - \$75 OBO. Webster tube intercom, 12 station, works good - \$15 OBO. Books: Audel's Eng. & Mech. Guide #8, 1921, vg cond. - \$15 OBO. Tektronix 2246 o'scope manual set, complete - \$50 OBO. Military diesel gen's. MEP-016B to MEP-026B manual set, complete - \$50 OBO. 1995 & 1996 N.O. Astronomical Almanacs, new - \$10 ea. WANTED: Uniden Bearcat DX-1000 comm. rcvr. Gary Richardson, PO Box 712708, San Diego, CA 92171. (619) 670-7590

FOR SALE: Music Master horn speaker, vg, mahogany bell, all original, underdriver guarantee tag, outside decal, works - \$235. Vocaline JRC-425 transceiver, two units with antennas, microphones, AC power cable, apparently unused, early citizen band, 425 MHz, work - \$60 for pair. British Ecco car radio CR-152/G, good, 3-band - \$25. Three WE-216A tubes, good files - \$75 ea. Stromberg-Carlson 1B, vg, NT, works - \$140. Leeds & Northrup bridge Model 5430-A, vg, oak box - \$25. Radiola UZ-1325 horn speaker, vg, works - \$125. Travler portable, (see Douglas, V2, p. 214), vg, NT - \$165. Geiger counter, Victoreen Model 28, transistorized, works well, calibrated, manual - \$35. Dosimeter, Victoreen Model 1A, works well, calibrated, manual - \$35. Postage extra. Richard A. Botzum, RD2, Box 419, Morgantown, PA 19543. (610) 286-0047. Fax: (610) 286-5315

FOR SALE: Harper's Electricity Book for Boys by Adams, 1907, 407 pages, includes making wireless apparatus - \$30 + ship. Neil Garner, 5897 Co. Rt. 24, Canton, NY 13617. (315) 386-3855

FOR SALE: N.O.S. 6A3's and 6B4's - \$30 ea. Used 6A3's - \$15. Fada 175-A - \$75. Airline 74BR-1502B - \$50. Stromberg-Carlson 1101 - \$30. Edison miner's lamp - \$75. Altec 1568 amp - BO. Mikes: American D4T - \$50. Dukane (EV 676) - \$55. Shipping extra. WANTED: Langevin 128-N rack mount amplifier. Frank Hagenbuch, 1440 Lafayette Pky., Williamsport, PA 17701. (717) 326-0932

FOR SALE: Philco Model 112 chassis & speaker, works - \$50 plus shipping. Dan Salerno, 1104 S. Main St., Taylor, PA 18517. (717) 562-1154

FOR SALE: Parts Patriot and Temple, perfect Bendix, 2 bullets, 2 Commanders, white Patriot, green BT-245 tombstone, 3-knob Sparton re-silvered, RCA 66X9, and tortoise 845 Fada bottom hairline. Also, Delco ribbon grille, ivory 706B and prewar 274 Emersons, cocoa GE H-500. Also blue Vanguard, Sony TR-84, M.I.B. Micrettes, others. Also have uncirculated vintage circus posters at lot prices. Ted Chronister, 7073 Carlisle Pike, #26, Carlisle, PA 17013. (717) 766-6436

FOR SALE: Emerson 520 Catalin, marbled - \$150; 520, damaged cabinet - \$50. Philco 49-901 secretary, rare - \$140; 40-130 - \$70; 37-602 - \$65. Crosley 56TD, ivory - \$135; 56TD, maroon, damaged - \$60; 10-135 - \$95. Motorola 522R Googie, rare - \$80. Truetone D 2615 Stroscope - \$125. Fada 260B - \$230. Zenith 6D311 Deco - \$165. Bulova 100, pink, rare - \$55. (170+) photo catalog - \$1 + LSASE 2-stamps. Bob Masterson, Box 172, Valley Cottage, NY 10989. (914) 353-3151

The Radio Collector's Directory and Price Guide, 1921-1965, 2nd Ed.

by Robert E. Grinder

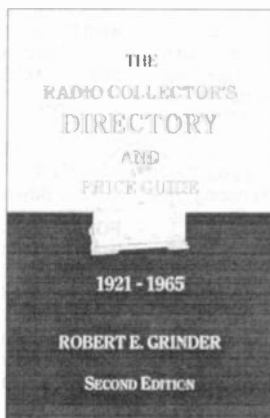

20,000+ Models Listed

U.S. models manufactured from 1921-1965.

Listing includes:

*Model Name,
Year of Production,
Type of Power,
Cabinet Style, and
Current Market Value Range.*

Rewritten Chapters On:

*Early Broadcasting,
Radio Broadcasting Regulation,
Advances Made in Receivers,
The Evolution of Radio Cabinet Styles.*

\$26.95 - Softcover

U.S. Orders - Enclose \$3.00 per order for packing & book-rate shipping if total order is under \$35.00. If using VISA or MasterCard, include name on card, card number and expiration date. Send payment with order. Mass. residents please add 5% sales tax. Money back return policy. Most orders shipped the same day received, but allow 2-4 weeks to receive order. Foreign orders - write fo: shipping costs, or use credit card and specify air or surface (allow 2-3 months for surface shipping).



**Send Order To: A.R.C., P.O. Box 2, Carlisle, MA 01741
or Call: (508) 371-0512 Fax: (508) 371-7129**



FOR SALE: NIPCO (in an International livery) Model 101 in box and complete with all accessories (see Lane back cover page) - \$100. Enrico Tedeschi, 54 Easthill Dr., Brighton, BN41 2FD United Kingdom Phone/fax: +441273 410749, anytime

FOR SALE/TRADE: Rider's Radio #8, 9, 11, 13 - \$15 ea. Radio News 1946-47, (10) - \$20. Radio & TV News 1949 & 51, (4) - \$10. Radiofax 1923-25, (22) - \$50. Citizen's Radio Callbook, 1926 - \$20. Champion Spark Plug AM - \$110. Shipping extra. Trade novelties. Dan Sipola, 2840 Copeland Rd., Maple Plain, MN 55359. (612) 972-8214

FOR SALE: Game Radio Questionnaire, copyright 1928 - \$40 + shipping. **WANTED:** Bezel for Gioritone Model 99, (E.O.R. 1, p. 145). Danny Thornton, 1175 Springdale Cir., Spartanburg, SC 29303. (803) 578-8518

FOR SALE: Radio schematics - \$2.75 ppd. Books: The Oscillator at Work, Rider 1940 - \$12. Servicing by Signal Tracing, Rider, 1939 - \$18. Servicing Superheterodynes, Rider, 1934 - \$12. Elements of Radio, Marcus, 1943 - \$10. Radio Engineers Handbook, Terman, 1943 - \$18. Working with the Oscilloscope, Saunders, 1968 - \$10. Photocopies: Rider's Radio Index, 1 through 23 - \$25. Service Manuals (photocopies) Zenith 31/42, 900+ pages - \$60. Crosley Volumes I & II, Philco - \$25 ea. SASE for list. Books & copies plus S&H. Dick Oliver, 28804 Schwalm Dr., Elkhart, IN 46517. (219) 522-4516

FOR SALE: Large heavy portable battery only transistor radios. GE 1920A AM-FM - \$10. GE P780A AM only - \$10. Magnavox FM-91 AM-FM - \$5. Also, AC only tabletop transistor radio, wood cabinet Realistic 99-350 73 M[?]X, dual speakers 21" h, 7" d, A-OK on AM, dead FM - \$15. Sylvania BT-1 AC-DC only tabletop AM-FM 7-tube. Zenith 6D615 AC-DC tube-type AM only - \$10. All above + UPS. Onerio L. Sabetto, 1717 Burgess Rd., Cleveland, OH 44112-1103. (216) 481-1036

ARBE-III - Universal Battery Eliminator

- ⇒ Specifically designed for early battery-operated radios.
 - ⇒ Custom wound xformer
 - ⇒ Quality components used
 - ⇒ Five-year warranty
 - ⇒ Proven accurate specifications
 - ⇒ Isolated A, B and C supplies for maximum flexibility
 - ⇒ Safety features not found in kits
 - ⇒ Over 450 satisfied customers
 - ⇒ Technical assistance available
- \$149.95 Shipped USA**

Contact: 

Antique Radios Inc.

Box 6352, Jackson, MI 49204

(517) 787-2985 or

Fax (517) 782-7422



FOR SALE: Zenith 7-S-258 shutter dial console - \$275. Zenith 10-S-566, water damaged - \$125. Brian Morelli, 1932 Las Gallinas Ave., San Rafael, CA 94903. (415) 472-2866

FOR SALE: Pickup only. (2) cathedrals - \$75, \$85. Several porthole TVs. Trans-Oceanic - \$35. Majestic 20. John Schehrer, 508 Gray, Joplin, MO 64801. (417) 781-4028

FOR SALE: Toshiba transistor Model TP-193 - \$150. Zenith Model 6D030 (Dec. A.R.C., p. 17) - \$50. Also have Multitone windup tabletop record player. Atwater Kent tombstone 145 - \$85 plus shipping. Thank you. Durell Derstine, Rt. 5, Box 287, Detroit Lakes, MN 56501. (218) 847-7415

RATE FOR ADDITIONAL WORDS:

25¢ per word

FIRST 20 WORDS FREE!

Cash or stamps OK for small amounts.

Your payment helps to keep A.R.C. healthy!

FOR SALE: Catalin Garod 6AU1, maroon and yellow wraparound, excellent - \$1,375. RCA 40X53 La Siesta, good - \$500. Majestic 5AK711, red, (Stein, p. 193), good - \$65. AK Jolly Jumper, excellent original - \$110. National Radio Institute Study Course set, (89) manuals and (1) Radio-trician binder, excellent - Offer. WE brass/brass fan, 12" blade - \$115. Robbins and Meyers brass/brass fan, 9" blade - \$140. Both clean and polished. Mark Delauter, 6253 S H 120, Metamora, OH 43540

FOR SALE: Atwater Kent 21, working, NT - \$300; with UV199's - \$375. Other AK items; SASE. Raymond Thompson, 3472 Cherry Tree Dr., Fulton, MD 20759. (301) 490-4448

FOR SALE: Fisher X-200 tube amp - \$100. FM-100C tube tuner - \$60. Both good with cases. **FOR TRADE:** Altec 803B woofer for 416A woofer. C.M. Steika, 24 Frederick St., Johnson City, NY 13790. (607) 797-9573

FOR SALE: N.O.S. transformers: 10 power tr. 44 to 200 mA sec. for 6V tubes (2) 2.5v, one military with 110/220 pri. priced - \$5 to \$25 ea. Stancor swinging choke C-1645 20-200 mA - \$10. Thordarson T-15A74 single plate to PP grids universal - \$10. T-17S12 PP 6L6 class ABI output - \$20. Merit A3123 14W output 4-5000Ωsec. - \$10. Stancor 5W A3877 output - \$5. (2) modulation tr. - \$3 ea. 11 vert. out tr. - \$10 for all 11. Still have tubes left from last mos. ad, also magazines like Radio News 1938-55, 123 for - \$75. Radio Electronics 1949-52, 19 for - \$10. Radio Craft 1938-47, 30 for - \$25. Popular Science, 15 for - \$10. About 15 misc. - \$5. Joe Svihel, 17227 Co. Rd. 54, Avon, MN 56310. (612) 356-7601

TRANSISTOR NETWORK

If you buy, sell, or collect transistor radios, you need the Transistor Network, a monthly transistor newsletter featuring transistor related articles and classified ads. Only \$17.00 for a one year subscription (12 issues) US, \$20.00 Canada, \$30.00 Foreign Air, \$22.00 Foreign Surface. US funds only.

Not sure? Send \$1 (refundable toward a subscription) for a sample copy. Transistor Network, 32 West Main Street, Bradford, NH 03221. Published by Marty & Sue Bunis.

WANTED: Philco cathedral cabinets, any condition. Dick Oliver, 28604 Schwalm Dr., Elkhart, IN 46517. (219) 522-4516

WANTED: Bipolar motors and dynamos, early electro-scientific items. Have cash or radios to trade. Tom Burgess, #9 Bellemeadow Ln., Little Rock, AR 72210. (501) 455-0773

WANTED: For the exhibition at Israel's Museum of Science on March '96, Marconi Stock Certificates. Bruno Pinto, 24 Remez St., #7, Tel-Aviv 62192, Israel. Fax: 972-3-6725285

WANTED: Help! I need dial stringing information for a 1938 European Philips Model 470A. Jeff Gault, 2571 Seminole, Ann Arbor, MI 48108. (313) 973-6445

WANTED: Philco 511 to 515. V. Bergamo, Al. Gralha 335, Alofia Da Serra, Morada Dos Passaros, Barueri, S. Paulo 06428-000 Brazil. Fax: 011-55-11-722-1610

WANTED: Top cover with handle for Edison Standard cylinder phonograph. Byron Bernor, 2479 W. Sierra Hwy., Acton, CA 93510. (805) 269-5459

WANTED: Detrola remote controls, with or without the radios that go with them. Scott Flaucher, 41100 Plymouth Rd., Plymouth, MI 48170. (313) 451-4221. E-mail: FlaughSM@po5.pl.unisys.com

WANTED: Gyro AM antenna for Panasonic RF-2200. Also Nordemende Globe Traveler 4 portable. Contact: Gerald Gold, 4 Arbor Rd., Roslyn Heights, NY 11577. (516) 621-0827, call after 6 pm

WANTED: General Instrument variable condenser 56A?W isolantite insulators .0003 or .0005 mmF. cap. Rodney K. Schrock, 402 Lincoln St., Somerset, PA 15501

WANTED: Crooke's and Geissler tubes, Wimshurst rotating disk static machine, Leyden jars. Louie Scribner, 1415 West Leigh Dr., Charlottesville, VA 22901. (804) 977-5521. E-mail: lls@virginia.edu

WANTED: Printed circuit board for Simpson 260 VOM Series 3. Louis D'Antuono, 8802 Ridge Blvd., Brooklyn, NY 11209. (718) 748-9612, after 6 pm

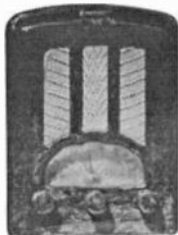

WANTED: Emerson Catalin radios. Nobody pays more than I. What an arrogant and inaccurate thing to say. I mean, like there isn't anyone wealthy enough, dumb enough, desperate enough – or any combination of the three – to pay even a dollar more than I would pay. I mean, c'mon, who am I trying to kid! Please write or call collect: Rain Buttignol, 214 State St, #7, Portsmouth, NH 03801. (603) 427-1384

WANTED: Serious collector needs ham QSL cards, prefer earlier ones, for major research project. Dirk van Oudenol, VE7DVO, 35469 Stafford Pl., Abbotsford, British Columbia, Canada V3G 2C7. (604) 850-0763

WANTED: Hammarlund or Bruno 4-pin plug-in coils; Meissner 6L6 oscillator/exciter; APR-5 maintenance manual. Dick Lowe, Box 296, Santa Clara, CA 05052-0296. (408) 984-1555

WANTED: Televisions from the 30's, 40's, and 50's and related advertising. Jerry Traub, 806 McDonald Ave., Santa Rosa, CA 95404. (707) 545-9425

WANTED: Chassis and escutcheon for Philco Model 39 cathedral (battery set). Cabinet similar to 89B, (Bunis 3, p. 171). Chuck Regen, 2724 N. 27th St., Sheboygan, WI 53083



WANTED: I will pay top dollar for the pictured Fairbanks-Morse tombstone radio in any restorable condition. Also seeking other unusual wood Deco radios. Call or write: Mark V. Stein, 2109 Carterdale Rd., Baltimore, MD 21209. (410) 466-2814. Fax: (410) 466-0815

WANTED: Bakelite panels 7x26x3/16 inch, and Selectone coils, transformers, and condensers. John T. Meredith, 2462 Stantonburg Rd., Suite 152, Greenville, NC 27834. (919) 551-1882

WANTED: National B, BM, or similar dials. Clive Beckwith, 465 Lighthouse Ave., Sebastian, FL 32958. (407) 388-0414

WANTED: Operating manuals for tube testers Eico 628, Supreme 599A, Jackson 648S, Mercury 990. G. Labbiento, 2335 Deschambault, Laval, Quebec, Canada H7E 1E2

WANTED: Good working Clegg 22er or Gonsset Communicator 4. Sylvania Halolight ads and paper. Gary Carter, WA4IAM, 1405 Sherwood Dr., Reidsville, NC 27320. (910) 349-1991

WANTED: Speakers. Hi-fi, theatre & commercial, coaxial, triaxial, corner speakers, horn speakers, drivers & crossovers. Altec, Jensen, Tannoy, Electro-Voice, Stephens, JBL (Lansing), Western Electric, IPC, Heath, RCA, etc. (Blown OK). Happy New Year. Sonny Goldson, 1413 Magnolia Ln., Midwest City, OK 73110. (405) 737-3312. Fax: (405) 737-3355

WANTED: Amrad 3366, any condition. Amrad 2634 det, 2-stage for parts; or complete. J.C. Woychowski, 17 Hope St., Niantic, CT 06357. (203) 739-6579

WANTED: Portable, shortwave radios for restoration: Andrea 6G63; Ansley Y-11; DeWald B-515; Emerson G-127; RCA 3BX-671, 7BX-10, 7BX-9H. Also needed: schematic for Hickok 5055 power supply. Gordon Duff, KAZ2NLM, 6910 Shalimar Way, Fayetteville, NY 13066. (315) 446-0569

WANTED: Table radios, transistors, tubes all makes, beetle, wood, Bakelite, plastic, etc. Bob Masterson, Box 172, Valley Cottage, NY 10989. (914) 353-3151

CRYSTAL CLEAR, Vol. 1

By Maurice L. Sievers

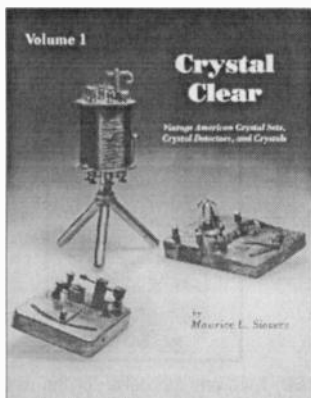

750 Illustrations – 570 Crystal Sets
341 Detectors – 207 Crystals
Perfect for the beginning collector!
Useful for the experienced too!

Crystal Clear is the most comprehensive reference for collectors, historians and anyone interested in early radio. In addition to the many excellent photos and reproductions of ads, *Crystal Clear* includes lists showing all sets by manufacturer, set name, selling price and date of manufacture. 8 1/2" x 11", 282 pages.

\$29.95 – Softcover

* **Crystal Clear, Vol. 2 – \$29.95 ***

COMMUNICATIONS RECEIVERS

3rd Edition – Revised & Expanded

By Raymond S. Moore

402 radios pictured!

Sharper, clearer photographs

A comprehensive guide to 700 vacuum tube communications receivers from 1932 to 1981. In addition to Collins, Hallicrafters, Hammarlund and National, 66 other manufacturers from Allied to Tobe are included. New section on military receivers.

The description of each set includes years, band coverage, type, filters, tubes, a photo in many cases and other info. 8 1/2" x 11", 115 pages.

\$19.95 – Softcover



U.S. Orders - Enclose \$3.00 per order for packing & book-rate shipping if total order is under \$35.00. If using VISA or MasterCard, include name on card, card number and expiration date. Send payment with order. Mass. residents please add 5% sales tax. Money back return policy. Most orders shipped the same day received, but allow 2-4 weeks to receive order. Foreign orders - write for shipping costs, or use credit card and specify air or surface (allow 2-3 months for surface shipping).



Send Order To: A.R.C., P.O. Box 2, Carlisle, MA 01741
or Call: (508) 371-0512 Fax: (508) 371-7129



CRYSTAL CLEAR, Vol. 2

By Maurice L. Sievers



479 All New Photographs and Illustrations Cumulative Index of Both Volumes

Crystal Clear, Vol. 2 supplements the first volume. It identifies an additional 172 crystal radio sets, 91 crystal detectors and 26 crystals by manufacturer, model, year produced, description and original selling price. Further research on many of the crystal sets covered in Volume 1. Detailed history on the Philmore Manufacturing Company and the Western Manufacturing Company. 8 1/2" x 11", 252 pages, softcover.

\$29.95

*** Crystal Clear, Vol. 1 is also available for \$29.95 ***

U.S. Orders - Enclose \$3.00 per order for packing & book-rate shipping if total order is under \$35.00. If using VISA or MasterCard, include name on card, card number and expiration date. Send payment with order. Mass. residents please add 5% sales tax. Money back return policy. Most orders shipped the same day received, but allow 2-4 weeks to receive order. Foreign orders - write for shipping costs, or use credit card and specify air or surface (allow 2-3 months for surface shipping).



Send Order To: A.R.C., P.O. Box 2, Carlisle, MA 01741
or Call: (508) 371-0512 Fax: (508) 371-7129



Order These Popular Books From Antique Radio Classified



Price
Guide

The Collector's Guide to Antique Radios 3rd Edition by Marty & Sue Bunis. 8,500+ Battery & AC sets from the '20s to the '60s. Updated prices. Over 650 all new photos, 278 pages. — \$18.95



Price
Guide

The Collector's Guide to Transistor Radios by Marty & Sue Bunis. This book will help you identify the most sought-after vintage transistor radios. Over 2,200 models, all with current prices. Over 400 color photos, 256 pages. — \$15.95

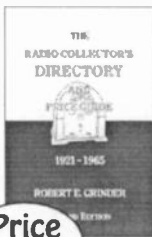

Price
Guide

The Radio Collector's Directory and Price Guide, 1921-1965, 2nd Ed. by Robert Grinder. Over 20,000 radios by manufacturer, model number, year, etc. with prices. Radio history, cabinet style chapters. No photos, 264 pages. — \$26.95

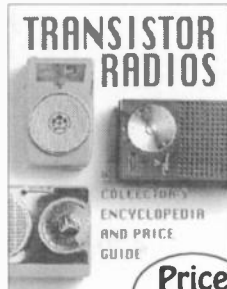

Price
Guide

Transistor Radios, A Collector's Encyclopedia and Price Guide by Robert Lane and David Lane. Identification guide to over 2,500 transistor and novelty radios. History and key to collecting chapters, 170 pages. — \$19.95

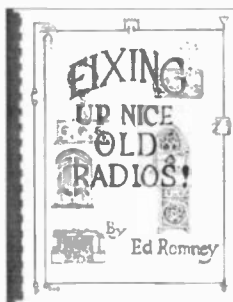

Fixing Up Nice Old Radios by Ed Romney. Written by a retired radio instructor. Plastic binding. 300+ figures, 185 pages. — \$19.00

Old Time Radios Restoration and Repair by Joseph J. Carr. A self-paced training guide. History, theory and practical operation of antique and classic radios. 200 illustrations, 256 pages. — \$18.95



U.S. Orders - Enclose \$3.00 per order for packing & book-rate shipping if total order is under \$35.00. If using VISA or MasterCard, include name on card, card number and expiration date. Send payment with order. Mass. residents please add 5% sales tax. Money back return policy. Most orders shipped the same day received, but allow 2-4 weeks to receive order. Foreign orders - write for shipping costs, or use credit card and specify air or surface (allow 2-3 months for surface shipping).



Send Order To: A.R.C., P.O. Box 2, Carlisle, MA 01741
or Call: (508) 371-0512 Fax: (508) 371-7129



(Jan-96)

Order These Popular Books From Antique Radio Classified



Crystal Clear Volume 1 and Crystal Clear Volume 2 by Sievers. *Comprehensive reference to crystal sets, crystal detectors, and crystals. Each volume contains different illustrations and information. Order by volume. — \$29.95*



Flick of the Switch by Morgan McMahon. *The classic photo reference guide for 1930s - 1950s radios. 1000+ photos of radios, 5" x 8", 263 pages. — \$11.95*



Guide to Old Radios, Pointers Pictures, and Prices, 2nd Ed. by Johnson. *Introduction to radio collecting. Includes hundreds of photos and a price guide. 272 pages. Available late October. — \$19.95*



Antique Radios Restoration and Repair, by Johnson. *Beginner's introduction to troubleshooting and repairing AC table model radios. 145 pages. — \$14.95*

**Price
Guide**



The Zenith Trans-Oceanic: The Royalty of Radios by Bryant and Cones. *Presents the fascinating story of the development and use of the Trans-Oceanic. Several photos, documents, ads, etc. 160 pages. — \$24.95*

Communications Receivers, 3rd Ed. by Ray Moore. *Information on vacuum tube receivers by 66 manufacturers. 402 radios illustrated, 115 pages. — \$19.95*

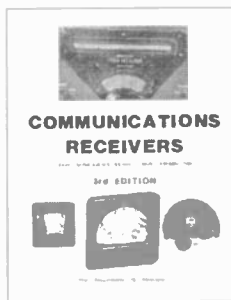

U.S. Orders - Enclose \$3.00 per order for packing & book-rate shipping if total order is under \$35.00. If using VISA or MasterCard, include name on card, card number and expiration date. Send payment with order. Mass. residents please add 5% sales tax. Money back return policy. Most orders shipped the same day received, but allow 2-4 weeks to receive order. Foreign orders - write for shipping costs, or use credit card and specify air or surface (allow 2-3 months for surface shipping).



Send Order To: A.R.C., P.O. Box 2, Carlisle, MA 01741
or Call: (508) 371-0512 Fax: (508) 371-7129



(Jan-96)

FOR SALE: GE radios. Send for list. Robert J. Stone, 721 Fisk St., Piqua, OH 45356-3729. (513) 773-2217

FOR SALE: Small 2 transistor coronet hearing aid - \$25. Globe Patrol science fair receiver in box - \$25. Blabber Mouth, good - \$25. Elgin 10 transistor with case, Model R-1100 - \$15. **WANTED:** Presentation box for Micronic Ruby SRG430. Doris Roberts, HC 63, Box 236-1, Clinton, AR 72031. (501) 745-6690

FOR SALE: Tubes, radio, TV, 40's thru 50's, SASE for list. Lee C. Dickinson, 401-3 Talcotville Rd., Vernon, CT 06066

FOR SALE: Tubes, schematics, service notes, Riders, Sams Photofac Folders and transistor books, etc. for early radios. LSASE for price list. Sam Faust, PO Box 94, Changewater, NJ 07831

FOR SALE: ICOM R-71A - \$500. Drake SPR-4 - \$250. Sony PRO-80 - \$225. All mint, instructions, shipping incl. Levy, 8 Waterloo, Morris Plains, NJ 07950. (201) 285-0233

FOR SALE/TRADE: Grebe CR9 - \$650. Collins 1940 transmitter, Collins 30L1. **WANTED:** Pre-1940 transmitter, Collins gear, CR13, DA2, HR, UX213 tubes. Stu Mount, 35 Grand, Highland, NY 12528. (914) 691-7957

FOR SALE: Philco 50-526, maroon repainted, pretty and recapped - \$45. Philco 52-545 clock, nice - \$28. Zenith G516, works good, clean - \$40. Polaroid 600 & N.I.B. radios - \$12 ppd U.S.A. **WANTED:** Escutcheon for Philco console 41-285. Classic Radio & Television, 541 Riverside Dr., Box 61, Augusta, ME 04330. (207) 623-2059

FOR SALE: Philco Model 7 Transitone, very ugly - \$40. Heathkit X-1 - \$35. Recoton video breakout box V800 - \$35. Fanon PA amp Power Plus 65 4 channel - \$100. Fanon mic PPM-1 - \$25. Lafayette mic MU-101, dual imp, original case w/cable - \$50. Zeniths: 6S254 - \$100; 7S258 - \$150; will separate components. Send want list & SASE for lists. Wilbur Gilroy, 129 Belmont Ave., Clarks Green, PA 18411. (717) 586-7356

FOR SALE: Rider's Television Manuals #3, 4, 5, 6, 7 - \$12 ea. Garrard turntable/changer Model 88/MKII, with Shure M7D cartridge and mounting box - \$35; (40) antique/globe tube duds, including (3) 245, (3) 171A, (4) 280, (5) 199, DeForest 247, 112, 201-A, and more - \$35; (2) #811 J.A.N. tubes, like new - \$12 ea. New GE tubes: 7581A/KT66 - \$22; 866A - \$12; 5Z3 - \$4; 6AQ5 - \$2; 6CB6/6CF6 - \$1. Herb Ratner, 3542 Westminster Ct., Holiday, FL 34691

FOR SALE: (1) Elkay near mint batt. set, no tubes, 1924? - \$175 + S.H. **WANTED:** Philco Chassis 89 Code 123 with or w/o tubes, must have wiring as from factory, no junk. Also, Philco 89 cabinet, could be basket case as long as it is all there. Thanks. Carlos Gimenez, 15091 Shamrock Dr., Fort Myers, FL 33912. (941) 482-0198

FOR SALE: Acquired more tubes and must sell cheap. New and used plus radios, novelties, parts, paper stuff and free advice. Example of cheap: 6J5GT or metal N.I.B. - \$1. All American Five set used, includes 12SA7, 12SK7, 12SQ7, 35 or 50L6 and 35Z5 tested on TV-7U tester - \$10. Satisfaction guaranteed! Send LSASE along with specific wants or advice needed to: Stan Lopes, KB6LGV, 1201-74 Monument Blvd., Concord, CA 94520. (510) 825-6865. E-mail: bqng17a@prodigy.com

FOR SALE: Victor R-35 1929 console, excellent working condition, unique dial, pick up only - \$150. Matthew Hinson, 1663 Bridge St., Merrick, NY 11566. (516) 379-3601

FOR SALE: Zenith R3000-1 - \$75. Zenith R7000 - \$100. Zenith M403 (see T402), cracked handle - \$20. Zenith 8H034 - \$50. Zenith L515W - \$40. Philco 38-10 - \$75. Philco 38-62 table - \$40. Bendix 753M - \$45. Mitchel (12507), needs light plastic - \$50. UPS extra. Victor Marett, 3201 N.W. 18 St., Miami, FL 33125. (305) 634-9569

FOR SALE: Xtals, all types. Buy individually or entire stock. Send wants or request list. Also, many tubes. Harry Kundrat, 29 Walton Ave., New Providence, NJ 07974. (908) 665-1873

**FAX NUMBER FOR
ANTIQUE RADIO CLASSIFIED
(508) 371-7129 - 24 hours a day
Ads - Subscriptions - Book Orders
See inside front cover for details**

FOR SALE: Tube caddy, 21x10x 126 hi, exc cond. - \$50. (2) Atwater Kent variometers w/tap switches, exc cond. - \$300 ea., both for \$500. Also numerous N.O.S. parts, SASE for list. Max Jennings, PO Box 1242, Nipomo, CA 93444. (805) 929-3933

FOR SALE: Piano radio parts: Set of brass foot pedals - \$15; wood music stand - \$15; plastic music stand for Bakelite radio - \$25. General Television wood piano radio - \$275. Geoff Shearer, 14101 Mesita Cliff Rd., NE, Albuquerque, NM 87112. (505) 293-8544

FOR SALE: KLH Mod 21 rec. - \$75. **WANTED:** Acrosound II amp, any condition. Charles Johnson, 21 Holly Hill Dr., Mercer Island, WA 98090. (206) 232-2040, fax/phone

FOR SALE: Karola coin-op radios, metal and wood, restored, (have 10) - \$95. Hotel radio, coin-op, all metal, no back, restored - \$95. RCA portable, 8BX7J - \$25. Motorola 600, black, 66L1 - \$35. Emerson USA, brown case, chip-out rear right side, no back, has grille cloth, knobs and dial - \$85. Automatic Electric pay phone, 3-slot, black, works - \$175. Case only Emerson portable, 85-A1 (?) with handle - \$15. WECCO Gem crystal radio - \$45. Blue Neutrowound needs veneer work, one knob, one cap, but it works - \$350. Zenith T-O, H-500, needs handle, works - \$75. LSASE and \$1 for long list of radio magazines and books. Thanks! Del Tysdal, 812 Broadway, Fargo, ND 58102. (218) 287-2562

FOR SALE: Orange Sentinel 284 N/A Catalin: loose grille cloth, crack in dial glass, original back - Offers. Have a supply of old car radios 1930-1950. Call with needs and I will see what is in the barn. Del Tysdal, 812 Broadway, #4, Fargo, ND 58102. (218) 287-2562

FOR SALE: RCA 15X - \$25. Mirror Tone Deluxe - \$50. UHF converters; Philco toaster radio; Emerson 708, red; Lafayette KT 200 - \$100. RCA 45 player 45-J2 - \$35. Monarch wood table AM/SW small tape recorders. Precision 910 tube tester - \$50. AK 55C; Philco 90A; lots of old literature; Hallicrafters S-40A - \$85. 8R40 CRX-2 - \$25. Watch case meters; Sony TV-511, picture tube rotators, old earphones. Gerald E. Perkins, RFD #2, Box 34, Milo, ME 04463-9605

FOR SALE: Hammarlund HQ 129X - \$175+. S-20-R - \$125+. Other rcvrs too. H.N. Felder, 7517 Granada Dr., Bethesda, MD 20817

The Collector's Guide To Antique Radios - 3rd Edition

By Marty & Sue Bunis



8,500+ Battery & AC sets from the '20s - '60s
Expanded listing of radios from the '60s
Over 650 all new color photographs
Updated prices
\$18.95 - Softcover

There are no transistor radios listed in the third edition. You will find them in *The Collector's Guide to Transistor Radios* available from A.R.C. for \$15.95.

U.S. Orders - Enclose \$3.00 per order for packing & book-rate shipping if total order is under \$35.00. If using VISA or MasterCard, include name on card, card number and expiration date. Send payment with order. Mass. residents please add 5% sales tax. Money back return policy. Most orders shipped the same day received, but allow 2-4 weeks to receive order. Foreign orders - write for shipping costs, or use credit card and specify air or surface (allow 2-3 months for surface shipping).



Send Order To: A.R.C., P.O. Box 2, Carlisle, MA 01741
or Call: (508) 371-0512 **Fax: (508) 371-7129**



(Mar-98)

FOR SALE: Working \$20 ea. in-circuit capacitor testers PACO C-25, Olson KB-147. + shipping. Leon Bitters, 4209 Logtown Rd., Lena, WI 54139. (414) 834-3707

FOR SALE: Box of new assorted IF transformers, large & small chokes, RF coils, etc., all for - \$95 plus \$20 shipping. Maurer TV, 29 So. 4th St., Lebanon, PA 17042. (717) 272-2481

FOR SALE: Motorola 7" television Golden View VT71, excellent condition, original tubes and finish - \$140. Tom Mercier, 246 Lakewood, Detroit, MI 48215. (313) 824-4449

One Month Free!

BONUS FOR EARLY RENEWALS

If you renew before the month shown on your mailing label (your expiration month), you will receive an extra month on your subscription: 13 months instead of 12! 26 months for an early 2-year renewal!

FOR SALE: TV sets. RCA 721 table - \$150. RCA 8T241 - \$150. RCA 21D 7425 console, restored - \$190. RCA 24D 679, fruit wood - \$250. Magnavox MU320, maple and leather - \$200. Hallicrafters 12" table - \$150. DuMont RA105 table - \$200. RCA TC166 console - \$85. GE 12T7 - \$50. GE 1949 table model, N.O.S. not completed. RCA - \$630, \$200. RCA 8TR-29 with AM, FM table set - \$150. Gertz 21" Long Islander - \$150. RCA 8T244 table w/doors - \$175. RCA 71T200 metal cab. - \$80. RCA TC125 console - \$100. DuMont RA113 modern - \$250. DuMont RA110 - \$200. Sylvia 21" Halolight - \$300. Call: Vaughn Rudisill, 11 E. Marie St., Hicksville, NY 11801. (516) 822-4501

FOR SALE: Pilot TV-271, WT - \$30. Zenith 5-S-250 chassis, WT - \$30. TSMs: 52, 53, 54, 56, 58, 61, 62, 64, 67, 71, 77, 83, 84. All have upper right-hand corner of cover torn - \$4 ea. or \$30 all 13. Jerry Nutter, 111-32 112th St., Jamaica, NY 11420-1026. (718) 835-1132. E-mail: 70424,1254 (CIS)

FOR SALE/TRADE: Stromberg-Carlson 1204 - \$95. RCAs 9-X-562, 75-X-11, 45-X-13 - \$55 ea. Radiola 60 - \$100. Emersons: 645, EC-301, DP-332, - \$50 ea. GE 62-C, 535-C, AM/phone - \$45 ea. Peter DeGregorio, 85 Burroughs Rd., Fairfield, CT 06430-3504. (203) 331-9155

FOR SALE: Westinghouse pocket-size transistor in box Model H798P7 - \$15 plus shipping. Cute pocket-size RCA Victor transistor Model 1-TP-2J, both are older transistors - \$17 plus shipping. Jim Montague, 1907 South Stanley Ln., Spokane, WA 99212. (509) 535-9576

FOR SALE: 3 scopes: RCA WO-33B - \$95. OS-106, solid-state, 4"DC to 5MHz - \$149. Tektronix 7603, 100MHz - \$450. John Kirby, 298 West Carmel Dr., Carmel, IN 46032. (317) 843-2212

FOR SALE: Navy TCS-12 Collins receiver, original 200-page instruction book, excellent condition - \$55 delivered. Joe Duffin, 4 W. Central Ave., Moorestown, NJ 08057. (609) 778-1436

FOR SALE: Emerson U5A, brown - \$200. French Sonorette, brown - \$750. Emerson Clockette 572A, blue marble - \$250. Anthony Vaccaro, 1530 84th St., Brooklyn, NY 11228. (718) 837-9371

FOR SALE: Test eqpt. Heath IG 102 sig. gen. - \$25. Accurate Inst. 153 sig. gen. - \$27. Lafayette KT208 sig. gen. - \$27. Eico 320 sig. gen. - \$30. Heath TO-1, 5 fixed freqs. BC bands - \$20. Eico 950-B res. cap. tester - \$35. RCA WA 44 audio osc. - \$40. Tube testers: Superior TV11, roll chart, papers, port. case - \$35. Heath TC-1, roll chart, papers, homemade case - \$35. Heath TC-2, roll chart, papers, early model port. case - \$35. Heath TC-3 roll chart counter top - \$35. Heath IT17 roll chart with papers, test to 12-pin tubes - \$40. Also other testers, radio and pix tubes. Eico 1050, 6-12 volts, 10 amps, A elm, 2 meters - \$35. Heath BE2, 6 volt, 10 amps, A elm - \$35. Have variacs 1. to 10 amps. Junking Radiola 80. Philco 86, 95, 112 parts. Have 1000's of unlisted N.O.S. and used parts, tubes, service info on RCA, Philco, GE, Motorola, Admiral Radio TV. Allied Radio Catalog 1954 - \$15. 25 Fun to Build Projects and Radio Receiver Servicing Guide, both - \$7.50. Engineering Electronics, Fink - \$9. Thordarson radiomanual, 2 old, 1 less cover, both - \$7.50. Shortwave Radio, 1934, (5) copies, all - \$25. 101 Radio Electronics Circuits - \$10. 1937 Radio Data Book - \$10. Shortwave Craft 1936, special hook up number - \$11. Have other books, magazines - write wants SASE. Emund Model 196 wood cab. German radio, plays, AM/FM, (6) tubes - \$37.50. Edison 1/4" phono records - \$5 ea. (7) CB hand mics, all - \$35. (5) Turner, Motorola CB mics, all - \$35. Turner 254-C desk mic - \$30. Turner plus 3 desk mic - \$30. RCA MI-11030 mic - \$15. Bundle 25+ radio course How it Works - \$15. ARRL Handbooks 1959-71, 74, 78, 80, 88 - \$10 per copy. Mobile Handbook, 1955 - \$10. 1949-1964 Antenna book - \$6 ea. TV and Radio Tube Troubles - \$5. Radio News, 1949 to 1958 copy - \$2.50. Radio Electronics, 1947 to 1968 - \$1.50 copy. Elementary Electronics Radio Experimenter, 10 for - \$15. Peerless magnetic speaker in a wood cathedral cab. - \$35. Magnavox R3 horn speaker, paint scratched - \$125. Antenna glass or porc. insulators, small - 55¢; med. - \$75¢ ea. Shipping extra on all items. Min. parts orders - \$8. SASE for replies. F. Krantz, 100 Osage Ave., Somerdale, NJ 08083-1136. (609) 783-0400, 9 am-9 pm EST

FOR SALE: Atwater Kent original instruction manuals, all excellent condition & postpaid: 1928, Models 40, 42, 44 - \$28.50; 1927, Models 30, 32, 33, 50 - \$48.50; 1925, Vol. 2, Models 12, 19, 20, 21, 24 - \$48.50. Larry Kellough, PO Box 849, Canton, CT 06019-0849. (203) 693-8269

FOR SALE: Brach U.S. Army Signal Corps World War One field inductive telegraph unit, identical to the one on page 20 of the November issue. Will take offers over \$2,000. Hobson Appliance, 238 Schoolhouse Rd., Ghent, NY 12075

FOR SALE: R-390A manual set (repro), 400 pages, spiral bound - \$58. Limited quantity - call first. MES-SAGE: SP-600-JX-17 and R-648/ARR-41 handbooks - sold out. WANTED: Amperite #11-20 (2 pin) ballast tube. Bob Bakinowski, 1524 Saint Tropaz, Tucson, AZ 85713. (520) 624-8029

FOR SALE: Freed-Eisemann NR-20, 1924, superb original condition and works, pick-up only - \$395. Ralph Trotter, 103 Beach Rd., Bristol, RI 02809. (401) 253-7749

FOR SALE: Philco #70 - \$395. AK 10C - \$950. Zenith Royal #7000, all mint. List LSASE. Richard Bednarcik, 28 Steele Ave., Lincoln Park, NJ 07035. (201) 694-6374

WANTED: Radio Boys books, need one to complete collection. Aiding the Snowbound by Chapman. Anyone help? Pay cash or have trades. Jeff Hoskins, 834 E. Madison Ave., Stuart, FL 34996. (407) 283-2291, after 7 pm

WANTED: A radio part from the Henry Ford Museum auction. Two RCA UC-1820 tuning condensers mounted together and sporting a large red tag. Stephen C. Brown, KD4YFY, 3808 Champaign St., Charlotte, NC 28210. (704) 847-1301



WANTED: This Lewol radio with metal trim & other sets with metal grilles or trim. Jay Malkin, 1250 Galapago, #206, Denver, CO 80204. (303) 623-6451

WANTED: RCA LC1A speakers, and studio monitor cabinet. Thanks. Vern Oehlke, Box 112, Ghent, NY 12075. (518) 392-4945

WANTED: Crystal radios pre-1960, catwhiskers, detectors, parts, incompletes, crystal boxes and tins, germanium diode radios, variometers, loose couplers, DeForest DT600 box, Boonton 260A ohmmeter. Collection at (105) pieces, trade my duplicates for yours. The Crystal Radio Guy, Galen Feight, 3104 S.E. 20th, Portland, OR 97202. (503) 231-9708

WANTED: Zeniths. Also, sell, trade. Reasonable only. No calls, write: Harvey Leners, 5426 So. 185th, Omaha, NE 68135

WANTED: Tubes. Amperex Bugle Boy 12AX7, 6DJ8; Mullard 6CA7; Tung-Sol 6550; WE 211, 212D. Heath W6 amps. John Birck, 458 E. 600 N, Orem, UT 84057. (801) 224-4809



WANTED: E.H. Scott Laureate Grande with Philharmonic chassis, or any E.H. Scott radio with wireless remote. Eddie Burris, 2837 Winterbrook Dr., Lawrence, KS 66047. (913) 841-4174. E-mail: burris@cstp.umkc.edu

WANTED: Manuals (copies OK) for Hickok 6000A, Tel-Ohmike TO-4, Tennenec MCP-1 scanner; good tubes 7189(4), KT-66(2); R-390A line filter. Dennis Hoffman, KW9G, 3519 Hoffman Rd., Chippewa Falls, WI 54729. (715) 831-1855, evenings

WANTED: Schaub Lorenz Savoy 10 receiver, either working or for parts usage. Please call, ask for Steve Osterwyk: Steve Osterwyk, 6403 W. Pierson Rd., Flushing, MI 48433. (810) 659-5000, 8:00 am to 4:30 pm EST

WANTED: Allied catalogs: 1953, 1954, 1958, 1961. Sams Audio Amplifiers AA-1 and AA-6. Doc Waterman, 800 Walavista Ave., Oakland, CA 94610-1150. (510) 465-5757, days

WANTED: Old electro-therapy books, literature, equipment. Hank Andreoni, c/o 250-D So. Lyon Ave., Hemet, CA 92543

WANTED: McMurdo Silver Model 802 superheterodyne receiver, poor condition OK. Will buy or trade. William Shibley, Sr., W3QII, 5899 Barnes Ave., Bethel Park, PA 15102. (412) 835-7015

One Month Free!

BONUS FOR EARLY RENEWALS

If you renew before the month shown on your mailing label (your expiration month), you will receive an extra month on your subscription: 13 months instead of 12! 26 months for an early 2-year renewal!

WANTED: Brass-based, tipped WB-800 ballast tube, looks like a brass-based, tipped WD-11, need for radio restoration. Stephen C. Brown, KD4YFY, 3808 Champaign St., Charlotte, NC 28210. (704) 847-1301

WANTED: AK Model M horn complete, good working condition. Bill Schultz, 11605 Versailles Ave. NE, Albuquerque, NM 87111. (505) 294-5302

WANTED: Power transformer for RCA TM-21 21" color TV studio monitor #213987. J. Ballard, 39 Boston St., Middleton, MA 01949. (508) 774-4041

THANKS!

*Thanks for suggesting
A.R.C. to your friends.*

*Did you know that nearly 20% of
our new subscriptions come from
referrals from subscribers?*

So spread the word about A.R.C.!

*Give the center coupon to a
collector, or ask us to send a
friend a free sample copy.*

*Help A.R.C. and
radio collecting grow!*

FOR SALE: White with red grille insert Fada bullet - \$2,500. Purple with pumpkin trim Fada bullet - \$750. Offers. Chuck Sundgren, 1818 Alder Ave., Richland, WA 99352-2424. (509) 943-2753

FOR SALE: Motorola 53H (Collins 2, p. 94, 95; Stein, p. 147), perfect condition - \$75. Remler intercoms; this is a set of (2) matching Bakelite cabinets, same as the Skipper model; excellent condition - \$50. Airline Model 93BR-421B cabinet only, no cracks, (E.O.R., p. 36) - \$20. Emerson Aristocrat Catalin - \$295. All plus UPS. Thank you. Bob Furtado, 23 Garden Rd., Alameda, CA 94502. (510) 521-3084

FOR SALE: Sencore MU150 tube tester mutual conductance and emission, last checker Sencore made, won't check antique tubes - \$150 plus \$35 shipping. Maurer TV, 29 South 4th, Lebanon, PA 17042. (717) 272-2481

FOR SALE: Zenith Trans-Oceanic 3000-1 - \$125 plus shipping. Zenith Royal 500 Deluxe, long distance, maroon in color - \$60 plus shipping. Both in real nice condition. Jim Montague, 1907 South Stanley Ln., Spokane, WA 99212. (509) 535-9576

FOR SALE: AK 82 - \$425. Charlie McCarthy - \$850. Radiola 60 - \$150. GE S22 tombstone - \$275. Sparton Bluebird - \$1,950. Fireside Wireless, 1507 Ridge Ave., New Castle, PA 16101. (412) 654-9335. Fax: (412) 657-8755. E-mail: prsk30a@prodigy.com

FOR SALE: RCA #7C-9D clock radio, black, case cracked - \$15. Bulova clock radio, damaged case - \$15. Howard #700 table - \$30. Sentinel #315W - \$20. Crosley 56TV-0, wood, fair - \$20. Zenith lime green walnut #6D029G - \$40. Johnson #658 tube tester - \$15. Teletone #122 cloth covered - \$25. RCA #8X-6M, yellow, red light on front - \$10. Telechron #8H67 clock radio, radio & clock works great, cabinet sad - \$20. RCA #6Xd-5, green - \$20. Car radios: Motorola #309 under dash (missing 1 knob) - \$25. Automatic #MB????-under dash - \$40. WANTED: Any information on Silvertone Model #4524, very large tombstone (battery), or will trade for good Zenith set. Manuals for Hickock tube tester, Model #534B (photocopy OK). Information (manuals, etc.) for Silvertone #7057 (record recorder/photo/radio) photocopies OK, Rider's manuals 18, 19, 20, 21, 22, & 23. Any information on a large Crosley console with spindle-type legs and full doors that close on the front, can't find model number, "How to Repair Old Time Radios" book, Mallory Service Encyclopedia Vol. #5 or 6. All above items for sale at price plus UPS. Thanks. Tom Zenisek, c/o Lucky Awards, Inc., 3310 1st Ave. NE, Cedar Rapids, IA 52402. (319) 366-3686, days

WANTED

WESTERN ELECTRIC

TUBES, SPEAKERS, HORNS & AMPS

TUBES: Telefunken, Genalex, RCA, Radiotron, etc. General Electric, Amperex, JAN, Sylvania, GEC, National Union

McIntosh, Marantz, Dynaco, Jensen, Linn, Levinson, Fisher, Leak, Tannoy, Altec, EV, Thorens, EMT, JBL ... Amps, Spkrs., Turntables

MAURY CORB

12325 Ashcroft, Houston, TX 77035

Tel: (713) 728-4343 Fax: (713) 723-1301

FOR SALE/TRADE: Vacuum tube amps: Scott L-48-K - \$150. (2) Scott 99-B's - \$250. Heathkit tuner - \$50. Harman Kardon Trio - \$95. Knight KN-940 - \$95. Channel Master 6601 - \$100. (4) Newcomb E-20's - \$95 ea. Newcomb E-40 - \$125. Rauland 50 watt EL-34's - \$100. Bogen J-050 - \$90. Challenger - \$85. Peter DeGregorio, 85 Burroughs Rd., Fairfield, CT 06430-3504. (203) 331-9155

FOR SALE: Sams MHF/TR/TSM - \$10. CB - \$7. AR - \$5. All new plus S/H. Ed Crockett, 128 Buccaneer, Hattiesburg, MS 39402. (601) 264-4755. Fax: (601) 264-0226

FOR SALE: Atwater Kent lamp with original shade, mint - \$1,950. Grebe CR-8 Ser. No. 168, mint - \$950. Larry Wright, 131 Hilltop Dr., Lake in the Hills, IL 60102. (708) 658-7328

HAS YOUR SUBSCRIPTION

EXPIRED?

It has if your mailing label reads
"EXP=JAN96" or earlier.
Renew now!

*BONUS: Renew before
your "EXP" month and receive
13 issues per year instead of 12!*

Renewal rates are:

\$36.95 for Second-Class Mailing

\$53.95 for First-Class Mailing

(Two-year renewals are twice above rates.)

FOR SALE: Western Electric Tennis Ball, duds, assorted types, good display tubes - \$38 ea. J. Arndt, 1215 Division St., Manitowoc, WI 54220. (414) 684-8830, machine on 24 hrs. a day

FOR SALE: Novelty radios: Steinway spinet piano 8 transistors, M.I.B. - \$150. Carrier central air conditioner, M.I.B. - \$75. Overland Stagecoach, M.I.B. - \$75. Windsor TWA Jumbo Jet radio C9WB - \$100. Knight radio with face, loose - \$60. Space Satellite crystal set, M.I.B. - \$125. Roller Skate, loose - \$40. Silver Ghost Rolls Royce, M.I.B. - \$60. Love is, loose - \$50. Baseball player Sox, loose - \$40. Tea kettle by Guild, bat. op., mint - \$100. The Town Crier by Guild, mint - \$150. Continental phone Stars & Stripes, loose, mint - \$40. French style phone, M.I.B. - \$50. Lunch 'N' Tune, yellow, clean, loose - \$40. Headphones radio, M.I.B. - \$50. 1963 Cadillac convertible, M.I.B. - \$40. Rolls Royce Phantom II, metal, M.I.B. - \$40. Polaroid 600 Plus, M.I.B. - \$30. Safe bank radio, loose - \$20. Carl Dahlia, 7339 W. Addison, Chicago, IL 60634. (312) 889-2836, or (708) 398-0946

FOR SALE: Crosley Showbox, good condition, untested - \$50. Magnavox Micromatic record changer, Admiral record changer RC1708 no charge, Radiola 61-10 w/tubes - \$25. Philco Transitone w/tubes - \$30. All plus UPS. Fenton Wood, 109 Shoreline Dr., S.H., Malakoff, TX 75148. (903) 498-0204

FOR SALE: Dewald Harp Catalin, mint - \$600. Corona Model 43-8190, ivory/blue - \$225. Fada 1000, white/butterscotch - \$500. Art Martinez, 3254 E. Forge, Mesa, AZ 85204. (602) 830-2501

WANTED: Audio equipment. Western Electric, RCA, McIntosh, Dynaco ST-70 (chrome), Altec. Other equipment considered. Dee Alquist, PO Box 371, Crimora, VA 24431. (540) 949-8300, leave msg.

WANTED: Written materials on Philco Predictas (articles, ads, original sales brochures, owner's manuals/info, etc.). Photocopies OK. Will reimburse expenses+. Ron Ries, 400 Carr, #103, Vermillion, SD 57069. (605) 624-8255

WANTED: Western Electric 713C, Lansing 801, Weston #431 0-200 mls KS-6184 meter. Vincent Gallo, 532 LaGuardia Pl., #600, New York, NY 10012. (212) 274-0432. Fax: (212) 274-9416

WANTED: Schematic/manual for Dynaco FM-1 and PAS-2, schematic for Arborphone 27, tube socket for Radiola III. Paul Ernst, 238 Meadow Ln., Webster, NY 14580. (716) 787-9879

WANTED: Meissner Traffic Master, Traffic Scout, communications receiver circa 1936-40 kits. Any condition - call collect: Bruce C.E. Russell, VE7HII, Suite 220, 4411 Hastings East, Willingdon at Hastings, Burnaby, British Columbia, Canada V5C 2K1. (604) 299-1116

WANTED: Heathkit IM meter. Heathkit Legato spkr. Dynaco PAM-1 p. supply. **FOR SALE:** Garrard Click and Pop machine. SAE 5000. Russell Coco, 5505 Loranger Dr., Baton Rouge, LA 70809

WANTED: Junker SX-28 rec. or front panel and plastic dials for same. Any reasonable price. John Mohn, 12810 Deer Oak, San Antonio, TX 78253. (210) 679-6147

WANTED: Octal tube bases, N.O.S. Fred Cranshaw, 1624 Bitter Ck., Garland, TX 75040. (214) 494-4917

WANTED: Stock market ticker-tape machine. Send price and condition to: L.H. Braskamp, 1459 Via Cortez, Placentia, CA 92670

WANTED: Crystal sets, crystal radio kits, toy crystal sets and pocket crystal radios. Erwin Macho, Amnbrosweg 17/A/8, A-1230 Vienna, Austria

WANTED: Weston 431, 0-200 mA KS-6184 meter. Meters in quantity, cheap. Strange or unusual meters, flight instruments, meter books and pamphlets. Chris Cross, Box 94, McConnell, IL 61050



WANTED: Pilot set pictured and similar, also Pilots with drum-type dials. Pay to \$1,200 or have trades. Pay finders fee for information leading to purchase. Shipping from anywhere no problem. Thanking everyone in advance. Bill Moore, 3049 Box Canyon Rd., Huntsville, AL 35803. (205) 880-1207

WANTED: WE-7A amplifier in good condition. Please write or fax with price and condition. Minoru Muraoka, 2-18-30-503 Kikuna, Kohoku-ku, Yokohama, Kanagawa 222, Japan. Fax: 81-45-401-1499

WANTED: Hallicrafters S-37 circular main tuning dial and S-meter. John MacJannet, 15910 Colfax, Lowell, IN 46356. (219) 696-8002

WANTED: J.J. & William B. Duck Co. (1908-1932) radios, catalogs, crystal sets, loose couplers. DeForest DV/DL only these types: DV-1, DL-2, DV-3A, DL-3, DV-6, DV-6A, DV-7, DL-7, DL-9, DL-14. Sodian S-13, D-21. RCA - Cunningham WD-11 BBTT or C-11 BGTT. QRS Red Top VT-10/CG-916 w/sockets. All tubes must be good, N.I.B. or N.I.C. Edison stock certificates and boxed 2-minute cylinders. Carbon button microphones w/stands. Send postcard, e-mail or fax to: Jeff Brooks, 512 West Park St., Lakeland, FL 33803-1232. (941) 686-5186, voice. (941) 683-3471, fax or e-mail: Vacuum2be@aol.com



WANTED: This Majestic metal grille set & other radios with metal grilles or trim. Jay Malkin, 1250 Galapago, #206, Denver, CO 80204. (303) 623-6451. E-mail: klaaslaw@aol.com

WANTED: Speaker, or just the audio output transformer, for Philco cathedral Model 20A. Hank Trabold, 2058 Nakiska Ct., Toms River, NJ 08755. (908) 244-2345

WANTED: Electron tubes, ball bearings, Collins radio parts and equipment, aircraft parts & instruments, helicopter parts, lamps synchros. Hy Ness Company, 709B Delair Rd., Cranbury, NJ 08512. (609) 395-1116. Fax: (609) 395-1117

WANTED: Collins ARN123 for museum restoration of HH52A helicopter. Jeary Vogt, 3 Brampton Rd., Malvern, PA 19355. (610) 296-2162. E-mail to: Jeary@aol.com

WANTED: Manual & schematic for Hickok 810 transistor radio tester. Reproduction OK. Michael Burke, PO Box 439, Westminster, MA 01473. (508) 874-0908

WANTED: ARC R-11, R-23, R-148, BC-453 receivers, any condition; will buy or trade for R-19. Also: want unused 5AP1 and 5BP1 CRTs, and 11-pin sockets for them. Also: want CRT tester for above. Bruno R. Ruchalski, PO Box 2153, Clifton, NJ 07015

WANTED: Emerson 199 chassis. AK 55/60 interstage transformers. Isolation transformer. Larry Kellough, PO Box 849, Canton, CT 06019-0849. (203) 693-8269

WANTED: Dud WE 216A tubes, and Atwater Kent breadboard variable capacitor housing (only). Steve Pazar, 4950 Deerwood Dr., Santa Rosa, CA 95403. (707) 544-8142. E-mail: pazar@sr.hp.com

WANTED: Hallicrafters SX-28 and SX-28A, working condition, with or without cabinets. State price, shipping. John A. Benyo, 25 Schley St., Garfield, NJ 07026

WANTED: Type 145/245/345/445 tubes, N.I.B. @ \$50, used @ \$27. H. Kato, c/o Mr. T. Kato, 6868 Chelsea Rd., McLean, VA 22101

FOR SALE: Interesting old test equipment: Believe both from the 1930's. Both appear complete with manuals and adapters. AC bridge analyzer Mod BR-44, beautiful brown and gold, near mint - \$60. Readrite #1000 resistance & capacitance tester - \$30. Both great to display with those old radios. Heathkit motion detector alarm, GD-39, complete unassembled kit - \$50. Heathkit logic probe, IT-7410, w/manual - \$15. B-K Precision solid-state RF signal generator, Model E-200D, with manual, top of the line - \$90. Chrome Calrad preamp, #PRE-105 - \$25. Kenwood solid-state stereo amp, #KA-1400G, nice - \$55. Sun- powered radio kit, unassembled - \$12. All plus UPS. Jim Watson, PO Box 41, Coarsegold, CA 93614. (209) 683-7260, phone/fax

FOR SALE: Sparton Model 89 Equasonne, very ornate. Gerald E. Perkins, RFD #2, Box 34, Milo, ME 04663-9605. (207) 943-5204

FOR SALE: Craftsmen C400 amp - \$175. Wurlitzer wide range amp 6L6 - \$40. Harman Kardon mono int. amp 5881 - \$50. Lafayette LA 235 int. stereo amp - \$75. Magnavox amp from console 4 6V6 - \$40. RCA hi-fi mono int. amp 6V6 - \$40. PAT-4, PAT-5 - \$50 ea. Scott 340B receiver - \$100. SAE preamp - \$30. Bozak 6-channel stereo mixer - \$75. Harman Kardon Citation tube stereo tuner - \$60. Heath shortwave GR64 - \$45. Univox echo chamber, needs tape - \$30. Scott 299, 7189 output stereo - \$125. Grundig Satellit 500, needs one dial cord, plays - \$100. Custom-built 2A3 triode mono amp U.T.C. output transformer, all new parts - \$250. Emerson 888 - \$30. Jensen P12S Concert Alnico - \$85. Weltron 2001 tape radio unit - \$40. Altec Lansing 604C - \$300. Lafayette tube stereo tuner - \$40. General Electric A1400 12" coaxial - \$40. Fisher output transformer PR 7591 - \$40. Heath A-9 amp potted transformers - \$150. All plus shipping. Frank DeFilippi, 62 Second Ave., Massapequa Park, NY 11762. (516) 798-6577, 6-10 EST

FOR SALE: Extensive radio collection. Many cathedrals, numerous tombstones, battery sets, plastics include Bakelite, Plaskon and one Catalin. Metal includes one Hopalong Cassidy. Floor model Sparton 301. This is a sample listing. Pick up only. Bill Mann, 2nd Rd. Warden Pl., Harveys Lake, PA 18618. (717) 639-2707

FOR SALE: Operating Guide Zenith Super Trans-Oceanic portable, H500, chassis 5H40, near mint - \$40 ppd U.S.A. Darrell Combs, 6587 Pacheco Way, Citrus Heights, CA 95610. (916) 969-0635

FOR SALE: Thousands of tested tubes w/warranty! Send for new list with improved discounts and monthly specials. Both xmit and rec. tubes. I have acquired many common tubes recently. Buy those spare tubes for your tube radio, audio, ham and electronics. Most tubes are used at about 33% of new, many are about \$1. I have bunches of octal, older, 7- and 9-pin tubes. All tubes are tested on TV-7D/U tester and then boxed. I give a 30-day warranty. Send wants or SASE with two stamps for list. Daniel Nelson, 1025 E. Desert Ln., Phoenix, AZ 85040. (602) 243-7421, evenings. E-mail: djn@indirect.com

FOR SALE: Mint Dynaco PAS 3X. WANTED: MC60's, George Gott G30, EICO HF60s, working. Dave Barth, 8320 Bevan St., San Gabriel, CA 91775. (818) 286-6503

FOR SALE: RCA IMBT6, incomplete - \$45. RCA MI-7771A FM transmitter - \$45. Meissner 9-1076 calibrator - \$35. Allen Jochem, 2205 Broadway, Quincy, IL 62301. (217) 223-6751

FOR SALE: Grommes G60AR rackmount power amplifier, Fanon BC350 PA background music system, both heavy, as found. Zenith 950 console unusual 1935 model, some repairable cabinet damage. WANTED: Detrola chairside, Super PeeWee chassis. Dennis Smith, KN8H, Box 113, Trenton, MI 48183. (313) 675-5847

NEW — RADIO POSTER

**FULL
COLOR
26" x 20"**

**An
Illustrated
Radio
Timeline**

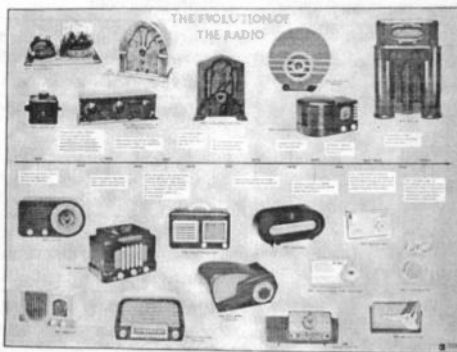

**20 Radios
From Pup
to
Transistor**

**Only
\$10.95**

U.S. Orders - Enclose \$3.00 per order for packing & book-rate shipping if total order is under \$35.00. If using VISA or MasterCard, include name on card, card number and expiration date. Send payment with order. Mass. residents please add 5% sales tax. Money back return policy. Most orders shipped the same day received, but allow 2-4 weeks to receive order. Foreign orders - write for shipping costs, or use credit card and specify air or surface (allow 2-3 months for surface shipping).



**Send Order To: A.R.C., P.O. Box 2, Carlisle, MA 01741
or Call: (508) 371-0512**

Fax: (508) 371-7129



(Jan-96)

WANTED: Bennett wireless intercom Model 100 matching component; instruction manual, schematics? I have base unit only. Automobile 45 rpm record player reel-to-reel prerecorded 4-track tapes, i.e. Van Morrison, Moondance; Ventures, Walk Don't Run; Boz Scaggs, Silk Degrees; It's A Beautiful Day, same; Steely Dan, A.J.A. Bill South, 13101 Foster Rd., Anchorage, AK 99516. (907) 345-9006

WANTED: Broadcast microphones; tube limiters, equalizers, mixers; guitars, guitar amps. Mike States, Box 81485, Fairbanks, AK 99078. (907) 456-3419, phone/fax

WANTED: Lafayette SK-180 loudspeakers. Only tweeters & midranges need to be working. Walter Bernd, 674 Fairfield Beach Rd., Fairfield, CT 06430. (203) 254-8140

WANTED: Black JVC Videosphere television, original box for JVC Pyramid & Videosphere televisions. Lee White, 86 Spruce St., Framingham, MA 01701. (508) 788-0359

WANTED: International Kadette Bakelite radios, odd horn speakers, and tube-operated bicycle radios. Greg Farmer, 71 Rice Creek Way, Fridley, MN 55432. (612) 571-6062

WANTED: Crosley Oracle, Show Boy, Elf, and other 1930-1935 Crosleys; any condition. I will buy or trade. Jim Watson, 8220 Scenic Hwy., Pensacola, FL 32514-7807. (904) 476-2563. E-mail: oldradio@cheney.net

WANTED: Prewar Bakelites, no cracks, with backs: Belmont 602, 526, 534, 521A. Karen McCoy, 8104 N.W. 114, Oklahoma City, OK 73162. (405) 722-0595

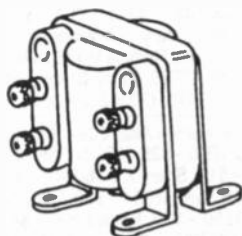

WANTED: Somewhere out there west of Laramie are a couple of the items pictured. It's an audio transformer mfg. by Conn. Tel. and Tel. Co., painted black with or without a nickel-plated band around the sides and top. I think it's printed "Type J-121" but not sure. Will take it open or not, duds OK. Please look thru your spare audio boxes and see if you can help. Thanks. Dave Crocker, 6 Raymond St., Sandwich, MA 02563. (508) 888-6236

WANTED: General Radio items: Pre-1930 tube testing equipment and accessories, pre-1935 catalogs and other paper, Model #605B signal generator, Type 303 4" vernier dial, Type 299 socket. **FOR SALE/TRADE:** Edison cell (108) B battery, has never had electrolyte in cells, commercial unit, rare piece - \$285. Lane Upton, 11284 Clinton Bar Rd., Pine Grove, CA 95665. (209) 223-4638

WANTED: Zenith Trans-Oceanics, all models, tube and transistor, any condition. Zenith military Trans-Oceanics R520/URR and R520A/URR. All Zenith WTM manufactured between 1935 and 1942. Frank J. Manzano, 82 Monhegon Ave., Oakland, NJ 07436. (201) 337-5263

WANTED: BC-312-C/BC-342-N receivers, and SCR-536 walkie-talkies. Michael Harrington, PO Box 7619, Little Rock, AR 72217

WANTED: Instruction book for Sprague Tel-Ohmike TO-5, copy OK. Bob Gidney, 411 W. Spruce St., West, TX 76691. (817) 826-5105

WANTED: Hallicrafters SX-122, SX-62B, SX-117, SX-71. National NC-400, NC-190, NC-270, NC-190. Gerald Silver, 10863 W. Clairmont Cir., Tamarac, FL 33321. (305) 720-1972

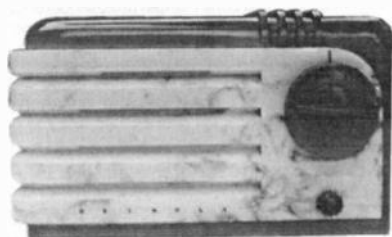

WANTED: More prewar plastics by Detrola, RCA, Kadette, Air King, et al. Take all my money before the relatives do. They are trying to hurry my already imminent demise. Please write or call collect: Rain Buttigton, 314 State St, #7, Portsmouth, NH 03801. (603) 427-1384

WANTED: S50240 music octave synthesizer IC, Radio Shack catalog #276-1780 (1981). Alvin J. Bernard, PO Box 690098, Orlando, FL 32869-0098. (407) 351-5536

WANTED: Good condition small case/mini wood cabinet tombstones. Parts chassis for Emerson R-156. Dave Stott, 29 Willow Bee Ln., Middletown, CT 06457. (203) 344-0697

WANTED: 15U269, 15U270, 15U272, 15U273, good condition or better, cash, pickup 300 miles. Larry Cooper, 425 Court St., Rockwell City, IA 50579. (712) 297-7232

WANTED: Western Electric G40/1095 mic & amp, WE 630-A Eight Ball. Yoke for 639A/B Altec M21-B Coke bottle & power supply. Have some RCA Altec ribbons, tube cord for trade. Ward Kremer, 301 S.W. 16 St., Ft. Lauderdale, FL 33315. (305) 524-5652, ph/fax

WANTED: Owners manual/instruction booklet copy for Truetone D-1845 console radio/phono combination. Dennis Kane, 2615 N.E. 49 St., Ft. Lauderdale, FL 33308

WANTED: Freed-Eisemann Model FE-15. My case also says No 410F. I have the case only (no works or speaker) and would like to have someone restore/rebuild it as exact original, or I am willing to purchase a complete, working set including the morning glory speaker. Will buy speaker separately. My "radio" originally belonged to my 92-yr.-old father, and I would like to make his day. Can you help me? Roger Hansen, 9220 Summit, Rockford, MI 49341. (616) 866-1930

WANTED: Colonial tombstone wooden pre-WWII BC & (2) SW Model 656. (2) 78; (1) 75; (1) 41; (1) 42; (1) 80. Charlie Rhodes, 10105 Howell Dr., Upper Marlboro, MD 20772. (301) 574-0214

WANTED: 1939 Fax radio receiver. Bill Banner, WIOS-TV, Asheville, NC 28802. (704) 255-4500

FOR SALE: Emerson television #70 AC - BO. Emerson Radio & Television dealer sign, fluorescent lit - \$250. Call for details. Noel, S&G Electronic, 618 S. 62nd St., Philadelphia, PA 19143. (215) 474-7663

FOR SALE: Dokorder 9100 - \$150. Roberts 1630 - \$75. Plus shipping. Stan Kotschi, 1421 W. New York Ave., Oshkosh, WI 54901. (414) 426-1912

FOR SALE: Motorola L43GGB1010 Type CC3012T; Hammarlund Model FM50A 5949; Saba tape recorder - \$85 ea. Tubes: Good selection of vintage tubes. Send LSASE for list. All items plus shipping. **WANTED:** Tuning knob for Airline Lone Ranger radio Model 05GCB-1541. Gil Jungert, 3061 Wellington Ave., Grand Junction, CO 81504. (970) 434-5000. Fax: (970) 434-0419

FOR SALE: Signal Corps I-177B tube tester - \$75. Superior Model TV-11 tube tester - \$40. WE 350B tube N.I.B. - \$350. WE 407A N.I.B. - \$3. WE 408A N.I.B. - \$2. WE 403B N.I.B. - \$8. WE 717, N.I.B. - \$15. Used tubes: 6V6 GT - \$10. 6AS7G - \$8. 6F6GT - \$5. 12BH7A - \$10. 12AZ7A - \$2. 12AX7A (U.S.) - \$10. 5U4 GT - \$10. 5V4 G/GA - \$8. 5R4WG - \$5. 1625 & 1625C - \$3. 41 - \$5. 25L6 - \$5. 24A - \$7. Frank Brewster, RR2, Box 201C, Baxter Springs, KS, 66713. (316) 856-3220

FOR SALE: (12) E.H. Scott consoles for sale, including a beautiful Warrington Philharmonic. Call for info. We accept Visa and MasterCard. Alan Jesperson, PO Box 17338, Minneapolis, MN 55417. (612) 727-2489, 8 am to 8 pm, 7 days, or fax only (612) 727-1908

FOR SALE: Tuners, receivers; Eico MX99 multiplex - \$100. Knight KN260 - \$100. Fisher 500T - \$125. Heath AJ12 - \$100. Sansui 1000 - \$50. Heath AJ41 - \$100. Dyna FM3 - \$100. Pilot MKII - \$30. Fisher R200 - \$250. Heath AR-15 - \$100. Heath AR 29 - \$100. Scott 433 digital tuner, last U.S.A. made - \$525. Plus shipping. Stan Kotschi, 1421 W. New York Ave., Oshkosh, WI 54901. (414) 426-1912



Vacuum tubes for Audio
are back...
and they sound better
than ever!

Glass Audio

brings together yesterday's tubes
and today's improved components,
making smooth sound possible
from your audio again.

**Ask for your first FREE
issue, without obligation!**

Glass Audio

PO Box 176, Dept. ARC6
Peterborough, NH 03458-0176 USA
FAX (603) 924-9467

FOR SALE: Original Emerson 1937 Mickey Mouse radio chassis - \$150. Emerson Radio Mod 414 Wheat Repwood - \$225. Larry Drago, 383 Lincoln Dr., Cheshire, CT 06410. (203) 272-6030

FOR SALE: Toggle switches at wholesale prices, electronic supermarket, 1001 items, call or write, free list. Fertik's, 5400 Ella St., Philadelphia, PA 19120. Ph./fax: (215) 455-2121

FOR SALE: Amps: Heath W4B - \$400/pr.; Scott 200B - \$50; Fisher KX200 - \$225; Dyna PAS2 - \$100; Dyna PAS3 - \$125; Citation I - \$150; Citation II cage original tube - \$900; Citation II new tubes, polypropylene caps - \$1,000; HK A700 Award - \$75; Heath W5M - \$175-\$225; RCA MI12188a - \$450/3; Pilot 232 amp, SP210 preamp - \$400; Heath AA151 - \$90; Heath AA100 - \$100; Marantz 7T - \$500; Heath SA-3 - \$30; Bell 2315 - \$65; ARC D76 new outputs - \$1,100; VM 1448 amp, 1465-2 preamp - \$100. Plus shipping. Stan Kotschi, 1421 W. New York Ave., Oshkosh, WI 54901. (414) 426-1912

FOR SALE/TRADE: 1938 Patterson PR-16 receiver, all chrome chassis, w/speaker and manual - \$600. National 183 - \$250. National R.A.S.5 w/speaker, power supply, rack full of coils, and manual - \$575. Larry Drago, 383 Lincoln Dr., Cheshire, CT 06410. (203) 272-6030

FOR SALE: Two very good SW radios: Drake 2b with extra crystals - \$135; Hallicrafters S-38 - \$75. Plus shipping. Carl Blomstran, 2107 Heather Green, Houston, TX 77062. (713) 486-5262

FOR SALE/TRADE: The following Radiola speakers Mod 103 w/nice tapestry - \$200; Mod 101 - \$50; 1003 - \$50; Mod UZ-1325 - \$175; 100A - \$75. Also Radiola Mod III 2-tube battery set w/correct UZ-1325 horn speaker - \$350; and Radiola Mod 5 with crystal detector on front panel - \$700. Larry Drago, 383 Lincoln Dr., Cheshire, CT 06410. (203) 272-6030

FOR SALE: Emerson Atlas 888 - \$85. Emerson P-115 - \$30. EICO TR-6 - \$25. NEC NT-68 - \$40. Panasonic RKP-155B - \$12. Sharp FX-16004A - \$40. Sony TFM-3700W - \$25. Sony 6R-11 - \$20. Sony TR-4100 - \$25. Sanyo RP-1250 - \$20. Bulova 290 - \$45. GE P-850C - \$30. Motorola X25J - \$25. Zenith R-13Y - \$20. Zenith RB-21Y - \$25. Panasonic RF-728 - \$30. Tube radios: Arvin 540T - \$70. Monarch, AM, 4 tubes, bat., portable - \$45. GE 212 - \$70. Silvertone 1919 - \$150. **WANTED:** Heathkit portable GR-78 circuit diagram. All items plus UPS. Charles Boller, 3108 N.W. 91st, Seattle, WA 98117. (206) 782-8318

FOR SALE: DeWald A-502, yellow, perfect, all original except for repro knobs (Kris Gimmy) - \$500 or trade. Ritchie Fiegler, PO Box 18247, Fountain Hills, AZ 85268. (602) 837-2918

FOR SALE: Beautiful Grundig console with reel-to-reel & shortwave radio, excellent condition. Call for details. Noel, S&G Electronic, 618 S. 62nd St., Philadelphia, PA 19143. (215) 474-7663

FOR SALE/TRADE: Sunbeam 5-tube battery set - \$200. 7-tube Premier radio made in Defiance, Ohio - \$225. Acme Regenoflex kit 5-tube battery set - \$325. Western Electric Mod 100F loudspeaker amplifier - \$275. Zenith Mod 3000 Trans-Oceanic - \$150. Larry Drago, 383 Lincoln Dr., Cheshire, CT 06410. (203) 272-6030

WANTED: Old guitars & guitar amps, speakers, & effects boxes (reverb, echo, fuzz, wah wah, etc.) Fender, Vox, Gibson, Rickenbacker, Gretsch, Martin, Supro, Univibe, Maestro, Premier. Some old microphones. Altec, Western Electric, Neumann, etc. Happy New Year. Sonny Goldson, 1413 Magnolia Ln., Midwest City, OK 73110. (405) 737-3312. Fax: (405) 737-3355

WANTED: Ugly 50's Philco 49-501, Philco 49-506, Philco 48-230, Motorola 56CD, 57CC, Motorola 56H, Motorola 57R. Bob Masterson, Box 172, Valley Cottage, NY 10989. (914) 353-3151

WANTED: Pre-1920 telegraph keys. Also early or odd-ball bugs. SASE or e-mail for list of duplicates for trade. Neal McEwen, K5RW, 612 Stillmeadow, Richardson, TX 75081. (214) 234-1653. E-mail: nmcewen@metronet.com

WANTED: And I will pay your price for a manual for Heathkit Mod S3 electronic switch. And I done got me an Eico Mod 288. Also, don't know how to use either one, copy? Bill Miller, 3410 Hunnicutt Ln., Sacramento, CA 95821-3520. (916) 489-1703

WANTED: RCA RC-30 tube manual. **FOR SALE:** Radiotron Designer's book, 4th ed. Rick Krzemien, 5398 Concerto Cir., Concord, CA 94521-3250. (510) 687-2719

WANTED: Eveready radios, speakers, old flashlights, flashlight catalogs, related items. Subscribe Flashlight Newsletter - \$12 year. Bill Utley, PO Box 4095, Tustin, CA 92681. (714) 730-1252.

WANTED: Will pay top prices for scarce pre-1926 items. I like horn speakers, crystal sets and detectors, wireless equipment, one-tube sets, regenerative sets, tubes, amplifiers, or what have you? Ed Bell, 5311 Woodsdale Rd., Raleigh, NC 27606. Phone/fax: (919) 851-1517

WANTED: McIntosh and Marantz tube hi-fi equipment, working or not. Call: Richard Sharisky, PO Box 521, Belmont, MA 02178. (617) 484-5784. Fax: (617) 489-6592



WANTED: Air King Skyscraper radios, except for that unbearably ugly model with the third (tuning) eye at the top that bears better resemblance to a flourer than to the face of a building. Please write or call collect: Rain Buttignol, 214 State St, #7, Portsmouth, NH 03801. (603) 427-1384

WANTED: Garod peak-top chassis and yellow knobs. Buying any Catalin parts or damaged sets. Ray Carroll, 158 Oakwood Dr., Wayne, NJ 07470. (201) 696-1149

WANTED: Unbuilt Heath and Knight kits. Also, Mohican, any condition. Gene Peroni, Box 58003, Philadelphia, PA 19102

WANTED: Signs, clocks, thermometers, banners, displays by RCA, others. Collins, Dumont, etc. Drugstore tube tester, the quackier the better. Pair nice cabinets for 15" speakers. Collins 26U tube limiter. Always looking for tube amps, EQs compressors by Mac, Marantz, Altec, WE. Vintage mics by RCA, Sony, Altec, WE, Neumann. LSASE for new 1-96 list. Ward Kremer, 301 S.W. 16 St., Ft. Lauderdale, FL 33315. (305) 524-5652, ph/fax

WANTED: Speaker for Cobra 2000. Also small RF gain knob for same. Dan Schlie, 60 Maple Ave., Port Byron, NY 13140. (315) 776-4596



WANTED: Cabinet for Fada 290, pictured, console or tombstone, any condition. Winston Burt, 185 N. Poland Rd., Conway, MA 01341. (413) 369-4469

WANTED: Cabinet and escutcheon for Philco 45 butterfly grille table radio, any condition OK. James S. Fisher, 344 Harrison Ave., Manville, NJ 08835. (908) 725-7476

WANTED: Base for Utah Superflex speaker. See Dave Crocker article, July 1995 A.R.C. Buford Chidester, 785 Locust St., Mount Wolf, PA 17347. (717) 266-4450

WANTED: Operating manual and schematic for Triplett 3434 sweep generator. Thanks. Bill Kowaleski, 459 Burncoat St., Worcester, MA 01606. (508) 856-9893

WANTED: Help, help, help. Need Philco coils #32-2627 and #32-2628 for shortwave bands on Philco 38-116 code 125 or Philco 38-690. Will buy parts or complete chassis. Thanks. Kip Wallace, 1001 Horn Dr., Minnetonka, MN 55305. (612) 544-2547, home; (612) 631-8151, fax work

WANTED: Good speaker for Philco 70. 8.5/8" diameter. Thanks. Don Hughes, 219 21st St., Huntington Beach, CA 92648. (714) 969-4542

WANTED: Speaker for Philco, chassis for Gloritone Model 26P, operating manual for Heathkit transistor checker IT-18. **FOR SALE:** GE tube checker TC-3A, books good - \$40 plus UPS. Ross Ellis, 206 Gregg Dr., Battle Creek, MI 49017. (616) 962-1514

WANTED: Manual for Philips PM 3262 oscilloscope or any 3200 Series model. Geoff Fors, WB6NVH, Box 342, Monterey, CA 93942. (408) 373-7636. Fax: (408) 373-2345

WANTED: Bearcat 300 scanner working or not, any condition. Also Panasonic PV1730 VCR. Ted Demsk, 5806 225 Pl. SW, Mountlake Terrace, WA 98043. Phone/fax: (206) 778-7100

WANTED: Early televisions, television kits, literature, etc. Will buy or trade radios and related. David Petrozelio, 80 Lincoln Ave., Johnson City, NY 13790. (607) 770-4026

FOR SALE: Philips 940A 2-tube mini dome-top Bakelite, early 1930s, works fine - \$450. Late 1920's Regentone 2-tube small Bakelite radio, working, speaker separate, rare - \$475. Sparta crystal set, brown Bakelite, nice - \$450. Rare WE ebonite horn, excellent - \$650. Philco 444 peoples radio, 4 tubes, 1936 black Bakelite cathedral, original condition, works well - \$950. Ekco AD36 round Bakelite, 4-tube, 1936, excellent, original - \$950. All plus UPS. Jim Taylor, G4ERU, No. 5 Luther Rd., Winton, Bournemouth, England BH9 1LH. Phone/fax: U.K 01202-510400

FOR SALE: Crosley collectors attention: Crosley 50 - \$125; Crosley VI - \$180; Ace V - \$150; XJ - \$175; Ace 3B - \$185; 52 - \$120; 51P - \$175; Triryn Regular - \$90. Radiola III - \$110; Radiola balanced amp - \$150; Aeriola Sr. - \$150. M.W. tombstone 62-164, mid 30's, nice set, works - \$85; (2) WD11's, good filaments - \$40 ea.; (4) UX99's, test weak, work good - \$12.50 ea.; (1) BBT UV200, weak, works good - \$30; WE 10D speaker - \$145. Trimm rex horn speaker - \$110. Bob Barnes, 511 N. Chestnut, Monroe City, MO 63456. (314) 735-2945

FOR SALE: Blue glass Arcturus Wunderlich tube with maroon base, fil good - \$50 OBO. Allan Haasken, 8422 Berea Dr., Vienna, VA 22180. (703) 560-4869

FOR SALE: RCA Berkshire tuner - \$500. Lots of tube ham gear, write for list. V. Vogt, 2311 Pimmit Dr., #114E, Falls Church, VA 22043

FOR SALE: Regency TR-1, red, fine crack, W/C - Make Offer. Sony TR-730. Jim Martes, 15400 E. 2nd St., Independence, MO 64050-2295. (816) 836-0668

The Olde Tyme Radio Services Directory is now available. Find the services and parts needed to restore that old radio or t.v., also included are clubs and publications all categorized and sorted by state for easy look-up. Over 225 suppliers listed, and always adding more each year. Send \$4.00 ppd. Andrew Mooradian, 5 Priscilla Lane, Winchester, MA 01890

WANTED: Tubes: 300A/B, 274A/B, 262A/B, 275A, 252A, 101D, 104D/F, 211A/D/E, 271A, VT2, 205D/E/F, VT52, 272A, 244A, 284D, 348A, 349A, 293A, 290A, 285A, 301A, 216A, 345A, 351A, 339A, 306A, 422A, 303A, 292A, 347A, 398A, 440A, 442A, 310A (S. H.M. H). Other: 50/250/350/450, 183/483, 45A, 845/W, VT52, VT62, 5C24, AB150, HF120, HF140, 211B/D, C182, C183, 2A3H, 1276, 2A3 (M.P). European tubes, old power tube only. Transformers: WE, Peerless, Langevin, UTC, Triad, other. Parts: Capacitor, resistors, cloth-covered wire, other. Jazz LPs: 1950's, 1960's. Speakers unit: 8"-15", old only. Kouji Matsuo, 6-2, Tsurumi-Cho, Beppu-Shi, Oita 874, Japan. Tel/fax: 81-977-23-9579

WANTED: Collins Radio Company Catalogs, promotional literature, manuals 1933-1983. Jim Stitzinger, 23800 Via Irana, Valencia, CA 91355. 1-805-259-2011

KEYSTONE BIBLIOPOLIST - "Re-cyclers of technical literature since 1981" Radio and Electronics Books/Manuals...Large inventory, thousands of individual titles covering Equipment and General-Subjects: Amateur/Commercial/Military for a list of catalogs; send large SASE to: P.O. Box 34427 Omaha, NE. 68134

FOR SALE: RCA Review, by RCA Institutes Technical Press, Quarterly Journal of Radio Progress, nine editions, over 1,000 pages, beginning with July 1936, Volume 1, Number 1, through July 1938, including articles on early television, nice condition - \$90 for all. Ellsworth O. Johnson, 364 S. Coeur d'Alene St., Spokane, WA 99204. (915) 655-6123

FOR SALE: Philco PT-41 - \$45. Crosley 129 - \$250. Philco 37-61 - \$130. Astatic microphone Model DN-HZ with F stand - \$50. Abbotwares horse radio - \$300. Blue Neutrowound Model 1928 - \$500. Transmitting tubes; Admiral 5F11-N - \$35. Packard Bell 501 - \$45. Westinghouse H-574T4 - \$25. GE JB-420 - \$45. Philco 60B - \$130. Motorola 58R11 - \$35. Will dicker on most all. Steve Russell, 121 Horseshoe Dr., Kaispell, MT 59901. (406) 755-3321

FOR SALE: Admiral 10" Bakelite console TV, electronically and cosmetically restored, excellent picture - \$400. Al Anderson, 510 Park Ave., Mechanicville, NY 12118. (518) 664-6846

FOR SALE: Radio Shack complete home security system with accessories, N.I.B., cost \$240, sell - \$120. Clyde Powell, 3822 Edwards Ter., Chattanooga, TN 37412. (423) 867-5022

FOR SALE: Audio: pair of Macintosh MC-60. Pair of Ampex stereo reel-to-reel. Fisher amp and Spacexpander. Garrard stereo turntable. Fisher HK-10 Spacexpander and amp. Pair Collins hi-fi floor speakers. Bill Coolahan, 1450 Miami Dr., NE, Cedar Rapids, IA 52402-2933. (319) 393-8075

FOR SALE: Rider Radio Vols. 1-5 Abridg., 6, 7, 8, 9, 10, 12, 13, 14 & most TV vols. - Offer. Robert Haan, 2885 E. Beltline, Grand Rapids, MI 49505

FOR SALE: Radio Operators License Q&A Manual - \$10. Radio Manual by Sterling - \$12 plus UPS. Ed Povraznik, 9606 Biddulph Rd., Brooklyn, OH 44144-3015. (216) 661-0032

FOR SALE: SASE for list of about (30) reasonably priced table radios, no pricey exotics. A.T. Shost, 1307 Maple Ln., Sedalia, MO 65301. (816) 827-2655

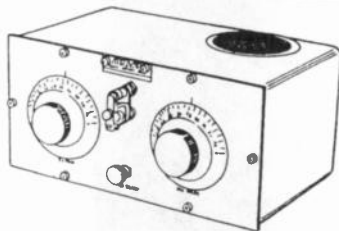

WANTED: Pre-1926 radios by AMRAD. Also, Amrad radio parts, accessories, and literature. Richard Sharisky, PO Box 521, Belmont, MA 02178. (617) 484-5784

WANTED: Radio Callbooks 1900 thru 1927. Bob Arrowsmith, W4JNN, PO Box 166, Annandale, VA 22003. Collect (703) 560-7161

WANTED: Fairbanks Morse console Model 9C or 12B preferred. Charles E. Patterson, 2621 Sweetwater Rd. SP#33, National City, CA 91950. (619) 475-7141

WANTED: Metal back for 10" Admiral console television. Stamped with No. 16D14. Steve Cavell, 30144 Torry Ave., Flat Rock, MI 48134. (313) 379-3254

WANTED: Need a knob and a dial pointer, and a dial cord tension spring for a Crosley, Model No. 11-101U, please. Thank you. Joe DeBari, 194 Ramah Church Rd., Barnesville, GA 30204. (770) 358-0798

WANTED: Collecting vintage audio & trading fairly since 1972. I'll significantly better offers on important wants. Paying up to: \$2,400 - Marantz 7; \$1,500 - 8B; \$3K - consolettes; \$3,500 - twos; \$3K - McIntosh MI200AB; \$1,300 - Fisher SA1000; \$800 - FMR-1; \$1,200 - F. Lincoln; \$1,100 - Scott 4310; \$1K - 4100, 4120; \$1K - Regency HF 1000; \$6K - Patrian; \$2K - Jensen Imperial; \$2K - Hadley amp; \$6K - WE 1086; \$1,800 - S. Carlson 475RF system; \$350 - Technics stylus gauge; \$1K - R.E.L.; \$800 - Altec 1570A; \$1,600 - Laguna Capistrano; \$700 - Ionovac; \$500 - K. Monks; \$60 - 2A3; \$45 - EL37; \$60 - EL34 metal b. Also: Tung-Sol 6550, WE 300, KT66, 77, 88, 6LF6, 7591, 811, 8005, 8045, 845, black caps, seleniums, U.T.C., Acro. Partridge xmrs, Shure cartridge analyzer, tube x'overs, A.R. LST, LST2, J.B. Lansing, Lowther, Klangfilm Eurodyn Klipschorn, Tannoy, Trichannel, Vitavox. Beverage, Brociner, Brook, Cotter L, EICO, Fairchild, Futterman, Gray, Grommes, Heath, Garrard 301, KLH 8, Karg XT3, Pilot, Puresonic, Quad II, ESL, RCA, Radiocrafts, Sony SME 3012, Leak, Sequerra FMI, Sinclair TV, Sony portable. E.L. cassette, Rogers professional, WE eqpt., Win cartridge. I'll respond on specific items of interest. Ed Schneck, 1401 Ocean Ave., Brooklyn, NY 11230. (718) 377-7282, M-F, 3-6 pm

WANTED: RCA 240 chassis/speaker. Tubes wanted: 58, 47, 6A3. Thanks. Paul A. Froehlich, 4152 Hwy. J, Cross Plains, WI 53528. (608) 798-4905. E-mail: pafroehlich@hosp.wisc.edu

WANTED: One set of knobs for Silvertone Model 6439A, 6438, 6446, 6497 or 6346, Eico Model 2536 FM stereo schematic and source for Motorola transistor 126-00073 or equivalent for use in phase linear Model 400 audio amp. Thanks. Henry Tessier, 945 Commercial St., E. Weymouth, MA 02189. (617) 337-7279

SOLID-STATE VIBRATORS for automobile radios 1932-58. Exact duplicates of originals in metal cans. Synchronous, Non-sync, European. Dealer inquiry invited. Free catalog. Visa, MasterCard, Discover. Antique Automobile Radio Inc., 700 Tampa Road, Palm Harbor, FL 34683. (800) WE FIX AM 933-4926, or Fax (813) 789-0283

RADIO SCHEMATICS PLUS DATA STILL \$3.00 EACH. TV \$4.00, POSTPAID USA. STAMP FOR TUBE AND TEST EQUIPMENT LIST. JOSEPH R. FORTH, 321 LONG VUE ACRES, WHEELING, WV. 26003. (304) 277-3154

PHONO NEEDLES & CARTRIDGES: (Ceramic & magnetic) What do you need? Send SASE. J.J. Papovich, 53 Magnolia Ave., Pitman, NJ 08093. (609) 582-8279

ANTIQUA RADIO RESTORATION Satisfaction - Guaranteed. Ray Sanders, 342 South Third, Cottage Grove, OR 97424. 541-942-0866

WANTED: Sony 630 tape recorder, deck or model that has speakers. Call or write to: Ray Rice, 525 E. 4th St., Newport, KY 41071. (606) 581-7074. E-mail: careercom@aol.com

WANTED: Classic plastic radios (Sideli book) or other Catalin books. C. Moriarty, 4928 N. 105 St., Omaha, NE 68134. (402) 493-1474. (402) 636-3055. E-mail: cmoriarty@oppd.gov

WANTED: Band selection shaft (pot metal) for Zenith 12H689 chassis. A.J. Long, 11830 Heath Rd., Chesterland, OH 44026. (216) 729-8451

WANTED: Hallicrafters R-50 speaker in good condition. Bill Walls, 605 Ashland Dr., Mebane, NC 27302. (919) 563-5543

WANTED: Speakers for AK 410; Zenith 7S260 or 7S261. Chassis and speaker for AK 317 console. Jack Mattox, 1443 Platte Ave., Alliance, NE 69301. (308) 762-8831

WANTED: Stellar baseball radio, baseball trophy radio or any sports radio. Alex Kertesz, 605 Pelican Way, Delray Beach, FL 33483. (407) 276-5021

WANTED: Emerson chest L-AC-5; Radiola 64 chassis, speaker, switch panel for 9-54, Electrola 2nd generation. Sid Greenspan, 1808, 500 S. Ocean Blvd., Boca Raton, FL 33432. (407) 368-2019

WANTED: Philco Model 49-501, in good or excellent condition, need not be working. Will pick up 150-mile range. Rod Kennedy, 2 Teodora Ct., Moraga, CA 94556. (510) 376-7885

WANTED: Does anyone sell replacement labels for large AC Pepsi bottle radio? Call me collect or write. Sharon Fullerton, 2327 E. Livingston Ave., Columbus, OH 43209. (614) 237-2621

WANTED: Knight-kit C100 walkie-talkies. Knight Safari 1 CB transceiver. **FOR SALE:** Sony stuff - SASE for list. David Koesche, 61 S. Barrington Rd., South Barrington, IL 60010. (708) 382-7997

Victrola Repair Service: Windup phonograph repairs, parts, springs, needles via U.P.S. Rod Lauman, 19 Cliff St., St. Johnsbury, VT 05819. (800) 239-4188, eves.

WANTED, ANY CONDITION: RBY, Hallicrafters S-35, PR-1, Collins 478R-1, Squires-Sanders SS-1V panadaptors; also schematics, manuals, ads, articles, technical data on them. John A. Benyo, 25 Schley Street, Garfield, NJ 07026

MESSAGE: The Michigan Antique Radio Club announces that **EXTRAVAGANZA '96** will be held July 12-14, 1996, in Lansing, Michigan. Please **MARC** your calendars now! To be put on the **EXTRAVAGANZA '96** mailing list, send postcard to: **EXTRAVAGANZA '96, PO Box 585, Okemos, MI 48805-0585**

SPEAKER PARTS: Adhesives, Cone, Dust Caps, Gaskets, Voice Coils (Round and Edgewound) Spiders and Terminals. Refoam Kits - \$14-\$18 for speakers. Cat. avail. \$10.00 (Refund.) 800 order line Visa/MC/Am.Ex. Speaker Parts Co., PO Box 14731, Fremont, CA 94539. 510-490-5842/510-490-1961 FAX

FOR SALE: Collins S Line: 32 S-2, 75S-2, 312B-5VFO, 516F2, KWM-2A, PM-2, SM-3, CP-1, 136B-2, 351D-2 new CC-2, all excellent. Call: Edward H. Freeman, 631 Orchard Dr., Redlands, CA 92374. (909) 792-6779

FOR SALE: Over (75) novelty radios. Send LSASE for list featuring many desirable models. Nick Carrieri, 77 Haven Ave., Ronkonkoma, NY 11779

FOR SALE: Scott LK-110 lab FM tuner, LT-72 lab amp - \$100/pair plus shipping. Michael Franzen, 405 East Sinto, Spokane, WA 99202. (509) 325-7354

FOR SALE: Crystal set information for experimenters, restorers, and collectors. A SASE brings you a summary sheet covering four Crys Tech reports now available, plus No. 5 soon to be released, with historical background, restoration and reproduction of early day components, analysis, design, and even practical construction data meeting crystal set requirements. Write to: Crys Tech, c/o P.A. Kinzie, PO Box 6805, Kingman, AZ 86402

FOR SALE: RCA 5T, manual - \$50 plus UPS. Upright 3-spidercoil one-tube - \$100. Details, SASE. Radiola III/III-A tech-list free for LSASE. David P. Smith, PO Box 81, Olney, IL 62450

FOR SALE: Zenith Trans-Oceanics, all are original complete, cosmetically restored and work: 7G605 bomber grille - \$295; 7G605 sailboat grille - \$350; 8G005Y - \$175; G-500, made only one year - \$185; H-500 - \$175; Y600 - \$175; L600 - \$175; B600 - \$175; T600L tan leather - \$275. Zenith full-color repro ads, circa 1940's - \$7 ea. Atwater Kent #55 - \$175. Fada 1000 bullet repro M.I.B. - \$75. Philco R/P #46-1230 - \$95. Frank J. Manzano, 82 Monhegon Ave., Oakland, NJ 07436. (201) 337-5263

FOR SALE: Capacitors, limited quantity: Sprague 2x10 mFd. @450 VDC, 1 3/8" dia. x 3" high can. 0.87" threaded mount, N.O.S., lug terminals com-gnd, ins. from Can. - \$3.50 ea., \$30/10. Shipping extra. Antique Radio Restorations, 109 S. Oak St., O'Fallon, IL 62269. (618) 632-7423

WANTED/FOR TRADE: Will trade namebrand high quality radios for old fountain pens by Parker, Sheaffer, Waterman, Mont Blanc, Conklin, etc., or pay cash for the pens. Contact: Frank Weissman, 4 Shadbush Ln., Westport, CT 06880. (203) 454-1267, after 9 pm EST

VINTAGE MANUALS AVAILABLE for amateur, audio, and radio-related equipment. Quality is always our number one customer priority. Satisfaction guaranteed. Send two 32¢ stamps for catalog. Pete Markavage, THE MANUAL MAN, 27 Walling St., Sayreville, NJ 08872-1818. (908) 238-8964

FOR SALE: JIM CLARK'S E.H. SCOTT RADIO COLLECTORS GUIDE (1925-1946), 88 pages with over 190 pictures that identify their radios, cabinets and accessories including their original prices. Send \$29.95 plus \$2.00 handling to: JCE, 1292 Starboard, Okemos, MI 48864 or VISA/MAS-TERCARD orders call (517) 349-2249

WANTED: 1930 to 1942 Police Radio communication equipment. Any 6 VDC mobile communication equipment. Raymond Miller, 953 N. 1st St., Albemarle, NC 28001. (704) 982-0228

FOR SALE: 1941 Hardware Catalog, has section on Fada radios, over (20) pictures including the bullet Model 115 for \$19.95. Photocopies of 7 pages - \$5. The Little General ad from The Saturday Evening Post - \$8. Books: The Radio Instructor, 1924, hardcover book on theory, design, operation, & maintenance of radio - \$12.50. (2) books by John F. Rider: Automatic Frequency Control Systems, 1937 - \$9; and Vacuum Tube Voltmeters, 1941 - \$9. Pamphlets: 4-page RCA on Amplifier & Pre-Amplifier - \$6; 20-page RCA 5-D Transmitter - \$10; 16-page Advance Relays - \$7; 30-page Simpson Operator's Manual for Model 260 Volt-ohmmeter - \$7; Sylvania 1958 Cathode Ray and TV Picture Tube, 30 pages - \$8; Montgomery Ward, 32-page Air Line Electronic Equipment Catalog - \$8; 1951 IRC Resist-o-Guide pocket cards - \$5; WWII Transmitting Tube Eimac 450TL - \$50. Metal Philco small service box full of tubes - \$35. 10"x21" Majestic Radio showroom poster - \$65. Triplett volt-ohmmeter in wood case with instructions Model 625NA - \$35. Don Wagon, 1221 Camino Real, Fairview, TX 75069. (214) 562-0621

FOR SALE/TRADE: RCA 77-D microphone, good condition - \$950 or cash/trade for Zenith Waltons. Tony Rizzini, 6 Chiswick Rd., Greenville, RI 02828. (401) 949-3741

FOR SALE: Admiral 5X12N - \$25. Admiral 4202B6, ivory - \$40. Crosley 58TL, ivory - \$50. Philco 46-250 - \$50. RCA's 8X542, ivory - \$45; 8X541 - \$45; 7-BX-8J Globetrotter - \$30; 56X3 - \$45. Silvertone 6424 - \$65. Sonora RBU-176 - \$50. Zeniths: 7H820 - \$45; K-622 - \$20; 5D610 - \$35. Westinghouse H420TS - \$20. Prices negotiable. Peter J. Meskunas, 10 Skyline Dr., Waterbury, CT 06706

FOR SALE: Philco 49-1240 TV, good condition - \$50/Offers? Colin Spence, 1603 Benedict Pl., Baldwin, NY 11510. (516) 623-1452

FOR SALE: Rider's 1-5 abridged and 6-13 - \$150 for set plus shipping. Other single volumes for sale as available - \$15 to \$50 ea. Also have Sams AR, MHF, TSM and folders. Ray Schmidt, 607 1 Ave. SW, Austin, MN 55912. (507) 433-0069. (507) 433-3250

WANTED: Broadcast-type MICROPHONES. Early carbon, condenser, ribbon, dynamic, etc. Cash or trade. James Steele, PO Box 620, Kingsland, GA 31548-0620. (912) 729-2242

WANTED: Parts for a 1961 Columbia Masterworks, Model 1066. The parts needed: pot transformer number #507-1 and a push-button slide type made by Oak Inc. switch number #69589-130. Call or write. Kurt A. Wieseman, 25735 Lorain Rd., #117, North Omsted, OH 44070. (216) 777-6038, call after 7:30 pm

WANTED: BRUNSWICK UPRIGHT PHONOGRAPH w/curved sides in oak or walnut, v. good or better cond. I'll pay your price for the right one! Call or write: Bo Brock, 4858 Willow Ln., Orchard Lake, MI 48324. (810) 681-7133, evs.

WANTED: KLH-8, KLH-13, related accessories and any KLH-8 manuals or literature. Also any Tandberg radios. Gary Klawans, 825 Thordale Ct., Lake Zurich, IL 60047. (708) 654-9100, ext. 2940, 9 am-4 pm weekdays, or (708) 438-7339, after 7 pm, or e-mail: binkyboo@aol.com

WANTED: Bakelite radios normally worth \$200+, but damaged. Include price! Ed Schneck, 1401 Ocean Ave., Brooklyn, NY 11230

WANTED: Six good 01-A tubes. Also looking for National R-39 coil forms, (almost) any condition. Paul Eisenbarth, 1365 McDonald Dr., Reno, NV 89503

WANTED: Santa damaged the goods coming down my chimney. Wanted: Top for Prestone battery radio. Chassis and knobs for Pilot Lone Ranger and chassis for General Television piano radio. Alan Piorek, 1050 N. Paulina St., Chicago, IL 60622. (312) 235-1523

WANTED: Catalin radios, cabinets, knobs, parts; large Addison Model 5 yellow knobs, Fada 652 yellow or red knobs, DeWald knobs, others; call me before you run your ad; items made of Catalin; DeForest D-10 coils; Burns black horn bell, can be broken; Music Master wood ball; UZ1325 base; miscellaneous horn speakers and parts; early battery and xtal sets. Call before 2 pm EST or call later and leave message. John Pisarki, 114 Evans Rd., Norristown, PA 19403. (610) 539-0756

WANTED: Chassis for the following sets: Stewart-Warner Companion, Motorola 52, Kadette 5 knob cathedral, Angeles cathedral. Cases for: AK 36, Philco 20, 70, Aeriola Senior. Richard B. Jehlik, 14441 North River Rd., Omaha, NE 68112. (402) 457-4604, after 7 pm CST

WANTED: Speaker for Majestic Model 20. Jerry Gilchrist, 2145 Sugar Valley Rd., Ohatchee, AL 36271. (205) 892-0703

WANTED: Philco 49-501, 49-503, 49-506, 50-526, 51-930, 52-548, 51-532, 53-566, TP-7, T-1000. KLH 8 and accessories. AR-1 speakers. Mint Philco Predictas, plus instructions, service information, sales literature. Marantz, Acrosound, Fairchild, Fisher, Hadley, Karg, REL, etc., tube hi-fi equipment, accessories, sales literature. 1950's-1960's hi-fi books, plus Allied, Lafayette, Heathkit, etc., catalogs. Promotional items, such as signs, banners, clocks, tube caddies, etc., by hi-fi manufacturers and tube companies. Paul Creasy, 6216 Worlington Rd., Bloomfield Township, MI 48301. (810) 737-0429. E-mail: 74664.1153@compuserve.com

WANTED: AK 80 cabinet, Tuska 225 transformers, tube cover Radiola 26. Bob Nicholson, 3423 S. Long, Topeka, KS 66605-2486. (913) 266-9473

ELECTRON TUBES: Over 1 Million Tubes in Stock. Buy & Sell. Daily Electronics, 10914 NE 39th St. #B-6, Vancouver, WA 98682. 800-346-6667. 360-896-8856. 360-896-5476, fax

WANTED: Hallicrafters Models S-2, S-33, S-35, SX-112, EP-132, HT-2, HT-3, HT-8, HT-12, HT-14, console speaker R-8, RCA Model AVR-1, AR-88, Philco 38-690, Midwest 20-38 chassis & speaker. Chuck Dachis, The Hallicrafter Collector, 4500 Russell Dr., Austin, TX 78745. (512) 443-5027

CAPACITOR REBUILDING - We rebuild any can type capacitor. Typical turn-around time now 2-4 weeks maximum. Twist-Locs, old wet type & tubulars rebuilt. Call for prices. FRONTIER CAPACITOR, Box 218, Lehr, N.D. 58460. Phone or fax: 701-378-2341. Via UPS, to 403 S. McIntosh St. Everett Hoard - owner

WANTED: Chassis for Philco 39-17T, Aircastle 106B, Airline 62-455, Truetone D-2610, Silvertone 7020. Mike Anderson, 1371-B Baker Dr., SE, Albuquerque, NM 87116. (505) 254-9957

WANTED: Philco mystery control box for 39-116. Ken Gorman, 493 Hillcrest Cir., Warminster, PA 18974-5452. (215) 675-7032. E-mail: kgorman@thunder.ocis.temple.edu

WANTED: Majestic Melody Cruiser chassis using octal tubes, also knobs for same. Roland Emerick, 7257 Jones Rd., Baldwinsville, NY 13027. (315) 635-3864

WANTED: Any brass- or nickel-based tipped tubes at reasonable prices. Gary Formica, 8233 91st St., Niagara Falls, NY 14304. (716) 283-2274. E-mail: radio.ns.moran.com

WANTED: Philco speaker Model 211 for Philco 511 radio. Ken Voyles, 7425 Brushmore NW, N. Canton, OH 44720. (216) 494-5648

WANTED: Minerva W-117, Belmont Boulevard 5P113. Ichiro Yamada, 10-21 Chiyodadai-cho, Kawachi Nagano-shi, Osaka, Japan 586. Phone/fax: 011-81-721-52-4695

WANTED: 3/8" diameter volume control knob and dial pointer for green Zenith Model #H615-Z. Marv Glassman, 19300 Romar St., Northridge, CA 91324. (818) 993-4560

BOXED CLASSIFIED ADS WORK! This is a boxed classified ad. These ads can be run more than two months. See the inside back cover for details. Boxed ad deadline: the 1st of the month.



WANTED: Tube Hi-Fi components & commercial amplifiers by Marantz, McIntosh, Tannoy, Acrosound, Brook, Brociner, Fairchild, Hadley and others. Also want Western Electric theater amplifiers, speakers, tubes, & microphones. Richard Sharisky, PO Box 521, Belmont, MA 02178. Phone (617) 484-5784. Fax (617) 489-6592

WANTED: Vintage Electronic Music Synthesizers and modules by the following manufacturers, especially the listed models. Aires Modular, System III. ARP 2500. Buchla Modular, 100, 400. E-mu Modular. EML Electrocomp 100, 101, 200. EMS Synthi A, Synthi AKS, VCS3. Korg Modular PS-3100, PS-3200, PS-3300. Moog Theramin, Modular, Series 15, 35, 55. Oberheim SEM modules, 2-, 4- & 8-Voice Systems. Paia Modular 2700, 4700. Roland Modular Systems 100, 700. Serge Modulares, System 79. Synton Modular System. Call and surprise me; make my day! John V. Terrey, 498 Cross St., Carlisle, MA 01741. (508) 369-9770. Fax: (508) 371-7129.

FOR SALE: Fada Bullet Model 115, 1941, perfect shape - \$1,000 plus shipping. Robert J. Stone, 721 Fisk St., Piqua, OH 45356-3729. (513) 773-2217

FOR SALE: RCA T5 tombstone, vg, working - \$175. Califone Model #1925 phono/PA 4-speed 12" speaker, late model, mint condition - \$150. Atwater Kent 165 cathedral - \$295. Industrial Panasonic VHS vcr's NV8310, NV 1310, working - \$125 ea. Heathkit AA-21D stereo amp, working - \$100. Misc. Delco GM factory AM/FM auto radios from the 1960's - Call. Add shipping, SASE. Ted Demski, 5806-225 Pl. S.W., Mountlake Terrace, WA 98043. Phone/fax: (206) 778-7100

FOR SALE: Siemens High Performance HF receiver, 1960's. German WWII: Torn Eb HF receiver. **WANTED:** German FuHe-receivers. Rag Otterstad, Hosterkobvej 10, DK-3460 Birkerød, Denmark 011-45-4281 5205. E-mail: danmec@inet.uni-c.dk

FOR SALE: N.O.S. 4CX250B - \$45; 841 - \$15; 6BN8 - \$4.50. **WANTED:** PP-1175 (for Lafayette). Joseph Pinner, KC51JD, 201 Ruthwood Dr., Lafayette, LA 70503. (318) 981-7766. E-mail: kc51jd@aol.com

FOR SALE: Electro-Voice SP12B speaker - \$30. Assorted Nortronics tape heads, CQ 1958-69 - \$10/year. Bob G. Mahrenholz, K4QQK, 307 Old Fort St., Tullahoma, TN 37388. (615) 455-5217

FOR SALE: Projection bulbs, N.O.S. - from \$7 to \$13. Call for availability. Bob Putnak, 1507 4th St., Monongahela, PA 15063. (412) 258-6236

FOR SALE: Eico 667 tube tester - \$100. **HELP:** Need copy schematic Magnavox AM/FM radio 1E9252. Rich Yoch, 22410 Bartlett Dr., Rocky River, OH 44116. (216) 331-9206

FOR SALE: Atwater Kent, wood console Model 328, cabinet needs minor work, must pickup LA - \$225. Bob Zuch, PO Box 4242, Chatsworth, CA 91313. (818) 719-2608, day; (818) 700-9509, evening

A.R.C. BACK ISSUES

April '87 to current issue: Originals available
32 to 100 pages each.

Oct. '86 to Mar. '87: Reprints available
*Reprinted from original artwork; 28 to 32 pgs. ea.
Quality & appearance same as an original copy.*

June '84 to Sept. '86: Photocopies available
Not original quality, useful for info.; 16 to 28 pages each.

Publication of *Antique Radio Classified* began in 1984 which had only five issues: June, Sept., Oct., Nov. & Dec. 1984. 1985 through current year have had 12 issues each.

**\$4.00 each - Postpaid to
U.S., Canada and Mexico.**

Orders of 6 issues or more may take a 10% discount. Orders for a full calendar year may take a 50% discount. Foreign orders other than Canada and Mexico: \$6.00 each by air. Mass. residents, please add 5% sales tax.

A.R.C. UNCUT, UNFOLDED COVERS

June 1991 to the present
9.25" x 12.5" - \$9.95 each

Postpaid to U.S., Canada, & Mexico

Mass. residents, please add 5% sales tax.

Send Order To:

A.R.C., P.O. Box 2, Carlisle MA 01741

Or Call (508) 371-0512

ARCA



FOR SALE: Hard-to-find specifications booklets on tubes, radio, TV, CRT, audio, transmitting types, RCA, Mullard, Amperex, Sylvania circa 1950's printing, (11) assorted - \$60 plus \$7 postage. Maurer TV, 29 S. 4th St., Lebanon, PA 17042. (717) 272-2481

FOR SALE: Zenith Trans-Oceanics (2) Taiwan R7000's, 1 plays good with average cosmetics - \$200. The other has great cosmetics but doesn't work well - \$275. Gary Mac Norius, 14770 N.W. Gardens Dr., Miami, FL 33168-4925. (305) 681-6589

**HAVE YOU MOVED? ARE YOU MOVING?
PLEASE NOTIFY US A.S.A.P.
SEND US YOUR...
OLD ADDRESS
NEW ADDRESS and
SUB #
MANY THANKS!!!!**

FOR SALE: Literature: Radio Designs magazines - \$8; RMA "Better Radio Reception" (printed by Atwater Kent) - \$5; Philco Parts & Service Instrument Catalogs 1934-1948 - \$5 ea.; RCA Technical Lessons - \$2 ea.; Beitman/Supreme Master index for TV & Radio up to 1965 - \$15; Zenith 7G605 Trans-Oceanic Service Data - \$4 ppd; Hi-Fi/Stereo Review magazines, 60's - \$2.50 ea.; Sony Tape Recorder & Microphone Catalog, 60's - \$5; Hickok Obsolete Tube Test Data for Testers II 533A, 600A, 605A, 800, 800A, 800K, 1946-50 RCA Service Directory for TV & schematics - \$10; TSM Sams 26-127 - \$6 ea.; Operators Manuals - all \$4 ppd; Simpson 262, Philco 7001, Sencore LC3, B&K 650 tube tester, Supreme 546 scope, Eico 1060, Realistic SW-60, Sencor TC136, Sylvania 139. Tube tester, B&K 500 tube tester, Fisher 201, Norelco 401 tape deck, RCA 40-56A scope, Eicor 15, RCA Voltohmyst (WV-98A), RCA Voltohmyst (WV-87A), AMID-80 jukebox. **WANTED:** Pilot radios, any model, any condition. Bill Moore, 3049 Box Canyon Rd., Huntsville, AL 35803. (205) 880-1207

WANTED

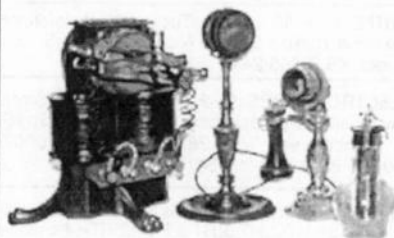

**Batteries, Broadcasting
Microphones, Telephones,
Bi-Polar Motors, Related
Parts, Catalogs, and Early
or Unusual Fans.**

**Alan Willms
1823 El Camino Real
Redwood City, CA 94061
(415) 571-9070**

WANTED: Please help! Radio Boys; Breckenridge, Lost Atlantis; Chapman, Iceberg Patrol, To The Rescue. Jerry Katz, 290 Marlborough St., Boston, MA 02116. (617) 262-2171

WANTED: Ozarka radios, literate, manuals. Also grille for Ozarka J-1 Junior or good photocopy. Don Patterson, 636 Cambridge Rd., Augusta, GA 30909. (706) 738-7227

WANTED: Colorful Japanese pocket radios. Tube-type or transistor. Will trade older wooden and plastic American radios, American transistors, or novelty radios. Send description, Xerox, and tell me what you like. Will pay cash if you're not interested in a trade. Bruce Phillips, 127 Bunker Hill, Stratham, NH 03885. (603) 772-3796, after 5 pm

WANTED: Book: Radio & Television Receiver Troubleshooting and Repair, by Ghirardi & Johnson. Top dollar. Paul Kawerau, 35 Cloke Ct., Hamilton, Ontario, Canada L8T 1N4. (905) 389-2781, evenings. Or fax: (905) 389-0340, anytime

WANTED: Phillips Norelco car record player, car TV ant. RCA BK4 mike. Jay Howard, 4210 Tangle Dr., Charlotte, NC 28211. (704) 365-2830. E-mail: jaycoll123@aol.com

WANTED: Paragon Amplifying Transformer Model 80, open-frame audio. Will pay your price! Thanks! Rick Ammon, 1249 Solstice Ln., Fort Collins, CO 80525-1239. (970) 221-4001

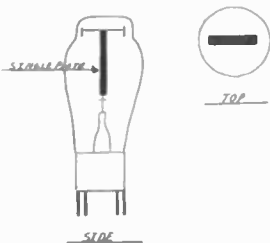

WANTED: 2A3 single plate tubes, used, paying \$60, looks same as regular 2A3 except plate is flat as pictured. Also used C585, used paying \$120. KT88 new in original box, paying \$120. Tim Metz, 221 Wheatland, Fairview, OK 73737. (405) 227-2456

WANTED: Zenith Stratosphere and other high tube count radios. Also Zenith and other pre-1950 advertising. We will buy or trade. Alan Jespersion, PO Box 17338, Minneapolis, MN 55417. (612) 727-2489

WANTED: Art Deco style sets with fancy inlaid or highly stylized cabinets. Sets with chrome or metal grilles. Adam Schoolsky, 15149 S.W. Cabernet Dr., Tigard, OR 97224. (503) 579-1080. E-mail: Adam@Art Deco.com

WANTED: Crystal detector with Bakelite knob, and audio transformer for RCA Radiola V. Don Sturzenbecher, Rt. #3, Box 28, Sioux Falls, SD 57106. (605) 368-2135

WANTED: Rider's Volume 20 and above. Contact: Fulton Loebel, 2103 N. Shartel Ave., Oklahoma City, OK 73103. (405) 521-1550

WANTED: Conversion manuals, military 1 & 2. Also, collecting military & WWII radio receivers like BC & AN Type. Please advise. C.R. Filer, Jr., 1163 Hawksbill Ln., Sugarloaf Key, FL 33042-3159. (305) 745-1801 EST

WANTED: Pocket size tape or wire recorders with 2" or smaller reels. Thank you. Guy Doss, 736 Los Padres Blvd., Santa Clara, CA 95050. (408) 241-2437

WANTED: Fisher 260 amplifier, (2-piece). **FOR SALE:** Transmitting tubes, 304 TL, 304th, ed. Please write or call. Mike Fletcher, 1204 Cedar St., Niles, MI 49120. (616) 684-2174

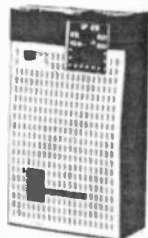

WANTED: Offer stands at \$1,500 (U.S.) for Sony, Tokyo Tsugin Kogyo Ltd. TR-52. Tom Christopher, 5350 Alum Rock Ave., San Jose, CA 95127. (408) 926-2808

WANTED: Philco 84B chassis and knobs, junker OK. **FOR SALE:** Majestic 72 cabinet. Andrew Mitz, WA3LTJ, 4207 Ambler Dr., Kensington, MD 20895. (301) 897-5531. E-mail: arm@helix.nih.gov

WANTED: Radiotron Designers Handbook, 4th edition only. Paying up to \$45. Call: Frank Bequaert, Rainy Day Books, PO Box 775, Fitzwilliam, NH 03447-0775. (800) 215-0046

WANTED: Browning LTD 23-channel mobile unit from the mid- to late-60's. This earlier model features a heavier wood grain brown cover than the later '70's models. Craig Blankenbecler, 621 Branch St., Kingsport, TN 37660

WANTED: Altec mixer (old grey hammetone) or parts unit, old Altec bookshelf speaker. Sumner McDanel, 3104 So. 147th E. Ave., #0, Tulsa, OK 74134. (918) 437-5403

WANTED: Schematic, or copy, for Heathkit tube checker Mod TT-1. Jeff Hoskins, 824 E. Madison Ave., Stuart, FL 34996. (407) 283-2291, after 7 pm

One Month Free!

BONUS FOR EARLY RENEWALS

If you renew before the month shown on your mailing label (your expiration month), you will receive an extra month on your subscription: 13 months instead of 12! 26 months for an early 2-year renewal!

WANTED: A radio part from the Henry Ford Museum auction. A black, moulded variometer with a broken off at the mounting. I believe this to be the one I've been searching for. Stephen C. Brown, KD4YFY, 3808 Campaign St., Charlotte, NC 28210. (704) 847-1301

WANTED: National S-meter with round bezel. Also NC-66, NC-100. Niel Wiegand, WA5VLZ, 12105 Mustang Chase, Austin, TX 78727. (512) 219-8548

WANTED: Owner's manual, schematic, for Fisher Custom 60, 24-tube console. John C. Allport, 1140 Canterbury, Liberty, MO 64068

FOR SALE: Philco Predicta 17" and 21" - \$200 ea. 1930's Shure ring spring microphone. Electro-Voice 623 and stand - \$100. Astatic recording microphone. Turner stands. RCA receiver AVR-15 - \$25. National S meter. Lincoln SW-31, PS, speaker. HP-23 manual. HRO-500 manual. (16) Collins mech. filters - \$200. Mech. filters books - \$50. KWM speaker - \$175. Bill Coolahan, 1450 Miami Cir., NE, Cedar Rapids, IA 52402-2933. (319) 393-8075

FOR SALE/TRADE: Federal 61, Paragon RA10/DA2. WANTED: Fada 140A, Moon C1 or C2. Craig Ball, 10101 Oak Hollow Cir., Austin, TX 78758. (512) 837-8129, after 7 pm

Classified Ad Deadline Noon

Jan. 10 for Feb. 1996 Issue

Feb. 10 for Mar. 1996 Issue

Boxed, Photo, & Display Ads - 1st

FOR SALE: B&W video camera, single lens, 16mm, all tubes, including video con., commercial quality with manual, vg - \$150 + 30 lbs. shipping. John Nosbaum, 2743 Wilmette Ave., Wilmette, IL 60091-2273. (708) 256-0547

FOR SALE: Bendix 536 Catalin - \$500. RCA 143 tombstone - \$300. Wurlitzer 412 jukebox, circa 1936, nice! - \$1,400. Stromberg-Carlson 925 console - \$150. Old Empire turntable, needs needle - \$85. Skip Shaw, 954 Greenwood Ct., Clarksville, TN 37040. (615) 647-7220

FOR SALE: 1-177-B military tube checker w/chart - \$50. Hallicrafters S-38-E - \$35. Hallicrafters 5R100A - \$35. EICO tuner HFT-90 - \$15. RCA 45EY3, not working - \$20. Plus UPS. Bill Adams, 608 No. G St., Imperial, CA 92251

FOR SALE: Crosley 124 cathedral, restored - Best Offer. Tube plastic tabletop radios - LSASE list. Charles Zafonte, RFD 1, Box 75, Fort Kent, ME 04743. (207) 834-6273, eves.

FOR SALE: Arvin sunburst red 707B, two-inch crack top side - \$65. Westinghouse refrigerator, white, H126, repainted - \$85. All working, ppd. Gregory Sheppard, KA3DBG, 4402 Jupiter St., Rockville, MD 20853-3255

FOR SALE: Transistors: Crown TR-770R, vvg, white - \$30; Global GR-711, blue, vvg - \$100; General Electric P787, coat pocket, vvg - \$15; Holiday 11P601, exc cond. - \$40; Motorola X14R, boxed, red, some wear on escutcheon, vvg - \$65; Magnavox AM-80, small chip on side - \$15; Penney 6TP-555, vvg - \$25; Realtone TR-861, hairline on side, vg - \$65; Westinghouse H619P7, red, sharp looking - \$50. Sylvania 4P14 horizontal, 4 transistors, aqua/blue, vg - \$50. Arvin 9574, tan pressed metal portable, exc cond. - \$45. Emerson P3400, radio given to "special fans of the Phillies Baseball Club", N.I.B. - \$35. Black Regency TR-1 with box, vvg, no chips or cracks - \$500. Postage extra. Kay Botzum, R.D. 2, Box 419, Morgantown, PA 19543. (610) 286-0047. Fax: (610) 286-5315

FOR SALE: Heath V-6, V-7, RCA Voltomyst 97A VTVM's - \$7.50 ea. Joe Brady, Box 8 Star Rt., Huntingdon, PA 16652. (814) 643-0603

FOR SALE: Emerson 702 radio, Ingraham cabinet; Zenith 6D525; Graetz Super 160W. Charles Harper, 2000 Jackstown Rd., Paris, KY 40361. (502) 769-0404

FOR SALE: Tubes: C-11, same as WD-11, N.I.B., have (3) - \$65 each. Gold Airlines GX-201A, N.I.B., have (4) - \$65 each. Plus postage, Ed Bell, 5311 Woodsdale Rd., Raleigh, NC 27606. Phone/fax: (919) 851-1517

FOR SALE: Philco 50 cabinet, nice with speaker - \$45 OBO. Philco 46-350, nice, working - \$65 OBO. (3) new 1L6 - \$12.50 ea. Send SASE for list of transistor radios for sale, some N.I.B. Bob Gidney, 411 W. Spruce St., West, TX 76691. (817) 826-5105

FOR SALE: Panasonic RF-B600 digital multiband - \$225. Precision 10-12 tube tester with manual - \$35. DEC professional portable microfiche reader - \$80. WANTED: RCA 140 (or GE K-80) tombstone. Zenith 9S324. Armand Cote, 11 Berge Ln., Derry, NH 03038. (603) 437-4431, before 10 pm EST

FOR SALE: Hewlett Packard amplifier Mod 450A, metal case - \$35. Car speaker, 9" round bell chrome w/clock in center, @9, all original - \$35. Varivac by General Radio in metal case w/jacks - \$50. David Roche, 10 Hospital Rd., Monson, MA 01057. (413) 289-1037

FOR SALE: American Marconi spark gap holder on 12" x 24" hinged panel. This is the piece removed when the 2 KW P8 transmitter was converted to tubes, exc cond. w/RCA & Ford tags - \$375. Kennedy 220 w/525 amp, exc cond., nice original finish, even the dials are nice - \$1,650/pr. E.I.Co. 1" spark coil, oak w/E.I.Co. disc, works - \$125. SE 1603 RF driver, BFO unit for early Navy receivers, nice - \$265. Craig Smith, 1935 1st Ave. S, St. Petersburg, FL 33712. (813) 822-7592

FOR SALE: \$25 ea.: Heathkit WA-P2 preamp, Zenith M-403, Yaesu FRA-7700. WANTED: Drake R-4C. Mike Brillhart, 12551 Maiden Creek Rd., Abingdon, VA 24210. (540) 944-4387

FOR SALE: Emerson Aristocrat Model 400 - \$585. Riders Manual Vol. 13 - \$7. Emerson 295 - \$160. Prices are negotiable. George Kollar, 137 Harris Hill Rd., Shavertown, PA 18708. (717) 696-2523

FOR SALE: Vacuum tubes, N.O.S. and used. Send larger SASE for List #3. Neal Simpson, 27-1 Queen Rd., Lambertville, NJ 08530

FOR SALE: Globetrotter globe radio - \$400. RCA double button microphone - \$75. Set of Scott Allwave superheterodyne coils - \$60. Zenith 5G403 - \$35. Tresco sectional universal amp, case rough - \$75. Majestic 651 - \$100. Philco J775-124 - \$45. Charles Haynes, 219 W. Spring, Marissa, IL 62257. (618) 295-3664

FOR SALE: Selsyn motors, 1941, heavy duty, pair - \$30. Ham stuff, books, more, SASE list. Bill Tucker, W4FXE, 1965 S. Ocean Dr., Apt. 15-G, Hallandale, FL 33009. (954) 456-1349

FOR SALE: January special, must pay Christmas bills! Capehart T-30, Motorola 56B1 - \$25/both plus shipping. Michael Dalzell, 5073 Winfield Ct., Bensalem, PA 19020. (215) 638-3889

FOR SALE: Philco 37-33 cathedral - \$65. Coronado 550 tombstone - \$45. Radiola 18, vg, plays - \$75. Peerless cathedral speaker - \$45. Newcombe-Hawley speaker - \$45. Philco 16X console, very nice cabinet - \$85. American Bosch 28 - \$75. Crosley 51 - \$50. All plus UPS. Mark Thornquist, 45 Second St., Glens Falls, NY 12801. (518) 761-4143

FOR SALE: Axial lead electrolytics. Fresh new Nichicon miniature 22 mFd. at 450 Vdc - \$1.25 ea. for 8 or more. Includes P&H. Many other types in stock. Write, phone, or fax for free flyer. DH Distributors, PO Box 48623, Wichita, KS 67201. (316) 684-0050 v/f

FOR SALE: UHF converter, BT Labs Model 99, like new - \$15 ppd. L. Gardner, 458 Two Mile Creek Rd., Tonawanda, NY 14150

FOR SALE: Philco 38-93B tombstone, exc - \$105. Meters: Heathkit IM18 vacuum tube V.M. - \$22. Weston's #1 milli-V.M. - \$28. Allied 339 60's amp - \$14. All plus S&H. Sam Mannino, PO Box 233, Swarthmore, PA 19081. (610) 353-6747

FOR SALE/TRADE: 1929 Neutrodyne Radiotrope in highboy cabinet, not working but complete - \$45, prefer pickup. John Koop, 48 Wheelbarrow Ln., Wantagh, NY 11793. (516) 731-6711, eves.

FOR SALE: Crystal radio kits, complete with face panel and baseboard, 365 variable capacitor, large prewound coil, and many other parts for an old style crystal radio, remit - \$19.50 plus \$3 shipping. Carl & Grace Ent., 5636 Romeyn, Detroit, MI 48209

FOR SALE: Radiola 18 with Model 100 drum speaker, works - \$130. Other radios and TVs. Rod Rowland, 4211 Woodland Ave., Drexel Hill, PA 19026. (610) 623-6141

FOR SALE: Hallicrafters: SX-17 - \$175; S41W - \$125; S20R - \$125; HT-18 - \$60; SX-62A - \$300; SX101 MK3 - \$225; WR600 - \$60. Many others, call/write for list. Richard Prester, 131 Ridge Rd., West Milford, NJ 07480. (201) 728-2454

FOR SALE: Arvin 442, black, works, but needs new IF - \$45 + UPS. Jeffrey Williams, 201 E. 62nd St., Apt. 8C, New York, NY 10021. (212) 754-5865

FOR SALE: Electrodynamic Wave Theory of Physical Forces, Discovery of the Causes of Magnetism, Electrodynamic Action and Universal Gravitation, 1917 1st, T.J.J. See, hb - \$25. FM An Intro. to Frequency Modulation, J. Rider, 1940, hb/dj - \$10. FM Trans. & Recept., Rider/Usulan, 1948 1st prntg., dj/hb - \$10. Cathode-Ray Tube and Typical Applications, DuMont Labs, 1948, pb - \$10. 1979 Radio Amateur's Call Book, pb - \$8. 1980 Radio Amateur's Call Book, pb - \$8. Hi-Fi, Mayer/Conly, 1st prntg. 1956, hb/dj - \$8. TV & Other Receiv. Antennas Theory/Pract., 1950, A.B. Bailey, hb - \$20. Intro. Electric Circuits, H.W. Jackson, 2nd Ed. 1965, hb - \$10. 1977 Radio Amateur's Handbook, hb - \$10. Intro. Electric Circuits, H.W. Jackson, 2nd Ed. 1965, hb - \$8. TV & Radio Repairing, J. Markus, 1953, 1st Ed. - \$12. Complete Guide to Reading Schematic Diagrams, J.D. Young, 2nd Ed. 1980, pb - \$7. From Tin Foil to Stereo, Evolution of the Phonograph, Oliver Reed/W. L. Welch, 1st Ed., hb - \$20. Plus shipping. Byrl T. Jenkins, Box 489, RR#1, Williams, IN 47470. (812) 388-7346, after 6 pm

FOR SALE: (400) tube radios - \$10 ea., must take all. Will throw in free with deal many speakers, chassis, empty cabinets, test equipment, parts & thousands of tubes! No list, call for more details. Pick up only. Marty Bunis, 32 West Main St., Bradford, NH 03221. (603) 938-5051, before 8 pm

FOR SALE: Fada 1000, blue, mint, rare, works - \$2,500. Bob Masterson, Box 172, Valley Cottage, NY 10989. (914) 353-3151

FOR SALE: Mic ID plates, CBS, NBC, clip-on type. **WANTED:** Broadcast microphones, any shape, will trade. Taking offers on wooden Garod 3-band radio, works. Mike Dupuis, 116 First Ave., Tuckerton, NJ 08087

FOR SALE: Zenith 6A26, white - \$50. AK 185A - \$185. RCA R7 - \$40. Coca-Cola cooler, 1949 - \$595. Airline 93-BR-715 - \$120. RCA 7T-1, restored - \$160. Penetrola 1-tube set in exc condition - \$150/BO. U.S. Radio Apex Model 10, restored - \$140. Quelle Simmantu-German table radio with turntable on top, exc cabinet, (4) bands - \$45. Zenith 5-tube console w/black dial, restored - \$145. **MESSAGE:** Dealers: get ready for March 17 show and sale in Ct.! Drawing for free antique radio to be held day of show. Table prices, etc., same as always. Ray Lamont, 70 Litchfield Rd., Unionville, CT 06085-1318. (203) 675-6327

FOR SALE: Stewart-Warner Mod 801 Series B w/435 matching spkr w/tubes, @9 - \$160. Steinite 7-tube blk walnut case, A/O, @9 - \$125. AK 55C chassis w/knobs & faceplate, @10 - \$70. GE M-H73, 9 P/B, A/O, N/D, plays - \$115. (3) Philco rad-phonos M1206, one @9/P, 2 for parts, all 3 for - \$75. Zenith Mod R512V table, fire red, 6 P/B on top, no C/C - \$55. Plus pkg. & Shpg. Bernie Samek, 113 Old Palmer Rd., Palmer, MA 01069. (413) 245-7174

FOR SALE/TRADE: Emerson 878 - \$60. RCA 4X641 - \$40. Emerson 569 w/o cord - \$45. Motorola 68L11 w/o knob - \$50. Hallicrafters Sky Buddy - \$75. Trade for mini keychain license plates, made by Disabled American Veterans. Also, motorcycle plates, any states. Brunswick 1923 phonograph Model 101, excellent condition - \$200 plus UPS. John Williams, Jr., PO Box 1545, Scarborough, ME 04070-1545. (207) 883-8249

FOR SALE: Philco cathedral 37-34 - \$50. Zenith G-500 - \$55. Gerald E. Perkins, RFD #2, Box 34, Milo, ME 04463-9605. (207) 943-5204

Catalins Wanted



Fada • Emerson • Motorola
Addison • Air King • Arvin • Detrola
Crosley • Symphony • Tom Thumb
I buy all makes and models.

Michael Lawlor
P.O. Box 179 • Santa Barbara, CA 93102
(805) 682-2336

FOR SALE: New photo catalog, (170+) radios, good for reference, monthly update - \$1 + LSASE 2-stamps. Bob Masterson, Box 172, Valley Cottage, NY 10989. (914) 353-3151

FOR SALE: The room over my garage is stacked with **FXR** speakers that I'm not gonna fix up. No phone sales. No shipping. Motivated seller. Bring your truck. Bring your cash. Bring your imagination. Ed Bell, 5311 Woodsdale Rd., Raleigh, NC 27606. Phone/fax: (919) 851-1517

FOR SALE: Sylvania radio/TV sign, fluorescent, works - \$125. Geloso (Italian) tape recorder, tan, multi-color control buttons - \$65. Western Union telegraph key was promo for Bazooka Gum Co. with box, dated 1958 - \$50. Silvertone, white candy-cane radio, red knobs/push buttons in original Sears box - \$135. Audio-engineer radio controlled toy to control electric trains, M.I.B. - \$40. Brumberger, Code Master radio telegraph signal set, M.I.B. - \$40. Coffee cup/saucer novelty radio, works - \$55. Guild Country Belle, telephone/radio - \$45. Silvertone, brown candy-cane dial, push buttons, immac. Bakelite case - \$85. Minifon P55, wire recorder with case - \$65. RCA transistor, 3RH22G, turq./white, M.I.B., presentation case - \$45. Toshiba transistor C/R, 6TC-485, works - \$75. Stan Rosenstein, 506 Academy Ave., Owings Mills, MD 21117. (410) 363-4873

FOR SALE: Ware, Type T, (Bunis 1, p. 157) - \$165. Pfanstiehl 28 - \$65. Trans-Oceanic T600, no tubes - \$85. Microphones - send SASE for list. Dennis Schrank, 3129 S. Quincy Ave., Milwaukee, WI 53207. (414) 744-3374

FOR SALE: Splittorf 1927, nice - \$75+. German Rigoletto 59 - \$50+. Fred Hegel, 1901 Frank Pl., S. Daytona, FL 32119. (904) 760-7632

FOR SALE: Old tubes, books, catalogs, booklets, other paper material. SASE for list. Charles Stinger, 404 Ross Ave., Hamilton, OH 45013. (513) 867-0079

FOR SALE: (3) Ballantine AC VTVM, Bendix BC221-C, Biddle Wht. Stn. Bridge, Boonton 65B, 170A, Comm. Meas. 1520, (2) Davin T-692, Foxboro 610-HT-OH (N.I.B.), Gen. Rad. 605B w/PS, 713B, 1203B, 1212A, 1217A, Heath ES-600, SQ. WV. Gen., EUW15, HP43C, 302A, 400A, B, D, 411A, 425A, Quan-tech 317, 420, Textronic 121, 190A, 551 w/53 plug-in, USN CAG60006, WE19C, 19" rack 48" high w/ slant face. All items \$10.00, as is. Pick up or you pack and ship. Jim Koehler, 242 Guy Lombardo Ave., Freeport, NY 11520. (516) 623-0035

FOR SALE: Compactor adapters, set of (2) adapters which allow 9-pin and 12-pin compactor sweep tubes to be tested on TV-7 type tube testers. This lets popular tubes such as 6JB6, 6JE6, 6JF6, 6JM6, 6JS6, 6JU6, 6JZ6, 6KD6, 6KM6, 6KN6, 6LB6, 6LF6, 6LQ6, 6LR6, 6LX6, 6ME6, 6MJ6, 12BJ6, 20LF6, 21JS6, 23JS6, 24JE6, 27LF6, 30KD6, 40KD6, 8950, 7868 be tested on TV-7 testers which do not have compactor sockets. Tube test setup and test data are supplied for the TV-7 tester series only. This includes switch settings and bias values as well as minimum and "as new" test values. (2) adapters as well as tube test information and pin-out conversion data are supplied. Please send \$25 to Daniel Nelson, 1025 E. Desert Ln., Phoenix, AZ 85040. (602) 243-7421, evenings. E-mail: djn@indirect.com

FOR SALE: Pace & Gonsel CB's - \$5 for parts. Wharfedale & Frazier column speakers - \$100 & \$35, p/u only. Norelok AM/FM/SW/LW port., NW - \$75. Old Motorola 7", good cab., might fix up - \$30. Ampex 4460 RTR, Teac RTR - BO on ea. **WANTED:** Chassis, speaker Zenith 6S27. **FOR TRADE:** Nice MC-30 for tabletops, transistors. Thanks! Michael L. Hagan, 428 Sharron Dr., Waco, TX 76712. (817) 776-4760

FOR SALE: Magazines: Popular Electronics 1956 to 1976, and others, call or send SASE for list. Dave Minchella, KE2GE, 80 Campfire Rd. North, Henrietta, NY 14467. (716) 359-3337

Heathkit, A Guide to the Amateur Radio Products

by Chuck Penson

Documentation of ALL Heathkit's amateur products

Complete history of the company

200+ sharp photos



NEW! Available Now!

Most products are pictured with a full-page description

256 pages

\$24.95

U.S. Orders - Enclose \$3.00 per order for packing & book-rate shipping if total order is under \$35.00. If using VISA or MasterCard, include name on card, card number and expiration date. Send payment with order. Mass. residents please add 5% sales tax. Money back return policy. Most orders shipped the same day received, but allow 2-4 weeks to receive order. Foreign orders - write for shipping costs, or use credit card and specify air or surface (allow 2-3 months for surface shipping).



**Send Order To: A.R.C., P.O. Box 2, Carlisle, MA 01741
or Call: (508) 371-0512**

Fax: (508) 371-7129



(Dec-95)

FOR SALE: Philco 37-116X console, (15) tubes, (4) speakers, needs restoration - \$175. Pick up only. Dan Schlie, 60 Maple Ave., Port Byron, NY 13140. (315) 776-4596

FOR SALE: RCA 10-inch AM/FM/TV, condition excellent, N.W. - Best Offer. Ampex amp plus speaker Model 620, in a brown case, excellent condition - Best Offer. Bob Piekarz, 111 East 29th St., La Grange Park, IL 60526. (708) 352-0648

FOR SALE: Air King 511-110, nice body - \$30. Zenith Y506L portable, excellent leather - \$25. Bob Puttre, 637 Stratford Rd., Baldwin, NY 11510. (516) 223-9667

FOR SALE: RCA No. 66BX metal case, Westinghouse No. 7-126, transistors DS501. Louis L. Veltre, 643A Sherwood Ct., Lakehurst, NJ 08733-4207. (908) 657-7592

**NOTICE TO ALL
CLASSIFIED ADVERTISERS!
OUR CLASSIFIED AD DEADLINE IS
12:00 NOON
ON THE 10th OF EACH MONTH**

FOR SALE: (7) 485 tubes, good used - \$35. (200) N.O.S. 7- and 9-pin TV tubes - \$100. No tube caddy junk! Pete Putra, 1429 Lawndale Ave., Racine, WI 53403. (414) 632-2543

FOR SALE: Crosley E-75RD, black plastic, clock works, radio needs filter, noisy - \$15. Crosley 5M3 wood, very nice, plays - \$35. Plus UPS. Ferdinand Estree, 660 Fineview, Kalamazoo, MI 49004. (616) 394-0231

FOR SALE: Dumont 346 - \$90. Zenith 7S529 - \$65. Philcos: 80 Jr. chassis - \$30; and 60 cabinet - \$25. Dan Merz, 312 Sierra St., Richland, WA 99352. (509) 375-1334

FOR SALE: Clapp-Eastham HR receiver, excellent condition - \$475. Westinghouse RC, excellent condition - \$325. Richard Sharisky, PO Box 521, Belmont, MA 02178. (617) 484-5784. Fax: (617) 489-6592

FOR SALE: Zeniths: 7S529 - \$80; 6D030 - \$55. Motorola 5R1-2A - \$35. Philco H765-124 - \$50. Precision 98 VTVM, needs work - \$15. Add UPS. J. Lowe, 3025 Harpers Ferry Rd., Sharpsburg, MD 21782. (301) 432-2420

FOR SALE: Hammarlund HQ-190 w/man. - \$250. HX-50 w/all papers, not tested - \$150. RCA CR88A w/19" cabinet - \$250. Globe 303 w/VFO & manuals, not tested - \$100. Lafayette HA350 w/manual - \$65. Johnson & B&W Lo pass filters - \$25 ea. Hallicrafters S-107 - \$35. Pick up only. Jim Koehler, 242 Guy Lombardo Ave., Freeport, NY 11520. (516) 623-0035

**REPLACEMENT DRIVERS FOR
ATWATER KENT HORNS**

Driver w/housing for Model M & Pooley horns (this assembly replaces all pot metal) \$65.75 + \$4.75 s&h

Driver w/repair ring for Models G, H, & L (repair ring replaces threads in base) \$59.85 + \$4.75 s&h

All drivers above include diaphragm, gaskets, spacer, and spring. All parts are also sold separately. Send SASE for price list.

M. Harold Ezzone, 4861 Park Drive
West Des Moines, IA 50265 - (515) 221-9447

FOR SALE: Floor models cheap: Philco 41-285, Majestic 20, Grunow 1191, small Silvertone, cabinets fair + and better - \$45 ea., you pick up. CRT-1/CPRC-26 by Rogers Majestic Canada, no microphone - \$20. Radiola AR-812 parts set, cabinet bad - \$35. N.O.S. H-65/U headphones, 4,000 ohm - \$15. Carnival record player with 8+ boxes of records, needs motor - \$75. Following radios are best reasonable offer: Silvertone 4500A, GE S-22 tombstone, no stand; Zenith 6D312; Fada 252 Series wooden; Philco 70; Philco 19; Trav-Ler cathedral; Stewart-Warner tombstone 1272; Philco Butterfly; Emerson 31A; Crosley 58TC, dark purple with black swirls. LSASE for calculator list, selling whole collection only. Michael Crain, 3 Hillside Ave., Harveys Lake, PA 18618-9782. E-mail: mcrcrain@aol.com

FOR SALE: Bakelites/plastics (all photo-referenced in Machine Age): Admiral 372-5R (similar Mantola 477-51Q with brass dial bezel), stress crack top - \$125. Airline 93-WG-542A, professionally repainted - \$140. Automatscope (see Lafayette JA84), left side cracked - \$33. Bendix 114, 1/4" screw-hole crack left rear - \$275. Clinton 363 (see Sonora TS105) - \$50. Emerson 561, wrong knobs & other problem - \$36. Emerson BA-199, crack right side, needs dial glass & no back - \$38. Fada 550 - \$70. Fada 260G, ivory with brass, chipped, bottom rear, no back - \$235. General Television (p. 111 top) - \$125. Garod 5-A-1, black, (similar 5-A-2) - \$85. Imperial (similar Trav-Ler, p. 201 middle right) - \$45. Mirrotone (see Olson), crack on top - \$29. Philco 52-940 - \$60. Silvertone 9000 - \$35. Silvertone 6002, stress crack top - \$75. Stromberg-Carlson 1500, red repaint - \$24. Zenith K412R Crest, brown - \$95. All plus UPS. Mike Stambaugh, 506 W. Springettsbury Ave., York, PA 17403. (717) 854-1368. E-mail: mlstam@yrkpa.kias.com

FOR SALE: 1925 Gilfillan GN-4, very good, dud tubes - \$300 plus shipping. Ed Bell, 5311 Wooddale Rd., Raleigh, NC 27606. Phone/fax: (919) 851-1517



*Craig L. Graybar
Furniture Works Ltd.*

(414) 258-2390

SPECIALISTS IN RESTORING,
REPAIRING AND REPRODUCING
CLASSIC STYLED ANTIQUE TV,
RADIO & PHONOGRAPH CABINETS

Send us your plans or your project
via UPS for immediate price quotes



1535 S. 84th St.
West Allis, WI 53214



"We Turn Ideas Into Heirlooms"

FOR SALE: Raw speakers: EV SP12B - \$100. Calrad CR12AE, N.I.B. - \$30. Oxford LA60T4SB-6", N.I.B. - \$25. Acoustral Labs 8164-16RFE 8", N.I.B. - \$25. 12" woofer, made in Denmark, N.I.B. - \$45. Plus shipping. Stan Kotschi, 1421 W. New York Ave., Oshkosh, WI 54901. (414) 426-1912

FOR SALE: Catalins: Sentinel 284-W, nice - \$1,150. Garod peak-top, yellow & red, (3) stress lines, looks great - \$1,350. Fada 652, pea-green open grille, has hairlines, some red marbling, nice - \$550. Fada 845, white marbled, not perfect, repro knobs - \$250. RCA Model 8-B-43, marbled plastic - \$75. Sonora TR-281, ivory 98% - \$85. Zenith 3000-1 Trans-Oceanic, nice - \$125. Prices plus UPS. Vernon Shatwell, Rt. 5, Box 195, Sapulpa, OK 74066

FOR SALE: WRL Globe Scout Model 680-A amateur transmitter - \$25. Donald Schuhrek, W191 57500 Richdorf Dr., Muskego, WI 53150. (414) 679-0212

**IF YOUR EXPIRATION DATE IS
JANUARY OR BEFORE, RENEW TODAY!
EARLY RENEWALS
RECEIVE AN EXTRA ISSUE!**

FOR SALE: Electro-Voice microphone, Model V2 - BO. Bing Crosby Jr. jukebox - \$275. Victor VV XI oak console crank phono - \$325. Polly Royal, 5-tube - \$75. American Bosch 808P, butterfly grille - \$85. Edison 10-panel straight phono horn - \$125. AK 55 & AK L chassis, clean U/T - \$50 ea. Victor 1-2 small crank phono - \$150. AK E sprk & Peerless cathedral sprk - \$35 ea. Realistic 7 1/4 stereo reel-to-reel, working - \$35. RCA 45 only turntable - \$20. **WANTED:** Wooden phonograph horns & escutcheon for Echophone S5, (repro OK). Jahan L. Acciavatti, PO Box 231, Southborough, MA 01772. (508) 476-3229, eves.

FOR SALE: Scott 310E - \$350. RCA 3BX 671 portable - \$100. Hallicrafters 8R40 - \$75. Pair of RCA Midget ribbon mikes - \$400. Radiotron Designer's Handbook, 4th edition - \$75. Larry Kays, 6 Old Ivy Dr., Harwich, MA 02645. (508) 430-0462

FOR SALE/TRADE: SASE or e-mail for my list of reasonably priced radios. Kevin Schroeder, N8SXU, 950 W. Main St., Ottawa, OH 45875. E-mail: kev@bright.net

FOR SALE: Rider's Manuals 1 through 15 - \$190, pick up only. Fred Schultz, 1246 Lincolnway S, Ligonier, IN 46767. (219) 894-3779, 9-5, faxes after 5 pm

FOR SALE: Antique (not reproduction) Atwater Kent 10C breadboard parts in excellent condition: (3) tuning condenser in metal can. (1) audio frequency tube island. Rider's Volumes 1, 9, 13. RCA tube manuals from late 40's or early 50's - \$10 ea. Freed-Eisemann NR-5 and NR-7. RCA 3-BX-671 Strato-World portable; seven bands, tan leather, excellent condition, working but dial belt broken - \$75. Bob Warren, Church St., PO Box 219, Waverly, PA 18471. (717) 587-2405

FOR SALE: Saba Vollautomatik 125/stereo, mint - \$550. Saba Sabine-M - \$150. Philips, Holland, 9-tube high-power, bi-ampli - \$125. Grundig Teddy Boy, rare - \$100. Grundig transistor Concert Boy - \$90. Nordmende multiband Globe Traveler - \$125. Loewe-Opta Luna Luxus - \$90. Sony CRF5100, mint - \$150. **WANTED:** Schematic for Zenith Royal 555. John Sarkies, 75 Breakwater Shores, Hyannis, MA 02601. (508) 771-5955

FOR SALE: Nat. NC-109 rcvr - \$85. Sears plastic Silvertone - \$50. GR amateur band freq. meter Type 558 - \$100. All good working condition. Al Sundberg, 32 Sabinas St., Toms River, NJ 08757. (908) 286-0819

FOR SALE: Rickenbacher electro amplifier, black wrinkle finish, 4 tube, (2) 47's, 53, 80, untested - BO. Zenith Royal 2000, AM/FM, works - \$50. James brown Catalin clock, works - \$45. Bromwell's Radio flour sifter, 1920's - \$40. Silvertone Model 9636 speaker, looks like set of books - \$25. Radio shot 1920's toy marble game, mfg. by American Toy & Game Corp., 5 1/2 x 11 1/2, red & yellow - \$100. Return call if item still available. Steve Veney, Box 41, Bremen, IN 46506. (219) 546-2734

FOR SALE: Dozens of tubes, used-N.O.S. Riders Volumes 4 thru 15 - \$25 ea. or will trade some for 19 thru 22. Sams TSMs, Sams CB Vol. 24, Sams Tape Recorder Vols. 12, 28, 49. Sams Hi-Fi Components Vols. 37, 52. RCA Reference Book, 1962. Majestic Schematic Catalog, 1933. Call for prices. Richard Bruning, 1901 U.S. Highway 150 N, Apt. B, Galesburg, IL 61401. (309) 344-1968

FOR SALE: Needles Genuine Shure for Shure V15 Type III cartridge, hyperelliptical, reg. \$61.95, special - \$50 + \$2 shipping. Deluxe needles in stock. J.J. Papovich, 53 Magnolia Ave., Pitman, NJ 08071. (609) 582-8279

FOR SALE: Clapp-Eastham HR - \$225. R. Burick, Second Chance Collectibles, 399 Maplewood Ave., Ambridge, PA 15003. (412) 266-4516

FOR SALE: Rack AM/ham home-brew transmitting unit - \$300. RCA AR-1300, RCA AA-1400 - \$250. Vance Rayburn, 2718 Homestead Rd., Madison, WI 53711. (608) 274-3002

FOR SALE: Oldsmobile Transportable - \$120. Universal transistor #PTR-62B - \$35. Crosley left-handed bulls-eye, tan - \$100. Robert Lutz, 9041 Gillette St., Lenexa, KS 66215. (913) 894-1327

FOR SALE/TRADE: MiKern Rotary Quench spark gap - \$400. Will trade for crystal stands or sets. Wallace McPeak, Rt. 4, Box 293A, Canton, TX 75103. (903) 567-6653

FOR SALE: Zenith 12-tube chassis & (2) speakers - \$150. Jim Berg, 4261 Wilcox Rd., Box A, Northport, WA 99157. (509) 732-4047

FOR SALE: (6) Sylvania 2A3's, very lo-hours - \$20 ea. Altec 604-8G's w/x-overs - \$800. Dave Faulds, 1136 Kirkwall Dr., Akron, OH 44321. (216) 666-6805

FOR SALE: N.I.B. 1970's NRI color TV kit with CRT, (3) boxes - \$125. Dennis Osborne, 711 E. Whitaker Mill Rd., Raleigh, NC 27608. (919) 834-9112

FOR SALE: Western Electric (U.K.) mahjong, mint in original shipping box, fancy brown speaker, mint. A.R. Nolf, 539 Kastelic Pl., Burlington, Ontario, Canada L7N 3S9. (905) 333-4557

FOR SALE: DeWald P1400 stereo tube receiver and tube FM stereo tuner R-1103 - \$80. Regency TR-4, ebony, clean - \$225. Large Addison Catalin, dk. green, butterscotch - \$1,200. Robin R.P.P., repaired back - \$35. Koyo KR-6TS33, lt. blue, pearlescent dial - \$45. Hoffman OP708, maroon/white R.P.P. - \$45. Zenith Royal 7000 American Model - \$225. Also (50) other transistor radios, send \$1 for list. Happy New Year! Mike Herman, #2-1731 Rockland Ave., Victoria, British Columbia, Canada V8S 1W6. (604) 595-2829

FOR SALE: Back issues A.R.C., Jan. 1989-Dec. 1993, (60) issues for - \$90 ppd. Ray Schmidt, 607 1 Ave. SW, Austin, MN 55912. (507) 433-0069. (507) 433-3250

FOR SALE: Setchell-Carlson unitized TV Mod C102, gold aluminum - \$70 OBO. Sony TC-730 stereo reel-to-reel - \$150 OBO. Robyn CB T-123B w/turner plus 3 mic - \$40. Voice of Music record changer #920B, 3 speeds - \$20. (5) records Norsk Grammofonkompani-Oslo - \$15. RCA 45HY4 45 rpm player - \$35. RCA 9Y51 radio/45 rpm player - \$40. Philco 49-605 alligator plastic w/manual portable - \$60. Kevin and Kathy Moe, 616 Lockrem St., Ottawa, IL 61350. (815) 433-4598, eves., weekends

— WANTED —

PICTURES FOR PHOTO REVIEW OR TELEGRAPH REVIEW PHOTOS MUST BE SHARP IN DETAIL A SHORT DESCRIPTION IS A MUST! SEE PHOTO REVIEW PAGES FOR ADDITIONAL INFORMATION

FOR SALE: Books: 101 Ways To Use Your Scope, Middleton, 1967 - \$5; Theory and Applications of Electron Tubes, Reich, 1944 - \$12; Radio & Television Receiver Circuitry & Operation, Ghirardi/Johnson, 1957 - \$20; Modern Radio Servicing, Ghirardi, 1935 - \$30; GE Transistor Manual, 7th - \$8; Elements of Radio, Marcus & Horton, 1950 - \$10. Trans. extra. Serge Casagrande, 1318 Norwick Dr., Lutz, FL 33549. (813) 949-6729

FOR SALE: Gilfillan cube - \$125. Zenith Major - \$80. Majestic #651 - \$150. Long SASE for list. Ed Ripley, Box 9374, North St. Paul, MN 55109. (612) 777-6791

FOR SALE: Bench supply, 300W 117VAC input, output 0-135VAC, isolated and meters - \$29 + shpg. Henry Mohr, 1005 W. Wyoming, Allentown, PA 18103

FOR SALE: Zenith 7S363 parts set. Call w/needs. **WANTED:** National NC183DTS speaker in good condition for NC183D. **MESSAGE:** Does anyone have the address of the A.F.C.A. (Antique Fan Collectors of America)? I have many old fans and some need more help than I can give them. Mark Shoup, 27 Dogwood Dr., Newton, NJ 07860. (201) 383-6417

FOR SALE: 1941 Zenith 10-S-599 R/P console - \$110, pick up only. Rich Stamer, 331 Virginia Ave., Collingswood, NJ 08108. (609) 869-0238

FOR SALE: Pocket radios: Zenith Royal 500 - \$50. Phillies baseball/MAMMA 50th Anniversary - \$90. Hitachi WH-822H AM/SW. Free list SASE. Chuck Vaccaro, 708 Booth Ln., #J, Ambler, PA 19002-5014. (215) 646-3641

WILL PAY \$1,500 FOR:



SONY TR 55
Any Color, Any Condition
\$ TOP DOLLAR PAID \$
Marty Bunis, 32 W. Main St.
Bradford, NH 03221
Phone (603) 938-5051
Fax (603) 938-2430

FOR SALE: All items good condition! H.H. Scott Type 250 amps, no cages - \$450/pr. 130 preamp - \$200. LT-10 - \$40. LT-110 - \$90. LT-110 - \$60. 330D AM/FM wood case - \$100. LM-35 adapter - \$90. 299 int. amp - \$90. Altec 1570B amps - \$700/pair. Knight 3050HD - \$40. Knight 3235 - \$30. Heath W-4 two output +2 chokes - \$60. Scott LK-48 x-formers - \$40. Stancor N.O.S. PC-8405 - \$15; P-4078 - \$15; A-3301 - \$20. UTC CG-41 - \$15. RCA 98680 - \$20. Hammond 1650K - \$60/pair. Hammarlund HQ-129X - \$125. Hammarlund HQ110 - \$100. **WANTED:** National HRO 500. Paul Busnuk, 2110 E. Lombard St., Baltimore, MD 21231, 6-10 pm EST

FOR SALE: Signal Electric Learner telegraph key and sounder, wood base, good condition - \$50 ppd. Gary Redfield, 214 Bailey Rd., Crystal City, MO 63019. (314) 933-0542

FOR SALE/TRADE: Truetone D3614A (Raytheon clone), pink/grey - \$450. Marvel 6YR-15A (M.I.J., p. 49) - \$75. David Mednick, 1450 Palisade Ave., #5H, Fort Lee, NJ 07024. (201) 461-3082

FOR SALE: Gilfillan console LN mahogany, w/spare tuner/amp, turntable, speaker, wire recorder and wires - Make Offer. G.E. Godsoe, 4327 Brookhaven Dr., Greensboro, NC 27406. Fax: (910) 674-2391

FOR SALE: Automatic Radio 50th Anniversary (1970) cuff link, tie clasp set - \$25 includes shipping. Herb Parsons, 5 Surrey Ln., Peabody, MA 01960. (508) 535-1009

FOR SALE: Tubes, new and used: Used 27, 6D6, 6C6, 24A, 6SN7, 78, 39/44, 43 - \$1.50 ea. Philco 47-205, working, could use cord - \$45. B&K small solid-state #1405 scope, working - \$55. Philco 38-116 chas. w/most tubes - \$75. **WANTED:** Tubes, Zenith 1936-1940, unusual horns. Have a blessed holiday! R. Dobush-Arcturus, 3554 W. 105, Cleveland, OH 44111. Phone/fax: (216) 647-3908

E. H. Scott Historical Society

The primary source
concerning the radios
and history of E. H. Scott

- Quarterly Bulletin: Scott News
- Service Manuals
- Reproduction Parts and Service
- Scott Video
- E. H. Scott the Dean by Marvin Hobbs

For more information write:
E. H. Scott Historical Society
3712 N. Broadway #4450
Chicago, Illinois 60613

**"Your One-Stop Spot
For All Things Scott"**

FOR SALE: Fisher 49T tuner & 49A amp - \$100/pr. RCA 8-BT-10K portable transistor AM radio, 1956 - \$35. RCA 6-B-5-B portable tube-type AM radio, 1955 - \$35. Zenith H724 AM/FM table radio, 1951 - \$35. University 8" trumpet speaker #1B-8, N.I.B. - \$20. Radiola 42 - \$75. H.H. Scott 296 dual laboratory amp - \$500. Remington Model 5 portable typewriter - \$35. Garrard RC88/4 record changer - \$75. Scott LT-112 stereo transistor FM tuner - \$45. Stromberg-Carlson 17CM2, 17-inch B&W console TV - \$75. EICO 625 tube tester - \$50. B&K transistor/FET tester, Model 162 - \$35. Picture tube brighteners for 1950's vintage B&W TVs - \$5 each. Hickok #546 tube tester with manual - \$375. Electro-Voice #EV-38 mono phono cartridges (same as Sonotone 2TA-S or Astatic 55T, etc.), and can be used in RCA 45 players - \$9 ea.; \$50/6. Tektronix 502A dual beam oscilloscope - \$200. All prices plus UPS. Bob Lynn, 26 E. Orchard St., Somerville, NJ 08876. (908) 685-9070

FOR SALE: Tube tape amplifiers; Webster Electric GL04 - \$150. Teac ARO D1 & D2 - \$200. Plus shipping. Stan Kotschi, 1421 W. New York Ave., Oshkosh, WI 54901. (414) 426-1912

FOR SALE: Majestic beetle plastic Rudolph radio, perfect - \$1,600. Sparton Bluebird, needs some restoration - \$1,600. Stromberg-Carlson radio apparatus dealer sign - \$150. Philco clock-radio similar to grandfather clock - \$450. RCA TRK 12 prewar TV - \$4,795. Stewart-Warner ad sign reverse paint - \$250. Jackson Bell Swan cathedral - \$475. White Silvertone vacuum cleaner radio - \$1,500. Kennedy 110 - \$2,100. Federal 59 - \$1,450. Federal 110 - \$695. Panasonic TV TR-001 - \$195. Sinclair TV - \$195. Singer TV with UHF antenna - \$150. Radiola IIIA - \$175. Blue Emerson Patriot, cracked - \$350. Brown Detrola Super PeeWee - \$225. Philco Predicta 17" table - \$275. Beige, mint cond. Grebe Synchrophase - \$250. AK 206 - \$295. AK 550 - \$595. AK 84 - \$595. Black Neutrowound - \$595. Radiola 103 speaker - \$195. Crosley Duette, maroon - \$150. White Emerson 540 - \$175; brown - \$150. RCA UZ-1325 - \$165. Magnavox horn type R3 Model C - \$175. AK 165 - \$350. Pilot 3" TV - \$250. Zenith 7C005 - \$350. Philco 37-610 - \$85. Radiola 60 - \$195. Hallicrafters TV 1-13, wood - \$195. Philco 45 butterfly radio - \$195. Zenith 5S-29 - \$150. Crosley Elf - \$795. Buddy Boy - \$475. Round cone speaker with knight in armor - \$175. Philco Transitone 48-230, maroon - \$165. Fada 260G - \$275. Federal Jr. crystal radio - \$350. Arvin metals, Zenith Trans-Oceanics, another Sony 8-301W TV - \$275. GE H500 - \$165. H-520 - \$195. Majestic 49B black lacquer - \$250. Sparton mirror dial tombstone - \$275. Chambers loose coupler - \$375. Zenith Royal 7000, works - \$295. Air King wood tombstone, same chassis & dial as the big bucks one - \$325. White Air King, the real one - \$2,700. Original inst. for Mignon RW4 - \$125. Brown Emerson Little Miracle, original window decals, unused for authorized dealer Crosley - \$95. Sparton - \$125. Zenith - \$125. RCA victor radio tubes with Nipper Dog logo - \$125. Channel Master transistor & tube radio banner - \$75. Sears & Roebuck Meteor loose coupler - \$250. Eric & Sirelle Fogel, 87 Sandra Dr., Parsippany, NJ 07054. Voice or fax: (201) 316-8424

FOR SALE: Collector tubes. Also special purpose tubes. SASE for list and prices. Antique Radio Store, 8376 LaMesa Blvd., LaMesa, CA 91941. (619) 668-5653

FOR SALE: Refinished 1939 Zenith 9S324 shutter dial table model; Philco 91 cathedral; General Motors 291 Queen Anne console radio-phonograph, exquisite - \$595; Airline Lone Ranger, minor hairlines; Charlie McCarthy; butterscotch Emerson Aristocrat, chip under handle - \$495; RCA 140 or GE K80 - \$395; xstr spark plug radio - \$135; N.I.B. Trimm Acme Deluxe headset - \$10; U.S. Apex 8A cathedral, refinished - \$225; 6-tube Mayfair cathedral - \$225; 1936 Philco 651 8-tube tombstone - \$225; Atwater Kent 112 - \$895; Philco 39-116 remote console - \$325; Nipper stuffed animal, new, 6" - \$15; 9" stuffed Nipper - \$25. Atwater Kent 92 cathedral - \$475; RCA cathedral 121 - \$295; Zenith LH cathedral, original finish - \$350; refinished Stromberg-Carlson 225H, rosewood - \$325. Rider's Manuals: 8-14 - \$15 ea. Call for current availability on other numbers. We have available all type Trans-Oceanics electrically restored, if requested, and guaranteed. Excellent color laser reprint of the original Trans-Oceanic 7G605 brochure - \$10 ppd. We have for sale many console radios not advertised: Stromberg, Philco, RCA, Airline and many others, call. Zenith consoles: 15S373A; 15S372; 15U270; 15U269; 12S569; 12S471; 12U159; 12U158; 12S370; 12S371; 12S265; 12S266; 12S267; 10S153; 10S155; 10S156; 9S262; 9S367; 8S154; 8S463 (5808); 8S359; 7S366; 7S363, 7S260; 7S258; 410 and many others. Zenith chair-sides: 8S451; 7S343; 6S241 bar radio; 6S239. If you are looking for a set not listed, please call for more info. We can and do ship consoles anywhere and we do it right. Zenith table models: 9S324; 5S228; 5S127; 5S226; 6D219; 6S330; 7S28; 7S323; 6V27, 6S27, 6S128; 6S222; 7S432; 807, 808 and many others, call. All radios unrestored electrically unless noted. Shipping extra unless noted. Satisfaction guaranteed, highest quality possible assured. Send for our free catalog showing restoration and shop supplies, owner's manual reprints, etc. When in Minneapolis, be sure to visit our retail location Great Northern Antiques, 5159 Bloomington Ave., just five minutes from the airport. We accept Visa and MasterCard. Alan Jespersen/Mike Emery, PO Box 17338, Minneapolis, MN 55417. (612) 727-2489 or fax only (612) 727-1908, ans. mach. after 4 rings. Our fax was malfunctioning and has been repaired, sorry. 8 am to 8 pm, 7 days

FOR SALE: All of this hi-fi gear looks and sounds great: Fisher FM-90 tuner - \$50; Dyna FM-3 tuner - \$50; Sansui 250 receiver - \$85; Pioneer SX-34B receiver - \$85; Pilot FM-602 receiver - \$105; Heath AA-32 amp - \$50; Knight KN-928 amp - \$35. Plus shipping. Carl Blomstran, 2107 Heather Green, Houston, TX 77062. (713) 486-5262

FOR SALE: Radio sale! Must clean out: Atwater-Kent Model 32, complete - \$125 OBO; Admiral Model 5J21N - \$25; Philco Model 42-220 - \$35; Philco 48-141 - \$20; RCA 8-X-541 - \$17.50. Many other inexpensive radios. Also tube tuners. SASE for list. Charles D. Blair, 815 N. 5th St., Cambridge, OH 43725. (614) 432-4453, 9-5

FOR SALE: Transistors, beautiful condition: Penney's (Toshiba) 6TP-243 red/white; Admiral Y2229 aqua w/ original box; Motorola X21; Bulover Super 6; King 2-transistor boy's radio blue/white. Adam Schoolsky, 15149 S.W. Cabernet Dr., Tigard, OR 97224. (503) 579-1080. E-mail: Adam@ArtDeco.com

FOR SALE: PRT4/PRR9 hand-held transmitter & helmet receiver, complete with manuals, accessories & batteries, operated on 51MHz. S&G Electronic, 618 S. 62nd St., Philadelphia, PA 19143. (215) 474-7663

FOR SALE: Remco Caravelle transmitter receiver radio in original box, complete with mic and code key, fine cond., Style 120, made 1960? - \$100. Crosley Mod 23 AR, 5 push buttons, 3 knobs, wood grille, gd. cond. - \$65. Dahlberg coin-oper. radio, 10¢ play, fine cond., restored with new capacitors - \$100. Harman Kardon mono-stereo amp, The Award Series A-30K, works fine - \$50. Pilot AM-FM tuner FA 540 - \$30. Harman Kardon AM-FM tuner 1040 theme 2, copper case - \$40. Cabinet only for David Gimbles Baby Grand Duplex, fine cond. - \$50. Joseph Gambaccini, 192 Division Ave., Shelton, CT 06484. (203) 924-0271

FOR SALE: Hammarlund clock, circa 1931-32 - \$275. 1937 Crosley Model 628-B, very good - \$100. Midwest 16 tube console, model? - \$400. Admiral console, (like Tilt Tuner p. 48 in F.O.S.) - \$450. RCA Globe Trotter 66BX - \$60. X-mtr tube nite light, approx. 12" tall - \$75. Philco radio bar w/most glasses - \$500. Royal 500's, 888's; Motorola 56T1 - \$150. Hoffman BP-709XS - \$150. Emerson 744B, red - \$300. All plus S&H UPS. Merritt Livingston, 4709 N.W. 76 St., Oklahoma City, OK 73132. (405) 722-7034

FOR SALE: Cathedrals and more! Philcos 37-84; 60; 80; 81; 89. Also have an interesting home diathermy machine Short Wave in beautiful shape with original FCC certificate for 11-28-42. Best offers? Michael Crain, 3 Hillside Ave., Harveys Lake, PA 18618-9782. (717) 639-2794

FOR SALE: Thousands of radios! Approx. 50 dealers will be selling at Cabin Fever Swap Meet in Columbus, Ohio, on January 27th. Come and join us. Call or write for info. Sharon Fullerton, 2327 E. Livingston Ave., Columbus, OH 43209. (614) 237-2621

FOR SALE: Really nice, working, Zenith Trans-Oceanic 3000 with book - \$145. U-ship. WANTED: R7000. Stephen E. Lipsky, W2VVN, 1254 Cox Rd., Rydal, PA 19046-1207. (215) 884-1817

FOR SALE: Professionally produced reprint of Gilbert Radio Apparatus, 1919, 64 pages, written by Clarence Tuska, Assoc. IRE. For your copy, send \$10.95 plus \$2 for shipping to: James Fred, R1, Cutler, IN 46920. (317) 268-2214

FOR SALE: Two-tube audio amplifier kits, breadboard-style pine base with plywood front panel, power switch, volume control and 4" speaker, octal tubes operate on D cell and (5) nine-volt batteries, works with one-tube regen. or crystal set, any radio normally requiring headphones, complete kit includes detailed assembly manual, everything except batteries - \$80 ppd U.S.A. only. Mail only please. Gregg Scholfield, 172 Ring Rd., Dayton, NV 89403-8013

FOR SALE/TRADE: Western Electric 5A oscillator, NT. Zenith 3000-1 T-O, near mint; Zenith R600 T-O, excellent and complete; Scott 299C (7591's good) stereo amp; home-brew crystal set; Hickock 600A conductance tube tester, working; Western Electric 104AA output transformer. Prefer trade for battery sets, speakers, but will sell. Dave Gonshor, 7121 S. Jellison St., Littleton, CO 80123. (303) 979-9511

FOR SALE: Zenith Royal 265, nice, works - \$20. Motorola PB500 FM tester, 1950, untested, no manual - \$35. Both postpaid. Milt Fairvre, K4EBT, 1445 2nd Rd., SW, Vero Beach, FL 32962. (407) 778-0648

FOR SALE: Akai M-8 tape recorder Crossfield (tubes), clean/excellent - \$85 + UPS. Mervyn Ellsworth, 2309 N. 25 St., Boise, ID 83702. (208) 345-6878

FOR SALE: Majestic 71 - \$150. Magnavox 1925T - \$135. Galvometer G.R.C. #129 - \$75. Write to: Paul Recuperero, 265 Union St., Portsmouth, RI 02871

FOR SALE: Shure microphone Model 555-B, untested - \$200/offer. B&K #465 picture tube tester chart - \$10. Don Mier, 4009 N. Foxdale Ave., Covina, CA 91722. (818) 338-9225

NEW AND USED TUBES WANTED

We urgently need the following tubes. All tubes must be well known brands such as GE, RCA, Sylvania, Tung-Sol, Phillips, etc. of US or W. Europe manufacture. New tubes must be in their original boxes. All tubes are subject to inspection. Ship by UPS (ground); we'll mail a check to you upon receipt and testing at prices shown plus your shipping charges. Call or fax for buying procedures and complete bid list. Call before sending more than 10 pieces of one type of tube.

NEW TUBES

01A	\$9.00	6F6G	\$5.20	12BH7A	\$5.10	274B(WE)	\$85.00	6146B/R298A	\$12.00
1L6	8.50	6G5/6U5	8.00	12DW7/7247	9.00	275A(WE)	85.00	6257/EF86	6.00
2A3	24.00	6K5G	5.00	20LF6	16.00	300B(WE)	250.00	6550A	12.00
2B6	6.00	6KD6	15.00	26LX6	6.00	350B(WE)	100.00	6550 (ST)	34.00
5R4GY/AB	3.40	6L6GC	8.40	35LR6	6.00	623	35.00	7189/A	5.30
5UJ4G	6.70	6LB6	7.50	45	30.00	808	16.00	7591A	20.00
5V4G	4.70	6LF66M/H6	18.60	50	110.00	805/331A	32.00	8005	50.00
5Y3G	3.80	6V6	6.00	71A	8.20	845	80.00	8068	20.00
6BKAC/6EL4A	8.00	6V6G	6.50	80(ST)	5.60	864	5.00	8908	27.50
6CA7/EL34	11.00	10	25.00	211(VT-4C)	35.00	5691	15.00	8950	25.00
6F5G	5.80	12A	11.00	274A(WE)	110.00	5692	18.00	M-2057	32.00

USED TUBES

01A	\$5.00	10	\$16.00	171A	\$7.00	245	\$23.00	845	\$31.00
2A3	12.00	12A	7.00	183483	9.30	246	11.00	7591	8.60
5AR4/GZ34	6.00	20LF6	7.30	210	20.00	247	8.00	8417	8.50
6B4G	6.50	42(GLOBE)	8.00	211(VT-4C)	14.50	250	65.00	8950	12.30
6LF66M/H6	9.20	45(VT-52)	25.00	230	6.20	280	12.00	V201A	6.50
6V6G	2.10	45	11.00	237	8.50	282	8.00	WD-11	35.00
		50	60.00	240	8.50	401-CARDON	9.60	WD-12	24.00

ANTIQUE ELECTRONIC SUPPLY™

LIMITED PARTNERSHIP

6221 S. MAPLE AVE. • TEMPE, AZ 85283 • (602) 820-5411 • FAX (602) 820-4643 or (800) 706-8789

FOR SALE: Transistors & novelties GE Mod 676, ivory, 1st GE transistor! fine, plays - \$100. Zenith Royal 500H, black with orig. leather case & earphone compartment fine, 2 initials on back cover - \$125. Mini Coca Cola cooler radio, new in box, red - \$35. Blabber Mouse on cheese radio, mouth moves with music - \$30. Joe radio with GI Joe headphones - \$30. Emerson Wondergram mini portable phono in original leather case, looks & plays fine - \$120. Joseph Gambaccini, 192 Division Ave., Shelton, CT 06484. (203) 924-0271

FOR SALE: Private Ear, maroon, mint - \$500; Sony ICR-200, orig. box & outside box with paperwork and charger - \$225. Plus postage. Sharon Fullerton, 2327 E. Livingston Ave., Columbus, OH 43209. (614) 237-2621

FOR SALE: Test equipment: Heath TC2 tube - \$25; T-3 visual-aural signal tracer - \$30; AF-1 audio freq. meter - \$20; 0-10 oscilloscope - \$30; AO-1 audio osc. - \$25. Eico 944 yoke tester - \$10. Chuan Hain Electric Works voltage control - \$10. Jackson 655 audio osc. - \$20. Bell & Howell digital multimeter - \$30. Plus shipping. Stan Kotschi, 1421 W. New York Ave., Oshkosh, WI 54901. (414) 426-1912

FOR SALE: Hallicrafters S20R - \$75. Hallicrafters S38 - \$45. RCA Globetrotter radio - \$15. Zenith R500 - \$65. Grundig portable 57U - \$75. Heathkit SW717 - \$25. RCA 54B1 portable - \$15. Clarion 220 tombstone - \$75. Marantz TT140 record player - \$20. RCA 21 radio - \$40. Bogen M60A 60-watt amp - \$75. Valley vibrator-type battery charger - \$15. RCA 4QR64X German-built radio - \$100. Grundig Majestic 3192 - \$100. Magazines: (10) QST, 1948 to '65 with (4) single-side band - \$15. 4" stack of TV & transistor training sheets - \$10. (8) Radio News, 1952 to '67 - \$5. (9) Popular Electronics & others, 1961 to '65 - \$9. (10) transistor radios, all work, no cracks, no batteries - \$35. **WANTED:** Tube cap for Neutrowound radio & dial escutcheons for Philco 111 & Model 6D. Walt Wrabek, Rt. 4, Box 370, Menahga, MN 56464. (218) 564-4623

FOR SALE: N.I.B. RCA 6550's - \$30 ppd. **WANTED:** 1960's Allied or Lafayette catalogs. Ray Kushnir, 216 S. Union Ave., Pueblo, CO 81003. (719) 543-8752, evenings 6-10 MST

FOR SALE: Microphones; Altec 632C, 633A salt shaker, Shure 430 Commando - \$45 ea. Display stands - \$15 ea. Kent Elliott, 3143 W. 46th Ave., Kansas City, KS 66103. Voice/fax: (913) 677-1824

FOR SALE: N.O.S. power transformer, Chicago Transformer #PCC 250 - \$50. Other trans. and chokes available. Ron Storm, 1916 Spruce Pl., White Bear Lake, MN 55110. (612) 429-1625

ANTIQUE VACUUM TUBE DATA BOOK
For the years 1918-1944
56 pages; 960 types
Includes Receiving tubes
Transmitting tubes
Klystrons, Magnetrons
Cold Cathodes, Thyrotrons
VT-Comm cross reference
Testing-Restoration Data
Deluxe 8x10 flip pages
FREE 1st Class Shipping World Wide
\$10 USA Can. \$12 Mex. \$14 Foreign
R. J. Buchan 28490 Portsmouth Drive
Sun City, Ca . 92586 U.S.A.



FOR SALE: Many VTVM's Heathkits, RCA, Knight-kits, etc. SW3 plug-in coil forms, WD-11 plug-in replacement tubes, WD-11 adapters, and WD-11 bases, 1996 color catalog \$3 ppd, audio trans. James Fred, R1, Cutler, IN 46920. (317) 268-2214

FOR SALE/TRADE: Rare BC-186, WWII receiver believed used for clandestine, covert operation, four ST tubes; RF amplifier, regenerative detector, two audios; uses two standard plug-in coils (four and five pin) to cover 2.7 to 3.8MHz, easily extended; operates from dry batteries, has meter, highly shielded; measures 10.875" w, 7" h, 6.875" d. Will trade for full-up SW-3, pre-1925 receivers, or sell for \$450. Stephen E. Lipsky, W2VVN, 1254 Cox Rd., Rydal, PA 19046-1207. (215) 884-1817

FOR SALE: Adams Morgan Paragon 4, (Douglas V1, p. 15), a nice example of its 1924 4-tube receiver, complete - \$335. Kodel's 1924 4-tube small receiver in leatherette cabinet - \$145. Cutting & Washington 15, a 1923 one-tube receiver including the UV-199 tube - \$525. Western Electric Navy receiver Model CW-389, lots of brass, meters, nameplate tags, includes (2) WE 216-A's, (2) VT-1's and a TT brass type 12 tube, price is - \$5,900 for this rare and beautiful piece (which is about half the selling price at Dearborn). Neutrowound, 1928 model, totally complete with tubes and original tube shields - \$785. Crosley Model XJ, (Douglas V1, p. 118), from my personal collection, the actual set used in Douglas' book, extra nice condition, and it plays! - \$225. RCA Radiola 60, was playing last time I knew, might need a little TLC to bring it back to original, but all there - \$125. Murdock loose coupler - \$185. Freshman Type A, their very first, complete - \$50. Freed-Eisemann NR-6, highly under-rated set, dusty but complete, nice panel - \$90. Magnutrol (V.R., p. 135), a quality-built 3-dial 5-tube TRF receiver - \$95. Leave a message at (508) 888-6236. I'll return your call if I still have the item. Thanks, and Happy New Year! Dave Crocker, 6 Raymond St., Sandwich, MA 02563.

FOR SALE: Saba Freiburg 400-18, rare, vgc - \$650. Saba Freiburg 7, vgc - \$425. Zenith 9S262 console, vgc - \$325. Zenith 770 console, vgc - \$225. Royal 3000-1, vgc - \$160. Royal 500H, gray/ft. grey, vgc - \$185. Royal 500N, dial lights up, exc - \$65. Royal 50, gray/white - \$40. Jeffrey Weber, 8507 Mohr Ln., Fogelsville, PA 18051. (610) 285-2421

FOR SALE: Antique collection. More than (50) radios include RCA 66X3, Satchell-Carlson Dorophone, Crosley E15WE, Philco 38-12, Coronado 908, Zenith 6D2520, Atwater Kent 70 with original manuals, etc. Send addressed envelope for list. Alfred Welch, 2248 S. 33rd St., Milwaukee, WI 53215. (414) 383-9908

- • • • •
• **OLD TIME RADIO BROADCASTS**
• **ON CASSETTES**
• Many of your old time radio favorites are
• available on quality cassettes at a reasonable
• cost. You select the shows you want and purchase
• them by the hour. Fast, friendly service
• too. Send for our catalog listing over 5,400
• shows arranged by show category & title,
• many including original broadcast dates.
• Only \$2.00 (P & H). Send request to:
• **ERSTWHILE RADIO — P.O. BOX 2284**
• **PEABODY, MA 01960**
• • • • •

FOR SALE: Guild Town Crier 380T - \$200. Zenith K731 - \$50. GE 507, red - \$100. Philco 41-220 - \$75. Hallicrafters 1000 - \$75. AK 4850-5150 chassis - \$40. Plus shipping. Stan Kotschi, 1421 W. New York Ave., Oshkosh, WI 54901. (414) 426-1912

FOR SALE: Regency TR-29, similar to TR-6. Large 33kv oil-filled transformer from early diathermy machine. Hammond Novachord, 1939 electronic musical instrument. Solavolt constant voltage transformer with 7.5 amp variac, 0 to 135v, output. Leslie organ amplifier with 15-in. dynamic speaker. J.&A. Television composite video generator Mod 30G1. Gen. Rad. UHF signal generator Mod 1021, 50-250MHz and 250-920MHz. Gen. Rad. one-meter slotted line with accessories. Princess telephone F-51910. Bearcat 210 scanner. All items best offer. Ken Voyles, 7425 Brushmore NW, N. Canton, OH 44720. (216) 494-5648

FOR SALE: Audio Research SP3A-1, needs fixing - \$175; & phase linear 400, needs fixing - \$75. Agreed? Renee May, 1242 N. El Centro, Los Angeles, CA 90038

FOR SALE: N.I.B. Cannon-Ball radio headset - \$30. N.I.B. Radio Clearatuner, helped get distant stations - \$50 or BO. Heathkit signal generator, Model SG-8, untested - \$20. Knight, sweep generator 0-240 meg./cycles - \$30. All plus UPS. Stephen L. Bonino, 107 Georgetown Rd., Glassboro, NJ 08028. (609) 881-0244

FOR SALE: New jukebox reproduction radios, 1960's style and 1950's diner wall box in chrome-type finish - \$85 ea. plus \$15 shipping. Both have cassette and AM/FM. Maurer TV, 29 S. 4th St., Lebanon, PA 17042. (717) 272-2481

FOR SALE/TRADE: Elements of Radio, complete edition & Elements of Radio, third edition (this has inverted cover), both by Marcus & Marcus - for cash or N.I.B. 6U5 tubes. A. Bruno, 24 Butternut Dr., New City, NY 10956. (914) 354-8899

FOR SALE: Original owners manuals Zenith D7000 - \$20 ea. Prof. copies - \$7 ppd. Kelly Nichols, Rd. 1, Box 103K, Greenwood, DE 19950. Fax/phone: (302) 349-5059

FOR SALE: Novelty radios: Harp, B Plate 410, vvg, black - \$65; Piano, B Plate 427, vvg - \$85; Gas Pump, B/B 560, M.I.B. - \$85; Gumbo, exc cond. - \$100; Cabin Cruiser, B Plate 39, mint cond. - \$80; Field radio, M.I.B., (Spirit of St. Louis Line) - \$65. Spirit of '76, exc cond., B Plate 231 - \$60. Statue of Liberty, B Plate 227, N.I.B. - \$65. Liberty Bell, B Plate 514, vvg - \$60. Please add postage. Kay Botzum, R.D. 3, Box 419, Morgan-town, PA 19543. (610) 286-0047. Or Fax: (610) 286-5315

FOR SALE: Drake TR-4CW/RIT+MS4 - \$375. Heathkit Twoer - \$30. Hallicrafters SR-150+WPS150 - \$200; SX-96 w/R46B speaker - \$200. John Malley, 19 Claremont Ave., Enfield, CT 06082. (860) 745-0733

FOR SALE: Tubes, parts, radios, Orion TR8A7, RCA T-1EH, O.M.G.S., Toshiba 8TP-686F, Zenith Royal 50. LSASE, 19 pp. W.F. Horn, 13110 Marsh Rd., Bealeton, VA 22712. (540) 439-9781

FOR SALE: Hallicrafters S-85, good working set - \$60. Ship speaker, very nice - \$195. WANTED: Thorla base, Utah, Thomson and Manhattan horns, (8) thumb-nuts for Crosley binding posts, (2) Crosley 51 or 52 dial knobs. Thanks. Bob Barnes, 511 N. Chestnut, Monroe City, MO 63456. (314) 735-2945

FOR SALE: N.O.S. tube: (8) Raytheon 171-A globe, Raytheon embossed on plate - \$30 ea. (10) Hytron 71A - \$15 ea. (4) Sylvania 26 - \$10 ea. (1) N.U. 50 - \$100. (4) RCA 2A3 - \$50 ea. (8) Raytheon 6LQ6/6JE6C - \$25 ea. Jim Traynor, 3198 Boudinot Ave., Cincinnati, OH 45211. (513) 662-4344

FOR SALE: Zenith AZ33, black and silver - \$35. Zenith H725, lt. blue grey - \$35. Zenith H511PH Consol-Tone, black, one knob missing - \$20. GE 547PH, ivory clock radio, one knob wrong - \$15. Jack Haslup, 17320 N. 77th Way, Scottsdale, AZ 85255. (602) 502-5791

FOR SALE: Short Wave Manual, 1934 - \$15. Radio Short Cuts, 1940 - \$6. Short Wave Log & Call, 1934 - \$12; Log & Lore, 1934 - \$10. Gernback's Radio Encyclopedia, 1931 - \$20. Mallory-Yaxley, 1937 - \$20. Rider AFC - \$10. Morgan Wireless, 1915 - \$20. Heath flyer 1952 plus (3) Eico's - \$10. Allied, 1968 - \$15. Lafayette, 1942 - \$12. Ward's, 1940 - \$15. Sears 1940, '41 - \$15 ea. Federated, 1938 - \$10. Fadolek, 1941 - \$10; 1942 - \$5. Allied 1967 - \$10; 1933-1942 - \$15 ea. Robert Shuck, 10512 Winston Ln., Fishers, IN 46038. (317) 849-0381

FOR SALE: Midwest CB54 cathode beamer, CRT analyzer/rejuvenator - \$25. RCA Senior Voltomyst WV-98A, needs work - \$10. Bearcat III scanners - \$65/3. 1970 Radio-Electronic Master - \$10. RCA tube handbooks HB3, one covers cathode ray tubes, other one covers miscellaneous and industrial tubes, Thyra-trons and photo sensitive devices - \$15 ea. James Homan, 401 Valley Dr., Valley Springs, SD 57068. (605) 757-6424

FOR SALE: McIntosh 2505 power amplifier - \$475. AR turntable - \$75. American-made Marantz Model 30 preamp, amplifier, walnut cabinet - \$235. JBL D-130 speaker frames - \$40/pr. (2) AR turntables for parts - \$30. Dyna PAT-4 - \$50. Michael Russ, PO Box 1077, Strathmore, CA 93267. (209) 568-0345, Sundays

JOIN THE

AWA

ANTIQUE WIRELESS ASSOCIATION

THE ORIGINAL AND LARGEST HISTORICAL RADIO-COLLECTOR GROUP

- Publishes *Old Timer's Bulletin* with:
 - Battery and AC receiver restoration
 - Vacuum-tube history and collecting
 - Old-time amateur-radio contests
 - Communications receivers
 - Free want-sell-swap ads
 - Early television
 - Horn loudspeakers
 - Reviews of current books
 - Keys and land-line telegraphy
 - News of U. S. and foreign clubs
 - Information on public radio museums.
- Maintains unique radio-TV museum.
- Produces the annual Rochester meet.
- Co-sponsors local meets.
- Publishes the annual *AWA Review*.

Membership is only \$12.00 per year (\$22.00 for two years). Mail check to:

Antique Wireless Association, Inc.
Box E, Breesport, NY 14816



FOR SALE/TRADE: Midwest Miraco Mod MA-4, (see Douglas, p. 176 bottom left corner) - \$525. Radiola Mod 5 with crystal detector on panel in working condition - \$700. Universal, 4-tube rcvr, circa 1920's, rare - \$1,200. Crosley Ace Mod 3-B w/3 WD-12 tubes - \$475. Workrite George Walker multi-unit set, 1 tube, with coil and coil adapter plug, (see Douglas V3, p. 245) - \$275. Larry Drago, 383 Lincoln Dr., Cheshire, CT 06410. (203) 272-6030

FOR SALE: Excellent gift idea: 77DX tie tacks/apel pins. These are salesman giveaways. If you are a collector of mikes, a radio or TV nut, an on-air personality, or heaven forbid a station owner, these are for you, from the blue network - \$25 ea. Sure 55 pins - \$20. RCA 44 pins - \$20. Don't hesitate, brass 1 1/2" tall RCA logo. Jon Prabel, 2733 Wood Eagles, St. Charles, MO 63303. (314) 947-1543

FOR SALE/TRADE: Philco 16-B tombstone, two-tone, black & walnut cabinet, near mint - \$500. RCA 810-T Superhet tombstone - \$200. Silvertone Mod 6319, ivory - \$175. Silvertone Mod 6178 bullet, ivory w/red knobs \$375. Larry Drago, 383 Lincoln Dr., Cheshire, CT 06410. (203) 272-6030

FOR SALE: Genelex tubes: (4) KT-66 measure 52-54 on TV-7A, (4) KT-88 measure 56-58 on TV-7A - \$1,500 OBO. Plus shipping. Stan Kotschi, 1421 W. New York Ave., Oshkosh, WI 54901. (414) 426-1912

FOR SALE: Superior Model TV-11 tube tester - \$35. B&K Dyna-quick Model 600 tube tester - \$30. Conar RF signal generator Model 280 - \$35. Elbert Marshall, Rt. 2, Box 239, Hillsville, VA 24343. (540) 398-2283

FOR SALE/TRADE: 1924 Connecticut Tel. and Tel. Telegraph Set for Boys in original box with literature; contains a pair of professional looking mahogany boxes w/brass keys and sounder on top w/original battery inside - \$375. Larry Drago, 383 Lincoln Dr., Cheshire, CT 06410. (203) 272-6030

Introducing Exciting New

ZENITH Grille Cloths

Authentic reproductions
based on original patterns
using original materials

- 3 NEW Zenith designs for 1939-1941 consoles. The 'block' and 'swirl' patterns from 1938 are coming very soon too.
- NEW Philco ribbed pattern made from cotton exactly like the original joins 7 other patterns for models 7090B; 60B; 80B; 84B. We also have a great "V" pattern.
- NEW 1937 Stromberg cloth available now.
- Need RCA 100A speaker cloth? Try us.
- 2 styles of Emerson cloth for those Ingrahams.
- This is the exclusive home of 1937 SCOTT cloth.
- New patterns created every month.
- Satisfaction or money back guarantee.
- Free installation instructions with every order

Send a 55¢ LSASE for samples to:
John Okolowicz, N3VSR
624 Cedar Hill Rd.
Ambler, PA 19002
E-mail: 70313.2564@Compuserve.com

FOR SALE: Speakers: AR-3 - \$300; ARLST-II - \$400; Bozak B302 - \$300; Bozak C5310B - \$2,500; KLH 9 - \$2,000; KLH 20 - \$40. Plus shipping. Stan Kotschi, 1421 W. New York Ave., Oshkosh, WI 54901. (414) 426-1912

FOR SALE: Brunswick combination Panatropé with radio, excellent original, (see Douglas, p. 94) - \$175. Bob Eslinger, 20 Gary School, Pomfret, CT 06259

FOR SALE/TRADE: RCA 77DX microphone - \$750. RCA Western Electric 639 microphone - \$525. RCA BK-1, N.I.B. - \$350. Shure Mod? is larger than 5-B - \$225. RCA Victor 45 rpm w/radio, The Skipper in beige and coral, Mod 6-BY-4, battery operated, with original manual - \$200. Larry Drago, 383 Lincoln Dr., Cheshire, CT 06410. (203) 272-6030

FOR SALE: The biggest VTVM I have ever seen, Precision EV-10 - \$45. Hickok 288X crystal-controlled signal generator - \$55. Plus shipping. Carl Blomstran, 2107 Heather Green, Houston, TX 77062. (713) 486-5262

FOR SALE/TRADE: Magnavox AC-2C (2 stage/2 tube) speaker amplifier, (see Douglas V2, p. 135), in beautiful/working condition - \$500. Music Master horn speaker Mod VI w/wood bell - \$275. Larry Drago, 383 Lincoln Dr., Cheshire, CT 06410. (203) 272-6030

FOR SALE: Grebe CR-9, nice - \$650. DeForest D-12 chassis complete except for xtal det. - \$250. Motorola VT-73 TV, brown leatherette, vg, no ant. - \$125. Radiola 104 spkr, good - \$50. Radiola 18 cab. refinished, with hdw., no hood - \$40. Magnavox electrodynamic spkr, v. nice cab. - \$75. Jewett Superspeaker, fair - \$75. Ozarka Model 89 metal box set w/tubes - \$100. RCA 630 TS, fair - \$75. Radiola 104, exc tapestry - \$250. RCA Victor Radio and Television outdoor sign 6'x3', exc - \$250, can deliver to meets. Buddy Boy, good - \$450. Sentinel suitcase 7" TV, good, one knob missing - \$100. UV-199's, good emission - \$20. UX-199, good emission - \$12 ea. Shipping extra on all above. Philco tuning condenser grommets, exact fit - \$5 ppd. Buddy Boy celluloid dial replacements - \$10 ppd. Don Patterson, 636 Cambridge Rd., Augusta, GA 30909. (706) 738-7227

FOR SALE: GE P808 box, never opened, mint; Westinghouse T-141A, H-830TS, H823L5, H803TS, N.I.B. Zenith Model G725, good, works; Philco 41-280 and 42-390 pickup only. Philco tombstone 39-80. Atlas battery transistor, Polaroid 600 radio. Radio Shack Navaho CB station Model TRC-492, mint. 12-volt or 120-volt transmitting tube #304TH-VT254, N.I.B. Audiovox Super 67 hearing aid. Dean Tanis, 14115 Western, #245, Blue Island, IL 60406. (708) 396-2883, leave message

FOR SALE: Collins R-368 with (3) mechanical filters - \$390. Radiola III with WD-11's, nice - \$145. UTC CVP-5 multi-match modulation transformer, unused in box - \$40. Wm. Ernst, 16300 Campbell Rd., Comins, MI 48619. (517) 848-5002

FOR SALE/TRADE: Connecticut Telephone & Electric rare telegraph set in original box w/manuals - \$375. Conn. Tel. & Tel. ring microphone, w/springs, 1922, very rare - \$400. Larry Drago, 383 Lincoln Dr., Cheshire, CT 06410. (203) 272-6030

FOR SALE: RCA 103 tombstone - \$75. GE M50 M51 - \$65 ea.; A52 - \$75. Don Reinsma, 610 Nix Rd., Pensacola, FL 32506. (904) 455-7721

FOR SALE: Nivico AST103EH (JVC) amp - \$25. Ampex 620F amplified speaker - \$100. Marantz Model 18 (U.S.A.) parts unit - \$50. KLH 16 - \$25. Plus shipping. Stan Kotschi, 1421 W. New York Ave., Oshkosh, WI 54901. (414) 426-1912

FOR SALE: Emerson: 515 Bakelite - \$40; 911 transistor/case - \$20. Stewart-Warner R-113 SW converter, early 1930's - \$75. Setchell-Carlson, pin-up calendar 1957 - \$50. Heathkit amp EA-1 recapped, new tube - \$50. Hallicrafters S-119 Sky Buddy II - \$45; SX-42, nice - \$325; S-20R as is - \$50. Hammarlund SP-400-X w/ spkr, clean - \$225. PAR 438 cm marine rcv PAF type - \$50. William McCuskey, Box 140, LaConner, WA 98257. (360) 466-4683

FOR SALE: From an early home-built radio; Atwater Kent mounted variometer, looks good - \$95. Nice working Philco Transitone 53-566, similar to the 52-548 (shown on p. 168, Bunis 3), except in burgundy color - \$70. Juliette 2.9" reel tape recorder, 2.5"x3.4"x7.3" chrome case, looks nice - \$25. All plus shipping. Ray Engel, 11061 North Evergreen Dr., Birch Run, MI 48415. (517) 652-8944

FOR SALE: N.O.S. U.S.A. tubes: 7027A (2) - \$60; KT88 - \$135; 8417 (2) - \$60; 6L6GC - \$18 ea., 6EU7 - \$9; 7868 - \$20; 12BH7 - \$8; 12AT7 - \$5; 6GM5 - \$14; 12AY7 - \$6; 6BQ5 - \$6. Roland Barbeito, 19 Murray Ave., Westfield, MA 01085. Phone/fax: (413) 572-4745

FOR SALE: Seeburg library model jukebox blonde wood cabinet with Seeburg metal cage amp - \$800 including shipping. Fada Model 845 table radio, yellow w/red knobs - \$425. Top Flight 2 transistor boys radio - \$65. Bill Constantine, PO Box 493, Glens Falls, NY 12801. (518) 792-7065

FOR SALE: Rider's Radio Manuals, (7) volumes, 6 thru 12 - \$135 plus shipping. Jeff Hoskins, 834 E. Madison Ave., Stuart, FL 34996. (407) 283-2291, after 7 pm

FOR SALE: Needles, Pfanstiehl & other brands, over (1,500) N.O.S. Call or write your requirements with model or cartridge numbers. Bob Lynn, 26 E. Orchard St., Somerville, NJ 08876. (908) 685-9070

FOR SALE: Tired of high tube prices? Check out my list of over (1,000) types of new tubes. Prices start at just 25¢ ea. **WANTED:** 7027A's and Lafayette KT-600, any condition. Charles D. Blair, 815 N. 5th St., Cambridge, OH 43725. (614) 432-4453, 9-5

FOR SALE: These are all great looking and working transistor radios: Zenith 500H, black - \$85; Emerson 911, black - \$30; turquoise - \$40; Rensie clock leather - \$20; RCA 1RJ10, black - \$15; Grundig SAT-6000 - \$95; Airline BR-1100A - \$140. Plus shipping. Carl Blomstran, 2107 Heather Green, Houston, TX 77062. (713) 486-5262

FOR SALE: Radios: Emerson Model 707-B Sun-burst, 5-tube. Stromberg-Carlson with carry handle, 6-tube. Sentinel Model 338, 5-tube. Bendix Model 526B with carry handle, 5-tube. Arvin Model 481TFM. Price, details - SASE. Elbert Marshall, Rt. 2, Box 239, Hillsville, VA 24343. (540) 398-2283

FOR SALE: Hallicrafters Model S-38D - \$50. S-38E - \$40. SX-43 - \$75. S-118 - \$50. S-120 - \$40. Restored S-22-5 - \$75. **WANTED:** Plastic dial trim for GE G-75. Cabinet for Philco Model 20 or 20 Deluxe. See last months adv. under Wanted. Larry Porter, 4115 Beam Rd., Crestline, OH 44827. (419) 683-2540

FOR SALE: Philco 95 chassis. **WANTED:** Viking 91 (Oct. A.R.C., p. 5) tuning gang, chassis, or parts set. Curt Schreiber, 3923 East Latoka St., Springfield, MO 65809. (417) 887-5184, collect

FOR SALE: Broadcasting, recording, theater & hi-fi audio. Microphones. **WANTED:** Philharmonic chassis, good chrome. Garrard prewar changer. Robert Van Dyke, 2 Squires Ave., East Quogue, NY 11942. (516) 728-9835

FOR SALE: Western Union Radio Station Naval Observatory square case clock. Weston test instruments. Electrical book list. Shipping additional. Henry Weiland, 8946 W. Grantosa Dr., Milwaukee, WI 53225. (414) 463-4681

FOR SALE: Scott 299B, excellent - \$100. George Stringe, 3075 Moorhead Ave., Boulder, CO 80303. (303) 494-9261

FOR SALE: Jackson Bell 62 roof-top swan grille cathedral - \$295. Radiola III - \$75. Minerva by Sleeper - \$40. Federal Jr. - \$395. Federal 110 - \$450. DeForest F-5 - \$250. Crosley Ace - \$135. Day-Fan 5106 & 5046 - \$75 ea. Scott Allwave 15 in Lido cabinet - \$1,400. Victor RE-75 - \$350. Victor O horn - \$195. Victor IV - \$1,500. Edison Standard Model E with S reproducer - \$595. Cylinder record cabinet 5 drawer - \$295. Cylinder records - \$4 ea. Large all brass cylinder player horn - \$95. Colombia mahogany tabletop player - \$95. **WANTED:** Record loading spindle for Victor 10-50, corner column for Victor III. John Hayes, 27 Highland Dr., Henniker, NH 03242. (603) 428-3053. Fax: (603) 428-8315

FOR SALE: Astatic 89-T cartridges in tonearms, N.O.S.B. - \$4. Tubes, N.I.B.: 4D32 - \$39; 3RP1 (CRT) - \$21; 83, 7587 - \$9.50; 5670W (2C51W), 12SL7GT, 5755 (420A) - \$1.50. Lowell Thomas, PO Box 15026, Fresno, CA 93702. (209) 277-1605

FOR SALE: RCA advertising signs, beautiful one-of-a-kind 1930's front window display! Adam Schoolsky, 15149 S.W. Cabernet Dr., Tigard, OR 97224. (503) 579-1080. E-mail: Adam@ArtDeco.com

FOR SALE: Fada Catalin case, small chip on bottom - Make Offer. **WANTED:** Zenith blonde porthole console TV Model #28T960E Waldon basket weave front, or Wilshire mahogany model. Phil Fabrizio, 15 Walnut St., Clifton Hts., PA 19018. (610) 623-5090

FOR SALE: Large collection radios, early TVs, and test equipment. Airline, Bendix, GE, Motorola, Philco, RCA, Atwater Kent, Belmont, and many others. For free list, send SASE to: William Johnson, 573 W. Park Ave., Oakhurst, NJ 07755

VACUUM TUBES

20's - 50's N.O.S. & USED

Reasonable Prices — Free List

ANTIQUÉ TRIODE
BOX A2, FARNHAM, N.Y. 14061

Fax/Phone (716) 549-5379

FOR SALE: Trans-Oceanic Royal 3000-1, works, complete, very clean! - \$125. This one won't last. Claude Chafin, NØFMO, 4223 E. 42nd Way, Independence, MO 64055. (816) 478-4518

FOR SALE: Nordemende Globe Traveler IV, radio has been updated, fantastic sound - \$350 + shipping. Gerald Silver, 10863 W. Clairmont Cir., Tamarac, FL 33321. (305) 720-1972

FOR SALE: Simpson 313 - \$125. GE portable - \$75. Admiral portable TV - \$75. Pickup only! Dewey Shaffer, R.D. 2, Box 104-B, New Paris, PA 15554. (814) 839-4728

FOR SALE: Toshiba baseball 6TP515, no stand - \$50. RCA 6T2, nice - \$100. Phico 46-451 - \$50. SASE for radio list. Glenn McCrory, 924 W. 6th St., Storm Lake, IA 50588. (712) 732-5588

FOR SALE: Secret CB Vol. 1-17 - \$150. WEKA Electronics Repair Manual - \$30 + UPS. G.G. Polcz, 2800 W. Berwyn Rd., Muncie, IN 47304. (317) 289-9363

FOR SALE: Radiola VIII Super VIII, needs work - \$200, you pick up. Tom Tamberelli, 106 Carpenter St., Muncy, PA 17756. (717) 546-6515

FOR SALE: Communications receivers: McMurdo Silver 5-C, nice - \$500; Drake R4C w/MS-4 speaker, mint - \$400, plus UPS. Merry Xmas. Chuck Bray, 1322 Ivy Rd., Bremerton, WA 98310. (360) 373-1013

FOR SALE: Red 6512 mint Chango Master - \$20. Quack device Williams oak box - \$20. 60's Realtone multiband - \$40. Joe Nocera, 1222 Finch St., New Castle, PA 16101-4840. (412) 658-7805

FOR SALE: Copies: Schematics for radios, also kit radios 1922-1950. Manuals: Test equip., ham gear, etc. Contact me for prices, availability. Duane Ballew, KB7QZK, 6813-152 St. Ct., NW, Gig Harbor, WA 98332. (206) 851-4505

Wanted

(Top Prices Paid)

1. Western Electric Tubes, Amps, Drivers, Horns, Speakers, Parts, etc.
2. Tube-type amps from Marantz, McIntosh, ARC, Quad, Leak, Dynaco, Fisher, etc.
3. Telefunken audio tubes & KT-66/77/88, etc.

Also Wanted... Vintage watches from Patek Philippe, Vacheron Constantin & Audemars Piguet

David Yo — Audio City USA
PO Box 80371
San Marino, CA 91118-8371
Telephone: (818) 441-3942

FOR SALE: Atwater Kent breadboard Model 5 - \$5,500; Model 9 - \$1,475; Model 10A - \$1,075; Model 20 big box - \$110; Model 20 small - \$110; Model 30 - \$125; (2) Model 35 - \$55 ea.; Model 35 in Red Lion cab. - \$125; Model 40/spkr - \$60; Model 44/spkr - \$60; Model 53/spkr - \$95; Model 55/spkr - \$60. Colin B. Kennedy Model V - \$450; Model VI - \$500; Model XV - \$595. Crosley Fiver - \$150; Model 5/39/lid - \$145; Trirdyn 3/3 - \$90; Bandbox/spkr - \$140; Model Super 3 tube - \$80; Model 51 - \$110. Crosley Pup - \$450. Morse cathedral AC - \$170. Magnavox Model Jr. - \$80. Neutrolette 5 tube - \$60. Phico cathedral Model 17B, rare - \$465. Radiola Model IV, missing wooden top - \$425. Radiola Senior - \$185. Radiola Model III - \$105. Westinghouse RA/DA - \$295. (8) Radio collectors books (all Alan Douglas, etc.) and entire sack of old advertisements and flyers, plus A.R.C. for 5 years, and Radio Age for 3 years, all for - \$210. (25) 01-A tubes - \$225. Spare breadboard parts and other parts, all for - \$250. Speakers: (2) AK Model E - \$60 ea. AK Model H - \$120. (2) AK Model M - \$125 ea. AK Model E - \$65. Sylvania Royal wood/chrome base, nice - \$125. Crosley Musicone/tags - \$90. (2) Howe crystal set - \$120 ea. Red Philmore crystal - \$125. Philmore black/gold crystal - \$160. Betts and Betts crystal - \$85. Homemade slide crystal, very unusual - \$80. (3) transistor radios, a Junebug and others - \$100 for all 3. All radios are in excellent to mint condition. Prices firm. Would sell entire collection. Mr. Larry Voris, 2511 Belle Terre Dr., Statesville, NC 28677. (704) 878-6710

FOR SALE: Telegraph key novelty transistor radio, mint condition, works - \$195. Gary Jahneke, 5752 W. Monte Cristo, Glendale, AZ 85306. (602) 439-1553

FOR SALE: TV-7B/U tube tester - \$75 plus shipping. Richard Jendrucko, 458 Hillvale Turn East, Knoxville, TN 37919. (423) 523-7323

FOR SALE: Phico #70 cathedral, nice - \$275. Edison Standard cyl. phono - \$425. Emerson mantle midget - \$70. American Bosch 808P, butterfly grille - \$70. Rare Thomas Edison radio, Model R6, complete, unrestored - \$250. Victor VVXI console phono - \$250. Phico #60 cathedral, nice - \$150. Silvertone metal 4-tube #8003 - \$55. Peerless cathedral spkr - \$35. RCA 101 drum spkr. - \$35. Spare Rider's 5, 9, 10, 11, 12, 13, 14 - \$15 ea. Call: Jahan L. Acciavatti, PO Box 231, Southborough, MA 01772. (508) 476-3229, eves.

FOR SALE: Isn't possible that every radio collector should have in his collection an original (made back in the 20's) home-brew 3-dialer. The one I have has (5) good 201A's and two Thordarson transformers, works fine. Lester Rayner, 5512 N. 71st Pl., Scottsdale, AZ 85253-5902. (602) 947-1375

I am not a dealer, but a serious collector and historian interested in all aspects of E. H. Scott.

Please contact me first if you are selling your E. H. Scott Radio, Selec-E-H-H Radio (tone Coils, World's Record Superhet, or Scott Transformer Co. items.

Always interested in any E. H. Scott stock certificates, literature, and military sets.

John T. Meredith
2462 Statonsburg Rd., Suite 152
Greenville, NC 27834 - (919) 551-1882

FOR SALE/TRADE: Dynaco Mark III amps - \$600 pr. Dynaco Mark II amp, all chrome - \$375. Scott Mod 355 AM & FM tuner preamp - \$375. Scott Mod 208 amp, 80 watt - \$500. Triad amp mono HF-10 - \$200 Two Bogen KO-100 amps (EL-34 push/pull tubes) - \$250/pair. H.H. Scott 99A Transcription amps - \$400/pair. Larry Drago, 383 Lincoln Dr., Cheshire, CT 06410. (203) 272-6030

FOR SALE: Thorens TD124 - \$225. JVC Direct Drive - \$20. Thorens TD126 - \$35. ARX-A - \$125. Many dual automatics cheap. Plus shipping. Stan Kotschi, 1421 W. New York Ave., Oshkosh, WI 54901. (414) 426-1912

FOR SALE: Excellent copies of the 1935, 1937 and 1939 Philco parts catalog - \$6/1; \$10/2; \$13/3. Carl Blomstran, 2107 Heather Green, Houston, TX 77062. (713) 486-5262

FOR SALE: Zenith end table console Model #12H851. RCA Radiola 18. Majestic 90B. Zenith Trans-Oceanic chassis & cases only. Other small radios available. Call for details & prices. Noel, S&G Electronic, 618 S. 62nd St., Philadelphia, PA 19143. (215) 474-7663

FOR SALE: Excellent stuff & working RCA 96X4 - BO. Drakes SW4A w/AL4 loop ant., original manual - \$450. SSR-1 w/manual - \$150. Coke cooler w/box - \$75. Bendix 753M - \$50. Crosley musical chef - \$55. Hallcrafters HW12A w/AC PS - \$100. HW12 & DC P/S - \$85. HA2 AC PS - \$125. All w/manuals. S-53A - \$65. Zenith 6-500 - \$110. JT 30 mike, N.I.B. - \$75. Fred Watson, KB8NRF, 581 W. Summit St., McClure, OH 43534. (419) 748-8798

FOR SALE: CRT 5AMP2-A. Boonton 207E, output 0.1 to 55MHz. Simpson 313 FET multimeter. Beckman 360 digital VOM. Ghirardi Modern Radio Servicing book. Phone only! Glen Richie, W4JGO, 643 Diamond Rd., Salem, VA 24153. (703) 389-3356

FOR SALE: Allied Radio Builders Handbook, copy, includes schematics for Ocean Hopper, Space Spanner, T-50 transmitter, etc. - \$8 ea. ppd. Jim Ford, NM1F, 194 Rocky Hill Rd., Plymouth, MA 02360. (508) 747-2224

FOR SALE: \$45 ea.: Dynaco SCA-80Q dynaquad amplifier, Jewel 560 radio service oscillator, mint; Zenith G1176X Spirit of '76 TV; tube CBS; General Radiotelephone Company MC-5; Heath CB-1 w/mic; RCA B-411 brown marbled portable, Guild Country Belle; Viscount AM/SW/phone. Transistors: Standard Micronic Rubies: SR-H436, vg I.B. - \$75; SR-G433 - \$45; Realtone TR-970 - \$35; Viscount 616 N.I.B. - \$20; CBS C-709 - \$25; Sony 3F61W, red, AM/FM - \$15. Fisher tube tuners: 50B AM/FM - \$35; FM-90X Gold Cascade AM/FM - \$55; FMR-1 AM/FM stereo mount rack broadcast monitor - \$175; Gates SA-39B tube limiter - \$245. Silvertone 7020 brown Deco metal - \$95. Firestone 4-A-70 midget - \$20. Always glad to trade for transistor radios! Send LSASE for long updated list of goodies! WANTED: Raytheon T-100 chassis or parts set. Hoffman Solar pink battery door. Happy New Year! Jon Hall, 39 Spring Oaks Ln., Ruckersville, VA 22968. (804) 985-3827, 8:30-10:30 pm. Fax: (804) 984-3299. E-mail: jon@halls.com

FOR SALE/TRADE: Philco Radio Neon & Etched Plate Glass sign, (see Philco Radio, Ramirez, p. 22) - \$675. Admiral neon sign, green color, 26" x 6", works beautifully - \$375. RCA 3' x 4' metal Radiotron Tube sign - \$225. Larry Drago, 383 Lincoln Dr., Cheshire, CT 06410. (203) 272-6030

FOR SALE/TRADE: Crystals in their original metal and wood container as follows: 1920 NAA (Galena/Newman and Stern Co.), (Crystal Clear, pp. 150 & 154), Philmore tested Galena (orange can), Westinghouse Radio Apparatus Co. Style 307450 (used in Aeriola Jr. and DB detector), 2 pieces, p. 156, Argenta/Star Crystal Co. (p. 156), Harris Lab tested crystal (p. 154), Super Sensitive Type 3901 on purple velvet pad, N.I.B., carborundum detector (p. 120). All containers are very collectible and in reasonably nice condition - \$200 takes all! Larry Drago, 383 Lincoln Dr., Cheshire, CT 06410. (203) 272-6030

FOR SALE: Profitable electronic surplus business for sale, operating for 30 years, one story sq. ft. building plus 5,500 sq. ft. parking. N.E. Philadelphia. Owner retiring. Call, fax, write: Leon Fertik, 5400 Ella St., Philadelphia, PA 19120. Ph./fax: (215) 455-2121

SEND ALL A.R.C. MAIL TO
Antique Radio Classified
P.O. Box 2, Carlisle, MA 01741

FOR SALE/TRADE: Atwater Kent Mod 165 cathedral - \$375. Philco Mod 38 cathedral, two-tone finish - \$200. Trav-Ler M-1 cathedral, two-tone maple and walnut finish - \$200. Zenith tombstone Mod 136 - \$175. Zenith Mod 319 brass escutch. w/ivory knobs - \$225. Graybar G78 tombstone, eight-tube - \$300. American Bosch Mod 28 w/cathedral-style speaker - \$250. Philco 89 cathedral - \$325. Larry Drago, 383 Lincoln Dr., Cheshire, CT 06410. (203) 272-6030

FOR SALE/TRADE: Old tube hi-fi & guitar equip. Mac, Fisher, Pilot, Ampex, Heath, Scott tuners & int., E.V., Citation, Dyna, Beam Echo, Ampeg Gem. VI, Fender 70's Twin (silver), 1930 Nat. Dobro lap steel w/amp, Silvertone guitar & amp, Roland GR700 & MK100, Epiphone 1930's amp. Sound City & Gilanti. Speakers, univ. Stevens, Wharfedale, Altec. Call: Tony DePasquale, 186 Randolph Ave., Emerson, NJ 07630. (201) 262-4970

FOR SALE/TRADE: Amos 'N Andy cardboard figures Pepsodent Toothpaste premiums, circa 1930, in color, 8" tall standing, beautiful collectibles - \$450. Jim Beam decanters of Charlie McCarthy and Mortimer Snerd - \$250/pair. Amos 'N Andy book, 1934 - \$75. Larry Drago, 383 Lincoln Dr., Cheshire, CT 06410. (203) 272-6030

FOR SALE: I have recently manufactured a very limited number of high quality rear canopy fiber cones for the RCA-103 Radiola loudspeaker. Each cone is beautifully crafted using 20 Pt. fibre board, .0165 inch Beryllium copper springs and includes the vibration suppression felt edge. Each fully meets RCA's original specifications. I am selling them at - \$60 ea. on a first-come first-serve basis while they last. Contact: Kenneth Erickson, 1049 Felspar, #33, San Diego, CA 92109-2844. (619) 483-2183, after 6 pm PST

FOR SALE: McIntosh MR-71 tuner, near mint - \$750. MR-67 - \$850. Dynaco ST-70 - \$350. Western Elec. Mod 214 amps - call for price. Dynaco PAS-2 - \$150. Two Dynaco Mark III - \$595. Scott 340B receiver - \$250. McIntosh C-24+C-26 tuners - \$400 ea. Pair EICO HF-14 amplifiers w/FM tuner, preamp and MX99 Multiplex system - \$500. EICO HF-60 amps, pair - \$1,600. Craftsman 550-C w/preamp, all chrome - \$495. Larry Drago, 383 Lincoln Dr., Cheshire, CT 06410. (203) 272-6030

FOR SALE: Universal dial belt kit. (5) belts, glue and instructions, satisfaction guaranteed. No radio disassembly necessary - \$8.50 ppd. To reference most Zenith models from 1920 to 1946 we offer our 60-page 11x17 Zenith Brochure Book with pictures and specs on most models - \$28.95 ppd. Our 1936 Zenith poster reproduction is art poster quality and shows the complete 1936 lineup plus all three Stratospheres - \$20 ppd. Visa and MasterCard accepted. Alan Jespersion, PO Box 17338, Minneapolis, MN 55417. (612) 727-2489

FOR SALE: Radio battery specials: 2-volt 20-amp-hour Willard batteries - \$22.50. 45-volt Eveready #738 - \$5. 45-volt with binding posts - \$5. 6-volt 12-amp-hour Nicad battery - \$35. Prices do not include shipping. Brochure available. S&G Electronic, 618 S. 62nd St., Philadelphia, PA 19143. (215) 474-7663

FOR SALE: Emerson 713 Ingraham cabinet, Arvin metal original hammertone paint. Adam Schoolsky, 15149 S.W. Cabernet Dr., Tigard, OR 97224. (503) 579-1080. E-mail: Adam@ArtDeco.com

**HAVE YOU MOVED? ARE YOU MOVING?
PLEASE NOTIFY US A.S.A.P.**

SEND US YOUR...

OLD ADDRESS

NEW ADDRESS and

SUB #

MANY THANKS!!!!

FOR SALE: Toggle switches at wholesale prices, full size, miniature, subminiature. Fertik's Electronics, 5400 Ella St., Philadelphia, PA 19120. Ph./fax: (215) 455-2121

FOR SALE: Send \$1 for sale list of electronic magazines and books. Being prepared for mailing sometime in November. Maurer TV, 29 So. 4th St., Lebanon, PA 17042. (717) 272-2481

FOR SALE/TRADE: Hallicrafters SP44 Skydrer Panoramic - \$200. National 173 communications receiver in like-new condition - \$200. National FB-7 w/3 coil sets - \$675. National 1-10 rcvr w/10 coils - \$425, circa 1934; rare complete National 5 setup includes receiver, power supply, speakers, coil rack w/7 coils all built into wood cabinet, real nice - \$600. Hallicrafters SX16 - \$550. Hallicrafters Mod SX-24 Super Defiant - \$250. National 183 - \$350; 75A-4 w/3 mech. filters - \$795. Collins 75A-4 2 filters - \$700; 75A-3 2 filters - \$300; SW-3 with 5 set coils - \$475. 1938 H.R.O. Prototype, w/five coils & manuals, one-of-kind in new condition - \$750. Larry Drago, 383 Lincoln Dr., Cheshire, CT 06410. (203) 272-6030

FOR SALE: Genuine Navy VTVM TS505 - \$25. Navy multimeter TS352/B with black Bakelite face & large round meter, includes high voltage range - \$25. S&G Electronic, 618 S. 62nd St., Philadelphia, PA 19143. (215) 474-7663

FOR SALE: Zenith T-shirts and sweat shirts: New!! Fabulous 1938 robot dial design with a green 6T5 tuning eye and Zenith long distance radio, ivory and green on black. Also, the classic Zenith logo, ivory on black or black on white. All shirts cotton high quality heavy-weight. Large, XL - \$12. XXL - \$14. XXXL - \$15. Sweatshirt robot dial only, XL - \$22. XXL - \$24. Add \$4 shipping per order. We accept Visa and MasterCard. Alan Jespersion, PO Box 17338, Minneapolis, MN 55417. (612) 727-2489

FOR TRADE: #2A folding autographic Brownie camera, would trade for nice radio. Offers? Doyle Roberts, HC 63, Box 236-1, Clinton, AR 72031. (501) 745-6690

FOR TRADE: Radio Boys, Flood Fighters, with dust jacket for your (3) N.I.B. 6U5, 6E5 tubes. A. Bruno, 24 Butternut Dr., New City, NY 10956. (914) 354-8899

FOR TRADE: Have old slide rules to trade for Zenith table radios or 1920's battery sets. Steve Hansman, 855 Arundel Dr. North, Arnold, MD 21012. (410) 974-0561

FOR TRADE: Cutting & Washington 11A, excellent cond., complete exc tubes for good working Philco 90, write or leave message. Don Ignatius, 9517 Brick Church Rd., Cambridge, OH 43725. (614) 439-9308

FOR TRADE: Handmade Hawaiian Koa wood ukulele for cathedral or unusual radio. Phil Boydston, 640-18 TeteLours, Mandeville, LA 70471. (504) 845-0867

HELP: Need manual and/or schematic for Utica 650 six-meter transceiver. Jack Campellone, KD4HAK, PO Box 232, Genoa, OH 43430. (419) 855-4420

HELP: Need info on what kind of radio goes in a Orpheus Victorian cabinet. I have a beautiful cabinet without a radio. Ralston Bailey, Rt. 1, Box 479, Benton, TN 37307. (423) 338-5923

MESSAGE: New antique store grand opening on antique row in Brooklyn, N. Y., Atlantic Ave. & Bond Sts., includes various radios, recorders, electronic parts, working radio batteries & more. Large selection of antique architectural artifacts & other non-radio-related items. S&G Electronic, 618 S. 62nd St., Philadelphia, PA 19143. (215) 474-7663

SERVICES: Schematic Service: Radio info from Rider Manuals 1 to 22, 1930 to 1950s. Send SASE, \$2.50; make and model to: Steve Rosenfeld, PO Box 387, Ocean Gate, NJ 08740. (908) 269-2022, days

SERVICES: Hickok, military & other major brands of test equipment repaired & calibrated. Technical & operator data, obsolete & foreign tube test data. **FOR SALE:** Wake up your sleeping beauty with a set of (4) new aftermarket 4-7 pin obs plug-in test adapters for 6000 Series Hickok tube testers - \$65 w/copy of Hickok 6000A obsolete test data, including shipping. Need octal socket savers for all types of tube testers - \$18 shipped separate; \$15 w/6000 adapters. Test equipment sale: (TV shop buy-out) first offering, B&K 1076 & 1077B TV analyzer, B&K 1460 o'scope (solid-state), triggered, 10MHz+. B&K 1801 freq. counter, (solid-state). B&K 667 TV/FM tube tester (solid-state). Amphenol 857 CRT commander, 860 color commander, & VTVM, all compact, highest quality, solid-state. Solar, CE, Sprague TO-4, EICO 950B, & Heathkit 1T2B condenser & resistor bridges. Hickok 690 VHF/UHF marker calibrator; 695 TV/FM alignment generator, sweep, VHF2TF; 691 marker adder w/leads; 610 sweep & marker generator; 605 tube tester. RCA color bar generator w/leads. Other test equipment by Hickok, Sencore, Saco, RCA, Triplett, HP, Daven, Sprague, Solar, Heath, Eico, Precision, Jackson, and more. All priced to sell. Call for more details & prices. **MESSAGE:** Best wishes for a happy & prosperous New Year to all my many A.R.C. friends. Wendell E. Hall, 3 Mockingbird Cir., Jeffersonville, IN 47130. (812) 282-9709

HELP: Help! Will the guy who bought the Crosley hi-fi from Patrick's Collectibles contact me, or if you know him, please call me. John May, 205 Wren, Scotia, NY 12302. (518) 377-9522

HELP: I need information and parts for Edison Voice-writer Ediphone. Quote your price. Charles Ahr, 2291 Sylveld Ln., Cincinnati, OH 45238

HELP: Wanted: Echophone 80, Neutrowound. Just needs be restorable. Need cabinet for AK 66, 308. Thomas A. Foral, N1RFF, 38 Summer Hill Rd., #58, Middletown, CT 06457. (401) 863-5856

HELP: Need station indicator for Crosley #11-103-U. John DeVincenzo, 24 Vogel St., West Roxbury, MA 02132. (617) 323-1797

HELP: Information, on German marine receiver, Debel 7201, and counter (Systron-Donner 6316A). Ernest Beetz, 2310 Eastmont Way W, Seattle, WA 98199

HELP: Need info on Austin Radio Co. Have 1933 cathedral model, 4 tubes. Dale B. Allen, 606 Third St., Herndon, VA 22070. (703) 904-9895. E-mail: dalen@melpar.esys.com

HELP: Need schematics for Hlcock 209 VTVM & Kalamazoo Reverb. 12 amp. Knobs & faceplate Zenith H500 Trans-Oceanic. Cabinet for Kolster K-130. Philco 41-608 parts unit & literature. Philco 624 cabinet, Philco 623 chassis. Kurt E. Strobach, 219 Plum St., Lake in the Hills, IL 60102-3326. (708) 658-2158

HELP: For TMC; cannot identify model number, has 17 tubes, rack mount, six bands, ham bands spread, need schematic. Charles A. Days, PO Box 80205, S. Dartmouth, MA 02748-0205

HELP: Need Radiola II large coil with two ticklers, approximately 3" dia. x 8" long, cover latch, GE knob 1 5/8" dia. Ted Babcock, 163 Long Island Dr., Moneta, VA 24121. (540) 721-1222

MESSAGE: Happy Holidays to all my friends in Radioland. Time to party - safely. Bill Timoszyk, 35283 Leon, Livonia, MI 48150

MESSAGE: Who was looking for cloth-covered wire in past issue? I have opened and unopened 1/4-lb. spools. William G. Turner, W2WV, 1243 Overview Ave., Clearwater, FL 34616. (813) 447-7707

MESSAGE: Anyone interested in console radios, pick up only. Robert J. Stone, 721 Fisk St., Piqua, OH 45356-3729. (513) 773-2217

SERVICES: Rider Radio Schematics, 1930 through 1950's. Includes alignment data. Send \$3 with make, model and SASE to: George M. Bonanno, WA2KPE, 34 Charles St., Clifton, NJ 07013. (201) 746-5953

SERVICES: Schematics 1920's thru 1950's mailed or faxed - \$3 radios, \$4 TVs, ppd. Robert Schrantz, 610 E. Juanita Ave., San Dimas, CA 91773. Phone/fax: (909) 394-1194

SERVICES: Repair/replacement of meters before 1945. **WANTED:** Old meters/galvos, as-is OK. Ye Old Meter Cellar, Leonard W. Cartwright, 879 Russet Dr., Sunnyvale, CA 94087. (408) 739-6025

SERVICES: Schematic Service: Radio info from Rider Manuals 1 to 22, 1930 to 1950s. Send SASE, \$2.50; make and model to: Steve Rosenfield, PO Box 387, Ocean Gate, NJ 08740. (908) 269-2022

SERVICES: 3-year guarantee. Radio Overhaul. Enjoy original performance, everyday. Professional shortwave specialist. Free: Brochure, estimates, send SASE. Captain Larry Rau's Occidental Radio Workshop, Box 1139, Occidental, CA 95465. (707) 874-1000

SERVICES: We re-cone all speakers. Many vintage parts. Best warranty! Tri-State Loudspeaker, 650 Franklin Ave., Aliquippa, PA 15001. (412) 375-9203

SERVICES: Rider Radio Schematics, 1930 through 1950's. Includes alignment data. Send \$3 with make, model and SASE to: George M. Bonanno, WA2KPE, 34 Charles St., Clifton, NJ 07013. (201) 746-5953

SERVICES: Vintage manuals available. Buy, trade and sell. Send two 32¢ stamps for catalog. Pete Markavage, The Manual Man, 27 Walling St., Sayreville, NJ 08872. (908) 238-8964

SERVICES: Repair of TV-7 tube testers w/calibration: I will fix and then verify calibration of your TV-7 tube tester for \$45 plus all shipping or return it no charge. Daniel Nelson, 1025 E. Desert Ln., Phoenix, AZ 85040. (602) 243-7421, evenings. E-mail: djn@indirect.com

MESSAGE: Announcement: John Okolowicz has just established a grille cloth headquarters on the World Wide Web. Point your browser to: <http://www.liberty.org/~grcloth> to see the complete portfolio of antique radio grille cloth on-line plus much, much, more. Discover the latest developments. You can now provide feedback directly and influence future products. So, what are you waiting for, the surf's up. John Okolowicz, 624 Cedar Hill Rd., Ambler, PA 19002

FOR TRADE: Zenith Trans-Oceanic 8G005, DuMont Chatham, wood Tele-Tone 7" TV, for odd-brand TV. What do you have? I can pay cash, also! Happy Holidays. Glenn Bubenheimer, 27851 Terrence, Livonia, MI 48154. (313) 421-5574

FOR TRADE: Kadette Classic white knobs for blue ones; also needed, brass dial pointer for Clockette. Ken Nevins, Nevins Museum of Radio, 406 Jipson St., Blissfield, MI 49228. (517) 486-3019, evenings please

FOR TRADE: Sams: AA, AR, CB, MHF, TR, TSM. For: AA, MHF, TSM or \$\$\$\$. Send wants & haves. Richard Gray, 11869 High Ridge Rd., Lakeside, CA 92040. Fax: (619) 390-8937

FOR TRADE: Regency XR-2A transistor for your Philco 20 Deluxe or 16B cathedral, good original finish only. Dan Schlie, 60 Maple Ave., Port Byron, NY 13140. (315) 776-4596

FOR TRADE: 18-tube Midwest console 18-36 for Zenith 9S262 or 10S153. Scott Beard, 2600 Garfield Ave., Terre Haute, IN 47804. (812) 466-9367

FOR TRADE: Transistor and novelty radios, for Hallcrafters ham equipment. Ed Eddy, 1209 E. Geneva Dr., Tempe, AZ 85282. (602) 966-1397

FOR TRADE: Trade only: First Zenith Trans-Oceanic, Bomber, Model 7G605 in excellent condition for excellent Crosley Pup. **WANTED:** One or two knobs for Crosley dashboard radio model, D25MN, any color. Contact: Bill Wiczorek, 1116 Cummings Dr., Boulder City, NV 89005. (702) 293-2548

FOR TRADE: Philco grandfather for large collection of Life magazines. Scott Cavallari, 1258 Rt. 94, New Windsor, NY 12553. (914) 561-7913



VIRGINIA - Jan. 3

TIDEWATER ANTIQUE RADIO ASSN. MEETING

7 pm - Call for location & directions
 Info: Phil Stroud, 2328 Springfield Ave.
 Norfolk, VA 23523 - (804) 481-2561, after 6 pm

WASHINGTON - Jan. 7

VINTAGE AUDIO LISTENERS AND VALVE ENTHUSIASTS - MEETING

Poulsbo, WA - Classic Radio
 1127 N.W. Bright Star Ln.
 10 am-2 pm
 Info: Dan Schmale - (360) 697-1936

ARKANSAS - Jan. 4

ANTIQUE RADIO COLLECTORS CLUB OF FORT SMITH - CLUB MEETING
 Fort Smith, AR - St. Luke Lutheran Church
 Waldron Road, at Free Ferry

7:30 pm
 Info: Paul Tucker, 4700 N. "N" Street
 Fort Smith, AR 72904 - (501) 782-8178

GEORGIA - Jan. 8

SOUTHEASTERN ANTIQUE RADIO SOCIETY MEETING

Norcross, GA - Picadilly Cafeteria
 3400 Holcomb Bridge Road
 6 pm - Mini-Meet; 6:30 pm - Meeting
 Info: Charles Milton - (404) 922-6507, or
 SARS, PO Box 500025 - Atlanta, GA 31150

WASHINGTON - Jan. 6

RADIO ENTHUSIASTS OF PUGET SOUND MEETING

Seattle, WA - Queen Anne Library
 400 W. Garfield
 2 pm

Info: REPS, 9936 NE 197th Street
 Bothell, WA 98011 - (206) 488-9518

ILLINOIS - Jan. 8

BELLEVILLE AREA ANTIQUE RADIO CLUB MEETING

Belleville, IL - Belleville Area College
 7 pm

Info: Karl Stegman, 4 Cresthaven Drive
 Belleville, IL 62221 - (618) 234-7992

NEW YORK - Jan. 7

GREATER NEW YORK VINTAGE WIRELESS ASSN. - SWAP MEET

Lake Ronkonkoma, NY - 367 Hawkins Ave.
 N. of L.I. Expressway, lg. white house
 9-12 am

Info: Chris Lieppert - (516) 471-9526, or
 Chris Bacon - (516) 821-7618

MISSOURI - Jan. 9

ANTIQUE RADIO COLLECTORS & HISTORIANS OF GREATER ST. LOUIS - MEETING

St. Louis, MO - Kirkwood Community Center
 7 pm

Info: Charles Juedemann, 2015 Hickory
 Ridge Rd., Union, MO 63084 - (314) 583-5116

OHIO - Jan. 7

BUCKEYE ANTIQUE RADIO AND PHONOGRAPH CLUB - MEETING

Brunswick, OH - Brunswick Library
 3649 Center Road, Rt. 303
 1-4:30 pm

Info: Rich Bradley - (216) 842-5937

PENNSYLVANIA - Jan. 9

DELAWARE VALLEY HISTORIC RADIO CLUB MEETING - SWAP MEET - AUCTION

Souderton, PA - 113 Main St.,
 N. Penn Amusements Bldg.
 7:30 pm

Info: DVHRC, PO Box 41031, Philadelphia,
 PA 19127-0031 - Mike Koste - (215) 646-6488

Although non-members are welcome at all events, joining may be required at some. Admission is charged at some events.

**SUBMISSION DEADLINE
 5th OF MONTH**

ARKANSAS - Jan. 11**ARKANSAS ANTIQUE RADIO CLUB MEETING**

Little Rock, AR - Call for location
7 pm

Info: Tom Burgess - (501) 455-0773

MISSISSIPPI - Jan. 14**MISSISSIPPI HISTORICAL RADIO & BROADCASTING SOCIETY - MEETING**

Meridian, MS - 2412 C Street
3 pm

Info: Randy Guttery, 2412 C. Street
Meridian, MS 39301 - (601) 693-5958

NEW JERSEY - Jan. 12**NEW JERSEY ANTIQUE RADIO CLUB MEETING**

Freehold, NJ - Grace Lutheran Church
West Main St. & Park Ave. (old Rt. 33)

7:30-9:30 pm - Meeting & Swap

Info: Don Cruse - (908) 542-2848

Tony or Kathleen Flanagan - (908) 462-6638

ONTARIO - Jan. 15**OTTAWA VINTAGE RADIO CLUB MEETING**

Ottawa, Ontario - Ottawa Citizen
Conference Room, 1101 Baxter Road
7 pm

Info: Tom Devey, 810 Edgeworth Avenue
Ottawa, Ontario K2B 5L5 - (613) 828-5152

OKLAHOMA - Jan. 13**OKLA. VINTAGE RADIO COLLECTORS CHRISTMAS PARTY/MEETING**

Oklahoma City, OK - Spencer's Barbeque
63rd and North May Avenue

6 pm - Dinner; 7 pm - Program

Info: Mike Lapuzza - (405) 745-3394, after 6 pm

OHIO - Jan. 16**ANTIQUÉ RADIO COLLECTORS OF OHIO MEETING**

Kettering, OH - National City Bank Basement
4100 Far Hills Ave., at Stroop Rd.

7:30 pm - Portable Radios with Handles

Info: Steve Geary - (513) 492-0972

OREGON - Jan. 13**NORTHWEST VINTAGE RADIO SOCIETY MEETING**

Portland, OR - NW Vintage Radio Museum
7675 SW Capitol Highway

10 am - Meeting

Info: Ed Charman, PO Box 82379

Portland, OR 97282-0379 - (503) 654-7387

CALIFORNIA - Jan. 17**SACRAMENTO HISTORICAL RADIO SOCIETY - MEETING**

N. Highlands, CA - SMUD Foothill Service
Center, Room D, 5026 Don Julio, 1 mi. W. of I-80
7-9 pm

Info: SHRS, PO Box 162612, Sacramento
CA 95816, or Don Steger - (916) 929-8274

TENNESSEE - Jan. 13**MUSIC CITY VINTAGE RADIO & PHONOGRAPH SOCIETY - MEETING**

Donelson, TN - Donelson Public Library
2315 Lebanon Road

6-8 pm

Info: Larry Chambers - (615) 833-2448

Marty Evans - (615) 459-0158

OHIO - Jan. 17**SOCIETY FOR PRES. OF ANTIQUE RADIO KNOWLEDGE/CINCINNATI CPT. - MEETING**

Cincinnati, OH - Richards Radio & TV
4041 Edwards Rd., I-71, Exit 6

7:30 pm

Info: Tim Kaiser, PO Box 81
Newport, KY 41071 - (606) 441-2548

COLORADO - Jan. 14**COLORADO RADIO COLLECTORS MEETING**

Denver, CO - 2020 West Barberry Place
Wazee Electric Building
Community Room

1 pm - Meeting,
followed by Swap Meet

Info: Rick Ammon - (970) 221-4001

OHIO - Jan. 17**SOCIETY FOR PRES. OF ANTIQUE RADIO KNOWLEDGE/COLUMBUS CPT. - MEETING**

Columbus, OH - DeVry Institute of Tech.
1350 Alum Creek Road, I-70 Exit 103B

7:30 pm

Info: Sharon/Ken Fullerton - (614) 237-2621

MARK YOUR CALENDAR

Dec. 26 - OH, Kettering - SPARK Meeting §
1996

Jan. 3 - VA, TBA - TARA Meeting §*
Jan. 4 - AR, Fort Smith - ARCCFS Meeting §*
Jan. 6 - WA, Seattle - REPS Meeting §*
Jan. 7 - NY, Lake Ronkonkoma - GNYVWA §*
Jan. 7 - OH, Brunswick - BAR&PC Meeting*
Jan. 7 - WA, Poulsbo - VALVE Meeting §*
Jan. 8 - GA, Norcross - SARS Meeting §*
Jan. 8 - IL, Belleville - BAARC Meeting §*
Jan. 9 - MO, St. Louis - ARCH Meeting §*
Jan. 9 - PA, Souderton - DVHRC Meeting §*
Jan. 11 - AR, Little Rock - AARC Meeting §*
Jan. 12 - NJ, Freehold - NJARC Meeting §*
Jan. 13 - OK, Okla. City - OKVRC Meeting §*
Jan. 13 - OR, Portland - NWVRS Meeting §*
Jan. 13 - TN, Donelson - MCVRPS Meeting*
Jan. 14 - CO, Denver - CRC Meeting*
Jan. 14 - MS, Meridian - MHR&BS Meeting §*
Jan. 15 - Ontario, Ottawa - OVRC Meeting*
Jan. 16 - OH, Kettering - ARCO Meeting §*
Jan. 17 - CA, N. Highlands - SHRS Meeting §*
Jan. 17 - OH, Cincinnati - SPARK Meeting §*
Jan. 17 - OH, Columbus - SPARK Meeting §*
Jan. 18 - NY, Goshen - HARPS Meeting §*
Jan. 20 - AZ, Phoenix - AARC Meeting*
Jan. 20 - CA, Valencia - SCARF Swap Meet*
Jan. 20 - MD, Burtonsville - MAARC Meeting §*
Jan. 20 - NH, Nashua - NEARC Swap Meet*
Jan. 20 - TX, Irving - VRPS Meeting*
Jan. 21 - NM, Albuquerque - NMRC Meeting §*
Jan. 21 - WA, Seattle - PSARA Meeting §*
Jan. 22 - AL, Birmingham - ALHRS Meeting §*
Jan. 23 - OH, Kettering - SPARK Meeting §*
Jan. 26-27 - TX, Houston - HVRA Mega Auction*
Jan. 27 - OH, Columbus - SPARK Swap Meet*
Jan. 27 - Ontario, London - LVRC Meeting*
Jan. 28 - BC, Richmond - CVRS/BC Meeting*
Feb. 2 - CA, Redwood City - CHRS Meet
Feb. 3 - MI, Grand Rapids - MARC Meet*
Feb. 4 - NY, TBA - GNYVWA Meeting §
Feb. 10 - AL, Decatur - SVWA Swap Meet*
Feb. 11 - MN, St. Louis Park - NARC Workshop*
Feb. 13 - CA, Redding - CHRS-NVC Meeting*
Feb. 17 - AZ, Phoenix - AARC Radio Roundup
Feb. 17 - CA, Van Nuys - SCARS Auction*
Feb. 17 - IN, Indianapolis - IHRS Meeting*
Feb. 25 - MA, Westford - GBARC Radio XXVII*
Mar. 3 - NY, Lake Ronkonkoma - GNYVWA §
Mar. 9 - AZ, Scottsdale - AARC Swap Meet
Mar. 17 - CT, Plainville - CVRC Show & Sale
Mar. 22-23 - NC, Charlotte - AWA Spring Meet
Mar. 30 - Ontario, London - LVRC Meeting
Mar. 30 - PA, Washington - Spring Fever
Apr. 13 - KY, Henderson - MSARC Swap Meet
Apr. 20 - NH, Nashua - NEARC Swap Meet
Apr. 28 - MI, Clare - MARC Spring Meet
May 3-5 - TX, Houston - HVRA Convention
May 17-18 - MN, Bloomington - Radio Daze '96
May 17-19 - OH, Dayton - 1996 Hamvention
May 18 - TX, Irving - VRPS Swap Meet
May 25 - Ontario, London - LVRC Meeting
Jun. 29 - Ontario, London - LVRC Meeting
Jul. 12-14 - MI, Lansing - Extravaganza '96
Jul. 20 - NH, Nashua - NEARC Swap Meet
Aug. 17 - TX, Irving - VRPS Swap Meet
Aug. 28-31 - IL, Elgin - ARCI Radiofest 1996
Sep. 4-7 - NY, Rochester - AWA Conference
Oct. 5 - KY, Lexington - MSARC Swap Meet
Oct. 26 - NH, Nashua - NEARC Swap Meet
Nov. 18-19 - CA, Los Angeles - SCARS Meet

* See expanded listing this month. § Monthly Meeting
† Date changed from original announcement

NEW YORK - Jan. 18

HUDSON VALLEY ANTIQUE RADIO AND
PHONO. SOCIETY/AWA - MEETING
Goshen, NY - Cataract Firehouse, Main St.
7-9 pm

Info: John & Linda Gram, Box 1, Campbell
Hall, NY 10916 - (914) 427-2602, 6-9 pm

ARIZONA - Jan. 20

ARIZONA ANTIQUE RADIO CLUB
MEETING

Phoenix, AZ - Home of Martin Bergan
2011 E. Flynn Lane - 2 pm

Info: Martin Bergan - (602) 248-0356

CALIFORNIA - Jan. 20

SOUTHERN CALIFORNIA ANTIQUE
RADIO FEST - SWAP MEET

Valencia, CA - Valencia Travel Village
27946 Henry Mayo Rd. (aka Hwy 126)

6 am-12 noon

Info: Jerry Simpson - (805) 251-7829, days
(805) 294-9009, eves.

MARYLAND - Jan. 20

MID-ATLANTIC ANTIQUE RADIO CLUB
MEETING

Burtonsville, MD - New Hope Seventh Day
Adventist Church gym - 6:30 pm

Info: Sam Cannan, 1010 Siske Road
Stony Creek, MD 21226 - (410) 255-7728

NEW HAMPSHIRE - Jan. 20

NEW ENGLAND ANTIQUE RADIO CLUB
SWAP MEET

Nashua, NH - Resurrection Center
Rt. 3 (Everett Turnpike), Exit 6

1 1/2 miles West on Rt. 130, 449 Broad St.

8 am - Early Admission

9 am-1 pm - General Admission

Over 100 tables - 50/50 Raffle - Catered

Old Equipment Contest

Reservations required to sell

Info: Gregg Thompson, PO Box 298
Newtonville, MA 02160 - NEARC: (617) 923-2665

TEXAS - Jan. 20

VINTAGE RADIO & PHONO. SOCIETY
MEETING

Irving, TX - Senter East Building - 1-5 pm

Info: George Potter - (214) 315-2553

NEW MEXICO - Jan. 21**NEW MEXICO RADIO COLLECTORS CLUB
MEETING**

Albuquerque, NM - Sierra Vista Bible
Church, 7509 Paseo Del Norte
1:30 pm - Zenith Radios

Info: Bill Schultz, 11605 Versailles Ave. NE
Albuquerque, NM 87111 - (505) 294-5302

ONTARIO - Jan. 27**LONDON VINTAGE RADIO CLUB
MEETING**

London, Ontario - Jaycee Building
317 Adelaide St. South
1 pm

Info: Don Hatch, 14 Kingspark Cres., London
Ontario, Canada N6H 4C4 - (519) 472-6167

WASHINGTON - Jan. 21**PUGET SOUND ANTIQUE RADIO ASSN.
MEETING**

N. Seattle, WA - Shoreline Museum
749 No. 175th St. & Linden Ave.

9 am - Swap Meet
12 noon - Meeting

Info: Al Atworth, PO Box 125
Snohomish, WA 98291-0125 - (360) 568-2698

BRITISH COLUMBIA - Jan. 28**CANADIAN VINTAGE RADIO SOCIETY
BRITISH COLUMBIA CHAPTER - MEETING**

Richmond, BC - Steveston Hotel
Steveston Village on Fraser River

12 noon - Swap Meet
2 pm - Meeting

Info: Fred Tutt, 4895 Mahood Dr., Richmond,
BC, Canada V7E 5C3 - (604) 275-2033

ALABAMA - Jan. 22**ALABAMA HISTORICAL RADIO SOCIETY
MEETING**

Birmingham, AL - Homewood Public Library
1721 Oxmoor Road

7 pm

Info: Earl Ridolphi, 2413 Old Briar Trail
Birmingham, AL 35226 - (205) 823-3314

MICHIGAN - Feb. 3**MICHIGAN ANTIQUE RADIO CLUB
WINTER SWAP MEET**

Grand Rapids, MI - Alport Hilton
4748 28th St. SE - (616) 957-1000

8 am-1 pm

Equipment Contest - Silent Auction
50/50 Raffle

Advance seller table reservations required
Info: Larry Anderson - (313) 274-1948, or
E-mail: 76020,2251

OHIO - Jan. 23**SOCIETY FOR PRESERVATION OF
ANTIQUÉ RADIO KNOWLEDGE - MEETING**

Kettering, OH - Cassano's Pizza
1680 E. Stroop Rd.

7:30 pm

Info: Harold Parshall - (513) 865-5900, days
(513) 268-2909, eves. until 9 pm

ALABAMA - Feb. 10**SOUTHERN VINTAGE WIRELESS ASSN.
SWAP MEET**

Decatur, AL - 9th St. Methodist Church
7 am-1 pm - Rain or Shine

Info: Jim Makar - (205) 233-8357

TEXAS - Jan. 26-27**HOUSTON VINTAGE RADIO ASSN.
MEGA AUCTION**

Houston, TX - Tides II Hotel, Lai Lai
Restaurant, 6700 Main Street

Fri. pm - Auction; Sat. afternoon - Auction
Info: Bill Werzner - (713) 721-2242

MINNESOTA - Feb. 11**NORTHLAND ANTIQUE RADIO CLUB
RADIO WORKSHOP**

St. Louis Park, MN - Pavek Museum
1 pm

Info: Steve Raymer - (612) 571-2084

OHIO - Jan. 27**SOCIETY FOR PRESERVATION OF ANTIQUE
RADIO KNOWLEDGE - SWAP MEET**

Columbus, OH - DeVry Institute of Tech.
1350 Alum Creek Dr., I-70 Exit 103B

7 am-12 noon

Info: Sharon/Ken Fullerton - (614) 237-2621

CALIFORNIA - Feb. 13**CALIF. HISTORICAL RADIO SOCIETY
NORTH VALLEY CHAPTER
MEETING**

Redding, CA - 7 pm

Info: Chris Galantine, 15853 Ontario Place
Redding, CA 96001-9785 - (916) 244-2337

CALIFORNIA - Feb. 17

SOUTHERN CALIF. ANTIQUE RADIO SOCIETY — ANNUAL AUCTION

Van Nuys, CA — St. Andrews Lutheran Church, 15520 Sherman Way

See Feb. SCARS Gazette for details

Info: Kosh — (213) 465-9919

Richard Gray — (619) 977-6033

INDIANA - Feb. 17

INDIANA HISTORICAL RADIO SOCIETY WINTER MEETING

Indianapolis, IN — Holiday Inn Southeast
5120 Victory Lane — (317) 783-7751

7 am-2 pm

Info: Dr. Mike Clark — (317) 738-4649

Alex Whitaker — (317) 535-4174

CAROLINA CHAPTER

**NEW CHAPTER FORMING
ANTIQUÉ WIRELESS ASSOCIATION**

From the people who bring you the
Charlotte, NC Spring Meet

Info: Kenny Mullis — (803) 285-6233, or
Steven Brown — (704) 847-1301

FLORIDA

**NEW CLUB FORMING — TREASURE
COAST ANTIQUE WIRELESS CLUB**

For coastal area from Melbourne to Stuart

Info: Milt Faivre, K4EBT, 1445 2nd Rd. SW
Vero Beach, FL 32962 — (407) 778-0642

KS.—MO.—OKLA.—AR.

**NEW CLUB FORMING
FOUR STATES ANTIQUE RADIO CLUB**

To serve collectors in S.E. Kansas,
S.W. Mo., N.E. Okla., and N.W. Arkansas

Info: Stephen Phipps, 1702 S. McKinley Ave.
Joplin, MO 64801 — (417) 659-8140

A free* listing on these pages is available for each coming radio event. Sponsors should provide description of event, date, time, place, directions, & information/contact person. Since listings are on a "space available" basis, no guarantee of listing is made.

Submission Deadline - 5th of month.

*Club/museum/non-profit events are listed free; other events are obtained from advertisements placed elsewhere in A.R.C.

MASSACHUSETTS - Feb. 25

GREATER BOSTON ANTIQUE RADIO COLLECTORS — RADIO XXVII

Westford, MA — Westford Regency Inn
I-495, Exit 32; West on Rt. 110 for .4 mi
Same giant (6500 sq. ft.) and warm location!
8 am-1 pm

Coffee, Donuts, Sandwiches, etc. available

For hotel reservations: (800) 543-7801; (In Mass. 800-543-7802) — Mention Radio XXVII

Seller Preregistration & Info:

Lisa Friedrichs, c/o A.R.C., PO Box 2,
Carlisle, MA 01741 — (508) 371-0512

LOUISIANA

**NEW CLUB FORMING
LOUISIANA GULF COAST CLUB**

Info: Phil Boydston, 102 Concorde Place
Mandeville, LA 70471 — (504) 845-0867

NY/N. JERSEY/LONG ISLAND

NEW CLUB FORMING

Meetings to start soon!

Swap Meets — Auctions — Newsletters
Education — Fun!

Info: Bob Masterson, Box 172
Valley Cottage, NY 10989 — (914) 353-3151

NORTH CAROLINA

**NEW CLUB FORMING
TRIANGLE ANTIQUE RADIO SOCIETY**

Info: Larry Dowell, 8490 Hurdle Mills Rd.
Hurdle Mills, NC 27541 — (910) 364-2756,
after 6 pm — e-mail: dowell1001@mc.duke.edu

PENNSYLVANIA

**NEW CLUB FORMING
CENTRAL PA. RADIO COLLECTORS CLUB**

Info: Frank Hagenbuch, 1440 Lafayette Pky.
Willamspport, PA 17701 — (717) 326-0932

SOUTH FLORIDA

**NEW CLUB FORMING
SO. FLA. ANTIQUE RADIO COLLECTORS**

Info: Thomas Valenti, 1717 N. Bayshore Dr.,
#1251, Miami, FL 33132 — (305) 536-2224

Although non-members are welcome at all events, joining may be required at some. Admission is charged at some events.

BUSINESS CARD ADS - \$45.00 FOR 3 MONTHS

VINTAGE RADIO SERVICES

Ken Hubbard
KA9WRN

P.O. Box 792
Beloit, WI 53512-0792
(608) 362-1896
6 pm Evenings

Repair of
Vacuum Tube
Equipment

Home-Auto

REPAIRS • BUY • SELL • TRADE
PRE '65 AC SETS & CAR RADIOS

FRED'S OLD RADIO EMPORIUM
1612 WEST 7TH AVENUE
CORNICANA, TEXAS 75110

F.L. GORDON, PROPRIETOR
BUSINESS (903) 874-5185 HOME (903) 874-7147



ESTES AUCTIONS

Specializing in Vintage Radios

7404 Ryan Rd
Medina, Ohio 44256

Bus. Phone 216-769-4992
Fax 216-769-4116
Res. Phone 216-769-3987

RADIOS & STRANGE MISCELLANEA
IF YOU VISIT THE BRIMFIELD FLEA MARKET... STOP BY FIRST!

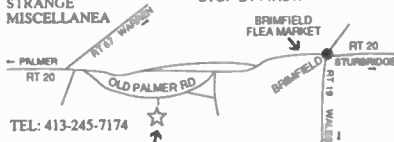

TEL: 413-245-7174

COUNTRY ROAD BARN - BERNIE SAMEK
OLD PALMER ROAD, BRIMFIELD, MASS.



ANTIQUE RADIO RESTORATIONS

109 S. Oak St., O'Fallon, IL 62269
618-632-7423

Collectors of Old Radios
Electronic Consultant, Dial Reproductions
Hickok Tube Testers, Service & Calibration

Clinton Blais, P.E.
Life Member I.E.E.E.
AWA, ARCA



The Sights and Sounds of Early 20th Century Broadcasting

Presented at Latwood's Historical Belmont Village - Denver Area
Sept/96 to March/96 - Mar-Sat - Infor (303) 967-7880

RADIOS □ TV'S □ VINTAGE STUDIO EQUIPMENT
LISTENING POSTS □ SPECIAL PROGRAMS

Can't make it? Order the museum gallery guide by mail
Pictures/Descriptions - Historical articles - Newcomer's radio dating

Only \$6 post/hnd included - Send cash, check or money order To:
The Colorado Radio Collectors Antique Radio Club (CRC)
8270 E. Nassau Circle, Englewood CO 80110

Are You Looking For Antique Radios, Parts, Tubes,
Schematics and Restoration Services?

For Free Flyer, a 2-Stamp LSASE is required to
insure a response to your request. Send to:

Olde Tyme Radio Company
2445 Lyttonsville Road, Suite 317
Silver Spring, MD 20910

Wish to contact us by phone or fax?
Our number is (301) 587-5280.
Please call 10 am to 10 pm (Local Time)

Antique Radios



David & Nancy Snow
P.O. Box 6352
Jackson, MI 49204
(517) 787-2985

We Buy, Sell, Repair
ARBE - III Battery Eliminators

1920-1970
SCHEMATICS + PAGES OF INFO
\$5.00 POSTPAID

MANUAL PRICES - SASE
RADIO/TV/HAM/MISC.

"IF I DON'T HAVE IT, YOU
PROBABLY DON'T NEED IT."

ALTON H. BOWMAN - 4172 EAST AVENUE
CANANDAIGUA, NY 14424-9564

ANTIQUE RADIO REPAIR

Repair - Restore - Buy & Sell

Schematic Service
Radios \$2.50, TVs \$4.50

DAMASKE ELECTRONICS

574-W16834 Janesville Road
Muskego, WI 53150
Phone: (414) 679-0838



New/Old Stock Parts
Reproduction Items
Books & Refinishing Supplies

\$2.00 for 20 page catalog.
Refundable with first order.

Vintage Tv & Radio

3408 West 105 St. Cleveland, OH 44111
216-671-6712

Radio & TV Tubes

— New Old Stock —

Call/write for price list & availability

db ELECTRONICS — 105 Rt. 47 South
Cape May Court House, NJ 08210
609-465-5005

BUSINESS CARD ADS - \$45.00 FOR 3 MONTHS

784-9417

784-9417

COSMOS TV

- Low Prices
- TV Repair

- Quality Used TVs
- Antique Radio Repair
- Buy, Sell, Trade

Free Estimates
784-9417

5919 15th Ave. N.W.
Seattle, WA 98107

WANTED: Tube Hi-Fi Components & Commercial Amplifiers of the 1950's & 1960's

**Marantz, McIntosh, Scott, Fisher, Brook
Acrosound, Brociner, Western Electric
Fairchild, Altec, Tannoy, JBL**

Richard Sharisky (617) 484-5784, phone
P.O. Box 521 (617) 489-6592, fax
Belmont, MA 02178

Free Estimates
Mrs - 10 AM - 7 PM EST.
Tues - Sat

Tel./Fax (800) 928-2628
E-Mail: ottradoc@aol.com



ANTIQUE RADIO RESTORATION & REPAIR

1920 - 1960's

Buy & Sell

Reasonable Rates, Tubes, Professional
Overhaul, Cabinet Refinishing Service
For All Antique Car, Table & Console
Radios, Communication Receivers &
Tube Amplifiers.



BOB ESLINGER

20 Gary School Road
Pomfret Center, CT 06259

VINTAGE HI-FI EQUIPMENT & NEW OLD STOCK TUBES WANTED

We also buy Used, New, & Vintage
Speakers, amps, parts, guitars, and pedals
Any condition - working or not
Top prices and shipping paid

GUITAR OASIS

7451 Warner Avenue, Suite 1 - Huntington Beach, CA 92647
Phone (714) 842-7402 - Fax: (714) 842-7462
MON-FRI 9:30-7:00 PST - SAT 12:00-6:00 PST

ANTIQUE RADIO RESTORATION

Since 1936 Repair - Buy - Sell
Complete Restorations - Prompt Service

COOPER'S RADIO SERVICE

425 Court Street
Rockwell City, Iowa 50579



LARRY COOPER
712-297-7232



PR NOVELTY

Glass Audio Specialists
Amplifier Rebuilding • Service
Surplus Parts Brokerage
(New Old Stock and Used)

"The Home of Mr. Happy Amp"

Paul Drobinski Audio Technician PO Box 140 • Milwaukee • WI 53201
Robin Richards General Manager 414 964 3392

Old Time Replications

"TURN TO US WHEN YOU NEED KNOBS"
KNOBS • PUSHBUTTONS • ESCUTCHEONS
PLASTIC GRILLS • HANDLES

LARRY BORDONARO

5744 TOBIAS AVE. VAN NUYS, CA 91411
PHONE (818) 786-2500 • FAX (818) 909-0241

WANTED ! JAPANESE MILITARY RADIOS

any kind of WW-2 radios & aircraft instruments

Takashi Doi



FAX : 011-8145-301-8069
1-21-4, Minamidai, Seyaku, Yokohama, Japan



HARD TO FIND BATTERIES

that really run your antique radios!!
1 1/2 to 135 volts of various sizes &
shapes! Also available: new & used panel
meters; VTVM & multimeters; JAN
16mm projectors, UHER reel-to-reel
recorders and more! Wanted: Meters &
reel-to-reel recorders.

S&G ELECTRONICS 618 S 62nd St, Phila, PA 19143
Phone 215-474-7663 - Fax# 215-726-9761

BETA-TEK ANTIQUE RADIO SERVICE

- Repair of Radios, Communications
Receivers & Test Equipment
- Power Supplies for Battery Sets



RAY BINTLIFF
2 Powder Horn Lane
Acton, MA 01720
508 283-7435



THE RADIO MAN

Buy-Sell-Trade
Antique Radios • Tubes • Parts

DICK MORGAN
RES: (214) 564-6464

P.O. BOX 481485
GARLAND, TX 75046-1485

20 Years
Experience

Telephone/Fax
1-615-456-2529

Specializing in Antique Speaker Repair

- Very large stock of
 - Can repair any type speaker
 - Fast turn-around
 - Reasonable prices
- SHOP CLOSED JAN → FEB**

Work
Guaranteed

Hank Brazeal
103 N. Lake Point Ct.
Crossville, TN 38555

BUSINESS CARD ADS - \$45.00 FOR 3 MONTHS

Carbon Resistors • Capacitors • Vacuum Tubes

ALLTRONICS

Electronic Component Supply

2300 Zanker Road • San Jose, CA 95131
Voice (408) 943-9773 • Fax (408) 943-9776
BBS (408) 943-0622 • 24 Hrs. • N-8-1

Call or Fax for Catalog

50 years **CHUCKS** of service!

**Any Tube Radio Repaired and
 Guaranteed to work good.
 \$25 plus parts & UPS**

CHUCKS
167 LYNN DRIVE - PO BOX 598
NEW HAVEN, WV 25265 - PH (304) 882-2220

78 RPM Cartridges Repaired



Dead cartridges rebuilt right. New crystals etc., as needed. Allow 3-4 weeks. Most crystal and "horseshoe" magnet types \$34.50
 100 hr. sapphire setscrew neodes (list \$2.50 ea.) ... 4/\$5.50



Joe Smolalek
 835-A Pleasant Street
 Framingham, MA 01701

Inquiries: (508) 879-2778, evenings and weekends. Prices include return postage. Please include payment with order.

PHILCO PREDICTAS WANTED!



BUY • SELL • TRADE • RENT • RESTORE

DAVID WEDDINGTON
 (615) 890-7498

2702 Albany Ct.
 Murfreesboro, TN 37129

ELECTRON TUBE ENTERPRISES

BOX 8311 11 LINDEN LN
 ESSEX, VT. 05451

BUY TEL: 802-879-1844 **SELL**

FAX: 802-879-7764

INTERNET: ETETUBES @ AOL.COM

WRITE FOR FREE 1996 CATALOG

(Lowest prices for new & used tubes)

INSTRUMENTS



Jim & Rhoda
 Morris

Radio, Telegraph,
 Historical Instruments,
 & Books For Sale
 Catalogs
 & Lists
 Available

Antiques of Science & Technology
 A of ST Box 1852 Wakefield Ma. 01880 U.S.A.
 Tel 617 245 2897 Fax 617 245 3572

COMMNAV EQUIP
 RADIO SETS
 NAVAL AIR FIELD
 U.S. FOREIGN

CHARLES DICICCA KA1GON
 561 MYSTIC VALLEY PKWY
 MEDFORD, MASS. 02155
 PHONE: 617-386-8354



MILITARY ELECTRONICS

BUY

WANTED

TRADE

"The Early Sound Man"

Mr. John P. Andolina, Jr

Antique Phonographs



34 Glen Oaks Dr.
 Roseton, NY 14824
 (716) 247-3056
 Reasonable prices

Collect • Repair • Restore
 Edison, Victor, Columbia
 Cylinder • Disc Records
 Phonograph Advertising
 Quality Repairs Since 1973



AWA
 Member

REPRODUCERS rebuilt



THE FINISHING TOUCH



Todd E. Hirman Restorations

SHOW WINNING FINISHES

— AUTO INTERIOR WOOD —

- RADIOS
- 78 RPM JUKEBOXES
- MECHANICAL
- ELECTRONICS



203-274-0705

203-268-6080



182 JUDD FARM ROAD
WATERTOWN, CONN. 06788

All Tube Equipment Repaired



"The Fisher Doctor"

Al Pugliese
 718-948-7489

27 Daleham Street
Staten Island N.Y. 10308

VINTAGE FISHER PRODUCTS
 Bought • Sold • Traded • Repaired

SUNSHINE SOUNDS

WANTED:



Hi Fi TUBE & COMMERCIAL AMPS

McIntosh, Marantz, Dynaco, Heath,
 Altec, Scott, RCA, Fisher, Craftsman,
 Grommes, Fender, Ampex, W.E. Vox,
 Brook, Acro, Pultec, Fairchild

SPEAKERS & HORNS

Altec, Jensen, RCA,
 E.V., Western Electric,
 JBL, Tannoy

Phone: 405-737-3312 or Fax: 405-737-3355
 Sonny - 1413 Magnolia Ln., Midwest City, OK 73110

Looking for early, portable electronic calculators (1970-78)

(Any that have LED or other "lighted" displays)

- Will Trade Transistor Radios (or buy outright) •
- Especially: Basicom, Berkey/Keystone, Califax, Columbia, Commodore, Decimo, Educacal, Garrett, Ian Jones, JCE, Kingspoint, M.I.T.S., Monroe/Litton, Olympia, Royal, Sanyo, Sinclair, Sperry Remington, Summit, Victor.

Guy "Mr. Calculator" Ball Fax-(714) 730-6140
 14561 Livingston St., Tustin, CA 92680

BUSINESS CARD ADS - \$45.00 FOR 3 MONTHS

SPY EQUIPMENT WANTED!

- Code Machines
- Secret Radios
- Clandestine Weapons
- Secret Cameras
- OSS, SOE, CIA, KGB!
- I Buy or Trade!

Keith Melton
P.O. Box 5755 Bossier City, LA 71171
(318) 747-9616 Days: FAX (318) 747-9010



If you buy, sell or like Jukeboxes you need **ALWAYS JUKIN--THE MONTHLY JUKEBOX MAGAZINE!!** Subscribers in 25 countries, **ALWAYS JUKIN LEADS THE WAY:** Articles, photos, show reports, ads, new products, price guides, restoration tips, repairs--everything you need to know about **JUKE-BOXES--** the fastest appreciating collectible in the world!!! Fun & a great investment. Sample copy, \$3. \$33 per year. **ALWAYS JUKIN, 221 YESLER WAY AR, SEATTLE, WA. 98104. (206) 233-9460.** *Master/Visa ok.*



HAROLD C. BRAMSTEDT

C & N ELECTRONICS
6104 Egg Lake Road North
Hugo, MN 55038

612-429-8397
800-421-8397
Fax 612-429-0292



- Buy
- Sell
- Transmitting & Industrial Tubes

SECOND CHANCE COLLECTIBLES



399 Maplewood (Corner of 4th St.)
Ambridge, PA 15003 266-2565

* BUY & SELL



Vintage Radio



30 years experience  
Jackson Speaker Service
Expert Antique Loudspeaker Repairs
(Cone Types) And Rebuilding A Speciality.
Speaker Parts And Repair Service On
Virtually Any Speaker Made Including
Stereo, P.A., And Antique Auto Speakers.
217 Crestbrook Dr. Owner
Jackson Mich 49203 Ron McGee
Ph.-(517)789-6400, Ans. 4th ring
Wk-days 10:am-7pm Wk-Ends 9-5pm



Get your ZENITH Transoceanics working again... on batteries! It only takes 6, maybe 7 "D" cells. You need the PORTA-POWER, CVA-9 converter. It works on others sets too.

You can get everything you need directly from me at the low price of \$84.50 plus \$4 shipping. Over 200 sold! Peter Yanczer
TESLA ELECTRONICS (314) 822-1748
836 BRICKEN, ST. LOUIS, MO 63122



CRYSTAL SETS

PARTS - PLANS - KITS - BOOKS
CATALOG \$1.00

Largest source of Vintage and New Variable Air Condensers, Variometers, Vario-Couplers, Tap Switches, Tap Points, Galena and Germanium Detectors, Detector Stands, Cat Whiskers, Terminals, Sliders, Headsets, Dial Knobs, Coil Forms, Magnetic Wire, etc.

MIDCO
P.O. Box 2288
Hollywood, FL 33022
(305) 925-3670
B.A. Turko, Ph.D. E.E.



Martin

Gibson

We Buy, Sell, and Trade

"PLAY IT AGAIN"

Vintage Guitars, Amps,
Stereo Equip, Alnico Speakers, & Antique Radios
Tube Equipment Our Specialty

1-203-331-9155

Montosh

* PETER DeGREGORIO *

Marantz

85 Burroughs Rd, Fairfield, Conn.
06430-3504

(510) 490-5842

Fax (510) 490-1961

Speakerworld®

Expert Speaker Refoaming and Reconing

2000 Warm Springs Ct. #6 Visa/ *Free Return
Fremont, CA 94539 MC Freight by UPS

*For Antique Speakers Only

Vintage Radio

Bob's Radio & TV

- ◆ Repairs
 - ◆ Restorations
 - ◆ Specializing in all tube type car and home radios
 - ◆ FM additions
- 2300 Broad St
San Luis Obispo
California 93401
(805) 543-2946

Full warranty on work performed, walk-ins welcome, stop by and see our antique radio museum

CAPACITORS - TUBES RADIO SERVICE ITEMS
Thousands in jam-packed illustrated 24-page catalog No. 49

INFORMATIVE INTERESTING FUN-TO-READ

Send \$3 U.S./Canada \$5 overseas (U.S. funds) for a Heavy-Paper limited edition copy NOW!

DON DIERS 4276 North 50 St. Dept. ABB Milwaukee, WI 53216-1313

Phono Needles/Style 1500 Types
Magnetic - Ceramic - Crystal Cartridges

Rebuild Astatic and All Types of Crystal Ceramic Cartridges



Rebuild Obsolete Idlers
New Idlers and Belts
Fabricate 78 RPM Needles

West-Tech Services

648 N. Ridgewood Dr. #11
P.O. Box 1415
Sebring, FL 33871

STEVE KARPIAK C.E.T
Phone (941) 471-0922

BUSINESS CARD ADS - \$45.00 FOR 3 MONTHS



K4G1T

RADIO ELECTRIC SUPPLY

We Specialize In Receiving and Special Purpose Tubes

Send For Price List

Dorothy and Don Gies
Owners

Box 2790 RR#2
Melrose, FL 32666
904-475-1950
Phone or Fax

**PUT
YOUR BUSINESS CARD
HERE!**

\$45 FOR 3 MONTHS - \$78 FOR 6 MONTHS
DON'T HAVE ONE? SEND AN EXTRA \$6.50 AND
WE WILL TYPESET ONE FOR YOU.

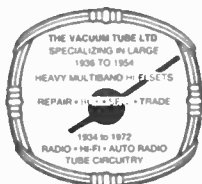

Michael K. Truemper
110 Lynwood Terrace
Chatsworth, New York
14225 U.S.A.
By Appointment
(716) 834-8180

MAGNAVOX STROMBERG-CARLSON MIDWEST HOWARD

Play Things of Past

Sales - Service - Restoration of vintage
radios, tv's, jukeboxes and electronics.



Retail Sales Store

3552 W. 105th St.
Cleveland, OH 44111
216-251-3714
Hours: 6-9PM Wed, 12-6PM Sat.
Other times by chance

Mail Address

Gary Schneider
Play Things of Past
9511 Sunrue Blvd., #J23
Cleveland, Ohio 44133
216-582-3094

**5,000,000 Vacuum Tubes In Stock
Industrial & Receiving Types**

Electronics Emporium Inc.

107 Trumbull Street
Elizabeth, NJ 07206

Buying & Selling, Call For Prices & Delivery

800 - OLD TUBE
(653 - 8823)

Ph: 908-351-0100

Fax: 908-351-8600

**Allan H. Weiner
Radio Engineer
Antiques of Technology**

Electrical, Electronic, Scientific, and
Mechanical Artifacts.
Early WWII Radar a Speciality.

97 High St.
Kennebunk, ME 04043 (207) 985-7547

Buy • Sell • Trade

• GRUNDIG • SABA • TELEFUNKEN • NORDMENDE • PHILIPS • SIEMENS •
- SPECIALIZING IN REPAIR OF EUROPEAN RADIO SETS -

**The Bavarian
Radio Works**



Ross A. Hochstrasser
(617) 447-4299

162 BELLAIR ST.
WETHAM, MA 02382

LOGANS TV-RADIO

SINCE 1952

BUY • SELL • TRADE

100's of N.O.S. PARTS, TUBES IN STOCK.
PARTIAL OR TOTAL RESTORATION AVAILABLE.

412-837-5580

REAR 526 Mt. PLEASANT ST., GREENSBURG, PA 15601

WANTED
PRE 1900
ELECTRICITY
MEDICAL • X-RAY
TELEGRAPHY • TELEPHONE

PRE 1925
RADIO • WIRELESS
PRE 1940
TELEVISION

BOOKS • TUBES • ARTIFACTS
MAGAZINES • AUTOGRAPHS
CATALOGS • EPHEMERA



**NEW WIRELESS
PIONEERS**
P.O. BOX 398
ELMA, NY 14059
716-681-3186

**WHAT...
You have CATALINS?**

I'll Pay Top \$'s — Any Models

Please Send a Photo and Price To:
Kunihiko Suzuki
2173 Takao, Fukuroi-Shizuoka, Japan 437
(Fax) 81 538 43 3188

RADIO BOOKS FOR SALE

Large selection of books on Radio and Related Technology
Call or write for our List of Catalogs
Always buying, single items or collections.

RAINY DAY BOOKS

P.O. BOX 775, FITZWILLIAM NH 03447
(603)-585-3448

**** WANTED ****

Masco. Newcomb PA Systems
Turner, Shure, Astatic Mics
Jensen 8", 10" speakers,
any condition.

* Gary (203) 777-7426 *

Radios

of the Baby Boom Era

Six Volumes — 2000 pages — From Sams' Archives
1946 to 1960 — 274 Brands — 3494 Illustrations (B&W)
6769 Models — Catalin, Bakelite, Wood, Transistor Radios & More



All Volumes Available!

Vol.	Brands	Included
1	56	Admiral to Clearsonic
2	54	Co-op to Gelo
3	58	GE to Monitoradio
4	36	Motorola to RCA Victor
5	35	Realtone to Stratovox
6	35	Stromberg-Carlson to Zenith



1/2 Page for each illustrated radio including:

- Large illustration of the radio including knob functions
- Short description of the radio
- Number of tubes
- Power supply type (AC, Battery, etc.)
- Tuning range
- Manufacturer
- Sams Photofact Set number & year Photofact published.

Each Volume: \$16.95 – Softcover
8 1/2" x 11" – Approx. 328 pages

ALSO

- Index by model number listing tubes in radio
- List of similar radio models indexed to pictured radio
- List of manufacturers and suppliers indicating their brand names
- Basic trouble-shooting hints

U.S. Orders - Enclose \$3.00 per order for packing & book-rate shipping if total order is under \$35.00. If using VISA or MasterCard, include name on card, card number and expiration date. Send payment with order. Mass. residents please add 5% sales tax. Money back return policy. Most orders shipped the same day received, but allow 2-4 weeks to receive order. Foreign orders - write for shipping costs, or use credit card and specify air or surface (allow 2-3 months for surface shipping).



Send Order To: A.R.C., P.O. Box 2, Carlisle, MA 01741
or Call: (508) 371-0512 Fax: (508) 371-7129



(Jan-96)

Transistor Radio Books



The Collector's Guide to Transistor Radios by Marty & Sue Bunis. *This book will help you identify the most sought-after vintage transistor radios. Over 2,200 models, all with current prices. Over 400 color photos. 5 1/4" x 8 1/4". 256 pgs.*

\$15.95 - Softcover

Made In Japan by Roger Handy. *A stunning book on the development and growth of the transistor radio featuring over 175 transistor radios in full color. 10" x 9 3/16". 108 pgs.*

\$16.95 - Softcover



The Portable Radio in American Life by Michael Schiffer. *Approximately 50 pages on transistor radios, beginning with the Regency TR-1 through to the later sets made overseas. 450 photographs, 193 transistor radios pictured. 8 1/2" x 11". 259 pgs.*

\$24.95 - Softcover
\$45.00 - Hardcover

Collector's Guide to Novelty Radios by Marty Bunis & Robert Breed. *This book is the source for novelty transistor radios in all shapes and sizes. Radios are described in detail with current prices. Over 600 all new color photographs. 8 1/2" x 11". 224 pgs.*

\$18.95 - Softcover



Transistor Radios, A Collector's Encyclopedia and Price Guide by David Lane & Robert Lane. *Identification & price guide to over 2,500 transistor and novelty radios. History & key to collecting chapters. 8 1/2" x 11". 170 pgs.*

\$19.95 - Softcover

U.S. Orders - Enclose \$3.00 per order for packing & book-rate shipping if total order is under \$35.00. If using VISA or MasterCard, include name on card, card number and expiration date. Send payment with order. Mass. residents please add 5% sales tax. Money back return policy. Most orders shipped the same day received, but allow 2-4 weeks to receive order. Foreign orders - write for shipping costs, or use credit card and specify air or surface (allow 2-3 months for surface shipping).



Send Order To: A.R.C., P.O. Box 2, Carlisle, MA 01741
or Call: (508) 371-0512 Fax: (508) 371-7129



(Jan-96)

COLLECTOR BOOKS AVAILABLE FROM A.R.C.

BOOKS MARKED WITH "es" ARE THE MOST POPULAR AND ARE ESPECIALLY RECOMMENDED FOR NEW COLLECTORS!

Antique Radio Restoration Guide, 2nd Ed., Johnson. <i>Beginner's introduction to troubleshooting and repairing AC table model radios.</i> 1992. 145 pgs.	\$14.95
The AWA Review. <i>Collections of articles.</i> Vol. 6: Hawaiian Wireless, U.K. TV, SCR-RC-BC Dir., NYC Wireless, etc. Vol. 7: Poldhu xmitters, Navy Equipment, Arc xmitters, etc. Vol. 8: Keys, Federal Co., KFS-Federal-Mackay Story, Nat'l Electrical Supply Co., Navy Electronics Dir., etc. Vol. 6-8, ea. \$10.00	
Vol. 9: Marconi, The Int'l Contest for Radar, The Magnetron Story, F. Lowenstein, Ham Licensing. . Vol. 9, NEW	\$17.00
The Antique Radio Boys and the Garrulous Grebe, Dryer. <i>Thrilling adventure story written in the traditions of the '20s and '30s.</i> 5 1/2" by 8 1/2". 51 pgs.	\$4.95
The Auto Radio: A Romantic Genealogy, Matteson. <i>Info, photos & ads from the early days of the auto radio through the 1950s.</i> 316 pgs. (hardcover)	\$34.95
Behind the Front Panel, Rutland. <i>Reviews radio circuits and radio history. Easy descriptions.</i> 25 pics. 158 pgs.	\$18.95
Blast from the Past, A Pictorial History of Radio's First 75 Years, Rhoades. <i>The performers, programs, & technology that made radio a part of everyday life.</i> 100s of rare, never-before-published photos. (hardcover) NEW	\$39.95
Broadcasting's Forgotten Father: The Charles Herrold Story, Adams. (Videotape, VHS). <i>One-hour documentary on this amazing inventor. Featuring his family, students, and photos to document his work</i>	\$29.95
Classic TVs, Wood. <i>Prewar to 1950s, with price guide.</i> 140+ color photos, plus repros of catalogs & ads. 86 pgs.	\$16.95
es The Collector's Guide to Antique Radios, 3rd Ed., Bunis. <i>This guide covers radios from 1920s to 1960s. Over 8,500 prices and over 650 all new color photos are included.</i> 1994. 278 pgs.	\$18.95
The Collector's Guide to Novelty Radios, Bunis & Breed. <i>The source for novelty transistor radios. Full descriptions with current prices. Over 600 color photos.</i> 1994. 224 pgs.	\$18.95
The Collector's Guide to Transistor Radios, Bunis. <i>Identifies the most sought-after vintage transistor radios. Over 2,000 models, 400+ color photos, with current prices.</i> 1993. 256 pgs.	\$15.95
Communication Receivers, 3rd Ed., Moore. <i>Information on 738, 1932 to 1981, vacuum tube receivers by 66 manufacturers.</i> 402 radios illustrated. New section: 3 pages of military receivers. 125 pgs.	\$19.95
The Compleat Talking Machine, Reiss. <i>A guide to restoration of antique phonographs.</i> 183 pgs.	\$19.95
Crystal Clear - Vintage American Crystal Sets, Crystal Detectors and Crystals, Sievers. Vol. 1 - <i>Comprehensive reference with 750 illustrations, 570 crystal sets, 341 detectors, 207 crystals.</i> 282 pgs.	\$29.95
Vol. 2 - <i>479 All new & different illustrations, more crystal sets, detectors and crystals identified.</i> 252 pgs. NEW	\$29.95
E.H. Scott Radio Collectors Guide, 1925-1946, Clark. <i>The reference for collectors of Scott radios, cabinets and accessories. Lists original prices of cabinets and accessories. Over 200 photos with descriptions.</i> 88 pgs.	NEW \$29.95
Early Radio, In Marconi's Footsteps, Jensen. <i>Realistic description of Marconi's work and his surroundings. Early construction projects with diagrams. Color and B&W photographs.</i> 170 pgs. (hardcover only) NEW	\$39.95
Empire of the Air, Burns. (Videotape, VHS). <i>2-hour video based on Lewis' book.</i>	\$24.95
Empire of the Air, Lewis. <i>Biographical radio history on De Forest, Armstrong and Sarnoff.</i> 1991. 421 pgs.	\$13.00
Evolution of the Radio, L-W Books. <i>Radios pictured and priced, plus reproductions of catalog pages and ads.</i> Vol. 1 - <i>Eight-hundred + radios.</i> 1991. 227 pgs., 118 pgs. in color.	\$22.95
Vol. 2 - <i>Totally different from volume one with new photos, etc.</i> 1993. 654 color photos. 226 pgs.	\$24.95
Firco Radio Equipment, John Firth & Co., Inc. (reprint). <i>Twenty-six-page booklet of the Firth Co. through battery sets, superhets and communications receivers.</i> 1990. 300+ figures, 185 pgs.	\$19.00
es Flick of the Switch, McMahon. <i>The classic photo reference guide for '30s - '50s radios.</i> 1000+ photos. 263 pgs.	\$11.95
Great Radio Personalities (reprint). <i>B&W pics of the golden days of radio - Abbott & Costello, etc.</i> 128 pgs.	\$11.95
es Guide to Old Radios - Pointers, Pictures & Prices, 2nd Ed., Johnson. <i>Introduction to radio collecting. Includes hundreds of photos and a price guide.</i> 1995. 272 pgs. (Available Now) NEW	\$19.95
Hake's Guide to TV Collectibles. <i>Price guide and photos for 1600 TV shows, comic books, etc.</i> 1990. 185 pgs.	\$14.95
Heathkit, A Guide to the Amateur Radio Products, Penson. <i>Documentation of all Heathkit's amateur radio products, a complete history of the company, 200+ sharp photos.</i> 256 pgs.	NEW \$24.95
Hertz: The Beginning of Microwaves, Bryant. <i>Photos and descriptions of Hertz's apparatus and experiments. A book prepared for the IEEE Hertz Centennial exhibit.</i> 50 pgs.	\$15.00
Inventing American Broadcasting, Douglas. <i>A careful weaving of technology, social forces, and business decision making from the days of Marconi to broadcasting in the 1920s.</i> 1987. 363 pgs.	\$14.95
Los Angeles Radio Manufacturing, Paul. <i>History of radio manufacturers in the L.A. area from 1922 to 1942. Features Echophone, Gilfillan, Jackson Bell & 9 others.</i> 88 pgs.	\$10.50
Supplement No. 1, Paul. <i>Coverage of additional manufacturers, people and sets.</i> 1993. 48 pgs.	\$6.75
Made in Japan, Handy. <i>A stunning book on the rise of the transistor radio. 175+ radios in color.</i> 1993. 108 pgs.	\$16.95
The Mechanics of Television, Yanczer. <i>History and explanation of mechanical television, plus construction details for a working system.</i> 1987. 5 1/2" by 7 1/2", 170 pgs.	\$24.95
Most Often Needed 1926-38 Radio Diagrams and Servicing Information (reprint). <i>600+ diagrams for mostly AC radios from '26-'38.</i> 240 pgs.	\$11.95
Novelty Radios, Breed. <i>500+ transistor novelty radios in full color with current prices.</i> 1990. 217 pgs.	\$24.95
1994 Price Update - Novelty Radios, Breed and Bunis. 14 pgs.	\$4.95
Official Radio Service Manual (reprint). <i>100s of pre-1930 circuits & notes.</i> 356 pgs.	\$24.95
Old Gramophones, Bergonzi. <i>The development of phonographs and gramophones.</i> 64 photos 32 pgs.	NEW \$4.95
Old-Time Radios! Restoration and Repair, Carr. <i>How to repair vacuum-tube and transistor radios. A self-paced training guide.</i> 200 illustrations, 256 pgs.	\$18.95
Philco Radio: 1928-1942, Ramirez. <i>A reference book on Philco. Shows receivers and company history year-by-year.</i> 464 color photos, 364 black & white photos and drawings. 1993. 160 pgs.	\$29.95
Portable Radio In American Life, Schiffer. <i>Traces the development of the portable radio and how it affected American culture and society.</i> 450 photos and drawings, 259 pgs. (hardcover: \$45.00)	\$24.95
Poster's Radio & Television Price Guide, 1920 - 1990, 2nd Ed. <i>875+ TV's, 650 transistor radios and 2,200 other radios listed.</i> 600 sets illustrated. 75 in color. 1993. 7" x 10". 264 pgs.	\$17.95
Price Guide to Plastic Collectibles, McNulty. <i>Describes types of plastics, etc. (Radio is 8 of 207 pgs.)</i>	\$17.95
RCA Radiolas, Radiotrons, and Accessories (reprint). <i>Twenty-page booklet summarizing RCA's 1926 product line including the Radiola III, 20, 25, 26, 28, etc.</i>	\$4.50
Radio Art, Hawes. <i>A chronological, illustrated history of the technical and stylistic progress of the radio. Mostly British, but American sets are featured as well.</i> 250 photos, 150 in color, 128 pgs. (hardcover only) Low Price	\$9.95

COLLECTOR BOOKS AVAILABLE FROM A.R.C.

BOOKS MARKED WITH "E" ARE THE MOST POPULAR AND ARE ESPECIALLY RECOMMENDED FOR NEW COLLECTORS!

- Radio Art Postcard Deck. 30 full-color photographs from Haves' book. \$7.50
- Radio Collector. (Videotape, VHS). The five-part Emmy-nominated PBS series combined on one 130-minute videotape. Meet collectors, see collections, attend swap meets, learn about radio restoration. \$29.95
- The Radio Collector's Directory and Price Guide, 1921-1965, 2nd Ed., Grinder. Directory of over 20,000 radios by manufacturer, model number, year, etc., with prices. Radio history, cabinet styles, vacuum tube development chapters. Over 1,200 trade names listed. Thoroughly revised and expanded. 500 pgs. \$26.95
- Radio Collector's Guide, McMahon. Listing of 9,000+ radios made by some 1200 companies from 1921 to 1932. Gives manufacturer, year, model name and other info. No photos, 264 pgs. \$11.95
- The Radio Collector's Guide to Philco Bakelite Block Condensers, Bintliff. A detailed description of Philco Bakelite block condensers with illustrations and parts lists. 1994. 52 pgs. \$9.95
- Radio Craft - 50 Years of Radio (reprint). March 1938 issue of Radio Craft magazine. Numerous articles on the development of radio, then 50-years old, and on early radio pioneers. 144 pgs. \$15.95
- Radio Equip. & Supplies. (reprint). 1922 radio catalog, accessories, etc. RCA, Clapp-Eastham, etc. 168 pgs. \$19.95
- Radio-The Golden Age, Collins. Full-color book on the colorful Catalin and Bakelite radios from the late 1930s to the early 1940s. 128 pgs. (hardcover \$29.95) \$17.95
- Radio Horn Speaker Encyclopedia, Paul. Listing of horn speakers for over 320 manufacturers for the 1920s. Expanded information on ten manufacturers. Over 145 photos, 80 pgs. \$14.90
- Radio Horn Speaker Notebook, Rev. H. Paul. The companion to the Encyclopedia. Over 450 horn picture ads are shown, over 325 manufacturers are identified. Photocopy. New Index. 1995. 72 pgs. \$15.90
- Radio Manufacturers of the 1920's, Douglas. Three comprehensive volumes. Vol. 1 covers A-C Dayton thru Ferguson. 225 pgs. (softcover only) \$24.95
 Vol. 2 covers Freed-Eisemann thru Priess. 266 pgs. (softcover only) \$29.95
 Vol. 3 covers RCA thru Zenith. 292 pgs. (hardcover: \$39.95) \$29.95
- Radio Poster, Sonoran Publishing. Color 20" x 26". A radio timeline. 20 radios from the Pup to transistors. NEW \$10.95
- Radio! Radio!, 2nd Ed., Hill. Revised easy-to-read subject index, separate A-Z directory listing of 1,000 + British radio models with clearer photographs than first edition. 978 photos, 244 pgs. (hardcover only) \$44.95
- Radio Redux, Collins. Subtitled "Listening in Style." This book showcases the sleek lines and luscious colors of over 80 gleaming sets from the collection of Philip Collins. 120 pgs. (hardcover: \$29.95) \$17.95
- Radio/TV Finder, Okolowicz. Reference to nearly 7,000 radio and TV pics found in 24 books. No photos, 110 pgs. \$13.95
- Radio & T.V. Collector's Guide Book, Biraud. The "Vintage Radio" illustrated guide to European sets from early wireless to the 1930s (a few later). Text is in both French and English. Vol. 1: History & Manufacturers A to P. 256 pgs. Vol. 2: P to Z & T.V., Speakers, Tubes, Loops, Parts & Novelties. 256 pgs. (Per Volume) \$49.95
- Radios of the Baby Boom Era. Pictures and info from Sams Photofacts. 3,494 radios illustrated plus 3,275 additional radios listed. 1946 thru 1960. Six volumes, 300+ pages per volume. Order by volume: Vol. 1: Admiral - Clearsonic. Vol 2: Co-op - Gelo. Vol 3: GE - Monitorradio. Vol 4: Motorola - RCA. Vol 5: Realitone - Stratovox. Vol 6: Stromberg-Carlson - Zenith. (Per Volume) \$16.95
- Refinishing Old Furniture, Wagoner. Written by a furniture restoration instructor. A step-by-step guide to furniture (or radio) restoration, from removal of finishes right up to the final polish. 178 pgs. \$14.95
- Saga of the Vacuum Tube, Tyne. The development of vacuum tubes - 1880 to 1930. From Edison, Thomson and Fleming to de Forest, Philips, Siemens and many more. 100+ tube photos, 495 pgs. \$18.95
- Sound & Vision Yearbook 1995/96. An annual directory of radio & TV collectors, primarily European. NEW \$6.95
- Syntax and Spark, Aiken (reprint). Subtitled "The Origins of Radio." Describes the development of radio from Maxwell's work in the 1860s through the contributions of Hertz, Lodge and Marconi. 1976. 347 pgs. \$16.95
- S. Gernsback Radio Encyclopedia (reprint). 1927 classic encyclopedia on radio. From "A" Battery to Zirconium, with 1000s of entries in between. 100s of illustrations, 175 pgs. \$9.95
- 70 Years of Radio Tubes and Valves, Stokas. The story of the radio tube from the laboratory to the commercial market. 247 pgs. \$25.95
- 75 Years of WE Tube Manufacturing, Magers. A log book history 750+ WE tubes. Illustrated. 133 pgs. \$16.95
- Tomart's Price Guide to Radio Premium and Cereal Box Collectibles, Tumbusch. Includes comic character, pulp hero, TV and other premiums. 1991, 3,000+ illustrations, 176 pgs. \$22.95
- Transistor Radios, A Collector's Encyclopedia and Price Guide, Lane. Identification guide to over 2,500 transistor and novelty radios. History and key to collecting chapters. 1994. 170 pgs. \$19.95
- Vintage Radio, McMahon. The classic photo reference guide for collectors of radios prior to 1930. Crystal sets, battery sets, tubes, horns, parts, etc. Over 1000 pictures, 263 pgs. (Temporarily Out-Of-Print) \$11.95
- The Weekend Refinisher, Johnson. A complete guide to stains and finishes and tips for setting up your own workshop. A handy furniture "first aid" kit for quick repairs. Illustrated. 296 pgs. \$10.00
- Westinghouse Catalog (reprint). 1920s catalog of the RA-DA and other early Westinghouse equip. 8 pgs. \$4.00
- Wireless Communication in the U.S., Mayes. Early development of American radio operating companies. Alternators, coherers, stock promotions, unpublished letters, etc. 160 illustrations, 240 pgs. \$29.95
- The Xtal Set Society Newsletter, Anderson. Complete set of the Society's newsletter. Order by volume. Vol. 1: 7/91 to 5/92 - Field Strength Meter, HF Broadcasting, FM Xtal Set, Xtal Sets & Wireless, & more. Vol. 2: 7/92 to 5/93 - The Lead Pencil Detector, Detector Biasing, The Universal Xtal Set, etc. Vol. 4: 1/94 to 11/94 - Measuring Coil Capacitance, home-brew headphones and curve tracers, etc. (Per Vol.) \$9.95
- The Xtal Set Handbook, Anderson. Formulas for coil inductance, a procedure for measuring coil capacitance, circuit matching theory, & more. Also included is Vol. 3 of the Xtal Set Society Newsletter. \$10.95
- Zenith Radio Corporation (reprint). The instructions for installation and operation for Models 39-39A Models 392-392A, and Electric Zenith Receivers. 3 schematics, 3 photos, 7 1/2" by 5", 16 pgs. \$4.50
- The Zenith Trans-Oceanic: The Royalty of Radios, Bryant and Cones. Presents the fascinating story of the development and use of the Trans-Oceanic. Several photos, documents, ads, etc. 160 pgs. NEW \$24.95

U.S. Orders - Enclose \$3.00 per order for packing & book-rate shipping if total order is under \$35.00. If using VISA or MasterCard, include name on card, card number and expiration date. Send payment with order. Mass. residents please add 5% sales tax. Money back return policy. Most orders shipped the same day received, but allow 2-4 weeks to receive order. Foreign orders - write for shipping costs, or use credit card and specify air or surface (allow 2-3 months for surface shipping).



Send Order To: A.R.C., P.O. Box 2, Carlisle, MA 01741

or Call: (508) 371-0512

Fax: (508) 371-7129



(Jan-96)

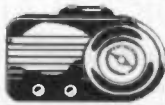

Our year-end DISCOVERY list!

As we look around the Posters' warehouse... have we *discovered* some great left-overs!

**FOR SALE:
 Emerson
 Patriot**

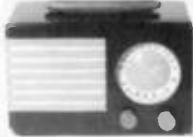

Beautiful blue bodied with red & white. Excellent condition-no cracks or breaks. Was \$1500...**Now \$1,999!**

**FOR SALE:
 Ambassador
 4-dialer.**



A nice assembled kit from "Ambassador Sales/Chicago and New York" but the front bakelite panel is cracked. Has Western Electric headphones. This Ambassador was priced at \$105...**it's now only \$66!**

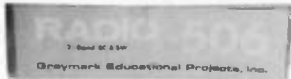

FOR SALE: Kits. Great winter projects: Graymark 506, 5 tube 2-band superhet. Box a bit squished. Just got another one in...priced at \$75. VTVM kit, Arkay VT-10, 11 meg-ohm input, complete with tubes, etc. Was \$89...**Only \$49!** Assortment: 2 power supplies, audio amp, and Computer Circuit with Fairchild u1914 chips! **\$40**



FOR SALE: Wollensak T-1515 Tape recorder. Found another one. Good quality unit but has some paint chipping. Last one was \$33...**This one \$24!**



FOR SALE: Harmon Kardon receiver and amplifier. SR600 transistor stereo FM tuner-receiver and hk560 DC power amp with AM/FM. The pair was priced at \$85...**now only \$45 for both!**



**FOR SALE:
 Crown CTV-12S.**
 1970s sub-mini TV. Comes with attached battery adapter. This was \$63, **Now priced at \$43!**

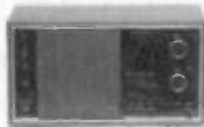

FOR SALE: Sony 8FS-50W. Great 22 transistor AM/FM stereo radio in an aluminum and walnut case. This quality radio was \$46...**but now it's only \$31.**

FOR SALE: Phonograph needles and cartridges. Sold the last batch, but we just found another. There's about 115 packages of new needles and cartridges, plus 20 arms, spindles, and adapters. **The lot....\$44**

FOR SALE: GE 810
 We sold our last two...but just bought another! Nice 10" wide 1948 television, complete and works but it has a reduced picture. Price-- **\$215**



**FOR SALE:
 RCA Bakelite
 Speaker.** This unusual wall hanging speaker is in good condition, with no breaks. It measures 12" x 15" and 5" deep. Was \$69...**now \$39!**



FOR SALE: Poster's tube and transistor Radio and TV Price Guide. Published at \$17.95 by Chilton Books, we do have a few more copies left! These are \$8, but buy anything else on this page, and you can buy one or more at **only \$6 each!**



FOR SALE: TV-Shop Banners.... Silk signs for your wall! SONY: "SONY" outlined in four colors, 41" W x 22" Hi and "Sony Integrated Music Systems" 41" Hi x 22" Were \$35+\$18...the pair \$30! GRUNDIG: 45" wide by 28" long "Grundig Radios Consoles HiFi Tape Recorders", was \$35...now priced at only \$20 PHILCO: "Television's Greatest Power Plant 1952 Philco" In yellow & white on green, was \$25-but now only \$20 MOTOROLA: "Motorola the Most Reliable TV Ever" in blue and white on maroon. Was \$30, now only \$20



CLASSIFIED ADVERTISING POLICY

ONE FREE 20-WORD AD for subscribers in each issue; additional words are 25¢ each. See details below. Classified ads sent by mail, fax or by any other method must be received (not just postmarked) by Noon Eastern Time on the classified ad deadline date to guarantee inclusion in the current issue. Late ads are held for the following issue. Please enclose correct payment with all ads. Stamps or cash are OK for small amounts. (Canadian and other foreign advertisers, please see "Payment" on page 2 for methods.) "Free words" cannot be accumulated from month to month; free words must be requested when ad is submitted.

Faxed & e-mailed ads: Please see additional information on the inside front cover.

When including ads with other A.R.C. correspondence, write the ads on a separate piece of paper. Include SUB# with ad. Ads may be sent in advance; but, write each ad on a separate piece of paper and indicate the month (or successive two months) you want the ad to run.

To minimize our typing errors: Please write legibly. Use both capital and small letters. Do not use a dash between words. Carefully write the following numbers and letters (especially in model numbers) since some can look alike; for example 1, l and I (the number one, the capital i and the small L.) Also: 0, O, o, Q and D; r and n; 6, b and G; V, U, u, v and Y; A and R; 5, S and 2; Z and z. We try to correct spelling errors, so when using an uncommon word or manufacturer which we might mistake as a more common word or manufacturer, note it so that we do not "correct" it. Editor's annotations are in [brackets].

Advertising is accepted only for early items related to radio, communication, etc. All items must be described fairly; reproductions, reprints and not-original items must be so identified. Advertisers must agree to respond promptly to inquiries and orders, to resolve problems promptly if the buyer is not satisfied, and to comply with a buyer's refund request on unaltered returned items.

The publisher reserves the right to edit ads without notification to the advertiser and to reject ads for any reason. Names other than the advertiser will be edited out of ads. Ads with non-radio-related items will be returned or edited unless the non-radio-related items are for trade of radio-related items, or they are incidental to and appear at the end of an otherwise acceptable ad. The publisher is not responsible for errors due to illegibly written ads or for any other reason.

Clubs: Since club activities receive free coverage on the *Coming Radio Events* pages, the free 20 words may not be used for club activity ads. See inside front cover for additional information.

CLASSIFIED AD DETAILS

Deadline: NOON ET— 10th of the month!

Classified ads must have a standard heading such as WANTED, FOR SALE, FOR TRADE, FOR SALE/TRADE, SERVICES, MESSAGE, HELP, AUCTION, MEET, etc. This heading is the only bold or all-capitalized words allowed in the ad. Capitalize only manufacturer names, model names, etc. This standard ad format makes scanning the ads easier.

Before writing your ad, please look over the ads in a recent issue of A.R.C., and try to write your ad in the same style. Full name (or company name) and address is required in all classified ads; we will add it if you forget.

To encourage varied content of the ads, the same classified ad may be run only once per issue and for only two consecutive months. (To run an ad longer, use a boxed classified or display ad.)

Classified Ad Rates per Month

Subscribers:

First 20 words: FREE*

25¢ per word for extra words over 20 plus

10¢ per word for a shaded ad (count all words including free words).

* Subscribers may take 20 free words on only one ad each month.

Non-Subscribers:

41¢ per word plus

10¢ per word for shaded ad.

Please do not forget to send in the extra 22¢ per word when your classified ad runs over the free 20 words; your payment will be appreciated, and it will help to keep A.R.C. healthy.

BOXED CLASSIFIED AD DETAILS

Deadline: 1st of the month!

Boxed classified ads can run unchanged for three months or more. No words are free. Ads may be shaded and may include bold and all-capitalized words freely. The ad need not begin with "For Sale," etc. Minimum run is 3 months, prepaid. Discount: 10% for 6 months; 20% for 12 months.

Boxed Classified Ad Rates per Month

Nonshaded ads:

36¢ per word for all words,* none free, plus

10¢ per word for each bold word plus

10¢ per word for each all-caps word.

Shaded Ads (All words are bold at no charge):

45¢ per word for all words* plus

10¢ per word for each all-caps word.

Non-Subscribers:

Add 20¢ per word to above costs.

*Three words can be bold-all-caps at no extra charge.

PHOTO & DRAWING DETAILS

Deadline: 1st of the month

for all ads with drawings or photos!

Drawings and photos are encouraged as the response to your ad is much larger and the reader knows better what you want or are selling. Send in your drawing or photograph, and A.R.C. will reduce it or enlarge it as needed.

Photo and Drawing Rates per Month

\$20.00 per month for each photo or drawing

(If ad is canceled, this amount cannot always be refunded.)

CHANGES & CANCELLATIONS

Please check your ads carefully before sending them in. Once ads are received, it is not always possible to refund the amount sent, pull the ad or make changes.

IMPORTANT — COUNTING WORDS — IMPORTANT

The standard headings: WANTED, FOR SALE, etc., count as one word each time used in an ad. Name, address and (one) telephone number, count as 6 words, regardless of length. Ham call letters and business name can be included in the 6 words and do not count extra. Full name (or company name) and address is required in all classified ads. Each additional word, abbreviation, model number or number group, extra telephone numbers, fax, e-mail, etc. count as one word each. Hyphenated words count as two words.

SECOND CLASS



A.R.C., P.O. Box 2, CARLISLE, MA 01741

RETURN POSTAGE GUARANTEED

**CLASSIFIED AD
DEADLINE JAN. 10th
Noon Eastern Time**