



# ANTIQUE RADIO CLASSIFIED



VOLUME 10

OCTOBER 1993

NUMBER 10



## Absolutely All There Is!

### "A" Power Direct from Socket to Tube



# Battery-less Kellogg Radio

Licensed under application for letters patent of Radio Frequency Laboratories, Inc. (R.F.L.)



A.R.C. — THE NATIONAL PUBLICATION FOR BUYERS AND SELLERS OF OLD RADIOS AND RELATED ITEMS — PUBLISHED MONTHLY

## ANTIQUE RADIO CLASSIFIED

Antique Radio Classified (ISSN:8750-7471) is published monthly, 12 times per year, by John V. Terrey, One River Road, P.O. Box 2, Carlisle, MA 01741. Second-class postage paid at Carlisle, MA, and additional mailing offices. Telephone: (508) 371-0512, 9:00 AM to 5:00 PM ET weekdays; machine answers phone at other times.

Annual subscription rates within the U.S. are \$29.95 by Second Class mail and \$44.95 by First Class mail.

Annual foreign rates. By air: Canada - \$48.00; Mexico - \$47.00; Other foreign countries - \$85.00. Surface mail: Canada - \$39.00; Other foreign countries - \$43.00. (Surface delivery to countries other than Canada may take two or more months and cannot be guaranteed.)

Two-year subscriptions are twice these rates and receive an extra month. Sample issues are available free on request.

© Copyright 1993 by John V. Terrey.

**POSTMASTER: Send address changes to Antique Radio Classified, P.O. Box 2, Carlisle, MA 01741.**

### STAFF

Publisher and Editor:

John V. Terrey

Production Manager:

Scott J. Young

Office Manager:

Lisa A. Friedrichs

Publishing Staff:

Dave Crocker

Dick Desjarlais

Chris Frederickson

Bobby Lyman

Shirley Sauer

Dorothy Schecter

Founding Publisher/Editor:

Gary B. Schneider

Contributing Writers:

Mike Adams

Richard L. Arnold

Ray Blintoff

Ron Boucher

Paul J. Bourbin

Norman S. Braithwaite

Dave Crocker

Alan S. Douglas

Richard C. Foster

Fred Geer

Jim Kreuzer

Ron Ramirez

Henry Rogers

Ian L. Sanders

Gary B. Schneider

Daniel Schoo

Dwane Stevens

Frank R. White

Ralph Williams

**PURPOSE.** Antique Radio Classified is published for people involved in the radio collecting hobby. Its purpose is to stimulate growth of the hobby through the buying, selling and trading of radios and related items, and to provide a monthly forum for the interchange of ideas and information.

### CONTACTING ANTIQUE RADIO CLASSIFIED.

All correspondence should be sent to:

A.R.C., P.O. Box 2, Carlisle, MA 01741.

Send only UPS, Federal, etc. items to One River Road.

Telephone: (508) 371-0512; Fax: (508) 371-7129

Please, no classified ads by telephone; thanks.

Your ads, renewals, letters, etc. can be handled faster and more efficiently if (1) each is on a separate piece of paper, and (2) your name, address and SUB# are written on each.

Unfortunately, A.R.C. is not staffed to answer letters

with questions about antique radios or requests for advice. However, A.R.C. does solicit letters of interest to its readers and publishes them as space permits. A.R.C. assumes that permission is given to edit and to publish all correspondence and articles received unless otherwise indicated.

**GURANTEE.** You may cancel your subscription at any time and receive a pro rata refund for issues not yet mailed. If errors to ads are made by A.R.C., upon request a free correction will be run in the next available issue.

**PAYMENT.** Please send in full payment with your order or ad. A.R.C. does not carry accounts; all subscriptions, ads, etc. must be prepaid (except for the 6 and 12 month display ads indicated below.) Pay in U.S. funds. Checks drawn on a U.S. bank, money orders, VISA or MasterCard (\$10.00 min.) are preferred. Make check out to "A.R.C." U.S. stamps or cash are OK for small amounts. Canadian payers may send a Canadian check but specify U.S. funds. Subscriptions will be prorated to amount sent if amount is incorrect.

**CHANGE OF ADDRESS.** Please notify us 4 weeks in advance of a change of address. Send both your new and old address, and include your SUB# and effective date of your new address. Temporary address changes can be made also.

**SUBMISSION OF MATERIAL.** Antique Radio Classified welcomes and solicits information that pertains or relates to radio history or collecting. This may include articles, book reviews, photos, information on upcoming radio events, meetings, antique radio organizations, radio auctions and price reports, sources of old radio and restoration supplies, and other related and interesting material. All material submitted should be neat and verified for accuracy. Unless prior arrangements are made, all submitted materials may be edited, become the property of Antique Radio Classified and will not be returned.

**MAILING OF ISSUES.** U.S. subscribers can receive A.R.C. by First or Second Class mail (Second Class is the way most magazines are mailed). The mailing of First Class copies is staggered over one to four days with faraway copies mailed before local copies. Non-U.S. copies are mailed on the first day. Second Class copies are mailed on the last day. Mailing dates change each month, but mailing is usually completed by the 26th of the month. First Class copies usually are received by the fifth of the month; copies by Second Class mail, by the tenth.

**ETHICS.** No person involved in the production of A.R.C. is to act on any information in the magazine until the day after local copies are mailed.

**DISCLAIMER.** The publisher is not responsible for any buying and selling transactions incurred, or for any other use of the contents of this publication.

Antique Radio Classified subscription rates, frequency of publication, content, policies, size and ad details, and rates are subject to change at any time by A.R.C.

### DISPLAY AND BUSINESS CARD ADS - DETAILS AND RATES

*The deadline is the first of the month for display and business card ad artwork, payment and repeat requests.*

Advertising is accepted only for early items related to radio, communication, etc. All items must be described fairly; reproductions, reprints and non-original items must be so identified. Advertisers agree to respond promptly to inquiries and orders, to resolve problems promptly if the buyer is not satisfied, and to comply with a buyer refund request on unaltered returned items.

Advertising must be prepaid, except as noted below; see "Payment" paragraph above for details. Late ads will be run only if space and time permit. Since artwork is reduced to 63% in the printing process, originals must be the artwork size listed below. Do not send in artwork on art board or send negatives. Ads should be typeset or typed neatly with a carbon ribbon, black printing on white. No reverse type if A.R.C. is to make up the ad. If you want us to prepare your ad, include the one-time cost below for A.R.C. to make up the ad.

Photos should be at an 85-line screen; otherwise, add \$10.00 per photo for screening. Do not cut or trim photos or glue photos to artwork; submit separately.

If you are confused by these requirements and terms,

please contact A.R.C. before beginning to prepare your ad. We will be happy to advise you on your ad ideas, estimate how much the ad will cost, recommend an ad size, etc.

We assume that advertisers want all ads which are submitted to run without delay; therefore, we will run the ad and bill for any additional work required for the ad to meet these specifications. A late ad will run beginning with the next month. "Tear sheets" will be sent only for 1/2 and full page ads, and only if requested when the ad is submitted.

**Business card ads are limited to one per advertiser.**

The 3-month rates represent about an 11% discount, the 6-month rates, 23%, the 12-month rates, 30%. Placement requests for display ads: add 15% but call first. Clubs: write for discount policy.

Page	ARTWORK SIZE (SEND IN THIS SIZE)		As Printed (size in magazine)		Cost for 1-month	Cost for 3-months	Cost for 6-months	Cost for 12-months	One Time up Ad
	H x W (inches)	H x W (inches)	H x W (inches)	H x W (inches)					
Full	12 3/16 (or 10 1/2)	x 7 1/2	7 3/4 (or 6 5/8)	x 4 3/4	\$188.00	\$499.00	\$869.00*	\$1580.00**	\$60.00†
1/2 H	5 1/4	x 7 1/2	3 5/16	x 4 3/4	94.50	252.00	435.00	790.00**	30.00†
1/2 V	12 3/16 (or 11 13/16)	x 3 9/16	7 7/16	x 2 1/4	94.50	252.00	435.00	790.00**	30.00†
1/4	5 1/4	x 3 9/16	3 5/16	x 2 1/4	47.75	127.00	220.00	399.00	15.00†
1/8	2 5/8	x 3 9/16	1 5/8	x 2 1/4	24.50	65.00	112.00	199.00	7.50†
Business Card	2	x 3 3/4	1 1/4	x 2 3/8	not avail.	34.00	59.00	107.00	5.50†

\* Full page, 6-mos.: 1/2 due with order; 1/2 due in 3 mos. \*\* Full & 1/2 page, 12-mos.: 1/2 due with order; 1/2 due at 3, 6 & 9 mos.

† For 6 and 12 month ads, no ad make-up charge if no change is made to ad for entire run.



## EDITOR'S COMMENTS

The Kellogg Type 401 tube on our cover revolutionized the home radio. Although electricity had been available in many homes for years, the lack of a tube that could be powered directly by the available AC current necessitated the use of automobile-type storage batteries, which had to be recharged. These unsightly batteries usually sat next to the radio and endangered the living room rug. A bulky A-battery eliminator was an option for some. In our lead article, Dwane Stevens introduces us to the 1925 Kellogg Type 401 — "The tube that eliminates radio batteries."

Just a few years earlier, in 1922, the technology available was crude by comparison, as shown in our reprint from *Radio Digest Illustrated*. The DeForest Interpanel set required three B batteries and one 40+ ampere-hour storage battery. Early DeForest and Kellogg sets are both prized by collectors today.

Researching obscure radios is a source of endless interest and cooperation among A.R.C. readers and contributors. Reader Jim Beaudet's effort to find out more about his Triangle Electric set led to input from Ron Ramirez and Chuck Dachis. The result is Ray Bintliff's composite article, which allows us all to share in their contribution.

Ron Boucher updates his listing (A.R.C., April 1992) of left-handed radios. It is interesting that of the thousands of radio models made, the number of sets with the dial to the left of the speaker can be listed on one page.

Ever since Philip Collins' striking book, *Radios — The Golden Age*, appeared in 1987, controversy has surrounded the chrome plated sets he shows. Most recently, in the June 1993 issue of A.R.C., Stan Lopes likened chrome plating to converting a radio cabinet to a bar. We present three letters this month, including one from Philip Collins, which should establish a milestone in this discussion.

The second largest annual gathering of radio collectors — Radiofest — is reported in this issue. Over 800 registrants attended this Elgin, Illinois, event, which included an expanded flea market, an outstanding transistor radio exhibit, and an old equipment contest. The auction brought in almost \$30,000. The Pennsylvania Alderfer Vintage Radio auction of nearly 300 radio lots is also reported.

And don't overlook two of our regular features,

*Photo Review* and *Radio Miscellanea*. Additional short articles of interest include Richard Arnold's piece on the RCA 45X and 46X Series and Gerald Schneider's helpful hints on displaying your radio collection.

**New Book Update.** The hot collectible of the year — the transistor radio — will soon have its own price guide. Marty and Sue Bunis have compiled a 256-page, 400-photo book describing and pricing over 2,000 transistor models. This book is expected to be out in October. Ron Ramirez's Philco book has been delayed and is not expected until the end of the year. And Harry Poster is publishing an updated and expanded *Poster's Radio and Television Price Guide — 1920-1990*, which lists 3,725 radio and TV sets. This book, which is unusual in its inclusion of 875 TV sets, should be available soon. Check with A.R.C., Antique Electronic Supply, and other book sellers for availability.

**Classified Ad Policy Change.** A small change has been made in our classified ad policy — names of persons other than the advertiser are no longer allowed in ads. Some individuals do not want their names included in ads by others, even in a friendly fashion.

**Renew now and Save!** Rate increases are always announced in advance so that subscribers will not be surprised when they renew their subscriptions. Because of the continuing growth in the size of A.R.C. (100-page issues are becoming the norm) and rising costs, an increase of approximately 6% in most rates will be instituted January 1, 1994. Avoid the increase and renew now for up to 5 years; remember that all early renewals receive 13 months for each annual extension.

**Club Events.** As fall approaches, the club scene is still active, with the annual Antique Wireless Association (AWA), Rochester, New York, gathering occurring while this issue is going to press. A full report on this meet will appear next month. A.R.C. plans to attend the AWA meet as well as the WRPMS meet in Irving, Texas, and the NEARC meet in Nashua, New Hampshire, in October. Other coming multiday activities are the Akron, Ohio, BARPC Mall show; Old Time Radio Days in Nebraska City, Nebraska; and the SCARS meet in Norwalk, California, in November.

Happy Collecting!

John V. Terrey

## OOPS!

Our short article entitled "Early Radio" in the September 1993 issue contained two errors — Hertz experimented with radio waves in the 1880s, not the 1980s, and Fessenden obtained about 229 patents, not over 500.

## ON THE COVER

The art work on our cover shows the Kellogg Type 401 tube. It is taken from a 1927 Kellogg radio book of advertisements to be run over each distributor's name in principal publications in his territory. (From the collection of John V. Terrey.)

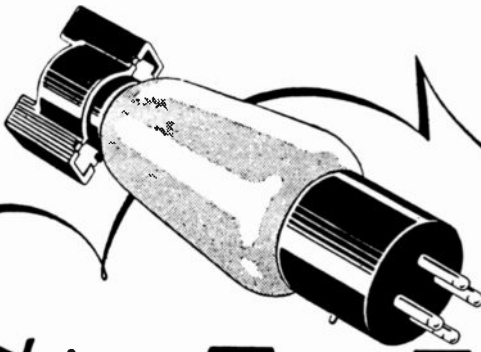

The A. C. radio tube developed and made by Kellogg—experienced lamp makers for many years. This tube is used in Kellogg A. C. sets and sold generally to the trade.

# *This is* **THE TUBE** that eliminates **Radio Batteries**

**T**HE Kellogg A. C. Tube! It ushers in a new era in radio history. It draws its "A" power from the alternating current electric light line. It needs no batteries. Positively **NONE!** No "A" batteries; no "B" batteries; no "C" batteries. Actually, no batteries of any kind.

Kellogg perfected and manufactures this A. C. tube. And Kellogg makes the new A. C. Radio Set you have been hearing so much about. Yes, battery-less radio is now a **FACT**. You will accept it with confidence when you know it is *completely Kellogg*—tubes, parts, and all, down to the tiniest wire. One responsibility—one guarantee—and that from Kellogg, known throughout the world as a leader in telephone manufacturing for thirty years.

Kellogg Switchboard & Supply Company, Chicago  
Member R. M. A. and N. E. M. A.

(DISTRIBUTOR'S NAME HERE)

Licensed under  
application for letters  
patent of Radio Fre-  
quency Laboratories  
(RFL).

# **Kellogg** **Radio**

Advertisement for use by local Kellogg dealers, taken from a Kellogg distributor's notebook.



# VINTAGE VACUUM TUBES

## The Kellogg Type 401 Vacuum Tube An AC Tube Milestone

BY DWANE STEVENS

The history of the vacuum tube provides an interesting and colorful account from the earliest experiments in the 1800s until the decline of the tube with the invention of the transistor in 1947. One interesting milestone in the evolution of the vacuum tube is the development of the AC tube. Previously DC tube radios had dominated the scene and necessitated constant care and recharging of messy batteries. But with the advent of the AC tube in 1925, really convenient plug-in AC home radios became a reality.

One such early AC tube responsible for this convenience was the Kellogg AC Type 401. The Kellogg Switchboard & Supply Co., located at 1006 West Adam Street, Chicago, Illinois, started out making AC tubes for Frederick S. McCullough in 1926. Later, the company manufactured the same tubes under its own name.

Figure 1 shows a Type 401 tube which was used as a detector and an amplifier. These early AC tubes incorporated a cathode heater which was electrically separate from the electron emitting surface and terminated at the top of the tube. The 401 was, therefore, a "double-ended" tube and required a special top connector for the two prongs connecting to the heater supply.

Figure 2, on the following page, shows an original 10" x 15" specification and application sheet from my collection boasting of the many advantages of this wonderful new tube. A few interesting comments from the sheet are the following: "The Kellogg A.C. tube is designed to operate from the A.C. house lighting circuit through the use of a small step-down transformer, thereby eliminating the necessity of the "A" battery as a source of filament supply; ...the actual cathode heating unit is entirely separate from the cathode or emitting surface; ...the tubes work equally well on 25 or 60 cycle current."

The actual ratings for the 401 were given as follows: Heater Volts = 3.00, Heater Amperes = 1.00 and Plate Volts (Max.) = 150. Also, the promotional intent of the specification and application sheet can be clearly seen by the many subheadings discussing various aspects of the tube, such as "Cathode Heater Supply," "Plate Voltage and Grid Bias," "Oscillation and Volume Control."

Under "Application of the AC Tubes to Standard Circuits," two very interesting schematic diagrams illustrate the conversion of a typical 3-tube regenerative set and a typical 5-tube TRF set for use with the new AC tubes. Further attention to detail is seen in discussions about using a fixed resistance in series with the cathode heater supply to eliminate line disturbances when the tube is used as a detector. Ways to control oscillation and volume are also addressed.

As mentioned earlier, the Kellogg 401 was a milestone tube bringing about the convenience of plug-in AC home radios for the first time. In 1927, tubes like the 401 gave way to more practical AC tubes such as Types 226 and 227. These in turn made possible early AC home sets such as the Radiola 18 presented in Richard Arnold's article in the May 1992 issue of A.R.C.

### References:

- McMahon, Morgan E. *Vintage Radio*. Palos Verdes Peninsula, CA: Vintage Radio, 1981, pp. 180-188.
- Tyne, Gerald. *Saga of The Vacuum Tube*. Tempe, AZ: Antique Electronic Supply, 1977, pp. 344-346.
- Specification and Application Sheet for Kellogg A.C. Tube-Type 401*. Chicago: The Kellogg Switchboard & Supply Co., 1925.
- Stokes, John W. *70 Years of Radio Tubes and Valves*. The Vestal Press, Vestal, NY, 1982, pp. 43-44.
- Advertisements from the collection of John V. Terrey.

(Dwane Stevens, KC5MT, Rt. 3, Box 25A, Ardmore, OK 73401)

*Dwane Stevens, an amateur radio operator for 15 years, holds an Advanced Class license, while his wife and daughter hold Technician Class licenses. New to vintage radio collecting, he enjoys repairing and restoring pre-1940 radios and collecting tubes, repair manuals and magazines.*

**Attention Kellogg fans:** If you would like to write an article about the Kellogg Company, A.R.C. has photos and line art for Models 507, 508, 510, 511, 514, 515, 516, and 517, all from a distributor's notebook, for use in your article. Contact A.R.C. for details.

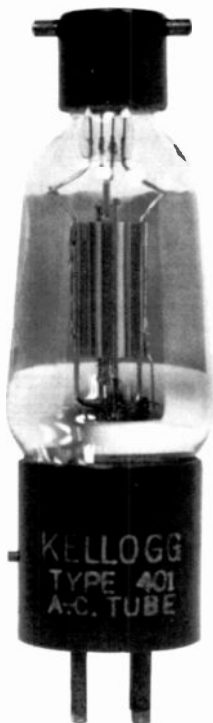

Figure 1. Kellogg Type 401 tube.



# KELLOGG A. C. TUBE—TYPE 401

## DETECTOR AND AMPLIFIER



### RATING

Heater Volts .....	3.00
Heater Amperes .....	1.00
Plate Volts (Max.) .....	150

### GENERAL

The Kellogg A. C. tube is designed to operate from the A. C. house lighting circuit through the use of a small step-down transformer, thereby eliminating the necessity of the "A" battery as a source of filament supply.

The cathode or electron emitting surface of the A. C. tube corresponds to the filament of the ordinary type tube. This cathode has only one lead for connection instead of the two filament terminals employed with the ordinary type tube. The two filament terminals of the ordinary type tube are necessary in order that a current may be passed through the filament for the purpose of heating it to the electron emitting temperature.

In the case of the A. C. tube the actual cathode heating unit is entirely separate from the cathode or emitting surface. The cathode heating circuit terminates at the small base on the top of the tube and two prongs are provided for connection to the heater supply.

The large 4 prong base on the lower end of the tube fits in the standard tube socket. As shown in figure 1 the plate and grid leads are taken from the usual terminals and the cathode lead is taken from what is ordinarily termed the negative "A" battery terminal.

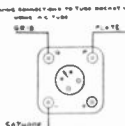

### CATHODE HEATER SUPPLY

A small step-down transformer used for the cathode heater supply. This transformer should have a secondary or low voltage output of 3 VOLTS at normal line voltage (usually 110 to 115 volts). The A. C. tube is designed to withstand a voltage variation of 10% plus or minus normal heater voltage without greatly affecting the operation of the tube. This takes care of line voltage variations which sometimes occur.

It is much more desirable to run the cathode heaters at a reduced voltage rather than excessive voltage as an increase in heater voltage above 3 VOLTS does not increase the output of the tube but only tends to shorten the life of the tube considerably.

Unless a heater supply transformer of known voltage and rating is used it is advisable to connect a suitable voltmeter across the heater supply terminals to indicate the voltage applied.

Figure 2 shows the heater supply transformer; note the center tap from the secondary which is to be grounded.

Figure 3 shows an alternative method of obtaining this center tap where the transformer is not provided with a center tap lead.

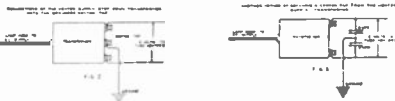
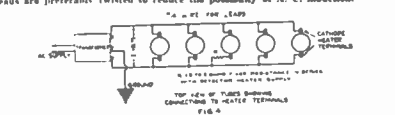

Figure 4 shows the method of making connections from the transformer to the cathode heater terminals. The cathode heaters are all connected in parallel. This may be done by running two flexible leads from the transformer secondary along the tops of the tubes with clips and these leads for making connection to the cathode heater terminals. The cathode heater leads should be the equivalent size of at least a number 16 wire to insure ample carrying capacity. Also the leads are preferably twisted to reduce the possibility of A. C. induction.



It is advisable to insert a fixed resistance of 1.5 to 2.5 ohms in series with the cathode heater supply lead of the detector tube. Operating the detector tube at reduced heater voltage (approx. 2 volts), will increase the detecting efficiency and also eliminate undesirable line disturbances which sometimes occur. Care should be taken to use a resistance of sufficiently large carrying capacity to prevent it from overheating.

### PLATE VOLTAGE AND GRID BIAS

Figure 5 shows several sockets connected for use with the A. C. tube. This scheme of connections should be followed regardless of the number of tubes used.

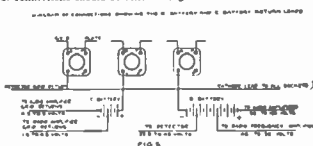

As will be seen from this diagram all the cathode leads are connected together. The positive "A" battery and also the negative "B" battery lead connected to the cathode lead.

The detector grid return is connected direct to the cathode lead as the detector operates most efficiently with a zero grid bias.

The audio frequency amplifiers require a negative grid bias of 4.5 to 9 volts. The radio frequency amplifiers require a negative grid bias of 1.0 to 4.0 volts. A plate voltage of 75.0 to 65 may be used on the detector, 45 to 90 volts on the radio frequency amplifiers and 90 to 135 volts on the audio frequency amplifiers.

### APPLICATION OF THE A. C. TUBES TO STANDARD CIRCUITS

The A. C. tubes will operate in any type of circuit that the ordinary tubes operate in. The changes necessary to adapt the A. C. tubes to a standard set will be apparent from a study of figure 6 as described above, and the diagrams which follow.

Figure 6 shows a standard 3 tube regenerative set equipped with A. C. tubes. The resistance R obtained by the condenser C-3 is used as an oscillation and volume control.

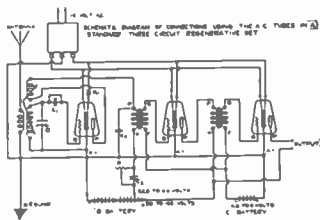
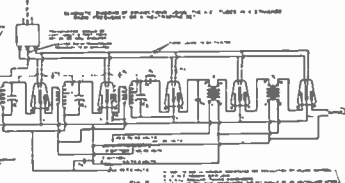

Figure 7 shows the A. C. tube as used in a standard form of 5 tube set. The resistance R is used as an oscillation and volume control. The rest of the circuit is self-explanatory.



In some types of circuits it may be found necessary to shield the detector tube to eliminate a slight amount of A. C. induction which may occur. This may be done by enclosing the detector tube in a copper shield, this shield being grounded.

In figure 6 and 7 note that the cathode lead is grounded; this is important for proper operation.

### OSCILLATION AND VOLUME CONTROL

When using the ordinary type of tube it is possible to control the oscillation and volume by means of the filament rheostat.

When using the A. C. tubes it is not practical to use a variable resistance in series with the heater supply. This is due to the fact that the cathode temperature does not instantly respond to a change in heater current. It is therefore apparent that some other method must be used for controlling the A. C. tube. This may be done in a number of ways, a few of which will be outlined here as follows:

- (1) A variable resistance of approximately 300,000 ohms shunted across the secondary of the radio frequency transformer.
- (2) A variable resistance of approximately 300,000 ohms in series with the plate lead of the radio frequency amplifiers.
- (3) A variable resistance of approximately 400 to 1000 ohms (max. value) shunted across the primary of the last radio frequency transformer.
- (4) Where a volume control only is needed as in the case of a non oscillating set, a 500,000 ohm potentiometer may be shunted across the secondary of the audio frequency transformer.

The A. C. tube will operate satisfactorily with any form of good "B" battery eliminator, thereby making an all A. C. operated set.

The A. C. tubes work equally well on 50 or 60 cycle current.

In case the tube does not function properly the connections should be checked over very carefully.

NOTE—About 45 seconds are required from the time the heater voltage is turned on until the cathode reaches its normal operating temperature. This means that about 45 seconds will be required until the signal strength reaches its normal volume.

MANUFACTURED BY  
**KELLOGG SWITCHBOARD & SUPPLY COMPANY**  
CHICAGO, ILLINOIS

Figure 2. Reproduced here is a Kellogg specification and application sheet for the Type 401 A. C. tube. In order to print the entire spec sheet, the type became small—but get out your magnifying glasses, there is a lot of interesting information here! Note: For those interested, A.R.C. will make 11" x 17" copies available, postpaid for \$1.00 each. Write to A.R.C., Box 2, Carlisle, MA 01741.

# WITH THE COLLECTORS

## Triangle Electric/Silver-Marshall Model 47-A

COMPILED BY RAY BINTLIFF FROM INFORMATION PROVIDED BY JIM BEAUDET, CHUCK DACHIS AND RON RAMIREZ

An early history of the Silver-Marshall Company appeared in the June 1993 issue of A.R.C. This article prompted reader Jim Beaudet to ask for help in researching information for the "mystery" radio described below. (Editor)

The small table radio pictured here was found by Jim Beaudet at an auction. As he stated in a letter to Ron Ramirez, "It's nothing exceptional. The only reason that I bid on it was because I had never heard the name before."

However, the radio is unusual in several respects. As the photograph shows, the front panel of the radio carries a nameplate that reads "Silver-Marshall Manufacturing Co., Model 47-A." The schematic diagram for this radio is shown below. Based on conventional labeling practices the nameplate designation seems a bit odd. A front nameplate that reads "Triangle Electric," along with a rear panel label reading "built by Silver-Marshall Manufacturing," would be more appropriate. The radio is a 4-tube AC/DC TRF set, which is out of character with other radios produced by the Silver-Marshall Manufacturing Company.

The radio appears to have been manufactured in 1934 or 1935. During that period, the exact status of the Silver-Marshall Manufacturing Company is not clear. It was originally a holding company for the Silver-Marshall Company. After Silver-Marshall's bankruptcy in 1932, Bill Halligan of Hallicrafters fame acquired the rights to the Silver-Marshall Manufacturing Company. It is possible that this radio was produced by the Halligan-owned operation.

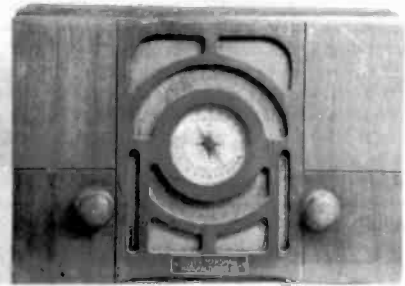

Early Hallicrafters communications receivers, such as the Models S1 and S2, were manufactured by Silver-Marshall Manufacturing. But again, there is little resemblance between the early Hallicrafters communications receivers and this low-priced broadcast-only radio.

A Triangle Electric automobile radio, Model 6P, appears in Volume VII of Rider's, dating it at about 1935. Unfortunately, the available information for this radio provides no clues regarding its manufacturer.

Perhaps some A.R.C. readers can provide additional information about Triangle Electric and these radios.

The photo and the schematic from the set itself are courtesy of Jim Beaudet.

(Ray Bintliff, 2 Powder Horn Lane, Acton, MA 01721)

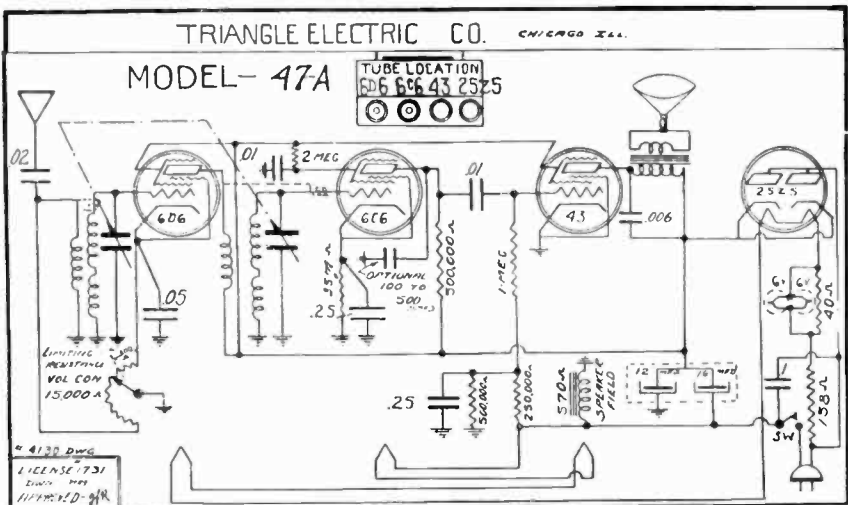

# WITH THE COLLECTORS

## Left-Handed Radios — Part II

BY RON BOUCHER

After my article on left-handed radios was published in the April 1992 A.R.C., I received additional information about other left-handers from A.R.C. readers. I also have found a few more myself and have updated my list, which is shown below.

You'll notice that in my list, I include the covers of the two Bunis radio books. The cover of the first edition is what got me to notice left-handers in the first place; there are three of them in the drawing. The second edition cover has the radio that was in my April A.R.C. article.

My list is limited to pre-1960s radios and doesn't include clock radios with the radio on one side and the clock on the other.

Manufacturer & Model	Reference Book	Page	Comments	Year
Arvin 358T	Johnson II & Bunis 2nd Ed.	113 25	Painted Bakelite	1948
Arvin 532	Classic Plastics	36	Catalin	1938
Arvin 532A †	Blasts From Past	294	Catalin	1938
Globe 551	Radios of Baby Boom Era #3	76	Catalin	1946
Arvin GR-532	Evolution of the Radio (1991)	79		1941
Arvin 544	Johnson II	99	Bakelite	1946
Barker 88 (English)	Evolution of the Radio (1991)	116		1940s
Crosley 566	Johnson II	80	Farm Set	1937
Crosley 7AE	Puett Vol. 4	16	Compact Fiver	1937
Emerson 708	Local Radio Meet			1952
GE F-70	Evolution of the Radio (1991)	142		1937
GE T-100A to T-104A	Tom French **			1953
Globe 5BP1	Radios of Baby Boom Era #3	76	Catalin	1946
Globe 551	Radios of Baby Boom Era #3	76	Catalin	1946
Meck CM-500	Radios of Baby Boom Era #3	233	Portable	1948
Midwest (9 tubes w/eye)	Swap Meet			1946?
Philco 51-537	Flick of the Switch	141	Clock Radio	1950
Philco 51-538	Bunis 1st Ed.	116	Clock Radio	1951
Silvertone 3351 *	Bunis 2nd Ed.	167	Bakelite	1941
Silvertone 3461 * †	Bunis 1st Ed.	139	Bakelite	1941
	& Bunis 2nd Ed.	Cover Art		
Silvertone 3561 * †	Radios Redux	63	Plastic	1941
Silvertone 7004 * †	Evolution of the Radio (1991)	61	Plastic	1941
Silvertone 7006 * †	Evolution of the Radio (1991)	61	Plastic	1941
Silvertone 7008 * †	Evolution of the Radio (1991)	61	Plastic	1941
Silvertone 7020 * †	Evolution of the Radio (1991)	181	Top Handle	1941
Silvertone 4611	Victor Maret ** (A.R.C. 8/92)			1938
Silvertone 7000	Bob Barr **			
	& Evolution of the Radio (1991)	61	Plastic	1941
Silvertone 7002 †	Evolution of the Radio (1991)	61	Plastic	1941
Silvertone 7022 *	A.R.C. Article 4/92	7	Painted Metal	1941
Silvertone 7025 * †	Johnson II	99	Bakelite	1941?
	& Evolution of the Radio (1991)	180		
Truetone RCP	Johnson I	61	Farm Set	1937?
Unknown	Bob Barr **			1937?
Zenith G-723	Bunis 2nd Ed.	210		1950
Zenith G-724 †	Alvin Heckard **			1950
Zenith H-723Z	Alvin Heckard **			1956
Zenith U-723 †	Bunis 1st Ed.	174	Plastic	1956
Zenith Y-724 †	Bunis 1st Ed.	174	Plastic	1956
Zenith Y-723 †	Bunis 2nd Ed.	212		1956



## Notes to the table on the previous page:

- † A radio indented and marked † is essentially the same design as the radio above it. Usually the only difference is color.
- \* These are Silvertone "candy cane dial" designs. Some are plastic cabinets; others are metal. Some publications (including my previous article) list these as 1946, but the schematics are in the prewar Rider's manuals. Perhaps these radios were reissued after the war??
- \*\* The A.R.C. reader who contributed the entry.

This is my complete listing to date. Keep in mind that there are many hundreds of "right-handed" radios in these same publications.

(Ron Boucher, P.O. Box 541, Goffstown, NH 03045)

After several years in the radio mail order business, Ron Boucher is now doing radio art work and cartoons for various publications. He is also updating his radio-related computer software for general distribution. Cathedrals and allwave sets of the mid-1930s, as well as some novelties, are his radio interests.

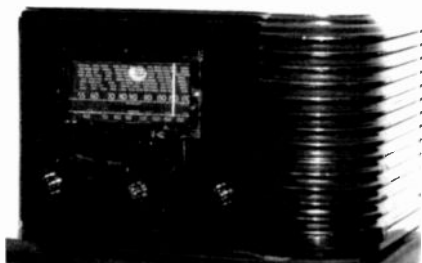

Crosley left-handed radio ca. 1937. (Photo courtesy of Rick Lindquist, Radford, Va.)

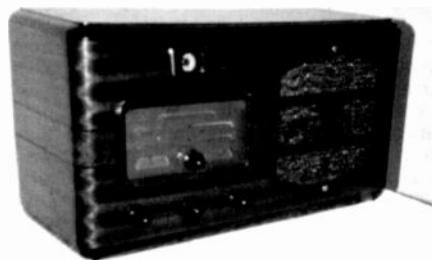

General Electric Model F-74 left-handed radio. (Photo courtesy of Ron Brokloff, State College, Pa.)

---

## RCA's 45X and 46X Series — 1940

BY RICHARD ARNOLD

In February of 1940, RCA came out with eleven new AC/DC table model receivers. Housed in either plastic or wood cabinets, these receivers made a rather smart addition to the 1940 RCA radio line.

These radios were made in four individually styled series. Each series has its own cabinet, dial and knob design, along with different chassis features. One of these designs is represented by the radio pictured at right — an RCA 45X11 5-tube superhet in a mahogany brown, plastic Art Deco cabinet. The tubes used in this set are one each of the following: 12SA7, 12SK7, 12SQ7, 35Z5, and 50L6.

All the sets in the series have a family resemblance, although different styling was used in each series. They are all superhet chassis with beam power output which provided good tone quality.

Two identical plastic models are included in each series — one in brown mahogany plastic and the other in unpainted antique ivory. Knobs match the plastic finish. The lowest priced series included two 5-tube plastic models of horizontal design. Page 155 of *Flick of the Switch* shows four other designs of this series.

All of the new sets had a 4-inch super-sensitive electrodynamic speaker, a hank or loop antenna, and a back cover color finished to match

the cabinet. Each set measures 5 inches high, 8 ½ inches wide and 4 ½ inches deep.

(Richard Arnold, Box 275, Lone Grove, OK 73443)

**Reference:**  
*Radio News*, February 1940, pp 28-29.



The RCA 45X11 5-tube superhet in a mahogany brown, plastic Art Deco cabinet.

From the Pages of...  
**Radio Digest Illustrated**

## The De Forest Inter-Panel Set

*This article is adapted from the May 27, 1922, issue of "Radio Digest Illustrated" and is one of a series showing how to hook up and operate popular sets of the 1920s. Certain spellings and syntax that are no longer standard remain unchanged, since this is basically a reprint. (Editor)*

The De Forest Inter-Panel receiver, built from four units — one tuner, one vacuum tube detector and two vacuum tube amplifiers — is explained this week. The set, manufactured by the De Forest Radio Telephone and Telegraph Company of New York, uses various sizes of primary and secondary honeycomb coils and can receive stations with from 150 to 27,000 meters wavelength. This broad scope includes every wavelength in use. With the two stages of amplification, a well constructed antenna and a good ground, its possibilities are great.

### EXPLANATION OF PANELS AND CIRCUIT

The circuit employed is a double primary, single secondary, triple honeycomb coil mounting, with primary vernier variable condenser arranged with switch so as to be placed in series or parallel, and a parallel secondary vernier variable condenser. The variable condensers provide the only variations in primary and secondary inductance, using three given honeycomb coils, but the additional variations for the wide range of wavelengths are obtained by use of various combinations of honeycomb coils, a table of combinations for which is given in this article. This much of the circuit is contained in the tuner unit, known as MT-200, and shown as the panel farthest to the right in the top, and farthest to the left in the bottom photograph on the opposite page.

From the secondary of the tuner unit, the leads go to the conventional vacuum tube detector circuit, all of which is contained in unit MP-100, the audion control panel, shown as first panel to left of tuner panel in top, and to right in bottom photograph on the opposite page. The control panel contains a variable grid leak and condenser, filament current control rheostat, plate current voltage control switch (gives variations of from 16 1/2 volts to 22 1/2 volts, 1 1/2 volts each switch contact, increases as turned clockwise), receptacle for detector vacuum tube, and the tube itself.

To the left of the detector panel, top, and right, (bottom photograph on the opposite page), comes the first and then, second amplifier units, each contained in a separate panel. Each panel contains a filament current control rheostat, an audio frequency amplifying transformer, and two telephone jacks. When facing the front of the set (top photograph on the opposite page), the telephone

jack shown in use gives two stages of amplification, while the jack farthest to the right gives use of the detector alone.

### EXTERNAL CONNECTIONS TO SET

In setting up the set for use, directions for making external connections are simply explained by the photo-diagram. The aerial or antenna is connected to binding post A, and ground to E. The antenna for the set should consist of a single wire, 100 to 125 feet in length, overall, including length to point in actual contact with ground. For extra long wave reception, an antenna not less than 200 feet in length should be used.

A good ground connection is essential. It is even more important than the antenna. Connection by means of ground clamp to a well scraped water or gas (preferably water) pipe on the street side of the meter will usually suffice. Soldered ground connections are best.

Three 22 1/2-volt "B" or high voltage batteries, one of which should have taps at 16 1/2, 18, 19 1/2, and 21 volts, should be connected to the rear of the detector and amplifier panels shown in the diagram. Care must be taken to see that these are properly connected, watching the polarity on all leads. Lead wires to connect to the batteries are provided with the set.

The "A" or filament lighting battery should be a 6-volt, 40 to 60 ampere hour storage battery and should be connected to the two binding posts on the left amplifier panel as shown in top photograph, opposite page. Polarity must again be watched in making this connection.

### OPERATION OF SET

After insertion of proper tubes in the sockets in the back of the panel, with filament current sure to be turned off, and with telephone receiver plug in jack "TEL No. 1" (farthest to the right), the filament rheostat, detector unit, is turned to the right slowly until the tube is burning at incandescence. The two amplifier tube rheostats should be on the "off" position. Then the proper size honeycomb coils are placed in the triple mounting. These are selected according to the chart reproduced on this page, depending on the wavelengths which are desired to be received. The chart also serves as a guide as to whether the condenser switch (right panel, top photograph) should be thrown to the left in the "SERIES" position, or to the right in the "SHUNT" position.

The secondary coil selected should be placed in the center receptacle of the triple mounting, and the two primary coils selected in the two movable receptacles. Adjusting the movable coils so that the angle between each and the second-

# Radio Receiving Sets

## The How of De Forest Inter-Panel Set

The De Forest inter-panel receiving set, consisting of honey-comb coil tuner No. MT-200, detector unit No. MP-100, and two audio frequency amplifier units No. MP-200, is explained diagrammatically below by RADIO DIGEST in its fifth chart on standard receiving sets. On page four, first column, will be found the explanation of the operation of the set here shown.

This receiver is manufactured by the De Forest Telephone and Telegraph Company, New York, and has, with proper honeycomb coils and antenna, a wave length range of from 150 to 27,000 meters.

Inasmuch as an understanding of one instrument will aid in the understanding of one of different make, the beginner should read this page and the accompanying explanation on page four carefully.

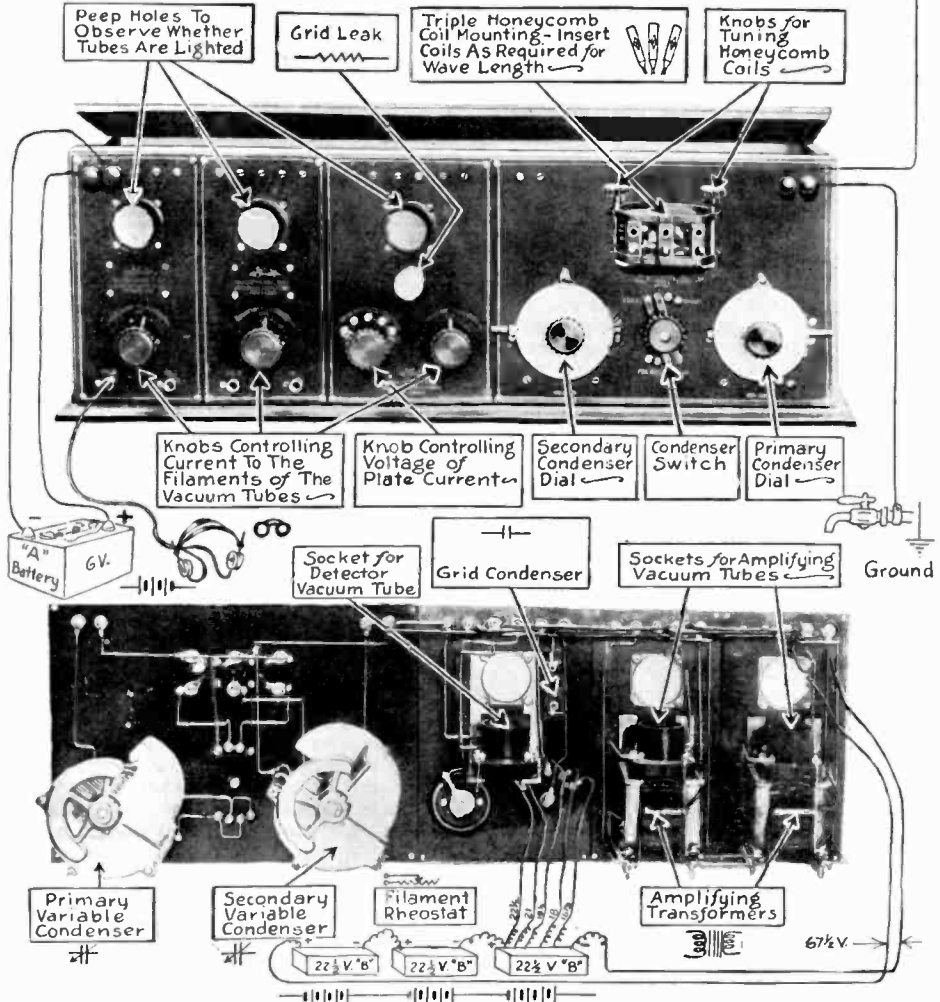

ary coil is about 0 to 40 degrees, and with the primary condenser at zero, the secondary variable condenser is turned until the signal is heard the loudest. The primary condenser is next turned until the signal is loudest. Then the angles between the two primaries are adjusted to eliminate

interference, and the two condensers re-adjusted. The greater the angle between the primaries and the secondary, the sharper the signals will tune, and the less will be the interference from other stations.

(Continued on following page)

(De Forest Interpanel, continued)

Having adjusted the tuner panel satisfactorily, finer adjustment of the detector unit is to be made. Now the switch varying the plate voltage is adjusted until the signals are loudest. Next, the rheostat controlling the detector filament current is more finely adjusted.

#### VARYING GRID LEAK RESISTANCE

At this point, should a sound resembling the throbbing exhaust of a gasoline engine be heard in the telephone receivers — one which cannot be eliminated by manipulation of the "B" battery switch and the detector filament lighting rheostat control — the grid-leak resistance needs adjustment. This is done by removing the nickle-plated cap (turn to left a little and pull) and by drawing soft lead pencil lines between the two brass screw heads until the noise is just eliminated. Too many pencil lines make the tube insensitive, in which case the excess can be removed by means of an eraser.

Now the telephone receiver plug is removed from the jack it is in and put in the jack farthest to the left. The amplifier filament control rheostats

#### Honeycomb Coil Chart for De Forest MT-200 Tuner

Wave Length Range	Primary Coils (2)	Secondary Coil (1)	Primary Condenser
150-355	50	25	Series
305-710	100	50	Series
460-1050	150	100	Series
835-1950	250	150	Series
1760-4000	500	250	Series
3950-8450	1000	500	Series
6000-12500	1500	1000	Series
12000-20000	1000	1500	Shunt
16000-25000	1500	1500	Shunt

are next turned on until both filaments are incandescent at the proper brilliancy. Too much brilliancy here indicates an excessive current and means a material shortening of the lives of the tubes. The amplifier rheostats should be adjusted for maximum brilliancy of tube filaments.

## Displaying Your Radio Collection

BY GERALD SCHNEIDER

A good radio collection is one that you are proud to show off! Too often, however, radio collectors end up only "warehousing" what they collect. While they and their collector friends may welcome just looking at radios, spouses, roommates and non collecting visitors tend to see radio collections differently. What is heavenly to radio collectors is often viewed as junk by others.

But good radio presentation brings visitor praise, and provides social satisfaction for otherwise hostile spouses and roommates! Receiving acclaim for your attractively displayed radio collection will also make you prouder of it. This attention to your display may even make you a more astute collector who always goes for quality over quantity!

#### NEUTRAL-COLORED BACKGROUNDS

Radios should be displayed against walls that are shades of white, beige, or light colors. Proper display shelves will be glass and brass, or plastic and wood in a color the same as or similar to the walls. The idea is to entice viewers to look at your radios, not the walls or shelving!

Avoid brown or dark stained/painted shelving. There is probably too much brown from the coloring of the radio cabinets already!

#### GOOD LIGHTING

Nothing beats track lighting or its equivalent! Radios must be properly lighted to be seen at their best. Track lights allow you to direct light where it should go to accent your radios. Viewing eyes tend to follow the path of light and skip over other areas, including surroundings.

An exception to the rule is when showing radios as furniture in a period setting. Here you will want lighting that comes from a floor or table lamp of the same era as the radios involved.



#### RADIO PLACEMENT

Radios uniformly lined up face forward on shelves can look boring! Better to vary the angles of the radios shown to emphasize interesting side, top, and back as well as front views. Related radio sale ads, and small, colorful collectibles from the same era can be mixed in with the radios to avoid monotony. Properly selected items will complement and add historical significance to radios!

Display radios whenever possible at eye level for average-sized persons. Table model radios are best seen when they are placed between 4 and 6 feet above floor levels. Most console radios will fit under shelving that high, and can be left that way. But special console radios should be displayed on neutral-colored pedestals that bring them up to usual eye planes.

(Gerald Schneider, 3103 Blueford Rd., Kensington, MD 20895-2726)



## RADIO MISCELLANEA

"Antique Radio Classified" invites its readers to contribute letters and information for inclusion in "Radio Miscellanea" and elsewhere in the magazine. The topic should be of general interest and sent to A.R.C., P.O. Box 2, Carlisle, MA 01741. All material submitted should be verified for accuracy and may be edited for publication, which is not guaranteed. See the masthead for more details.

### Proper Contact Cleaning

Dear Editor:

I would like to comment on the letter in your September 1993 "Radio Miscellanea" suggesting the use of rubber erasers to clean electrical contacts. The proper method of contact cleaning was presented in an application note published by Hewlett-Packard several years ago. They claimed that at no time should an eraser be used to clean electrical contacts for two reasons: (1) The binders and plasticizers will leave a gooey film on the contact and cause poor electrical conduction; (2) When used on card edge connectors, the static electricity generated by the rubbing will destroy semiconductor components.

The correct cleaning method suggested was to wipe the contacts gently with a swab soaked in Freon TF or 1,1,1 Trichloroethylene. (This information was distributed in the days before Freon was politically incorrect.) I have used denatured alcohol with equal success. If the contacts are in very bad shape, I swab them gently first with alcohol to remove the grease, and then with Tarn-X to remove the tarnish. I then swab with water to clear the Tarn-X and dry with a dry swab. In extreme cases, I use Brasso and follow up with alcohol to remove the residue.

Daniel Schoo, DeKalb, IL

### Jig Source Found at "Allied Radio"

To Our Readers:

In answer to Harold Wright's question about a source of a jig to support a radio chassis on a workbench [A.R.C., September 1993], A.R.C. has found one answer in the 1991 Allied Electronics Catalog. Page 329 shows several devices made by PanaVise that will hold small chassis and components.

Although on page 25 of our June 1991 issue, we wrote about the "demise of Allied Radio," the company is still very much alive and issues an 800-plus page catalog. With over 60 branch offices nationwide and catering mainly to the industrial market, Allied Electronics is a subsidiary of Hall-Mark Electronics Corp. and is located at 7410 Pebble Drive, Fort Worth, TX 76118. (800) 433-5700. (Editor)

### Who Knows About Pot Metal?

Dear Editor:

While engaging in the restoration of an old radio with crumbling pot metal, I began wondering about the composition of pot metal and the reasons for its tendency to crack and distort. Perhaps A.R.C. readers can provide some answers.

Ray Bintliff, Acton, MA

### Kudo to A.R.C.

Dear Editor:

I look forward to getting your magazine every month. I really like the history and how-to-fix-it articles.

Andy Lagerstrom, Nebraska City, NE

### More on Philco Tube Codes

Dear Editor:

The June article on Philco tube codes was very interesting and nostalgic. I worked in a Philco dealership from 1937 to 1949. The coding in the late 1930s and early 1940s was correct, as Ron Ramirez described. However, to complete the story, there was a set of only four letters used. They were O, P, U, and S. Each letter represented a quarter of the code year.

We were taught to remember the letters as a word — OPUS. This way it made it easier to remember the code as well as the sequence, O being the first quarter, P the second, and so on. This coding lasted at least to the end of the war years, 1945, as I have a tube coded U5 M-R.

For those who don't know, the letters M-R stamped on the base of a tube of any brand or manufacturer indicated that the tubes were made during the war years and sold for civilian use. We were told the letters stood for "Military Reject" or "Maintenance and Repair."

Tom Margaretic, Merced, CA

### More on Line Voltages & Old Radios

Dear Editor:

I guess I stirred things up a bit about high voltage for old radios [A.R.C., February 1993]. I'm glad people wrote in about the bad things that could happen to old radios on high voltage. Mine is at 130 volts when I check it. Yesterday I got a transformer that goes from 25 volts on up. When I set my transformer at 100 volts it's right on 110 volts on my meter. ...Now I don't worry about high voltage. Thanks for all the information that turned up from readers.

Donald Manssen, Danforth, IL

Dear Editor:

I read with great interest the "Restoration Topic" on line voltages and old radios. Up until this article came out, I had been using a Variac to lower the voltage to around 112 volts so that my Radiola 18 wouldn't suffer under the increased tensions. The transformer idea worked great and takes up much less room. I am sure that other collectors have benefited from this article as well.

Sam W. Wrenn, Arlington, TX

Dear Editor:

I liked the article "Line Voltages and Old Radios," but I think the problem of higher line voltages these days may be even more of a problem than the article indicated. Don't forget that power (or heat) equals the square of the voltage times the load resistance [ $P=V^2 \times R$ ]. Since the load is more or less constant, the increase in heat generated is a function of the square of the increase in line voltage! Thus a 10% increase in line voltage results in a 21% increase in the amount of heat generated ( $1.10 \times 1.10 = 1.21$ ). I think that makes the importance of proper line voltage all the more obvious.

Thanks for a great service.

Larry Babcock, East Amherst, NY



# PHOTO REVIEW



This column presents in pictorial form many of the more unusual radios, speakers, tubes, advertising, and other old radio-related items from our readers' collections. The photos are meant to help increase awareness of what's available in the radio collecting hobby. Send in any size photos from your collection. Photos must be sharp in detail, contain a single item, and preferably have a light-colored background. A short, descriptive paragraph **MUST** be included with each photo. Please note that receipt of photos is not acknowledged, publishing is not guaranteed, and photos are not returned.



**ZENITH ZENETTE MODEL 230** – This 1932 model has 8 tubes. (*Alexandria Nelson – Albuquerque, NM*)

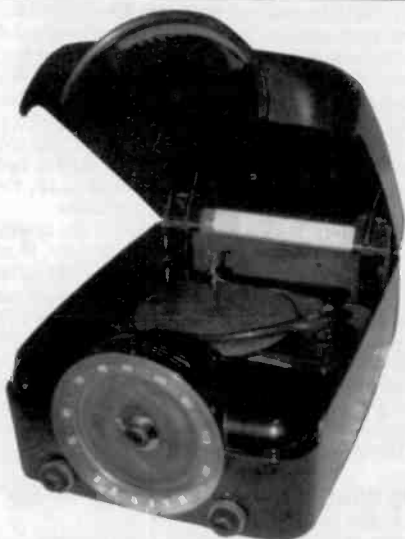

**ZENITH MODEL H-664** – Housed in a Bakelite cabinet, this 1951 table top radio-phonograph has a 4-speed record player which uses a cobra tone arm. (*Brian Fuls – Cottonwood, CA*)

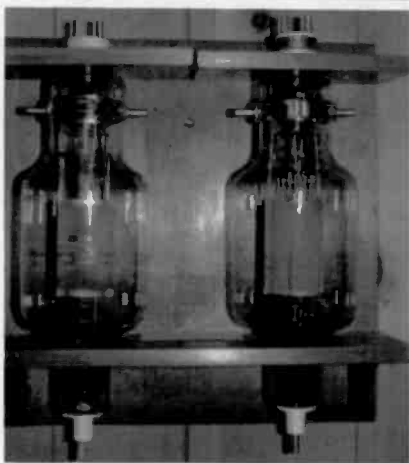

**WESTERN ELECTRIC TYPE 251A TUBES** – These tubes are extremely large — 21" long and 6" in diameter. They are displayed in their original wall-mounted rack which was used to keep spare tubes handy at a transmitting station in case of failures. The top wooden pieces that retain the tubes have old "seashell" type hinges (behind the bases) that allow quick removal of the tube when needed. These tubes were probably used in small AM broadcast stations and marine radio-telephone transmitters. (*Robert B. Enemark – Duxbury, MA*)

---

## PHOTO REVIEW

---



**WESTINGHOUSE MODEL TBW-4** – This portable (?) radio transmitting equipment was manufactured for the U.S. Navy. It consists of the CAY20084 rectifier modulator unit, the CAY52238 intermediate frequency transmitter, and the CAY52239 high frequency transmitter. (Michael Crain – Harveys Lake, PA)



**PHILCO MODEL 57** – A real signal grabber, this old timer, ca. 1932, has 4 tubes. It receives the old police band, and the band switch is located at the rear of the chassis, next to the trimmers. The tube complement is (1) Type 80, (1) 42, and (2) 77s. (Joseph C. Burke – Weehawken, NJ)



**MOHAWK CHEROKEE** – Made in Chicago, ca. 1925, this 1-dial, 6-tube battery set uses (5) Type 01-A tubes and (1) 200-A tube on a black Bakelite chassis. This radio uses a Bristol Baby Audiophone speaker and is in nice original finish. (John and Joan Balliett – Muncy, PA)



**SILVERTONE MODEL 7270 TV/RADIO** – Although manufactured by RCA, this 1939 set carries the Sears Silvertone name. Electrically, this set is identical to the early versions of the RCA Model TRK12 TV. Fewer than 59 of these sets were produced and displayed in the New York City area Sears stores, concurrent with the introduction of television at the 1939 World's Fair. (John Folsom – Palm Bay, FL)



# HOMEBREWING

## Building a Wireless AM Broadcaster "Your Hit Parade"

BY LOU TRAMONTOZZI

Lou Tramontozzi's engineering skills proved helpful in the project he describes here. He was able to take a schematic for an AM "broadcaster," published in the October 1947 issue of "Radio News," and modify it to make it safer. These broadcasters allowed phonograph records to be played through an AM radio with-

out the need for direct connection. This wireless capability was an attractive feature because not all radios of that period came equipped with phonograph input jacks. Wireless transmitter kits are available today from several suppliers for those of you who may not be as ambitious as Lou. (Editor)

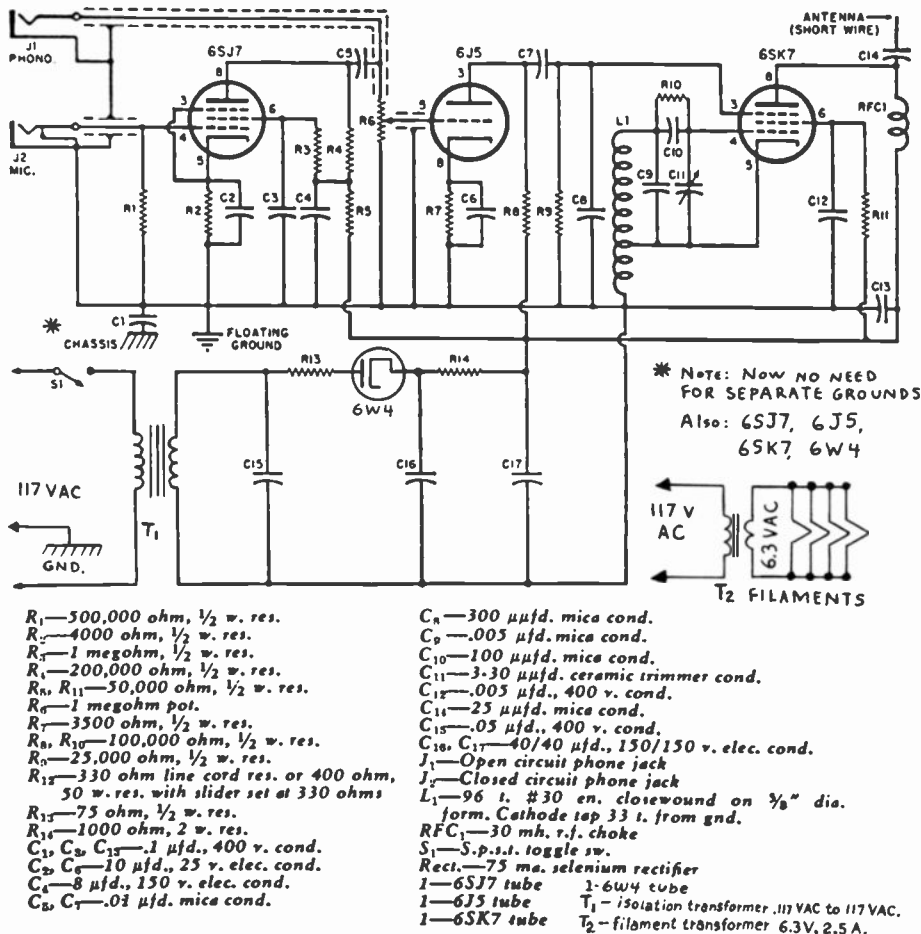

Figure 1. Modified schematic for AM broadcaster, from "Radio News," October 1947.



I have in my possession quite a number of old radios. You know the type — large, free-standing consoles with names like Zenith, and smaller, table-top models with names like Philco. I have restored these radios to like-new condition, and they play well, giving new life to AM broadcasts. However, old radios should be playing old music, like 1940s swing, jazz, etc., which is difficult, if not impossible to find on the AM band these days. So, what to do?

Well, I was pouring through some of my old radio magazines, and I found a design for a "wireless AM broadcaster," which, if you're old enough to remember, is a device that takes an audio input, and modulates a carrier for broadcast into any AM radio. "Perfect!" I thought. With some cassette tapes of Benny Goodman, Tommy Dorsey, etc., and this unit, my radios will feel right at home playing the music they used to play (sort of my version of "Your Hit Parade").

The broadcaster, which appeared in the October 1947 issue of *Radio News* is a tube design, which seemed appropriate for this application. This broadcaster uses a Type 6SJ7 tube as a low-level preamplifier, a Type 6J5 as an audio amplifier and a Type 6SK7 as an electron-coupled, screen-modulated oscillator. The design uses a typical transformerless, "suicide" type power supply. The AC power line is directly connected to the tube filaments and B+ supply.

I made some changes to make it safer; the result is shown in Figure 1. I added a 6.3-volt filament transformer (T2) and ran the filaments in parallel, after checking the current requirements. Also, I used a separate "high-voltage" transformer (T1), and a 6W4 rectifier (remember those?) to get approximately 150 VDC B+. Finally, I included a 3-prong line cord with the chassis grounded for further safety.

[A silicon rectifier may be substituted for the 6W4 rectifier tube. Use of a solid-state rectifier will permit the use of a smaller filament transformer (6.3v at 1.0A) and reduce power consumption/heat dissipation by 7.5 watts.]

The construction of the unit is shown in Figure 2. All the tubes plug in to Millen ceramic sockets (just for aesthetic beauty). The primary oscillator coil is wound in a single layer on a Millen 4-prong, plug-in-type form. The output frequency can be varied by turning a trimmer capacitor. Separate jacks are provided for microphone and source inputs. A separate gain control (R6) helps to prevent overmodulation.

After checking my wiring with the diagrams, I plugged in the line cord, turned on the power switch, and waited for maximum smoke! Instead, what I got were four nicely-glowing tubes, and a nice carrier wave on my nearby receiver. Howev-

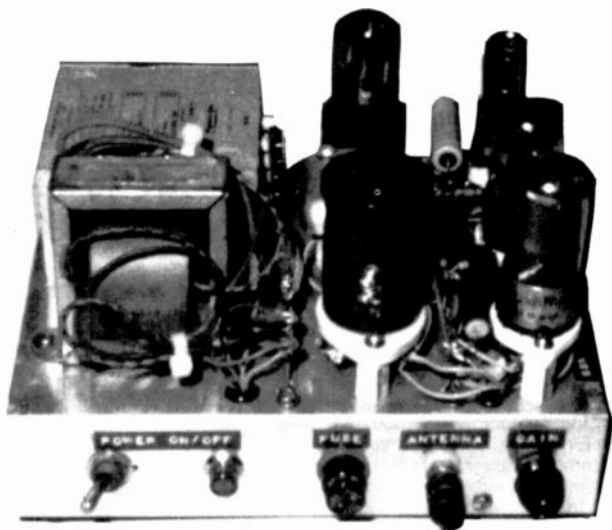

Figure 2. A modified AM broadcaster — the final product!

er, the frequency was way off! Apparently, the original author had miscalculated the value of the fixed capacitor needed to resonate with the oscillator coil.

I changed the value of the capacitor (C9) to 0.005  $\mu\text{F}$  to get the carrier where I wanted it — in a clear spot at the low end of the AM broadcast band. After connecting a small length of wire to the antenna post of the unit and hooking up my cassette player, I finally got that 1940s music sounding the way it should — coming out of a 1940s radio!!!

#### Reference:

Parmenter, Richard L. "Wireless Pre-Amp." *Radio News*, October 1947, pp. 64-65, p. 146.

*Lou Tramontozzi, a senior engineer for Raytheon Company, is a ham radio operator and the President of the Middlesex Amateur Radio Club (MARC). He has been collecting and restoring antique radios and radio-related items, with emphasis on 1930s receivers and hardware, for about 13 years. His collection also includes some early TVs.*

#### Sources of wireless broadcasting transmitters from the pages of A.R.C.

Antique Electronic Supply, 6221 S. Maple Ave., Tempe, AZ 85283

Antique Audio, 5555 N. Lamar, Suite H-105, Austin, TX 78751

Chris Cuff, 2674 Rt. 42, Forestburgh, NY 12777

Pat Ryan, 2122 Marconi Ave., St. Louis, MO 63110

# MEET & AUCTION REPORT

## Antique Radio Club of Illinois — Radiofest 1993

Elgin, Illinois — August 4-7

COMPILED FROM REPORTS BY LARRY BABCOCK, JEFF AULIK AND JOHN V. TERREY

The Antique Radio Club of Illinois (ARCI) held its eleventh annual Radiofest on August 4-7, 1993, at the Holiday Inn Holidome/Convention Center in Elgin, Illinois. Ideal weather and over 800 registered attendees made this one of the most memorable radio events of the season.

The flea market was a tremendous success this year. More than 400 sellers' permits were issued, and vendors spread their wares around three sides of the hotel, even spilling over into the adjacent fields. In a fast walk-through of the area, your editor counted 179 vendors set up at mid-day Thursday. Although the meet began a day earlier this year, activity seemed to hold quite steadily, as even on Saturday morning, numerous vendors were still selling.

The main exhibit featured transistor radios and included a continuous showing of Norm Smith's video entitled "Transistoradio — A Blast From the Past." Shuttle buses took guests to the Motorola

Museum and to Ralph Muchow's Historical Radio Museum, where over 3,000 sets are on display.

The Thursday auction started at 3 p.m. and lasted over 8 hours. It included more than 400 lots, which sold for a total of \$29,445.50, excluding buybacks. The 255 registered bidders were kept intrigued by the fast auctioneer, who started with a minimum bid of \$25. An interesting aspect of this year's auction is that owners were allowed to bid up their own items.

Highlights of the auction were two French crystal sets, selling at \$425 and \$600; an Atwater Kent lamp with a repro shade at \$375; a Regency TR-1 at \$425; a Western Electric microphone at \$725; and a Fada F55 Catalin, with a chipped cabinet, at \$1,900.

A very useful additional feature this year was the presence of Mailboxes Etc. on site to pack and ship purchases. This excellent service was also available at Extravaganza '93, and A.R.C. recommends that radio clubs consider it as a standard service at future meets and auctions.

The following is a list of selected items from the auction.

e=excellent, vg=very good, g=good, f=fair, p=poor, unk=unknown, NT=no tubes, WT=with tubes, N.O.S.=new, old stock

Addison Catalin .....	\$350
Admiral color TV sign .....	45
Admiral console, refinished, works .....	110
Aetna, 1937, brown plastic .....	50
Air King 600 Catalin, brown trim, butterscotch ..	550
Aircastle table model w/slide rule dial and push buttons .....	25
Airline, TRF, 3-knob, 1920s, wood .....	35
Ampex tape moving electric sign .....	300
Arvin 422, midget, chrome .....	85
Arvin metal, ivory .....	35
Arvin wood table model w/slide rule dial .....	25
Atwater Kent 10 breadboard, Catalog No. 4340 with label and tag, 5 good tubes .....	850
Atwater Kent 10 breadboard, no tag, orthogonal RF coils .....	650
Atwater Kent 10C breadboard, w/tags .....	900
Atwater Kent 20, large, NT .....	45
Atwater Kent 33, 1- dial tuning .....	40
Atwater Kent 35, Freed-Eisemann FE-15, General Radio wavemeter .....	55
Atwater Kent 35, w/speaker .....	55
Atwater Kent 84, cathedral, g .....	200
Atwater Kent 337, not working .....	150



Norm Smith proves "It pays to advertise." Norm is known for his video "Transistoradio — A Blast from the Past."

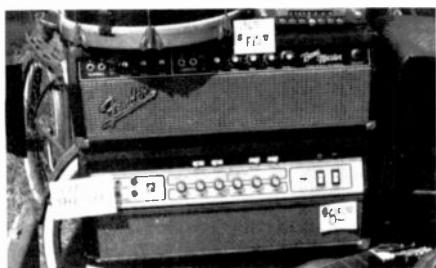

Could A.R.C.'s recent article on guitar amplifiers (August 1993) have prompted their appearance in the flea market? Note that the "Free - Take One" sign was not for the amplifiers.

Atwater Kent Commander, 1929, Kiel table	100
Atwater Kent cone speaker,	45
Atwater Kent crate cover, for Model 90 (?)	35
Atwater Kent E cone speaker, vg	50
Atwater Kent Jolly Jumper advertisement	80
Atwater Kent lamp, repro shade, works, e	375
Automike, small mike, nickel plate, w/handle	35
Stewart-Warner Porto Baradio w/glassware	150
Stewart-Warner Porto Baradio w/glassware, g	125
Beer sign radio	25
Bell transistor radio	50
Belmont 4B115	120
Belmont Truetone, brown plastic, w/push buttons, nice	85
Bendix radio table model, w/legs, works	75
Blue mirror clock (bluebird color)	80
Bosch AM radio and speaker, 2 pieces	110
Branson loop antenna, no base	65
Bremer Tully, TRF, 3 knobs, works	45
British toy bank radio, like round Eico radio	180
British ultra Deco tombstone, wood	250
Capacitor cabinet, full 3, kV-6 kV	45
"Clarion Radio" neon sign, 9"h x 24"w	275
Coke cooler radio, repaired	375
Coronado 43-201	35
Crosley 3R3, g	50
Crosley 51P, Federal, Gernsback (3 vols.)	85
Crosley Model 56 Buddy Boy, Repwood cathedral	250
Crosley 127	150
Crosley 148 cathedral	85
Crosley 167 cathedral, f	55
Crosley banner, large, 30"h x 8"w	130
Crosley Gembox w/carton	110
Crosley gemchest metal console, 2 knobs missing, works	200

Crosley plastic table model, large, red, slide rule dial	35
Crosley Showbox radio, metal case	25
Crosley Supertrirdyn, Fada, Apex, untested	45
Crosley tombstone, wood, chrome escutcheon	45
Crosley Trirdyn, (2), and Micro Quad	45
Crystal set lamp	25
Dahlberg pillow radio, white,	75
Detrola 362	250
Dion Quintuplets small table radio, g	200
Eagle B, Murdock Neutrodyne 110, (2 sets)	90
Echophone cathedral, g	140
Echophone Type 3, exposed 199 tubes, like Ware radio	325
Edison medical quack device	85
Emerson 547 in clear red plastic case, can see guts through cabinet	300
Emerson 558	40
Emerson Aristocrat, dark tan	400
Emerson AU190, Catalin tombstone, ivory, 1 knob missing	550
English console radio, cute-different	160
Fada 115, bullet, untested, minor dial damage, butterscotch w/red trim and knobs	600
Fada 652 Catalin	375
Fada 1000, bullet, dark red and ivory trim	550
Fada bullet, Catalin, dark maroon and butterscotch	425
Fada F-55, Catalin, green grille, butterscotch cabinet, big chip	1,900
Farnsworth 51	60
Federal A10, Crosley, home brews, (2)	75
Figuring lamp radio	225
Football Gridiron radio	500
Freed-Eisemann FE15 w/brass 01-A tubes	55
French crystal set, wood box, horizontal Bakelite panel, vg	600
Freshman Masterpiece, works, W/T, 3-knob TRF, built-in horn speaker	85
Futura transistor radio (picture of ballet radio with ballet dancer and radio)	55
Garod first AC set, looks like late '20s	35
GE 542 tombstone, w/tapestry grille cloth	75
GE clock radio display Ferris wheel	60
GE glass sign (plate only), 10" x 20"	55
GE portable for car or 110v, 1930s	35
GE T12 cathedral, f	60
"GE Electron Tube" lighted clock, 1940s	150
Globe 1920s, 2-knob receiver, wood case	55
Gloritone Marshall Field, large, cathedral, tall	80
Grundig 21204	40
Grundig clock radio, plast c	25
Grundig console, shortwave, phono, w/tape recorder	25
Grunow wood table model, works	35
Halsion Catalin	450
Home brew crystal set w/loose coupler	50
Home brew crystal set, looks like Tin Man	55
Home brew crystal, 2-slide tuner, new	40
Home brew loose coupler and crystal, new	50
Home brew SW radio	40
Horn speaker, black gooseneck, works	60
Howard Model O cathedral, nice	230
TV camera tube, no vacuum(?)	300
Jackson Bell, swan on grille	225
Japanese meter in wood case	25
Kellogg Symphony horn speaker, works	75

(Continued on following page)

**A warning:** Auction prices are not current values. A listing such as this cannot adequately include the condition of cabinets, chassis, transformers, tubes, the operating status of the set, and the inclusion of incorrect, restored or replica components, etc. Auction prices are the result of the excitement of the auction process, the skill of the auctioneer and the specific interests of the participants. Nevertheless, auction prices serve as useful references and as another element in the value determining process. The possibility of error always exists, and if we are notified, corrections will be reported.

(Radiofest '93, continued)

Kennedy 281, works, vg .....	500
Kit radio, 2 tubes, 1920s .....	25
Kit, 3 knobs, TRF, NT, f .....	25
Kit, early, 2 wood variometers, speaker, 1 tube .....	45
Kodel Model S1 crystal set, cracked panel .....	300
Kolster, works, WT, 1-dial tuning, large, g .....	45
Magnavox horn speaker, straight neck, 4 terminals .....	90
Majestic 161 tombstone, chrome grille, nice .....	210
Majestic 460, square wood cabinet, chrome grille, f .....	40
Majestic 461 tombstone, chrome trim .....	80
Majestic cardboard sign, g .....	130
Majestic horn speaker, g .....	70
Malone-Lemon, TRF, 3-knob, sloping panel .....	200
Marshall Radio w/Art Deco top speaker .....	30
Midwest 3515 console, WT and paper, g .....	150
Midwest 3618 console, works, WT .....	550
Midwest Imperial, 1937 .....	300
Miniature tubes, N.O.S., (600) .....	30
Mirage black/silver mirror radio, works, e .....	600
Mirrortone white translucent plastic set .....	60
Mitchell lamp radio .....	25
Monarch 6-tube tombstone, wood, round dial .....	40
Motorola 6S31 (?) transistor, pretty .....	95
Motorola 4-tube portable, 1950, green plastic, no cracks, .....	100
"Mr. Radio Man" framed sheet music .....	25
Music Master wood horn, 1 crack in bell .....	85
National NC60 special .....	55
Nestles Crunch radio .....	45
Old Timer's Bulletin, 1977-present .....	65
Operadio cone speaker, works .....	45
Orphan Annie Ovaltine mug w/shaker, 1930 or 1931, N.I.B .....	55
Oscilloscope-probe for 150 MHz, works .....	35



A beautiful Ozarka Viking cathedral on display in the contest.

Ozone generator, Catalin case .....	50
Peerless cathedral speaker, works, wood, vg .....	35
Philco 20 cathedral, (2) .....	115, 135
Philco 20 cathedral, g .....	110
Philco 37-610 .....	35
Philco 40-180 .....	25
Philco 60 .....	100
Philco 70 cathedral .....	150
Philco 70 cathedral, WT, poor cabinet .....	55
Philco 80 cathedral, speaker cone bad .....	70
Philco 84, cathedral, g .....	95
Philco 90 cathedral, g .....	350
Philco 1203 .....	55
Philco large metal breadbox, works, f .....	25
Philco neon clock, glass cracked, works .....	250
"Philco Radio" sign, lights, 9"h x 20"w .....	275
Philco salesman's books, 1950-1956 .....	40
Philco spice chest radio .....	45
Philmore 2-tube set with 1 plug-in coil .....	175
Philmore Blackbird crystal set .....	200
Picture, 1920s, baby with headphones, oval frame, 8" high .....	90
Play Pal, wood case, not working, g .....	40
Premier, Stewart-Warner 325, home brew, w/3 knobs .....	70
Professor Jack Mart (?), French crystal set, small, w/ phone .....	425
Radio Craft, 1936-1941, 25 issues .....	35
Radio Craft, 1942-1948, 41 issues .....	40
Radio Glo, stained glass cabinet, all original glass, rechromed .....	1,500
Radio News, 1930-1938, 26 issues .....	60
Radio News, 1939-1944, 33 issues .....	35
Radio News, a bunch 1950s, etc. ....	25
Radiodyne .....	30
RCA Radiola II portable, no phones, f .....	250
RCA Radiola 16, works, WT, no speaker .....	45
RCA Radiola 20 w/199 tubes, needs cleaning, g100 .....	100
RCA Radiola 24, no cover .....	85
RCA Radiola 60, Everyman 4, misc. parts .....	25
RCA Radiola 60, e .....	65



Bo Brook (left) and Nate Alexander (right) carefully examine one of the many transistor radios offered at the meet this year.

RCA Radiola 66 .....	140
RCA Radiola Superhet AR812, w/tubes, g.....	110
RCA 100A speaker, vg .....	35
RCA 102 chrome table model, works .....	110
RCA 103 speaker, not orig. grille cloth, speaker cover missing .....	45
RCA chair white cushions .....	75
RCA lighted sign, w/clock .....	65
RCA Nipper, 9'h, wood base, age (?) .....	90
RCA Nipper, plaster 14" high .....	45
RCA radio and Nipper picture, large, framed, .250	
RCA radio-TV sign .....	125
RCA Red Seal records display sign .....	125
Red Book Practical Wireless + (2) books .....	25
Regency TR1, no cracks, grey w/leather case	425
Regency TR5C transistor set, near mint .....	115
Regency TR7 transistor radio, g .....	40
Rider's TV Manuals 1-26 w/Index, g.....	40
Rider's volumes, (10), Radiola 18 .....	45
Rudolph the Red Nosed Reindeer radio .....	700
Sams Photofact 1-400 Series .....	35
Scotch cooler radio .....	115
Scott 800B, 2-piece, no cabinet, works, f .....	70
Scott coils, box (7), work, f .....	25
Sentinel 284 Catalin .....	450
Sentinel 284 Catalin, restored white cabinet, butterscotch trim .....	500
Shortwave Craft, 1932-1935, 19 issues .....	30
Shortwave Craft, 1935-1936, 20 issues .....	40



*The actual speaker that appeared in the July 1993 A.R.C. article "The Kylectron Electrostatic Speaker" by Daniel Schoo was displayed and working in the contest. This view shows the overhanging desk-type top.*



*A Standard SR-G430 Micronic Ruby, in the original box with instructions and carrying case.*

Sign, "Television Service, RCA Tubes," lighted, 8"h x 28"w .....	95
Silver Marshall tombstone .....	95
Silvertone 4505 .....	75
Silvertone wood table model, chrome trim, round dial .....	30
Silvertone, like small Arvin, brown, metal (?) ..	25
Simpson tube tester, Meissner radio .....	25
Sonora cathedral with tubes, large skirt base .	150
Sonora Navigator Globe radio, vg .....	475
Sonora horn speaker in rectangular wood box ..	60
Sony 5" TV, works .....	30
Sparton 557 blue mirror radio .....	1,000
Sparton 558 peach cabinet, no guts .....	1,200
Sparton 636SX .....	25
Sparton 931 console .....	25
Sparton Canadian Bluebird, works, e .....	2,100

Sparton poster, 6'h x 30"w, red, early 1930s .....	150
Sparton poster, violin player, early 1930s, 6'h x 30"w, red, .....	50
Standard Micronic Ruby in box .....	150
Stewart-Warner 301A SW converter .....	70
Stewart-Warner dancing girls speaker, works .	170
Stewart-Warner Gulliver's Travels radio, white cabinet, decals f .....	100
Stromberg-Carlson console .....	375
Superadio II transistor radio .....	25
Tektronix oscilloscope, dual trace, vg .....	110
Telefunken 2-stage amp .....	325
Telefunken stein, wood set, f-g .....	25
Telefunken table radio .....	60
Telegraph sounder .....	45
Thorola horn speaker, goose neck w/round base, works .....	135
Transistor novelty radios, (8) .....	25
Trav-Ler cathedral, works, g .....	225
Trav-Ler portable .....	45
Trav-Ler portable, black w/cover, g .....	55
Truetone battery console .....	70
Truetone table model and Philco 1201 .....	25
Truetone tombstone .....	130
Tube tester, 1922, and Atwater Kent Model 35 bathtub radio .....	45
Tube, big, 16"h, on base, type unknown .....	25
Tubes, big, with ceramic bases, (15) .....	25
Tubes, (600) .....	25
Tubes, 01-As, UV200s, etc., N.I.B., (2), g .....	175
Tubes, N.O.S., (500) .....	30
TV & radio knobs, (1,000+) .....	35
TV lamp .....	25
TV test instruments, (3) .....	25
Vibroplex Flash key .....	95
Waltham Micronic Ruby, in box .....	50
WE mike case and element, no springs .....	725
Webster wire recorder w/mike and wire, works ..	25
Westinghouse 501 .....	75

*(Continued on following page)*

(Radiofest '93, continued)

Westinghouse H204 slide rule, green .....	25
Wilson SA100 Canadian code key .....	85
World novelty transistor set .....	25
Wurlitzer 3-knob .....	45
Zenith 4B131 tombstone, small round black dial .....	55
Zenith 4B231 .....	30
Zenith 4F153, tombstone, small square black dial .....	55
Zenith 4F227 .....	30
Zenith 4T26 tombstone .....	55
Zenith 5R312, black plastic .....	95
Zenith 6-S-128, tombstone, needs work .....	55
Zenith 6D311, brown plastic, works, weak .....	75
Zenith 7-S-364 console, works .....	60
Zenith 75 chairside, very small .....	150
Zenith 315 .....	75
Zenith 500 transistor radio, small chip, cleaned and tuned, works, round speaker grille ...	100
Zenith 500H transistor radio, grey .....	60
Zenith 500H transistor radio, cleaned and tuned, black/gold .....	75
Zenith 1000 .....	65
Zenith 3000 .....	50
Zenith 3000, f .....	35
Zenith 3000, not working .....	35
Zenith 3000, working .....	55
Zenith 3000-1 transistor portable .....	50
Zenith AM/FM, plastic TM .....	25
Zenith antenna kit .....	25
Zenith Bullseye, little chip in front, white .....	40



Adam Schoolsky (left) and David Snow (right) are ready for business in the flea market.



It may be a little early in the season, but Rudolph the Red-Nosed Reindeer was well represented in the contest.

Zenith Chromacolor sign .....	45
Zenith clock .....	80
Zenith color TV sign .....	30
Zenith cube-shaped radio, round black dial, needs work .....	95
Zenith G600, port., black case, w/original carton .....	45
Zenith notebook and paper work, etc. ....	225
Zenith spinet console .....	200
Zenith Trans-Oceanic H500, untested, nice .....	25
Zenith Trans-Oceanic H600 .....	40
Zenith Trans-Oceanic, brown, f .....	75
Zenith Trans-Oceanic, not working .....	40
Zenith TV color sign, broken .....	45

Photos by John V. Terrey

(Larry Babcock, 8095 Centre Ln., East Amherst, NY 14051; Jeff Aulik, 1708 Parkview Ave, Rockford, IL 61107; John V. Terrey, c/o A.R.C., P.O. Box 2, Carlisle, MA 01741)

Information on joining the Antique Radio Club of Illinois (ARCI) may be obtained from Carolyn Knipfel, RR 3, 200 Langhorn, Morton, IL 61550. Annual dues are \$12, and a quarterly newsletter is published. In addition to the annual Radiofest, there are usually two swap meets a year.

## Alderfer Vintage Radio Auction Hatfield, Pennsylvania — August 18, 1993

CONTRIBUTED BY DALE MARTIN

The Alderfer Auction Company of Hatfield, Pennsylvania, conducted its semiannual radio auction on Wednesday, August 18, 1993. The auction began at 4 P.M. with more than 200 bidders ready to take part in the excitement. The radio collection contained over 288 lots of radios, parts, phonographs, radio manuals and advertising items in various styles and conditions. Bidders were collectors looking for that one special and rare model, and there was something for everyone — beginners, restorers, and dealers.

Some of the highlights of the evening were a Victor 10-50 floor console radio in original condi-

tion selling for \$1,400; a Troy blue-mirrored radio for \$425; a Tom Thumb 933 miniature Art Deco radio with a blue metal case and blue Catalin knobs for \$380; a 1932 French Thomasson rose glass radio, missing one knob, for \$375; "The Fisk" Radiola brown Bakelite Skyscraper tombstone for \$310; and an Emerson "5+1" Catalin, red with grey trim, for \$235.

Alderfer's next radio auction will be held in January 1994. Please call Dana Pfister at (215) 368-9319 for consignment information.

The following is a select list of items. No conditions were recorded.

Admiral 398-6M, ivory Plaskon .....	\$10	Philco end table radio .....	40
Admiral signal booster .....	20	Philco floor model radio .....	25
Air King, black Bakelite tabletop, small .....	45	Philco tombstone radio, wooden .....	45
Airline 62-352 .....	80	Philco, brown wooden radio .....	45
Airline 62-455 .....	45	Pioneer CD player .....	45
Aria Deco, brown Bakelite, ca. 1938 .....	30	Radio service manuals .....	20
Arvin streamlined radio/phono in metal case ..	20	Radiola, "The Fisk," 1937 brown Bakelite	
Belmont 6D111, brown Art Deco case w/push		Skyscraper tombstone, Australian .....	\$310
buttons .....	85	RCA and Westinghouse radios .....	10
Belmont 526, ivory Plaskon .....	95	RCA poster and other poster .....	12.50
Belmont 534, Art Deco, ivory .....	205	RCA radio w/center dial .....	7.50
Belmont/Grantline, Deco, ivory .....	65	RCA Radiola 62 .....	80
Benrus unusual solid brass clock radio .....	17.50	RCA record bags .....	8
Beverly radio, large .....	25	RCA Red Books set .....	45
Bic turntable .....	5	RCA Service Notes .....	115
Books/papers/manuals/reference, 2 boxes .....	60	RCA small window sign, cardboard .....	15
Capehart Panamuse w/drop changer, console .....	65	RCA tube carrying case w/tubes .....	25
Centennial white radio .....	5	RCA Victor brown Bakelite, small .....	80
Copeland records .....	8	RCA Victor phonograph/radio .....	75
Crosley radio, black .....	10	RCA w/tri-color wood case, tabletop .....	25
Crosley radio, white .....	40	RCA wooden radio w/push buttons .....	15
Crosley white Bakelite case .....	7.50	Record players, 45 rpm, (2) .....	17.50
Crosley, blue, and Emerson .....	45	Remler 26, Scottie .....	75
DeForest radio and parts .....	290	Rolls Royce car model radio .....	10
Emerson 5+1 Catalin, red w/grey trim .....	235	Sams Photofact folder set, lot (2) .....	15, 25
Emerson 8CW-334M ivory Bakelite .....	4	Sentinel and GE radios, white .....	25
Emerson 109, brown Bakelite .....	50	Sentinel, ca. 1947, miniature red Bakelite .....	60
Emerson 718B clock radio, stylish black/chrome ..	10	Service guides, crate full .....	25
Emerson black Bakelite miniature .....	15	Silvertone 109-216 Pee Wee, black w/red .....	35
Emerson brown Bakelite radio .....	5	Silvertone 6178A streamlined Deco Bakelite	
Emerson electric display .....	40	miniature .....	180
Emerson green Bakelite .....	5	Silvertone radios, (2)...12.50, w/wooden case ..	95
Emerson, black square Bakelite .....	7.50	Silvertone white miniature style radio .....	25
Emerson, brown Bakelite case .....	20	Silvertone, brown Bakelite, toaster style case ..	40
Fada 1000 Catalin, case only .....	30	Silvertone, burgundy tone radio .....	12.50
Fada brown miniature Bakelite .....	120	Silvertone, black Bakelite, toaster style case .....	10
Fada white radio .....	65	Slimline speaker .....	10
Fada wooden case .....	2.50	Sonora white radio .....	40
Farnsworth BT-20 .....	25	Spartan radio, blue, (2) .....	35, 45
Fisher tuner .....	25	Stewart-Warner, collegiate red w/ivory .....	55
French radio, peach mirrored .....	375	Stromberg-Carlson brown Bakelite radio .....	20
GE brown plastic radio .....	12.50	Stromberg-Carlson table radio, brown w/white	
GE console radio, restored .....	20	knobs .....	45
GE white radio, (2) .....	15	Television analysis equipment .....	15
GE wooden case radio .....	25	Tom Thumb 933 miniature Art Deco .....	380
GE wooden table radio .....	5	Transformers, (2) .....	7.50
Gernsback's Trouble Shooters magazines .....	55	Trav-Ler radio, white and brown Bakelite ..	17.50
GM radio/phono, in Queen Anne console .....	175	Troy blue mirrored radio .....	425
Gramophone Little Nipper, Australian .....	100	Truetone radio, white .....	25
Grebe radio, long black case .....	450	Truetone Stratoscope .....	240
Grundig phonograph .....	5	TV magnifier .....	12.50
Harman Kardon radio .....	35	Victor 10-50 automatic orthophonic console .....	1,400
Holograph equipment .....	105	Western Electric speaker .....	30
International Kadette, Gothic black .....	45	Westinghouse clock radio, white .....	10
Lafayette JA-84 .....	40	Westinghouse radio, wooden .....	12.50
Majestic LA-51 .....	5	Westinghouse refrigerator radio .....	65
Mantola, Art Deco, black/chrome .....	65	Westinghouse refrigerator style radio .....	35
Mende 148W, Art Deco, brown Bakelite Art		Zenith black portable radio .....	5
Deco cathedral, ca. 1937, German .....	200	Zenith Deco, shutter dial console .....	170
Microtone Deluxe, Emerson and other, (3) .....	20	Zenith large dial radio .....	7.50
Miracle-Six, Art Deco, brown .....	50	Zenith oval design, brown Bakelite .....	7.50
Motorola unusual wood table set w/push		Zenith radio phonograph .....	12.50
buttons .....	15	Zenith Trans-Oceanic .....	40
Ohmmeters, (2) .....	25	Zenith Trans-Oceanic w/wave magnet .....	30
Philco 444 .....	100		
Philco 600 .....	35		
Philco brown Bakelite sets, (2) .....	20		
Philco brown radio w/fabric grille .....	30		

(Dale Martin, Alderfer Auction Company,  
Inc., 501 Fairgrounds Rd., P.O. Box 640, Hatfield,  
PA 19440-0640)

# RESTORATION TOPICS

## Authentic Restoration vs. Aesthetic Improvement

COMPILED FROM LETTERS FROM RICHARD BELL, PHILIP COLLINS, AND STAN LOPES

*Stan Lopes' article on metal radios [June 1993] opened up a philosophical discussion about whether or not a collector's idea of aesthetic improvement, such as chrome plating, is a destructive rather than a constructive process. The following article includes a provocative letter from Richard Bell, along with responses to that letter from Philip Collins and Stan Lopes. Both sides of the argument are food for thought for all collectors. (Editor)*

To the Editor:

In the June 1993 issue of A.R.C., Stan Lopes compared chrome plating radios to "gutting a beautiful wooden console to convert it to a bar or storage cabinet." I take exception to his inaccurate analogy. Lopes seems to be confusing two processes — constructive and destructive. Radio restoration is a constructive process, whereas "gutting a beautiful wooden console to convert it into a bar or storage cabinet" is a destructive process.

Chrome plating creates a more interesting piece and broadens restoration options. It does not modify the original design of the radio. The purpose of paint is twofold: first, to protect the underlying metal, and second, to provide a pleasing and coordinating color scheme that fits into the decor of the room. Chrome plating meets these requirements without jeopardizing the physical integrity of the radio. Furthermore, it is even possible to remove the chrome plating through an electrical process known as "stripping." This is accomplished by reversing the polarity on the metals in the plating solution.

If his argument is applied to restoring vintage automobiles, most of them would be of only one color — Henry Ford's chosen color. Whereas, if you've ever been to a vintage car show, it is obvious that modern color schemes and creative ideas add to the interest, excitement, and uniqueness of the automobiles.

I will agree that if the radio cabinet and original paint are in excellent condition, every effort should be made to preserve the originality of the piece. However, where it is obvious that the radio is in drastic need of aesthetic improvement, radio collectors should be allowed the freedom to make subtle changes in the restoration process equal to that of those who restore vintage automobiles.

(Richard Bell, 100 South Meyers Dr., #1304, Lafayette, LA 70508)

*The following is Philip Collins' response.*

This is a hoary chestnut and can be reduced in simple terms to subjective appreciation. No one, as far as I am aware, has died as a result of seeing a metal radio that has been chromed. That anyone should be moved to passionate rhetoric on cosmetic

appearances of \$10 flea market items is amusing.

There is a misplaced reverence attached to old radios that mystifies. There will always be those who repaint, restore, embellish, and otherwise alter their possessions, much as there are those who prefer earrings, nose studs, tattoos and tooth jewelry. Personally, I draw the line at adhering nose studs to radios. But, if anyone wants to do it — it's their business.

(Philip Collins, El Royale #406, 450 North Rossmore Ave., Los Angeles, CA 90004)

*The following is Stan Lopes' response.*

First of all, I do not consider comparing chrome plating or converting an old radio cabinet to more modern use by removing the "heart" of the manufactured radio an "inaccurate analogy." Webster defines an analogy as a similarity or parallel (sameness). Additionally, Webster defines restoration as "giving back or making something look like new again." Sure, chrome looks like new, but not original.

A good example of misuse of the definition of restoration is on page 75 of Philip Collins' first book [*Radios — The Golden Age*] showing 9 Airline radios in various color combinations, when the little set came in brown and ivory. Mr. Collins' intent is not known, but it was either to excite the reader/viewer or create Art Deco where it did not exist. Pity the first-time collector who spends (or wastes) his time and postage looking for one of those sets.

Chrome plating (actually most are nickel, as it is cheaper) doesn't improve the original design of the radio, but indicates an inability to repaint in one of the original colors. I place it in the same category as drilling a hole in the side of a cathedral to wire a switch to an external speaker. It is a modification pure and simple, and restoration would include removal and patching of the hole.

So those who *modify* a set can do as they please for their own collection, but please don't try to sell me those radios unless the price is right, and I can correct the abomination!

If you want another controversy, I am not a purist when it comes to the underside of a chassis. I do not gut electrolytic capacitors and install modern ones inside. I do try to retain the original look when there are holes from missing parts visible from the back of the set by installing replacement parts, and sometimes I install a defective part and the proper part out of sight under the chassis.

I hope these comments, although biased, will contribute to an article in A.R.C. I appreciate the interest in the subject.

(Stan Lopes, 1201-74 Monument Blvd., Concord, CA 94520)





# CLASSIFIED ADVERTISEMENTS

**FOR SALE:** 1926 tube radio, battery operated X brand. Complete with 2-UX99, 1-UX120, variocoupler, 1 large 1 small variable capacitor, 2 interstage transformers, 4 WW rheostats. Front panel broken (we supply new panel). Also DX list posted inside cover dated 3/27/26. \$150 plus S&H. (Parts listed value over \$200). Photo available. J. J. Papovich, 53 Magnolia Ave., Pitman, NJ 08071. (609) 582-8279

**FOR SALE:** Many types of radio, TV, and industrial tubes. DH Distributors, PO Box 48623, Wichita, KS 67201. (316) 684-0050

**WANTED:** Knight (Allied Radio) 10 in 1 kit set from the 1950's or 1960's. Robert Stapleford, 1800 S.W. Randolph Ave., Topeka, KS 66604

**SERVICES:** Amateur radio repair, tube or transistor, most models maximum labor charge - \$96. Dan Rupe, W7HBF, 1302 S. Uplands, Camano, WA 98292 (206) 387-3558

**WANTED:** Grebe Synchrophase Seven, 1927, in good mechanical condition with intact finish, preferably un-restored. Alan Douglas, Box 225, Pocasset, MA 02559

**WANTED:** Dial escutcheon and the four knobs from a 1938 Silvertone Model 4763, or 4784, or 4723, or 4743. Will buy any one of these models for parts. Melvin R. George, PO Box 24934, San Jose, CA 95154. (408) 267-0697

**FOR SALE:** 1963 Panasonic walnut cabinet AM/FM table radio, vg exterior, excellent working, very attractive 60's radio - \$40, includes UPS in U.S.A. 1950's Sure Bros. microphone, Model CR80M, good, original, used - \$15 includes UPS in U.S.A. Jasper LeFarre, 17 Seldin Ave., Staten Island, NY 10314-2722. (716) 761-6559, 981-1218

**FOR SALE:** Tubes, new and used. Large assortment on hand. Send want list to: PR Novelty, PO Box 140, Milwaukee, WI 53201

**WANTED:** Catalin & Plaskons; radios & parts, early Bakelites, radio; brochures, flyers and sales catalogs. Ross Litrenta, 1 Wilton Rd., Eastchester, NY 0709. (914) 337-7176

**FOR SALE:** Code keys, telegraph items, parts, radio, quack, memorabilia, meters, etc. 9-page list - \$1 plus LSASE. Dr. Joe Jacobs, 60 Seaview Ter., Northport, NY 11768

**SERVICES:** Restoring burned out filament 201A tubes into "brand new" working condition. Send LSASE. Jacob Anthes, Box 52, Lutz Rd., Glidden, WI 54527. (715) 264-5004

**WANTED:** Oil and mercury vacuum pumps and gauges for radio tube mfg. and science. Ed Graper, 5960 Mandarin Ave., Goleta, CA 93117. (805) 964-717

**WANTED:** Early (vacuum tube) novelty radios, parts or basket case sets. Jack Gray, 1162 Broadmoor Dr., Napa, CA 94558. (707) 226-2550

**WANTED:** Up to \$1,000 paid for certain 78 rpm records! Send \$2 + LSASE for our illustrated want list with actual prices paid. Nauck's Vintage Records, 6323 Inway Dr., Spring, TX 77389-3643

**WANTED:** Electrical and optical antique demonstration, scientific apparatus. Early microscopes. Allan Wissner, Box 102, Ardsley, NY 10502. (914) 693-4628

**FOR SALE:** Arvin 450T - \$50. Grunco 632 - \$95. AK 435 chassis - \$35. List. Dave Sutherland, PO Box 201, Spofford, NH 03462. (603) 363-4459

**WANTED:** Reasonably priced small AM transistor radios, working or not, will buy your collection. Douglas Ferrero, WB8YNZ, 33673 Chatsworth, Sterling Heights, MI 48312. (313) 268-3677

.....  
 • A.R.C. Advertising Policy  
 • Sellers and Buyers, Please Note!  
 • Advertising is accepted only for early items  
 • related to radio, communication, etc. All  
 • items must be described fairly; reproduc-  
 • tions, reprints and not-original items must  
 • be so identified. Advertisers agree to re-  
 • spond promptly to inquiries and orders, to  
 • resolve problems promptly if the buyer is not  
 • satisfied, and to comply with a buyer's  
 • refund request on unaltered returned items.  
 • .....

**WANTED:** Instruction manuals and update charts for Supreme tube testers, Model 589 and 599. Stan Marlin, Box 1035, Assiniboia, Saskatchewan, Canada S0H 0B0

**WANTED:** VOX AC-30 guitar amplifier. Will pick up within 200 miles. Frank Czaja, 8968 West Forest Home, #4, Milwaukee, WI 53228

**FOR SALE:** Tubes over 1,000, Type 6550 7077, 6901, 6AV5GA, TV, industrial, etc. Send SASE to: John Lopez, 825 Lees Dr., Las Cruces, NM 88001

**FOR SALE:** RCA Model BCS4 Deluxe Transicharger for the RCA IBT3 transistor radio, N.I.B. - \$40. John Kelly, 17510 Sir Galahad Way, Ashton, MD 20861. (301) 774-8186

**WANTED:** McMurdo Silver radios, brochures, parts (no test equipment). Have cash and excellent trades. Don Hauff, Box 15351, Minneapolis, MN 55416. (612) 374-9739

**FOR SALE:** Philco #20 cathedral - \$335. Radiola #28 - \$275. Transistors & books. List LSASE. Richard L. Bednarcik, 28 Steele Ave., Lincoln Park, NJ 07035. (201) 694-6374

**WANTED:** SABA radios, stereos, speakers. Daryl Jorud, R #1, Box 180, Battle Lake, MN 56515. (218) 864-5725

**WANTED:** Wanted to buy or trade: Browning-Drake radio and CB items. Carl Webster, 503 W. Porter, Palestine, IL 62451. (618) 586-5122

**WANTED:** Surplus electron tubes. Let us bid on your electron tube list. Mail or fax us a copy. **MESSAGE:** Call or write for a copy of our tube catalog, Tube Times. A comprehensive listing of new and used tubes and parts for restoration, repair and experimenting. John Burdick, S&J Electronics Inc., 2219 Industrial Dr., Madison, WI 53713. (608) 222-4900. Fax (608) 222-4970

**WANTED:** For 1949 Admiral dual chassis 10" TV Model 24A12, back cover and static shield, prefer N.O.S. Also, looking for old telephones. Gary Prato, 2140 Beech Knoll Rd., Los Angeles, CA 90046. (818) 789-7117

**RATE FOR ADDITIONAL WORDS:**

**17¢ per word**

**FIRST 20 WORDS FREE!**

*Cash or stamps OK for small amounts.*

*Your payment helps to keep A.R.C. healthy!*

**WANTED:** Sears Part Nos.: R57231 escutcheon dial w/ glass; R57207 dial pointer; R40243AG dial cord; R40224 spring; 52-593 knob; 52-594 knob for Sears Silvertone Model 7067 dial plate assembly. Dennis Evans, 206 Walnut St., Clearfield, PA 16830

**WANTED:** Eveready #2 speaker. Eveready radios. Flashlights & catalogs. Subscribe to Flashlight Newsletter - \$12/year. Bill Utley, PO Box 1425, Tustin, CA 92680. (714) 730-1252

**FOR SALE:** Audio, TV, tubes wholesale prices. LSASE or call. Jim Dicke, 25580 Clifton Ct., Moreno Valley, CA 92553. (909) 242-5422

**WANTED:** For vintage television projects, new/used but good 930 and others gas photo-tubes and neon bulbs. Any Canadian subscribers interested in the above? D'Arcy Brownrigg, PO Box 292, Chelsea, Quebec, Canada J0X 1N0. (819) 827-0128

**WANTED:** Philips/Norelco portable transistor radio Model L6X38T/54 in excellent to mint cond. Ed Kalpakian, 4622 Melbourne Ave., Los Angeles, CA 90027

**FOR SALE:** Stock certificates: Collins - \$20; Emerson Phonograph Co. 1915 - \$50; Orpheum Theaters 1920 - \$25; Admiral, Sentinel, ATT, Western Union, IRC, Tung-Sol, Philips NV, Jefferson Travis - \$10 ea. ppd. J. J. Papovich, 53 Magnolia Ave., Pitman, NJ 08071. (609) 582-8279

**FOR SALE:** Reproduction Zenith dial glass. Made from unbreakable Lexan poly-carb. Better than original. Two rectangular sizes available; 6 3/4" x 7" and 5 3/4" x 7". Price including P&H is \$14 each. Dealer inquiries welcome. DH Distributors, PO Box 48623, Wichita, KS 67201. (316) 684-0050

**WANTED:** Zenith Trans-O R-7000 1 or 2 in excellent condition, but will consider less. Phil Marie, 197 Main St., Niantic, CT 06357. (203) 739-9686

**WANTED:** Restoring National RAS. Need plug-in coils one thru seven and storage panel. Give price first letter. William H. Robertson, W4NZP, 3552 Clarke Rd., Memphis, TN 38115

**FOR SALE:** New old stock Radio Dial Glass from late 1940's and 1950's: Farnsworth, Philco, RCA, Zenith, Hoffman, Packard-Bell, Bendix, others - \$10-\$15 ea. plus shipping. Some escutcheons available. Send Xerox or drawing, what you are seeking. Ellsworth O. Johnson, 364 S. Coeur d'Alene St., Spokane, WA 99204. Phone/fax (509) 838-2161

**FOR SALE/TRADE:** Catalins; Emerson AX235, red - BO; Sentinel 284, red - \$1,900; Garod 6 AUI, red - \$1,600; Fada 1000 rly, - \$900 OBO; others, send SASE. Lairy Wilcox, PO Box 7658, Berkeley, CA 94707. (510) 524-3928

**WANTED:** RCA 103 tapestry grille cloth. Radiola 60 receiver chassis only. N. Hill, 9530 Cross St., Missoula, MT 59802-9510. (406) 258-6388, 3:30 pm M-F MST

**WANTED:** Sonora 301 Bakelite chrome trim, looks like 40's car grille. Arnold Hornstein, 21 Golden Hill Ct., Baltimore, MD 21228

## TUBES WANTED

We need the following tubes to replenish our stock (first digit on 3 digit types is optional). You may ship your tubes to us by UPS or Parcel Post. We'll mail our check upon receipt and testing of tubes. We pay prices shown plus shipping charges. We buy all types of receiving and transmitting tubes. Send us your list for our bid.

### USED GLOBE OR BALLOON SHAPE TUBES - ALL MUST TEST GOOD

WD-11*..... \$ 35.00	184..... \$ 7.00	230..... \$ 5.00	250..... \$ 40.00
WD-12*..... 25.00	UV-199*..... 13.00	233..... 4.00	256..... 6.50
WX-12*..... 20.00	UX-199*..... 11.00	240..... 8.00	280..... 8.50
112A..... 8.00	UV-201A..... 6.50	245..... 15.00	281..... 7.50
120*..... 11.00	UX-201A..... 6.50	246..... 8.00	282..... 7.50
171/A..... 8.00	210..... 10.00	247..... 7.50	403KELLOG..... 20.00
183/483..... 7.00	*Tubular		

### USED ST SHAPE TUBES NEEDED

01A..... \$ 5.00	6L6G..... \$ 3.50	12A..... 5.50	45..... \$ 8.00
6F5G..... 2.00	10..... 4.50	40(ST)..... 3.50	50..... 30.00
6K5G..... 2.00			

### NEW TUBES URGENTLY NEEDED

01A(ST)..... \$ 8.00	6A5/G..... \$ 10.00	6K5G..... \$ 4.00	42..... \$ 6.50
2A3..... 15.00	6B4G..... 9.00	6L6G..... 7.00	45..... 16.00
2A5..... 4.50	6F5G..... 3.50	6N6G..... 7.00	47..... 8.00
2B6..... 6.00	6F6G..... 3.00	6V6G..... 3.50	48..... 4.50
5U4G..... 4.00	6GM5..... 4.50	10..... 6.50	50..... 40.00
5Y3G..... 2.50	6J5G..... 3.00	12A..... 10.00	71A..... 7.50
5V4G/GA..... 3.00	6J7G..... 2.00	40..... 6.00	75..... 3.50

## ANTIQUE ELECTRONIC SUPPLY

6221 S. MAPLE AVE., TEMPE, ARIZONA 85283 PHONE (602)820-5411 FAX (602)820-4643



 Light Art

Industrial design of France,  
recreated as it existed  
in the 1940's. Hand formed in  
Radio Bakelite plastic with  
adjustable arm of chrome and brass.

Lights up at any angle and  
automatically shuts off when  
folded down. Only ten available  
in Vandyke Brown, 10" x 7" x 6"  
(extends to 17") . . . \$100.00

MC/Visa accepted.

To Order Call  
Xonex International Inc.  
(216) 442-1600

**J·U·M·O**  
*Lamp*

**FOR SALE:** Retiring at 84. Close-out of tubes and radios continuing. Send for list. Robert Gordon, 18560 Jewel Crest Dr., Muskego, WI 53150. (414) 679-1232

**FOR SALE:** Rare vintage tube CB's. Drake 2A receiver, mint. Zenith F615. MFJ 422B keyer. Charles Zafonte, N1FRX, RFD 1, Box 75, Fort Kent, ME 04743. (207) 834-6273, evenings

**SEND ALL A.R.C. MAIL TO**

**Antique Radio Classified  
P.O. Box 2, Carlisle, MA 01741**

**WANTED:** Info: Heath GR-21, GR-36, IO-11, HR-10; Lafayette HE-30; RCA Q190. Will reimburse. Thanks. Mike Harla, N2MHO, 1337 Norris Dr., Vineland, NJ 08360. (215) 843-8628

**WANTED:** Emerson 888's in excellent or better condition. Harold S. Trieb, 644 8th St. N, Hudson, WI 54016. (715) 386-2098

**HELP:** Need bandswitch lever for a Stromberg-Carlson Model 61-Z or 58-T. Steve Pazar, 4950 Deerwood Dr., Santa Rosa, CA 95403. (707) 544-8142

**WANTED:** Philco 37-116-122, working or easily restorable. Dick Friedman, 1502 Elmwood, Wilmette, IL 60091. O: (708) 803-3050; H: (708) 256-1432

**FOR SALE:** Radio dial belts - \$4 ea. ppd. Indicate belt size or radio model. Bob Zimmer, 205 Brigham Hill Rd., Milton, VT 05468. (802) 879-7235

**WANTED:** Mustang promotional plastic car/AM radios from the mid-60's. Not reproductions. Jerry Becker, 3331 Larry Dr., Plover, WI 54467. (715) 341-7610

**WANTED:** Escutcheon for AK-84. Philco 17B cathedral Melodyne battery set. Butterscotch bezel for Fada 115. Theodore P. Depto, 818 5th Ave, Patton, PA 16668. (814) 674-8834

**NEW LOCATION - ALL INDOOR!**



**WHEN:** Saturday, Oct. 23rd, 8am-4pm

**WHERE:** Holiday Inn, Middletown, NY  
(Easy Highway Access - Exit 122, Rt. 17)

**ADMISSION:** \$1.00 at the door

**Sponsored by Hudson Valley Antique  
Radio & Phonograph Society**

**Refreshments available.**

**For information call:**  
914-561-0132 or...  
914-427-2602 evenings.

**WANTED:** The radio chassis for a RCA His Master's Voice console. Unfortunately no model no. Has sloping dial, sliding pointer, approx. dim of console: H90.0 x L57.5 x D37.5 cm., two holes for knobs on sides of the dial and one on right side of console. One more hole above dial for tuning eye. Has a pick-up "Grawor[?]" on top. Can anyone help identify this console radio? Argirios L. Adamidis, 19 Kampouridi St., Panorama, Thessaloniki, Greece 552 36

**FOR SALE:** Marelli pink mirror glass 1937, Philco People's radio A527, matching Philco heater, Stewart-Warner book radio, CC1932; Marconi V2; also V3 in red Chinese lacquer cab.; Gnome Midget; WWI British 2-tube trench set; German WWII airborne radios. **WANTED:** WWI radios. Jim Taylor, G4ERU, No. 5 Luther Rd., Bournemouth, BH9 1LH, England. 0202-510400

**WANTED:** Zenith Model 500H transistor in good or better condition. John Stützer, 708 Roberts Ter., Marshalltown, IA 50158. (515) 752-6351

**WANTED:** Emerson BD-197 Mae West, any condition. Philco 45, good condition. Jiri Placek, 60 Applewood Ln., Boyertown, PA 19512. (215) 367-0861

**FOR SALE:** Seeburg jukebox amplifier (78). Several jukebox repair manuals including "Singing Tower". Philco 1966 Mustang mocel promo radio. Zenith R500 hand-wired 7X. Turner Lavalier microphone 82-3H. Regency TR5C. Raytheon 8TP2, brown leather. Motorola X48E. Motorola X11E, (A.R.C., April '93, p. 6) w/ logo factory installed upside down. RCA 4RG51. Seminole 1010. Windsor 2013. Crown TR333 black w/black behind clear front. Toshiba 6P-15. GE detachable set (A.R.C., July '93, p. 15). Computron binocular radio. Budweiser radio. Sonic TR99. Bradford, sme as Realtone (A.R.C. April '93, p. 4). Many mini metal tape recorders. Thank you. Robert Rogers, 1407 Riverside Rd., Old Hickory, TN 37138. (615) 847-2475, 4 pm CST

**America's Radio Club**

**Fulfill Your  
Collecting Dreams:**



- Local chapters
- The GAZETTE quarterly
- See many of your favorite radios in "Living Color"
- The only magazine for the hobby printed in color
- Large membership certificate
- Members in all 50 states and many foreign countries
- National convention each June
- Local meets during the year and special events
- Dues \$12.00 - will be \$14.00 January 1

— Sample GAZETTE \$3.50 —

**Antique Radio Club of America, Inc.**  
300 Washington Trails, Dept. C  
Washington, PA 15301-8210

**FOR SALE:** (2) Bang and Olufsen Model 53 ribbon microphones with B&O stereo mount - \$700. Dan Wood, 248 Carpathia Rd., Winnipeg, Manitoba, Canada R3N 1S9. (204) 488-6662

**FOR SALE:** Zenith Royal 500 (burgundy), Zenith Royal 500D Deluxe (black), both for - \$150 or BO. Harry Kundrat, 29 Walton Ave., New Providence, NJ 07974. (908) 665-1873

**FREE - 20 WORD AD EACH MONTH**

To get your free 20 words,  
include your SUB# with your Ad.  
Additional words are 17c each.  
Read inside back cover for details.  
**MANY THANKS!!!!!!**

**WANTED/FORTRADE:** Microphones. Hi-fi/professional audio, radio/TV broadcasting equipment. WE & RCA items. Robert Van Dyke, Squires Ave., East Quogue, NY 11942. (516) 728-9835

**WANTED:** Crystal detector, knob/pot, metal covers to complete our Radiola V. Please help, thanks. Nevins Museum of Radio, Ken Nevins, 406 Jipson St., Blissfield, MI 49228. (517) 486-3019, eves.

**FOR SALE:** McIntosh MC275 reissue, sealed - \$3,800 or BO + shipping or pickup. **WANTED:** McIntosh MA6 mpx unit. Walt Fleming, 182 Plain Hill Rd., Norwich, CT 06360. (203) 889-5018

**WANTED:** Motorola transistor and small tube portables. Hoffman P411 and Emerson 843 and 856 portables. Jeffrey Viola, 475-B Elton Rd., Jackson, NJ 08527. (908) 928-0666

**FOR SALE:** Zenith 8-S-661 - \$225. Zenith 5-S-237 - \$150. Zenith catalog reprints - \$12 each. (70) different JFD dial belts with case and catalog - \$45. Shipping extra. Steven DiMattia, 1212 Ardmore Ct., Apt. TC, Frederick, MD 21702. (301) 695-8408

**FOR SALE/TRADE:** EE-8 phones. Shure 55S, 520 SL. 3-1000Z, SK 510, SK 516, SB 220. Ray Williams, 4521 Whitfield Ln., St. Louis, MO 63134-3821

**FOR SALE:** (75) wood, plastic, Bakelite radios. List avail. SASE. Greg Bogel, RD#2, Box 93, Cherry Tree, PA 15724. (814) 743-9028

**WANTED:** Kitzon Model 125 detector/amplifier. See Radio Manufacturers of the 1920's, Volume II, p. 170 Phillip Drexler, 1175 E. Ripley Ave., St. Paul, MN 55109 (612) 771-8630

**FOR SALE:** Retiring - may have something you may need, please contact: Harry J. Blair, 3401 S. Lituania Ave., Chicago, IL 60608. (312) 247-7949, anytime

**FOR SALE:** New old stock, German-made Electrostatic tweeter speakers, four available, circa late 1950's - \$7.50 ea. Ellsworth O. Johnson, 364 S. Coeur d'Alene St., Spokane, WA 99204. Phone/fax (509) 838-2161

**WANTED:** Manual and schematic for Hickok Mode 6005 dynamic mutual conductance tube tester. Mike Martin, 710 Colorado Ave., Louisville, KY 40208

**FOR SALE:** Philco 38-116 console, electrically restored, beautiful original cabinet - \$450. Westinghouse WR-8 grandfather clock, electrically restored - \$400. Philco 42-395 console beautiful cabinet unrestored - \$125. Philco 40-190 console, electrically restored - \$300. RCA 110-K unrestored console - \$200. Vance Rayburn, 2718 Homestead Rd., Madison, WI 53711. (608) 274-3002

**FOR SALE:** 400+ used tubes, all tested, mixed types, 1930s-1950s - \$15/all. Pickup only. Michael Dalzell, 5073 Winfield Ct., Bensalem, PA 19020. (215) 638-3889

**HELP:** Need schematic and/or manual for a Heathkit Model HW-100. Rich Crispi, 143 Franklin Rd., Apt. 1. Hamden, CT 06517. (203) 230-8189



## Ralph's Radios

c/o Ralph Bonamo  
229 Ramona Ave.  
Staten Island  
NY 10312

(718) 356-3410  
Please call  
for details !

### FOR SALE: Repro Radios

Phonograph .....\$75  
Multi-color, light-up Jukebox.....55  
Cathedral .....45  
Patriot/Bullet/Jewel Box .....30

- AM/FM, most with cassette player
- Ask about discounts for ten or more  
  [For five or more with the multi-color, light-up Jukebox]
- Excellent for shows, stores, flea markets, etc. !!
- Send LSASE for color flyer
- Prices do not include UPS
- All checks made out to Ralph Bonamo

**MESSAGE:** Collect them before they're all thrown away! Meanwhile join the only organization for collecting early portable electronic calculators. Membership includes informative quarterly newsletter - \$8/yr., sample - two 29¢ stamps. International Association of Calculator Collectors, 14561 Livingston, Tustin, CA 92680

**FOR SALE:** Manufacturers catalogs, signal equipment, door bells annunciators, electrical apparatus. Analog test instruments needed. Henry Weiland, 8946 West Grantosa Dr., Milwaukee, WI 53225. (414) 463-4681

**PHONE NUMBER FOR  
ANTIQUE RADIO CLASSIFIED  
(508) 371-0512**

**Best time to call is weekdays:  
9 am to 5 pm Eastern Time**

(Please no classified ads by phone. Thanks!)

**WANTED:** Edison records. Send large SASE for free want list. Jim Polsene, 602 Chicago St., Manitowoc, WI 54220. (414) 682-0999

**FOR SALE:** Detrola 1939 wood, table model SW/BC Model 159 - \$50. Large Emerson plastic table model, circa 1939 - \$50. RCA large wood table radio, Model 56 X 3 has tone control, 5 louvers across front, 2 tone - \$40. Zenith white AM/FM Model 722, 6 tubes - \$35. Silver-tone white Cat. #16, large old table model, tone control, 10 vertical louvers - \$35. All sets work plus shipping. John Kara, 1700 Baltimore Ave., Whiting, NJ 08759. (908) 849-4318

**FOR SALE:** Precise transistor kit, Model T8 - \$25. Bendix 526 A, black plastic - \$25. Emerson Model G 1702 white, tubes - \$25. Zenith Model M 730, wood cabinet - \$40. Sylvania Model 614, green plastic mesh across front, dials on side, old, Model 614 - \$35. Panasonic Sphere radio (size of soft ball), white - \$20. John Kara, 1700 Baltimore Ave., Whiting, NJ 08759. (908) 849-4318

**FOR SALE:** Attention Edison collectors, a rare book, nice condition, 1927 first edition "The History of the Incandescent Lamp" hardbound, 208 pages, authored by John W. Howell and Henry Schroeder - \$35. Ellsworth O. Johnson, 364 S. Coeur d'Alene St., Spokane, WA 99204. Phone/fax (509) 838-2161

**FOR SALE:** (2) Zenith "Owls," 1 Royal 500 Deluxe, 1 Royal 500; both work and in very good to excellent condition - Best Offer. John Snow, 4539 Bartlett, Shorewood, WI 53211. (414) 964-0194

**WANTED:** Speaker for a Drake 1-A receiver. I will also consider the speaker plus a 1-A receiver. Dave Noon, VE3IAE, 19 Honeysuckle Cr., London, Ontario, Canada N5Y 4P3

**FOR SALE:** Guild New Englander roll-top desk console - \$2,500. Ed Quirk, 46 Kelsey Ave., West Haven, CT 06516. (203) 933-2714

**FOR SALE:** Zenith Trans-Oceanic 3000-1 with manual and AC adapter - \$95. Zenith Trans-Oceanic 3006-1 with manual - \$120. Zenith Trans-Oceanic A600 - \$70. Zenith Trans-Oceanic A600 - \$85. Zenith Trans-Oceanic 7000-Y has a few problems, works good - \$90. Zenith 500E, white - \$70. Jim Montague, 921 S. Cuba, Spokane, WA 99202. (509) 535-9576

**WANTED:** Hammarlund HQ160 operating and service manual to buy or copy. Steve Easterday, N9ICL, 3299 E. 716 N, Huntington, IN 46750-8303. (219) 672-9228

**FOR SALE/TRADE:** Zenith black dial MD 10-B-2 chassis, tubes, rotor wavematic, speaker for good pocket transistor or cash. Paul Fulton, 711 Jacquelyn Rd., Westwood, NJ 07675. (201) 664-5260

**FOR SALE:** Wiring diagram Solovox Model J Edition 4 - \$7.50. **WANTED:** Swan 160X, TS820S parts set, used 8874. Meade, 12711 Pinebrook, Hudson, FL 34667

**SATISFACTION GUARANTEED**

# J.D.'S Radiowear

**BREADBOARD**

**T-SHIRTS:**

PRINTED FRONT & BACK IN BROWN, BLACK, FOREST GREEN AND GOLD ON WHITE 50/50 COTTON BLEND SIZES M, L, XL (XXL \$1.00 EXTRA)

**GREETING CARDS:**

12 PER PACK W/ ENV SINGLE COLOR ON WHITE

SEND CHECK OR MONEY ORDER TO J.D.'S RADIOWEAR 1161 SW MULVANE TOPEKA, KS 66604 (913) 232-0128



FRONT



BACK

\$13.95 PP

\$4.50 PP



**Craig L. Graybar  
Furniture Works Ltd.**

(414) 258-2390

**SPECIALISTS IN RESTORING,  
REPAIRING AND REPRODUCING  
CLASSIC STYLED ANTIQUE TV,  
RADIO & PHONOGRAPH CABINETS**

Send us your plans or your project via UPS for immediate price quotes

**1535 S. 84th St.  
West Allis, WI 53214**

**VISA** **MasterCard**

*"We Turn Ideas Into Heirlooms"*

**FOR SALE:** Axial lead electrolytics, fresh new Nichicon miniature 10 mfd at 450 VDC - 98¢ each for 10 or more. Includes P&H. DH Distributors, PO Box 48623, Wichita, KS 67201. (316) 684-0050

**WANTED:** Nameplate (tag) for Lionel J-36 bug, or complete Lionel Vibroplex or J-38 key. James J. McGrath, W210J, 2 Centerview Ln., West Seneca, NY 14224. (716) 675-0160

**WANTED:** Allen Chapman's Radio Boys book with original dust jackets only. Please write: Henry O'Meara, PO Box 384, Honeoye, NY 14471

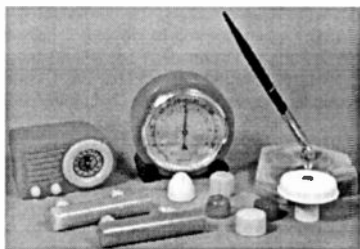

**FOR SALE:** Repro. Catalin parts. Novelties, decals, supplies. Send stamp for catalog. JM Technical Arts, 30 Music Sq. W. #156, Nashville, TN 37203. (615) 244-6892

**WANTED:** Zeniths of all types. Send details. Cash or non-Zenith trades considered! Harvey Leners, 5426 So. 185, Omaha, NE 68135

**WANTED:** Ad from magazine for Frost Fones with the caption, "Where's the varmit that stole my Frost Fones?" Will pay \$20 for the first one who calls. Douglas Lee, 12085 Duttlinger Ln., Wheatfield, IN 46392. (219) 956-3237

**HAVE YOU MOVED? ARE YOU MOVING?  
PLEASE NOTIFY US A.S.A.P.**

**SEND US YOUR...**

**OLD ADDRESS**

**NEW ADDRESS and**

**SUB #**

**MANY THANKS!!!!**

**FOR SALE:** Books: Electricity and Electrical Engineering. Electricity and Magnetism Vol. II by Gordon, 1884, 332 pp. - \$75. Hawkins Electrical Guide #8 by Audel, 1915, 275 pp., gold-edged pages - \$15. Swopes Lessons in Practical Electricity, 1926, 694 pp. - \$20. Standard Handbook for Electrical Engineers, 1933, 2,816 pp. - \$35. Electrical Engineering by Dawes, Volume I (1927), Volume II (1934), 1,300 pp. in both books - \$15 each book. Transformer Principles and Practice 1st Ed., 1937, 210 pp. - \$20. Industrial Electricity by Naddon and Gelmine, 1939, 607 pp. - \$20. American Electricians Handbook by Croft, 1942, 1,634 pp. - \$25. AC for Technical Students by Bishop, 1943, 424 pp. - \$10. Audels Practical Electricity, 1924, 1,500 pp. - \$20. Audels Oil Burner Guide, 1947 - \$10. Synchros and Servos AN256, 1954 - \$10. Send LSASE w/58c postage for complete book list. J. J. Papovich, 53 Magnolia Ave., Pitman, NJ 08071. (609) 582-8279

**FOR SALE:** RCA Radiola 25, RCA RC (Rada), Freshman & Murdock crystal detectors, Marian Special crystal set, Arnold loose coupler. Send SASE for large list of other items! Jerry Finamore, 87 Stonewood Pl., Cata-sauqua, PA 18032. (215) 264-8412

**FOR SALE:** B&K Model 700 tube tester, good condition - \$75. B&K digital bench meter, like new, with booklet - \$50. All plus shipping \$15. Other test equipment, send needs & SASE. Maurer, 29 South 4th St., Lebanon, PA 17042. (717) 272-2481

**WANTED:** Pre-1900 telegraph keys, sounders, relays, registers, etc. Pre-1920 wireless keys. I am seeking nice examples of early telegraph instruments but also want income etc or damaged telegraph items for parts. Larry Nutting, 4025 Slate Ct., Santa Rosa, CA 95405. (707) 539-1883

**WANTED:** 1929 advertisements featuring Graybar 600 highboy. May have appeared in Saturday Evening Post. Bruce Dahl, 4134 Blueberry Knoll, Eagan, MN 55123-1407. (612) 452-6545

**FOR SALE:** Zenith 1SU269, 7S232, 10S153, 5S319, AK 82, AK 84, Philco 90, Fada Bullet 1300. Kent Martin, 7803 Butterfield Dr., Elkridge, MD 21227. (410) 796-1953

**WANTED:** Hallicrafters S10, SX11, S14, SX15, SX18. Robert Braze, N1PRS, 49 Fifth St., East Providence, RI 02914. (401) 438-8927

**WANTED:** Tubes all kinds and quantities, tube sockets, old paper and old caps, Sprague Black Beauties, Vit-Q, Westcap, etc. Mail or fax inventories or inquiries to: Kurluff Ent., 4331 Maxson Rd., El Monte, CA 91732. (818) 444-7079, fax (818) 444-6863

**FOR SALE:** Zenith 10S669 parts, incl. excellent grille cloth. **WANTED:** Magnavox service info for R7001-10 FM multiplex adapter used in early 60's console. Chris Jones, 38 Southridge Trl., Fairport, NY 14450. (716) 223-0095

**WANTED:** Power transformer for Stewart-Warner chassis 01-8B, speaker for RCA Radiola 64. Jerry Gilchrist, 2145 Sugar Valley Rd., Ohatchee, AL 36271. (205) 892-0703

## 1930'S GRILLE CLOTH

AS GOOD AS THE ORIGINAL  
SEND 29¢ LSASE FOR SAMPLES

Patterns currently in stock:

- #1a Large Diamonds
- #1b Large Diamonds
- #1c Large Diamonds
- #2 Herringbone
- #2a Herringbone (Black/Silver)
- #3 Philco 70/90
- #4 Small Diamond (as in Peter Pan)
- #5 RCA/Zenith/Echophone
- #6 Philco 'V' (Green)
- #7 Philco 'V' (Brown)
- #8 Philco "Ribbed" (for late '30s)
- #9 Atwater Kent Yellow (165, 217, etc.)
- #10 Basic "Generic" pattern
- #11 Emerson AU 190
- #12 RCA/GE Orange

STILL LOOKING FOR  
NEW PATTERNS TO REPRODUCE !!

MICHAEL KATZ  
3987 DALEVIEW AVENUE  
SEAFORD, NY 11733  
(516) 781-6202 (EVENINGS)

**FOR SALE:** Scott 23 tube Imperial radio, all restored, beautiful cabinet, asking - \$1,495. Larry Drago, 383 Lincoln Dr., Cheshire, CT 06410. (203) 272-6030

**FOR SALE:** AK 35 W/T, nice shape - \$65. Hallicrafters S-120, near mint - \$45. Zenith Trans-Oceanic 3000-1 w/charts, very nice - \$95. Rare Detroit coin-operated floor model, wooden cabinet, vg - \$75. Add shipping. **WANTED:** Speaker for AK 84 in working condition. Dial and bezel for Silvertone 4564, hole in cabinet is 4 1/2 inches, outside diameter of bezel is 5 inches. Emerson portable Model 645. Fada Models C-34 and L-33. Sonora Candid, in nice shape. Tony Parjus, 816 Richard Ln., Gretna, LA 70056. (504) 393-0099

**WANTED:** Radiola, must be in excellent condition. Michael Stern, 1285 Alum Creek Dr., Columbus, OH 43209. (614) 252-4422

**FOR SALE:** Prewar marbled radios by Kadette, Detrola, RCA, etc. Rare Catalins; early breadboard, and portables; early transistors; Atwater Kent advertising, several rare pieces; piano radios in wood and Bakelite, both excellent; crystal sets; quack medical device; TVs; miniature portables from WWII, excellent condition; Emerson 744 in red and silver (Collins); New World Globe; etc. Call or write for list. Rain Buttignol, 214 State St., #7, Portsmouth, NH 03801. (603) 427-1384

**FOR SALE:** Tubes, N.O.S. and used, mostly modern. Multisection twistlock can capacitors to 500VDC. Earlier Sams Photofacts, years 1956-1975. Send SASE for lists. Turner Electronics, 16701 Main St., Ste. 121, Hesperia, CA 92345

**WANTED:** Several 5" Dynamic speakers 1000 to 2000 ohm field. Bob Barnes, 511 N. Chestnut, Monroe City, MO 63456

**FOR SALE/TRADE:** Approx. 1325 N.I.B. tubes. **WANTED:** Crystal, 1-tube, amateur. LSASE. Richard Gentry, Box 9274, Phoenix AZ 85068

**WANTED:** Zenith Stratosphere 16 or 25 tube model. Will buy or trade generously from our huge inventory. Alan Jespersen, PO Box 17338, Minneapolis, MN 55417. (612) 727-2489

**FOR SALE:** Transistors: Arvin Model 60R69 w/case; Philco Model T-67. White plastic Sylvania 519; GE 518-F white plastic; GE 10A brown plastic; tape recorder Wollensak T-1515; Army multichannel receiver R-278; Jeep radio PP112-GR; Navy navigation device, many odd test units, teletype boxes. For list and photos send large SASE and a buck to help offset Xerox costs to: John Strattan, 701 Waterson Trl., Middletown, KY 40243-1852

**FOR SALE:** Catalin Motorola Model #52 box - \$200. **WANTED:** Fada #711 chassis, Fada #5F60 grille. Any color, I will buy damaged sets or parts. Ray Carroll, 158 Oakwood Dr., Wayne, NJ 07470. (201) 696-1149

**FOR TRADE:** Maroon and yellow Fada Temple for green Bendix 526C or other Catalin radio. Cash offer also considered. Richard O. Gate, PO Box 187, Chesterfield, VA 23832. (804) 748-0382

**FOR SALE/TRADE:** Thinning out my collection, unusual Bakelite, Plaskon, Beetle sets. Tombstones, cathedrals, phonographs, radio and TV advertising. Most items first time offered. Send large SASE for free picture list. **WANTED:** Unusual prewar colored plastic and beetle sets by Detrola, Kadette or surprise me. Mark Alzapiedi, 21 Peach Tree Ln., Leominster, MA 01453. (508) 840-0466

**FOR SALE:** Packard-Bell Model 2602 TV chassis, circa 1952; complete, all tubes and CRT good - \$50, pick-up. Steve Pazar, 4950 Deerwood Dr., Santa Rosa, CA 95403. (707) 544-8142

**WANTED:** Majestic Model 15 chassis for parts. #45 tubes and #23 Riders. Robert Vanderwarker, 607 Braecrest Cir., Stei'acoom, WA 98388. (206) 588-0295

# THANKS!

*Thanks for suggesting A.R.C. to your friends.  
Did you know that nearly 20% of our new subscriptions  
come from referrals from subscribers.  
So spread the word about A.R.C.!!  
Give the center coupon to a collector, or  
ask us to send a free sample copy.  
Help A.R.C. and radio collecting grow!*



**FOR SALE:** Attention collectors seeking RCA Red-book. The equivalent, except it says "General Electric," covers all radios 1930 through 1935. (RCA made all General Electric radios in those days and all cross-reference to each other) hardbound, 887 pages, cover shopworn, otherwise good - \$35 plus postage. Ellsworth O. Johnson, 364 S. Coeur d'Alene St., Spokane, WA 99204. Phone/fax (509) 838-2161

**FOR SALE:** Vibroplex key S/N 164364, excellent condition - \$55. I ship. John Snow, W9MHS, 4539 Bartlett, Shorewood, WI 53211. (414) 964-0194

**WANTED:** Old panel meters and meter parts, any condition. Any catalogs or books showing pictures, manufacture, or repair of meters. Chris Cross, PO Box 94, McConnell, IL 61050

**WANTED:** Hallicrafters 5000 ohm speaker for use with Super Skyrider SX-28. Jim Wilson, 888 Pearse Rd., Schenectady, NY 12309. (518) 372-9625

**FOR SALE:** Radios. Freshman console G7. Zenith Elect. M. 10a1. Philco console, elect., 8 tubes. Table Models. Battery. Wheeler Mfg. Co. King Quality 5 tubes. Crosley REL 5 tubes. Elect. table models. Zenith M h725. Philco P t 44. Zenith 5 tubes. Motorola M 52 M I U. Will be sold in one lot to the highest bidder. All in good shape & work. No shipping. Clarence Erickson, 6622 Channel Rd., Waterford, WI 53185. (414) 662-4176

**WANTED:** Looking for radios by Aviola, Westcraft, Powell, Robertson and Marshall. Jeff Peterson, 563 W. Pepper, Mesa, AZ 85201. (602) 834-4643

**WANTED:** Commercial gear: coherer, magnetic detector, Fleming valve, DeForest Audion, commercial spark-gap transmitter and receiver, stock-ticker, parts for D-10, and maroon tuning knob and dial plate for RPM breadboard. Chisman, PO Box 1111, Clemson, SC 29633. (803) 639-2939

**FOR SALE:** SASE for new list. **WANTED:** Hallicrafters speakers, 5" in separate cabinet. Carl R. Shirley, 824 Fairwood Dr., Columbia, SC 29209. (803) 776-6850

**FOR SALE:** Fada 115 Bullet, blue w/white swirls, pumpkin trim, restored case & chassis - \$2,250. Jim Downes, 607 East 12th Ave., Covington, LA 70433. (504) 893-7057

## One Month Free!

### BONUS FOR EARLY RENEWALS

If you renew **before** the month shown on your mailing label (your expiration month), you will receive an extra month on your subscription: 13 months instead of 12! 26 months for an early 2-year renewal!

**WANTED:** Schematics & manuals for copies of Tandburg; Allied Radio catalogs. Scott Model #296 amplifier or other amplifiers. Ed Ellis, 1559 S.W. 23 Ter., Deerfield Beach, FL 33442. (305) 421-9999

**WANTED:** Documentation and schematic for Patterson PR-15 communications receiver. Jesse R. Callahan, PO Box 424, Brookeland, TX 75931. (409) 698-9466

**FOR SALE:** Tektronix Maintenance Manual for Model L plug-in or Tectronix Model 160 Series units. Or Hewlett Packard Model 425 A; these are original not copies - \$5 each plus UPS \$1 S/H. Ted Stewart, W6NPB, 2157 Braemar Rd., Oakland, CA 94602. Phone(510) 531-7042; fax (510) 531-7072

**FOR SALE:** Atwater Kent small size acorn nuts & bases such as used on fixed RF transformers, potentiometers and Radiodyne coil tops, etc. - \$33 per dozen sets incl. shipping. Paul Thompson, 315 Larkspur Dr., Santa Maria, CA 93455. (805) 934-2778

# Racal and the RA.17 Communications Receiver

Mention the RA.17 (or its US-made counterpart, the RA.71) and watch the eyes of many old-timers (and some not-so-old) light up!

The story of one of the UK's best-known radio manufacturers, and of its first and probably most famous product, is currently featured in

*The vintage wireless magazine*  
**Radio  
Bygones**

*Amateur radio • aviation • broadcasting • marine • military • mobile • domestic radio and TV • recording*

*Reminiscences • personalities • equipment • techniques  
Plus a full-colour photo-feature in every issue*



Radio Bygones is published by G C Arnold Partners (AC),  
9 Wetherby Close, Broadstone, Dorset BH18 8JB, England.  
Phone/FAX: 0202 658474 - International +44 202 658474

VISA

**WANTED:** Pocket-size radios (transistor, tube, or crystal) made in U.S. or Japan. Eric Wrobbel, 20802 Exhibit Ct., Woodland Hills, CA 91367. Phone or fax (818) 884-2282

**FOR SALE:** Rare transcription turntables from California. Play those great old 16-inch radio programs, 33/45/78 speeds in self-contained suitcase style institution type units, serviced & playing, just plug in and lift the 2-inch speaker in lid for playback, has PA inputs and great sound suitable for large rooms. Order by phone w/ American Express card; good, fully operational units - \$295 each; non-operational ones - \$95 w/o stylus. Also have smaller 12-in. max. size 3 speed units - \$95, fully operational & - \$35 non-op w/o stylus. While they last. Robt. DeMars, 222 Lakeview Ave., Suite 160256, West Palm Beach, FL 33401. Phone: (407) 832-0171, fax (407) 832-6939

— WANTED —

**PICTURES FOR PHOTO REVIEW  
PHOTOS MUST BE SHARP IN DETAIL  
A SHORT DESCRIPTION IS A MUST!  
SEE PHOTO REVIEW PAGES FOR  
ADDITIONAL INFORMATION**

**FOR SALE:** Majestic Treasure Chest, vg - \$250. Majestic 461 Deco tombstone, black, brown chrome, vg - \$345. Guild Spice Chests, vg, maple - \$95; pine - \$75. Arvin Hopalong Cassidy, complete, black - \$495. Stewart-Warner Porto Baradio with glasses, repainted black with silver escutcheon and handles, g - \$275. Gillfillan 32, g - \$70. Silvertone 1 small metal brown - \$70. Rolls Royce transistor box paper, vg - \$30. Zenith 6-S-229 tombstone, vg - \$295. Zenith 6-G-128, g - \$250. Above all work. Lots more. All plus shipping. SASE for radios, test equipment, earphones and windup phonographs. Eugene Rippen, 105 Donnington, Auburn, CA 95603. (916) 885-6147

**WANTED:** Clarion 61 tuning condenser or junker chassis with tuning condenser. Also Brunswick Model 11 chassis and Philco 38 chassis. Thanks. Bob Barnes, Box 275, Monroe City, MO 63456. (314) 735-2945

**AUCTION:** Antique Radio & Phonograph Auction, Sunday, Oct. 31, 11 a.m. Many battery radios, consoles, cathedrals, plastics, Bakelites, transistors. Also boxes of early radio parts, tubes, books, etc. Sale held inside, one half mile north of Rt. 50 and Rt. 130 intersection. Watch next month's A.R.C. for listing or for a flyer contact auctioneer: Eric L. Buner, 1000 S. West, Olney, IL 62450

**WANTED:** Kit amplifiers by U.T.C., Triad, Stancor. Also hi-fi transformers, catalogues, and related info. Leif Blackman, 4 Larson Rd., North Reading, MA 01864. (508) 664-0174

## Stromberg-Carlson

Several nice S-C sets for sale/trade;  
incl. 935M, 250M, 145L, 130H, misc.  
tombstones/tabletops, ship or  
can take to Elgin or Rochester; CALL

Looking for S-C Models 74, 734, 744;  
others desired, also S-C paper.

John M. England Jr.  
P.O. Box 59136  
Schoumburg, IL 60159  
(708) 823-5287

**FOR SALE:** As usual there are radios for everybody. Call and reserve any radio, they go quick. 100% money back on any radio you are not happy with. Red table model Predicta - \$485. Pilot TV, perfect cabinet, 3' screen - \$350. Philco 20 - \$195. Philco Butterfly cabinet radio - \$150. Arvin 540T white, tan trim - \$95. Crosley color radio, green D-10GN - \$185. Crosley 51 - \$145 with tubes. AK 30 - \$145. Hallicrafters TW-500 green case - \$175. Philco cathedral Model 60 - \$145. Mickey Mouse radio, ivory body, green trim with back - \$1,350. Sparton 557, 3-knob, excellent original - \$2,200. Sparton Bluebird, exc original - \$3,000. Sparton 7-sided blue mirror, exc original - \$2,500. RCA black oriental design hand painted - \$195. Emerson oriental design with handle, doors & rhinestone - \$175. Speakers: Crosley Musicone - \$125. Pathé cone speaker medical/symbol - \$295. Victor wooden speaker - \$350. Pathé cone speaker large tower - \$295. Dictograph radio loudspeaker horn - \$225. Dictograph gold horn black base - \$275; all are in exc original condition. Zenith Consoltone H511W - \$85. 6D2615 - \$75. DeWald white Plaskon JD-115 - \$75. A perfect RCA Radiola 16 - \$275. Radio keg beer keg radio, exc working - \$295. New in the box 1947 Motorola auto radio green metallic body marbled with swirled trim with tuner & original antenna - \$250. Detrola chrome front (cover of Collins II), perfect with green body - \$250. Motorola 53H (Collins II), green body, green grille - \$185. Norelco SW, AM portable, ivory push buttons - \$65. Setchell-Carlson white Plaskon frog eye - \$85. Grundig Model 97 green cabinet, SW, ivory push buttons - \$135. Farnsworth ET-065 chrome front, black handle & knobs, silver grille, ivory body - \$165. Westinghouse RADA exc - \$325. RADA separate cabinets, exc - \$575. AK Model 9 breadboard, exc original - \$1,750. AK 10 black (?) with matching black AK speaker exc - \$1,350. Michigan Radio Apparatus amplifier 2 tube - \$375. Radiola III - \$90. Rare Belmont Deco Model A-5D118 - \$325. Fada Catalin yellow bullet - \$675. New York World Fair radio RCA, exc original - \$1,250. White Plaskon Pilot tombstone Model X203AB - \$1,300. Philco Predicta mahogany barber pole Predicta - \$795. Loose coupler with Marconi patents - \$575. Air King white tombstone with globe inserts - \$3,700. Perfect black Colonial globe - \$1,300. Transistors: 2 tran. boys radio-mellow tone with case, blue body, gold grille, white front red logo - \$65. Zenith Royal 500, white - \$100. Tan with (2) very small chips - \$150. Geranium rocket radio with box - \$50. Bulova Comet Model 620, red body, black grille, rare - \$450. Blue Pioneer 888 slight hairline - \$95. Black Atlas 888 - \$100. White Atlas - \$250. Red Vanguard 888, small hairline on bottom - \$195. White Royal 500H oval speaker, gold grille - \$225. White Regency TRI small hairlines - \$475. DeWald portable K701A 2 color slight marblizing - \$75. Red 888 Vanguard, small chip on top - \$75. Grey 888 Pioneer - \$95. Zenith Royal 1000 with manuals - \$125. Zenith Royal 7000, exc working - \$275. That's it. How's that for this month list. Doesn't get much better than this. With good radios getting harder to obtain and more and more collectors. Call now before it's too late. All are great investments. Also stop by and pick out a radio, call first. Less than 28 miles west of George Washington Bridge, Exit 47 on Route 80, easy on easy off. Phone anytime, fax after 10 pm Eastern Time to 10 am Eastern Time. Eric & Sirelle Fogel, 87 Sandra Dr., Parsippany, NJ 07054. (201) 316-8424

**WANTED:** Clarostat RPC-5A, dual ganged 500k ohms potentiometers. Jun Mizuno, 933 Portswood Cir., San Jose, CA 95120. (408) 268-4016



*Sparton Model 1186 Nocturne, an original promotional photo*

Nocturne "Redeaux" manufactured by the "Buckeye Group," Cleveland, Ohio. The receiver is built with original radio type tubes, no transistors. This limits the amount of units that can be produced. Built to original specifications. Other Sparton original models are also available.

For additional information,  
Call 216-831-9110 or Fax 216-292-7529

**FOR SALE:** Attention literature collectors, a rare book, mint condition, "Electrolytic Capacitors," 1938 First Edition, published by Cornell-Dubilier Electric Corp., authored by Paul McKnight Deeley, illustrated, hard-bound, everything about design and manufacture and testing electrolytic capacitors, published 1938 - \$50. Ellsworth O. Johnson, 364 S. Coeur d'Alene St., Spokane, WA 99204. Phone/fax (509) 838-2161

**FOR SALE:** 500 plus new 7 pin PC mount tube sockets. AES lists them at - \$1.90 ea., Best offer and trades welcome. John Snow, 4539 Bartlett, Shorewood, WI 53211. (414) 964-0194

**FOR SALE:** Rider's Manuals: Volumes 1-17, prices range from \$12.50 to \$85 per volume. LSASE for price list. Sam Faust, PO Box 94, Changewater, NJ 07831

**FOR SALE:** Jackson scope CRO. Hickok signal gen. 615. Hickok VOM 209. Sencor color gen. 6141. Write or call: (Jay's) Ann Bichanick, 15 1/2 W. Lake St., Chisholm, MN 55719. (218) 254-4421

**WANTED:** Clean chassis for Philco 37-640, with knobs. Michael J. Doback, 592 E. Southlawn, Birmingham, MI 48009. (313) 646-6944

**FOR SALE:** Tektronics 2337, 100MHz scope cost \$5,500, calibrated to Feb. 1994, price - \$1,675. Hy Ness Company, 709B Delair Rd., Cranbury, NJ 08512. (609) 395-1116

**FOR SALE:** 1939 Sentinel black, no cracks, dial tuning is reversed, 9 louvers in front, handle, works well - \$40. Philco portable Model E 676124, topgrain cowhide case, blue - \$49. Knight VTVM, grey metal case, old - \$25. Motorola clock radio, Model 51C1, black plastic old - \$25. John Kara, 1700 Baltimore Ave., Whiting, NJ 08759. (908) 849-4318

**WANTED:** Early Zenith battery sets like 1R, 2R, etc. Also early Zenith literature, signs, etc. up through 1940. Sale or trade. Steve Melvin, 34 Deep Brook Harbor, Suffield, CT 06078. (203) 668-6821 or fax (203) 668-8888

**FOR SALE:** Curved DeWald lenses, like original - \$45. Alex Kertesz, 3439 West Brainard Rd., Ste. 260, Woodmere, OH 44122. (216) 831-9110

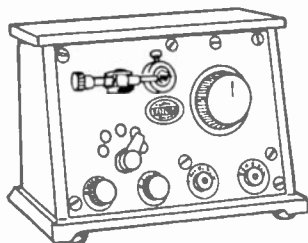

**WANTED:** The crystal radio pictured made by the Kodol Co. A small leatherette-covered cabinet with Bakelite panel. Has a gold oval decal, but it's either scratched or missing sometimes. If you have one, I'll pay cash or swap something nice. Let's haggle! Please drop me a line, I'd really like to find one, any condition. **FOR SALE:** Truly excellent Federal Tel. & Telegraph Co. Model 110 (1924). One of the best-looking of the Federal battery receivers, beautiful condition, with tubes and phones - \$750. Note new address - yes, I've moved again! Dave Crocker, 6 Raymond St., Sandwich, MA 02563. (508) 888-6636

**FOR SALE:** N.O.S. 5TP4 projection CRT, guaranteed - \$600 plus UPS. Joe Anderson, Box 890232, East Weymouth, MA 02189. (617) 337-9302

**FOR SALE:** Restored Radioglow radio, blue and yellow-creamy glass nearly perfect - Best Offer or trade. Lew Magrish, 706 Dumas St., Dallas, TX 75214. (214) 827-7585

**HELP:** I am in possession of (two) Westinghouse electronic tubes #KX-642-4 prong, circa unknown, very old (read antique). Any takers? Duke Gordon, 240 S.W. 56 Ter., #203, Margate, FL 33068. (305) 972-5134

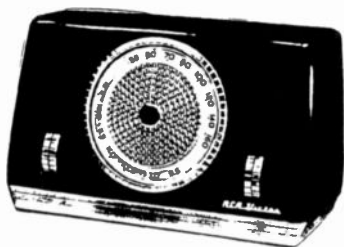

**WANTED:** RCA 8X681 or 8X682 as pictured. John Okolowicz, 624 Cedar Hill Rd., Ambler, PA 19002. (215) 542-1597

**FOR SALE:** Tubes, radio, TV, 40's thru 50's - SASE for list. Lee C. Dickinson, 478 Main St., Cromwell, CT 06416

**FOR SALE:** 1925 Radiola 26 portable Superheterodyne, with battery box, 6-199 tubes, plays, very new condition. Ken Flockhart, 425 So. 18th St., Fort Dodge, IA 50501. (515) 573-5477

**WANTED:** Channel selector knob for Philco 48-700 TV. Also complete knob set for Philco 50T-702 Bakelite TV. Barry Dalton, N7XEP, 196 Kilborn Dr., Grants Pass, OR 97526

**FOR SALE:** Sams TV Photofacts #1-800, 1946-65 - \$225. Seeburg amp MA1-L6 in fair shape - \$30. Phil Boydston, 102 Concorde Pl., Mandeville, LA 70448. (504) 845-0867

**WANTED:** Huge dollars for AK 555; book radio by RCA, Stromberg-Carlson; Zenith grandfather clock radio. Gordon Wilson, 11108-50 Ave., Edmonton, Alberta, Canada T6H 0H9. (403) 434-6257

**FOR SALE:** Crystal Radio Kit No. 2, complete with face panel, base board, variable capacitor, prewound coil, and many parts for old style radio, remit - \$19.50 plus \$3 shipping. Carl & Grace Ent., 5636 Romeyn, Detroit, MI 48209

**WANTED:** 46 Westinghouse r/p#H-122 (detach radio). 46 Electromatic r/p#512 (Johnson). 48 Philco r/p#48-1401 (Bunis). 46 RCA #66X3, zebra cloth, (Bunis). 48 Sentinel #313W. 42 Philco #42-350 (Johnson). Send photos/polaroids to: Doggett, 7250 Franklin, Los Angeles, CA 90046

**WANTED:** Electronic tubes, connectors, relays, aircraft radios and parts, ball bearings, relays, transmitters. Hy Ness Company, Hy Ness, 709B Delair Rd., Cranbury, NJ 08512. (609) 395-1116

**FOR SALE:** New Crystal Radio Price Guide, 415 listings, 15 pages - \$7.50 plus 52c LSASE. Dick Kowalski, KB8MR, 32823 Gloede Dr., Warren, MI 48093

**FOR SALE:** Guild Grafonola with separate, optional amplified speaker in excellent working condition, asking - \$195 plus \$105 for speaker. Ed Quirk, 46 Kelsey Ave., West Haven, CT 06516. (203) 933-2714

**FOR SALE:** Dummyload DA-22/U, 8200 to 12400 Mcs. 175 watts with CV-769/VRM-62 case - \$50. Early TV test equipment plus some Sams envelopes. SASE for list. Galbraith, 1214 S. Alvard Blvd., Evansville, IN 47714. (812) 476-7601

**WANTED:** Peerless A-100A or 10722 integrated amp; 1276, 7027A and 6A5 tubes. **FOR SALE:** 5U4GB, N.I.B. - \$5. Mike Somers, 852 W. Aldine #1, Chicago, IL 60657. (312) 868-1696

**FOR SALE:** New old stock, Audio Output transformers, American made, single triode to 8 ohm voice coil, probably 5 watt or better, 50 pieces available - \$1.50 ea. Discount for quantity buyer. Should work OK with some pentode output tubes. Ellsworth O. Johnson, 364 S. Coeur d'Alene St., Spokane, WA 99204. Phone/fax (509) 838-2161

**FOR SALE:** Old/antique Morrow 5BR-1 converter for ham bands, very good to excellent condition in original shipping carton - \$45, 1 ship. John Snow, 4539 Bartlett, Shorewood, WI 53211. (414) 964-0194

**WANTED:** Information, schematic, etc. on a 1925 battery-operated radio called the "Bonnie" DX Super Harmonic receiver manufactured (by) (for) the Radio Shop, 610 Court St., Ottawa, Ill. Any info would be helpful. Thanks. F. E. Hartnell, PO Box 1910, Huntington Beach, CA 92647

**WANTED:** Chassis for LaFayette cathedral Model 80, in working or repairable condition. Frederick C. Thomas, PO Box 27, West Oneonta, NY 13861

**FOR SALE:** Antique tubes. Free list - stamp appreciated. Ron Pfeffer, 653 Commercial St., Farnham, NY 14061

**WANTED:** Marantz, REL, Karg, Fairchild, Hadley, Acrosound, etc., tube hi-fi equipment. Western Electric sound equipment. 1950's-1960's hi-fi brochures, catalogs, and books. Audiocraft, Audio Engineering, and Audio, etc., magazines 1950-1965. Paul Creasy, 6216 Worlington Rd., Bloomfield, MI 48301. (313) 737-0429

**WANTED:** Pilot TV cabinet. Broken top OK. Nick Filipis, PO Box 8, Frankfort, IL 60423. (708) 479-5577

### Classified Ad Deadline Noon

Oct. 10 for Nov. 1993 Issue

Nov. 10 for Dec. 1993 Issue

Boxed, Photo, & Display Ads - 1st

**WANTED:** I like a challenge and I run a lot of ads that no one answers try try again. Need chassis, escutcheon and knobs for an Emerson L-559 chest. Also still looking for information on Clago, Universal and Marshall. Can someone help! Peter Burton, 39 E. Walnut St., Belcher-town, MA 01007. (413) 323-5019

**WANTED:** In-line capacitor checker. Fada 185-90. McMurdo-Silver. E. M. Lucas, 480 Border Hill Dr., Los Altos, CA 94024. (415) 941-3675

**FOR SALE:** Self-service (drugstore type) tube tester, console model, 38" high by 19" wide, very good condition, includes copies of tube settings - \$135 plus shipping.

**WANTED:** Old brass microscopes, and optical gear. Hallicrafters Sky Challenger. John W. Sherman, W6KAS, 5913 E. Buena Vista Blvd., Bakersfield, CA 93307. (805) 845-0119

**WANTED:** Power transformer for Sparton 931. 600v, 5v, 5v, 3v all CT. H. Seeselberg, 22 Christy Dr., Warren, NJ 07059

**WANTED:** Electronic scientific calculators from the 60s, 70s and early 80s. Bob Armstrong, 201 S. Fourth St., #722, San Jose, CA 95112. (408) 294-5502

## WIRELESS COMMUNICATION IN THE UNITED STATES

The Early Development of  
American Radio Operating Companies

BY THORN L. MAYES, W6AX  
240 Pages - 160 Illustrations - Softcover

The glory days of high powered wireless, spark transmitters, arc transmitters and mighty Alexanderson alternators.

Factual accounts of alternators, arcs and sparks, and of coherers, barretters and tickers!

Unscrupulous stock promotions that by chance yielded technical breakthroughs.

Unpublished letters...early drawings of spark transmitters.

"Coherent history of the brash early years of wireless...photos are rare gems...the Mayes book is it!" - Ludwell Sibley, *AWA Old Timer's Bulletin*.

"Superbly printed - the photos are clear and sharp. Some of the photos are truly unbelievable. Great book...buy it." - Barry Wiseman, *The Electric Radio*.

"On a scale of one to ten, *Wireless Communication in the U.S.* certainly rates a ten," Jim & Felicia Kreuzer, *Antique Radio Classified*.

Send \$29.95 plus \$3 for S&H to: The New England Wireless and Steam Museum, Inc.  
697 Tillinghast Road, East Greenwich, RI 02818

WIRELESS COMMUNICATION  
IN THE UNITED STATES

THE EARLY DEVELOPMENT OF AMERICAN RADIO OPERATING COMPANIES

BY THORN L. MAYES



THE "443"

THE NEW ENGLAND WIRELESS AND STEAM MUSEUM

**WANTED:** Back for 17" Predicta. Buying pre-'53 TVs in Midwest, any condition. Thanks. Glenn Bubenheimer, 27851 Terrence, Livonia, MI 48154. (313) 421-5574

**WANTED:** Want to buy your 50's-60's crystal radios. Call: Lew Magrish, 706 Dumas St., Dallas, TX 75214. (214) 827-7585

**FOR SALE:** 7,000 plus TV-radio tubes, pullouts, not boxed - 25¢ each, must buy all or best offer. Duke Gordon, 240 S.W. 56 Ter., #203, Margate, FL 33068. (305) 972-5134

**FOR SALE:** Philco 38-62 - \$65. DeWald D519, tan & white swirl, has crack across top - \$50. Jewel 505 pin-up - \$85. Jewel 5040 API clock radio - \$50. Fada 790 - \$85. Fada 740 - \$55. Motorola A4G - Make Offer. Motorola 64X - \$40. Motorola At25BN - Make Offer. Stewart-Warner 03-5C1 - \$30. Bendix 553U - \$40. Admiral 69C19 - Make Offer. Trav-Ler 5356 - \$80. Philco 48-200 - \$40. Zenith 6G801 - \$45. RCA 2XF91 - \$40. GE amplifier AS-2A - \$50. Sears amplifier 1483 - \$25. Stromberg-Carlson C5 - \$40. Sams TV Photo-facts - \$1.50 ea. per set. TV tubes, N.O.S. - \$1 ea. Good used TV tubes - 50¢ ea. Send SASE for list. All prices plus shipping costs. Jim McDowell, 8 Blanchel Ter., Jeffersonville, IN 47130. (812) 283-6387

**WANTED:** Panasonic Command Series multiband radios, preferably RF-2200, RF-2600, RF-2900. Gerald Silver, 10863 W. Clairmont Cir., Tamarac, FL 33321. (305) 720-1972

**FOR SALE:** (2) GE Pyronal filter capacitors, 10 mFd., 600 Vdc - \$10 each. (4) new 814 transmitting tubes - \$10 each. Bill Riley, W7EXB, 863 W. 38th Ave., Eugene, OR 97405

**FOR SALE:** Wurlitzer 71 jukebox - \$3,700. Emerson 400, green/brown Catalin, cracked - \$300 OBO + shipping. John Kendall, PO Box 436, Fallston, MD 21047. (410) 483-3884

## Southeastern Antique Radio Society

1993 Fall Swap Meet !  
Saturday, October 30, 8 am

New Location just 15 min. from I-285  
East of Atlanta I-20 to Exit 41  
C. E. Steele Community Center  
1040 Oakland Ave., Conyers, GA

Contest  
Radio Flea Market  
Indoor-Outdoor Facilities  
Door Prizes

Information: Charles Pierce  
4380 East Brookhaven Drive  
Atlanta, GA 30319 - (404) 233-1340  
or Charles Milton - (404) 922-6507

**FOR SALE:** New old stock, Auto Radio Front-end Tuner-AM, 3 gang-tracking, slug tuned coils; has dial, escutcheon, etc., from the 1950's, nice chromed metal casting - \$10 ea. plus shipping. Ellsworth O. Johnson, 364 S. Coeur d'Alene St., Spokane, WA 99204. Phone/fax (509) 838-2161

**FOR SALE:** The International "At A Glance" radio valve and TV tube equivalents and substitution manual for British, U.S.A., European and service types, 46 pages (copies) - \$20 ppd. John Snow, 4539 Bartlett, Shorewood, WI 53211. (414) 964-0194

### One Month Free!

#### BONUS FOR EARLY RENEWALS

If you renew **before** the month shown on your mailing label (your expiration month), you will receive an extra month on your subscription: 13 months instead of 12! 26 months for an early 2-year renewal!

**FOR SALE:** Browning-Drake, Model 5R, beautiful 5-tube battery set - \$150. Philco Model 42-390, 7-tube console, 3 bands including early FM, very nice - \$145. Fifty or more clean original sets available, always thinning my collection. Sorry, no shipping; come see my inventory! Dickering done here. All inquiries to include SASE. Francis W. Pond, 98 High Rd., Lee, NH 03824. (603) 659-3831, no calls after 9 pm EDT

**WANTED:** Does anyone have any info-plans for Simpson Model 85 transceiver? Harry J. Blair, 3401 S. Lituonica Ave., Chicago, IL 60608-6719. (312) 247-7949, anytime

**FOR SALE:** Tube mono reel recorders, good condition - \$25 to \$125. Send SASE for list or call. Alex Sandoval, 33 Brook Cir., Pella, IA 50219. (515) 628-2510

**FOR SALE:** 1. Airline twin speaker clock model 1824A - \$28.50. 2. Firestone Airchief Model S-7403-3, cabinet refinished - \$40. 3. Zenith clock model T-524R - \$25.50. 4. Emerson Model CQ-269, AM-SW, large table - \$37.50. 5. RCA Model 8X541 - \$25.50. 6. Emerson Model CY-269, large table AM-SW, hairline on side about 2 in. - \$37.50. 7. Philco Model 40-120, AM-SW, wrong knobs, cabinet refinished - \$30. 8. Tele-Tone Model 195, crack on top reglued - \$7.50. 9. Zenith Black Dial Model 6-D-510, cracked on top - \$12.50. 10. Emerson cube model 805B - \$18.50. #'s 7, 8, 9, don't play; others all OK. Total \$263. Buy all 10 for \$225. Plus UPS. This is very near wholesale. Jean-Bpte. Desautels, K4VGD, 616 N. Silver Cir., Silver Shores, Key Largo, FL 33037-3840. (305) 852-2109

### FULL RANGE ELECTRON TUBE SHOP - HONG KONG

— HIGH PRICES PAID —

McIntosh MC275, 225, 240, MI200, C8, C11, C22, MR67, MR71. Marantz 1, 2, 3, 4, 5, 6, 7, 8B, 9, 10B. Fisher Model 80AZ, 100, 200, 50AZ, or any brand.

— TUBES WANTED (NEW OR USED) —

KT66, KT77, KT88 (British made), EL34 Mullard or Ampex. 12AX7, 12AT7, 12AU7 Telefunken, Ampex Bugle Boy. 7728, 7729, 7591, 8005, 811A, 2A3, 6A3, 6B4G, PX4, PX25, DA30, EL156, EL37.

Jonathan Woo Yik Fan Tel: (852)-771-5957  
Fax: (852)-771-5850

**FOR SALE:** Selection of early DeForest tubes, Fisher 70A power amp - \$85. Majestic B power supply, very nice - \$20. Williamsen power amp, English made, two part - \$135 or BO. **WANTED:** Pilot radios, any make, any model, any condition. Bill Moore, 3049 Box Canyon Rd., Huntsville, AL 35803. (205) 880-1207

**FOR SALE:** This month I'm offering an interesting selection of mainly late 1940's Moderne style Canadian radios. I have the following for sale: Northern Electric Baby Champ 2 tone Model 5500 brown/white, Northern Electric Midge Bullet type Model 5508 in green, Northern Electric Model 5200 in red, Northern Electric Baby Champ Deco Waterfall Model 5000 in brown, Addison maroon & white small style two-tone, Marconi Model 264 two-tone brown/white. I also have a Silvertone Model 7024 in brown, Setchell-Carlson Frog Eye Model 416 brown/white, a few novelties Tom & Jerry, Yogi Bear, Green Sprout, Hockey Puck, California Faisins, AM Coffee Cup. A couple of other interesting items. Bozo salt & pepper shakers, and mini plastic 50's style TV set viewers. Popular Culture, College Park, PO Box 46056, 444 Yonge St., Toronto, Ontario, Canada M5B 2L8



**WANTED:** Fada Catalin radios from rags to riches. Who said money can't buy happiness? Please write or call collect: Rain Buttignol, 214 State St., #7, Portsmouth, NH 03801. (603) 427-1384

**FOR SALE:** RCA Model 811K chassis complete, no tubes - \$40 plus shipping. Gregg Humanic, 540 Wicklow Ln., Monroe, OH 45050

**FOR SALE:** The following good small tube type radios. Philco 51-634 aqua, AC or battery portable - \$25. Admiral gray plastic, AC - \$20. Motorola 56-A, AC, black Bakelite - \$20. GE red plastic, AC, brass trim large dial - \$25. Motorola A21N toke[?] plastic AC - \$20. Philco 40-81 battery portable, fabric covered - \$20. RCA 66X15 Bakelite - \$22. Plus UPS. M. B. Gaskins, 227 Risen Ave., Campbellsville, KY 42718. (502) 465-3755

**WANTED:** Tube pre-amp w/phono, Audible Illusions II-III, Meles MA222, Matisse, Convergent SLI, tube head amp, power amp. 70'-90's turntable good condition, any kind of tube receiver manuals, premium tubes N.O.S. Lawrence Yip, 13/F Jardine House, 1 Connaught Pl., Central FNBC, Hong Kong. Fax (852) 844-9318

**FOR SALE:** Wood table radios, fair to good condition, not working. Silvertone 1571, 3 bands - \$75. Bendix 0636-C w/unusual metal grille - \$50. RCA Victor 28-X, 2 bands - \$75. Westinghouse H-130 - \$60. Arvin, chassis 518, brown & ivory - \$50. Pack. Bell 5 "Kompak," unusual, wood w/plastic front panel - \$75. Stewart-Warner 51T126 - \$65. Gilfillan 56-B - \$75. All plus UPS. Take care. Chuck Bray, 1322 Ivy Rd., Bremerton, WA 98310. (206) 373-1013

**FOR SALE:** UTC LS 10 & LS10X - \$65 both. Raytheon 3-chan. remote mixer - BO. LSASE. Maurice Pope, 39 Highland Ave., Gorham, ME 04038

**FOR SALE:** Transistor radios: Powertone, Japanese - \$20 ppd; GE P1757, P2790 - \$15 ea. ppd. R. J. Eastwick, N2AWC, 224 Chestnut St., Haddonfield, NJ 08033. (609) 429-2477

#### CLASSIFIED AD NOTICE

Please check your ads carefully before sending them in. Once ads are received, it is not always possible to refund the amount sent, pull the ad or make changes.

**FOR SALE:** Predicta barber pole - \$600. Emerson 400 green/brown Catalin, cracked - \$300 OBO + shipping. John Kendall, PO Box 436, Fallston, MD 21047. (410) 483-3884

**FOR SALE:** Capehart AM/FM radio/phono ca. 1948. Changer, not recently operated, flipped 78 rpm records to play both sides. Cabinet 44" x 23" x 38" high, excellent condition. L. D. Nichol, 290 Forest Ave., Glen Ellyn, IL 60137. (708) 858-5279

**WANTED:** Eico multiplex adapter. Dynaco Mark III amplifier and preamp. David Carson, HCO1, Box 19A Long Lake, NY 12847-9704. (518) 624-4812

**FOR SALE:** Radio schematics - \$2.50. Rider's radio manuals 1 through 16 - \$325 including Index 1 through 23. All plus shipping. Dick Oliver, 28604 Schwalm Dr., Elkhart, IN 46517. (219) 522-4516, evenings

**FOR SALE:** Sams TSM 24 thru 138 complete. Sell as lot only for \$175 plus 120 pounds shipping. Ray Schmidt, 607 1 Ave. SW, Austin, MN 55912. (507) 433-0069, (507) 433-3250

**WANTED:** Plastic handle for Zenith Trans-Oceanic transistor Model 3000-1, band selector for 3000-1, front cover for 3000-1, front cover for 1000 model or will consider junkers with above parts. Also want Zenith tube portable Model 6G004Y Global. Also Zenith Trans-Oceanics Models 3000 and 1000-1, and Model 7000 Taiwan. Also Philco Deco wood table Model #37-610. Also Zenith wood table Models 7S633, 7S529, 7S530, 7S635, and 9S324. Also Zenith portable radio 4K600 poket radio. Frank Manzano, 82 Monhegon Ave., Oakland, NJ 07436. (201) 337-5263

**WANTED:** Help! Need 5 push buttons for Zenith Model 6S330; cabinet or junker with good cabinet for Bendix Model 110W; Rider's 11 to 5 and 2C to 23; also tube caddy with or without radio tubes. Chuck Alexander, 4933 Del Monte Ave., Sarasota, FL 34235. (813) 355-2582

## WANTED

*Mint Predicta or NEW Old Stock  
in Original Box*

*Original Instructions*

*Advertisements Also Wanted*

Contact: Dr. Miami

EMEDIA, Inc.

3300 East First Avenue #330

Denver, CO 802C6

Tel: 303-377-9100 Voice Mail #3

**WANTED:** Help! I need the following parts to complete some projects! Motorola B-150 bike radio battery box. RadioCraft D-4 and D-6 cabinets. Lyric S-7 chassis, speaker. Connecticut Sodian DJ-11 amplifier for DR-6 radio. Kennedy V front panel retainers. Amrad Radi-formers. Federal Pleiophone base. Midwest console cabinets. I will buy the above parts, or entire radios. Greg Farmer, 71 Rice Creek Way, Fridley, MN 55432. (612) 571-6062

**FOR TRADE:** Have Western Electric N.I.B. tubes: 102-D; 102-F; 102-L for early transistor set. Harold Trieb, 644 8th St. N, Hudson, WI 54016. (715) 386-2098

**FOR SALE:** Zenith Radio Locator Index 1920-1968. Over 1500 models listed and 26 publications indexed as to where to locate information and photos covering Zenith radios - \$14.95 ppd. Sound Remedy, 331 Virginia Ave., Collingswood, NJ 08108. (609) 869-0238

**FOR SALE:** Complete TV shop including 5000 TV tubes. Lots of good equipment. 2519 Sams in 2 sets. 5-4 drawer steel cabinets and 600 Sams in volumes. Hundreds of new parts. Everything to repair tube type sets. All tubes on shelf so you can inspect and inventory. Total weight about 3 tons. If you will come and look we can deal. Will consider selling tubes separately or Sams. Clarence B. Shippey, PO Box 741, Midvale, UT 84047. (801) 566-8593, day; (801) 568-1989, evenings or Sunday until 10 pm Mountain time

**WANTED:** Older, handheld electronic calculators. Will trade for transistor radios. Send list of haves. Guy Ball, 14561 Livingston, Tustin, CA 92680

**FOR SALE:** Philco 70 - \$300. Radiola UZ 1325 horn speaker - \$70. Philco 46-1201, with original shipping box - \$90. Atwater Kent 145 tombstone - \$175. Zenith Royal 500 transistor with excellent leather case - \$80. Other early transistors. R. Burick, 21B North Earl St., Shippensburg, PA 17257. (717) 530-5040

**MESSAGE:** Anybody have recordings of KDKA's "Party Line" program with Ed & Wendy King? David P. Smith, Box 81, Olney, IL 62450. (618) 392-6601

**FOR SALE:** National NC 188 - \$75. Zenith A600 Trans-Oceanic - \$65. RCA AR-8711 radio direction finder - \$35. Hallicrafters S-38D, S-38B, Heathkit GR81 regenerative rcvr., National AC200 power supply - \$25 ea. Jim Ford, NM1F, 194 Rocky Hill Rd., Plymouth, MA 02360. (508) 747-2224

**FOR SALE:** Town Crier by Guild Model 380T, excellent - \$200. Fada Catalin Model L-56, maroon and yellow, excellent - \$2,500. RCA Catalin Model 66X7, excellent and has back - \$600. Frank D. Atwood, 117 E. Main St., Merrimac, MA 01860. (508) 346-8100

## VINTAGE SAMS

OWN THE FINEST SERVICE DATA  
FOR YOUR VINTAGE  
RADIO AND TV

A.G. TANNENBAUM  
P.O. BOX 110  
EAST ROCK AWAY N.Y. 11518

516 887 0057

**FOR SALE:** Supplement book to "Los Angeles Radio Manufacturing", 1922-1942, send - \$8.50. Floyd A. Paul, 1545 Raymond Ave., Glendale, CA 91201. (818) 242-8961

**WANTED:** Bottom cover for CB base station Gemtronics GTX5000, Teabarry T or Robyn T240D. George Cortelyou, 1409 Madison NE, Albuquerque, NM 87110. (505) 255-3347

**WANTED:** Manual, schematic, or any information related to an RCA MI-12182 theater amp. John H. Apps, 323 Orchard Ln., Green Bay, WI 54301. (414) 339-8793

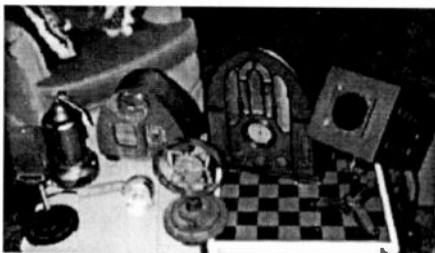

**FOR SALE:** Zenith 6D-0157 brown plastic, nice, plays - \$60. Emerson 12" brass blades Type 6250-K toggle switch, oscillates, nice, runs - \$65. GE whiz 10" brass blades, stationary, nice, runs - \$65. Emerson Baby Beaver crystal set, excellent - \$450. Silver crystal set, excellent - \$250. Detroit wood cathedral clock radio 302, has Detroscope, needs no antenna or ground, all original, ex-nice, plays, see picture - \$370. Silver-Marshall cathedral 401, all original, ex-nice, plays - \$395. See picture. Zenith De-Lux Royal 500-L white, fine, and Zenith Royal 500 long-distance black with gold round speaker, ex-nice, owl type knobs, the two - \$225. (as in picture) Spectro chrome therapy. Treatment of diabetics, restoration of the human. Radioactive and radio emanative equilibrium; quack device, has 5 changeable lens, nice - \$250. Radio Lite-tenna bronze, light bronze shade, 10" high, 5" bottom, works, ex-nice - \$125. In picture. Electro-Voice Model 100-D early cast iron, carbon mike - \$200. As in picture. Magnavox loudspeaking transmitter Type ST-4 (mike), all chrome hand type, ex-nice, as in picture - \$150. Master-Mic mike No. VR-0505, 14" high, like new, Akron, Ohio - \$100. Master-Phone very early amplifier in black case, nice, in picture - \$100. Gibson early amplifier 10-tube 6L6-GC, on chassis, 86 amps, wood case 26" fine - \$150. Edison diamond silver reproducer for thick Edisons, nice - \$60. Edison diamond needle gold reproducer in original black case for thick Edisons - \$85. Majestic grandfather clock radio Model 15, works, nice, all original - \$550. You pick up. Hallicrafters S-38-E, nice, plays - \$95. Edison Mabry, I Collect Best In Radios, 715 W. Longview Ave., Mansfield, OH 44906. (419) 526-1175

**WANTED:** Dial foil for Arvin 402 or 442, original or repo. Philco 90 cathedral cabinet, with or without speaker. Jim Cook, 1446 Raymond Rd., Columbus, OH 43220-3833. (614) 459-3892

**MESSAGE:** Tom's Closet buying/selling vintage radios and watches. See me when in Salt Lake City. Tom Turner, 251 S. State, #6, Salt Lake City, UT 84111

**FOR SALE:** Rider's radio manuals #4, #5 - \$25 each; #6 thru #14 - \$15 each; plus UPS. Bill Lowe, 10 Meadowbrook, Candler, NC 28715. (704) 665-2727



**FOR SALE:** Philco 50-922 - \$50. Zenith 4K035 - \$45. Watterson 527 - \$40. Mitchell - \$35. Philco 46-250 - \$40. Motorola 5X11U - \$45. Emerson big portable - \$35. Philco 40-130 - \$60. GE 408 - \$40. Detrola 579 - \$40. RCA 6BX63 - \$40. Federal 101 R/P - \$40. S/H extra. Polaroids dollar each plus SASE. Bud Santoro, 3715 Bower Rd., Roanoke, VA 24018. (703) 774-9153

**WANTED:** Dial glass for Philco 40-195. Hal Griffin, 1055 Kottinger Dr., Pleasanton, CA 94566. (510) 462-6839

## One Month Free!

### BONUS FOR EARLY RENEWALS

If you renew **before** the month shown on your mailing label (your expiration month), you will receive an extra month on your subscription: 13 months instead of 12! 26 months for an early 2-year renewal!

**WANTED:** Manual including clear, complete schematic for NC300 and RBG-2/CHC-46140. Tom Clinton, 3600 Ashley Estates, Marietta, GA 30067

**FOR SALE:** ARFS 16" transcription disks, 12" AFRS "V" disks - \$5 each. Receivers 51JH and SP-600, checked, working - \$200 each. Heathkit DX-60B, HR-10B, HG-10B, Scanalyzer 620 - \$75 each. Johnson Thunderbolt, clean, not checked out - Best Offer. Plus HQ-180 - \$75 and NC-300 - \$50. No manuals. All above plus shipping. Kenneth Hunt, 24737 Thunderbird Dr., Chugiak, AK 99567

**FOR SALE:** Altec 639B mic. - \$650. **WANTED:** Cool old guitar amps, send pix, description & price. Craftsman C500, Knight KN632, RCA SP20, Thordarson T9013 transformer, replacement cone for WE 728B speaker and mate for same. Thomas Crocker, PO Box 11582, Glendale, CA 91226. (818) 246-4757, eves.

## Mid-South Antique Radio Collectors

Invite you to our Fall Antique Radio Show & Swap Meet !

Saturday, Oct. 9 - The Kentucky Inn  
525 Waller Ave., Lexington, KY  
8 am - 4 pm (EDT)

Discount room rates. Call: (606) 254-1177 or 1-800-221-6652 and mention MSARC - Make plans now to attend.

Events include: Swap Meet, Old Equipment Contest (9 Categories!), Lunch Buffet and Auction

- Join MSARC today !
- Only \$10 per year !

Advance table reservations advised  
Info: Lewis Owens - (606) 233-0376

**FOR SALE:** Brass Rosette head speaker screws, pkg. 4 - \$2.50 shipping incl. Ed Parise, 2441 Hartland Ave., St. Louis, MO 63114. (314) 423-9626

**FOR SALE:** AK Model G horr. speaker bell - \$15 + S/H. Sam W. Wrenn, 2314 Serrinole Dr., #1207, Arlington, TX 76010

**FOR SALE/TRADE:** General: AT&T Teletypewriter #19, 1914 signal buzzer, 1943E Japanese field phone, Dinshah Spectro-Chrome Metry, 13" Paillard music box, (8) typewriters, (40) quack devices, (45) Ampico rolls, and (450) boys series books (avg.). Sell or trade for commercial spark-gap transmitter and receiver, magnetic detector, Fleming valve and stock-ticker. Chisman, PO Box 1111, Clemson, SC 29633. (803) 639-2939

**WANTED:** Desperately : Dial glass for Stromberg-Carlson octagonal style with numbers increasing clockwise, green, white & red markings. Kevin Westbrook, 20 Hu-ton Ave., Toronto, Ontario, Canada M4C 3L3. (416) 4E7-7451

**FOR SALE:** Radiola 927 with Model 100 speaker, excellent condition and working - Make Offer. Art Crane, 2099 Chip Dr., Lk. Havasu, AZ 86406. (602) 453-3546

**WANTED:** Phonograph for Stromberg-Carlson Model 14 lowboy. Please help. Richard Brown, 3502 Meadow Dr., Rolling Meadows, IL 60008. (708) 392-0557

**WANTED:** Motorola radios especially portables and TV in good cond tion. Michael Storey, 71 Riverside Dr. W, Okotoks, Alberta, Canada T0L 1T3. (403) 938-3122

**FOR SALE:** Bell and Howell 300 reel-to-reel tape recorder SEP L-1, 250 watts, 7 tubes, 2 neon indicators, 2 speakers, 3 motors, 1 power transformer, price - \$50 plus UPS. RCA Selectavision video cassette recorder Model No. VJT-275, price - \$50 plus UPS. Panasonic Color Omnivision II VHS, price - \$50 plus UPS. Phil Weingarten, 57-61 Alderton St., Rego Park, NY 11374. (718) 896-3545

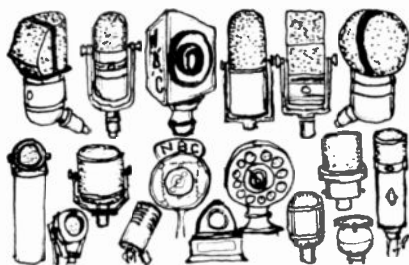

### WANTED

#### FOR MY BROADCASTING MUSEUM

Microphones, stands, call letter plates. Tube amplifiers, mixers, compressors, Hi-Fi equipment. Speakers, on-air lights, equalizers. Disk, wire & tape recorders. Blank recording disks. Catalogs, magazines, manuals. 16" transcriptions, turntables, arms, pickups. Early TV cameras & receivers. Elaborate console, deco, plastic, mirror, novelty & wireless radios. Jukeboxes & parts. Acoustic photographs.

We are looking for all makes of equipment, and especially Western Electric, Telefunken, Neumann and RCA. The museum contains various duplicates and items surplus to our needs, and many of these articles are available for sale or trade. The collection is located in my Victorian seaside inn, The Caffrey House, situated on a bay next to the ocean, in the Southampton resort area of Long Island. A trade of equipment for a stay at the hotel is always encouraged.

Robert Var Dyke, 2 Squires Ave., East Quogue NY 11942  
516-728-9835

**WANTED:** Kennedy SWR-6, LWR-20, 311, X, XVI, Royal Seven. Ed Bell, 5311 Woodsdale Rd., Raleigh, NC 27606. Fax/phone (919) 851-1517

**WANTED:** Hickok Traceometer Model 156, complete (except for probes) but not working. Sam W. Wrenn, 2314 Seminole Dr., #1207, Arlington, TX 76010

**WANTED:** Any 50s-60s books about home construction/designing tube audio amplifiers. Steve Melkisetian, c/o Angela Instruments, 10830 Guilford Rd., Suite 309, Annapolis Junction, MD 20701. (301) 725-0451. Fax (301) 776-2892

**FOR SALE:** National Electric radio wavemeter (1918) Model SE-392, wavelength 75-2000 meters, in leather case - \$250. Cliff Cannon, 1106 Donnell Dr., Daytona Beach, FL 32119. (904) 788-6666

**FOR SALE:** Satisfaction guaranteed on all items: very nice brass fan with brass cage - trade for early radio; pocket transistor sets include Starlite Champion, Zephyr ZR-620 in box, Japan Viscount 616, etc. Plus several coat pocket transistors with brass handles; Philco cathedral 84 damaged but restorable - \$80; Plus a good inventory of test equipment, literature, early parts, and many other radios. Please send a SASE or call after 7:30 pm Montana time. Neil O'Donnell, 1809 Sampson St., Butte, MT 59701. (406) 494-8162

**WANTED:** Pictures or ads of 1934 General Electric radios of these models: M-63, M-665, M-66, M-85, M-86, M-69, M-89, M-129. Please write to: John A. Checchio, 806 East Indiana Ave., Elkhart, IN 46516

**FOR SALE:** 1945 Fada Bullet, Model 1000, marbled blue with yellow ribbed knobs, handle & dial ring, mint condition - \$4,000. 1937 Emerson cathedral, yellow marbled, excellent condition - \$1,500. 1946 Bendix Model 526C, marbled green & black, mint condition - \$900. Or all three for \$6,000. Call Bill Cuculic, 6651 N. Campbell Ave., Tucson, AZ 85718. (602) 299-6332

## WANTED!

### ★ 1920-1924 Battery Sets ★

Amrad, Clapp-Eastham, Cutting & Washington, De Forest, Federal, Grebe, Kennedy, Marconi, Paragon, Radiola, Tuska, AK, Leutz, Crosley, Crystal Sets, and Horn Speakers.

Serious collector. Will consider others and entire collections. Can travel.

Ed Bell — 5311 Woodsdale Rd.  
Raleigh, NC 27606  
FAX/PH: 919-851-1517

**FOR SALE:** Radios/misc. SASE list. Many restorable/restored radios & misc. Reasonable offers accepted. Tom Tetzlaff, WL7AEC, 23 Nelson Dr., Silver Bay, MN 55614

**WANTED:** AK 30 tuning parts, outside and center spools and two connecting steel belts. Gary Finzer, KB8JCI, 413 Dover Rd., Sugarcreek, OH 44681. (216) 852-4010

**WANTED:** Manual and probes for RCA WO-33 oscilloscope. Don Meggs, 501 Kintyre Dr., Monroe, NC 28112. (704) 283-1788

### IF YOUR EXPIRATION DATE IS OCTOBER OR BEFORE, RENEW TODAY! EARLY RENEWALS RECEIVE AN EXTRA ISSUE!

**FOR SALE:** Seeburg W, restored - \$3,900. Seeburg 222, nice original - \$2,700. Remler Scottie - \$150. Mike Lynch, 851 Enchanted Dr., Midvale, UT 84047. (801) 262-3211

**FOR SALE:** First postwar RCA television (1946) color, historic set - Best Offer or will trade for Color Wheel. Fred London, 3716 South Country Club Way, Tempe, AZ 85282. (602)345-1091

**WANTED:** Schematic for Trygon power supply HR40-3B and service manual for a TRS IV computer. S. Goldhor, 2147 Trombas, San Leandro, CA 94577. (510) 357-3788

**FOR SALE:** Vintage tube CB's, list - LSASE. **WANTED:** Hallicrafters SX-88, Collins 51J-4, Collins R390, R392 receivers. Charles Zafonte, N1FRX, RFD 1, Box 75, Fort Kent, ME 04743. (207) 834-6273, evenings

**FOR SALE:** Drake TR-7 transceiver with extra VFO, extra speaker, AC power supply and Drake MN-2700 tuner, no manual, works good, asking - \$500 for the works. Carl Hawkins, 315 Duval St., NW, Live Oak, FL 32060. (904) 364-5240

**WANTED:** Original Philco 90 escutcheon; Philco 20-70-90 speaker. Robert Perlstein, 17 Vine St., Medford, MA 02155. (617) 391-3026

**FOR SALE:** CQ & QST 40s; radio mags. 30s wt. 20# - \$20 UPS prepaid. Rauland amp, wt. 30# - \$20. Grommes amp - \$10. Thordarson amp - \$10. All amps have tubes. John Martin, 817 Cook Ave., Billings, MT 59101. (406) 252-4287

**FOR SALE:** Plastic lighted Sparton radio/TV sign in original box - \$50. Radiola 18 - \$75. **WANTED:** Detrola PeeWee or Super PeeWee. Vance Rayburn, 2718 Homestead Rd., Madison, WI 53711. (608) 274-3002

RADIO RESTORER'S SPECIALS		Each	20+
32 mFd	150 v tubular	\$0.60	.50
47 mFd	160 v radial	85	.75
10 mFd	450 v radial	90	.80
22 mFd	450 v tubular	1.20	1.05

The following are 600v rated "greenie" Mylars:  
.001, .0047 ..... \$0.25 .20  
.02, .01 ..... 30 .25  
.03, .047 ..... 35 .30

Send a SASE for our *New Flyer!*

We believe these are the lowest priced fresh stock capacitors ever advertised in this publication. Add \$3 shipping to any order. Michigan residents add 4% tax. Check or M.O. only.  
Antique Audio (of Michigan)  
41560 Schoolcraft, Plymouth, MI 48170

**FOR SALE:** TV 37 Pilot 3" TV, excellent cabinet, inoperative - \$230; repaired - \$290. James R. Lopaz, 888 E. 5575 So., Ogden, UT 84405. (801) 476-1470

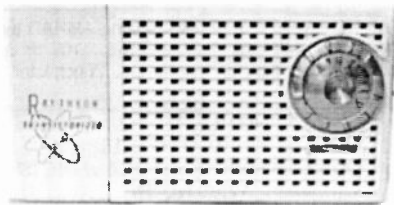

**WANTED:** Raytheon T-100 Series and T-150 Series. Marty Bunis, RR 1, Box 36, Bradford, NH 03221. (603) 938-5051, before 8 pm EST

**FOR SALE:** Emerson 706B, small case - \$45. Bendix 55P2U - \$25. General Electric 220 BC/SW - \$20. Philco 48-2001 - \$35. 42-PT-7, wood - \$20. B569 - \$15. Admiral 4L26A, small table, yellow plastic - \$20. RCA 56X - \$25. 75X11 - \$25. 9X561 - \$30. 8X541 - \$25. 4C-532, ivory - \$15. DeWald A500, white - \$60. **WANTED:** RCA 45 rpm phono, Model 7EY1, red & white plastic. John Ortale, 44 Barden St., Waterbury, CT 06706. (203) 754-8346

## HAS YOUR SUBSCRIPTION

### EXPIRED?

It has if your mailing label reads  
"EXP=OCT93" or earlier.  
Renew now!

*BONUS: Renew before  
your "EXP" month and receive  
13 issues per year instead of 12!*

Renewal rates are:

\$29.95 for Second-Class Mailing

\$44.95 for First-Class Mailing

(Two-year renewals are twice above rates.)

**FOR SALE:** Marantz SLT-12U straight-line turntable (1960's) - \$75. Mahogany 1950's speaker cabinet (Electro-Voice Regency?) - \$50/BO. Knight Ocean Hopper w/coils & cabinet - BO or trade. H.H. Scott 299D tube integrated amp w/cabinet, NR - \$60/BO. Advent #500 SoundSpace reverb system, untested - \$20. Clough-Brengle CLB-60007 RC bridge (WW2) - \$25. Magnavox CR197 AM-SW (5-18 Mc.) chassis, with speaker (1940's) - \$30. Zenith console-type 4-turn loop antenna - \$5. Heath IT-11 capacitor checker - \$12.50. Walnut audio-component cabinets - \$5 each. **WANTED:** Klipschorn, 1950's-1960's; toy electronics/radio kits (REMCO, etc.). I live 5 minutes from AWA Conference. Dave Minchella, KE2GE, 80 Campfire Rd. N, Henrietta, NY 14467. (716) 359-3337

**FOR SALE:** Reproduction dial glass, DeWald, Addison - \$45 each, postpaid. David Brenner, 71 Burdette Rd., Atlanta, GA 30327. (404) 257-1665

**FOR SALE:** (58) Radio Digest Illustrated 1922-1923 - \$8 each. (73) RCA Institutes Technical Lessons - \$200 OBO. Stephen Polednak, 6 Irving Rd., Weston, MA 02193. (617) 894-1274

**WANTED:** Set of rosette knobs (2 small, 2 large) for my RCA R-28 cathedral. **MESSAGE:** Thanks to all at Elgin, for the good conversation and knowledge shared with this young(ish) collector! Pleasure meeting you all! Kent Leech, 16 E. Rincon, Orinda, CA 94563. (510) 253-9757

**WANTED:** Grebe audio transformers 251 and 421. Please help. Ed Bell, 5311 Woodsdale Rd., Raleigh, NC 27606. Fax/phone (919) 851-1517

**FOR SALE:** TV's, radios, parts, books **WANTED:** Ham 6 meter FM transceiver. Send want list with SASE. Don Weiler, 4641 Kawanee Ave., Metairie, LA 70006

**WANTED:** Audiola 627 cabinet, will buy junker with restorable cabinet. I am also looking for Van Horne tubes, literature, etc. William Michael, 850 N. Main St., Franklin, OH 45005. (513) 746-1910

**FOR SALE:** Webcor portable phonograph, ca. 1953, original instruction book, good condition - \$45/offer. Carl Steinberg, 5 Cannan Rd., Monsey, NY 10952. (914) 352-0701

**WANTED:** Zenith Model 17 schematic, tuning knob, speaker, dial belt, flywheel, legs, any literature. Steve Melvin, 34 Deep Brook Harbor, Sufield, CT 06078. (203) 668-6821

**FOR SALE/TRADE:** Rare Trophy Bowling Ball radio (Collins, p. 54), vg+/no cracks. Take best trade in Catalins or early American transistors or cash by November 10, 1993. Bruce Phillips, 127 Bunker Hill, Stratham, N-H 03885. (603) 772-3796

**WANTED:** Schematic for Crosley 52 and cabinet for AK 33. Thanks. Steven VanderLinden, KC6YRB, 2123 Elizabeth Ave., Winston-Salem, NC 27103. (919) 727-1247

**WANTED:** Plan for back of Emerson EP-375. Majestic 72 with or without cabinet. N.O.S. cloth double headphone cords. Restorable Philco 89 cabinets. Philco 60 chassis and speaker. Herman Gross, 1705 Gordon Dr., Kokomo, IN 46902. (317) 459-8308

**FOR SALE:** Tubes, N.O.S. and used mostly modern and TV types. SASE for complete lists. Turner Electronics, 16701 Main St., Ste. 121, Hesperia, CA 92345

**WANTED:** Philco cathedral cabinets for the following: Models 17, 44, 33, 84. Leon Bitters, 4209 Logtown Rd., Lena, WI 54139. (414) 834-3707, evenings

**WANTED:** Owner's manual for Edison C-2 radio-phonograph or Xerox copies of same. Also sales literature. Stuart Hunter, 1239 Yosemite Ave., San Jose, CA 95126. (408) 297-3210

### Attention Technicians and Experimenters

- Tubes
- Test Equipment
- Cellular Telephone Surplus
- Old Radio Books and Magazines
- Master Card & Visa accepted
- Send \$2 (cash, stamps, or check) for our catalog. Price of catalog refunded with first order. Send for you copy today!

Classic Radio

P.O. Box 800742

Houston, Texas 77280-0742



**FOR SALE:** Emerson Patriot parts - (2) blue star knobs and chassis with red pointer - \$100. GE tombstones: A-70 - \$110, A-53 - \$95, A-62 - \$115, M-61 - \$90. Zenith tombstones: 6-S-128 (excellent original) - \$325, 5-S-127 - \$195, 6-S-229 (super clean) - \$175, 807 - \$175, 6-S-228 (needs refinishing) - \$120, 6-S-218 Cube - \$110, 10-S-130 - \$750. Emerson AR-176 trapezoid tombstone - \$235. RCA 98-X - \$85. Majestic 194 Gothic mini-cathedral - \$375. Truetone D2210 metal/chrome - \$165. Fada 119 - \$75. Motorola 5X-1U (Redux, p. 85) - \$95. Yellow Motorola 5T22Y - \$95. Stewart-Warner Plaskon Bullet - \$225. Silvertone metals #6002 - \$75, and #1 - \$65. Philco 45 Butterfly, refinished - \$195. Bendix 114 brown swirl/tan, repaired - \$150. Pilot #53 tombstone, painted - \$195. Zenith 5-S-319 oval dial, beautiful example - \$150. Emerson DS-436, big watts! - \$70. Crosley 515 - \$65. Echo-phone S-3, beautiful original finish - \$250. Climax Midget - \$110. Automatic 612X \$95. Red Plaskon Emersonette, postwar - \$375. Farnsworth half-moon dial Bakelite - \$90. Grunow chrome, (E.O.R., p. 147), needs refinishing - \$75. Belmont Airline 14BR-514B - \$95. Red Coronet boy's radio, N.I.B. - \$75. Much, much more. Send SASE and \$1 for October photo catalog including Rochester purchases and a bunch more new stuff. **WANTED:** Chrome or metal grille wood radios made before WWII. I also continue to search for early Emerson wood tombstones and mantel radios. Will trade generously from above sale items or my collection for desired sets. Please call or write with description. Mark V. Stein, 2109 Carterdale Rd., Baltimore, MD 21209. (410) 466-2814

**WANTED:** Motorola 7X24W; Hoffman Nugget; Belmont Boulevard. Steven D. Martin, 8625 E. Bellevue Pl., #1023, Scottsdale, AZ 85257. (602) 947-2853

**WANTED:** Manual (or copy) for RCA AV-11 aviation receiver. Pat Stewart, W7GVC, 1404 Ruth Ave., Walla Walla, WA 99362-3558

## JOIN THE AWA

### ANTIQUE WIRELESS ASSOCIATION THE ORIGINAL AND LARGEST HISTORICAL RADIO-COLLECTOR GROUP

- Publishes *Old Timer's Bulletin* with:
  - Battery and AC receiver restoration
  - Vacuum-tube history and collecting
  - Old-time amateur-radio contests
  - Communications receivers
- Free want-sell-swap ads
- Early television
- Horn loudspeakers
- Reviews of current books
- Keys and land-line telegraphy
- News of U. S. and foreign clubs
- Information on public radio museums.
- Maintains unique radio-TV museum.
- Produces the annual Rochester meet.
- Co-sponsors local meets.
- Publishes the annual *AWA Review*.

Membership is only \$12.00 per year (\$22.00 for two years). Mail check to:

Antique Wireless Association, Inc.  
Box E, Breesport, NY 14816



**WANTED:** Crosley. 51 Deluxe, crystal set, 4-29 portable, RFL-60 and 75 with cherubs, VIII, VIII portable, 3C, Audion detector unit, early ACE, DeForest - Crosley 50, 51, and 52. Ed Bell, 5311 Woodsdale Rd., Raleigh, NC 27606. Fax/home (919) 851-1517

**WANTED:** Need one of the following AMRAD tuning units to go with my det/amp 2596, 3108 or 3475. Andrew Mooradian, 5 Priscilla Ln., Winchester, MA 01890

### NOTICE TO ALL CLASSIFIED ADVERTISERS! OUR CLASSIFIED AD DEADLINE IS 12:00 NOON ON THE 10th OF EACH MONTH

**WANTED:** Consoles: Stromberg-Carlson Model 84, and Atwater Kent Models 112N, 318K and 711. Bob Alexander, 20 Haycamp Rd, St. Paul, MN 55127-6507. (612) 483-6177

**FOR SALE:** Bell Sound Systems Pacemaker amplifier, Model PM10, 12" speaker, cable - \$25 plus UPS. Rich Yoch, 22410 Bartlett Dr., Rocky River, OH 44116. (216) 331-9206

**FOR SALE:** Federal 110 panel - \$75. Radiola III panel, complete - \$30. All plus UPS. Stephen Polednak, 6 Irving Rd., Weston, MA 02193. (617) 894-1274

**WANTED:** Complete electronic wax cylinder dictating machine with microphone in working condition. Chisil Chislowksy, 2947 Ave. V, Brooklyn, NY 11229

**WANTED:** Pre-1940 telephones. Rider's #23, pay top \$ John Sudduth, 1842 Hwy. 92 North, Fairburn, GA 30213

**FOR SALE:** Tube checkers: Heath IT-3117 and copy of manual - \$22. Sencore TC136 & book - \$22. Sencore TC 162 & book - \$40. All plus UPS. Dan Mason, RR 1, Box 204F, Santa Fe, NM 87501. (505) 455-3416

## RESTORATION SERVICES & SUPPLIES

### ANTIQUE AUDIO

AUSTIN, TEXAS

- **VACUUM TUBES** For antique radio restoration, hi-fi amplifiers, televisions, amateur radio, and industrial equipment.
- **CAPACITORS** Axial and radial lead high-voltage mylar capacitors. High voltage electrolytic capacitors.
- **TRANSFORMERS** Power and audio transformers for vacuum tube circuits.
- **KITS** Crystal radio sets, 100 mw AM hi-fi transmitters, battery eliminators.
- **SERVICES** Schematics for early radio through television, stereo sets, and VCRs.
- **HARD-TO-FIND** Crystal set parts, Zenith dial belts, hardware.
- **BOOKS** Radio collecting and restoring, broadcast and radio history, television collecting. Autographed copies of *Border Radio*.

### CATALOG \$2.00

5555 N. Lamar, H-105 • Austin, TX 78751  
PHONE [512] 467-0304  
24-HOUR FAX [512] 467-2944

**AUCTION:** Auction spectacular. Vintage TV's, and antique radio auction 1st weekend Nov. 93. Charlotte, North Carolina. There will be 5,000 antique dealers in town that weekend, this will be prime time to add to or thin out your collection. Don't miss this event. For details contact: Bob Wojdyla, 11808 Painted Tree Rd., Charlotte, NC 28226. (704) 541-8514

**WANTED:** Radio News: 9/25, 2/21, also pre-1921. Radio & TV: 10/41. Shortwave Radio: 1/34, 6/34. All Wave Radio: 7/38, 5/36, 6/36, 9/35, 10/35. Radex: 1/42, 12/41, 4/37, 10/37, 11/37, 12/37, 4/32, 5/31, 10/31, also pre-1931. Also seeking copies of pre-1953 (plus 1958) World Radio Handbooks. Contact: Jerry Berg, 38 East-ern Ave., Lexington, MA 02173. (617) 861-8481

## One Month Free!

### BONUS FOR EARLY RENEWALS

If you renew **before** the month shown on your mailing label (your expiration month), you will receive an extra month on your subscription: 13 months instead of 12! 26 months for an early 2-year renewal!

**FOR SALE:** Antique French style telephones (2) w/ separate oak crank type ringer box - \$250 ea. N.I.B. 10" GE 10VADP4 color picture tube - \$125. 1930 Ford Model A headlight (1-only) - \$50. Open to reasonable offers on above plus shipping. Xerox copy of Original Service Manual for 7" Motorola TV Model VT71, 80 pages, plus schematics for (6) chassis versions - \$15 + \$3 postage. Don Mier, 4009 N. Foxdale Ave., Covina, CA 91722. (818) 338-9225

**WANTED:** Philco 211 speaker in very good condition that matches a brown Philco 511. James W. Walcher, 1311 Janet Dr., Wilmington, IL 60481. (815) 476-9184

**WANTED:** Philco Model 70 dial escutcheon, tuning knob. Also need Sentinel suitcase TV junker for chassis, and knobs for Raytheon TV A10DX22. Interested in buying any 50's color TV and parts, pre-'53 TV's in any condition. **FOR SALE/TRADE:** Admiral 10" Bakelite console, 024, 0A2 tubes - \$1. Glenn Bubenheimer, 27851 Terrence, Livonia, MI 48154. (313) 421-5574

**FOR SALE/TRADE:** Fada 252 variation (Sideli, p. 76. Plate 110), maroon/white - \$325 and black/ivory - \$225. Emerson 572 heavy blue marbling - \$300. Crosley Duette maroon - \$250 and ivory - \$250. Crosley Robot Head 11-108U, maroon - \$60. Westinghouse refrigerator radios: green, white and brown plus great self-standing advertising piece; sold as a set - \$600. Also, I am offering for the first time a collection (to be sold as a set) of (20) Crosley Coloradios: round dial 10-135, 10-136, 10-137, 10-138, 10-139 and 10-140 and rectangular dial E-15 BE, E-15 CE, E-15 WE, E-15 SL, E-15 TN as well as the double dial clock radio D-25 WE, D-25 GN, D-25 MN, D-25 BE, D-25 CE, D-25 BK, D-25 TN, 11-124 U (robin egg blue), 11-125 U (bright metallic blue) - call for further details. Peter Aresty, 140 Riverside Dr., New York, NY 10024. (212) 496-2306

**WANTED:** Drum dial, or junk chassis for Zenith Model No. 760. Richard Jelinek, Rt. 1, Box 54, Denton, NE 68339

**WANTED:** RCA Model 140 tombstone. Apex Model 8A cathedral. Richard Mountjoy, 1915 S. 39th St., No. 44, Mesa, AZ 85206. (602) 926-8174

**WANTED:** Stromberg 501, 502, 601, 602, 633, 634, 635, 636, non-working or junker. Liberal payment. S. Greenspan, 4701 Willard Ave., Chevy Chase, MD 20815. (301) 951-0232

**WANTED:** Wanted to buy: Nice 2 or 3 tube shortwave radio or home brew SW with plug-in coils. Harold Atkins, 479 E. Chukar Way, Clifton, CO 81520. (303) 434-3735

**HELP:** Need the battery on/off switch for my Zenith 4R. Thanks, anyone? Hal But, 5306 So. Broadway Cir., Englewood, CO 80110

**FOR SALE:** Large collection of books, manuals, magazines, catalogues relating to radio, TV, hi-fi, broadcasting, SW. Many old radios. SASE for list. Bill Rolf, 30131 Center Ridge, Westlake, OH 44145. (216) 871-4547

**FOR SALE:** Used tubes Arcturus blue: good 2-12, 5-127, 1-126, 1-58; duds 126, 2-127, 1-124, 1-147. Majestic sprayed tubes: good 2-5-57, 1-658, 1-624, 1-62A7; dud 66Y5. Ameco 2 and 6 meter xmt. Gonset Communicator GC105 2MTR AC and 12YDC. Pete Putra, 1429 Lawndale Ave., Racine, WI 53403. (414) 632-2543

**WANTED:** These transistor radios: Crestline 6T-180, Audition with large gold V surrounding the tuning dial, Linmark T-80, Jefferson-Travis JT-H204, Linmark T-63. Suzanne Wyatt, Box 83, Dearborn, MO 64439. (816) 992-8811

**WANTED:** General Electric E-71 chassis, working or not. Cash or trade. Thanks. Henry Tessier, 945 Commercial St., East Weymouth, MA 02169. (617) 337-7279

**FOR SALE:** Two N.O.S. 6A3 tubes - \$20 ea. Two used 2A3 tubes - \$15 ea. Cecil L. McLaggan, Jr., 2005 Pearl Ave., Albany, GA 31707. (912) 436-9396

**FOR SALE:** Transistors: Zenith Royal 500H, 500 hand wired, 20, 60, 265. Motorola X15N, RCA 9BT9E, Silver-tone 9201. Crown CTV-12 4" B&W TV early. Following radios are \$40 ea. + ship: GE 400, 7025, Zenith 4K422, RCA 6XD5B, 1BX78, Olympic 7-42 IV, Philco 48-200, 46-250, Silver-tone #6, Emerson 578A. N.O.S. tubes. West. Elect 205-D's & 215-A's, WD-11 BB/TIP. **WANTED:** Audio tubes 7591, 6550, EL-34, KT-88, 8417, 7199, EL-37, KT-66, 6L6, 12BH7. Mike Virtue, 3464 Aquamarine Dr., Rockford, IL 61102. (815) 963-4930

**WANTED:** Two good UV201 and one UV200 tubes. Not the A version. Please write: Jim O'Neill, 170 Devon Rd., Delaware, OH 43015. (614) 363-3682, evenings

**WANTED:** Atwater Kent breadboard radios and parts. Misc. AC + battery sets plus other AK parts for trade. Jim Peters, 983 Chapel Ct. South, Glen Ellyn, IL 60137. (708) 790-9699

## Radio Grille Cloth

E. H. SCOTT  
Philco, Emerson, RCA  
& ZENITH  
radios & speakers  
Send LSASE for FREE  
samples to:

John Okolowicz  
624 Cedar Hill Rd.  
Ambler, PA 19002

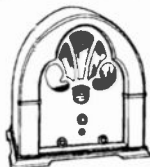

Select from  
12 patterns

**WANTED:** Hallicrafters SX62 A or B in nice condition.  
**FOR SALE:** BC221-J frequency meter with books (as issued) - \$60. Hallicrafters S-120 - \$20. Hallicrafters CRX2 - \$20. Hallicrafters WR2000 - \$25. Hallicrafters S351D, red, in original packing with papers - \$95. Eico 720 transmitter - \$35. Lafayette PF200 - \$25. Freshman Masterpiece 3 dial with tubes - \$60. Crosley 51 complete and nice - \$120. Philco 39-17 table model - \$25. Little Wonder Mic - \$10. (2) Stromberg-Carlson 60 tombstones, 1 complete, 1 no tubes - \$60 for the pair. Fairchild curve tracer Model 6200B - \$70. Heath Model 10-14 scope - \$15. Sun-Kraft cold quartz UV ray therapy lamp - \$30. General Electric Model 260 portable, metal case with wet battery - \$20. Radiola 33, clean and complete but with bad white metal on case - \$45. All items as found. UPS shipping extra. C - 2 - C, 77 County Rd., E. Freetown, MA 02717-1629. (508) 763-3052, machine after 4 rings

**WANTED:** Hallicrafters S10, SX11, S14, SX15, SX18. Robert Braza, N1PPS, 49 Fifth St., East Providence, RI 02914. (401) 438-8927

**FOR SALE:** Philco 16B tombstone - \$225. Philco 60 cath. - \$120. Case 60A, NT - \$75. Zenith Royal 500E - \$55. Auto Radio Manual 57-58 - \$10. Fada 169 - \$55. GE 260 - \$35. Ralph Ripke, 9580 Caribbean Blvd., Cutler Ridge, FL 33189-1555. (305) 233-2621

**FOR SALE:** RME 69 with speaker and manual, good condition - \$165. Buyer pays packing and shipping. Jim Barrows, W4BCT, 15121 41st Ave. SE, Bothell, WA 98012. (206) 337-4880

**WANTED:** Outside horn Victor, Edison, or Columbia tabletop windup phonographs. Need not be working or complete. Also want phonograph related items: needle tins, record dusters, Nipper, Edison and RCA Victor advertising. Immediate cash paid. Bernie Seiberger, 801 Sand Wedge Ct., Warrington, PA 18976. (215) 343-7743

Buy • Trade  
**CATALIN  
 RADIOS**



I'LL BUY ANY RADIO IN  
 ANY CONDITION • TOP PRICES PAID

**Gaëlle Reboul**

7010 S.W. 48th Lane • Miami, Fl. 33155  
 (305) 662-1986

**WANTED:** Radiola 6, 7, 7B. Ed Bell, 5311 Wooddale Rd., Raleigh, NC 27606. Fax/phone (919) 851-1517

**FOR SALE:** SASE for list, (2) RCA 75 X 17 black orientals. **WANTED:** Shure 55S microphone. Sumter Hickman, KB5QHD, 1008 West 10th St., Plainview, TX 79072. (806) 293-5809

— **WANTED** —  
**PICTURES FOR PHOTO REVIEW  
 PHOTOS MUST BE SHARP IN DETAIL  
 A SHORT DESCRIPTION IS A MUST!  
 SEE PHOTO REVIEW PAGES FOR  
 ADDITIONAL INFORMATION**

**FOR SALE:** Rider #16 - \$20. Zenith Service Manuals 1 & 2 - \$30. All plus UPS. Thomas Burnside, 4383 S. Westhaven Dr., Jackson, MS 39209-4711. (601) 922-2235

**WANTED:** Grebe and early Crosley radios, amps, literature and especially parts. WE microphones. Frank Hagenbuch, 1440 Lafayette Pkwy., Williamsport, PA 17701. (717) 326-0932

**WANTED:** Catalin radios. Just clip my display ad on page 75 of last month's A.R.C. for my permanent want list. Michael Lawlor, PO Box 179, Santa Barbara, CA 93102. (805) 682-2336

**FOR SALE:** Plastic reproduction dial covers for Fada 1000, Belmont 6D111, Emerson 375, 400, 520, AU190 - \$14.50 ppd, others with old cover or drawing. Doyle Roberts, HC63, Box 236-1, Clinton, AR 72031

**FOR SALE:** Zenith H500 w/manual and papers - \$75. Fisher 500C receiver - \$110. Fisher 220 receiver - \$50. Scott Type 299 amp - \$90. Sony 5-307 UW tiny transistor TV - \$60. RCA R-93-B tiny 45 player - \$65. Others. Call: Jon Steinhauer, 636 Westminster Rd., Baldwin, NY 11510. (516) 223-9878

**WANTED:** Westinghouse RA, DA, RC, RT AR. Clapp-Eastham HR, HZ, UV200, UV201 tubes. Stu Mount, K2OA, 35 Grand St., Highland, NY 12528. (914) 433-7714

**FOR SALE:** Pilot filament transformer, 1.5v-5A, 2.5v-5A, 5v-8A - \$9. GE portable, LB530, junker - \$8. Franklin transformer, 1500v (CT705V) 0.300A, (2) 7.5v, (1) 5v - \$50. All postpaid. Jack Shaymow, Vintique Electronics, 522C Tilford, Deerfield Beach, FL 33442. (305) 427-1222

**FOR SALE:** Atwater Kent Model 46 metal AC, green & black with matching speaker, exc condition, plays - \$165. (3) Bakelites: Bendix 626A, Emerson 653B, Clarion C102. Paul or Roy Swiatek, 1261 Commercial St., Pittsburgh, PA 15218. (412) 343-3032

**TUBES BOUGHT & SOLD**

**Industrial - Power - Receiving  
 Special Purpose - CRT's**

Vast Inventory  
 Contact Donna, Sales Manager  
 (201) 751-2591 - (800) 526-1275  
 Fax: (201) 481-1524

**UNITED ELECTRONICS CO. est. 1920  
 Complete Tube Manufacturing  
 Equipment For Sale  
 1177 McCarter Highway  
 Newark, New Jersey 07104**

**WANTED:** Power transformer for Philco 40-180, Philco Part #32-8052-N, uses tubes #1232, (7J7 or 6J8), 7B7, 7C6, 2-41-S and 84 rectifier. Some transformer in Models #40-185, 40-190, 40-150, 40-155 or will buy Universal transformer that fits. Horizontal mount 2 1/2 inch by 3 inch. Could use vertical mount or will buy chassis for above model or table model complete. Clarence B. Shippey, PO Box 741, Midvale, UT 84047. (801) 566-8593, day; (801) 568-1989, evenings or Sunday

**MESSAGE:** Do you collect handheld electronic calculators? Join the International Association of Calculator Collectors for \$8/yr. Get our quarterly newsletter. Sample 2-29¢ stamps. IACC, 14561 Livingston, Tustin, CA 92680

**FOR SALE:** Tuner crystal microphone Model #80, with base, works - \$75 + postage. **WANTED:** Handwired Zenith Royal 500s, and TV Guides. Don M. Maurer, 29 South 4th St., Lebanon, PA 17042. (717) 272-2481

**FOR SALE:** Crosley Super Sextette (Blast, p. 309), nice original bronze finish, correct knobs, plays - \$85. Majestic International, nice small wood radio, good refinishing, new caps, small round airplane dial, plays - \$50. Kingston Gothic style small cathedral, nice chrome escutcheon, good original grille cloth & finish, correct knobs, hums but plays - \$120. American Bosch, model unk., horizontal wood table radio, right airplane dial, plays - \$25. Mantola (3) Bakelite radios: R654PM, brown, v. good, plays, complete - \$35; R654PV, ivory, good original finish, complete, one knob disfigured, plays - \$30; model unk., right airplane style dial, left vertical louvers, hidden hairline, complete, plays - \$27.50. Emerson 641 (like 659, Bunis 1, p. 61), mine BC only, hidden hairline, plays - \$20. Trav-Ler, Model unk., ivory Bakelite, small center sliderule dial, good original finish, plays, wrong knobs, right era - \$25. GE J501W, ivory plastic, circa 1941, repaired crack on top, plays - \$12.50. UPS extra. Thanks. Happy collecting! Lloyd (Bud) Noel, 494 Clark St., Galesburg, IL 61401. (309) 342-2825

**WANTED:** Zenith Model 12S370. 23EP4 picture tube. Robert Schoenbeck, 9301 Texhoma Ave., Northridge, CA 91325. (818) 993-7174

**FOR SALE:** Radios - tube/trans/novelty: Since last ad sold and added - LSASE. **WANTED:** RCA Mod 21 chassis. W.F. Horn, Rt. #2, Box 181, Bealeton, VA 22712. (703) 439-9781

**WANTED:** Panel & transformer for Grebe Rork, dial & speaker or junker set for Kennedy Model 63, also Radiola AR & RT. Have ans. machine. Thanks. Raymond Schober, 4503 West Dr., N. Little Rock, AR 72118. (501) 771-1480

**FOR SALE:** Knight head, exc - \$30. Rolls Royce, exc - \$20. Philco #46-250, exc - \$33. Arthur Kreitner, 2013 E. Belle Ave., Belleville, IL 62221. (618) 233-5610

**FOR SALE:** Used to be TV shop. Parts & equipment, and building. Ann Bichanich, 15 1/2 W. Lake St., Chisholm, MN 55719. (218) 254-4421, evenings

**WANTED:** Knob to fit an Arvin radio. The on & off switch has a flat side 2/16". John H. Shaffer, Jr., 63089 Dunning Ln., Cambridge, OH 43725

**FOR SALE:** Riders 4, 5 - \$35. Riders 6-15 - \$23 ea. Postpaid. Nice condition. Gary A. Micaneck, 226 Henry Ave., Manchester, MO 63011. (314) 227-7046

**FOR SALE:** Radiola III - \$150. Radiola 20 - \$175. Crosley 51 - \$150. AK 35 with original instruction book - \$100. Tower Meistersinger horn speaker - \$100. Crosley 5-38, mint - \$150. Music Master cone speaker in table model cabinet - \$100. Frank D. Atwood, 117 E. Main St., Merrimac, MA 01860. (508) 346-8100

**FOR SALE:** Enlarged Radiola III diagram with professional parts list giving all values - \$3 plus LSASE. Set of data sheets detailing several hookups for Radiola III use as crystal set - \$3 plus LSASE, both \$5 ppd. List covering Radiola III/III-A literature, WD-11 subunits, Modern Radio Labs handbooks, Philmore manuals, and more included or free for 2-stamp LSASE. David P. Smith, Box 81, Olney, IL 62450. (618) 392-6601

**WANTED:** Manual for Conar Model 190 receiver Model 400 transmitter. Jim Ford, NM1F, 594 Rocky Hill Rd., Plymouth, MA 02360. (508) 747-2224

**FOR SALE:** Philco 37-650 console, includes original dipole antenna, pick up only - \$175. **WANTED:** Philco 45 cabinet. Paul Brouillette, KABLMC, 611 Illinois St., Geneva, IL 60134. (708) 208-6406

**FOR SALE/TRADE:** SCR-543/BC-669, AN/PRC-9A/RT-175 transceiver, PE-110 and PE-157 power supply. **WANTED:** Any piece, or part, of SCR-274N, or AN/ARC-5. Crystals for: TBS; TCS; SCR-522, in CR-1A, or DC-11 holders; in FT-243 holders for, AN/GRC-9A; marked for, "in 620"; "in 611". Wm. Stokesbury, #305 W. 142nd St., Ocean City, MD 21842-4428

**MESSAGE:** Welcome to interesting old junk (W2IOJ) Thanks for all Vibroplex keys and parts. James J. McGrath, W2IOJ, 2 Centerview Ln., West Seneca, NY 14224. (716) 675-0160

**FOR SALE:** Airline, pink, clock radio GRX-1650, brass time-face, plays good - \$20. Koss K6A stereo headphones 10-16,000 Hz freq.-response, like new in original box - \$40. Ms. Jean Marcella, PO Box 3115, Laguna Hills, CA 92653

**FOR SALE:** Military 53-260 MHz AMFM, UHF receiver, nice - \$125. Zenith 6D219 AM/SW wooden table - \$75. Kenwood R2000 N.I.B. - \$499. TR4&AC - \$350. Ernest Odeneal, 2710 Lee St., Greenville, TX 75401. (903) 455-2113 or 5788

**WANTED:** Will pay \$50 for a copy of the Guitar Amplifier Handbook by Jack Darr. Also want B&K 801 capacitor analyst, working please. Bill Hall, 1864 Pennoyer, Grand Haven, MI 49417. (616) 847-9039, collect

**WANTED:** Dual volume control for Philco 20: 1 megohm, 1/2 watt lead end resistor. Doug Fox, 603 S. 12th Ave., St. Charles, IL 60174. (708) 584-5915

## TRANSISTOR NETWORK

More and more radio people are discovering the excitement of novelty and regular transistor collecting. Why not join the fun? Now is the time to subscribe to the Transistor Network - a monthly transistor newsletter featuring transistor related articles and classified ads. Only \$12.00 for a one year subscription (12 issues).

Not sure? Send a SASE for a sample copy and find out what you've been missing! Call or write: Transistor Network, RR 1, Box 36, Bradford, NH 03221. (603) 938-5051

**FOR SALE:** Vibrators for most automobile radios, vibrator transformers. Dealer discounts, free catalog. Dan Schulz, Antique Automobile Radio, Box 892, Crystal Beach, FL 34681. (800) 933-4926 or fax (813) 789-0283

**FOR SALE:** Wheatstone high-speed telegraph transmitter shown on page 23 in May issue. Antique tape punch. Offers invited. Ragnar Otterstad, Hosterkobvej 10, DK-3460 Birkerød, Denmark. Tel.: 011-45-42 81 52 05

#### CLASSIFIED AD NOTICE

Please check your ads carefully before sending them in. Once ads are received, it is not always possible to refund the amount sent, pull the ad or make changes.

**WANTED:** Chassis for Crosley Buddy Boy, Radio Boys books. **FOR SALE:** Radiola 66. Phil Harris, 183 Ashley Ln., Rincon, GA 31326. (912) 754-6057

**WANTED:** Gonsset G-76 w/PS. G-77 and G-66. Heath HW-12 and HW-22. Can pick up. Jeff Kyle, KF6WX, 4933 Midway Rd., #40, Vacaville, CA 95688. (916) 678-6154

**FOR TRADE/WANTED:** For trade antique hearing aid "Teutophone", nice piece. Wanted for it Radiola balanced amplifier (for Rad. III), working. Bob Robbins, 253 Standish Rd., Merion Sta., PA 19066. (215) 664-2178, between 6 am & 6 pm

**FOR SALE:** Catalins: Emerson AX-235, restored, white, mild tube burn on side - \$750. Emerson 520's - Make Offer. Sentinel 284-N, yellow with red outline grille & knobs - \$2,400. Crosley Fiver - \$75. All prices plus UPS. Vernon Shatwell, Rt. 5, Box 195, Sapulpa, OK 74066. (918) 224-4551, after 7 pm

**WANTED:** IF transformer between oscillator and 2nd detector for Philco Jr. Model 81. A. J. Long, 11830 Heath Rd., Chesterland, OH 44026. (216) 729-8451

**FOR SALE:** Earphones by Connecticut Tel. & Tel., Davis, Frost-Fone, Federal, Stromberg-Carlson, Brandes, Murdock, all with good cloth head bands - \$20 ea. Larry Drago, 383 Lincoln Dr., Cheshire, CT 06410. (203) 272-6030

**FOR SALE:** The Craftsmen RC-2 amplifier and RC-10 AM/FM tuner; B&K 510 transistor tester; books: Terman's Radio Engineering 1937 - \$15; Henney's Radio Engineering Handbook - \$10; Radiotron Designer's Handbook 1974 - \$15; Troubleshooting Without Service Data Middletone 1989 - \$20. G-shaped tubes for Zeniths new and used; used AC/DC minitubes - 50¢. Orphan Annie decoder pin - \$50 ppd. Others. Plus UPS. LSASE for free list, 6 pages to: Stan Lopes, KB6LGV, 1201-74 Monument Blvd., Concord, CA 94520. (510) 825-6865

**WANTED:** General Electric Model GD-520 small plastic radio with brass on front. Please call or write me if you have one of these, I have nice stuff for trade or case. Thanks. Jon Steinhäuser, 636 Westminster Rd., Baldwin, NY 11510. (516) 223-9878

**FOR SALE:** Automatic Radio 50th Anniversary (1970) cuff link, tie clasp set - \$25 includes shipping. Herb Parsons, 5 Surrey Ln., Peabody, MA 01960. (508) 535-1009

**WANTED:** Zenith Royal 950 Golden Triangle, any condition considered. Thanks. Marty Dzik, 412 Gregory St., Schererville, IN 46375-2290. (219) 322-4104

**FOR SALE:** Receiver Saver 200 extends the life of your vintage radio receiver by protecting against damage due to inrush current during warm-up, excessive line voltage, surges and spikes on the power line, and shorted components. Features aluminum enclosure, plug-in installation (six-foot cord included), and 200-watt load capability. Only \$25 each postpaid in U.S.A. SASE brings brochure. Jeff Kincaid, WA6BIL, 5529 West 140 St., Hawthorne, CA 90250

## WANTED — AIRWAY SETS

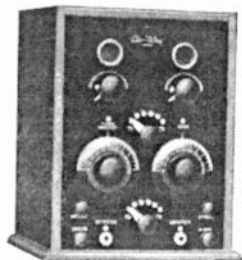

Airway Model "B"

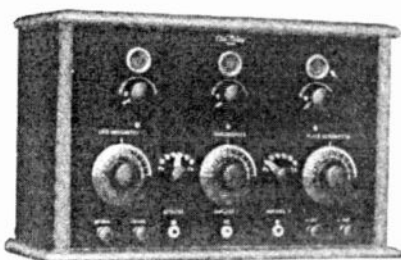

Airway Model "C"

Other Airway Sets Wanted: Models "G" & 51

**ALSO WANTED:** Cutting & Washington 8A, 9A, 11, 12, 14 & Teledyne; Federal 8, 56, 60 & 142; Grebe CR-10, CR-11, CR-17, CR-18, CR-19, RORC, RORD (early), RORG, RORL & RORJ; Kennedy 100, 311 (with amp), X, Xi & Vi; Tuska 221, 222, 223 & 227; Western Electric 2-A Ant. Tuner, 4-A & 20A Filter; Zenith 2R & 1M Amp.

As it may be a long time before I find any of these sets, remember to call me if and when you can part with yours. I am putting together a broad collection of early broadcast and wireless equipment from many manufacturers, and adding to it each month. I buy single sets or collections - also, books, catalogs, manuals and other related documentation. Now that I have moved my business (A.R.C.) out of my home, I have lots of room!

Call and surprise me; make my day! — Please leave a message if my answering machine answers. Thanks.

John V. Terrey, 498 Cross Street, Carlisle, MA 01741 — (508) 369-9770



**FOR SALE:** Rider's complete index (copy) for Vols. 16 thru 22 (no 23) - \$10 postpaid. John Snow, 4539 Bartlett, Shorewood, WI 53211. (414) 964-0194

**FOR SALE:** Pair of open frame units look like Synchros with Japanese nameplate - \$15 plus UPS. Also Thorderson T13R11 replacement transformer - \$20 plus 5 lbs. UPS. John Uscinowski, RR #1, Box 379, Greenwich, NY 12834-9519. (518) 692-7538

**WANTED:** Lid, carrying handle, lever knobs for EICO 667 tube tester. Larry Townsend, 423 Indian Creek Bay, Coolin, ID 83821

**FOR SALE:** Escutcheon for Grunow Majestic 90 - \$8 ppd. Hugo M. Kann, 2320 Kings Ct., Marion, IA 52302

**FOR SALE:** Crosley 56TC-L - \$40. Detrola 568-1 - \$60. Zenith Trans-Oceanic H-600 - \$100. Airline 62-345 battery, untested - \$45. Admiral 6T06-4A1 battery, untested - \$55. Ensign AB battery for Admiral above AB48, 90 volt is dead, 1 1/2 volt is alive, looks good - \$30. All plus UPS. Art Kiel, 8710 Sheridan, Montague, MI 49437. (616) 894-9253

**WANTED:** Pocket radios with tubes. Please provide model, condition, and price. Michael B. Schiffer, 2718 E. 10th St., Tucson, AZ 85716. (602) 325-3532

**WANTED:** 2A3, 50, 250 350, 274A, 274B. N.C.S. only. Hidekazu Nakajima, 6-18-502, Taruyamachi, Akashi, 673, Japan. Phone 81-78-914-1810. Fax 81-78-914-3340

**FOR SALE:** Stromberg-Carlson 601, good, complete, warped gears - \$90. Sonochoorde loudspeaker, slight fraying in several cloth pleats, otherwise nice - \$80. Gary Nitkin, 102 Long Highway, Little Compton, RI 02837. (401) 635-2816

**FOR SALE:** Information. Send SASE for list of information for new collector and others. Charles Ahr, 2291 Sylvan Ln., Cincinnati, OH 45238

**FOR SALE:** AK Model 10C breadboard, No. 4700, both tags, no tubes - \$975. Scott Hagerman, 3 Deer Trail Rd., Decatur, IL 62521. (217) 692-2373

**FOR SALE:** Fisher 500 receiver, Zenith Trans-Oceanics H500/R500, all as-is - Best Offer. Mark Gutekunst, 2600 Martin Rd., Willow Grove, PA 19090. (215) 830-0425

**WANTED:** Westinghouse Aeriola amplifier. Philco Safari TV. Philco 50-701 TV. Brass base WD-11. TV & radio banks. Tony DeMara, 40231 Day, Clinton Township, MI 48038. (313) 263-0325

**FOR SALE:** Zenith 8G005Y Trans-Oceanic, black, fine condition - \$55. Bendix 0626, Bakelite - \$30. Satchell-Carlson 416, brown - \$30. Zenith 6D-315, Motorola 54AA, both for parts - \$15 each. Many others, thinning collection. Shipping extra. SASE or call for more info. Greg Carlson, 1075 Washington Ave. S., #8, Bemidji, MN 56601. (218) 751-6479

**FOR SALE:** Sprague TVLU electrolytic cans 90038 N.O.S. - \$3 ea., 125 avail. **WANTED:** XLR power cord. Renee May, 1242 N. El Centro, Los Angeles, CA 90038. (213) 464-8278

**WANTED:** Restorable cabinets for RCA 816K and/or RCA Regenoflex. Steve Link, 630 E. 20th, Sioux Falls, SD 57105. (605) 339-2769

**FOR TRADE:** My Sherwood FM tuner, Model S-8000 & Sherwood amp for your tombstone or console. A. Bruno, 24 Butternut Dr., New City, NY 10956. (914) 354-8899

**FOR SALE:** Collins KWN-1, KWM2A, Drake TR4C, L4 console. Joel Levine, WB2BMH, 67 Derby Ave., Greenlawn, NY 11740. (516) 757-7641

**WANTED:** Crosley 5526 parts chassis; NRI Vols. 1 & 2; Most Often Needed 52, 55, 56; Rider's 17 & 18; Radio Boys books; 6U5's. Wilbert Kimple, 3015 Kelsey Creek Rd., Spartanburg, SC 29302. (803) 585-6465

**OLD TIME  
RADIO BROADCASTS  
ON CASSETTES**

Many of your old time radio favorites are available on quality cassettes at a reasonable cost. You select the shows you want and purchase them by the hour. Fast, friendly service too.

The Great Gildersleeve

The Whistler

Suspense

Jack Benny

Sherlock Holmes



Lux Radio Theater

Amos 'n' Andy

Sgt. Preston

The Lone Ranger

Fibber McGee & Molly

Send for our catalog listing nearly 5,000 shows arranged by show category and title, many including original broadcast dates.

Only \$2.00 (P & H). Send request to:

**ERSTWHILE RADIO  
P.O. BOX 2284  
PEABODY, MA 01960**

**Bellingham  
Antique  
Radio  
Museum**

The museum wishes to obtain more examples of pre-1927 radios.

We will pay top dollar for single pieces or entire collections.

We have some duplicate material for trade.

Please call Jonathan Winter:  
(206) 734-4168

or write to us at:  
1421 Saint Paul Street  
Bellingham, WA 98226

# ORDER THESE SELECTED Old Radio Collector Books FROM ANTIQUE RADIO CLASSIFIED!

*Every radio collector from the novice to the experienced should have a copy of this book:*



## GUIDE TO OLD RADIOS

A primer to collecting. 128 pages, 350 photos and 3300 current prices. 7" x 10". Johnson. Softcover.....\$16.95

*A guide to repairing vacuum tube and transistor sets:*



## OLD-TIME RADIOS! RESTORATION AND REPAIR

A self-paced training guide. History, theory and practical operation of antique and classic radios. 256 pages, 200 illustrations. 7" x 10". Carr. Softcover.....\$16.95

*Price guide for over 7,400 battery & AC sets from 1920-1959:*

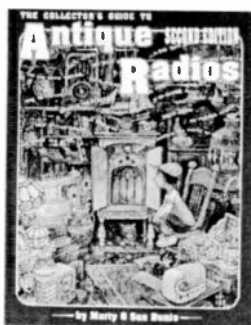

## A COLLECTOR'S GUIDE TO ANTIQUE RADIOS - 2<sup>ND</sup> EDITION

Collectors Marty & Sue Bunis have consolidated data from auctions, ads, flea markets, etc. in this beautifully illustrated price guide. Over 540 new color photos. 8 1/2" x 11". Bunis. Softcover .....\$17.95

*A book to help every collector get those old battery and AC sets playing again:*

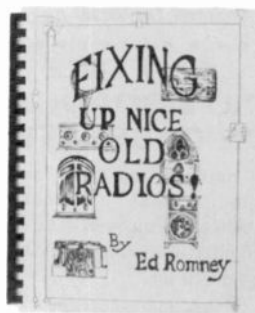

## FIXING UP NICE OLD RADIOS

Written by an old radio instructor. 185 pages, 300+ figures. 8 1/2" x 11", plastic binding. Romney. Softcover.....\$19.00

*U.S. Orders - Enclose \$2.50 per order for packing & book-rate shipping if total order is under \$35.00. If using VISA or MasterCard, include name on card, card number and expiration date. Send payment with order. Mass. residents please add 5% sales tax. Money back return policy. Most orders shipped the same day received, but allow 2-4 weeks to receive order. Foreign orders - write for shipping costs, or use credit card and specify air or surface (allow 2-3 months for surface shipping).*



Send Order To: A.R.C., P.O. Box 2, Carlisle, MA 01741  
or Call: (508) 371-0512 Fax: (508) 371-7129



# ORDER THESE SELECTED Old Radio Collector Books FROM ANTIQUE RADIO CLASSIFIED!

*This book is a must for anyone collecting radios and crystal sets from the 1920s:*

*This book is a must for anyone collecting radios from the 1930s to the 1950s:*



**NEW!**  
**The Weekend Refinisher**  
by Bruce Johnson  
296 pages  
Illustrated  
**SHIPPING NOW!**  
\$10.00 - Softcover



## VINTAGE RADIO

Standard photo reference guide for radios before 1930. 1000+ pictures. 5" x 8". McMahonia.  
Softcover.....\$11.95

## FLICK OF THE SWITCH

Standard photo reference guide for 1930s to 1950s radios. 1000+ pictures. 5" x 8". McMahonia.  
Softcover.....\$11.95

*A must for collectors of 1920s battery sets:*

*For collectors of '30s & '40s plastic and other collectible radios:*



**RADIO MANUFACTURERS OF THE 1920s.** Douglas. 1920s battery sets. 8 1/2" x 11".  
Vol 1. A-C Dayton - Ferguson ... (softcover only) \$24.95  
Vol 2. Freed-Eisemann - Priess ..... (\$39.95\*) \$29.95  
Vol 3. RCA - Zenith ..... (\$39.95\*) \$29.95  
(\* Hardcover Prices)



**CLASSIC PLASTIC RADIOS FROM THE 1930s AND 1940s.** Sidell. 200+ Catalin models in full color. 8 1/2" x 11" ... (\$19.95\*) softcover remainders: \$9.95  
**RADIOS - THE GOLDEN AGE.** Collins. Full color. 10" x 8 1/2". ..... (\$25.00\*) \$14.95  
(\* Hardcover Prices)

*U.S. Orders - Enclose \$2.50 per order for packing & book-rate shipping if total order is under \$35.00. If using VISA or MasterCard, include name on card, card number and expiration date. Send payment with order. Mass. residents please add 5% sales tax. Money back return policy. Most orders shipped the same day received, but allow 2-4 weeks to receive order. Foreign orders - write for shipping costs, or use credit card and specify air or surface (allow 2-3 months for surface shipping).*



**Send Order To: A.R.C., P.O. Box 2, Carlisle, MA 01741**  
**or Call: (508) 371-0512**

Fax: (508) 371-7129



**FOR SALE:** EH Scott consoles for sale: Warrington Philharmonic pointer dial, chassis has corrosion; Waverly Allwave 23; Milton Grande Allwave 23; Warrington Allwave 23, one original, one refinished; Tasman Allwave 23; Wilshire 16; Westminster Allwave 15; Regent Allwave 15; Lido Allwave 15; Acoustacraft late Super 12; Oxford Phantom. McMurdo Silver 15-17 in Oxford cabinet, chrome 80%, 15-17, no cabinet, chrome 90%. We ship consoles anywhere and can probably arrange delivery if desired. Unless noted all radios are unrestored electrically but integrity is guaranteed. Satisfaction guaranteed, shipping extra. Alan Jespersion/Mike Emery, PO Box 17338, Minneapolis, MN 55417. (612) 727-2489, 8 am - 8 pm 7 days. Fax only (612) 727-1908, 8 am - 8 pm

**FOR SALE:** Manual copies - FM 24-24, 1977, Radio and Radar Reference Data, 192 pages - \$15. FM 24-25, Dec. '83, Wire and Multichannel Reference Data, info on telephones, switchboards, radio terminals, and similar equip., 304 pages - \$25. TM 11-5800-213L, Sept. '84, list of manuals for Army communications electronic equip., 421 pages - \$30. TO31R-18, 1961, Radio Equip. Directory, copy of a copy, cover sheet missing, 340 pages - \$25. Copies are unbound. Add \$2.90 shpg. per manual. Tartan Electronics Inc., PO Box 36841, Tucson, AZ 85740-6841. (602) 577-1022

**WANTED:** AK 84 chassis for parts, general interest in any other AK items. John & Kathy Slusser, PO Box 144, Mendon, NY 14506. (716) 624-9755

**FOR SALE:** New shipment of tested tubes w/warranty! Buy those spare tubes for your tube radio, audio, and electronic gear. I have a bunch of octal, older and several thousand 7- and 9-pin tubes. All tested on TV-7 tester and boxed. I give a 30-day warranty. Send wants or SASE with two stamps for list, massive list. **FOR SALE:** Repair of TV-7 tube testers and calibration: I will fix and then verify calibration of your TV-7 tube tester for \$45 plus shipping or return it no charge. Please no units with bad meter movements or missing components. Unit must be repairable and not a basket case. Daniel Nelson, 1025 E. Desert Ln., Phoenix, AZ 85040. (602) 243-7421

**FOR TRADE:** Marconi V2A/A2 amplifier; Fuller Sparta crystal set, tortoise shell panel; French Radiocapte; Australian Radiolette tombstone (lustrous black) larger version with ivory fretwork and feet; Venus Champion Globe, blue, small repair. Many other interesting, different and classic collectible radios for quality Catalan or exciting trades! Simon Wade, Finchcroft, Broadwater Down, Tunbridge Wells, Kent TN2 5PE, United Kingdom. (44) 892 543505, evenings

**FOR SALE:** Philco 70 - \$325. Paper maché Nipper Dog, 36" - \$850. **WANTED:** Brass electric fans. Rick Padron, 1005 E. Idlewild Ave., Tampa, FL 33604. (813) 238-8535

**WANTED:** Power transformer for Philco 90 with two #45 tubes; Philco #4938, 60Hz. Paul Geraghty, 1245 Lyon Ave., Waterloo, IA 50702. (319) 233-3520

**WANTED:** Dahlberg pillow speakers. Pathé speaker cones 14 1/2" and 17 1/2" diam. Write. Thanks. Gil Zaleski, 5100 Chingford, Columbus, OH 43232

**FOR SALE:** (2) Peerless World Globe transistor radios, one for parts, other to repair, both - \$20. RCA #1X (Bunis II) excellent - \$45. Plus UPS. C. Hill, 6934 Orion Ave., Van Nuys, CA 91406. (818) 787-0376

**WANTED:** Nordemende Electra U.S.A. Model #58, must be in excellent condition. Michael Stern, 1285 Alum Creek Dr., Columbus, OH 43209. (614) 252-4422

**WANTED:** Small off/on knob for 1930 floor model Majestic, Model 130A. Write: Bob Barr, 3130 Bellanca St., Columbus, GA 31909

**MESSAGE:** I buy cathedrals, good conditions, working, under \$100. Send photo. Federico Rimonti, PO Box 19, 15040 Castelceriolo Al, Italy. Fax 39 131 235854

**FOR SALE:** Philco 70 - \$275. Radiola 20 chassis OK, cabinet needs veneer work - \$100. Nora, German radio, needs speaker & tube - \$90. Radola 60 & floor stand - \$125. Pearson battery op., fair condition - \$75. Monroe battery op., fair cond. - \$75. Airline battery op. - \$100. Crosley Playtime grandfather clock radio - \$325. Fairbanks-Morse 12A console - \$215. Radiola Radiotrope console - \$145. Amrad console - \$60. National speaker for 183D - \$50. National 2-40D with speaker - \$325. Hammarlund Comet Pro - \$225. Stromberg-Carlson MC-41 mic - \$85. Altec 630 mic - \$125. American Microphone Co., N.I.B., ca. 1961, chrome hand held mic, mint - \$95. Meck [?] brown Deco - \$50. UPS extra. Joe Szabat, 1019 Hiland Ave., Coraopolis, PA 15108. (412) 264-7498

**FOR SALE:** Uniden Bearcat 200-XLT handheld scanner, exc condition, original box, all accessories, spare battery pack, Metro West Pro-Power charging stand - \$175 including UPS shipping. Richard Stedman, 22B Tamarac Dr., Greenville, RI 02828. (401) 949-2888

**FOR SALE:** Zenith Service note, Vols. I & II - \$80. Atwater Kent 10C - \$1,000. Atwater Kent 35 - \$95. Atwater Kent 708 - \$475. Philco Model 45, butterfly - \$125. Atwater Kent 20, no tubes - \$75. Waves has many other things in stock, let us know what you are looking for. We are always looking for radios, phonographs, etc.; let us know what you have. Shop hours 12-6 Tues.-Fri., Sat. 12-5. Waves, 32 E. 13 St., New York, NY 10003. (212) 989-9284, fax (201) 461-7121

**WANTED:** Silvertone 4763 schematic, knobs. RCA 115 knobs. Will buy parts sets or rent knobs for reproductions. Curt Schreiber, 3923 East Latoka St., Springfield, MO 65809. (417) 887-5184

**FOR SALE:** Thinning collection! Vintage radios, tubes, parts, too much to list. Send \$1 for new ten-page superlist. Air King 252, wooden log cabin table model - \$139. Philco 37-62 - \$139. 1928 Airline Mystery, single-dial battery tabletop - \$119. Microphones: Electro-Voice 635 - \$119. Turner 22X w/stand - \$89. Radiola 16 - \$99. All + UPS. **WANTED:** Army WWI crystal set BC-14. Steve Lipsky, 1254 Cox Rd., Jenkintown, PA 19046-1207. (215) 884-1817

**FOR SALE:** AK Model 10 breadboard complete - \$1,000. AK Model H horn speaker - \$200. Shipping extra. Dennis Ritchie, 146 Worth Ave., Hamden, CT 06518. (203) 248-3961

**WANTED:** For Canadian Phonola, Model 8AB62P, one walnut wooden bonnet knob. Diameter 1 5/16". Ernest D. M. Yeaw, RR#3, Tatamagouche, Nova Scotia, Canada B0K 1V0. (902) 657-2554

**FOR SALE:** Cathedral Philco Model 37-93, refinished good condition - \$95. USL Model RC-5 battery set good condition - \$100. Philco Model 46-420 Bakelite, good condition - \$30. Gary Pirkkala, 18 Old Hickory Rd., New Castle, PA 16102. (412) 667-1166 after 5:30 pm

WANTED: "Phillips" code book to use, any cond., any vintage. Brass keys: Bunnell, Signal Elect., Manhattan Elect., etc., any cond. "The Telegraph Instructor" and any other books on early telegraphy. Also, historical telegraph paper. Robert W. Butt, N1KPR, 8 Little Fawn Dr., Shelton, CT 06484. (203) 924-1120, 9-9 EDT

WANTED: Peerless A-100A or 10722 integrated amp, Brook mark; 6A5; 211 N.I.B. tubes; capacitors 4 uF min/1500vDC min one or more; also 2uF/2000v round. FOR SALE: 5U4 rectifier - \$105. Mike Somers, 852 W. Aldine #1, Chicago, IL 60657. (312) 868-1696

— WANTED —

PICTURES FOR TELEGRAPH REVIEW  
PHOTOS MUST BE SHARP IN DETAIL  
A SHORT DESCRIPTION IS A MUST!  
REQUIREMENTS FOR TELEGRAPH REVIEW  
ARE THE SAME AS FOR PHOTO REVIEW

FOR SALE: Radiola IIIA, Aeriola Sr. receiver Type RF, Radiola AC 2-stage audio amp. All units complete in original wooden cases w/ tubes. Cases must be re-glued. Bunis says, value for all \$550. I say - \$350 plus S&H. B. Nostrant, PO Box 441, Peru, NE 68421. (402) 872-6985

FOR SALE: Clark's console. Rare coin-operated radio. Clothing hamper look. Excellent condition! Shippable - \$185. Gerald Schneider, 3101 Blueford Rd., Kensington, MD 20895-2726. (301) 929-8593

WANTED: E.H. Scott receivers models Philharmonic or Imperial. Cloyd Briley, 725 Christine Dr., Vacaville, CA 95687. (707) 447-5866

FOR SALE: One-of-a-kind Atwater Kent Kiel table (see photo A.R.C. 5/93, p. 55) - \$1,000. Jim Clark, 1292 Starboard, Okemos, MI 48864. (517) 349-2249

FOR SALE: 1933 circa LANG radio, Art Deco wood design, original condition - \$100. Larry Drago, 383 Lincoln Dr., Cheshire, CT 06410. (203) 272-6030

FOR TRADE: My Harvey Wells TBS-50 or Globe DSB-100 for your AK tombstone. A. Bruno, 24 Butternut Dr., New City, NY 10956. (914) 354-8899

WANTED: Still seeking back for Admiral 10" dual chassis console TV Model No. 24A12. Steve Cavelli, 30144 Torry Ave., Flat Rock, MI 48134. (313) 379-3254

FOR SALE: Sparton 409-GL blue mirror radio, very good original condition, working - \$1,500. Gary Watkins, 8006 Greenwald, Belton, MO 64012. (816) 322-0773

FOR SALE: Majestic cathedral - \$195. Columbia Grafanola (phonograph) tone arm - \$45. Silvertone 4465 (up-right) radio. Jeff Gentry, 708 Locust Ave., Charlottesville, VA 22902-4913. (804) 979-0699

WANTED: St. Regis cathedral on cover of "Guide to Old Radios." Call or write. Alan Porek, WB9RAD, 1050 N Paulina St., Chicago, IL 60622. (312) 235-1523

FOR SALE: Kenwood R-5000 with installed filter YK-88A-1 VS-1 voice Synthesiser unit. Cable for 12v operation never ran mobile dust cover, in excellent shape - \$715 ppd in 48. Jean-Bpte. Desautels, K4VGD, 616 N. Silver Cir., Silver Shores, Key Largo, FL 33037-3840

FOR SALE: A few nice consoles. Pick up only. Chuck's Antiques, PO Box 598, New Haven, WV 25265

WANTED: Lafayette FS-110 transistor radio. Harold Deppe, PO Box 31656, Tucson, AZ 85751

FOR SALE: Philco cathedral Model 89 ("cream puff") all original, except grille cloth, restored and plays, nice addition to collection - \$300 or BO plus UPS. Stephen L. Bonino, 107 Georgetown Rd., Glassboro, NJ 08028 (609) 881-0244

FOR SALE: Nice Tom Thumb camera radio - \$175 + UPS. Don Howland, 4621 W. Shawnee, Spokane, WA 99208. (509) 466-0939

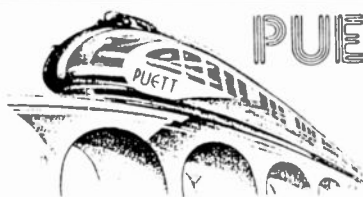

# PUETT ELECTRONICS

P.O. BOX 28572 DALLAS TX 75228



CATALOG 77/PLL-2 (56-PAGES) ----- \$5.00 POSTPAID

YOU RECEIVE A \$6.00 DISCOUNT COUPON WITH THIS CATALOG!

MORE THAN 1,500 DIFFERENT ANTIQUE RADIO PUBLICATIONS  
FROM 1902 TO THE 1960'S OFFERED, REPRINTED BOTH SIDES  
OF THE PAGE AND BOUND!

WE OFFER BOOKS, INSTRUMENT MANUALS, SERVICE DATA, SALES BROCHURES, ATWATER KENT, RCA, CROSLY, ZENITH, ETC. FACTORY SERVICE MANUALS, SCOTT, MC MURDO SILVER, STROMBERG CARLSON, CAPEHART, FISHER CLASSIC RADIO LITERATURE, DIRECTORY OF ANTIQUE RADIO SERVICES, SCHEMATIC DIAGRAMS, OLD TIME RADIO PROGRAMS ON CASSETTES, TUBES, TUNING DIALS, KNOBS, 30-SERVICES & DISCOUNTS WITH THE PUETT ELECTRONICS ANTIQUE RADIO CLUB AND MUCH MORE - ORDER YOUR CATALOG TODAY!

OUR NEW BOOK "THE WORLDS LARGEST RADIOS" IS NOW AVAILABLE, PHOTOS, SCHEMATICS, BY J.W.F. PUETT - \$14.95 PLUS \$2.00 HANDLING.  
INCLUDES SCOTT, MC MURDO SILVER, PHILCO, RCA, ZENITH, LINCOLN, FREED EISEMANN, FISHER, MEISSNER, MAGNAVOX, CROSLY + MANY MORE!

**FOR SALE:** Capehart Model 111K2 radio phono. Turn-over record changer, excellent, original, asking - \$1,100. Aaron Krueger, 3719 Woodland Ridge Rd., Wausau, WI 54401. (715) 675-6674

**FOR SALE:** Eico Audio Oscillator Model 377 - \$30. Zenith Trans-Oceanic 3000-1 - \$50. RCA Tube Manual RC 15 - \$4. RCA Designers Handbook, third edition - \$12. All plus UPS. Ed Povraznik, 9606 Biddulph Rd., Brooklyn, OH 44144. (216) 661-0032

**WANTED:** Schematic and/or operating manual for Stromberg-Carlson Model 350-M. Will pay. Loren H. Dudley, 14 Valley Rd., Bath, ME 04530. (207) 442-8419

**FOR SALE:** Mount Vernon radio made in Los Angeles, Calif. Manufacturer built it inside a miniature furniture model with 2 drawers on top and doors in front. Real unusual example of interesting radios - \$150. Larry Drago, 383 Lincoln Dr., Cheshire, CT 06410. (203) 272-6030

**FOR SALE:** BC-348 receiver, 8 tubes, 6 bands, with 28VDC-115VAC conversion instruction manual - BO. Bob Puttre, 637 Stratford Rd., Baldwin, NY 11510. (516) 223-9667

**WANTED:** Chassis for Spartan Polo radio. I will pay your reasonable asking price for chassis or junker. Mark V. Stein, 2109 Carterdale Rd., Baltimore, MD 21209. (410) 466-2814

**FOR SALE:** Stromberg 1500h - \$65. Isolation transformer, 5 amp - \$25. **WANTED:** Brass fans - cash/radio trades. Dave Friedlund, 36006 S.W. Bald Peak Rd., Hillsboro, OR 97123. (503) 628-1439

**FOR SALE:** Books for sale: near mint Radio Physics Course, Second Edition, circa 1933, Ghirardi; and The Radio Manual, Sterling, circa 1928, Second Edition; asking - \$15 each, or both for \$25 plus UPS. Wes Chatellier, W5DPM, 1950 Chevelle Dr., Baton Rouge, LA 70806

## TUBES WANTED

— TOP PRICES PAID ! —

**WESTERN ELECTRIC TUBES  
NEW AND ORIGINAL BOXES:**

300 A/B, 104D, 274 A/B, 205 D/F,  
252 A, 242 C, 284 D, 339 A

\*\*\*\*\* INVITATION \*\*\*\*\*

I am looking for people all over the world to find tubes for me, and I will pay a bonus to the people who supply me with the best tubes!

**FOR SALE:** Record player, EMT 950 for studio use. Nice condition & looking. \$15,000 (U.S.) with shipping.

**TRIODE SUPPLY JAPAN**  
1-101 227 Kasimada Saiwaiku  
Kawasakisi Kanagawaken Japan  
Fax 81-44-511-3492  
Tel 81-44-511-6343

**FOR SALE:** The famous improved Kleertone - \$4. Loop 54" x 36" will supply 100' new wire, base not orig. wood disc, can take apart to ship - \$40. Old 3 tube batt amp 4 K&H audios - \$70. Samson PAM 16-4 tube amp uses 1-27, 2-210, 1-281 (no tubes), from early 1930's - \$75. RCA Radiola 18 power unit, clean - \$30. Small metal case toy mics, need new cords - \$10 ea. Polish stick and brush - \$3.50/both. First model elect. solder gun, Model B - \$12. Motorola solder pot for printed board service - \$20. 1937 Philco Hi Eff. aerial, N.O.S., #40-5922 - \$35. Superior TV-11 tube tester, clean, port. roll chart - \$35. RCA desk hand mics, MI12039 - \$40; MI 12039-A - \$40. 4 pin plastic coil forms - \$6/all. Westinghouse Aeriola Jr., Type RE, mt, cab. - \$20. RK34 MIL tube - \$2.50 each. Zenith floor model loop ant. wavemagnet - \$15. Have some Blue Arcturus tubes - List. (7) ass'd 4T06 pin plug in coil forms - \$18/all. (6) Nat. 6 pin coil forms - \$25/all. Set plug in coils 5 pin w/handle, set of 5, N.O.S. Pilot Wasp 17-500 meters - \$45. Beede meter 0-300v DC plugs into 201-A tube socket to read B+ volts, N.O.S., old - \$18. Acme R-2-3-4 coils, (7) ass'd, all need repairs - \$10.50/all. TV tuner band change detent. FD1, FD2 - \$10/both. 7 pounds horn magnetic parts driver units - \$25/all. (5) pair headphones, all need repairs - \$20/all. Lot headphone bands - \$10. Weston industrial circuit tester, port. case, 785 VOM, panel has been repaired - \$20. Radio Master, 1962 - \$20. Electronics Buyers Guides 1953-54-55-56-57-59 - \$5 each. Lafayette 1971-1972 - \$6 each. Lafayette 74-76 - \$9.50/both. (6) ass'd Radio Shack 1972 to 1988 - \$15/all. 16 pounds mixed TV knobs - \$20/all. 14 pounds wass N.O.S. bypass cond's., .022-200v - \$30/all. N.O.S. RCA scope probe - \$12. RCA VTVM probe - \$14. Phono pickups, (10) used - \$30/all. (25) ass'd needles, N.O.S. - \$20. (50) ass'd dial bulbs - \$7.50. (50) ass'd cart. fuses - \$7.50. 2 1/4 pounds, 1 watt lead end resistors cut outs - \$15/all. 1/2 pound, 1/2 watt - \$6. 2 1/2 pounds, 1/2 and 1 watt lead ends, unused - \$30. 3 1/2 pounds old carbon resistors clip outs short leads - \$12/all. (12) ass'd on-off SW's for vol. controls-phono-auto radio - \$7.50/all. 4000v insulation fil. transformer, 5 volts, 10 amps, 210-250 AC input - \$12.50. Have 1000's of unlisted new and used parts. RCA 18 Radiola power unit, clean - \$30. Gang cond. less dial scale - \$27.50. For relays SASE. Have lists on following, each list a SASE: keys sounders, crystal sets dets, radio catalogs, books-magazines, horn speakers, old ham and tune coils, AM-FM tuners hifi amps, old tubes, N.O.S. boxed parts and no box old, set builders parts, have test eqpt., tubes, parts, min. parts orders \$8. All plus hand. and shipping. Krantz, 100 Osage Ave., Somerdale, NJ 08083. (609) 783-0400

**WANTED:** Philco Model 21. Dale Kinstler, W1361 Aasen Rd., Bangor, WI 54614

## TUBES - CAPACITORS - ETC.

**ALL-NEW GREATLY ENLARGED  
1992-93 ILLUSTRATED 16 PAGE  
CATALOG #48**

Jam-packed with thousands of tubes, etc. with current prices

Send \$2 (cash, stamps or check)  
(Canada \$3 - Overseas \$4)  
**FOR YOUR COPY NOW!**

**DON DIERS** 4276 North 50 St. #AD11  
Milwaukee, WI 53216-1313

**FOR SALE:** (38) crystals various frequencies for use in military UHF equipment Ted/Red Series. Crystals are barrel shape wih connectors on both ends. Entire sets at - \$15. FT-243 crystals various frequencies (non-ham frequencies) mostly military frequencies - 55¢ ea. in lots of 10, 50¢ ea. in lots of 20, 45¢ ea. in lots of 30. S/ Hextra. Loren H. Dudley, KA1PRV, 14 Valley Rd., Bath, ME 04530. (207) 442-8419

**FOR SALE:** Cathedrals: Philco 90 - \$450, Sparton Jr. - \$350, Majestic 50 with stand - \$425, Philco 20 - \$275, Philco 60 - \$180, Philco 84 - \$150, Crosley Mod 125 - \$150. Larry Drago, 383 Lincoln Dr., Cheshire, CT 06410. (203) 272-6030

**WANTED:** Bakelite Motorola Model 51C (as pictured in last month's A.R.C., Sept., p. 12). Wood Traveler Model 315 (in Bunis #1, p. 152), high priority. Call or write: Randall D. Giles, 12552 Camarero Ct., San Diego, CA 92130. (619) 792-9291; fax (619) 792-7376

**FOR SALE:** B&K oscilloscope Model 1590A. 100 MHz, quad input, eight trace, two 10:1 attenuator probes, manual, A-1 condition - \$600. Max Friedman, 10620 W. Clairmont Cir., Tamarac, FL 33321. (305) 720-1721

**FOR SALE:** Ham Radio, QST & 73 Magazines, 1953 up, sell collection as lot - 700 @ 35¢ ea. Inquire for fewer. Larry Kellough, PO Box 849, Canton, CT 06019-0849. (203) 693-8269

**FAX NUMBER FOR**

**ANTIQUÉ RADIO CLASSIFIED**

(508) 371-7129 - 24 hours a day

Ads - Subscriptions - Book Orders

Charge to VISA/MasterCard

Minimum Charge: \$10.00

**FOR SALE:** Hallicrafters models: S-20R, SX-25, EC-114, S-119, S-120, as found. Also C-87/ART-13 control box - Offer. John Webb, W6RCW, 12736 E in Dr., Auburn, CA 95603. (916) 885-9556

**FOR SALE:** Moving, selling radios, TV's, Predicta parts, picture tubes, books, test equipment. PU only. Bob Baker, 35326, Shenandoah Dr., Shingletown, CA 96088. (916) 474-1650

**WANTED:** Superman in a Phone Booth novelty radio. Gary Arnold, 615 Oak St., Marion, NC 28752

**FOR SALE:** Guitar amp, (5) tubes - BO. Zenith Model L515 clock radio - \$45. Zenith Model Z515 clock radio - \$45. Zenith Model A515 clock radio - \$45. Zenith Model H835 - \$50. Zenith Model K725, crack - \$30. RCA Model 8R75 - \$45. GE Model 546 clock radio, very good - \$50. Gramovox Stereo Fidelity radio/phono, tubes \$50. GE Model 50 clock radio - \$40. Philco Model 51-537 clock radio, good - \$45. Philco Model 37-61 cathedral - \$220. Thank You. Luis Amory, 43 Monroe Pl., Bloomfield, NJ 07003. (201) 748-9373, after 4:30 pm

**FOR SALE:** EC-2 Echophone Hallicrafters radio - \$250. Rare 1909 Adams Bagnall Gyro ceiling fan, beautifully restored, brass blades and cages - \$4,500. Monty Young, 4200 Sunshine Rd., Miami, FL 33133. (305) 661-6245

**FOR SALE:** Simpson capacitor checker, Model 383-A w/manual - \$30. Sencore CRT checker, Model CR128 - \$30. Heath oscilloscope Model 01 - \$35. All plus UPS. Stephen L. Bonino, 107 Georgetown Rd., Glassboro, NJ 08028. (609) 881-0244

# VINTAGE RADIO RESTORATION VIDEO TAPE

## THE RADIO DOCTOR

**Volume 1: VINTAGE RADIO REPAIR and RESTORATIONS**  
 -COVERS THE COMPLETE RESTORATION OF A 1930s SET  
 -INCLUDES COSMETIC RESTORATION OF A WOOD CABINET  
 -COVERS ELECTRONIC REPAIR AND ALIGNMENT  
 -DESIGNED FOR THE BEGINNER AND INTERMEDIATE LEVEL RESTORER, PRESERVATION IS STRESSED  
 -"HEARTILY RECOMMENDED... FOR THOSE WITH A YEARN TO LEARN" 5-92 Radio Age review  
 -4 HOURS ON 2 VHS VIDEO TAPES

### → NEW VIDEO TAPE ←

**Volume 2: CONSOLE RESTORATIONS**  
 -PICKS UP WHERE VOLUME 1 LEAVES OFF  
 -COVERS MORE ADVANCED RESTORATION TOPICS  
 -THE FORMAT DIFFERS FROM VOL. 1 WHICH FOLLOWED ONE SET FROM START TO FINISH, VOL. 2 USES SEVERAL DIFFERENT SETS TO SPOTLIGHT MANY DIFFERENT RESTORATION PROBLEMS.  
 -CONSOLES ARE THE FOCUS BUT THE PRINCIPLES APPLY TO ALL TYPES OF SETS.  
 -4 HOURS ON 2 VHS VIDEO TAPES

**TAPE PRICES \$23.95 EACH VOLUME PLUS SHIPPING TAPE SHIPPING \$4.00 for one or both tapes.**  
**SPECIAL OFFER:** Any books ordered at the same time as a RADIO DOCTOR video will be shipped for free. (Must still pay tape shipping)  
**SPECIAL OFFER EXPIRES OCT 31, 1993**

## NEW Bargain Books

- R) EVOLUTION OF THE RADIO WITH PRICES VOL 2, 1993**  
 NEW LIST PRICE \$24.95 OUR PRICE \$21.25
- S) PHILCO RADIO: 1928-1942**, by Mon Ramirez, 1993  
 NEW LIST PRICE \$29.95 OUR PRICE \$25.50
- T) MADE IN JAPAN: Transistor Radios of the 50s & 60s, 1993**  
 NEW LIST PRICE \$16.95 OUR PRICE \$14.50
- A) COLLECTOR'S GUIDE TO ANTIQUE RADIOS; 2nd Ed. 1992, Bunis. List \$17.95 OUR PRICE \$15.25**
- H) EVOLUTION OF THE RADIO WITH PRICES, 1992**  
 List Price \$22.95 OUR PRICE \$19.50
- C) RADIO MANUFACTURERS OF THE 1920's**, by Douglas
- 1) **VOLUME 1: A.C. DAYTON TO J.H. FERGUSON**  
 a) SOFTCOVER List \$24.95 OUR PRICE \$21.25  
 2) **VOLUME 2: FRED-EISEMANN TO PREISS**  
 a) SOFTCOVER List \$29.95 OUR PRICE \$25.50  
 b) HARDCOVER List \$39.95 OUR PRICE \$34.00
- 3) **VOLUME 3: RCA TO ZENITH**  
 a) SOFTCOVER List \$29.95 OUR PRICE \$25.50  
 b) HARDCOVER List \$39.95 OUR PRICE \$34.00
- NEW/OCT) COLLECTOR'S GUIDE TO TRANSISTOR RADIOS, 1993**  
 by Bun. s LIST \$15.95 OUR PRICE \$13.25
- OCT) COLLECTING TRANSISTOR NOVELTY RADIOS, 1990**  
 by Breed. List \$24.95 OUR PRICE \$21.25
- P) 70 YEARS OF RADIO TUBES and VALVES by Stokes**  
 List Price \$25.95 OUR PRICE \$22.00
- G) RADIOS: THE GOLDEN AGE, 1987**, by Collins.  
 a) SOFTCOVER List \$17.95 OUR PRICE \$15.25  
 b) HARDCOVER List \$25.00 OUR PRICE \$21.25
- H) ANTIQUE RADIO RESTORATION GUIDE, 2nd Ed., 1992**  
 by Johnson LIST \$14.95 OUR PRICE \$12.75
- I) RADIOS REDUX: Listening in Style, 1992, Collins**  
 a) SOFTCOVER List \$17.95 OUR PRICE \$15.25  
 b) HARDCOVER List \$29.95 OUR PRICE \$25.50
- O) CLASSIC TVs: PREWAR thru 1950s with prices**  
 List Price \$16.95 OUR PRICE \$14.25
- NEW/OCT) POSTER'S RADIO & TV PRICE GUIDE 2nd Ed 1993**  
 LIST PRICE \$17.95 OUR PRICE \$15.25

**BOOK SHIPPING:** \$2.50 for one, \$1 each additional  
 SEND SASE FOR OUR COMPLETE LIST.

## OSARK VINTAGE RADIO

DEPT. A  
 3923 East Latoka Street  
 Springfield, MO 65809

**FOR SALE:** Telephone shopping for books! Call and we'll browse our extensive stock of radio and related books and magazines. Any day 9 am to 9 pm. Credit cards accepted. Frank Bequart, Rainy Day Books, PO Box 775, Fitzwilliam, NH 03447. (603) 585-3448

**FOR SALE:** Peerless Model OPR 300, Japanese tube type portable, forest green, like new in box, AC/batt. - \$150. Sprague T05 capacitor analyzer with manual - \$50. Would consider trading Sprague for nice Bakelite or colored plastic Zenith I do not have (prefer red but like others also). Phil Brunais, 14185 Pleasanton Hwy., Bear Lake, MI 49614

**WANTED:** Owners and/or service manuals for Harman-Kardon ST-6 and Garrard RC-88/4 turntables. Got any stray Howard radios? Bring them and yourself to the V.R.P.S./A.W.A. meet in Dallas, in October. Thomas Peters, PO Box 3925, McAllen, TX 78502

**FOR SALE:** RCA 45 players 45-EY2 - \$75, 45EY1 - \$85, 45-EY3 - \$65, 45-EY26 Alice in Wonderland - \$90. All of these phonos have been restored. Majestic Model 651, grille bars missing - \$50. Airline Model 93WG602B tuning eye, missing push buttons - \$45. John Ortale, 44 Barden St., Waterbury, CT 06706. (203) 754-8346

**FOR SALE:** Transistors: Zenith Royal 275, 1 chip - \$30. Magnavox 2-AM-70 - \$20. Both w/leather cases. Zenith Consolone 6D015W, works, touched up ivory paint - \$40. Emerson 529 BC SW electronically redone - \$70. Set of 2 orig. 8 repro. push buttons and 6 orig. labels for 1937-39 Zenith consoles - \$40/set. Shipping extra. Sam Mannino, PO Box 233, Swarthmore, PA 19081-0233. (215) 353-6747, 2-9 pm

**WANTED:** Tubes, new or used, most all types wanted. Here's examples of prices I pay. 50 - \$50, 2A3 single plate - \$25, 845 - \$70, VT2 - \$75, VT 52 - \$30. Western Electric tubes 205 - \$85, 252 - \$100, 274 - \$90, 275 - \$85, 300 - \$200, 350 - \$90. Tim Metz, 221 Wheatland, Fairview, OK 73737. (405) 227-2456

mf/ volts	manuf	each	20 & up
.001/600	Sprague 715P	\$ .40	\$ .35
.002/600	Sprague 715P	.41	.36
.0047/600	Sprague 715P	.42	.37
.01/400	Xicon (radial)	.26	.21
.01/600	Sprague 715P	.54	.49
.015/600	Sprague 6PS-	.50	.45
.02/400	Xicon (radial)	.27	.22
.022/600	Sprague 715P	.65	.60
.047/400	CMC (axial)	.35	.30
.047/600	Sprague 715P	.68	.63
.05/400	Xicon (radial)	.35	.30
.1/400	Xicon (radial)	.50	.45
.1/600	Sprague 715P	1.00	.90
.22/600	Sprague 715P	1.50	1.35
2.2/450	Rubycon (axial)	.65	.60
4.7/450	ICC (axial)	.66	.61
10/450	Xicon (axial)	.98	.91
22/160	Rubycon (axial)	.75	.70
22/450	Xicon (axial)	1.30	1.25
33/160	Xicon (radial)	.88	.83
33/160	Rubycon(axial)	1.08	1.03
47/160	Xicon (radial)	1.30	1.15
47/160	Xicon (axial)	1.30	1.15
47/450	Rubycon(axial)	1.95	1.80
80/450	CWI (axial)	2.60	2.20
shipping charge, U.S.A. flat \$ 4.00			
FRANKENSTEIN'S RADIO LABORATORY			
4010 Fairmont Pkwy, Suite 285			
Pasadena, Texas 77504			
(713) 998-0130			

**FOR SALE:** Zenith 6D311 in beautiful condition - \$150. Wood cube, AM only - \$100. Shutter dial chassis - \$150. Three Art Deco 50's style Zeniths - \$50 ea. Larry Drago, 383 Lincoln Dr., Cheshire, CT 06410. (203) 272-6030

**FOR SALE/TRADE:** Sparton 557, Rudolph mint in the box, Emerson Patriot & other radios. **WANTED:** Air King Model 52/66. Victor Zummo, 20344 Mobile St., Canoga Park, CA 91306

**FREE - 20 WORD AD EACH MONTH**  
**To get your free 20 words,**  
**Include your SUB# with your Ad.**  
**Additional words are 17¢ each.**  
**Read inside back cover for details.**  
**MANY THANKS!!!!**

**WANTED:** The book How to Repair Old-Time Radios by Clayton Hallmark. Thanks. Joe Benvotato, 1802 Sagebrush Rd., Plant City, FL 33567. (813) 754-3856

**WANTED:** Johnson Smith and Co. electrical and electronic gadgets such as radios, xtal sets, motors, microphones, etc., etc. sold through the Johnson Smith and Co. from their Detroit location prior to 1965. Old Johnson Smith catalogs before 1965. Sears Roebuck catalog from 1945 through 1950 only. Richard Matiasek #3, 2212 S. 139th Ct., Omaha, NE 68144

**FOR SALE:** Emerson 888 Pioneer, green, parts - \$20. Mitchell 1267B ivory (Bunis II, p. 114), good - \$45. Crosley 10-135, white, parts - \$20. RCA X-551, excellent - \$40. GE 415, ivory, very nice - \$30. Travler 55-37, good, black - \$20. Sentinel 529, small, brown, fair - \$20. All plus UPS. Scott Olson, 1405 25th Ave. S, Apt. 104, Fargo, ND 58103. (701) 293-9238

**FOR TRADE:** My Ocean Hopper, Star Roamer and Space Spanner for your SX-100 or SX-117. **WANTED:** Allied 1932, 1935. Jack McCreary, 7783 Wildcreek Trl., Huntsville, AL 35802. (205) 882-0037

## A.R.C. BACK ISSUES

Feb. '87 to current issue: Originals available 32 to 100 pages each.

Oct. '86 to Jan. '87: Reprints available Reprinted from original artwork; 28 to 32 pgs. ea. Quality & appearance same as an original copy.

June '84 to Sept. '86: Photocopies available Not original quality, useful for info.; 16 to 28 pages each.

Publication of *Antique Radio Classified* began in 1984 which had only five issues: June, Sept., Oct., Nov. & Dec. 1984. 1985 through current year have had 12 issues each.

**\$4.00 each - Postpaid to U.S., Canada and Mexico.**

Orders of 6 issues or more may take a 10% discount. Foreign orders other than Canada and Mexico: \$6.00 each by air. Mass. residents, please add 5% sales tax.

## A.R.C. UNCUT, UNFOLDED COVERS

June 1991 to the present 9.25" x 12.5" - \$9.95 each

Postpaid to U.S., Canada, & Mexico Mass. residents, please add 5% sales tax.

Send Order To:

A.R.C., P.O. Box 2, Carlisle MA 01741

Or Call (508) 371-0512



**FOR SALE:** AK 20 Big Box - \$175. AK 45 - \$75. AK Model L horn speaker w/o driver - \$35. Larry Drago, 383 Lincoln Dr., Cheshire, CT 06410. (203) 272-6030

**FOR TRADE:** National RAS-5 (internally modified) w/ ps, coils and storage container; six RAS-5 coils; HRO-7 AA coil; Hallicrafters S-118; Monitoradic mobile receiver; Motorola FMTR-140D-C3-R3-(A)-1-C w/ controls; Bendix MN-26C; BC-645; TU-26-B; WE T-26 microphone. **WANTED:** National HRO-5 E, G, H, J coils, MCS speaker, SM-57, 5880-AB ps for SW-3, catalogs and manuals. Rider's 22. Wayne Childress, 1903 Jerome Pl., #3, Helena, MT 59601. (406) 443-7255

**FOR SALE:** Breting 9, communications receiver, re-stored, very nice, (Comm. Recs., 2nd Ed., p. 15) - \$150. Dick Igou, 8435 Twisted Oaks, Garden Ridge, TX 78266. (210) 651-9049

**FOR SALE:** Admiral 5A33 - \$20. Crosley D-25GN (blue) - \$95. Philco 37-98 - \$165. Zenith 6-S-229 - \$150. RCA 25B - \$15. Panasonic R-1038 - \$10. Sony TR-3800 - \$10. Continental TR-801 - \$45. Toshiba 7TP-352m - \$45. Cenco Bakelite Photoelometer (looks like train) - \$45. Cranston Ford Gyron in box - BO. Will trade for tube hi-fi and guitar amplifiers. Sonny Goldson, 1413 Magrolia Ln., Midwest City, OK 73110. (405) 737-3312

**FOR SALE:** Novelties: My Little Pory - \$10, Popples - \$15, Statute of Liberty in box - \$75, Helping Hand, unopened - \$65. Pocket transistors: R26Y Zenith - \$20, AIWA AR-666 - \$30. Fisher 400C receiver, nice - \$35. Early spring mic with stand - \$195. Early 50's large half Bakelite/half wood Telefunken Concertino - \$110. Misc. radio ads and magazines, large selection. Still have large selection of early Pilot ports and they are getting cheaper. **WANTED:** Top collar paid for Pilot radios, any model, any condition, any origin. Westinghouse WR-214, WR-314, WR-206, WR-306 receivers. Bill Moore, 3049 Box Canyon Rd., Huntsville, AL 35803. (205) 880-1207

**MESSAGE:** Notice: Leaf peeping in New England this autumn? Visit our shop in southwestern New Hampshire for an outstanding selection of radio and related books and paper. Call or write for directions. Frank and Lucia Bequaert, Rainy Day Books, PO Box 775, Fitzwilliam, NH 03447. (603) 585-3448

**WANTED:** Good working Baldwin (mica) earphones, also 2000 ohm w/ phones for batt. & crystal. Bakelite panel and coil forms, celluloid forms, loose coupler crystal set. Harold Borchers, 1636 Silver Lake Rd. NW, Bemidji, MN 56601. (218) 243-2510

**SEND ALL A.R.C. MAIL TO**  
**Antique Radio Classified**  
**P.O. Box 2, Carlisle, MA 01741**

**WANTED:** International projector (I.P.C.) or Motigraph field coil high or low freq. drivers. Sumner McDanel, 3104 South 147th E Ave., Apt. O, Tulsa, OK 74134. (918) 437-5403

**FOR TRADE:** McMurdo Silver in chrome chassis. DeForest "Interpanel set". DeForest "Unit panel set", 16 pieces. A.J.S. two valve see "The Cat's Whisker", p. 59. **WANTED:** Marconi, DeForest, Navy couplers, X-sets, WWI receivers, etc. Frank Dewaele, Losweg 1, 9030 Ghent, Belgium-Europe. Tel (011) 3292267845; fax (011) 3292361588

**FOR SALE:** Zenith 1000D, 3000D - \$90. Champion spark plug radio - \$95. Tom Thumb compact - \$125. Emerson jewelry box radio - \$65. Jeff Van Assche, 103 W. Silver-Meadow, Midwest City, OK 73110. (405) 732-5747

**FOR SALE:** Vacuum tubes - SASE for list. Grace Holstein, 1515 Sashabaw, Ortonville, MI 48462

**NEW VIDEO!!! LENGTH: 90 MIN. ONLY \$29.95**

## **IN QUEST OF THE LIGHT; VISIBLE & INVISIBLE**

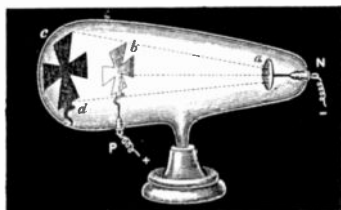

A HISTORY AND DEMONSTRATION OF GEISSLER AND CROOKES TYPE VACUUM TUBES FROM THE LATE 19TH THROUGH THE EARLY 20TH CENTURIES, AND THEIR ULTIMATE CONTRIBUTION TO THE DISCOVERY OF THE X-RAY.

**PRESENTING HISTORICAL ELECTRICAL APPARATUS FROM THE  
COLLECTION OF JAMES & FELICIA KREUZER**

**ORDER FROM: NEW WIRELESS PIONEERS  
BOX 398, DEPT. A1, ELMA, N.Y. 14059 716-681-3186**  
(Please add \$2.00 for postage & handling)

**FOR SALE:** Hammarlund HQ100 with matching speaker. Grundig 2065 AM-FM-SW. Philco 44 cathedral. Guild 556 Country Belle radio. Broadcasters commercials timer, Bakelite. RCA B411 portable, nice. Silvertone 210 marbled green portable. Gates Sta-level AGC audio unit, great for ham use. Xonex Sparton Bluebird reproduction set. Belle of Louisville riverboat transistor radio. Philco G4242 Predicta. **WANTED:** Detrola 106 radio. Truetone AM-FM, Model D-2026, (Bunis 2, p. 187). Charles Harper, 150 Duncan Ave., Paris, KY 40361. (502) 769-0404, 6:30-10:30 pm Eastern

**FOR SALE:** DeForest RJ4 Audion control box w/good spherical audion tube. Best offer. Jim Clark, 1292 Starboard, Okemos, MI 48864. (517) 349-2249

**FOR SALE:** Truetone Boomerang radio, brown Bakelite, in mint condition - \$175. Larry Drago, 383 Lincoln Dr., Cheshire, CT 06410. (203) 272-6030

**WANTED:** Unusual early tubes prior to 1927. Single items, accumulations, collections. Dead or alive. Ed Bell, 5311 Woodsdale Rd., Raleigh, NC 27606. Fax/phone (919) 851-1517

**FOR SALE:** Very rare German tube (RV-2P 800). Grey metal housing with one end having a blue dot with the word Valvo above. On the metal housing is the Reich symbol and the ID number. Will sell or trade for best offer. Also have Connecticut J117 in near mint condition. Jon Winter, 1421 Saint Paul St., Bellingham, WA 98226. (206) 734-4168

**FOR SALE:** Radio World mags. Feb. 13, Feb. 20, Oct. 29 and Nov. 26 all 1932 - \$10 ppd. Thomas F. Pollock, WB6ZYE, 243 West Lime Ave., Monrovia, CA 91016. (818) 359-8013

**WANTED:** Catalins by Emerson in all forms. Allow me to satisfy your appetite for greed! Please write or call collect: Rain Buttignol, 214 State St., #7, Portsmouth, NH 03801. (603) 427-1384

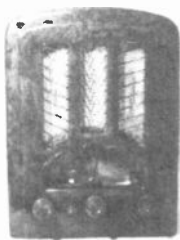

**WANTED:** Info, circuit diagram for DeForest, Crosley 52. Martin Lamonde, 265 Du Pont, Apt. 101, Quebec, Quebec, Canada G1K 6L8

**FOR SALE:** BC342N, clean, manual, needs alignment - \$60. R375/APR4X radar search rcvr, CV253 band-switching tuner installed, 38-1000 MHz, 115 AC - \$100. Eimac VS2 vacuum switch - \$20. National MB40SL network - \$20. B&W 350 audio network - \$10. 6E5, panel mount - \$7. Over (100) panel meters. Also old transmitting tubes, capacitors, misc. old parts. List SASE. Shipping extra. George H. Goldstone, W8AP, 1010 Burnham, Bloomfield Hills, MI 48304. (313) 647-3399

**FOR SALE:** "Transistoradio A Blast From the Past" video - \$25, plus \$3 for shipping. Send orders to: Norm Smith, 7203 17th Ave. NW, Bradenton, FL 34209. (813) 792-0003

**WANTED:** Old Timer's Bulletins pre Vol. 17, telegraph keys good or parts. R. D. Chenez, RFD 2, Box 437-J, Plymouth, NH 03264

**MESSAGE:** Tubes - will have a list of rare scarce old collectors tubes about Nov.-Dec. List will cost \$4 plus large SASE. 52c stamps. Order list CTL400. Krantz, 100 Osage Ave., Somerdale, NJ 08083

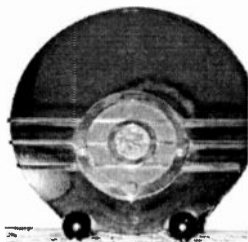

**FOR SALE:** 1936 Sparton, blue mirrored radio, in excellent condition and is completely original - Best Offer over \$3,500. J. Simonsen, PO Box 1136, Burlington, TX 76097-1136

**WANTED:** Zenith 71 model radio 12S267, also chassis 1204 and speaker for same model. James R. Young, Rt. 14, Box 593, Florence, AL 35633. (205) 764-5969

**WANTED:** To buy or borrow original Pilot blueprints for kits. Will pay for borrow. Bill Moore, 3049 Box Canyon Rd., Huntsville, AL 35803. (205) 880-1207

**FOR SALE:** Navy 6 band tuner Mod DB20 by Radio Mfg. Engineers Inc. of Peoria - \$40. 4 track (yes 4 track) Automatic tape player for car - \$50. Signal Corp U.S. Army Code training set - \$100. Walt Wrabek, Rt. 4, Box 370, Menahga, MN 56464. (218) 564-4623

**WANTED:** Hallicrafters tilt base for SX-42, SX-28 or SX-29A in excellent condition. Dick Igou, 8435 Twisted Oaks, Garden Ridge, TX 78266. (210) 651-9049

**FOR SALE:** RCA 66X8 red Catalin, Arvin yellow/tortoise Catalin, Sonora wooden RCV-208, Howard wooden Model 906. Ted Chronister, 27 North Cameron St., Harrisburg, PA 17101. (717) 766-6436

**WANTED:** Little Spitfire horn speaker, label must be perfect. Mike Parker, KB7RSS, 945 S.E. Linn St., Portland, OR 97202

**WANTED:** Tube hi-fi & commercial amplifiers, speakers & horns. Altec, Scott, Fisher, Marantz, Dynaco, McIntosh, Leak, RCA, Jensen, Brook, Craftsman, Western Electric, Heath, Eico, Electro-Voice, J.B. Lansing, Acrosound. Audio power tubes KT-66, KT-77, KT-88, 6550, 6CA7, 7591A, etc. Sonny Goldson, 1413 Magnolia Ln., Midwest City, OK 73110. (405) 737-3312

**RATE FOR ADDITIONAL WORDS:**

17c per word

**FIRST 20 WORDS FREE!**

Cash or stamps OK for small amounts.

Your payment helps to keep A.R.C. healthy!

**FOR SALE:** Worn but good reading copies: \$5 each: Lescarboura, Radio for Everybody, 1922; Nilson, Practical Radio Communication, 1943; Henney, Principles of Radio (5th) 1945; Department of Commerce, Radio Instruments and Measurements, 1924/37; Terman, Radio Engineers' Handbook, 1943; Kendall, Radio Simplified, 1923; Popular Science, Everybody's Radio Manual, 1942; Signal Corps, Principles Underlying Radio Communication, 1921. Add \$3 postage per order. Frank Bequaert, Rainy Day Books, PO Box 775, Fitzwilliam, NH 03447. (603) 585-3448

**FOR SALE/TRADE:** Misc. parts for Emerson Patriot/Aristocrat, 520; Fada 845 (chassis); Dahlberg coin-op; Mitchell lamp-radio; Setchell Carlson 416 frog-eye; 1970's Heathkit catalogs. **WANTED:** Grille for S/C 416, Zenith chassis 5529 for Models 5S3??, Zenith battery holder for 3000-1. Bill Timoszyk, 35283 Leon, Livonia, MI 48150. (313) 421-2076, 8 pm - 11:59 pm

**WANTED:** Two single tube bases for an Atwater Kent 12 breadboard, or equivalent. Gary Watkins, 8006 Greenwald, Belton, MO 64012. (816) 322-0773

**WANTED:** National AGS or SRR plug in coil receivers. **FOR TRADE:** Neon-chrome Crosley radio sign. Niel Wiegand, WA5VLZ, 12105 Mustang Chase, Austin, TX 78727. (512) 219-8548

**FOR SALE:** Royal 500, coral - \$150. Rider I to V abridged - \$45. Rider's NR1 Service Manual (Vol. I to XII abridged) - \$45. UPS extra. John Schehrer, 508 Gray, Joplin, MO 64801. (417) 781-4028

**FOR SALE:** Grunow Model 508 table farm set. 6Vdc/120AC, recap, works good, cracked lens. SX24, modified. RME 45, wrong knobs. HP608A, excellent. **WANTED:** Coils for HR07. Jack Iverson, N9KYT, 1110 Old Mill Dr., Palatine, IL 60067. (708) 359-0941

**WANTED:** Will pay up to \$500 for mint condition receivers and amplifier combinations made by Conn Tel. & Tel. before 1925, i.e. sodion or similar style. Reward for information leading to purchase. Larry Drago, 383 Lincoln Dr., Cheshire, CT 06410. (203) 272-6030

**FOR SALE/TRADE:** Antique TV camera, RCA 30's or 40's with tubes and iconoscope and lens, undamaged but not tested. Trade for new Camcorder or BO. H. Hart, PO Box 165, Whitethorn, CA 95589

**FOR SALE:** N.O.S. military PR-102/CB communications device - Best Offer/trade. See September A.R.C. ad, much left. Michael Crain, RR 1, Box 472, Harveys Lake, PA 18618-9782. (717) 639-2794

**FOR SALE:** Signal Corps equipment; telephone/telegraph converter TA-182/U, cover missing - \$45. TG-34A code machine w/ (25) reels of tape, works - \$100 firm. Vietnam era code machine, Electronics Futures, two 22 track tapes, three manuals, receiver, oscillator modules - \$45. All heavy, share shipping. Robert W. Butt, N1KPR, 8 Little Fawn Dr., Shelton, CT 06484. (203) 924-1120, 9-9 EDT

**FOR SALE:** Sceptre Boys radio 2 transistor, N.I.B. - \$65. Avon radio - \$15. Recordio 6B10 parts - \$15. Jim Smith, KB7LBY, 113 E. Jefferson, Riverton, WY 82501. (307) 856-9304

**WANTED:** Arvin metal sets, Models 40, 402, 302A, 522A, 444, 444AH, 442, 341T, 243T, 440T, 540T, 840T and the Pilot 3" TV set: dollars offered by international money order or credit card. **FOR SALE:** English crystal sets, also for swap with Arvin sets or Pilot TV set. Rudi Sillen, Limberg 31, B-2230 Herselt, Belgium

**FOR SALE:** Panasonic ball R-70 - \$12.95. RE-6280 in box - \$25. Webster Chicago 100-608 changer - \$12.50. Jerry J. Schaefer, 932 North 4th St., Grand Forks, ND 58203. (701) 772-2991

**FOR SALE:** Radios, hi-fi, etc. - new 3-page lists; publications, manuals - added 4 pages. SASE please. Chuck Vaccaro, 708 Booth Ln., #0, Ambler, PA 19002. (215) 646-3541

**HELP:** Is the Trans-Oceanic battery plug 100 ohm resistor usec in battery operation? Jim Dolensky, 14N755 Covered Bridge Rd., Dundee, IL 60118. (708) 428-4488

**WANTED:** Service manual for TEAC reel tapecorder Model A4010S. Ray Barnes, 38 Woodmere Rd., Framingham, MA 01701. (508) 877-6040

**WANTED:** Quack medical, scientific, and optical devices. Especially violet rays in mint condition. Richard Cane, 1333 N.W. 127th Dr., Sunrise, FL 33323. (305) 846-7116

**OLD TECH** *Early*  
**BOOKS** *Technical*  
**& THINGS** *Books & Apparatus*

**Announcing - Catalog No. 1**  
**Available Soon\***  
**Write For Free Copy.**

**We Specialize In:**

Wireless - Radio - Television - Telegraph  
Telephone - Electricity - Computers - Slide Rules  
Electro-Medical - Calculators - Typewriters  
Atomic Energy - Astronomy - Skiing

**We Buy & Sell:**

Books - Juveniles - Catalogs - Magazines  
Manuals - Ephemeris - Novelties - Apparatus  
Anything Related!

*Send us a list of your general & specific wants.*

**OLD TECH - BOOKS & THINGS**

John V. Terrey, Proprietor

P.O. Box 803, Carlisle, MA 01741 U.S.A.

*\*Still delayed, but eventually I will get it finished!*

**TOGGLE SWITCHES AT WHOLESALE PRICES**  
**SWITCHES-SWITCHES-125V or 1/2 RATING AT 250V**

— FULL SIZE TOGGLE SW. 1/2" Dia. —

Type	Mod.#	Cont.Rat.	Lead	Price/100	1/000
SPST	S125	6A/125V	6" WIRE	.75	.65
SPST	S128	4A/125V	Solder	.55	.45
DPDT	S126	5A/125V	Solder	.75	.65
DPDT/	S127	10A/125V	Solder/	1.15	1.05
		5A/250V	Screw		

— MINIATURE TOGGLE SW. 1/4" Dia. —

SPST	S131	6A/125V	Solder	.55	.45
SPDT	S132	6A/125V	Solder	.59	.49
SPDT	S141PC	6A/125V	PC	.59	.49
SPDT	S145PC	6A/125V	PC/Rt-Ang	.59	.49
SPDT/	S129	6A/125V	Solder	.75	.65
		3A/250V			

MOM-OFF-MOM	S134	6A/125V	Solder	.75	.65
-------------	------	---------	--------	-----	-----

— ON-OFF-ON 3A/250V

DPDT	S133	6A/125V	Solder	.65	.75
DPDT	S143PC	6A/125V	PC	.65	.55
DPDT	S146PC	6A/125V	PC/Rt-Ang	.65	.55
DPDT/	S135	6A/125V	Solder	.90	.80
		3A/250V			

— ON-OFF-ON 3A/250V

DPDT/	S144PC	6A/125V	PC	.90	.80
		3A/250V			

— ON-OFF-ON 3A/250V

DPDT/	S130	6A/125V	Solder	.90	.80
		3A/250V			

— MOM-OFF-MOM 3A/250V

— SUB-MINIATURE TOGGLE SWITCHES 1/8" Dia. —

SPDT	S136	3A/125V	Solder	.80	.70
DPDT	S137	3A/125V	Solder	.90	.80

— MOMENTARY PUSHBUTTON SWITCHES 1/4" Dia. —

SP-NOR OPEN MS-1	3A/125V	Solder	.25	.22
SP-NOR CLOSED MS-2	3A/125V	Solder	.25	.22

FERTIK'S ELECTRONICS

5400 Ella Street, Philadelphia, PA 19120 - (215) 455-2121

**WANTED:** For my extension of QST. 1916 Jan., Feb., Apr., Jul., Sep., Nov., Dec. 1917, 1918, 1919, 1920, 1921, 1926 Aug., Sep. 1927 Feb., Apr., May, Jun., Jul., Aug., Sep., Oct., Dec. 1928 Jan. **FOR TRADE:** All my doubles of QST. 1922 Feb., Mar., Aug., Sep., Oct., Nov., Dec. 1923 Feb. 1925 Jan., Feb., Mar., Apr., May, Jun., Jul., Aug., Nov., Dec. 1962 Feb., Mar. 1928 Sep., Dec. 1929 Jun., Jul. 1931 Aug., Sep. For information: Frank Dewaele, Losweg 1, 9030 Ghent, Belgium, Europe. Tel. 0113292267845. Fax 0113292361588

**FOR SALE:** RME converter 152A - \$35. Radiomarine GRM-R1A, 3 band 2-3 MH, no crystals, rack mount - \$100. Radio Club of America 1959 Golden Jubilee Yearbook - \$50. All plus shipping. Lisaius, 116 Orton Rd., W. Caldwell, NJ 07006. (201) 226-7943

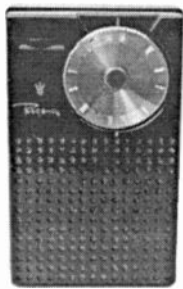

**WANTED:** Regency TR-1, TR-1G, TR-4. Any color, any condition. Marty Bunis, RR 1, Box 36, Bradford, NH 03221. (603) 938-5051, before 8 pm EST

**FOR SALE:** Taking bids on 1954 Capehart TV in solid cherry cabinet with doors. Tube 18", screen size 23 1/2". Send by October 20. L. Sharp, Box 1027, Dennis, MA 02638

**WANTED:** Speaker Philco console radio Model 38-4, spkr #H29, Part #36-1293. Ed's TV, 4415 S. Kings Hwy., St. Louis, MO 63109

**WANTED:** 500Ω speaker for Hallicrafters S-38A "off-tone positions" switch for SX-110 and similar models, N.O.S. 6550 tubes for personal use, chassis for Zenith 5R312. **FOR SALE:** RCA 9X571 Bull Horn, good condition, maroon horn, works - \$50. Pioneer F101T tuner-timer, like new - \$95. oyna FM 3 tuner, works, fine condition - \$75. Series 20, C-21 preamp - \$125. Akai-X100D, reel-to-reel with orig. case and box, works good - \$70. Steve Greene, 8157 Staples Mill Rd., Richmond, VA 23228. (804) 276-9808

**FOR SALE:** RCA 1938 No. 32 tube in original, unopened, Nipper box, vg-exc (3) - \$30 each & postage. Bank MO only. Terry Reilly, 3232 Clifton, No. 6052, St. Louis, MO 63139

**WANTED:** Philco automatic television timer Model #AT-200. Tony & Lynn DeMara, 40231 Day, Clinton Township, MI 48038-4739

**WANTED:** Information about Sylvania SN4 and SN5. Thanks. John Uscinowski, RR #1, Box 379, Greenwich, NY 12834-9519

**FOR SALE:** Bendix 114, tan and marbled brown, few minor stress lines in tan - \$250 OBO. Howard wooden set, Model 906 - \$30. Ted Chronister, 27 N. Cameron St., Harrisburg, PA 17101. (717) 766-6436

**WANTED:** Will pay \$50 for a good condition copy of the Guitar Amplifier Handbook by Jack Darr. Published by Sams. Bill Hall, 1864 Pennoyer, Grand Haven, MI 49417. (616) 847-9039

**FOR SALE:** New old stock, American made, audio output transformers, single pentode to 4 ohm voice coil, PC mount, 100 available - \$1.50 ea. plus shipping, quantity discounts. Ellsworth O. Johnson, 364 S. Coeur d'Alene St., Spokane, WA 99204. Phone/fax (509) 838-2161

**FOR SALE:** Riders radio manuals 6 thru 15, very good to excellent - \$18 ea., l ship. John Snow, 4539 Bartlett, Shorewood, WI 53211. (414) 964-0194

**WANTED:** Japanese transistor radios. Please send photo, sketch or Xerox copy with price to: Roger Handy, Box 24527, Los Angeles, CA 90024. (310) 451-4040

**WANTED:** Fold-down handle and correct knobs for Westinghouse Little Jewel portable refrigerator radio.

**FOR SALE:** Rider manuals, old tubes and radios. Send your needs and SASE to: Bill Wieczorek, 1116 Cummings Dr., Boulder City, NV 89005. (702) 293-2548

**FOR SALE:** RCA "Color Television" banner, 1960's? - \$95. Thorotest "Mission Impossible" mini tape recorder - \$30. John Casper, 2605 S. Peninsula Dr., Daytona Beach, FL 32118. (904) 767-2075

**FOR SALE:** RCA signal and marker generator WR-99A (19-260 MHz) - \$28. Voltamp battery No. 2 Solace unit FULD current regulator made by Truax Greene Co., in wood box - Offers. Allied Knight KN-740 amp parts - \$10. Garrard RC98/4L turntable w/Bakelite base, 1950's - \$40. (4) NE-30 neon reg. base bulbs. Kevin L. Moe, 616 Lockrem, Ottawa, IL 61350. (815) 433-4598, evenings

**FOR SALE:** E.H. Scott Phantom Deluxe FM chassis with speakers - \$1,500. Rider TV Manuals 1 to 16 - \$350, Canadian funds, you ship. Sam Waskeba, 44 Massey St., Toronto, Ontario, Canada M6J 2T4. (416) 368-6532

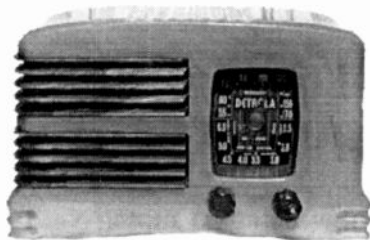

**WANTED:** Symphony and Detrola Catalins. Carpe Catalin; ne plus ultra! Please write or call collect: Rain Buttignol, 214 State St., #7, Portsmouth, NH 03801. (603) 427-1384

**FOR SALE:** Serious WW2 collectors only: Japanese field radio receiver with wooden case, rope/leather handles, very good condition with Japanese markings on receiver and case, patterned after HRO with plug-in coils, spare parts in case. Polaroids available. Expensive. Galbraith, 1214 S. Alvord Blvd., Evansville, IN 47714. (812) 476-7601

**WANTED:** Motorola 53H1 table radio. Also Zenith Y733G. JVC HR-D566 vcr any condition. Al Manieri, 384 Bates St., Phillipsburg, NJ 08865. (908) 454-3699

**WANTED:** I am seeking copies of Broadcasting and Telescreen Yearbooks from 1949-1957 in good condition. Will consider reasonable offers. David Shapiro, 484 Hammond Dr., Griffin, GA 30223-4024

**FOR SALE:** Uncommon Rembrandt 10" table model TV. When was the last time you ever saw one? - \$1,000. Jim Clark, 1292 Starboard, Okemos, MI 48864. (517) 349-2249

**FOR SALE:** GE H-51 console, a magnificent radio in pristine condition, works very well, heavy carved walnut finish - \$225. Larry Drago, 383 Lincoln Dr., Cheshire, CT 06410. (203) 272-6030

**WANTED:** Antique light bulbs with tips, brass blade & cage fans. Cash or radio trades. Gene Baudouin, 247 Lowe St., Hahnville, LA 70057. (504) 783-2610

**FOR SALE:** 1946 Silvertone Model 6002, midget metal, needs paint - \$40. 1949 Airline Model KR-1520B, midget metal, ivory - \$55. Silvertone Model #1, small metal set - \$55. 1948 Bendix Model 110W, ivory, nice - \$60. 1946 Airline Model 14BR-514B, brown Eakelite, plays good, crack on bottom - \$50. 1946 Truetone Stratoscope Model D2615, streamline, 6 push buttons - \$95. 1942 Stewart-Warner Model 206FA, Bakelite tombstone, nice - \$75. 1936 Stewart-Warner Model R1691, 4 knobs, large black dial, top mounted speaker, nice - \$95. 1936 Fada Model 260V, ivory plastic with plastic back cover, Deco bars, airplane dial - \$100. 1939 Crosley Model 744, tombstone, 4 knobs, large center dial, top mounted speaker - \$100. D720 Truetone chassis complete with tubes - \$20. Hallicrafters Model 38C - \$20. Hallicrafters Sky Buddy - \$45. TV-7U tube tester, w/manual, not working - \$32. 1932 Sentinel Model 1560, cane, plays with AC or plug in for car - \$100. All items plus UPS. George Jones, 1943 Palm Dr., Fernandina Beach, FL 32034. (904) 261-6533

**FOR SALE:** Rare pieces. (39) RCA Mexican La Siesta, exc cond. - \$850. (33) Philco 60 cathedral, exc cond. - \$450. Selectronic #100 AM/FM solid 7/16" mah./cab./g/cond. - Offer. (48) Watterson #511 farm-batt. E.Z. restorable - Offer. + p-s@i. J. J. (Jess) Sevier, 13927 Jaycreek Ct., Houston, TX 77070. (713) 376-6034

**FOR SALE:** 1927 radio receiver metal battery set, Model AR8503, made by Radio Marine Corporation of America in N.Y.C.; believed to have come from early U.S.A. cruise ship of that era - \$250. Larry Drago, 383 Lincoln Dr., Cheshire, CT 06410. (203) 272-6030

**FOR SALE:** Cathedrals: Majestic 50, GE K 64, Philco 60, Philco 38A, Philco 84, Clarion 80, Philco 80 Jr., Majestic 56 Ardnriara, Silvertone 1589, RCA 7T. Tombstones: Gilfillan 63X, Philco 610, Zenith 4T26, Philco battery, Philco 66, Motorola 5T, Philco 37-38, Cardinal 60, GE 53. Other radios: Zenith R600 brown, RCA 73Y-10, Eveready 3, Graybar 31 with speaker, Kolster 20 with speaker, Stewart-Warner 301A, shortwave converter. Battay sets: Grebe MU1, Freshman, Federal E10, Airline 6, AK 35, AK 49, Gilfillan 11, Speakers: RCA UZ1325, AK mount, AK F2 Electro. Jim Stratton, North 6902 Post, Spokane, WA 99208. (509) 328-8471

**WANTED:** Wincharger items: complete generators, parts, literature, whatever. Bob Hays, 18 Canning St., Council Bluffs, IA 51503-4723. (712) 323-8510

**FOR SALE:** Porto-Baradio no chips or cracks, works fine - \$185. Crosley Buddy Boy Model 54, looks and works very good - \$295. Philco 20 cathedral, looks & works good - \$180. Majestic treasure chest, looks very good, works - \$185. Zenith 5S29, v/good cabinet & works - \$175. Double slide tuner, factory built, nice - \$75. Stromberg-Carlson 1A and 2A horn speakers, both work - \$120 ea. Stewart-Warner horn speaker, very good - \$115. Seven Kylelectron speaker panels - \$8 ea. Bob Barnes, Box 275, Monroe City, MO 63456. (314) 735-2945

**FOR SALE:** Test equipment manuals for Eico, PACO, Precision, Triplett and Simpson. Copies only. Write your needs. Include large two-stamp envelope. Sams, car radio manuals AR-70 to AR-135, price - \$63. Plus \$15 shipping. Lot sale only. Clayton Mundine, 6112 S. Flores St., San Antonio, TX 78214

## TUBES • PARTS • SUPPLIES YOUR COMPLETE SOURCE

### TUBES:

3000 audio, receiving and industrial types in stock, including early and foreign types. Discount prices!

### CAPACITORS:

High voltage electrolytic and mylar capacitors for tube circuits.

### TRANSFORMERS:

Hard-to-find power transformers, audio transformers, and filter chokes for tube equipment.

### SUPPLIES:

Chemicals, test equipment, wire, batteries, tools, etc.

### LITERATURE:

Extensive offering of literature and books on antique radios, hi-fi, communications equipment, tube data, and circuit diagrams.

### PARTS:

Resistors, lamps, tube sockets, potentiometers, grill cloth, knobs, vibrators and more.

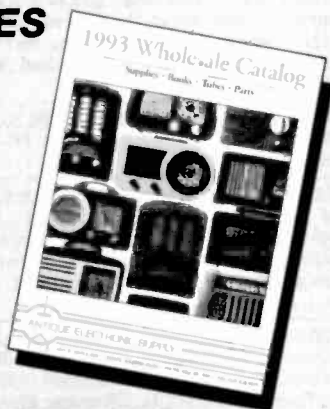

*"Write or call for our 32 page wholesale catalog"*

# ANTIQUE ELECTRONIC SUPPLY

6221 S. Maple Avenue. Tempe, AZ 85283, Phone (602) 820-5411, FAX (602) 820-4643

**FOR SALE:** Radiola 3, 3A, 18, UZ1325, UZ1320, AKM horn speakers, Crosley 51, 52, Supertridyln. **WANTED:** Glass dial & side speaker grille brown for Nordemend Tanhäuser U.S.A. Model T.N.R. E338, a glass dial for Telefunken Allegro, Nordemende Globe Travel Pro. Phillip S. Gilliana, 5733 Warren Ave., Morton Grove, IL 60053. (708) 965-7327

**FOR SALE:** DC power cable for T-195, GRR-5, MD-203, CV-278, GRC-106, others, unused - \$15. C-7673/ PCC-1 AC pow. sup. for PRC-25, 10 lbs., used - \$25. AT-271 antenna, used - \$8. PRC-47 radio set w/ accessories, chest, used, uncheckd - \$150. Accessories for PRC-47 - Write. URM-25D, 10-50MHz, sig. gen. for parts, 45 lbs. - \$25, 2 for \$40. Tartan Electronics Inc., PO Box 36841, Tucson, AZ 85740-6841. (602) 577-1022

**WANTED:** Pilot FM tuner Model T601, must be in excellent condition. Michael Stern, 1285 Alum Creek Dr., Columbus, OH 43209. (614) 252-4422

**FOR SALE:** RCA transistor battery counter display, mint - \$85. Air King 512, brown Bakelite with white knobs, N.I.B. - \$95. Rider's 6-14, excellent - \$15 each. Avon cathedral radio bottle - \$15. Magnavox 2-AM-80, N.I.B. - \$80. Avon jukebox bottle, N.I.B. - \$25. Emerson 888 aqua Pioneer - \$60. All plus UPS. Barry McDaniel, PO Box 5544, Little Rock, AR 72215. (800) 755-3326

**WANTED:** Hammond & other 2A3/6A3 amps. Also Brook, Radiocraftsmen, Leak & Regency mono amps. My offers are still highest for clean units and finder's fee gladly paid as well on: Hadley, Marantz, McIntosh MI200 or parts, 18" field coils, WE, Fairchild, Fisher, Eico, E.V., Vintage speakers, new used 8005, WE 300A/B, 6550, 6LF6, 7591, KT66/88. Ed Schneck, 1401 Ocean Ave., Brooklyn, NY 11230. (718) 377-7282, M-F, 2-6 pm or leave message

**FOR SALE:** Early tube hi-fi equipment: Heathkit 25 watt amp, Model AA-121 - \$30; Heathkit 14 watt amp - \$25; Sherwood Model S5003, 80 watt stereo amp - \$30; Fisher Model 500 tuner/amp - \$35; Ampex Model A621 amplifier/speaker (have 2) - \$25 ea.; Ampex Model A121(?) tape deck - \$18; Panasonic RE77A stereo - \$25. Richard Haneline, 3600 Cuba Blvd., Monroe, LA 71201. (318) 387-6764

**WANTED:** Hallicrafters shortwave SX96, SX99, SX100. #80 tube with base. Walter Mosley, PO Box 1131, Crosby, TX 77532

**WANTED:** Lafayette Model HB333 or similar 23-channel CB radio with mike. Also Lafayette portable 3" reel-to-reel tape recorder with mike! I will pay top dollar for these items in mint or near mint condition! Robert T. Cosby, Jr., 6727 Wilber Cir., Richmond, VA 23228. (804) 261-6939

**FOR SALE:** Bendix brown/tan 114. Early Japanese owl transistor. Fada 711 yellow/red trim. RCA BP-10 black/chrome, flip-lid portable. Airliner 94-BR 1535A. (2) Original Fada 652 dial glass. Ted Chronister, 27 No. Cameron St., Harrisburg, PA 17101. (717) 766-6436

**FOR SALE:** Rider's manuals: Volumes 1-17. Prices range from \$12.50 to \$85 per volume. LSASE for price list. Sam Faust, PO Box 94, Changewater, NJ 07831

**WANTED:** Complete set of tube chart supplements issued since 1957 for Eico tube tester Model 625. Will pay fair compensation. Stanley E. McGrane, WA1BPE, 7 Debbie Ln., South Dennis, MA 02660. (508) 398-9470

**FOR SALE:** Fada 260G white Plaskon with gold trim, like Chinese red in Collin's #1 - \$275. 14" Philco etched glass and neon dealer window sign, 1931 - \$550. Stromberg-Carlson shortwave converter, 1934 - \$150. RCA 111 - \$110. Philco Mystery Control unit - \$60. Philco banner advertising demonstration of the new Mystery Control - \$115. Colonial peaked top tombstone, walnut and black lacquer - \$150. Wurlitzer Lyric cathedral S63 original - \$225. AK 84, worn finish - \$365. Pilot FM tuner - \$35. Howard FM tuner - \$110. Arvin Rhythm King console - \$750. Arvin 518 Phantom Baby - \$125. Black Zenith pocket radio 4K600 portable excellent condition - \$145. Stewart-Warner Varsity 97-562, brown - \$225. 1931 Bakelite Ekco M23 tombstone - \$750. RCA 21T tombstone; RCA T-10-1 tombstone refinished; (3) Zenith chrome fronts: 809, 829, 835. Zenith consoles: 15U270; 15U269; 15S373A; 12S371; 12S370; 12U159; 12U158; 12A58; 12S265; 12S266; 12S267; 9S365; 9S262; 9S367; 8S154, 8S463; 7S366; 7S363, 75, 410, 880 and many others. Zenith chair-sides: 12S245; 9S344; 9S244; 9S242; 7S240; 7S343, 6S249 and many others. If you are looking for a set not listed, please call for more info. We can and do ship consoles anywhere and we do it right. Zenith table models: 807; 4B131; 5S126; 5S119; 5S127; 5S228; 5J217; 6D311; 6S223; 6D117; 7S323; 6S27; 6V27; 6D413, crack; 6P428; 6D425; 7S432; 6S527; 6D525; 7S633; 7S634 and many others. To reference most Zenith radios, we offer a 60-page 11" x 17" Zenith Brochure Book depicting models from 1920 to 1946 - \$28.95 ppd. Zenith Trans-Oceanics: 1000 - \$175; 3000 - \$175; 7000 - \$295. We accept Visa and MasterCard. All radios unrestored electrically unless noted. Shipping extra unless noted. Satisfaction guaranteed highest quality possible assured. Contact us for professional speaker reconing and repair. When in Minneapolis, be sure to visit our retail location in our own Radio Row, just a few minutes from the airport. Alan Jerspenson/Mike Emery, PO Box 17338, Minneapolis, MN 55417. (612) 727-2489, 8 am to 8 pm Central time, 7 days. Fax only (612) 727-1908, 8 am to 8 pm

**WANTED:** Any information on 2.3 to 6.6 MHz CW/PH transmitter/receiver using 1D8, 2-1N5, 1A7 and (3) 6V6 tubes. John Webb, W6RCW, 12736 Erin Dr., Auburn, CA 95603. (916) 885-9556

**FOR SALE:** Signal, Clapp-Eastham loose couplers. Chelsea ZR4, Airliner 1 tube, Sodon horn. **FOR TRADE:** Grebe CR14. Victor Lotrich, 725 Bent Ln., Newark, DE 19711. (302) 733-0639

**FOR SALE:** Showroom quality RCA 125 tombstone, all original, shortwave, airplane dial - \$225. AK 84, all original - \$365. RCA 9KZ console, all original, good working shape - \$200. Zenith 3000-1 w/original AC adapter, excellent - \$165. Zenith H500, excellent - \$75. Chrome Courier 23+, working - \$150. Open to offers or trades for communication gear or transistors. Fred Watson, KB8NRF, PO Box 58, 581 W. Summit St., McClure, OH 43534. (419) 748-8798

**FOR SALE:** National receivers: NC-98, mint collector quality, manual - \$165; HR050T-1, vg, manual - \$250. Dick Prester, 131 Ridge Rd., West Milford, NJ 07480. (201) 728-2454

**WANTED:** Bakelite back cover for Emerson Model U4B, 1936, or junker. Similar to Collins I, plate 31. Mervyn Ellsworth, 2309 N. 25th St., Boise, ID 83702. (208) 345-6878

**FOR SALE:** Magnavox AM/FM radio/phono ca. 1950's. Cabinet 38" x 24" x 41" high, excellent condition. L. D. Nichol, 290 Forest Ave., Glen Ellyn, IL 60137. (708) 858-5279

**FOR SALE/TRADE:** Hallicrafters SX-62 and SX-62A with R46. **WANTED:** Skyriders, Nationals, ACR111, eye tube sets. Jim Dillon, 201 Seward St., Juneau, AK 99801. (907) 586-3223, 10-6 PDT

**WANTED:** Chassis for Jackson Bell Model #6 tapestry radio. Doug Bennet, 2297 Richland Ave., San Jose, CA 95125. (408) 448-2597

**FOR SALE:** 3-tube Lafayette Explor-Air radio, worldwide, 4 bands, built-in speaker, 6 dials - main tuning, ant. tuning, bandspread, regeneration, bandswitch, off volume, very good - \$85 + shipping. Ken Flockhart, 425 So. 18th St., Fort Dodge, IA 50501. (515) 573-5477

**FOR SALE:** Hickok mutual conductance tube tester Model 533, works - \$65. Plus shipping. Donald R. Schoenheide, 1830 S. Christine, Westland, MI 48185-4455. (313) 595-7762



**HELP:** Need assistance identifying year and model number of RCA radio, Serial Number 55028. Rod Kennedy, 2 Teodora Ct., Moraga, CA 94556. (510) 376-7885

**FOR TRADE:** Catalin RCA-350. Want RCA-44, 77, etc. microphone. Jon Tanner, 717 E. Geneva Dr., Tempe, AZ 85282. (602) 967-3288

**WANTED:** General Electric E-71 tombstone cabinet or complete. Harold Grissom, 5013 4 Ave., Meridian, MS 39305. (601) 485-4427

**WANTED:** Grunow 550 5D chassis, need tuning capacitor 27150, dial scale maybe 27174. DuMont RA103 Chatham TV. Zenith 1203 repairable chassis for 12U158, 12U159. What radio chassis fits Magnavox VM18A 12" table model TV? **FOR SALE:** Splidtorf Lorenzo AC console. Silvertone 6437 13 tube 7 band console. Cannot ship. Stromberg-Carlson 1121 chassis. Test equipment clearance. Always over 150 radios, TV's, parts sets available. SASE for latest illustrated list. Dennis Smith, KN8H, Box 113, Trenton, MI 48183

**FOR SALE:** The following tubes test on TV-7 tester. (1) C-301-A - \$8. (1) 814 - \$10. (10) 5U4G - \$2.50. (20) 5U4GB - \$2. WE (1) 310A - \$6. WE (1) 247A - \$7. (2) 523 - \$3. (1) GLC KT88 - \$20. Tube tester bulbs NE45 - \$1.50, NE 51 - 75c, #81 - 75c. Telefunken stereo amp # ? with two ECL82 tubes, untested - \$20. All plus shipping. Robert Nicholson, General Delivery, Manilla, Ontario, Canada KOM 2J0. (705) 357-1466

**FOR SALE:** Communications receivers. Allied Mod #A-2515, looks very good and works - \$40. Hammarlund HQ120, looks original and case in very good condition, needs new dials - \$40. UPS extra. James E. Inglett, Rt. 1, Box 206, Midway, AR 72681

**FOR TRADE:** Little Gem crystal sets. Want quality crystal set, 1 tube set, horn speaker, Kadette Bakelite set, etc. Greg Farmer, 71 Rice Creek Way, Fridley, MN 55432. (612) 571-6062

**FOR TRADE:** Have Rider's Trouble Shooter's Manual How It Works, special section of Volume XI; Rider's XVI; Rider's XVII for early transistor set. Harold Trieb, 644 8th St. N, Hudson, WI 54016. (715) 386-2098

**FAX NUMBER FOR ANTIQUE RADIO CLASSIFIED (508) 371-7129 - 24 hours a day**  
**Ads - Subscriptions - Book Orders Charge to VISA/MasterCard**  
**Minimum Charge: \$10.00**

**WANTED:** Zenith Trans-Oceanics, tube or transistor models, any condition. Frank Manziano, 82 Monhegon Ave., Oakland, NJ 07436. (201) 337-5263

**WANTED:** Kit-built beginner radios with 1-3 tubes or transistors. Philmore, Revell, Western, etc. Hugh Miller, 6400 Maltby Rd., Woodinville, WA 98072-8375

**FOR SALE:** Rider's Volumes 1, 17, 18, 20 - \$30 to \$40 plus shipping. Robert J. Shuck, 10512 Winston Ln., Fishers, IN 46038. (317) 849-0381

**FOR SALE:** Emerson portable Model #560. Standard Micronic Rubys SRQ460F, SRK71F. Telefunken 5340MX. R. Oliver, 200 W. 70th St., #8G, New York, NY 10023. (212) 877-5678

**WANTED:** Lid & cover for Garod 4A1 portable. Rich Stamer, 331 Virginia Ave., Collingswood, NJ 08108. (609) 869-0238

**WANTED:** Amateur tube transceiver. Please state all information plus price & surface mailing to: Rogerio Carpinteiro, CT1ADK, PO Box 76, 2711 Sintra, Portugal

**FOR SALE:** Sonora semi cathedral - \$55. Garod 5A2 - \$35. Tiny Silvertone - \$45. LSASE list. John Lyle, 1161 S.W. Mulvane, Topeka, KS 66604-1456. (913) 232-0128

**WANTED:** Atwater Kent Models 93, 112, 275. Emerson Mae West. Jeff Aulik, 1708 Parkview Ave., Rockford, IL 61107. (815) 399-1902

**SERVICES:** Repair/replacement old meters. **WANTED:** Old meters/galvo's, open frame meters - as is. Ye Olde Meter Cellar, Leonard W. Cartwright, 113 Sea Terrace Way, Aptos, CA 95003. (408) 662-2977

**FOR SALE:** Philco Transitone 53-563, red - \$40. Clock radios; Crosley JC-6TNN, tar leatherette - \$30. Firestone 4-A-110, wood - \$20. John Koop, 48 Wheelbarrow Ln., Wantagh, New York 11793. (516) 731-6711



## WANTED

Will pay up to \$250 for the pictured Amrad 2575 crystal set. I also want pre-1926 Amrad sets & parts.

Andrew Mooradian  
5 Priscilla Lane  
Winchester, MA 01890  
Tel. (617) 729-1873 after 7 pm

**FOR SALE:** Zenith 8H061 working chassis, wavemagnet, speaker, miscellaneous parts - \$40 plus S/H. Bud Santoro, 3715 Bower Rd., Roanoke, VA 24018. (703) 774-9153

**FOR SALE:** Beautiful Catalin butterflies, red or green swirled, standup 2" w x 2 1/4" h x 1/2-5/8" d - \$50; thin ones - \$20. Ed Parise, 2441 Hartland Ave., St. Louis, MO 63114. (314) 423-9626

**WANTED:** Base and/or driver for AK Model R horn speaker. Driver assembly for AK Model L horn speaker. Sam W. Wrenn, 2314 Seminole Dr., #1207, Arlington, TX 76010

**FOR SALE:** DeForest Audion explanation and description. Franklin Institute 40-page reprint Xerox from 1920 - \$15 ppd. Gil Arroyo, 2766 S.W. 167 St., Seattle, WA 98166

**FOR SALE:** Book: Rider, Uslan Cathode Ray Oscilloscopes, Uses, 1955, 998 pages - \$27.50 ppd. Jim & Nadiene Farago, 4017 42nd Ave. S, Minneapolis, MN 55406-3528. (612) 722-0708

**WANTED:** Books, magazines containing radio construction projects. Single, dual 365pF/section variable capacitors. David Dameron, KG6BP, 819 Boundary Pl., Manhattan Beach, CA 90266-6621. (310) 318-5311

**SERVICES:** Antique radio & TV repair, 40 yrs. ex., 2 wks. turnover, excluding major parts. T. Romano, 8 Howe Ln., Millbury, MA 01527. (508) 865-6293

**WANTED:** National or Hallicrafters which has a F.B.O. Frank Potts, 435 West Twelfth St., Traverse City, MI 49684. (616) 941-8068

**WANTED:** Paragon RA-10, DA-2. Cash, trade up or down (AK-10 available). Brian Roberts, 3068 Evergreen Rd., Pittsburgh, PA 15237

**FOR SALE/TRADE:** WWII British Bomber Command receiver R-1155E, unaltered, orig. cond. - \$650. Sam Hevener, W8KBF, The Signal Corps, 3583 Everett Rd., Richfield, OH 44286-9723. (216) 659-3244

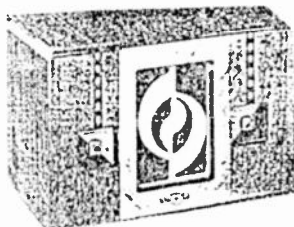

**WANTED:** Still looking for this Majestic chrome grille set and other chrome grille radios by all manufacturers. Jay Malkin, 1250 Galapago, #206, Denver, CO 80204. (303) 623-6451

**FOR SALE:** New list, 75+ radios, all types, some rare, no Cats. SASE. Don May, 16 Gulley Dr., South Windsor, CT 06074

**FOR SALE:** Dero Electronics Model PT-1 picture tube circuit tester for old black and white sets using large base picture tubes, very unusual and compact (3" x 1 1/2"), plugs into picture tube socket and uses a 6AF6-G eye tube to test filament and first anode voltage, bias and video signal - \$12 postpaid. Ken Greenberg, 4858 Lee, Skokie, IL 60077. (708) 679-8641

**WANTED:** Still looking for a power transformer for an RCA Model 121, 122, 221, 320, 321 or any lug-mounted RCA power transformer with minimum dimensions of 3 3/4" x 3 1/4" x 4" high. Bad unit OK. Ray Bintliff, 2 Powder Horn Ln., Acton, MA 01720

**WANTED:** H.H. Scott Model 280 tube amplifier. Wesley Carroll, 735 Blanchard St., Baton Rouge, LA 70806. (504) 387-9807

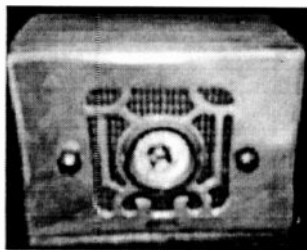

**FOR SALE:** Very very rare 1930's Van Dyke made by GE & Westinghouse, Hazeltine. There is one in the Smithsonian Institution. \$5,000 firm. John Bedross, 19147 Posledon, Cerritos, CA 90701. Phones (310) 865-6491, (714) 373-1087

**WANTED:** Tonberg 1055 receiver schematics, owner's manual or copies. Allied catalogs, Scott stereo amplifiers, tuners. Ed Ellis, 1559 S.W. 23rd Ter., Deerfield Beach, FL 33442. (305) 421-9999

**FOR SALE:** Radiola AR1375 crystal detector set with the 1-tube converter. This AR1375 has been "reconverted" back to a crystal set, see Alan Douglas article in Radio Age, Vol. 9, Number 2, February 1983. Also Echophone Model A, made by the Radio Shop, Sunnyvale, Calif. A and P Standard 5 tube receiver. Philmore Super radio crystal set, with original box. For list of additional items for sale, send SASE. David T. McKenzie, K0SVJ, 516 South Exeter St., Eustis, FL 32726. (904) 589-0149

**WANTED:** E.H. Scott Philharmonic receiver. Cloyd L. Briley, 725 Christine Dr., Vacaville, CA 95687. (707) 447-5866

**FOR SALE:** Fisher Series 80C master audio control. Also more tubes! See my adv. August A.R.C., page 47. Glen Richie, W4JGO, 643 Diamond Rd., Salem, VA 24153. (703) 389-3356

**FOR SALE:** Test equipment and literature - SASE for list. National Union (Riders) #2 - \$30. Parting Airline 93WG-1001C chassis. **WANTED:** Rider's 18-22. Mark S. Davidson, 2527 57th Ave. NE, Tacoma, WA 98422-3407. (206) 927-4838

**WANTED:** Manual 'or Supreme radio analyzer Model 336. Majestic 15 chassis, speaker, knobs and escutcheon, or will buy complete radio (cabinet unimportant). Bob Savary, 240 Cider Mill Rd., Tolland, CT 06084. (203) 872-2299

**FOR SALE:** Hickok 539-B tube tester with CA-5 adapter and manuals - \$275 plus UPS. Chuck Ochs, 19 Millfield Street, Woods Hole, MA 02543. (508) 548-3505

**FOR SALE:** Philco 37-690 console, 20 tubes, 7 speakers, 2 chassis, 15+ watts audio, PP6B4's, pickup - Bids. Francis H. Yonker, P.E., W2IBH, 1229 Inverary Pl., State College, PA 15801. (814) 867-1400



**FOR SALE/TRADE:** Miscellaneous collectible and usable tubes, some good, some display only - SASE for list. Sam W. Wrenn, 2314 Seminole Dr., #1207, Arlington, TX 76010

**FOR SALE:** RCA Victor Service Notes 1923-28, 29-30, 31-32, 33, 34, 35, 36 - \$200 + UPS. Victor Electrola VE-1070 - \$1,500. RCA AP952 power amplifier unit - \$65 + UPS. Pete Shoemaker, 2150 Forrest, Beaumont, TX 77703. (409) 832-6768

**FOR SALE:** AK 70 refinished and restored, very good condition - \$200. Pick up only. Thurman Coss, 13614 Starridge St., Poway, CA 92064. (619) 748-7695

**WANTED:** Speaker for Zenith 12S265; unrestored high-quality Zenith consoles/chairsides. Eddie Burris, 4224 Stoneham Ln., NW, Rochester, MN 55901. (507) 282-1879

**WANTED:** For Arvin Model 243T, knob and dial knob. Instruction manual, copy okay, for Precision signal generator Model E-200-C. Russ Linsin, 11872 Bellefontaine Rd., St. Louis, MO 63138. (314) 741-8832

**FOR SALE:** TD-55 tube tester, with approx. (100) old receiver tubes & some parts - \$150/all ppd. Paul Burgess, 12305 Harbor Dr., Woodbridge, VA 22192-2224. (703) 494-5403

**WANTED:** Model 157 tube tester by Accurate Instrument if reasonable. Larry Ray Cook, 362 E. South, Richland Center, WI 53581. (608) 647-4678

**FOR SALE:** RCA tombstone R-8, works good - \$75. Truetime tombstone Model 404 farm radio - \$60. Radiola, ivory 61-9 radio, works - \$25. Add UPS charges. Clark Trissell, 3530 Pawnee, Lincoln, NE 68506. (402) 488-5263

**HELP:** Can anyone provide a photo of the top raised panel on a Zenith 10-S-160? Bob Bakinowski, 1524 Saint Tropic, Tucson, AZ 85713. (602) 624-8029

**WANTED:** Any tube manual by RCA, Telefunken, CBS, Tung-Sol, Mullard, M-O Valve, Sylvania, and others. Steve Melkisetian, c/o Angela Instruments, 10830 Guilford Rd., Suite 309, Annapolis Junction, MD 20701. (301) 725-0451. Fax (301) 776-2892

**WANTED:** Realtones TR 555, TR 801, TR 8611; will trade wristwatches for these radios. Frank Prince, 3316 10th Ave., Racine, WI 53402. 414-639-9307

**FOR SALE:** LS-52 output trans.; SX28A rcvr, manual; Wurlitzer 510, ukebox amp. J. M. Stueber, 8920 Lexington Ave., NE, Albuquerque, NM 87112. (505) 299-2414

**WANTED:** Standard light bulbs from 20s-30s, 40 watt or 60 watt. Call: Mario Montemurro, 545 8th West, Prince Rupert, British Columbia, Canada V8J 2R1. (604) 627-4641, leave message

**WANTED:** Standard Micronic Fubies, Sony Micro 1R81, as well as other Micros, M.I.B. Victor Visalli, 48 Cedar Ave., Maywood, NJ 07607. (201) 845-0463

**FOR SALE:** Hickok 752-A laboratory & communications transconductance tube tester, excellent condition, serviced, with manual and old, new & foreign tube data - \$95 + UPS. Alan Kriss, 1872 Portsmouth Way, Union, NJ 07083. (908) 688-2092

**WANTED:** Arvin metal radios and Canadian Fleetwood metal sets. Jay Malkin, 1250 Galapago #206, Denver, CO 80204. (303) 623-6451

**WANTED:** Zenith tombstone, Model 10S130. Johnny Johnson, 2201 Newton St., Denver, CO 80211. (303) 455-3421

**FOR SALE:** Electronics magazines. Radio News, 1943-1948 - \$5 ea. Radio and Television News, 1948-1953 - \$5 ea. QST, 1962-1944 - \$3 ea. Popular Electronics, 1962-1963 - \$2 ea. CQ, 1963-1964 - \$3 ea. SASE for list. Plus UPS. Stephen Polednak, 6 Irving Rd., Weston, MA 02193. (617) 894-1274

## WANTED

### Top Prices Paid

**Radio & Audio Tubes:** 2A3, 45's, 50's, 845, 8005, KT66/88, etc.

**Western Electric Tubes:** 101, 102, 104, 203, 305, 211, 212, 242, 244, 252, 262, 264, 271, 274, 275, 276, 284, 285, 300, 301, 310, 339, 345, 347, 348, 349, 350, 421, 422, VT25A, VT52, etc.

**W.E. Speakers & Tweeters:** 555, 594, 595, 596, 597, 713, 728, 754, 755, 756, 757, TA4151, 4153, 4181, 4191, 4194, etc.

**W.E. Consoles & Amps:** 25B, 41, 42, 46, 86, 91, 92, 94, 95, 105, 106, 117, 118, 120, 121, 124, 129, 130, 131, 142, 143, etc.

**W.E. Horns:** 22, 24, 25, 26, KS-6368, 12024, 12025, 12027, etc.

**W.E. Microphones & Parts,** etc.

*Also looking for:*

*Tube-type equipment by McIntosh, Marantz, Westrex, ARC, Leak, Quad, Langevin, Altec, Telefunken, Siemens, Neuman, etc.*

*Vintage speakers, units, by Tannoy, Jensen, Altec, JBL, EV, Telefunken, Siemens, etc.*

**Audio City USA, PO Box 802, Northridge, CA 91328-0802  
(818) 701-5633**

**FOR SALE:** Fisher 400 receiver - \$100. X-100B Amp - \$70. Rek-O-Kut Rondine Jr. L-37 - \$75. Audax tone arm - \$35. CBY-52208 transmitter - \$20. Home brew Kilowatt linear, uses 810's, needs HV supply, coils, with tubes - \$85. Extra 810 - \$35 ea. Conar capacitor checker, works - \$25. **WANTED:** Eico HF-20, Grommes 221 amplifiers. Doug Weiss, 7305 Reynard Ln., Charlotte, NC 28215. (704) 531-7200, before 9 pm EDT

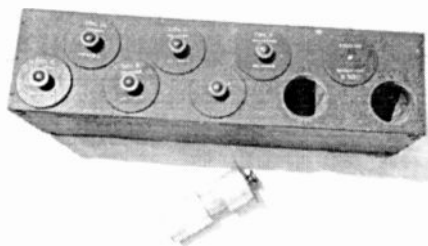

**HELP:** Does anyone know the manufacturer of the set of plug-in RF coils shown? 9 coils cover range of 70 kHz-40 MHz, all marked "Mod. 14A, #18." Eugene Gustafson, 1294 Swamp Rd., Furlong, PA 18925

**FOR SALE:** WHO 15 (TKR&TC-Chicago) small portable int. leather - \$60. Brogen-Challenger Mod CHB35 amp w/floor mike Cal-Rad DM17 - \$50. Alkay-preamps (skeletons) M-FL10 chass. w/tubes & Mod-A12, 4 KN - \$45/both. Tall case, c/Rad GE No. #1932, works, no apologies - \$350. Console RCA phono table w/large RCA head w/remote, @9 - \$50. RCA C11-1 @10+ console - \$150. RCA Table M-46X3, N/D, w/original wood back - \$60. Transistors: A/FM w/ant. W/House MH908PN9GP black-chrome, @9 - \$30. Ch/Master M-6229, black-chrome, @10 - \$35. Faircrest M-015F blk chro @, 8 - \$25. Ch/master M-PF6722 w/ant, @8 - \$15. GE M-7-2500C blk-chro, @9 - \$22. Car radio - Chieftan w/clock spkr Delco M-784817, (2) units, @9 - \$50. Sylvania M-430L bat port by Colonial-Buffalo, @7, in looks - \$25. Plus pkg. & shipping. Bernie Samek, 53 Old Palmer Rd., Palmer, MA 01069. (413) 245-7174

**WANTED:** TV's old or unusual, early handheld and mini-screen TV's, JVC Pyramid, Panasonic Flying Saucer, any unusual TV, Sony grey metal TV. Lee White, 25 Hawthorne Ln., Weston, MA 02193.

**FOR SALE:** Doll's House radio c.a 1933 by Pure Oil Co. U.S.A; German WWII Enigma code machine, Rarest 4-rotor model; Clydelco tubular twin detector x'tal set; Cosmos round moulded x'tal set, boxed; German 1930's Bakelite people's sets; will trade for rare Catalins or early toys. Jim Taylor, G4ERU, 5 Luther Rd., Winton, Bournemouth, BH9 1LH, United Kingdom. 0202-510400

**FOR SALE:** Heathkit: IG-4505 oscilloscope calibrator - \$35. SM-20A VTVM, factory assembled - \$30. Cantenna dummy load - \$20. IG-4540 5 MHz solid state oscilloscope - \$65. SM-5238 solid state factory assembled ACVM - \$40. Poor man's spectrum analyzer kit - \$65 with above scope - \$45. Much more - RF generators, audio oscillators, scopes, meters, etc. List - LSASE. Kirk Ellis, KK4YP, 203 Edgebrook Dr., Pikeville, NC 27863. (919) 242-6000, evenings

**FOR TRADE:** GE 321, PB finish restored, S-C 1101/1100, BL restored, Zenith 6R886, BC/Ph wood, Philco 51-530-121, BL. All vg to exc. **WANTED:** 3-5" scope @ 5 MHz±, and a digital frequency counter. Please help. Don Urban, 111 S. Davis St., Anamosa, IA 52205.

**WANTED:** Motorola and Toshiba pocket portable radios. Other transistor and small tube portables. Ten-Tec ham band radios. Jeffrey Viola, 784 Elton Rd., Jackson, NJ 08527. (908) 928-0666

**WANTED:** Circular louvered dial lens for Zenith 7H920, broken is OK. Dial glass for American Bosch 620. **FOR SALE:** Ross "Magnifique" 13-transistor AM/FM/SW portable with Conelrad and (2) telescoping antennas, very nice all chrome front - \$70. Zenith J615W, exc cond. - \$65. RCA 2X62 - \$40. All are plus shipping. Lars Roose, 10100 Chapala Ct., NE, Albuquerque, NM 87111. (505) 296-4129

**FOR SALE:** Microphones, have moved into a condominium and must part with my collection. RCA 44BX with swing out leg desk stand, RCA 77DX radio and TV models, RCA BX-11A, WE 639-A, Altec 639-A, Altec 21B/150A tube mic (not working), excellent 44BX screen, photos available. John White, 1920 S. First St. - 1404, Minneapolis, MN 55454. (612) 333-5719

**FOR SALE:** 1940 Admiral Model #34F5 travel radio with Bakelite front, good working condition, missing handle for carrying (F.O.S., p. 49) - Best Offer. Bill Doggett, 7250 Franklin #116, Los Angeles, CA 90046. (213) 878-0673

**WANTED:** Westinghouse DA; dial glass for Radiocraftsmen 10 tuner (will buy junker unit); power supplies and interconnect cables for Brook 4B preamps; tube hi-fi equipment, especially Brook, Marantz, Western Electric. **FOR SALE:** AK M horn, no base - \$25. Radiocraftsmen RC10 tuner, broken dial glass, not working - \$10. Al Wirtenberg, 15 Wilson Rd., Weston, CT 06883. (203) 544-9270

**FOR SALE:** Philco wood tabletops: 48-482 AM-FM-SW - \$85. 42-PT-7 Transitone - \$55. Daryl Jorud, R#1 Box 180, Battle Lake, MN 56515. (218) 864-5725

**FOR TRADE:** Marbleized brown Emerson AU-190. **WANTED:** Fada or Motorola Catalin radios. Tom Dell, 214 Pleasant St., Hanover, PA 17331. (717) 637-8875

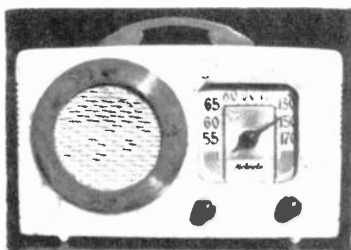

**WANTED:** Motorola Catalins, Motorola Catalins, Motorola Catalins, ad-hoc, ad-infinitum, ad-lib, ad-cetera. Please write or call collect: Rain Buttignol, 214 State St., #7, Portsmouth, NH 03801. (603) 427-1384

**FOR SALE/TRADE:** 1. Radiola III and bal amp. 2. Tuska 224. 3. Trego 3-tube regen. 4. Airline 5-tube T.R.F. 5. Magnavox AC3 amp, mint. Bob Fuschetto, 1758 Michael Dr., Whitehall, PA 18052. (215) 435-8944, call bet. 7 pm & 9 pm

**MESSAGE:** Check my ads Sept. issue, pages 39 and 78. Most items still available. Bret Johnson, 13495 102nd Ter. N, Largo, FL 34644. (813) 595-9287

**FOR SALE:** Eimac 250TH - \$95. Bendix green Catalin knob - \$25. Atwater Kent 20C - \$50. Zenith Royal 500, handwired, crack - \$80. Six 01-A tubes - \$30. Midwest 10 tube table model, stripped - \$75. Greg Farmer, 71 Rice Creek Way, Fridley, MN 55432. (612) 571-6062

**WANTED:** Bulova 250 transistor N.I.B. Harold Trieb, 644 8th St. N, Hudson, WI 54016. (715) 386-2098

**FOR SALE:** "Made in USSR" portable multiband transistor - \$25 plus UPS. Include SASE for info. funds return. **WANTED:** WW2 electronic equip. of German, Italian, Japanese forces, any condition. Also: U.S. 1930-1955 military radio, sonar equipment. Civilian boat and aircraft radio, will consider any years. Mobile radio or electronic equip. manuals, any years. Thank you! Hugh Miller, 6400 Maltby Rd., Woodinville, WA 98072-8375

**FOR SALE:** Sparton 1072 wood table radio, very good condition, great sound - \$45. Philco 42-335 wood table radio, good condition, complete, untested - \$40. Both + UPS. Rich Stamer, 331 Virginia Ave., Collingswood, NJ 08108. (609) 869-0238

**FOR SALE:** Used test equipment, textbooks, Sams, "How To" books. New tubes, 600v capacitors, used tubes, speakers, miscellaneous components for AC sets. Ten page list available for residents of U.S.A. and Canada. Sue Coulter, 4200 Prince St., Bakersfield, CA 93301

**WANTED:** Wavemagnet and extension cables, (2) for Zenith Trans-Oceanic Model H500. Bill Engstrom, 218 Bent Creek Dr., Greenville, NC 27834. (919) 355-8732

**FOR SALE:** Sonora TW49, cracked top knob, or buy your junker with good knob. Musicair 576 mini console (G.O.R., p. 99) - \$125. Harman Kardon F50XK stereo tuner - \$60. **WANTED:** Small wood Emersons with cabinets made by Ingraham. Jim Ciulla, 2224 Virginia Rd., Fullerton, CA 92631. (714) 879-0177, am B-4 2:30 or leave message

**FOR SALE:** Good used balloon tubes #24 - \$2, #26 - \$3, #27 - \$2. ST shaped tubes: #24A - \$1.75, #26 - \$2.50, #80 - \$2.50, #42 - \$4, #45 - \$15, #47 - \$4, 5Z3 - \$2. Philco #90 bezel - \$20. Erie tube amp kit, unbuilt, in box - \$45. Shipping extra, Rick Yerke, PO Box 392, Moscow, PA 18444. (717) 842-4857

**FOR SALE:** RCA Radiola 66 instruction booklet, 12 pages, illustrated, like new - \$25 postpaid. Charles Randall, 8711 Greens Ln., Randallstown, MD 21133. (410) 922-1623

**WANTED:** Vogue picture records, 45s, record cutting machines, microphones, hi-fi amplifiers, pedal cars, toys, jukeboxes. Kim Gutzke, 7134 15th Ave. S, Minneapolis, MN 55423. (612) 866-6183

**FOR SALE:** Capehart 413N console, works, no speaker - \$400. Rider's - \$30 each. **WANTED:** Tube hi-fi. V. Vogt, 330 S.W. 43rd St., #247, Renton, WA 98055. (206) 251-5420, x247

**FOR SALE/TRADE:** Zenith 12-A-58, 12-S-370, very nice. **WANTED:** Majestic #906 Riviera console. Zenith 12-S-265. David Gamer, 1210 19 1/2 St. S, Apt. 6, Moorhead, MN 56560. (218) 236-5598

**WANTED:** Heathkit power supply Model # HP-23. Also want junker Heathkit SSB transceiver, Model #HW-100. Will consider a fair price on a complete working set. Harry Mac Mullan, 2662 Bancroft Dr., Aston, PA 19014

**FOR SALE:** Hallicrafters SX-42 original manual and schematics - \$20. 1950 Navy transmitters and receivers instruction book - \$25. Alex Sandoval, 33 Brook Cir., Pella, IA 50219. (515) 628-2510

**FOR SALE:** Dynaco, Heathkit, Phase Linear, Marantz (1060) owners/service manuals - \$10 each. Dan Wrzblewski, 415 41st Ave. NW, Rochester, MN 55901. (507) 282-9601

## THE COLLECTOR'S GUIDE TO TRANSISTOR RADIOS

BY MARTY & SUE BUNIS

Over 400  
Full Color  
Photos

Over 2,000  
Models

Current Prices

248 Companies



Shipping  
in October

Only \$15.95, U. S.  
Canada, \$16.95 US\$  
Foreign, \$19.95 US\$  
surface

256 Pages

5 1/2 x 8 1/2  
Softcover

This beautiful new book will help you identify the most sought-after vintage transistor radios beginning with the very first Regency TR-1. Special offer for ARC readers: Buy directly from the authors and save shipping charges. Order your copy today!

Send check or money order for \$15.95 for each book ordered to:  
Marty & Sue Bunis, RR 1, Box 36, Bradford, NH 03221.

**FOR SALE:** LSASE for list of new/used receiving tubes; octal, loctal, miniature, some older. Sell or trade for old or unusual tubes or related material for my collection. John H. Walker, Jr., 16112 W. 125th St., Olathe, KS 66062. (913) 782-6455

**FOR SALE:** The following Art Deco radios Delco R-1238 (Collins Redux, p. 72) - \$85. Philco 41-226 - \$100. RCA 9X571 bull horn - \$85. Truetone D-2018 brown (Collins Redux, p. 86) - \$185. Zenith 6D311 - \$150. Philco 37-602 - \$75. Zenith 5-J03 - \$75. Zenith wood with "V" dial 6-D 029 - \$85. Zenith M-403 (Collins Redux, p. 98), pink - \$70. Setchell-Carlson "Frog" radio - \$90. Larry Drago, 383 Lincoln Dr., Cheshire, CT 06410. (203) 272-6030

**HAVE YOU MOVED? ARE YOU MOVING?  
PLEASE NOTIFY US A.S.A.P.  
SEND US YOUR...  
OLD ADDRESS  
NEW ADDRESS and  
SUB #  
MANY THANKS!!!!**

**WANTED:** Amperite Ballast Tubes-2H8. Cloyd Briley, 725 Christine Dr., Vacaville, CA 95687. (707) 447-5866

**WANTED:** Meter for Supreme Model 599-A tube tester or junker set with good meter, output transformer for an Atwater Kent Model 82 radio, dial glass for Zenith Model 6S229. Paul M. Williams, 2364 Beaver Valley Pike, New Providence, PA 17560-9622. (717) 786-3803

**FOR SALE:** American Bosch Model 28, excellent condition - \$200. AK Model 46 - \$75. Larry Drago, 383 Lincoln Dr., Cheshire, CT 06410. (203) 272-6030

**FOR SALE:** Bosch 58. Philco 38-4. **WANTED:** Round plastic lens for Admiral radio-phonograph 6S12N. Robert Rossi, 10936 Melbourne St., Allen Park, MI 48101. (313) 386-8321

**WANTED:** Hallicrafters Sky Riders with entire front panel silver color; also S-30, S-33 S-35 pan adaptor, SX-112, HT-2, HT-3, HT-8, HT-12, HT-14, EP-132; wood console speakers R-8, R-12; parts, advertising & memorabilia. Chuck Dachis, The Hallicrafter Collector, 4500 Russell Drive, Austin, Texas 78745

**WANTED:** AN/TRC-10 radios; AN/PRC-1; AN/PRC-5; M-209 Cipher machines; any radios beginning with letters "SS" (example "SSR-5"). Keith Melton, Box 5755, Bossier City, LA 71171. (318) 747-9616

**SOLID STATE VIBRATORS** for most automobile radios 1932-57. Exact duplicates of originals in metal cans. Synchronous, Non-sync, European. One-year guarantee. Dealer prices. Free catalog. Order toll free: 1-800-WE FIX AM. Visa, Mastercard. Antique Automobile Radio, Box 892, Crystal Beach, FL 34681. (813) 785-8733

**ELECTRON TUBES:** Over 1 Million Tubes in Stock. Buy & Sell. Daily Electronics, 10914 NE 39th St. #B-6, Vancouver, WA 98682. 800-346-6667. 206-896-8856. 206-896-5476, fax

**WANTED:** Collins Radio Company Catalogs, promotional literature, manuals 1933-1983. Jim Stitzinger, 23800 Via Iranov, Valencia, CA 91355. 1-805-259-2011

**FOR SALE:** This could be your once-in-a-lifetime opportunity to own a fantastic Norden Hauck Admiralty Super 10, complete w/original shipping carton, table cabinet and original blueprints. But hold on there is more! In addition there is an extremely rare Norden Hauck N-17 Laboratory shortwave converter unit, complete with all coils. Also included are the original instructions for both units, a Norden Hauck color brochure and an original signed letter, 1926, on Norden Hauck stationary regarding the original purchase and shipment of this set. Best offer. Jim Clark, 1292 Starboard, Okemos, MI 48864. (517) 349-2249

**FOR SALE:** Boys' books on electricity and science. Send 29c stamp for catalog Y-2: Rainy Day Books, PO Box 775, Fitzwilliam, NH 03447. (603) 585-3448

**WANTED:** Metal back for an RCA 621TS tabletop television. Small right hand knob for a Philco Model 514 metal radio. Still looking for speaker or similar replacement for Crosley Gemchest Model 609 console radio (mine missing). Jim Corio, 180 Hollow Rd., Skillman, NJ 08558. (609) 466-0395

**WANTED:** Hallicrafters Model PS-150-120 power supply. Still looking for power supply Hallicrafters Model PS-500A-AC. Loren H. Dudley, 14 Valley Rd., Bath, ME 04530. (207) 442-8419

**FOR SALE:** Electone T5TS3 grey metal - \$50. Zenith 5D810 - \$45. Zenith 7H820 - \$40. Motorola CX2N clock radio with detachable radio - \$40. Atwater Kent 1930 sales brochure - \$20. Brunswick sales brochure 1930's - \$20. Postage extra. R. C. Moore, 452 West Park Ave., Aurora, IL 60506. (708) 264-0488

**FOR SALE:** Hallicrafters S40B, looks like new - \$100. Emerson 838, small chip - \$25. Channel Master 6506B - \$20. Panasonic 8 MW and SW with case - \$30. Musical John 1967 6TR radio - \$20. Tim Yeany, PO Box 23, Rimersburg, PA 16248. (814) 473-8345

**BOXED CLASSIFIED ADS WORK!** This is a boxed classified ad. These ads can be run more than two months. See the inside back cover for details. Boxed ad deadline: the 5th of the month.



**WANTED:** Early tube Hi-Fi components and studio equipment by Marantz, McIntosh, Tannoy, Acrosound, Brook, Brociner, Fairchild, Hadley and others. Also want Western Electric theater amplifiers, speakers, tubes, & microphones. Richard Sharisky, PO Box 521, Belmont, MA 02178. (617) 484-5784

**WANTED/FOR TRADE:** Will trade namebrand high quality radios for old fountain pens by Parker, Sheaffer, Waterman, Mont Blanc, Conklin, etc., or pay cash for the pens. Contact: Frank Weissman, 4 Shadbush Ln., Westport, CT 06880. (203) 454-1267, after 9 pm EST

**FOR SALE:** Arcturus blue used tubes - \$25 ea. Call for available numbers. Larry Drago, 383 Lincoln Dr., Cheshire, CT 06410. (203) 272-6030

**FOR SALE:** Battery radios: Arborphone 27 w/tubes - \$150; Atwater Kent 4340 Radiodyne breadboard w/ binding posts - \$1900; Beaver Electric, 1926, 1st cathedral (?) - \$625; Crosley 51 portable w/tubes, excellent - \$275; Hayes (Grand Haven, MI) w/tubes - \$175; RCA AR-812 crate - \$60; unusual Western Air Patrol (Giffillan) - \$125. Communication receivers: Hallicrafters Sky Challenger, working - \$225; RME HF10, 1939 - \$195. Consoles: EH Scott AW15 in Westminster cabinet, working - \$895; blonde Moderne cabinet only for Scott 800B - \$225; unusual Sparton grandfather clock/radio - \$75. Deco/novelty: Gridiron football tube radio (black/gold like Notre Dame), excellent - \$895; Crosley lime green Bakelite - \$175. Fada 254 red Plaskon (Collins, p. 27), cracks - \$425; Motorola black Bakelite radio - \$125; Philco 41-230 (European look), brown Bakelite - \$125; Philco, 1950's, green Bakelite radio - \$75; small Setchell-Carlson, brown/ivory radio - \$140; red Sharper Image repro of European Sonora radio, discontinued - \$175; Airline Long Ranger radio - \$1,250; Sparton 500 Cloisonne w/yellow front - \$2,000; Silvertone black 6110 vacuum cleaner radio, v. nice. Speakers: rare RCA 102 drum speaker - \$295; Saal floor speaker - \$325; Ampli-tone speaker, uses headphones - \$275. Table radios: Atwater Kent 246 cathedral, nice - \$550; Grunow tombstone, project - \$60; Philco 70 chassis and speaker for grandfather clock or cathedral radio - \$125; Stewart-Warner, display vertical or horizontal - \$175; Zenith 5S29 tombstone - \$150; scarce Zenith 6D116 - \$95; scarce Zenith 6D117 - \$95; electrified Zenith 5B127, needs finish - \$125; Zenith 5S127 - \$120; large beautiful Zenith 8S129 tombstone - \$475; Zenith 6S229 tombstone - \$175; Zenith Waltons chassis only, Model 7S232 - \$175. Transistor radios: Zenith Royal 56 solar transistor radio in display box - \$450; rare Quaker Oats novelty transistor radio, (3) novelty transistor football helmet radios (Redskins, Broncos, Oilers) - \$35 each; (2) Hoffman solar radios w/cases, one green, one black. Jim Clark, 1292 Starboard, Okemos, MI 48864. (517) 349-2249

**WANTED:** Indoor antenna for BCB(?) rcvr. Joel Levy, 8 Waterloo, Morris Plains, NJ 07950. (201) 285-0233

**WE'RE STILL HERE!** Tubes: "Oldest," "Latest." Schematics. SASE for lists to Steinmetz Electronics, 7519 Maplewood Ave., Hammond, IN 46324

**FOR SALE: FOAM SURROUND REPLACEMENT KITS.** Kit includes two foam surrounds, cement, centering shims & thorough instructions. 10" Kit = \$24.95, 12" Kit = \$29.95. (N.J. residents add 6% sales tax) + \$3.00 S/H. Sound Remedy, 331 Virginia Avenue, Collingswood, NJ 08108. (609) 869-0238

**FOR SALE:** Receiving Tubes, Used, Guaranteed: Under \$2.85. Sams 183-450: Under \$3.50. CQ, QST, Ham Gear, Antiques, Test Gear, Parts. LSASE to DMI, 47 Hazel Drive, Pittsburgh PA 15228.

**WANTED POCKET TRANSISTOR RADIOS.** Will buy one or entire collection, please call or write with description and price. 919-623-4633. Richie Richardson, 515 Spruce St., Eden, NC 27288

**FOR SALE:** Steinmetz, Thompson and Morecroft are all represented in our catalog PO-3: Books on Electric Power Generation and Transmission Send 52c in stamps: Rainy Day Books, PO Box 775, Fitzwilliam, NH 03447. (603) 585-3448

**WANTED:** BC 659 military receiver, power supply 117C, 120A, B or C and F + 250 radio mount. Cloyd Briley, 725 Christine Dr., Vacaville, CA 95687. (707) 447-5866

### Classified Ad Deadline Noon

Oct. 10 for Nov. 1993 Issue

Nov. 10 for Dec. 1993 Issue

Boxed, Photo, & Display Ads - 1st

**WANTED:** Eiac 300T and 500T. Industrial/Special purpose tube manuals or pamphlets. Also any odd or out of the ordinary tube types. John H. Walker, Jr., 16112 W. 125th St., Olathe, KS 66062. (913) 782-6455

**FOR SALE:** Radiola Mod. 18, made in Canada by GE, a very unique radio to add to your Radiola collection - \$175. Larry Drago, 383 Lincoln Dr., Cheshire, CT 06410. (203) 272-6030

**FOR SALE:** From closed TV shop: B&K Model 700 tube tester - \$75. B&K Model 283 digital bench-type multimeter - \$50. Illuminated Motorola "All Transistor Color TV" sign - \$150, illuminated "Quasar Works in a Drawer" sign - \$125; both have clocks. All plus \$15 shipping. Maurer TV, 29 So. 4th St., Lebanon, PA 17042. (717) 272-2481

**WANTED:** Low band sweep oscillator, 100Kc - .... RCA 150, or similar. Richard Gray, 9181 Chesapeake Dr., San Diego, CA 92123. (619) 560-4162

**WANTED:** Bendix radios. Do not have to be working. Aaron Mall, 503 Dropleaf Ct. Baltimore, MD 21208. (410) 486-8813

**WANTED:** Broadcast-type MICROPHONES. Early carbon, condenser, ribbon, dynamic, etc. Cash or trade. James Steele, PO Box 620, Kingsland, GA 31548-0620. (912) 729-2242

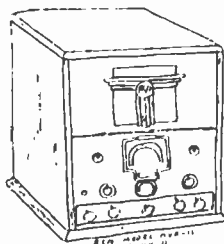

**WANTED:** RCA Model AVR-11 (AV-11) airport receiver as shown, any condition, housed in a steel tabletop cabinet approximately 20"W x 24"H x 16"D, 1937 vintage. Similar to the ACR-111 but is not the same radio. Chuck Dachis, The Hallicrafter Collector, 4500 Russell Dr., Austin, TX 78745. (512) 443-5027

**WANTED:** Thordarson amplifiers: 2A3 Pono Amp T-30W10, T-31W10 etc. Heathkit WA-1. Schematics and other related items. Paul Gil, 180 Union Ave., Belleville, NJ 07109. (201) 751-5959

**FOR SALE/TRADE:** RCA 1946 TK31 Image Orthicon camera, power supply, lenses, cables, C.C.U., excellent condition. Want prewar TV. Neil Dorfman, 7028 Clements, West Bloomfield, MI 48322. (313) 661-8770

**FOR SALE:** Grundig #2066PX - \$125. GE Musaphonic dual speakers, nice sound, mahogany, T-150A - \$45. Hallicrafters SX-101, nice - \$175. Nordemende Globe Travler Jr. - \$30. Hallicrafters S-72 AC-DC battery portable, works good - \$95. Zenith Trans-Oceanic - \$75. Call Fred Hegel, 1901 Frank Pl., S. Daytona, FL 32119. (904) 760-7632

**WANTED:** Garod Commander with wraparound grille. Will consider junker but must have perfect grille. Will pay better than average value. Larry Drago, 383 Lincoln Dr., Cheshire, CT 06410. (203) 272-6030

**WANTED:** Pre-1970 Western Electric Type 300A/B tubes, N.I.B. @ \$270, used @ \$180. H. Kato, c/o Mr. Omura, 3852 Mohr Oak Ct., Fairfax, VA 22033

**FOR SALE:** 1938 Zenith bookshelf radio, Model 7S261. This uncommon radio is in good original condition and available for \$2,500 OBO. Jim Clark, 1292 Starboard, Okemos, MI 48864. (517) 349-2249

**WANTED:** Knobs and 1st oscillator coil, or bandswitch assembly for Midwest Model 162R console. Mark W. Hilliard, N3NBL, 523 N. Law St., Allentown, PA 18102. (215) 432-8089

**FOR SALE:** Books: The Radio Boys on the Mexican Border - \$12. The Radio Boys with the Iceberg Patrol - \$14. The Radio Manual by Sterling and Monroe, 1950 - \$15/all plus h/s. Don Nichols, RFD 2, Box 3695, Oxford, ME 04270. (207) 539-4823

**FOR SALE:** Farnsworth ET-064 - \$90. Mitchell 1251 - \$70. Zenith 6D015 - \$65. GE F63 - \$65. Steve Lange, 1351 N. 58 St., Milwaukee, WI 53208. (414) 259-1031

**Victrola Repair Service:** Windup phonograph repairs, parts, springs, needles via U.P.S. Rod Lauman, 8 Sunset Circle, St. Johnsbury, VT 05819. (802) 748-4893, eves.

**WANTED: CALLBOOKS, Amateur, Broadcast, Government, Commercial and Military, 1900-1930. Bob Arrowsmith, W4JNN, PO Box 166, Annandale, VA 22003. (703) 560-7161 Collect**

**PARTS for collectors.** Hard to find Electrolytics, High Voltage Capacitors, High Power Resistors, Plugs, Switches and more. Free Catalogue. A.G. Tannenbaum, P.O. Box 110, East Rockaway, NY 11518. 516-887-0057. FAX 516-599-6523

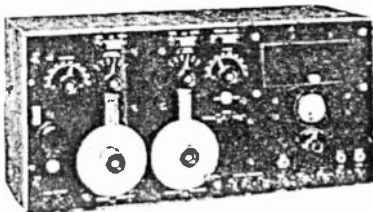

**FOR SALE:** RCA IP-501A 1922 marine receiver with two-stage audio amplifier. \$2,850. Cliff Cannon, 1106 Donnell Drive, Daytona Beach, FL 32119. (904) 788-6666

**FOR SALE:** Detrola Table Model, AM/RP with "Make your own record cutter, microphone, base and sample acetate record" - \$150. Also silver-tone AM/RP table set Mod 141-417 - \$100. Larry Drago, 383 Lincoln Dr., Cheshire, CT 06410. (203) 272-6030

**WANTED:** Zenith console Models 15S479 or 15S495 chassis 1503. Clyde Briley, 725 Christine Dr., Vacaville, CA 95687. (707) 447-5866

**WANTED:** DeForest Type 430 through 440 tubes for collection. Duds ok. John H. Walker, Jr., 16112 W. 125th St., Olathe, KS 66062. (913) 782-6455

**NOTICE TO ALL  
CLASSIFIED ADVERTISERS!  
OUR CLASSIFIED AD DEADLINE IS  
12:00 NOON  
ON THE 10th OF EACH MONTH**

**FOR SALE:** Majestic Model 15 grandfather clock - BO over \$450. Tubes: new/boxed: (5) Philco 01-A ST., (1) Philco 12AST, (1) RCA 807; used: (2) 2A3ST, (3) 807, (3) 71AS; lot - \$145/BO. **WANTED:** AK 82 cathedral cabinet. Mark Gutekunst, 2600 Martin Rd., Willow Grove, PA 19090. (215) 657-8552

**FOR SALE:** RCA 103 tapestry speaker - \$125. Spartan 6A66 (Collins II, p. 49, not chromed) - \$65. McMurdo Silver 906 RF generator - \$25. Grommes Custom LJ-2 mono tube amplifier - \$25. RCA 45 rpm changer - \$45.

**WANTED:** Hitachi TH-666 and older transistor radios, cabinet for Stewart-Warner 301A one tube chassis. Jon Hall, 39 Spring Oaks Ln., Rockersville, VA 22968. (804) 985-3827, 8-11 pm or leave message

**WANTED:** Stromberg-Carlson 235-H. I also need a sprk for Zenith 9H081. Thanks. Dave Tripe, 1673 Macon St., Aurora, CO 80010. (303) 364-2812

**FOR SALE:** OST and CQ magazines, 1940 thru 60s - \$1/month, \$10/year. Jim Corliss, 2446 Vista Dr., Up-land, CA 91784. (909) 985-9967

**FOR SALE:** National NC-200 (Silver Anniversary) with speaker, fair, pickup only - \$100. Dave Erli, 9 Tewkesbury Dr., Wyomissing Hills, PA 19610. (215) 678-2913

**MESSAGE:** I would like to hear from anyone else who owns a Hot Spot 14, fourteen tube receiver from 1927.

**WANTED:** Need following manuals, copies OK. Hallicrafters: S72R, RE1, TW600, TW2000, HT17, HO1(scope). Hammarlund: RBG2. Heath: EK2, CM1, 10-21, C2, C3. Knight: Star Roamer. National: 60, 105, 109, 120, 125, 183D, 240D, 300. Philmore: CR5AC. RCA: AR8712. RME: 6900. Sargent: Streamliner '39. Clegg: 99'er. Gonsset: GSB100. Globe: Scout 65. Harry Blesy, N9CQX, 2409 Northgate, North Riverside, IL 60546. (708) 442-8855

**FOR SALE:** Rider's radio manual set 1-5 abridged, 6-19 as a set only - \$270 OBO. David Boyle, 7169 W. David Dr., Littleton, CO 80123. (303) 979-5403, evenings

**FOR SALE:** Sams 177 to 1801. Also Sams AR's, TSM's, MHF's. \$2.50 each plus postage. Maria P. Troutman, PO Box 760, Brewer, Maine 04412-0760

**WANTED:** Fairbanks Morris console Model 9C or 12B preferred. Charles E. Patterson, 2621 Sweetwater Rd. SP#33, National City, CA 91950. (619) 475-7141

**FOR SALE:** Pioneer RT-707 stereo tape deck, low use, original box, excellent condition - \$250 + shipping. Chuck Sundgren, 1818 Alder Ave., Richland, WA 99352-2424. (509) 943-2753

**FOR SALE:** Tuska Junior Model 301/3 tube battery set, cabinet/box needs restoration - \$250. Larry Drago, 383 Lincoln Dr., Cheshire, CT 06410. (203) 272-6030

**WANTED:** Antique TV sets 1930s, 1940s only. Muntz, Hoffman, Esprey 3", Coronado, Truetone, Viewtone, 7 and 10" sets. Send list and prices to: Auman Antique Television Museum, 4316 Murray Rd., NW, Dover, OH 44622. (216) 364-1058, evenings

**PHONE NUMBER FOR  
ANTIQUE RADIO CLASSIFIED  
(508) 371-0512**

**Best time to call is weekdays:  
9 am to 5 pm Eastern Time**

(Please no classified ads by phone. Thanks!)

**FOR SALE:** Heathkit electronic keyer, HD-11 - \$25 + \$5 shpg. Heathkit Q multiplier, QF-1 - \$15 + \$5 shpg. Eico 30 w/power amp, HF30 - \$25 + \$10 shpg. Aircraft Radio Corp. Model 11A, less 2 tubes and tube cover - \$25 + \$5 shpg. Precision E-200C signal generator - \$40 + \$7.50 shpg. Simpson multi-range milliamp-ohmmeter, Model 1699 - \$50 + \$7.50 shpg. Heathkit voltage calibrator - \$10 + \$4 shpg. Several VTVMs at - \$20 each + \$4 shpg. Knight-kit VFO, Model V-107 - \$20 + \$5 shpg. Sencore CRT tester, CR125 - \$20 + \$5 shpg. James Fred, R1, Cutler, IN 46920. (317) 268-2214

**FOR SALE:** Magazines complete to date: CG from 1946, 73 from 1960. Textbooks, ARRL, Equipment. Bill Tucker, W4FXE, 1965 S. Ocean Dr., Apt. 15-G, Hallandale, FL 33009. (305) 456-1349

**FOR SALE:** Fisher FM-1000 cabinet, exc - \$85. **WANTED:** Home brew tube-type amps, other tube-type amps, preamps, tuners, any condition. Allied catalogs 1950 to 1958. 807 5691 & 5692 tubes. Manual for Heath W-1 amp. **FOR TRADE:** Allied catalog, 1949, Radio-Electronics 1949-1962. Rick Graves, 4500 Ninth Ave. NE, #300, Seattle, WA 98105-4762. (206) 632-9929, fax (206) 633-6038

**FOR SALE:** Zenith cathedral, fair cond., needs restoring - \$85. Emerson wood table radio, good cond., plays - \$45. No name, large horn speaker - \$50 + shipping. Robert Sticher, 1600 Sable, #169, Aurora, CO 80011. (303) 341-2913

**FOR SALE: PHONO NEEDLES & CARTRIDGES** (ceramic - magnetic). What do you need? Send SASE. J. J. Papovich, 53 Magnolia Ave., Pitman, NJ 08071. (609) 582-8279

Join Crystal Set Society. \$9.95 brings six bi-monthly newsletters on designing, building, understanding sets. Phil Anderson, 789 N. 1500 Rd., Lawrence, KS 66049-9194

**NOTE:** New prices on capacitor can rebuilding: Single section can \$12. postpaid return - Dual section can \$13. postpaid return - Triple section can \$14. postpaid return - Quad section can \$15. postpaid return - Maximum 450. Volts at these prices. **FRONTIER ELECTRONICS** - Box 38 Or 403 S. McIntosh St., Lehr, N.D. 58460. PH. 701-378-2341 Recorder after 5th ring

**FOR SALE:** Rare Canadian Spartron Bluebird mirror radio, very diferent from U.S. version, excellent condition. Will be sold to the highest offer over \$3,000. Jim Clark, 1292 Starboard, Okemos, MI 48864. (517) 349-2249

**FOR SALE:** Microphones-Astatic Mod. N-30 chrome with stand - \$120. Shure Mod. 55 "The Elvis Microphone" in excellent condition - \$195. 1920 chrome ring mic element by American Microphone Corp. Mod S.J. with original base but unfortunately no ring - \$175. Amperite withstand Mod P.F.H.G. - \$150. Larry Drago, 383 Lincoln Dr., Cheshire, CT 06410. (203) 272-6030

**WANTED:** Speaker and escutcheon for a Philco 60 cathedral. Geoff Shearer, 13115 Rounding Run Cir., Herndon, VA 22071. (703) 860-1617

**FOR SALE:** Untested Hallicrafters SX-100 receiver and HT-37 transmitter - \$75 ea. or \$135 both + shipping. James McCracken, Box 176 "A" St., Crawfordsville, OR 97336. (503) 367-2643

**WANTED:** Decent console for 1938 Zenith 12-tube shutter-dial chassis. Armand Cote, 11 Berge Ln., Derry, NH 03038. (603) 437-4431

**FOR SALE:** Small Remler in exc/playing condition. Trade or buy. Write. D. May, 16 Gulley, S. Windsor, CT 06074

**WANTED:** Speaker for Philco 70 cathedral. Cabinet for Crosley Model V radio. Lewis M. Owens, 2824 Dan Patch Dr., Lexington, KY 40511. (606) 233-0376

**FOR SALE/TRADE:** Philco 51 cathedral, excellent condition. Hammarlund Super Pro, and RCA RAL 7 receivers. M.chael Payne, 803 S. Taylor, Alvin, TX 77511. (713) 331-9217

**FOR SALE:** Emerson #543 (Bunis II), urea, hairline on side, looks good, plays well - \$40. Airline #6D3 Series, Bakelite, push buttons, exceptional audio - \$55. RCA (U.S.A.) shirt pocket transistor #3RH-31, full view dial, brass pointer, vernier tuning, excellent, 4 volt, untested - \$10. Plus UPS. C. Hill, 6934 Orion Ave., Van Nuys, CA 91406. (818) 787-0376

**FOR SALE:** Used technical books: radio, electronics, magazines, manuals, etc. Catalog - \$1 (stamps OK). Softwave, Dept ARC, 1515 Sashabaw, Ortonville, MI 48462

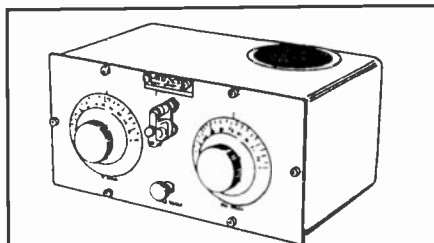

**WANTED:** Pre-1926 radios by AMRAD. Also, Amrad radio parts, accessories, and literature. Richard Sharisky, PO Box 521, Belmont, MA 02178. (617) 484-5784

**RADIO SCHEMATICS,** Sams, Riders, Beitman Gernsback. \$2.50 each. Postpaid USA. Joseph R. Forth, 321 Long Vue Acres, Wheeling, WV 26003. (304) 277-3154

**WANTED:** Old binding post, small - 50c, large - \$1. Contacts for cap switches. David Swartz, 2727 Oakland, St. Joseph, MO 64506

**WANTED:** Correct original type speakers for Atwater Kent 20C and Hallicrafters SX-25. Bob Remes, 2815 Suffock, Kingman, AZ 86401

**WANTED:** Owners manual, advertising for Crosley Roamio #4A1 car radio. Knobs and dial window. David Edyvean, 2508 Campbell Ave., Schenectady, NY 12306

**FOR SALE:** Radios: Fada 41 Series portable - \$30. Zenith Trans-Oceanic H500 with original instruction book - \$80. Channel Master 8534 - \$10. Crosley 56TN wood cabinet - \$65. Winham, unknown model no., wood case, 1934 model - \$50. Shipping extra. Robert J. Stone, 721 Fisk St., Piqua, OH 45356-3729. (513) 773-2217

**WANTED:** Inca 1-45 transformer. Information for Pathex 9mm projector and camera. Both crank operated. Michael Nemesh, 502 Green St., Freeland, PA 18224

**WANTED:** Hallicrafters SX-42, Motorola A1, 5A7, Arvin 40, Philco 41-81. Ichiro Yamada, 10-21 Chiyodai-Cho, Kawachi Nagano-Shi, Osaka, Japan 586. 0721-52-4695, eve., local

**WANTED:** Schematic for RCA Institutes RF signal generator vintage 1959-1960. Al Bernard, PO Box 690098, Orlando, FL 32869-0098. (407) 351-5536

**WANTED:** Heathkit con. and res. checker reasonable. Larry Ray Cook, 362 East South, Richland Center, WI 53581

**FOR SALE:** Transistors: Perfect, working. Zenith Royal 500 long-distance two-tone white/brick - \$95. Zenith Royal 500H, black - \$150. Global GR711, black - \$75. Admiral 582, red, black dial - \$95. Admiral 7M14, white/tan - \$85. Richard S. Lambert, 166 E. 34th St., Apt. 13-H, New York, NY 10016. (212) 684-6564, eves.

**WANTED:** Western Electric tubes, parts and Dat-sheet. 101, 102, 104, 205, 211, 212, 216, 242, 252, 262, 271, 274, 275, 276, 284, 300, 310, 339, 347, 348, 349, 350, 418A, 421, 422, VT1, VT2, VT25A, VT52. Also Western Electric amp, spkr, socket, xfmr, wire, Data-sheet. Others: RCA50/250/350, VT62/801A, 845, European tubes. Will pay top-\$\$\$ Jun Mizuno, 933 Portswood Cir., San Jose, CA 95120. (408) 268-4016

**IF YOUR EXPIRATION DATE IS  
OCTOBER OR BEFORE, RENEW TODAY!  
EARLY RENEWALS  
RECEIVE AN EXTRA ISSUE!**

**WANTED:** Dial cover, knobs and nameplate for Charlie McCarthy. Info on Tourist 8 and Kustombilt Radio Mfgs, S. F., Calif. Also on the following brands: 501 Beaver and Onado. Eugene Rippen, 105 Donnington, Auburn, CA 95603. (916) 885-6147

**WANTED:** Battery sets, Radio Service Laboratories R212, Mohawk 100, Priess, Slagle, Eisemann RF2, 6D. Mike Molnar, 134 Observatory Rd., Glen Gardner, NJ 08826. (908) 638-6553

**FOR SALE:** White Majestic 5C3 - \$50. Crosley E-15 blue - \$35. Emerson 724 - \$45. Sentinel 343 - \$25. Bendix 65P4U - \$25. RCA 45 record changer - \$30. Etalag Magi-clock - \$40. Assorted transistors, call. Lee Gentry, 2121 Windbrook Rd., Knoxville, TN 37923. (615) 694-8903

**FOR SALE:** Emerson Model 600 TV 6-inch screen with leatherette case - \$110. Claratone battery set from Hughesville, Pa. - \$60. Home brew battery 3 dialer - \$30. Trimm horn speaker - \$75. Zenith chairside 5S237 - \$125. AK 708, cabinet rough - \$85. Vance Rayburn, 2718 Homestead Rd., Madison, WI 53711

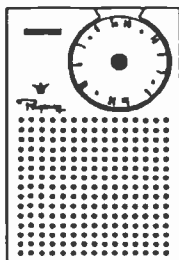

**WANTED:** Paying \$500+ for nice Regency TR-1 or TR-1G transistor radio with pearlescent deluxe finish in any of the following colors: pearl white, lavender, pink, lime, or meridian blue. Also looking for similar looking radio (tuning knob may be different) with the name Mantola (prefer ivory or black cabinet) and also willing to pay several hundred dollars for the Firestone (Model F-4D) version of this radio (any color!). In addition, I need an excellent Regency TR-4 in any color other than black or ivory. In addition I am looking for cosmetically excellent examples of the Regency TR-1G in any color other than black. In lieu of money, if you wish I will swap very generously for any of these items, and especially for the special pearlescent deluxe colors of the TR-1. Please let me hear from you if you have any of these special radios made by Regency. Thank you. Bill Burkett, PO Box 1204, Peoria, AZ 85380. (602) 878-7386, or fax (602) 486-4484

**FOR SALE:** DeWald 561 Catalin, maroon/yellow, repro knobs - \$550. RCA 77 DX microphone, working - \$500. RCA 74B microphone - \$175. Zenith Royal 500 7XT4021, nice - \$75. Crosley 58TW, white - \$30. Also have assorted Catalin knobs to sell or trade. Please call before 9 pm. Thanks. Brad Jones, 4107 Crabapple Ln., Greensboro, NC 27405. (919) 375-6340

**FOR SALE:** RCA BP10, needs grille cloth - \$40. Transistors: Zenith 12 - \$25, Channel Master 6506 - \$40, Airline GEN 1127A - \$25, Toshiba 6TP314 with leather case - \$40. Mark van Roojen, 11 Braman St., Providence, RI 02906. (402) 438-3724 (Sept. 23-26); (401) 272-7754 (thereafter)

**SERVICES:** Restore those transistor radios to like-new condition - exactly as original. I fix cracks, dials, grilles, and restore lettering in paint or real foil per original. Many happy customers already - try me! Eric Wrobel, 20802 Exhibit Ct., Woodland Hills, CA 91367. Phone or fax (818) 884-2282

**FOR SALE:** (2) Admiral tabletop radio-phono combinations w/Bakelite cabinets, nice appearing for display, not working, 1949 & 1955 models approx. - \$45 each. Zenith Trans-Oceanic, 1950s, exc condition, Model SH40, works perfectly - \$95. 1947 Pilot Ray TV w/3-in. screen, looks very good & fully serviced - \$495. Mid 50s Zenith radio-phono tabletop combination w/Bakelite cabinet & Cobramatic changer, works well & real 50s looking - \$250. Robt. DeMars, 222 Lakeview Ave., Suite 160256, West Palm Beach, FL 33401. Phone: (407) 832-0171, fax (407) 832-6939



**FOR SALE:** Crosley Fiver 517 chassis, dial and glass, variable condensers, coil bank, IF trans., electrolytic cans. S. Greenspan, 4701 Willard Ave, Chevy Chase, MD 20815. (301) 951-0232

**FOR SALE:** MCA wire recorder, Ampro 731 tape recorder, Akai 1700 4 track tape recorder. Art Collatz, N7818 Barker Lake Rd., Winter, WI 54896

**FOR SALE:** Cathedrals: Philco 80 Junior - \$100. Century 4-tube, small - \$110. King 4-tube, small, nicely refinished, works - \$120. Tombstones: Crosley 535 farm set, good - \$50. Silvertone 4520 farm - \$35. Zenith 7-D-127 AC black dial, wrong knobs, good - \$135. Zenith 6V27 farm, excellent, wrong knobs - \$200. Table models: RCA 56X2 white Bakelite - \$25. Similar one in brown, chip in top rear - \$15. Trav-Ler 5015, nice Bakelite but cracked on bottom and side - \$10. Fairbanks-Morse 43 large horizontal wood farm set, 6 volts, looks and works fair - \$35. Delco R-1235 brown Bakelite - \$20. Silvertone 6119 1930's wood, fair, with push buttons and eye tube - \$20. Portables: Mantola R652N suitcase, 1940's - \$20. Zenith sailboat 6G601, black - \$30. Zenith 5402G grey plastic - \$15. RCA aqua Globetrotter 7BX8L - \$15. Motorola 5P31A tan and maroon slim model - \$10. Silvertone Cat. #225, reddish-brown, resembles guitar amp - \$20. TV: Sony 5-303W small metal portable missing small knobs and some accessories - \$25. Consoles: Philco Model 111, high box type - \$75. Others - call. **SERVICES:** Repairs on old radios and some early tube TV's, typically \$25 for small tube table radios (All-American Five). Extra for UPS shipping and packing materials/labor, or can deliver to 50 mile radius from Charlotte, N. C. (or further in special cases). David DeBetta, 5916 Potter Rd., Matthews, NC 28105. (704) 821-4666

**WANTED:** Restorable cathedral and tombstone wood radios. Any brand or model. Hopeless cases OK. James S. Fisher, 344 Harrison Ave., Manville, NJ 08835. (908) 725-7476

**FOR SALE:** B&D 4R, excellent, w/tubes - \$100. Emerson 840, 4-tube portable in leather - \$25. Fada 209, tiny Bakelite w/handle, 1939 - \$35. Philco 37-84 cathedral, vg - \$95. Zenith 6-S-511W, white Bakelite, BC/SW, vg - \$40. All plus UPS. LSASE for new list. Wally Worth, 2 W. Elm Ave., Wollaston, MA 02170. (617) 479-4512

**FOR SALE:** Fada 652 Temple, maroon/gold, exc - \$525. Belmont 6D111, exc - \$150. Edison Standard cyl. phono - \$395. Dahlberg pillow spkr radio, exc, missing spkr - \$130. Philco Bing Crosby - \$55. Radiola #18 - \$55. Sonora suitcase phono - \$40. RCA R7 tombstone, fair - \$45. Westinghouse green refridge - \$65. Tower speaker (Sept. A.R.C. cover) - BO. J. L. Acciavatti, PO Box 231, Southborough, MA 01772. (508) 476-3229

**WANTED:** Schematic/manual or copy for General Radio Type 1C01-A signal generator. Thanks! Glenn Ledger, 2626 Lomond Dr., Kalamazoo, MI 49008. (616) 349-3725

**WANTED:** Power transformer for Philco 46-480, Part 32-8243. 650v @ .075A, 6.5v @ 2.9A, 6.5v @ .3A. Jim Rose, 1419 Indian Dr., Enid, OK 73703. (405) 234-6686

**FOR SALE:** AK-184 - \$200. Philco 610 - \$75. Zenith 5R135 - \$125. Freed-Eisemann NR6 cabinet w/front panel only - \$25. Crosley RFL-75 - \$50. Cabinet needs help, Majestic 15A - \$115. Stewart-Warner tombstone R-1272A - \$150. American Bosch 440 round top tombstone, has some problems - \$50. **WANTED:** Always want AK breadboard parts, any condition. Bob Nicholson, 3423 S. Long, Topeka. KS 66605-2486. (913) 266-9473, after 4:30 pm

**WANTED:** N.O.S. 12AU7's. Paying \$1.75 ea. + shipping. Need about 25. Robert A. Warren, Church St., PO Box 279, Waverly, PA 18471. (717) 587-2405

**FOR SALE:** Reproduction knobs for Hopalong Cassidy and Pepsi Cooler radios - \$40 per pair. Kris Gimmy, 1441 Nottingham Dr., Aiken, SC 29801

## ARBE\* — III

### \* Antique Radio Battery Eliminator



#### FEATURING:

- Adjustable high current "A" supply
- 8 different "B" and "C" voltages
- 5-year limited warranty

~ \$149.95 Shipped ~  
within continental U.S.A.  
(Michigan Residents add 4% sales tax)



Call or write for complete data sheet:

Antique Radios Inc. - P.O. Box 6352, Jackson, Michigan 49204  
Phone 517-787-2985, Fax 517-782-7422



**FOR SALE:** Trans Air radio kit, never opened manufactured in 1952 - \$50 plus \$5 shipping. John Kara, 1700 Baltimore Ave., Whiting, NJ 08759. (908) 849-4318

**FOR SALE:** Victrola-Electrola 7-26 (phono with Radiola 18) great original condition - Best Offer, pick up only. Radiola III instruction booklet - \$25. American Telephone Practice, 1905, 99 pp. - \$25. Ned Connors, 29 Allen Ave., Barrington, RI 02806. (401) 246-0164

— WANTED —

**PICTURES FOR TELEGRAPH REVIEW PHOTOS MUST BE SHARP IN DETAIL A SHORT DESCRIPTION IS A MUST! REQUIREMENTS FOR TELEGRAPH REVIEW ARE THE SAME AS FOR PHOTO REVIEW**

**WANTED:** Tapes of old radio broadcasts 77 WABC, 1010 WINS, WMCA, WORFM, CKLW, WFIL, WIBG, WLS. Philco Butterfly, Philco 38-15, Emerson 520. Bob Masterson, Box 172, Valley Cottage, NY 10989. (914) 353-3151

**WANTED:** Toshiba 6TR-186. Hoffman P410 "Home & Travel." Continental 160. Emerson 999. Top dollar paid! David Mednick, 1450 Palisade Ave., Apt. #5-H, Fort Lee, NJ 07024. (201) 461-3082

**FOR SALE:** Tube testers: Signal Corps I-177B, very nice, rugged military tester by Triplett - \$75. Jackson 103 - \$20. Superior TV-12 - \$25. Radios: Porto Smokette, combo radio and pipe rack/ashtray/humidor; with current rage against smoking, sure to increase in value - \$250. Zenith Royal 780 Navigator, CD AML/W - \$40. Arvin 61R58 transistor - \$20. **WANTED:** Motorola transistor portables. Motorola 45P1, 45P2. Jeffrey Viola, 784 Eltone Rd., Jackson, NJ 08527. (908) 928-0666

**FOR SALE:** Tired of dial belts that slip? Try our Dial Belt Kit. You get 5 universal dial belts, super glue and instructions and guaranteed satisfaction, all for - \$8.50 ppd. We sell owners manual reprints for over 250 radios reproduction knobs, parts, apparel, etc. Zenith T shirts - \$10 plus \$4.50 shipping. Send for free catalog. Alan Jerspenson/Mike Emery, PO Box 17338, Minneapolis, MN 55417. (612) 727-2489, 8 am - 8 pm CDT

**WANTED:** Heathkit digital multimeter IM102, need not work. Also MCR1 in good condition. Bill Crawford, Cushman Rd., Patterson, NY 12563. (914) 878-4653

**WANTED:** Early TV cameras, both military and broadcast type. Early electron microscopes. Early electrical equipment, motors, dynamos, mercury arc lamps, motor lamps, gas discharge lamps. If it's strange, old, and electric, I'm interested. Allan H. Weiner, 14 Prospect Dr., Yonkers, NY 10705. (914) 423-6638

PRE-1955 TV BOOSTERS & CONVERTERS (products, data sheets) PROCEEDINGS IRE 9/30, 10 31,

12/33, 11/34 & 3/36 RADIO I 36, 4 40,

12 40, 4 41

7, 8, 10 37, HISTORIAN ELECTRONICS RADIO EL-

ELECTRONICS NEEDS ASSISTANCE ALL '19, some CRAFT '16,

some '17, '48 RADIO NEWS some '39 -

'48 TELEVISER Journal Of Television (All) Book

ELECTRONIC TELEVISION (1936) PAY in US\$,

provide US ship-to address

RB COOPER, BOX 330, MANGONUI, FAR NORTH  
NEW ZEALAND (FAX: 64 9 406 1083)

**FOR SALE:** RCA 74B microphones. Have two for sale: one good, one excellent - \$175 and \$250. Frank Nocera, 1572 Argyle Dr., Fort Myers, FL 33919. (813) 936-7197, after 6 pm

**FOR SALE:** Test equipment: PACO T60 tube tester - \$25. Eico 315 signal generator - \$25. Hickock 470A VTVM - \$25. 691 bar gen. - \$15. Precision EV10A VTVM - \$25. Pete Grave, PO Box 175, Ottsville, PA 18942-1075. (215) 847-2214

**WANTED:** Back cover and front "Philco" decal for 42-KR5. Volume knob for GE C-498B. John Osborne, 2 Lake St., Winthrop, ME 04364. (207) 377-2519

**FOR SALE:** Full bottles of Radio Girl Perfume, N.O.S., advertised as "sold only over the radio" during the 1950's, approximately 2"H x 1"W with cathedral shaped Deco style label - \$7, includes postage & insurance. Joseph Gambaccini, 192 Division Ave., Shelton, CT 06484. (203) 924-0271

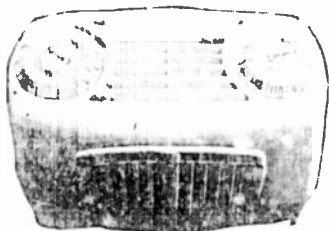

**WANTED:** Late '40's Sonora "Gem" plastic radio #WJU-252. Gardner Kiskask, Box 73, Douglas, MI 49406, or (708) 755-1436

**FOR SALE:** Fisher 49T tuner & 49A amp - \$100 pr. Fisher K10 SpaceXpander - \$45. Jetronics OS-46A/U 5" scope - \$75. B&K 415 sweep-marker generator - \$50. Tube tester/VOM, Mercury 300 - \$50. Eico 2715 receiver - \$65. Stromberg-Carlson AU-58 amp - \$50. Arvin 68 - \$85. Tektronix Scopemobile - \$50. Stromberg-Carlson AR-411 mono amp. Tektronix 502A dual beam oscilloscope w/probes & manuals - \$200. Rek-O-Kut N34H turntable - \$75. RCA WV-77E VTVM - \$35. Eico 944 yoke tester - \$25. Stromberg-Carlson 130R - \$85. Roberts/Rheem 1720 R-R tape rec. - \$85. Emerson 522 - \$35. Relay rack open - \$50. Heathkit W4-AM amp - \$150. WA-P2 preamp - \$50. Bob Lynn, 26 E. Orchard St., Somerville, NJ 08876. (908) 685-9070

**FOR SALE:** Atwater Kent Model 40 receiver, very good condition - \$100. Mike Kennedy, 3417 W. Magill Ave., Fresno, CA 93711. (209) 435-3159

**WANTED:** No longer wanted: Mitchell radios or any other Mitchell appliances! Just joshing you this month - you know darn well we're never gonna fall out of love with those beautiful Mitchell, Mitchell, Mitchells! Appreciatively, Lee Mitchell, The Mitchell Collector, 175 East Delaware Pl., Chicago, IL 60611. (312) 266-7100, 337-3123

**FOR SALE:** E. H. Scott 24-tube Phantom w/15" speaker, cabinet rough, has two tuning eyes - Best Offer. Nice AK 40 w/tubes - \$50. AK 20C, clean - \$100. Radiola 33, w/tubes - \$75. 1947 Chevy auto radio, AM, 4 SW bands, rare - \$400. Zenith 4-K-310 Bakelite, looks like 5-R-312, but no push buttons and is battery operated - \$50. Classic Radio and Television, R 1, Box 393, Solon, ME 04979. (207) 643-2799

**FOR SALE:** Does your radio hum? Does your cabinet need refinishing? Let me fix it reasonably. Specialize in table radios. Help me pay for school. Thanks. Bob Masterson, Box 172, Valley Cottage, NY 10989. (914) 353-3151

**FOR SALE:** Reproduction cast aluminum mic flags for RCA 44 Series microphones. Just 3 left from the one-time casting of 50 flags—\$29.95 plus \$3 shipping. Frank Nocera, 1572 Argyle Dr., Fort Myers, FL 33919. (813) 936-7197, after 6 pm

**WANTED:** H. H. Scott Steromaster Type 340, Must be in excellent condition. Michael Stern, 1285 Alum Creek Dr., Columbus, OH 43209. (614) 252-4422

**FOR SALE:** Silvertone Bullet—\$80. Motorola 68X12Q (Bunis II, p. 118)—\$125. Bendix 55P3 (Bunis I, p. 35)—\$85. Robert Lutz, 9041 Gillette St., Lenexa, KS 65215. (913) 894-1327

**FOR SALE:** Portables all work: Motorola 68L11—\$65, 4065 BP1—\$45, 5A7C—\$40. Zenith 6G501—\$55, 6C40—\$45, 6G601—\$55. Emerson 505—\$25. Admiral 6Y18, with original batteries—\$35. Pete Grave, PO Box 175, Ottsville, PA 18942-1075. (215) 847-2214

**WANTED:** Operators manuals for Knight R100A receiver, HP1720A oscilloscope, HP27121 oscillator, SMG39 sweep generator. Robin Hannah, 3285 W. Dudley, Fresno, CA 93722. (209) 275-2834, ans. mach./fax #

**WANTED:** Silvertone 3002 ivory (516 similar to Bunis II, p. 167 photo). David Habermehl, 516 West Randle Lebanon, IL 62254. (618) 537-6785, evenings

**FOR SALE:** Wood cabinet for Mod 60 RCA with all front panel hardware—\$30 plus UPS. Motorola Service Manual 1952, radios, record changers, 2-inch thick—\$12, add shipping. C. F. England, 98 Montague Ave., S. Zanesville, OH 43701

**WANTED:** Plastic cabinet for Philco Model 50-527, Silvertone Model 4500 or 4500A. Complete record changer & power supply for Victor Electrola Model VE9-16X 1850, 1929, mounting board 16 1/2" x 13". Handbook & tube charts for Weston Tube Checker Model 672, Type 2. Larry Porter, 4115 Beam Rd., Crestline, OH 44827. (419) 583-2540

**FOR SALE:** Hammarlund: BC-799 rec, BC-1004 rec., R-84 and R-94 power supply. National: HRO 5TA1, coils, p. supply, spkr, manual; HRO 50 and 60 speakers; RAS coils; RAS rec. for parts; RAS power supply; National transmitter kit AB-1. Hallicrafters: S-15, S-40, S-85, SR-150; ransceiver complete. Bill Coolahan, 1450 Miami Dr. NE, Cedar Rapids, IA 52402. (319) 393-8075

**WANTED:** Interior horn, driver and grille for Magnavox Model 25. Wil. buy junker radio for parts. Lance Wilson, 8429 Via Linda, Scottsdale, AZ 85258. (602) 483-8993

**WANTED:** Will pay \$100+ (as much as \$500 for certain models!) for the following cosmetically nice transistor radios: any Admiral solar powered portable; Arvin 8576; Arvin 9577; Bulova 250; Bulova 620; Bulova 720; Emerson 849; Emerson 999; Firestone F-4D; any Hoffman solar powered set; Magnavox AM-2; any Mantola; any Mitchell; coat pocket Motorolas with antenna in handle/stand (56T1, 66T1, 6X39A, 7X23E, 7X24S, 7X24W); any Raytheon coat pocket set; any shirt pocket Regency (TR-1, TR 1G, TR-4); RCA 7-BT-9J; any Sentinel; any horizontal Sonora; any Sparton; Sony TR-63; or any Sony marked "Tokyo Tsushin Kogyo, Ltd."; Standard SR-F22; Sylvania Thunderbird; any Toshiba with "lace" grille; Toshiba 6TP-309; Toshiba 8TP-90; Toshiba 9TM40; Zenith Golden Triangle; Zenith Royal 500 (tan or pink only). Thanks. Bill Burkett, PO Box 1204, Peoria, AZ 85380. (602) 878-7386, fax (602) 486-4484

**WANTED:** Min. consoles, Blue 199 dud OK, Toshiba Flying Saucer. Greg Bogel, R.D. #2, Box 83, Cherry Tree, PA 15724. (814) 743-9C28

Run <sup>up</sup> Atwater Kent/Zenith/RCA/Federal/Croley/Grube/Magnavox/Marconi/Freshman



# Battery Eliminator Kits



Westinghouse/Freed Eismann/Western Coil/Howard/Stromberg-Carlson/GE/etc.

- Best Specifications
- All outputs fully protected
- High quality components and design
- Safe and simple to operate
- Printed Circuit means no wiring
- 1 Hour or less to assemble

## A-B Farm Set Specifications:

- A - Output 1.25 to 8 volts adjustable (1.8 Amps max)
- B - Output 90 Volts Fixed (emulates two 45 volt batteries) at 25 mA
- Total of 5 different terminals.

## A-B-C Bench Top Specifications:

- Will run nearly any battery set ever produced
- A - Output 1.25 to 8 Volt adjustable (3 Amps max)
- B - Output 22, 45, 67, 90, 115 at 70 ma (135 V optional)
- C - Output 5 terminal 0 to -16 Volts in increments
- Variable Output 0 to -22 adjustable
- Panel mounted A and C adjustable dials
- Total of 15 different terminals

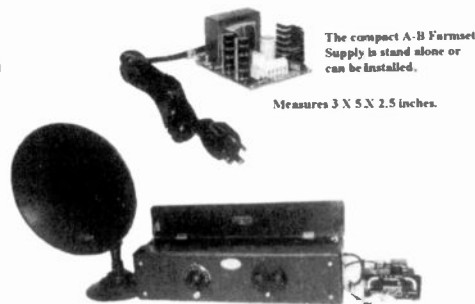

An Atwater Kent Model 33 being powered by the A-B-C Benchtop Supply (Right)  
Measures 5.5 X 7 X 3.5 inches.

Our battery eliminators out perform all others. Check and compare our prices, features and specifications. No one comes close. These easy to assemble kits include all parts and easy to read instructions. Assembly takes 1 hour or less. All you need is a soldering iron, wire snips and a small flat head screwdriver. All kits are guaranteed. A-B-C Supply is \$79.95, A-B Supply is \$39.95. Add \$6.00 S/H. We ship the next business day. To order call Peptronics toll free at 1-800-259-3005 or write Peptronics, 103 Rio Villa Dr. Punta Gorda, Florida 33950. Visa and Mastercard accepted.

**WANTED:** Emerson #BW231, EOR2, must be in excellent condition. Michael Stern, 1285 Alum Creek Dr., Columbus, OH 43209. (614) 252-4422

**MESSAGE:** Just for shipping & packaging: 1. Crosley 66TC with phonograph only; 2. TV Field Strength Meter #A-460; 3. Jackson oscilloscope #CR02. Cleo McAlexander, Box 4, Stanleytown, VA 24168. (703) 629-2972

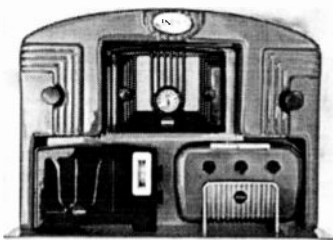

**FOR SALE:** Replica AM/FM transistor radios. Top: Emerson BA199 style. Left: RCA 9X Catalin series. Right: Crosley 56TDR style. All radios - \$25 ea. plus shipping. Also limited number of display cases as seen in photo to old radios - \$35 ea. I had these at Elgin and sold out in 1 1/2 hours. Replica AM/FM transistor Coke dispenser radios, 1955 style and present-day style - \$30 ea. plus shipping. All radios are new in box, while supplies are available. Jeff Gault, 2571 Seminole, Ann Arbor, MI 48108. (313) 973-6445

**WANTED:** To correspond with owner of SABA 4000 console. Also, copies of owner's manual for same. Thanks. Phil Holahan, 30 Worcester St., PO Box 392, Grafton, MA 01519. (508) 839-3765, ext. 260

**FOR SALE:** Radios from 1930's-1940's. Send SASE. Glenn A. Heimroth, 268 Hudson Ave., Hopatcong, NJ 07843. (201) 398-0566

**FOR SALE:** Crosley Buddy Boy, excellent original finish, chassis complete with shield & balloon tubes, needs dial scale, untested - \$475, or interesting trade. RCA advertising clock - \$65. GE tubes back-lighted clock, super condition - \$270 or trade. Hallicrafters metal TV bank - \$25. Adam Schoolsky, 38007 Stenhammer Dr., Fremont, CA 94536. (510) 791-0330

**WANTED:** RCA 103 tapestry grille speaker, excellent only. R. Monterosso, 4156 Harriet Rd., Bethpage, NY 11714. (516) 796-3804

**FOR SALE:** The REMCO collection including three N.I.B. 1950's transistor/crystal sets. Call for details. Unparalleled radioactivity! Henry B. Cohen, Mister Transistor, 2459 Eighth St., Fort Lee, NJ 07024. (201) 585-0030, fax (201) 585-1659

**FOR SALE/TRADE:** Addison Model 5; rare light green, maroon trim; restored, perfect - \$1,850. Red Cyarts - \$1,950. Emerson 5+1, light green, matching handle, no rivets, restored, quarter-inch hairline - \$2,300. **WANTED:** Spartan Cloisonne blue or red front. Other Catalins?? Mark Davis, 217 Gravatt Dr., Berkeley, CA 94705. (510) 540-1939

**WANTED:** Owner manual, maintenance manual, schematic, etc. for National NC109. Jerry L. Parker, 10 White Oak St., Etowah, NC 28729. (704) 891-4279

**FOR SALE:** Marconiphone M-9, Mercury Super 10, AK 10, Rogers 220. A. R. Nolf, 539 Kastelic Pl., Burlington, Ontario, Canada L7N 3S9. (416) 333-4557

**FOR SALE:** (4) broadcast microphones used at WMT-600 in Cedar Rapids, Iowa. (4) extra stands, elements, 20 lbs. of cable. Made by Turner Co. Cedar Rapids. Manual. Old chrome Supro guitar amp. (5) old headphones, Murdock, Brush, WLS. 6 P.A. amps. Zenith 8S-154 chassis and speaker - \$75. Zenith 5S-28 - \$150. Philco 20 cathedral - \$250. Trimm Concert horn speaker. Rogers and Myers horn speaker. Crosley bandbox and Gem box for parts. Silvertone gold face tombstone - \$125. Little battery set table with spkr. Bill Coolahan, 1450 Miami Dr. NE, Cedar Rapids, IA 52402. (319) 393-8075

**FOR SALE:** Clean, original finish AK 20; beautiful, like new inside, with original tags on bottom, works, NT - \$100. Nice, original finish AK 40, completely gone through, rebuilt power supply, WT, works - \$100. Utah electrodynamic cone speaker with built-in AC field coil supply, mantle clock cabinet, refinished but tastefully and correctly done sounds great, (Blast, p. 4) - \$85. You pay UPS. Lance Wilson, 8429 Via Linda, Scottsdale, AZ 85258. (602) 483-8993

**WANTED:** Paying \$25+ for colorfully attractive, undamaged, shirt-pocket Japanese made transistor radios with under-painted plastic fronts. "Under-painted" indicates that a sizeable area around the tuner is made of a clear plastic which has been painted on the underside (generally in white or gold and highlighted with details in other colors). Write (photos helpful) or call with full details including your selling price, or send radios (package well & insure!) for my telephone offer. I pay postage both ways if offer not accepted. Thanks. Bill Burkett, PO Box 1204, Peoria, AZ 85380. (602) 878-7386, fax (602) 486-4484

**FOR SALE:** Western Elec. tube #308-B, N.I.B. - \$140. RCA 834, N.I.B. - \$10. Novelty radios: Sonic Radio Man, N.I.B. - \$25; Mickey in chair - \$20; Mickey tuning ears - \$15; Smurf singing - \$15; Michael Jackson - \$30; Blabber Mouse - \$25; Night Rider, small crack - \$15; G.B. Marshmallow Man, N.I.B. - \$20; Dancing Slimmer, N.I.B. - \$28; Winston Cooler radio - \$30; Lunch Box - \$15; Newsweek Bathsound - \$10; Fake radio whiskey flask - \$10. Transistor radios: GE P800A - \$18; Channel Master 6528 - \$15; RCA sportman, N.I.B. - \$20; Starlite Deluxe - \$10; GE 5616 - \$18; Trancel T-11 - \$8; RCA 3-R6B4 - \$20; Penney's 6TP-555 - \$20; GE P1807B - \$20; Motorola X23V - \$18; Juliette, chip - \$18; Philco NT 802WH6 - \$20; Montclair green/white tube set - \$20. Telex miniature pillow speaker in box - \$20. Box of old phonograph needles & cartridges plus some replacement arms & other parts - \$50. Drink Coca-Cola blue & white 7 trans. radio with SW band, CD marks - \$45. Admiral #221 - \$25. GE P798C - \$20. All plus shipping. Danny Thornton, 1175 Springdale Cir., Spartanburg, SC 29303. (803) 578-8518

**FREE - 20 WORD AD EACH MONTH**  
To get your free 20 words,  
include your SUB# with your Ad.  
Additional words are 17¢ each.  
Read inside back cover for details.  
**MANY THANKS!!!!**

**FOR TRADE:** (14) fountain pens for nice cathedral or tombstone. Phil Boydston, 102 Concorde Pl., Mandeville, LA 70448. (504) 845-0867

**FOR SALE:** Aurora Transistor 6 Japanese shirt pocket, ivory, unkn. model no. - \$20/offer. A. T. Shost, 1307 Maple Ln, Sedalia, MO 65301. (816) 827-2655

**WANTED:** Western Electric amps Models 43, 46, 86, 91, 92, 124 and parts. WE555, 594, 597, TA4181. Jun Mizuno, 933 Portswood Cir., San Jose, CA 95120. (408) 268-4016

**WANTED:** Wanted for research: Information, catalogs, discs, etc. on war-time Packard-Bell Co., especially their Phonocord home recording machine. Will pay for photocopying. Ned Connors, 29 Allen Ave., Barrington, RI 02806. (401) 246-0164

**FOR SALE:** Low prices! (100) assorted knobs - \$18. Fada 252, yellow/red, vg, small hairline crack - \$375. Fada 1000 yellow/red, exc - \$450. Bendix 526, green, vg+ - \$325. Philco 41-230, exc - \$40. Rare Monarch Deco, fair - \$15. Sanyo AM/SW, tuning eye, vg - \$20. Heathkit AM rec, vg - \$20. GE AM/FM clock radio, vg - \$10. Emud Jr. 196, vg - \$30 & \$15. RCA Radiola 18, vg - \$40. Speaker 100A, vg - \$35. Emerson 7KW, vg/exc - \$50. RCA T-60, vg - \$40. Silvertone 2004, red, exc, repainted - \$25; white, exc - \$25. Crosley 56TD, damaged but nice - \$45. GE 546 clock radio, vg - \$20. Same - parts - \$5. Admiral 5J21, exc - \$25. Silvertone AM/FM, vg, crack - \$10. Philco portable, fair, ca. 1941 - \$12. Emerson 543, white, exc, repaired chip - \$28. Send \$2 for photo price list. Bob Masterson, Box 172, Valley Cottage, NY 10989. (914) 353-3151

**FOR SALE:** DuMont combo TV RA-101 20" tube, 1946, AM-FM-SW-TV, all work, mint - \$250. RA-103 trapezoidal Chatham, 1947, mint, plays - \$350. Panasonic TR-005 silver Flying Saucer, mint - \$350. All sets play perfect. T. Romano, 8 Howe Ln., Millbury, MA 01527. (508) 865-6293

**WANTED:** Microphones for Ficorder and Minifone. Sony ICR-100 radio & 8-301 TV. Gilfillan GN-1. Any Japanese WWII set, i.e. 1 tube TRX Type 94-6 & TX Type 94-5. Old telegraph keys and bugs. German military tubes. Noriyoshi Tezuka, JA1NTF, 3-8-7 Seta, Setagayaku, Tokyo 158, Japan

**FOR SALE:** Monarch 2 station code kit - \$25. 1935 Sentinel 5 tube with handle, no cracks - \$35. Philco Model 46-200, crack on top - \$30. Granco FM Model 610 U, small black case, mint, gold numbers - \$30. All sets work. Plus shipping. John Kara, 1700 Baltimore Ave., Whiting, NJ 08759. (908) 849-4318

**FOR SALE:** So you want to know how to fix those radios of the 20's. OK, here's a (1924-27) course of 20 lessons, Practice and Theory of Modern Radio by A. G. Mohaupt, copy - \$30, original - \$50. J. J. Papovich, 53 Magnolia Ave., Pitman, NJ 08071. (609) 582-8279

**WANTED:** Prewar German television receiver. Up to \$5,000 in real U.S. dollars offered for the real thing - just try me. Can arrange U.S.A. shipping address or collection, cash payment. Send me good sketch or Polaroid, all markings, general condition, etc. Also paying good money for books, 16mm film, etc. to do with prewar television in Europe. Andrew Emmerson, 71 Falcutt Way, Northampton, NN2 8PH, England. Phone 011 44 604 844130, fax 011 44 604 821647

**WANTED:** Still looking for a restorable 3 knob Spartan Bluebird chassis. Frank Nocera, 1572 Argyle Dr., Fort Myers, FL 33919. (813) 936-7197, after 6 pm

**FOR SALE/TRADE:** AK 84, restorec - \$475. Philco 3762 - \$90, 42323 - \$55. Trav-Ler 5054 - \$60. Philco 80 - \$150. Crosley E15, white - \$75. GE 62 clock, white - \$45. Stewart-Warner 300, no tubes - \$85. For communications gear. Pete Grave, PO Box 175, Ottsville, PA 18942-1075. (215) 847-2214

**FOR SALE:** Emerson 520 Catalin, brown, yellow swirls, good condition, very restorable - \$140 negotiable. Lou Hiltz, 95 Perry St., Harrisonburg, VA 22801. (703) 433-3202

**WANTED:** Escutcheons for Graybar 330, or junker cabinet with good escutcheons. Willis Watkins, 11517 Belmont, Kansas City, MO 64134. (816) 761-5701

# Active Antenna

## Model AA10

Allows antique radios which were designed for a long wire outdoor antenna to operate on a 42" indoor whip antenna. Operates from 9 volt battery.

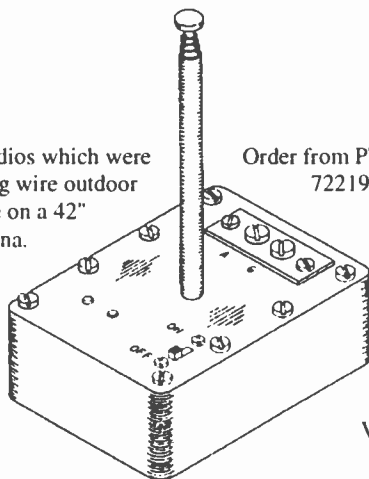

Only \$34.95

Order from PTI, Box 191117, Little Rock, AR 72219, (501)568-1995. Orders shipped UPS, prepaid in continental U.S. Please allow 3 weeks for delivery. Arkansas residents add 5% sales tax.

Visa and MasterCard accepted

**WANTED:** See what we brought back from Rochester along with other recent purchases from collections, etc. Always lots of new inventory each month, guaranteed! Send \$1 and SASE for our October list. Radiomania, 2109 Carterdale Rd., Baltimore, MD 21209

**WANTED:** Cutting & Washington. Anything! Any condition! Parts, literature. Ed Bell, 5311 Woodsdale Rd., Raleigh, NC 27606. Fax/phone (919) 851-1517

**FOR SALE:** Micronic Ruby, SR-G430 B&W - \$45. GE, P23 tube - \$10. Philmore Jr. microphone #500, N.I.B. - \$50. Zenith Royal 1000 service manual - \$10. Fred Gear, 6042 Brookridge Rd., Jacksonville, FL 32210. (904) 771-7828

**FOR SALE:** Old ARRL and Radio handbooks. New stock, lower prices. Send LSASE for list. Charles Simmons, W6PDH, PO Box 6238, Buena Park, CA 90622-6238. (714) 994-6843

**WANTED:** Will pay top dollar for a remote control for a Philco Model 39-55 console. It need not work. Robert Prillwitz, Box 212, Rt. 1, Black River Falls, WI 54615. (715) 284-9847, call collect

**WANTED:** Original or reproduction oval dial glass for Zenith 5S319 or 5S327. Copy of Philco Service Bulletin #282. Tube shield for Apex 8A cathedral. Dennis Schrank, 3129 S. Quincy Ave., Milwaukee, WI 53207. (414) 744-3374

**FOR SALE:** Character & novelty radios: 1. Nixon radio, rare - \$150. 2. Alligator radio - \$100. 3. Piano radio Tokai - \$100. 4. La Belle Francaise phone radio, loose - \$30, M.I.B. - \$50. 5. Caribbean Cruiser radio, M.I.B. - \$100. 6. Tandy spaceship radio, M.I.B. - \$50. 7. Deville 7 transistor phone radio, M.I.B. - \$50. 8. Antique Cannon radio, M.I.B. - \$30. 9. Marlboro, M.I.B. - \$100. 10. Standing knight - \$40. 11. Phonograph white & gold - \$50. 12. Guitar Nashville picker - \$50. 13. Globe Old World type - \$40. 14. Bugs Bunny Sing-A-Long, M.I.B. - \$30. 15. True Value baseball - \$15. 16. Barbie headset, M.I.B. - \$30. 17. 600 Plus, M.I.B. - \$15. 18. Jealco standup piano, white - \$80. 19. Football player 12 - \$30. 20. Space shuttle - \$30. Repair service available - (312) 889-2836. Dealer in character-related merchandise from the 40's thru 70's. Make checks payable to Carl Dahlia. Celebrity Resale, 7339 W. Addison, Chicago, IL 60634

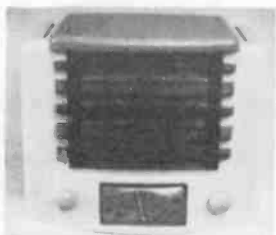

**WANTED:** Kadette radios in any color, form, and condition. I the Jethro of radio; lean on smarts and fat in the pocket! Please write or call collect: Rain Buttignol, 214 State St., #7, Portsmouth, NH 03801. (603) 427-1384

**FOR SALE:** Radiola 24 front panel, excellent, all parts intact, except tuning pointers and catacomb missing - \$65 plus UPS. Ted Stewart, 2157 Braemar Road, Oakland, CA 94602. (510) 531-7042. Fax (510) 531-7072

**WANTED:** Jewel clock radio 935, Radio Broadcast, February 1925, 7" & 10" TVs. **FOR SALE:** Hickok model CRT test adapter - \$20. Tony & Lynn DeMara, 40231 Day, Clinton Township, MI 48038-4739

**WANTED:** Larkin - Larcoflex, Larcophone, Larcophon - radios, speakers, tubes, catalogs, parts, etc. Please help locate items from this manufacturer. Joe Pawell, 6 Augustine Ave., Ardsley, NY 10502. (914) 693-9374

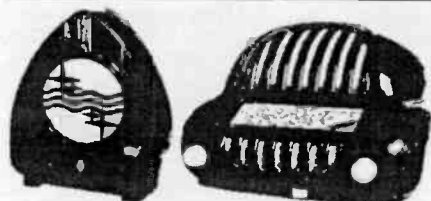

**FOR TRADE:** Philips 930 Ham Tin, Philips Ovaltiney; Sonorette, Sonora Cadillac, Ecko "trees," black/white Ecko AD97, round Ecko A22, Tesla Talisman (all in Radio Art). Various collectible crystal sets, some 1920's sets. Look at July/September A.R.C.s. Want quality Catalan and novelty sets. Simon Wade, Finchcroft, Broadwater Down, Tunbridge Wells, Kent, United Kingdom TN2 5PE. (44) 892.543505, evenings

**FOR SALE:** (100) Sprague TVL caps, N.O.S. - \$3 each. Bendix 626C, not working, case NM - \$100. Renee May, 1242 N. El Centro Ave., Los Angeles, CA 90038

**WANTED:** Small Emerson, wood table radios: Models 504, 510, 578A, 578B, 519, 503. Bob Turner, PO Box 2313, Fair Oaks, CA 95628. (916) 721-9063

**FOR SALE:** Need space. Six consoles working. No junkers: Philco Model 630, Philco Model 37-9, Philco Model 635, Wash ngton Amrad 1929 model, Delco Model R1249. Pick up only. BO over \$1,100. Jimmie Wootton, K4CMH, 778 Selma Rd., Wendell, NC 27591. (919) 365-6737

**WANTED:** Capehart 400P Series cabinet. Tom Klein-schmidt, 506 N. Maple St., Prospect Hts., IL 60070. (708) 255-8128

**WANTED:** Truetone D2661, black; Belmonts 151, 521A, 4B115, 5D118; and radio drama transcription discs. Merrill Mabbs, 709 Pluma Dr., Rapid City, SD 57702. (605) 342-4090

**FOR SALE:** Miscellaneous issues of Absolute Sound - \$3 ea. **WANTED:** Pioneer and Kenwood stereo receivers. Send for SASE - Book/Magazine list. Ernest Naaz, PO Box 6719, New York, NY 10128

**WANTED:** Tube audio and theater equipment, broken or not. Also tubes and drivers. Khanh Do, 1161 Copper Verde Ln., Modesto, CA 95355. (209) 525-8359 (h), (209) 835-9759 (w)

**WANTED:** Emerson, GE, Firestone, and Stromberg-Carlson sales literature, brochures, handouts, etc., showing wood table sets and model numbers, from 1935 thru 1942. Copies only. Bob Schafbuch, 2811 Highland Ave., Carrollton, KY 41008. (502) 732-7618

**WANTED:** Zenith 7S634 or 7S634R cabinet, solid, good or better. Robert Wheaton, W5XW, 16015 White Fawn, San Antonio, TX 78255. Answer machine (210) 695-8430. Fax (210) 695-2936

**FOR SALE/TRADE:** Collins 51J-4. Collins tube type amps. Collins Autotunes with manuals. Collins winged logos. SSB books. 32V manual. 32SR-1 manual. MR-150 manual and control panel. 1934 portable transmitter. Collins wire rack with color-coded wire. Collins microphone base. Collins 60th year commemorative stamp, pin, key chain, coin, and lighted helicopter. Collins 60th Year Signal Magazine. Other odds and ends. 212-A, 212-B broadcast consoles. Bill Coolahan, 1450 Miami Dr. NE, Cedar Rapids, IA 52402. (319) 393-8075

**FOR SALE:** CRTs: 3BP1, 3RP1, 5NP1, all new; TV pic tube, 14QP4A; vibrators, Mallory 3-prong and 4-prong. Many tubes, new and used available. Let us know your wants. Power Bros. Electronics, PO Box 70, Gladys, VA 24554-0070. (804) 376-2405

**WANTED:** Metal cased small radios, any condition or make. Thanks. Joe Montanaro, 1308 Dover Hill Rd., Santa Barbara, CA 93103. (805) 962-8796

**FOR SALE:** Zenith Royal 750 - \$25. Zenith Royal 790, Super Navigator - \$25. Zenith Royal 755 - \$25. Emerson 869 - \$30. Channel Master, green, 6511 - \$25. Tandberg portable 41, teak wood - \$30. Jefferson-Travis JT-G104 black airplane grille - \$45. Novelties: Mickey Mouse pendant, N.I.B. - \$40, Marlboro cigarette, in box - \$25, Tony the Tiger - \$30. **WANTED:** Emerson 888 Explorer, green in excellent condition only. Harold Herp, 6615 Michele Ct., Huntingtown, MD 20639. (301) 855-7071

**FOR SALE:** Mint 1959 Weathers Industries MM-1 Deluxe FM pickup system diamond LP stylus. E. K. Russell, 903 Blackstone Ave., Conneltsville, PA 15425. (412) 628-5031

**WANTED:** RCA C8-15 console RCA AR/CR 88, Hammarlund Super-Pros, Hallicrafters HT-6, HT-9, HT-20, TMC GPT750, T368. **FOR TRADE:** Large quantity of vintage ham & military equipment. LSASE for list or trade for your list. Thank you. Shane Ward, N1DMX, 14 Pond St., Amesbury, MA 01913. (508) 388-9716

**FOR SALE:** Johnson Viking Valiant transmitter; Hammarlund HQ170 receiver - \$425 for both + shipping. Call after 6 pm. Glen Woody, PO Box 44, Mountain View, AR 72560. (501) 269-8522

**FOR SALE:** 7" Hallicrafters TV, wood cabinet, nice - \$175. Bill French, 7104H Kensington, Indianapolis, IN 46226. (317) 545-5784

**WANTED:** Case for Airline #93WC-604 (see Collins I, p. 71), must be in excellent condition. Michael Stern, 1285 Alum Creek Dr., Columbus, OH 43209. (614) 252-4422

**FOR SALE:** Radiola III & balanced amp, vgc - \$225. Red Star, 3-valve British battery set, vgc, good valves - \$225. Marconi Model 23, two-valve battery set, gc, with original owners booked & good valves - \$265. RCA 15BP table set - \$50. RCA 96T5 T.S. - \$40. Guild Spice Chest #484 - \$80. GE 260 portable - \$25. Tucker radio box - \$20. Philco remote - \$50. Fisher RK1 remote - \$50. Monacor TS-20 speaker, N.I.B. - \$20. Marantz 105 - \$45. RME 4350 - \$45. Utah coax spkrs - \$40. BTC 99R tuner sub - \$40. Trimm Concert Master horn, working, gc - \$110. Arcturus blue 01-A, N.I.B. - \$35. (8) 6336, tubes - \$25 ea. (2) WD-11's, Bakelite bases, good htrs - \$35 ea. Philco 90 chassis & knobs, vgc - \$110. **WANTED:** Marantz tube gear & Fada consoles. Dave Christensen, 1732 W. Minnehaha Ave., St. Paul, MN 55104. (612) 646-0908 or 639-0331

**FOR SALE:** GE 140 metal portable - \$45. Emerson DX356, Ingraham cabinet - \$85. Sony 5-303W micro TV with carrying case - \$45. All excellent and working. Shipping extra. Walt Kiefner, 6233 51st Ave. NE, Seattle, WA 98115. (206) 524-1388

**FOR SALE:** Zenith Trans-Oceanic H500, exc - \$95. Motorola 57X11, exc - \$50. GE clock radio 65, exc - \$40. GE L660 wood, vg/exc - \$55. Crosley 56TN, vg - \$40. RCA 12X, vg+ - \$35. Philco 48-500, mint - \$50. Belmont 6D-111, exc - \$185. Emerson 520, exc - \$190. Zenith 6D030, vg - \$50. Plus shipping. Bob Masterson, Box 172, Valley Cottage, NY 10989. (914) 353-3151

**WANTED:** 5" speaker with 2500Ω field. Need all 3 knobs for Detroit Model 4J. **FOR SALE:** Rider's Radio #15, or will trade for Rider's #16. Tom Arbogast, 3743 Painesville, Warren Rd., Southington, OH 44470. (216) 889-3399

**FOR SALE:** Zenith Trans-Oceanic H-500 with book, all original, nice black case, plays on all buttons - \$125. Silvertone Model 1954 Art Deco tombstone green round dial, plays - \$175. Zenith T-600, plays on all buttons, fine - \$85. Very unusual, early homemade radio, uses two WD-11 nice and clean - \$150. (Zenith Royal 500 fine, black, oval dial - \$150.) Zenith De-lux 500-L, grey with silver front, fine - \$100. Zenith 50C long distance, plays, round gold dial, excellent, black - \$100. Novelty tube mike-phone black radio, 1600 on your dial, WAOL call letters, nice, plays - \$175. GBBS G503 all chrome mike with springs 18", nice - \$250. Peerless 16" brass-brass fan, fine, works - \$100. Westinghouse 12" brass-brass lg tank type motor runs, it's nice - \$150. Zenith console Model 1103 10-tube black round dial, plays, all original, excellent - \$200, you pick up. Hallcrafters 5-38-E, nice, plays - \$85. Roger Majestic Canada U.S. Army receiver transmitter CRT-1/CPRC-26 1953 Type-A - \$85. Majestic grandfather clock radio Model 15, all original, excellent, plays, all works, you pick up - \$500. Edison Mabry, I Collect Best in Radios, 715 W. Longview Ave., Mansfield, OH 44906. (419) 526-1175

**FOR TRADE:** Radiola 26, 24, 2, Zenith's 500, Emersons 888's, early Motorola, TR1's. **WANTED:** Radiola 1, Grebe CR18, Sony CRF1, CRF230, CRF320, CRF330. Phil P.S. Gilliana, 5733 Warren Ave., Morton Grove, IL 60053. (708) 965-7327

**WANTED:** Maas organ amplifier Model L500, uses 4-6L6's. Victor Gregowski, 3635 Orvall Dr., Fort Gratiot, MI 48059. (313) 385-9479

**WANTED:** Any 50's color TVs to 1960, whole or parts; what do you have? Phil Fabrizio, 15 Walnut St., Clifton Heights, PA 13018. (215) 623-5090

## **New Book !** **PHILCO RADIO: 1928 - 1942**

Only \$29.95 plus \$4.00 postage & handling

### **Also available:**

#### **→ VINTAGE RADIO REPAIR**

Quality Service - Reasonable Rates

All Makes and Models (Specializing in Philco)

#### **→ REPRODUCTION FRONT PANELS**

For Philco 21, 70 & 90 Cathedral Cabinets

#### **→ REPRODUCTION PHILCO PAPER MATERIAL**

Send SASE for FREE flyer

Ron Ramirez, 811 Maple St., Providence, KY 42450

**FOR SALE:** Crystal set, 1958 Ti-Nee in plastic case in good condition with copy of original magazine sales ad - \$85 plus ship. Doyle Roberts, HC63, Box 236-1, Clinton, AR 72031. (501) 745-6690

**FOR SALE:** Emerson 850 - \$45. Radiola 61-8 - \$45. Teletone Model 7 small Bakelite w/tan grille - \$75. Freed-Eisemann Model 10 w/5201A's - \$95. Philco 49-501 Boomerang - \$225. Emerson 640 pearl color w/ orig. box - \$85. RCA 100 speaker - \$45. Emerson EC-301 - \$35. Bulova 120 pink & gold - \$45. Emerson 109 (Collins 1, p. 30) - \$125. Blaupunkt Verona 2608 - \$85. Others, call. Jon Steinhauer, 636 Westminster Rd., Baldwin, NY 11510. (516) 223-9878

**WANTED:** 60's Zenith 3 band Super Navg. Royal 790 in working cond. Robert Rettmer, 9223 N.E. 192nd, Bothell, WA 98011. (206) 483-5741

**FOR SALE:** Emerson Vanguard 888 - \$55. GE H401 - \$95. Hallicrafters S120 - \$50. DeWald 561-2 - \$400. Eico 315 signal generator - \$25. Charles Voigt, 94 Cleveland St., Norfolk, MA 02056. (508) 528-7928

**FOR SALE:** Radio magazines, over (390) from early 1920's thru 1952. SASE for list. Herman Fothe, 10 Jackson St., Sloatsburg, NY 10974. (914) 753-2090

**WANTED:** Crystal sets, crystal radio kits, toy crystal sets and pocket crystal radios. Erwin Macho, Ambrosweg 17/A/B, A-1230 Vienna, Austria. (01143)-1-8814203

**WANTED:** Parmak radios in good complete, working condition. Donald McCrory, 10213 Foster, Overland Park, KS 66212. (913) 381-9916

**FOR SALE:** Loop antenna 1925 RCA, excellent copy, looks original - \$125, free shipping continental U.S.A. Howard Page, 93 James Page Rd., Port Angeles, WA 98362. (206) 452-2407

**FOR SALE:** Elementary Radio Servicing, Guide to Mobile Radio, Elements of Tape Recorder Circuits, Radio Operating Questions and Answers - \$10 ea. Audels Radiomans Guide, Big Red Book '42 - \$20. Motorola table radio, fifties, pink and white plastic, A16P3 - \$30. Bill Cherensky, 6 Kate Ln., Metuchen, NJ 08840. (908) 549-2165

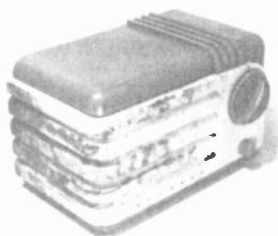

**WANTED:** Detrola, Kadette, RCA, Silvertone and many other prewar (That's World War II and soon to be III). I'll pay your sellers premium when it comes to auction times. Please write or call collect: Rain Buttignol, 214 State St., #7, Portsmouth, NH 03801. (603) 427-1384

**FOR SALE:** Big find of antique and collectible radios from Elgin Fest; hundreds of other radios, transistors, televisions. For list send 2-stamp LSASE to: John Enigl, Sr., K9HJL, 5425 Cherry Ln., Egg Harbor, WI 54209. (414) 743-3672

**FOR SALE:** Tube tester TV-7 made in 1953 by Supreme Inc. - \$85. Sony reel-to-reel Model TC-500, works, missing head cover - \$75. Magnecorder reel-to-reel deck Model PTG-A - \$55. Military radar indicator Model ASB-7A CPJ-55AER - \$35. DuMont 3" scopes, Models 164E & 245 - \$45 ea. Viking GN2 - \$55. Hallicrafters S-38, 38A, 38C, 38D, 38E, S-81 - \$50 ea. Transistor radio Marshmallow Man, not working - \$10. Emerson transistor radio Model P-3400c, brown, N.I.B. - \$15. Rider 13 - \$15. All plus shipping. **WANTED:** The following Sams Folders: 1107, 2297, 2314. Cabinet for Majestic 50 or good front piece. Dial glass for GE-L-660. Wire recorders. Peter Dieguez, 36-48 34th St., Long Island City, NY 11106. (516) 625-0429

**WANTED:** Paying \$300 (plus or minus, depending on the color and cosmetic condition of your particular radio) for the pictured Mitchell transistorized radio (Models 1101, 1102, or 1103). If you don't want money, I will swap heavy-duty to get examples of this radio into my collection. Thank you. Bill Burkett, PO Box 1204, Peoria, AZ 85380. (602) 878-7386, or fax (602) 486-4484



**FOR SALE:** Truetone D1012, mint - \$110. Westinghouse H126, mint - \$125. Philco 630 tombstone, mint - \$130. Chris or John Watts, 133 Prospect St., Plantsville, CT 06479-1116. (203) 621-3523

**WANTED:** Serious collector looking for American sets of the 1920's; some items wanted: DeForest D-10, Grebe amplifier RORC/RORB(?), Kennedy 102 portable, Ozarka portable, Tuska 222, Radiola I-IV-V-VIIB, Zenith 3-R and 4-R, Super Zenith VII, Vocolara loud-speaker, ornate Pathé speakers, collapsible antennas. Items nice, original and working condition only. Please write or send a fax with the prices to: Peter Sanzin, via diaz 11, 34170 Gorizia, Italy. Fax: 011-39-481-33415

**FOR SALE:** Old 1923 crystal set board, signed by H. Wilcox, coils, terminal posts, dials and crystals in original container, take all for - \$95. Larry Drago, 383 Lincoln Dr., Cheshire, CT 06410. (203) 272-6030

**MESSAGE:** McElroy is coming. W1M0Q's big illustrated biography of T.R. McElroy, World's Champion Radio Telegrapher. Includes every Mac Key. Limited hardcover edition - \$39.95, order by November 1 to assure availability. Softcover - \$19.95. Add \$2 shipping to order. Publication early December. Artifax Books, Box 88-A, Maynard, MA 01754

**FOR SALE:** 3350 N.O.S. radio/TV tubes - 75c each, circa 1930 thru 1960's. All in original boxes. Buyer takes all. Will include free, 1000 N.I.B., RCA, Clarostat, Sylvania, Stancor, Philco, etc. replacement parts 1940's-1960's. Total price \$2,500 plus UPS. Approx. 500 lbs. Joe Waskel, 26606 S. Pear Tree Dr., Sun Lakes, AZ 85248. (602) 895-1473

**WANTED:** RCA horn speaker. Also looking for horn speakers in good condition. James Bailey, 803 N. Waukesha, Bonifay, FL 32425. (904) 547-4985

**WANTED:** Audio amp for Seeburg 222 SHFA-1. Selection receiver TSR6, Seeburg 161. Bill Adams, 608 N. G St., Imperial, CA 92251. (619) 355-4221





### MINNESOTA - Oct. 2

#### PAVEK MUSEUM OF BROADCASTING BASIC ELECTRICITY CLASS

St. Louis Park, MN - 3515-17 Raleigh Ave.

9 am - Class for elementary students

Students & volunteer instructors needed.

The first 6 weeks of the class will satisfy requirements for the Boy Scout Radio Badge.

Info: Pavek Museum - (612) 926-8195

### ARKANSAS - Oct. 7

#### ANTIQUA RADIO COLLECTORS CLUB OF FT. SMITH CLUB MEETING

Ft. Smith, AR - St. Luke's Church,  
Waldron Road, at Free Ferry

7:30 pm

Info: Illa Davenport - (501) 795-4929

### NEBRASKA - Oct. 2-3

#### MIDWEST RADIO CLUB OLD TIME RADIO DAYS RADIO SHOW & SWAP MEET

Nebraska City, NE - Memorial Building  
810 First Corso - Show indoors

10 am - 5 pm - Both Days

Swap Meet & Flea Market in parking lot

Contests: Nicest Floor Model Radio,  
Nicest Table Set, and Nicest Display

Info: Randy King, 3017 Orwell Street  
Lincoln, NE 68516 - (402) 423-9621, days

### NEW JERSEY - Oct. 8

#### NEW JERSEY ANTIQUA RADIO CLUB MEETING

Freehold, NJ - Grace Lutheran Church  
West Main St. & Park Ave. (old Rt. 33)

7:30-9:30 pm - Meeting & Swap

Info: Don Cruse - (908) 542-2848

Tony or Kathleen Flanagan - (908) 462-6638

### KENTUCKY - Oct. 9

#### MID-SOUTH ANTIQUA RADIO COLLECTORS FALL SHOW & SWAP MEET

Lexington, KY - The Kentucky Inn  
525 Waller Ave. - (606) 254-1177

8-11:30 am - Swap Meet

11:30 am - Lunch Buffet

12 am - Meeting

1-3 pm - Auction

Old Equipment Contest - Nine Categories:

20's Sets, Cathedrals, Tombstones,  
Farm Sets, Bakelites, Catalins, TVs,  
Transistor/Novelty, and Miscellaneous

Advance table reservations advised

Info: Lewis Owens - (606) 233-0376

### NEW YORK - Oct. 3

#### GREATER NEW YORK VINTAGE WIRELESS ASSOCIATION SWAP MEET

Lake Ronkonkoma, NY - 367 Hawkins Ave.  
North of Long Island Expressway

lg. white house across fr. Dairy Barn store

9-12 am

Info: Steve Conklin - (516) 324-3012, or

Chris Bacon - (516) 981-6538, or

Chris Leippert - (516) 471-9526

### TEXAS - Oct. 5

#### HOUSTON VINTAGE RADIO ASSOC. MEETING

Houston, TX - Astrodome Marriott  
2100 South Braeswood

7-10 pm

Info: Richard Collins, 8722 Reamer St.

Houston, TX 77074 - (713) 778-0271

### OKLAHOMA - Oct. 9

#### OKLA. VINTAGE RADIO COLLECTORS MEETING

Oklahoma City, OK - Spencer's Barbeque  
NW 63rd and May Avenue

6 pm - Dinner

7 pm - Crystal Sets by Ray Long

Info SASE to: OKVRC, PO Box 72-1197

Oklahoma City, OK 73172-1197

Karen McCoy - (405) 722-0595, or

Jim Collings - (405) 755-4139, evenings

Enclose a SASE when requesting info.

## FLORIDA - Oct. 9

### FLORIDA ANTIQUE WIRELESS GROUP MONTHLY TAILGATE MEET

Orlando, FL - Radio Relics, 321 Evans St.  
8 am

Info: Paul Currie - (407) 365-9305, or  
FAWG - (407) 895-0146

## ILLINOIS - Oct. 11

### BELLEVILLE AREA ANTIQUE RADIO CLUB MEETING

Belleville, IL - Belleville Area College  
7 pm - Meeting Topic: Tombstone

Info: Karl Stegman, 4 Cresthaven Dr.  
Belleville, IL 62221 - (618) 234-7992

## ALABAMA - Oct. 9

### SOUTHERN VINTAGE WIRELESS ASSN. FALL SWAP MEET

Decatur, AL - Ninth St. Methodist Church  
From I-65 take Decatur Exit Hwy. 20  
Church on corner of Ninth and Hwy. 31  
8 am - 2 pm

Info: Bill Moore - (205) 880-1207

## GEORGIA - Oct. 12

### SOUTHEASTERN ANTIQUE RADIO SOCIETY MEETING

Chamblee, GA - Shoneys Restaurant  
Peachtree Industrial, 1 mi. North of I-285  
6:30 pm - Meeting: Foreign Sets

6 pm - Mini Meet before monthly meeting  
Info: Charles Pierce - (404) 233-1340, or  
David Martin - (404) 578-1270

## OREGON - Oct. 9

### NORTHWEST VINTAGE RADIO SOCIETY MEETING

Portland, OR - Rasada Museum  
7675 SW Capitol Highway, at 32nd St.  
10 am - Meeting

Info: Ed Charman, PO Box 82379  
Portland, OR 97282-0379 - (503) 654-7387

## OHIO - Oct. 12

### ANTIQUÉ RADIO COLLECTORS OF OHIO MEETING

Kettering, OH - First Natl. Bank Basement  
4100 Far Hills Avenue  
SE corner of Far Hills Ave. and Stroop Rd.  
7:30 pm - FM

Info: Stan Kleen, 200 Castle Drive  
Dayton, OH 45429 - (513) 293-3194

## INDIANA - Oct. 9

### INDIANA HISTORICAL RADIO SOCIETY MEETING

Greenfield, IN - Riley Park  
7:30-12 am - Swap & Trade  
Noon - Lunch & Meeting

Info: Glenn Fitch - (317) 565-6911

## PENNSYLVANIA - Oct. 12

### DELAWARE VALLEY HISTORIC RADIO CLUB MEETING - SWAP MEET - AUCTION

Souderon, PA - 117 Main St.  
N. Penn Amusements Building - 7:30 pm  
Info: Radio Attic, PO Box 624  
Lansdale, PA 19446 - (215) 368-2520

## ILLINOIS - Oct. 10

### ANTIQUÉ RADIO CLUB OF ILLINOIS AUTUMN MEETING

Elgin, IL - Holiday Inn, 345 River Rd.  
7 am-noon - Swap Meet in west parking lot  
11 am - Business Meeting

Info: Jeff Aulik, 1708 Parkview Ave.  
Rockford, IL 61107 - (815) 399-1902

## CALIFORNIA - Oct. 12

### CALIF. HISTORICAL RADIO SOCIETY NORTH VALLEY CHAPTER MEETING

Redding, CA - 7 pm  
Info: Norm Braithwaite - (916) 246-4209,  
or Chris Galantine - (916) 244-2337

## MARYLAND - Oct. 10

### MID-ATLANTIC ANTIQUE RADIO CLUB ANNUAL PICNIC & MEET

Myersville, MD - Ed Lyon's "Near Neighbor  
Farm, 11301 Woodland Way

9 am til Dark - Meet  
Noon - Picnic

Auction & Silent Auction - Flea Market  
Repair Clinics - Rain or Shine - Huge Tent

Info: Ed Lyon - (301) 293-1773

## MISSISSIPPI - Oct. 12

### MISSISSIPPI HISTORICAL RADIO AND BROADCASTING SOCIETY MEETING

Meridian, MS - 2412 C Street - 7 pm  
Info: Randy Guttery, 2412 C. St.  
Meridian, MS 39301 - (601) 693-5958

## MISSOURI - Oct. 13

### ANTIQUE RADIO COLLECTORS & HISTORIANS OF GREATER ST. LOUIS MEETING

St. Louis, MO - Library at Lindbergh Blvd. (Route 67) and Route 40

7 pm - Bring item for show & tell

Info: Charles Juedemann, 262 Churchill Ln. Ballwin, MO 63011 - (314) 256-3727

## ARKANSAS - Oct. 14

### ARKANSAS ANTIQUE RADIO CLUB MEETING

Little Rock, AR - The Auditorium S.W. Bell Bldg., 120 W. 8th Street

7 pm

Info: Tom Burgess - (501) 565-1753

## TEXAS - Oct. 15-17

### VINTAGE RADIO & PHONOGRAPH SOCIETY ANTIQUE WIRELESS ASSOCIATION CONVENTION '93

Irving, TX - Holiday Inn, 4440 W. Airport Freeway, Dallas-Ft. Worth Airport South

VRPS Rates: (214) 399-1010

Shuttle Service from DFW Airport

Friday - Oct. 15

9:30 am - 1 pm - Contest Check-in

1:30-3 pm - Technical Session

3-6 pm - Contest Viewing

4-5 pm - Silent Auction (check-in 3-4 pm)

9:30 am - 5 pm - PM Auction Check-in

6-10 pm - Fri. PM Auction

Saturday - Oct. 16

8-11:30 am - Reg. Auction Check-in

9 am - 3 pm - Contest Viewing

10-11 am - Silent Auction (check-in 9-10)

Noon- 5 pm - Sat. Regular Auction

6:30-7:30 pm - Reception

7:30-9:30 pm - Awards Banquet

Wes Wise, Guest Speaker

Sunday - Oct. 17

8-12 am - Flea Market (inside)

Info: VRPS, PO Box 165345, Irving, TX 75016  
C.F. Crandell - (214) 337-2823, after 6 pm  
Don Nordenholt - (214) 423-9175, after 7 pm

## MICHIGAN - Oct. 16

### MICHIGAN ANTIQUE RADIO CLUB 8th ANNUAL FALL SWAP MEET

Dearborn, MI - Armenian Hall

8 am - 1 pm

Silent & Donation Auctions  
Contest and 50/50 Raffle

Advance Table Reservations Advised

Info: Don/Nancy Colbert - (313) 274-1948

## MARK YOUR CALENDAR

Oct. 2 - MN, St. Louis Park - Museum Class\*  
Oct. 2-3 - NE, Nebraska City - Radio Days\*  
Oct. 3 - NY, Lake Ronkonkoma - GNYVWA \$\*  
Oct. 5 - TX, Houston - HVRA Meeting \$\*  
Oct. 7 - AR, Ft. Smith - ARCCFS Meeting \$\*  
Oct. 8 - NJ, Freehold - NJARC Meeting \$\*  
Oct. 9 - AL, Decatur - SVWA Swap Meet\*  
Oct. 9 - FL, Orlando - FAWG Meet \$\*  
Oct. 9 - IN, Greenfield - IHRS Meeting\*  
Oct. 9 - KY, Lexington - MSARC Swap Meet\*  
Oct. 9 - OK, Oklahoma City - OKVRC Meeting \$\*  
Oct. 9 - OR, Portland - NWVRS Meeting \$\*  
Oct. 10 - IL, Elgin - ARCI Meeting\*  
Oct. 10 - MD, Myersville - MAARC Picnic \$\*  
Oct. 10 - MN, St. Louis Park - Pavek Reunion  
Oct. 11 - IL, Belleville - BAARC Meeting \$\*  
Oct. 12 - CA, Redding - CHRS-NVC Meeting\*  
Oct. 12 - GA, Chamblee - SARS Meeting \$\*  
Oct. 12 - MS, Meridian - MHR&BS Meeting \$\*  
Oct. 12 - OH, Kettering - ARCO Meeting \$\*  
Oct. 12 - PA, Souderton - DVHRC Swap Meet \$\*  
Oct. 13 - MO, St. Louis - ARCH Meeting \$\*  
Oct. 14 - AR, Little Rock - AARC Meeting \$\*  
Oct. 15-17 - TX, Irving - VRPS/AWA '93\*  
Oct. 16 - MI, Dearborn - MARC Fall Swap Meet\*  
Oct. 16 - TN, Brentwood - MCVR&PS Meet\*  
Oct. 17 - Alberta, Edmonton - AVRS Meeting\*  
Oct. 17 - WA, Seattle - PSARA Meeting \$\*  
Oct. 20 - CA, N. Highlands - SHRS Meeting \$\*  
Oct. 21 - NY, Goshen - HARPS Meeting \$\*  
Oct. 23 - FL, Orlando - FAWG Meet/Auction\*  
Oct. 23 - NJ, Hightstown - NJARC Flea Market\*  
Oct. 23 - NY, Middletown - HARPS Show\*  
Oct. 23 - NC, Greensboro - VRUS Show\*  
Oct. 25 - AL, Birmingham - ALHRS Meeting \$\*  
Oct. 26 - OH, Dayton - SPARKS Meeting \$\*  
Oct. 30 - GA, Conyers - SARS Swap Meet\*  
Oct. 30 - NH, Nashua - NEARC Meet\*  
Oct. 30 - Ontario, London - LVRC Workshop  
Oct. 30-31 - OH, Akron - BARPC Mall Show\*  
Nov. 6 - CA, Redwood City - CHRS Meet\*  
Nov. 7 - KS, Kansas City - MAARC Auction\*  
Nov. 7 - NY, Rochester - AWA Meeting  
Nov. 13 - AZ, Tempe - AARC Meet & Auction\*  
Nov. 14 - CO, Denver - CRC Meeting  
Nov. 19-20 - CA, Norwalk - SCARS Meeting\*  
Nov. 27 - Ontario, London - LVRC Meeting  
Dec. 4 - TX, Irving - VRPS Christmas Cheer  
Dec. 11 - FL, Bradenton - AWA/Fla. Meet  
Dec. 12 - Alberta, Edmonton - AVRS Meeting  
Jan. 15 - NH, Nashua - NEARC Meet  
Jan. 22 - MI, Grand Rapids - MARC Meet/Auction  
Feb. 19 - IN, Indianapolis - IHRS Meeting  
May 13-14 - IN, Kokomo - IHRS Meeting  
Jul. 7-9 - MI, Lansing - MARC Extravaganza '94  
\* See expanded listing this month. \$ Monthly Meeting

## TENNESSEE - Oct. 16

### MUSIC CITY VINTAGE RADIO & PHONOGRAPH SOCIETY AUTUMN SWAP MEET & MEETING

Brentwood, TN - River Park  
Concord Rd. Exit off I-65

across from WSM Tower & Transmitter

7 am - 2 pm - Swap

2 pm - Meeting

Info: Marty Evans - (615) 227-3464

### MENTION A.R.C. WHEN CONTACTING CLUBS!

### **ALBERTA - Oct. 17**

#### **ALBERTA VINTAGE RADIO SOCIETY MEETING**

Edmonton, Alberta - 12845 102 Avenue  
Alberta Provincial Archives Lecture Room  
1 pm

Info: Nap Pepin - (403) 424-2214  
AVRS, PO Box 43012 Metropolitan Pl. P.O.  
Edmonton, Alberta, Canada T5J 4M8

### **NEW YORK - Oct. 23**

#### **HUDSON VALLEY ANTIQUE RADIO & PHONOGRAPH SOCIETY**

**OLD-TIME RADIO & PHONO SHOW**  
Middletown NY - Middletown Holiday Inn  
Exit 122 off Route 17  
8 am - 4 pm

All indoor - Refreshments available  
Info: John & Linda Gramm - (914) 427-2602  
Art Kingsley - (914) 446-4091

### **WASHINGTON - Oct. 17**

#### **PUGET SOUND ANTIQUE RADIO ASSN. MEETING/SWAP MEET**

Seattle, WA - Shoreline Museum  
749 North 175th St. & Linden Ave.  
1 mile West of I-5, Exit #176  
12 noon

Talk by Capt. Viggo Conradt-Eberlin  
Info: Al Atworth, PO Box 125  
Snohomish, WA 98291-0125 - (206) 568-2698

### **NEW JERSEY - Oct. 23**

#### **NEW JERSEY ANTIQUE RADIO CLUB FLEA MARKET**

Hightstown, NJ - Hightstown Country Club  
NJ Turnpike Exit 8, East on Route 33  
for 200 yards on the left  
8 am - 1 pm

Ballroom Grounds - Outside  
Info: Tony Flanagan - (908) 462-6638

### **CALIFORNIA - Oct. 20**

#### **SACRAMENTO HISTORICAL RADIO SOCIETY MEETING**

N. Highlands, CA - SMUD Foothill Service  
Center, Room D, 5026 Don Julio  
7-9 pm

Info: Secretary SHRS, PO Box 162612  
Sacramento, CA 95816

### **NORTH CAROLINA - Oct. 23**

#### **VINTAGE RADIO UNIQUE SOCIETY "DIEHARD" COLLECTORS TRADE/SHOW**

Greensboro, NC - The Cottonmill Square  
I-40 Exits 214 & 214-B, North on Wendover,  
Exit Clifton Rd. to Cottonmill Square  
Area motels at I-40 Exits 214 & 217

Oct. 22: 6:30 pm - Early Arrivals Reception,  
at the Cottonmill Cafe

Oct. 23: All Day - Open Air Trade Market  
(inside if weather bad)

10 am - Ladies' Shopping, various on site  
10 am - Enter display item/s, noncontest  
Amateur Radio Talk-in on +146.61 Repeater

Info: Jerryl Sears, WB4JGZ  
312 Auburndale St., Winston-Salem, NC  
27104 - (919) 765-4302, 6-9 pm

### **NEW YORK - Oct. 21**

#### **HUDSON VALLEY ANTIQUE RADIO AND PHONOGRAPH SOCIETY/ARCA MEETING**

Goshen, NY - Cataract Firehouse, Main St.  
7-9 pm

Info: John & Linda Gramm, Box 1, Campbell  
Hall, NY 10916 - (914) 427-2602, 6-9 pm

### **ALABAMA - Oct. 25**

#### **AL. HISTORICAL RADIO SOCIETY MEETING**

Birmingham, AL - Homewood Public Library  
1721 Oxmoor Road  
7 pm

Info: Earl Ridolphi, 2413 Old Briar Trail  
Birmingham, AL 35226 - (205) 823-3314

### **FLORIDA - Oct. 23**

#### **FLORIDA ANTIQUE WIRELESS GROUP MEET/AUCTION**

Orlando, FL - VFW Hall,  
4444 Edgewater Dr.  
8 am - 4 pm

Morning Swap Meet  
Afternoon Equipment Auction  
Info: Paul Currie - (407) 365-9305  
FAWG - (407) 895-0146

Listings on these pages are free to  
antique radio clubs, as space permits.  
Please include date, time, where, direc-  
tions, & information/contact person.  
Submission Deadline - 5th of month.

Mention A.R.C. when contacting clubs!

## OHIO - Oct. 26

### SOCIETY FOR PRESERVATION OF ANTIQUE RADIO KNOWLEDGE MEETING

Dayton, OH - ITT Technical Institute  
3325 Stop Eight Road

7:30 pm

Info: Harold Parshall - (513) 298-4044, days  
(513) 268-2909, evenings

## CALIFORNIA - Nov. 6

### CALIF. HISTORICAL RADIO SOCIETY MEET

Redwood City, CA - Ampex Corp., Bay Rd.  
3 Blocks South of Woodside Road  
8 am

Info: CHRS, PO Box 31659, San Francisco,  
CA 94131 - (415) 978-9100, 24-hr. info

## NEW HAMPSHIRE - Oct. 30

### NEW ENGLAND ANTIQUE RADIO CLUB MEET

Nashua, NH - Resurrection Center  
Rt. 3 (Everett Turnpike), Exit 6

1 1/2 miles West on Rt. 130

8 am-1 pm

Info: Ray Lumb - (508) 865-1290

## KANSAS - Nov. 7

### MID-AMERICAN ANTIQUE RADIO CLUB AUCTION

Kansas City, KS - Best Western Village Hall  
501 Southwest Blvd.

1 block S. of I-35 and 7th St. Exit Ramp

8:30 am - Check-in & Preview

10 am - Auction

Info: MAARC, c/o Stephen Phipps  
10201 West 52nd Ter., Merriam, KS 66203  
(913) 362-4427

## GEORGIA - Oct. 30

### SOUTHEASTERN ANTIQUE RADIO SOCIETY FALL SWAP MEET

Conyers, GA - C.E. Steele Community Center  
1040 Oakland Ave., 15 min. from I-285

East of Atlanta I-20 to Exit 41

8 am

Contest - Radio Flea Market

Indoor-Outdoor Facilities - Door Prizes

Info: Charles Pierce, 4380 E. Brookhaven Dr.  
Atlanta, GA 30319 - (404) 233-1340, or  
Charles Milton - (404) 922-6507

## ARIZONA - Nov. 13

### ARIZONA ANTIQUE RADIO CLUB FALL SWAP MEET & AUCTION

Tempe, AZ - 6221 S. Maple Avenue  
Antique Electronics Supply Parking Lot

8 am - Swap Meet

11 am - Auction

Info: Debbie Krol - (602) 820-5411

## OHIO - Oct. 30-31

### BUCKEYE ANTIQUE RADIO AND PHONOGRAPH CLUB SHOW

Akron, OH - Chapel Hill Mall  
2000 Brittain Road

Show during regular Mall hours

Info: Bob Lowry - (216) 633-5443

## CALIFORNIA - Nov. 19-20

### SOUTHERN CALIFORNIA ANTIQUE RADIO SOCIETY MEET

Norwalk, CA - Ramada Inn

12 noon Friday through Saturday

Programs - Mini-Auction - Speakers  
Lunch and Dinner

Info: Floyd Paul - (818) 242-8961

Enclose a SASE when requesting info.

Non-members welcomed at all meets!  
Admission charged at some meets.

## BUSINESS CARD ADS - \$34.00 FOR 3 MONTHS



### TRI-STATE LOUDSPEAKER

Complete Speaker Engineering, Factory Authorized Services  
Warranty Repairs, Re-Coning & Parts For All Speakers

650 Franklin Ave.  
Alliquipp, PA 15001  
(412) 375-9203

Dennis Gino McNeill  
Speaker Engineer BSET  
Res. 375-4728

Free Friendly Estimates!

## ★ ★ WANTED ★ ★



- McMurdo Silver, Lincoln, Zenith chrome chassis radios
- Advertising brochures, literature, etc. for these sets



- Prewar televisions
- Don Hauff (612) 374-9739  
P.O. Box 16351  
Minneapolis, MN 55416

**BUSINESS CARD ADS - \$34.00 FOR 3 MONTHS**

**RADIO ROADMAP**

**PRE-1945 RADIO SCHEMATICS**

**\$4.00 EACH POSTPAID**

**LANCE WILSON 602-483-8993**

**8429 VIA LINDA**

**SCOTTSDALE, ARIZONA 85258**

**WANTED**

**SONY CRF320  
CRF330**

Chris Clark, 117 Hudson Street, NYC, 10013  
TEL. (212) 219-1783

Free Estimates  
Hrs - 10 AM - 7 PM  
Mon - Sat

Tel / Fax (203) 928-2628



**ANTIQUÉ RADIO  
RESTORATION & REPAIR**  
1920 - 1960's



*Buy & Sell*  
Reasonable Rates Tubes,  
Parts & Service on all  
Antique Car, Console &  
Table Radios Tube Amps  
& Phonos

20 Gary School Road  
BOB ESLINGER Pomfret Center CT 06259



**john d. eckland**

*vintage american & european radio repair*

969A ADDISON AVENUE PALO ALTO CALIFORNIA 94301  
415/323-0101

**ANTIQUÉ RADIO RESTORATION**

Since 1936 Repair - Buy - Sell  
Complete Restorations • Prompt Service

**COOPER'S RADIO SERVICE**

425 Court Street  
Rockwell City, Iowa 50579



**LARRY COOPER**  
712-297-7232

PAUL

ROBIN

**DR NOVELTY**  
JUKEBOX AMPLIFIER REBUILDING

414 964 3392

**Old Time Replications**

"TURN TO US WHEN YOU NEED KNOBS"  
KNOBS • PUSHBUTTONS • ESCUTCHEONS  
PLASTIC GRILLS • HANDLES

**LARRY BORDONARO**

5744 TOBIAS AVE. VAN NUYS, CA 91411  
PHONE (818) 786-2500 • FAX (818) 909-0241

**SPECIAL PURPOSE TUBES SEMI-CONDUCTORS**  
**PICTURE TUBES RECEIVING TUBES**

**Donna L. O'Connor**

(201) 751-2591  
(201) 471-8120

824 MAIN ST.  
BELLEVILLE, NJ 07109

Schematics Repair Notes History

**Radio Schematic Service  
And Research Information**

Don Davis K4ZDB  
8833 Brucewood Drive  
Richmond, VA 23235  
(804) 272-4452

\$4 + SASE Per Schematic  
Provide Mfr., Model,  
and/or Tube Layout.  
Quotes on other info.

**BETA-TEK**

**ANTIQUÉ RADIO SERVICE**



• Repair of Radios, Communications  
Receivers & Test Equipment  
• Power Supplies for Battery Sets

**RAY BINTLIFF**  
2 Powder Horn Lane  
Acton, MA 01720  
508 283-7435



**THE RADIO MAN**

*Buy-Sell-Trade*  
Antique Radios • Tubes • Parts

**DICK MORGAN**  
RES: (214) 251-3099

TEL: (214) 276-5458  
FAX: (214) 272-1831  
P.O. BOX 461485  
GARLAND, TX 75046-1485

**Cone and Voice  
Coil Replacement**

**Field Coils  
Retrumb**

Specializing in

**Antique Speaker Repair**

*18 Years  
Experience*

**Conventional  
PM Speaker Repair**

**Mark Wenzel**  
103 N. Lake Point Ct.  
Crossville, Tn. 38555  
1-615-456-2529

**BUSINESS CARD ADS - \$34.00 FOR 3 MONTHS**

**WANTED**

*Pre-1940 Aircraft and Airport Radios, Equipment, Memorabilia.*

James Treherne  
11909 Chapel Rd., Clifton, VA 22024  
703-830-6272

• GRUNDIG • SABA  
• TELEFUNKEN • NORDMENDE

ALL WORK GUARANTEED

The Bavarian Radio Works

SPECIALIZING IN REPAIR OF EUROPEAN RADIO SETS

ROSS A. HOCHSTRASSER  
(617) 447-9104

162 BEULAH ST.  
WHITMAN, MA 02382



Everett Hoard  
Box 38  
403 S. McIntosh St.  
Lehr, N.D. 58460  
(701) 378-2341  
CAPACITORS



**ANTIQUE RADIO RESTORATIONS**

635 S. Lincoln Ave., O'Fallon, IL 62269  
618-632-7423

Collectors of Old Radios  
Electronic Consultant, Dual Reproductions  
Catacombs - Restored

Clinton Blais, P.E.  
Life Member I.E.E.E.  
AWA, ARCA, ARCI, MAARC

Ron Blais

**ELECTRON TUBE ENTERPRISES**

(DEALERS IN SURPLUS ELECTRON TUBES)

BOX 8311  
ESSEX, VT. 05451  
TEL:802-879-0611  
FAX:802-879-7764

FREE 1993 CATALOG AVAILABLE

Dedicated to the Preservation of Radio Antiquity



**MARCONI ELECTRONICS**

Late 20's to Late 50's Vintage  
Radio Repair and Restoration

Pat Ryan  
2122 Marconi Avenue • St. Louis MO 63110 • 314-664-7080

Andrew Mooradian

Wanted Pre-1926 Radios by

**AMRAD**

Also, Radio Parts, Accessories  
and Literature

5 Priscilla Lane, Winchester, MA 01890

**CLASSIC RADIO SERVICE**

55-60-70 80-90	100-110-120-130 140-150 160
----------------	-----------------------------



P.O. BOX 764, 25 MAPLE ROAD  
WOODACRE, CA 94711



DAN HEALY

Telephone: 415-488-4596



THE FINISHING TOUCH



Jodd E. Hinman Restorations  
SHOW WINNING FINISHES

— AUTO INTERIOR WOOD —  
• RADIOS • MECHANICAL  
• 78RPM JUKEBOXES • ELECTRONICS



203-274-0705

203-268-6060



182 JUDD FARM ROAD  
WATERTOWN, CONN. 06795



**GOLDEN AGE RADIO**

Antique Radio  
Sales & Repairs

WE BUY ANTIQUE  
RADIOS, TUBES, PARTS  
& ADVERTISING

1609 Ceddox St.  
Curtis Bay, MD 21226

410-354-0LDE  
354-6533

Wed - Fri 1-8

Sat & Sun 10-6 SAM, WILL, KAREN, FRANK & DON

**SUNSHINE SOUNDS**

WANTED:



Hi Fi TUBE & COMMERCIAL AMPS

McIntosh, Marantz, Dynaco, Heath,  
Altec, Scott, RCA, Fisher, Craftsman,  
Grommes, Fender, Ampex, W.E. Vox,  
Brook, Acro, Pultec, Fairchild

SPEAKERS & HORNS

Altec, Jensen, RCA,  
E.V., Western Electric,  
JBL, Tannoy

405-737-3312

Sonny - 1413 Magnolia Ln., Midwest City, OK 73110



**ANTIQUE RADIO SERVICE**

RADIOS REBUILT  
BOUGHT SOLD TRADED

Auto and Home

WE BUY AUTO RADIOS

(508) 651-2418

RICHARD FOSTER  
12 Shawmut Ave  
Cohasset, MA 01778

## BUSINESS CARD ADS - \$34.00 FOR 3 MONTHS

### SPY EQUIPMENT WANTED!

- \* Code Machines
- \* Secret Radios
- \* Clandestine Weapons
- \* Secret Cameras
- \* OSS, SOE, CIA, KG81
- \* I Buy or Trade!

Keith Melton  
P.O. Box 5755 Bossier City, LA 71171  
(318) 747-9616 Days: FAX (318) 747-9010



If you buy, sell or like Jukeboxes you need ALWAYS JUKIN--THE MONTHLY JUKEBOX MAGAZINE!! Subscribers in 25 countries, ALWAYS JUKIN LEADS THE WAY: Articles, photos, show reports, ads, new products, price guides, restoration tips, repairs--everything you need to know about JUKE-BOXES--the fastest appreciating collectible in the world!!! Fun & a great investment.  
Sample copy, \$5. \$30 per year.  
ALWAYS JUKIN, 221 YESLER WAY AR, SEATTLE, WA. 98104. (206) 233-9460.  
Master/Visa ok.

"Dead Radios Brought Back to Life"

### FRANKENSTEIN'S RADIO LABORATORY

Specializing in Antique Radios.  
Old Radio Cadavers and Parts Bought and Sold  
Mail Order Sales of New, N.O.S. and Used Parts

MAIL ORDER SALES  
4010 Fairmount Pkwy., Suite 285  
Pasadena, Texas 77504

Gordon R. Rolston  
Repairs by Appointment  
(713) 998-0130

TUBES

TUBES

TUBES



### QUEST ELECTRONICS, INC.

955 BANNOCK · DENVER, CO 80204  
PHONE (303) 623-7700 · FAX 620-0904



30 years experience

### Jackson Speaker Service

Expert Antique Loudspeaker Repairs  
(Cone Types) And Rebuilding A Speciality.  
Speaker Parts And Repair Service On  
Virtually Any Speaker Made Including  
Stereo, P.A., And Antique Auto Speakers.  
217 Crestbrook Dr. Owner  
Jackson Mich 49203 Ran McGee  
Ph. - (517) 789-6400, Ans. 4th ring  
Wk - days 10: am - 7pm Wk - Ends 9 - 5pm



RELIABLE - PROMPT - GUARANTEED

### SOUND REMEDY LOUDSPEAKER REPAIR SERVICE

331 Virginia Avenue  
Collingswood, New Jersey 08108

Richard G. Stamer

Telephone  
(609) 869-0238



### CRYSTAL SETS

PARTS - PLANS - KITS - BOOKS  
CATALOG \$1.00

Largest source of Vintage and New  
Variable Air Condensers, Variometers,  
Vario-Couplers, Tap Switches, Tap  
Points, Galena and Germanium  
Detectors, Detector Stands, Cat  
Whiskers, Terminals, Sliders,  
Headsets, Dial Knobs, Coil Forms,  
Magnetic Wire, etc.

MIDCO  
P O Box 2288  
Hollywood, FL 33022  
(305) 925-3670  
BA Turbo Ph DEE

### TUBES

### ALL TYPES → BUY-SELL

GREAT SELECTION AND PRICES  
Quick Service

MIKE MARX — #6 BARBARY LANE  
St. Louis, MO 63146  
(314) 432-4587

(510) 490-5842

Fax (510) 490-1961

### Speakerworld®

Expert Speaker Refoaming and Reconing

2000 Warm Springs Ct. #6 Visa/ Free Return  
Fremont, CA 94539 MC Freight By UPS

784-9417

784-9417



### COSMOS TV

- Low Prices
- TV Repair

- Quality Used TVs
- Antique Radio Repair

Buy, Sell, Trade

Free Estimates  
784-9417

5919 15th Ave. N.W.  
Seattle, WA 98107

### WE PAY MORE FOR VINTAGE HI-FI !

ANGELA  
INSTRUMENTS



10830 Guilford Rd., Suite 309  
Annapolis Junction, MD 20701

Phone (301) 725-0451  
Fax (301) 776-2892

Cash for tube gear by  
Marantz, McIntosh, Dyna,  
Western Electric and most  
other makers. Also buying  
all audio tubes, tube testers,  
old mics, output transformers,  
books about tube electronics  
and hi-fi, related clocks  
and signs, etc.

HAVE CASH  
WILL TRAVEL ANYWHERE!

### RADIO BOOKS FOR SALE

Large selection of books on Radio and Related Technology  
Call or write for our List of Catalogs  
Always buying, single items or collections

### RAINY DAY BOOKS

P.O. BOX 775, FITZWILLIAM NH 03447  
(603)-585-3448



## BUSINESS CARD ADS - \$34.00 FOR 3 MONTHS

**WANTED**  
PRE 1900  
**ELECTRICITY**  
MEDICAL • X-RAY  
TELEGRAPHY • TELEPHONE  
PRE 1925  
RADIO • WIRELESS  
PRE 1940  
TELEVISION



**NEW WIRELESS  
PIONEERS**  
P.O. BOX 398  
ELMA, NY 14059  
716-681-3166

BOOKS • TUBES • ARTIFACTS  
MAGAZINES • AUTOGRAPHS  
CATALOGS • EPHEMERA

COMM/NAV BOMF  
RADIO SETS  
NAVAL AIR FIELD  
U.S. FOREIGN

CHARLES DE BCCA KALIGON  
501 MYSTIC VALLEY PKWY  
MIDDOPD, MASS 02155  
PHONE 617-986-9354



**MILITARY ELECTRONICS**

BUY                      WANTED                      TRADE

**ANTIQUA RADIO REPAIR**  
*Repair - Restore - Buy & Sell*  
Schematic Service  
Radios \$2.50, TVs \$4.50

**DAMASKE ELECTRONICS**  
S74-W16834 Janesville Road  
Muskego, WI 53150  
Phone: (414) 679-0838

RADIOS & STRANGE MISCELLANEA

*IF YOU VISIT THE BRIMFIELD FLEA MARKET...  
STOP BY FIRST!*

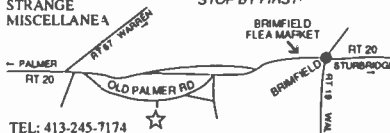

TEL: 413-245-7174

COUNTRY ROAD BARN - BERNIE SAMEK  
OLD PALMER ROAD, BRIMFIELD, MASS.

50 years                      **CHUCKS**                      of service!

**Any Tube Radio Repaired and  
Guaranteed to work good.  
\$25 plus parts & UPS**

**CHUCKS**  
167 LYNN DRIVE - PO BOX 598  
NEW HAVEN, WV 25265 - PH (304) 882-2220

**VACUUM TUBES**  
*Electronic Components*

Write or call for list

Network Sales                      (708) 773-4733  
5N105 Rt. 53  
Itasca, IL 60143

Are You Looking For Antique Radios, Parts, Tubes, Schematics and Restoration Services?

For Free Flyer, a 2-Stamp LSASE is required to insure a response to your request. Send to:

*Olde Tyme Radio Company*  
2445 Lyttonsville Road, Suite 317, Silver Spring, MD 20910

Wish to contact us by phone?  
Our number is (301) 585-8776.  
Please call 10 am to 10 pm (Local Time)

**Antique Radios**



David & Nancy Snow  
P.O. Box 6352  
Jackson, MI 49204  
(517) 787-2985

We Buy, Sell, Repair  
**ARBE - III Battery Eliminators**

WANTED: Tube Hi-Fi Components & Studio Equipment of the 1950's and 60's

**Hirantz, McIntosh, Scott, Fisher, Brook  
Acrosound, Broelner, Western Electric  
Fairchild, Altec, Tannoy, JBL**

Richard Sharisky  
P.O. Box 521  
Belmont, MA 02178                      (617) 484-5734

**E.H. Scott Radio**  
Collector Historian Admirer



JIM CLARK  
1292 STARBOARD  
OKEMOS, MI 48864  
(517) 349-2249

**1920-1970  
SCHEMATICS + PAGES OF INFO  
\$5.00 POSTPAID**

**MANUAL PRICES - SASE  
RADIO/TV/HAM/MISC.**

**"IF I DON'T HAVE IT, YOU  
PROBABLY DON'T NEED IT."**

**ALTON H. BOWMAN - 4172 EAST AVENUE  
CANANDAIGUA, NY 14424-9564**

RADIO - TELEVISION - Hi Fi  
Tubes 1940 & Later  
Send S A S E for Catalog and Prices

**KIRBY**

Up To 90% Off List Price  
John Kirby  
298 West Carmel Dr  
Carmel, IN 46032



317-843-2212

# Radios

of the Baby Boom Era

Six Volumes — 2000 pages — From Sams' Archives  
1946 to 1960 — 274 Brands — 3494 Illustrations (B&W)  
6769 Models — Catalin, Bakelite, Wood, Transistor Radios & More

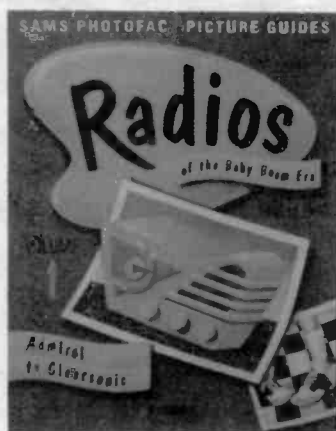

## All Volumes Available!

Vol.	Brands	Included
1	56	Admiral to Clearsonic
2	54	Co-op to Geloso
3	58	GE to Monitoradio
4	36	Motorola to RCA Victor
5	35	Realtone to Stratovox
6	35	Stromberg-Carlson to Zenith

### 1/2 Page for each illustrated radio including:

- Large illustration of the radio including knob functions
- Short description of the radio
- Number of tubes
- Power supply type (AC, Battery, etc.)
- Tuning range
- Manufacturer
- Sams Photofac Set number & year Photofac published.

Each Volume: \$16.95 — Softcover  
8 1/2" x 11" — Approx. 328 pages

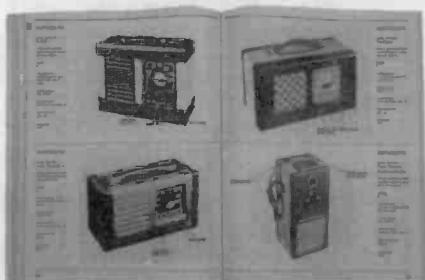

### ALSO

- Index by model number listing tubes in radio
- List of similar radio models indexed to pictured radio
- List of manufacturers and suppliers indicating their brand names
- Basic trouble-shooting hints

U.S. Orders - Enclose \$2.50 per order for packing & book-rate shipping if total order is under \$35.00. If using VISA or MasterCard, include name on card, card number and expiration date. Send payment with order. Mass. residents please add 5% sales tax. Money back return policy. Most orders shipped the same day received, but allow 2-4 weeks to receive order. Foreign orders - write for shipping costs, or use credit card and specify air or surface (allow 2-3 months for surface shipping).



Send Order To: A.R.C., P.O. Box 2, Carlisle, MA 01741  
or Call: (508) 371-0512 Fax: (508) 371-7129





# OCEAN STATE ELECTRONICS

## VERNIER DIALS

Surface mounting for 1/4" shaft. Drive ratio approx. 8 to 1. Dial Calibrated 180°.



NO	DIA	READING	PRICE
VD112-10	1 1/2"	0-10	\$8.25
VD112-100	1 1/2"	0-100	\$9.25
VD2	2"	0-100	\$10.25

## CLOTH COVERED HOOK-UP WIRE



#20 stranded copper wire covered with lacquered cloth braid. Resembles wire used in most antique sets. Available on 25 foot spools. Specify color - black, white, green, orange, blue, or violet.  
\$2.00/spool

## DIGITAL LCR METER

Finally a way to instantly identify those unmarked capacitors, inductors, and resistors all in one handy and affordable unit. Measures capacitors from .1PF to 200µF, inductors from 1µH to 200H and resistors from .1Ω to 20MΩ. 2 year warranty.

LCR1801 ..... \$119.95

## 600 VOLT POLYESTER CAPACITORS

Radial lead. Equivalent to Sprague "Orange Drops". New Stock.

µF	Price	µF	Price
001	.39	.022	.51
0012	.39	.027	.69
0015	.39	.033	.69
0018	.39	.039	.71
0022	.39	.047	.71
0027	.39	.056	.74
0033	.39	.068	.74
0039	.39	.082	.74
0047	.39	.1	.80
0056	.39	.12	.90
0068	.39	.15	.92
0082	.43	.22	1.05
.01	.43	.27	1.10
.012	.48	.33	1.30
.015	.48	.39	1.40
.018	.51	.47	1.60



## SIGNAL INJECTOR/TRACER

This handy tester is both a signal generator and receiver. As a generator use it to check out an amplifier, stage by stage. Also tests AM radio IF and RF stages. As a receiver you can pin point where a defective part exists. Will transmit and receive simultaneously. Assembled or kit.  
ST-751 Assembled ..... \$24.95  
K-21A Kit ..... \$18.95

## GERMANIUM DIODES

NO. ....	1-9	10+
1N34A .....	.20	.15
1N60 .....	.25	.20
1N270 .....	.35	.30

## VARIABLE CAPACITORS BROADCAST TYPE - 1/4" SHAFT

BC14400 1 GANG .....	\$7.75
14-365PF 1 5/16W x 1 1/8D x 1 5/16H	
BC13300 2 GANG .....	\$8.75
13-380/13-390PF 1 5/16W x 1 5/8D x 1 1/4H	

HUNDREDS MORE AVAILABLE FROM HAMMURLUND, NATIONAL, CARDWELL, BUD, ETC. CALL OR WRITE WITH REQUIREMENTS.

## Q-DOPE

Solution of pure polystyrene in solvents. Dries fast and leaves a clear, protective coating on toroids, coils and transformers, with no or minimal effect on inductive values. May also be used as a cement for molded or fabricated items made of polystyrene.  
10-3702 (Brush 2 fl. oz. 59ml) ..... \$3.75



**A MUST IF YOU WIND YOUR OWN COILS.**

## HIGH VOLTAGE ELECTROLYTICS

Axial leads - NEW STOCK

µF	VOLTS	PRICE	µF	VOLTS	PRICE
1	250	.52	22	350	2.30
2.2	250	.58	33	350	2.70
3.3	250	.64	47	350	3.60
4.7	250	.95	1	450	.85
10	250	1.05	2.2	450	.90
22	250	1.40	3.3	450	.95
33	250	1.90	4.7	450	1.35
47	250	2.40	10	450	1.70
1	350	.75	22	450	2.10
2.2	350	.75	33	450	3.40
4.7	350	1.10	47	450	3.75
10	350	1.60	100	450	4.90

QUANTITY DISCOUNTS AVAILABLE  
RADIAL LEADS ALSO STOCKED

**TO PLACE AN ORDER  
Call 1-800-866-6626**

## MAGNET WIRE

Enamel coated solid copper. For winding coils, transformers and toroids. Prices for 1/4 lb. spools.



#14	\$3.85	#28	\$3.95
#16	\$3.85	#30	\$4.00
#18	\$3.85	#32	\$4.00
#20	\$3.85	#34	\$4.80
#22	\$3.85	#36	\$4.90
#24	\$3.85	#38	\$5.25
#26	\$3.95	#40	\$5.65

## CALL US FOR

- Resistors (1/4W TO 25W)
- Test Equipment
- Potentiometers
- Capacitors (All Types)
- Kits
- Hardware
- Semiconductors
- Wire/Cable
- Knobs
- Toroids
- Books
- Connectors
- Tools
- Panel Meters
- Enclosures
- Power Supplies
- Crystals
- Antenna's
- Coils/Chokes
- Relays
- Switches
- Much More

**Ocean State Electronics**  
P.O. Box 1458 6 Industrial Drive  
Westerly, R.I. 02891

Mail in orders please include \$4.50 shipping  
ALASKA & HAWAII \$9.00  
CANADA \$7.00  
OVERSEAS \$12.00  
Minimum order \$10.00 (before shipping)



R. I. Residents add 7% Sales Tax  
Local calls 596-3080

## DELUX ALIGNMENT TOOL KIT

Contains 16 of the most used alignment tools. Includes handy roll type case of durable leatherette.

8280 ..... \$20.63

**TUBES**  
OVER 30,000 IN STOCK.  
2000 TYPES.

ALL NEW AND BOXED.  
NO PULLS.

**CALL OR WRITE FOR OUR FREE 112 PAGE CATALOG 1-401-596-3080**

# NEW BOOKS FOR THE COLLECTOR

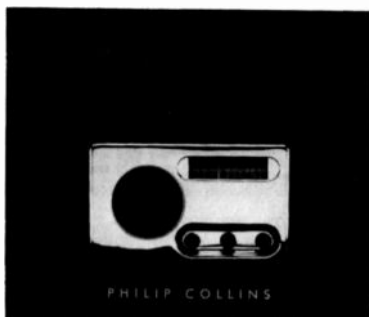

**RADIOS REDUX BY PHILIP COLLINS.** Subtitled "Listening in Style," this book showcases the sleek lines and luscious colors of over 80 gleaming sets from the collection of Philip Collins. 120 pages, 10" by 8 3/4" ..... **HARDCOVER: \$29.95. SOFTCOVER: \$17.95**

**AND STILL AVAILABLE...**

**RADIOS: THE GOLDEN AGE BY PHILIP COLLINS.** Collins' first book of the colorful Catalin and Bakelite radios from the late 1930s to the early 1940s. 128 pages, 10" by 8 3/4".

..... **HARDCOVER: \$25.00. SOFTCOVER: \$14.95**



**SPECIAL  
PURCHASE!**

**NEW LOW  
PRICE!**

**RADIO ART BY ROBERT HAWES.** This outstanding book is a chronological illustrated history of radio that celebrates the technical and stylistic progress of the radio. Although the coverage of the book is mostly British, many American sets are featured as well. 9 1/4" by 12", 128 pages. 250 photos, 150 in color. .... **HARDCOVER: ~~\$29.95~~ \$19.95**

**RADIO ART POSTCARD DECK.** 30 full color photographs from Hawes' book ..... **~~\$9.95~~ \$7.50**

**ALSO...**

**JUKEBOX ART BY CHRIS PEARCE.** The evolution of the jukebox from coin-operated record changer to the rock and roll generation. 9 1/4" by 12", 128 pages. 120 color photos. .... **HARDCOVER: \$29.95**

**JUKEBOX ART POSTCARD DECK.** 30 full color photos from Pearce's book ..... **\$9.95**

*U.S. Orders - Enclose \$2.50 per order for packing & book-rate shipping if total order is under \$35.00. If using VISA or MasterCard, include name on card, card number and expiration date. Send payment with order. Mass. residents please add 5% sales tax. Money back return policy. Most orders shipped the same day received, but allow 2-4 weeks to receive order. Foreign orders - write for shipping costs, or use credit card and specify air or surface (allow 2-3 months for surface shipping).*



**Send Order To: A.R.C., P.O. Box 2, Carlisle, MA 01741**  
**or Call: (508) 371-0512** Fax: (508) 371-7129



(Aug-93)

**NEW**  
**2nd Edition**

— Jonathan Hill's

# **Radio! Radio!**

**Second Edition**



---

*“Radio! Radio! is a fine work... one that no serious collector or historian can afford to overlook”*

*(Richard Foster,  
A.R.C. Sept. 1993)*

---

## **244 Pages - 978 Photographs of British Sets**

Comprehensive overview of the development of wireless covering the 1920s to the 1960s. Illustrated chapter on the history of wireless. Descriptive information on each radio pictured. Revised, easy-to-read subject index, making it easier to find the particular radio you are interested in. A-Z directory listing of 1,000+ radio models.

**Hardcover Only: \$44.95**

**Individually signed and numbered!!**

**Dealer Inquiries Invited**

*U.S. Orders - Enclose \$2.50 per order for packing & book-rate shipping if total order is under \$35.00. If using VISA or MasterCard, include name on card, card number and expiration date. Send payment with order. Mass. residents please add 5% sales tax. Money back return policy. Most orders shipped the same day received, but allow 2-4 weeks to receive order. Foreign orders - write for shipping costs, or use credit card and specify air or surface (allow 2-3 months for surface shipping).*



**Send Order To: A.R.C., P.O. Box 2, Carlisle, MA 01741**  
**or Call: (508) 371-0512**      **Fax: (508) 371-7129**



# Radio Manufacturers of the 1920's

BY ALAN DOUGLAS



***"The definitive book on American broadcast receivers of the 1920s"***

**Volume 1:** A-C Dayton - Adams Morgan - Air-Way - All-American Mohawk - American Bosch - Amrad - Amrad S-Tube - Apex - Atwater Kent - Bremer Tully - Browning-Drake - Clapp-Eastham - Crosley - Cutting & Washington - Day-Fan - DeForest - Eagle - ERLA - FADA - Federal - Ferguson. 225 Pages.

**Volume 1: \$24.95 (only softcover in print)**

**Volume 2:** Freed-Eisemann - Eisemann - Freshman - Garod - Gilfillan - Grebe - Howard - Jones (Lester/Melco) - Jones (Jos.) - Kellogg - Kennedy - King - Kodel - Kolster - Leutz - Magnavox - Majestic - Marti - Metro - Klitzen/Michigan - Midwest - Mu-Rad - Murdock - Music Master - Neutrowound - Operadio - Ozarka - Pfanstiehl - Philco - Pilot - Priess. 266 Pages.

**Volume 2: \$29.95 (hardcover: \$39.95)**

**Volume 3:** RCA - Scott - Silver-Marshall - Slagle - Sleeper - Sonora - Sparton - Splitdorf - Steinite - Stewart-Warner - Stromberg-Carlson - Thermiodyne - R.E. Thompson - Thorola - Tri-City - C. D. Tuska - Ware - Western Coil - Western Electric - Workrite - Zenith. 292 Pages.

**Volume 3: \$29.95 (hardcover: \$39.95)**

*U.S. Orders - Enclose \$2.50 per order for packing & book-rate shipping if total order is under \$35.00. If using VISA or MasterCard, include name on card, card number and expiration date. Send payment with order. Mass. residents please add 5% sales tax. Money back return policy. Most orders shipped the same day received, but allow 2-4 weeks to receive order. Foreign orders - write for shipping costs, or use credit card and specify air or surface (allow 2-3 months for surface shipping).*



**Send Order To: A.R.C., P.O. Box 2, Carlisle, MA 01741**  
**or Call: (508) 371-0512**

**Fax: (508) 371-7129**



# SPECIAL PURCHASE NEW LOW PRICES!!

John Sideli's

## Classic Plastic Radios of the 1930s and 1940s A COLLECTOR'S GUIDE TO CATALIN MODELS



ADDISON  
AIR KING  
ARVIN  
AUTOMATIC RADIO  
BENDIX  
CROSLLEY  
CYARTS  
DEWALD  
EMERSON  
ESPEY  
FADA  
GAROD  
GENERAL ELECTRIC  
GENERAL TELEVISION  
HALSON  
KADETTE  
LAFAYETTE  
MOTOROLA  
R.C.A.  
SENTINEL  
SONORA  
SPARTON  
STEWART-WARNER

127 Pages – Over 200 Illustrations of Radios in Full Color

55 different models from 25 manufacturers are extensively covered. Included for each is a description, the year of manufacturer, dimensions, colors found and photos illustrating the various colors and variations. A 15-page introduction describes the growth of Catalin radio collecting, the Catalin material itself, the "Catalin" style, rarity and value, and colors and restoration. The introduction contains an additional eighteen photos, twelve in full color.

Hardcover : ~~\$29.95~~ \$19.95      Softcover\* : ~~\$19.95~~ \$9.95

\*Remainder Copies - Complete, slight mark on bottom edge indicating that they are remainders.

*U.S. Orders - Enclose \$2.50 per order for packing & book-rate shipping if total order is under \$35.00. If using VISA or MasterCard, include name on card, card number and expiration date. Send payment with order. Mass. residents please add 5% sales tax. Money back return policy. Most orders shipped the same day received, but allow 2-4 weeks to receive order. Foreign orders - write for shipping costs, or use credit card and specify air or surface (allow 2-3 months for surface shipping).*



Send Order To: A.R.C., P.O. Box 2, Carlisle, MA 01741  
or Call: (508) 371-0512

Fax: (508) 371-7129



# COLLECTOR BOOKS AVAILABLE FROM ANTIQUE RADIO CLASSIFIED

☞ BOOKS MARKED WITH "☞" ARE THE MOST POPULAR AND ARE ESPECIALLY RECOMMENDED FOR NEW COLLECTORS!

- Antique Radio Restoration Guide, 2nd Ed., Johnson.** *Beginner's introduction to troubleshooting and repairing AC table model radios.* 1992, 145 pgs. .... \$14.95
- The AWA Review.** *Collections of extended articles.* Vol. 1: Tesla, Farnsworth TV, WWI Ham Radio, National Co., Atwater Kent, etc. Vol. 2: DeForest, Spark Transmitters, Atwater Kent, Hammarlund, Telegraph Keys, etc. Vol. 6: Tubes, Hawaiian Wireless, U.K. TV, SCR-RC-BC Directory, NYC Wireless, etc. Vol. 7: Tubes, Poldhu Transmitters, Navy Equipment, Arc Transmitters, etc. 1986 to 1992, 120 - 180 pgs. ca. .... (Per Volume) \$10.00
- The Antique Radio Boys and the Garrulous Grebe, Dryer.** *Thrilling adventure story written in the traditions of the '20s and '30s.* 5 1/2" by 8 1/2", 51 pgs. .... \$4.95
- The Auto Radio: A Romantic Genealogy, Matteson.** *Information, photos & ads from the early days of the automobile radio through the 1950s.* 316 pgs. .... (hardcover) \$34.95
- ☞ **Classic Plastic Radios of the 1930s and 1940s - A Collector's Guide to Catalin Models, Sideli.** *Provides expert information about all aspects of this popular collecting field. Over 200 models from 25 manufacturers are illustrated in full color.* 127 pgs. .... (hardcover \$19.95) softcover remainders: \$9.95
- Classic TVs, Wood.** *Prewar to 1950s, with price guide.* 140+ color photos of television sets plus reproductions of old catalog pages and magazine ads. 86 pgs. .... \$16.95
- ☞ **The Collector's Guide to Antique Radios, 2nd Ed., Buris.** *This guide covers radios from 1920 to 1959. Over 7400 prices and over 540 new color photos are included.* 1992, 208 pgs. .... \$17.95
- The Collector's Guide to Transistor Radios, Buris.** *Identifies the most sought-after vintage transistor radios. Over 2,000 models, 400+ color photos, with current prices.* 1993, 256 pgs. .... (Available Oct.) NEW \$15.95
- Communication Receivers, 2nd Ed., Moore.** *Information on 700, 1932 to 1981, vacuum tube receivers by 51 manufacturers. 330 radios illustrated.* 115 pgs. (200 more radios illustrated than 1st ed.).... \$17.95
- The Compleat Talking Machine, Reiss.** *A guide to restoration of antique phonographs.* 183 pgs. .... \$19.95
- Crosley Catalog (reprint).** *1923 catalog covering the early Harko through the XX models.* 32 pgs. .... \$4.95
- Empire of the Air, Burns.** (Videotape, VHS). *2-hour video based on Lewis' book.* .... \$24.95
- Empire of the Air, Lewis.** *A biographical history of radio focusing on Lee de Forest, Edwin H. Armstrong and David Sarnoff.* 1991, illustrated, 421 pgs. .... (hardcover \$25.00) \$13.00
- Evolution of the Radio, L-W Books.** *Radios pictured and priced, plus reproductions of catalog pages and ads.*  
Vol. 1 - *Eight-hundred + radios.* 1991, 227 pgs., 118 pgs. in color. .... \$22.95  
Vol. 2 - *Totally different from volume one with new photos, etc.* 1993, 654 color photos, 226 pgs. .... NEW \$24.95
- Firco Radio Equipment, John Firth & Co., Inc. (reprint).** *Twenty-six-page booklet of the Firth Company with bulletins, descriptions of accessories and original prices.* .... NEW \$4.95
- Fixing Up Nice Old Radios, Romney.** *Written by an old radio instructor, this book covers Olmi's law, through battery sets, superhets and communications receivers.* 1990, 300+ figures, 185 pgs. .... \$19.00
- ☞ **Flick of the Switch, McMahon.** *The classic photo reference guide for collectors of radios from the '30s to the '50s.* 1000+ photos of radios. 263 pgs. .... \$11.95
- Great Radio Personalities (reprint).** *Black & white portraits and info on all the favorites from the golden days of radio - Abbott & Costello, Baby Snooks, and more.* 128 pgs. .... \$11.95
- ☞ **Guide to Old Radios - Pointers, Pictures & Prices, Johnson.** *The latest book by the Johnsons describes the history of radio and includes 350+ photos and a price guide to 3300 sets.* 1989, 128 pgs. .... \$16.95
- Hake's Guide to TV Collectibles.** *Price guide and illustrations for 1600 TV program premiums, games, puzzles, comic books, action figures, lunch boxes, toys and other collectibles.* 1990, 185 pgs. .... \$14.95
- Hallcrafters Co. 1932-1982; A Partial Product Listing Covering 50 Years of Production, 5th Ed., Dachis.** *Listing of over 500 receivers, transmitters, televisions, speakers and accessories. No photos.* 44 pgs. .... \$12.50
- Hertz: The Beginning of Microwaves, Bryant.** *Photos and descriptions of Hertz's apparatus and experiments. A book prepared for the IEEE Hertz Centennial exhibit.* 50 pgs. .... \$15.00
- Illustrated Price Guide to Vintage TV and Deco Radios, Poster.** *100+ illustrations.* 1991, 77 pgs. .... \$15.95
- Inventing American Broadcasting, Douglas.** *A careful weaving of technology, social forces, and business decision making from the days of Marconi to broadcasting in the 1920s.* 1987, 363 pgs. .... \$14.95
- Jukeboxes - Obscure, Mysterious and Innovative American Jukeboxes, Adams.** *First volume of a history of the lesser known manufacturers of phonographs, music boxes and jukeboxes.* 182 pgs. .... \$29.95
- Jukebox Art, Pearce.** *The evolution of the jukebox from the coin-operated record changer to the flashing lights of the rock-and-roll generation.* 250 photos, 128 pgs. .... (hardcover only) \$29.95
- Jukebox Art Postcard Deck.** *30 colorful photos from Pearce's book.* .... \$9.95
- Lawlor's Radio Values.** *Price guide for radios in Collins & Sideli books.* 1991, no photos. 32 pgs. .... \$12.50
- Made in Japan, Handy.** *A stunning book on the development and growth of the transistor radio featuring 175+ transistor radios in full color.* 1993, 108 pgs. .... NEW \$16.95
- The Mechanics of Television, Yanczer.** *History and explanation of mechanical television, plus construction details for a working system.* 1987, 5 1/2" by 7 1/2", 170 pgs. .... \$20.00
- Most Often Needed 1926-38 Radio Diagrams and Servicing Information (reprint).** *600+ diagrams for mostly AC radios from '26-'38.* 240 pgs. .... \$11.95
- Novelty Radios, Breed.** *500+ transistor novelty radios in full color with current prices.* 1990, 217 pgs. .... \$24.95
- Official Radio Service Manual (reprint).** *100s of pre-1930 circuits & notes.* 356 pgs. .... \$24.95
- Old-Time Radios! Restoration and Repair, Carr.** *How to repair vacuum-tube and transistor radios. A self-paced training guide.* 200 illustrations, 256 pgs. .... \$16.95
- Philco Radio: 1928-1942, Ramirez.** *A reference book on Philco. Shows receivers and company history year-by-year.* 464 color photos, 364 black & white photos and drawings. 160 pgs. 1993. (Delayed, Avail. Dec.) NEW \$29.95
- Portable Radio in American Life, Schiffer.** *Traces the development of the portable radio and how it affected American culture and society.* 450 photos and drawings, 259 pgs. .... (hardcover: \$45.00) \$24.95



# COLLECTOR BOOKS AVAILABLE FROM ANTIQUE RADIO CLASSIFIED

BOOKS MARKED WITH "CS" ARE THE MOST POPULAR AND ARE ESPECIALLY RECOMMENDED FOR NEW COLLECTORS!

- Price Guide to Plastic Collectibles, McNulty. Describes types of plastics, etc. (Radio is 8 of 207 pgs.) \$17.95  
 RCA Radiolas, Radiotrons, and Accessories (reprint). Twenty-page booklet summarizing RCA's 1926 product line including the Radiolas III, 20, 25, 26, 28, etc. ....\$4.50
- Radio Art**, Hawes. This outstanding book is a chronological, illustrated history of radio that celebrates the technical and stylistic progress of the radio. Although the coverage is mostly British, many American sets are featured as well. 9 1/4" by 12", 250 photos, 150 in color, 128 pgs. .... (hardcover only) **NEW Low Price! \$19.95**
- Radio Art Postcard Deck**. 30 full-color photographs from Hawes' book. .... **NEW Low Price! \$7.50**
- Radio Collector**. (Videotape, VHS). The five-part Emmy-nominated PBS series combined on one 130-minute videotape. Meet collectors, see collections, attend swap meets, learn about radio restoration. .... \$29.95
- Radio Collector's Guide**, McMahon. Listing of 9,000+ radios made by some 1200 companies from 1921 to 1932. Gives manufacturer, year, model name and other info. No photos, 264 pgs. .... \$11.95
- Radio Craft - 50 Years of Radio** (reprint). March 1938 issue of Radio Craft magazine. Numerous articles on the development of radio, then 50-years old, and on early radio pioneers. 144 pgs. .... \$15.95
- Radio Enters the Home**, RCA (reprint). A 1922 catalog including the Aerials Jr. and Sr. the RA, DA, RC, Grand, etc., plus parts and accessories. 128 pgs. .... \$16.95
- Radio Equipment & Supplies**, Robertson-Cataract Electric Company (reprint). 1922 catalog of radios, accessories and other equipment. Includes RCA, Clapp-Eastham & others. 168 pgs. .... \$19.95
- Radios-The Golden Age**, Collins. Full-color book on the colorful Catalin and Bakelite radios from the late 1930s to the early 1940s. 128 pgs. .... (hardcover \$25.00) \$14.95
- Radio Manufacturers of the 1920's**, Douglas. Three comprehensive volumes.  
 Vol. 1 covers A-C Dayton thru Ferguson. 225 pgs. .... (softcover only) \$24.95  
 Vol. 2 covers Freed-Lisemann thru Priess. 266 pgs. .... (hardcover: \$39.95) \$29.95  
 Vol. 3 covers RCA thru Zenith. 292 pgs. .... (hardcover: \$39.95) \$29.95
- Radio! Radio!**, 2nd Ed., Hill. Revised easy-to-read subject index, separate A-Z directory listing of 1,000+ radio models with clearer photographs than first edition. 978 photos, 244 photos. (hardcover only) **NEW \$44.95**
- Radio Redux**, Collins. Subtitled "Listening in Style." This book showcases the sleek lines and luscious colors of over 80 gleaming sets from the collection of Philip Collins. 120 pgs. .... (hardcover: \$29.95) \$17.95
- Radio/TV Finder**, Okolowicz. This handy guide provides a ready reference to nearly 7000 pictures of collectible radios and TVs found in 24 popular collector books. No photos, 110 pgs. .... \$13.95
- Radio & T.V. Collector's Guide Book**, Biraud. The "Vintage Radio" illustrated guide to European sets (very few British sets) from early wireless to the 1930s (a few later). Text is in both French and English.  
 Vol. 1 - Early History & Manufacturers A to P. 256 pgs. .... \$49.95  
 Vol. 2 - P to Z & T.V., Speakers, Tubes, Loops, Parts & Novelties. 256 pgs. .... \$49.95
- Radios of the Baby Boom Era**. Pictures and info from Sams Photofacts. 3494 radios illustrated plus 3275 additional radios listed. 274 brands. 1946 thru 1960. Six volumes, 300+ pages per volume. Order by volume: Vol. 1: Admiral - Clearsonic. Vol 2: Co-op - Gelsco. Vol 3: GE - Monitoradio. Vol 4: Motorola - RCA. Vol 5: Realtone - Stratovox. Vol 6: Stromberg-Carlson - Zenith. .... (Per Volume) \$16.95
- Radio Trouble Shooting**, Haan (reprint). 1928 guide to troubleshooting battery sets. 317 pgs. .... \$14.95
- Refinishing Old Furniture**, Wagoner. Written by a furniture restoration instructor. A step-by-step guide to furniture (or radio) restoration, from removal of finishes right up to the final polish. 178 pgs. .... **NEW \$13.95**
- Syntony and Spark**, Aiken (reprint). Subtitled "The Origins of Radio." Describes the development of radio from Maxwell's work in the 1860s through the contributions of Hertz, Lodge and Marconi. 1976. 347 pgs. .... \$13.95
- S. Gernsback Radio Encyclopedia** (reprint). 1927 classic encyclopedia on radio. From "A" Battery to Zirconium, with 1000s of entries in between. 100s of illustrations, 175 pgs. .... \$11.95
- 70 Years of Radio Tubes and Valves**, Stokes. The story of the radio tube from the laboratory to the commercial market. 247 pgs. .... \$25.95
- 75 Years of Western Electric Tube Manufacturing**, Magers. A log book history of over 750 Western Electric tubes. Illustrated. 133 pgs. .... \$13.95
- Tomart's Price Guide to Radio Premium and Cereal Box Collectibles**, Tumbusch. Includes comic character, pulp hero, TV and other premiums. 1991, 3000+ illustrations, 176 pgs. .... \$15.95
- Vintage Radio**, McMahon. The classic photo reference guide for collectors of radios prior to 1930. Crystal sets, battery sets, tubes, horns, parts, etc. Over 1000 pictures, 263 pgs. .... \$11.95
- The Weekend Refinisher**, Johnson. A complete guide to stains and finishes and tips for setting up your own workshop. A handy furniture "first aid" kit for quick repairs. Illustrated 296 pgs. .... **NEW \$10.00**
- Westinghouse Catalog** (reprint). 1920s catalog of the RA-DA and other early Westinghouse equip. 8 pgs. .... \$4.00
- Wireless Communication in the U.S.**, Mayes. Early development of American radio operating companies. Alternators, coherers, stock promotions, unpublished letters, etc. 160 illustrations, 240 pgs. \$29.95
- Zenith Radio Corporation** (reprint). The instructions for installation and operation for Models 39-39A Models 392-392A, and Electric Zenith Receivers. 3 schematics, 3 photos, 7 1/2" by 5", 10 pgs. .... \$4.50

U.S. Orders - Enclose \$2.50 per order for packing & book-rate shipping if total order is under \$35.00. If using VISA or MasterCard, include name on card, card number and expiration date. Send payment with order. Mass. residents please add 5% sales tax. Money back return policy. Most orders shipped the same day received, but allow 2-4 weeks to receive order. Foreign orders - write for shipping costs, or use credit card and specify air or surface (allow 2-3 months for surface shipping).



Send Order To: A.R.C., P.O. Box 2, Carlisle, MA 01741  
 or Call: (508) 371-0512 Fax: (508) 371-7129



BUYING: TRANSISTOR & DECO RADIOS

VINTAGE TELEVISIONS  
BUY • SELL • RENT • REPAIR • PARTS



HARRY  
POSTER

DAYS: (201)794-9606

FAX: (201)794-9553

P.O. Box 1883 • South Hackensack, NJ • 07606

24 HRS: (201)410-7525

FOR SALE: PREDICTA picture tubes:  
What not come Predicta CRT's and can offer

## *It's out...nearly!*

Our new Price Guide covers A.C. Dayton to Zenith:

- Nearly 650 early transistor and novelty transistor radios
- Nearly 2200 models and variations of early battery, crystal & tube radios
- Over 875 vintage TV's!

600 sets are illustrated including 75 in color plates!

Are you tired of buying countless price guides?  
Now you need only ONE!

**RADIO and TELEVISION  
PRICE GUIDE, 1920-1990**  
Second Edition  
by Harry Poster

256 pp + 8 color pp, 7 x 10  
October Release  
ISBN #0-87069-687-4, pb  
Chilton Book Company  
\$17.95 USA

Order from your local bookstore  
or see the special below!

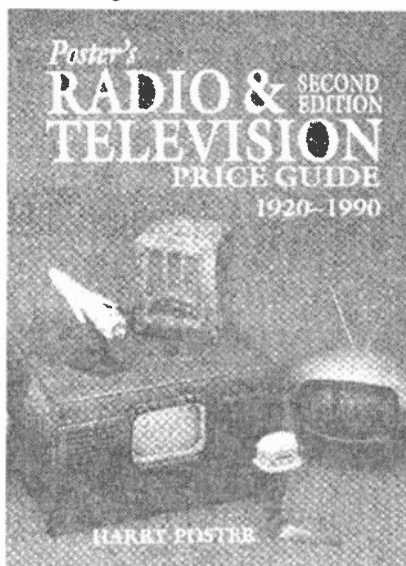

**Send \$18. today---we'll pay the shipping!**  
**(Shipped insured UPS postpaid, October 1993)**  
**Harry Poster PO Box 1883 So. Hack., NJ 07606**

(201)794-9606 or FAX days : (201)794-9553.

# CLASSIFIED ADVERTISING POLICY

**ONE FREE 20-WORD AD** for subscribers in each issue; additional words are 17¢ each. See details below. Classified ads must be received (not just postmarked!) by **Noon Eastern Time** on the ad deadline. Late ads are held for the following issue. Please enclose correct payment with all ads. Stamps or cash are OK for small amounts. (Canadian and other foreign advertisers, please see "Payment" on page 2 for methods.) "Free words" cannot be accumulated from month to month; free words must be requested when ad is submitted.

**Please write each ad on a separate sheet of paper**, especially when included with other A.R.C. correspondence. Include SUB# with ad. Ads may be sent in advance; but, write each ad on a separate piece of paper and indicate the month (or successive two months) you want the ad to run.

**Please write legibly and use both capital and small letters. Do not use dashes between words.** Some numbers and letters can look alike, for example 1, I and l (the number one, the capital i and the small l.) Write the following characters clearly (especially in model numbers): 1, I and l; 0, O, o, Q and D; r and n; 6, b and G; V, U, u, v and Y; A and R; 5, S and s; 2, Z and z. We try to correct spelling errors, so when using an uncommon word or manufacturer which looks similar to a common word or manufacturer, note it so that we do not "correct" it. Editor's comments are in [brackets].

**Advertising is accepted only for early items related to radio, communication, etc. All items must be described fairly; reproductions, reprints and not-original items must be so identified. Advertisers agree to respond promptly to inquiries and orders, to resolve problems promptly if the buyer is not satisfied, and to comply with a buyer's refund request on unaltered returned items.**

Publisher reserves the right to edit ads without notification to the advertiser and to reject ads for any reason. Publisher is not responsible for errors due to illegibly written ads or for any other reason. Since club activities receive free advertising on the *Coming Radio Events* page, the free 20 words may not be used for club activity ads. See inside front cover for additional information.

## CLASSIFIED AD DETAILS

**Deadline: NOON ET— 10th of the month!**

Classified ads must have a standard heading such as **WANTED, FOR SALE, FOR TRADE, FOR SALE/TRADE, SERVICES, MESSAGE, HELP, AUCTION, MEET**, etc. This heading is the only bold or all-capitalized words allowed in the ad. Capitalize only manufacturer names, model names, etc. Wanted and For Sale ads are mixed together to encourage the reading of all ads, including the Wanted ads. This standard ad format makes scanning the ads easier.

Before writing your ad, please look over the ads in a recent issue of A.R.C., and try to write your ad in the same style. Full name (or company name) and address is required in all classified ads; we will add it if you forget.

To encourage varied content of the ads, the same classified ad may be run only once per issue and for only two consecutive months. (To run an ad longer, use a boxed classified or display ad.)

### Classified Ad Rates per Month

Subscribers:

First 20 words: **FREE\***

17¢ per word for extra words over 20 **plus**

10¢ per word for a shaded ad (count all words including free words).

\* Subscribers may take 20 free words on only **one** ad each month.

Non-Subscribers:

33¢ per word **plus**

10¢ per word for shaded ad.

Please do not forget to send in the extra 17¢ per word when your classified ad runs over the free 20 words; your payment will be appreciated, and it will help to keep A.R.C. healthy.

## BOXED CLASSIFIED AD DETAILS

**Deadline: 1st of the month!**

Boxed classified ads can run unchanged for three months or more. No words are free. Ads may be shaded and may include bold and all-capitalized words freely. The ad need not begin with For Sale, etc. Minimum run is 3 months, prepaid. Discount: 5% for 6 months; 10% for 12 months.

### Boxed Classified Ad Rates per Month

Nonshaded ads:

28¢ per word for all words,\* none free, **plus**

10¢ per word for each bold word **plus**

10¢ per word for each all-caps word.

Shaded Ads (All words are bold at no charge):

38¢ per word for all words\* **plus**

10¢ per word for each all-caps word.

Non-Subscribers:

Add 20¢ per word to above costs.

\*Three words can be bold-all-caps at no extra charge.

## PHOTO & DRAWING DETAILS

**Deadline: 1st of the month**

**for all ads with drawings or photos!**

Drawings and photos are encouraged as the response to your ad is much larger and the reader knows better what you want or are selling. Send in your drawing or photograph, and A.R.C. will reduce it or enlarge it as needed.

### Photo and Drawing Rates per Month

\$10.00 per month for each photo or drawing (If ad is canceled, this amount cannot always be refunded.)

## CHANGES & CANCELLATIONS

Please check your ads carefully before sending them in. Once ads are received, it is not always possible to refund the amount sent, pull the ad or make changes.

## IMPORTANT — COUNTING WORDS — IMPORTANT

The standard headings: **WANTED, FOR SALE**, etc., count as **one word** each time used in an ad. **Name, address** and (one) **telephone number**, count as **6 words**, regardless of length. Ham call letters and business name can be included in the 6 words and do not count extra. Full name (or company name) and address is required in all classified ads. Each additional word, abbreviation, model number or number group, extra telephone numbers, etc. count as one word each. Hyphenated words count as two words.

**ANTIQUE RADIO CLASSIFIED**



**A.R.C., P.O. Box 2, CARLISLE, MA 01741**

**RETURN POSTAGE GUARANTEED**

SECOND CLASS

758

25

48 50

GAD SUB# 27-777  
JOE W MCCLUGHAN

431 OGDEN LN  
NEW BRAUNFELS TX

EXP=DEC93

78130

**CLASSIFIED AD**

**DEADLINE OCT. 10th**

**Noon Eastern Time**