



# ANTIQUE RADIO CLASSIFIED



VOLUME 9

JULY 1992

NUMBER 7



*Vintage  
High-Fidelity  
Equipment*



**THE NATIONAL PUBLICATION FOR BUYERS AND SELLERS  
OF OLD RADIOS AND RELATED ITEMS - PUBLISHED MONTHLY**

## ANTIQUE RADIO CLASSIFIED

Antique Radio Classified (ISSN:8750-7471) is published monthly, 12 times per year, by John V. Terrey, One River Road, P.O. Box 2, Carlisle, MA 01741. Second-class postage paid at Carlisle, MA, and additional mailing offices. Telephone: (508) 371-0512, 9:00 AM to 5:00 PM ET weekdays; machine answers phone at other times.

Annual subscription rates within the U.S. are \$27.00 by Second Class mail and \$40.00 by First Class mail.

Annual foreign rates. By air: Canada - \$43.00; Mexico - \$43.00; Other foreign countries - \$75.00. Surface mail: Canada - \$35.00; Other foreign countries - \$38.00 (Surface delivery to countries other than Canada may take two or more months and cannot be guaranteed.)

Two-year subscriptions are twice these rates and receive an extra month. Sample issues are available free on request.

© Copyright 1992 by John V. Terrey.

**POSTMASTER: Send address changes to Antique Radio Classified, P.O. Box 2, Carlisle, MA 01741.**

### STAFF

Publisher and Editor:

Production Manager:

Office Manager:

Publishing Staff:

Dick Desjarlais

Bobby Lyman

Dorothy Schecter

Founding Publisher/Editor:

Contributing Writers:

Richard L. Arnold

Paul J. Bourbin

Dave Crocker

Richard C. Foster

Jim Kreuzer

Henry Rogers

Gil Schlehman

Frank R. White

John V. Terrey

Scott J. Young

Lisa A. Friedrichs

Dave Crocker

Chris Frederickson

Shirley Sauer

Gary B. Schneider

Mike Adams

Ray Bintliff

Norman S. Braithwaite

Alan S. Douglas

David W. Kraeuter

Ron Ramirez

Ian L. Sanders

Gary B. Schneider

Ralph Williams

**PURPOSE.** Antique Radio Classified is published for people involved in the radio collecting hobby. Its purpose is to stimulate growth of the hobby through the buying, selling and trading of radios and related items, and to provide a monthly forum for the interchange of ideas and information.

### CONTACTING ANTIQUE RADIO CLASSIFIED.

All correspondence should be sent to:

A.R.C., P.O. Box 2, Carlisle, MA 01741.

Send only UPS, Federal, etc. items to One River Road.

Telephone: (508) 371-0512; Fax: (508) 371-7129

Please no classified ads by telephone; thanks.

Your ads, renewals, letters, etc. can be handled faster and more efficiently if (1) each is on a separate piece of paper, and (2) your name, address and SUB# is written on each.

Unfortunately, A.R.C. is not staffed to answer letters

with questions about antique radios or requests for advice. However, A.R.C. does solicit letters of interest to its readers and publishes them as space permits. A.R.C. assumes that permission is given to edit and to publish all correspondence and articles received unless otherwise indicated.

**GUARANTEE.** You may cancel your subscription at any time and receive a pro rata refund for issues not yet mailed. If errors to ads are made by A.R.C., upon request a free correction will be run in the next available issue.

**PAYMENT.** Please send in full payment with your order or ad. A.R.C. does not carry accounts; all subscriptions, ads, etc. must be prepaid. Pay in U.S. funds. Checks drawn on a U.S. bank, money orders, VISA or MasterCard (\$10.00 min.) are preferred. Make check out to "A.R.C." U.S. stamps or cash are OK for small amounts. Canadian payers may send a Canadian check in U.S. funds, but please add \$1.00 (U.S.) for bank charges. Subscriptions will be prorated to amount sent if amount is incorrect.

**CHANGE OF ADDRESS.** Please notify us 4 weeks in advance of a change of address. Send both your new and old address, and include your SUB# and effective date of your new address. Temporary address changes can be made also.

**SUBMISSION OF MATERIAL.** Antique Radio Classified welcomes and solicits information that pertains or relates to radio history or collecting. This may include articles, book reviews, photos, information on upcoming radio events, meetings, antique radio organizations, radio auctions and price reports, sources of old radio and restoration supplies, and other related and interesting material. All material submitted should be neat and verified for accuracy. Unless prior arrangements are made, all submitted materials may be edited, become the property of Antique Radio Classified and will not be returned.

**MAILING OF ISSUES.** U.S. subscribers can receive A.R.C. by First or Second Class mail (Second Class is the way most magazines are mailed). The mailing of First Class copies is staggered over one to four days with faraway copies mailed before local copies. Non-U.S. copies are mailed on the first day. Second Class copies are mailed on the last day. Mailing dates change each month, but mailing is usually completed by the 26th of the month. First Class copies usually are received by the fifth of the month; copies by Second Class mail, by the tenth.

**ETHICS.** No person involved in the production of A.R.C. is to act on any information in the magazine until the day after local copies are mailed.

**DISCLAIMER.** The publisher is not responsible for any buying and selling transactions incurred, or for any other use of the contents of this publication.

Antique Radio Classified subscription rates, frequency of publication, content, policies, size and ad details, and rates are subject to change at any time by A.R.C.

## DISPLAY AND BUSINESS CARD ADS - DETAILS AND RATES

*The deadline is the first of the month for display and business card ad artwork, payment and repeat requests.*

Advertising is accepted only for early items related to radio, communication, etc. All items must be described fairly; reproductions, reprints and not-original items must be so identified. Advertisers agree to respond promptly to inquiries and orders, and to resolve problems promptly if the buyer is not satisfied.

All advertising must be prepaid; see "Payment" paragraph above. Late ads will be run only if space and time permit. Since artwork is reduced to 63% in the printing process, originals must be the artwork size listed below. Do not send in artwork on art board or send negatives. Ads should be typeset or typed neatly with a carbon ribbon, black printing on white. No reverse type if A.R.C. is to make up the ad. If you want us to prepare your ad, include the one-time cost below for A.R.C. to make up the ad.

Photos should be at an 85 line screen; otherwise, add \$10.00 per photo for screening. Do not cut or trim photos or glue photos to artwork; submit separately.

If you are confused by these requirements and terms,

please contact A.R.C. before beginning to prepare your ad. We will be happy to advise you on your ad ideas, estimate how much the ad will cost, recommend an ad size, etc.

We assume that advertisers want all ads which are submitted to run without delay; therefore, we will run the ad and bill for any additional work required for the ad to meet these specifications. A late ad will be run beginning with the next month. "Tear sheets" will be sent only for 1/2 and full page ads, and if requested when the ad is submitted.

**Business card ads are limited to one per advertiser.**

The 3-month rates represent about a 10% discount, the 6-month rates, 20%. Placement requests for display ads: add 15% but call first. Clubs: write for discount policy.

Page	ARTWORK SIZE (SEND IN THIS SIZE)		As Printed (size in magazine)		Cost for 1-month	Cost for 3-months	Cost for 6-months	One-time Cost for A.R.C. to make up Ad (if requested)
	H x W (inches)	H x W (inches)	H x W (inches)	H x W (inches)				
Full	12 3/16 (or 10 1/2)	x 7 1/2	7 3/4 (or 6 5/8)	x 4 3/4	\$169.00	\$455.00	\$799.00	\$55.00
1/2 H	5 1/4	x 7 1/2	3 5/16	x 4 3/4	85.00	230.00	399.00	28.00
1/2 V	12 3/16 (or 11 13/16)	x 3 9/16	7 7/16	x 2 1/4	85.00	230.00	399.00	28.00
1/4	5 1/4	x 3 9/16	3 5/16	x 2 1/4	43.00	116.00	199.00	14.00
1/8	2 5/8	x 3 9/16	1 5/8	x 2 1/4	22.00	60.00	99.00	7.00
Business Card	2	x 3 3/4	1 1/4	x 2 3/8	not avail.	31.00	55.00	5.00



# ANTIQUE RADIO CLASSIFIED



## EDITOR'S COMMENTS

Just as the amplifiers and receivers of the 1920s have been collectible for a number of years, the more recent amplifiers and speakers of the 1930s through the 1960s are collectible today. Authors Mark Van Roojen and Leif Blackmon introduce us to a few classics of this period from manufacturers like Western Electric, McIntosh and Marantz.

It is interesting to note the somewhat cyclical pattern of the development of separate-component/single-cabinet audio equipment in the mid-twentieth century. When radio was first available to consumers in the 1920s, the receiver, amplifier and speaker were separate components. Usually, the receiver itself had only enough volume to drive the headphones. To fill a room with sound, two additional components were necessary: a separate amplifier and a speaker, each of which might be from a different manufacturer.

Meanwhile, single-cabinet sets also became popular in the '30s, '40s, and '50s. However, with better recordings making sound improvement possible and with the development of FM radio and stereo, a return to separate components made high-fidelity sound a reality.

Two articles present more commonly collected AC and battery sets — one by Richard Arnold and one from a 1920s reprint. Richard describes the 1939 Zenith Model 5R-312, a radio that featured push-button tuning. Although a screw driver is needed to set the station for each button, this feature was a welcome convenience for the operator of a small table radio. Our reprint from *Radio Digest* is an article on Aerex Models BR-1, BA-2 and ALS-3 — a tuner with a crystal detector, an audion detector and a two-step amplifier. In 1922, these units cost a total of \$68.

The battery eliminator and battery chargers sold in the 1920s are not commonly found in collections today. However, Walter Worth collects them and describes for us the wide variety manufactured in the '20s. Wally lists over 36 manufacturers in his article.

In *Restoration Topics*, Richard Foster answers the question posed several months ago by Phil Brunais of Bear Lake, Michigan, about whether or not and how to restore dial escutcheons. Richard stresses that the answer is specific to each set. One should first determine the original finish, and then and only if necessary, attempt to restore the escutcheon to original. Richard says, "We have a responsibility...to preserve, not to personalize."

We have several one-page articles this month. Kevin Silva contributes a report on how the very important material Bakelite was invented. The Mid-South Antique Radio Collectors' meet and auction (including several A.C. Radio Renegade events, announced in our April issue) is reported this month by Ron Ramirez. Doug Heimstead reports on the second Wickstrom estate auction at the Pavek Mu-

seum. A spotlight on the relatively new Alabama Historical Radio Society is included this month also. Next month's issue will have a full report on the third Wickstrom estate auction and the meets in Minnesota and Pittsburgh.

Our three-page *Photo Review* this month includes battery sets, tombstones, cathedrals, table radios and a couple of interesting cone speakers.

**No Subscription Rate Increase Yet.** You may have noticed that summer has arrived without an increase in A.R.C.'s subscription rates. We have taken a number of steps to keep our costs down and believe that these measures have not compromised the quality of our monthly issues. However, more than likely, as the new year approaches, a small increase will be necessary, and now may be the time to renew at the current rates. Simply complete the coupon in the center of this issue and mail it along with your payment, and we will extend your subscription. You may also renew by phone using VISA or MasterCard. An additional note — your purchases of books from A.R.C. help to keep us financially healthy, and although we say that we ship your order within 4 days, your books usually go out the day we get your mail or telephone order.

**Club Events.** The club event scene continues to be active, with over two-dozen events scheduled for July. Two-day meets are to be held in Wisconsin, Michigan and North Carolina. Of special note — Jim Clark and John Meredith have formed a new association, the E.H. Scott Historical Society, and its first public meeting will be held at the Michigan Antique Radio Club's Extravaganza '92 on July 11. Happy Collecting.

John V. Terrey

---

## ON THE COVER

High-fidelity amplifiers from our lead article by Mark Van Roojen and Leif Blackmon are pictured on our cover this month. The McIntosh MC60 from the late 1950s is shown above the 1930s vintage Western Electric Model 124E.

---

## OOPS!

The Heath Model XR-1 photo in our May 1992 *Photo Review* is upside down.

---

## PRINTED WITHOUT COMMENT

Last month we reported that we had received several reports regarding failure and/or difficulty in receiving items and/or refunds from Ed MacFalls of Lakemont, PA 16602. We have not yet received any confirmation that the issues have been resolved from either Mr. MacFalls or from the several persons reporting the problems.

# VINTAGE HI-FI

## Vintage High-Fidelity Equipment

BY MARK VAN ROOJEN AND LEIF BLACKMON

*Mark van Roojen and Leif Blackmon present A.R.C.'s first article on vintage hi-fi equipment. They remind us that with each decade another type of equipment becomes a collector's item. Perhaps more than the sets of the 1920s, vintage hi-fi equipment may well evoke strong feelings of nostalgia in our younger readers. (Editor)*

The golden age of tube-type high-fidelity equipment began in the late 1940s and lasted until the early 1960s. Although major advances in audio technology had been made prior to that period, the general public's interest in "hi-fi" did not become widespread until after World War II. The Great Depression and the war, along with the lofty prices of equipment, caused the use of high-fidelity equipment to be restricted mostly to commercial applications such as theaters and recording studios.

With the end of the war, this situation began to change. Improvements in disc-recording technology produced phonograph records capable of delivering a wider frequency response and greater dynamic range. The long-playing record and

---

**"Because of their quality, as well as their value to collectors, many of the older tube-type, high-fidelity pieces are still desirable today"**

---

the 45 rpm record, made of vinyl, eventually replaced the 78 rpm shellac records. The LPs and 45s provided a quieter playing surface as well as improved frequency response and dynamic range.

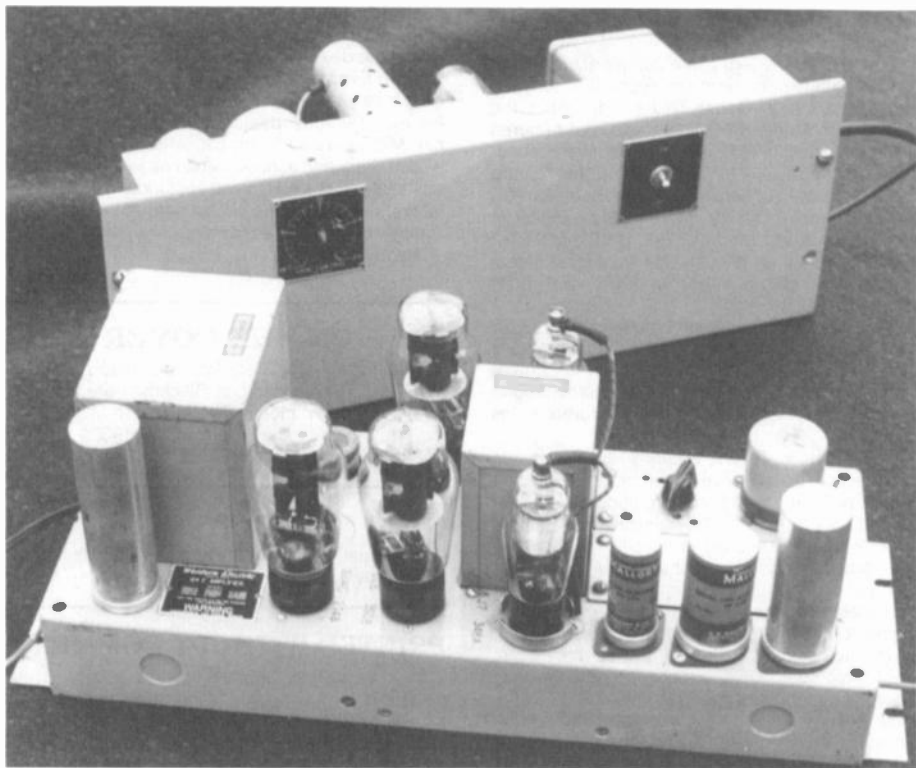

Figure 1. Western Electric Model 124E amplifier.



Figure 2. McIntosh Model MC60 amplifier.

The public's interest in high quality audio reproduction grew further when tape recorders became available commercially and FM broadcasting became prevalent. Improvements in the quality of these audio sources demanded similar advances in playback equipment.

#### THE WILLIAMSON AMPLIFIER

In 1947, D. T. N. Williamson published his now famous articles in the British magazine *Wireless World*. These articles described an amplifier capable of producing 15 watts of audio power over a frequency range of 10 to 20,000 cycles per second with less than 0.1% distortion. This amplifier used Type KT66 tubes and an output transformer of special design. The articles included instructions for constructing this special transformer.

An American version of the Williamson amplifier was detailed in a 1949 issue of *Audio* magazine. The American version substituted Type 807 tubes for the British KT66s. Soon hobbyists on both sides of the Atlantic were building these high quality amplifiers. And the pursuit of hi-fi began in

earnest. The Williamson Amplifier is described more fully on page 6.

#### FACTORY-BUILT EQUIPMENT

At about the same time, a number of companies began to offer factory-built equipment, and the availability of high quality audio equipment was no longer limited to persons capable of building their own gear. Among the producers of factory-built units were such familiar names as H.H. Scott, Altec, Fisher, Brook, Radio Craftsmen, McIntosh and Marantz. Heath-kit bridged the gap between factory-built and "roll-your-own" by providing parts-kits and instructions that enabled individuals with little knowledge of elec-

tronics to build their own hi-fi sets. Naturally, the manufacturers of transformers got into the act by offering kits for the home constructor. Among these suppliers were Stancor, UTC, Thordarson and Acrosound.

A wide range of playback equipment became available as either factory-built or kits. These units included preamplifiers, power amplifiers, equalizers, tuners, speaker systems and speaker enclosures. Tape recorders, or "tape decks" became popular and quickly replaced disc recorders as the recording medium in the home.

#### MAJOR IMPROVEMENTS

Improvements were not limited to the electronic circuits. Magnetic phonograph cartridges began to replace the older crystal variety. The old-style replaceable steel phonograph needle gave way to the "permanent" jeweled stylus. Pickups and arms were improved, and tracking pressures were reduced. Once measured in ounces, stylus pressures were now measured in grams. Reduced stylus pressure resulted in longer life for

(Continued on page 7)

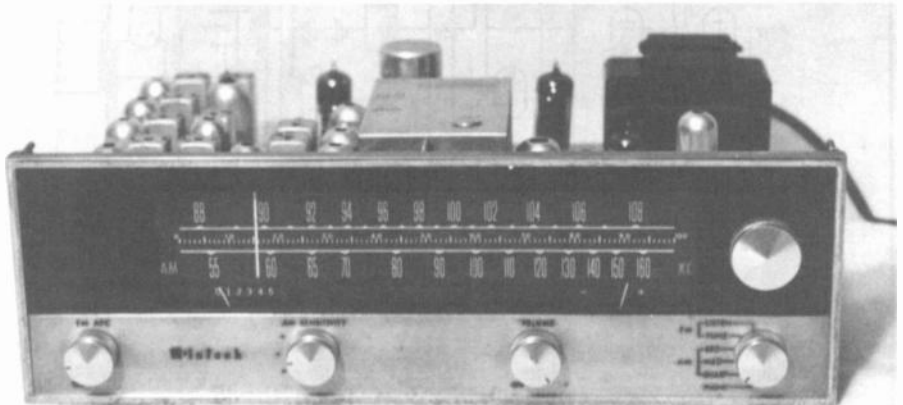

Figure 3. McIntosh Model MR55A, an early monaural tuner.

# THE WILLIAMSON AMPLIFIER

Adapted from a reprint of "Design for a High-quality Amplifier" by D. T. N. Williamson which originally appeared in the April and May 1947 *Wireless World*.

Recent improvements in the field of commercial sound have made practicable the reproduction of a wider range of frequencies than hitherto. The useful range of shellac pressings has been extended from the limited 50-8,000 c/s to some 20-15,000 c/s. This increase in the frequency range has been accompanied by an overall reduction in distortion, the absence of frequency peaks, and by the recording of a larger volume range. The substitution of low-noise plastic material for the present shellac composition is likely to provide still further enhanced performance.

Full utilization of these recordings and transmissions demands reproducing equipment with a standard of performance higher than that which has served in the past. The requirements within the audible frequency spectrum of 10-20,000 c/s of such an amplifier may be listed as:

- (1) Negligible non-linear distortion.
- (2) (a) Linear frequency response.
- (2) (b) Constant power handling capacity for negligible non-linear distortion.
- (3) Negligible phase shift within the audible range.
- (4) Good transient response.
- (5) Low output resistance.
- (6) Adequate power reserve.

It is difficult to produce an adequate frequency response characteristic in a multi-stage amplifier because the effect of multiple valve capacitances and the output transformer primary and leakage inductances becomes serious at the ends of the a.f. spectrum. The application of negative feedback results in a more or less complete solution.

The functions of negative feedback are:

- (a) To improve the linearity.
- (b) To improve the frequency response.
- (c) To reduce the phase shift.
- (d) To reduce the low-frequency characteristics.
- (e) To reduce the output resistance.
- (f) To reduce the effect of random changes in the parameters of the amplifier and in the supply voltage.

A very brief description of the circuit follows:

**Initial Stages, V1 & V2.** In order to keep the phase shift in the amplifier at low frequencies as small as possible, the first stage has been directly coupled to the phase splitter, V2, eliminating one R-C coupling.

**Driver Stage, V3 & V4.** Provision is made for varying the plate load resistance to allow compensation for any inequality in gain.

**Output Stage, V5 & V6.** Provision is made in the cathode circuits for altering the grid bias of each valve giving complete control over the static conditions of the stage.

**Output Transformer.** [Detailed core specifications and winding data are included in the article.]

**Negative Feedback.** The negative feedback network is a potential divider consisting of R25 and the cathode bias resistor of the first stage, R4.

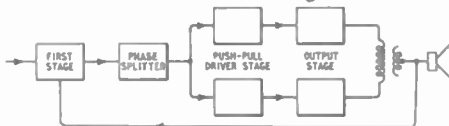

Block diagram of the Williamson amplifier circuit.

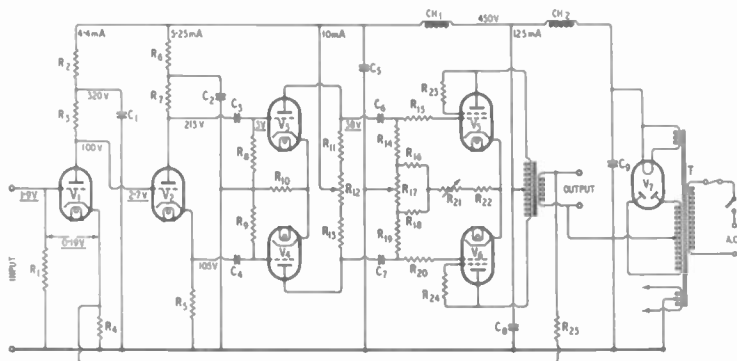

Circuit diagram of complete amplifier. Voltages underlined are peak signal voltages at 15 watts output.

## CIRCUIT VALUES

R <sub>1</sub>	1 MΩ ½ watt ± 20 per cent
R <sub>2</sub>	33,000 Ω 1 watt ± 20 ..
R <sub>3</sub>	47,000 Ω 1 watt ± 20 ..
R <sub>4</sub>	470 Ω ½ watt ± 10 ..
R <sub>5</sub> , R <sub>6</sub> , R <sub>7</sub>	22,000 Ω 1 watt ± 10 ..
R <sub>8</sub> , R <sub>9</sub>	0.47 MΩ ½ watt ± 20 ..
R <sub>10</sub>	300 Ω ½ watt ± 10 ..
R <sub>11</sub> , R <sub>12</sub>	39,000 Ω 2 watt ± 10 ..
R <sub>12</sub>	25,000 Ω 1 watt wire-wound variable.
R <sub>14</sub> , R <sub>15</sub>	0.1 MΩ ½ watt ± 20 ..

R <sub>16</sub> , R <sub>20</sub>	1,000 Ω ½ watt ± 20 per cent
R <sub>18</sub> , R <sub>18</sub>	100 Ω 1 watt ± 20 ..
R <sub>17</sub> , R <sub>21</sub>	100 Ω 2 watt wire-wound variable.
R <sub>22</sub>	160 Ω 3 watt ± 20 ..
R <sub>23</sub> , R <sub>24</sub>	100 Ω ½ watt ± 20 ..
R <sub>25</sub>	1,200 Ω speech coil impedance, ½ watt.
C <sub>1</sub> , C <sub>2</sub> , C <sub>3</sub>	8 μF 450 V, wkg.
C <sub>4</sub> , C <sub>6</sub>	0.05 μF 350 V, wkg.
C <sub>5</sub> , C <sub>7</sub>	0.26 μF 350 V, wkg.

C <sub>8</sub>	8 μF 650 V, wkg.
C <sub>9</sub>	8 μF 600 V, wkg.
CH <sub>1</sub>	30 H at 20 mA (min.)
CH <sub>2</sub>	10 H at 150 mA (min.)
T	Power transformer.
	Secondary 425-0-425 V,
	150 mA (min.) 5 V, 3A, 8.3
	V, 4A, c.t.
V <sub>1</sub> to V <sub>4</sub>	1A3
V <sub>5</sub> , V <sub>6</sub>	KT68.
V <sub>7</sub>	U82.



Figure 4. Marantz Model 8B stereo amplifier.

*(Vintage High-Fidelity Equipment, continued)*

both stylus and records. Turntable rumble was reduced, and rotational speed accuracy improved.

Manufacturers and circuit designers sought further improvements in the performance of power amplifiers. The use of triode tubes in power amplifiers was favored by some hi-fi enthusiasts because triodes produce lower levels of higher order harmonic distortion than pentode tubes. For example, Brook produced several amplifier models that used Type 2A3 tubes. Some models included an automatic variable bias circuit which permitted greater power output. At low output levels, the 2A3s were operated in Class A. At higher output levels, the automatic bias circuit caused the amplifier to operate as a Class AB amplifier that produced greater power output.

The relatively low power output available from amplifiers that used triodes, as opposed to those using pentode tubes, was offset by the high efficiency of large horn-type speakers then in common use.

Not all hi-fi enthusiasts advocated the use of triodes by any means. Perhaps equally vocal were the supporters of the pentode and beam-power tubes. The RCA-developed beam-power tubes — particularly the Type 6L6 tube — were used widely in prewar public address amplifiers and "high-end" radio/record players.

A system of negative feedback was employed in these amplifiers to reduce distortion and broaden the frequency response while still providing high output power. The use of negative feedback was pioneered by Western Electric well before World War II. High fidelity amplifiers described in hobby magazines in the early 1940s frequently made use of a negative feedback circuit also referred to as "inverse feedback."

In another effort to improve the performance of power amplifiers, David Hafler and Herbert Ker-

oes of Acrosound popularized the ultralinear circuit. Their design utilized a special output transformer which used taps on the primary winding for connection to the screen grids of the output tubes. This circuit provided high power output along with improved frequency response and lower distortion. This amplifier became extremely popular.

The availability of high-power amplifiers made it practical to use less efficient but more compact speaker systems. The upper frequency range of some of these speakers was extended by the use of stiffer cones, "whizzers" and separate tweeters.

Most hi-fi sets consisted of separate units — preamplifier, tuner, amplifier and turntable. Some sets included a tape deck. The preamplifier usually had an input switch that allowed the selection of a magnetic or crystal phono pickup, a tuner or a tape deck.

Some preamplifiers had the ability to choose a particular type of phonograph compensation. During that early period, despite attempts to standardize recording characteristics, many record companies used different frequency emphasis curves in their recording processes. As a consequence, different playback compensation was required to correct for the frequency emphasis curves used in the recording studio. In addition to phonograph compensation, preamplifiers usually provided separate bass and treble tone controls so that the system's frequency response could be adjusted to suit the listener.

Because it was used so frequently, the preamplifier was located in a convenient position. The amplifier, because of its greater weight and heat dissipation, was more remotely placed. The problem of acoustical feedback usually required physical separation of the turntable and speaker system.

## STEREO

The next major development was stereo. Western Electric pioneered stereo sound as early as 1933. Some early attempts to produce stereo sound were rather primitive such as the use of dual pickups in a phonograph arm and the need to wear headphones. The development of the stereo phonograph record and stereo tape players made stereo practical. Initially, the availability of true stereo recordings was quite limited; hence, many existing monaural records were electronically remastered to produce simulated stereo.

As the availability of stereo source material grew, so did the public's interest in upgrading their systems to play stereo records and tapes. Upgrading could be accomplished by purchasing a second amplifier and speaker along with a new

*(Continued on following page)*

(Vintage Hi-Fi Equip., continued)

stereo preamplifier, or by replacing the old monaural system with a new stereo set. By the early 1960s, stereo had become predominant.

### SOME NOTEWORTHY EQUIPMENT

During the 1920s and 1930s, Western Electric and its sister company, Electrical Research Products, Inc., did much of the pioneering work that led to high-fidelity sound reproduction. The work by Western Electric found its way into amplifiers used in recording studios, theaters, and public address systems. Dating from the 1930s, the Model 124E amplifier, shown in Figure 1, used the Western Electric-developed type 350B power tetrode tube. The 350Bs rated plate dissipation of 25 watts was greater than that of the contemporary 6L6 tube which was rated at 18 watts.

Perhaps the best known manufacturer of tube-type amplifiers was the McIntosh Company. The company marketed amplifiers featuring a patented transformer which used bifilar windings. The early versions were industrial-looking, hammer-tone grey contraptions. Later models were artistic triumphs of chrome and black. Pictured in Figure 2 is a Model MC60 from the late 1950s, list priced at \$198.50. McIntosh also made stylish glass-faced tuners and preamplifiers. An early monaural tuner, Model MR55A, is shown in Figure 3.

In the late 1950s, Saul Marantz set up shop in New York City and began producing hi-fi amplifiers of legendary quality. These power amplifiers with brown enameled chassis featured Type EL34 tubes and a choice of triode or ultra linear operation along with built-in bias meters for amplifier adjustment. The amplifiers were conservatively engineered. Marantz also manufactured beautiful gold-faced preamplifiers of fine quality. A Model 8B, 35-watt per channel, stereo amplifier, is depicted in Figure 4. Its list price in 1962 was \$249.

H.H. Scott offered a wide range of high-fidelity equipment starting with a dynamic noise suppressor in the late 1940s — remember, those shellac 78 rpm record surfaces were very noisy. Scott's strong suit was in tuners, styled with soft brass-colored faces, brass-colored anodized knobs and walnut cases. A Scott Model 350B tuner appears in Figure 5.

### BUYING/SELLING TUBE HI-FI

Because of their quality, as well as their value to collectors, many of the older tube-type, high-fidelity pieces are still desirable today. Many pieces of equipment now sell for more than their original list prices, while others do not. Current market value depends upon such factors as the equipment's original quality, present condition and scarcity, as well as the fickle tastes of collectors. With most collectors, "separates" tend to com-



Figure 5. H.H. Scott Model 350B tuner.

mand higher prices than do integrated sets and receivers. This relationship is not necessarily reflected in asking prices at garage sales.

Sources of older high-fidelity equipment tend to be similar to those of old radiq equipment — garage sales, swap meets, attics and so on. If you wish to sell hi-fi equipment, the situation is much the same. A.R.C. is a good place to find buyers. And the ground rules are much the same as when selling radios. There are a few sharp characters around, so do not get talked into sending off a piece of equipment without receiving payment first. Shipping C.O.D. is relatively safe. If you are in doubt about prospective buyers, ask for references or check with fellow collectors with whom they have done business.

Collecting vintage hi-fi equipment can be quite exciting, especially when you discover, that in terms of performance, much of the old "high-end" equipment compares favorably to much of today's equipment.

(Mark van Roojen, P.O. Box 83836, Lincoln, NE 68501-3836)

(Leif Blackmon, 4 Larson Road, North Reading, MA 01864)

Mark van Roojen is an assistant professor of philosophy at the University of Nebraska, Lincoln. While in graduate school at Princeton, he took up guitar-making which led to tube musical instrument amplifier building and restoring. This hobby, in turn, led to collecting vintage high-fidelity and theater equipment and to researching older equipment in the university library. Currently, his collection concentrates on old tube gear hi-fi equipment, some mono, some stereo.

Leif Blackmon's interest in vintage tube high-fidelity equipment was in part spurred on by his work as a senior customer representative with a Boston based loudspeaker manufacturer. Being involved with contemporary high-fidelity equipment each day set him to thinking about its origins. He collects hi-fi kit amplifiers and parts marketed by transformer companies such as UTC, Triad, and Acrosound, as well as general tube hi-fi gear.



# WITH THE COLLECTORS

## The Story of Bakelite

BY KEVIN SILVA

In 1907, Leo Baekeland, the Belgium-born American chemist, combined two kinds of ordinary molecules and broke them down into components, which then reassembled themselves into the first commercially valuable giant molecule created by man. The result was the first true synthetic — Bakelite.

By mixing phenol, derived from coal tar, and formaldehyde, in turn derived from coal and wood smoke, Baekeland had fabricated an entirely new material which cannot be made from any substance that is found in nature. Two simple substances had been turned into a complex substance entirely unlike either of the original two; a man-made polymer had been created in the laboratory.

### THE BEGINNING

Before taking up his research on synthetics, Baekeland had already established his reputation as a chemist. In the late 1890s, while he was still in his thirties, he invented Velox, the first photographic paper on which pictures could be printed by artificial light. Although Baekeland expected no more than \$50,000 for his invention, George Eastman of Kodak offered him a million. With this fortune, Baekeland was able to retire to his private laboratory in Yonkers, New York, and turn his attention to projects that interested him.

### THE PROCESS

Among the foremost of these projects was the possibility of synthesizing an artificial shellac — one not dependent on the resinous secretions of *Laccifer lacca*, an insect found in Southeast Asia. Through research, Baekeland found that, in 1871, a German chemist, Adolf Von Baeyer had mixed phenol with a smelly preservative, formaldehyde, to produce a horn-like material. If heated, the mixture foamed, bubbled and stank; if cooled, it congealed into a hard, porous, insoluble gray mass — resin.

To 19th century chemists, resinous reaction products were very troublesome because they could not be dissolved. As a result, they clogged test tubes and vessels, leaving these receptacles useless.

Baekeland set out to search for ways to make the phenol-formaldehyde resin useful. Like all mavericks, he deliberately decided to do all the things that earlier chemists had tried to avoid. Rather than inhibit it, he encouraged the reaction which caused the phenol and formaldehyde to

combine. Instead of cooling the mixture once it was formed, he heated it. To prevent the higher temperatures from keeping it permanently in a liquid state, he put the mixture under pressure. Finally, he added ingredients to speed the entire process.

When the reactions had run their course, the vessel contained a clear, hard, amberlike material. It was molded into the hemispherical shape of the apparatus in which it had been cooked, and it faithfully reproduced the pattern of each of the vessel's rivets and seams. Baekeland called this new material "Bakelite."

### THE WONDER OF BAKELITE

One of the most versatile man-made products, Bakelite has become useful in virtually every industry. Its many desirable properties include the following: it is hard, very strong, yet light in weight, and insensitive to heat, acids and weather; it can be colored and dyed, machined and molded; and it is an electrical insulator. Bakelite is used to make everything from buttons to telephone equipment, from knife handles to coils, switches and distributor heads for automobiles, from counter covering to cameras — and, of course, radios!

With today's technology, chemists can manipulate small molecules to produce giant molecules that conform to predetermined specifications and can produce all sorts of miracle products from clothing to nose cones of spaceships. By synthesizing this new substance called Bakelite, Leo Baekeland set off a scientific and industrial revolution that has extended throughout the 20th century.

(Kevin Silva, 4620 N. Elmhurst, Indianapolis, IN 40226)

### Reference:

Mark, Herman F. *Giant Molecules*. New York: Time-Life Books, 1968.

*About four years ago, Kevin DeVere Silva was given a beautiful 1924 Model 20 Atwater Kent compact. He knew that his grandfather, Albert "Dick" DeVere Silva had worked for Atwater Kent, and Kevin spent the next year researching his life. Kevin's radio collection relates mostly to this research — radios built by Atwater Kent and Arvin, the two companies which had employed his grandfather.*

# WITH THE COLLECTORS

## The Zenith 5R-312 Push-Button Radio

BY RICHARD ARNOLD

The Zenith 5R-312, a 1939 model year push-button radio, is shown in Figure 1. Figure 2 shows the 5R-312 side by side with the Model 6D-516 of the 1940s, a similar style but without push buttons.

A *Radio News* article dated December 1937 describes the advantages of push-button models as follows: "Push-button station selection gives the ultimate in convenience and simplicity of tuning... These advantages are so immediately evident that radio dealers and servicemen consider this feature the most forceful selling point offered in recent years.

"The vast improvement in the performance of present-day push-button tuning over the expensive, complicated systems in use years ago is due in considerable measure to

---

**"Push-button station selection gives the ultimate in convenience and simplicity of tuning to the owner of a 1939 model receiver."**

---

other developments in receiver design which bear no direct relationship to push-button tuning. In particular, automatic frequency control and high-fidelity, broad-band IF transformers overcome the mechanical difficulties of hair-line tuning which



Figure 1. The Zenith 5R-312.

caused designers of push-button systems so much distress in years gone by, while modern oscillator circuits have a degree of frequency stability not hitherto realized."

Figure 3 shows the tuning ranges for the automatic station selector push buttons on Model 5R-312. Before stations can be automatically selected, these buttons must be set by a slight tuning operation achieved first by removing the cap covering the adjusting screw opposite each button. Insert a pin or the fingernail under the edge of the cap and gently pull it out. Each of the four adjusting screws thus exposed tunes the corresponding button. It should be noted that each button adjustment does not cover the entire broadcast band. The four buttons each have a definite frequency range, which means that only a station within its limits can be set for that button.

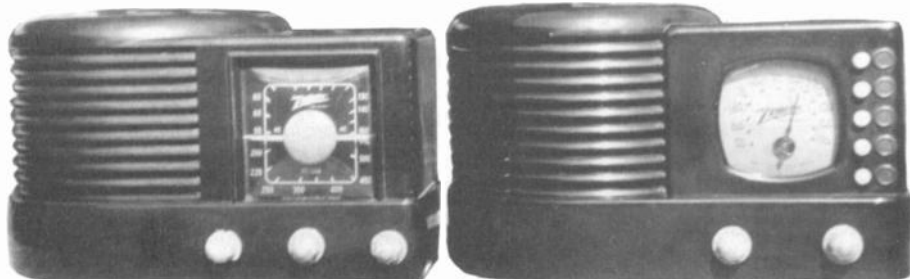

Figure 2. The Zenith 5R-312 beside the 6D-516, a similar style set of the 1940s, but without push buttons.

The lowest button disconnects the automatic tuning and allows the manual tuning knob to become operative. There is no adjustment for this button.

The 1939 Zenith 5R-312 is a 5-tube superheterodyne AC receiver covering frequencies from 545 to 1740 Kc. The Zenith Metaglas tube complement consists of one each of the following: 6ABG converter; 6K7G IF amplifier; 6Q7G diode detector, automatic volume control (AVC), and audio amplifier; 6K6G power output; and 6X5G rectifier.

The radio came in three colors. For \$19.95 you could purchase it in Franciscan brown plastic. For only a few dollars more — \$22.95 to be exact — you could purchase it in either ivory finish plastic, or ebony plastic. Another 1939 push-button model, the Model 6D-312 (not pictured), was made but with six tubes — an added ballast tube. This set looked exactly like the 5R-312 and came in the same colors.

(Richard Arnold, Box 275, Lone Grove, OK 73443)

References:  
*Radio News*, December, 1937.  
 "Zenith Radio Installation and Operating Instructions for Zenith 5R-312."

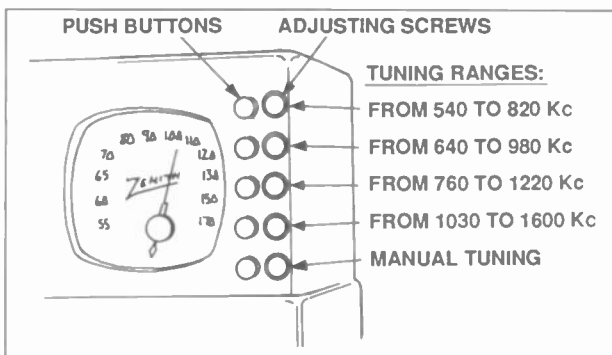

Figure 3. Diagram of the push buttons on the Zenith 5R-312.

Richard Arnold is a frequent contributor to *A.R.C.* Since 1985, his own collecting interest has been primarily in cathedrals and 1920s battery sets. His collection of over 60 radios ranges from crystal sets to a 1928 American Bosch desk radio in a Pooley cabinet. His prize is the 1932 J.B. Peter Pan featured in the June 1991 issue of *A.R.C.*



## Characteristics of Miniature Lamps

BY RAY BINTLIFF, K1YDG

Listed below are the ratings and characteristics of panel lamps commonly used in older radios.

Type	Filament Voltage	Filament Current Amps*	Base	Bulb	Bead Color†
40	6-8	0.15	Screw	T-3-1/4	Brown
41	2.5	0.50	Screw	T-3-1/4	White
42	3.2	0.35	Screw	T-3-1/4	Green
43	2.5	0.50	Bayonet	T-3-1/4	White
44	6-8	0.25	Bayonet	T-3-1/4	Blue
45	3.2	0.35	Bayonet	T-3-1/4	Green
46	6-8	0.25	Screw	T-3-1/4	Blue
47	6-8	0.15	Bayonet	T-3-1/4	Brown
48	2.0	0.06	Screw	T-3-1/4	Pink
49	2.0	0.06	Bayonet	T-3-1/4	Pink
50	6-8	0.25	Screw	G-3-1/2	White
51	6-8	0.25	Bayonet	G-3-1/2	White
55	6-8	0.45	Bayonet	G-4-1/2	White

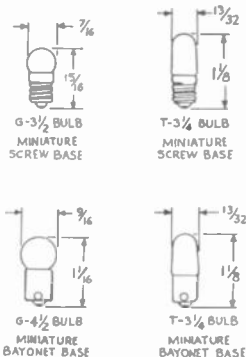

Notes:

\* All filament current ratings are expressed in amperes.

† Bead color refers to the color of the glass bead attached to the filament support wires inside the glass envelope. The bead color serves as an identifier and may be useful when a lamp's type marking is not legible. In modern production lamps, the bead may be clear glass.

(Ray Bintliff, K1YDG, 2 Powder Horn Ln., Acton, MA 01720)

From the Pages of...  
**Radio Digest Illustrated**

## The Aerex Combination Units

*This article is adapted from the June 10, 1922 issue of "Radio Digest Illustrated" and is one of a series showing how to hook up and operate popular sets of the 1920s. (Editor)*

The set shown on the opposite page is the Aerex Radiophone Corporation combination units of crystal detector, audion detector and 2 step amplifier. The crystal detector unit is known as BR-1, the audion detector unit as BA-2, and the 2 step amplifier unit as ALS-3. This combination set is exceptional both in the unusual circuit used for crystal detector and also in its connections for using the Audion detector and 2 step Audio Frequency amplification connections.

### CONNECTIONS

In the diagram page, taking the front view of the 3 units, the one on the left is the Audion detector unit, the one in the center is the tuning and crystal detector unit, and the one on the right is the 2 step amplifier unit. On the right hand side of the Audion detector unit are 2 binding posts marked "Antenna" and "Ground" corresponding to the similar two on the left hand side of the tuning unit. The antenna binding posts are connected together and in addition the aerial is connected to one. Likewise the 2 ground binding

posts are connected together and the ground will be connected to one. The 2 binding posts marked "Telephone" in the lower right hand corner of the tuning unit, and the 2 binding posts marked "in" in the lower left hand corner of the amplifier unit are connected together. In the lower left hand corner



of the Audion detector unit and in the lower right hand corner of the amplifier unit are 2 binding posts marked "A-" and "A+," to which the terminals of the "A" battery are connected. The third terminal in the detector unit is marked "B-" and should be connected to the negative side of the "B" battery. The "B" battery is made up of 2-22 1/2 volt units in series. The positive terminal of the first battery is connected to the binding post marked "No. 2" in the detector unit. The negative

side of the first "B" battery is also connected to the binding post corner of the amplifier unit. The positive side of the second "B" battery in the series is connected to the binding post marked "B+" in the amplifier unit. The binding post in the lower right hand corner of the Audion detector unit is connected to the No. 1 binding post, on the tuning unit. The receivers or loud speakers are connected to the 2 posts marked "Out" on the right hand side of the amplifier unit.

### TUNING

The tuning of this set is practically the same whether the crystal or Audion detector is used except that the Cat



## Uncertainty Overcome

In producing the AEREX BR-1 CRYSTAL RECEIVING SET we have eliminated all technical complications. The machine is operated very simply and requires no electrical knowledge on your part. Attach the Aerex—that's all—and you are ready to receive whatever is being broadcast—concerts, news items, lectures, etc.

### Prices

Crystal Detector  
\$20.00

(Receiver Only)

Audion Detector  
\$12.00

2-Step Amplifier  
\$35.00

### Features

Maximum Audiability  
Maximum Tuning  
Elimination of Interference

*These features combine to make a receiving set of unusual excellence and service.*

**BR-1** gives you anything within a radius of thirty-five miles—with its special connections you are enabled to attach an Audion detector unit which increases the range to one hundred miles—the price of this Audion Detector unit model BA-2 is \$12.00 or should you want a loud speaker attachment, the Aerex model BR-1 is also equipped with connection for two-step amplifier. MODEL ALS-3, the price is \$35.00.

*Ask your dealer or write direct to us  
—sets shipped postpaid anywhere  
in the United States*

**AEREX RADIOPHONE CORP.**  
342 Madison Avenue, NEW YORK CITY

# Radio Receiving Sets

## Aerex Combination Set

Antenna

In giving the readers of RADIO DIGEST every possible help in explaining standard sets, we offer the seventh of the series, The Aerex Two Step Amplifying Receiving Set.

This set has the feature of combining crystal with vacuum tube units. The circuit

is unusual, but simple and easily tuned.

The explanation of operation of the set will be found on page four, first column.

An understanding of this type will be of material assistance in operation of sets of other makes.

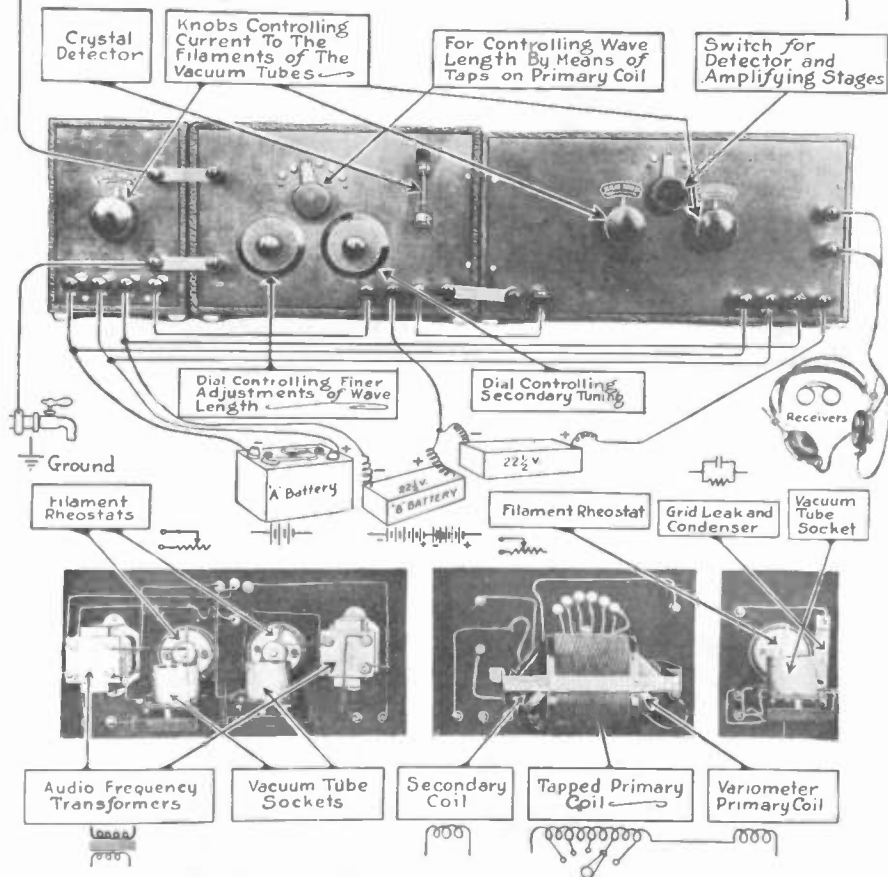

Whisker on the crystal set should not be touching while the Audion detector is being used. The tapped switch in the tuning unit controls the windings on the primary or antenna circuit. This, therefore, gives the rough wave length adjustment. The large dial on the left is connected to the variometer coil, permitting finer adjustment for wave length. The large dial on the right controls the tuning of the secondary circuit, when the crystal detector is used, but acts as a feedback control, when the Audion is used. The knob on

the audion detector unit and the 2 corresponding knobs on the amplifier unit control the filament current adjustment. The 3 point switch in the top center of the amplifier unit is used to connect the phones into the detector, first or second stages of amplification.

In actual tuning the top switch on the tuning unit is first adjusted, then the dial on the left hand side, afterwards the dial on the right hand side. Of course, the filament current for each stage must be adjusted at the proper time.



# PHOTO REVIEW



This column presents in pictorial form many of the more unusual radios, speakers, tubes, advertising, and other old radio-related items from our readers' collections. The photos are meant to help increase awareness of what's available in the radio collecting hobby. Send in any size photos from your collection. Photos must be sharp in detail, contain a single item, and preferably have a light-colored background. A short, descriptive paragraph **MUST** be included with each photo. Please note that receipt of photos is not acknowledged, publishing is not guaranteed, and photos are not returned.

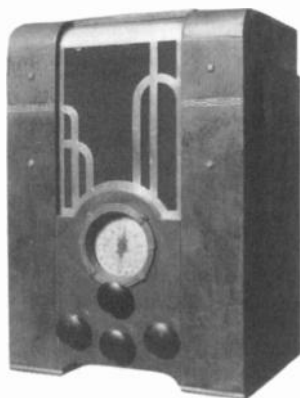

**ZENITH MODEL 809** - This is a 1935 vintage wood radio with an Art Deco chrome front. The knobs on this example are not original, and I'm not sure which ones are used on this set. It has six tubes and uses the same chassis as the more common model 808. *(Ron Boucher - Goffstown, NH)*



**EMERSON MODEL 850 BATTERY PORTABLE** - Batteries take up most of the space inside this portable. A 67.5-volt B battery lies in the bottom, while two 1.5-volt A batteries are mounted one on each side. *(David Walker - Waterloo, IL)*



**CROSLY MODEL 5-38** - The Crosley Radio Corp. made two versions of this 1926 receiver. The earlier one has three moving arrow pointers; this later style has three window dials. The "5" in the model number indicated five tubes; the "38" indicated the price. *(Dave Crocker - Duxbury, MA)*

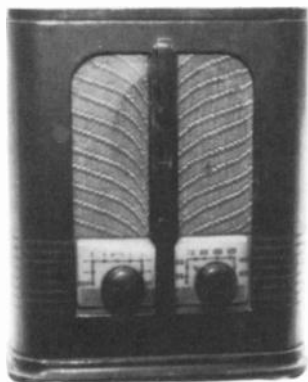

**GENERAL ELECTRIC MODEL H-531** - This small 1940 tombstone has a vertically mounted chassis with a 12SA7GT, 12B7, 12Q7GT, 35L6GT, and 35Z5GT tube lineup. It was available with a wood finish, as shown here, or with a cloth-covered cabinet. *(David Kraeuter - Washington, PA)*

---

## PHOTO REVIEW

---



**HERALD CONE SPEAKER** - This speaker has a lever in the center to adjust the tone. The small metal body is finished in bronze and lamp black. The driver is hidden behind the tone control plate. (Fred Geer - Jacksonville, FL)

---

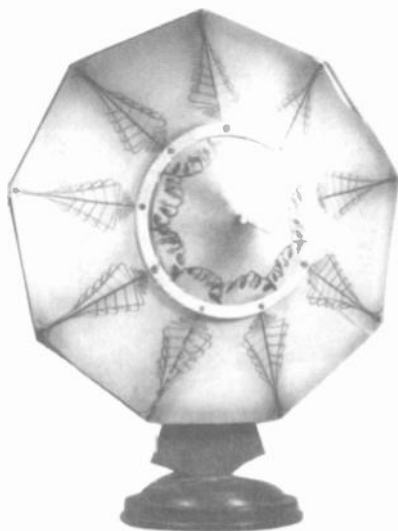

**CONE SPEAKER** - This cone speaker has an Art Nouveau print. Only the center cone produces sound; the rest is support and decoration. The model number is unknown. (Fred Geer - Jacksonville, FL)

---

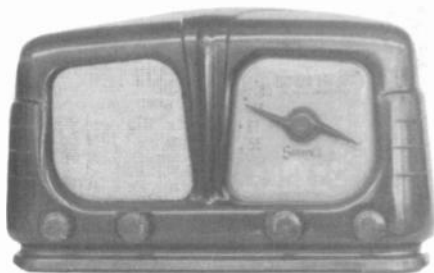

**SONORA WEU-262** - Produced in 1948, this set looks almost automotive in its cabinet design. The brown Bakelite is nearly perfect, and the grille cloth has been replaced. (David Walker - Waterloo, IL)

---

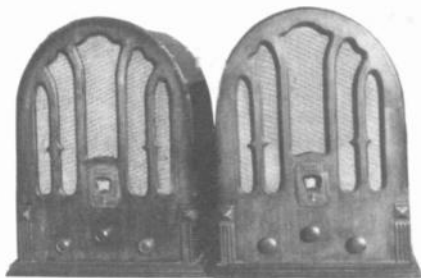

**SHARP TYPE 40 CATHEDRALS** - These 4-tube TRF receivers were made in Japan around 1932-1933. The knobs on the radio at the right are not original. (J. W. Stokes - Auckland, New Zealand)

---

**PHILCO MODEL 511** - In late 1927, the Philadelphia Storage Battery Co. entered the radio business with their Philco Model 511 receiver. This metal box neutrodyne set is AC-operated and uses seven tubes. Offered also as a console, some versions had flowers painted on the metal cabinets. (Ron Ramirez - Providence, KY)

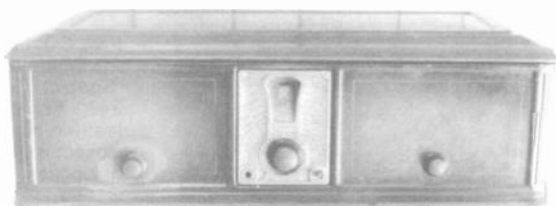

---

## PHOTO REVIEW

---



**KENNEDY AMPLIFIER** - To amplify the signal of the Kennedy Model 281 1-tube receiver, the Colin B. Kennedy Co. offered this Model 521 2-stage amplifier in 1921. This is the St. Louis version; others were manufactured in San Francisco. (Dave Crocker - Duxbury, MA)

---



**EMERSON** - This late 1930s set has an Ingraham cabinet, (Bristol, Ct.), with wood veneer, inlaid stripes and wooden speaker grille cover. It covers 55-155Kc and 200-500 meters. The model number is unknown. (David Lewis Eynon - Bryn Mawr, PA)

---

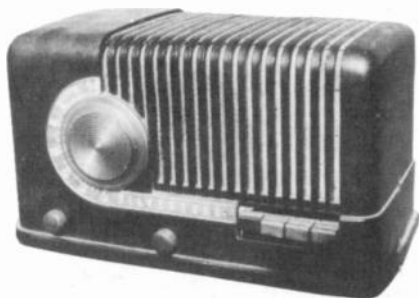

**SILVERTONE MODEL 3351** - This 1946 table model features a dial plate in the shape of a candy cane. It was also available in white. Another version came without the pushbuttons. (Ron Boucher - Goffstown, NH)

---

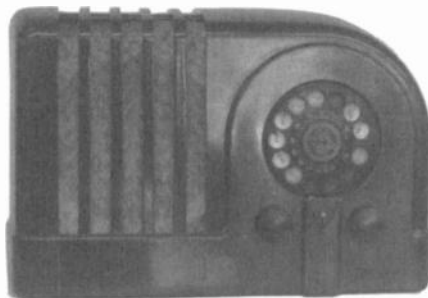

**WARDS AIRLINE MODEL 62-455** - This unique set features a translucent, lighted telephone type tuning dial. Built in the late 1930s, its construction quality is very high. (David Walker - Waterloo, IL)

---



**PHILCO MODEL 53-658** - This early 1950s AC/DC/battery portable boasts an additional "Special Services" band covering 1700 to 3400 Kc. With its suitcase-style handle and leather case, and with the dial face door closed, it could easily be mistaken for a piece of luggage. (David Kraeuter - Washington, PA)

---



# CLUB SPOTLIGHT

## ALABAMA HISTORICAL RADIO SOCIETY, INC. ALHRS

Several radio hobbyists in the Alabama area originated the Alabama Historical Radio Society (ALHRS) in June 1989. Beginning with 8 founding members, the society now has over 50 members, and membership is scattered throughout the state, the society's operating area.

Most of the long-time collectors in ALHRS have extensive collections; for example, member Don Kresge's collecting hobby dates back to 1923. These collections will eventually go to the society, which plans to provide a building for such.

The society is interested in Alabama's rich radio history. The first Birmingham radio station opened in April 1922, less than two years after the first station, KDKA Pittsburgh, started in November 1920. Many radio experimenters worked in the Birmingham and Auburn area. In 1926, the Birmingham Radio Products Corp. manufactured the Superflex radio receiver.

In addition to researching and preserving the history of radio in Alabama, and encouraging the retention and preservation of antique radios and related items and artifacts, the society has a service function. ALHRS is planning and developing training programs for youngsters and adults, to interest them in radio construction and shortwave listening. The area's fine library association will allow both urban and rural residents access to these programs.

The two-page monthly *Alabama Historical Radio Society Newsletter* contains meeting minutes, details of upcoming meetings, and classifieds.

At the club's regular monthly meetings the members discuss society business and radios. The radio discussions are primarily nontechnical. The swap table at meetings displays samples of material, such as grille cloth, and copies of publications. The meetings occur on the fourth Monday evening of the month, except for December, at 7:00 P.M. at the Homewood Public Library, 1721 Oxmoor Road, Birmingham.

The two-day ALHRS Show/Swap Meet, held with the Birmingham Hamfest, attracts around 4,000 radio buffs from all over the Southeast. This

annual event takes place generally in May at the Civic Center in downtown Birmingham. The old-time radio exhibit displays sets from as far back as 1918, with emphasis on the Simplex radio manufactured in Birmingham in 1926. The event also includes a large flea market, a complete swap meet, door prizes, a banquet, and forums. The forums on radio history and on shortwave listening and reception feature a display of old communication equipment and amateur gear.

The ALHRS library presently is distributed among the members. The joint collection contains books by Leutz, Ghirardi, and others, as well as a complete set of Rider manuals, including the earliest ones, and Sams 1 to 1,000, from vacuum tubes to solid-state.

The society gave the patent issued to a local manufacturer in 1926 to the archives of the local library. Also, ALHRS has original company stock certificates and a Superflex radio receiver set, designed and manufactured in Birmingham from 1926 to 1930. The society plans to have a museum for such equipment and artifacts.

The organization, listed by the Internal Revenue Service, is tax-exempt for contributions of money and/or old sets.

### Alabama Historical Radio Society, Inc. ALHRS

Yearly dues: \$20.00

Publication: Newsletter, published monthly

Membership year: 12 months from joining

Officers:

President: David Johnson

Vice President: Dave Cisco

Secretary: George Bates

Treasurer: Joe Domnanovich

Corresponding Secretary: John C. Hill

For membership information:

David Johnson

1305 Pleasant Grove Road

Pleasant Grove, Alabama 35127

(205) 744-7075

Alabama Historical Radio Society  
SUPERFLEX

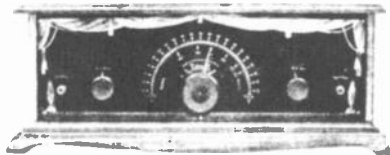

The society's logo includes the Superflex set of the Radio Products Corp., 1926, Birmingham, Alabama.

# WITH THE COLLECTORS

## Collecting Battery Eliminators & Chargers

BY WALTER V. WORTH

In reading the stories in A.R.C. and seeing the pictures of the things radio collectors collect, I am surprised that more of us don't collect the power supplies that often powered the 1922 to 1930 "battery" sets. Some representative types are shown in Figures 1 through 6. After all, these power supplies represent an important milestone in the history of radio development and helped propel the battery set into more homes than ever before.

Of course, a real drawback to the battery sets of the early twenties was the necessity of charging the A storage battery and replacing the B batteries to keep the set in top-notch operating condition.

A partial solution to this problem was first devised for the A battery supply. This consisted of a storage battery with a battery charger permanently connected to its terminals so as to charge the battery whenever the radio was turned off — a great help, in that the battery was always charged up automatically. These so-called "Trickle Chargers" were small units of ½-ampere to 2-ampere capacity. They were able to deliver sufficient current to keep the batteries, which were on for long periods of time, charged. However, only the battery powered the radio.

The later sets that used the Type 199 low drain tubes helped the situation as far as the A battery was concerned. They used dry cells instead of storage batteries, but the B batteries were still a nuisance.

Because of this problem, the B eliminators were developed first and they did away with the necessity of replacing these batteries every few months or so. The A storage battery still needed to be charged though.

The B eliminators furnished from 22 ½ VDC to 180 VDC and solved the B battery problem. Most of these devices had a variable DC supply for the detector tube, as well as a higher variable voltage supply for the

amplifiers. Milliampere delivery was from 35 to 80 mA.

However, the A battery eliminator was a more difficult proposition because of the higher amperage that had to be passed through the filter system. The amperage of up to 5 amperes, needed for the early Type 201 and 201A tubes, required a DC supply free of hum — something difficult to achieve with the paper capacitors, or even the early electrolytic capacitors of the day. This was true because the high amperage to be delivered



Figure 1. Right: GE tungar battery charger, 3 cells at 5 amperes or 6 cells at 3 amperes. Center: GE Tungar charger, 3 cells at 5 amperes, 6 cells at 3 amperes or 40 cells at ¼ ampere. Left: Westinghouse Rectigon charger, 2 to 96 volts at 2 amperes to ¼ ampere.



Figure 2. Right: Kodol Radio B "Transifier" Model 61, Capacity (6) 201A tubes. Center: Ferguson "Hi-Power" Eliminator Type FM, Mayolian Radio Corp. Left: Greene-Brown Mfg. Co. 135 volts at 35 mA.



Figure 3. Right: Westinghouse Trickle Charger, 6v at  $\frac{3}{4}$  amp. Center: Balkite Trickle Charger, 6v at  $\frac{1}{2}$  amp. Left: GE Tungar Trickle Charger, 6v at  $\frac{1}{2}$  amp.



Figure 4. Kuprox Trickle Recharger, Kodel Radio Corp., Cincinnati, Ohio.

demanded very high capacity in the filter condensers to insure low ripple current; even massive filter chokes that had to carry the 5 amperes were used.

At first the A battery eliminators and the B battery eliminators were sold separately, but enterprising manufacturers like Valley Electric, Balkeit, Majestic, and Sterling soon were offering A and B eliminators combined in one case. Even the C battery voltage was supplied in some models, as in the "Perfect" ABC model shown in the United Sales Co. ad in Figure 7. These combinations claimed to make a "Light Socket Radio"

out of your old battery set — and they did!

Other manufacturers of these devices were the following: Abox, Acme, All American, Arco, Belmont, Briggs and Stratton, Crosley, Cloverleaf, DeWitt-LaFrance, Dynamic, Elliott Radio, Ferbend, Pfanstiehl, Ferguson, General Radio, Greene-Brown, Interstate Electric, Kingston, Knapp, Kodel, Kokomo Electric, Kuprox, Modern Electric, Muter, Peerless, Radio Receptor, Roll-O, Rectigon & Rectox, Sentinel, Silver-Marshall, Storar, Townsend, Triple A Specialty, Tungar, Webster, Willard, and Yaxley.

These offerings energized the radio industry through 1926 and 1928, and in turn, were shunted aside by the new scheme of building the ABC eliminators right into the radio cabinet, as in the Atwater Kent Model 36 and the Garod Model EA.

There was a brief fling at replacing the dry cell B batteries with a bank of wet cell storage B batteries, but these also required charging and were initially expensive. Also available were combination wet cell B batteries and integral chargers, like the Philco, Willard, and Edison products.

After the introduction of power supplies built into the cabinet to make an AC set out of a battery powered set, the next step was to eliminate the need for DC voltage on the filaments altogether. Thus the AC powered tubes like Types 26 and 27 were introduced, and the first real AC sets were welcomed to the market.

The Radiola 17 and 60 models, along with the AK 37 and 40, swept the market; many others joined the trend to all AC sets. No more batteries or chargers!!

Thus, the A and B eliminators, and also the battery chargers, though having only a brief exposure in the radio spotlight, were the necessary forerunners of all the pure AC sets.

Most of the B eliminators used the then new Raytheon BH tube, a so-called cold-cathode rectifier type with no filament to burn out. These BH tubes held the stage until the 85 milliamperes current that this

tube delivered was deemed too low for the multi-tubed sets of the day. The Type 80 tube, rated at 125 mA, then took over and was the rectifier of choice for many years.

The A eliminators used a variety of rectification systems. The chemical cell was used for a short time in both chargers and eliminators, but the salts used in the electrolyte crept over the lip of the jar, and the water had to be replenished occasionally. "Battery Oil" was sold for the purpose of preventing the water from evaporating and the salt from working its way over the

(Continued on following page)



Figure 5. Right: Balkite B Eliminator. Center: All American ABC Supply. Left: "Dynamic" A Unit.



Figure 6. Right: Acme B&C Supply Model E25. Left: Majestic "Super-B" Eliminator.

(Collecting Battery Eliminators, continued)

edge of the jar. This oil was poured on the surface of the electrolyte in the jars to form a thin film, but it took no part in the chemical action.

Another device was the mechanical rectifier that used a vibrating reed to make synchronously a contact and thus allow one way (or DC) current to pass.

Still another method was the copper oxide rectifier (the first solid-state type?) that "operated with no noise or chemicals or fragile tubes," as it was then advertised. This device was a stack of lead and copper discs clamped tightly together with a through bolt. The copper discs, before assembly, were heated red hot and allowed to cool in the air, producing the copper oxide on both sides of the disc. These copper and lead discs were alternated in such a way as to make a

full-wave rectifier of good amperage rating.

These various A and B eliminators are now readily available and deserve a place on the radio collector's shelf as an accessory to the early radios. Most were very well made and are still operable today, attesting to the quality of products manufactured in those earlier days. Do you have a few in your collection? I have never seen a Tungar type bulb used in an A battery eliminator — have you?

(Walter V. Worth, 2 West Elm Ave., Wollaston, MA 02170)

At age 15, Walter Worth began saving his paper route money to buy parts for one-tube sets. Then in 1986, 50 years later, he started to collect anything that needed cabinet work. A former sales engineer in power transmission equipment, now retired, he enjoys working on radios in his shop. His diverse collection ranges from crystal sets and 1920 battery sets to AC sets, transistor radios, multiband sets, and even novelty radios. He also collects early tubes and both horn and cone speakers.



**KODEL**  
POWER SPECIALISTS SINCE 1912

If—You've got a good radio receiver—  
**Electrify !**  
—and Keep It !

Don't be stampeled into trading in your present set on an AC receiver which may not prove up to expectations. You can now make your present set fully electric for a fraction of new set cost.



This Perfect "Bone-Dry" Power Pack  
is easily and quickly installed—

**KNOW YOUR VOLTAGE**

Jewell quality voltmeter or 11 meter, specially adapted for power requirements. Complete with 9 tap switch for instant reading of detector in-tube-rectifier and amplifying voltages. Made to handle black metal case for convenience use at nearby separately in standard Jewell boxes with written instructions.

Meter, boxed, \$7.55  
Meter, plain, \$6.45

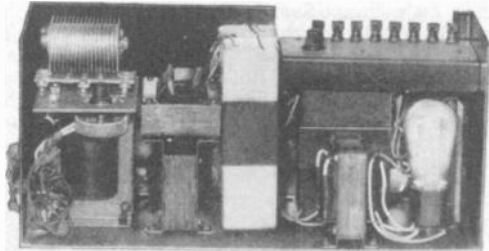

It fits in any console and forever ends your battery troubles. No liquids to spill—no acid fumes to irritate. If you have a dependable "B" eliminator our guaranteed "Bone-Dry" A Power Unit will completely electrify your receiver. Use the same tubes now in the set. No rewiring necessary.

Perfect ABC, Stripped Model, Complete, \$42.25;  
Perfect Dry A, \$19.85

Specify make and model set or "C" voltage required

**UNITED SALES COMPANY**  
9713 Cottage Grove Ave. Chicago, U. S. A.

Figure 7. "Bone Dry" power pack, United Sales Co. advertisement.

# MEET & AUCTION REPORT

## Mid-South Antique Radio Collectors Show and Swap Meet

April 11, 1992 — Madisonville, Kentucky

### A.C. Radio Renegade Events Featured

CONTRIBUTED BY RON RAMIREZ

The Mid-South Antique Radio Collectors (MSARC) held its first meet on Saturday, April 11, 1992, at the Days Inn in Madisonville, Kentucky. The meet was a huge success. The event was well attended, and many people joined the club that day.

Demand for sellers' tables was so high that the Old Equipment Contest had to be moved into the hallway. Sellers spilled out into the hallway and the parking lot. During the peak of the swap meet, the Derby Room was nearly packed with radio equipment and people.

The following were among the 37 items sold in the consignment and donation auction:

Airline 04BR720A .....	\$17
Barker & Williamson audio oscillator .....	9.50
Bogen PA amplifier (2) .....	5, 4
Crosley 5M3 tombstone, f-g .....	17
Hammarlund Outercom, looks like CB rig .....	9
Headphones, old-time sets (2) .....	5.50/both
Motorola 51X19 wood table model .....	15

Philco 40-145 .....	8
RCA 100A sprk (2), f-g .....	10, 12

As announced in "The Eliminator" section of A.R.C.'s April 1992 issue, a plastic Fada, donated by Dr. Radio of the A.C. Radio Renegades, was the door prize. Dorris Hall of Old Hickory, Tennessee, was the lucky winner. In addition, the "Radio Toss" engendered a lot of excitement. Several people participated to see who could throw a Zenith G516 Bakelite clock radio the farthest. John Jennings of Evansville, Illinois, was the winner.

For more information about the activities of the Mid-South Antique Radio Collectors, write to MSARC, c/o Ron Ramirez, 811 Maple St., Providence, KY 42450. The next swap meet will be held Saturday, October 10, 1992, at the Kentucky Inn in Lexington, Kentucky.

(Ron Ramirez, 811 Maple St., Providence, KY 42450)

## Second Wickstrom Estate Auction Pavek Museum — April 13, 1992

BASED ON A REPORT BY DOUG HEIMSTEAD IN THE NARC NEWSLETTER

The second Wickstrom Estate Radio Auction was held on April 13, 1992, at the Pavek Museum of Broadcasting, St. Louis Park, Minnesota. With 63 registered bidders attending, a total of 158 lots were sold in a little less than 4 hours.

The items were from the very large collection of Ted Wickstrom, a loyal Northland Antique Radio Club (NARC) member who passed away last summer after a short illness. The first Wickstrom Auction results were reported in the May 1992 issue of A.R.C. The final Wickstrom Auction was scheduled for May 29, 1992, at NARC's Radio Daze '92 Auction, St. Louis Park, Minnesota.

The sales of this second auction consisted of an amazing variety of box lots full of tubes, resistors, capacitors, books, magazines and miscella-

neous parts. Some of the items sold were the following:

24-hour station clock .....	\$25
Admiral 7" Bakelite TV .....	65
AK Model 35 radio .....	25
Du Mont oscilloscope .....	25
Edison early electric console radio .....	65
Fada 160 battery set, missing lid .....	70
Hallcrafters S41G Sky rider Jr. receiver .....	40
Pioneer reel-to-reel tape deck .....	150
Radio Craftsman turntable .....	22
Radio/TV magazines, 1950s, (56) .....	25
Sams Photofacts, large boxes (4) .....	30
Tubes, Type 01-A, fil good .....	53

(Doug Heimstead, 1349 Hillcrest Dr., Fridley, MN 55432)

# RESTORATION TOPICS

## Dial Escutcheons To Refinish or Not To Refinish

BY RICHARD C. FOSTER

An A.R.C. reader recently asked about refinishing brass escutcheons. He feels that they look nice polished, and notes that a number of ads, as well as photos in Alan Douglas' *Radio Manufacturers of the 1920's, Volume 1*, show escutcheons that are very light. Whether or not to refinish escutcheons is a question that comes up frequently, so a discussion is in order.

Two cautions at the start. First, many ads are made from mock-ups, artists' conceptions or photographs that have been retouched or adjusted for contrast; thus, their accuracy is in question. Second, the photo on the cover of Douglas' Volume 1, for one example, is of a Majestic radio that has been refinished and whose escutcheon has been polished or brightened. Printing a picture like that tends to make it authoritative even if that wasn't intended.

I have researched a lot of ads for pictures and copy on this subject and have found no mention of the coloring of escutcheons, not even for the introduction of the well-known Zenith automotive face escutcheon in *Radio Retailing*. There are some very good pictures of escutcheons, such as the Stewart-Warner faces, in these ads. In particular, the Zenith shows a face that is largely stippled, with some smoother lines standing out.

Some of these escutcheons appear either brighter or darker than well-preserved ones seen at most shows or in collections. The only reference to brass that I have ever come across is from a 1931 GE brochure which mentions the "Antique Bronze Handle" of the well-known Model S-22.

The word "bronze" in this context seems significant. In observing radios from the Radiola Superhet of 1923/1924 up to 1936, I have noted the following details:

### GOLD FINISH

A number of companies used either gold or a gold finish. Well known are the studs on the nameplates and on the front of Atwater Kent Model 20s. The Grebe Synchrophase is another good example — the dial escutcheons change color remarkably when the gold finish is buffed off. The Radiola Superhet has a gold finish on its dial rings, which turns quite a different color when it is taken off. Gold finish is an authentic historic detail. In my judgment, it is an error to buff it off, especially if it is gold plating, for it gets expensive to put it back.

Some European collectors also like the color

change that occurs when the nickel is removed from the nickel-plated switch points and binding posts. It is common to take off the nickel and to brighten the brass rather than to replating.

### CHROME AND ALUMINUM FINISH

Some sets have bright-work in the front; for example, Majestics and Zeniths of 1934 with chrome grilles, or some of the Emersons with polished aluminum grilles. At the same time, the ads take care to note that the styling is not too radical for a normal home. Special mention is made of the high polish, while the finish of the brass is not mentioned — an odd omission, if the brass was shiny. When chrome is the original finish, nobody seems tempted to take it off to get to the steel beneath.

### CHEMICALLY SHADED FINISH

Many sets have those somewhat dark, brownish-looking faceplates that seem to cry out for polishing because they have in certain areas brighter brass color peeking through. The color ranges from yellow brass all the way to almost black in some areas. Close observation of many radios that have come through my shop, Philcos and Zeniths in particular, reveals a shading which was apparently done chemically.

Highly polished brass doesn't appear until about the 1937 model year, where it shows up, for example, on the Scott Philharmonic dial bezel.

### BRASS FINISH

I have four radios, seemingly typical of their era, whose escutcheons appear to have withstood the ravages of time. They remain today almost as when they were first manufactured.

The first is a Radiola 26. Most people are familiar with the coppery finish of the tube cover on these sets. It is clearly original and un tarnished, yet it is not brightly polished. Rather it appears to have been antiqued by one of the browning or blackening processes used on copper and brass. It may even have been treated by electroplating. It would be nice to find a former RCA employee who had made these.

The second is a GE J-100 cathedral with its escutcheon in perfect condition. It is two-toned, with a brushed yellow center panel surrounded by a browned area. It has a finish of some kind, but its texture is not bright.

The third is a Philco 20 cathedral, whose little

plate is similar to that of the GE J-100, with the lettering lighter than the background.

Last is a Stewart-Warner from 1933, which has a plate varying in tone from a straw color on the lettering and raised lines to a dark color in the lower portions.

Some conclusions can be drawn here. One is that much of the area on these escutcheons was never intended to be polished, either because of the dimply texture, as on Zenith automotive dials, or because of their difficult recesses. Another is that since so many good, surviving examples were apparently not polished, there must have been another technique.

### ANTIQUÉ BRONZE FINISH

That technique might have been the antique bronze finish which is also found on antique bronze handles. It might be that brass escutcheons were really meant to imitate bronze, not brass. Certainly enough radios sit on my shelves with plates that are carefully shaded from light to dark (just as the cabinets often were shaded in various tints of lacquer) to convince me that their finish is original.

In addition, I have always had a lot of trouble imagining the lady of the house having any desire to spend time polishing the radio escutcheon around which would inevitably accumulate the residue of polish and brass that gets rubbed off. Even carefully lacquered, bright brass tarnishes with time and use, leaving doubts that many of these plates were really bright.

### PROBLEM CASES

There are two problem cases that present themselves. One is the set that has been exposed to moisture and whose plate has turned green. The other is the one like my Ozarka where the whole plate has been dipped in something to clean it, leaving no contrast and making it difficult to read the name at all. The one must be cleaned and then finished, the other just finished.

I treat them both the same by using a bronzing recipe to color the brass and then wiping some off over the letters so that they appear brighter than the background. The Ozarka looks odd to me with its brown lacquer finish, small-diamond gold/black grille cloth and brilliant one-color escutcheon in the middle.

Many regard restoration as a matter of person-

al opinion. Our hobby is getting to the point now where, like car restorers, we need to be carefully informed. Most radios, like most autos, were manufactured goods made to be sold for a profit at margins that were all too small. One could hazard the generalization that radios had good, but not superb, finishes and plated, not polished, chassis for the most part.

Only a couple of manufacturers went to any lengths to chrome-plate or polish their chassis, and even Atwater-Kent binding posts and sockets on breadboards show tool marks. Few radios came with 30 coats of hand-rubbed lacquer. The

---

## "We have a responsibility...to preserve, not to personalize."

---

issue becomes one of over-restoration, where although the radio may look pretty spectacular in some ways, it doesn't really resemble its original condition.

Finally, do what you want, but keep a thought or two in mind. If you have the wrong knobs and trim on your Catalin, will it bring as much as the correct one? Does your Simon Willard clock excite clock lovers more with its original face intact or with the face repainted? What would the judges say at a national meet if the dashboard of your antique auto were painted instead of showing the correct wood-grain finish?

I believe that the ideal restoration is the one that cannot be detected, and that we have a responsibility, if we call ourselves restorers, to preserve, not to personalize. Hence anything we do should be done with careful thought and accurate information.

*(Richard C. Foster, 12 Shawmut Ave., Cohasset, MA 01778)*

*Richard Foster is a professional woodworker who specializes in the restoration of antique radios. He has published many articles in A.R.C. and elsewhere and has given demonstrations and workshops on rebuilding and refinishing wooden radio cabinets, including repairing the electronic components. Also knowledgeable about Philco receivers, he is frequently called upon for his widely known expertise.*

---

## Removing Rivets

BY DICK MACKIEWICZ

Removing parts from old radios (output transformers, for example) quite often means that rivets will have to be drilled out. *Never* try to remove rivets by drilling through the stem. You will only ruin the part you're trying to remove.

Here's the proper way. First, use a very sharp center punch to punch the head of the rivet as close to the center as possible. Then use a 1/16" drill bit to indent the rivet head enough so that a

1/4" drill bit won't "skate" on the head. (If the rivet spins, a bit of extra pressure on the drill will help.) Now drill off the rivet head with the 1/4" bit. You can use this same procedure to remove rusted fasteners. Just be sure to use a drill bit *larger* than the fastener stem.

*(Dick Mackiewicz, 1549 N. River Rd., Coventry, CT 06238)*



# CLASSIFIED ADVERTISEMENTS

**FOR SALE:** Tubes. WE 215-A - \$18. UV 199 - \$18. UX 199 - \$15. Closeout on ass'd odd brands. Type 201-A Style - \$9 each. 201-A brass base no tip - \$18. RCA N.O.S. UV 877 ballast - \$4. 931 Elect. mult. tube - \$8. Ass'd Nixie tubes. Ass'd sizes and bases photo flash tubes. Other old tubes in stock. Heath TC1 tube tester - \$32.50. Precision tube tester Model 10-12, port. case, roll chart - \$70. Also have VOM, VTVM, signal generators, AM/FM-sweep for sale. Tube sockets for 201-A tubes, Federal - \$8. Signal - \$7. Fada - \$6. DeForest - \$8. Cotoco - \$8. Plastic - \$2. Metal shell - \$3.50. Delmonico transt. port. TV 4" and power unit has sound and pix tuner contacts, need cleanup - \$75. Ass'd resistors - \$4.50/pound. Bypass cond. - \$4. Tube caddy - \$25. (5) Garod Pyrex 201-A tube sockets, fair - \$30/all. Assorted old battery chargers, wet, dry, VIB, bulb type. Philco Service Data bound Xerox from 1928 to 1936 - \$22. Radio Instrument Co. RF amp transformer DX1, 170 to 450Kc and bases - \$18/for 2. Remler IF transformer Type 600 - \$15/for 2. Murad T11 transformer 150M to 500M - \$10/both. (3) ass'd ant. matching transformers - \$12/all 3. Type 5000 radio freq. amp transf. by Coto Coil Co. - \$18. (3) radio freq. transf., 300 to 500 meters, fits into a tube socket - \$12/all 3. (3) Sampson HW-R1, 60Kc transf. - \$20/all 3. (2) Tricoil RF transf. N.O.S. - \$8 ea. Improved Kleertone N.O.S. - \$4. (5) ass'd RF ant. coils with sliders - \$15/all. Old type cord, one piece screw in units to socket - \$3.50. Junking parts for Philco 20, 87, 77, 86, 112; Radiola 17, 18, 33, plus more. (50) pair ass'd headphones, no Baldwins - \$10 to \$18/pair. NRI Professional tube tester, port. case, roll chart - \$35. RCA magnetic speaker units - \$14. RCA Selectivision video disc stylus Part #154100 - \$22.50. 120V line monitor panel meters - \$8. 100 feet Litz loop wire, 27 gauge - \$4. 5-amp Variac - \$22.50. Ass'd small 120v AC motors. QST mags, (9) mags 1941 to 75 - \$10/all. Radio Craft, 10 mags, 1947-48 - \$15/all. QST 1964 50th Anniversary issues, for the year - \$24. Parts catalogs: Lafayette 1970 - \$6, 1971 - \$6, 1972 - \$5, 1974 - \$5, 1979 - \$5. 4-gang cond. and dial scale - \$6. 14" Electro dy. speaker and output transf., needs recone - \$15. Random copies of Radio News for 1945, 49-51, 52, 53, 54 - \$2/per copy. QST random copies: 1929, 1930, 1935, 1936 - \$2/per copy. Radio Shack: 1951-53-62 - \$10/for 3. Radio catalogs, (6) assorted 1947 to 1962 - \$6. Books: The Creative Ordeal, The Story of Raytheon Co., 428 pages - \$8. The Founders Touch, The Life of Paul V. Galvin-Motorola, 240 pages - \$9. Popular Electronics, 10 copies of 1962 to 1969 - \$15/all. CQ 1975, The Golden Years of Radio, Story National AGS Rec. - \$6. Electronics Exp. Handbook, 1965 - \$4. Have N.O.S. and pull-outs tubes, parts, speakers, coils, test eqpt., 1000's of unlisted items. Write wants - SASE. New color print by Bill Bell, The Music Box - \$15 includes shipping in U.S.A. (50) assorted radio cabs - \$5 to \$8 each, pickup on this item. Tubes used, tested, S Type 26, 27, 24, 51 - \$3.50 each. ST Type 45 - \$7. 80 - \$5. 71-A - \$7. ST Type 26, 27, 24, 35 - \$2.75 each. Shipping and hand. on all items. Sales service since 1930. Krantz, 100 Osage Ave., Somerdale, NJ 08083. (609) 783-0400

**WANTED:** Oil and Mercury Vacuum Pumps and Gauges for Radio Tube Mfg. and Science. Ed Graper, 5960 Mandarin Ave., Goleta, CA 93117. (805) 964-7117

**WANTED:** Early telegraph gear from undersea cable era such as needle telegraph, siphon recorders. Gil Schlehman, K9WDY, 335 Indianapolis, Downers Grove, IL 60515. (708) 968-2320

**FOR SALE:** N.O.S. and used radio and TV tubes, no picture tubes, send LSASE for lists. C. Elmer Nelson, 11 S. Church St., Princeton, IL 61356

**WANTED:** Diagrams for Cleartone TDA4-55, RCA Victor M4X661, Arvin M242T, and Zenith M5G500. Robert Stapleford, 1800 Randolph, Topeka, KS 66604

## SELLERS ... PLEASE NOTE

### A.R.C. ADVERTISING POLICY...

• ALL ITEMS MUST BE DESCRIBED FAIRLY.  
• REPRODUCTIONS, REPRINTS AND NOT-ORIGINAL ITEMS MUST BE SO IDENTIFIED.  
• ADVERTISERS AGREE TO RESPOND PROMPTLY TO INQUIRIES AND ORDERS.  
• AND TO RESOLVE PROBLEMS PROMPTLY IF THE BUYER IS NOT SATISFIED.

**WANTED:** Tool (serrated pliers or driver) for installing 0.6" serrated rings on toggle switches. Jack Gray, 1162 Broadmoor Dr., Napa, CA 94558. (707) 226-2550

**SERVICES:** Message: Quality repairs on all vintage radio audio components & TVs. Test equipment too! UPS or walk-in. Salt Marsh Electronics, 19 Millfield St., Woods Hole, MA 02543. (508) 457-9220

**WANTED:** Cone speaker by Baker Smith. See B.F.T.P., p. 3. Ed Bell, 5311 Wooddale Rd., Raleigh, NC 27606. (919) 851-1517

**FOR TRADE:** A 1938 ARRL Handbook for my 1936 Handbook in excellent condition. John Kelly, N3GVF, 17510 Sir Galahad Way, Ashton, MD 20861. (310) 977-9319, w

**WANTED:** Speaker, antenna, and a photograph/sketch, front view, of Westinghouse Model WR-326 console radio. John Lopez, 825 Lees Dr., Las Cruces, NM 88001

**FOR SALE:** Popular Science, (8) different issues of 1932, nice clean issues with good covers - \$40/for all postpaid. Charles Combs, 508 E. Daniel, Albany, MO 64402. (816) 726-3038

**FOR SALE:** Tubes, capacitors, parts (old stock from closed radio-TV stores). Extensive listings in 16-page illustrated catalog - \$2 (\$3 foreign). Don Diers, 4276 North 50 St. #A33, Milwaukee, WI 53216-1313

**WANTED:** Collector looking for 1920's European crystal and battery sets. Ian L. Sanders, 16725 Wild Oak Way, Morgan Hill, CA 95037. (408) 778-7547



# SPARTON BLUEBIRD

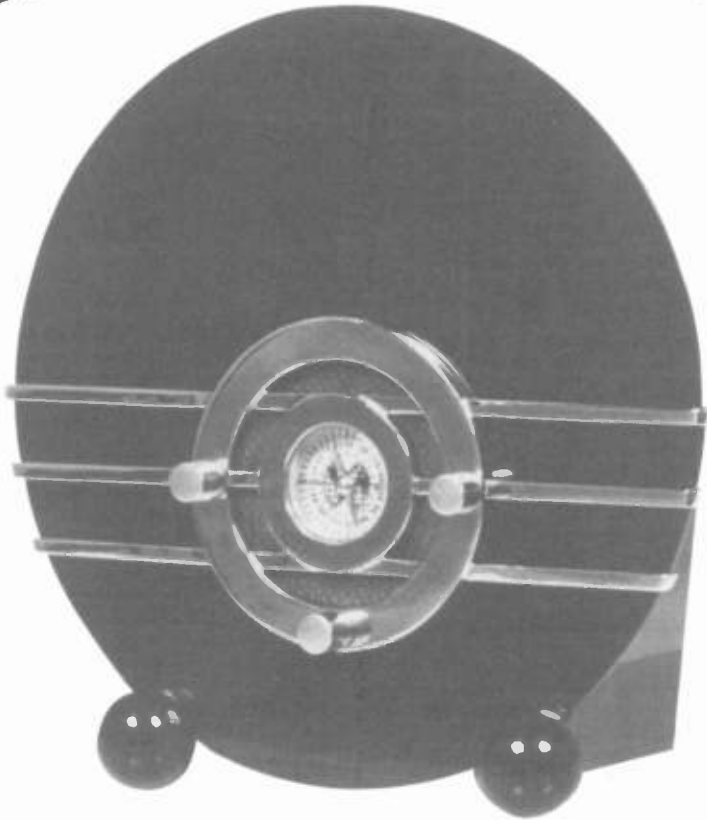

THE PERFECT RECREATION OF BLUE MIRROR MODEL 506 WITH SONY STATE OF THE ART TECHNOLOGY. DESIGNED, ENGINEERED AND CRAFTED BY HAND IN FRANCE. HARDWOOD CASE PERMITS THE ULTIMATE RESONANCE IN AM OR FM RECEPTION WITH AFC. LIMITED PRODUCTION AT \$300.00 PER SET. FREE FREIGHT WITH PREPAID ORDERS ON A FIRST COME BASIS. (OHIO RESIDENTS ADD 7% SALES TAX) XONEX INTERNATIONAL, INC., 750 BETA DRIVE, MAYFIELD VILLAGE, OHIO 44143 (216) 442-1600

**FOR SALE:** Belmont 6D111 - \$185. Emerson 517 blk. w/red grille (orig.) - \$90. Stromberg-Carlson 1400, white - \$100. Arvin 540T, green - \$80. Silvertone 7004 (G.O.R., p. 99) - \$85. Olympic 7-421V white (G.O.R., p. 101) - \$75. Franklin Gramophone nov. transistor - \$75. Camden small wood superhet - \$75. Catalins for sale or trade for Plaskons or other radios or 7" TVs. Emerson 400 brown. Garod 6AU1 butterscotch. Stewart Warner 62T3. Please call or write. Jon Steinhauer, 636 Westminster Rd., Baldwin, NY 11510. (516) 223-9878

**FOR SALE:** Raytheon T2500 transistor radio. RCA 621 TV, old dealer stock, never sold, excellent. Crosley 54 Buddy Boy cabinet and speaker, nice. Philco 60B cathedral. Starlite TR24 two-transistor "boys" radio, in original box. DuMont 1210 transistor, N.I.B. Motorola 6X Bakelite, airplane dial. Motorola 5A5. CBS 5440 black clock radio. Novelty transistors, Old World Globe, Belle of Louisville river boat. Zenith Major AM-FM, nice. Toshiba 7TH-4254 transistor wall radio. Cross gold pen and pencil set with RCA logos. Charles Harper, 2081 Harmony Ct., Lexington, KY 40502. (606) 268-8549

**WANTED:** AK 84 chassis. Other AK cathedral parts. Thanks. Merrill Bancroft, 169 S. Row Rd., Townsend, MA 01469. (508) 597-6623

**WANTED:** University Diffusicone 12 speaker, any condition. Lakes Loudspeaker Service, 4400 W. Hillsboro Blvd., Coconut Creek, FL 33073. (800) 367-7757

**FOR SALE:** Tubes & high-voltage capacitors: RCA "Reds" CRC-5693 - \$10 ea. 12 AU7 with tube guard - \$5 ea. CRC-829B - \$6 ea. All unused. Caps: 150 VDC - \$10/5. 450 and 600 VDC - \$15/5. S+G Electronic, 618 S. 62nd St., Philadelphia, PA 19143. (215) 474-7663

**FOR SALE:** Classic Accessory in original packaging - Fedro's Private-Lee earphone adapter. One available - \$40 ppd. Steven B. Johnston, 3350 Oakham Dr., York, PA 17402. (717) 764-1155

## Bellingham Antique ★ Radio ★ Museum

The museum wishes to obtain more examples of pre-1927 radios.

We will pay top dollar for single pieces or entire collections.

We have some duplicate material for trade.

*Please call Jonathan Winter:  
(206) 734-4168*

*or write to us at:  
1421 Saint Paul Street  
Bellingham, WA 98226*

**FOR SALE:** Bendix Model 111, nice looking, plays good - \$40. Stromberg-Carlson Model 1101, nice Deco look, white painted Bakelite, some paint chips, plays good - \$50. Truetone Model D1014, nice wood case, AM/SE, plays great! - \$55. Satchell Carlson Model 427, 1/2-inch crack above dial (minor), dial pointer hangs up but otherwise nice, unusual thumbwheel knobs on top - \$70. All prices + \$5 shipping. Many other table radios and books for sale. Send LSASE to: Mark Neubrand, 618 Gypsum, Salina, KS 67401



**WANTED:** Detrola (pictured), Kadette, RCA, Silvertone, Air King - and everything beyond and between - plastic radios for the 30's in any condition. I am currently outbidding myself on radio purchases. Please write or call collect: Rain Buttignol, 214 State St., #7, Portsmouth, NH 03801. (603) 427-1384

**FOR SALE:** Hallicrafters SX111 with speaker, very good condition. Gramophone cylinders, Addison radios, AK breadboard. A. R. Nolf, 539 Kastelic Pl., Burlington, Ontario, Canada L7N 3S9. (416) 333-4557

**FOR SALE:** C. R. Leutz, Inc. 9 Trans-Oceanic 1927 battery radio, table LP metal Phantom 9T, 5 Dial. Hammarlund HQ-180 with speaker & Inst. & Schematic manual (clean). National NC-98. Frank Atwood, 117 E. Main St., Merrimac, MA 01860. (508) 346-8100

**WANTED:** The following FT-243 crystals marked "for BC-1335"; (Channel No., - Frequency in kHz), 298 - 6375, 379 - 8400, 331 - 7200, 333 - 7250, 336 - 7325, reply to: Wm. A. Stokesbury, Box 200B, Fenwick Island, DE 19944

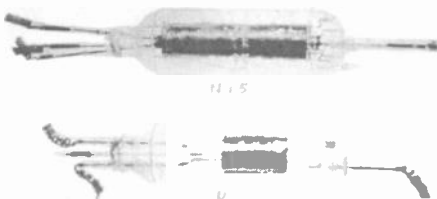

**FOR SALE:** Early silica transmitting triode by Marconi-Osram Valve Co., Type NT54. About 23" overall length. Also silica rectifier Type NU30. No name but probably same make. Best offer. **WANTED:** Any panel that uses spherical audion. Audio transformers for RA/DA. Radiola I, Radiola II. Any early DeForest. David Cheney, 338 Arlington Cres., Beaconsfield, Quebec, Canada H9W 2K3. (514) 694-3240

**WANTED:** Airline (Wells Gardner 6F) Model 62-197 receiver chassis. Gernsback ORM Volumes 3, 4, 5, & 8. George Harris, 3212 36th St., Lubbock, TX 79413. (806) 795-5604

**WANTED:** Eagle Neutrodyne or Eaglet. Perimeter clips for Zenith shutter dial glass. Thompson 3-dial battery. Ted Depto, 913 5th Ave., Patton, PA 16668. (814) 674-8834

**FOR SALE/TRADE:** Mint 1934 RCA Cunningham tube manual. AC-DC and transistor radios. Old tube amps. And changers. Old scopes. Old radio books. Solid-state CBs. **WANTED:** Last issue RCA Tube Manual. James Tewmøy, 819 Moberly Rd., Harrodsburg, KY 40330. (606) 734-5579

**WANTED:** Early American and Japanese transistor radios. Send sketch or model number with price. John Hoffnagle, 10 Sunset Ave., New Oxford, PA 17350

**WANTED:** Large dial for Tuska 222 and Kennedy VI. Please help. Tuska is same for several sets. Ed Bell, 5311 Woodsdale Rd., Raleigh, NC 27606. (919) 851-1517

## One Month Free!

### BONUS FOR EARLY RENEWALS

If you renew **before** the month shown on your mailing label (your expiration month), you will receive an extra month on your subscription: 13 months instead of 12! 26 months for an early 2-year renewal!

**SERVICES:** Used telegraph, wireless, radio, TV books, bought and sold. Please contact: Jerry Simkin, Book-seller, 10 Avalon Ln., Matawan, NJ 07747. (908) 583-5196

**FOR SALE:** Rider's TV Manuals, 4 through 27, 24 manuals - \$200. Meters: Welch (2692) galvanometer-voltmeter-ammeter - \$50. Weston VOM (785) w/ instruction book - \$50. Jewel (174) wattmeter-voltmeter-ammeter - \$50. Weston (571) output meter - \$20. Weston mv. meter (301) - \$5. Triplett VOM (630) - \$20. Simpson TV antenna compass meter (351) - \$25. Lafayette VOM (90-5071) - \$10. Micronta VOM (22-204) - \$10. Sun HA (?) meter (2R) - \$7. EMC transistor checker (212) - \$10. Sencore (TF26) Cricket transistor checker - \$20. RCA TV bias supply (WG-307B) - \$20. Sencore (CG22) color bar generator - \$30. RCA Volt-hmyst Jr. - \$10. RCA (WV97A) Sr. Volt-hmyst - \$20. RCA (WV87A) for parts - \$10. EICO (232) VTVM - \$25. Sears pocket voltmeter - \$7. Plus shipping. Meters as-is. J. J. Papovich, 53 Magnolia Ave., Pitman, NJ 08071. (609) 582-8279

**FOR SALE:** Accepting bids on Dalhberg white hotel radio, 10¢ coin-operated, works, reportedly from Ritz Carlton Hotel in Atlantic City. 1959 Predicta TV console, not working, pick up. RCA Geiger counter from 1950's, WF11A, with booklet on prospecting for uranium. Bidding ends July 31, 1992. Maurer Television, 29 South 4th St., Lebanon, PA 17042

## VINTAGE SAMS

OWN THE FINEST SERVICE DATA  
FOR YOUR VINTAGE  
RADIO AND TV

A.G. TANNENBAUM  
P.O. BOX 110  
EAST ROCK AWAY N.Y. 11518

516 887 0057

**WANTED:** Help: Does anybody have a schematic and/or an operators manual for a Hickok Model 47 electrical tester and possibly an operators wire harness (plug-in) for a Jewell Model 444 radio set analyzer? Cannot seem to find these items anywhere! Name your price. Gary Formica, 823 91st St., Niagara Falls, NY 14304. (716) 283-2274, leave message

**WANTED:** Triad kit amplifiers and catalogues, UTC LS54 and HA135 transformers, Amperex or Mullard EL34's & EL86's, Genalex KT61's. As always looking for UTC kits, LS transformers, and catalogues. Thank you to everyone who has taken the time to write or call. Leif Blackmon, 4 Larson Rd., N. Reading, MA 01864. (508) 664-0174

**FOR SALE:** U.S. Army Signal Corps receiver Model BC-342-N - BO. **WANTED:** Literature, parts, etc. for Carco Vari-unit. Chassis & speakers for Echophone twin speaker cathedral. Speaker for Thompson Minuet. Small brass bezel for Grunow Teledial Model 568. Larry Porter, 4115 Beam Rd., Crestline, OH 44827. (419) 683-2540

**WANTED:** Crystal sets. Thinking of selling yours? Top prices paid, give me a chance. American & European sets wanted for my collection. Thanks. Kent A. Ise, 224 Cowesett Rd., Warwick, RI 02886. (401) 885-7558

**WANTED:** Majestic Model 20 chassis and Crosley Model 125 chassis in any condition. John Popp, 4250 Beverly Ave., Jacksonville, FL 32210. (904) 387-5119

**FOR SALE:** Philco 70/90, Philco 20, and Emerson reproduction grille cloth for sale. SASE for samples and price sheet. John Okolowicz, 624 Cedar Hill Rd., Ambler, PA 19002

**FOR SALE:** Abbottwares radio Venus nude women in brass, rare, sensual, appraised unlimited, definitely for the best collections. Photos - \$3. Seller reserves the right to reject any/all bids. Highest bid by July 18, 1992. Eugene Claus, 2305 W. Rice, Sioux Falls, SD 57104

## 1930'S GRILLE CLOTH

AS GOOD AS THE ORIGINAL  
SEND LSASE FOR SAMPLES

### Patterns currently in stock:

- #2 *Herringbone*
- #3 *Philco 70/90*
- #4 *Small Diamond (as in Peter Pan)*
- #5 *RCA/Zenith/Echophone*
- #6 *Philco 'V' (Green)*
- #7 *Philco 'V' (Brown)*
- #8 *Philco "Ribbed" (for late '30s)*
- #9 *Atwater Kent Yellow (165, 217, etc.)*
- #10 *Basic "Generic" pattern*

### Other patterns on order:

- *LARGE DIAMONDS PATTERN*
- *EMERSON AU-190 CATALIN*

WATCH THIS SPACE FOR FURTHER DEVELOPMENTS!!

MICHAEL KATZ  
3987 DALEVIEW AVENUE  
SEAFORD, NY 11783  
(516) 781-6202 (EVENINGS)

**WANTED:** Ionue (Varitronics), 2-meter rigs, Johnson Viking Avenger. SASE for radio list. Sumter Hickman, KB5QHD, 1008 West 10th St., Plainview, TX 79072. (806) 293-5809

**FOR SALE/TRADE:** Choice radios, jukeboxes, broadcasting & audio equipment – SASE. Want professional audio equipment, literature, microphones. Robert Van Dyke, Museum of Broadcasting, Film & Recording, 2 Squires Ave., East Quogue, NY 11942. (516) 728-9835

**HAVE YOU MOVED? ARE YOU MOVING?  
PLEASE NOTIFY US A.S.A.P.**

**SEND US YOUR...**

**OLD ADDRESS**

**NEW ADDRESS and**

**SUB #**

**MANY THANKS!!!!**

**FOR SALE:** Sams manuals, most Volumes AR76-159; also Volumes MHF35-236 – \$2.50 each includes shipping. Bill Lowe, 10 Meadowbrook, Candler, NC 28715. (704) 665-2727

**WANTED:** Zenith 7D 127 or 5S127 cabinet, dial glass 6 3/4", and Z pointer (F.O.S., p. 193). Jim Dolensky, 14N755 Covered Bridge Rd., Dundee, IL 60118. (708) 428-4488

**WANTED:** Philco Transitone 49-501, any color. Private collector. Philco Transitone 49-501. Please help. Bruce Phillips, 127 Bunker Hill Ave., Stratham, NY 03885. (603) 772-3796

**FOR TRADE:** 1937 Lincoln limousine for pre-1930 radio collection. Up or down. Ed Bell, 5311 Woodsdale Rd., Raleigh, NC 27606. (919) 851-1517

**WANTED:** Fadas Models 212, 350V, 360G, 254D or any in the series. Grille and knobs for Fada 5F60. Also back for 354 Fada. Sonora TW49 and TV48. Victor Zummo, 20344 Mobile St., Canoga Park, CA 91306. (818) 883-8468, after 6 pm Pacific

**FOR SALE:** Paperback at last! The Portable Radio in American Life at – \$24.95, available in July. Order from me now and I'll pay shipping. Michael Brian Schiffer, 2718 E. 10th St., Tucson, AZ 85716. (602) 325-3532

**WANTED:** Eveready #2 speaker. Eveready radios, flashlights, catalogs. Subscribe to Flashlight Newsletter – \$12/year. Bill Utley, PO Box 3572, Downey, CA 90242. (310) 861-6247

**FOR SALE:** Currently over 100 old radios, TVs. No lists or shipping. By appointment. Old West Antiques, PO Box 180, Dolores, CO 81323. (303) 882-7911

**FOR SALE:** Send stamp for vintage flyer of parts. Mail order electronics since 1954. Bigelow Electronics, PO Box 125, Bluffton, OH 45817-0125

**WANTED:** Micronic Rubies (transistor radios) by Standard Radio Co. of Japan. Pay your price! Kent Ise, 224 Cowesett Rd., Warwick, RI 02886. (401) 885-7558

**FOR SALE:** Synchronous detector for 455 kHz IF receivers. Dramatically improves AM: reduces fading distortion, selectable sideband cuts interference. Kit – \$139. Built/tested – \$199. Info – \$3. Steve Johnston, PO Box 3420, York, PA 17402-0420

**FOR SALE:** Fender Showman – \$75. Heath triggered oscilloscope, overhauled factory wired – \$50. Radio books – \$8. TV yokes – \$5. S. Goldhor, 2147 Trombas Ave., San Leandro, CA 94577. (510) 357-3788

**WANTED:** Power transformer for HRO-60 Part Number SA2909 or S515-1. Spencer Cromwell, 7607 Stevenson Way, San Diego, CA 92120. (619) 582-8280

**WANTED:** Radios and radio-related items made in Cleveland, Ohio. Gary B. Schneider, 9511 Sunrise Blvd., #J-23, North Royalton, OH 44133

**FOR SALE:** N.O.S. and used radio and TV tubes, no picture tubes, send LSASE for lists. C. Elmer Nelson, 11 S. Church St., Princeton, IL 61356

## New Wireless Pioneers Books, Magazines, Literature Bought and Sold

New Wireless Pioneers buys and sells books, catalogs, magazines and other literature from the 1800's to 1950 that deal with early radio, wireless and electricity. A selection from our list of specialties:

Pre-1900 Electricity  
Pre-1925 Radio or Wireless  
Pre-1950 Computers

Pre-1900 Telegraphy  
Pre-1940 Television  
Early X-Ray

Magazines, Catalogs, Autographs or Ephemera related to the above topics. Also: Pre-1920 Wireless and Telegraph Apparatus – Radio-Related Novelties and Advertising – Early Vacuum Tubes and Electrical Devices.  
*Some items available in other technical subject areas also.*

Several catalogs featuring items for sale are published each year.

**New Wireless Pioneers – Jim & Felicia Kreuzer**  
P.O. Box 398, Elma, NY 14059  
(716) 681-3186

**FOR SALE:** Radio Bar #508 with good chrome, mirror, cab. vg - BO. Maroon & orange Fada Bullet, nice, hairline on bottom - \$525. Philco #90 cathedral, works & looks exc - \$400. AK #725 tombstone, works well, cab. solid, finish fair - \$95. Zenith 3000-1, exc, works like new - \$175. Edison Dictaphone sys., 3 pcs. - \$175/ for all. Seeburg jukebox wall unit w/key - \$100. Philco mantel clock radio exc, works perf. - \$375. Send 2-stamp SASE for list (many new items). Satisfaction guaranteed. J. L. Acciavatti, PO Box 231, Southborough, MA 01772. (508) 476-3229

**WANTED:** Clearfield glass cabinet battery set. Pay your price for a nice one. Ed Bell, 5311 Woodsdale Rd., Raleigh, NC 27606. (919) 851-1517

## HAS YOUR SUBSCRIPTION

### EXPIRED?

It has if your mailing label reads "EXP=JUL92" or earlier.

Renew now!

**BONUS: Renew before your "EXP" month and receive 13 issues per year instead of 12!**

Renewal rates are:

\$27.00 for Second-Class Mailing

\$40.00 for First-Class Mailing

(Two-year renewals are twice above rates.)

**WANTED:** Output transformer for an RCA BP-10 or junker radio for parts. Thanks. Carlos Gimenez, 15091 Shamrock Dr, Fort Myers, FL 33912

**WANTED:** 7JP4 TV CRT, good condition. Edward R. Barbacow, 330 Ceylon Rd., Carmichaels, PA 15320

**FOR SALE:** GE console S 42, operating, pick-up. B. H. Wright, 13 Clifton Pl., Pennsville, NJ 08070. (609) 678-5592

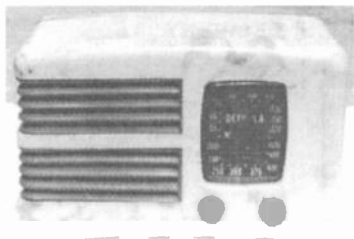

**WANTED:** Early Detrola (and other manufacturers) plastic sets in gorgeous, not so gorgeous, and downright ugly color combinations. I will pay more for a whole lot less. (Annoying phone bids accepted.) Please write or call collect: Rain Buttignol, 214 State St., #7, Portsmouth, NH 03801. (603) 427-1384

**FOR SALE:** Pilot MD X-131 chassis, dial glass & escutcheon - \$15 + UPS. Paul Fulton, 711 Jacquelyn Rd., Westwood, NJ 07675. (201) 664-5260

**FOR SALE:** Red, white and blue Emerson Patriot, no cracks, 1 scratch, repro knobs - Best Offer over \$800. Send \$1 and SASE for 3 pictures. Karl Stegman, 4 Cresthaven Dr., Belleville, IL 62221. (618) 234-7992

**WANTED:** Sony TR-86 shirt-pocket radio. Tom Thumb TT-600 hybrid, preferably N.I.B. Robert Davidson, 310 Main St., Concord, MA 01742. (508) 369-2007

**WANTED:** Sams Volume TR-190. Also any other TR's or TSM's you have. Dwain Ludlow, PO Box 552, Stigler, OK 74462. (918) 967-8002

**FOR SALE:** Cathedrals: Philcos #70 - \$375, #20 - \$335, #60 - \$225. American Bosch 440T - \$365. Bendix Catalin 526C, repaired crack - \$500. All mint. List LSASE. Richard L. Bednarck, 28 Steele Ave., Lincoln Park, NJ 07035. (201) 694-6374, eves.

**FOR SALE:** Philco 39-25 chassis only, w/tubes, no dial, no glass - \$50. Philco 40-165 chassis w/tubes, complete dial + glass + knobs - \$65. Philco 37-93 chassis w/ tubes, no glass - dial - knobs - \$50. Shipping extra. J. J. Papovich, 53 Magnolia Ave., Pitman, NJ 08071. (609) 582-8279

**WANTED:** Tube sockets for UV-199 with round bases, Radiola II operating manual, photography OK. Carl Steinberg, 5 Cannan Rd., Monsey, NY 10952. (914) 352-0701

**WANTED:** Tuning knob for Atwater Kent Mod 60 bread-board. Jeff Kaufman, 431 Warren St., Scotch Plains, NJ 07076. (908) 889-8917

**FOR TRADE:** Zenith 500E, black, looks nice, plays exc, trade for Hallicrafters Model S38C or B, must be good case and play exc. Denise Gimenez, 15091 Shamrock Dr., Fort Myers, FL 33912. (813) 482-0198

**WANTED:** For 1951 RCA B/W TV KCS42A, flyback transformer (74588) and yoke (74262 or Thordarson Y3). Kurt Lofback, 320 Main St., Safety Harbor, FL 34695. (813) 725-5640

**FOR SALE:** Brass faceplates for the Victor Talking Machines, 1901-1908, beautiful - \$20 ea. Charlie Bradley, 10720 Zenith Avenue S, Bloomington, MN 55431. (612) 888-7437

## TUBES PARTS SERVICE

**VACUUM TUBES** For antique radio restoration, hi-fi amplifiers, televisions, amateur radio, and industrial equipment.

**CAPACITORS** Axial and radial lead high-voltage mylar capacitors. High-voltage electrolytic capacitors.

**TRANSFORMERS** Power and audio transformers for vacuum tube circuits. Vintage interstage and output transformers for early battery radio sets.

**TELEVISION PARTS** Picture tube breners, knobs, books.

**SERVICES** Field-coil rewinding, speaker re-coning, schematics for early radio through television, stereo sets and VCR's.

**HARD-TO-FIND** Crystal set parts, Zenith dial belts, hardware

**BOOKS** Radio collecting and restoring, broadcast and radio history, television collecting.

### ANTIQUE AUDIO

5555 N. Lamar, Suite H-105  
Austin, TX 78751

[512] 467-0304 or 24-HOUR FAX [512] 467-2944

WRITE OR CALL FOR OUR 1992 WHOLESALE CATALOG

**WANTED:** Complete Admiral AM/FM 6Q12 table radio for personal collection. Condition is important. Don Russell, 55 Bilodeau Ct., Burlington, VT 05401. (802) 860-7034

**WANTED:** Early TV cameras and parts; flag for RCA 44, 77. Neil Dorfman, 7028 Clements, West Bloomfield, MI 48322. (313) 661-8770

**FOR SALE:** Check out our growing inventory of high voltage capacitors. Many types and values. Plus N.O.S. and surplus parts. Visa/MC. Send large SASE for new Spring Catalog. Two Fox Electrix, PO Box 721, Pawling, NY 12564. (914) 855-1829

**WANTED:** Knobs for the following radios, Detrola Pee Wee, Fada #855, and Emerson #540. James A. Di Ruzza, 2607 Old Troy Pike, Dayton, OH 45404. (513) 233-5004, eves.

**WANTED:** Reasonably priced small transistor radios. Will buy all you have. Write or call. Doug Ferrero, WB8YNZ, 33673 Chatsworth, Sterling Heights, MI 48312. (313) 268-3677

**FOR TRADE:** 1966 Chevy Impala (red) promotional car/AM radio for other 60's promo radio. Jerry Becker, 1704 Larry Dr., Plover, WI 54467

**FOR SALE:** Radios, test equipment, and related items. Send large SASE with 52 cents postage for large list. Will ship most items by UPS. Rod's Vintage Electronics, PO Box 211, Earlsville, VA 22936

**WANTED:** Philco 37-660 chassis in any condition. Also any radio built by Robert Lawrence Co. John Popp, 4250 Beverly Ave., Jacksonville, FL 32210. (904) 387-5119

**WANTED:** Riders Vol. 1, adapter for Stark tube tester #AZ-5 for testing Rodgers AC32 tubes. Robert Nicholson, 4 Superior Ave., #47, Toronto, Ontario, Canada M8V 2M4. (416) 252-4838

**FOR SALE:** Complete electronics course, publications, manuals - SASE for list. Phil Whitney, Rt. 2, Box 231, Stephens City, VA 22655

**FOR SALE:** 1950 Zenith Model L600 Trans-Oceanic radio, working. Charlene Meier, PO Box 485, New Milford, CT 06776. (203) 354-9295

**WANTED:** Manuals for ESI bridge, Model 250; GR generator, Model 1161; Jenkins: Boyhood of Inventor. H. Layer, KK6HY, PO Box 27676, San Francisco, CA 94127

**FOR SALE:** Knight RF sweep generator, excellent - \$50 + UPS. Charlie Roudabush, PO Box 2122, Tijeras, NM 87059. (505) 281-0379

**FOR SALE:** American Bosch Machine Corp. Model 28, 1931-36, 8 tubes, untested, good cabinet, have schematic - \$45 + UPS. Atwater Kent Model #42, good for parts, power pack good - \$35 + UPS. Zenith Model Z575 clock radio, untested, unusual cabinet - \$40 + UPS. RCA Model 65F, battery untested, looks good - \$35 + UPS. Emerson, red battery set Model 560, untested - \$35 + UPS. George W. Ambrester, 3084 N. River Dr., Lanexa, VA 23089. (804) 566-1580

**WANTED:** Set of tube covers for a Neutrowound. Ed Bell, 5311 Woodsdale Rd., Raleigh, NC 27606. (919) 851-1517

**FOR SALE:** Kenman 5-battery set, Guild Country Belle telephone radio, exc condition. Gene Baudouin, Rt. 1, Box 206, Hahnville, LA 70057. (504) 783-2610

**WANTED:** 60's era Remco kits with 1T4, 45v battery, peg board. Bob Ferrey, Jr., N3DOK, 9821 Presidential Dr., Allison Park, PA 15101. (412) 367-2393

**FOR SALE:** Loop antenna, 1925, RCA, excellent copy, looks original - \$125. Free shipping Continental U.S.A. Howard Page, 93 James Page Rd., Port Angeles, WA 98362. (206) 452-2407

## THE COLLECTOR'S GUIDE TO ANTIQUE RADIOS, 2ND EDITION BY MARTY AND SUE BUNIS

NO SHIPPING CHARGES FOR U.S. DELIVERY

**Over 540  
All-New  
Full Color  
Photos**

**Over  
7,400  
Models**

**208 Pages**

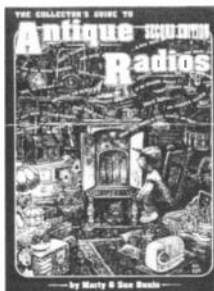

**Only \$17.95, U.S.  
Canada, add \$1.00  
Foreign, add \$4.00  
surface**

**8 1/2 x 11  
Softcover**

**Current  
Prices**

Welcome to the wonderful world of antique radios! In addition to updated pricing on all the models from their first book, Marty and Sue have included 2,400 new models and over 540 all-new full color pictures in this second edition of *The Collector's Guide to Antique Radios*.

Send check or money order for \$17.95 for each book ordered to:  
Marty Bunis, RR1, Box 36, Bradford, NH 03221

**FOR SALE:** Table models, very good condition. Write for list. Robert Remes, 2815 Suffock, Kingman, AZ 86401

**FOR SALE:** Zenith Service Manual Vols. 1 and 2. Zenith Chassis 14. Zenith 52 for parts. 11E cabinet. Zenith 705, 06, 07 knobs. Zenith 6" speaker. Original Zenith glass tubes. RCA 17 or 18 speaker. RCA 6T tombstone. 7T mint chassis. Bill Coolahan, 1450 Miami Dr. NE, Cedar Rapids, IA 52402. (319) 393-8075

**FOR SALE:** Ozarka cathedral Model 94. Serious inquiries only, please! Kent A. Ise, 224 Cowesett Rd., Warwick, RI 02886

**WANTED:** Jewell Pattern 199 radio set analyzer. Also Jewell tube sellers. Randolph Warren, 2911 Monroe Pl., Falls Church, VA 22042. (703) 241-4904

**FOR SALE:** 1939 Worlds Fair - \$1,200. Black Globe radio - \$1,150. Fada Bullet, yellow - \$850. Spartan Bluebird repro - \$225. Charlie McCarthy - \$1,500. Emerson tombstone: AU-190s, yellow and green; Addison red, yellow, green; yellow - \$1,850; red - \$2,000; green - \$1,850. Several other Catalins for sale. Will be in Elgin. Alex Kertesz, 3439 West Brainard, #260, Woodmere, OH 44122. (216) 831-9110 or (216) 831-4199

**FOR SALE:** Early auto radio manuals. \$1 and SASE for list. Wallace Horton, 1132 Connway, Heath, OH 43056

**WANTED:** Chrome grille wooden radios, any manufacturers, & Arvin metal radios. Jay Malkin, 1250 Galapago #206, Denver, CO 80204. (303) 623-6451

**FOR SALE:** Paco resistance-capacity-ratio bridge Model C-20 - \$20. DuMont multi-voltmeter Model 405 - \$23. Heathkit resistance substitution box Model RS-1 - \$10. Triplett signal generator Model 3432 - \$25. EICO capacitor tester Model 955 - \$18. U.S. Navy signal generator Model TS-323/UR with frequency charts, spare parts, nice - \$50. EICO VTVM Model 249 - \$22. Heathkit VTVM Model IM-18 - \$14. Precision VTV-ohmmeter Model 68 - \$20. Sprague Kwik-Test Model KT-1 in circuit condenser tester - \$27. Hewlett-Packard VTVM Model 410B with all probes - \$27. Leeds and Northrup/Western Electric null voltage tester Model KS-10376 - \$40. Stancor multivoltage isolation transformer, 105 to 230 volts - \$45. Voltage control meter, early Japanese by Tokyo Kyoel Electric Co. - \$25. Weston Model 788/Navy Model OQ1 tube tester, beautiful oak case, dated 3-23-42. All items plus UPS. George Jones, Rt. 4, Box 31, Fernandina Beach, FL 32034. (904) 261-6533

**FOR SALE:** B&K 1500 Transistor P.A. amp mono - \$35. Heathkit AJ-53 AM tuner - \$25. Lafayette solid state P/A amp PA 50A - \$55. Bogen R701 AM/FM tuner - \$60. Columbia Model 105 record player - \$40. Philco Model M-15 w/needle, clean, brown Bakelite - \$95. RME preselector Model CME-50063.55-32MHz - \$75. RME preselector 80-10M - \$45. B&W distortion meter Model 400 - \$30. Bell & Howell Auto Load 332 cassette player - \$35. Hammarlund HQ-110 - \$85. John F. Dubino, KA1SBN, 73 Devens St., Greenfield, MA 01301. (413) 774-5826

**FOR SALE:** McMurdo Silver Masterpiece Six in cabinet - Taking Offers. 1930's wood table radios. Alan Wohl, 247 Prospect Ave., Cedarhurst, NY 11516. (516) 295-5614

**FOR SALE:** Tubes 50L6GT, 35Z5GT, 12SA7GT, all tubes are new, bulk-shipped tubes originally shipped in 1948, they are not in individual boxes. - \$2 ea., plus estimated shipping, free shipping with 10 or more. Will trade tubes for cathedrals. William Michael, 850 N. Main St., Franklin, OH 45005. (513) 746-1910

**FOR SALE:** Thinning collection of 1930's "known" treasures. Deco plastic, push button, AM/SW, wood, cathedral, metal table radios. All cosmetically great. Now selling either as working or easy Ufix with schematics, super reduced prices. Many specials! (No time is problem!) Hallicrafters, Shure, Collins 51J3, repro brochures - \$7 ea. Send \$1 and SASE for famous 10-page pixlist. List your wants and excess on the pixlist computer. **WANTED:** Early sets, horns, crystal, single dial, battery, AC operated tube type. AK 35, Amrad, Grebe, Federal, etc. Need knobs and schematic for General Instrument 671. Steve Lipsky, W2VVN, Antique Technology Ventures, 1254 Cox Rd., Rydal, PA 19046-1207. (215) 884-1817

**WANTED:** Vintage tube guitar amplifiers, Jensen speakers, Shure 55, Astatic JT-30 microphones. Warren Dasho, 26 Kingston St., Reading, MA 01867. (617) 944-0470

**FOR SALE:** Radiola III - \$80. Crosley tombstone batt., mid-30's - \$70. Philco 54C - \$65. Philco portable 39-6760 (F.O.S., p. 126) - \$40. R. Burick, 21 N. Earl St., Shippensburg, PA 17257. (717) 530-5040

**FOR SALE:** Zenith D7000 T.O., works very well - \$150. Chelsea Super Five with window dials - \$110. Tom Boy by Automatic Radio, tiny portable - \$65. Remler Type 8 tube HB Superhet, vg case - \$95. All plus UPS. SASE for list. Wally Worth, 2 W. Elm Ave., Wollaston, MA 02170. (617) 479-4512

**WANTED:** Crystal sets, parts, detectors, what have you. Also trades available. Kent A. Ise, 224 Cowesett Rd., Warwick, RI 02886. (401) 885-7558

## Play Things Of Past

Store Address: 3552 West 105th St. Cleveland, OH 44111  
Mail Address: 9511-23 Sunrise Blvd. Cleveland, OH 44133

Phone: 216-582-3094, 9:30 PM to 10:45 PM

### Radio Sales - Service - Restoration MONTHLY SALES LIST

## CATALOG #0692 — Available late June — Price - \$2.00 Ppd

Catalog #0692 is in the process of being completed and should be ready in late June 1992.

The catalog contains thousands of parts, tubes, books, radio magazines and catalogs. If you collect, build, restore or repair pre-1930's radios, this catalog is definitely a must.

This is our yearly catalog and is about 40 pages in length.

**FOR SALE:** High voltage parts: discs, axials, Mylars, diodes, resistors. Free flyer. Greg Chase, Midwest Electrotec Inc., 2411 Holly Dr., Pekin, IL 61554. (309) 347-3950

**FOR SALE:** 1. Kennedy 521 – \$500. 2. RCA 66X9 – \$400. 3. Mike Radio – \$125. 4. Rocket lamp radio – \$165. Ralph Howard, 7 Church St., Dansville, NY 14437. (716) 335-7916, eve.

**WANTED:** Detrola 218 or 219. Belmont 510 (Blast, p. 217). Wilcox-Gay A-17 (Blast, p. 176). Bob Lutz, 9041 Gillette St., Lenexa, KS 66215. (913) 894-1327

**FOR SALE/TRADE:** Gorgeous Philco 49-501, Zenith Wavemagnet – \$200. Fada 845 tortoise – \$295. All brown Addison A2A – \$325. GE H-400 – \$125. Other Additions for trade only. Call: Graeme Weeks, #1102-1666 Pendrell St., Vancouver, British Columbia, Canada V6G 1S9. (604) 688-5232

**FOR SALE:** 1946 AMI-A jukebox, mint condition – \$4,500 or trade for Catalins. C. King, #5 Larchmont Ct., St. Peters, MO 63376. (314) 281-2788

**WANTED:** Three chrome tube shields for a McMurdo Silver Masterpiece VI. Mike Clark, RR 2, Box 90, Franklin, IN 46131. (317) 738-4649

**FOR SALE:** Wood and plastic table models. No Catalins. Send SASE for list. Leo Vanderpot, 765 N. Broadway, Hastings-on-Hudson, NY 10520. (914) 478-4092

**FOR SALE:** 1920's home brew battery radios (have 3). Philco 46-?, large table model radio/phone – \$25. Truetime D2210 metal radio with wood grain finish and chrome grille and trim. Panasonic FM-AM RE-777 stereo receiver (tubes) – \$25. Realistic DX150-A solid-state communications receiver – \$25. Radiola 18 – \$15. Zenith 4U31 tombstone (battery set) – \$35. Eveready Model 2 – \$55. Stromberg-Carlson AD34 PA unit – \$15. Richard Haneline, 3600 Cuba Blvd., Monroe, LA 71201. (318) 387-6764

**WANTED:** The following transistor radios. For those shown in the new 2nd edition Bunis book I will pay the full listed price (more for exceptional sets). Admiral 7L12, 7L14, 7L16, or 7L18 with leather case and Sun Power Pak. Airline BR-1100A, GTM BR-1109A. Arvin 8576, 9577. Bulova 250, 620, 620[?]. DeWald K-701A, K-701B. Emerson 849, 999. GE 675, 676, 677, 678. Hitachi TH-621, TH-666. Magnavox AM-2. Majestic 6G-780. Mitchell 1101, 1102, 1103. Motorola 56T1, 66T1, 6X39A, 7X23E, 7X24S, 7X24W. Packard Bell 6RT1. Raytheon T-100-1, T-100-2, T-100-3, T-100-4, T-100-5, T-150-1, T-150-2, T-150-3, T-150-4, T-150-5. RCA 7-BT-9J, 8BT-7J, 8-BT-7LE, 8-BT-8FE, 8-BT-7JE. Regency TR-1, TR-1G, TR-4, XR-2A, TR-8. Any Sentinel, Sonora, or Sparton. Sony TR-2K, TR-8, TR-33, TR-52, TR-55, TR-62, TR-63, TR-72, TR-86, TR-510, TR-610, TRW-621, TFM-151. Standard SR-F22, SR-G430. Sylvia Thunderbird. Toshiba 5TR-193, 5TR-194. Truetone D-3614A. Westinghouse H-587P7/A, H-588P7/A, H-589P7/A, H-610P5, H-611P5, H-612P5, H-617P7, H-618P7, H619P7. Zenith Royal 555, Royal 500-H, Royal 800. Bill Burkett, PO Box 1204, Peoria, AZ 85380. (602) 878-7386. Fax (602) 486-4484

**WANTED:** RCA 16X13. Radiola 61-1. Ichiro Yamada, 10-21 Chiyodadai-cho, Kawachi, Nagano-shi, Osaka, Japan 586

**FOR SALE:** Grebe MU1 with chain, all original, excellent, beautiful finish – \$285. AK horn Model L, a very nice speaker – \$150. AK horn Model H, very nice – \$125. Majestic cathedral Model 20, excellent, plays – \$235. Philco cathedral Model 60, excellent, plays – \$160. Dayton Model XL-20, excellent – \$200. Grebe MU1 with chain about fine – \$195. Edison Mabry, 715 W. Longview, Mansfield, OH 44906. (419) 526-1175, call evens.

**WANTED:** Philco Model 71 cathedral junker chassis for parts. Jim Wilson, 888 Pearse Rd., Schenectady, NY 12309. (518) 372-9625

**FOR SALE:** Original copy of book, RCA Victor Service Notes for 1933 – \$30 plus UPS. Alva R. May, R1, Box 313, Shenandoah, VA 22849. (703) 652-8638

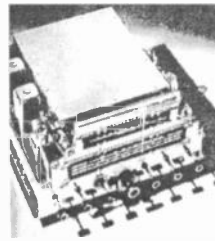

**WANTED:** Any E. H. Scott radio featuring this chassis. Any condition. Also looking for mid-1930s Majestic, Fada, World, Ultramar, Pilot, American-Bosch, Westinghouse, Fairbanks-Morse, Sparton and Canadian brand radios. Michael Feldt, 12035 Somerset Way E, Carmel, IN 46033. (317) 844-0635

**FOR SALE:** Radio on the cover of Collins latest book, Radios Redux, works – \$135. Larry Dowell, Rt. 2, Box 17A, Hurdle Mills, NC 27541. (919) 364-2756

**FOR SALE:** Mint, original box, Philmore Junior microphone #500 – \$50. (30) Edison Diamond Disc records, 20's and 30's and (10) old 78 rpms – \$40. Homemade combo crystal set and 2-dial tube amp, uses ERLA fixed crystal detector and 201A's – \$75. Zenith Royal 500, black – \$50. RCA 66X13, mint wood case – \$55. Starlite 10 transistor World Globe, very heavy – \$50. Americana 6 transistor pocket – \$15. French Style desk telephone – \$35. Military URC-11 243MHz micro transmitter – \$20. (2) Tube CB's as is – \$15/both. Jeffrey Viola, 475-B Eltone Rd., Jackson, NJ 08527. (908) 928-0666

## rainy day books



PO Box 775  
Fitzwilliam, NH 03447  
(603) 585-3448  
frank bequaert  
lucia bequaert

### Radio and Other Technical Books, Catalogs and Magazines Bought and Sold

Specializing in Wireless,  
Broadcasting, Electric Power,  
Computers, Electronics,  
Microscopes,  
Civil Engineering and Steam

*Send for our list of catalogs*



**WANTED:** Grundig Satellit 2100 in top operating condition. Barry Bass, 3672 San Pasqual St., Pasadena, CA 91107. (818) 792-9530

**WANTED:** National NC-183D. Hammarlund SPC-10. Hallicrafters parts. **FOR SALE:** Scott RCH receiver. Joe Reda, KC6TXU, 380 Dunster, Campbell, CA 95008

**FOR SALE:** 1923 Jones/Kellogg Symphony, no tubes or tag (hever had one), very good - \$285 plus shipping. Ed Bell, 5311 Woodsdale Rd., Raleigh, NC 27606. (919) 851-1517

**FOR SALE:** Butterscotch Circle Grille Motorola, original mint - \$3,000. RCA BP-10, vg - \$200, good - \$75. Philco 48-360, (Bunis p. 14 bottom left) - \$40. RCA 8X682, (E.O.R., p. 176 middle right), exc - \$45. RCA 75X17, (Bunis, p 129), working, mint - \$195. Zenith Trans-Oceanics: H-500, mint - \$135; R-600, vg - \$95; 8G005, avg - \$75; Universal 6-G-001YX - \$35. Philco cathedrals, various - \$145 ea. Color photo (35mm) of item: send \$1 and SASE. For catalog of items currently for sale with pictures, send \$1 and LSASE. Call 11 am 12 mid. ET. Best time after 10 pm. Answering machine fourth ring. Eric And Sirelle Fogel, 87 Sandra Dr., Parsippany, NJ 07054. (201) 316-8461

**WANTED:** Philco 37-650 chassis and speaker 70 chassis, 90 brass escutcheon, 20 power supply and 20 cathedral cabinet either version. Cathedral Models 14B and 17B. Also Philco advertising signs, clocks, etc. Will accept collect calls, please call or drop a note. Rudy Wiggins, PO Box 1133, Clewiston, FL 33440. (813) 983-5755

**WANTED:** Knobs for RCA Victor 6-XY-5B or complete parts unit. Also need one small knob for H.H. Scott LK-72 amp. Knob is maroon in color with gold trim. Any Sonotone IP phono cartridges. **FOR SALE:** AM/FM tuner chassis from Philco console hi-fi, works - \$20 plus shipping. Al Manieri, 384 Bates St., Phillipsburg, NJ 08865. (908) 454-3699

**WANTED:** Manual for Conar Instruments (Division of National Radio Institute) Model 230 signal tracer. Junius J. Bailey, W5FTW, 1002 Reeves St., Abilene, TX 79602. (915) 675-6006

**WANTED:** Knight-kit, Ocean Hopper, price according to condition. Also want Zenith Royal 200, 250, and Jupiter transistor radio. Mike Russ, 20147 Rd. 192, Strathmore, CA 93267. (209) 568-2713

**FOR SALE:** Heathkit TC-2 cased tube tester, manual, supplement picture tube adapter - \$40 + ship. J. Lisaius, 116 Orton, W. Caldwell NJ 07006. (201) 226-7943

**WANTED:** Knight-kits, Knight-kits all types, pre- & postwar, any condition. Allied catalogs 1932-1938, 1944, 1945. Jack McCreary, 7783 Wildcreek Trl., Huntsville, AL 35802. (205) 882-0037

**FOR SALE:** Aurora cathedral, mint - \$175. GE 61 cathedral needs refinishing - \$95. GE all-transistor P808H white, near mint - \$55. Trav-Ler 5170 - \$20. Menominee #4 telegraph key and coils - \$50. Sylvania, yellow, #2107 - \$20. Zenith 5D810Y, black - \$20. National Panasonic 4-band, R-470 - \$35. Air Master battery, tombstone - \$75. RCA battery BT-42 - \$40. RCA 66 X 3, AM/SW - \$40. International 1019 - \$15. 2-Utah 12" speakers - \$18 ea. 2 Unitone 5 dials - \$10 ea. **WANTED:** Slide rules, fountain pens, trains. Del Tysdal, 812 Broadway, Fargo, ND 58102. (701) 293-9328

**WANTED:** Help: Need osc. and final coils for Hallicrafters HT6. Can someone supply coils data? R. Haworth, W2PUA, 112 Tilford Rd. Somerdale, NJ 08083. (609) 783-4175

**WANTED:** U.S. Radio Model 25A for parts, any condition. Dwight Baker, 4137 E. 24th St., Des Moines, IA 50317

**FOR SALE:** Gloritone cathedral Model 26, good shape, needs TLC, untested - \$150. Kent A. Ise, 224 Cowesett Rd., Warwick, RI 02886. (401) 769-9000

## WANTED

### Top Prices Paid

**Radio & Audio Tubes:** 2A3, 45's, 50's, 845, 8005, KT66/88, etc.

**Western Electric Tubes:** 101, 102, 104, 203, 305, 211, 212, 242, 244, 252, 262, 264, 271, 274, 275, 276, 284, 285, 300, 301, 310, 339, 345, 347, 348, 349, 350, 421, 422, VT25A, VT52, etc.

**W.E. Speakers & Tweeters:** 555, 594, 595, 596, 597, 713, 728, 754, 755, 756, 757, TA4151, 4153, 4181, 4191, 4194, etc.

**W.E. Consoles & Amps:** 25B, 41, 42, 46, 86, 91, 92, 94, 95, 105, 106, 117, 118, 120, 121, 124, 129, 130, 131, 142, 143, etc.

**W.E. Horns:** 22, 24, 25, 26, KS-6368, 12024, 12025, 12027, etc.

**W.E. Microphones & Parts, etc.**

### Also looking for:

*Tube-type equipment by McIntosh, Marantz, Westrex, ARC, Leak, Quad, Langevin, Altec, Telefunken, Siemens, Neuman, etc.*

*Vintage speakers, units, by Tannoy, Jensen, Altec, JBL, EV, Telefunken, Siemens, etc.*

**Audio City USA, PO Box 802, Northridge, CA 91328-0802  
(818) 701-5633**

**FOR SALE:** Exel three-dial TRF NTNR. Many Bakelite, plastic, wood radios — \$10 to \$25. Also TVs, misc. SASE for list. **WANTED:** Detrola sales brochures. Dennis Smith, KN8H, Box 113, Trenton, MI 48183

**WANTED:** Paying over \$1,000 for Zenith 15-U-270 in good condition, or other 1938 15-tube sets, except 15-U-269. Also seeking Spartan 1867. Jim Berg, 4261 Wilcox Rd., Box A, Northport, WA 99157. (509) 732-6155

**FOR SALE:** Gosnet G11 AC CB, Citizens Communicator, untested — \$30. Crosley 516, nice cabinet, plays — \$45. Plus UPS. Robert Rathbone, RD #1, Box 127, Ossipee, NH 03864. (603) 539-2762

**FOR SALE:** Philco 48-1256 — \$15. Philco TR-200 7" reel-to-reel — \$20. 1949 RCA 9-T-256 10" tabletop television — \$25. James Homan, 401 Valley Dr., Valley Springs, SD 57068. (605) 757-6424

**WANTED:** Coronado 527A (as seen in Vintage Radio calendar) and early transistor radios. Richard Bell, 3070 230 Lane SE, #J202, Issaquah, WA 98027



**FOR SALE:** Portobar SW 9008B, original decanters, glasses and bowl missing — \$250. Bosch wood #352 — \$75. Zenith 6D615 Consoltone — \$75. All working. Steve Lange, 1351 N. 58 St., Milwaukee, WI 53208. (414) 259-1031

**WANTED:** Six-meter FM ham transceiver. **FOR SALE:** Radios, books, etc. Send want list with SASE. Don Weiler, 4641 Kawanee Ave., Metairie, LA 70006

**FOR SALE:** Zephyr Model 1, pink plastic case, early Japanese — \$30. (4) Sets of old headphones — \$8 ea. 1938 Emerson Model BM-215 — \$33. 1934 Philco Model 59C, compact — \$50. 1940 Philco Model 40-155T, slant front, push buttons, Deco grille, BC/SW, nice — \$75. Belmont Model 6D111, nice set — \$130. 1946 Emerson Model 520, Catalin, nice — \$215. GE Model 250, all metal portable radio with Willard battery — \$40. 1934 RCA Model 118 tombstone, round front dial, BC/SW — \$90. 1947 Radiola Model 61-7, white plastic, 3 knobs, BC/SW — \$35. Fada Model 790, Bakelite, nice — \$90. Silvertone Model 8003, blue midget metal, not playing — \$45. 1937 Fada Bakelite, BC/SW, 3 knobs, Deco grille, nice — \$90. 1947 Philot Model T-521 BC/FM, 4 knobs — \$35. 1946 Temple Model E-514, wood with upper slide rule dial — \$25. 1939 Philco Model 39-25, slant front, plays, parts — \$35. 1946 Bendix Model 0526E — \$28. 1950 Arvin Model 450TL, black plastic — \$25. 1940 Philco Model PT-6, two-tone wood — \$30. All items are plus UPS. George Jones, Rt. 4, Box 31, Fernandina Beach, FL 32034. (904) 261-6533

**WANTED:** The Sound of High Fidelity by Robert Oakes Jordan and James Cunningham. Electronics Made Easy by Lothar Stern. How to Convert Silent Movie Projector to Sound by Popular Mechanics Press. The Boy Electrician by Morgan. Richard Matisek, 2212 S. 139th Ct., Apt. #3, Omaha, NE 68144

**WANTED:** SABA 410 stereo table radio, SABA separate speakers. Also, need information on Orion (manufacturer) Pacsirta (model) Hungarian radio. Thank you. Phil Holahan, 30 Worcester St., PO Box 392, Grafton, MA 01519. (508) 870-0312, ext. 260

**FOR SALE:** Bendix 526C, green — \$900. RCA 66X9, green — \$1,200. Dale Parsons, 5312 Koontz Dr., Cross Lanes, WV 25313. (304) 776-2180

**FOR SALE:** Moss 247 emission tube tester, circa 1947, excellent cond. — \$25 plus shipping. Charles Closson, 1290 Glenwood Ave., San Jose, CA 95125. (408) 294-4702

**WANTED:** Wartime German, Italian, Japanese radio equipment, part or whole. U.S.A. mobile radio 1930-1945: military, Forest Service, boat and aircraft. Mobile radio manuals, including CB, any years. Thank you! Hugh Miller, 6400 Maltby Rd., Woodinville, WA 98072-8375

**FOR SALE:** Airline #05BR-1526C, ivory — \$30. Stewart-Warner #A61P1 — \$55. Radio Boys at the Sending Station — \$10. Century tube tester, oak case, #FC-1, nice — \$35. Airline, wood, clean #04WG-731B — \$35. Truetone #D-719, 6-volt, beautiful condition — \$40. RCA Victor #66X1 — \$45. Cathedral coaster set — \$10. Zenith Royal 810 — \$20. Motorola #5P31A portable — \$15. Brownie Hawkeye camera & flash — \$20. Zenith console speaker #49H416 — \$10. Philco #39-70 table radio, good condition but could stand refinishing — \$60. All sold as is. Buyer assumes all responsibility. Plus UPS. Darrell Combs, 6587 Pacheco Way, Citrus Heights, CA 95610. (916) 969-0635

**WANTED:** Service data for JVC Model 3060. L. Luke, LB415, Coshocton, OH 43812

**FOR SALE:** Emerson Aristocrat, black — \$875. GE L571, yellow — \$700. Both exc cond. Anthony Scarfogliero, 13 Fourth St., Brooklyn, NY 11231. (718) 858-1231

**WANTED:** Mitchell Lullaby bedlamp radio Model TSB47, preferably, or 1250-51, any condition. Stephen M. Mauck, 428 S. Purdy, Lyons, KS 67554

**FOR SALE:** Zenith glass rod (?) table set, very nice and original. Kent/Isz, 224 Cowesett Rd., Warwick, RI 02886. (401) 885-7558

**FOR SALE:** Hallicrafters SX43 gen. cov. rcvr with matching speaker, in good working cond., asking — \$125. Rhyne Killian, 4 Walter Cir., Westford, MA 01886. (508) 392-9943

**FOR SALE:** Collins 75A3 — \$195. National NC 125 — \$175. Viking II, w/VFO — \$125. Knight T-150, 6-80M, transmitter — \$150. Ernie Odeneal, 2710 Lee, Greenville, TX 75401. (901) 455-2113 or 5788

**WANTED:** (4) Used 6336B tubes. **FOR SALE:** Bulova 660 Series portable, clean — \$65. Peter Palm, 4900 Madison Road, Madisonville, OH 45227. (513) 561-4411

**WANTED:** Six brown push buttons, front knob. Truetone D2615 (Bunis, second edition, p. 188). Brian Kurrel, 208 Crafton Rd., Bel Air, MD 21014. (410) 838-6534, (410) 592-6202, daytime

**WANTED:** Pocket-size radios from U.S. or Japan. Tube, transistor, or crystal. **FOR TRADE:** Zenith 500H new-in-box for pink Royal 500. Eric Wrobbel, 20802 Exhibit Ct., Woodland Hills, CA 91367. (818) 884-2282 phone or fax

**WANTED:** Phillips 212 turntable service manual (copy); knob for Zenith 5R135 tombstone model. Ray Barnes, 38 Woodmere Rd., Framingham, MA 01701. (508) 877-6040

**FOR SALE:** Nice Eico signal generator Model 315, works, no manual - \$20, about 2.5 lbs., plus shipping. Randy Blevins, Box 113-A, Rte. 1, Lexington Park, MD 20653. (301) 863-8687

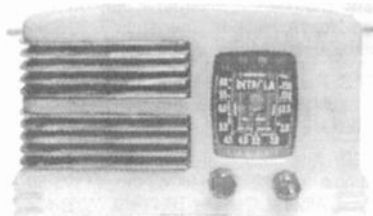

**WANTED:** Detrola Catalin radios in any shape, size, or color. "Split-grille" design also came in similar Symphony and Crosley models. Remember: I'm the guy that buys from the people that buy from the people who pay more than the people paying more than anyone else - except me. Please write or call collect: Rain Buttignol, 214 State St., #7, Portsmouth, NH 03801. (603) 427-1384

**FOR SALE:** Emerson 502 Catalin, excellent condition - \$150 plus shipping. John B. Drew, 28 Babcock Rd., North Stonington, CT 06359

**WANTED:** Type N AK 11" spkr. Restorable chassis for AK 84. Spkr for AK 145, junker OK, need field coil. Bob J. Moretz, K14EC, Caller Service 112, Lenoir, NC 28645. (704) 758-2383, day; (704) 758-1995, night

**FOR SALE:** Service notes for the following radios: Radiola 16, 17, 20, 30, 30A, 32, 60, 64, 80 & Radiola 105 loudspeaker. Also GE E-101, 105, 106, & 126, Hallcrafters SX-24 and Capehart 400K. Comb bound with vinyl covers - \$10 + \$1.70 First Class postage. Bruce Landey, 45 East Flower St. 233, Chula Vista, CA 91910. (619) 427-2745

**HAVE YOU MOVED? ARE YOU MOVING?  
PLEASE NOTIFY US A.S.A.P.  
SEND US YOUR...  
OLD ADDRESS  
NEW ADDRESS and  
SUB #  
MANY THANKS!!!!**

**WANTED:** Miller's crystal hi-fi tuner, Federal Jr. crystal set and any other crystal sets. Erwin Macho, Ambrosweg 17/A/8, A-1230 Vienna, Austria

**WANTED:** Wire recorder in good working condition. Jack Martin, Rt. 1, Box 183, Wesley, AR 72773. (501) 456-2984

**FOR SALE:** Old plastic and wooden radios. SASE for 50 item list. David S. (Sam) Cope, KC4HMK, 2111 Hillsboro Heights, Knoxville, TN 37920

**FOR SALE:** (7) Simpson 300 Series meters, xmtr filter chokes, variable caps, filter caps, fil. xfms, coils, insulators, resistors, panel meters, knife sws., diodes, MFJ memory keyer #482 & more. Thomas B. Waters, 3703 Bonview Avenue, Baltimore, MD 21213. (410) 488-5356

**WANTED:** QST's before 1927 in good condition front & back covers. Ed White, WA3BZT, 809 Seymour Rd., Bear, DE 19701-1121. (302) 322-1313

**WANTED:** Set of legs for Super Zenith VII. Ed Bell, 5311 Woodsdale Rd., Raleigh, NC 27606. (919) 851-1517

**HELP:** How many original colors were there for the Westinghouse refrigerator radio H-126? Dave McClean, 1086 Trailridge Ln., Atlanta, GA 30338

**FOR SALE:** Atwater Kent breadboard Model 5-A, all original untouched factory tags on bottom, factory tag on center of board. It's all there! Serious inquiries only. Kent A. Ise, 224 Cowesett Rd., Warwick, RI 02886. (401) 885-7558

**WANTED:** Driver for an AK 20 speaker in a Pooley Model 1900 console cabinet. Also need set of knobs for an RCA Model ACR-155 communications receiver. Joseph Loubriel, 524 James St., New Milford, NJ 07646. (201) 385-1677

**WANTED:** Precision 612 tube test data sheet for TV Compactrons (like 6KD6's), copy OK. James J. McGrath, W2IOJ, 2 Centerview Ln., West Seneca, NY 14224. (716) 675-0160

**FOR SALE:** J.D.'s Radiowear T-shirts - \$13.95 ppd, sweatshirts - \$19.95 ppd, \$1.00 extra XXL. Cathedral and Deco styles available. J.D.'s Radiowear, 1161 S.W. Mulvane, Topeka KS 66604. (913) 232-0128

**WANTED:** Mounting studs for Philco 37-690X receiver chassis. Thanks. Harry Akkerman, Dintelstr 751, 1079 BA Amsterdam, Holland. 011-31-20-642 5716

**FOR SALE:** RCA 103 speaker. **WANTED:** 1-, 2- and 3-tube receivers and amplifiers. Wood bell horns. Doug Koehn, 609 S. 15th, Quincy, IL 62301. (217) 228-2115

**FOR TRADE:** My two Motorola teledial/clock consoles for your Zenith console or ? A. Bruno, 24 Butternut Dr., New City, NY 10956. (914) 354-8899

**3RD ANNUAL  
OLD-TIME RADIO  
& PHONOGRAPH  
SHOW**

August 15th 1992  
Campbell Hall, NY

**WHEN: Saturday, August 15th, 8am-4pm**  
**WHERE: Otterkill Engine Co.,  
Campbell Hall, NY 10916**  
(30 min. from exit 17, NYS Thruway)  
**ADMISSION: \$1.00 at the door**  
**Show to be held rain or shine,  
so make a day of it.**  
**Refreshments available.**  
**For information call:  
Victorian Talking Machine Co.  
914-561-0132 or...**  
**Gramm-O-Phone Antiques  
914-427-2602 evenings.**

**FOR TRADE:** The following radios and additional items are available for trade for E.H. Scott Allwave 23's or Philharmonics and McMurdo Silver Masterpiece V or VI's in excellent original finish console cabinets. Zenith 15U29, 7S232 & 9S232 Walton tombstones, 10S153, 10S443, 5S319, AK 82, AK 84, Philco 90, Zenith Trans-Oceanic, Fada Bullet 1000, small Arvin metal table radio. I also have available for trade a large collection of original Maxfield Parish prints and an excellent Lionel and American Flyer 1950's train collection. Contact: Kent Martin, 7803 Butterfield Dr., Elkridge, MD 21227. (410) 796-1953

**WANTED:** Stromberg-Carlson 935/1035 chassis, rust free w/good glass & working condition preferred. Also need RCA 18T chassis, 1940. Skip Shaw, 2095 North Ford St., Clarksville, TN 37042. (615) 642-7220

**FOR SALE:** General Radio Company 1-15 meter type, condition excellent - \$75. Wave meter Type 75A, condition excellent - \$50. General Radio output meter Type 483-F, condition broken SW - \$25. Measurements sq. way generator Model 71, condition good - \$45. Weston meter Model 508, condition good - \$25. General Radio meter fan type Model 271, condition good - \$25. National receiver Model 1-10A with power supply speaker & complete set of coils, condition excellent - \$150. Code instructed graph with tapes - \$35. Hallicrafters Sky Buddy, condition good - \$100. Hallicrafters Model S38, condition good - \$60. Johnson match box, condition excellent - \$50. (4) Hammond power amplifiers, 30 watt ea. with 2-12 in. speaker, condition good - \$40 ea. Kenwood Model TS820 transmitter good, receiver dead - Make Offer. John Lygeros, R.R. #1, Monument, KS 67747. (913) 846-7821

**FOR SALE:** New tubes - \$3 ea. 6AB7, 5W4, 6R7, 12AH7, 6K8, 12K8, 12SJ7, 14A7, 117N, 1R5, 3S4. **WANTED:** Aircraft instruments & radios and industrial electron tubes. Hy Ness Company, 709B Delair Rd., Cranbury, NJ 08512. (609) 395-1116

**MESSAGE:** Help: I'm interested in meeting other collectors/clubs in Alaska, Yukon or Northern B.C. Hoby Irwin, Box 3913, Whitehorse, Yukon, Canada Y1A 5M6. (403) 667-2176

**WANTED:** One or more Atwater Kent Radiodyne bread-board RF transformers. Complete or form only. Will pay your price or have breadboard parts to trade. Paul Thompson, 315 Larkspur Dr., Santa Maria, CA 93455. (805) 934-2778

**FOR SALE:** Signal Corps power supply No. 1 for wireless sets No. 19, Mk II. R. Chenez, RFD 2, Box 437-J, Plymouth, NH 03264

**WANTED:** Radiola, Mod 812, 6-tube, superhet, portable w/o cabinet. AK Mod 35 complete. Send quotes to: Dan Schulte, 3130 Mesa Verde Ln., El Paso, TX 79904

**WANTED:** Any chassis with large face panel to fill cabinet hole 9 x 12. Gordon Wilson, 11108-50 Ave., Edmonton, Alberta, Canada T6H 0H9. (403) 434-6257

### Classified Ad Deadline Noon

**Jul. 10 for Aug. 1992 Issue**

**Aug. 10 for Sep. 1992 Issue**

Box. Ads with Photos & Display Ads - 1st

**WANTED:** Dragon fly speaker, small drum speakers, crystal calib. for NC-300. F. W. Nicholas, PO Box 37094, Phoenix, AZ 85069. (602) 864-9987

**WANTED:** Escutcheon (half-round shape) for AK Model 84 or 84B. Call collect. Knox Lee, 630 Shadowbrook Dr., Columbia, SC 29210. (803) 772-6593

**FOR SALE:** Military entertainment receiver R-100/URR made by Majestic, looks decent, untested. Another R-100/URR manufacturer unknown. Case Rusty, doesn't play. **FOR TRADE:** National NC-77X nice condition, Echophone Commercial good condition, for Hallicrafters S-38EM, WR-3500, SX-105. Both receivers play. Loren H. Dudley, KA1PRV, 14 Valley Rd., Bath, ME 04530. (207) 442-8419

**WANTED:** Vol. control with off & on SW for Znith Royal 500. Knob for Hallicrafters SX108. Walter G. Lascok, 8706 N.W. 57 Ln., Tamarac, FL 33321. (305) 721-3473

**WANTED:** Lone Ranger radio by Airline; willing to pay up to \$500 for one in mint condition. Emerson 540 in green. Philco 90, only in unrestored, original, excellent condition. Novelty tube radios. Transistor radios, no novelties, in excellent condition, willing to pay. Call 11 a.m. - 12 mid. ET. Best time after 10 p.m. Answering machine fourth ring. Eric and Sirelle Fogel, 87 Sandra Dr., Parsippany, NJ 07054. (201) 316-8461

### **TRANSISTOR NETWORK**

More and more radio people are discovering the excitement of novelty and regular transistor collecting. Why not join the fun? Now is the time to subscribe to the Transistor Network - a monthly transistor newsletter featuring transistor related articles and classified ads. Only \$12.00 for a one year subscription (12 issues).

Not sure? Send for a free sample copy and find out what you've been missing! Call or write: Transistor Network, RR 1, Box 36, Bradford, NH 03221. (603) 938-5051

**FOR SALE:**  
Reproduction Radios.  
Finest quality. Excellent  
for shows, flea markets,  
stores. Call for more info.  
(718) 356-3410

 <b>SALE: \$55.00</b>	 <b>SALE: \$75.00</b>
 <b>SALE: \$45.00</b>	 <b>SALE: \$75.00</b>
 <b>SALE: \$40.00</b>	 <b>SALE: \$45.00</b>
 <b>SALE: \$65.00</b>	 <b>SALE: \$45.00</b>

**RALPH'S RADIOS**  
Ask About  
Discounts for  
Volume Orders  
**RALPH'S RADIOS**  
Ralph Bonomo  
229 Ramona Avenue  
Staten Island  
New York 10312  
(718) 356-3410

**FOR SALE:** Now available: Catalog #10, listing hundreds of desirable books on early radio, electricity wireless, television telegraph & telephones. Please send \$1 to receive this juicy catalog. New Wireless Pioneers, Box 398WT, Elma, NY 14059. (716) 681-3186

**FOR SALE:** I thought I had sold it, but I never received the money so therefore, the 1937 Zenith Service Manual is still for sale, covers 39 models - \$10 includes shipping. Lloyd Spivey, WLLS AM/FM, Hwy. 231 South, Hartford, KY 42347. (502) 298-3268

**WANTED:** Help! Need Realistic Concertmate AM/FM-FM stereo portable radios, Model 12-708, sold by Radio Shack thru early 1980's. Working/not. Accurate description please. Jeffrey A. Muehleman, 094506, PO Box 747, Starke, FL 32091

**WANTED:** Original crystal set, tube, or transistor radio catalogs and owner manuals. Excellent condition only. No copies or reproductions please. Send price and good description, including date, model/s and/or brand, number and size of pages, and any other pertinent information. All correspondence will be answered. Bill Burkett, PO Box 1204, Peoria, AZ 85380. (602) 878-7386, Fax (602) 486-4484

**FREE - 20 WORD AD EACH MONTH**  
To get your free 20 words,  
include your SUB# with your Ad.  
Additional words are 15¢ each.  
Read inside back cover for details.  
**MANY THANKS!!!!**

**FOR SALE:** Mac FQ, Jensen spkr, tab. radios. SASE. P. Spiker, 3970 Kumquat Ave., Miami, FL 33133

**WANTED:** Information and top & bottom panels for a Navy Model RBD rcvr. John McCarty, N9HRT, 1524 George St., Downers Grove, IL 60516. (708) 969-5297



**FOR SALE:** Grand Piano radio, General TV Company Model 534, size 12" x 10" w x 5" h, 5 tubes: 35Z5, 50L6, 12SQ7, 12SK7, 12SA7 - Best Offer by July 25. J. J. Papovich, 53 Magnolia Ave., Pitman, NJ 08071. (609) 582-8279

**WANTED:** Will pay \$300 U.S. for Thordarson All Star Senior receiver. Interested in All Star also. H. K. Fredrickson, 218 Skeena Cres., Saskatoon, Saskatchewan, Canada S7K 4G8. (306) 242-9275

**FOR SALE/TRADE:** Motorola 50XC Catalin, brown with tortoise - \$3,200 or BO. Sparton 506 Bluebird - \$2,700 or BO. Both excellent. Lairy Wilcox, PO Box 7658, Berkeley, CA 94707. (510) 524-3928

**FOR SALE:** German and Austrian early transistor portables (Philips, Akkord, Ingelen) of 50s/60s. Wolfgang Hornik, Hedwigstr-11, 8 Munchen 19, West Germany. 011-49-89-1292750

**FOR SALE:** Large collection of plastic and wood table and console radios from the 1920's through 1960's. Also 1940's TV sets and 1950's-1960's transistor radios, test equipment. Call after 7:30 Central or send LSASE to: John Enigl, Sr., 5425 Cherry Ln., Egg Harbor, WI 54209. (414) 743-3672

**MESSAGE:** Ed Myzurak? Wife tossed phone number away. Hates my hobby! Call me, we'll talk turkey on the Hallicrafters PM-23 you want. Loren H. Dudley, KA1PRV, 14 Valley Rd., Bath, ME 04530. (207) 442-8419



**FOR SALE:** Delco AM Transposable pop-out Buick radio Model 989131 in operating condition. Best Offer. Angelo J. Anello, 1915 W. Waters Ave. #1, Tampa, FL 33604. (813) 933-6009

**WANTED:** Philco Model 680. 1936 console, uses 6A3 output tubes, 5Z3 and 80 rectifiers. Seeking a restorable or good/excellent set. Charles Rhodes, 3906 Quisenberry Dr., Alexandria, VA 22309. (703) 739-3850, days; (708) 780-0719, home

**FOR SALE:** Or possible trade, 1925 Clearfield 6-tube plate glass radio, excellent original condition - Best Offer around \$3,000. Herb Ellmers, 603 Howard St., Ft. Pierce, FL 34982. (407) 466-0926

**FOR SALE:** Three Giblin-Remler coils w/o base: 25, 35, 50 turns - \$10. RCA TMV-118-B regulated power unit, 1930's, works but one regulator tube faulty; 90v fixed and 130-250v variable; with 80, 2A3, 57, two 874s - \$15. Beautiful 1919 General Radio wireless var. condenser in oak box (V.R., p. 163) - \$35. Carborundum detector unit "open" rheostat (V.R., p. 168) - \$20. Leeds-Northrup wireless var. cond. in metal case - \$25. Telephone ground meter in oak case - \$35. Leeds-Northrup 1919 fixed condenser assembly, walnut box - \$15. Twelve receiver escutcheons - \$15. Twenty large 1920's mica condensers - \$10. Plus shipping. SASE. Arthur Harrison, 501 Arbor Dr., Columbia, MO 65201. (314) 474-8729

**WANTED:** Amateur receivers such as Hallicrafters SX-62, SX-42, SX-43, S-27. Thanks. Jimmy D. Weaver, 1007 E. Bridges, Wynne, AR 72396. (501) 238-8328

**FOR SALE:** Telegraph material (k.o.s. 1955, parts, paper); USN flameproof, new (N.O.S. 1955) - \$59. Refundable \$1.00 and SASE for 7-page illustrated list. Dr. Joe Jacobs, 60 Seaview Ter., Northport, NY 11768

**FOR SALE:** Branston coils #1250 and #1500 - \$5 ea. Crystals, hearing-aids, nuvistors and sub-mini tubes. LSASE. Walt Belsito, Sr., 409 Willow St., Waterbury, CT 06710

**WANTED:** McIntosh stereo tube equipment. Studio disc recorders by Neumann, Westrex, RekOkut, & others. Fairchild limiters, turntables, 16" tonearms. Records & jukeboxes. SERVICES: 33/45/78 custom records made. Noise elimination from older recordings. Kim Gutzke, 7134 15th Ave. S, Minneapolis, MN 55423-3428. (612) 866-6183

**FOR SALE:** Sams AR TR CB, new - \$1 each. Riders 9 to 14 - \$25. Louis L. Veltre, 42A Sterling St., Lakehurst, NJ 08733. (908) 657-7592

# EXTRAVAGANZA '92

Proudly Announced & Sponsored by

## THE MICHIGAN ANTIQUÉ RADIO CLUB



&



## THE ANTIQUE WIRELESS ASSOCIATION

-- JULY 10-12, 1992 --  
Friday, Saturday & Sunday

### FEATURING:

- Open Air Flea Market
- Equipment Contest
- Equipment Auction
- Hospitality Suite
- 3 Programs
- Women's Luncheon
- Donation Auction
- 50/50 Raffles
- Informal Social Hour with E. H. Scott Radio Display

At The  
**Holiday Inn Lansing  
Conference Center**  
7501 W. Saginaw  
Lansing, Michigan 48917  
(517) 627-3211

For information contact:  
**EXTRAVAGANZA '92**  
P.O. Box 585  
Okemos, MI 48864

*Holiday Inn*

**L A N S I N G  
C O N F E R E N C E C E N T E R**

7501 West Saginaw • Lansing, Michigan 48917  
Telephone: 1-517-627-3211  
Fax Reservations: 1-517-627-3211\*241



**FOR SALE:** Zenith Cube 5-S-218 - \$150. Zenith 5-S-29 black dial tombstone - \$200. RCA wood Nipper 40X-55 - \$110. Emerson 511 pistachio green/gold swirl Plaskon - \$190. Emerson Wondergram - \$200. Zenith 5-S-237 chairside - \$175. **WANTED:** Wooden radios: Chrome grilles, unusual Emersons (model numbers under 500) and Zeniths (pre-1940). Call or write with description. Mark V. Stein, 822 Guilford Ave., Suite #130, Baltimore, MD 21202. (410) 366-3823

**FOR SALE:** Tubes, radio, TV, 40's thru 50's. SASE for list. Lee C. Dickinson, 478 Main St., Cromwell, CT 06416

**WANTED:** Farnsworth, Learadio, and Roland table model radios. Must be in working condition. Dennis Kane, 2615 N.E. 49th St., Ft. Lauderdale, FL 33308

**FOR SALE:** Pickup Edison phonographs. MG horns & cranes, (4) standards, (2) homes, package deal - \$3,000. Warren Chamberland, 120 Depot, Westford, MA 01886. (508) 692-2862

**FOR SALE:** 1874-1887 books by Dr. Theodore Kasser "The Latest Discoveries" (10 volumes), excellent condition, printed in German script, many pictures including galvanometer using 2 rectifier bulbs - Best Offer. **FOR SALE/TRADE:** Catalin Garod 6AU1 for Federal 61. Matt Kurzdorfer, 107 Falconer St., North Tonawanda, NY 14120. (716) 695-0036

### RATE FOR ADDITIONAL WORDS:

15¢ per word

**FIRST 20 WORDS FREE!**

*Cash or stamps OK for small amounts.*

*Your payment helps to keep A.R.C. healthy!*

**WANTED:** Help me find a prisoner the following radio: Realistic Concertmate AM, FM/FM stereo Model 12-708 or a GE Super radio Model 7-2880-A. Fred Gear, 6042 Brookridge Rd., Jacksonville, FL 32210. (904) 771-7828

**FOR SALE/TRADE:** Motorola 9T1, nice Bakelite TV, has sound/no pix - \$125. **WANTED:** RCA Q-44, 12-Q-4. Jay Myers, 1010 Graybar, Nashville, TN 37204. (615) 297-5886

**FOR SALE:** Zenith Royal 500, plays - \$35. NRI automotive solid-state ign. scope, exc cond. less cable - \$70. GE P777A port. - \$8. (70) old TV knobs - \$10. Silvertone 5-tube creme Bak. port., no cracks, not wrkg. - \$10. GE C4330 clock radio, needs work - \$8. Box Phenolic resin P/C boards w/small components, wt. 20# - \$10. American Bosch 386 tombstone bat. - \$15. GE LB61 AC/DC port., needs work - \$10. Box N.O.S. TV brighteners & circuit parts - \$15. John Martin, 817 Cook Ave., Billings, MT 59101. (406) 252-4287

**WANTED:** Western Electric tubes 274A/B, N.I.B. - \$110; used - \$55. Also, 310A/348A. H. Kato, c/o Mr. Shiraishi, 900 Pepper Tree Ln. #1616, Santa Clara, CA 95051

**WANTED:** Radio & Television Retailing, May 1949 & March 1949. 7" & 10" TVs from the 40's. Tony DeMara, 40231 Day, Mt. Clemens, MI 48044. (313) 263-0325

**FOR SALE:** Zenith brown T-600 Trans-Oceanic. Zenith black 500 Trans-Oceanic. Bob Shivers, 1233 W. Vine St., Taylorville, IL 62568. (217) 824-9546

**FOR SALE:** Ampex 1100 open reel stereo tape deck, clean, untested, no cabinet - \$75. Tom Townsend, 3 Cobblers Ln., Dix Hills, NY 11746. (516) 499-8226

**FOR SALE:** (2) B&W video cameras, single lens 16mm, all tubes, including Videocon, commercial quality with manuals, vgc - \$125 ea. + 30 lbs. shipping. John Nosbaum, 2743 Wilmette Ave., Wilmette, IL 60091. (708) 256-0547

**FOR SALE:** Port-A-Fone Wireless intercom set with case, about 1935?, excellent cond. - Best Offer over \$50. Gil Paquette, 42 Strohmaier Rd., Rising Sun, MD 21911. (410) 658-2260, eves.

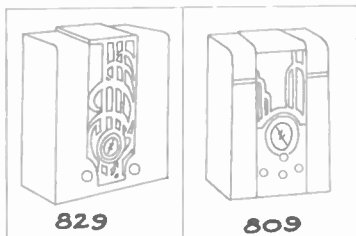

**WANTED:** The pictured Zenith chrome grille radios and others made by Majestic, Grunow, Wurlitzer, etc. Have much to trade from or will buy outright. Call or send description. Mark V. Stein, 822 Guilford Ave., Suite #130, Baltimore, MD 21202. (301) 366-3823

**FOR SALE:** White Motorola 67X12 - \$25. Zenith Royal 500, black - \$50. RCA R7 Superette tombstone - \$90. StarLite World Globe 10 transistor, very nice with brass accents - \$50. Grundig 2520U - \$25. **WANTED:** Neutrowound and other breadboard radios, such as Atwater Kent Models 5, 9, 10, 12. RCA 103 speakers. Emerson Models 300, L559 and other Jewel Box or Treasure Chest radios. Jeffrey Viola, 475-B Eltone Rd., Jackson, NJ 08527. (908) 928-0666

**FOR SALE:** Philco Predicta, tabletop, exc cabinet not working - \$325. Radiola 18 with Model 103 speaker in excellent condition. Bryan Conti, 20 Dewey St., Providence, RI 02909. (401) 946-4899

**WANTED:** RCA 1937 table radio Model 87T in excellent condition. Jim Coleman, PO Box 2348, Pasadena, CA 91102. (818) 584-4263

**CLASSIFIED AD NOTICE**

**Please check your ads carefully before sending them in. Once ads are received, it is not always possible to refund the amount sent, pull the ad or make changes.**

**FOR SALE:** RCA paper, approximately one inch thick, notes from Nipper and more - \$5. I have collected so much Philco Service data, that I have a 5-inch thick spare collection of Philco data for sale; some TV, record changer/phonograph, auto radio, most home radio, most vgc, some water stains, sold as lot - \$40, includes shipping. Color TV, theory and servicing, 154 pages by Philco, vgc - \$15, includes shipping. (20) Philco electronic supervisors from late 50's, great info on everything, lots of pictures - \$15, includes shipping. Lloyd Spivey, WLLS AM/FM, Hwy. 231 South, Hartford, KY 42347. (502) 298-3268

**WANTED:** Grille pattern for Philco 70. Hallicrafters SX88, Crosley 587. **FOR SALE:** Philco transistor T4-124, blue/black - \$30. Small wood Philco PT-25 - \$45. Philco 40-155, excellent - \$100. SABA 90 - \$80. Vance Rayburn, 2718 Homestead Rd., Madison, WI 53711. (608) 274-3002

**FOR SALE:** RC-20 RCA Receiving Tube Manual 1960 - \$10. Tektronix 503 Oscilloscope Service Manual - \$20. Heathkit IT-3120 FET/Transistor Tester Manual - \$10. Heathkit Model HD-1515 Phone Patch Manual - \$10. Heathkit IM-58 Harmonic Distortion Meter Manual - \$10. Heathkit Audio Analyzer IM-48 Manual - \$10. Heathkit IB-1103 Frequency Meter Manual - \$10. Heathkit IM-36 Transistor Tester Manual - \$10. All prices include shipping. All vgc. Lloyd Spivey, WLLS AM/FM, Hwy. 231 South, Hartford, KY 42347. (502) 298-3268

**FOR SALE:** Military R-1051B/U receiver for sale, 2-30 MHz, excellent condition both physically and electrically - \$325. Gary Gleicher, 242-01 Alameda Ave., Douglaston, NY 11363. (718) 423-1906, eves.

**WANTED:** 12" 275 ohms speaker for 15U270, 1938 Zenith. Will trade heavy for this part, or will buy outright, basket case OK. Also wanted Warrington cabinet, or other Deco cabinet big enough to fit Philharmonic. Plus any Peter Pan sets made by Jackson Bell. **FOR SALE/TRADE:** 12S268, 12S266, 6S222. Thanks. Mark Kunkel, PO Box 373, Lemon Grove, CA 91946. (619) 465-7271

**FOR SALE:** Silvertone portable 8214 - \$20. Philco 48-461 (Bunis, p. 115) - \$35. RCA 9X561 (Bunis, p. 127) - \$35. Admiral R-13-M - \$12. Panoramic RE 6231 - \$12. Bill Kelley, 830 Orleans Ave., New Orleans, LA 70116. (504) 524-8929

**WANTED:** Chassis, etc. for Crosley New Buddy 54G, 1930, Repwood cabinet, or cabinet available. Gerald Schneider, 3103 Blueford Rd., Kensington, MD 20895-2726. (301) 929-8593

**FOR SALE:** Stock certificates: Admiral Corp. - \$10. Sentinel radio - \$10. Collins radio - \$10. ATT - \$10. Western Union, 1950's - \$10. Western Union, 1970's - \$10. IRC - \$10. Tung Sol, 1970's - \$10. Baird TV Limited, 1930's - \$55. J. J. Papovich, 53 Magnolia Ave., Pitman, NJ 08071. (609) 582-8279

## Wade's World

OF  
"KNOBS"

Reproduction knobs, lenses,  
handles, cabinets, etc.

L. W. Terrell, 7109 East Arbor Avenue  
Mesa, AZ 85208. (602) 830-7849

See you in Elgin !!

**FOR SALE/TRADE:** AK F-2 speaker - \$70. AK 30 - \$60. Eveready Model 3 with speaker - \$125. Zenith 5G41 (F.O.S., p. 196) - \$55. Transistors: Magnavox 2AM70 - \$35. Arvin 61R58 - \$50. Philco T84 - \$25. Bulova 890 - BO. Beitmans, 1940, 1941, 1942, 1949 - \$12 each. **WANTED:** Aeriola Jr., early Radiolas, original Radiola manuals. Mike Heffner, 724 Elmira St., Williamsport, PA 17701. (717) 323-3647

**WANTED:** GE-K64/RCA-121 chassis. Scott Phantom cabinet. ICOM 271H/471H all modes. Doug McManus, 20 Deland Pk. A, Fairport, NY 14450. (716) 388-1275

**WANTED:** DeForest D-7, D-7A, D-10. Ian L. Sanders, 16725 Wild Oak Way, Morgan Hill, CA 95037. (408) 778-7547

**FOR SALE:** Final call on spare book clearance! All books - \$5 each including shipping. Must go! Coyne R/TV Circuits; Coyne Transistor Circuits; Frequency Modulation/Rider; Oscillator at Work/Rider; AC in Radio Receivers/Rider; Resonance and Alignment/Rider; Jim-Pak 7400/74LS Data Book; Understanding Microwaves/Rider; VTYM by Rider. All OK. Lloyd Spivey, WLLS AM/FM, Hwy. 231 South, Hartford, KY 42347. (502) 298-3268

**FOR SALE:** Zenith Trans-Oceanic 6T40, circa 1951 - \$50. RCA dealer sign, 1950 era, 40" x 24" - BO over \$275. **WANTED:** Tube hi-fi amps: Fisher 90 & 125, Scott 265, Eico HF-60 or HF-89. Fisher FM-1R, FM-1000 or Scott 4310-R. Rich Brown, PO Box 686, Farmington, CT 06034. (203) 677-4828

**WANTED:** Car radio owners/installation manuals, pre-1962. Also automobile record players. Dan Schulz, Antique Automobile Radio, PO Box 892, Crystal Beach, FL 34681. (813) 785-8733 or (800) 933-4926

**WANTED:** (3) knobs for Philco Model 70. Also escutcheon. Edmund DeCann, 307-3rd Ave. W, Osakis, MN 56360. (612) 859-4282

**FOR SALE:** Brown Catalin Emerson 520, super condition - \$195. Novelty transistors: Early Japanese Poodle - \$30. Mississippi Fire Pump - \$30. Elvis Presley - \$70. Photo Cube radio - \$25. Tony-the-Tiger, N.I.B. - \$40. Early transistors: Royal 500 - \$25. Zenith 7000, near mint - \$225. Zenith 1000 - \$100. Philco T-78 - \$25. Toshiba 6P15 - \$20. Harold Herp, 6615 Michele Ct., Huntingtown, MD 20639. (301) 855-7071

**FOR SALE:** Modern Radio Servicing by Ghirardi - \$25. Radio Physics Course by Ghirardi - \$20. Essentials of Radio by Slurbzberg & Osterheld - \$15. Basic Electrical Principles by Suffern - \$10. Principles & Practice of Radio Servicing by Hicks - \$10. Mallory Yaxley Radio Service Encyclopedia - \$19. Radio Handbook 1939 - \$9; 1946 - \$9. ARRL Handbooks: 1938 - \$15, 1947 - \$12, 1950 - \$9, 1951 - \$9, 1964 - \$5, 1970 - \$5, 1976 - \$5. Titan power supply 0-500 VDC at 200 mA - \$29. Arvin metal radio #RE-200 - \$65. Fada #790, brown, fair - \$35. Rick Yerke, PO Box 392, Moscow, PA 18444. (717) 842-4857

**WANTED:** Help! Need 2nd IF transformer for Grigsby-Grunow 800 chassis (Models #85, 86 & 998). This is a 175Kc transformer, primary 140 ohms with two secondaries 70 ohms each, Part #11014. Bob Turner, 11649 Co. Rd. 48, Fairhope, AL 36532. (205) 928-0051

**FOR SALE:** Changers, BSR-stereo, new: Model C271.E.1, 2-speed - \$50; Model C123R-B-1, 3-speed - \$65. Base - \$20. Cables - \$10. 45 rpm spindles for Garrard, PE, Zenith, Webcor, RCA, Admiral, Magnavox and BSR - \$12 each. Idler wheels BSR, RCA, VM, Philco, etc. - \$10 each. Cartridges and needles for all phonographs. Plus Shipping. J. J. Papovich, 53 Magnolia Ave., Pitman, NJ 08071. (609) 582-8279

**FOR SALE:** 1940's catalogs, flyers, books, transistors, testers, kilowatt linear parts, no list, request desires. Francis H. Yonker, P. E., W2IBH, 1229 Inverary Pl., State College, PA 16801. (814) 867-1400

## WANTED — FEDERAL SETS

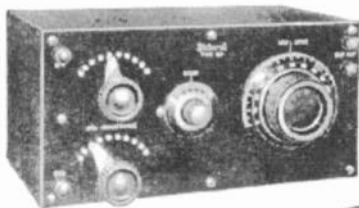

No. 60 Tuner (above), two tuned circuits for broadcast reception.

All units are in black metal cabinets and are designed to be used in combination with each other and the No. 55 RF amplifier and the No. 9 AF amplifier, already in my collection.

No. 56 1-stage RF Amplifier & Detector (right).



No. 8 Detector & 1-stage AF Amplifier (left).

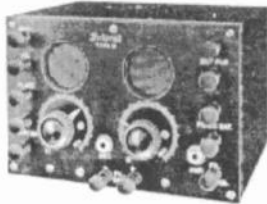

As it may be a long time before I find any of these sets, remember to call me if and when you can part with yours. I am putting together a collection of early broadcast and wireless equipment and adding to it each month. I buy single sets or collections - also, books, catalogs, manuals and other related documentation. Now that I have moved my business (A.R.C.) out of my home, I have roooooom!

*Call and surprise me; make my day!*

John V. Terrey, 498 Cross Street, Carlisle, MA 01741 — (508) 369-9770



**FOR SALE:** Fada 115 Bullet, very rare, green with yellow trim and knurled knobs, near mint original condition - Best Offer over \$2,000. Cliff Bolt, 112 Ripka St., Philadelphia, PA 19127. (215) 482-4576

**WANTED:** Barbie radio. Bob Knapp, Box 7234, San Diego, CA 92167. (619) 488-1666

**FOR SALE:** Complete index for abridged Riders Perpetual Troubleshooters Manual Volumes 1 to 5 - \$10. (2) new Sencore accessory pouches - \$10 each. Motorola Cap, new - \$5. All prices include shipping. Lloyd Spivey, WLLS AM/FM, Hwy. 231 South, Hartford, KY 42347. (502) 298-3268

**FOR SALE:** Old CBS Radiomans Tube Caddy, with total 74, 4, 5, 6, prong, octal, loctal tubes, mostly new old stock, boxed; including 2 balloon types, 227, 986 rectifier, similar to 280 - \$35 plus UPS. Ellsworth O. Johnson, 364 Coeurdalene St., Spokane, WA 99204. (509) 838-2161

**WANTED:** Sterling-Deluxe; any round Ecko and other unusual European radios; Radio Glo; Kadettes. David Mednick, 1450 Palisade Ave., #5-H, Fort Lee, NJ 07024. (201) 461-3082

**FOR SALE:** 50-piece assortment N.O.S. phono cartridges, needles - \$60. LSASE for summer sale list. F. Parker Heinemann, W1YG, 87 Cove Rd., Lyme, CT 06371

**FAX NUMBER FOR  
ANTIQUÉ RADIO CLASSIFIED  
(508) 371-7129 - 24 hours a day  
Ads - Subscriptions - Book Orders  
Charge to VISA/MasterCard  
Minimum Charge: \$10.00**

**WANTED:** 16-inch transcription turntable with similar size platter. Steve Guss, 1536 S. Hillcrest Ave., Clearwater, FL 34616. (813) 443-2587

**FOR SALE:** Arvin 444AM metal original - \$35. Jewel 5200 white - \$25. Majestic 5A430 wood - \$30. Motorola 55X11A Bakelite - \$30. Arvin 66R58 TXR - \$22. Emerson AC205 - \$30. 106 original - \$45. Add \$5 UPS. Don Lindsy, 5341 S. Garland Way, Littleton, CO 80123. (303) 972-8811

**WANTED:** Tube CB's/ham radios, linear amplifiers. Hallicrafters S-27. Old Fender/Gibson guitars/amps. C. Zafonte, N1FRX, RFD 1, Box 75, Fort Kent, ME 04743

**MESSAGE:** If you have purchased one of our universal interstage transformers, the instruction sheet is misprinted. The secondary winding should be the green and black wires. Gary B. Schneider, Play Things of Past, 9511-23 Sunrise Blvd., Cleveland, OH 44133

## TUBES - CAPACITORS - ETC.

**ALL-NEW GREATLY ENLARGED  
1992-93 ILLUSTRATED 16 PAGE  
CATALOG #48**

Jam-packed with thousands of tubes, etc. with current prices

Send \$2 (cash, stamps or check)  
(Canada \$3 - Overseas \$4)  
**FOR YOUR COPY NOW!**

**DON DIERS 4276 North 50 St. #AD8  
Milwaukee, WI 53216-1313**

**FOR SALE:** Fabulous brown Philco Boomerang with original instruction manual, Fada 652 Temple plum with yellow trim, not perfect - \$375. L. H. Grove, 4584 W. Ivanhoe St., Chandler, AZ 85226. (602) 961-4281

**FOR SALE:** More tubes; old radio, industrial, special and television - Send SASE for 4 pages. Chuck Vaccaro, 708 Booth Ln. #K, Ambler, PA 19002-5014. (215) 646-3641

**WANTED:** Westrn Coil & Electrical Co. radios, parts, information; have radios to trade. Eric Sanders, 3295 W. 246th St., Sheridan, IN 46069. (317) 758-4988

**FOR SALE:** Novelties, Golfcart, Superman, JEM-1 car, Dice, Guild Tea-kettle. Now or Nashua 7/18. Call: Don May, 16 Gully Dr., S. Windsor, CT 06074. (203) 644-0258

**WANTED:** Cabinet for Philco 40-150 wooden table radio. State condition & price. A. J. Long, 11830 Heath Rd., Chesterland, OH 44026. (216) 729-8451

**FOR TRADE:** My Moorhead VT-32, N.I.B., good fil. for your Westinghouse WR-21D or?. Tod Prowell, W3URG, 413 North York Rd., Mechanicsburg, PA 17055. (717) 697-5227, ans. mach.

**WANTED:** Two butterscotch knobs and one marbled oxblood red back for Sentinel 284NI. Bruce Hoven, 120 S.E. 11 Court, Deerfield Beach, FL 33441

**FOR SALE:** 1969's Organ Service manuals, 1930's home brew radio, magnetic speaker & misc. - LSASE for list. C. F. Hooper, 1629 Keystone Ct., Clearwater, FL 34616

**FOR SALE:** H/B book Shortwave Voice of the Word - \$5. Philco Model 50-52 round shoulder with white knobs - \$17.50. Zenith Model Y506L genuine tan leather with gold metal grille, AC/DC - \$20. All items plus UPS. Phone or write: Thomas Burnside, 4838 S. Westhaven Dr., Jackson, MS 39209. (601) 922-2235



*Craig L. Graybar  
Furniture Works Ltd.*

(414) 258-2390

**SPECIALISTS IN RESTORING,  
REPAIRING AND REPRODUCING  
CLASSIC STYLED ANTIQUE TV,  
RADIO & PHONOGRAPH CABINETS**

Send us your plans or your project  
via UPS for immediate price quotes



**1535 S. 84th St.  
West Allis, WI 53214**



*"We Turn Ideas Into Heirlooms"*

**FOR SALE:** Heathkit IO-4540 5MHz single trace solid-state scope. Triggered sweep, calibrated time base, 200 ms - .2µs/CM. 20mv/CM vertical sensitivity. 8 x 10 CM CRT. Late 1970's, includes manual, excellent condition, calibrated - \$65 + UPS. Alan Kriss, 1872 Portsmouth Way, Union, NJ 07083. (908) 688-2092

**WANTED:** Junker or basket case Riders Vols. 1 to 6 (water damaged or worm eaten but serviceable). All replies answered. State condition and price. Itsuo Yano, 80 Lehua St., Kahului, HI 96732

**WANTED:** Data sheets for tube types KT-88 and KT-90, copies OK, will pay your expenses. Alan Schreier, WA5DJU, 12805 Powderhorn St., Austin, TX 78727. (512) 835-2056

**FOR SALE:** Webcor & Webster/Chicago 78 rpm record changers, new old stock, original boxes, not tested. Some available with GE magnetic cartridge holders, some with crystal cartridge holders. These had the reputation of being about the best record changer in the old 78 rpm days - \$20 each plus UPS. Ellsworth O. Johnson, 364 Coeurdalene St., Spokane, WA 99204. (509) 838-2161

**FOR SALE:** Assorted dog bone type carbon resistors from late 1920's or early 1930's. 1,047 new and 108 used. \$60 for the lot. Herman Fothe, 10 Jackson St., Sloatsburg, NY 10974. (914) 753-2090

**WANTED:** EICO Model 460 oscilloscope power transformer. P.N. 30015, 12 wires. Sam W. Wrenn, 2314 Seminole Dr. #1207, Arlington, TX 76010

**FOR SALE:** Victor Electrola VE-7-26 console, chassis Radiola 18 with dynamic speaker, all tubes and knobs - \$150. Victor VE-7-26 phonograph complete with all controls and magnetic head - \$125. Above items listed page 186 in Look for the Dog book. Plus shipping. J. J. Papovich, 53 Magnolia Ave., Pitman, NJ 08071. (609) 582-8279

**WANTED:** Type E-3 speaker (working) and round grille wire for AK 52 metal console. Bob J. Moretz, KI4EC, Caller Service 112, 1216 Blowing Rock Blvd., Lenoir, NC 28645. (704) 758-2383, day; (704) 758-1995, night

**WANTED:** 6F6G, 6C5G, 6A8G tubes N.I.B. I pay \$10 ea. for guaranteed good tubes. Also want 5Y3G, 6E5, 6U5, N.I.B. Need working, original shadow meter for Zenith 12A88. Will buy junker chassis if necessary. Looking for nice, original Zenith 7S232, 9S232, 12S265, 15U246, 12S245, 6S249. John Anderlie, 509-2nd Ave. S, Hopkins, MN 55433. (612) 566-4674, days; (612) 622-6655, pager (include area code) Thanks!!

**IF YOUR EXPIRATION DATE IS  
JULY OR BEFORE, RENEW TODAY!  
EARLY RENEWALS  
RECEIVE AN EXTRA ISSUE!**

**FOR SALE/TRADE:** Tuska 225. **WANTED:** See want list p. 36 March 1992 A.R.C. Bill Timoszyk, 35283 Leon, Livonia, MI 48150. (313) 421-2076

**FOR SALE:** Plastic reproduction dial lens for Emerson 520 and 375 - \$12.50 ppd. Others send sample or drawing. Doyle Roberts, HC63, Box 236-1, Clinton, AR 72031. (501) 745-6690

**WANTED:** Books on commercial radio broadcasting 1930's and/or 1940's. Books on home recording and (disc) commercial recording 1930' and/or 1940's. Chisl Chislowsky, 2947 Ave. V, Brooklyn, NY 11229

**WANTED:** Dial for Philco 60, repro or N.O.S. Got carried away cleaning! Julia Kay, 5 Fiske St., Worcester, MA 01602

**FOR SALE/TRADE:** Remler 5410 Scottie, white Bakelite with leatherette covering and handle. Prototype? David Brinkley, 1170 Neale Dr., Santa Rosa, CA 95404. (707) 575-4799



**WANTED:** Catalin radios by Motorola in any color combination and any condition (interred and exhumed OK). I am now paying 10% over top dollar plus shipping. Please write or call collect: Rain Buttignol, 214 State St., #7, Portsmouth, NH 03801. (603) 427-1384

**FOR SALE:** Test Equipment Circuit Manual (Middleton), ca. 1963, 191 pages, 97 instrument diagrams - \$40. Ellsworth O. Johnson, 364 Coeurdalene St., Spokane, WA 99204. (509) 838-2161

**WANTED:** Chassis or junker Zenith 5S119, 5S126 (A.R., p. 62), 5S127, 5S150, 5S151 (Blast, p. 178), 5S161, all chassis 5516. 7D119, 7D126, 7D127 (F.O.S., p. 193), 7D138, 7D148, 7D151, 7D162, 7D168, all chassis 5707. Also same models with 7DA—with chassis 5708E. 6S203 (Evolution, p. 196), 6S222 (F.O.S., p. 192), 6S223, 6S229 (Bunis #1, p. 167), 6S239, 6S241, all chassis 5638. Curt Schreiber, 3923 East Latoka St., Springfield, MO 65809. (417) 887-5184

**TUCKER SURPLUS STORE**  
1717 RESERVE STREET  
GARLAND, TX 75042

**TEST INSTRUMENT MANUALS  
FOR SALE!**

WRITE US WITH MANUFACTURER AND  
MODEL NUMBER.

**TUBES**

Tucker Electronics has a large inventory of new & "pulls" Tubes at attractive prices. Please send for prices and availability.

**LARGE SELECTION OF NEW AND USED TEST INSTRUMENTS.**

**WE SPECIALIZE IN HARD-TO-FIND, OLDER TEST INSTRUMENTS.**

**WRITE FOR INFORMATION AND FREE CATALOG!**

**WANTED:** Larkin, Larcoflex, Larcophone. I'm looking for products offered by the Larkin Co. of Buffalo N. Y., even a good photograph! Thanks. Joe Pawell, 6 Augustine Ave., Ardsley, NY 10502. (914) 693-9374

**FOR TRADE:** Trade only: German tube tester, prewar, very elaborate with manuals and socket adaptors for a mint Telefunken auto radio. Other prewar European auto radios considered. Wilford Wilkes, Box 103, Brinsbin, PA 16620. (814) 378-8526. Fax: (814) 378-6149

**WANTED:** Antique demonstration, scientific apparatus. Electrical and optical. Early microscopes. Allan Wissner, Box 102, Ardsley, NY 10502. (914) 693-4628

**WANTED:** Original or copy of Operating and Maintenance Manual for an RCA WO-33B oscilloscope. Will pay reasonable price for same. Paul Dilliard, 1313 E. Wheeling St., Lancaster, OH 43130

#### **CLASSIFIED AD NOTICE**

**Please check your ads carefully before sending them in. Once ads are received, it is not always possible to refund the amount sent, pull the ad or make changes.**

**FOR SALE:** RCA Victor R-32 console - works, cabinet exc., instruction book - schematics - \$130. Zeltan console & chassis, no speaker - \$45. Pick up only. Dick Desjarlais, Dick's Radio Days, Box 629, Littleton, MA 01460. (508) 486-9018

**WANTED:** Tube hi-fi amps, preamps, tuners, any condition. Xfmrs: Chicago PV200, Merit P3155, Triad R-21A or Thordarson 24R07U. Rick Graves, 4500 Ninth Ave. NE, #300, Seattle, WA 98105-4762. (206) 632-9929

**WANTED:** Cabinet for Kennedy 20 or VI. Ed Bell, 5311 Woodsdale Rd., Raleigh, NC 27606. (919) 851-1517

**FOR TRADE:** 1933 Scott instruction manual (copy) for copy of other old manual. John McDonald, 513 Whitnell, Murray, KY 42071

**WANTED:** Schematic for VHF marine FM radio Pearce-Simpson Bimini 1202. H. H. Sutherland, #3, 3333 S. Ridgewood, Port Orange, FL 32119. (904) 760-3198

**WANTED:** Original catalogues prior 1926 from Tuska, DeForest, Amrad, Kennedy, Crosley, Paragon, etc. Ed Bell, 5311 Woodsdale Rd., Raleigh, NC 27606. (919) 851-1517

**FOR SALE:** New tubes - \$3 ea.: 6AB7, 6BX6, 5W4, 6R7, 12AH7, 6K8, 12K8, 12SJ7, 14A7, 117N7, 1R5, 3S4, 1L4. Hy Ness, 709B Delair Rd., Cranbury, NJ 08512. (609) 395-1116

**WANTED:** Knight Spanmaster II shortwave receiver, circa 1970, or just manual/schematic for same. Alvin Bernard, PO Box 690098, Orlando, FL 32869-0098. (407) 351-5536

**WANTED:** Crystal sets by Giblin Radio Ear or Standard Radio Co. Paying more than anyone for this type of radio apparatus or what have you? Kent A. Ise, 224 Cowesett Rd., Warwick, RI 02886. (401) 885-7558

**FOR SALE:** Sams Photofacts, 291 sets between 121 and 613 - \$250 all. AR manuals, 149 books between 18 and 159 - \$3.50 ea. All plus UPS. Jack A. Freeman, 2512 Sunnycrest Dr., Reidsville, NC 27320

**WANTED:** Hallicrafters speakers. Horn speakers. Philco cathedrals. Zenith tombstones. Rider's #23. Western Electric, Sodian, brass based and tipped tubes (duds OK). Walter D. Ikes, Jr., N8NXT, 12485 Concord Ct., Plymouth, MI 48170-3036. (313) 459-1859

**MESSAGE:** The New England Antique Radio Club will hold its Summer Swap & Sell Meet, Sat. July 18, 1992, 8 am to 1 pm at Resurrection Center, Nashua, N. H. Over 100 tables! Hundreds of radios! 50/50 raffle! Two old equipment contests featuring TV's & Post-WWII crystal sets! For more info, call or write & be sure to ask for a free sample copy of the club newsletter. NEARC, RR 1, Box 36, Bradford, NH 03221. (603) 938-5051

# SWAP MEET

OHIO AREA ANTIQUE RADIO CLUB

AUGUST 2, 1992 \* 8:00 AM TO 4:00 PM

MORaine CIVIC CENTER

3050 KREITZER RD. DAYTON, OHIO

SET UP & ADMISSION FREE

INDOOR FACILITIES AVAILABLE \* OUTDOOR SPACES ON BLACKTOP

MORaine CIVIC CENTER IS ONE BLOCK WEST OF DRYDEN RD. ON KREITZER RD.

TAKE EXIT 50-A FROM I-75 SOUTH ON DRYDEN RD 1/4 MILE TO KREITZER RD.

INFO - JIM DIRUZZA - (513) 233-5004

HAROLD PARSHALL - (513) 298-4044 - DAYS

(513) 268-2909 - NIGHTS

**WANTED:** Cabinet for my Scott Imperial Allwave. Enclose picture. Earl Christiansen, 1428 Arden View Dr., Arden Hills, MN 55112. (612) 631-9560

**WANTED:** Pre-1950 ARRL Handbooks and HRO-50/60 coils G/J/AA/AB. Barry Nadel, Box 29303, San Francisco, CA 94129. (415) 346-3825

**FOR SALE:** Message: Travelers West find over 100 old and older radios at: Old West Antiques, WØCFL, 315 Central, Dolores, CO 81323. (303) 882-7911



**WANTED:** Silvertone Model 6402, table, plastic, midget, seriously seeking, please call or write. Richard Spratley, 2112 McLain St., Chesapeake, VA 23324. (804) 545-2402

**FOR SALE:** Shipping free! GE M-62 tombstone - \$105. GE T127 white plastic N.I.B. AM radio - \$50. RCA 56X3 wood - \$45. RCA 8X542 ivory plastic (Boomers, p. 268) - \$35. Philco 47-304 and 305 antique leather finish wooden - \$50 ea. Sentinel 343 brown plastic polished, restored - \$50. Silvertone repainted Model 1, restored - \$65. Zenith H615Z brown (G.O.R., p. 122) - \$45. Zenith B600, works - \$90. Zenith K731 wood - \$20. Send for complete list tubes, parts, novelties, etc. Stan Lopes, KB6LGV, 1201-74 Monument Blvd. Concord, CA 94520. (510) 825-6865

**FOR SALE:** Motorola 53H, green AM - \$65. Philco "Mystery Control" banner - \$35. Prices include shipping. Robert Burleson, 1731 Naudain St., Philadelphia, PA 19146. (215) 545-5726

**WANTED:** Pre-1958 transistor radios. My earliest so far is 1959. I would love to have any Regency TR-1, any color, any condition, must work. 1980 Zenith American-made (Chicago) Trans-Oceanic 7000. 1967 (1968?) Motorola AT25BN 6 tube. If anybody knows of a later tube radio, as always, let me know. Attention radio advertisement collectors: I am looking for advertisements for early transistor radios (Regency TR-1, Raytheon 8-TP-1, Zenith Royal 500, etc.) for wall display. Attention TV collectors: I have room for only one (1) antique TV, preferably a 1946 RCA 630TS, but anything before 1950 will do. Bryan Cowan, 4677 Cimarron Way, Roseville, CA 95661

**FOR SALE:** Zenith Royal 285, nice & works great - \$12.50. Jerry J. Schaefer, 932 North 4th St., Grand Forks, ND 58203. (701) 772-2991

**FOR SALE:** National NC-125, BC 221M, ZTO's, components for AC and AC/DC sets, used books, new and used tubes, new American-made capacitors. List available. Sue Coulter, 4200 Prince St., Bakersfield, CA 93301

**WANTED:** Need a good complete chassis with speaker for a U.S. Apex 7A cathedral, will consider selling cabinet. Thanks. Keith Dennison, PO Box 109, Victory Mills, NY 12884. (518) 695-6723

**FOR SALE:** Electronic books: 1952, Basic Theory and Appreciation of Radio Tubes, U.S. Army TM U-662 - \$7. 1951, Electrical Fundamentals, TM U-681 - \$5. 1951, Pulse Techniques, TM U-672 - \$5. 1974, Transistor Electronics, H1003 - \$5. 1961, Communication Electronics Math, TM 11-684 - \$7. 1970, Semiconductor Fundamentals - Philco Ford Laboratory Manual - \$5. 1962 Automatic Digital Computers (Philco) Laboratory Manual - \$5. EIA, 1958, Basic Electronics Radio-TV - \$5. EIA, 1965, Electronic Instruments Laboratory Manual - \$5. EIA, 1969, Electricity-Electronic Fundamentals Laboratory Manual - \$7. EIA, 1967, Basic Electronics (Z Bar) - \$7. EIA, 1969, Basic Radio: Theory and Service - \$10. 1968, Television Circuit Analysis, H34 Philco Laboratory Manual - \$5. 1954, USN Microwaves/Wave Guides - \$5. Plus \$1. postage/each book. J. J. Papovich, 53 Magnolia Ave., Pitman, NJ 08071. (609) 582-8279

**FOR SALE:** 1 3/8-inch Zenith bar knob - \$11 ppd. 15-inch Utah speaker V15P3 N.I.B. - \$35 ppd. J. Stueber, 8920 Lexington Ave. NE, Albuquerque, NM 87112. (505) 299-2414

**WANTED:** Working old Tesla coil - top price paid. Also, rotary spark gap. Rosenthal, 5 The Strand, New Castle, DE 19720

**WANTED:** L. Bamberger AC port. radio w/handle, circa 1941. D. Klein, 25 Trinity St., Danvers, MA 01923. (508) 774-2554. (508) 774-4179 Fax

**FOR SALE:** Old tuning condensers, Acme A-600, (as pictured in V.R., p. 163) - \$40 ea. Steve Pazar, 4950 Deerwood Dr., Santa Rosa, CA 95403. (707) 544-8142

**WANTED:** Case for a Philco 91 cathedral or similar with good front arch. Consider entire set for parts. Thomas Bisel, 2266 Halyard Ct., St. Louis, MO 63129. (314) 846-0025

**FOR SALE:** Hammond Solovox, ca. 1950's, converts your piano to a combination piano/electronic organ, with photocopy of instructions and service manual. This particular one was one of the last models manufactured and considered their best one, excellent condition - \$150. Ellsworth O. Johnson, 364 Coeurdalene St., Spokane, WA 99204. (509) 838-2161



**WANTED:** Rider TV schematics on a 1 to 13 channel Telequip 7-in. TV. Have Rider TV schematics pages 6-1 through 6-8 chassis 12TR, 14T, 14TR, 16, 16TR, 19T, 19TR, but are not the right schematics; also need back and six knobs for this same Telequip TV. Willing to pay for all of these items. Note: Have no chassis number for this TV. Radio & Phonograph Americana, c/o Leon R. Miller, 8110 E. 124th St., Bixby, OK 74008

**FOR SALE:** Arvin AC-DC-bat., tube portable, Model 852P, good condition - \$12.50 plus 8 lbs. UPS. John Uscinowski, RR #1, Box 379, Greenwich, NY 12834-9519

**FOR SALE:** AK 82 cathedral – \$350. AK Radiodyne breadboard, nice original with tags – \$1,450. Fada KO-C cathedral – \$200. Philco 16 cathedral, nice – \$325. Philco 610T and 38-620 round end table sets – \$85 ea. RCA R-73 tombstone – \$175. RCA 100-A speaker – \$35. Victor Borgia II, working – \$1,200. Victor VE-120 – \$200. Zenith 715, nice and working – \$350. Zenith S-829 chrome front tombstone – \$750. Edison cylinder records: 2-minute – \$4 ea., 4-minute – \$3 ea.; nice lot of Billy Murray and Uncle Josh – \$130/15. Radio Boys books, nice condition – \$40/5 ppd. **WANTED:** Zenith 10S-130 tombstone. John Hayes, 27 Highland Dr., Henniker, NH 03242. (603) 428-3053

**FOR SALE:** Loop antenna 1925 RCA, excellent copy, looks like original – \$125. Miniature crafted radio display as pictured with slight variations – \$20. Send \$1.50 for color picture of displays. Free shipping Continental U.S. Howard Page, 93 James Page Rd., Port Angeles, WA 98362. (206) 452-2407



**MESSAGE:** We want to thank Don Patterson for his kind words about our Extravaganza event in his recent Editor's Comments in the June 1992 issue of Radio Age. Don stated "I think good policy for clubs to use would be to limit events to no more than three days with one day to include Sunday. Most omit that day entirely. To me, the people in the Michigan club and Southwest Vintage Radio Society have the right idea. I am going to put them tops on my list." Yes, Extravaganza really does start on Friday, so please don't arrive early and spoil it for everyone else. For more information, write: Extravaganza '92, PO Box 585, Okemos, MI 48864

**FOR SALE/TRADE:** Belmont 5D144 white Deco, (same as Bunis II, p. 94) – \$20. Fada 5F50, white, (B.F.T.P., p. 225) – \$110. Toshiba 7TH-425, black, 1959, pinwheel design – \$200. Truetone D2615, brown Deco, (Bunis II, p. 188) – \$185. PDR Magic Tone glass tube whiskey bottle – \$275. Airline, small, brown, (Collins, p. 75) – \$75. Automatic Radio 602, brown, (Bunis, p. 32) – \$80. Stromberg-Carlson 1500H, white, (Bunis, p. 150) – \$55. Atwater Kent 944 cathedral – \$300. Philco Transitone push button, (B.F.T.P., p. 226) – \$50. Tower "adventurer" cast iron ship speaker – \$200. **WANTED:** Prewar plastics, Plaskons, unusual small radios by Detrola and Kadette, Catalin & colored Bakelite radios. Need dial pointer knob for Philco (see B.F.T.P., p. 249 center bottom). Have excellent parts for trade. Thanks! Mark Alzapiedi, 21 Peach Tree Ln., Leominster, MA 01453. (508) 840-0466

**FOR SALE/TRADE:** Novelties, California Raisin – \$30. Big Bird leaning on 1930's radio – \$33. Armchair Mickey – \$25. Mickey (Breed 116) – \$20. Mini cathedral – \$18. AM wristwatch LCD radio with micro headphones – \$35. All N.I.B. and shipping included. Nick Carrieri, 11 Kuni-gunda Pl., Islip Terrace, NY 11752. (516) 277-6438

**MESSAGE:** Antique Phonographs & Radio newsletter to start ASAP for Mid-Atlantic collectors seeking members for classifieds. Questions, comments and contributions to: Don Menez, 4117 Colonial Ave., Alexandria, VA 22309. (703) 360-3413

**MESSAGE:** Mr. Transistor announces another incredible first. It's the buy one get one free (BOGO) offer on the most collectible transistor radio in the world. **FOR SALE:** The mahogany (brown marble) Regency TR1. While the cost is extremely high, you'll get a working, near mint, set in its original box with papers. The freebie is in fine shape and would be an enormously valuable find in itself. Combined with the other, the buyer will obtain a large percentage of all known mahogany TR1s. These are important sets and only the most serious buyers should call. To add frosting to the cake, this month I'm also offering the Zenith 500 hand-wired collection. Each set represents one of the three iterations and are in superb shape and working perfectly. Once again, the sets are pricey. Other stunning collectibles include a perfect tan Motorola X15, a 6X31C in turquoise/white, a N.I.B. silver/grey Emerson 838 hybrid with leather case, a Philco T7, a GE P-746A in turquoise/white, a NEC NT-625 in white/gold, a Panasonic R-607 in black/chrome, two black Emerson 888 Vanguards, a Bulova 290P (Jet) in black, an Emerson 988 in black/white, an Arvin 61R58 in tan leather, a Five Stars MT portable (Japanese knockoff of an Emerson 747) in cream/burgundy. All these sets are in mint or near mint working condition. And I've got metal sets, cathedrals, tombstones, consoles and Catalins. All are restored and work like new. **MESSAGE:** You can now reach Mr. Transistor on The Collectors BBS as I'm the antique radio sysop. Just call (201) 635-4519 (2400-9600 baud) or (201) 635-6579 (1200-2400 baud) and say hello. Remember "Mister Transistor is radioactive." Henry B. Cohen, 2459 Eighth St., Fort Lee, NJ 07024. (201) 585-0030. Fax (201) 585-1659

**FOR SALE:** Notice: I will be bringing lots of nice portables and wood table sets to the Lansing Extravaganza. Some Zeniths, Crosleys and Arvins. A few nice TRF and very old homebrew sets. See me on July 10, 11, and 12. The Magic Eye-Classic Radios, Mike Clark, RR 2, Box 90, Franklin, IN 46131. (317) 738-4649

**VINTAGE TV & RADIO SUPPLY**  
3496 WEST 105TH STREET, CLEVELAND, OHIO 44111

**Our New Catalog  
Is Available!**

**Call or write for one.  
216-671-6712**

# ORDER THESE SELECTED Old Radio Collector Books FROM ANTIQUE RADIO CLASSIFIED!

*Every radio collector from the novice to the experienced should have a copy of this book:*



## GUIDE TO OLD RADIOS

A primer to collecting. 128 pages, 350 photos and 3300 current prices. 7" x 10". Johnson.

Softcover ..... \$16.95

*Price guide for over 7,400 battery & AC sets from 1920-1959:*



## A COLLECTOR'S GUIDE TO ANTIQUE RADIOS - 2<sup>ND</sup> EDITION

Collectors Marty & Sue Bunis have consolidated data from auctions, ads, flea markets, etc. in this beautifully illustrated price guide. Over 540 new color photos. 8 1/2" x 11". Bunis. Softcover ..... \$17.95

*A NEW guide to repairing vacuum tube and transistor sets:*



## OLD-TIME RADIOS! RESTORATION AND REPAIR

A self-paced training guide. History, theory and practical operation of antique and classic radios.

256 pages, 200 illustrations. 7" x 10". Carr. Softcover ..... \$16.95

*A book to help every collector get those old battery and AC sets playing again:*

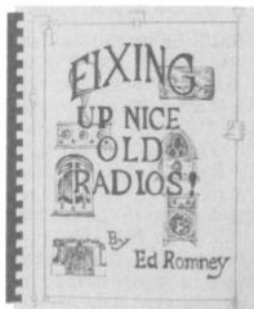

## FIXING UP NICE OLD RADIOS

Written by an old radio instructor. 185 pages, 300+ figures. 8 1/2" x 11", plastic binding. Romney.

Softcover ..... \$19.00

*Send payment with order. Enclose \$2.50 shipping for orders under \$35. VISA and MasterCard accepted; include card number, expiration date and name on card. Money back return policy. Most books shipped within 4 days, but allow 2 to 4 weeks to receive order. PRIORITY MAIL: \$5.00 per book. Mass. residents add 5% sales tax. Foreign orders - Write for shipping costs or use credit card and specify surface or air (foreign surface shipping is \$4.00 per book).*



**Send Order To: A.R.C., P.O. Box 2, Carlisle, MA 01741**  
or Call: (508) 371-0512

Fax: (508) 371-7129



(July-92)

# ORDER THESE SELECTED Old Radio Collector Books FROM ANTIQUE RADIO Classified!

*This book is a must for anyone collecting radios and crystal sets from the 1920s:*

*This book is a must for anyone collecting radios from the 1930s to the 1950s:*



## VINTAGE RADIO

Standard photo reference guide for radios before 1930. 1000+ pictures. 5" x 8". McMahon.

Softcover.....\$11.95

## NEW!

## Radios Redux

Subtitled "Listening in Style"

by Philip Collins

120 pages

80 Sets Illustrated

**SHIPPING NOW!**

\$17.95 - Softcover

\$29.95 - Hardcover



## FLICK OF THE SWITCH

Standard photo reference guide for 1930s to 1950s radios. 1000+ pictures. 5" x 8". McMahon.

Softcover.....\$11.95

*A must for collectors of 1920s battery sets:*

*For collectors of '30s & '40s plastic and other collectible radios:*



**RADIO MANUFACTURERS OF THE 1920s.** Douglas. 1920s battery sets. 8 1/2" x 11".

Vol 1. A-C Dayton - Ferguson... (softcover only) \$24.95

Vol 2. Freed-Eisemann - Priess ..... (\$39.95\*) \$29.95

Vol 3. RCA - Zenith ..... (\$39.95\*) \$29.95

(\* Hardcover Prices)



**CLASSIC PLASTIC RADIOS FROM THE 1930s AND 1940s.** Side'i. 200+ Catalin models in full color. 8 1/2" x 11"..... (29.95\*) \$19.95

**RADIOS - THE GOLDEN AGE.** Collins. Full color. 10" x 8 1/2"..... (\$25.00\*) \$14.95

(\* Hardcover Prices)

*Send payment with order. Enclose \$2.50 shipping for orders under \$35. VISA and MasterCard accepted; include card number, expiration date and name on card. Money back return policy. Most books shipped within 4 days, but allow 2 to 4 weeks to receive order. PRIORITY MAIL: \$5.00 per book. Mass. residents add 5% sales tax. Foreign orders - Write for shipping costs or use credit card and specify surface or air (foreign surface shipping is \$4.00 per book).*



**Send Order To: A.R.C., P.O. Box 2, Carlisle, MA 01741**  
**or Call: (508) 371-0512**

**Fax: (508) 371-7129**



(July '92)

**FOR SALE:** Batteries for antique radios!! Now available: 67 1/2v with snaps for portable radios. Rebuilt with fresh cells, guaranteed excellent - \$15/2. Also available: AA alkaline cells in strings of 10 for rebuilding your own battery packs - \$3/10. D alkaline cells in strings of 5 - \$4. Great for building large batteries or single cell use. Don't forget our 90v, 45v, 22 1/2v and other specialty batteries. Call or SASE to: S+G Electronic, 618 S. 62nd St., Philadelphia, PA 19143. (215) 474-7663

**MESSAGE:** You better not dress up to come to our "informal" Social Hour that takes place Saturday evening at Extravaganza '92 - rather come as our are! The highlight of the evening will come at 9 pm when we will raffle off a classic Zenith 9-tube Walton's radio to some lucky ticket holder. Each person registering for the meet gets one free Walton raffle ticket, and others can be purchased during the meet! In addition there are other prizes to be given away along with a schedule of fun and games to include a "Scott" toss! At the same time you will be able to enjoy the sounds of some big band music in the background. Be sure to bring your camera to take pictures of the outstanding Scott radios that will be on display at the same time in the same room. Lastly, we will announce the winner of the People's Choice contest award that was voted on the previous day. As you can see, our Saturday "informal" Social Hour is a fantastic and delightful way to spend your evening. Won't you come join us?! For further information, write: Extravaganza '92, PO Box 585, Okemos, MI 48864

**WANTED:** Any plastic or Catalin radios by Detrola, Sparton, Majestic, Kadette, RCA Little Nipper. Jon Steinhauser, 636 Westminster Rd., Baldwin, NY 11510. (516) 223-9878

**FOR SALE:** Field radar set PPS-4, complete with tripod - \$500. **WANTED:** Early radar equipment, units or complete systems. Also prewar oscilloscopes and CRTs. Allan Weiner, 14 Prospect Dr., Yonkers, NY 10705. (914) 423-6638

**FOR SALE:** McIntosh MC-60 with factory variable damping - \$450. McIntosh 20-W2 \$100. RCA AR-88F - \$75. HP 200ABR - \$40. HP 202ALF Function generator - \$35. B&K 1406 oscilloscope, very clean - \$100. All of the above with manuals. CBS SQ 4200 and SQ 2400B quadrophonic encoder and decoder, untested - \$40 both. HP 206A audio signal gen. - \$35. General Radio 1723A VTVM - \$12. Sherwood S-3000 II mono tuner - \$14. Scott 299 stereo amp, missing tubes, untested - \$12. Bulk-packaged 6AS7 tubes - \$1 ea., 6137 tubes (premium 6SK7) - \$8 ea. Thousands of TV tubes and many parts, new and used, please call or write needs. Add shipping. Haggling and trades welcome. Richard Matthews, 300 West 84 St., New York, NY 10023. (212) 874-0137

**WANTED:** Owner's manuals, advertising for a Kellogg Wave Master, Kennedy V, Sparton Equasonne 301, copies OK. James W. Walcher, 1311 Janet Dr., Wilmington, IL 60481. (815) 476-9184

**FOR SALE/TRADE:** (4) volumes GE Radio Communication Equipment, Sylvania 1950 TV Dealer's Manual, Sams, Riders. Scott Teichmann, 103 Pleasant, Jerseyville, IL 62052. (314) 256-6263

**FOR SALE:** McIntosh 225 amplifier, excellent condition - Best Offer over \$400. Barry McDaniel, PO Box 5544, Little Rock, AR 72215. (800) 755-3326, days

**WANTED:** Atwater Kent advertising items, company letters, breadboards and parts, and anything AK. James Moneghan, Jr., PO Box 176, Lincoln, RI 02865. (401) 728-5431

**FOR SALE:** At Radiofest '92, Elgin. Three 24' truckloads of tubes, radio parts, papers, books, and ham equipment from 1915 to current. This material represents the lifetime accumulation of a retired engineer who worked for RCA/NBC from 1940 to 1972, and who was licensed as an amateur operator in 1921. Dave McClellan, 1086 Trailridge Ln., Atlanta, GA 30338

## TUBES • PARTS • SUPPLIES YOUR COMPLETE SOURCE

### TUBES:

3000 audio, receiving and industrial types in stock, including early and foreign types. Discount prices!

### CAPACITORS:

High voltage electrolytic and mylar capacitors for tube circuits.

### TRANSFORMERS:

Hard-to-find power transformers, audio transformers, and filter chokes for tube equipment.

### SUPPLIES:

Chemicals, test equipment, wire, batteries, tools, etc.

### LITERATURE:

Extensive offering of literature and books on antique radios, hi-fi, communications equipment, tube data, and circuit diagrams.

### PARTS:

Resistors, lamps, tube sockets, potentiometers, grill cloth, knobs, vibrators and more.



*"Write or call for our 32 page wholesale catalog"*

# ANTIQUE ELECTRONIC SUPPLY

6221 S. Maple Avenue, Tempe, AZ 85283, Phone (602) 820-5411, FAX (602) 820-4643



**FOR SALE:** Philco 48-1256, large tabletop radio/phone - \$30. 201XX and 38-4 (chassis and speaker only) - \$50 each. Master/remote intercom - \$30. RCA 1023C coin-op hotel radio BC/SW, works great - \$50. 9K chassis and speaker - \$50. Radiola 82/GE H-51 highboy, very good, plays - \$200. Craftsman 800A tuner, excellent - \$45. Magnavox 50's 2-speaker AM/SW/phone, excellent radio, good console. Heath GR-91 comm. receiver - \$20. Need room - Make Offer. Bill Rogers, 13305 Court Ridge Rd., Midlothian, VA 23112. (804) 744-3955

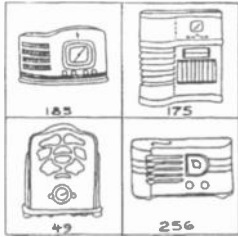

**WANTED:** The pictured radios and other unusual Emerson wood radios manufactured prior to WWII (model numbers under 500). Also seeking any Emerson advertising materials and literature. Have all kinds of stuff to swap or will buy outright. Call or send description. Mark V. Stein, 822 Guilford Ave., Suite #130, Baltimore, MD 21202. (301) 366-3823

**FOR SALE:** 75S-3C round, SW xtals, spkr, manual, serviced by Collins tech - \$650. Levy, 8 Waterloo, Morris Plains, NJ 07950. (201) 285-0233

**WANTED:** Gonset G-76. Ten-Tec PM3. VFO 80-10 meters. Chris Schlotz, K2PGB, 15 Runyon Mill Rd., Ringoes, NJ 08551. (908) 782-7414

**MESSAGE:** 15% Off sticker price of antique radios and electrical equipment if you bring this issue of A.R.C. to Burlington Antiques and Art Center, Route 6, Burlington, Penn. (between Towanda and Troy in Bradford County). Open Thursday, Friday and Saturday 10 am - 4 pm and Sunday 1 pm - 4 pm. Brooks Eldredge-Martin, RR 2, Box 359, Ulster, PA 18850. (717) 888-9349

— WANTED —  
**PICTURES FOR PHOTO REVIEW  
 PHOTOS MUST BE SHARP IN DETAIL  
 A SHORT DESCRIPTION IS A MUST!  
 SEE PHOTO REVIEW PAGES FOR  
 ADDITIONAL INFORMATION**

**FOR SALE:** Transistors: Sony TR-610, G.I. Joe 1982. Radios: Zenith 6S632 wood tabletop, Motorola 1935 6-tube car radio, RCA chassis RE-18-A, GE Mickey Mouse phonograph, Clarion early 1960's 4-transistor tape recorder, Precision Apparatus Model 860 multirange selector. Paper: books: Radio Girls on the Program, Penrose, 1922; Principles of Radio for Operators, Atherton, 1945. Radio Digest Illustrated 6/23/23, GE World News with Edison on cover 12/7/23. Program: Radio Amateurs Convention, Stockton, California 9/4-6/37. Paul Gonsowski, 106 N. Ferry St., Schenectady, NY 12305-1611. (518) 393-6421

**FOR SALE:** (5) Brass based, tipped, UV201A's - \$15 each. **WANTED:** Chassis for the following, Zenith 10S160, 8S154, 7S53, Simplex Model K. Escutcheon for Crosley 167 (Bunis II, p. 52) or similar power transformer for Crosley 156. Larry Schichtel, 319 Fulton St., South Waverly, PA 18840. (717) 888-5078

**WANTED:** Schematic and/or tube layout for a Philco #89 chassis and a National Ham radio Model #S101. Harry MacMullan, 2662 Bancroft Dr., Aston, PA 19014

**WANTED:** Zenith/CRL literature, prefer originals, but copies OK. William Wade, 657 14th Ave., Prospect Park, PA 19076

**FOR SALE:** Zenith Model 6D311 - \$175. Guild Spice Chest and Lantern radios - \$90 each. James Kroegel, 856 Old Farm Rd., Columbus, OH 43213. (614) 864-8327

**WANTED:** Rider's radio manuals Vols. 16 through 23. Phil Boydston, 102 Concorde Pl., Mandeville, LA 70448. (504) 845-0867

**WANTED:** Old meters, galvos, scientific instruments, open frame motors; old electrical books, any subject. Ye Olde Meter Cellar, Leonard W. Cartwright, 113 Sea Terrace Way, Aptos, CA 95003. (408) 662-2977

**FOR SALE:** Jewell #560 analyzer, with 2 good 430 tubes - \$50. SASE for list. Mike Prague, 40 Loomis Ave., Watertown, MA 02172. (617) 924-6146

**FOR SALE:** Riders Nos. 6 through 13 - \$15 ea. or \$100 for all eight. Riders TV #1 - \$35. **WANTED:** 4-pin coil forms, grooved ceramic 1 1/2" diameter, 3 1/4" long. Also 4-pin Bakelite Octo coil forms mfg'd by Shortwave and Television Company. Parker Heinemann, W1YG, 87 Cove Rd., Lyme, CT 06371. (203) 434-7783

**WANTED:** Copy of manuals for Lafayette HA-700, HA800B, National RCE, Precision E-200-C, Realtone Globepacer; Heathkit T-2, T-3 signal tracers. Tom Provost, 19 Ivanhoe Dr., Robbinsville, NJ 08691. (609) 259-7634

**FOR SALE:** Bristol Type A amplifier - \$125. Daven radio MU-20 tube, N.I.B. - \$25. National SOJ-1 - \$25. Harvey Wells TBS-50 transmitter - \$100. Jack Smith, 288 Winter St., N. Andover, MA 01845. (508) 686-7250

## BUYING!

★ 1920-1924  
 Battery Sets ★

Amrad, Clapp-Eastham,  
 Cutting & Washington,  
 De Forest, Federal, Grebe,  
 Kennedy, Marconi, Paragon,  
 Radiola, Tuska, AK, Leutz,  
 Crosley, Crystal Sets, and  
 Horn Speakers.

Serious collector. Will  
 consider others and entire  
 collections. Can travel.

**Ed Bell — 5311 Woodsdale Rd.  
 Raleigh, NC 27606  
 PH: 919-851-1517**

**FOR SALE:** Radios, console & table models. SASE for list. F. Vaillancourt, PO Box 601, Woodstock, VT 05091. (802) 457-1331

**FOR SALE:** Kids are all married and we should sell this big barn of a house. However, wife says basement electronic equipment is not leaving quickly enough. So, I'm cutting prices even more on stuff that hasn't moved: Heath TC-3 tube tester, works, roll chart, no manual - \$20. Elderly audio generator, black wrinkle case - \$15. Mallory 3-gang inductor 54-216 MHz - \$10. Philco 50-260 parts set - \$10. Allied radio headphones, 4k - \$8. RMS VHF video booster - \$10. Johnson CB Matchbox, mint - \$8. Turner 99 Hi-imp dynamic mike - \$15. Books: RCA Schematics 1950-51 TV's - \$12. Beitman TV-17, 1960 - \$5. Coyne TV Cyclopeda - \$5. All items plus UPS except books, which are postage prepaid. R. J. Eastwick, N2AWC, 224 Chestnut St., Haddonfield, NJ 08033. (609) 429-2477

**WANTED:** QST Oct. '37, Feb. '38, Aug. '40, June '42. Radio Oct., Nov., Dec. '27. WE 348A & 351A tubes. Rodney Schrock, 402 Lincoln St., Somerset, PA 15501

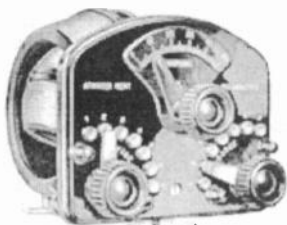

**FOR TRADE:** Will swap my AK mounted variocoupler (shown in photo) for your AK Type 11 tuner. **FOR SALE:** Philco 42-KR3, refrigerator-top white painted wood deco - \$65. RCA 100-A mantle speaker, works - \$35. **WANTED:** Sodian DR-6 by Conn. Tel. and Elec., AK Model 555 square, lift-top radio, Spraton 1930 console Model 235 "Ensemble." Dave Crocker, 60 South St., Duxbury, MA 02332. (617) 582-2052, before 9 pm please

**WANTED:** Still looking for Packard Bell 5R1's (G.O.R., p.121). Let me know what you have color & price. Also, want corresponding clock radio 5RC1 (Boom 4:150), (Sams 372-11), any color. Packard Bell 531 (same as 5R1 but metal grille. Any advertisements pertaining to above models. Motorola 53H1. Philco 48-230 or 49-503. Thanks. Kenneth D. Burton, 399 S. San Antonio Rd., Los Altos, CA 94022. (415) 948-5344

**FOR SALE:** Philco wood table Model 42-350 with BC, SW, FM, AC, works. Zenith Trans-Oceanic Model T600 with operating book, SW, works. Speaker Peerless wood cone cabinet. Pat Bailey, 551 Carlton Ave., Millville, NJ 08332. (609) 825-2468

**FOR SALE:** Philco signal generator Model 7200, works, no manual - \$40. Variac powerstat 120/140VAC, 10 amps, receptacle w/fuse, near mint - \$40. Plus UPS. Stephen Bonino, 197 Georgetown Rd., Glassboro, NJ 08028. (609) 881-0244

**WANTED:** Replica Edison light bulb and base. Earl Stump, 15 North May Ave., Athens, OH 45701. (614) 593-6420

**FOR TRADE:** Radios for old brass bladed electric fans. **FOR SALE:** Mitchell bedlamp radio - \$35. Dave Friedlund, 36006 S.W. Bald Peak Rd., Hillsboro, OR 97123. (503) 628-1439

**FOR SALE:** Zenith gold tube shields, 1 1/2 inch diameter - \$5 ea. Airline #14BR-514B, brown, (Bunis, p. 17), fair - \$55. Ten good used #80 tubes - \$4 ea. Philco 46-350 roll-top lid - \$25. Mercury 1000 mutual conductance tube tester - \$30. Dial cord stringing guide Vol. #1 - \$15. Zenith #G-723, good, (Bunis #2, p. 210) - \$25. Zenith #6-D-525 (Bunis #2, p. 201), fair - \$30. **FOR TRADE:** Kiss transistor radio with box for Philco clock or sign. Rick Yerke, PO Box 392, Moscow, PA 18444. (717) 842-4857

**FOR SALE:** Tubes, some N.I.B., some not. 250TH, 100TH, 3B22, 717-A, 829B, 4X150A, 3B28, 4-65A. Half AR list price. Xtal Dow FS-6 2670 Kc - BO. Crosley TV J-21CKBFN - BO. **MESSAGE:** Thanks Paul Bourbin and Michael Haria for 666 TT charts. **WANTED:** Have nice Coronado console with automatic tuning. Need complete set of knobs (5 or 6) and 16 push buttons. Cabinet Series A2-6, chassis #C7812 or A2331397 and instructions. Would appreciate any information on this radio. Can't find in my books. James Smith, KB7LBY, 113 E. Jefferson, Riverton, WY 82501. (307) 856-9304

**WANTED:** E.F. Johnson millimeter. Collins speaker, vernier knob. EV664 mic. **FOR TRADE:** GE K50. Brian Roberts, 3068 Evergreen Rd., Pittsburgh, PA 15237

**FOR SALE:** Audio and electronics books, tube amps, transformers, parts. Send for list. **WANTED:** UTC LS-10 and LS-10X. Richard P. Robinson, 868 South Main St., Plantsville, CT 06479. (203) 269-4465, Fax (203) 294-1745

**FOR SALE:** Power transformers, N.O.S., OP-580VCT-275mA, 5V-2A, (3) 6.3V-2.2A, 6.3V-1.2A - \$10/3. OP-12.2VCT-6A, 8.5V-5A - \$10/3. OP-24VCT-8A or 12V-16A - \$18, \$50/3. OP-40VCT-1.5A - \$3, \$10/4. OP-48VCT-3A, 15VCT-1A, 25VCT-2.5A - \$10/3. Sockets: octal - \$4/8, miniature 7- or 9-pin - \$3/9. + UPS. LSASE. Thousands of great buys. Fertik's, 5400 Ella St., Philadelphia, PA 19120. (215) 455-2121

**WANTED:** Any of the following: Dynamic mutual conductance tube testers, Hickok 6000A, Hickok 539-B, Triplett 3444-A, Sencore MU150, Eico 666 or 667. Paul M. Williams, 2364 Beaver Valley Pike, New Providence, PA 17560-9622. (717) 786-3803

**FOR SALE:** Volumes of Rider's Radio and TV manuals, only - \$3 ea. G. Fender, PO Box 639, Escatawpa, MS 39552. (601) 769-3826

**FOR SALE:** Blonde EV Aristocrat and Bogen Model DB130 hi-fi amp like new with papers - \$100. **WANTED:** Silvertone 1207 and Realtone TR 1088 transistor radios. Russell King, 10 Home Ave., Terre Haute, IN 47803. (812) 235-0698

#### CLASSIFIED AD NOTICE

Please check your ads carefully before sending them in. Once ads are received, it is not always possible to refund the amount sent, pull the ad or make changes.

**WANTED:** Stromberg-Carlson 601 and 501 tuning gears, Abbey Splitorf Jr. chassis cover and a Grebe AC-7. Ken Martin, 12667 Eckard Way, Auburn, CA 95603. (916) 885-0243

**WANTED:** Complete restorable chassis, escutcheon, and knobs for Philco 60B or complete parts set. Also small knob for Crosley 10-138 series, any color. Rod Galloway, 2220 Woodbury Rd., Melbourne, FL 32935. (407) 254-0280

**FOR SALE/TRADE:** Small table: RCA 8X521 blk. - \$50. Emerson 578A wood - \$50; 548A blk. - \$60. Silvertone #1 metal - \$60. Firestone S-4702-7 marbled - \$50. Large table: Zenith H511F grn. - \$90; 4K422 - \$75. Olympic LP-162 wht. - \$60. Spartan metal wood grain cab. with chrome trim - \$150. Bendix 110/0526 - \$60. Crosley 10-136E red w/gold trim - \$150. GE 400 red marbled - \$80. Philco 48-250 - \$50. N.I.B. Toshiba 8TH-428R - \$50. Wood: Philco 610 - \$150. Delco R1125 - \$60. Freed NR-6 - \$75. Echophone 70 - \$250. Stereo equip.: Leak ST20, point one & tuner - \$300. Dynaco N.I.B. kit QSA-300 - \$400; ST-400 - \$300; ST-150 meters - \$250; PAT-5 - \$60; PAT-4 - \$50. Mike Virtue, 3464 Aquamarine Dr., Rockford, IL 61102. (815) 963-4930

**FOR SALE:** Convair RC bridge and signal tracer, both nice - \$10 ea. Rada chron[?] & ERLA clock cathedrals - BO. TV-7 tube tester - \$35. Blue early Universal transistor - \$25. Red plastic Philco Transitone, unusual & nice - \$30. Swirled plastic Corsair radio - \$30. Blue & white plastic Motorola 50's Deco. **WANTED:** Pilot radios, any model, any condition. Bill Moore, 3049 Box Canyon Rd., Huntsville, AL 35803. (205) 880-1207

**WANTED:** 5" x 7" x 3" aluminum chassis. Electronics Illustrated, June 1961. Electronics World, October, December 1961. Al Bernard, PO Box 690098, Orlando, FL 32869-0098. (407) 351-5536

**WANTED:** Original owners manual for 1959 RCA All Transistor Globe-Trotter portable radio; Models IT5J or IT5L. Mike Hanke, 1036 So. 15th Ave., Wausau, WI 54401

**FOR SALE:** Freshman Masterpiece, all good tubes, built-in speaker untested, exc, (Bunis, 2nd ed., p. 82) - \$100. Home brew Neurorodyne with Fada Neuroformers units, 5 all good tubes, 3 tuning dials, exc workmanship - \$65. Ferdinand Estree, 660 Fineview Ave., Kalamazoo, MI 49004. (616) 344-0231

**FOR SALE:** Capacitors for sale; Electrolytic 4.7 uf 450v Rad - 75c, 10uf 400v - 75c, 10uf 500v - \$1.10, 22uf 160v - 80c, 22uf 160v Rad - 70c, 22uf 400v Rad - \$11.0, 20uf 250v - \$1, 47uf 200v Rad - 90c, 47uf 250v Rad - \$1, 60uf 200v - \$1, 100uf 160v - \$1.20, 100uf 160v Rad - \$1.10, 100uf 250v - \$1.40, 100uf 250v Rad - \$1.30, 4700uf 35v Rad - \$2, 6800uf 35v Rad \$2.25. Capacitors marked Rad are radial, not marked are axial. Mylar capacitors 400v .01uf - 30c. .33 - 45c ea., 630v .0012 - 30c, .047 - 40c, .22 - 60c. Orange drop capacitors .1600v, .0015uf, .004uf - 50c. 10% off over \$20, flat shipping rate of \$3. Robert Nicholson, 4 Superior Ave., #47, Toronto, Ontario, Canada M8V 2M4. (416) 252-4838

**FOR SALE:** Sony PV 120-U 2" reel-to-reel video corder, practically unused, for parts or repairable. Free Majestic Model 91 cabinet for pickup. **WANTED:** KT66 tubes. Heathkit W5M and AA 40 amplifiers. Good RCA Radiotron UX226 and UX 171-A tubes. New 6F6-G tubes. Heathkit Model IO-105 oscilloscope for parts. Carlton Carver, 303 Magnolia Dr., Washington, NC 27889. (919) 946-2358, eves.

**WANTED:** Zenith Trans-Oceanic Models 7G605, G500, and Hallicrafters R-48 speaker, good or better condition. John Stitzer, 708 Roberts Ter., Marshalltown, IA 50158. (515) 752-6351

**FOR SALE:** Radios, SASE list. **WANTED:** SECO Electronics Model 1000/3000 customer-operated tube-tester schematic. Tom Tetzlaff, 23 Nelson Dr., Silver Bay, MN 55614

**FOR SALE:** Like new 78 rpm AC motor, turntable and pickup arm from Majestic 181 radio/phono console - \$25 includes UPS. Also available, 2-transistor Mickey Mouse radio (ears are knobs) from early '60s; looks fair, kinda works - Make Offer. **WANTED:** Still looking for GE Tunnel Diode Manual. Jim Wood, 5936 Plateau Dr., Felton, CA 95018. (408) 458-0552, days

# Active Antenna

**Model AA10**

**Only \$34.95**

Allows antique radios which were designed for a long wire outdoor antenna to operate on a 42" indoor whip antenna. Operates from 9 volt battery.

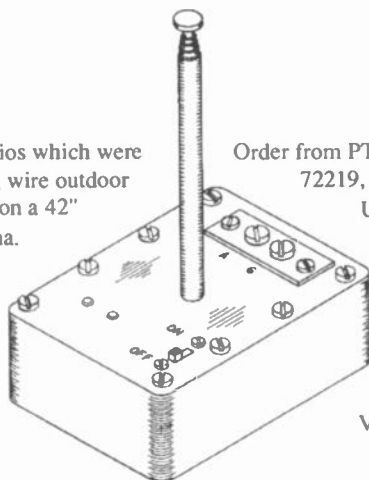

Order from PTI, Box 191117, Little Rock, AR 72219, (501)568-1995. Orders shipped UPS, prepaid in continental U.S. Please allow 3 weeks for delivery. Arkansas residents add 5% sales tax.

Visa and MasterCard accepted

**WANTED:** Rudy Vallee and Paul Whiteman memorabilia. Pictures of items will be gladly returned. David Edyvean, 2508 Campbell Ave., Schenectady, NY 12306

**WANTED:** Any crystal set. Collection now at 263 pieces; seeking more. Erwin Macho, Ambrosweg 17/A/8, A-1230, Vienna, Austria

**FOR SALE:** ARRL Radio Handbooks for years 1948, 49, 51, 53, 63, 65, 66, and 67. Most in good to excellent cond. Asking \$10 each. Rhyne Killian, 4 Walter Cir., Westford, MA 01886. (508) 392-9943

**FOR SALE:** Philco floor model 41-315 Code 121. Zenith table model H724. Fisher 500C stereo FM multiplex receiver - \$300 or Best Offer. Joe McCloskey, 548 Brook Rd., Milton, MA 02186. (617) 698-0159

**FOR TRADE:** Have list of earphones to trade for ones I need. Send your list. Gilferd L. Baker, 112 Pearl St., Box 139, Emden, IL 62635

**WANTED:** Brown Zenith Royal 400, maroon Royal 300 and aqua Royal 200. Jack Philpot, 632 E. 160th Ct., South Holland, IL 60473. (708) 596-0580

**FOR SALE:** Wireless Age magazine: Vol. 1, Nos. 1-9, 1913-1914; Vol. 2, Nos. 1 & 6, 1914-1915; Vol. 3, Nos. 2, 3, 4, 9, 1915-1916. Excellent condition. Asking \$275. E. Hansen, 221 Follen Rd., Lexington, MA 02173. (617) 862-5922

**WANTED:** Working or not. Gibson and Fender tube amps, Rhythm box, reverb units. 6EU7 tubes, older model non-pedal steel guitars. Cecil J. Wallace, The Steel Player, 2408 W. 5th St., Washington, NC 27889. (919) 946-1793

**WANTED:** National NC-80, SW-4, SW-45, SW-58 & RME 9D - cash or have nice trades. Also, sell me your RAS speaker/coil panel or buy my nice RAS-4, 7 coil sets & rack power supply (HRO-JR). Robert Enemark, W1EC, Box 1607, Duxbury, MA 02331. (617) 934-5043

BUY • SELL • TRADE

# CATALIN RADIOS



I'll buy single pieces or  
whole collections. Top prices paid.

**RADIOART**

Jim Meehan  
P.O. Box 102 • Centerbrook, CT 06409  
(203) 873-3360

**WANTED:** Chassis for Crosley Model 148 and also chassis for Zenith Model RH/RH4/CH4/L/A4/B4/C4. Also speaker and enclosure for Philco metal radio Model 511. Contact: Gary J. Formica, 823 91st St., Niagara Falls, NY 14304. (716) 283-2274

**FOR SALE:** Atwater Kent Model 325 chassis with all tubes, speaker and glass dial cover with escutcheon. The power transformer and a resistor terminal strip are missing. As is - \$35 plus shipping. Transformer supplied for \$15 extra. This chassis also subs for AK Model 145. Tested tubes - \$2. Miniatures and sub-miniatures are ppd. All others are 98¢ for the first tube and 46¢ for each additional one. Send LSASE for list. Power supplies, 5, 12 and 13.6 volts in a variety of current ratings, reasonably priced. Send me your needs. The guts out of Philco battery eliminator, ca. 1925. The transformer has been rewound to use an 80 tube (not supplied) to replace the glass jar rectifiers, supplies, fixed and variable B voltages. \$25 plus shipping. Enameled copper magnet wire sizes #27 and smaller - \$5 a pound plus shipping. Send LSASE for list. Elmer H. Thom, 11717 Kingfisher Ln., Saint Marys, OH 45885-9335. (419) 394-1104



**WANTED:** Emerson Catalin Models BT245, AU190 (pictured), 375, 564, and AX235 in any color combinations, perfect or parts condition. Please write or call collect: Rain Butignol, 214 State St., #7, Portsmouth, NH 03801. (603) 427-1384

**FOR SALE:** Philco Model 6P1-6P2 AC-DC. Zenith Model A424W. Silvertone Model 2225. Grundig Yacht Boy 210. Russell Schoen, E7340 Nietzke Rd., Clintonville, WI 54929. (715) 823-6744

**FOR SALE:** Limited quantity of the classic 1957 Chevy AM/FM, cassette, red, N.I.B. - \$65 plus \$5 shipping. Earl Christiansen, 1428 Arden View Dr., Arden Hills, MN 55112. (612) 561-9560

**HELP:** Need info on Trav-Ler wood table radio, 5 tubes, electrodynamic speaker and no IF transformers. Jack Philpot, 632 E. 160th Ct., South Holland, IL 60473. (708) 596-0580

**FOR SALE:** Speakers: Burns 205B Dictogrand R-3 (copper horn), N&K 12" round/paper, RCA UZ-1320, Rico Tri-Pole, Rola Re-Creator, Utah 16" round/wood, Utah 7" high/rubber, Vogue #12. Battery sets: Radiola 20, Radiola 25, Westgale 61P w/original speaker-manual-tubes (all good), Zenith 27 (Super 8). Consoles: Fada #KW (Flash-o-Graph), RCA RAE-59, Spartan #18. Misc.: Set Riders Radio Manuals Vols. 1-15 (1-5ab), Samson #2 Glass Battery, Seeburg 100 wallbox, RCA 7BX10 Strato-World, Zenith 6D520?, Zenith 5R216, Radiola 17 & 18 & 60, AK 42. Akai GX 260D reel-to-reel. All nice condition. Bob Baker, 35326 Shenadoah Dr., Shingletown, CA 96088. (916) 474-1650

**WANTED:** Tubes, schematic, info for Siemens K32-GWB WWII German troop entertainment radio. John Newman, 822 Laurelwood Ct., San Marcos, CA 92069-1851. (619) 471-0034

**FOR SALE:** Military AC freq. meters BC221AH and TS174U—\$35 ea. shipped. J. M. Stueber, 8920 Lexington Ave. NE, Albuquerque, NM 87112. (505) 299-2414

**FOR SALE:** New transformers, primary 220/240 volt 50/60 Hz. Secondary 115 volt at 175 VA. step up/down. Lot of five — \$11.50 ea. Ten lot — \$10.50 ea. Twenty-five lot — \$9.75 ea. Plus shipping. Northwest Electronics, 2509 West 11th, Eugene, OR 97402. (503) 485-3016

**WANTED:** Cabinet for AK 33. Escutcheon for United Delco console RC1. Cabinet for S53. Thank you. James E. Inglett, Rt. 1, Box 206, Midway, AR 72651. (501) 431-8430

**WANTED:** Zenith 6-volt DC radio Model 6-B-107 or 4-B-106. Also 6-volt DC farm radio. George M. Bonanno, 34 Charles St., Clifton, NJ 07013. (201) 746-5953

**NOTICE TO ALL  
CLASSIFIED ADVERTISERS!  
OUR CLASSIFIED AD DEADLINE IS  
12:00 NOON  
ON THE 10th OF EACH MONTH**

**FOR SALE:** AK 20 with E2 speaker, 5 good 201A tubes, (brand match) A 10+ inside excellent cabinet. Zenith: Has 8T01 chassis large dial in front of speaker in center of brown beautiful cabinet. A 10. **WANTED:** Philco 40-155. Cabinet must be good. Shelby STS, William L. Clark, RR 2, Box 60A, Shelbyville, MO 63469. (314) 633-2297

**FOR SALE:** Communications receiver collection, 18 receivers. Hallicrafters Super Seven, SX-16, Howard 430, 435, Meissner Traffic Master home-brew Hdbk regenerative superhet, Hammarlund HQ-150, many others. Other old items. Prefer pickup of entire lot. Best offer. Ray Moore, 116 Walnut St., Walpole, MA 02081. (508) 660-1481

**WANTED:** Pay \$400 for complete SCR-274N sets, \$450 for complete ARC-5 sets. Sam Hevener, W8KBF, The Signal Corps, 3583 Everett Rd., Richfield, OH 44286

**FOR SALE:** Crosley 51-S, nice and original — \$120. General Television 1A5, leatherette case, same chassis and trim as Catalin — \$60. RCA 100 speaker driver only, no cabinet — \$25. Red Hollywood toy TV with filmstrips — \$90. WLS tennis racquet, needs restringing! — \$15. Add for shipping. **WANTED:** Majestic Six AC-DC set, Model 411. Interesting trades available. Steve Baron, 435 Park Ave., Lexington, KY 40502. (606) 269-2832

**FOR SALE:** 888 Pioneer — \$50. H-126 — \$75. 5R312 — \$100. 6J257 — \$150. (Pickup only) S-38B — \$45. 6G001Y — \$45. 6D015 — \$50. H-723 — \$40. Philco 42-350 — \$60. JVC TV, round — \$125. (3) Royal 500's — \$55 ea. Truetone Sessions BT-407-WC, old clock radio — \$65. Philco clock-timer — \$40. **WANTED:** Zeniths: 5G442, 5G441, 6D455, 6P430, 7S445, 6J436, 8S531, 7J142, Merritt Livingston, 616 N. Canadian Ter., Mustang, OK 73064. (405) 745-4974

**WANTED:** Information about General Motors Radio Corporation and any info about my 110 mA cathedral. Lou Youngren, PO Box 122, Jennerstown, PA 15547. (814) 629-9093

**WANTED:** Art Deco 1933-34 Majestic console radio Model 776, name the Lido. Please send a picture to: John A. Checchio, Jr., 806 East Indiana Ave., Elkhart, IN 46516. (219) 295-7230

**WANTED:** Hi-fi tube equipment & speakers for the 40's, 50's & 60's. McIntosh, Marantz, Altec, Scott, Dynaco, Heath, Fisher, RCA, Grommes, Western Electric, Jensen, JBL, Tanny, Electro-Voice. Some guitar amps for Fender, Vox Gibson. Sonny Goldson, 1413 Magnolia Ln., Midwest City, OK 73110. (405) 737-3312

**FOR SALE:** Antique radio/furniture restoration and maintenance products and supplies. Send LSASE for price list, product list and brochure explaining the proper use of each product. **WANTED:** Magazines: Radio Craft, Radio News, or Radio Review 1930's or older. Plastic, wood radio knobs interested in all kinds and quantities. GC radio dial belt sets. Jerry's Antique Radio, 2191 Graham Cir., Dubuque, IA 52002. (319) 556-3050

**WANTED:** Dynaco tube equipment working or not. Send condition and price. Bruce Brown, RR 1, Box 50, Valley Springs, SD 57068

**WANTED:** Dial mechanism including brass gears for tuning condenser for 15-tube Philco 38-116. Or will buy complete chassis. Carl Bryant, 269 Melbourne Way, Lexington, KY 40503. (606) 278-7355

**FOR SALE:** Consoles/pickup. Bremer Tully Model 81 — \$100. Eveready 54 — \$150. GE H-31 — \$100. Many others. Earl Russell, WR1Y, 98 Skyfields Dr., Groton, MA 01450. (508) 448-5822

**FOR SALE:** 1926 RCA Victor Radiotrons Selling Fool advertising figure, excellent condition — \$875. Novelty radios: Hamburger Helper, Welch's Grape, Nachos Corn Chips — \$35 ea. KMPC radio, Dodger's baseball, Polaroid with box — \$12 ea. Seagrams Cooler, AM Coke bottle, Nestle's Souptime, Tilex shower — \$18 ea. Sun Oil Co. gas pump, with headphones and original box — \$65. Atlas Battery, full size, '50's — \$275. Have others, call. Frank Rose, 1600 Olympic Blvd., Santa Monica, CA 90404-3805. (310) 450-1731, days; (818) 789-1106, evenings, weekends



**FOR SALE:** Riders Original Radio Manuals, Red Vol. I, Vol. II, III, IV and V, and Riders Television Manuals Vol. I, 14, 15, 16 and 17. For the lot — \$200 plus shipping. Joe Povich, 630 Dunellen Ave., Dunellen, NJ 08812. (908) 968-2833

**WANTED:** Knobs and amplifier unit for Blaupunkt Frankfurt X-416752. Howard Hartzell, RD 1, Box 1022, Glen Rock, PA 17327. (717) 227-0459

**FOR SALE:** GE 635 leather A-1, Arvin RE200 poor, 2581 vg, plastics, Zeniths F728, N508B, N615W, GE T1225, C4100. Air King A511-2, Heath GR-78, Gonset 3002 poor. Bearcat U2 with 453MHz. xtals, 2-Sola CVS 120v, 9-amp line stabilizers — \$100 ea. RCA WP24A isol. transformer. Precision Electronics 200, AF-RF sig. tracer. WWII items T17D, T30V mikes, Collins 23270 rem control. KS10376 galvo. Pot Box L&N for W.E.1., Vic 20, IBM 5182-1 vg color 17" printer — \$75. Weston 615 FC meter, 5 B&L spec. 20. Hawkins Mechanical Dictionary 1925, leatherette, gold edge. Hawkins-Audel 10 Vol. Electrical Guide 1924, nr. mint. Ron Brokloff, PO Box 811, State College, PA 16804

**FOR SALE:** Day-Fan 5 - \$65. Stewart-Warner 300 - \$65. Federal E-10 - \$85. Crosley 516 - \$75. General Electric 212 - \$40. Motorola 79XM218, green - \$45. RCA 56X2 - \$30. RCA 65X1 - \$30. Zenith J615W - \$45. Rider's 1-5 abridged, 6-14 - \$200. All plus shipping or can deliver to Elgin. **WANTED:** Front panel for Tuska 224. Chassis panel and audio transformers for DeForest F-5. Don Sturzenbecher, Rt. 3, Box 28, Sioux Falls, SD 57106. (605) 368-2135

**FOR SALE:** New summer issue. Send for our catalog: old radios, test equipment, parts - \$2 ppd. Northwest Electronics, 2509 West 11th, Eugene, OR 97402. (503) 485-3016

**WANTED:** One tuber: Kodak C11, Kellogg. Sub-Mt portables: Privatear, Hoffman BP402 & Westinghouse H508P4. Radiola I, 24, 25, 60 & Special (1 tube). RCA UZ1320 speaker. Gilfillan GN-1&2. Rider's Radio Vol. 19 & 21. TV 3, 4 & 5. Knobs for SX-28. Knobs & front panel components for WE 4B. UV199/C299. Sodiion tubes S-11, 14&D-21. WE 205D, 216A, 239A & 264A. Noriyoshi Tezuka, 1-10-7-807 Higashigotanda, Shinagawaku, Tokyo 141, Japan. Fax 011-813-3440-8396

**FOR SALE:** Wizard microphone in broken box - Best Offer. Home brew crystal set - \$75. Crystal detector in glass - \$30. Small Sparton wood radio (?) - Best Offer. Two tipped light bulbs, open - \$10 ea. Operating instructions for Recordio with two blank records - \$15. Charles Juedemann, 262 Churchill Ln., Ballwin, MO 63011. (314) 256-3727

**WANTED:** Kitchenaire table radio by Radio Craftsmen from 1946. Send condition and cost to: Gary Arnold, 615 Oak St., Marion, NC 28752. (704) 652-6893

**FOR SALE/TRADE:** Catalin Emerson 520, green. **WANTED:** Bakelites, Catalins, parts, also Philco 70 escutcheon. Ross Litrenta, 1 Wilton Rd., Eastchester, NY 10709. (914) 337-7176

# CATALIN CARE

**FOR CATALIN RADIOS ONLY !**

Bring back that luster and deep marble shine to a "Like New" Appearance.

Catalin Care removes fine scratches and abrasions.

Enhance and increase your radio's value \$\$\$.

Send \$19.95 for a 4 oz. bottle of Catalin Care ppd. to:

Midwest Broadcast Service  
P.O. Box 190133  
St. Louis, MO 63119

**FOR SALE:** Many types of radio, TV, and industrial tubes. DH Distributors, PO Box 48623, Wichita, KS 67201. (316) 684-0050

**WANTED:** Help: Need Riders Radio Volumes #17, 20, 21. Please call or write. Chuck Alexander, 4933 Del Monte Ave., Sarasota, FL 34235

**MESSAGE:** Will the person with the "mint" 3000 Zenith Trans-Oceanic at the May 16th SCARS Flea Market at Torrance, Ca., please call me. **WANTED:** (2) knobs for Emerson Model AX-212 (A.R.C. March '92, p. 9), prefer original - repro OK. Don Mier, 4009 N. Foxdale Ave., Covina, CA 91722. (818) 338-9225

**FOR SALE:** Hallicrafters TV, 1940's, has Channel 1 selector. Hoffman portable radio. Military radios: MX-128-ART-13, receiver BC 342-N, transmitter Type CAY52239, P20-ARC-5, Western Electric BC 454B. Best offers plus shipping. Jim Webb, 15117 Hamlin St., Van Nuys, CA 91411. (818) 769-6738

**FOR SALE:** Zenith Y615G, gray EC - \$75. Telechron 8H59, white - \$35. Westinghouse H-310TS, white - \$30. Airline GTM-1200A - \$25. Zenith Royal 750 - \$25. Zenith Royal 790 - \$25. RCA BP-1 - \$30. Sentinel 309, white small - \$40. Aetna, rare - \$35. Emerson 823, white EC - \$30. Emerson 165B, small - \$25. **WANTED:** Crosley Buddy Boy. Sonny Goldson, 1413 Magnolia Ln., Midwest City, OK 73110. (405) 737-3312

**WANTED:** Bendix radios wanted. Need not work. Call or write. Aaron Mall, 903 Dropleaf Ct., Baltimore, MD 21208. (410) 486-8813

**FOR SALE:** Operating manual for Solar Capacitor Analyzer Type CB & CC, copy - \$3.50. John Schehrer, 58 Gray, Joplin, MO 64801. (417) 781-4028

**FOR SALE:** Patent Notes for Engineers, Tuska - \$7. Principles of Electric and Magnetic Circuits, Boast - \$8. Transients in Linear Systems, Vol. 1, Gardener and Barnes - \$10. Principles of Radio Engineering, Glasgow - \$7. All postpaid, U.S.A. Bob Dennison, W2HBE, 82 Virginia Ave., Westmont, NJ 08108. (609) 854-3301

**WANTED:** AK 84 cathedral and Lyric Mohawk table set, circa 1931. Michael Katz, 3987 Daleview Ave., Seaford, NY 11783. (516) 781-6202, after 7 pm

**FOR SALE:** Philco 60 cathedral, good original finish, hums - \$125. Freshman Masterpiece, refinished, very nice, working - \$75. GE M-50 tombstone, BC/SW, nice original, working - \$85. Paul Roche, 7368 Eden Brook Dr., #634, Columbia, MD 21046. (410) 381-0471

**FOR SALE:** Proc. IRE complete from April 1942 thru Dec. 1963 - \$300 plus shipping. Joseph Dunlap, 325 N. Ridgeland Ave., Oak Park, IL 60302. (708) 383-5037



Doug Heimstead  
1349 Hillcrest Dr.  
Fridley, MN 55432  
(612) 571-1387

**WANTED !**  
Radio Retailing &  
Radio Today Magazines.



**FOR SALE:** Approx. 250 Jensen N.O.S. needles, mostly 78 rpm, (list available) - \$75, includes shipping. Alan Ford, 1238 Academy St., Scranton, PA 18504. (717) 347-4218

**FOR SALE:** Sonar SRT 120 TX - \$95. Bristol-Donle tubes, 1920's tubes, 1925 home-brew RX - \$75. Dual 813 RF deck - \$150. Stu Mount, K2OA, 35 Grand St., Highland, NY 12528. (914) 433-7714

**WANTED:** I'm looking for someone who can collect and send to Italy the radios I require against cash payment or exchange with Italian or European models. Fax me at 011 +39 131 235854 to make arrangements. Federico Rimonti, PO Box 19, 15040 Castelceriolo AL, Italy

**WANTED:** CU-286/FRR-33 antenna coupler. WWII German military radio equipment. Accessories. Why?  
**FOR SALE:** Morse keys, mostly WWII military. European tubes. British Army W.S. 58. W.S. 38. W.S. 19. Ragnar Otterstad, OZ8RO, Hosterkobvej 10, DK-3460 Birkerød, Denmark. Tel. 011-45-42 81 52 05

**FOR SALE:** Nordemende Electra C D-128, 4-band, tuning eye W. Germany - \$120. RCA Victor 6B5 small battery portable - \$110. Admiral 4Z12 portable w/case & instructions \$125. RCA Victor 4RH-11, x'tor - \$90. Motorola XP-69BE x'tor w/case - \$75. Relax 6TP-315 x'tor w/case - \$75. Zenith Royal 275 x'tor - \$90. Regency TR-6 x'tor - \$125. Federal Telephone & Telegraph headphones 53-W - \$75. Zenith Gold Eagle Radio Log book w/blank card stock pages - \$40. Arvin RE-278, metal - \$100. Two small, 4" x6" x 1.5", metal wall-mount telephones w/watchcase receivers - \$200. Radio Magazines 40's to 80's - 2-stamp LSASE for list. All plus UPS. Take care. Chuck Bray, 1322 Ivy Rd., Bremerton, WA 98310

**FOR SALE:** General Radio Model #724-A wavemeter. This is in like-new condition, great instrument of the past - \$199.95 plus shipping. Northwest Electronic, 2509 West 11th, Eugene, OR 97402. (503) 485-3016

**FOR SALE:** RCA 66X13, beautiful wood case - \$50. Motorola 67X12, white - \$30. Zenith Trans-Oceanic 5H40 - \$40. RCA R7 Superette tombstone, big, with original grille cloth - \$90. StarLite transistor World Globe, very nice! - \$50. Grundig 2520U with tuning eye - \$30. **WANTED:** Neutrowound radios with blue or red case. Majestic 381 Treasure Chest radio. Emerson 300, L559. Super Airline GX-201A tubes with the gold-colored glass. Jeffrey Viola, 475-B Eltone Rd., Jackson, NJ 08527. (908) 928-0666

**FOR SALE:** Collins Radio: Manuals R-392, KWM-380, 651S-1, 75A-4 and advertising. R-392 speaker. 100IKC plug in crystal. Collins 50-volt, 14 amp power supply. Collins Model 100A power supply. U.S. Army radio compass. Model 508 IMC isolation amp. Booton 190-A Q meter. Booton 250-A RX meter. Collins color-coded wire and rack. 21" rack cabinets. Collins pen and pencil set, new - \$25. Collins winged LoGo's - \$25 each. 3' Nipper the dog, new, mint - \$450. Bill Coolahan, 1450 Miami Dr. NE, Cedar Rapids, IA 52402. (319) 393-8075

**WANTED:** White plastic cabinet for a 1951 Zenith H615-W (G.O.R., p. 122), in excellent condition, no cracks or chips, will take junker set with a good cabinet. **FOR SALE:** 1928 Majestic console radio in excellent condition - \$225. Robert Schrantz, 610 E. Juanita Ave., San Dimas, CA 91773. (714) 394-1194

**WANTED:** Figural radios, Mickey, Snow White, Charlie McCarthy, etc. Prefer original non-repaired. Howard Whitelaw, 9400 Steinway, Cleveland, OH 44104. (216) 439-2159

**FOR SALE:** Emerson Mickey Mouse - \$1,350. Pilot Dragon cathedral - \$225. AK 627 cathedral - \$375. (Radiola 5, GE version, nice!). Kent A. Ise, 224 Cowesett Rd., Warwick, RI 02886. (401) 885-7558

**HELP:** Please furnish information on how to run string on Mark Twain novelty...will sell same. Cleo McAlexander, Box 4, Stanleytown, VA 24168. (703) 629-2972

## ARBE\* — III

### \* Antique Radio Battery Eliminator



#### FEATURING:

- Adjustable high current "A" supply
- 8 different "B" and "C" voltages
- 5-year limited warranty

~ \$149.95 Shipped ~  
within continental U.S.A.  
(Michigan Residents add 4% sales tax)



Call or write for complete data sheet:

Antique Radios Inc. - P.O. Box 6352, Jackson, Michigan 49204  
Phone 517-787-2985, after 7:00 PM EST

**WANTED:** Philco T-9 transistor Trans-Oceanic type set. Zenith black face tombstone and Zenith cathedrals. David Martin, 1502 Wood Thrush Way, Marietta, GA 30062. (404) 578-1279

**FOR SALE:** 1000's of tubes, new and used, old and odd. Also, 8 1/2 x 11 reprints of 1920's Day-Fan service manuals, brochures and instruction booklets. Also several hundred N.O.S. metal can capacitors. Send SASE for lists, or see me at the ARCO auction and swap meet August 29 in Dayton, Ohio. Jim Cross, 2817 Parklawn Dr., Dayton, OH 45440-1538. (513) 298-5827



**WANTED:** GE Model K85, complete or any portion. Also interested in other models with same chassis: GE K80, K80X, RCA 140, 141, 240, 340. Fred Smead, 31 Chapel Rd., Amherst, MA 01002. (413) 253-2784, after 5 pm

**FOR SALE:** AK Model 12, No. 4910 breadboard, speaker not included - \$775 firm, will ship. J. Whitesel, PO Box 924, Hastings, NE 68902. (402) 463-2588

**FOR SALE:** Echophone, Model S-5, nice 8-tube cathedral works well - \$195. Airline, Model 62-293, movie dial, 13-tube, twin speaker console, looks good, missing tubes - \$175. Fifty or more clean original sets available, thinning my collection. Sorry no shipping; come see my inventory! Dickering done here. All inquiries to include SASE. Francis Pond, 98 High Rd., Lee, NH 03824. (603) 659-3831, no calls after 9 pm EDT

**WANTED:** Manual or copy for Heathkit VTVM Model IM-21. Help. Carlos Gimenez, 15091 Shamrock Dr., Fort Myers, FL 33912. (813) 482-0198

**WANTED:** Aircraft radios and instruments and industrial electron tubes. Hy Ness, 709B Delair Rd., Cranbury, NJ 08512

**FOR SALE:** Federal French style telephone, working, nickel plated brass with hard rubber trim, ca. 1915, a nice complement to your Federal radios - \$175. Richard Mountjoy, 1915 S. 39th St., No. 44, Mesa, AZ 85206. (602) 926-8174

**FOR SALE:** 1 meg pot, tap at 200K with switch, 2" round AL shaft, N.O.S. - \$8.30 ea. 500K pot with switch, N.O.S. - \$5.25 ea. **WANTED:** Olson's (Akrad) Radio Catalog of Akron, Ohio. Frankenstein's Radio Laboratory, 4010 Fairmont Pkwy., Suite 285, Pasadena, TX 77504. (713) 998-0130

**WANTED:** HH Scott 399 tuner amp, chassis for Bosch 260C, G, F & E coils for HRO-5, SM AFT#256. Ed Allison, 5525 20th Ave., Sacramento, CA 95820. (916) 454-1788

**WANTED:** Hallcrafters SX-62, or SX-62A, or SX-62B, or SX-105. **FOR SALE:** Two Hallcrafters S-119, one very good the other ain't. Both play well. S-40A looks decent but does not play. S-94 good condition. Hallcrafters CB-3A Littlephon, condition unknown. Will include microphone and new S meter accessory "free." Loren H. Dudley, KA1PRV, 14 Valley Rd., Bath, ME 04530. (207) 442-8419

**WANTED:** Books. Modern Radio Reception 1928 edition. Short Waves, 1930. By Leutz. Ed Bell, 5311 Woodsdale Rd., Raleigh, NC 27606. (919) 851-1517

**WANTED:** RCA radio-phono consoles: D22-1, D11-2, U-109. Will consider any condition but prefer good unrestored. Charles Degges, 11730 Moffitt Ln., Manassas, VA 22111. (703) 791-3065, after 9 pm EDT

**FOR SALE:** These consoles can be delivered to Elgin or Kansas City. Airlines: 48A - \$40; 93WG1001A - \$47.50; AE-10 - \$85; 1920's lowboy - \$80. American Bosch 260 with tuning meter & twin speaker - \$60; 1930's lowboy - \$60. Kingsbury lowboy - \$60. Sentinel 3113725 - \$45. Zeniths: 10S464 - \$135; 10S567 - \$125. RCA's: 8K - \$65, R78 \$100; Radiola 80 - \$50, 87K - \$50. Spartan 966 - \$75. Philcos: 38-3 - \$65; 19-89 - \$65; 71 - \$75. Silvertones: 4784 - \$42.50; 4584 - \$55; 1930's lowboy - \$35. U.S. Apex 28 - \$85. Victor RE57 - \$85. Truetone red, white, blue dial - \$100. GE's F-75 - \$65; G-56 - \$45; Delco - \$65. AK 70 - \$75. Philco Predicta - \$70. John Lyle, 1161 S.W. Mulvane, Topeka, KS 66604. (913) 232-0128

**FOR SALE:** MacIntosh 20-W-2. EM Stereoscope (1" CRT) tube control center preamp. Marconi tube RLC bridge, very nice. McMurdo VTVM with tube probe. McMurdo signal tracer. Pair only. Gen. Radio 732-b noise & dist. meter exc, heavy. Make offer. Scott 314 stereo tuner, missing one knob - \$35. Bob Gaulin, 82 East 2nd St., New York, NY 10003. (212) 673-7366

**WANTED:** Crosley Gemchest 609, 1929, red-painted metal console, flamingo grille, and false hinges. Gerald Schneider, 3101 Blueford Rd., Kensington, MD 20895-2726. (301) 929-8593

**FOR SALE:** New old stock transmitting tubes: 3E29 - \$12, 866A - \$11, CWL 803 - \$25, 3C24 - \$30, 808 - \$20, Hy-69 - \$25, CRC 814 - \$20, 837 - \$6. All plus shipping. Bids accepted on following: JAN800-VT64, 826-SC961A, Klystron 2K-28, GL810-SCIS30A VT4C, 7094. Also Taylor tubes in original cartons 3-T21, one-T25, one-TB35, one TB20. Maurer Television, 29 South 4th St., Lebanon, PA 17042. (717) 272-2481

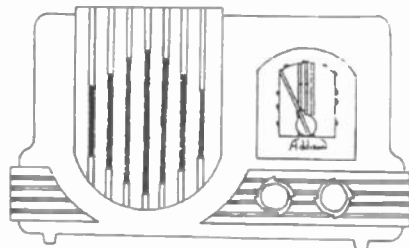

**WANTED:** Addison radios wanted by collector. I'm hooked on Addisons and will buy or trade whatever it takes. Don't wonder if you got the best deal for your Addison, call me before you sell/trade your set. I will treat you fairly and honestly. Tom Ducro, 6805 Palmetto St., Cincinnati, OH 45227. (513) 271-0156, call collect, machine after four rings

**FOR SALE:** GE H639 table R/P - \$45. See HJ624 (G.O.R., p. 85) for look-alike. Don Baldwin, 26 Schoolhouse Dr., Medford, NJ 08055. (609) 654-0344

**FOR TRADE:** Grebe MU-1, superb; trade for interesting Edison, Columbia stuff, any condition. Léon Brassard, 2272 Aladin, Laval, Quebec, Canada H7K 1M2



E · H ·



## HISTORICAL SOCIETY

It is with pleasure the E. H. Scott Historical Society announces its first public meeting. This first meeting will be at the MARC EXTRAVAGANZA in Lansing, Michigan on July 11, 1992 during the informal social hour.

Several special events are scheduled for those individuals interested in E. H. Scott Radios.

Meet Marvin Hobbs, Chief Engineer E. H. Scott Radio Laboratories. Mr. Hobbs will be on hand during the social hour to answer questions on the history of this company.

23 Tube Imperial in a Tasman cabinet, fully restored, will be auctioned with the proceeds going to benefit the E. H. Scott Historical Society. Auction time will be on Saturday morning, July 11.

Memberships in the E. H. Scott Historical Society will be available to the general public at this meeting. Membership includes subscription to the SCOTT NEWS, the society's journal.

The SCOTT NEWS, the first reissuing in 40 years and the society's journal, will be available to interested parties at this meeting.

Mark your calendars now to be at the MARC EXTRAVAGANZA 1992 in Lansing, Michigan.

For more information contact: John T. Meredith, Director, EHSMS, 1792 Nemoke Trail, Haslett, MI 48840 (517) 349-4348. After August 1, 1992, contact: E. H. Scott Historical Society, P.O. Box 1070, Niceville, Florida 32588-1070

The SCOTT NEWS, the SCOTT Stradivarius of Radio Receivers symbol, and the name of this society are under copyright and are trademarks of the E. H. Scott Historical Society with duplicating prohibited unless by permission.

**FOR SALE:** Crosley 10-136E. Silvertone AM/SW. Fada Special, parts missing. Simplex & Ellsworth cathedrals. Antique flashlights. SASE, photo list. Doug Koehn, 609 S. 15th, Quincy, IL 62301. (217) 228-2115

**FOR SALE:** 1. Hallicrafters Model S-120, good shape, works - \$35. Zenith radio Model H-500 Trans-Oceanic, good shape, great (no book of manual) - \$75. 3. DeWald AM&FM tuner, untested - \$10. 4. Chevrolet car radio, 6-volt tubes, light, as-is (1940?) - \$25. 5. RCA radio chassis Model 610, AM OK, FM weak, no cabinet, with tubes, working, also have knobs - \$20. 6. Fisher Radio Corp. AM & FM radio and phono, floor model chassis #J-10, Ser. #7804, 1955 yr., works - \$75. 7. Zenith Radio Corp. AM & FM radio and phono Model H880, floor model, works - \$30. 8. Westinghouse radio Model WR368, floor model, works - \$150. 9. Montgomery Wards Airline AM & FM radio and phono Model 84BR-2719A, works, cabinet needs refinishing - \$25. 10. Philco table radio, brown plastic, Model 51-532-123, excellent condition - \$75. 11. RCA radio chassis, Model K-9, have tuning eye and front panel from cabinet, no knobs or speaker; chassis looks good shape, needs cleaning up; (2) blown electrolytic caps, untested, all tubes in chassis - \$25. 12. Mantola radio, brown plastic table radio, Model R664PM made by RCA for B. F. Goodrich Co. - \$50. 13. Zenith 24" B&W TV, Chassis 22120, Model 2574R, fully restored, works great, cabinet like new - \$250. 14. 24CP4 B&W picture tube, weak: rebuildable - \$25. All plus UPS or freight. David C. Lyons, 623 Carlson St., Sycamore, IL 60178-2401. (815) 895-6862

**WANTED:** Pilot TV ads/manuals/literature. Mitchell radios/appliances. Grey speaker for NC-125 receiver. Lee Mitchell, 875 North Michigan Ave., 3412, Chicago, IL 60611. (312) 266-7100, 337-3123

**FOR SALE:** Publications, manuals, catalogs, etc. SASE for list. Phil Whitney, Rte. 2, Box 231, Stephens City, VA 22655

**WANTED:** Collins 32V-3 transmitter. Fenton Wood, KB5VQ, 109 Shoreline Dr. S.H., Malakoff, TX 75148

**WANTED:** Knight-kit of any type pre- or postwar, need DXer, R-195 solid-state receivers, any condition. Jack McCreary, 7783 Wildcreek Trail, Huntsville, AL 35802. (205) 882-0037

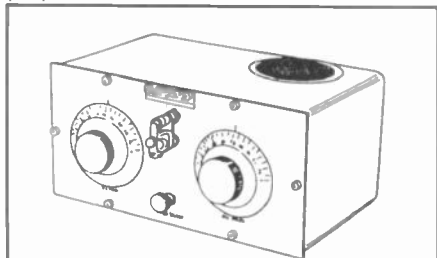

**WANTED:** Pre-1926 radios by AMRAD. Also, Amrad radio parts, accessories, and literature. Richard Sharisky, PO Box 521, Belmont, MA 02178. (617) 484-5784

**WANTED:** Model #U-9 RCA Victrola, 1940. Must be in working condition. Gerald C. Smith, 715 Frierson Lane, Kingstree, SC 29556. (803) 354-7150

**FOR SALE:** Crosley XJ, working - \$165. Philco 60, excellent original condition - \$160. Frank Hagenbuch, 1440 Lafayette Pkwy., Williamsport, PA 17701. (717) 326-0932

**SERVICES:** Repairs of all small radios, tube, transistor. Normal \$35 plus parts, UPS shipping. Ted LaFlaur, 52333 Av. Bermudas, LaQuinta, CA 92253. (619) 564-1687

**FOR SALE:** Macintosh stereo FM tuner, Model MR67, Serial #126T4 - \$250. Seth Ward, KC3YE, 83 Ruthred Dr., Pittsburgh, PA 15241. (412) 835-6603

**WANTED:** Atwater Kent Type 11 tuner. Pay up to \$200. Jerald Hueber, 1368 King Richard Pkwy., W. Carrollton, OH 45449. (513) 866-6958

**FOR SALE:** Sams transistor service manuals 40-155 less 11 volumes - \$150 + UPS. Allen Jochem, 2205 Broadway, Quincy, IL 62301. (217) 223-6751

**WANTED:** Still looking for Radiola 21. Bryan Durbal, N8RPY, 2447 W. Duncan, Highland, MI 48357

**FOR SALE:** Paragon operation manual reprint, 1924, 35 pages - \$15 ppd. D. Hauff, Box 16351, Minneapolis, MN 55416

**WANTED:** H. H. Scott tube tuners, amplifiers, and related paper, any condition. John Byrns, 4390 N. Cottonwood Trail, Hoffman Estates, IL 60195. (78) 202-1394

**FOR SALE:** Sampson 460 DVM, excellent condition, the first DVM made by Sampson - \$90 or offer. Heath triggered oscilloscope, factory wired works - \$50. Sidney Goldhor, 2147 Trombas Ave., San Leandro, CA 94577. (510) 357-3788

**FOR SALE:** AK 10C breadboard, good condition, original - \$850. Shipping extra. Will Jensby, 645 Giannini Dr., Santa Clara, CA 95051. (408) 296-6071

**WANTED:** Photocopies of owner's manuals for RCA Victrola U9, Automatic Radio 614X, Stromberg-Carlson 345-M. Doug Fox, 603 S. 12th Ave., St. Charles, IL 60174. (708) 584-5915

**FOR SALE:** Send \$1 (refundable) for large photo radio list. Items from 1920's through 1960's. Robert A. Warren, Church St., PO Box 279, Waverly, PA 18471. (717) 587-2405

**FOR SALE:** Rider's I to XXII with Index - \$275 + UPS. Richard C. Foster, 12 Shawmut Ave., Cochituate, MA 01778. (508) 653-2418

**FOR SALE:** PHONO NEEDLES & CARTRIDGES (ceramic - magnetic). What do you need? Send SASE. J. J. Papovich, 53 Magnolia Ave., Pitman, NJ 08071. (609) 582-8279

**WANTED:** FM converter, auto type. Made by Ford. Circa 1958-65. Closed out by Radio Shack. Radio and Wheelcover World, 2718 Koper, Sterling Heights, MI 48310. (313) 268-2918

**SERVICES:** We will rebuild and return prepaid, wet capacitors at \$9 each; and twist loc capacitors at \$9 to \$14, not exceeding 450 volts. FRONTIER ELECTRONICS, Everett Hoard, Box 38, 403 South McIntosh St., Lehr, ND 58460. (701) 378-2341 (Recorder on 4th ring.)

**WANTED:** Transistor radios with built-in watches. **FOR SALE:** Bendix green and black Catalin - \$625. Lee and Carolyn Bruton, 1140 S. Reed Unit E, Lakewood, CO 80232. (303) 937-7325

**FOR SALE:** Majestic 90B chassis & spkr, working. Philco 112 or 212, working. Trans-Oceanic H500, 8G005YT, working. Robert Rossi, 10936 Melbourne St., Allen Park, MI 48101. (313) 386-8321

**WANTED:** National FB7 or SW3 coils. C. G. Rainville, 3209 5th Ave., Castlegar, British Columbia, Canada V1N 2V6. (604) 365-2387

**FOR SALE: Jukebox Collector Magazine (sample \$3, subscription \$30), 2545 S.E. 60th Ct., Des Moines, IA 50317. (515) 265-8324**

**WANTED:** Tube shields for Philco 90 and Crosley Model 160. Dale Kinstler, W1361 Aasen Rd., Bangor, WI 54614. (608) 486-2589

**FOR SALE:** Two dozen radios, hundreds of paper items, parts, junk. Send SASE for list. P. Majewski, PO Box 92, Tamaqua, PA 18252

**FOR SALE:** Rek-O-Kut N33H turntable, wood base, outside belt drive. - Cash or trade radio. Mike Parker, 945 S.E. Linn St., Portland, OR 97202

**SERVICES:** Loudspeaker reconing. Contact: Sound Remedy, 331 Virginia Ave., Collingswood, NJ 08108. (609) 869-0238

**FOR SALE:** Philco 620, good condition - \$65. Zenith 3000-1 Trans-Oceanic, no cover - \$35. Gary Pirkkala, 2306 Audley Ave., New Castle, PA 16105. (412) 658-0534

**FOR SALE:** Eico ST70 - \$75. Heathkit IM-11 VTVM - \$15. SASE for details, tubes and transformer list. D. Weiss, 7305 Reynard Ln., Charlotte, NC 28215

**WANTED:** Philco 47-1227 knobs and dial. Philco 38-4 knobs. Philco 41-296 bezel. Richard Pauley, 14 Highbanks Pl., St. Cloud, MN 56301. (612) 252-0145

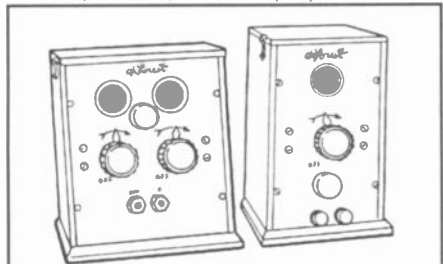

**WANTED: DEFOREST and RADIOCRAFT sets, SP-1, SP-3, SP-4, DT-600, DT-700, DT-800. Top \$ paid. Richard Sharisky, PO Box 521, Belmont, MA 02178. (617) 484-5784**

**WANTED:** Midwest 24-tube "Royale," 18-tube "Imperial," other Midwest 18+ tube consoles of the mid 1930s. Chuck Dachis, 4500 Russell Drive, Austin, TX 78745. (512) 443-5027

**WANTED: MARTIAN BIG 4 OR LITTLE GEM. PAYING ASKING PRICE. CONTACT DENISE LEMOAL, 5757 WESTHEIMER, #3139, HOUSTON, TEXAS 77057. (713) 680-8102 Fax, (713) 680-8110 phone**

**WANTED:** Two good audio transformers for my Crosley 3R3 Tridynd, for reasonable price. Thanks for your help, and a special thanks to those who responded to my letters concerning this radio. Lloyd A. Noel, 494 Clark St., Galesburg, IL 61401. (309) 342-2825

**FOR SALE:** Zenith Oceanics, fair to good overall condition T600, not working, no suction cups - \$28; Y600, working - \$48; vg B600, working - \$87. Prices include shipping. **WANTED:** Grille and wavemagnet to brown case 600L Oceanic. Cord to broadcast wavemagnet 8G005YT. Gregory Sheppard, KA3DBG, 4402 Jupiter St., Rockville, MD 20853. (301) 946-6460

**FOR TRADE:** Very rare Casio Model TV-10, the first B/W LCD pocket TV, for Regency TR-1. Bill Ross, 875 Gordon Terrace, Winnetka, IL 60093. (708) 441-6462

**SERVICES:** Radio restoration by collector, expert work guaranteed. **WANTED:** Assorted collections of radio parts. Dave Dameron, KG6BP, 819 Boundary Pl., Manhattan Beach, CA 90266-6621. (310) 318-5311

**FOR SALE/TRADE:** 1935 RCA AR60 rcvr, 1920's tubes. S. Mount, 35 Grand, Highland, NY 12528. (914) 433-7714, or K20A

**FOR SALE:** Voice of Music tube-type stereo reel-to-reel, Model 722, with matching extension speaker/amp. 1962 model with mikes, adapters, cords and all paperwork incl. Sams service notes, excellent working cond., looks great - \$325. Thomas Crocker, PO Box 11582, Glendale, CA 91226. (818) 246-4757

**WANTED:** Dashboard faceplate for 1949-50 Chevrolet auto radio, Models Automatic C-300 or Firestone 4B57. Vintage Electronics, Jack Shaymow, 52-C Tilford, Deerfield Beach, FL 33442. (305) 427-1222

**FOR SALE:** Hundreds of military manuals & handbooks. Send 29c stamp for list "5/21/92". Rainy Day Books, PO Box 775, Fitzwilliam, NH 03447. (603) 585-3448

**ELECTRONIC ITEMS FOR SALE:** Radios, tubes, books, test equipment, audio equipment, records, knobs, meters, ham items and crystals, components, vibrators, software, etc. For a letter of lists for sale, send a LSASE properly stamped (no postcards) to: Richard and Rose's Radio Mart, PO Box 691443, Tulsa, OK 74169

**WANTED:** I will pay \$200.00 for this Mitchell transistor radio in brown leather, and in mint condition. P. J. Roach, 8640 E. Florence Ave., Downey, CA 90240. (310) 869-3001, days. (310) 927-0936, after 5 pm

**FOR SALE: Sams 177 to 1801. Also Sams AR's, TSM's, MHF's. \$2.50 each plus postage. Maria P. Troutman, PO Box 760, Brewer, Maine 04412-0760**

**FOR SALE:** Capacitors from new 25. volt to used oil filled @ 2000.V. Dual tubular 33. $\mu$ F./47. $\mu$ F. @ 160. Volt - \$10/four ppd. JULY SPECIAL: 47. $\mu$ F./47. $\mu$ F. @ 160. V. - \$10/five ppd. Triple 33. $\mu$ F./33. $\mu$ F./47. $\mu$ F. @ 160.V. - \$10/three ppd. Triple 33. $\mu$ F./47. $\mu$ F. @ 160. V. plus 22. $\mu$ F. @ 25.V. - \$10/three ppd. Dual 10. $\mu$ F./10. $\mu$ F. @ 450.Volt common negative - \$10/four ppd. Same with isolated negatives - \$10/three ppd. FRONTIER ELECTRONICS, Everett Hoard, Box 38, Lehr, ND 58460. (701) 378-2341, ans. mach. 4th ring

**FOR SALE:** Riders TV Manual #10. 1960 Picture Patterns & Schematic for Transistor radio. 1955 Transistors Handbook. Heathkit TC2 tube tester. Ted Gasiorek, 201 Golden Ave., Briggsville, WI 53920. (608) 981-2051

**FOR SALE:** Transistors: Emerson 911 - \$25. Magnavox AM-80 - \$25. Arvin 9595 - \$25. GE P746A (P.R.A., p. 189) - \$30. GE P760A - \$15. GE P 750A - \$25. Channel Master 6459 with automatic tuning - \$25. Sears Micro transistor 7216 with display case and owners manual, near mint. Large portables: Arvin 8572 - \$30. Motorola 5P32R - \$15. All above in working condition. All plus shipping. 1949 Airline television wooden case, 7-inch screen, pickup only. Suzanne Wyatt, Box 83, Dearborn, MO 64439. (816) 992-8811

**WANTED:** RCA 4T, 7T, 9T, 10T for my collection, any condition. Please help! Bruce E. Young, 4030 Quiltman, Denver, CO 80212. (303) 458-7408

**FOR SALE:** Plastic radio. Seafoam green, dark woodgrain brown, Coronado, 35RA37-43-8355, good - \$25.95. Add UPS. David L. Borino, 1480 Glenaire Dr., Casper, WY 82609. (307) 237-2368

**FOR SALE:** Assorted older industrial test instruments (potentiometers, recorders, etc.). SASE for list. David Betz, 449 Chandlee, Rising Sun, MD 21911. (410) 658-6130

**WANTED:** Still desperately seeking National SW3 Universal model, uses octal tubes. Also collect commercially built ham transmitters of the 30s and 40s and accessories for them. Early crystals, microphones, headphones, etc. Dean Showalter, WA6PJR, 36308 Panorama Dr., Yucaipa, CA 92399. (714) 797-1782

**WE'RE STILL HERE!** Tubes: "Oldest," "Latest." Schematics. SASE for lists to Steinmetz Electronics, 7519 Maplewood Ave., Hammond, IN 46324

**RUBBER - REPRO PHILCO** triangular chassis mounts, 4 pack - \$5.00 plus \$3.00 postage. Barry Dalton, 196 Kilborn Dr., Grants Pass, OR 97526. (503) 474-2524

**WANTED:** Knight-kit R100 receiver, old version with shadow cabinet. Contact Doug Cooper, Rt. 2 Box 100, Huddleston, VA 24104. (703) 297-7614

**WANTED:** Leather case for RCA BP10; Bristol Jr. or Sr. horn; Saga of Vacuum Tube hardback; Robert Perlstein, 17 Vine Street, Medford, MA 02155. (617) 391-3026

**FRONTIER ELECTRONICS** will rebuild your can capacitor, round or rectangle, twist loc or wet type. Typical price range is a flat \$9.00 for a wet round capacitor, twist locs - \$9 to \$14. These prices are complete & include prepaid return to you. Other examples are Philco Mod 20 for \$24 ppd & Model 70 for \$32 ppd. Send your can to: Frontier Electronics, Everett Hoard, 403 So. McIntosh St., Lehr, ND 58460. (701) 378-2341, ans. mach. 4th ring

**SAMS WANTED:** Any Number any quantity. We also need Specialized Books and VCR Service Data SAMS and Manufacturers. A. G. TANNENBAUM, P.O. BOX 110, East Rockaway, NY 11518. (516) 887-0057

**FOR SALE:** Nipper reproduction items, many unusual items. SASE will bring list and prices. Jack Hofeld, 61 Trinidad Bend, Coronado, CA 92118. (619) 429-0165

**FOR SALE:** Crosley D-25MN maroon clock radio. **WANTED:** Help! Desperately need AK 84 power transformer, P.N. 19070, or junker. Larry Albertelli, 7 Crestwood Rd., Owego, NY 13827. (607) 687-0822

**WANTED:** Telefunken owners and service manual to an Opus 5430MX hi-fi stereo, Ser. #751963. Keith Mathe-ny, 360 N. Avon Ave., Wadsworth, OH 44281. (216) 334-1315

**FOR SALE:** Free list of current price guides and color picture books on jukeboxes, Coke machines, pinballs, radios. Send SASE. Jukebox Collector Magazine, 2545 S.E. 60th Ct., Des Moines, IA 50317

**WANTED:** AK Model E speaker. Chassis for Arvin 617, or 617B. Chassis for Stromberg-Carlson 140P. Chester Johnson, PO Box 883, Cedar Park, TX 78613. (512) 258-6461, evening

**FOR SALE:** Several Philco cathedrals - \$125 ea. Wurlitzer 1015 jukebox - \$5,000. Wooden Zenith radios - \$65 ea. Radio, broadcast and hi-fi magazines - \$4 ea. Hi-fi catalogues - \$6 ea. Rider's Volume 7, 10, 13 - \$15 ea. Ceramic Spartan Blue Bird novelty radio - \$20. Fada Bullet reproduction - \$25. Microphone radio - \$35. RCA Redbook - \$45. Mallory Encyclopedia - \$20. Large list of radios, books magazines - SASE. Bill Rolf, 30131 Center Ridge, Westlake, OH 44145. (216) 871-4547

**FOR SALE:** Majestic, Bremer Tully, Stewart-Warner, old tall-legged empty cabinets - \$50 ea., \$100/all 3. Orgatron, Wurlitzer parts. Piano roll players. 45 rpm changers. Telephones and swbds. Pick up on large. SASE for details. M. S. Small, 407 West Walnut St., Leitchfield, KY 42754. (502) 259-3765

**WANTED:** Broadcast-type MICROPHONES. Early carbon, condenser, ribbon, dynamic, etc. Cash or trade. James Steele, PO Box 620, Kingsland, GA 31548-0620. (912) 729-2242

**WANTED:** AN/TRC-10 radios; AN/PRC-1; AN/PRC-5; M-209 Cipher machines; any radios beginning with letters "SS" (example "SSR-5"). Keith Melton, Box 5755, Bossier City, LA 71171. (318) 747-9616

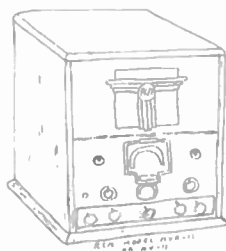

**WANTED:** RCA Model AVR-11 (AV-11) airport receiver as shown, any condition, housed in a steel tabletop cabinet approximately 20"W x 24"H x 16"D, 1937 vintage. Similar to the ACR-111 but is not the same radio. Chuck Dachis, The Hallicrafter Collector, 4500 Russell Dr., Austin, TX 78745. (512) 443-5027

**FOR SALE:** Tuning unit TN-16/APR-4 in original carton - Make offer. **WANTED:** Anything Carco, mfgd. by Carter Mfg. Co. Plastic cabinet for Philco Model 50-527. Dial glass & semaphore dial mechanism for Fairbanks-Morse Model 91-C-4. Dial glass for Emerson Model AF176. Larry Porter, 4115 Beam Rd., Crestline, OH 44827. (419) 683-2540

**WANTED:** Fada, Model 460-A. Advise condition and price (including shipment). G. Eisenberg, Belvedere Towers, Apt. 108, 1190 West Northern Parkway, Baltimore, MD 21210. (410) 435-8351

**FOR SALE:** Copies of Precision Series 620 tube/ckt. tester, 22 pages - \$8 ppd. T. R. Apple, 1498 Cobblegate Ln., Reynoldsburg, OH 43068. (614) 864-3634

**FOR SALE:** Radio keg - \$375. Jewel 5057U - \$40. GE 62, ivory, like new - \$45. Globe 456 - \$15. AK 42 - \$45. AK 76 - \$90. Spark plug, (Breed #314) - \$110. Crosley D-10CE, pale green - Make Offer. **WANTED:** Sylvania sign with bubble tubes on top. Steve Lange, 1351 N. 58, Milwaukee, WI 53208. (414) 259-1031

**WANTED:** Emerson U-5A chassis and black plastic back. Handle for RCA 40X56 or 40X57 San Francisco Expo radio. Brown push buttons for Lafayette BE-79, or Lafayette 519 pictured on page 55 right side second from top. Last of all, I've come across a small metal Gilfillan with a lithograph, of the 1935 San Diego Expo, by American Can Co. in Los Angeles, Calif. If anyone knows about this radio, please call or write. Steven P. Berglund, 617 S.W. 146, Seattle, WA 98166. (206) 244-6428

**FOR SALE:** Reproduction dial glasses for Catalins. FADA 652 and Sentinel 284 - \$35 ea. plus \$2 postage. Radioart, Box 102, Centerbrook, CT 06409

**SOLID STATE VIBRATORS** for most automobile radios 1932-57. Exact duplicates of originals in metal cans. Synchronous, Non-sync, European. One-year guarantee. Dealer prices. Free catalog. Order toll free: 1-800-WE FIX AM. Visa, Mastercard. Antique Automobile Radio, Box 892, Crystal Beach, FL 34681. (813) 785-8733

**WANTED:** Amateur Radio Callbooks. Govt. or Private. From Whenever Thru 1936. Bob Arrowsmith, W4JNN, PO Box 166, Annandale, VA 22003, or call collect (703) 560-7161

**WANTED:** Hallicrafters Sky Riders with entire front panel silver color; also S-30, S-33 S-35 pan adaptor, SX-112, HT-2, HT-3, HT-8, HT-12, HT-14, EP-132; wood console speakers R-8, R-12; parts, advertising & memorabilia. Chuck Dachis, The Hallicrafter Collector, 4500 Russell Drive, Austin, Texas 78745

**CATALIN WANTED,** Serious Collector interested in buying RARE models for my collection, condition is important. I am not a dealer! WHY SELL TO OTHERS WHO SELL TO ME? SELL DIRECT!!! I will pay all shipping charges! Please leave message w/details and/or send any photos w/price to: Albert Molinaro, 7404 Sunset Blvd., Los Angeles, CA 90046. (213) 288-1557

**WANTED:** Chassis for Clarion AC-85, 80 or 81 (junker w/good transformer OK), complete Zenith 5S228 chassis, case for Kadette Jr. (Bunis II, p. 102), radio drama transcription discs. Merrill Mabbs, 709 Pluma Dr., Rapid City, SD 57702

**FOR SALE:** Arvin 12R27 5-tube AM table set, works - \$15. Arvin 61R58 transistor leather portable, untested - \$15. Blonder Tongue R-98B AM-FM 6-tube set, not working - \$15. Above + UPS. Donald Sochurek, W191, S7500 Richford Dr., Muskego, WI 53150. (414) 679-0212

**FOR SALE:** Zenith Trans-Oceanics 2-1000 and one 3000-1, A600. Zenith Universal portable pop-up dial radio. Jim Montague, 921 S. Cuba, Spokane, WA 99202. (509) 535-9576

**FOR SALE:** 1938 DuMont television Model 180 - Best Offer over \$7,500. ARRL Handbooks, 1 thru 6, excellent condition - \$550. David T. Boyd, W3IFY, 13917 Wisteria Dr., Germantown, MD 20874. (301) 972-2777, 8 pm to 11 pm

**BOXED CLASSIFIED ADS WORK!** This is a boxed classified ad. These ads can be run more than two months. See the inside back cover for details. Boxed ad deadline: the 5th of the month.



**WANTED:** Early tube Hi-Fi components and studio equipment by Marantz, McIntosh, Tannoy, Acrosound, Brook, Brociner, Fairchild, Hadley and others. Also want Western Electric theater amplifiers, speakers, tubes, & microphones. Richard Sharisky, PO Box 521, Belmont, MA 02178. (617) 484-5784

**WANTED:** In good working condition: Hallicrafters SX-24, SX-25, S-20-R, S-38. All letters answered. Tom Whittle, K4UTJ, Rt. 5, Box 203A, Galax, VA 24333

**WANTED:** Old fountain pens by Parker, Sheaffer, Waterman, Mont Blanc, Conklin, etc. Will trade name-brand high quality radios for them or pay cash for the pens. Contact: Frank Weissman, 4 Shadush Ln., Westport, CT 06880. (203) 454-1267, after 9 pm EST

**FOR SALE:** Battery eliminator kits. Very high quality computer generated printed circuit board design. These powerful, newly developed kits beat all others in electrical specifications, ease of assembly, quality, performance and price. A-B Supply - \$39.95; A-B-C Benchtop Supply - \$79.95. Check us out. Visa. Peptronics, C.O. Thunder Drilling, 10105 80 Ave., Edmonton, Alberta, Canada T6E 1T6. (403) 433-1670 or (403) 424-2214, after hours

**WANTED:** Horn and stand for Edison Standard. Reproducer and arm for Victor VV-IV. Will also trade radios for phonographs. Doug Koehn, 609 S. 15th, Quincy, IL 62301. (217) 228-2115

**FOR SALE:** See what you're gettin' before you get it! "One picture worth a 1000 words." A video, showing a variety of radios TVs from the '20's to '50's. Hear and see most of them in operation with close-ups. Also featured are radio-related items and parts plus jukeboxes, Coke items, etc. from my 30-yr. collection. Price list included with each tape - \$6.50 including postage. If you're looking for an item out of the 20's or 30's, I probably have it - call. R. Mead, 7429 Jefferson Rd., Ashtabula, OH 44004. (216) 998-2180

**FOR SALE:** Test equipment: I'm moving, nearly all items 50% off of price from previous lists. HP: 3200B 10-500MHz RF gen. - \$75; 200AB oscillator - \$18; 5004A signature analyzer - \$30. Leader 15MHz dual trace scope - \$78. Lectrotech CRT rejuvenator - \$12. B&K 1246 color bar gen. - \$19. Polartron 0-600VDC metered power supply - \$15. Heathkit HW-32 20M SSB, mobile power supply - \$35. Knight signal tracer - \$12. RCA WR-49B RF generator, 85kHz-120MHz - \$12. List - LSASE. Kirk Ellis, KK4YP, 18 Foxfire, Selma, NC 27576. (919) 965-9577, evenings

**WANTED:** Fisher service literature from 1950 and earlier, Philharmonic Radio Co. service literature from 1942 and earlier, motorized volume control for Scott 800-B, and any information about Erres radios made in Holland. Kenneth Snowden, 1238 Grove St., San Francisco, CA 94117. (415) 921-1326

**FOR SALE:** Reproduction Zenith dial glass, made from unbreakable Lexan poly-carb, better than original, two rectangular sizes available: 6 3/4" x 7" and 5 3/5" x 7". Price including P&H is \$14 ea. Dealer inquiries welcome. DH Distributors, PO Box 48623, Wichita, KS 67201. (316) 684-0050

## OLD TIME RADIO BROADCASTS ON CASSETTES

Many of your old time radio favorites are available on quality cassettes at a reasonable cost. You select the shows you want and purchase them by the hour. Fast, friendly service too.

The Great Gildersleeve

The Shadow

Suspense

Jack Benny

Sherlock Holmes

Fibber McGee & Molly



Lux Radio Theater

Amos 'N' Andy

Sgt. Preston

The Lone Ranger

Send for our catalog listing nearly 5,000 shows arranged by show category and title, many including original broadcast dates.

Only \$2.00 (P & H). Send request to:

**ERSTWHILE RADIO  
P.O. BOX 2284  
PEABODY, MA 01960**

**WANTED:** Lower half of a Bendix 526C radio (black section). A full size photo of a Jackson Bell 25UV radio - (Peter Pan). Carl Bier, 4021 Via Picaposte, Palos Verdes Est., CA 90274

**WANTED:** Herbert Horn Tiffany Tone 156A, (F.O.S., p. 185), any condition. **FOR SALE:** Grebe MU1 case and panel, no escutcheons - \$15. Eveready Model 2, wood case, escutcheon, instructions (no chassis) - \$15. Plus UPS. Mark Yeshe, 610 Hollins, Helena, MT 59601. (406) 442-1942

**FOR SALE:** Scott 16A chassis rough - \$100. Wilcox-Gay 7E40 Recordio console - \$25. Cannot ship. DuMont T3A1 TV tuner, N.I.B. - \$20. BC216A amplifier, WWII - \$5. RCA 8K chassis recapped - \$30. Zenith Royal 2000 - \$60. Zenith Y-832 AM-FM blonde - \$15. RCA 58AV console combo - \$25. Cannot ship. Will be at Lansing Friday, and at Elgin. Doug Houston, 3441 S. Hadley Ln., Ortonville, MI 48462. (313) 627-4141

**RATE FOR ADDITIONAL WORDS:**

**15¢ per word**

**FIRST 20 WORDS FREE!**

*Cash or stamps OK for small amounts.*

*Your payment helps to keep A.R.C. healthy!*

**FOR SALE:** TV-7 tube tester with tube test data - \$85. Lambda LUS-8A-5, 5 VDC, 3A power supply - \$20. Lambda LUS-11-28, 28 VDC, 3.6A power supply - \$25. HP-628A signal generator 15 to 21 GHz - \$150. DuMont 304A oscilloscope DC-50 kHz - \$50. TS-382 audio oscillator 20 Hz to 200kHz - \$50. HP-211A square wave generator 1Hz to 1MHz \$50. Kay 860E Vari-Sweep generator 2 to 220 MHz - \$60. Fluke 803B differential voltmeter 0.1 to 500 volts AC/DC - \$50. Ballantine 9601M (military USM 413) true R.M.S. analog AC meter - \$35. DY-66B/ARN-14 27.5 VDC dynamotor - \$20. **WANTED:** Power transformer for a Heathkit SB-200 RF amp. Manuals for AN/FRR-26, T-19/ARC-5 ARC-2, CCT-46/45, CCT-52211, BC-453B, R-15, CCT-46077, T-67/ARC-3. Call or write: Mark Steel, KB5NCY, Rt. 1, 99 Robin Hood Ln., Freeport, TX 77541. (409) 233-8845

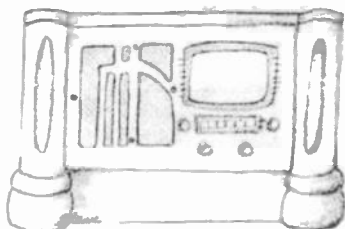

**WANTED:** Silvertone wood tabletop Model 6262. Bill Allred, Rt. 2, Box 262B, Jay, FL 32565. (904) 675-3510, after 4 pm

**FOR SALE:** Radiola III/III-A owners: SASE brings literature list related to your radio. Restoration details, hookups as a crystal set, owner's manuals, WD-11 substitute units and more. \$2.00 plus LSASE brings circuit diagram with itemized parts list on Radiola III or \$3.00 sent ppd. and unfolded. David P. Smith, Box 81, Olney, IL 62450

**FOR SALE:** E. H. Scott Allwave 15, with speaker and power supply, works!, no cabinet, chrome good - \$300 OBO. Call Dick (309) 342-2825 or if no answer, call: Lloyd A. Noel, 494 Clark St., Galesburg, IL 61401. (309) 342-2825

**FOR SALE:** Signal Corps BC-610E plus cabinet full of coils & tuners. Also teletype machine plus spare parts. Lloyd Lewis, Route 2, Box 102, Plattsburg, MO 69477

**FOR SALE:** Reprod. cloth wave magnet covers, fit Zenith 11S474. **WANTED:** Owner's manual for Hickok 203 V-O-milliamper meter. Glenn W. Stark, 428 W. 7, Haysville, KS 67060

**WANTED:** Chassis for my Metrodyne Super 7 cabinet. Wayne King, 408 Forbes Dr., Shelbyville, KY 40065. (502) 633-6564

**FOR SALE:** Fada 12" rectangular screen console TV, has doors - \$45. Admiral 10" console TV, mahogany - \$95. DuMont RA-103 console TV, 12" - \$75. RCA C13-2 console radio, 13 tubes - \$125. Philco 37-116 console 15 tubes - \$175. Philco 41-610 console, makes own records, with microphone - \$75. Riders 10 and 12 - \$15 ea. National Union (green) Riders, 7, 8, and 10 - \$15 ea. 45-volt B batteries, tapped at 22 1/2 - \$5 ea. Add UPS (consoles must be picked up). Call for details. Rick Weibezahl, 305 Belvidere Ave., Washington, NJ 07882. (908) 689-3276

**WANTED:** High quality Variac with voltmeter or voltmeter and ammeter. Triplett 3444 tube tester. All Marantz tube audio equipment. Fairchild amplifiers. Hadley 601 amplifier. REL tuners. 1950's-1960's hi-fi and stereo books and catalogs. Audiocraft, Audio Engineering, and Audio magazines, 1950-1965. Paul Creasy, 6216 Worlington Rd., Bloomfield Township, MI 48301. (313) 737-0429

**FOR SALE:** Axial lead electrolytics. Fresh new Nichicon miniature 10 mfd at 450 VDC - 98¢ each for 10 or more. Includes P&H. DH Distributors, PO Box 48623, Wichita, KS 67201. (316) 684-0050

**WANTED:** Regency TR-1 and Sony TR-63. Will buy or have to trade Zenith 5808, black face console, 8-tube; Zenith 12A1, black face console, 12-tube; Philco 20 two-tone cathedral for trade; Bendix 526-C, green Catalin. Cannot ship. Will bring to Nashua meet or to the AWA meet in Rochester. Marty Bunis, RR 1, Box 36, Bradford, NH 03221. (603) 938-5051

**FOR SALE:** Novelty pen radios, new in box - \$17.95. This price includes shipping. Kent A. Ise, 224 Cowesett Rd., Warwick, RI 02886. (401) 885-7558



**WANTED:** Fada Catalin radios in all color combinations. I am interested in any models in any condition and will pay a lot more than the average K-Mart shopper. Please write or call collect Rain Buttignol, 214 State St., #7, Portsmouth, NH 03801. (603) 427-1384

**FOR SALE:** Selling out my personal collection of 40 years, books, service manuals, N.O.S. parts, old parts, radios, tubes, plus more. SASE for details. Write. Krantz, 100 Osage Ave., Somerdale, NJ 08083

**WANTED:** Hallicrafters SX43. Wanted: Junkers or specific parts for AK 60 chassis and Crosley 124 chassis. Cleo McAlexander, Box 4, Stanleytown, VA 24168. (703) 629-2972

**WANTED:** Round face 2" metal or Bakelite, postwar. DC mA 0-10, 10 or 500. Metal base EL34 tubes. Field coil speakers 15" or 18" by WE, Jensen, RCA, etc. for very high prices. Also paying 15% finders fee for WE, Hadley, Regency, Marantz, McIntosh amps and Tannoy, WE, Patrician, JBL, Hartsfield, etc. Paying \$900 for REL items. Edw. Schneck, 1401 Ocean Ave., Brooklyn, NY 11230. (718) 377-7282, M-F 2-6 pm

**FOR SALE:** Ampex Mod. 621 amplifier, excellent condition - \$65 plus shipping. John Snow, 4539 Bartlett, Shorewood, WI 53211. (414) 964-0194

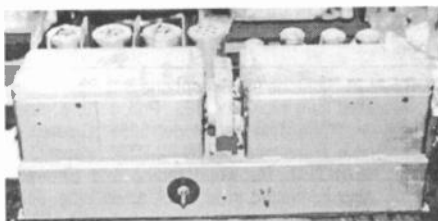

**WANTED:** Chassis for Pooley desk cabinet; RCA Mod 21 w/ sprk. Help. Bill Horn, Rt. #2, Box 181, Bealeton, VA 22712. (703) 439-9781

**FOR SALE:** Catalin radios. SASE for list DeWald, Addison dial glass - \$40 ea. David Brenner, 71 Burdette Rd., Atlanta, GA 30327

**WANTED:** Schulmerich Carillon and Bell Carillon cartridge tape player systems, any age or condition. Also, pre-recorded cartridge tapes of carillon (chime) music. The cartridges are similar to 8-track tapes in appearance. Alan Ford, 1238 Academy St., Scranton, PA 18504. (717) 347-4218

**FOR SALE:** Hallicrafters S76 - \$75. Hallicrafters SX62 - \$70. HBR13 minus 2 - \$45. Heathkit SB10 sideband adapter with manual - \$65. Bug made by Lionel - \$55. BC221M - \$15. Polycrom CB - \$15. Globe CB100 - \$20 Lafayette Comstat 25 - \$15. Regency Range Gain CB - \$35. Hallicrafters CB9 - \$10. Hammarlund crystal switch N.I.B. for HQ105 - \$12. Hawkins Electrical Guide 1 thru 10 - \$25. RCA 306A audio frequency meter - \$40. Radiocraft magazines 1931 to 1940. Radiola 18 case - \$10. AK 20C case \$15. Rolls Royce pewter transistor - \$40. Mirco AM radio - \$25. Add UPS. Call for details. Raymond Filozof, 339 Howertown Rd., Catasaquua, PA 18032. (215) 264-4733

**WANTED:** Desperate: Need schematic Model 4085 Grundig - Majestic, immediately. Ray Sanders, 342 So. Third, Cottage Grove, OR 97424

**WANTED:** Someone to rebuild Willard Wet B for Panatope. 1 door pull & door moldings. Cabinet only for Silvertone 4500. **FOR SALE:** Heathkit package 2-WAP2, 2-W5M, 1-FM3A, 1UA-1, 1BC1A - Best Offer. John A. Myers, Wilson, NY 14172-0098. (716) 751-6053, evenings. Fax (716) 751-6236

**FOR SALE:** E.H. Scott AM-FM, old Phantom DeLuxe, Chippendale Grande cabinet, pick up only - \$1,000.

**WANTED:** Philharmonic in Warrington console. Arthur Johnson, 15312 Woodruff Pl., Bellflower, CA 90706. (310) 925-5853

**WANTED:** Escutcheons of Philco 60 and 89 cathedrals. Crosley 5-75 schematic. Delco 1106 cabinet. Herman Gross, W9ITT, 1705 Gordon Dr., Kokomo, IN 46902. (317) 459-8308

**WANTED:** Zenith brand tubes, new old stock or good used: 6V6G (2), 6J5G (2), 6H6G, 5Y4G; 6K7G; 6L7G, 6T5/6G5/6U5. Cleo McAlexander, Box 4, Stanlytown, VA 24168. (703) 629-2972

**FOR SALE:** AK 376 console - \$175. AK 55 console - \$135. GE K-62 console - \$150. Majestic: Grandfather clock & case only - \$150. Model 52 cathedral - \$200. Grunow Teledial - \$200. Pilot TRF, 1927. Philco 1933 H console Type 118 chassis - \$150. RCA P32 console, 1930? - \$150. Stromberg-Carlson Treasure Chest w/ meter - \$175. Highboy 638 console - \$275. Zenith ZE-11 console. Edward Schneck, 1401 Ocean Ave., Brooklyn, NY 11230. (718) 377-7282, weekday afternoons

**FOR SALE:** Gloritone 99. Echophone S-3. Sparton Jr., ex. Musette, very nice. AK 165. Philco 70. Meteor. Revere Jr. White Trav-Ler Model 5356. Crosley F-25BE. Philco Transitone, Model 42-PT95. Pepsi-Cola Cooler. **WANTED:** Repwood radios and Emerson AX212. Also interested in all RCA advertising. John Miller, 8144 Scott Blvd., Cottage Grove, MN 55016. (612) 459-0939, call after 6:30 pm CST

**WANTED:** AC power supply that will work for ART-13 xmtr. F. W. Nicholas, PO Box 37094. Phoenix, AZ 85069. (602) 864-9987

**FOR SALE:** Hallicrafters radio, Model S-38C. **WANTED:** Crank phonograph parts, junk machines or horns, any condition. Dave Faehrich, 8215 Stone Rd., Independence, OH 44131. (216) 447-0837

**FOR TRADE:** Zenith BH semi-cathedral, ERLAS-21 for test equipment. David Collins, 481 E. Center, Medina, NY 14103

## ALL A.R.C. BACK ISSUES AVAILABLE

**Feb. '87 to current issue: Originals available**  
32 to 92 pages each.

**Oct. '86 to Jan. '87: Reprints available**  
*Reprinted from original artwork; 28 to 32 pages each. Quality and appearance same as an original copy.*

**June '84 to Sept. '86: Photocopies available**  
Not original quality, useful for info.; 16 to 28 pages ea.

The above availability is as of July 1992.

As stocks of original copies are exhausted, reprints will be substituted for the issues after January 1987. Publication of *Antique Radio Classified* began in 1984 which had only five issues: June, Sept., Oct., Nov. & Dec. 1984. 1985 through 1989 have had 12 issues each.

**\$3.50 each - Postpaid to U.S., Canada and Mexico.**

*Orders of 6 issues or more may take a 10% discount. Foreign orders other than Canada and Mexico: \$5.50 each by air. Massachusetts residents, please add 5% sales tax.*

Send Order with Payment to:  
**ANTIQUÉ RADIO CLASSIFIED**  
P.O. BOX 2, CARLISLE, MA 01741

**FOR SALE:** Riders Manual No. 3 (III), good condition - \$20 plus postage. Transformers, from 3 to 25 lbs., some are identified by mfr., some are not, not higher than - \$15. About 50 Sams folders, most of 1950's, vintage random vols. Many tubes of the 30's & 40's, some used but most new in orig. box, reasonable price. Still have some save a sockets - \$4 ea., \$10/3, plus UPS. Test equipment of the 20's & 30's. More details in my new list which will be ready July 15th. Send SASE for your copy. I am still looking for an adapter for the #3 chart of military Model 177 tube tester. C. F. England, 98 Montague Ave., Zanesville, OH 43701

**FOR SALE:** 1933 Radiobar, Art Deco version, Fairbanks-Morse chassis, no speaker or knobs, cabinet needs total restoration; contains following original glassware, four decanters brandy, bourbon, vermouth, rye, 4 glasses, 3 shot glasses, one glass shaker, one metal shaker, ice holder, 6 metal shot glasses - \$500, pick up only. **FOR TRADE:** WWI service buzzer, Signal Corps U.S. Army, Model 1914, used for sending code or talk through like telephone, never issued, like new. Trade for fancy horn speaker. Don Howland, 4621 W. Shawnee, Spokane, WA 99208. (509) 466-0939

**SEND ALL A.R.C. MAIL TO**  
**Antique Radio Classified**  
**P.O. Box 2, Carlisle, MA 01741**

**WANTED:** Crosley RFL-60, any condition. NBC chimes. National SW-2 with coils. David T. Boyd, W3IFY, 13917 Wisteria Dr., Germantown, MD 20874. (301) 972-2777, 8 pm to 11 pm

**FOR SALE:** Bendix 676-D (Bunis #1, p. 36), original, complete, nice - \$50 + shipping. David Wills, 7551 Ash St., Richmond, British Columbia, Canada V6Y 2S2. (604) 270-4606

**MESSAGE:** Radio/Phono Show, Saturday, August 15, 1992, 8 am - 4 pm, Otterkill Engine Co., Campbell Hall, New York. Sponsored by Hudson Valley Antique Radio & Phonograph Society. For info call: John & Linda Gramm, Gramm-O-Phone Antiques, Box 1, Rt. 207, Campbell Hall, NY 10916. (914) 427-2602 or (914) 561-0132, evenings

**FOR SALE:** Box of 15 transistor radios including red Emerson 856; all in fair to good condition, untested, list available - \$65. Admiral brown Bakelite AM radio-phonograph, Model 6S12N, untested - \$25. GE Model 125, maroon plastic AM table radio, fair, untested - \$10. Grundig 4670 AM-SW-FM stereo large table radio, very good condition, not working - \$25. RCA 9X571, fair, 1 diffuser cracked, works - \$15. RCA 96T2 parts set, no push buttons - \$25. Philco 49-909 AM-FM table radio, wood, cabinet fair, untested - \$25. HH Scott 99A transcription amplifier, mono, good condition, working - \$10. Telefunken Jubilate 5161W, AM-FM-SW table radio, very good condition, untested - \$35. Zenith 6D510 parts set - \$8. Zenith S-9017 turntable, green plastic, strange shape, made in France, good condition but runs fast - \$25. Alan Ford, 1238 Academy St., Scranton, PA 18504. (717) 347-4128

**FOR SALE:** Pepsi Cola bottle-shaped radio, 24" high, 5-tube, complete including wiring diagram, no decals, good condition, not restored - Best Offer. Albert Silver, PO Box 1166, Paterson, NJ 07509-1166. (201) 523-5525



**FOR TRADE:** Used tested good 6A3's. Need 01-A thru 6Z7 types. List, SASE or call. Dick Kowalski, KB8MR, 32823 Gloede Dr., Warren, MI 48093. (313) 294-6831

**FOR TRADE:** Edison Model C reproducer in original box. Swap for original Victor orthophonic reproducer. Ernest D. M. Yeaw, RR #3, Tatamagouche, Nova Scotia, Canada B0K 1V0. (902) 657-2554

**WANTED:** Western Electric tubes, amp, parts & data sheet. WE/101, 102, 104, 205, 211, 212, 216, 242, 252, 262, 271, 274, 275, 276, 284, 300, 310, 339, 347, 348, 349, 350, 421, 422, VT1, VT2, VT3, VT25, VT52. RCA-50/250/350, 845, 211, VT62/801. Will pay top \$\$\$ Jun Mizuno, 6711 Mt. Leneve Dr., San Jose, CA 95120. (408) 268-4016

**FOR SALE:** Giffillan Neutrodyne GN-2 chassis only, good condition - \$25 plus shipping. John Snow, 4539 Bartlett, Shorewood, WI 53211. (414) 964-0194

**FOR SALE:** Crosley 10-135 - \$70. Crosley 56-TU, clear handle - \$75. **WANTED:** Knobs for RCA 97-T and GE K-60. Paul Ernst, 3465 Eddy Rd., Marion, NY 14505. (315) 589-9471

**FOR SALE:** Airline PA mono amp, RCA PA mono amp - \$75 each. Huge! RCA table radio - \$200 OBO. Francis A. Canlas, 508 N. Isabel St., #D, Glendale, CA 91206. (818) 243-0171

**WANTED:** Farnsworth, Sonora, Lexington and Olympic table model radios, must be in working condition. Dennis Kane, 2615 N.E. 49 St., Ft. Lauderdale, FL 33308



**FOR SALE:** Beckley-Ralston battery radio as shown. exc cond., complete, has all tubes (good). Need works, schematic or experience will do it. Asking \$250, includes shipping. **WANTED:** Tube-type 4H4C. Dial glass for Wards-Airline #62-390. Schematic for Nordemende Tannhauser U.S.A. stereo radio. Osc. coil for Grunow Model 750. The Vacuum Tube, Ltd., Michael K. Tremper, 956 Newark St., Aurora, CO 80010

**MESSAGE:** Two, two, two auctions in one! That's right, at Extravaganza '92 you can enjoy two auctions! On Saturday we offer our "inside" auction with professional auctioneer Jeff Bub. Last year our auction sales exceeded \$25,000!! This year we already have consigned some super items to include: an EH Scott AW23/Tasman cabinet, fully restored; 2 Atwater Kent breadboards, Spartan Bluebird mirror radio, yellow Kadette Clockette Catalin, Fada blue/white 1005, Cutting & Washington battery set and more. Even with these outstanding consignments, we still can use more auction items so plan to bring some of your dynamite pieces for our auction. Note that we pay the sellers immediately at the conclusion of our auction. On Sunday we cap off our event with our ever popular Donation Auction where any items that have been donated to the club (those things you tried to sell but couldn't and the wife told you not to bring home) are auctioned off! For further information, write: Extravaganza '92, PO Box 585, Okemos, MI 48864

**FOR SALE:** Airline 01AA (ST) - \$30/set of 5. Assortment of Acorn tubes and sockets, Raytheon BH, original sticker, original brochure. Door knob and lighthouse tubes. Many collectible tubes in original colorful cartons including Majestic 4GS. Send SASE for Dick's green sheet, loads of one of a kind items from recent workshop cleanup! **WANTED:** Songbird anything! Doesn't anyone out there have even one piece of Songbird advertising? Copies are fine. Still buying dud 4-pin tubes - please don't toss them out! Need L-K phones, any horn drivers, open OK, any phono attachments. I have phones, some drivers for trade. Thanks. Support your local radio club, help a new collector. Dick Mackiewicz, 1549 N. River Rd., Coventry, CT 06238. (203) 742-8552

**FOR SALE:** The following three high-end radios pictured in new Collins book, Radios Redux: Emerson Snow White (p. 28) - \$1,995. Airline 62-445 (p. 59) - \$395. Crosley 10-140 (p. 87) - \$75. Admiral 6C22AN (Bunis I, p. 9), white - \$45. Emerson 547A (Bunis II, p. 65), ex - \$50. GE 60 (F.O.S., p. 95 far left) - \$35. Motorola 52M2U, maroon portable w/flip up front, lattice grille - \$65. RCA 65BR9, wet battery/AC portable - \$45. Sonora KG-80 Candid (E.O.R., p. 60) - \$165. RCA 66X2 (F.O.S., p. 158, Bunis I, p. 128), white - \$75. GE L660 - \$50. Pilot-tuner T-601 (G.O.R., p. 108) - \$35. Supreme radio analyzer Model 333, early test equipment, wooden case - \$115. Color photo (35mm) of item: send \$1 and SASE. Call 11 am - 12 mid. ET. Best time after 9 pm. Answering machine fourth ring. Eric and Sirelle Fogel, 87 Sandra Dr., Parsippany, NJ 07054. (201) 316-8461

**FOR SALE:** Tubes, new and used. Sams separate folders. **WANTED:** Old tubes. Zenith 1936-40. Celluloid horn speakers. Thanks. R. Dobush, 3554 W. 105, Cleveland, OH 44111. (216) 647-3908

**WANTED:** Western Electric tubes 205D/E, 274A/B, 252A. Jun Mizuno, 6711 Mt. Leneve Dr., San Jose, CA 95120. (408) 268-4016

mf/ volts	manuf	each	20 & up
.001/600	Sprague 715P	\$ .40	\$ .35
.0047/600	Sprague 715P	.42	.37
.01/400	Xicon (radial)	.26	.21
.01/600	Sprague 715P	.54	.49
.015/600	Sprague 6PS-	.50	.45
.02/400	Xicon (radial)	.27	.22
.022/600	Sprague 715P	.65	.60
.047/400	CMC (axial)	.35	.30
.047/600	Sprague 715P	.68	.63
.05/400	Xicon (radial)	.35	.30
.1/400	Xicon (radial)	.50	.45
.1/600	Sprague 715P	1.00	.90
.22/600	Sprague 715P	1.50	1.35
2.2/450	Rubycon (axial)	.65	.60
4.7/450	ICC (axial)	.66	.61
10/450	Xicon (axial)	.98	.91
22/25	Transcap (ax)	.32	.27
22/160	Rubycon (axial)	.75	.70
22/450	Xicon (axial)	1.30	1.25
33/160	Xicon (radial)	.88	.83
33/160	Rubycon(axial)	1.08	1.03
47/160	Xicon (radial)	1.30	1.15
47/160	Xicon (axial)	1.30	1.15
47/450	Rubycon(axial)	1.95	1.80
80/450	CWI (axial)	2.60	2.20
shipping charge is a flat \$ 4.00			
FRANKENSTEIN'S RADIO LABORATORY			
4010 Fairmont Pkwy, Suite 285			
Pasadena, Texas 77504			
(713) 998-0130			

**WANTED:** 1942 Philco radio dealer sales catalog and sales brochure: originals only. Also 1942 Philco External Aerial Kit Part Number 45-2817, or just the plug in aerial coupler. Gregg Humanic, 540 Wicklow Ln., Monroe, OH 45050. (513) 539-8926

**FOR SALE:** Early sixties Westinghouse AM transistor radio Model H7L9P7 leatherette, vg - \$25. GE AM FM transistor Model P977B leatherette, g - \$20. Westinghouse 9-transistor AM FM pocket radio leatherette - \$10. Radiola 18 radio, plays, good cabinet, fair - \$55. All prepaid. M. B. Gaskins, WB4MNZ, 227 Risen Ave., Campbellsville, KY 42718. (502) 465-3755

**FOR SALE:** Test equipment manuals for Eico, Precision, Paco, Simpson and Triplett, copies only. Send two-stamp large envelope for lists. Have some tubes not lists. Write your needs. Clayton Mundine, 6122 S. Flores, San Antonio, TX 78214

**WANTED:** RCA 100B, Philco 511, Brunswick A speakers; must have good grille cloth; knobs for Music Master 175; RCA remote control box & cable; Spartan mirror in lid TV parts; unrestored AK 36. Rick Taylor, 7407 Ziegler Rd., Chattanooga, TN 37421. (615) 855-0174

**WANTED:** Copy of operators manual or information concerning what two 4-prong tubes go inside U.S. Army combination tube tester Espey Model 104-TC Type SC. Raymond Humphreys, 1044 N. Jackson, Macon, MO 63552

**FOR SALE:** RF generators Heathkit SG-8 - \$25. Pattern generator Heathkit LP-2 - \$25. Sweep generators Jerrold 602 - \$50. Jerrold 900A - \$150. Stereo amp Knight KG-870 - \$30. Multiplex tuner Lafayette LT-78 - \$30. All in good working condition. You pay shipping. **WANTED:** AK Model R horn speaker in good condition. Jack Cothran, 8121 Russell Rd., Alexandria, VA 22309. (703) 780-5297

### Classified Ad Deadline Noon

Jul. 10 for Aug. 1992 Issue

Aug. 10 for Sep. 1992 Issue

Box, Ads with Photos & Display Ads - 1st

**FOR SALE:** Magnificent 1937 rack RME-69/LSI. SX-42 and base reflex speaker. SX-28 cabinet. SX-32 for parts. National NC-240D and speaker. HRO-50+1. HRO-500. PRO-310. Two Super Pros for parts. 1939 Jensen ham speaker. Bill Coolahan, 1450 Miami Dr. NE, Cedar Rapids, IA 52402. (319) 393-8075

**FOR SALE:** Zenith 6D312, very nice - \$150. Hallicrafters Continental, green - \$90. Crosley 10-138, maroon - \$65. Ward Eaton, 184 Sawyer Dr., Owego, NY 13827. (607) 687-1102, after 6 pm

**WANTED:** Good BC348. Also manual or copy for Lafayette HA-225 receiver. John L. File, Box 566, Tolono, IL 61880

**FOR SALE:** Still have few Heath AJ21 AM tuner kits left at - \$25 plus shipping. H. Lejuez, 46-16 160 St., Flushing, New York City, NY 11358. (718) 463-4110

**FOR SALE:** Guild Town Crier - \$85. Rotary Spark Gap CW-20 - \$75. WE 4D - \$500. Marc Ingenthron, 9748 Outlook, Overland Park, KS 66207

**WANTED:** RCA Strato-World portable 3BX671 or 7BX10, prefer mint. William Windle, 805 Greensburg Cr., Reno, NV 89509. (702) 786-8647

**FOR SALE:** Scott RCH, mint. Philco 112L (F.O.S., p. 121). Bel Geddes signed, extremely rare Pilot cathedral - Mail Offer. John Richardt, W2WIY, 94 Bald Eagle, Hackettstown, NJ 07840. (908) 852-7278

**FOR SALE:** Philco 90 cathedral, nice! Kent A. Ise, 224 Cowesett Rd., Warwick, RI 02886. (401) 885-7558

**WANTED:** Schematic and any info on Standard Radio of New York. Standard Five. **FOR SALE:** AK 33, no cabinet, clean, untested - \$75. NC 57, nice - \$75. Dennis Atkinson, Upper Park St., Phillips, ME 04966. (207) 639-3111



**FOR SALE:** RCA Victor B&W portable 14", Model 14-PD 8053U UHF-VHF. In operating condition. Best offer. Angelo J. Anello, 1915 W. Waters Ave. #1, Tampa, FL 33604. (813) 933-6009

**SERVICES:** Will repair American-made early transistor portable radios. David Headley, 651 S. Yale, Wichita, KS 67218. (316) 684-0050

**FOR SALE:** 1/ Magnavox spkr 580088-1 - \$15. 2/ Testers: Hickok M110 A/O - \$75, FSM 5000 - \$35. 3/ Pye xmtr w/ant @ 10 - \$100. 4/ Cab. United Music Co. by Imperial @ 7 - \$40. 5/ AK 60 Chass. w/Pooley cab. - \$70. 6/ Emerson no #s wd case top handle A/O @ 10 - \$70. Have 7 more. 7/ Crosley M66TC A/O N/D - \$60. 8/ W/house M-H602-P7 port. tan cowhide D/C A/O @ 10 - \$50. 9/ Detrola R/P A/O N/D cab @ 7 - \$25. 10/ Philco M89 console A/O N/D - \$50. 11/ Grundig-Maj stereo M140V w/2 Deco spkrs - \$125, pick up only. 12/ Adv 18" Rd poster blue/red Radio Foods Co., Lawrence, Mass. - \$30. 13/ Panasonic (2) MRC1091 cream & matt pink 10's - \$55/both. 14/ Philco M89 w/19 chass A/O cab @ 9 slant spkr - \$75. UPS plus pack. Bernie Samek, 53 Old Palmer Rd., Palmer, MA 01069. (413) 245-7174

**WANTED:** No. 11 tuner and potentiometer for an AK 4066 breadboard. Don Hatch, 14 Kingspark Cres., London, Ontario, Canada N6H 4O4. (519) 472-6167

**FOR SALE:** 92 EEM Master, tube testers, tubes, miniature reel recorder, Geophysical Exploration Device. Ed Davis, Box 203, West Baden, IN 47469. (812) 936-9611

**FOR SALE:** RCA 45-J-2 player in very good condition except will not complete change cycle - \$25 plus shipping. Remo J. Vinassa, HCR 61 Box 222, Norfolk, AR 72658. (501) 499-7685

**WANTED OR TRADE:** Zeniths of 30's, 40's, 50's. Other brands also. Harvey Leners, 5426 So. 185th, Omaha, NE 68135

**FOR SALE:** 1948 Pilot TV with bubble to portable carrying case - \$250. Walt Keith, 269 White St., So. Burlington, VT 05403. (802) 862-4394

**WANTED:** Big-Band records, 45 & 78; esp. Goodman, Miller, Dorsey, and Live Remotes. Eric A. Harris, 3 Malvern Ave., No. 4, Richmond, VA 23221. (804) 353-2189

**FOR SALE:** New! A silver T-shirt with the Zenith logo emblazoned in red, large and xlarge - \$13.50, xlarge - \$14.95, ppd. Micronic Ruby transistor, red and white - \$285. Regency TR1-G with case, black, slight chip on side - \$285. Sonora TW49 (Collins, p. 47) - \$165. Zenith 95232 Walton's set, relacquered. Zenith chrome front tombstone 809. Zenith chrome front tombstone 829. RCA 1940 La Siesta Mexican radio (Collins 2, p. 51) - \$450. Crosley 166 Art Deco walnut, black and silver wood - \$185. Philco 37-600 Art Deco table model - \$165. Radiola 26 with battery box - \$295. Very fine Radiola III with tubes - \$195. Silvertone 3051 brown Bakelite, like 640 in Bunes 1 - \$135. Emerson USA brown Bakelite tombstone, with back - \$285. Ekco M23, 1931 British Bakelite angular Art Deco tombstone (Radio! Radio! - p. 121) - \$775. (2) Zeniths (Collins 2, p. 98), coral, T400 - \$85; green, M403 - \$95. Silvertone 6177A black with white (Collins 2, p. 27) - \$295. Pacific Radio Bakelite (like Collins 1, p. 68) - \$95. Philco 45 - \$165. Zenith 5R317 glass rod set - \$225. AK 225 tombstone - \$185. Packard Bell white Plaskon - \$145. Bizarre white Plaskon Firestone Air Chief, hairlines - \$225. GE A82 large tombstone, spectacular, 10" speaker, 8 tubes, (B.F.T.P., p. 155) - \$285. Butterscotch/red Fada 652, open grille - \$900. Coronado Plaskon 43-8190, white with blue trim (Collins, p. 77), crack on side - \$195. 11-100 Series Crosleys: green, repro knobs - \$180; white with clear original knobs, some wear - \$150. Belmont 6D120 original white with paint chips - \$195. Belmont 6D120, brown - \$215. Belmont 526, brown, slight crack - \$175. (2) Belmont 5D128s, one perfect original - \$250; second (Lafayette) white original with paint chips - \$185. Advertising clocks: Stewart-Warner neon completely original, 1940's - \$625. Zenith square, backlit - \$125. Raytheon - \$135. Tungsol - \$125. Sylvania - \$125. CBS Tubes - \$115. "National Union Tubes" flange sign, looks like tube - \$125. Small Tom Thumb Buddy tube-type portable, 1946 - \$100. Philco 39-116, top-of-the-line console with remote control, very good - \$450. Zenith tombstones: 6S128; 808 - \$260; 807 refinished - \$175; 5J217 - \$175; 5S127 - \$165. 6B129 - \$285; 8S129 - \$350. Philco 44 cathedral, refinished - \$185. Philco remote unit, circa 1939 - \$55. Grunow Teledial 12. Extra clean Zenith 5R312 (Collins 1, p. 71) - \$185. Zenith 6D315 Wavemagnet - \$250. Zenith wooden table models: 7S323, 6S321, 6S322. Zenith Trans-Oceanics: 8G005 - \$175; H500 - \$125; 7000 American - \$295. Zenith shutter dial consoles: 15U269; 15S372; 12S475; 12S568; 12S265; 12S370; 9S367; 9S365; 9S244 chairside. Other Zeniths: 12A57; 11S474; 10S153; 10S155; 10S156; 10S160; near mint 8S154; 7S53; 7S363; and many others in restorable condition, including chairside. Call for more info. An 11 x 17 photocopy book of the Zenith line from 1920 to 1946 is available for \$28.95 ppd. EH Scotts: Allwave 12 in early Tasman, Allwave 15 or 23 in Westminster, Allwave 23 in Windsor and more. RCA 13K; RCA 811K; Philco 37-116; and many others. Many of the radios we sell never make it to our yard. If you're looking for a Zenith shutter dial or other hard-to-find set, we may have what you need. We ship anywhere and we do it right. Please call, mornings best. Don't forget to send for our free merchandise catalog featuring T-shirts, owner's manuals, restoration supplies, etc. We have a limited supply of used and N.O.S. dial glass and used radio parts, primarily Zenith, please inquire. We accept Visa and Mastercard. Satisfaction guaranteed, shipping extra unless noted. We will be at Michigan and Elgin for delivery. Fax only please 8 am to 10 pm CDT (612) 727-1908. Alan Jesperson, PO Box 17338, Minneapolis, MN 55417. (612) 727-2489, ans. mach. after 4 rings, 8 am to 8 pm CDT, 7 days

**FOR SALE:** Battery sets: The following are all mint original, working, complete w/tubes. 1924 Michigan MRC3 - \$450. 1924 Michigan MRC12 - \$350. 1924 Michigan MRC2, rare 2-tube set - \$350. 1924 Klitzen 3-tube ornate, gold plated hardware - \$450. 1925 British "Red Star" 3-valve regen. - \$325. Western Electric cone speaker, excellent, working - \$110. AC radios: Majestic Melody Cruiser ship radio, looks & works great - \$450. Philco 90 cathedral, vgc, works great - \$475. Arvin 540T, yellow painted metal, vg, working - \$100. Stewart-Warner 1235R, ornate, small w/chrome grille, needs refinishing - \$225. Dave Christensen, 1732 W. Minnehaha Ave., St. Paul, MN 55104. (612) 644-8341, day; (612) 646-0908, night

**FOR TRADE:** Have Guild Spice Chest radio for Firestone 4A27 or 4A61 or Clinton product. Jay Kinnard, 623 Amesbury Ln., Austin, TX 78752. (512) 452-7018

**WANTED:** Bottom left push-button assembly for 1941 Zenith Spinet console 10H571. Johnny Johnson, 2201 Newton St., Denver, CO 80211. (303) 455-3421

**FOR SALE:** Crosley XJ, Crosley Pup, RCA RF-73, GE S-22 with good flower grille cloth, Grebe CR-9, Utah mushroom horn speaker. Belmont 6D111, Philco 71, Atwater Kent glass sign, missing base. **FOR TRADE:** Four Atwater Kent cathedrals: 165, 206, 246, 627. **WANTED:** Early battery radios. Unusual horn speakers, crystal sets, and wireless sets and parts. Jerry Finamore, 87 Stonewood Pl., Catasauqua, PA 18032. (215) 264-8412

**FOR SALE:** Battery sets. General Instruments - \$100. Newlands - \$100. Crosley tombstone 6H2 - \$125. Westinghouse WR290 - \$75. Joe Trovato, 1013 Bell Ave., North Braddock, PA 15104. (412) 271-2813

**WANTED:** Western Electric amps: 86, 91, 43, 46, 7A. Jun Mizuno, 6711 Mt. Leneve Dr., San Jose, CA 95120. (408) 268-4016

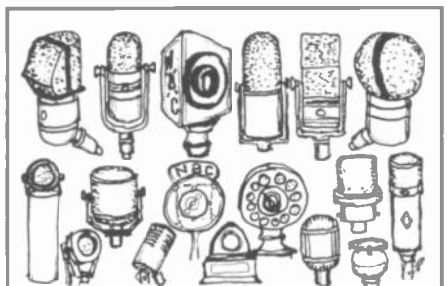

**WANTED  
FOR MY BROADCASTING MUSEUM**

Microphones, stands, call letter plates. Tube amplifiers, mixers, compressors, Hi-Fi equipment. Speakers, on-air lights, equalizers. Disk, wire & tape recorders. Blank recording disks. Catalogs, magazines, manuals. 16" transcriptions, turntables, arms, pickups. Early TV cameras & receivers. Elaborate console, deco, plastic, mirror, novelty & wireless radios. Jukeboxes & parts. Acoustic phonographs.

We are looking for all makes of equipment, and especially *Western Electric*, *Telefunken*, *Neuharn* and *RCA*. The museum contains various duplicates and items surplus to our needs, and many of these articles are available for sale or trade. The collection is located in my Victorian seaside inn, *The Caffrey House*, situated on a bay next to the ocean, in the Southampton resort area of Long Island. A trade of equipment for a stay at the hotel is always encouraged.

Robert Van Dyke, 2 Squires Ave., East Quogue NY 11942  
516-728-9835

**FOR SALE/TRADE:** Fada 21, vg, no marks, butter-scolch. Westinghouse RA-DA2-panel, 1 box wt. Crosley wood condenser w/dial. Predicta Remote. WR8-R w/ remote, needs refinishing. HRO-50T1 w/ A, B, C, D, E coils. Trade for Digital, Schulmetronic Bell Unit w/Bogen B-51W807s. Radiola phono panels, 2-catacombs, 1-TRF wood grain, 1300 panel, cond., coil socket & jack. (3) New P.A. drivers. (3) Motorola tube mobiles - for \$45 + shipping. (5) PA tube amps 30 to 60W - \$100 + shipping. John A. Myers, Wilson, NY 14172-0098. (716) 751-6053, evenings; Fax (716) 751-6236

**WANTED:** Buy or trade novelty promotional, advertising radios, old or new. Send for my list of traders. No SASE needed. Cliff Watts, 51 Glendale Rd., Brantford, Ontario, Canada N3T 1P5. (519) 753-5087

**FOR SALE:** Capehart 15K4 chassis - \$45. **WANTED:** Westinghouse H-558P4 portable. RCA 44 mic. R. Goode, PO Box 129, Cambridge, MA 02140. (617) 661-6885

**FOR SALE:** Tubes: industrial, power, receiving, special purpose, CRT's, vast inventory. Complete tube manufacturing equipment for sale. Contact Donna, Sales Mgr., United Electronics Co., est. 1920, 1177 McCarter Hwy., Newark, NJ 07104. (201) 751-2591, (800) 526-1275. Fax (201) 481-1524

**WANTED:** Crosley 50 manual. Transformer and yellow capacitor for Radiola III, need not be good. **FOR SALE:** Repaired Crosley book condenser, looks, works good - \$10 ppd. Tim Healy, 18 Abby Ln., Syosset, NY 11791

**FOR SALE:** Zenith 5L07, excellent - \$35. Zenith A510Y, nice - \$27. Zenith 8Y02, nice - \$30. Silvertone 132.877, white, nice - \$30. R. C. Moore, 452 West Park Ave., Aurora, IL 60506. (708) 264-0428

**FOR SALE:** Radio schematics, pre WWII - \$2.75; two models or more - \$2.50 each. LSASE. Dick Oliver, 28604 Schwalm Dr., Elkhart, IN 46517. (219) 522-4516, evenings.

**FOR SALE:** Hammarlund Super Pro, SP-110-LF-X, vgc with PS, manual - \$250. National speaker, large model with 10" speaker, gc - \$80. Philco MN 42-123 wood console cabinet only. Part No. is 10543 - \$95. National NC-125 in vgc with manual, built-in Select-O-Ject and matching speaker - \$150. Please write or phone for list of goodies. Clyde Sakir, N71OK, 4243 E. First St., Tucson, AZ 85711. (602) 323-1120

**FOR SALE:** Western Electric tube data photocopies contains from four to seven pages per tube - \$7 postpaid. Eight-transistor radio kits, N.I.B., have 4 - \$30 postpaid. Radiola 20 - \$150. National 183 D in cabinet - \$130. Military radio receiver R48/TRCB - \$150. Viking GN2 transmitter - \$65. Heathkit transceiver, 6 meters, Shawnee - \$145. Scott Marine radio model SLRM - \$185. May be too heavy to ship. Hallicrafters SX42 rack mounted - \$110. S38 A, B & E, S82, S102 - \$50 each. All plus UPS. Have list of transistor radios & general radio test equipment for SASE. **WANTED:** Wire recorders, no Webster, Chicago. Peter Dieguez, 36-48 34th St., Long Island City, NY 11106. (516) 625-0429

**WANTED:** Coto Coil Symphonic Broadcast receiver. Giblin made sets. Any Rhode Island made items. Leonard J. Arzooonian, 61 Columbus Ave., North Providence, RI 02911. (401) 232-0869

**FOR SALE:** Collection of 40 years. Collection of old radios, TVs, tube collection, books, magazines, service data, old boxed parts, used parts, old test eqpt. meters, loads of all types of used parts from junked sets, audios, power transformers, test eqpt., AM FM tuners, amps, plus more. By appointment only. Pick up only. Cash. Will not ship. Sales service since 1930. Krantz, 100 Osage Ave., Somerdale, NJ 08083. (609) 783-0400

**FOR SALE:** Philco 37-84 cathedral, good, working, repro dial and cloth - \$85. Fairbanks Morse 71 tombstone, good, works - \$65 + UPS. James S. Fisher, 344 Harrison Ave., Manville, NJ 08835. (908) 725-7476

## TUBES WANTED

We need the following tubes to replenish our stock (first digit on 3 digit types is optional). You may ship your tubes to us by UPS or Parcel Post. We'll mail our check upon receipt and testing of tubes. We pay prices shown plus shipping charges.

### USED GLOBE OR BALLOON SHAPE TUBES - ALL MUST TEST GOOD

WD-11*..... \$35.00	184..... \$ 6.00	227..... \$ 2.00	250..... \$27.00
WD-12*..... 20.00	UV-199*..... 10.00	230..... 5.00	256..... 6.00
WX-12*..... 15.00	UX-199*..... 9.00	237..... 6.00	280..... 7.00
112A..... 8.00	200A..... 6.00	240..... 5.00	281..... 7.00
120*..... 10.00	UV-201A..... 6.00	245..... 12.00	282..... 7.00
171/A..... 6.50	UX-201A..... 5.50	246..... 7.00	403 KELLOG.. 15.00
183/483..... 6.00	210..... 10.00	247..... 6.50	*Tubular

### NEW TUBES URGENTLY NEEDED

O1A(ST).... \$7.00	5Y3G..... \$3.00	6L6G..... \$9.00	42..... \$6.00
2A3..... 15.00	6A3..... 9.00	10..... 6.50	45..... 15.00
2B6..... 5.00	6B5..... 6.00	12A..... 8.00	47..... 5.50
5AR4..... 5.50	6CD7..... 8.00	15..... 8.00	50..... 30.00
5V4G..... 2.50	6F6G..... 3.00	26..... 3.00	71A..... 5.50

We buy all types of receiving and transmitting tubes. Send us your list for our bid.

## ANTIQUE ELECTRONIC SUPPLY

6221 S. MAPLE AVE., TEMPE, ARIZONA 85283 PHONE (602)820-5411 FAX (602)820-4643

MESSAGE: Finders fee paid to anyone who can tell me the location of the Pilot 393 table radio that was sold at the Water Village Radio Auction II in Nashua, New Hampshire, on April 18. Thanks. Bill Moore, 3049 Box Canyon Rd., Huntsville, AL 35803. (205) 880-1207

FOR SALE: 29 Vol., 2900 pp., Radio College Canada TV service man. 1953-67, vg cond. - \$50 U.S. plus ship. Dowdall O'Dacre, 548 Melton St., Pembroke, Ontario, Canada K8A 2S1. (613) 732-9597

FOR SALE: MFJ-1112 multiple DC power outlet - \$22, \$6 shipping. Pyramid III adjustable power supply, 4.5v-10v, 10-15v, mint - \$69 + \$10. Philco refinished cabinet wood, no play - \$42 + \$7. Models 40 & 120, both cabinets wood, painted white - \$42 + \$7. Heath DX-60 & book - \$60 + \$8. Windham table AM, 1/2" solid wood, works fine - \$40 + \$6. Zenith table FM only (Bunis, p. 168), works OK - \$42 + \$7. RCA table Bakelite 8X541 with handle - \$30 + \$7. Tele-Tone #195 - \$10 + \$5. Firestone wood table AM-AC, 1939, works fine - \$80 + \$8. Model S-7403-3 has handle. Heath Model C-3 cap. tester - \$23 + \$6. Case repainted professionally. Emerson CY-269 Bakelite, ex-nice AM & SW, hairline on side about 2" unseen - \$50 + \$10. Jean-Bpte. Desautels, K4VGD, 616 N. Silver Circle, Silver Shores, Key Largo, FL 33037-3840. (305) 852-2109

WANTED: Zenith Royal 500H, black or 2-tone gray, working condition. Write: Marty Dzik, 412 Gregory St., Schererville, IN 46375

WANTED: Crosley console 1126 and American Bosch sets. Will be at Elgin. Klaus Beckmann, General Delivery, Tofield, Alberta, Canada T0B 4J0. (403) 662-3518

**SEND ALL A.R.C. MAIL TO**  
**Antique Radio Classified**  
**P.O. Box 2, Carlisle, MA 01741**

WANTED: QSL's wanted. The Committee to Preserve Radio Verifications, a committee of the Association of North American Radio Clubs, is seeking individual QSL's or entire collections for an already well established archive of old QSL's. Our main interest is in standard broadcast and shortwave broadcast QSL's, not ham cards. If you know of any such QSL's that need a new home, contact: Jerry Berg, CPRV Chair, 38 Eastern Ave., Lexington, MA 02173. (617) 861-8481

MESSAGE: Help, need info: Rest of Mac-Key "Property of" legend. (Of who?). Thanks. Tom French, W1IMQ, 120 Great Rd., Maynard, MA 01754. (508) 897-2226

WANTED: Glass dial for Philco Model 42496, field coil speakers, old fan parts. Wayne Himel, 5230 August Ave., Marrero, LA 70072. (504) 348-4076

WANTED: Powell radios in any condition. Bill Hossfield, 50 Oakwood Dr., Ringwood, NJ 07456. (201) 839-9053, call aft. 7 pm

FOR SALE: Ambassador Super 80 transistor, red with cowhide case - Best Offer. Ned Connors, 29 Allen Ave., Barrington, RI 02806. (401) 246-0164

WANTED: AK 708 chassis, speaker, knobs, or a complete junker. Jon Kummer, WA2QJK, 23-35 Bell Blvd., Bayside, NY 11360. (718) 428-9070

WANTED: 1925-6 Zenith Deluxe. Also Super VIII audio transformer. Tobias M. Goodman, 41 East Ave., West-erly, RI 02891. (401) 596-7736

## Bargain Books

**A) THE COLLECTORS GUIDE TO ANTIQUE RADIOS** SECOND EDITION, 1992, by Bunis. Completely updated from the 1991 edition with 540 completely new full color photos and updated prices on 7,400 sets. List price \$17.95. **OUR PRICE \$15.25**

**B) EVOLUTION OF THE RADIO WITH PRICES**, 1992. 217 pages picturing over 1500 sets with over 600 in color. B&W pix are repro's of original ads. List price \$22.95. **OUR PRICE \$19.50**

**C) RADIO MANUFACTURERS OF THE 1920'S** by Douglas. Well researched and heavily illustrated of all major and many small makers in the 1920's. Packed with information. SOFTCOVER ONLY.  
**VOL. 1(A.C. Dayton to Ferguson)** List \$24.95 **OURS \$21.25**  
**VOL. 2(Fress-Fis. to Preiss)** List \$29.95 **OURS \$25.50**  
**VOL. 3(RCA to Zenith)** List \$29.95 **OURS \$25.50**

**D) GUIDE TO OLD RADIOS: Pictures, Printers and Prices** 1989, by Johnson. Real collectors book with helpful text and 350 photos. Brief company histories. List price \$16.95. **OUR PRICE \$14.50**

**E) COLLECTING TRANSISTOR NOVELTY RADIOS:** A Value Guide, 1990, Breed. 217 pages with 500+ full color photos and price information. List price \$24.95. **OUR PRICE \$21.25**

**F) CLASSIC PLASTIC RADIOS of the 1930's and 1940's** by Sidell. Covers the beautiful, popular and valuable Catalin plastic radios. 220+ color photos. List price \$19.95. SOFTCOVER **OUR PRICE \$17.00**

**G) RADIOS THE GOLDEN AGE**, by Collins, 1988. Studio quality photos of 120+ sets with emphasis on classic styles including Art Deco. SOFTCOVER ONLY. List price \$14.95. SOFTCOVER **OUR PRICE \$12.75**

**H) ANTIQUE RADIOS: RESTORATION AND PRICES**, by Johnson, 1982. Excellent intro to the hobby. List price \$14.95 **OUR PRICE \$12.75**

**I) RADIOS REDUX: LISTENING IN STYLE**, by Collins. 1992 follow up to the popular 1988 book (G above). 119 pages with color photos of 80 new sets. List price \$17.95. SOFTCOVER **OUR PRICE \$15.25**

**BOOK SHIPPING: \$2.50 for the first, \$1.00 each for each additional book.**

## VINTAGE RADIO RESTORATION VIDEO TAPE

### THE RADIO DOCTOR

Volume 1:  
Vintage Radio

Repair and Restorations

- 4 HOURS ON 2 VHS VIDEO TAPES
- COVERS THE COMPLETE RESTORATION OF A 1930'S SET
- INCLUDES COSMETIC RESTORATION OF A WOOD CABINET
- COVERS ELECTRONIC REPAIR AND ALIGNMENT
- DESIGNED FOR THE BEGINNER AND INTERMEDIATE LEVEL RESTORER, HOWEVER ADVANCED COLLECTORS HAVE COMMENTED THAT THEY LEARNED A FEW THINGS TOO.
- "HEARTILY RECOMMENDED... FOR THOSE WITH A YEARN TO LEARN", from MAY 1992 RADIO AGE review.

**TAPE PRICE \$23.95 TAPE SHIPPING \$4.00**

SPECIAL OFFER: ORDER THE TAPE AND ORDER ANY NUMBER OF BOOKS AT THE SAME TIME AND PAY NO EXTRA SHIPPING FOR THE BOOKS! (MUST STILL PAY TAPE SHIPPING)  
SPECIAL OFFER EXPIRES AUG. 1, 1992.

**NOTE: ALL SHIPPING APPLIES TO CONTINENTAL USA ONLY.**

## OZARK VINTAGE RADIO

3923 East Latoka Street  
Springfield, MO 65809

**WANTED:** Need the speaker that fits into an RCA 103 (working or not). Dahlberg Pillow Radio Model 4130-D. James Bailey, 803 N. Waukesha, Bonifay, FL 32425

**WANTED:** Green cloth-covered enameled wire, full or partial spools; Radio Age magazines, 1925 and 1926. Parker, W1YG, 87 Cove Rd., Lyme, CT 06371. (203) 434-7783

**FOR SALE:** The following radios are all in excellent condition and work. Pilot 123 - \$160. Graybar Radio 8 - \$185. Atwater Kent 165 - \$275. Belknap cathedral - \$250. Crosley cathedral 125 - \$190. GE A63 - \$170. DeWald 523 - \$60[?]. RCA 128 - \$250. Zenith 807 - \$185. Kolster 110 - \$190. Zenith 808 - \$180. Eley cathedral - \$90. Philco 60 - \$140. Philco 90 - \$500. Philco 41-256 - \$140. RCA 119 - \$150. RCA T7-5 - \$175. RCA 118 - \$180. Contact: Frank Weissman, 4 Shadbush Ln., Westport, CT 06880. (203) 454-1267, after 9 pm EST

**FOR SALE:** Sony dealer in store sign in form of a swag lamp; alternately lights, red, green blue - \$35. Ellsworth O. Johnson, 364 Coeurdalene St., Spokane, WA 99204. (509) 838-2161

**WANTED:** 6A5, and 211 tubes, Peerless S226Q transformer; hi-fi, theater & industrial amplifiers for collection. Mark van Roojen, PO Box 83836, Lincoln, NE 68501-3836. (402) 438-3724

**SERVICES:** Professional will restore any wood radio cabinet. Basket cases to simple repairs accepted. Send photo and description for quote. Carl McKenney, 4661 Norma Dr., San Diego, CA 92115. (619) 282-2275

**WANTED:** For Troy Model 15 right tuning escutcheon and both knobs. Will buy junker if it has above parts. For Remler Model 43, 1 or 2 black squarish knobs. For Telechron or Sessions clocks, small plastic or brass plated knobs. Craig Bergsma, 2616 E. 10th, The Dalles, OR 97058. (503) 296-3414, eve.

**FOR SALE:** Attention TV-Guide collectors, first 4 issues of Panarama TV magazine; this was a short lived publication in 1980 by same publishers as TV-Guide - \$38. Harry Belsy, N9CQX, 2409 Northgate, No. Riverside, IL 60546. (708) 442-8855

**WANTED:** Picture tube for Predicta 21EAP4. Lee Adams, 537 Bowman Ave., Daytona Beach, FL 32114. (904) 257-6745

**WANTED:** Crosley 11-107U in excellent condition, any color. R. C. Moore, 452 West Park Ave. Aurora, IL 60506. (708) 264-0428

**FOR SALE:** Radio Boys Books, by Chapman: At Ocean Point - \$10, At Mountain Pass w/dj - \$15; by J. W. Duffield: In the Flying Service - \$10. Write for Tom Swift list. J. J. Papovich, 53 Magnolia Ave., Pitman, NJ 08071. (609) 582-8279

**WANTED:** Philco 70 chassis & speaker, and AK 42 with speaker. M. L. Harrington, PO Box 7619, Little Rock, AR 72217

**WANTED:** Clock movement for a Philco 70 grandfather clock/radio. Thank you. Jose Reyes, 3198 Roosevelt St., Hollywood, FL 33021. (305) 985-8103

**FOR SALE:** Old U.S. and Japanese transistor radios. Send SASE for list. No calls please. John Neal, 2221 5th St. South, St. Petersburg, FL 33705

**WANTED:** Escutcheon and/or knobs for a Flint radio. Knobs have an F on front. Richard Gray, 9181 Chesapeake Dr., San Diego, CA 92123. (619) 560-4162

**WANTED:** Hallicrafters operating/service manual for Model 5-38D; speaker Model R-46B or R-47 or R-48. Technical, operating, service manual for vacuum tube voltmeter Model TS-375 A/U. Good photocopies okay. Need salvage chassis for Philco Model 89. Jim Patterson, 815W. Main St., Tupelo, MS 38801. (601) 844-6300, days

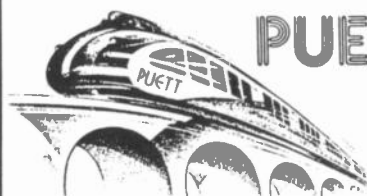

# PUETT ELECTRONICS

P.O. BOX 28572 DALLAS TX 75228

**NEW CATALOG 77**

GET THIS  
**WORLDS  
GREATEST  
RADIO  
CATALOG**

OUR PAST CATALOGS AND PRICE LISTS ARE NOW OBSOLETE.

CATALOG 77 (20-PAGES) OUR BASIC CATALOG \$2.00 POSTPAID.  
YOU RECEIVE A \$3.00 DISCOUNT COUPON WITH CATALOG 77.

CATALOG 77/PLL-2 (56 PAGES) -- \$5.00 POSTPAID.  
YOU RECEIVE A \$6.00 DISCOUNT COUPON WITH CATALOG 77/PLL-2.

WE NOW HAVE MORE THAN 1,500 DIFFERENT ANTIQUE RADIO PUBLICATIONS AVAILABLE! CATALOG 77/PLL-2 LISTS EVERYTHING WE HAVE TO OFFER!

WE OFFER BOOKS, INSTRUMENT MANUALS, SERVICE DATA, SALES BROCHURES, ATWATER KENT, RCA, CROSLLEY, ZENITH, ETC. FACTORY SERVICE MANUALS, STROMBERG CARLSON, CAPEHART, SCOTT, McMURDO SILVER, FISHER CLASSIC RADIO LITERATURE, DIRECTORY OF ANTIQUE RADIO SERVICES, SCHEMATIC DIAGRAMS ON NEARLY ANY RADIO, OLD-TIME RADIO PROGRAMS ON CASSETTES, TUBES, TUBE MANUALS, BOOKS ON WIRELESS AS OLD AS 1902, TUNING DRIVE BELTS, TUNING DIALS, TUNING-DIAL GLASS COVERS, KNOBS, OUR OWN PERIODICAL "ANTIQUÉ RADIO TOPICS" WITH THE ANTIQUÉ RADIO NEW ACQUISITIONS LIST, AND MUCH MUCH MORE!! ORDER OUR CATALOG TODAY!!!!!!!

**FOR SALE:** Tectronic Type 575 transistor curve tracer, with ACC and manual. Mathew Lineberger, Matt's Radio Shop, 295 Grove St., Providence, RI 02909. (401) 274-4836

**FOR TRADE:** 1893 souvenir of Chicago World's Fair Flag, 18" x 21" framed. **WANTED:** Factory 1-tube radio. Will bring to next Orient or Ronkonkoma Radio Show. Otto W. Nill, 192 Grant Ave., Islip, NY 11751

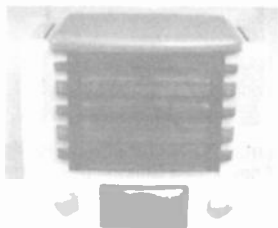

**WANTED:** All plastic models by Kadette in any color combination and any condition. I am now paying pre-Japanese recession prices in U.S. funds. Please write or call collect: Rain Buttignol, 214 State St., #7, Portsmouth, NH 03801. (603) 427-1384

**FOR TRADE:** (650+) Electrolytic capacitors (cans), about half N.I.B. Trade for tubes of equal value or what have you. Walt Murray, Encore Cassettes, PO Box 231340, San Diego, CA 92194. (619) 271-1858

**WANTED:** Plastic Detrolas (Pee wee, Super Pee Wee and split grille series) in any condition. Write or call collect. Mark Lucas, PO Box 192, Finleyville, PA 15332. (412) 348-6174

**FOR SALE:** International Kadette (1932) plastic table radio. Several small metal Silvertone radios. German Schaub-Lorenz Savoy Stereo 10 table radio with instruction book. Frank Atwood, 117 E. Main St., Merrimac, MA 01860. (508) 346-8100

**FOR SALE:** Freed-Eisemann NR-5, working, w/tubes - \$125 + UPS. R-100/URR, working - \$75. **WANTED:** Philco 680, 1936 console 5Z3, 80 rectifiers, 6A3 output. Charles Rhodes, 3906 Quisenberry Dr., Alexandria, VA 22309. (703) 780-0719



**WANTED:** This pictured Knight-Kit amplifier, or just the schematic. Model S-753. Uses two 6V6's, two 6SN7's, one 5Y3, ten watts output. Made about 1956. Richard Matiasek, 2212 S. 139th Ct., Apt #3, Omaha, NE 68144

**FOR SALE:** 95-page booklet published by Zenith Radio Corporation in 1943: Trailblazers to Radionics and Reference Guide to Ultra High Frequencies compiled by E. Kelsey unused but dusty - \$12 including shipping. Atwater Kent Model 32, nice original finish, working condition, with tubes - \$100. 30's Chevrolet auto radio Model No. 600565 with separate speaker, mounts on firewall, good condition, looks complete - Best Offer. Mike Kreuser, 1004 Dobson St., Evanston, IL 60202-3817. (708) 869-1952

**WANTED:** By TV historian, TV news magazine, early 30's. Felix the Cat doll. R. Brewster, 454 Diablo Dr., Pittsburg, PA 15241. (412) 833-4287

**WANTED:** Philco 46-1201 R/P, RCA 103 silk back form, inexpensive broadcast microphone, RCA 811K parts, record dusters, needle cutters and any phonograph related items. Portable tube tester. **FOR SALE/TRADE:** RCA 103 \$150. RCA 100 - \$35. Victrola 7-11 R/P - \$200. Diamond discs - \$1.50 ea. DD-C-19 - \$225. DD-C-100 - \$150. Don Menez, 4117 Colonial Ave., Alexandria, VA 22309. (703) 360-3413

**FOR SALE:** Triplett 2413 tube tester. Eico 610 tube tester adapter. Triumph 77 oscillograph Wobulator. Art Collatz, N7818 Barker Lake Rd., Winter, WI 54896

**FOR SALE:** Motorola 7" TV, VT71. Truetone DC-2857 turquoise. Zenith D-720 FM. Emerson G-1707 FM. John Koop, 48 Wheelbarrow Ln., Wantagh, NY 11793. (516) 731-6711

**WANTED:** Emerson 888, Pioneer, Vanguard, Explorer, Satellite, mint condition, all colors. Will purchase or trade American, Japanese, novelty transistors. Richard S. Lambert, 166 East 34th, Apt. 13-H, New York, NY 10016. (212) 684-6564, evenings

**WANTED:** Philco 5-701 7" Bakelite TV, RCA 621, Hallicrafters, National, Automatic 7" TVs; wood, metal, Bakelite. Jon Steinhauer, 636 Westminster Rd. Baldwin, NY 11510. (516) 223-9878

**FOR SALE:** Riders TV Manuals 1 to 6, 8, 15 to 26; excel ent condition - \$18 ea. or \$300 for all plus shipping. John Kara, 1700 Baltimore Ave., Whiting, NJ 08759. (908) 848-4318

**FOR SALE:** DeForest DV-3, DL-2, good, in cans - \$45/\$35. RCA UX210, N.I.B. - \$35. Eimac 4-100, N.I.B. - \$95. All plus shipping. J. Pawell, 6 Augustine Ave., Ardsley, NY 10502. (914) 693-9374



## Antique Radio Enthusiasts



Subscribe now to... **WIRELESS TRADER**

- ★ Published Twice Monthly ★
- ★ Delivered via First Class ★
- ★ Free Ad With Subscription ★
- ★ Easy to Read Format ★

*Wireless Trader* is a "must-have" for anyone engaged in the buying or selling of antique radios, TV's, or related equipment. Send \$16.95 for one year's (24 issues) subscription to:

**Trader Publications**  
4290 Bells Ferry Rd., Suite 106-36A  
Kennesaw, GA 30144



**FOR SALE:** Browning FM tuner RV-31 - \$40. Philco 53-958 horizontal wood AM/FM - \$45. RCA 1X53, green (see Bunis) - \$30. Zenith B835E blonde horizontal wood, AM/FM - \$45. Cabinets for Espey 6516 and Crosley 881A radios. **WANTED:** Brown knob for FADA 845. White bullet knob for Majestic 5LA5 (see R.G.A.), Emerson BA-199 parts set. Speaker and output transformer for Emerson 25-A (F.O.S., p. 82). Rod Matzko, 3 Coloma Ct., Sterling, VA 22170. (703) 406-2713

**FOR SALE/TRADE:** Emerson 888 Transtimer II with original instructions and fact-tag. **WANTED:** See ad page 36, March 92 A.R.C. Bill Timoszyk, 35283 Leon, Livonia, MI 48150. (313) 421-2076

**WANTED:** Marconi! Marconi! Marconi! Will purchase or have many wonderful items to trade. Barry A. Janov, 2454 Dempster St., Ste. 416, Des Plaines, IL 60016. (708) 827-1400

**FOR SALE:** RCA 74 Velocity Jr. microphones: MI-9645, very early model, brass case; MI-4036, black and chrome; both have original paint, both are in good cond., both function perfectly - \$400 each, OBO. **WANTED:** Jensen, UTAH 6", 8", 10", 12", 15" speakers. Thomas Crocker, PO Box 11582, Glendale, CA 91226. (818) 246-4757

**FOR SALE:** National choke coil, in metal can, marked 1 Henries, 1700 ohm resistance - \$10 + \$3 shpg. Audio transformers, old cases new 1:3 ratio winding inside, AK, Scott, Thordarson, etc. - \$15 each plus \$3 shpg. Jackson audio signal generator, book copy available - \$25 plus \$7.50 shpg. Bulova shirt-pocket-size transistor radio with leather case - \$15 ppd.; Omegas 9-transistor radio, knob missing, green plastic small case - \$10 ppd.; both untested. Benrus solid brass case clock radio, looks to be gold flash over brass, new speaker, capacitors, plays well - \$100 plus \$10 shpg. N.I.B. astatic disc recorder - \$50 plus \$5 shpg. 6-, 10-, 12-inch new recording discs available. James Fred, R1, Cutler, IN 46920. (317) 268-2214

**WANTED:** AK-10 RF coils, any condition. AK-567, 447, 228, others. Cabinet for AK-93. Bob Nicholson, 3423 S. Long, Topeka, KS 66605-2486

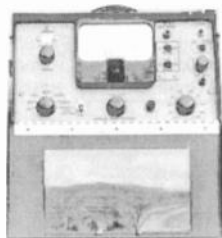

**FOR SALE:** Jerrold TV/FM signal level meter Model 704B. condition unknown. Best Offer. Angelo J. Anello, 1915 W. Waters Ave. #1, Tampa, FL 33604. (813) 933-6009

**MESSAGE:** \$100 to \$200 paid for Pilot 393 table radio that was sold at the Water Village Radio Auction II in Nashua, New Hampshire. Thanks. Bill Moore, 3049 Box Canyon Rd., Huntsville, AL 35803. (205) 880-1207

**FOR SALE:** Cheap Bakelite radios. Send SASE for photo list. I want to buy Boomerang. Don Moody, 1600-M Glenwood Ave., Raleigh, NC 27608. (919) 821-3530, eve.

**PHONE NUMBER FOR  
ANTIQUA RADIO CLASSIFIED  
(508) 371-0512**

**Best time to call is weekdays:  
9 am to 5 pm Eastern Time**

(Please no classified ads by phone. Thanks!)

**FOR SALE:** I offer 100% refunds on any item that you are not pleased with. No junk! All my sets are cleaned, working & ready for display unless otherwise noted. New literature includes Riders manuals and original indexes, Ghirardi, Coyne, NRI, etc. New parts include earlier hi-fi Jensen horns & parts from the early to mid-1920's. Radios include: Fada 652 butterscotch with one small hairline and repro knobs, plays well, very attractive - BO over \$500; Airline 62-361 Deco wooden radio - \$75; Sparton 6-26 BC/SW, very attractive - \$85; Telechron 8H59 unique clock radio - \$45; transistor novelties: picture cube, owl, tiny cathedral, antique phone. Other transistor sets include N.I.B. Westinghouse early pocket radio, tiny: many more radios, parts & literature and test equipment. Please call after 5:00 pm Montana time or send SASE for a five-page list to: Neil O'Donnell, 1809 Sampson St., Butte, MT 59701. (406) 494-8162

**WANTED:** Philco table radio, 42-350 must be very good to mint. Has to be complete & original. Ray Rhodes, 3631 Willis Dr., Napa, CA 94558. (707) 255-8976, after 5 pm

**FOR SALE:** Copies: Warped records straightened - \$10. 101 Ways Using VOM & VTVM - \$10. Tube Substitution Guide - \$5. 1923 Radio Hookups - \$10. 1931 How To Use Radio Set Analyzers - \$10. Radio Guide DC-1 For Dial Restrng., 1938 to 1947 - \$8. Guide DC-2, 1947 to 1950 - \$8. Radio Tube Replacement Guide, 1938 to 1948 - \$20. J. J. Papovich, 53 Magnolia Ave., Pitman, NJ 08071. (609) 582-8279

**FOR SALE:** Radiotron Designer's Handbook, third edition - \$20. RCA TV Pictoguide, Volume III - \$20. Richard Yoch, 22410 Bartlett Dr., Rocky River, OH 44116. (216) 331-9206

**OLD TECH  
BOOKS  
& THINGS**

*Early  
Technical  
Books &  
Apparatus*

**Announcing - Catalog No. 1  
Available Soon\*  
Write For Free Copy.**

**We Specialize In:**

Wireless - Radio - Television - Telegraph  
Telephone - Electricity - Computers - Slide Rules  
Electro-Medical - Calculators - Typewriters  
Atomic Energy - Astronomy - Skiing

**We Buy & Sell:**

Books - Juveniles - Catalogs - Magazines  
Manuals - Ephemera - Novelties - Apparatus  
Anything Related!

*Send us a list of your general & specific wants.*

**OLD TECH - BOOKS & THINGS**

**John V. Terrey, Proprietor  
P.O. Box 803, Carlisle, MA 01741 U.S.A.**

*\*Still delayed, but eventually I will get it finished!*





# COMING RADIO EVENTS

## INDIANA - Jun. 27

INDIANA HISTORICAL RADIO SOCIETY  
SUMMER MEET

Elkhart, IN - Highdive Park Pavilion  
500 E. Beardsley  
8:30 am to ?

Info: Terry Bunn, 1420 Olive Street  
Elkhart, IN 46514 - (219) 262-3291

## WEST VIRGINIA - Jul. 4

WEST VIRGINIA CHAPTER  
ANTIQUÉ RADIO CLUB OF AMERICA  
ALL DAY MEET

Huntington, WV - Musuem of Radio & Technology, Inc., I-64, Exit 6 - Follow Signs  
7:30 am - Museum Open - Tours All Day  
8 am - Traders Market  
9 am - Classroom Seminars:  
How To Help Your Museum Grow - Radio Restoration, Collecting & Display Tips  
10:15 am - Perry's American Museum Tour  
10:15 am - 14th Street Antique Shop Tour  
12:30 pm - Museum Covered Dish Dinner  
1:30 pm - Auditorium Grand Auction

Parking - Tours - Free Admission  
All Events Indoor If Weather Turns Bad  
Outside Presentations (weather permitting)

Info: Geoffrey Bourne, 405 Eighth Avenue  
St. Alban, WV 25177 - (304) 722-4690, home  
Museum - (304) 525-8890

## ONTARIO - Jun. 27

LONDON VINTAGE RADIO CLUB  
ANTIQUÉ RADIO FLEA MARKET

London, Ontario - London Jaycee Premises  
317 Adelaide St. South

Public welcome - Refreshments available  
Bring your own table - 50-50 draw

Info: Dennis Curtis - (519) 686-9748

## WISCONSIN - Jun. 27-28

WESTERN WISC. ANTIQUÉ RADIO  
COLLECTORS CLUB  
NOSTALGIC RADIO 92

Onalaska, WI - Onalaska Community Center  
515 Quincy St., Hwy. 35 Exit from I-90  
8 am - 5 pm daily

Info: WWARC, 1025 Oak Ave. S, #B-21, Onalaska  
WI 54650 - (608) 783-1852, or (608) 788-9299

## NEW YORK - Jul. 5

GREATER N.Y. VINTAGE WIRELESS ASSOC.  
SWAP MEET - 9 am

Info: Steve Coughlin - (516) 324-3012 or  
Chris Bacon - (516) 981-6538

## ARKANSAS - Jul. 2

ANTIQUÉ RADIO COLLECTORS CLUB  
OF FT. SMITH - CLUB MEETING - 7:30 pm

Ft. Smith, AR - Creekmore Park  
Magnolia Room, Greenwood and Rogers

Info: Wanda Conatser - (501) 646-7147

## TEXAS - Jul. 7

HOUSTON VINTAGE RADIO ASSN.  
MEETING

Houston, TX - Astrodome Marriott  
2100 South Braeswood - 7 pm

Info: Richard Collins, 8722 Reamer St.  
Houston, TX 77074 - (713) 778-0271

## MISSOURI - Jul. 4

MID-AMERICA ANTIQUÉ RADIO CLUB  
SWAP MEET

Kansas City, MO - I-70 Drive-In, on 40 Hwy.  
7 am - Swap & Shop  
Contest for Ugliest Radio

Info: Carleton Gamet, 2307 W. 131 St.  
Olathe, KS 66061 - (913) 764-3430

## ARKANSAS - Jul. 9

ARKANSAS ANTIQUÉ RADIO CLUB  
CLUB MEETING

Little Rock, AR - The Auditorium  
S.W. Bell Bldg., 120 W. 8th St. - 7 pm

Info: Tom Burgess - (501) 565-1750

## NEW JERSEY

NEW CLUB FORMING  
CENTRAL JERSEY ANTIQUÉ RADIO CLUB

Info: Tony Flanagan, 92 Joysan Ter.  
Freehold, NJ 07728 - (908) 462-6638

*Attend a club event near you, learn,  
meet others in the hobby, and perhaps  
find an item or two for your collection!*

## **MICHIGAN - Jul. 10-12**

### **MICHIGAN ANTIQUE RADIO CLUB ANTIQUE WIRELESS ASSOCIATION EXTRAVAGANZA '92**

Lansing, MI - Holiday Inn Conference Center, 7501 W. Saginaw - (517) 627-3211

Jul. 10-12: All day - Open Air Flea Market

Jul 10: 1-3 pm - Contest Voting

3-10 pm - Contest Viewing

6 pm - Program w/John Reinicke

7:30 pm Program w/George Fathauer

Jul. 11: 11 am -1 pm - Auction

7:30 pm - Social Hour w/exhibit

9 pm - Raffle - Zenith Walton's radio

Jul 12: 9 am - Program w/Mark Oppat

11 am - Donation Auction

Info: Extravaganza '92, PO Box 585 Okemos, MI 48864

## **GEORGIA - Jul. 14**

### **SOUTHEASTERN ANTIQUE RADIO SOCIETY MEETING**

Chamblee, GA - Shoneys Restaurant  
Peachtree Industrial, 1 mi. North of I-285

6:30 pm - Meeting

6 pm - Mini Meet before Monthly Meeting

Info: Charles Pierce - (404) 233-1340, or  
David Martin - (404) 578-1270

## **OHIO - Jul. 14**

### **ANTIQUE RADIO COLLECTORS OF OHIO MEETING**

Kettering, OH - First Natl. Bank Basement  
4100 Far Hills Avenue - 7:30 pm

Info: Karl Koogle, 2929 Hazelwood Ave.  
Dayton, OH 45419 - (513) 294-8960, after 6 pm

## **MICHIGAN - Jul. 11**

**E.H. SCOTT HISTORICAL SOCIETY  
NEW CLUB FORMING - MEETING**  
Lansing, MI - Holiday Inn, Regency Room  
7:30 pm

Info: John T. Meredith, 1792 NemokeTrl.

Haslett, MI 48840 - (517) 349-4348

After Aug. 1: E.H. Scott Historical Society  
PO Box 1070, Niceville, FL 32588-1070

## **PENNSYLVANIA - Jul. 14**

### **DELAWARE VALLEY HISTORICAL RADIO CLUB MEETING - SWAP MEET - AUCTION**

Souderton, PA - 117 Main St. - 7:30 pm

Info: Radio Attic, PO Box 624, Lansdale, PA  
19446 - (215) 368-2520

## **CALIFORNIA - Jul. 11**

### **CALIF. HISTORICAL RADIO SOCIETY SWAP MEET**

San Francisco, CA - St. Anne of the Sunset  
Church, Funston at Irving Street  
8 am - Setup

Info: John Wentzel - (415) 731-1920

## **CALIFORNIA - Jul. 15**

### **SACRAMENTO HIST. RADIO SOCIETY MEETING**

N. Highland, CA - SMUD Foothill - 7-9 pm  
Service Center, Room D, 5026 Don Julio

Info: Secretary SHRS, PO Box 162612,  
Sacramento, CA 95816

## **COLORADO - Jul. 12**

### **COLORADO RADIO COLLECTORS MEETING - SWAP MEET**

Denver, CO - South West Bank Bldg.  
Community Room, 1380 S. Federal Blvd.

Meeting - 1 pm; 3 pm - Swap Meet

Info: Rick Ammon - (303) 224-5446

## **NEW YORK - Jul. 16**

### **HUDSON VALLEY ANTIQUE RADIO AND PHONOGRAPH SOCIETY MEETING**

Goshen, NY - Cataract Firehouse - 7-9 pm

Info: John & Linda Gramm, Box 1, Campbell  
Hall, NY 10916 - (914) 427-2602, 6-9 pm

## **OHIO - Jul. 12**

### **BUCKEYE ANTIQUE RADIO AND PHONOGRAPH CLUB PICNIC**

Richfield, OH - Behind the Richfield Town  
Hall, on Rte. 303 - 1-5 pm

Info: Kim Graca, 916 State Rd.

Hinckley, OH 44233 - (216) 278-4516

## **N. CAROLINA - Jul. 17-18**

### **VINTAGE RADIO UNIQUE SOCIETY ANNIVERSARY - SWAPFEST/SHOW**

Hickory, NC - Ramada Inn - (704) 322-5533  
I-40 take Exit 123 Rt. 70/321 N), then 1st Exit

Open-air Swapfest both days - 9 am - 5 pm

Fri. pm Jul. 17: "Unique" Symbol

Unveiling/Commentary - Radio Cake Social

Jul. 18: Contest - Viewing - Awards - Program

Info: Jerryl Sears, 312 Auburndale St.,  
Winston-Salem, NC 27104 - (919) 765-4302,  
after 6 pm

Enclose a SASE when requesting info.

## **MARYLAND - Jul. 18**

### **MID-ATLANTIC ANTIQUE RADIO CLUB MEETING - OLD EQUIPMENT CONTEST**

Laurel, MD - Applied Physics Lab  
John Hopkins University - 6 pm  
Info: Joe Koester - (301) 725-4229

## **NEW YORK - Jul. 19**

### **ANTIQUÉ RADIO CLUB OF SCHENECTADY MEETING**

Flea Market - 1:30-2 pm; Meeting - 2 pm  
Info: Jack Nelson, W2FW, 915 Sherman St.,  
Schenectady, NY 12303

## **OREGON - Jul. 18**

### **NORTHWEST VINTAGE RADIO SOCIETY ANNUAL SUMMER SWAP MEET**

Salem, OR - 7455 O'Neil Rd.  
8 am - 2 pm  
Outdoors - Rain or Shine  
Info: Speed Feldschau - (503) 390-3928

## **ALABAMA - Jul. 27**

### **AL. HISTORICAL RADIO SOCIETY MEETING**

Birmingham, AL - Homewood Public Library  
1721 Oxmoor Road - 7 pm  
Info: ALHRS, 4721 Overwood Circle  
Birmingham, AL 35222 - (205) 595-2856

## **NEW HAMPSHIRE - Jul. 18**

### **NEW ENGLAND ANTIQUE RADIO CLUB SUMMER SWAP & SELL MET**

Nashua, NH - Resurrection Center, Rt. 3  
(Everett Turnpike), Exit 6,  
1 1/2 miles West on Rt. 130  
8 am - 1 pm

Old Equipment Contests: Post-World War II  
(1945) Crystal Sets & TVs

Over 100 Tables - 50/50 Raffle - CATERED  
Free Parking - Reservation required to sell

Info: Marty Bunis, RR 1, Box 36  
Bradford, NH 03221 - (603) 938-5051

## **CALIFORNIA - Aug. 1**

### **CALIF. HISTORICAL RADIO SOCIETY SWAP MEET**

Redwood City, CA - Ampex Corp.  
8:30 am

Info: Jim McDowell, 2265 Panoramic Dr.  
Concord, CA 94520 - (510) 676-2605

## **ONTARIO - Jul. 18**

### **ANTIQUÉ WIRELESS ASSOCIATION REGIONAL MEETING**

Guelph, Ontario - Hammond Museum  
10 am - Flea Market  
12 noon - Meeting with lunch  
Museum Tour

W/ London Vintage Radio & Toronto Clubs  
Info: Dennis Curtis - (519) 686-9748

## **INDIANA - Aug. 1**

### **INDIANA HISTORICAL RADIO SOCIETY SUMMER MEET 2**

Sheridan, IN - Biddle Memorial Park,  
20 minutes North of Indianapolis

Swap Meet - 8 am - 1 pm  
Indoor/Outdoor - Bring Tables

Info: Eric Sanders, 3295 W. 246th St.  
Sheridan, IN 46069 - (317) 758-4988, home  
(317) 451-8928, work

## **TEXAS - Jul. 18**

### **VINTAGE RADIO & PHONOGRAPH SOCIETY MEETING**

Irving, TX - 906 Senter Street  
Info: George Potter - (214) 315-2553

## **MISSOURI - Aug. 1**

### **MID-AMERICA ANTIQUÉ RADIO CLUB SWAP MEET**

Kansas City, MO - I-70 Drive-In, on 40 Hwy.  
7 am - Swap & Shop - No Contest

Info: Carleton Gamet, 2307 W. 131 St.  
Olathe, KS 66061 - (913) 764-3430

## **WASHINGTON - Jul. 19**

### **PUGET SOUND ANTIQUÉ RADIO ASSN. MEETING**

Seattle, WA - Shoreline Museum  
749 North 175th St., 1 mile W. of I-5, exit 176

11 am - Swap Meet - 1 pm - Meeting  
"The Wonderful World of Shortwave," M. Kaplan

Info: Al Atworth, PO Box 125  
Snohomish, WA 98291-0125 - (206) 568-2698

## **CENTRAL N.Y.-N. Pa. - Aug. 1**

### **CENTRAL NEW YORK/NORTHERN PA. ANTIQUÉ RADIO CLUB MEETING - SWAP MEET**

In So. Waverly, PA  
Info: Larry Schichtel, 319 Fulton St.  
So. Waverly, PA 18840 - (717) 888-5078  
or Mark Gilbert - (607) 898-3519

**MENTION A.R.C.  
WHEN CONTACTING CLUBS!**

## OHIO - Aug. 2

### OHIO AREA RADIO COLLECTORS SWAP MEET

Dayton, OH - Moraine Civic Center, 3050  
Kreitzer, I-75 Exit #50A Moraine/Dryden Rd.  
8 am - 4 pm

Info: WQRP FM 88 - (513) 298-4044  
Harold Parshall - (513) 268-2909  
Jim Di Ruzza - (513) 233-5004

## ILLINOIS - Aug. 6-8

### ANTIQUE RADIO CLUB OF ILLINOIS RADIOFEST '92

Elgin, IL - Holiday Inn Holiday/Convention  
Center, 345 River Road - (708) 695-5000

Open Air Flea Market All Days

Thurs.: Auction & Tour of Motorola Museum  
Fri.: Trip to Muchow Museum & PM Banquet

Info: Dave Johnson, 2336 S. Kenilworth  
Berwyn, IL 60402 - (708) 484-2743  
evenings or weekends

## RHODE ISLAND - Aug. 8

### N.E. MUSEUM OF WIRELESS & STEAM YANKEE TUNE-UP

East Greenwich, RI - 697 Tillinghast Rd.

Radio historians are invited to test run  
antique receivers on a special bench fitted  
w/ A, B, C juice, active antenna and ground.

Info: Bob Merriam - (401) 884-1710

## CALIFORNIA - Aug. 11

### CALIF. HISTORICAL RADIO SOCIETY NORTH VALLEY CHAPTER - MEET

Redding, CA - 7 pm

Info: Norm Braithwaite - (916) 246-4209

## CALIFORNIA - Aug. 15

### SO. CALIF. ANTIQUE RADIO SOCIETY MEET

Torrance, CA - Velvet Turtle - 7 am - 2 pm

Info: Bob Baumbach - (818) 845-7807

## NEW YORK - Aug. 15

### HUDSON VALLEY ANTIQUE RADIO & PHONOGRAPH SOCIETY THIRD ANNUAL

OLD-TIME RADIO & PHONOGRAPH SHOW  
Campbell Hall, NY - Otterkill Engine Co.

8 am - 4 pm

Info: Linda Gramm - (914) 427-2602, or  
(914) 561-0132, eves.

## MARK YOUR CALENDAR

Jun. 27 - IN, Elkhart - IHRS Swap Meet\*  
Jun. 27 - Ontario, London - LVRC Flea Market\*  
Jun. 27-28 - WI, Onalaska - WWARC Nostalgic Radio\*  
Nov. 4-'93 - FL, Cypress Gardens - Exhibit  
Feb. 2-Jul. 12 - MA, Lexington - NEARC Display  
Jul.-Aug. - CT, New Britain - Exhibit  
Jul. 2 - AR, Ft. Smith - ARCCFS Meeting §\*  
Jul. 4 - MO, Kansas City - MAARC Swap Meet\*  
Jul. 4 - WV, Huntington - ARCA/WV Meet\*  
Jul. 5 - NY, Orient - GNYVWA Swap Meet §\*  
Jul. 7 - TX, Houston - HVRA Meeting §\*  
Jul. 9 - AR, Little Rock - AARC Meeting §\*  
Jul. 10-12 - MI, Lansing - MARC Extravaganza '92\*  
Jul. 11 - CA, San Francisco - CHRS Swap Meet\*  
Jul. 11 - MI, Lansing - ESHS Meeting\*  
Jul. 12 - CO, Denver - CRC Meet\*  
Jul. 12 - OH, Richfield - BARPC Picnic\*  
Jul. 14 - GA, Chamblee - SARS Meeting §\*  
Jul. 14 - OH, Kettering - ARCO Meeting §\*  
Jul. 14 - PA, Souderton - New SE Pa. Club §\*  
Jul. 15 - CA, N. Highlands - SHRS Meeting §\*  
Jul. 16 - NY, Goshen - HARPS Meeting §\*  
Jul. 17-18 - NC, Hickory - VRUS Swapfest\*  
Jul. 18 - MD, Laurel - MAARC Meeting §\*  
Jul. 18 - NH, Nashua - NEARC Meet\*  
Jul. 18 - Ontario, Guelph - AWA Meeting\*  
Jul. 18 - OR, Salem - NWWRS Swap Meet §\*  
Jul. 18 - TX, Irving - VRPS Meeting §\*  
Jul. 19 - NY, Schenectady - ARCS Meeting §\*  
Jul. 19 - WA, Seattle - PSARA Meeting §\*  
Jul. 27 - AL, Birmingham - ALHRS §\*  
Aug. 1 - IN, Sheridan - IHRS Summer Meet\*  
Aug. 1 - CA, Redwood City - CHRS Meet\*  
Aug. 1 - MO, Kansas City - MAARC Swap Meet §\*  
Aug. 1 - PA, S. Waverly - CNY/NPAARC\*  
Aug. 2 - OH, Dayton - OARC Meet\*  
Aug. 6-8 - IL, Elgin - ARCI Radiofest '92\*  
Aug. 8 - RI, E. Greenwich - Yankee Tune-Up\*  
Aug. 11 - CA, Redding - CHRS-NVC Meet\*  
Aug. 11 - GA, Chamblee - SARS Meeting §  
Aug. 11 - OH, Kettering - ARCO Meeting §  
Aug. 15 - CA, Torrance - SCARS Meet\*  
Aug. 15 - NY, Campbell Hall - HARPS Show\*  
Aug. 16 - WA, Seattle - PSARA Swap Meet  
Aug. 22 - MD, Laurel - MAARC Meeting §  
Aug. 29 - OH, Dayton - ARCO Swap Meet  
Sep. 12 - NE, Brownville - MRC Swap Meet  
Sep. 12 - RI, E. Greenwich - Yankee Steam-Up  
Sep. 12-13 - NE, Brownville - MRC Radio Days  
Sep. 19 - Ontario, London - LVRC Meeting  
Sep. 20 - OH, Brunswick - BARPC Meeting  
Sep. 23-26 - NY, Rochester - AWA Conference  
Sep. 26 - CA, Fairfield - CHRS Meet/Picnic  
Oct. 10 - CA, Redding - CHRS Swap Meet  
Oct. 10 - IN, Greenfield - IHRS Fall Meet  
Oct. 10 - KY, Lexington - MSARC Swap Meet  
Oct. 11 - MI, Southgate - MARC Park 'n Swap  
Oct. 16-18 - TX, Dallas - VRPS/AWA  
Oct. 17 - NH, Nashua - NEARC Meet  
Oct. 24 - CA, Benicia - CHRS Swap Meet  
Oct. 31-Nov. 1 - OH, Akron - BARPC Show  
Nov. 7 - CA, Redwood City - CHRS Swap Meet  
Nov. 20-21 - CA, Norwalk - SCARS Meet  
Nov. 21 - TX, Irving - VRPS Swap Fest  
Dec. 5 - TX, Houston - HVRA Party §

\* See expanded listing this month. § Monthly Meeting.

**BUSINESS CARD ADS - \$31.00 FOR 3 MONTHS**

**SPY EQUIPMENT WANTED!**

- Code Machines
- Secret Radios
- Clandestine Weapons
- Secret Cameras
- OSS, SOE, CIA, KGBI
- I Buy or Trade!

Keith Melton  
P.O. Box 5755 Bossler City, LA 71171  
(318) 747-9616 Days: FAX (318) 747-9010

WANTED

**SONY CRF320  
CRF330**

Chris Clark, 117 Hudson Street, NYC, 10013  
TEL. (212) 219-1783

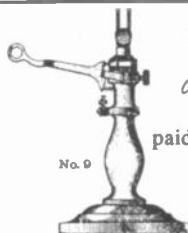

**\$\$\$ WANTED \$\$\$**  
*SHAPED  
CANDLESTICK TELEPHONES*

**\$1,000**  
paid for any set like this

Richard Mountjoy  
1915 S. 39th St., N#44  
Mesa, Arizona 85208  
(602) 926-8174

WANTED: Tube-type Amplifiers, Theatre Amplifiers, Tuners, Microphones and Electronics Books.

I collect older Hi-Fi gear and kits, P.A. Amplifiers, Industrial Amplifiers, 50s & 60s Speakers, Power Tubes, Audio Transformers - and any literature related to these.

Mark van Roojen  
P.O. Box 83836  
Lincoln, NE 68501-3836

(402) 438-3724



ROY M. GOODE



P.O. Box 129  
CAMBRIDGE, MA  
02140

**GOODESOUND**

SPECIALIZING IN VINTAGE MUSICAL EQUIPMENT  
REPAIRING • RESTORING • BUYING & SELLING

GUITARS-AMPLIFIERS-DRUMS-RECORDING GEAR-HIFI

**Play Things of Past**

Sales - Service - Restoration of Vintage  
Radios and Electronics.



**Gary Schneider**

Retail Sales Store

3952 W 105th  
Cleveland Oh 44111  
Hours 6-9pm Wed.  
12-6pm Sat.

Mail Address

9511-23 Sunrise Blvd  
Cleveland Oh 44133  
216-582-3094

Buy - Sell - Trade Radios, Tv's, Tubes, Parts

Free Estimates  
Hrs - 10 AM - 7 PM  
Mon - Sat

Tel / Fax (203) 928-2628



**ANTIQUE RADIO  
RESTORATION & REPAIR**

1920 - 1980 s

Buy & Sell

Reasonable Rates Tubes  
Parts & Service on all  
Antique Car, Console &  
Table Radios, Tube Amps  
& Phonos



20 Gary School Road  
BOB ESLINGER Pomfret Center CT 06259

*"The Early Sound Man"*

Mr John Andolma, Jr

*Antique Phonographs*

Collect - Repair - Restore  
Edison, Victor, Columbia  
Cylinder - Disc Records  
Phonograph Advertising



28 GLEN OAKS DRIVE  
ROCHESTER, N.Y. 14624



THE FINISHING TOUCH



*Todd E. Hinman Restorations*  
SHOW WINNING FINISHES

— AUTO INTERIOR WOOD —

- RADIOS
- MECHANICAL
- 78 RPM JUKEBOXES
- ELECTRONICS



203-274-0705

203-268-6080



182 JUDD FARM ROAD  
WATERTOWN, CONN. 06795



WANTED: UTC KIT AMPLIFIERS,  
kit, or transformers. Also interested  
in these companies:

ACROSOUND • PEERLESS • TRIAD  
STANCOR • DYNACO • EICO

KIT  
AMP  
COLLECTOR

Leif Blackmon • 508-644-0174  
4 Larson Road • North Reading  
Massachusetts • 01864

**REPAIRS  
TO ALL TUBE TYPE  
RADIOS**

George Huntley  
R.R. 4, Rockwood, Ontario. N0B 2K0  
(519) 856-4580



**ANTIQUE RADIO  
SERVICE**  
RADIOS REBUILT  
BOUGHT SOLD TRADED

Auto and Home

WE BUY AUTO RADIOS

(508) 653-2418

RICHARD FOSTER  
12 Shawmut Ave  
Cochituate, MA 01778

## BUSINESS CARD ADS - \$31.00 FOR 3 MONTHS

**WANTED**  
 PRE 1900  
**ELECTRICITY**  
 MEDICAL • X-RAY  
 TELEGRAPHY • TELEPHONE  
 PRE 1925  
 RADIO • WIRELESS  
 PRE 1940  
 TELEVISION

BOOKS • TUBES • ARTIFACTS  
 MAGAZINES • AUTOGRAPHS  
 CATALOGS • EPHEMERA



**NEW WIRELESS  
 PIONEERS**  
 P O BOX 398  
 ELMA, NY 14059  
 716-661-3186

COMM/HAV EQUIP  
 RADIO SETS  
 NAVAL AIR FIELD  
 US FOREIGN

CHARLES DICECCA KA1GON  
 501 MYSTIC VALLEY PKWY  
 HEDFORD, MASS. 02155  
 PHONE: 617-396-9354



MILITARY ELECTRONICS

BUY                      WANTED                      TRADE

### ANTIQUE RADIO REPAIR

*Repair - Restore - Buy & Sell*

Schematic Service

Radios \$2.<sup>50</sup>, TVs \$4.<sup>50</sup>

### DAMASKE ELECTRONICS

S74-W16834 Janesville Road

Muskego, WI 53150

Phone: (414) 679-0838

RADIOS & STRANGE MISCELLANEA      IF YOU VISIT THE BRIMFIELD FLEA MARKET...  
 STOP BY FIRST!

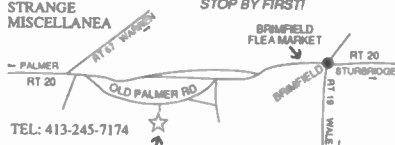

TEL: 413-245-7174

COUNTRY ROAD BARN - BERNIE SAMEK  
 OLD PALMER ROAD, BRIMFIELD, MASS.

50 years

## CHUCKS

of service!

Any Tube Radio Repaired and

Guaranteed to work good.

\$26.00 plus large parts & UPS

CHUCKS

167 LYNN DRIVE - PO BOX 598  
 NEW HAVEN, WV 25265 - Ptt (304) 882-2220

### ELECTRON TUBE ENTERPRISES

*(Dealers in Surplus Electron Tubes)*

BOX 8311      ESSEX, VT. 05451

TEL: 802-879-0611

FAX: 802-879-7764

FREE 1992 CATALOG AVAILABLE

Are You Looking For Antique Radios, Parts, Tubes, Schematics and Restoration Services?

For Free Flyer, a 2-Stamp LSASE is required to insure a response to your request. Send to:

*Olde Tyme Radio Company*  
 2445 Lyttonsville Road, Suite 317, Silver Spring, MD 20910

Wish to contact us by phone?

Our number is (301) 585-8776.

Please call 10 am to 10 pm (Local Time)

## Antique Radios



David & Nancy Snow

P.O. Box 6352

Jackson, MI 49204

(517) 787-2985

We Buy, Sell, Repair

ARBE - III Battery Eliminators

WANTED: Tube Hi-Fi Components & Studio Equipment of the 1950's and 60's

Marantz, McIntosh, Scott, Fisher, Brook

AcroSound, Brochner, Western Electric

Fairechild, Altec, Tannoy, JBL

Richard Sharisky

P.O. Box 521

Belmont, MA 02178

(617) 484-5784

**PUT  
 YOUR BUSINESS CARD  
 HERE!**

**\$31 FOR 3 MONTHS - \$55 FOR 6 MONTHS  
 DON'T HAVE ONE? SEND AN EXTRA \$5 AND  
 WE WILL TYPESET ONE FOR YOU.**

1920-1970  
 SCHEMATICS + PAGES OF INFO  
 \$5.00 POSTPAID

MANUAL PRICES - SASE  
 RADIO/TV/HAM/MISC.

"IF I DON'T HAVE IT, YOU  
 PROBABLY DON'T NEED IT."

ALTON H. BOWMAN - 4172 EAST AVENUE  
 CANANDAIGUA, NY 14424-9564

Antique Radios

COLLECT, BUY, SELL, TRADE & REPAIR

BOB GOAD (813) 885-1258

8441 FLAGSTONE DR TAMPA, FLORIDA. 33615

**BUSINESS CARD ADS - \$31.00 FOR 3 MONTHS**

784-9417

784-9417

**COSMOS  
TV**

- Low Prices
- TV Repair

- Quality Used TV's
- Antique Radio Repair
- Buy, Sell, Trade

Free Estimates  
784-9417

5919 15th Ave. N.W.  
Seattle, WA 98107

**Mitch's Antique Radio Repair**

old tube-type radios repaired  
reasonable rates

Call **Mitch Bonars** At 708 971 3890

located in Lisle Illinois

**FRANK T'S REPAIR SERVICE**

**Tube and Transistor  
Tuners - Receivers - Amplifiers  
Antique Radios and Hi Fi**

6 Williams Street  
Arlington, MA 02174 (617) 641-2055



**john d. eckland**

*vintage american & european radio repair*

969A ADDISON AVENUE PALO ALTO, CALIFORNIA 94301  
415 323 0101

**ANTIQUÉ RADIO RESTORATION**

Since 1936 Repair - Buy - Sell  
Complete Restorations • Prompt Service

**COOPER'S RADIO SERVICE**

425 Court Street  
Rockwell City, Iowa 50579



**LARRY COOPER**  
712-297-7232

**LYNN SHACKELFORD**  
KA6BRX

**LYNN RADIO**

Member N.E.A.R.C #159  
Repair and Restoration  
Antique Radios and Jukeboxes  
Buy • Sell • Trade

(603) 644-0389 Manchester, New Hampshire

*Old Time Replications*

"TURN TO US WHEN YOU NEED KNOBS"  
KNOBS • PUSHBUTTONS • ESCUTCHEONS  
PLASTIC GRILLS • HANDLES

**LARRY BOROONARO**

5744 TOBIAS VAN NUYS, CA 91411 (818) 786-2500

**RAY'S  
ANTIQUÉ ELECTRONICS**

Repair or Full Restoration

1920 to 1960

*Guaranteed Satisfaction*

342 South Third St.  
Cottage Grove, OR 97424 (503) 942-0866

**Victorian Talking Machine, Company**  
261 Robinson Ave. Newburg, NY 12550



GEOFF & JUDY  
SHOP HOURS BY APPT.  
6-9 PM Best Time To Call Us  
Phone: 914-561-0132  
FAX: 914-561-3851



*Antique Monographs*

*Cylinders Discs,*

*Buy, Sell Restore & Repair*

100 Needles ..... \$3 00  
Book & Parts Catalog \$3 00  
TELEPHONE ORDERS  
MC/VISA

**ANTIQUÉ RADIO SERVICE**

- \* Repair of Radios & Test Equipment
- \* Power Supplies for Battery Sets



**BETA-TEK ☎ 508 263-7435**

**RAY BINTLIFF**  
2 POWDER HORN LANE  
ACTON, MA 01720



**THE RADIO MAN**

*Buy-Sell-Trade*  
Antique Radios • Tubes • Parts

DICK MORGAN  
RE5 (214) 231-3099

TEL: (214) 276-5458  
FAX: (214) 272-1831  
P.O. BOX 461485  
GARLAND TX 75046-1485



**WAVES**

ANTIQUES

EARLY RADIOS

&

PHONOGRAPHS

BOUGHT • SOLD

REPAIRED

OPEN 12 8

547 2 5

CLOSED SUN & MON

FAX 20 861 9659

32 EAST 31st ST NEW YORK N Y 0003 2 2 989 9284

PROPRIETORS Bruce and Charlotte Mager

**BUSINESS CARD ADS - \$31.00 FOR 3 MONTHS**

**SELLING**

*Old TV Sets, Parts, Tubes  
+ Electronic Surplus  
— S.A.S.E. For Flyer —*

**EAST COAST ELECTRONICS**  
321 Long Vue Acres  
Wheeling, WV 26003  
304-277-3154



If you buy, sell or like jukeboxes you need **ALWAYS JUKIN'—THE MONTHLY JUKEBOX MAGAZINE!!** Subscribers in 25 countries, **ALWAYS JUKIN' LEADS THE WAY:** Articles, photos, show reports, ads, new products, price guides, restoration tips, repairs—everything you need to know about **JUKE-BOXES—the fastest appreciating collectible in the world!!!** Fun & a great investment.  
Sample copy, \$5. \$39 per year.  
**ALWAYS JUKIN', 221 YESLER WAY AR, SEATTLE, WA. 98104. (206) 233-9460.**  
Master/Visa ok.

**Blade & Cage Inc.**

Electric Brass Desk  
Fans Bought, Sold, Restored



M.L. YOUNG  
4200 Sunshine Rd.  
Miami, FL 33133

Member A.F.C.A.  
(305) 661-6245

**CLASSIC RADIO SERVICE®**

55-80-70-80-90-100-110-120-130-140-150-160



P.O. Box 764, 25 MAPLE ROAD  
WOODDACE, CA 94973



DAN HEALY Telephone: 415-488-4596

30 years experience  
**Jackson Speaker Service**  
Expert Antique Loudspeaker Repairs  
(Cone Types) And Rebuilding A Speciality  
Speaker Parts And Repair Service On  
Virtually Any Speaker Made Including  
Stereo, P.A., And Antique Auto Speakers.  
Owner  
217 Crestbrook Dr Ron McGee  
Jackson Ms 39203 Ph - (517) 789-6400  
wk-days 5pm-10pm wk-ends 9-5pm

RELIABLE - PROMPT - GUARANTEED

**SOUND REMEDY  
LOUDSPEAKER REPAIR SERVICE**

881 Virginia Avenue  
Collingswood, New Jersey 08108

Telephone  
(609) 869-0288

Authorized Waldom Dealer

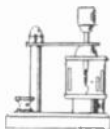

**CRYSTAL SETS**

PARTS - PLANS - KITS - BOOKS  
CATALOG \$1.00

Largest source of Vintage and New  
Variable Air Condensers, Variometers,  
Vario-Couplers, Tap Switches, Tap  
Points, Galena and Germanium  
Detectors, Detector Stands, Cat  
Whiskers, Terminals, Sliders,  
Headsets, Dial Knobs, Coil Forms,  
Magnetic Wire, etc.

**MIDCO**  
P.O. Box 2288  
Hollywood, FL 33022  
(305) 925-3670  
B.A. Turke, Ph.D.E.E.

**TUBES - CAPACITORS - ETC.**

**OLD STOCK FROM CLOSED  
OR BANKRUPT RADIO - TV  
STORES & DISTRIBUTORS**

Send \$2 (cash, stamps or check)  
(Canada \$3 - Overseas \$4)

For NEW Illustrated 16-Page  
Catalog #48 with Prices

DON DIERS 4276 North 50 St. #AB7  
Milwaukee, WI 53216-1313

"Dead Radios Brought Back to Life"

**FRANKENSTEIN'S  
RADIO LABORATORY**

Specializing in Antique Radios.  
Old Radio Cadavers and Parts Bought and Sold  
Mail Order Sales of New, N.O.S. and Used Parts.

MAIL ORDER SALES  
4010 Fairmount Pkwy., Suite 285  
Pasadena, Texas 77504

Gordon R. Rolston  
Reports by Appointment  
(713) 998-0130

**RETIRED  
AUTO RADIO EXPERT**

*Available For Restorations of  
Pre-Solid State Auto Radios*

**Angelo J. Anello  
Tampa, Florida  
(813) 933-6009**



**ANTIQUE RADIO MUSEUM**  
2022 Cherokee  
St. Louis, MO  
314-421-8313

Buy • Sell • Repair

Dedicated to the Preservation of Radio History

Buy Trade Sell

**STEVE THE "RADIO & RADAR" MAN**

Army - Navy - Air Corp's  
Military Radios From 1939 - 1945

**STEVE BARTKOWSKI** AWA — ARCI Phone  
Chicago, IL 60680 MVPA #1894 1-708-863-3080



# Outstanding Public Auction Radios, Paper Ephemera & Antiques

## Sat., July 11, 9:30 am

Lifetime collection of Howard & Marilyn Passel  
Alpine Lake Rd., Henryville, the Poconos, Pa.  
(Rt. 611 to Tannersville, take Rt. 715 north  
2.8 miles to Alpine Lake Road, follow auction signs)  
Inspection: 8 am to sale; refreshments available

**Radios:** Over 100 great radios inc. Crosley XJ completely restored by William Fizette; Atwater Kent model 42 w/ loudspeaker; Kolster model 60 completely restored by Fizette; Fizette; Silvertone model 93 (1929) with speaker; RCA Radiola 17 w/ loudspeaker Model 100; over 100 other radios, some by Federal, Emerson, Philco, GE, Motorola; many tabletop Bakelite radios; radio phonographs; many console radios by Philco, Silvertone & Atwater Kent; RCA lowboy radio; hundreds of vacuum tubes; tube caddies; Philco, Dumont & RCA, etc. test equip.; 1929 radio analyzer, meters, pre-1943 NRI radio pamphlets & magazines; old radio textbooks; US military training manuals; 1950 Bakelite television; early Zenith color TV; early TV pre-amp; plus much more.

**Antiques:** lots of great furniture, collectibles, WWII memorabilia. oak Victor phonograph; antiques phones and many collectibles. Call for complete list of other items. **Terms:** Cash or check approved prior to sale. **Note:** A very long sale under tent, bring lawn chairs, come early for best parking. **Sale ordered by:** Howard & Marilyn Passel.



## Teel Auctions

Robert C. Teel, Auctioneer  
License No. AU-002409-L

P.O. Box 128 Rt. 611, Mt. Bethel, Pa. 18343  
Daily Inquiries: (717) 897-TEEL

# REPRINT BOOKS ON EARLY RADIO - WIRELESS - TELEVISION TELEGRAPH - TELEPHONE

## RADIO

- Blake, G.C., *History of Radio Telegraphy and Telephony*. Early wireless schemes, developments and patents to 1928. 50-page bibliography. 449 pgs. ....\$35.50
- Codel, M., *Radio and Its Future*. 1930. A 1930's look into the future. A collection of articles including DeForest, Grunow, Kolster, Sarnoff, Maxim, Colpitts, Paley, Durstine and Codel. 375 pgs. ....\$28.00
- Dunlap, O.E., *Radio's 100 Men of Science*. 1944. Biographical narratives of pathfinders in electronics & television including Gilbert, Galvani, Faraday, Loomis, Hughes, Dolbear, Tesla, Hertz, Popoff, Nipkow, Branly, Jenkins, Conrad, Weagant, Kolster, DuMont, Olson. 330 pgs. ....\$25.00
- McNicol, D., *Radio's Conquest of Space*. 1946. A chronological treatment of the early days of radio, the scientists and their inventions. A few of the chapters: Spark Gaps & Oscillators, Wireless Spans the Atlantic, Regenerative Receivers, The Advent of Commercial Radio. 388 pgs. ....\$29.00
- Military Signal Communications*. A two-volume anthology of early documents covering the history of military communication, the Civil War to WWII. Includes visual signaling, telegraph, telephone and radio. 2 vols., 750 & 625 pgs. ...\$71.50
- Report of the Chief Signal Officer: 1919*. A record of the telegraph, telephone and radio in WWI. ....\$46.50
- Signaling and Communicating at Sea*. A two-volume anthology of over 50 articles. Semaphores, pigeons, flashing lights, flags, radio, teletype. 2 vols., 480 & 524 pgs. ...\$73.00
- Summers, H.B., ed., *Radio Censorship*. 1939. Collection of excerpts from articles & books + brief bibliography. ....\$23.50

## TELEVISION

- Abramson, A., *Electronic Motion Pictures: A History of the Television Camera*. Mechanical TV to Zworykin to 1940's. 228 pgs. ....\$24.50
- Dunlap, O.E., *The Outlook for Television: 1944*. Records the evolution of television from 1925 to 1932. Includes 22-page chronology of Radio-TV from 640 a.c. **SOLD OUT** .....\$24.50
- Hess, G.N., *An Historical Study of the DuMont Television Network*. 1960. A search for why the fourth television network failed. ....\$19.00

## TELEGRAPH TELEPHONE

- Bright, C., *Submarine Telegraphs: Their History, Construction and Working*. 1898. An account by a chief engineer, of early cable attempts, failures & successes, starting with the 1850 cable between England & France. 819 pgs. ....\$57.50
- Development of Submarine Cable Communications*. A two-volume anthology of over 50 articles. The 1858 and later trans-Atlantic cables, cable-laying ships, cable routes, technology thru 1973. 2 vols., 500 & 480 pgs. ...\$71.50
- Electric Telegraph: An Historical Anthology*. The rise and progress of the electric telegraph from the late 19th century to recent times. A collection of early writings. 625 pgs. ....\$4.00
- Eyewitness to Early American Telegraphy*. Reprints of reports and letters of Alfred Vail from the 1830's and 40's. An invaluable primary resource. 288 pgs. ....\$25.50
- Fahle, J.J., *A History of Electric Telegraphy to the Year 1837*. 1884. A definitive history of the earliest telegraph systems preceding Morse. 566 pgs. ....\$38.50
- Kingsbury, J.E., *The Telephone and Telephone Exchanges: Their Invention and Development*. ....\$40.00
- Prescott, G.B., *Bell's Electric Speaking Telephone*. ....\$38.50
- Smith, Willoughby, *The Rise and Extension of Submarine Telegraphy*. An engineer's and designer's autobiographical account of cable laying in the mid-1900s including the 1856-66 Great Eastern missions. 409 pgs. ....\$32.00

## THE FAMOUS M.I.T. RADIATION LAB. SERIES NEW LOWER PRICES!

- #13. *Propagation of Short Radio Waves*, 746 pgs. \$19.95
- #15 *Crystal Rectifiers*, 457 pgs. ....\$15.95
- #17 *Components Handbook*, 640 pgs. ....\$19.95
- #18 *Vacuum Tube Amplifiers*, 761 pgs. ....\$19.95
- #19 *Waveforms*, 799 pgs. ....\$19.95
- #20 *Electronic Time Measurements*, 546 pgs. ....\$19.95
- #21 *Electronic Instruments*, 735 pgs. ....\$19.95
- #22 *Cathode Ray Tube Displays*, 764 pgs. ....\$19.95
- #24 *Threshold Signals*, 400 pgs. ....\$15.95
- #25 *Theory of Servomechanisms*, 383 pgs. ....\$15.95
- #27 *Computing Mechanisms & Linkages*, 371 pgs. \$15.95
- Also #1, #2, #5, #7, #8, #9, #10, #11, #12, #16, #23 @ \$15.95 ea.

The above are quality reprints. Send for free list of over 80 reprints of books on early radio, television, broadcasting and telegraph available from A.R.C.

Send payment with order. Mass. residents add 5% tax. Allow 4 to 6 weeks to receive books. Add \$2.50 for shipping in U.S. Outside of U.S., please add 10% for shipping. Send order with payment to: Antique Radio Classified, P.O. Box 2, Carlisle, MA 01741

Nov-91

# NEW BOOKS FOR THE COLLECTOR



**RADIOS REDUX BY PHILIP COLLINS.** Subtitled "Listening in Style," this book showcases the sleek lines and luscious colors of over 80 gleaming sets from the collection of Philip Collins. 120 pages, 10" by 8 3/4". .....Hardcover: \$29.95. Softcover: \$17.95

**AND STILL AVAILABLE...**

**RADIOS: THE GOLDEN AGE BY PHILIP COLLINS.** Collins' first book of the colorful Catalin and Bakelite radios from the late 1930s to the early 1940s. 128 pages, 10" by 8 3/4". .....Hardcover: \$25.00. Softcover: \$14.95



**RADIO ART BY ROBERT HAWES.** This outstanding book is a chronological illustrated history of radio that celebrates the technical and stylistic progress of the radio. Although the coverage of the book is mostly British, many American sets are featured as well. 9 1/4" by 12", 128 pages. 250 photographs, 150 in color. ....Hardcover: \$29.95

**RADIO ART POSTCARD DECK.** 30 full color photographs from Hawes' book .....\$9.95

**ALSO...**

**JUKEBOX ART BY CHRIS PEARCE.** The evolution of the jukebox from coin-operated record changer to shrine of the rock and roll generation. 9 1/4" by 12", 128 pages. 120 color photographs. ....Hardcover: \$29.95

**JUKEBOX ART POSTCARD DECK.** 30 full color photos from Pearce's book .....\$9.95

*Send payment with order. Enclose \$2.50 shipping for orders under \$35. VISA and MasterCard accepted; include card number, expiration date and name on card. Money back return policy. Most books shipped within 4 days, but allow 2 to 4 weeks to receive order. Mass. residents add 5% sales tax. Foreign orders—write for shipping costs or use credit card and specify surface or air.*



**Send Order To: A.R.C., P.O. Box 2, Carlisle, MA 01741**  
**or Call: (508) 371-0512**

Fax: (508) 371-7129



(May-92)

# ORDER TODAY!

John Sideli's

## Classic Plastic Radios of the 1930s and 1940s

A COLLECTOR'S GUIDE TO CATALIN MODELS



ADDISON  
AIR KING  
ARVIN  
AUTOMATIC RADIO  
BENDIX  
CROSLLEY  
CYARTS  
DEWALD  
EMERSON  
ESPEY  
FADA  
GAROD  
GENERAL ELECTRIC  
GENERAL TELEVISION  
HALSON  
KADETTE  
LAFAYETTE  
MOTOROLA  
R.C.A.  
SENTINEL  
SONORA  
SPARTON  
STEWART-WARNER

127 Pages – Over 200 Illustrations of Radios in Full Color

55 different models from 25 manufacturers are extensively covered. Included for each is a description, the year of manufacturer, dimensions, colors found and photos illustrating the various colors and variations. A 15-page introduction describes the growth of Catalin radio collecting, the Catalin material itself, the "Catalin" style, rarity and value, and colors and restoration. The introduction contains an additional eighteen photos, twelve in full color.

Softcover: \$19.95

Hardcover: \$29.95

*U.S. Orders: Enclose \$2.50 per order for packing & book rate shipping if total order is under \$35.00.*

*If using VISA or MasterCard, include name on card, card number and expiration date.*

*Send payment with order. Mass. residents please add 5% sales tax. Allow 2-4 weeks to receive order.*

*Foreign orders – write for shipping costs, or use credit card and state surface or air; allow 2-3 months.*



Send order to A.R.C., P.O. Box 2, Carlisle, MA 01741



# NEW! Radios

of the Baby Boom Era

Six Volumes — 2000 pages — From Sams' Archives

1946 to 1960 — 274 Brands — 3494 Illustrations (B&W)

6769 Models — Catalin, Bakelite, Wood, Transistor Radios & More

## All Volumes Available!

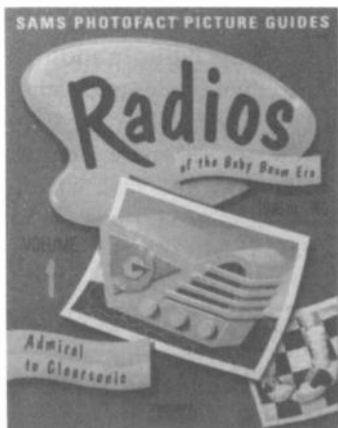

Vol.	Brands	Included
1	56	Admiral to Clearsonic
2	54	Co-op to Geloso
3	58	GE to Monitoradio
4	36	Motorola to RCA Victor
5	35	Realtone to Stratovox
6	35	Stromberg-Carlson to Zenith

**1/2 Page for each illustrated radio including:**

- Large illustration of the radio including knob functions
- Short description of the radio
- Number of tubes
- Power supply type (AC, Battery, etc.)
- Tuning range
- Manufacturer
- Sams Photofact Set number & year Photofact published.



### ALSO

- Index by model number listing tubes in radio
- List of similar radio models indexed to pictured radio
- List of manufacturers and suppliers indicating their brand names
- Basic trouble-shooting hints

Each Volume: \$16.95 – Softcover  
8 1/2" x 11" – Approx. 328 pages

Coming Soon: Volumes on TVs,  
Car Radios and HI-FI Components.  
WATCH FOR ADS IN A.R.C.

Send payment with order. Enclose \$2.50 shipping for orders under \$35. VISA and MasterCard accepted; include card number, expiration date and name on card. Money back return policy. Most books shipped within 4 days, but allow 2 to 4 weeks to receive order. PRIORITY MAIL (2-days): \$4 for 1st book + \$1 for each additional. Mass. residents add 5% sales tax. Foreign orders – write for shipping costs or use credit card and specify surface or air.



Send Order To: A.R.C., P.O. Box 2, Carlisle, MA 01741  
or Call: (508) 371-0512



(Sep-91)

# SHIPPING NOW!

## CRYSTAL CLEAR

By Maurice L. Sievers

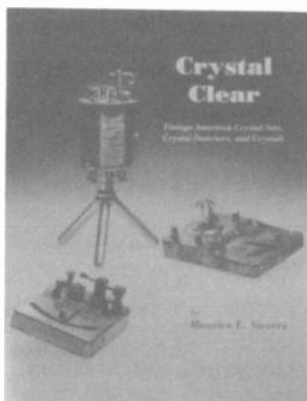

750 Illustrations – 537 Crystal Sets  
341 Detectors – 207 Crystals  
Perfect for the beginning collector!  
Useful for the experienced too!

*Crystal Clear* is a comprehensive reference for collectors, historians and anyone interested in early radio. In addition to the many excellent photos and reproductions of ads, *Crystal Clear* includes lists showing all sets by manufacturer, set name, selling price and year of manufacturer. 8 1/2" x 11", 282 pages.

**\$39.95 (Softcover)**

## COMMUNICATIONS RECEIVERS

### 2nd Edition— Revised & Expanded

By Raymond S. Moore



330 radios pictured!  
200 more than in the 1st Edition!

A comprehensive guide to 700 vacuum tube communications receivers from 1932 to 1981. In addition to Collins, Hallicrafters, Hammarlund and National, over 40 other manufacturers from Allied to Tobe are included.

The description of each set includes years, band coverage, type, filters, tubes, a photo in many cases and other info. 8 1/2" x 11", 115 pages.

**\$17.95 (Softcover)**

Send payment with order. Enclose \$2.50 shipping for orders under \$35. VISA and MasterCard accepted; include card number, expiration date and name on card. Money back return policy. Most books shipped within 4 days, but allow 2 to 4 weeks to receive order. PRIORITY MAIL: \$5.00 per book. Mass. residents add 5% sales tax. Foreign orders – Write for shipping costs or use credit card and specify surface or air (foreign surface shipping is \$4.00 per book).



Send Order To: A.R.C., P.O. Box 2, Carlisle, MA 01741  
or Call: (508) 371-0512



**SHIPPING NOW!**

# Volume 3!

**Radio Manufacturers of the 1920's**

**BY ALAN DOUGLAS**



***“The definitive book on American broadcast receivers of the 1920's”***

**Volume 3:** RCA - Scott - Silver-Marshall - Slagle - Sleeper - Sonora - Sparton - Splitdorf - Steinite - Stewart-Warner - Stromberg-Carlson - Thermiodyne - R.E. Thompson - Thorola - Tri-City - C. D. Tuska - Ware - Western Coil - Western Electric - Workrite - Zenith. 292 Pages.

**Volume 3: \$29.95 (hard cover: \$39.95) - Shipping Now!**

**Volume 2:** Freed-Eisemann - Eisemann - Freshman - Garod - Gilfillan - Grebe - Howard - Jones (Lester/Melco) - Jones (Jos.) - Kellogg - Kennedy - King - Kodel - Kolster - Leutz - Magnavox - Majestic - Marti - Metro - Klitzen/Michigan - Midwest - Mu-Rad - Murdock - Music Master - Neutrowound - Operadio - Ozarka - Pfanstiehl - Philco - Pilot - Priess. 266 Pages.

**Volume 2: \$29.95 (hard cover: \$39.95) – Shipping Now!**

**Volume 1:** A-C Dayton - Adams Morgan - Air-Way - All-American Mohawk - American Bosch - Amrad - Amrad S-Tube - Apex - Atwater Kent - Bremer Tully - Browning-Drake - Clapp-Eastham - Crosley - Cutting & Washington - Day-Fan - DeForest - Eagle - ERLA - FADA - Federal - Ferguson. 225 Pages.

**Volume 1: \$24.95 (only softcover in print) – Shipping Now!**

*Send payment with order. Enclose \$2.50 shipping for orders under \$35. VISA and MasterCard accepted; include card number, expiration date and name on card. Money back return policy. Most books shipped within 4 days, but allow 2 to 4 weeks to receive order. PRIORITY MAIL: \$5.00 per book. Mass. residents add 5% sales tax. Foreign orders – Write for shipping costs or use credit card and specify surface or air (foreign surface shipping is \$4.00 per book).*



**Send Order To: A.R.C., P.O. Box 2, Carlisle, MA 01741  
or Call: (508) 371-0512**



# EMPIRE OF THE AIR

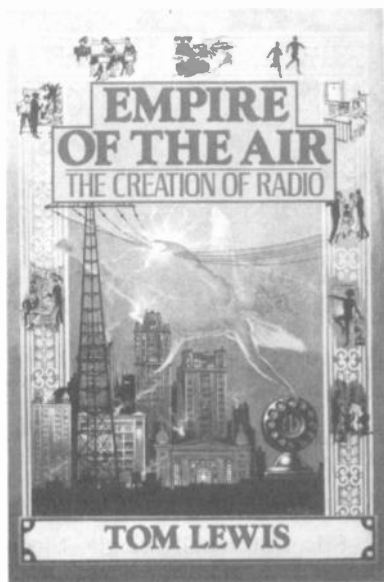

## The Video...

by Ken Burns

PBS series "The Civil War" Producer

Narrated by Jason Robards

120 minutes - VHS

Based on the book by Tom Lewis

A documentary spanning from 1906 to 1955 weaving together the lives of David Sarnoff, Lee de Forest and Edwin H. Armstrong.

Shipping now - \$19.95

## The Book...

by Tom Lewis

416 pages - Hardcover - Illustrated

A biographical history of radio focusing on David Sarnoff, Lee de Forest and Edwin H. Armstrong.

"...the best book on radio history ever written," Douglas. "We can't imagine anyone interested in radio history not being interested in this book," *The Pittsburgh Oscillator*.

Shipping now - \$25.00

Send payment with order. Enclose \$2.50 shipping for orders under \$35. VISA and MasterCard accepted; include card number, expiration date and name on card. Money back return policy. Most orders shipped within 4 days, but allow 2 to 4 weeks to receive order. Mass. residents add 5% sales tax. Priority Mail: book - \$5; video - \$4; both - \$6. Foreign orders - Call/write for shipping costs or use credit card and specify air or surface (foreign surface shipping is \$4.00 per book/video).



Send Order To: A.R.C., P.O. Box 2, Carlisle, MA 01741  
or Call: (508) 371-0512

Fax: (508) 371-7129





# COLLECTOR BOOKS AVAILABLE FROM ANTIQUE RADIO CLASSIFIED

★ BOOKS MARKED WITH "★" ARE THE MOST POPULAR AND ARE ESPECIALLY RECOMMENDED FOR NEW COLLECTORS!

- Antique Radios - Restoration and Price Guide, Johnson. *Beginner's introduction to collecting antique radios, how radios work, radio repair & restoration* 1982 99 pgs \$14.95
- The Auto Radio: A Romantic Genealogy, Matteson. *Information, photos & ads from the early days of the automobile radio through the 1950's* 316 pgs., hardcover \$34.95
- ★ Classic Plastic Radios of the 1930s and 1940s - A Collector's Guide to Catalin Models, Sideli. *Over 200 models from 25 manufacturers are illustrated in full color* 127 pgs (hardcover \$29.95) \$19.95
- ★ The Collector's Guide to Antique Radios, Bunis. *This 215-page price guide covers radios from 1920 to 1959. Over 7400 prices and over 540 new full color photos are included* NEW REVISED (2nd ed.) \$17.95
- Communication Receivers, Moore. *Information on 700 vacuum tube receivers by 51 manufacturers produced from 1932 to 1981. 330 radios are illustrated.* 115 pgs. REVISED (200 more radios illustrated than 1st ed.) \$17.95
- Crosley Catalog (reprint). *1923 catalog covering the early Harko through the XX models* 32 pgs \$4.95
- Crystal Clear - Vintage American Crystal Sets, Crystal Detectors and Crystals, Sievers. *Comprehensive reference with over 700 illustrations of crystal sets, crystal detectors and crystals* 282 pgs NEW \$39.95
- Empire of the Air, Lewis. *A triple-biography of de Forest, Armstrong and Sarnoff* 421 pgs. Illustrated (hc) NEW \$25.00
- Empire of the Air, Burns. (Videotape, VHS). *2-hour video based on Lewis' book* NEW \$19.95
- Evolution of the Radio, L-W Books. *800+ radios pictured and priced* 227 pgs., 118 pgs. in color 1991. NEW \$22.95
- Fixing Up Nice Old Radios, Romney. 1990. *Written by an old radio instructor, this book covers Ohm's law, through battery sets, superhets and communications receivers.* 185 pgs., 300+ figures \$19.00
- ★ Flick of the Switch, McMahon. *The standard photo reference guide for collectors for radios from the 30's to the 50's. 1000+ photos of radios* 263 pgs \$11.95
- Great Radio Personalities (reprint). *Black & white portraits and info on all the favorites from the golden days of radio - Abbott & Costello, Baby Snooks, and more* 128 pgs \$11.95
- ★ Guide to Old Radios - Pointers, Pictures & Prices, Johnson 1989. *The latest book by the Johnsons describes the history of radio and includes 350+ photos and a price guide to 3300 sets* 128 pgs \$16.95
- Hake's Guide to TV Collectibles. *Price guide and illustrations for 1600 TV program collectibles* 185 pgs \$14.95
- Halcrafters Co. 1932-1982: A Partial Product Listing, Dachs. *Over 700 products listed on photos* 41 pgs \$12.50
- Hertz: The Beginning of Microwaves, Bryant. *Photos and descriptions of Hertz's apparatus and experiments. A book prepared for the IEEE Hertz Centennial exhibit* 50 pgs \$15.00
- Illustrated Price Guide to Vintage Televisions and Deco Radios, Posler. *100+ illustrations* 77 pgs \$15.95
- Lawlor's Radio Values. *Price guide for radios in Collins & Sideli books. No photos* 32 pgs \$12.50
- Most Often Needed 1926-38 Diagrams (reprint). *600+ diagrams for common radios from '26-'38* 240 pgs \$11.95
- Novelty Radios, Breed. *500+ transistor novelty radios in full color with current prices* 217 pgs. 1990 \$24.95
- Official Radio Service Manual (reprint). *100's of pre-1930 circuits & notes* 356 pgs \$24.95
- Old-Time Radios! Restoration and Repair, Carr. *How to repair vacuum-tube and transistor radios. A self-paced training guide.* 256 pgs, 200 illustrations \$16.95
- Price Guide to Plastic Collectibles, McNulty. *Describes types of plastics, etc. Radio is 8 of 207 pgs* \$17.95
- Radio Collector. (Videotape, VHS). *The five-part Emmy-nominated PBS series combined on one 130-minute videotape. Meet collectors, see collections, attend swap meets, learn about radio restoration* \$29.95
- Radio Collector's Guide, McMahon. *Listing of 9,000+ radios made by some 1200 companies from 1921 to 1932. Gives manufacturer, year, model name and other info.* No photos 264 pgs \$11.95
- Radio - A Blast from the Past, Wolf/Jacobson. *Reprints of advertising from 1922 to 1942. Useful for identification of cathedrals, tombstones, consoles and table model radios of the period.* 321 pgs \$25.00
- Price List, Wolf/Jacobson. *Keyed by page number to Radio - A Blast from the Past* \$6.50
- Radio Craft - 50 Years of Radio (reprint). *Reprint of Golden Jubilee issue of 1938* 144 pgs \$15.95
- Radio Enters the Home, RCA (reprint). 1922 *The Aerola Jr and RC era* 128 pages \$16.95
- Radio Equipment & Supplies, Robertson-Cataract Electric Company (reprint). 1922 *catalog of radios, accessories and other equipment. Includes RCA, Clapp-Eastham & others* 168 pgs \$19.95
- ★ Radios-The Golden Age, Collins. *Full-color book on the colorful Catalin and Bakelite radios from the late 1930's to the early 1940's* (hardcover \$25.00) \$14.95
- Radio Horn Speaker Encyclopedia, Paul. *Listing of horn speakers for over 320 manufacturers for the 1920's. Expanded information on ten manufacturers* 80 pgs. Over 145 photos \$12.90
- ★ Radio Manufacturers of the 1920's, Douglas. *Three comprehensive volumes*
- Vol. 1 covers A-C Dayton thru Ferguson. 225 pgs (only soft cover in print) \$24.95
- Vol. 2 covers Freed-Eisenmann thru Priess. 266 pgs (hardcover \$39.95) \$29.95
- Vol. 3 covers RCA thru Zenith. 292 pgs NEW (hardcover: \$39.95) \$29.95
- Radio & T.V. Collector's Guide Book, Braund. *The "Vintage Radio" illustrated guide to European sets (very few British sets) from early wireless to the 1930's (a few later). Text is in both French and English*
- Vol. 1 - Early History & Manufacturers A to P. 256 pgs \$49.95
- Vol. 2 - P to Z & T.V., Speakers, Tubes, Loops, Parts & Novelties... 256 pgs \$49.95
- Radio Trouble Shooting, Haan (reprint). 1928 *guide to trouble shooting battery sets.* 317 pgs \$14.95
- Radios of the Baby Boom Era. *Pictures and info from Sams Photofacts. 3494 radios illustrated plus 3275 additional radios listed. 274 brands. 1946 thru 1960. Six volumes, 300+ pages per volume. Order by volume: Vol. 1: Admiral - Clearsonic. Vol 2: Co-op - Geloso. Vol 3: GE - Monitoradio. Vol 4: Motorola - RCA. Vol 5: Reallone - Stratovox. Vol 6: Stromberg-Carlson - Zenith (Per Volume) NEW All In Stock! \$16.95*
- S. Gernsback Radio Encyclopedia (reprint). 1927 *classic encyclopedia on radio* 175 pgs \$11.95
- Saga of the Vacuum Tube, Tyne. *Standard reference to vacuum tubes prior to 1930* 100+ photos 495 pgs \$15.95
- ★ Vintage Radio, McMahon. *The standard photo reference guide for collectors for radios prior to 1930*
- Over 1000 pictures. 263 pgs \$11.95
- Westinghouse Catalog (reprint). *Early 20's catalog featuring the RA-DA and other early Westinghouse equip* 8 pgs \$4.00
- Wireless Communication in the U.S., Mayes. *Early development of American radio operating companies. Alternators, coherers, stock promotions, unpublisher letters, etc.* 240 pgs, 160 illustrations \$29.95

All books softcover except those marked "hardcover." Send payment with order. Enclose \$2.50 shipping for orders under \$35. VISA and MasterCard accepted; include card number, expiration date and name on card. Money back return policy. Most books shipped within 4 days, but allow 2 to 4 weeks to receive order. Mass. residents add 5% sales tax. Foreign orders - write for shipping costs or use credit card and specify surface or air.



Send Order To: A.R.C., P.O. Box 2, Carlisle, MA 01741  
or Call: (508) 371-0512 Fax: (508) 371-7129



(July 92)



**HARRY  
POSTER**

(201) 794-9606

P.O. Box 1883 • South Hackensack, NJ • 07606

BEFORE 7 PM



**FOR SALE:**  
RCA TRK-120.  
This 1940 pre-war TV cabinet still has the radio, but the TV tube and chassis have been removed, and a phonograph was added. Very nice condition-priced at only **\$2,000.**

plus shipping. Please call: Harry Poster, (201)794-9606 before 7PM.

**KNOBS FOR SALE:**

Original television knobs from the 1940's are now available from my personal cache:  
RCA 621, 630, etc. Complete set.....\$35  
RCA 8TS30.....\$25 1949 RCA's.....\$25  
Raytheon 7" with large tuner knob.....\$35  
Tele-tone 7" models, complete.....\$25  
Sentinel 7".....\$25 GE 805/806.....\$25  
Motorola 7" VT71, mah or blonde.....\$20

Lots of others -please call or write! We pay postage on knob orders. Harry Poster, (201)794-9606 before 7PM.

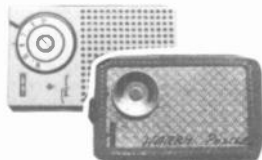

**WANTED: TRANSISTOR RADIOS.**

We pay \$250-\$400 for Mitchell, Madison, Bulova and other copies of the Regency TR-1 (plus the Regency TR-1 itself!).

We pay \$100-\$300 for miniature tube and hybrid (tube+transistor) radios, and great prices for other mid-1950's transistor sets.

We are still **THE** high-end transistor buyers--and we're willing to pay big bucks for sets we need! Please call: Harry Poster, Box 1883, So Hack, NJ 07606.

**RCA COLOR TV PARTS:FOR SALE**

CT-100 (CTC-2) Chassis with most tubes. From the first color set, c. 1954. AS IS..\$75

CT-100 face plate, mask, degauss coil...\$50  
15GP22 tube, working.....Available

21" CRT with yoke and magnets, 21AXP22, fits most early color TV's. Tests good...\$75

All prices picked-up, or plus shipping. Please write: Harry Poster, PO Box 1883, South Hackensack, NJ 07606.

**MESSAGE:** a request from Florida State Prison...a fellow radio collector is looking for a working Realistic "Concertmate" Model 12-708, AM/FM radio, or other powerful portable. Please call me for details--or write:

**Jeffrey A. Muehleman, #094506**  
**Florida State Prison, PO Box 747**  
**Starke, FL 32091**



**FOR SALE:** Original World's Fair card! From RCA--these show that you were televised in 1939 (on the TRK-12's set up at the RCA pavilion). Mint condition, only \$25 each, or all 5 for \$100. Please call Harry Poster, (201)794-9606 before 7PM.

**WANTED: 7" TV's from the 1940's!**

We pay \$150-\$750 for Automatic, Crosley, Meck, National, RCA, Raytheon, Silver-tone, Temple, Transvision, and Viewtone 7 inch TV's. Paying **TOP \$\$** for these 7 inch TV sets--table tops or consoles, complete or just the case, **Dead or Alive!!**

We are still **THE** TV buyers with over 250 vintage TV's, and we pay big bucks for items we need. Harry Poster, (201)794-9606 before 7PM.

# CLASSIFIED ADVERTISING POLICY

**ONE FREE 20-WORD AD** for subscribers in each issue; additional words are 15¢ each. See details below. Classified ads must be received (not just postmarked!) by **NOON** on the ad deadline. Late ads are held for the following issue. Please enclose correct payment with all ads. Stamps or cash are OK for small amounts. (Canadian and other foreign advertisers, please see "Payment" on page two for methods.) "Free words" cannot be accumulated from month to month; free words must be requested when ad is submitted.

Please write each ad on a separate sheet of paper, especially when included with other A.R.C. correspondence. Include SUB# with ad. Ads may be sent in advance; but, write each ad on a separate piece of paper and indicate the month (or successive two months) you want the ad to run.

**Please write legibly and use both capital and small letters. Do not use dashes between words.** Some numbers and letters can look alike, for example 1, l and I (the number one, the capital i and the small L.) Write the following characters clearly (especially in model numbers): 1, l and I; 0, O, o, Q and D; r and n; 6, b and G; V, U, u, v and Y; A and R; 5, S and s; 2, Z and z. We try to correct spelling errors, so when using an uncommon word or manufacturer which looks similar to a common word or manufacturer, note it so that we do not "correct" it. Editor's comments are in [brackets].

**Advertising is accepted only for early items related to radio, communication, etc. All items must be described fairly; reproductions, reprints and not-original items must be identified as such. Advertisers agree to respond promptly to inquiries and orders, and to resolve problems promptly if the buyer is not satisfied.**

Publisher reserves the right to edit ads without notification to the advertiser and to reject ads for any reason. Publisher is not responsible for errors due to illegibly written ads or for any other reason. Since club activities receive free advertising on the *Coming Radio Events* page, the free 20 words may not be used for club activity ads. See inside front cover for additional information.

## CLASSIFIED AD DETAILS

**Deadline: NOON - 10th of the month!**

Classified ads must have a standard heading such as **WANTED, FOR SALE, FOR TRADE, FOR SALE/TRADE, SERVICES, MESSAGE, HELP, AUCTION, MEET, etc.** This heading is the only bold or all-capitalized words allowed in the ad. Capitalize only manufacturer names, model names, etc. Wanted and For Sale ads are mixed together to encourage the reading of all ads, including the Wanted ads. This standard ad format makes scanning the ads easier.

Before writing your ad, please look over the ads in a recent issue of A.R.C., and try to write your ad in the same style. Full name and address is required in all classified ads; we will add it if you forget.

To encourage varied content of the ads, the same classified ad may be run only once per issue and for only two consecutive months. (To run an ad longer, use a boxed classified or display ad.)

### Classified Ad Rates per Month

Subscribers:

First 20 words: **FREE\***

15¢ per word for extra words over 20 plus

10¢ per word for a shaded ad (count all words including free words).

\* Subscribers may take 20 free words on only one ad each month.

Non-Subscribers:

30¢ per word plus

10¢ per word for shaded ad.

Please do not forget to send in the extra 15¢ per word when your classified ad runs over the free 20 words; your payment will be appreciated, and it will help to keep A.R.C. healthy.

## BOXED CLASSIFIED AD DETAILS

**Deadline: 1st of the month!**

Boxed classified ads can run unchanged for three months or more. No words are free. Ads may be shaded and may include bold and all-capitalized words freely. The ad need not begin with For Sale, etc. Minimum run is 3 months, prepaid.

### Boxed Classified Ad Rates per Month

Nonshaded ads:

25¢ per word for all words,\* none free, plus

10¢ per word for each bold word plus

10¢ per word for each all-caps word.

Shaded Ads (All words are bold at no charge):

35¢ per word for all words\* plus

10¢ per word for each all-caps word.

Non-Subscribers:

Add 20¢ per word to above costs.

\*Three words can be bold-all-caps at no extra charge.

## PHOTO & DRAWING DETAILS

**Deadline: 1st of the month**

**for all ads with drawings or photos!**

Drawings and photos are encouraged as the response to your ad is much larger and the reader knows better what you want or are selling. Send in your drawing or photograph, and A.R.C. will reduce it or enlarge it as needed.

### Photo and Drawing Rates per Month

\$8.00 per month for each photo or drawing

(If ad is canceled, this amount cannot always be refunded.)

## CHANGES & CANCELSATIONS

Please check your ads carefully before sending them in. Once ads are received, it is not always possible to refund the amount sent, pull the ad or make changes.

## IMPORTANT — COUNTING WORDS — IMPORTANT

The standard headings: **WANTED, FOR SALE, etc.**, count as one word each time used in an ad. Name, address and (one) telephone number, count as 6 words, regardless of length. Ham call letters and business name can be included in the 6 words and do not count extra. Full name and address is required in all classified ads — it does not cost extra! Each additional word, abbreviation, model number or number group, extra telephone numbers, etc. count as one word. Hyphenated words count as two words.

SECOND CLASS

# ANTIQUE RADIO CLASSIFIED



A.R.C., P.O. Box 2, CARLISLE, MA 01741

RETURN POSTAGE GUARANTEED

GZC SUB# 26-7701  
RAY SCHMIDT

607 1 AVE SW  
AUSTIN

MN

EXP=MAY93

55912

CLASSIFIED AD  
DEADLINE JULY 10TH