



ANTIQUE RADIO CLASSIFIED

VOLUME 4

OCTOBER 1987

NUMBER 10



AVALON

THE NATIONAL PUBLICATION FOR BUYERS AND SELLERS
OF OLD RADIOS AND RELATED ITEMS - PUBLISHED MONTHLY



ANTIQUE RADIO CLASSIFIED

A.R.C., P.O. Box 2, CARLISLE, MA 01741
RETURN POSTAGE GUARANTEED

SECOND CLASS
POSTAGE PAID
at Carlisle, MA

TO:

SUB# 23-1660
ERIC FOGEL
2922 BARNES AVE, #6K
BRONX

NY

10467

EXP=SEP88

POSTMASTER: Deliver Promptly

CLASSIFIED AD
DEADLINE OCT. 10TH

ANTIQUE RADIO CLASSIFIED



Publishing Details

Antique Radio Classified (ISSN:8750-7471) is published monthly, 12 times per year, by John V. Terrey, 498 Cross Street, P.O. Box 2, Carlisle, MA 01741. Telephone: (617) 369-9770, 9:00 AM to 9:00 PM only, thanks.

Annual subscription rates within the U.S. are \$18.00 for Second Class mailing and \$24.00 for First Class mailing. Two-year subscriptions are twice these rates. Subscriptions to Canada and Mexico are by First Class only and are \$24.00 per year. Other foreign subscriptions are \$33.00 per year by air. Sample issues are available free on request.

© Copyright 1987 by John V. Terrey.
POSTMASTER: Send address changes to A.R.C., P.O. Box 2, Carlisle, MA 01741.

Staff

Publisher and Editor: John V. Terrey
Publishing Staff: Mary E. Annavcedder
Chris Frederickson
Betsy Dumka
Founding Publisher/Editor: Gary B. Schneider
Contributing Writers: Richard L. Arnold
Norman S. Braithwaite
Alan S. Douglas
Richard C. Foster
Jim Kreuzer
Henry Rogers
Gary B. Schneider
Ralph Williams
Dave Crocker
Mike B. Feher
Frank Heathcote
Harry Poster
Gil Schlehman
Howard Stone
John P. Wolkonowicz

Purpose

Antique Radio Classified is published for people involved in the radio collecting hobby. Its purpose is to stimulate growth of the hobby through the buying, selling and trading of radios and related items, and to provide a monthly forum for the interchange of ideas and information.

Writing to Antique Radio Classified

All correspondence should be sent to:

Antique Radio Classified
P.O. Box 2, Carlisle, MA 01741.

Your ads, renewals, letters, etc. can be handled faster and more efficiently if (1) each is on a separate page or card and (2) your name, address and SUB# is written on each.

Unfortunately, A.R.C. is not staffed to answer letters with questions about antique radios or requests for advice. However, A.R.C. does solicit letters of interest to its readers and will publish them as space permits.

Guarantee

You may cancel your subscription at any time and receive a pro-rated refund of that part of your subscription not yet mailed. If errors to ads are made by A.R.C., the ad will be run in the next available issue, free, upon request.

Ethics

All persons involved in the production of A.R.C. are not to act on any information in the magazine until they receive their regular subscription copy in the mail.

Display and Business Card Ads - Details and Rates

The deadline for artwork and payment for display and business card ads is the first of the month. Payment for continuation of ads also should be received by this date to insure the continuation of your ad. Late ads will be run only if space and time permits.

As artwork is reduced to 63% in the printing process, originals should be the artwork size listed below. Ads should be typeset or typed neatly with a carbon ribbon. If you want us to prepare your ad, include the optional cost for layout listed below. Minor changes will be made to ads sent in or already running for a \$2.00 charge.

Page	Artwork		As Printed		Cost		Optional Cost for Layout
	H x W (inches)	H x W (inches)	1-month	3-months			
Full	10 1/2 x 7 1/2	6 5/8 x 4 3/4	\$45.00	\$121.50	\$20.00		
1/2 H	5 1/4 x 7 1/2	3 5/16 x 4 3/4	22.50	60.75	10.00		
1/2 V	10 1/2 x 3 9/16	6 5/8 x 2 1/4	22.50	60.75	10.00		
1/4	5 1/4 x 3 9/16	3 5/16 x 2 1/4	11.25	30.37	5.00		
1/8	2 5/8 x 3 9/16	1 5/8 x 2 1/4	5.75	15.52	3.00		
Business Card	1 5/8 x 3 1/2	1 x 2 1/4	3.90	10.50	2.00		

Photos should be at an 85 line screen. When A.R.C. is preparing the ad, add \$5.00 per photo. Write A.R.C. with your ad ideas, and we will be happy to give you an estimate as to how much the ad will cost and/or recommend an ad size, etc.

All items must be described fairly; reproductions, reprints and not-original items must be identified as such. Advertisers agree to respond promptly to inquiries and orders, and to resolve problems promptly if the buyer is not satisfied.

Advertising in A.R.C.

Each subscriber is entitled to one 20-word classified ad free of charge each issue; multiple insertions of the same ad are limited to two consecutive months. Boxed-classified ads, display ads and business card ads do not have the multiple insertion limitation. Display ad details appear below; classified ad details are on the inside back cover.

Payment

All payments must be made in U.S. funds; checks drawn on a U.S. bank or money orders are preferred. Make check out to "A.R.C." U.S. stamps or cash are OK for small amounts. Canadian payers may send a Canadian check in U.S. funds, but must add \$1.00 (U.S.) for conversion costs. Traveler's checks made out to A.R.C. are acceptable also. On request, subscriptions will be prorated to amount sent, provided the term is at least one year.

Please send in full payment with your order or ad. A.R.C. does not carry accounts; all subscriptions, ads, etc. must be prepaid.

Submission of Material

Antique Radio Classified welcomes and solicits any information that pertains or relates to the radio collecting hobby. This may include material such as articles, upcoming radio events, meetings, radio books and publication reviews, new radio clubs and organizations, radio auctions and price reports, sources of old radio and restoration supplies, and any other material that would be of interest to the hobby. All material submitted should be typewritten and verified for accuracy. Unless prior arrangements are made, all submitted materials become the property of Antique Radio Classified and will not be returned.

Mailing of Antique Radio Classified

A.R.C. is available by subscription in the U.S. either by First Class or Second Class mail. First Class copies usually are received by the first of the month; copies by Second Class mail, by the tenth. The mailing of First Class copies is staggered, with those living farthest away mailed on the first day, and local copies mailed the last day. All non-U.S. copies are mailed on the first day. All Second Class copies are mailed on the last day. Mailing is usually completed by the 25th of the month.

Change of Address

Please notify us 4 weeks in advance of a change of address in order to receive uninterrupted copies of A.R.C. Please include your old address, SUB# and expiration date along with your new address. Note when the new address is effective. Temporary address changes can be made also.

Fine Print

The publisher is not responsible for any buying and selling transactions incurred, or for any other use of the contents of this publication.

Antique Radio Classified subscription and ad rates are subject to change, as well as frequency of publication, content and size.

EDITOR'S COMMENTS

Collectors of 1930s and 1940s sets will be pleased to see this issue's articles on the FADA Bullet and AC-DC radio safety. Harry Poster's lead article describes several variations of the very popular Catalin, the FADA Model 1000, also known as the "Bullet". Concerned about those who are adding AC-DC sets to their collections, Bill Fox wrote an article explaining the electrical shock hazard with these sets. He reports that when an AC-DC set is turned on, one side of the line cord is actually connected to the chassis. He warns that the use of an isolation transformer is the only safe method of operating these sets.

More information on Vitus: Richard Foster has contributed a short history of this very collectible manufacturer. The development of the Vitus product line is shown using numerous advertisements from the 1920s.

Also in this issue is Dave Crocker's *Crosley Review* and the *Photo Review*.

Were you lucky this month? Did you mail in your ad later than usual and manage to make this issue? Every month a number of ads arrive on the deadline day, and a few arrive the day after. Occasionally, there is space on the classified ad pages to include a few late ads. But, if you have an important ad, please allow five+ days to be (almost) sure that we receive it by the deadline.

Speaking of classified ads, if you have not read the classified ad policy page recently, take another look at it; you may be overpaying for your ads.

Articles. Remember, the articles published in

A.R.C. are written by you, the readers. If you would like to see more coverage of your interests, send in an article, or encourage an "expert" friend of yours to submit one. A.R.C. is growing. A year ago each issue contained 28 pages; now an issue runs from 36 to 44 pages. Send in articles and photos to help fill those extra pages.

A New A.R.C. Service. This month, A.R.C. is initiating a new service for collectors. In the 1970s, the Arno Press reprinted a number of significant and rare books from the early days of radio, telegraph, television and telephone. Arrangements have been made to distribute the books which are still in print. For more information, see the ad on page 18. Send a SASE and request the entire list of available books or information on a particular book.

Renewals have been coming in very well. Please look at your mailing label to see when your subscription expires. If your issue came by First Class mail, your label is on the envelope (which you probably tossed out). Note also your SUB#: please always include it to speed up the handling of your ad, renewal and other inquiries.

Finally, **thanks** for the support all of you have given A.R.C. this past year. This issue marks the beginning of my second year as publisher and editor - the second, I expect, of many to come.

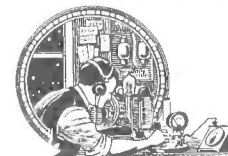

John V. Terrey

ON THE COVER

Lesser-known manufacturers - as well as Marconi, Atwater Kent, Scott and FADA - are popular with A.R.C. readers. The cover this month is a photo which was received along with the following comments.

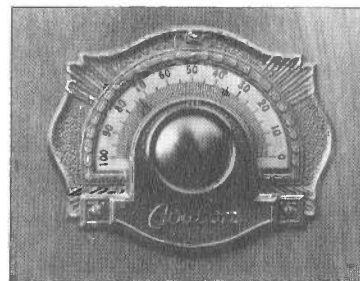

The Avalon's escutcheon and dial scale.

"About a year or so ago, I read Floyd A. Paul's article in the *California Antique Radio Gazette* entitled 'Los Angeles, Midget Radio Capital of the World.' There, Floyd listed about 75 brand names of radios built in the 1930-31 period. Many were names of which I had never heard, including "AVALON" which interested me sufficiently to place a wanted ad for such a brand name radio.

"One, and only one, was offered and I purchased it sight unseen. The set [which is pictured on this month's cover] was received in splendid, almost mint condition.

"An unusual feature of this set is, not only the name 'Avalon' embossed into the dial escutcheon, but the fact that the calibration reads from 0 to 100 in reverse order. Other than that, the chassis (circuit) is fairly common, 5-tubes (80-47-57-58) and dynamic speaker. The 15" wooden cabinet has contrasting inserts in its front panel. (Ray J. Miller, P.O. Box 306, AVALON, CA 90704)



WITH THE COLLECTORS

BY HARRY POSTER, P.O. BOX 1883, SOUTH HACKENSACK, NJ 07606

The FADA Bullet

"WANTED: COLORFUL BAKELITES, TWO-COLOR BAKELITES AND SWIRLED-BAKELITE RADIOS."

Take your choice, the want ads in every major antique and radio publication describe the sudden and constant quest for 1930's and 1940's radios in cast phenol formaldehyde cases!

Motorola, DeWald, General Electric and lots of other manufacturers were producing a rainbow of radio cabinets. Several companies, such as Crosley, even painted brown bakelite cabinets; today, these and the solid brown, black, and white bakelite cases are usually shunned. Even the thick opaque-colored bakelites are often left behind in a search for the translucent Catalin-type colorful cases. Learn the difference. The key is translucence: light can be seen dimly through the cabinet itself when a light is shined from behind. Bakelite cabinets transmit almost no light. Also, the bottom of a Catalin cabinet is closer to the original color of the cabinet. The rest of the cabinet can be faded, sometimes to a different color. It can be a costly mistake to pay in-



Figure 1. FADA Model 1000 "Bullet" with speaker grille formed as part of the cabinet.

flated prices for an unwanted cabinet!

Of all the manufacturers, FADA – the product line of Frank A. D. Andrea – is often the most sought after for valuable colored bakelites. And, out of the full line of FADA's, the Catalin-cabinet Models 1000 and 115 – collectively referred to as "the Bullets" – are among the most desirable. The asymmetrical styling and the fact that many early bakelite articles pictured the bullet-shaped sets have led to their popularity.

Although both the Model 1000 and the Model 115 share the same case, they can be distinguished by the face plate. All of the sets pictured on these pages are the Model 1000 with the name "FADA" just above the dial pointer. The Model 115 has the name "FADA" at the bottom of the dial, below the figure "325".

The Model 1000 is the most popular, originally offered in trade magazines in "FADA-lucent

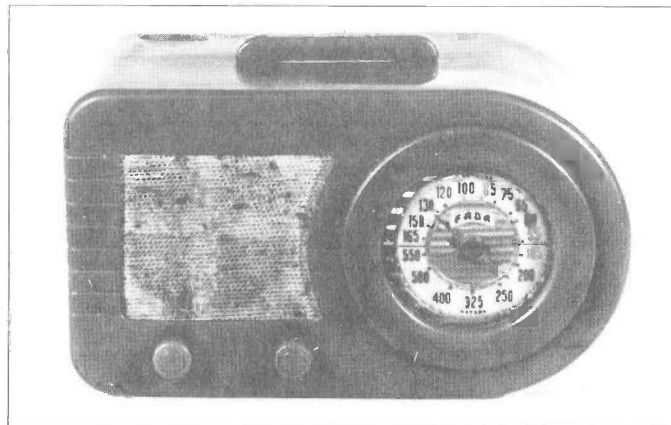

Figure 2. FADA Model 1000 "Bullet" with a cutout for the speaker and grille cloth instead of a slotted grille.

cabinets with the new Gemloid...dial." There are "five gorgeous color combinations resembling precious stones." The Catalin Corporation of America produced the Bullet cabinets for FADA in yellow, white, maroon, blue, and green (red and black cabinets have been reported).

Electrically, the Bullets offered several tube complements and three distinct cabinet styles. Early sets used six octal base tubes, but the post-war hybrid chassis shows up with one or more miniature tubes replacing the octals. Seldom is a Bullet found which agrees exactly with the schematic.

The body styles include the normal cabinet with slots in front of the speaker and grille cloth as shown in Figure 1. This set has a handle, two knobs, and trim ring around the dial, all of Catalin. The trim pieces are all the same color as, or a contrasting color to, the body color. The second style, as shown in Figure 2, is a cutout body; the speaker has a larger opening in front showing the exposed grille cloth.

The third, and scarcest type, shown in Figure 3, is the removeable-grille Bullet. Also called the "insert-grille," this style has a separate Catalin grille-piece inserted in front of the speaker and grille cloth.

All-yellow (pumpkin) is the most common found set; maroon and yellow with maroon are only a bit less common. White and blue (often faded to green) are less common. The one-piece body is usually found; the exposed grille cloth version is less often seen; the insert-grille variety is the scarcest and most valuable.

Examine the top, sides and bottom of the radios very carefully, and bear in mind that a \$500 Bullet can quickly become a \$50 parts set. Make sure your set has no "CBC's": no chips, no breaks, no cracks. A bad burn or missing trim can lower the value by \$50 to \$100 and more. How-

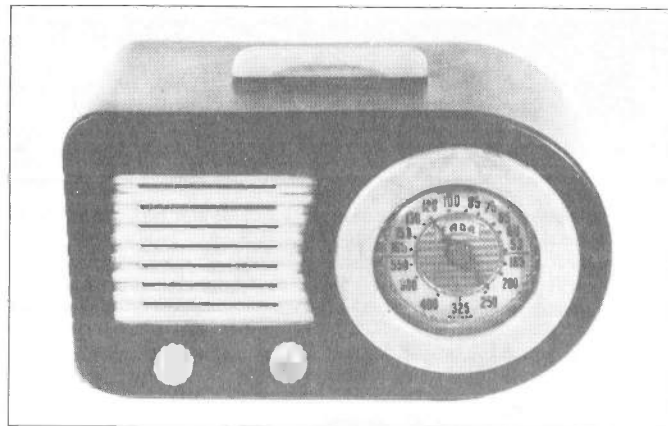

Figure 3. FADA Model 1000 "Bullet" with a separate insert for the speaker grille. This is the rarest of the bullet-styled Catalin-cases model 1000 radios.

ever, each knob and trim piece is of some value; so if the price is right, even a partial set will have some resale value.

All in all, not only are colorful bakelites a fascinating group of radios manufactured by many different companies, but there are interesting and valuable variations within each model run. Good hunting...you'll need it!

Note: The photographs in Figures 2, 3 and 4 are by the author. The photograph in Figure 1 is by Doug Heimstead.

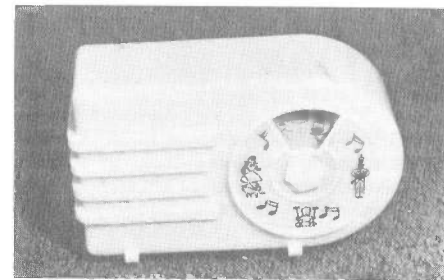

Figure 4. Not a radio, but a child's musical toy from the late 1950's, a copy of the FADA Bullet!

RADIO-BOOK BESTSELLERS

1. *The Radio Collector's Directory and Price Guide*, by Robert E. Grinder and George H. Fathauer: Ironwood Press, 1986.\$15.95
2. *Saga of the Vacuum Tube*, by Gerald F.J. Tyne: Antique Electronic Supply, 1987 ...\$15.95
3. *Radio-Craft, 50 Years of Radio*, (reprint): The Vestal Press, 1987\$14.95
4. *Antique Radios, Restoration and Price Guide*, by David and Betty Johnson: Wallace Homestead Book Company, 1982.\$10.95
5. *A Flick of the Switch, 1930-1950*, by Morgan E. McMahon: Vintage Radio, 1975...\$11.95
6. *How To Repair Old-Time Radios*, by Clayton L. Hallmark: Tab Books, 1979.\$8.95

7. *Radio Horn Speaker Encyclopedia*, by Floyd A. Paul: Floyd A. Paul, 1986.\$11.90
8. *The Golden Age of Radio in the Home*, by John W. Stokes: Craig Printing Co., 1986\$24.95
9. *Tube Substitution Handbook*, 21st Ed.: Howard W. Sams and Co., 1986.\$5.95
10. *Vintage Radio, 1887-1929*, by Morgan E. McMahon: Vintage Radio, 1981.\$11.95

Radio-Book Bestsellers, supplied by George A. Fathauer of Antique Electronic Supply, 688 W. First St., Tempe, Arizona 85281, is a ranking of the top-ten selling books of interest to radio collectors, according to sales over the past three months at A.E.S. Prices shown are the publisher's suggested retail prices.



CROSLLEY REVIEW

CONTRIBUTED BY: DAVID CROCKER, 6 OLD FARM RD., DUXBURY, MA 02332

Of all the radio manufacturers, one of the most popular with collectors is the Crosley Radio Corporation. Due to this wide spread interest, *Antique Radio Classified* in cooperation with David Crocker, a Crosley specialist, will present a series of articles showing the many models of Crosleys manufactured. This will help assist the collector in identifying the many types of Crosleys made, as well as increasing one's knowledge on the subject. Any comments or questions concerning this column should be directed to David with a S.A.S.E. for reply. See address above.

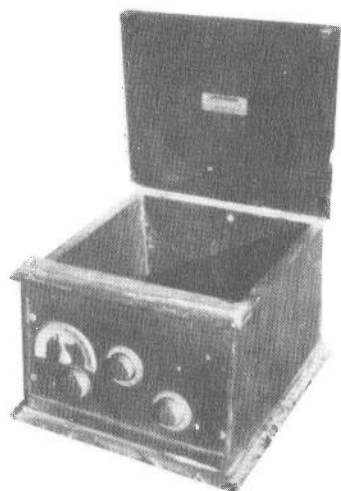

MODEL 51-SD - For those in 1925 who wanted a more "advanced looking" radio, Crosley offered this Model 51-SD (Special Deluxe) for the same price as the 51-S. It had the same cabinet but a few refinements... such as a vernier dial that rotated a stamped metal pointer over a stamped metal dial indicator strip. The regeneration "spiderweb" coils were operated by "turning" instead of "push-pull" by means of a worm drive on a shaft that resembled a drill bit. Stamped metal indicators replaced engraving.

MODEL 4-29 PORTABLE - For \$3.00 more, the 4-29 model was available in a portable version. The black leatherette case was similar but slightly larger than the 51-P and 52-P cases. Four 199's were visible as was the whole works behind the wood panel, with gold trim, by flipping back the top lid. With batteries installed, the thin leather carrying strap seemed inadequate because of the weight. This model is rarely seen. (Note: Lower fold-down door not shown in photo.)



MODEL 52-S - The Model 52 3-tube set got a facelift in late 1924 in the same manner as the model 51—a new slant-front cabinet with inside space for batteries. It cost \$35 (\$5 more than the standard Model 52). Binding post had already moved inside and off the panel for the portable version. Otherwise it was physically the same set.

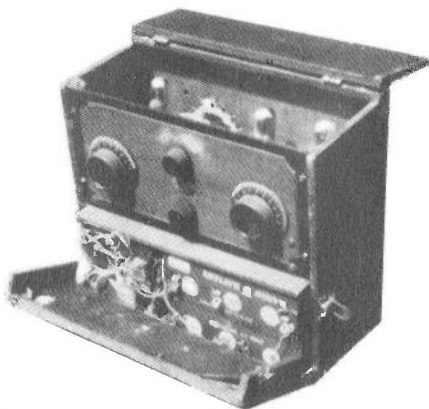

WITH THE COLLECTORS

BY RICHARD C. FOSTER, 12 SHAWMUT AVE., COCHITUATE, MA 01778

F. VITUS CONSTRUCTEUR

The July 1987 *Antique Radio Classified* contained an article by Ira Witthaus on his Vitus Radio Receiver. The article stated that the person that the receiver had been obtained from, M. G. Houghton, had said that it had been used by the French in WWI. As reported in the August issue under "Oops", A.R.C. received information from several readers who believed that the article contained errors, primarily, that the receiver was of early 1920's vintage rather than WWI.

Alan Douglas sent information and copies of advertisements for the set; some are shown in this article. Richard Foster, as a result of his interest in French sets, researched the Vitus Company and put together this article which briefly describes the F. Vitus Company and the type of equipment which would have been used during WWI.

Antique Radio Classified is, as the masthead states, "a monthly forum for the interchange of ideas and information." It is for this reason that these corrections and expansions of the article in the July 1987 issue are being printed. (John V. Terrey - Editor)

The photo of the Vitus radio set in the July 1987 issue of *Antique Radio Classified* intrigued me. I had just returned from France where I visited a collection with some of these beautiful sets. With due respect to Mr. Witthaus and Dr. Houghton, there are some serious problems with the information in Mr. Witthaus's article which should be rectified.

Although there is no doubt that the set came from France, it was not manufactured during the war; it never saw the trenches, and it most certainly did not direct artillery fire. (Did Dr. Houghton bring back something else after his service which became confused with this set that has not yet come to light?)

For directing artillery fire, spark transmitting sets of type PP-4 were used on spotter planes; later came the type K set with a rotary gap, 150 watts and covering approximately 100 to 500 meters. About 4000 of these were made. Following that, about 11,000 of type Y transmitters were manufactured and used.

Receivers were built-up using separate blocks or units, such as tuner, amplifier-detector and heterodyne oscillator. Tuning was done with variable condensers and circular switches with huge numbers of taps. One of the most familiar pieces is the ubiquitous three-tube amplifier, type 3-ter, used with the crystal set so often carried into the

LA TÉLÉPHONIE SANS FIL ^{sep 22}

EN HAUT PARLEUR

DANS VOTRE SALON

Plus d'antenne
Plus de lampes brisées
Plus de connexions ennuyeuses
Piles et Accumulateurs invisibles

VH

VITUS & HARDY
CONSTRUCTEURS
54, rue Saint-Maur, 54
PARIS (11^e)
Téléphone : Raquette 18-20

TOUS AUTRES APPAREILS
ET ACCESSOIRES

Poste complet, type "SALON"

Demandez nos Notices

Figure 1. Vitus & Hardy advertisement. September 1922, *La Science et la Vie*. Note that "sans fil" means "without wires"; "T.S.F." became the abbreviation for "wireless".

trenches. Although amplifiers like the L-1 of 1916 had its tubes on top, the 3-ter had its tubes inside.

Fernand Vitus began, like many others, selling parts for radio builders in the rue Damremont in Paris. Vitus began manufacturing radios sometime in 1922 with a colleague named A. Hardy; they had a business at 5 Rue St. Maur in Paris. The first ad I can find for them is in September 1922, when they tout an incredible "poste de salon," meaning "living room set," combining a four-tube set in a box with a large loop and a loudspeaker mounted in the loop! See Figure 1. Their pitch says that you don't have to hire a carpenter to build a box, an electrician to build the set, and then go out and buy the tubes, speaker or phones separately. They claim "no more broken tubes," "invisible batteries." This is

(Continued on following page)

La **TÉLÉPHONIE** sans FIL
et les **RADIO CONCERTS**
sont reçus avec le
POSTE AUTODYNE
Type "EUROPE"
GRAND PRIX Concours T.S.F.
CONDENSATEURS A AIR
PIÈCES DÉTACHÉES



F. VITUS
CONSTRUCTEUR
54, rue Saint-Maur
PARIS-XI^e
Tél.: Roquette 18-20

DEMANDEZ NOS NOTICES
Circulaire postale franco contre 0.75 timbres

Figure 2. Vitus advertisement after Vitus and Hardy split up. December 1922, *La Science et la Vie*. (An ad for this Vitus set also appeared in the November 1922 *L'Onde Electrique*.)

(Vitus, continued)

the set that undoubtedly won them the 1922 prize they mention.

By December of 1922, we find that they have split up. "Vitus et Hardy" are no longer, and Vitus is by himself at the same address, manufacturing his own set which the French call "lampes et selfs exterieures" or outside coils and tubes (see Figure 2). He has returned to "breakable" tubes! The set is the four-tube "Europe." The following month Hardy ran an ad (see Figure 3) with a new address showing a set that apparently used the loop from the Vitus et Hardy but with new apparatus. In February of 1923, Hardy shows a combined set again (see Figure 4) – somewhat different, in April some new sets again (see Figure 5).

Business boomed with new companies appearing. We should stress that all sets shown in the ads are artist's conceptions. For example, the Vitus "Europe" in the ad (see Figure 6) still has the VH logo as late as May 1923! Figure 7 shows an additional Vitus set.

The "Mondial" appears in December 1923 (see Figure 8). In January 1924, doubtless after some change, Vitus calls it the "Mondial II," his "nouveau poste" or new radio receiver (see Figure 9). It features separate rheostats for each tube as well as internal coils. Shortly after he

Febr 23
DERNIER CHIC
DANCING
PAR
T.S.F.
AVEC LE POSTE
BOUDOIR



A. HARDY DEMANDEZ MES GUIDES-TARIFS
CONSTRUCTEUR 5 - Avenue Parmentier - 5
PARIS (XI^e) - Téléph. : Roquette 45 70

Figure 4. Hardy advertisement showing a combined set similar to the one made by Vitus & Hardy in 1922. February 1923, *La Science et la Vie*.

Janv 23
LE PARADIS
DES
AMATEURS
DE
T.S.F.
ET DES
RADIO-
CONCERTS



A. HARDY DEMANDEZ MES GUIDES-TARIFS
CONSTRUCTEUR 5 - Avenue Parmentier - 5
PARIS (XI^e) - Téléph. : Roquette 45 70

Figure 3. Hardy advertisement after Vitus and Hardy split up. January 1923, *La Science et la Vie*.

added a panel meter. The "Mondail" or "Mondail II" set is the set shown in the July 1927 A.R.C. article.

The "Mondial" covers the "PO/GO" (broadcast and longwave) in one set. It does not feature a separate heterodyne for CW. Although we can see from the preceding paragraphs that the airplane artillery-directing sets fell into the present-day broadcast band, the combination of the two bands on a set is from the "broadcast" era. The Eiffel Tower began on 2650 m. in February 1922 and Radiola on 1780 m. shortly after. It wasn't until 1923 that the Paris PTT (Post Office) station began broadcasting on 450 m. The earliest English station that might have been receivable in France would have been BBC's 2L0, beginning in November 1922 on 365 m. A set with "PO" coverage (see the January 1924 ad) would not have received such stations before the PTT station. The 1922 Vitus & Hardy set evidently was a longwave set (look at the size of the loop), and the antenna could be "turned in the direction of the Eiffel Tower" according to a contemporary article. Vitus opened his own station – Radio Vitus – in 1926.

The set shown in the July 1927 ARC has unfortunately been altered to accept American tubes. The original tubes plugged into supports about 1/2" high, one for each prong. As the tube pin pattern for the early tubes was different,

Avr 1923
ALLO! **A. HARDY**
5, avenue Parmentier - 5 - PARIS (XI^e)
CONSTRUIT POUR VOUS



DEMANDEZ GUIDE-TARIF (in. timbre) 1 franc

HAUT-PARLEUR à 400 kilomètres
(Source remarquable)

Petite pour PARIS et ENVIRONS sur table

Figure 5. Additional Hardy sets. April 1923, *La Science et la Vie*.

Mai 23
La **TÉLÉPHONIE** sans FIL
et les **RADIO CONCERTS**
sont reçus avec le
POSTE AUTODYNE
Type "EUROPE"
GRAND PRIX Concours 1922
CONDENSATEURS A AIR
PIÈCES DÉTACHÉES



F. VITUS
CONSTRUCTEUR
54, rue Saint-Maur
PARIS-XI^e
Tél.: Roquette 18-20

DEMANDEZ NOS NOTICES
Circulaire postale franco 1 fr.

A.R.C. de Téléphonie sans Fil - Franco 6 fr.

Figure 6. The same Vitus advertisement as in December 1922 showing the V-H logo on the front, right corner of the top panel. May 1923, *La Science et la Vie*.

some new holes must have been drilled in the top panel. The set should have four TM's, the spherical brass-based military-type tubes – the only tube commonly available then for these early sets. (1922-23 are early sets in terms of French home radio; see the above dates for broadcasting.)

A couple of final notes might be of interest. Before you go looking for Vitus or Vitus et Hardy sets, be aware that there are no known examples of the 1922 V & H set surviving today. A Vitus "Mondial" (4-tube) in mint and original condition, when it turns up, will command a price in the \$5,000 range, so be prepared for some spirited bidding. The "Europe" turns up a bit more often;

Une MARQUE de GARANTIE

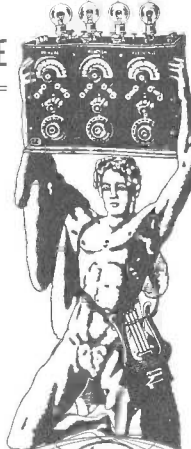

CONCERTS
Birmingham
Londres
Glasgow
Manchester
etc...

OPÉRAS
Ecole P. T. T.
Radiola
Tour Eiffel
Kempistaw
etc...

GRAND PRIX
PARIS 1922

DEMANDEZ
NOTICES

APPAREILS
à tous prix

TOUTES PIÈCES
détachées

Le "MONDIAL"
F. VITUS CONSTRUCTEUR
54 R. S^t-MAUR
PARIS XI^e

CATALOGUE GENERAL FRANCO UN FR.

Figure 8. The Vitus Mondiale. December 1923, *La Science et la Vie*.

La **Téléphonie sans Fil**
pour tous
AVEC DES
APPAREILS SÉRIEUX
Vitus
GRAND PRIX. Concours 1922
F. VITUS
CONSTRUCTEUR
54, rue Saint-Maur
PARIS

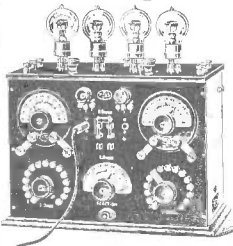

CATALOGUE illustré, franco, 1 fr. | A.B.C. de Téléphonie sans Fil, 1922 (Paris) | F. VITUS, Constructeur, Franco 6 fr.

Figure 7. Another Vitus set. May 1923, *L'Onde Electrique*.

recently one, with modifications, went for about \$1200. If you are really into one-of-a-kind sets, look for the "Super-Mondial" with six tubes and panel meters (there is one known to exist) or the Vitus superheterodyne with a huge nickel-plated loop. A table and speaker go with this one. There is one known set in existence today, and the owner was offered \$10,000 but refused...

Vitus built with beautiful quality, and the sets are highly prized today. As often as not they have been altered, which adds even more to the value of good ones. His beginning with the name "Europe" would suggest 1000-1500 km distance reception, and the name "Mondial" suggests worldwide coverage in terms of distance. He was clearly aiming at a clientele with money to spend. The same holds true today.

References:

Vasseur de la T.S.F. a L'Electronique, Paris: ETSF 1975.

Povzols Quand la Radio S'Appelait T.S.F. RTL. La Science et La Vie.

Postscript. In a telephone conversation with Mr. Witthaus, he said that he believed that his Vitus set was a prototype which Vitus had made during WWI and that it was a predecessor to the sets commercially manufactured and advertised.

A final note: Unfortunately, Mr. Witthaus's set was destroyed in a fire recently. The mystery of his set may never be solved to everyone's satisfaction!. (John V. Terrey - Editor).

Les Radio-Concerts pour tous

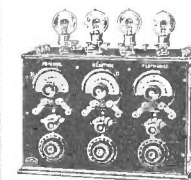

CARDIFF	353 m.	5 W A
LONDRES	363 m.	2 L O
MANCHESTER	370 m.	2 Z Y
BOURNEMOUTH	385 m.	6 B M
NEWCASTLE	400 m.	5 N O
GLASGOW	415 m.	5 S C
BIRMINGHAM	428 m.	5 T T
RADIO LA	1780 m.	
P.T.T. TOUR EIFFEL	etc...	

sont écoutés
à plus de 1.500 kilomètres
avec le nouveau poste
MONDIAL II
F. VITUS Constructeur, 54, rue Saint-Maur, PARIS-XI^e
Nouveau Catalogue général, franco 1 fr. | R.C. 1923 | 187896

Figure 9. The Vitus Mondiale II. January 1924, *La Science et la Vie*.



PHOTO REVIEW

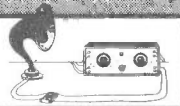

The "Photo Review" column is intended to present in pictorial form many of the radios, speakers, tubes, advertising, and other radio related items in the collections of other collectors. These photos are meant to help increase awareness of what's available in the radio collecting hobby. Photos are solicited from other collectors for use in future issues of A.R.C. Items desired are the more unusual radios and other items related to the hobby (covering the years 1900 to 1940's). Photos must be B&W (any size) and be sharp in detail, preferably with a light colored background. Please include a short description of each item submitted.

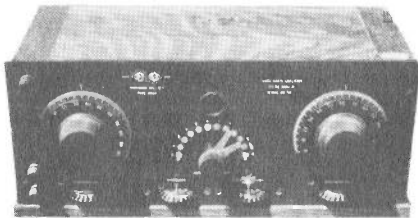

GREBE - Model "RORN", it is a one-stage tuned radio frequency amplifier. These RF amplifiers were inductively coupled via an output coil to any make of regenerative receiver. The RORN was originally supplied with four different ranges of output coils. The RORN was introduced by Grebe in mid to late 1922. (Craig Huseboe - Marshalltown, IA)

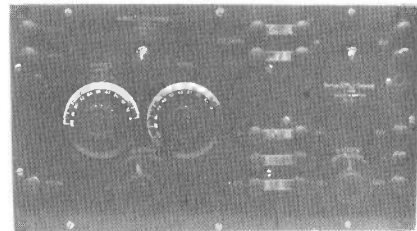

NORTHERN ELECTRIC - Model R-11, it is a low cost one tube detector unit with the peanut tube protruding from the panel. The matching amplifier is the R-15. Total price \$71.50. (Bob Murray - Winnipeg, Manitoba)

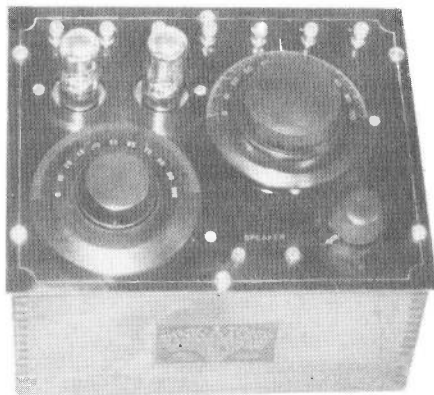

PINK-A-TONE - Two-tube Model 18, this set was advertised by the Sunbeam Radio Corp. of New York City. Sunbeam was the maker of Akrodyne radios and apparently had bought the rights for the Pink-A-Tone name from Pinkerton Electric Equipment Co. around 1925. This set sold for \$18.50. (Information supplied by Alan Douglas - Pocasset, MA), Radio from the collection of: Larry Chestnut



SPARTON - Sparks-Withington Co. of Jackson, MI made this cardboard store display, circa mid-1930's. It stands three feet high. (Karl Rommel - Lansing, MI)

PHOTO REVIEW

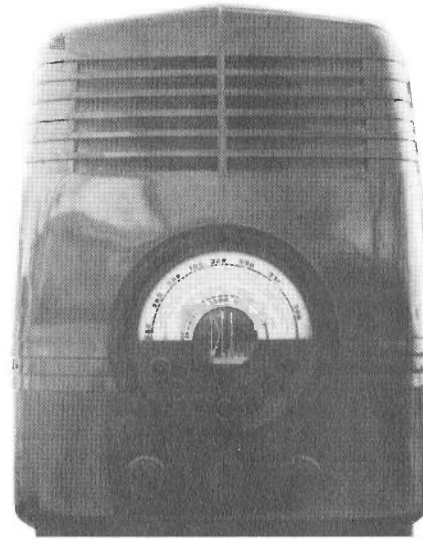

PHILCO - "Empire Automatic", model D-521, a 1938 5-tube dual wave (long and medium) superhet manufactured by the Philco Radio & Television Corporation of Great Britain Ltd. It uses American tubes 6A7, 78E, 85, 42E, and 80. The art deco style bakelite cabinet was designed by world famous designer Raymond Loewy, and was available in black or walnut. Loewy is probably best known for the 1953 Studebaker and the 1962 Avanti autos. The D-521 sold for 8½ Guineas, about \$50. Battery and AC/DC models were also available as was a three band model with shortwave. (Frank Heathcote - Logansport, IN)

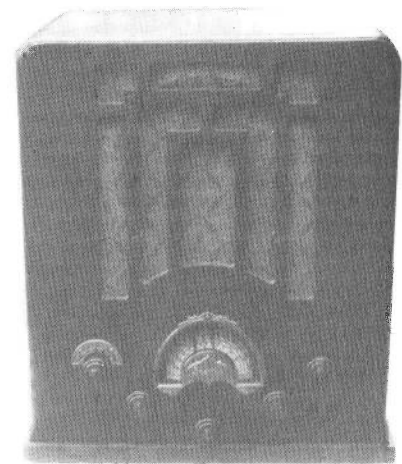

SPARTON - Model 75A, a 5-band receiver made by Sparks-Withington Co. An exceptionally sensitive combination shortwave and broadcast set for its day (1933). Uses 8 tubes - 3-58's, 1-57, 1-55, 1-56, 1-47, and 80 rectifier. (Bill Moore - Huntsville, AL)

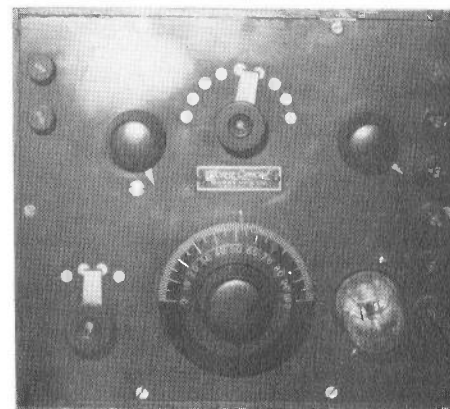

MORSE OPHONE - A crystal set manufactured by the Morse Manufacturing Co., Newark, New Jersey. (R.A. Hostler - Findlay, OH)

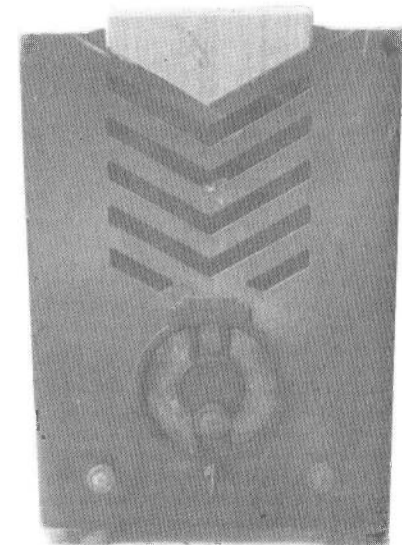

MIDWEST - Made about 1933/34, a 5-band set with incredibly cheap cabinet that was at one time painted to give a two-tone effect. Model number is unknown. Tube line-up is: 1-80, 1-2A5, 1-57, 4-58's. The unusual cabinet of this set would almost put it in the deco category. (Bill Moore - Huntsville, AL)

WITH THE COLLECTORS

BY BILL FOX, WB6NMP, HCR 60, BOX 8, GOULDSBORO, ME 04607

Owner Safety and the AC-DC Radio

The AC-DC radio first appeared on the market in the early 1930s and remained in vogue until the advent of the mass-produced transistor radio. These radios gained their popularity from small size and low price. Such sets usually employed five or six tubes and could be identified by the absence of a power transformer (one of the reasons for their low price).

As is the case with all things in life, tradeoffs must be made. When radio manufacturers sacrificed the power transformer in favor of low price and small size, they forfeited the safety of isolation of the chassis from the incoming utility company AC lines. (A transformer provides isolation since the wires on the input side are not directly connected to those on the filament and rectifier side.) Consumer safety was of little importance during the heyday of the AC-DC radio. Because there was a depression going on in the 1930s, the manufacturer had to build and sell his "New Deal Special" for the sum of \$17.95, with tubes.

All was well if the user simply bought the set, plugged it in and turned it on. The trouble began if the user attempted to attach an antenna and ground to the set. To understand the problem, a person must compare current wiring practices with those of the 1930s.

Figure 1 presents an example of a utility outlet and wire color codes wired according to present practices. (Note that the return pin is wider than the source pin.)

Figure 2 presents an example of a utility outlet and wire color codes wired according to practices of the 1930s.

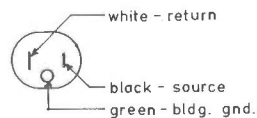

Figure 1. Today's utility outlet wiring.

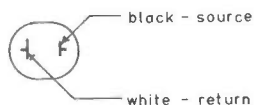

Figure 2. 1930's utility outlet wiring.

The majority of linecord plugs used on appliances manufactured in the 1930s had pins both



of the same dimensions. Because of this, the plugs could be inserted into the outlet in either of two directions. Appliances today use polarized three-pin plugs or two-pin plugs with one wide pin and one narrow pin (refer to Figure 1). Currently manufactured appliances can be plugged into an outlet only one way. According to current code, the white wire (return) and the green wire (building ground) should terminate at a common point within the structure's utility box and be grounded.

Considering this background information, an examination should be made of an application using a typical 1930's radio. The Emerson Radio Models AD-108, AD-110 and AD-125 were picked at random. The schematic for this radio can be found in Rider's "Perpetual Troubleshooter's Manual," Volume 8, page 1 of Emerson, or it can be found in Beitman's "Most Often Needed 1926 - 1938 Radio Diagrams," page 57. For the reader's convenience, this schematic is reproduced in Figure 3.

While realizing that the AC-DC radio can be plugged into the utility outlet in either of two directions, refer to the area of the schematic titled "AC or DC Line." Note that the ON-OFF switch, when on, actually connects one side of the AC line to the chassis!

Consider the possibility that the plug has been inserted into an outlet in a manner that connects the white utility wire, return, to the ON-OFF switch and, when the radio is turned on, to chassis ground. In this case there is no voltage potential between the radio chassis and building ground or true ground. A person could touch the

In their original wiring configurations, there is no way that the early AC-DC radios can be plugged into a utility outlet and still be totally safe.

...operational safety can be maintained by using an isolation transformer.

Use an isolation transformer. Otherwise, your local utility company might someday monitor you as a momentary dead-short on their lines.

radio chassis and a grounded object (water pipe, radiator, damp concrete floor, etc.) and suffer no harm. However, according to current electrical code, this arrangement is undesirable. With this plug polarity and the AC switch off, major areas within the set are still connected to the AC source.

Current electrical code requires that the black utility wire (the source) be the switched line. If the utility plug polarity is reversed to make the black utility line the switched line, then when the set is turned on, the black utility line is connected directly to the radio chassis. A person touching the radio chassis and some ground point is subject to a severe, if not lethal, electrical shock.

In their original wiring configurations, there is no way that the early AC-DC radios can be

plugged into a utility outlet and still be totally safe. If the radio is part of a display-only collection, there is no problem. However, in cases where the radio is to be operational, caution must be exercised when using the set. Never connect a ground to the radio chassis! If the owner desires that no modifications be made to the set, operational safety can be maintained by using an isolation transformer. These transformers have an input/output ratio of 1:1 and are available in a variety of power ratings. You plug the isolation transformer into a wall outlet and plug the radio into the isolation transformer. Isolation is restored between the utility lines and local equipment. Many TV repair shops make use of isolation transformers in the servicing of AC-DC television sets. If they work for TV, they will work for radio. Persons wishing to make use of an isolation transformer when working with an AC-DC radio might consult a local TV technician for aid in selecting a transformer.

Overall, many factors affect user safety when related to the servicing and use of early AC-DC radios. Questions that arise include the following:

How did the radio manufacturer wire the AC input circuitry?

Did the building electrical contractor wire all utility outlets correctly?

Too often these questions go unanswered until someone is injured. The fact that a particular radio is an AC-DC set calls for an immediate extra measure of caution. NEVER assume that the set is safe. A simple AC voltage measurement between the radio chassis and some grounded object can be quite revealing. If the measurement indicates a voltage potential, then extreme caution is called for. Use an isolation transformer. Otherwise, your local utility company might someday monitor you as a momentary dead-short on their lines.

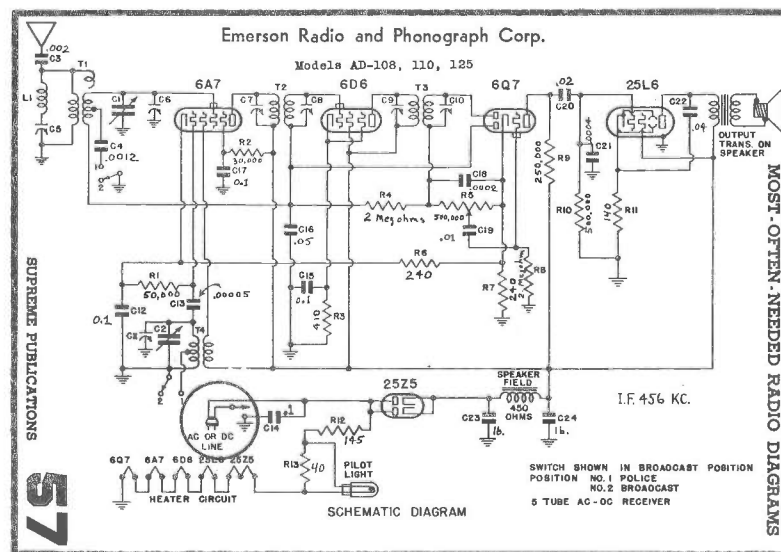

Figure 3. Wiring diagram of a typical 1930's AC/DC set.



CLASSIFIED ADVERTISEMENTS

WANTED: Philco Model 514. A.F. transformers for Neutrowound, 1927. Gale J. Roberts, Box 152, Clyman, WI 53016

WANTED: Midwest Radio Corp. 18-tube all band receiver sold in 1936. Art Robertson, W0IWW, 12110 W. Rice Pl., Morrison, CO 80465. (303) 979-3225, call collect

FOR SALE: Schematics 1920-1960 radio/ misc. — \$3.50 each. Full details in first letter. Satisfaction guaranteed. Alton Bowman, 4172 East Ave., RD 2, Canandaigua, NY 14424

CLASSIFIED AD DEADLINES

Oct. 10 for Nov. 1987 Issue
Nov. 10 for Dec. 1987 Issue
Dec. 10 for Jan. 1988 Issue

WANTED: Cash for pre-1950 TVs. **FOR SALE:** Early TV mags, books, Sams, etc. Don Hauff, 9988 107th Ave. N, Maple Grove, MN 55369. (612) 425-0089 24 hrs.

WANTED: Green Model 106 engraver. Stevens coil winding machine. Boonton 250A Q-meter. B. Turke, 660 North Dixie Highway, Hollywood, FL 33020

FOR SALE/TRADE: Scott Allwave Fifteen and Twenty-Three. Prefer to trade for/towards other classic sets. Will consider all proposals. Will be at V.R.P.S./A.W.A. convention in Dallas, in October. Thomas Peters, PO Box 3925, McAllen, TX 78502

WANTED: MX-949/U tube socket adapter kit for I-177 mutual conductance tube tester (WWII vintage). L. Sheats, 2909 Nutley St., Fairfax, VA 22031. (703) 273-4205

FOR SALE: Microphone collection. Many rare items. Brochure SASE. Broadcast items. W. Turner, Box 13069, Arlington, TX 76094

WANTED: Lincoln receivers and chassis, any model. **FOR SALE:** Bakelite panels. E.H. Scott parts. Grunow chrome front radio. SASE. Norman S. Braithwaite, PO Box 2443, Redding, CA 96099. (916) 246-4209 (message)

FOR SALE: Antique radio collection. Too many to list. D. Greger, PO Box 2620, Clearlake, CA 95422. (707) 994-2251

WANTED: Candlestick telephone, dial at base, prefer Western Electric. Send price and description. Pete Haas, PO Box 702, Kent, OH 44240

WANTED: Perlez battery radio, approx. 6-7 tube, made in Chicago 1926. F. Donahue, PO Box 230, Apple Valley, CA 92307

FOR SALE/TRADE: Peerless (Altec-Lansing) #S-265-Q ultra-linear output transformer — \$25. With amplifier — \$40. T. Walker, N2GIG, 154 Intervale Road, Mountain Lakes, NJ 07046

WANTED: Howard model w/Explorer, a nineteen-tube console. Also Howard 490 communications receiver. Will be at V.R.P.S./A.W.A. convention in Dallas, in October. Thomas Peters, PO Box 3925, McAllen, TX 78502

FOR SALE: Zenith Big Dial console. Crosley Ace, DeForest Radiohome. Books. Over 100 items. SA2SE. John Kendall, PO Box 436, Fallston, MD 21047

WANTED: Good DeForest dual wing audio & AP solenoid tube. Modern Electrics. Murdock gear. Reasonable. Marc Gottlieb, Box 1112, South San Francisco, CA 94083

FOR SALE: Schematics for radios 1920 to 1955 — \$2.50 ea. or 3 for \$6, make, model and SASE. Tube testers: Eico 666 and Superior TV-11 — \$45 ea. plus UPS. Antique Radio Service, 1517 Dennison Ave., Staunton, VA 24401. (703) 886-5125

WANTED: Large AC panel meters. Large DPDT knife switches. Large variable capacitors. Harry Goldman, TCBA, RD3 Box 181, Glens Falls, NY 12801

FOR SALE: Rare Eveready table Model #1, W12098 A/C receiver, original, does not work. Philco floor cabinet Model 810K1 9-tube superheterodyne 530-1720 Kc. Emory Robotham, 20 Farmstead Ln., Farmington, CT 06032. (203) 677-7038

WANTED: Scott Philharmonic Beam of Lite dial, in cabinet, no rust, Laureate Grande preferred — willing to pay top dollar. RCA 811K 5-band console. Will arrange pick up & shipping. John Baldwin, 210 Kaweni Pl., Kula, HI 96790. (808) 878-6374 eves. H.S.T.

FOR SALE: RME 69 receiver — \$200. 1940 vintage Precision electronic tube and set tester Model 954G — \$55. Drake 2-NT transmitter — \$75. All with original manuals. Ward Becht, 625 Tufts Ave., Burbank, CA 91504. (818) 842-3444

WANTED: Manual, schematic, and parts list for Hammarlund Model HQ-145X receiver. James B. Miller, R3 Box 515, Greenville, KY 42345

CLASSIFIED ADVERTISEMENTS

WANTED: FB-7, FB-7 coils. Have extra set 7.0-7.3 and 3.5-4.0 for sale or trade. Need power supply. Steve Barnes, 848 N. Silverwood, Upland, CA 91786

FOR SALE: Antique phonographs & juke boxes. 10,000 78 & 45 records. 1100 new vacuum tubes. SASE. Tony's Trading Post, 209 East Park St., Butte, MT 59701

WANTED: General Electric Model A-80, sold in 1936, 8 tube. Art Robertson, W0IWW, 12110 W. Rice Pl., Morrison, CO 80465. (303) 979-3225, call collect

HAS YOUR SUBSCRIPTION

EXPIRED?

It has if your mailing label reads
"OCT87" or earlier.
Renew now!

*BONUS: Renew before the end of
your "EXP" month and receive 13
issues per year instead of 12!*

Renewal rates are:

\$18.00 for Second-Class Mailing

\$24.00 for First-Class Mailing

(Two-year renewals are twice above rates.)

FOR SALE: Tube tester, Lafayette Model TE-50 with pull-out chart & case — \$25. Geo. Aimone, 130 Summertree Ct., Riverdale, GA 30296. (404) 996-6427

WANTED: New or used tube cartons, all sizes. Also manual for Knight 83Y135 signal tracer. Harry Pewowaruk, 1535 No. 8th Ave., St. Cloud, MN 56301

WANTED: AK 48 SN between 644,000 and 950,000. AK 35 SN lower than 740,000. Will buy or trade. Raymond Thompson, 7422 Cherry Tree Dr., Fulton, MD 20759

FOR SALE: R65/APN-9 receiver indicator, no tube — BO. Daniel Zavaro, 2850 - 21st St., San Francisco, CA 94110. (415) 282-1155

WANTED: Two octagonal 7/8-inch diameter knobs as used on AK 185, 510, 667, etc. Jeff Aulik, 803 N. Chicago, Rockford, IL 61107. (815) 399-1902

FOR SALE: Courier radio with Kyle condenser speaker. For more information, call or write: Paul Dilliard, 1313 E. Wheeling St., Lancaster, OH 43130. (614) 653-5268

WANTED: International Kodette Clockette. Pre-fer parts set. Bob Willis, 1047 Mariners Ct., Stone Mountain, GA 30083. (404) 296-1988

CLASSIFIED ADVERTISEMENTS

WANTED: Early tube hi-fi components, loudspeakers, literature manuals, etc. Complete or parts, working or not. Jack Smith, 288 Winter St., North Andover, MA 01845. (617) 686-7250

FOR SALE: Peerless cathedral speaker. AK 37 with Model E-3 speaker. Silvertone AC radio with speaker, looks like an AK metal radio. Crosley 656 mantle radio. Thermodyne TF-6, with Dealer Helps Binder, ad posters. Homebrew 2-tube, UV-199's, radio. 5-tube battery kit radio. Beckley-Ralston battery radio. Priced to sell. Dave Faehnrich, 8215 Stone Rd., Independence, OH 44131. (216) 447-0837

WANTED: Ozarka trademark label from inside lid of RC201 4-knob model. Steve Morton, 905 W. 1st, North Platte, NE 69101

FOR SALE: AK variometer & knob — \$125. Echophone — \$50. Sky Champion S-20R — \$75 FOB. Joe Santomas, 14 Railroad, Hammonton, NJ 08037

WANTED: Transformer for Eico 460 scope, Eico part no. 30015-2. Used with later hi-volt CRT 5DEP1. Would accept complete scope for parts, if transformer OK. Richard Cannon, 585 W. Hazelwood Ave., Rahway, NJ 07065

FOR SALE: Schematics for radios 1920 to 1955 — \$2.50 each, 3 for \$6.50. Send make, model number and SASE. Grundig Majestic 5040 W/3D, works — BO, plus 30 lbs. shipping. Antique Radio Service, 1517 Dennison Ave., Staunton, VA 24401. (703) 886-5125

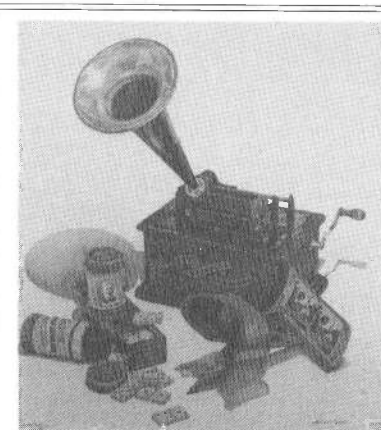

HOME ENTERTAINMENT

By JAMES TARDY
16" x 20"

\$30.00 Complete including U.P.S.

J.J. Papovich
216 Broadway
Westville, NJ 08093

CLASSIFIED ADVERTISEMENTS

WANTED: Meissner communication receiver with band-spread or related tuning unit, any condition, 1938-40. Jacques Dubois, 466 King St., Port Chester, NY 10573. (914) 937-2447

FOR SALE: Arborphone radio. Tower speaker. Radiola 55. Stromberg-Carlson treasure chest. All good. **WANTED:** Wooden speakers, horns and others. Greg Michaels, 29 Arden Rd., Scotia, NY 12302. (518) 346-2687

WANTED: Ten-Tec Eq. State price & condition. H.F. Schnur, Rt. 3 Box 151, Greenville, NC 27854

FOR SALE: Tubes new and used. Transmitting, receiving. SASE for list. Glenn Blizzard, K4HTI, PO Box 1364, Suffolk, VA 23434

WANTED: Round Ekco radio, U.K., Model 65, 36, 76 or 75, mint, prefer black or colors. Hall A. Acuff, 6833 Dartmoor Way, San Jose, CA 95129. (408) 252-1319

FOR SALE: Stromberg-Carlson 501 and (trade) 22" dia. Magnavox bell. Floyd A. Paul, 1545 Raymond Ave., Glendale, CA 91201. (818) 242-8961

WANTED: Chassis, speaker, escutcheon for Air-line 1355 (62-1955). Chassis, speaker for US Radio & TV Corp. Model 10 & 10C. Arvin radio Model #1127. General Electric radio Model E-155. **FOR SALE:** Sams folders - \$1/set. Rider's manuals. Linus Brown, R #2 Box 49, Wapakoneta, OH 45895. (419) 738-8069

ATTENTION!
WILL ALWAYS MEET ALL USA
AND FOREIGN PRICES
!FAST CASH FOR FAST CONTACT!

— WANTED —

**Western Electric, Westrex,
Langevin, MacIntosh, Marantz
Tube-Type & S.S. Equipment**

**"Over 15-Year Old" Speaker
Systems, Woofers, Drivers, Horns,
Crossovers, Parts from W.E.,
RCA, Jensen, Altec, JBL, Tannoy,
Trusonic, University, etc.**

Victrola Credenza 8-30 Model

**David Yo
P.O. Box 832
Monterey Park, CA 91754
Tele: (818) 576-2642**

CLASSIFIED ADVERTISEMENTS

FOR SALE: Blonder-Tongue one tube, BTC 99, UHF converter for TV, plays, exc. - \$30 ppd. **WANTED:** Original Hallicrafters catalogs showing sets, spkrs., etc. made by company. Reading only. Prefer fair & good, but as long as complete. Please Help! Ed Turner, 3536 Arden Blvd., Youngstown, OH 44511. (216) 782-6757

WANTED: National dog house or relay rack equivalent power supplies (example: HRO or SW-3). Roy T. Tucker, N6TK, 14109 Whiterock Dr., La Mirada, CA 90638. (213) 943-1150

ATTENTION SUBSCRIBERS!

SINCE THE APRIL 1987 ISSUE, YOUR MAILING LABEL CORRECTLY SHOWS THE LAST ISSUE OF YOUR SUBSCRIPTION!

Prior to the April 1987 issue, mailing labels showed the date of the issue following your last issue. The number of issues you will receive did not change, only the date on your label.

WANTED: Old radio collections and Lionel train collections. Bill Rolf, 30131 Center Ridge, Westlake, OH 44145. (216) 871-4547

FOR SALE: Scott 28 tube AM-FM Phantom Deluxe. Philco 70 grandfather clock radio. Philco 51 mantel clock radio. AK 206. RCA 128. GE S22. Philco 620 table model. Radiola 64. Philco chair-side Model 37-620. Philco chairsides with remote speakers Models 14 and 19. Majestic 51 on thin legs. 100 assorted consoles. **WANTED:** GE K60 & K80. RCA 140. AK 165, 275, 90, and other A/C sets. RCA Victor Models R74, R76, R77, 28B, 28C, 28D, 28E. Crosley Show Boy & Elf. 1930's Emersons. Grandfather clock radios. Cathedrals. Unusual table models to 1935. I will be at Canandaigua. John Kern, RD#2 Box 457, Quakertown, PA 18951. (215) 538-2128

WANTED: Schematic for Western Coil & Electrical Co. Radiodyne Mod. WC 15 Jr. A two-dial, slant-faced, metal-cased, five-tube battery set. If you have one or parts/info., please contact me. Thanks. Colin Hallgren, 2205 Oakes Ave., Everett, WA 98201

FOR SALE: Spark equipment for 1KW transmitter. Rotary spark gap 1800 rpm, beautiful - \$165. Two Thordarson Type R 25,000 volt speaker transformers - \$100 & \$125. Two oscillation transformers, very old. One flat-wound horizontal - \$75. One vertical, round conductors - \$75. Spark condenser rated 20k, works fine on 25K - \$30. Individual polaroids - \$1. All plus UPS. Paul C. Crum, W9LC, 6272 N. Cicero Ave., Chicago, IL 60646. (312) 282-3033

WANTED: Chassis for AK Model 165. Grebe SK4. Majestic chassis 300A. Jim Stratton, 6902 N. Post, Spokane, WA 99208. (509) 328-8471

CLASSIFIED ADVERTISEMENTS

WANTED: Correspondence course materials from American Jet School, Montana: avionics, missile technology, gas turbine mechanics. Zikes, 8841 W. 95 St., Box 172, Overland Park, KS 66212

FOR SALE: A few good 1930's consoles. Some parts you might want. 6-meter transceiver. SASE for list. Chuck, PO Box 598, New Haven, WV 25265

WANTED: For my mint RAO/NC-120, the military nameplates from the top cover of your junker RAO. Will pay junker price & you keep for parts. Set of good, brush earphones with or without headband. BC-342 in very good condition. RME-9 & silver-panel Super Skyriders. **FOR TRADE:** Rare, low frequency Howard 445 for good 435. Robert Enemarg, Box 1607, Duxbury, MA 02331. (617) 934-5043

SEND ALL A.R.C. MAIL TO
Antique Radio Classified
P.O. Box 2, Carlisle, MA 01741

FOR SALE: Retired. Selling out 60 year collection. 2224 used tubes, 241 new tubes in original name brand boxes. 4, 5, 6 pin, octals, loktals, metals, G's, GT's, 7 & 9 pin miniature. Neatly packed, sorted, labeled and indexed for fast retrieval. 3 tube checkers; Weston 682, Allied-Knight 83YX142, Eico 625. All in excellent condition and working order with charts. 4 RCA tube manuals, Sylvania tube complement book, Sams tube substitution book Vol. 8. - \$650 takes all. Write for list. Robert Gordon, S66 W18560 Jewel Crest Dr., Muskego, WI 53150

WANTED: Unusual telegraph gear like crickets, registers, midget or wind-up bugs, camelback keys, oil keys. Gil Schlehman, 335 Indianapolis, Downers Grove, IL 60515

FOR SALE: Tom Swift books: #1 Motorcycle, vg - \$20. #5 Wireless Message, vg - \$15. #10 Electric Rifle, vg - \$15. #17 Photo Telephone, vg - \$15. Many others. All Types Radio TV Service Books - LSASE. J.J. Papovich, 216 Broadway, Westville, NJ 08093. (609) 456-4071

WANTED: German RES164 tube, AK 3978 potentiometer. Flat socket for Myers RAC3 tube. Bob Murray, 3216 Assiniboine Ave., Winnipeg, Manitoba, Canada, R3K 0B1

FOR SALE: Character & celebrity items mail auction. Catalogue \$1. Mailed in fall. Mr. Mack, 408 Yorkshire Blvd. - AR, Syracuse, NY 13219

WANTED: Bakelite and plastic radios with deco or fifties design, 1930's-1950's. Especially interested in colored plastics. Peter Thomashow, 350 West 20th St., Apt. 4F, New York, NY 10011. (212) 989-0213

CLASSIFIED ADVERTISEMENTS

WANTED: Radio Book for Boys by A. Hyatt Verrill. Robert Stapleford, 1800 Randolph, Topeka, KS 66604

FOR SALE: Large radio collection 1927-1940's, including owner's manuals for Kennedy Royal 16, Model 20, Model 15 and Scott Phantom. Also autographed picture of Amos & Andy, & radio stations they were on from Pepsodent. Also radio & TV tubes, knobs and parts. Plus about 100 radios. Metal & plastic small table models from 30's up, tombstones metal cabinets, and floor models. Example: Metal Apex, Crosley Showbox, Metal Stewart Warner, Kolster Model K-20, National audio transformer Model S101, Trans-Oceanics, floor models Westinghouse, RCA, Philco, G.E. Atwater Kent Kiel table, Crosley grandfather clock and much more. May be seen. LaVerne Hoppe, 2302 Wismer, St. Louis, MO 63114. (314) 427-3529 after 6 p.m.

WANTED: National Radio Company NC5-W or NC5-S shortwave converter. Circa 1932, tube complement: 1-235, 2-224, 1-227, and 1-226. Other National equipment solicited. Bill Fox, W6GNP, HCR 60, Box 83, Gouldsboro, ME 04607. (207) 963-7623

FOR SALE: Metal boxes: Stewart-Warner. AK 55-46. Crosley Show Box, Atwater speakers. Radiola 18. Zenith Chairside. Radiola III. Consoles: Majestic S2 71 shadow dial battery. Philco bar radio. Knight Round Top DC. Hallicrafter SY62, SY32, SR25, S 19R. FADA 2.1924 Trans-Oceanics 5, different. Jim Stratton, 6902 N. Post, Spokane, WA 99208. (509) 328-8471

PUETT ELECTRONICS

P.O. BOX 28572 DALLAS TX 75228



48 PAGE CATALOG - \$2.00
A \$3.00 DISCOUNT COUPON WILL BE SENT WITH YOUR CATALOG IF YOU INCLUDE THIS CODE NUMBER WITH YOUR CATALOG ORDER:

ARC007-77

PUETT ELECTRONICS IS IN ITS FIFTEENTH YEAR - HELPING ANTIQUE RADIO COLLECTORS TO PRESERVE THE GOLDEN AGE OF RADIO!!!!!!!

CATALOG SEVEN

OUR NEW CATALOG --- MORE THAN 1,000 DIFFERENT ANTIQUE RADIO PUBLICATIONS, BOOKS, INSTRUMENT MANUALS, COMMUNICATIONS RECEIVER MANUALS, CATALOGS, SERVICE DATA, SALES BROCHURES, TECHNICAL DATA, FACTORY SERVICE MANUALS, AND OUR REPRODUCTIONS OF MANY FAMOUS RADIO BOOKS AND LITERATURE PRINTED ON BOTH SIDES OF THE SHEET AND WITH ATTRACTIVE COVERS! HUNDREDS OF DIFFERENT TYPES OF TUBES WHICH ARE USED IN ANTIQUE RADIOS, RIDER MANUAL INDEXES, TUBE MANUALS, TUNING DRIVE BELTS, LARGE LIST OF CLASSIC RADIO LITERATURE, SCHEMATIC DIAGRAMS ON NEARLY ANY RECEIVER, DIRECTORY OF ANTIQUE RADIO SERVICES, A.K. SERVICE MANUALS, APPRAISALS, HUNDREDS OF OLD TIME RADIO PROGRAMS ON CASSETTES!!!!!!! ANTIQUE RADIO TOPICS - A 14-SERVICES PUBLICATION SUBSCRIBERS GET 15% OFF ON ALL CATALOG ITEMS, 20% OFF ON TUBES!!!!!!!

REPRINTS OF HISTORICAL BOOKS AND PAPERS NOW AVAILABLE FROM ANTIQUE RADIO CLASSIFIED

During the 1970s, the Arno Press reprinted over 75 early books on the history of telecommunications. A.R.C. has made arrangements to distribute those still available. Although they are not inexpensive, mainly because their specialized nature and low press run, most books are still priced less than a hard-to-find original copy. Here is a convenient way to obtain a quality hardbound reprint copy of these historic books and documents.

Reprinted Books

- Archer, Gleason L. *Big Business and Radio*. The growth of radio from about 1922 to 1938. 1939.\$36.50
- Blake, George C. *History of Radio Telegraphy and Telephony*. Technical detail and 51-page bibliography. 1928.\$35.50
- Bright, Charles. *Submarine Telegraphs: Their History, Const. and Working*. 1898.\$57.50
- Dunlap, Orrin E., Jr., *Radio's 100 Men of Science*. Biographical narratives of men in electronics and television. 1944.\$25.00
- Fahie, J.J. *A History of Wireless Telegraphy*. A technical history of wireless telegraphy up to 1872. 1901.\$30.00
- Fahie, J.J. *A History of Electric Telegraphy to the year 1837*. 1884.\$38.50
- Harlow, Alvin. *Old Wires and New Waves: The History of the Telegraph, Telephone and Wireless*. 1936.\$36.00

Original Anthologies

- Development of Submarine Cable Communication*. 50+ articles, reports, book excerpts, etc. 1863 to 1971. 2-Vols. 1980.\$71.50
- Early American Telegraphy*. Three papers by Alfred and J. Cummings Vail. 1845 to 1914. 1 Vol. 1974.\$25.50
- Military Signal Communications*. 50+ articles, reports, book excerpts, etc. 1861 to 1965. 2-Vols. 1980.\$71.50
- Signalling and Communicating at Sea*. 50+ articles, reports, book excerpts, etc. 1863 to 1969. 2-Vols. 1980.\$73.00
- The Electric Telegraph*. 18 book excerpts, articles, etc. 1859 to 1962. 1-Vol. 1977. \$54.00

Out of Print - Advance Orders Only

Lodge, *Signalling through Space Without Wires*
Archer, *History of Radio to 1926*

Send payment with order.
Mass. residents add 5% tax.

SALE for full list or details on any book(s).
Add \$1.50 per order for shipping in U.S.
Allow 4 to 6 weeks to receive books.

Antique Radio Classified
P.O. Box 2, Carlisle, MA 01741

WANTED: Line cord resistance for a Farnsworth 3-way portable. Uses a 35Z5 rectifier. Model CT 59. Jerome J. Seurer, 308 E. Bank St., Fond Du Lac, WI 54935

FOR SALE: Test equipment: B&K 1075 - \$35. 1077 - \$50. B&K tube testers #600 - \$35. #747 - \$50. B&K digital capac. analyzer 830 - \$60. RCA color rig #10J105 - \$100. Marker generator WR99 - \$70. Sweep generator WR69 - \$50. VTVM WV98C - \$50. Isotap xfmr. #WP25A - \$40. Scope WO56 - \$65. Precision RF generator E200 - \$35. RF generator E400, AM/FM/TV - \$50. VTVM EV10 - \$50. Scope ES 500 - \$60. LSASE list. J.J. Papovich, 216 Broadway, Westville, NJ 08093. (609) 456-4079

WANTED: DeForest audion 1907. Frank Kodousek, 8658 N. Seruite Dr., Milwaukee, WI 53223. (414) 354-1274

FOR SALE: 1950 RCA 20" projection TV 9PC-41 with extra NOS projection tube, plays - \$500. AK 60 built into Kiel table, plays - \$400. 1930 Radiola 86 floor model with record player and recorder in top, restored - \$450. 1928 Model 28F Capehart Orchestrope juke box, restored - \$4000. 1927 Radiola 32, never sold, from RCA display, not tested - \$250. R. Mead, 7429 Jefferson Rd., Ashtabula, OH 44004. (216) 998-2180

WANTED: Help documenting my 1933 Collins 150 watt transmitter, consisting in part of the 10A exciter and 3A amplifier, also the Collins 32B 30 watt transmitter. Any originals or copies of manuals, schematics, promos, or recollections would be greatly appreciated. All costs incurred will be returned. David Swanson, WB9EIE, 127 Hollister Ave., Rockford, IL 61108. (815) 397-4184

WANTED: Colorful plastic radios from the 1950's. Any radio or advertising with fifties design. Peter Thomashow, 350 W. 20th St., Apt. 4F, New York, NY 10011. (212) 989-0213

FOR SALE: Unused and used tubes, capacitors, speakers, phono cartridges and needles. Used tubes - 40¢ up. Unused - 95¢ up. C. Elmer Nelson, 11 S. Church St., Princeton, IL 61356

WANTED: Sets built in foreign countries, no German, pre-transistor era. Randy King, 3017 Orwell St., Lincoln, NE 68516

FOR SALE: Howard Neutrodyne cabinet, panel, 3 capacitors and Vernier dials. Wayne Korn, Box 536, Eau Claire, WI 54702. (715) 723-8691

WANTED: Arcturus Blue #110 and #181. Tracy Sands, 1520 W. Juno Ave. #C, Anaheim, CA 92802

WANTED: Pre-60 German radios, Emud, Opta, Telefunken. Eric Marx, 2460 Bandon, Grand Blanc, MI 48439. (313) 695-0604

WANTED: RCA 45 phonographs #EY-15, 9-EY-35, 9-EY-36, V-M 45 phono #625. Tom LeVasseur, 1601 N. Fremont, Minneapolis, MN 55411

FOR TRADE: 4 vols., 1200 pages, Cyclopaedia of Telephony and Telegraphy, dated 1911. Want old call books (commercial), pre-1935. Walter Britton, 225 S. 17th St., St. Helens, OR 97051

WANTED: Three 3" O.D. bakelite coil forms approx. 6" long. Also 2.5" to 2.75" primary forms to fit inside. Also Browning Drake coils & black sleeving for #12 wire. Enclosed \$1 for additional charges. Hope to see you in Canandaigua. Rodney K. Schrock, KA3NMJ, 402 Lincoln St., Somers, PA 15501

SEND ALL A.R.C. MAIL TO
Antique Radio Classified
P.O. Box 2, Carlisle, MA 01741

FOR SALE: Zenith Trans-Oceanic portable Model 500, runs OK, W.T.S. - \$40. Philco tombstone 6 tubes superhet, runs OK, sim. to #116 (F.O.S. p. 124) - \$70. Hallicrafters S120 5-tube, looks & runs OK - \$40. Hallicrafters S20-R W.T.S., needs work - \$35. Acme Duo Cone spkr. - \$25. AK 55C table model W.T.S., metal case, works OK, spkr. available - \$70. Federal earphones, rare 4400 ohms, with plug - \$30. Want Radiola 2, any Kennedy model. William J. Key, W1DWD, 58 Sycamore Dr., Halifax, MA 02338. (617) 294-1831

WANTED: Parts for Federal 61. Antenna inductance control 0-8. Primary condenser control. Vernier secondary wavelength control. Loop antenna transfer switch. Selectivity control. RF amplification selector. Any or all. James Mason, 90 NW 150th Ave., Beaverton, OR 97006

FOR SALE: Hallicrafters SX-71 receiver, documented modifications, working condition, good appearance - \$160 plus shipping. C. F. Hooper, 1457 Young Ave., Clearwater, FL 34616

WANTED: Manuals and schematic for Paco, Model S-50 o'scope and Coastwise The Ferret Model 701 RF signal generator. John Hohn, 1823 Gaston St., Winston-Salem, NC 27103. (919) 724-6350

FOR SALE: Dial scales for AK 80 series, 82 & 84, Philco 60 & 20, eyeleted to your ring - \$8 plus \$1 ship & ins. Available now. Antique Radio Restorations, 635 S. Lincoln Ave., O'Fallon, IL 62269

WANTED: 2 rheostat knobs & pot. for Paragon D2A. Chassis for Zenith 715. Chassis for Echophone 3V. Case for Federal 59. Case for Kennedy 281. Have ans. machine. Also need complete metal dial for Ultradyne L2. Raymond Schober, 6938 Western Ave., Omaha, NE 68132. (402) 554-0366

FOR SALE: Grille cloth mounted on 16 x 23 baffle, 8 1/2" speaker opening, very good - \$5. Westinghouse Model 23, table radio vg - \$25. Westinghouse Model 184 tombstone, needs electrolytic, cabinet good - \$40. National Mazda, 40 watt bulb, brass base, pear shape, early 30s - \$5. All plus shipping. George Moritz, 31 Hart, Woburn, MA 01801

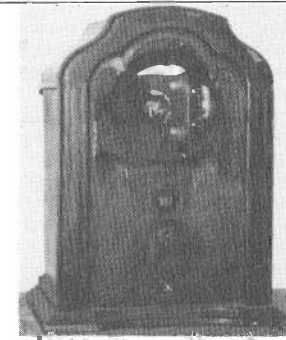

HELP: Need photo or tracing of grill area for Detrola, model number unknown. Len Aquino, 2 Somerset Lane, Putnam, NY 10579. (914) 528-6857

FOR SALE: Kolster 6D and Bosch Cruiser chassis and escutcheons only untested - \$15 each plus UPS. **WANTED:** Ozarka 93, any gold-embossed front panel radios, such as Crosley RFL60 + 75, Metrodyne, or Northland. Also base and driver for Magnavox horn and 1 good petal for Burns horn, prefer black, will take any. Thanx. J.L. Acciavatti, PO Box 231, Southboro, MA 01772. (617) 476-3229

WANTED: Grid dip meter with low frequency coverage down to 100 kHz. Henry Rogers, PO Box 501, Minden, NV 89423. (702) 267-2725

FOR SALE: 45 years IEEE consecutive issues, hundreds radio engineering textbooks, 25 years radio masters. SASE. Francis H. Yonker, W2IBH, 7 Old Farms Rd., Saddle River, NJ 07458. (201) 825-1895

WANTED: Passive radiator used in speaker system of Philco 38-116 or similar models. Karl Ayer, PO Box 665, Thiensville, WI 53092

FOR SALE: RCA TV 630 chassis, works - \$120, pick-up only. Grebe synchrophase, good audios, one small knob, two escutcheon plates missing - \$150. Freed-Eisemann NR5, good audios - \$80. RCA horn UZ1325, good driver - \$75. QST 1930 to 1939 - \$25 per year, all plus shipping. Peter Dieguez. (516) 625-0429

WANTED: Tube shields for Philco Model 60, 1 11/16" I.D. at base for ST envelope tubes w/grid cap. Rich Griffith, 7238 Magoun Ave., Hammond, IN 46324

CLASSIFIED ADVERTISEMENTS

WANTED: Arvin Model 4080T 8" TV. GE Model 806 TV. Early transistor radios. Cabinet back for Zenith Model 28T925 TV. HV transformer for Philco Model 50T 701 or 702 TV, Philco PN 32-9619. Belmont 7" TV, Model 22A21 or 22AX21, will buy one in any condition. Charles Harper, 2081 Harmony Ct., Lexington, KY 40502. (606) 268-8549

FOR SALE: Galvin 65T21 AC wood case - \$15. RCA 9-X-641 AC/DC plastic - \$10. Wards 938R-460A 1 1/2v. battery set, wood case - \$20. Coronado 951-A, battery, wood case - \$12.50. GE 226 plastic - \$10. GE plastic swirl - \$12. Zenith 6C05 wood case - \$15. GE AM/FM plastic Model 408 - \$10. Grundic Model 70WE plastic - \$7.50. Admiral 5121N plastic - \$7.50. Stewart-Warner 9161-A plastic, case cracked slightly - \$5. Richard Haneline, 3600 Cuba Blvd., Monroe, LA 71201. (318) 387-6764

WANTED: 1st I.F. transformer, Philco 70. Cabinet, Philco 90. Cabinet, Kadette Jr. (F.O.S. p. 101). Cabinet Airline 62-606. Telephone dial radio (F.O.S. p. 52). Buy or trade over 300 items. Thomas Romano, 31 Granby Rd., Worcester, MA 01600

FOR SALE: Rare Transvue Model 160L Entertainer, earliest remote control TV. Sentinel Model 400 TV. Guild Spice Chest radio. Excellent Dynakit equipment, including stereo 70 amp, FM 3 FM tuner, PAS 2 preamp. Charles Harper, 2081 Harmony Ct., Lexington, KY 40502. (606) 268-8549

WANTED: Need help in locating the tuning bar and white metal assembly mounts for Freed-Eisemann desktype Model NR-80. P. Burton, Box 912, Belchertown, MA 01007. (413) 323-5572

**A.R.C.
BACK ISSUES
AVAILABLE**

Sep. 84 - Vol. 1, No. 2	Dec. 86 - Vol. 3, No. 12
Oct. 84 - Vol. 1, No. 3	Jan. 87 - Vol. 4, No. 1
Nov. 84 - Vol. 1, No. 4	Feb. 87 - Vol. 4, No. 2
Jan. 85 - Vol. 2, No. 1	Mar. 87 - Vol. 4, No. 3
Mar. 85 - Vol. 2, No. 3	Apr. 87 - Vol. 4, No. 4
Apr. 85 - Vol. 2, No. 4	May 87 - Vol. 4, No. 5
Jul. 85 - Vol. 2, No. 7	Jun. 87 - Vol. 4, No. 6
Aug. 85 - Vol. 2, No. 8	Jul. 87 - Vol. 4, No. 7
Sep. 85 - Vol. 2, No. 9	Aug. 87 - Vol. 4, No. 8
Jul. 86 - Vol. 3, No. 7	Sep. 87 - Vol. 4, No. 9
Nov. 86 - Vol. 3, No. 11	

\$2.00 each - postpaid to U.S., Canada and Mexico
Other foreign orders - \$3.00 each
Mass. Residents Add 5% Tax
Send Order with Payment to:
ANTIQUA RADIO CLASSIFIED
P.O. BOX 2, CARLISLE, MA 01741

CLASSIFIED ADVERTISEMENTS

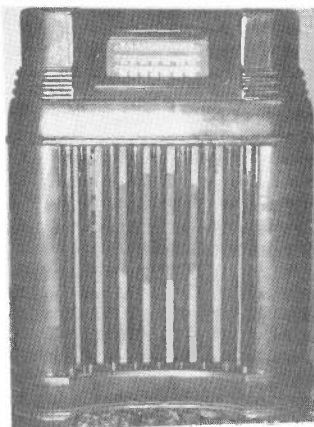

WANTED: Chassis for above Philco radio. Also Model # & mfg. date. R.C. Pottharst, 1230 State St., New Orleans, LA 70118. (504) 529-2622

FOR SALE: 16 Trans-Oceanics, tube type, will part out. Dyna PAS 3 - \$50. Dyna FM1 - \$25. Dyna FM5, missing small knob, doesn't work - \$25. Fisher MPX 100, no case - \$35. DeForest duds, DL4, DL5, DV5 - \$5 ea. Set of five plug-in coils for GR wavemeter, one with tap switch - \$20. Box only for Radiola balanced amp, good label, bad finish - \$7.50. Please include postage on orders and SASE for inquiries. **WANTED:** KLH #8, escutcheon for Philco Jr. Model 81. Steve Rayermer, 190 E. Island Ave., Minneapolis, MN 55401

WANTED: Deco collector seeking documentation on Classic 1936 Sparton Nocturne and other mirrored glass radios. Always paying generous fees. Ed Sage, 1781 Helane Ct., Benicia, CA 94510. (707) 746-5659

FOR SALE: Eimac 4-125A, unused - \$10. Hallicrafters S-40. Zenith L-600. Both have been professionally repaired. New American made 450v, 600v capacitors, pots, knobs, tubes, veneer, crinkle paint. Filament and audio xfms. Schematics through 1952. List of trash and treasures available from Sue Coulter, Box 11-A, 1000 W. Columbus, Bakersfield, CA 93301

WANTED: Copies of operating instructions and schematics for Eico: oscilloscoped Model 425, resistance-capacitance bridge Model 950B, signal tracer Model 147, signal generator Model 324. Chuck Childs, Box 15, Gotham St. Rd., Watertown, NY 13601. (315) 788-2487

WANTED: Radio-related sheet music, any showing radios on cover. Also, I still need these titles: Radio Jazz, Cupid's Wireless, Radio March, Radio Fingers, Just a Little Dance, Nod, Nod, Little Golden Rod, Tell Her I Love Her on the Radio. Gary B. Schneider, 9511 Sunrise Blvd., #J-23, North Royalton, OH 44133. (216) 582-3094

CLASSIFIED ADVERTISEMENTS

WANTED: Schematic for Echophone Model C. Need Echophone cathedral cabinet, damaged or good, dial, parts. RCA Victor Service Data Vol. III, 1943-46; Vol. IV, 1947-48; Vol. V, 1949; Vol. VII, 1951; Vol. VIII, 1952. Need Philco service bulletins, house radios, and Philco auto radio bulletins, Broadcasters. W.D. Huneycutt, Rt. 1 Box 189-A-20, McBee, SC 29101

FOR SALE/TRADE: Stromberg-Carlson 501A. PR 15 receiver. GA Arcturus tube. 864 tubes. 70H Shure mike, 1936. SASE. Floyd A. Paul, 1545 Raymond Ave., Glendale, CA 91201. (818) 242-8961

CLASSIFIED AD DEADLINES

Oct. 10 for Nov. 1987 Issue
Nov. 10 for Dec. 1987 Issue
Dec. 10 for Jan. 1988 Issue

FOR SALE: Old radios, theatre equipment, films, posters, slides, corn poppers, seats. Make flex shafts for old Manley poppers. Exchange VHS tapes. Gottschalk, Box 198, Vale, SD 57788

FOR SALE: Edison Amerol record cylinders, 50+ - \$7.50 ea. Send SASE for titles. Peter Oparowski, 15 Adams St., Medford, MA 02155. (617) 396-3559

MESSAGE: Apologies to those whose letters I have not answered. Was ill most of summer. Please write again if still interested. Thanks. John Sherrod, 4419 15th Ave So., St. Petersburg, FL 33711

CLASSIFIED ADVERTISEMENTS

WANTED: Coil winding rig, motor or manual driven. Chuck, P.O. Box 598, New Haven, WV 25265

FOR SALE: Volume controls! High quality Centralab assembly system. Tapped controls, AC switches, no problem. Send for list or send your clear & complete description. Enclose SASE. Mark Oppat, 167 Caster, Plymouth, MI 48170

WANTED: Hickock tube-tester roll charts Models 539-A 1960-newer, 539-B 1964-newer. Alan Kriss, 1872 Portsmouth Way, Union, NJ 07083. (201) 688-2092

FOR TRADE: Old radio tubes for tube Hi-Fi equipment. Send a list of what you have and what you need. Jack Smith, 288 Winter St., No. Andover, MA 01845. (617) 686-7250

SERVICE: The National Buyers Service may be able to help you find that specific radio and/or TV that you are looking for. Send SASE for details to National Buyers Service, Jim Clark, 1006 Pendleton, Lansing, MI 48917

FOR SALE: Electronics, bound 1930-57 - \$200. Electrical Communication, 1946-51, includes 30-page Federal Telegraph history - \$25. Radio Engineering, 1929-49, incomplete - \$120. Alan Douglas, Box 225, Pocasset, MA 02559

WANTED: Complete coil set for National HRO-50-1. Kent King, 3637 Liberty Road, Delaware, OH 43015. (614) 363-3219

1919/69

Radio Rcvr., Phono, Auto, TVs

30,000 SCHEMATICS

Send Brandname, Model No., SASE to:

J. Earl Scaramella
P.O. BOX ONE, WOONSOCKET, RHODE ISLAND 02895-0001

(401) 76-9376 9
76-XEROX

CLASSIFIED ADVERTISEMENTS

WANTED: Potentiometer for AK breadboard. Paul Thompson, 315 Larkspur Dr., Santa Maria, CA 93455. (805) 934-2778

FOR SALE: Radiola 26 portable, complete with six 199 tubes, all unchecked, with battery box, with ant.-tuner. Radio sits on box, radio about fine, no handle, 1" hole in grill cloth, bottom front of box needs ref. - \$375. Westinghouse RA-DA, no tubes, about fine, unchecked - \$200. Osarake Junior J-1, 5-tube slant front, tubes show through 2", 24" x 16" x 8" x 10", 5 knobs, looks like Wizard, as in A.R.C., June 1987, page 19, unchecked, solid, about fine - \$250. Model V-100 Victor RCA radio phonograph about 1934, plays one record, wood, art-deco front, 16" x 15" x 14", plays - \$75. Magnavox horn R 3 B No. 78336 decal on bell, weak, bat. type, about fine - \$150. All plus UPS. **WANTED:** Hot air fan or 6" brass blade fan, or ribbon air, brown, bakelite, ribbon, fan. Wind-up fly fan, beehive type with sweep, arm. Edison Mabry, 715 W. Longview, Mansfield, OH 44906

WANTED: For Magictone bottle radio, vol. knob and copy of paper tube layout on bottom cover, also a good signal tracer. Jimmy Downes, 607 East 12th Ave., Covington, LA 70433. (504) 893-7057

HELP: Novice collector needs a mentor who lives close to me. Don Garbutt, 443 G St., Idaho Falls, ID 83402

WANTED: Finials for top of Philco 1930s clock radio. Also Hopalong Cassidy radio, others. Otto Nill, 192 Grant Ave., Islip, NY 11751



**The Famous Logo
"Zenith Long Distance Radio"
on an all-cotton T-Shirt.
Ivory on Black.
Sizes: M-L-XL.**

\$11.95 PPD.

(Quantity Discounts Available)

Alan Jespersion
P.O. Box 17338
Minneapolis, MN 554187
(612) 727-2489

CLASSIFIED ADVERTISEMENTS

FOR SALE: 1988 Art-Deco calendars still available, with several color pictures of the most collectible plastics - \$11 ppd. The book Radios: The Golden Age available soon (late September or early October), and you can reserve a copy by sending \$29 hardback or \$18 soft. Both ppd. Your check or MO will not be cashed until shipped. Stan Lopes, 1201-74 Monument Blvd., Concord, CA 94520. (415) 825-6865

CLASSIFIED AD DEADLINES

Oct. 10 for Nov. 1987 Issue
Nov. 10 for Dec. 1987 Issue
Dec. 10 for Jan. 1988 Issue

WANTED: Disney character radios, deco style, wood or multi-colored bakelite, armchair, grandfather clock radios. Alex Kertesz, 24552 Dianne Dr., Cleveland, OH 44122. (216) 831-9110 or 831-4199

WANTED: Wire recorders. Send make, model #, price wanted to Russell Starkey, 855 Eisenhower, Jasper, IN 47546

FOR SALE: Radiola 25 w/loop/t + spk. Scott two-dial complete, v poor cab. Pair Radiola 46. Hewlett Packard low frequency std. W. U. Tel. Co. artificial line 5067A. Radiola 17 WT, no hood. Two Radiola 33 WDT, 1 cover. Nitrilizer 305AR, Mad Science Electronics, St. Louis. Majestic 70B console + extra power supply. Federal Radio (Buffalo) H, 2 pc. chassis. Jr. Spectrophotometer Canadian Lab. supplies. Trans-Portable 1958 Olds 98 complete. Roberts 1/2 track stereo, 2 pc., mint. **WANTED:** Dial scale, Radiola 32. AA1520. Baby Ultra 400. Myers phones. Two Heinze Electric, Mod. T type coils & box cover. John A. Myers, Wilson, NY. (716) 751-6053 evenings

WANTED: Blank recording discs. Audio disc, Soundcraft, Allied, etc. Also Allied Radio or Lafayette Radio catalogs, pre-1960. Bruce Leslie, Pro Recording Service, 13709 Maple Leaf Dr., Cleveland, OH 44125. (216) 662-1435

FOR SALE: 7 early phone plugs & 12 jacks - \$15. 7 DeForest HC coils, mounted - \$10 each. UV-203A in original box - \$35. F.W. Chapman, Apt. B218, 1130 N. Lake Parker Ave., Lakeland, FL 33805

WANTED: Zenith transistor Trans-Oceanic R2, 3 or 7000. Thanks. William M. Wade, 657 14th Ave., Prospect Pk., PA 19076

SERVICES: Meters repaired, from 1900 to 1930, movements, case, glass, no job too difficult. Odd scale meters repaired with just your useable scale and broken case. Thermocouple, hot wire, and standard coil movements. All work warranted. Quotes gladly given. Replacement meters also. No lists. Leonard W. Cartwright, 113 Sea Terrace Way, Aptos, CA 95003

CLASSIFIED ADVERTISEMENTS

WANTED: Broadcast type wire recorder. S-38. Rider's 18 and up. Tom Earnest, PO Box 603, San Angelo, TX 76902. (915) 653-0851 eves.

FOR SALE: Majestic tombstone radio Model 161, all chrome grill. Zenith armchair radio Model 8S647. Russell Schoen, E. 7340 Neetzhe Rd., Clintonville, WI 54929. (715) 823-6744

WANTED: Hammarlund HQ-140X BFO assembly, Part #26107-G1. Working Crosley 167 chassis. Radio Boys Mysteries. Brian Roberts, 3068 N. Evergreen Rd., Pittsburgh, PA 15237. (412) 931-4646

FOR SALE: Antique white beehive porcelain insulators - \$1 each. Miniature tubes - \$1. Octal, loctal - \$2. Inquire. **WANTED:** Mechanical filter 500KC, 6KC bandwidth. Levy, 2833 Junction Hwy, #15, Kerrville TX 78028. (512) 367-4741

**SEND ALL A.R.C. MAIL TO
Antique Radio Classified
P.O. Box 2, Carlisle, MA 01741**

WANTED: National Model GRSPU-6 power supply, 6.3v., for AGS receiver, speaker & rack for AGS receiver. Pat Stewart, W7GVC, 1404 Ruth, Walla Walla, WA 99362

FOR SALE: AK breadboard, mounting boards, mahogany. Send SASE for list. Larry DiBarry, 212 North 6th St., Chambersburg, PA 17201. (412) 263-3804

WANTED: Giveaways from radio shows, 1930's-1960's, in which a boxtop was sent in. Rings, decoders, manuals, anything from Capt. Midnight, Tom Mix, Lone Ranger, etc. Also items from cereal boxes same era. State cond. & price. Joseph Fair, 10 Crestwood Dr., RD-2, ARC, New Castle, PA 16101

FOR SALE: Two N.O.S. 7JP4 picture tubes - \$65 ea. Philco 40-217 (remote control) parts set, no speaker, with remote - \$60. Kennedy Model 30 AC chassis, works, needs tuning shaft - \$20. Zenith 9-S-262 parts chassis, no power xfmr. - \$20. G.E. J86 chassis - \$15. Sears 101. 549 chassis - \$10. Grunow 15W chassis - \$30. AK 368 10" speaker, reconed - \$25. **WANTED:** Help me find this stuff! Silvertone 4786 dial bezel, brown curved, 10 1/2" long, for slide rule dial. Need chassis & speaker for 1928-1931 Silvertone. Need 1264-1 Grunow speaker. AK70 chassis & speaker. Mark Oppat, 167 Caster, Plymouth, MI 48170. (313) 455-4169

WANTED: Grunow Model 670 (6D) or 750 (7B) tombstone Allwave. HRO power supply, non-rack preferred. Short Wave Manual by F.J. Camm, Editions 1, 2, 4 & other Camm books. L. B. Zimmerman, 8448 No. Harding Ave., Skokie, IL 60076

CLASSIFIED ADVERTISEMENTS

WANTED: SW receiver. **FOR TRADE:** Farnsworth, Motorola, G.E., Monitor, Trav-Ler. Levy, 8 Waterloo Dr., Morris Plains, NJ 07950. (201) 285-0233

FOR SALE: Radio News 1945 to 1958 - \$2 per copy. QST 1929-1930 - \$2.50 each, 1931 to 1934 - \$2 each. Modern Radio Servicing by Ghirardi - \$12.50. Radio Physics Course, some soil - \$12.50. All About Aerials, 1922, Cons. Radio Call Book Co. w/12 Blue Prints - \$5. Radio Craft 1939 to 1946 - \$2.50/copy. Radio World Weekly, 1930, 1931, 7 copies for - \$8.50. Radio Electronics, 1949 to 1953, 10 copies for - \$10. Rider's rec. tube sub. guide book - \$5. IRC vol. control replacement manual #4 - \$3.50. Rider's book Serv. Superhets - \$5. 101 Ways To Use Your VOM-VTVM - \$3. ABC's of elect. test eqpt. - \$3. Audel's Vol. #9 Wireless and Radio Guide - \$7. Audel's New Elect. Library, Vol. #9, Radio Wireless, TV - \$8.50. Fawcett Radio Manual #3, How to Build - \$5. N.O.S. dials 2 1/8" dia. 100° to 0°, 280° - \$5. for three. Assorted headphones - \$9.50 pair. Dial belts - \$3. #46 Dial bulbs, box 10 - \$2.50. N.O.S. volume controls, no tone taps, w/sw. - \$3.50 ea. N.O.S. 01-A - \$6 ea. Also have test eqpt., parts, tubes, speakers, Rider's, Howard Sams, RCA Philco service data. 1000's of unlisted parts. Write wants and SASE. All items plus shipping and insurance. SASE for list. Min. orders - \$7.50. Krantz, 100 Osage Ave., Somerdale, N.J. 08083

FOR SALE: Philco Predicta, tandem, 20' cable on C.R.T., vgc, works well! Taking offers. J. Downes, 607 East 12th Ave., Covington, LA 70433. (504) 893-7057

WANTED: Zenith speaker #49-416 for Model 10-S-669. Rider's Volumes 18-23. Jim Berg, 2648 W. Arkansas Ave., Denver, CO 80219

FOR SALE: I have 100's of radios, TVs, and related items available. Send SASE for current list. Jim Clark, 3720 Dell Road, Holt, MI 48842

Please Save this Want List!

- AMRAD**
- Crystal Set, 2575
- 2-Stage R.F. Amplifier, 3071
- 1-Stage R.F. Amplifier, 3290
- Variometer, 2752
- Variable Condenser, 2777
- 1-Stage A.F. Amplifier, 2766

GREBE
Coils for CR-18

It may be a long time before I find some of the sets I am listing in these ads, so remember to call me when you are ready to part with yours. I am putting together a collection of early broadcast and wireless equipment and adding to it each month. I buy single sets or collections. Also: books, catalogs, manuals and other related documentation.

Call and surprise me; make my day!
John V. Terrey, 498 Cross Street
Carlisle, MA 01741 - (617) 369-9770

CLASSIFIED ADVERTISEMENTS

FOR SALE: Scanning disk from early kit mechanical TV, 24" diameter with hub for 1/2" shaft; three sets of hole patterns, one set has square holes - \$350 ppd. Doug Heimstead, 1349 Hillcrest Dr., Fridley, MN 55432. (612) 571-1387

WANTED: Scott 800-B's. Also 800-B remote control keyboard and volume motor set-up. Michael Greene, 19113 Alpenglow La., Brookeville, MD 20833. (301) 774-3203

FOR SALE: Misc. old tubes (Arcturus, DeForest, etc.) & many TV yokes, flybacks. **WANTED:** Connecticut receiver. Arcturus 99, 01A, 50 (blue). Unusual horns and Crosley Repwood sets. Also need Burns horn driver. R. Dobush, 3554 W105, Cleveland, OH 44111. (216) 228-4953 eves.

WANTED: Kennedy 525 - St. Louis version. Clapp-Eastham HZ with panel knife switches, any condition OK. Also any type Baldwin headphones. Henry Rogers, PO Box 501, Minden, NV 89423. (702) 267-2725

WANTED: 1937 Stromberg-Carlson Model 145-L radio-phonograph. RCA tombstone or console on tubular chrome stand. Any Midwest. Mir-ray or other mirror front. Chrome or aluminum fronts, red or blue Neutrowound Model 1927. Grisby-Grunow colored horn. Buy or trade. Scott Hagerman, 392 Ann St., Cary, IL 60013. (312) 639-7745

WANTED: Winchester Repeating Arms Co. Radios. Any condition. Both electric and battery. Top dollar paid. Keith S. Shepard, PO Box 627, Midway City, CA 92655. (714) 841-2327.

FOR SALE: Sam's Photofacts #1 thru #1000 -\$3.00 each postpaid. For correspondence or research, send SASE. Joy Electronics, 2905 Lackland Rd., Suite C, Dept. A, Fort Worth, TX 76116-4155

SCHEMATICS for Radios, Power Supplies, Amplifiers, Plus. 1919 to 1945. Send SASE, \$1.00 per copy, brand name and model number. Gene Corn, 3 Barton St., Greenville, SC 29609

WANTED: BALANCED AMPLIFIER for RADIOLA IIIA, usable WD-11's. Also MAJESTIC CHASSIS no. 90 and speaker for HIGH BOY CONSOLE no. 92. Nick Spitzer, 9280 Knoll Dr., Galena, OH 43021. (614) 965-2538.

WANTED: Keys, bugs and telegraph instruments. Also related parts and publications. Will purchase or trade like kind. I am a collector not a dealer. This is an affair of the heart, not the wallet. Warren Berbit, K2UVV, 46A Mile Road, Suffern, NY 10901

WANTED: Scott Philharmonic in excellent condition. Any cabinet considered. John Sacra, 1720 Solomon Rd., Charlottesville, VA 22901. (804) 293-9985

CLASSIFIED ADVERTISEMENTS

WANTED: Junker Zenith table Model 750 for parts. James M. Seal, 3309 Boatman's Mountain Rd., Morristown, TN 37814

FOR SALE: Dial belts 9 & 1/16 inch, new - \$4.50 ppd in USA. Hallicrafters S-40, good working condition - \$75 + UPS. Sue Coulter, Box 11-A, 1000 West Columbus, Bakersfield, CA 93301

WANTED: Signal Corps headphones Type R-1, LM-1 tube, radio pamphlet No. 20. Also need junker 7G605 Trans-Oceanic. James Treherne, 11909 Chapel Rd., Clifton, VA 22024. (703) 830-6272

FOR SALE/TRADE: SX24, HRO 60 & spkr. & coils ABCD. **WANTED:** JFD dial belts. Rider's index for Vols. 14, 17 to 23. Junker AK 206 or 376 for T1 & T2 RF coils. A. Bruno, 24 Butternut Dr., New City, NY 10956. (914) 354-8899

WANTED: AK breadboard parts. AK 41, 50, 708, 735, 337, 155, 93 SW and others. Bob Nicholson, 3423 S. Long, Topeka, KS 66605. (913) 266-9473

FOR SALE: Over 750 1940-1960's electronic and ham radio type magazines. Take complete lot at 15¢ each, no shipping. Also have 5,000 + octal, locktal, and miniature tubes. These are new, used and pullouts. Take whole lot at 12¢ each. Also wish to sell my complete inventory of battery radio parts from the 1920s. Enough to fill a van. Price negotiable. Gary B. Schneider, 9511 Sunrise Blvd., #J-23, North Royalton, OH 44133. (216) 582-3094

FOR SALE: Phono Needles & Cartridges (ceramic - magnetic). What do you need? J.J. Papovich, 216 Broadway, Westville, NJ 08093. (609) 456-4079.

WANTED: National SW3, SW4, SW58 and SW34 receivers and accessories. Also buying usable parts for restoration of these radios. Premium prices paid for original coils. Dean Showalter, 36308 Panorama Dr., Yucaipa, CA. 92399. (714) 797-1782

TUBES. Thousands in stock. Send S.A.S.E. for list. Fala Electronics, P.O. Box 1376-3, Milwaukee, WI 53201

WANTED: Early open frame motor electric fans, motors, generators, medical devices, galvanometers, scientific instruments, etc. Richard Cane, 8391 N.W. 21 St., Sunrise, FL 33322. (305) 741-6838

WANTED: Old Electrical Apparatus - Test Equipment, Open-Frame Motors/Generators, Spark Units, Switchboard Meters, Bulbs, Tubes, Table Radios, Medical Devices, Books, Knife Switches, Trains & Accessories, Specialty Devices, etc. H. Andreoni, 250-D So. Lyon Ave., Hermet, CA 92343

CLASSIFIED ADVERTISEMENTS

WANTED: Early land line telegraphy, any condition. Have traders available. **FOR SALE:** Unusual extras. Roger W. Reinke, 5301 Neville Ct., Alexandria, VA 22310. (703) 971-4095

FOR SALE: One AK Model 35, cabinet vg, some tube missing, DC current - \$40 plus shipping. Thomas Burnside, 4838 S. Westhaven Dr., Jackson, MS 39209. (601) 922-2235

WANTED: RCA Red Books service data, three books: 1923-28, 1929-30, 1931-32. Gilbert Smith, 11908 South 36th St., San Diego, CA 92113. (619) 233-8646

One Month Free!

BONUS FOR EARLY RENEWALS

If you renew before the end of the month shown on your mailing label (your expiration date), you will receive an extra month on your subscription: 13 months instead of 12! 26 Months for a 2-year renewal!

WANTED: HRO-50/60 coils or parts receiver. Hallicrafters S-35 Panoramic receiver. National 7" TV. Sam Thompson, Box 101, Alameda, CA 94501

FOR SALE: Illustrated monograph on mechanically scanned, all solid-state television system - \$4.98. Ed Taylor, 245 N. Oakland Ave., Indianapolis, IN 46201

WANTED: Tubular dial and escutcheon for Sears Model 4680 radio. Jack Hortman, PO Box 456, Biglerville, PA 17307

FOR SALE: Majestic square knobs, solid walnut, 7/8 square reproduction - \$7 per pair ppd. Bill Allen, 2904 Greenway Dr., Bettendorf, IA 52722. (319) 355-1760

WANTED: AK 165. RCA Tambour. Art Deco table models. J. Johnson, 560 Meadowview Ln., Greenwood, IN 46142. (317) 888-7849

FOR SALE: Philco 38-93 semi-cathedral. Knight Ocean Hopper & coils. **WANTED:** Crosley cathedrals. Ben Montabana, 1133 Graham Dr., Birmingham, AL 35214. (205) 798-5289

WANTED: Crosley Wigit. Pilot Midget. Other unusual cathedrals. **FOR TRADE:** Philco 20. Philco 51. U.S. Apex Model 7A. Richard Haneline, 3600 Cuba Blvd., Monroe, LA 71201. (318) 387-6764

FOR SALE/TRADE: 16GP4A CRT, Radiola 20 cabinet. **WANTED:** Philco 91 cabinet. Freed-Eisemann NR-6 1st AFT. Stromberg-Carlson 635A tuning knob. Old WD-11 to UX-base adapters. Henry Brown, 160 French St., New Brunswick, NJ 08903. (201) 846-4820. Let's talk.

CLASSIFIED ADVERTISEMENTS

FOR SALE: Used technical publications. Specializing in radio, communications and electronics. We have many books, handbooks, catalogs, military and equipment manuals and magazines. (We also buy the above - send us your list.) 39¢ stamp for latest big list. Softwave, 1515 Sashabaw, Ortonville, MI 48462

WANTED: Northern Electric decals or any information as to source. Gordon Wilson, 11108-50 Ave., Edmonton, Alberta, Canada T6H 0H9

HELP: Need info, cabinet details, on Wurlitzer rcvr. Mod. 3-A. I have the chassis & panel but no cabinet. Sonny Clutter, 14330 NE Fremont Ct., Portland, OR 97230

WANTED: Data wanted on an RCA Brunswick Radiola Model AR 813 with Brunswick Balke-Collender phonograph console. Dick Randall, K6ARE, 1263 Lakehurst Rd., Livermore, CA 94550

FOR SALE: Edison graphophone cabinet - \$80. 10 Hawkins' Electrical Guide books, 1917 edition - \$20. 8 Crosley advertising postcards - \$1 ea. 62 table radios, send SASE for list & pictures. Clark Trissell, 3530 Pawnee, Lincoln, NE 68506. (402) 488-5263

WANTED: Cabinets for Preiss Straight 8 and Radiola IV. Chassis for Jackson-Bell 62 and Pittsburgh SP2 junker. **FOR SALE/TRADE:** Working Sentinel 108A chassis and misc. Preiss Straight 8 parts. Geo. Hausske, 1922 E. Indiana St., Wheaton, IL 60187. (312) 668-3845

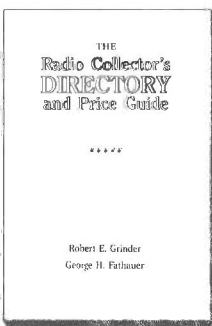

An important directory and price guide for the experienced and beginning radio collector. **The Antique Radio Collector's Directory and Price Guide**, by Grider and Fathauer, has received rave reviews in leading antique radio publications. Order your copy today! \$15.95 plus \$2.00 shipping.

Ironwood Publishing
P.O. Box 8464 Scottsdale, AZ 85252

CLASSIFIED ADVERTISEMENTS

WANTED: Late 50s, plastic 4-tube battery portable radios, using 1R5, 1U4 type tubes. Sets used 1 1/2 volt flashlight battery and 45 volt or 67 volt B battery no AC. Richard Marsh, 7350 Buchanan St., Hollywood, FL 33024

FOR SALE: Communications Receivers: The Vacuum Era. Book covers history, specs. on 700 receivers. 51 companies, 112 photos. \$14.95 + \$2 p/s. SASE for details. RSM Communications, Dept. A, Box 218, Norwood, MA 02062

WANTED: Name your price for vertical blocking oscillator transformer Stancor number A8121 primary 164 ohms, secondary 1.4K ohms. Zenith AM/phono table-top combo Model 6R886, must be working in good condition. RCA 45 changer with bakelite base. Ted Hill, PO Box 11281, Winston-Salem, NC 27106. (919) 722-3949

One Month Free!

BONUS FOR EARLY RENEWALS

If you renew before the end of the month shown on your mailing label (your expiration date), you will receive an extra month on your subscription: 13 months instead of 12! 26 Months for a 2-year renewal!

WANTED: AK 708. Kenneth Acord, PO Box 21503, Long Beach, CA 90801

FOR SALE: Majestic Continental (Telefunken), beautiful cabinet, FM & standard works, short-wave no - \$85 ppd. George Friedrich, 7162 Jacqueline, Custer, WI 54423

FOR SALE/TRADE: Cathedrals: Atwater Kent, Philco, Crosley and others. Battery sets: Crosley Pup, Aeriola Senior, Atwater Kent, Erla and Freshman. Horns & speakers: Amplion, Atwater Kent, Atlas, Bristol and others. Misc.: AC sets, parts, literature, tubes, RCA TV. **WANTED:** Crosley 58 chassis and speaker. Philco 60 chassis. Amplion AR19 driver. Dial for RCA 4X. Zenith speaker #49-143 for Model 5S-127. Breadboards. Cathedrals and unusual horns. Fireside Wireless, 1507 Ridge Ave., New Castle, PA 16101. (412) 654-9335

WANTED: Early 1930's cathedral chassis (large tubes), max. size 9 1/2" x 6 1/2", with 3 controls in triangular pattern, circular dial scale (not drum type). Will send template on request. Carl Reinke, 2724 N. 27th St., Sheboygan, WI 53083

FOR SALE: General Radio type 224 precision wavemeter, covers 75 to 24,000 meters, excellent, in case - \$95. Craig Smith, 1935 1st Ave. S, St. Petersburg, FL 33712. (813) 822-7592 days

WANTED: Adapters to use '99 tubes in WD-11 sockets. Paul Bourbin, 25 Greenview Ct., San Francisco, CA 94131

CLASSIFIED ADVERTISEMENTS

FOR SALE: Hallicrafters S-38A, exc. cond. - \$50 plus shipping or trade for old toys. Warren Burdine, 830 Geneva Dr., Prescott, AZ 86301. (602) 778-1608

WANTED: Sams Auto Radio Series Volumes 1-17, 35, 51, 160 and up. Dan Schulz, PO Box 892, Crystal Beach, FL 34681

FOR SALE: Fieron signaler - \$20. RCA WG-289 H. V. probe - \$10. Rider's novice Sound-N-Sight code course - \$20. Randy Seifert, Box 45, Middle, IA 52307. (319) 622-3568

WANTED: Grebe CR-6 & CR-7. DeForest Radiohome. **FOR SALE:** Rider's Vol. 7 & 10 - \$10 ea. Jim Collings, 12005 Victoria Pl., Oklahoma City, OK 73120

WANTED: Manuals (or Xerox) for: Pyramid capacitor/resistor analyzer, Model CRA-2. Jackson condenser tester, Model 112. Triplett signal generator, Model 1632. Precision sine/square wave generator, Model E300. Tektronix Model 561A oscilloscope. John Aikin, 3605 Overhulse Rd. NW, Olympia, WA 98502. (206) 866-8407

FOR TRADE: 1939 RCA World's Fair table model in pristine condition for interesting catalin radios. Philip Collins, 10965 Rochester Ave., Apt. 201, Los Angeles, CA 90024. (213) 479-0167

FOR SALE: WWII US military radio equipment, good to excellent: three CCT-46104 aircraft receivers, combined into one unit, 18 tubes. Army BC-923-A receiver, 17 tubes, schematic. Army TU-5-B transmitter tuning unit. Best offer by Nov. 15. Carl Reinke, 2724 N. 27 St., Sheboygan, WI 53083

WANTED: Instruction manuals for the following NRI Professional test equipment - Model 89 Signal Generator, Model 34 Signal Tracer and supplemental instruction sheet for a Model 70 tube tester. Also need instruction sheet for Hickock radio tube tester, Model AC 47. Jim Stoker, 14 Roberts St., Adams, NY 13605. (315) 232-4020 before 9 p.m., E.S.T.

FOR SALE: Triplett 3413, NRI 68 tube testers - \$10. Black, brown 4" tuning knobs. James Stueber, 8920 Lexington Ave. NE, Albuquerque, NM 87112

WANTED: Schematic for Bosch Model 520 table radio built about 1942. Vincent Forni, 21 Thomegan Rd., Brewster, MA 02631

FOR SALE: Tube-type transmit/receive equipment, good to excellent: 1930's Hallicrafters HT-11C Marine radiophone, 9 tubes, instr. book. Gonset Communicator II, 16 tubes, instr. book. HW-18 Heathkit SSB transceiver, 12 tubes. Best offer by Nov. 15. Carl Reinke, 2724 N. 27th St., Sheboygan, WI 53083

CLASSIFIED ADVERTISEMENTS

FOR SALE: 1000 watt W.E. 251A, 21" long, 6" diam, incl. instructions. G.E. 861. West. 831. Best offer. J. Wasiewicz, 229 Sarles Ln., Pleasantville, NY 10570

WANTED: Crosley Model 50 or 51, with or without cabinet. Dan Damrow, W9GQY, 5331 West 79 St., Burbank, IL 60459. (312) 422-3763

FOR SALE: Old battery radios, speakers, etc. Will sell all to one buyer. About fifty in all - \$3,000. Call after six p.m. George Stankus, Hiram, OH. 569-7570

WANTED: Zenith console, multiband large airplane-dial type radio. Thanks. Bob Babineaux. (318) 232-0102 after 6:30 p.m. C.S.T.

FOR SALE: Very large radio list. SASE 2 stamps plus \$1. Joe Szabat, W3LST, 228 Plummer St., Oil City, PA 16301. (814) 677-4042

WANTED: Brass escutcheon for Philco 70 grandfather clock radio. Joseph Kwoka, 123 Cooperskill Rd., Delran, NJ 08075

FOR SALE: AK 32 - \$100. AK 35 - \$50. AK 42 - \$50. Radiola 18 - \$50. RCA 6T - \$75. Zenith console 7S363 - \$75. All plus shipping. P. Currie, R1 B77, Denmark, ME 04022

WANTED: Grebe CR18 and/or antenna coils. National AGS, FB7X, FBXA rcvrs., FB7 coils & pre-selector. 1925 to 1930 ARRL Handbooks. Stu Mount, K2OA. (914) 691-7957

FOR SALE: Rare Holmes Telegraph burglar alarm, 1860's, less bell. Joe Santomas, 14 Railroad, Hammonton, IL 08037

WANTED: Chassis for a Majestic-Havenwood model 151. Cabinet for Freed-Eisemann NR-20. Large dial for an Air-Way Type F, Crosley Harko Senior, 50-A, X or other early Crosleys. **FOR SALE:** Remler Infra-Dyne amplifier with 3, 199's - \$95. Crosley RFL 75 with rare wood front panel, restored - \$95. Crosley Super Trirdyn regular, near mint - \$85. Greg Hamilton, RR #2, Flora IL 62839. (618) 662-2291 after 6 p.m.

FOR SALE: AK H & L speakers - \$65. ea. Signal loose coupler - \$180. Ace V - \$140. Stewart-Warner set of books radio - \$140. Philco 20 cathedral - \$150. Sea shell speaker - \$35. Wall telephone, W. E. - \$103. Much more. Send SASE for list. Bob Barnes, 511 N. Chestnut, Monroe City, MO 63456. (314) 735-2945.

FOR SALE: 3FP7 CRT, U.S.A. surplus - \$2.95 plus 4 lbs shipping. H V M Limited, 564 Sand Creek Road, Albany, NY 12205

WANTED: Speaker for Radiola 17 in working condition. W. D. Gallagher, K2AUS, PO Box 168, Ironia, NJ 07845. (201) 584-0783

CLASSIFIED ADVERTISEMENTS

FOR SALE: 2500 new tubes, 90% off regular G.E. list price - \$25 min. + UPS. J. J. Papovich, 216 Broadway, Westville, NJ 08093. (609) 456-4079

FOR SALE: 2 Murdock cased condensers - \$35 ea. Dud WD-11's - \$8. Two Michigan radios. Music Master 14" horn speaker. Large W.E. cone speaker, cone damaged. 30-tube fantastic Capehart. Scott 800B, others. National 101. Canadian version HQ120. DeForest audions. Crystal sets. 01A, 199 tubes, 80 and 10's, others. Aeriola Sr., also Aeriola case, 4CX250B, 4X150's. Taylor tubes. Slide tuners. Magnavox R3 speakers. Murdoch phones. Federal A10. Federal Bristol amp. Clapp Eastham HR. Grebe CR9. AK 20's. AK 32. Radiola 3, and 3A less tubes. National H.F.S. Cleveland radio, needs restored. 5 small-screen TV's. Sailing Ship speaker, no cone - \$55. Kleinschmid teletype, unused - \$150. Peerless speaker, no case - \$35. Crosley Musicone speaker - \$50. Converted 80 mtr. command rcvr. - \$35. Two early FADA battery sets. FB7. Crosley cathedral, needs xfrm. Radiola 100 & 100A speakers - \$37.50 ea. 1958 call book - \$20. Sodian tube S13. Unconverted Command xmtrs, mint. Dec. 1916 QST. Also early 20's Murdock ant. switch - \$50. Telegraph sounders, relays. 2 Crosley Pups. 3 Zenith Trans-Oceanics - \$65 ea. Large beautiful FADA console, Midwest chassis - \$35. Joseph Szabat, 228 Plummer St., Oil City, PA 16301. (814) 677-4042

FOR SALE: Crosley XJ - \$100. AK49 - \$40. Horn speakers - \$50 each. Truetone, Rola, Stromberg Carlson 2A, Saal, Black AK M. Westinghouse lighted sign - \$110. Mathieson loop antenna - \$95. Brown Charlie McCarthy radio for trade. Want Emerson Mickey Mouse, Snow White or other good novelty radios. Greg Farmer, 71 Rice Creek Way, Fridley, MN 55432. (612) 571-6062

WANTED: Knight Ocean Hopper, preferably working. Also to meet California collectors. Bart Lee, 327 Filbert Steps, San Francisco, CA 94133.

FOR SALE: Philco 20, mint, plays - \$150. Detrola Super Pee Wee, 2-color brown bakelite w/cream knobs, mint - \$155. Crosley 148, tombstone, chrome escutcheon, near mint - \$60. Zenith 807, tombstone - \$120. Zenith 5S29, tombstone - \$110. Zenith 9S54, console, w/added 6U5, pickup or arrange - \$225. Crosley Colorado series: 11-126, maroon, AM/FM - \$65; 10-136-E, black/chrome - \$80; 10-138, maroon/chrome - \$70. Aetna, tombstone - \$50. Sylvania Radio & TV Service clock, restored - \$60. Other Zenith console and table radios available. Shipping extra. Alan Jespersen. Mpls., MN (612) 727-2489.

FOR SALE: Set of 6 matching shot glasses for Penthouse or Pla-Pal bar radio. Not original but they are the right size - \$20. Guild 556 Country Belle Wall Telephone radio, very good condition, working - \$89. Doug Heimstead, 1349 Hillcrest Dr. Fridley, MN 55432. (612) 571-1387

CLASSIFIED ADVERTISEMENTS

FOR SALE: 1932 Majestic Model 15A—\$85. 1931 Crosley 127 10-tube tombstone, rare — \$175. 1931 Zenith Zenette cathedral — \$250 + UPS. All beautiful cabinets. D. Hall, 1500 Turner St., Old Hickory, TN 37138. (615) 847-5741

WANTED: Back for Philco 48-1000 TV, or photo. Pre-1950 televisions and related literature. Richard Anthony, 2551 Andler Rd., Placerville, CA 95667

FOR SALE: A few nice wood table models 1930's. Consoles from 1930s. Battery sets 1920's. SASE for list. Chuck, PO Box 598, New Haven, WV 25265

HAS YOUR SUBSCRIPTION

EXPIRED?

It has if your mailing label reads "OCT87" or earlier. Renew now!

BONUS: Renew before the end of your "EXP" month and receive 13 issues per year instead of 12!

Renewal rates are:
\$18.00 for Second-Class Mailing
\$24.00 for First-Class Mailing
(Two-year renewals are twice above rates.)

WANTED: Cousins of the National AGS receiver, the AGL, AGU, RHP. John Nagle, 12330 Lawyers Rd., Herndon, VA 22071. (703) 620-3066

FOR SALE: Flick of Switch, Vintage Radio, 1927 Radio Encyclopedia, Radio Collectors Guide — \$11.95 postpaid. Bill Rolf, 30131 Center Ridge Rd., Westlake, OH 44145

WANTED: Crosley Pup and Ace. Operating. Julian Young, 11 Willow Court, Totowa, NJ 07512

FOR SALE: Radio News, 1930, 9 issues; 1931, 3. Radio Craft, 1930, 8 issues; 1929-30-31, 1 issue each. Museum mint color. Make offer. SASE for list. K4UJZ, 608 W. Thompson Ln., Murfreesboro, TN 37130. (615) 893-5344

WANTED: Zenith consoles in excellent cabinet and working condition. Chuck Wheeler, 6210 Shull Rd., Huber Heights, OH 45424. (513) 236-4570

FOR SALE: Thomas Edison Model R2, lowboy console - chassis jr., working, good condition — Best Offer. Jack A. Freeman, 1206 Sunnycrest Dr., Reidsville, NC 27320

WANTED: FADA radios or TVs, any color, shape or size. Buy-sell-trade. Jonathan Dunaief, 38 4th Ave., Apt. 2K, Nyack, NY 10960. (914) 353-2769

CLASSIFIED ADVERTISEMENTS

FOR SALE: Philco 91, 20, Jr., AK 90, Echophone and Gloritone cathedrals. Crosley & Majestic grandfather clock radios. Porto-Baradio. Champion sparkplug, FADA #1000 maroon & gold, slight damage. **WANTED:** Dial and clock for Philco grandfather clock radio. Philco 70 chassis. Case for Kodol S-1 xtal set. Joe Szabat, 1417 Vance Ave. Coraopolis, PA 15108. (412) 264-7498

WANTED: Altec Lansing speaker for Scott 800B. Will trade 18" Jensen speaker used by McMurdo Silver. Vernon Oehlke, Box 307, Sollar Hts. Rd. Ghent, NY 12075. (518) 392-4945

FOR SALE: Junking AK 55, Kennedy 32 and Bosch 58. Need parts? SASE for quote. Steve Imms, 691C Maple St., Narragansett, RI 02882. (401) 783-5387

FOR SALE: AK 84 cathedral, doesn't work. Philco 20 cathedral, works. Arborphone 8-tube electrical, made by Consolidated Radio Corp. of Ann Arbor, Mich., works. Philco 38-2670, works fine. SW9003B works fine. G.E. YRB83-1, all wood table model, works. AK 33 w/matching E matching spkr., works. Sonora 5-tube ivory case, works; and Firestone 5-tube ivory case, works. Amplion AR19 spkr. Metal Operadio spkr. AK E-A spkr. Best offer. Paul H. Putnam, P.O. Box 724, Devil's Lake, ND 58301. (701) 662-4473

WANTED: Precision Mod. 912 tube tester inst. Heath Mod. T3 sig. tracer instructions, copies OK. RCA Mod. 125 chassis, and a Crosley Mod. 124 chassis. Also the push-pull input trans. and filter choke for Philco Mod. 20. Jeff Pomakis, 27 Fairview Ave #6, Ipswich, MA 01938. (617) 356-2343

FOR SALE: Please send SASE for list of goodies: chassis, parts, service data, etc. Gilbert Smith, 248 South 36th St., San Diego, CA 92113

WANTED: Eveready Model 20 or 21. Should be complete and in restorable condition. Ed Mondor, 121 Gateway Dr., Greenville, SC. (803) 268-0952

FOR SALE: Tubes: 12SA7GT, 6A8, 50L6 GT, 12SA7, 12SK7. Also G.E. #URC 027, 500M vol. controls — \$1 ea. plus UPS. 10 item min. Jeff Pomakis, 27 Fairview Ave. #6, Ipswich, MA 01938.

WANTED: Doron Bros. Electric Co., Hamilton, Ohio wireless equipment. Any ads, catalogs, etc. Charles J. Stinger, 404 Ross Ave., Hamilton, OH 45013. (513) 867-0079

FOR SALE: Garage full of radios, parts, equipment, tubes, magazines, books, manuals, meters. No list. Call and pick up. Must sell due to illness. Bill Thompson, 1095 NW 147 St., Miami, FL 33168. (305) 685-1993



MICHIGAN - Oct. 11

MICHIGAN ANTIQUE RADIO CLUB FALL MEET

Dearborn - Ford Field
Info: Jim Clark (517) 323-9595

ILLINOIS - Oct. 11

ANTIQUERADIO CLUB OF ILLINOIS ANNUAL MEETING & FLEA MARKET

Elgin - Holiday Inn
Junction Rt. 31 & Tollway
8 a.m. - Flea Market
11 a.m. - Meeting
Info: Jeff Aulik, 803 N. Chicago Ave., Rockford, IL 61107. (815) 399-1902

CALIFORNIA - Oct. 10

CALIFORNIA HISTORICAL RADIO SOCIETY REGIONAL MEET

Redding - 5280 Old Alturas Rd. - 7 a.m.
Swap Meet
Auction
Collection Tour
Info: Paul Bourbin, 25 Greenview Ct. San Francisco, CA 94131

MARYLAND - OCT. 17

MID-ATLANTIC RADIO CLUB MEETING

Laurel, Md. - Applied Physics Lab.
Johns Hopkins Univ. - 7:00 P.M.
Info: Joe Koester, 249 Spring Gap South Laurel, MD 20707. (301) 725-4229

KANSAS - Nov. 1

MID-AMERICA ANTIQUE RADIO CLUB FALL AUCTION

Overland Park - American Legion Hall
7500 West 75th St.
Noon - Check-in
1 p.m. - Auction
Info: Paul Winans, 3915 SW Ward Rd. Lee's Summit, MO 64082. (816) 537-6847

TEXAS - Oct. 17-18

VINTAGE RADIO & PHONOGRAPH SOCIETY and the A.W.A. 1987 ANNUAL CONVENTION

Dallas - Holiday Inn - Southwest
Old Equipment Contest, 18 Categories
Auction, Over 300 Lots
Saturday - Technical Sessions
Saturday Evening - Banquet & Awards
Sunday Morning - Swapfest
Info: Mike Sherman
Box 165345, Irving, TX 75016
(800) 527-9250 (outside Texas)

MINNESOTA - NOV. 7

NORTHLAND ANTIQUE RADIO CLUB ANNUAL BUSINESS MEETING

St. Louis Park - Joe Pavak's Museum
3515 Raleigh, Off 36th Ave.
Info: Greg Farmer - (612) 571-6062
Jim Thompson - (612) 822-4000
NARC, PO Box 18362, Mpls, MN 55418

RADIO CLUB LISTINGS

(ANTIQUERADIO CLUBS: Send club and meet information to A.R.C. for free listing here, as space permits)

Antique Wireless Association (AWA). P.O. Box "E", Breesport, NY 14816. Pub: *The Old Timer's Bulletin*, quarterly. Dues: \$10.00. National and regional conventions. Museum.

Antique Radio Club of America (ARCA). William Denk, 81 Steeplechase Rd., Devon, PA 19333. Pub: *The Antique Radio Gazette*, quarterly. Dues: \$12.00. National and regional conventions. Regional chapters.

Northland Antique Radio Club (NARC). P.O. Box 18362, Minneapolis, MN 55418. Pub: *NARC Newsletter*, six/year. Dues: \$10. About six meets/year.

Mid-America Antique Radio Club (MARC). Paul Winans, 3915 S. Ward Rd., Lee's Summit, MO 64063. Pub: *The Broadcaster*. Dues: \$8.00. Two auctions and additional meets each year.

Mid-Atlantic Antique Radio Club (MAARC). Joe Koester, 249 Spring Gap South, Laurel, MD 20707. Pub: *MAARC Newsletter*, monthly. Dues: \$10.00. Monthly meets.
Please mention A.R.C. when writing clubs.

BUSINESS CARD ADS - \$10.50 FOR 3 MONTHS



TELEPHONE • RADIOS
CLOCKS • DISHS BOUGHT & SOLD

Mary's Handies

ANTIQUES & GIFTS
HANDCRAFTED GIFTS

SO. HANNIBAL, NY 13074
COR. CO. RT 7 & 176

MARJORIE A. HANSEN
TEL. 315-592-2344



Antique Radio Service

REPAIR BUY
RESTORE SELL
Woodwork a Specialty

RICHARD FOSTER
12 SHAWMUT AVE.
COCHITUATE, MA 01778

617-655-2056

ANTIQUE RADIO REPAIR

Repair - Restore - Buy & Sell
Schematic Diagrams \$2.00

DAMASKE ELECTRONICS
S74-W16834 Janesville Road
Muskego, WI 53150
Phone: (414) 679-0838

Antique Radio Collectors



CHRIS & TANYA WARD
626 W. ADAMS ST.
CLINTON, IL 61727
(217) 935-2676

RADIOS & RELATED ITEMS 1920 TO 1940

Victorian Talking Machine, Company
PO Box 983, Pine Bush, NY 12566
MC & VISA (914) 744-3792



100, Steel Needles - \$3.00
5 - 78RPM & Sleeves - \$7.35

Antique Phonographs For Appt. 561-0152
Cylinders, Discs. We Shop Hours
Buy, Sell & Restore Sat & Sun 11-5:00

CHUCKS

Any Antique Tube Radio Chassis
Restored and Guaranteed
\$26.00 Plus Parts
Chuck Antique Radio
P. O. Box 598, New Haven, WV 25265
Phone: (304) 882-2220

WANTED

RADIO - WIRELESS
Pre-1925
ELECTRICITY - TELEGRAPHY
Pre-1900
Books, Magazines, Autographs, Catalogs, Ephemera
One Item or Entire Collection
New Wireless Pioneers
6270 Clinton, Elma, NY 14059 USA
(716) 681-3186

- WANTED - Old Transmitting Tubes

Amateur or Commercial types
FOR MUSEUM

Ye Olde Transmitting Tube Museum
Post Office Box 97
Crescent City, California 95531



Antique Radios



David & Nancy Snow
6024 Leora Ln
Jackson, MI 49201
(517) 750-4992

We Buy, Sell, Repair
Custom Made Battery Eliminators

TUBE AUDIO
AND RADIO
SERVICE
AND PARTS



NED CARLSON
P. O. BOX 148794
CHICAGO, IL 60614

(312) 871-7459

BUSINESS CARD RATES

Run your business card ad or a small display ad here for only \$10.50 for 3 continuous months. Artwork must be camera-ready or a business card. Typesetting is available for \$2.00 extra. Vertical or horizontal formats available.

High Wide
Horiz. 1 5/8" 3 1/2"
Ver. 3 1/4" 1 3/4"



HI-YO SILVER!

COLLECTOR OF
Lone Ranger
MEMORABILIA

KARL L. ROMMEL
737 CLOVERLEAF RD
LANSING, MI 48906
(517) 484-7865



S.F. MUSIC & GAMES
Juke Box, Pin Ball
Video Games and Components
Repair with Care and Knowledge
Also Buy and Sell Machines
2850 - 21st Street (corner Alabama St.)
San Francisco, California 94110
Bus. (415) 282-1155

DANIEL ZAVARO
Tech. in Electronic

SCHEMATICS 1920-1960 RADIO/TV/HAM/MISC.

FULL DESCRIPTION OF SET IN
FIRST LETTER PLEASE - \$3.50 EA.

ALTON H. BOWMAN
RD2 (CHAPIN VLG.)
CANANDAIGUA, NY 14424



WANTED

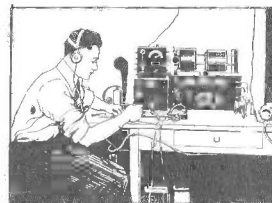
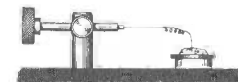

Radio and Wireless items - pre-1925:
Books, Magazines, Catalogs, Receivers,
Transmitters, Speakers, Crystal sets,
Detectors, Tubes, and Spark Gear.

Will buy entire collections! Qualified appraisals anytime, anywhere.
(References provided)

New Wireless Pioneers



Jim Kreuzer, N2GHD, 6270 Clinton St., Elma, NY 14059 (716-681-3186)

rainy day books

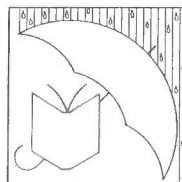

44 Bertwell Road
Lexington, MA 02173
(617) 861-8656

frank bequaert
lucia bequaert

Technical Books Catalogs and Magazines Bought and Sold

Radio - Wireless - Telephone
Television - Broadcasting
Electricity - Electronics
Radar - Electric Power

Repairing 1930's Radios?
We have the books and manuals!

Send SASE with specific interests
for list of items for sale.



WAVES
ANTIQUES
EARLY RADIOS
&
PHONOGRAPHS
78 RECORDS
BOUGHT • SOLD
OPEN 12 - 6
Closed Sun. & Mon.

32 EAST 13TH ST., NEW YORK, N. Y. 10003 212 989-9284

PROPRIETORS Bruce and Charlotte Mager

THIS MONTH'S SPECIALS:

1. Philco 16-B Cathedral, working.....\$225
2. RCA Victor TV Sign, reverse-lit.....145
3. Dictogrand Horn Speaker, black..100
4. AK 10-B Breadboard, black paint..550
5. Precision Ace, 1-tube Radio.....150
6. Crosley Buddy Boy, working.....375
7. RCA Catalin Radio, portable.....195
8. WAVES T-Shirts, yellow/black design..6
9. Atwater Kent Advertising Whistles 10

..SEE NEXT MONTH'S LIST FOR MORE..



1988 Vintage Radio CALENDAR

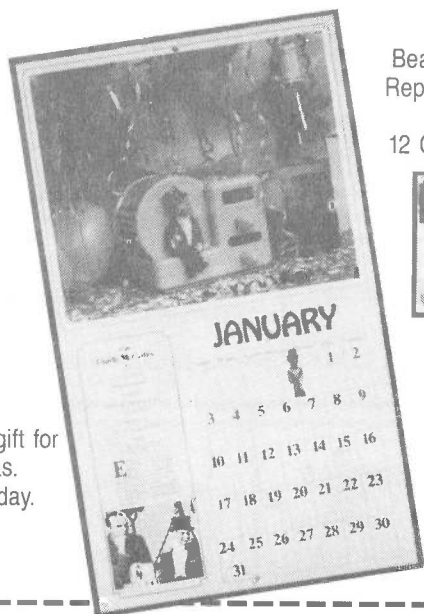

Beautiful full color Reproductions and Biography's of 12 Classic Radios.



A great gift for Christmas. Order today.

EAST OF THE MISSISSIPPI ORDER FROM AFFORDABLE ADVENTURES CALENDARS
P. O. BOX 518 • MENOMONEE FALLS, WI 53051
WEST OF THE MISSISSIPPI ORDER FROM
688 WEST FIRST STREET, TEMPE, ARIZONA 85281

Please send ___ calendars \$7.95 @ + \$2.50 for shipping and handling 40¢ for each additional

Name _____

Address _____

City _____ State _____ Zip _____

Check Money Order VISA MasterCharge

Account Number _____ Exp. Date _____

Allow 4 to 6 weeks for delivery. 5% sales tax for Wisconsin residents only.

FOR A TASTE OF THE GOOD OLD DAYS

THE JUKE BOX

AM/FM Radio with Cassette Player with Colorful Lights

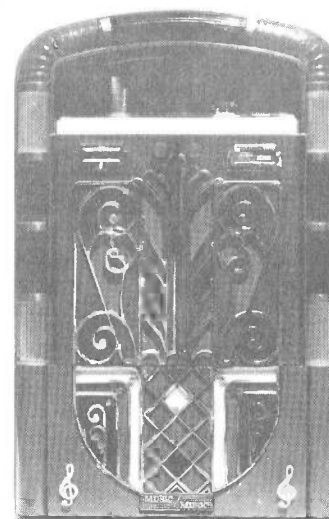

Reproduction juke box measures 11 1/2" H x 7" W x 6 1/4" D.

JUKE BOX AM-FM RADIO AND CASSETTE PLAYER 49.95 + \$5.00 SHPG. AND HNDLG. FREE GIFT OF ONE HOUR MUSIC CASSETTE WITH PURCHASE.

FREE: One Full Hour of the Original Broadcasts from Radio's Golden Age w/purchase.

CATALOG LIST AVAILABLE OF DRAMA, MYSTERY, COMEDY, HISTORY AND MUSIC ON CASSETTES

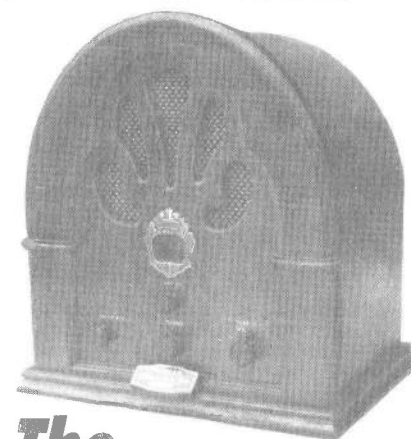

The Best of Radio

Now, it plays AM/FM and cassettes.

The all wood cabinet is of highest quality covered in walnut stained veneer (no plastic). Nostalgic fifty year old styling, but with a modern AM-FM cassette player with a 4" speaker for sound that would make the dog jump over the megaphone! Listen to today's and yesterday's sounds on AM-FM or plug in a cassette by the Count, the Duke or Glenn Miller and take a "sentimental journey" back in time. Reproduction radio measures 12 1/4" H x 11 3/4" W x 7" D; weighs 5 1/4 lbs.

RADIO AM-FM AND CASSETTE PLAYER \$89.95 + \$5.00 SHPG. AND HNDLG. FREE GIFT OF ONE HOUR MUSIC CASSETTE W/PURCHASE.

VISA MasterCard 1-704-692-1916

Return with us now to those thrilling days of Yesteryear, when beer cost a nickel, running boards were "in" and saddleshoes graced the jitterbuggers' feet. You'll laugh, you'll cry, you'll thrill and you'll chill... but most of all, you'll understand what Radio's Golden Age was all about.



N.P. DISTRIBUTORS

P.O. Box 160-ARC
Zirconia, NC 28790



WANTED

ELECTRON TUBES – ST SHAPE

50, ST16, same size as 2A3.....\$16 50, ST19, large size.....\$20

ELECTRON TUBES – ANTIQUE GLOBE SHAPE

37/237.....\$5 42/242.....\$7 45/245/345/445.....\$12
 50/250/350/450.....\$30 56/256.....\$5 80/280/380/480.....\$9
 585.....\$25 843.....\$7 10/210/310/410.....\$11
 UV201, with top tip.....\$12 UV202, with top tip.....\$20 UX 216/216B.....\$7

TRANSMITTING TUBES

211/VT4C.....\$12 845/VT43.....\$22

WESTERN ELECTRIC TUBES

VT1.....\$16	VT2/205 B.....\$30
101D/F/L.....\$6	102D/F.....\$6
104D.....\$8	101/102/104, tennis ball shape.....\$16
D86326/D86327.....\$16	205D/E, tennis ball shape.....\$30
205F.....\$14	211D/E.....\$30
217A.....\$15	242A/B/C.....\$22
247A.....\$6	252A.....\$100
262B.....\$8	271A.....\$20
275A.....\$15	276A.....\$22
300A.....\$100	300B.....\$70
310A, mesh plate.....\$7	339A.....\$12
347A.....\$8	348A.....\$8
350B.....\$24	VT 25/25A.....\$6
	VT52.....\$10

NOTE: All above prices are for "New, in Original Box" tubes. As for "Used" tubes, write for details.

WESTERN ELECTRIC EQUIPMENT – FOR THEATER & STUDIO

Drivers & Horns.....555(W), 594(A), 597A/B, 22A, 24A, 25A etc.
 Speakers.....TA4151, 4153, 4181, 4191, etc.
 Transformers.....171, 197, 618, etc. (List available)
 Cartridges & Arms.....1A, 3A, 4A, 7A, 9A, 10A, etc.

NOTE: We eagerly look for the above W.E. Theater & Studio equipment. We pay much more than any dealers in the U.S.A. Please inform us of their prices or your expected prices. We will never disappoint you.

ALSO BUYING

G.E. Variable Reluctance Cartridges: RPX 040/041/050, VR2, etc.\$20
 Needles for above G.E. Cartridges: for 33/45 RPM \$2 for 78 RPM.....\$4
 Tone Arms: FA 21A (G.E.), 108B/206/208(Gray) & for above cartridge.\$25
 Tube Sockets: UX 4-pin & UY 5-pin, Ceramic/Micanol with mount base type.
 Amphenol, James Millen & etc. We need large quantities.
 Please quote them and ask for details.

TRIAL ELECTRIC PRODUCTS, INC.

409 Yotsuya Sun Heights, 6-1 Yotsuya 4 Chome, Shinjuku, Tokyo 160 Japan

ANTIQUE RADIO CLASSIFIED

CLASSIFIED ADVERTISING POLICY

FREE 20-WORD AD for subscribers in each issue; additional words are 10¢ each. See details below. All classified ads must be received (not just postmarked!) by the ad deadline. Late ads are held for the following issue. Please enclose correct payment with all ads. Stamps or cash are OK for small amounts. (Canadian and other foreign advertisers, please see masthead for payment methods.)

Please write each ad on a separate sheet of paper, especially when included with other A.R.C. correspondence. A 3 x 5 card is suggested if the ad is short. Ads may be sent in advance; again, write each ad on a separate piece of paper and indicate the month you want the ad to run.

Please write legibly. Some numbers and letters can look alike, for example 1, l and I (the number one, the capital i and the small L.) Write the following characters clearly:

1, l and I 0, O, o, Q and D r and n 6, b and G V, U, u, v and Y A and R 5, S and s 2, Z and z

We try to correct spelling errors, so when using an uncommon word or manufacturer which looks similar to a common word or manufacturer, note it so that we do not "correct" it. Editor's comments are in [brackets].

Advertisers, please describe fairly all items, and identify reproductions, reprints and not-original items. Please respond promptly to inquiries and orders, and resolve problems promptly if the buyer is not satisfied.

Publisher reserves the right to edit ads without notification to the advertiser and to reject any ads. Publisher is not responsible for errors due to illegibly written ads or for any other reason; if requested, the ad will be run in the next available issue at no charge for errors made by A.R.C. All ad rates and details are subject to change by the publisher.

CLASSIFIED AD DETAILS

Classified ads must have a standard heading such as **WANTED, FOR SALE, FOR TRADE, FOR SALE/TRADE, SERVICES, HELP**, etc. This heading is the only bold or all-capitalized words allowed in the ad. Capitalize only manufacturer names, model names, etc. Wanted and For Sale ads are mixed together to encourage the reading of all ads, including the Wanted ads. This standard ad format makes scanning the ads easier for readers who are searching only one category.

Before writing your ad, please look over the ads in a recent issue of A.R.C., and try to write your ad in the same style.

To encourage varied content of the ads, multiple insertions of the same classified ad are limited to two successive months. (To run an ad continuously, use a boxed-classified or display ad.)

CLASSIFIED AD COSTS

Subscribers:
 First 20 words: **FREE**. Write SUB# on ad.
 10¢ per word for extra words over 20 plus
 10¢ per word for a shaded ad (count all words including free words.)

Non-Subscribers:
 20¢ per word plus
 10¢ per word for shaded ad.

Please do not forget to send in the extra 10¢ per word when your classified ad runs over the free 20 words; your payment will be appreciated, and it will help to keep A.R.C. healthy.

COUNTING WORDS

The standard headings: **WANTED, FOR SALE**, etc., count as **one word** each time used in an ad.

Name, address and telephone number count as **6 words**, regardless of length. Ham call letters and business name can be included in the 6 words and do not count extra. (Note: "Jim, (111) 111-1111" also counts as 6 words.) So, please include complete name & address in your ads.

After the above "seven" words, **13 words** are left for the rest of the text of a free 20-word ad.

BOXED CLASSIFIED AD DETAILS

Boxed classified ads run unchanged for three months or more. No words are free. Ads may be shaded and may include bold and all-capitalized words freely. The ad need not begin with For Sale, etc. Boxed classified ads are placed with the display ads on the lower portion of the page.

BOXED CLASSIFIED AD COSTS

Minimum run is 3 months, prepaid.
 Nonshaded ads:
 10¢ per word for all words,* none free, plus
 10¢ per word for each bold word plus
 10¢ per word for each all-caps word.

Shaded Ads:
 20¢ per word for all words* plus
 10¢ per word for each all-caps word.
 Note: All words in shaded ads are bold.

Non-Subscribers:
 Add 10¢ per word to above costs.

*Three of the total words can be bold-all-caps at no extra charge.

PHOTO & DRAWING DETAILS

The deadline for ads with drawings or photos is the first of the month.

Although the column on the magazine page you are holding is 2 1/4" wide, the artwork given to the printer has columns 3 9/16" wide. The printing process reduces everything to 63% of the original.

Drawings should fit within the 3 9/16" column. If a drawing is too large or too small, it must be resized photographically for an extra charge. Photos may be of any size since all must be converted to a half-tone for printing; in the process, the photo size can be changed.

PHOTO AND DRAWING COSTS

One-time charge of \$5.00 (no charge for drawing if size is OK) plus
 \$1.00 per 1/2 inch (on artwork) per month.

Drawings also may be requested to be run free and will be printed at the option of A.R.C. and as space permits.