

All-Wave Radio

DECEMBER

1937

25
CENTS



Converting Supers
For Amateur Use

The Home Workshop
What Tools To Use

Wide Range Radio
With Degeneration

Ultra-Short Waves
What To Listen For

OFFICIAL ORGAN RADIO SIGNAL
SURVEY LEAGUE

THE NEW AWR-RSSL

DX Reception Citations

ARE NOW BEING ISSUED!

ESTABLISH PROOF OF YOUR DX ABILITY BEYOND DOUBT IN ANY OR ALL THREE OF THE FOLLOWING BANDS:

SHORT WAVE BROADCAST STANDARD BROADCAST AMATEUR PHONE



OFFICIAL CITATION ISSUED TO S. W. BROADCAST DXERS. (APPROXIMATELY 1/9 ACTUAL SIZE—COLOR BLUE)



OFFICIAL CITATION ISSUED TO BROADCAST BAND DXERS. (APPROXIMATELY 1/9 ACTUAL SIZE—COLOR GREEN)



OFFICIAL CITATION ISSUED TO AMATEUR PHONE DXERS. (APPROXIMATELY 1/9 ACTUAL SIZE—COLOR BROWN)

Listeners, the world over, are now eligible to apply for individual citations, stating definitely their own DEGREE of DXing ability in each specific Band. Based on an entirely new and sound merit rating system, these DX CITATION CERTIFICATES are issued by ALL-WAVE RADIO only after qualifying verifications have been carefully checked and certified to by a judging body, composed of members of the staff of ALL-WAVE RADIO and the directors of the RADIO SIGNAL SURVEY LEAGUE, in accordance with the regulations. CITATIONS start with "FIRST DEGREE" based on the minimum requirements, and advance in ascending order (SECOND DEGREE, etc.) according to the applicant's record of accomplishments! Every DX CITATION CERTIFICATE of ascending degree carries a complete list of previous qualifying verifications in addition to those warranting its own issuance. An individual, duplicate record of verifications is kept on file, at RSSL Headquarters!

Distinctive, Dignified and Authoritative. The certificates, measuring 8½ by 11 inches, are printed on heavy high grade Bond paper with engraved borders and background each of the three being a different color and ready for separate framing. All certificates are mailed flat. DX RECEPTION CITATIONS **CANNOT BE PURCHASED!** CERTIFICATES ARE ISSUED AT NO COST TO THE APPLICANT OTHER THAN A SMALL POSTAGE FEE!

For complete information regarding the new AWR-RSSL Citation Certificates as well as the rules and regulations governing their issuance see page 517 of "October, 1937" ALL-WAVE RADIO or send a self-addressed stamped envelope to:

**CITATION DIVISION:
RADIO SIGNAL SURVEY LEAGUE
16 EAST 43 STREET, NEW YORK, N. Y.**

Make Christmas Last 12 Months!

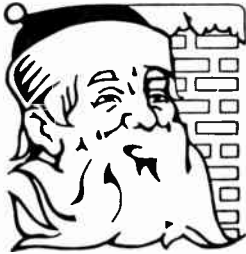

LOTS of folks only think of Christmas once a year. Then they have to push through crowds at stores or bargain counters and wonder what to get. Too often the present finally selected is of no real service or use to the recipient. But this year, you can do at least part of your shopping with a pen or pencil while sitting comfortably in your home. Furthermore, you can give a present that will be appreciated and last right through the year.

GIVE a year's subscription to ALL-WAVE RADIO. It won't be just one present, soon forgotten. It will be twelve monthly presents of one of the best radio magazines published.

If you like A W R, your radio friends will also enjoy receiving it. Each month as the wrapper is unrolled, it will be a new Christmas present from you. If he is already subscribing, extend his subscription for another year.

*In either case, a handsome Christmas card will be sent informing him of the gift and the giver. The January issue will follow, reaching him just before Christmas.



If you are not subscribing at present, why not give yourself a present? Include your own name for a year's subscription. Note the substantial savings by getting two or more subscriptions at this time.

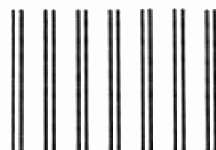

- One 12 month's subscription \$2.50
- Two 12 month subscriptions 4.00
- Three 12 month subscriptions 5.25
- Four 12 month subscriptions 6.50

Don't leave your Christmas shopping until the last minute! Mail today!

ALL-WAVE RADIO • 16 East 43 Street • New York • N. Y.

Enclosed please find \$.....for.....one year subscriptions as listed below—

Name of "Giver" Street
 City State

*(Cards will be sent unless otherwise instructed)

Name
 Street
 City State

Name
 Street
 City State

Name
 Street
 City State

Name
 Street
 City State

All-Wave Radio

COPYRIGHT 1937 BY MANSON PUBLICATIONS CORP.
16 EAST 43RD ST. NEW YORK, N. Y.

EDITED BY M. L. MUHLEMAN

VOL. 3, NO. 12

DECEMBER, 1937

COVER ILLUSTRATION

ACTION ON THE AIR WITH ONE OF THE LATEST WESTERN ELECTRIC 22A ULTRA-HIGH-FREQUENCY POLICE RADIO TRANSMITTERS. (PHOTO COURTESY WESTERN ELECTRIC CO.)

CONTENTS

CONVERTING B.C. SUPERHETERODYNES FOR HAM COMMUNICATIONS SERVICE	By R. M. Ellis, W9YSA	620
TOOLS FOR THE HOME WORKSHOP	By Willard Bohlen and Chester Watzel	624
IT GOES OUT ... THERE!	By W. E. McNatt, W7GEZ	626
ULTRA-HIGH	By Perry Ferrell, Jr.	628
GLOBE GIRDLING	By J. B. L. Hinds	630
CHANNEL ECHOES	By Zeh Bouck	635
NIGHT-OWL HOOTS	By Ray La Rocque	636
BROADCAST DX FORECAST	By Ray La Rocque	638
HAMFEST	By W8QMR	639
THE MB-100 C.W. KIT TRANSMITTER ...	A Proving Post Review	640
RADIO SIGNAL SURVEY LEAGUE NEWS		642
NOTES ON THE WIDE-RANGE SYSTEM		643
THE NEW SILVER MASTERPIECE VI	A Proving Post Review	644
QUERIES		647
U. S. BROADCAST STATION LIST		648
SHORT-WAVE BROADCAST STATION LIST		651
BACKWASH		656
ON THE MARKET		658
INDEX TO ADVERTISERS		672

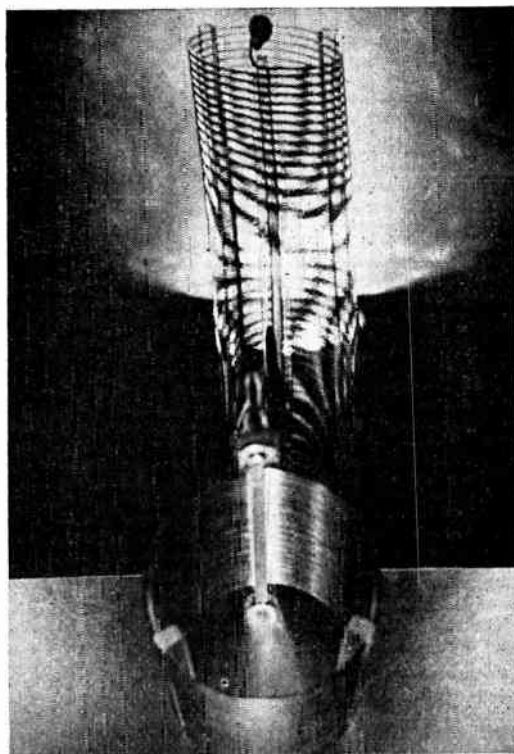

OSCILLATION A PHOTOGRAPHIC CONCEPTION OF A COIL IN AN OSCILLATING CIRCUIT, TAKEN BY KENNETH BOHLEN. THE "SHOT" IS OF A PARTIALLY COMPLETED AMATEUR TRANSMITTER AND WAS MADE UNDER ORDINARY CONDITIONS CAN YOU FIGURE HOW THE EFFECT WAS OBTAINED?

PUBLISHED MONTHLY by the Manson Publications Corporation, 16 East 43rd Street, New York, N. Y. Entered as second-class matter August 27, 1935, at the Post Office, New York, New York, under the Act of March 3, 1879. Additional entry as second-class matter, at East Stroudsburg, Pa., August 27, 1936. M. L. Muhleman, President and Secretary; Edwin W. Lederman, Vice President and Treasurer.

SUBSCRIPTIONS: Yearly subscription rate: \$2.50 in the United States and Canada; \$3.00 in foreign countries. Single copy price, 25 cents. Four weeks' notice is required for a change of address. In requesting a change, kindly give both the new and the old address.

NEWSSTAND COPIES: ALL-WAVE RADIO is distributed by the American News Company who make every effort to supply copies at all points where there is a demand. If you have had difficulty in obtaining ALL-WAVE RADIO where you reside, communicate with our Circulation Department who will see to it that your local newsstand is supplied with copies.

MANUSCRIPTS: All manuscripts, except those definitely contracted for, are submitted at the author's risk and cannot be returned unless accompanied by sufficient postage. However, the editors are always on the lookout for new material, and readers are invited to submit manuscripts for consideration. Notification of the acceptance or rejection of a manuscript is given within three weeks after receipt.

ADVERTISING OFFICES: Eastern Advertising Manager, Sanford L. Cahn, ALL-WAVE RADIO, 16 East 43rd Street, New York, N. Y. Telephone; MUrray Hill 2-8761. Midwestern Advertising Manager, Charles O. Stimpson, ALL-WAVE RADIO, 608 South Dearborn Street, Chicago, Ill. Telephone: WABash 1903.

OFFICIAL ORGAN OF THE RADIO SIGNAL SURVEY LEAGUE

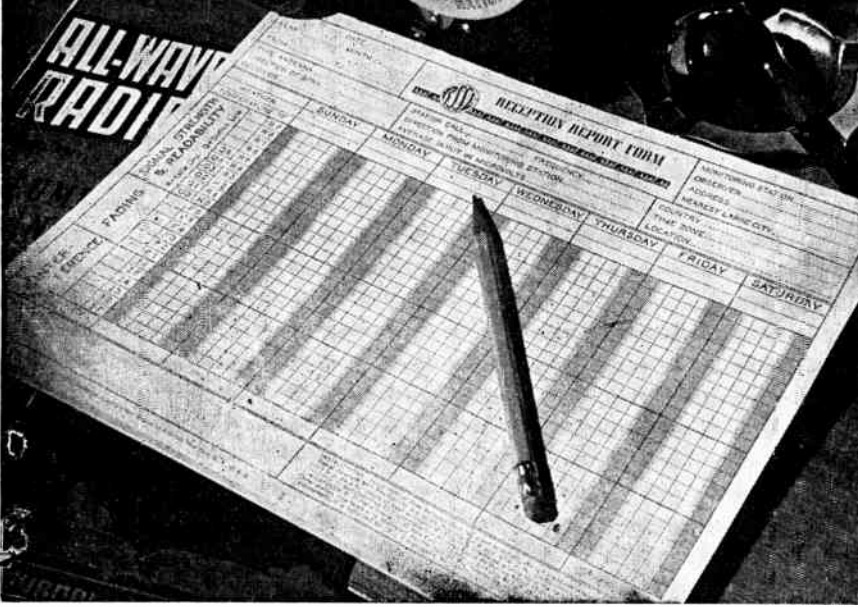

100 BLANKS TO EACH PAD

FOR THE

R.S.S.L.

MEMBER

• **REPORT FORM BLANKS** •

New in principle, these Report Form blanks have been specially designed for the recording of information essential in carrying on the work of the R.S.S.L. Printed in green ink on white bond paper, 8½x11, records can be made in either pencil or ink—each sheet covering a full week's report.

\$1.00 Per Pad • Postpaid

ARE YOU ELIGIBLE FOR MEMBERSHIP IN THE RADIO SIGNAL SURVEY LEAGUE?

There is only one requisite for Membership, namely: That you be sincere in your desire and efforts to assist the league in fulfilling its public service of "improving domestic and international radio transmission and reception conditions." Here is an opportunity to help make radio history and at the same time do a real public service.

JOIN THE R.S.S.L. TODAY! NO FEE! A POST CARD WILL FETCH YOUR APPLICATION BLANK.



• **QSL CARDS** •

No QSL Cards have, as yet, been prepared. In order that members may retain the individuality of their QSL Cards and at the same time indicate their association with the R.S.S.L., a Matrix ("Mat") has been prepared from which a metal cast can be readily made of the R.S.S.L. emblem at low cost. "Mats" can be had for either "Negative" (above) or "Positive" (right) type emblem. They are practically indestructible and are familiar to almost all printers. Be sure to specify "negative" or "positive." Above illustrations are actual size!

"MATS" 25c Each Postpaid

METALETTE R.S.S.L. SEALS

Are gummed on one side. Blue embossed on Silver. Same size as above illustration. They have the handsome appearance of real metal. Can be used on stationery, letterheads, QSL cards, etc.

25 Seals 15c • Postpaid

IMPORTANT: Above supplies may be purchased by R.S.S.L. members **ONLY!** Be sure to give your Monitoring Station number with order. No orders sent C.O.D. Be sure to enclose check, stamps or M.O. with order and send to:

RADIO SIGNAL SURVEY LEAGUE
16 East 43 Street, New York, N. Y.

MEMBER STATIONERY



Every member will be proud to use this handsome R.S.S.L. Members' Stationery for his radio correspondence. Printed in blue ink on 8½ x 11 white bond paper, it bears the Radio Signal Survey League's official emblem.

Note: Those who prefer to design their own stationery or who would like to add the R.S.S.L. emblem to stationery they already have can secure "Mats" (Matrices) of the above two illustrations (actual size). For details see section headed "QSL CARDS."

100 Sheets 50c

• 250 Sheets \$1.00

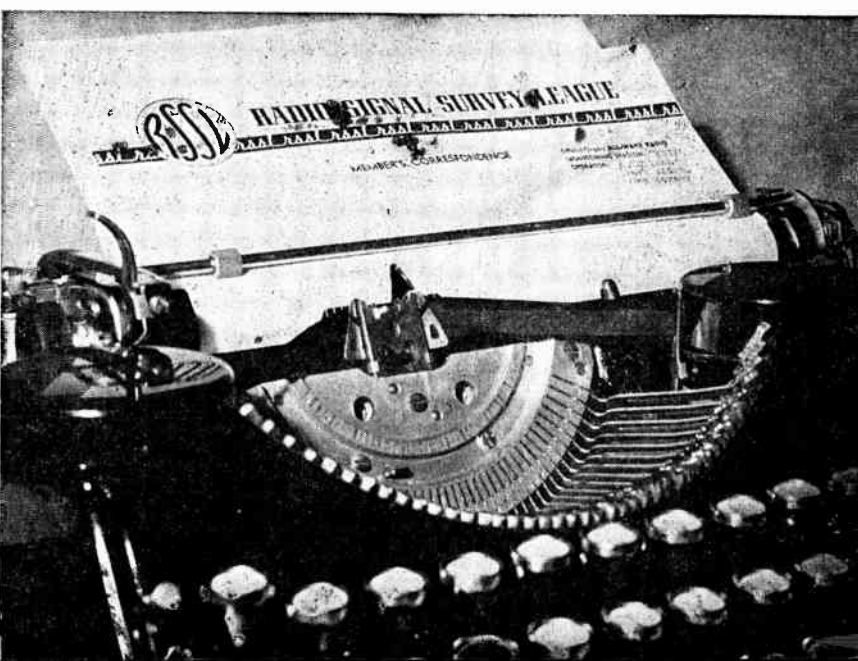

CONVERTING B. C. SUPERHETERODYNES

By R. M. ELLIS • W9YSA

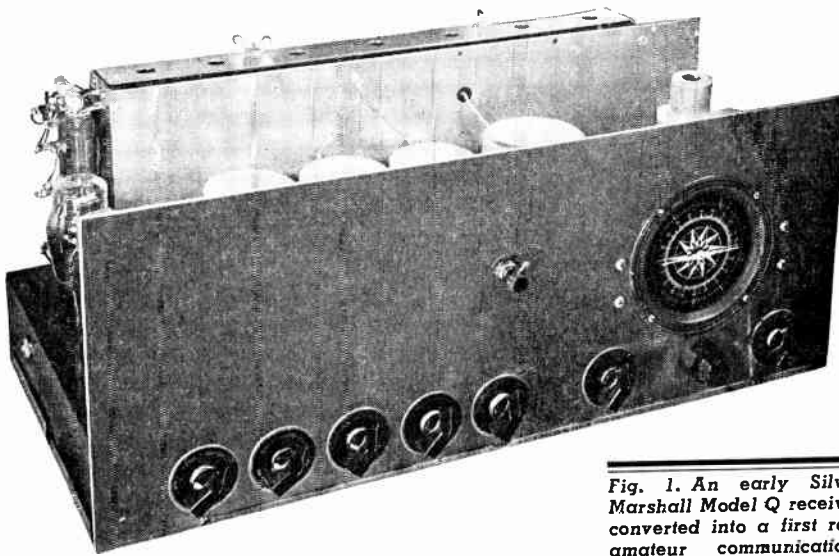

Fig. 1. An early Silver Marshall Model Q receiver converted into a first rate amateur communications job. Note modern dial and bank of controls.

Of course it is nice to build a new receiver from "scratch." It is grand to be able to select each component, then to plan the physical layout so that the best results will be secured.

But unfortunately the financial aspect of the constructor enters into the situation. Most amateurs are long on ideas and short on cash. One solution to the difficulty is to convert a broadcast superheterodyne for short-wave work. The older types of superheterodynes can be purchased for almost a song and have very acceptable components in the way of the power transformer, i. e. transformers, choke, heavy chassis, etc. Many amateurs and SWL's will have such a receiver on hand.

Consequently this article will treat the problem of converting broadcast receivers for communication work and will start with the assumption that such a receiver is available.

The Victim

Figs. 1, 2 and 3 show a converted Silver Marshall Model Q, the receiver on which is based the constructional data given herein. The choice of this particular set was dictated by the fact that it was in the writer's possession—any other receiver would probably have been just as satisfactory.

Fig. 4 shows the circuit employed. No claim is made for the originality of any part of the circuit. On the contrary it is the result of a very careful survey that was made of a large number of commercial and home-built superheterodynes. Amateur handbooks were consulted and radio magazines were reviewed. Acknowledgment, too, must be given

the engineering departments of Sylvania and Kenrad for their co-operation in supplying special data and graphs on suppressor-grid modulation.

It will be noticed that the receiver described in this article makes use of the older type glass tubes, rather than the newer types of octal based glass or metal tubes. This fact should not in any way be considered as a condemnation of the newer types of tubes. This is a receiver conversion, and for obvious reasons it was desired to use tube types which duplicated the original tube complement as closely as possible. In building a brand new receiver we would suggest the use of the now standard octal base types.

The performance of the finished receiver was very satisfactory in every respect. It is hoped that the data given in this article will be of practical assistance to amateurs and SWL's who are contemplating the construction or conversion of a receiver by eliminating the necessity of wading through reams of sometimes conflicting data on the subject.

The practical problems to be solved in making conversions are—

1. Tuning method for ample band-spread.
2. Pre-selection or image suppression.
3. Addition of b.f.o. (beat-frequency oscillator)
4. Noise suppression.
5. Voltage distribution and filtering.
6. Voltage stabilization to prevent oscillator drift.

Input Circuit Considerations

In effecting the conversion of a broadcast superheterodyne one of the first things to be decided is the type of input

circuit to be used. Where there are no restrictions as to cost or space it is desirable that one or two r.f. stages precede the first detector to suppress images and lower hiss level. However, such construction makes plug-in coils somewhat impractical. With two r.f. stages a total of 20 plug-in coils would be required to cover the five principal amateur bands—a drawer full indeed!

However, by applying regeneration to the first detector the gain and selectivity of the detector stage can be increased tremendously, so that satisfactory performance can be obtained without the use of additional tuned circuits. Furthermore, this improvement is greatest at the higher frequencies where turned r.f. stages lose much of their selectivity and amplification. The price paid for this simplification of construction is the addition of one comparatively non-critical regeneration control, the screen-grid potentiometer P5.

Selection of 1st Detector Tube

The selection of the proper first detector tube was a matter of concern since in addition to providing satisfactory gain, the detector should respond smoothly to feed-back and should approach the oscillation point without having any tendency to spill over or become unstable. Low input and output capacity is desirable, particularly at the higher frequencies. Also the construction of the tube should be such as to provide for convenient injection of oscillator voltage without introducing capacity coupling to the control grid. Capacity or inductive coupling between the oscillator and detector circuits must be avoided, otherwise an annoying interlocking effect of the tuning controls will occur at the higher frequencies. A type 57 tube with a form-fitting shield was finally selected as being the most satisfactory. If your receiver employs 6.3-volt tubes a 6C6 will give exactly equivalent results. Oscillator injection is through the suppressor grid and is accomplished simply by connecting the grid of the oscillator to the suppressor. According to tube data, maximum suppressor transconductance occurs when the suppressor is approximately 30 volts negative. In this circuit the suppressor grid is biased mainly by the grid current of the oscillator tube, and partially by the grid bias resistor, R1, in the detector cathode circuit.

Control of detector regeneration is accomplished by means of the 50,000-

FOR HAM COMMUNICATIONS SERVICE

ohm linear taper control, P5, which varies the screen voltage of the detector tube. The cathode tap of the detector coil should be placed so that oscillation occurs with 65 to 90 volts on the screen. If oscillation occurs at a lower voltage the full gain of the first detector will not be realized. The oscillation point of the first detector also depends on the setting of the antenna coupling condenser. This condenser should be set for as little capacity as possible consistent with satisfactory gain.

In service, the screen voltage should be adjusted so that the first detector operates near the point of oscillation in order that maximum pre-selection will be obtained. Receiver volume should be adjusted by means of the sensitivity or audio gain control. The first detector should never be allowed to actually oscillate.

Band-Spread Requirements

For c. w. work on the crowded 40-meter band it might be said that it is almost impossible to have too much band-spread. Many amateurs use X- or Y-cut crystals that are heavily loaded and the frequency creep in the received signal sometimes calls for rather constant retuning. When QRM is bad, and you are copying an S5 signal against S9 interference it is easy to tune past the desired signal and lose it for a moment or two or perhaps for good. To overcome this it is desirable to build sufficient electrical band-spread in the tuning unit to give as great as possible rotation of the condenser plates in covering the amateur bands and then to supplement this with a two-speed dial which will give further mechanical reduction.

Electrical Band-Spread

There are a number of ways of achieving electrical band-spread, such as the use of tapped coils, series condensers, etc. The method adopted for the conversion was to use a low capacity two-gang tuning condenser (30 mmfd. maximum capacity) shunted by two 100 mmfd. midget condensers — these being provided with knobs so that adjustment can be made from the front of the panel. The degree of band-spread is regulated by the proportion of shunt fixed pad capacity to the capacity of the tuning condenser. Table I gives suggested coil specifications. If more band-spread is desired, simply reduce the number of turns so that more padding capacity is required. If less band-

spread is desired increase the number of coil turns.

In operation the oscillator pad condenser is set so that the center of the amateur band tunes at one-half rotation of the two-gang tuning condenser. Then the antenna pad condenser is tuned to resonance. Except when tuning the lower frequency bands, very little readjustment will be required of the antenna pad condenser. On the 160-meter band a slight amount of adjustment of the antenna pad may be required when tuning from one extreme of the band to the other. It is suggested that the dial settings of the pads be marked on the respective coil forms so that the receiver can be instantly adjusted to any amateur band.

Mechanical Band-Spread

Since the receiver we are describing was to be used principally on the crowded 40-meter band we desired to add as much mechanical band-spread as practical. To this end we selected a Crowe 401 Micromaster Dial. This dial has a two-ratio drive with a fast ratio of 18-to-1 and a slow-speed ratio of 100-to-1 in 360 degrees. The dial also is provided with two pointers which permits the close logging of stations, es-

pecially desirable for round-table QSO's, or for keeping schedules.

lem in communication receiver design. Unless special care is used in the design of the high-frequency oscillator, fading and detuning of signals will result from frequency change in the oscillator arising from variations in the plate supply voltage.

Another effect which may be noted in some receivers results from common coupling between the power tube and the high-frequency oscillator; plate voltage varying in step with the audio signal causes oscillator variation so that a received c.w. signal rises and falls in pitch like the signal from a poorly adjusted self-excited transmitter.

There are two ways of meeting these difficulties. It is possible to use a screen-grid tube for the oscillator and balance the components so that a certain compensation occurs. When used as an oscillator, changes in plate and screen voltage have a tendency to affect the frequency in any opposite manner.

However, the writer has desired to eliminate the trouble by going to its source and providing a simple neon tube regulator which will hold the oscillator voltage substantially constant regardless of fluctuations in the supply. An 874 voltage regulator tube is ideal, but rather expensive. Satisfactory results

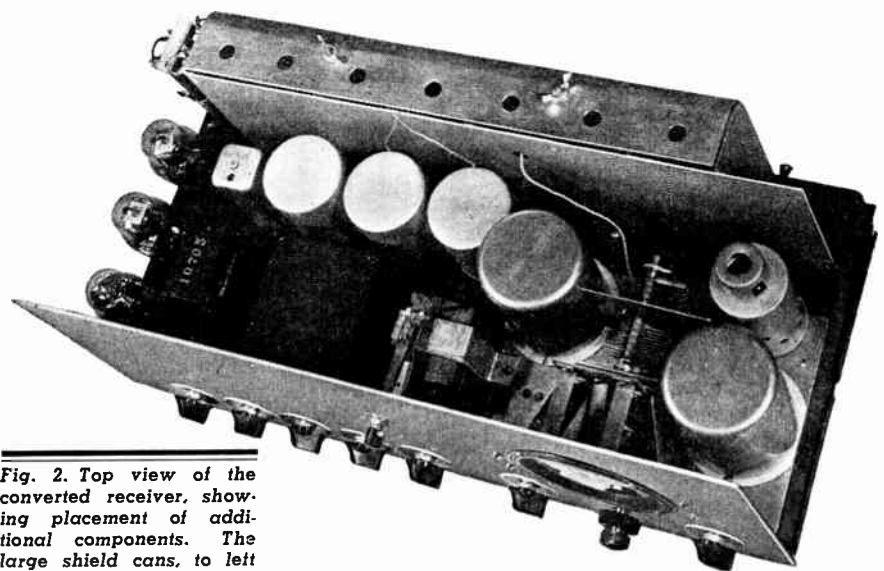

Fig. 2. Top view of the converted receiver, showing placement of additional components. The large shield cans, to left and right of gang condenser, house the r.f. coils.

High Frequency Oscillator Considerations

The present wide-spread use of electrical refrigeration and other devices which place an intermittent load on the lighting circuit has created a real prob-

lem in communication receiver design. Unless special care is used in the design of the high-frequency oscillator, fading and detuning of signals will result from frequency change in the oscillator arising from variations in the plate supply voltage.

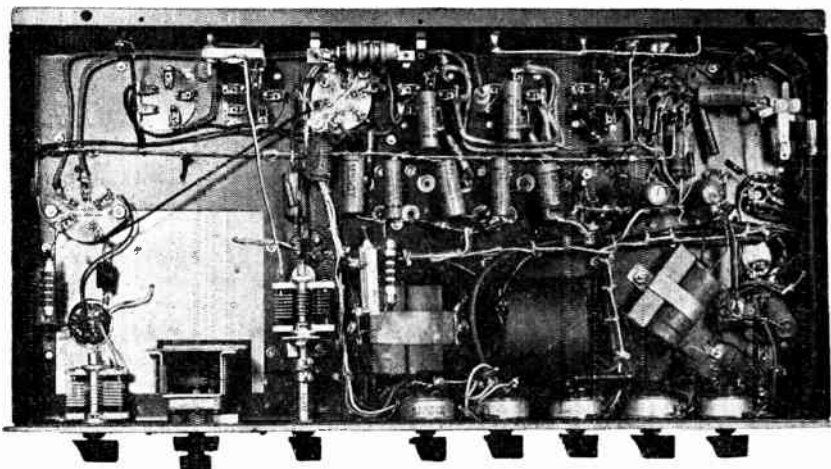

Fig. 3. Under-chassis view of the converted receiver. This clearly shows the location of each control, and such components as are mounted below deck.

a substantially constant 140-volt source of potential for the high-frequency oscillator.

Preparing the Neon Lamps

To use common neon lamps for voltage-regulating purposes it is necessary that the limiting resistors be removed from the base. This can easily be accomplished by the following procedure:

First unsolder the lead in the center of the base bottom so that this wire is free. It is not necessary to unsolder the wire attached to the top of the screw base. Then hold the metal shell of the lamp in boiling water for a few minutes. This will soften the cement so that a firm steady pull will separate the brass shell from the glass bulb. Do not twist the shell—to do so may break the glass seal and spoil the lamp. The limiting resistor will be found attached to the short lead wire at the base of the bulb. Remove this resistor, solder extensions on the lamp leads, then remount the lamp either in the old brass base or in the base from a discarded radio tube; the latter mounting being preferred so that standard radio tube sockets can be used throughout the receiver.

Standard 2 or 3 watt, 115-volt neon lamps, with pear-shaped bulb and semi-circular electrodes are to be preferred for the service. Since in the circuit shown, the neon lamps are operated at about half the rated wattage, long life should be secured.

The voltage drop across the lamp will remain at approximately 70 volts regardless of wide fluctuations of line voltage.

Stabilized voltage for the high-frequency oscillator is taken from the junction of the 10,000-ohm dropping resistor, R4, and the two neon lamps. The value of this resistor should be adjusted so that the neon lamps do not cease to glow with any adjustment of the receiver. About 10 milliamperes

bleed through the lamps under conditions of normal line voltage will be satisfactory.

If the constructor does not wish to employ the neon lamp stabilizing scheme, oscillator voltage can be obtained directly from a tap on the voltage divider—though it is recommended that the lamps be used since the improvement in receiver performance is decidedly noticeable.

Controls

The first control of the receiver is the tone control located at the left-hand side of the chassis. This control is of the conventional type consisting of a 50,000-ohm right-hand taper potentiometer, P1, and a .05 mfd., 600-volt condenser, C23, connected between the power tube plates and the chassis. If a single power tube is used the tone control condenser may have a capacity of .03 mfd. Since the Yaxley K12 used is a left-hand tapered control, the center and left-hand terminals (when the control is viewed from the shaft end with terminals down) are used, and maximum bass will be with the control knob turned to the extreme left-hand position. The tone control also carries the off-on switch for the entire receiver.

The second control is the volume or audio gain control, P2, which functions as a potentiometer to vary the output of the diode second detector. This circuit is familiar to every radio amateur and experimenter so that it will suffice to say that a 500,000-ohm left-hand taper potentiometer works very satisfactorily in this application.

The third control, P3, is the manual squelch or Class C audio control which functions to vary the bias on the first audio stage. A more complete description of the functions of this control is given elsewhere in this article. The control itself is a 50,000 ohm linear control. On the back of the control is an off-on switch which controls the beat-frequency

COIL SPECIFICATIONS

160-METER BAND COILS (1½" diameter forms)

Antenna Coil

L1—1⅜" winding of No. 27 single cotton enamel wire, close wound, tapped at 1¼ turns.

Oscillator Coil

L2—1" winding of No. 27 single cotton enamel wire, close wound
L3—14 turns No. 27 single cotton enamel wire.

80-METER BAND COILS (1½" diameter forms)

Antenna Coil

L1—30 turns No. 22 enamel wire, space wound to cover 1¼", tapped at 1¼ turns

Oscillator Coil

L1—25 turns No. 22 enamel wire, space wound to cover 1"
L3—9 turns No. 27 single cotton enamel wire

40-METER BAND COILS (1½" diameter forms)

Antenna Coil

L1—12 turns No. 18 enamel wire, space wound to cover 1⅜", tapped at 1 turn

Oscillator Coil

L2—11 turns No. 18 enamel wire, space wound to cover 1⅜"
L3—6 turns No. 22 enamel wire

20-METER BAND COILS (1½" diameter forms)

Antenna Coil

L1—12 turns No. 18 enamel wire, space wound to cover ¾", tapped at ¾ turn

Oscillator Coil

L2—5 turns No. 18 enamel wire, space wound to cover ¾"
L3—3 turns No. 22 enamel wire

20-METER BAND COILS (1" diameter forms)

Antenna Coil

L1—8 turns No. 18 enamel wire, spaced the diameter of the wire, tapped at ½ turn

Oscillator Coil

L2—7 turns No. 18 enamel wire, spaced the diameter of the wire
L3—3¼ turns No. 27 cotton enamel wire

10-METER BAND COILS (1" diameter forms)

Antenna Coil

L1—4 turns No. 18 enamel wire, spaced the diameter of the wire, tapped at ⅓ turn

Oscillator Coil

L2—3½ turns No. 18 enamel wire, spaced the diameter of the wire
L3—1¾ turns No. 27 cotton enamel wire

Note: Inductances are mounted in National B30 coil shields with the socket flush with the base.

Top of L2 is the ground end—bottom is the grid end.

L3. On all coils close wound, and spaced ⅛" from ground end of L2.

oscillator. Combining these controls is satisfactory since neither the manual squelch nor the beat-frequency oscillator will be used for phone reception.

The fourth control, P4, is the sensitivity control which regulates the gain of the i. f. stages, and functions by varying the control-grid bias. This control is ordinarily used only for c. w. reception—for phone reception the knob is turned to the extreme left so that the single pole, double throw switch, SW3, connects the grid returns to the diode detector so that complete a. v. c. action is secured. A 50,000-ohm linear control is used in this position.

It was found necessary in the laboratory model to use shielded wire for the a. v. c. lead between the switch, SW3, and the diode detector. Without this a slight hum was experienced, probably caused by the electrostatic pick up on the a.v.c. lead which parallels the filament and B plus leads.

The fifth control, SW4, is the standby switch which simply breaks the B plus voltage to the screens of the i. f. tubes so that the receiver will be inoperative during transmission. The sixth control, P5, is the first detector regeneration control and functions by varying the screen voltage on the first detector.

Again a 50,000-ohm linear control is used for the application. The remaining controls are for tuning the receiver.

While at first glance it may seem that there is an alarming number of controls to this receiver, analysis will show that each control has a special function and in actual use the operation of the receiver is very simple indeed.

Manual Squelch

A valuable feature which can be added to any receiver is a manual squelch, or as sometimes called "Class C" audio. This is a variable bias control for the

(Continued on page 657)

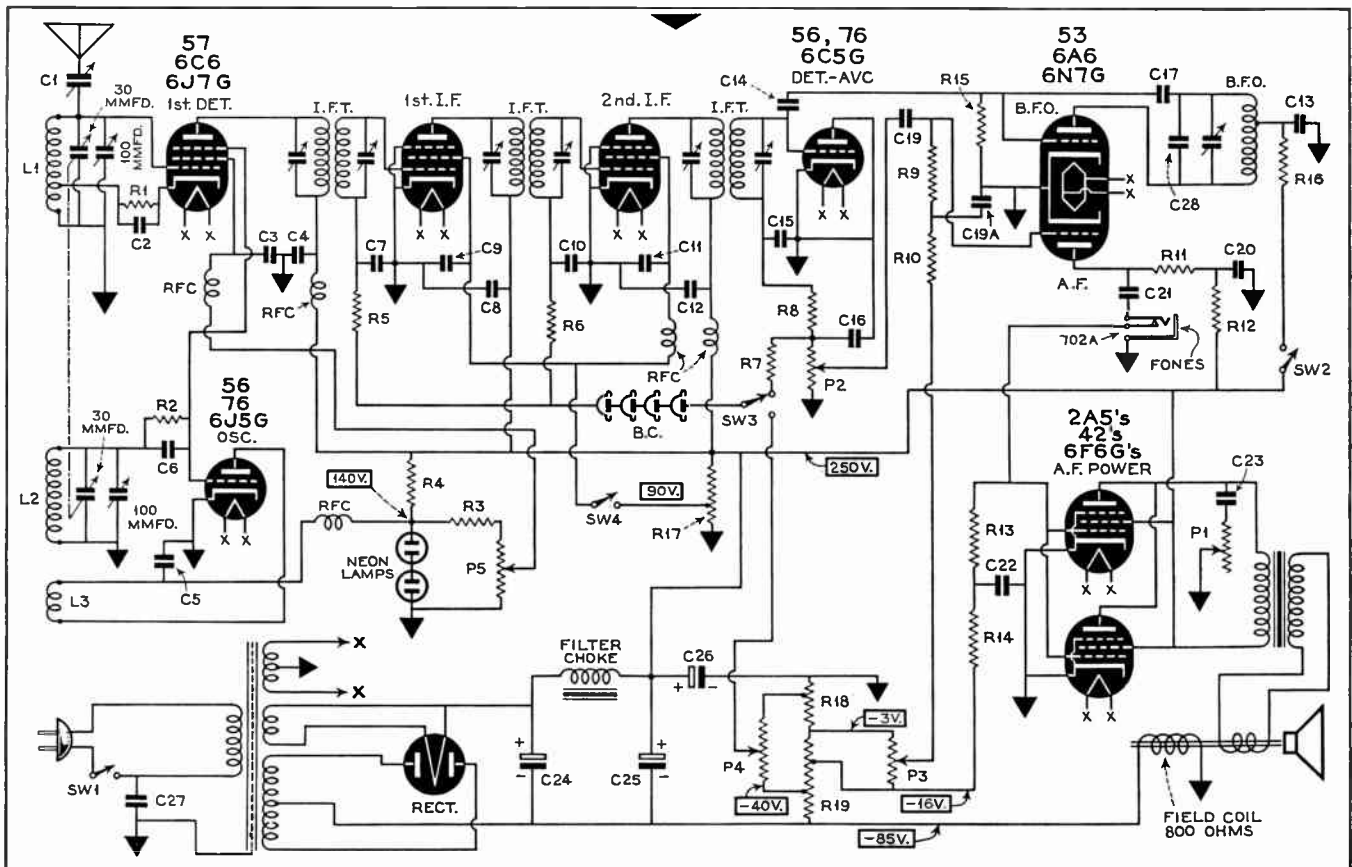

Fig. 4. Schematic diagram of the converted receiver. Values are given below. Note the bank of four grid-bias cells, "B.C."

CONDENSERS

C1	—5-35 mmfd. mica trimmer
C2	—Mallory TP436 .05 mfd. 200 volts
C3	—Mallory TP438 .1 mfd. 200 volts
C4	—Mallory TP428 .1 mfd. 400 volts
C5	—Mallory TP426 .05 mfd. 400 volts
C6	—Fixed mica .0001 mfd.
C7	—Mallory TP436 .05 mfd. 200 volts
C8	—Mallory TP428 .1 mfd. 400 volts
C9	—Mallory TP438 .1 mfd. 200 volts
C10	—Mallory TP436 .05 mfd. 200 volts
C11	—Mallory TP438 .1 mfd. 200 volts
C12	—Mallory TP428 .1 mfd. 400 volts
C13	—Mallory TP428 .1 mfd. 400 volts
C14	—Gimmick—see text
C15	—.0005 mfd. mica
C16	—.0001 mfd. mica
C17	—.0001 mfd. mica
C18	—Mallory TP440 .25 mfd. 200 volts
C19	—Mallory TP426 .05 mfd. 400 volts
C19A	—Mallory TP428 .1 mfd. 400 volts
C20	—Mallory CS131 .4 mfd. 450 volts
C21	—Mallory TP428 .1 mfd. 400 volts
C22	—Mallory TP441 .5 mfd. 200 volts
C23	—Mallory TP415 .05 mfd. 600 volts
	(or TP413 for single tube)
C24	—Mallory CS136 16 mfd. 450 volts
C25	—Mallory CS136 16 mfd. 450 volts
C26	—Mallory CS136 16 mfd. 450 volts
C27	—Mallory TP428 .1 mfd. 400 volts
C28	—.0001 mica

TUNING CONDENSERS

Band Setting—2 Hammarlund MC-100-S
100 mmfd. midjet variable condensers
Band Spread—Hammarlund MC-D-35-MX dual
30 mmfd. midjet variable condenser

A.V.C. BIAS

B.C.—4 Mallory Grid Bias Cells

RESISTORS

R1	— 1,500 ohms	1/2 watt
R2	— 50,000 ohms	1/2 watt
R3	— 25,000 ohms	1 watt
R4	—Mallory Truvolt Type A-100, 10,000 ohms	
R5	—100,000 ohms	1/2 watt
R6	—100,000 ohms	1/2 watt
R7	— 1 megohm	1/2 watt
R8	— 50,000 ohms	1/2 watt
R9	— 1 megohm	1/2 watt
R10	— 1/2 megohm	1/2 watt
R11	— 50,000 ohms	1 watt
R12	— 10,000 ohms	1 watt
R13	—100,000 ohms	1/2 watt
R14	— 50,000 ohms	1/2 watt
R15	— 50,000 ohms	1/2 watt
R16	— 10,000 ohms	1 watt
R17	—Mallory Variohm 5 AV 30,000 ohms	

R18—Mallory Truvolt Type A-1 1,000 ohms
R19—Mallory Variohm 5 AV 10,000 ohms

Note: 1/2 watt and 1 watt resistors are IRC Insulated Resistors, Types BT-1/2 and BT-1.

CONTROLS

Tone and On-Off Switch
P1 —Yaxley K12 50,000 ohms
SW1—Yaxley No. 6-9 Switch

Volume
P2 —Yaxley N 500,000 ohms

Manual Squelch and B.F.O. Switch
P3 —Yaxley Y5OMP 50,000 ohms
SW2—Yaxley No. 6-9 Switch

Sensitivity and A.V.C. Switch
P4 —Yaxley Y5OMP 50,000 ohms
SW3—Yaxley No. 8 Switch

Standby Switch
SW4—Yaxley 20

Detector Regeneration
P5 —Yaxley Y5OMP 50,000 ohms

Beat-Frequency Oscillator
Hammarlund STB-465

Two-Speed Vernier Dial
Crowe Name Plate No. 401 Micromaster

TOOLS

For The

HOME WORKSHOP

By WILLARD BOHLEN and
CHESTER WATZEL

THE construction of present-day radio equipment is largely a matter of metal working. In view of this, many constructors of limited experience seem at a loss in choosing the proper tools. Some seem to believe that power tools are necessary in order to do a satisfactory job. This, fortunately, is not the case. Metal panels and chasses may be worked easily and neatly with an inexpensive set of hand tools. We are presenting here photos and notes on a set of tools which is adequate to construct any equipment appearing in ALL-WAVE RADIO; they are, in fact, the actual tools used in the AWR laboratory.

Layout Tools

The following tools are used in layout work:—

Steel Rule: A wooden rule should never be used due to its inaccuracy. A six-inch steel rule is used here. A longer 12-inch rule would be very useful. For a 12-inch rule we use the rule out of the—

Square: This has a removable 12-inch steel rule. The square is indispensable in laying out metal chasses and panels. A small scriber, removable, is a part of the square. This is necessary for marking painted work, where a pencil line would not show. If no scriber comes with the square, or it becomes lost, as in our case, it is permissible to substitute a—

Compass: The sharp point of the compass is excellent for scribing. The main use of the compass, however, is for scribing circles on material where a pencil line will show. For scribing circles on painted material it is necessary to use a pair of—

PART I

Dividers: These are also useful for measuring the distance between two points when a ruler will not fit into the layout. The divider is laid on a ruler to determine the measurement.

Center Punch: After the work is laid out a center punch is used to make a small depression in the metal so as to accurately start the drills. It is almost unnecessary to state that, to make said depression, the punch must be "socked" with a—

Hammer: The use of this article is hardly necessary to describe; even the cavemen had 'em. So we go into the next class of tools which are used for—

Drilling

Hand Drill: The hand drill is used for all size drills up to about a quarter inch, depending on the particular one used. The most useful sizes of drills are as follows:

1/16"—Used for drilling wire holes in coil forms. Also very useful for starting holes in metal after they have been center punched. Starting a hole with a large drill often throws the hole off center.

5/32"—This size drills holes that will clear 6/32 bolts.

3/16"—This size drills holes that will clear 8/32 bolts.

7/32"—This size drills holes that will clear 10/32 bolts.

1/4"—This size makes the right size hole for mounting the insulating washers

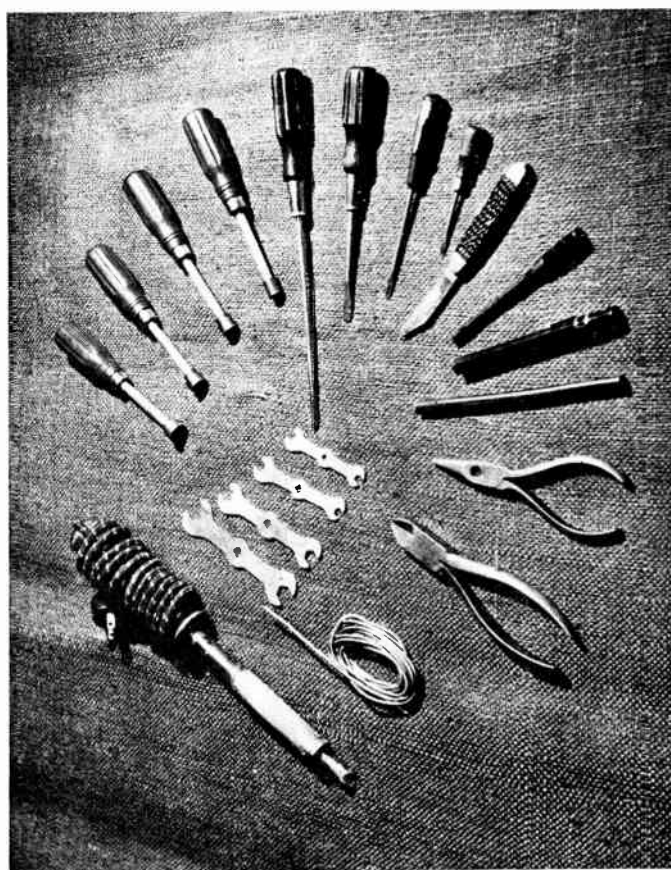

The beginning of an ideal home workshop—“spintite” wrenches, screw drivers, a knife, “neutralizing” tools, a “Magic Wand”, short-nose and diagonal pliers, open-end wrenches, solder, and a soldering iron.

of binding posts. This size hole will also do as a “bushing” in panels to pass 1/4” shafts.

Carpenter’s Brace: This tool may seem to be out of place in metal working but is actually very useful. It takes the larger size of drills, as well as other large tools such as the reamers, countersinks and circle cutters. The slow speed of the brace is of distinct advantage in handling these larger drills and tools. In order to prevent slippage the tools to go into the brace should be of the square shank type. Drill sizes useful with the brace are as follows:

3/8"—This is a much-used size. Most all of the single-hole mounting types of radio components, such as volume controls and midget tuning condensers, mount in this size hole.

7/16"—This takes most toggle switches, also a few of the controls and condensers of older types.

1/2"—A few toggle switches and similar components require this size of hole. We also use this drill in connection with making chassis cutouts, to be mentioned later.

Reamer: The particular reamer we find most useful is a little over three inches long, with a maximum diameter of 7/8”.

This, of course, has the square shank. It is very useful for enlarging and rounding out holes. It will make holes of any diameter desired, between available drill sizes. It also fills the gap between the $\frac{1}{2}$ "-inch drill and the—

Circle Cutter: The circle cutter fashions holes down to $\frac{7}{8}$ " in diameter, where the reamer leaves off. The large size Pavood circle cutter illustrated will drill holes up to a maximum of $5\frac{1}{2}$ " in diameter. Other types of circle cutters of various sizes are available, but the particular one shown has been found the most versatile. It is well to get this size instead of a light-duty one, as the latter will not last any too long. It is cheaper in the end to start with the heavy-duty type, which will last indefinitely.

Countersink: (not illustrated). The countersink reams out holes to the proper depth and angle when it is desired to employ flat-head or french-head bolts instead of the more usual round head type.

Cutting

Four types of tools will handle all ordinary cutting operations. The most familiar is the—

Hacksaw: One disadvantage of the hacksaw is that the frame limits the length of the cut to a few inches. It is therefore most useful for work such as cutting shafts, angle and similar material. For long cuts we prefer the—

Metal-Cutting Saw: These are procurable at most hardware stores for the small sum of a quarter. They will make any length cut, even in steel. They are useful in making cutouts in chasses or panels, such as are necessary to mount many types of transformers. A half-inch hole is drilled at each corner of the proposed cutout, or at least two diagonally opposite corners. These holes will permit the insertion of the saw blade sufficiently to start the side cuts. This method of making cutouts is easier and quicker than would first be imagined. The resulting holes have straight, clean cuts which need only a little touching up with a file to smooth the edges. This method is infinitely superior to the more common method of "chopping" out the hole with a cold chisel. The latter method usually leaves a messy job unless very skillfully done.

Cold Chisel: While the chisel is not the best instrument for making cutouts it is desirable for another purpose; that of taking the burrs off drilled holes. A tap of the hammer on the chisel will remove the burrs cleanly. This is a simple trick that is not as well known as it should be.

Files: The file is a tool that is generally familiar to the constructor. Three general types, all illustrated, should be on hand. The large flat file is used mostly for trimming off rough edges on long metal cuts. The small, three-cornered

file gets into places where the flat file is too large. The three-cornered file is also handy for making notches, such as for starting a cut on a volume control shaft. The round file is used for enlarging holes when they are drilled "off center" and for filing curved edges. It would be a good idea to have two sizes of round files, the smallest available for getting into small holes, with the larger size for working on large holes and curved edges.

Assembly

Three types of tools are employed for assembling component on chasses and panels. The most familiar are the—

Screw Drivers: Several sizes are shown, and should be owned by the constructor. The nature of the work being done will indicate which size is most suitable for that particular job. Get good ones that will not slip and will retain their edges indefinitely.

"Spintite" Wrenches: As a complement to the screw-drivers these wrenches are very useful. The screw should be kept from turning with the screw driver while the nut is tightened with the wrench. This will prevent damaging of the screw heads. Four sizes, which are available in sets, will take practically all standard size nuts. The $\frac{1}{4}$ " and $\frac{5}{16}$ " sizes will take $\frac{6}{32}$ and $\frac{8}{32}$ nuts. The $\frac{3}{8}$ " and $\frac{7}{16}$ " sizes will take the $\frac{10}{32}$ and other large nuts such as come with various types of insulators.

Open-End Wrenches: This set of four open-end wrenches are not as expensive as one might believe. We paid the sum total of eight cents (American money,

69 cents to the dollar) for all four. This makes them rather inexpensive at 2 cents per. The local auto accessory store provided this bargain. Don't kick if you have to pay a few cents more; they are worth it. They are particularly useful for tightening panel nuts on volume controls and similar parts which are of the single-hole mounting type. They will do this without scratching the panel and nut, which is likely to happen if the tightening job is done with pliers. The eight sizes of nuts these four wrenches fit make them useful for tightening any nuts the Spintites will not reach.

Wiring

Only four tools are necessary in order to do a satisfactory job of wiring. They are, first, the—

Soldering Iron: The soldering iron chosen should be neither too light nor too heavy. A light iron has not sufficient heat to properly solder large pieces of metal, producing a "cold" joint. A heavy iron, on the other hand, will not get into crowded places, such as are inevitable under the chassis of a receiver or a similarly complicated piece of radio equipment. A medium size iron will be satisfactory for all general radio work.

A roll of solder, which is not exactly a tool, slipped into the photograph for "local color" when our backs were turned. In order to "cover up" the photographer's artistic touch we will make a few remarks on the right kind of solder to use. For practically all radio work rosin-core solder should be em-

(Continued on page 655)

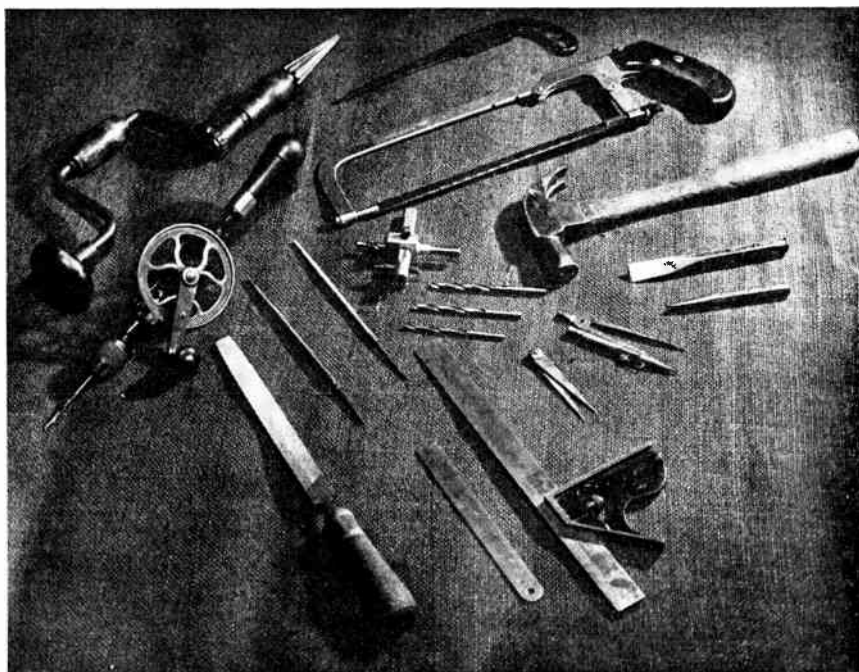

The remainder of the tools for a good workshop—carpenter's brace (with reamer in chuck), a hand drill, a hack saw, a metal cutting saw, a circle cutter, drills, hammer, compass, a scriber, a center punch and a cold chisel. Also a round, a flat and a three-cornered file, a steel ruler and a square.

IT GOES OUT... THERE!

By W. E. McNATT • W7GEZ, ex-W6FEW

VERTICAL antennas for the high-frequency bands, 14 mc. on up, are desirable for several reasons. The advantages over a horizontal antenna are: 1—the initial cost is less; 2—the mechanical set-up is simpler; 3—less room is required, and 4—the radiation characteristics of the vertical are easier to control than is the case of the horizontal layout.

Undoubtedly there are many hams who use vertical antennas, and who just “stuck them up” at any convenient height without knowing what the effects would be. For those hams who are in the latter classification, and for those who are contemplating the erection of a vertical, it is hoped that the radiation patterns shown in Fig. 2 will give them something more definite to work from.

These patterns are the result of calculations based upon ideal conditions, and therefore represent theoretical and probably unattainable performance. Ground conductivity, electrical length of the antenna, height of same, current distribution along the antenna, frequency of transmission and guy wires (and other reflecting bodies in the immediate vicinity are some of the major factors influencing the performance.

It is not difficult to see that the only factors within the immediate control of most of us are those of antenna height, its length, and the frequency of transmission. Since most of us have our favorite band, the matters of antenna length and transmission frequency are eliminated, leaving only antenna height to be considered. Although the greater percentage of installations will not give the results shown for any one value of height (H° in Fig. 2), the performance will not vary too widely from that

Fig. 2. Vertical-plane radiation patterns of vertical half-wave antennas. Pick your angle and let 'er squirt.

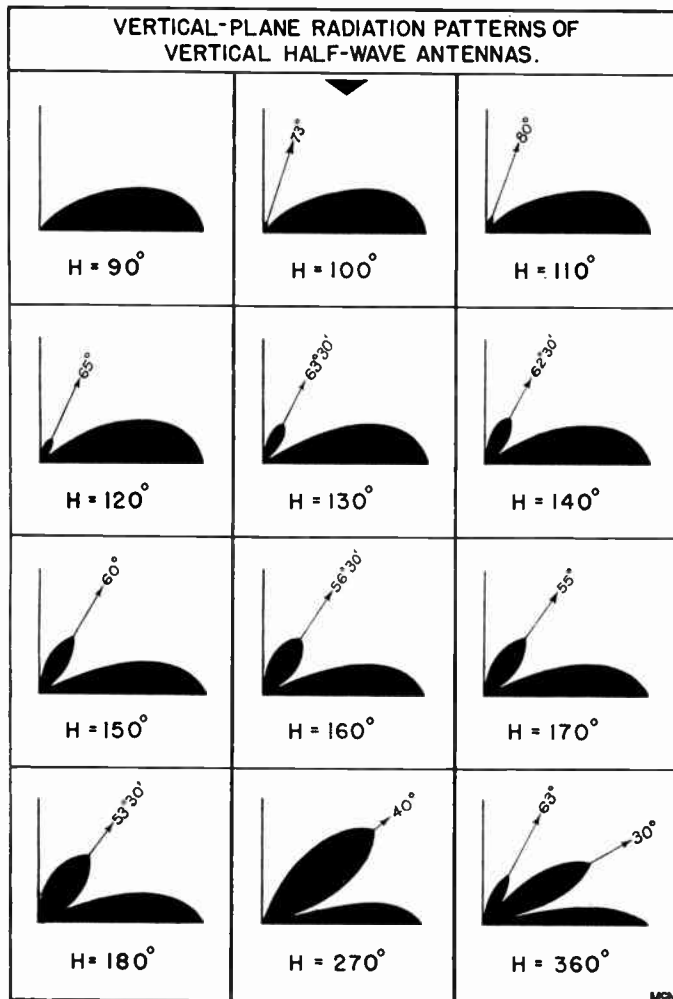

shown unless conditions surrounding the antenna are absolutely hopeless. Most amateurs do not have the money nor the time to engineer their stations as thoroughly as do the commercial fellows, but we can and do try to improve whenever and wherever possible.

Half-Wave Verticals

Since the majority of the hams do not go in for directional antennas, the patterns shown are only for single-wire, vertical half-wave antennas at varying distances above the ground. The horizontal pattern of this antenna appears as a circle (theoretically) with the end view, or diameter of the antenna wire, as its center. Of course, in practical installations, both the vertical and horizontal patterns will, to some extent, be altered by guy-wires and other nearby reflecting bodies. Metal roofs, power-lines, power-pole guy-wires and the like are good examples of reflecting bodies.

Fig. 1 illustrates the values of H° given below each pattern in Fig. 2, and the value of d in Fig. 3. The use of Fig. 3 in conjunction with the patterns of Fig. 2 is quite simple.

Let us suppose that you, the reader, choose the radiation pattern resulting from an antenna having a height, H° , of

130°. Assuming that this pattern is desired on 29 mc., the middle of the 10-meter band, we refer to Fig. 3. At 130°, at the bottom of the graph, we follow the line “up” until it crosses the line marked “29 mc.” At that point, we go to the side of the drawing where d , in feet, is given. This, we find, for 29 mc., is 3.8 feet, which is the distance from the lower end of the antenna wire to the ground. Similarly, for a half-wave antenna to operate of 7150 kc., at a height of 110° we find that the bottom of the antenna will be 7.5 feet above ground. Of course, for any half-wave antenna having an electrical height, H° , of 90°, its lower end will always be on (but insulated from) ground, regardless of the operating frequency.

The electrical height, H° , to the center of a half-wave antenna is found by a simple calculation:

$$H^\circ = \frac{L \times 360^\circ \times f}{3.28 \times 3,000,000}$$

where f is the frequency in kilocycles, and L is the distance in feet from the center of the antenna to ground. L is found easily by adding *half* of the total length, in feet, of the antenna to be used to the distance desired between the bottom of the antenna and ground. Plenty

of information and directions regarding the calculation of half-wave antenna length is available in Handbooks, so there is no point in going into the matter here. Remember, however, to use *half* the length of the *half-wave* antenna for the frequency desired.

Grounds for Good Grounds

Comparatively recent opinions seem to be towards the idea that an antenna is no better than its ground, or rather, the ground used with it. Broadcast stations using vertical antennas (their number is growing rapidly) seem to favor the use of 120 radials, each wire one-half wave in length and buried from 8 to 20 inches in the ground.

In only comparatively few cases do we find a ham with a backyard roomy enough to accommodate such an array. Even if we had enough room, the job of burying 120 wires would be enough discouragement unless there were some handy gadget available. Broadcasters have developed such a gadget, in the form of a plow. Everything is conventional with the exception of the blade, which is a straight piece of heavy iron plate. The blade is drilled so as to carry wire from a reel mounted on the plowhandles down into the ground to the desired depth. As the plow travels hither and yon over the terrain, the wire meekly goes to its resting place . . . and stays there. When the burial is started, the end of the wire is tied to an anchor point at the center of the system. Such plows have found popularity with many stations who recently have installed the radial-wire ground. (Brown, Lewis and Epstein, of RCA, show such a plow in the June, 1937, Proc. I.R.E.)

Even though most of us cannot work out the large, 120-wire system, we should be able to afford 30 or 60 quarter-wave wires, especially if we are operating on 20 or 10 meters. In burying these wires, their center in the ground is directly below the line of the antenna extended to the ground. This point is easily found by dropping a plumb-bob or other small weight from the lower end of the wire. All radial wires should be thoroughly soldered together at the center of the system, and also include another wire to run to the ground point of the transmitter. This wire should be equal in size to that of the wires in the radial system. For powers up to 250 watts, No. 12 should be adequate. Higher powers should be favored with at least No. 10 B&S.

Determining Angle

The angle between any two adjacent wires in the ground can be found easily by:

$$\theta = \frac{360^\circ}{n} \text{ where } n \text{ is the number of}$$

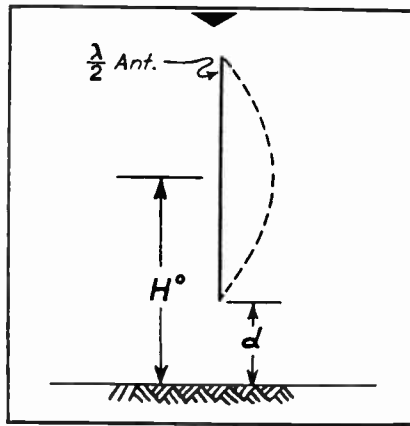

Fig. 3. Height of vertical above ground. The use of this sketch in conjunction with the patterns of Fig. 2 is quite simple.

wires used. So, for the 60-wire ground, the angle between any two adjacent wires will be 60° . These angles can be laid off with reasonable accuracy by placing the center point of an 8- or 10-inch paper protractor (which is quite inexpensive) at the center of the radials. By stretching a string from that point over the desired angle on the protractor scale, on out to the full length of the wire to be used, and placing stakes at intermediate points, a fairly good line can be laid out for the small wire trenches.

In digging the ditches, it is sufficient to make only cuts of 8 or 10 inches in the ground. This can be done quite easily with a "square-pointed" shovel (if there is such a thing). The same tool can be used to shove the wire down in the cut, when the radials are laid.

Although the above is seemingly a complicated job, it is not so tough if you operate on the higher frequencies—a half-wavelength of wire, on 10 or 20 meters, isn't too much bother to bury.

Broadcasters certainly swear by, not at, this form of ground since they have installed it. This should be a good hint for us, from the broadcast boys; certainly they have taken a good many hints from ham practice. At any rate, if you stick to business, and have a helper similarly inclined, one full Sunday should find one good ground system installed.

Individual Patterns

Returning to the subject of antennas proper, those who are interested in working out radiation patterns for their own particular set-up can do so by following a simplified equation for the radiation characteristics of a vertical antenna. Since the characteristic is all we are concerned about, the equation for field strength in microvolts, or microamperes, is not given. Relative values are entirely sufficient.

$$I_\theta = \sin \theta \cos (H^\circ \cos \theta)$$

where I_θ is the relative signal intensity at any angle θ between the vertical (0°) and the horizontal (90°). In plotting the pattern, a suitable scale is that of 4 inches for unity, which occurs at 90° , other values of I_θ being plotted to the same scale, proportionately H° is the electrical height of the antenna, i.e., the height in degrees of the center of the half-wave antenna, or the center of current distribution (dotted line in Fig. 3) from the ground.

$$H^\circ = \frac{D \times 360^\circ}{\text{wavelength}}$$

where D is the distance, in feet, from the ground to the center of the antenna, and wavelength is also in feet. (wavelength, ft. = wavelength, mtrs., $\times 0.3048$)

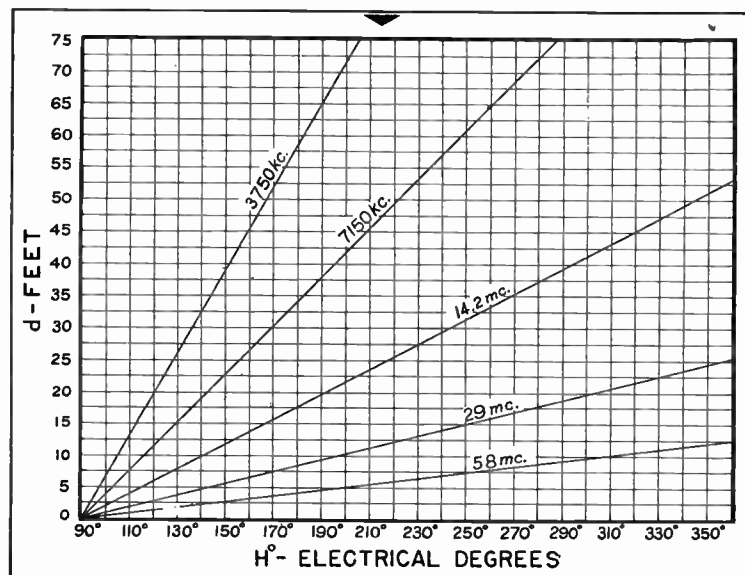

Fig. 1. The values of H° , which are given below each pattern in Fig. 2, and the values of d in Fig. 3.

ULTRA-HIGH

WHEN TO LISTEN—WHAT TO LISTEN FOR

By PERRY FERRELL, Jr.

MR. and Mrs. DXer — experience a new thrill by giving the ultra-high-frequency bands a twirl. Hear R8 signals from the other side of the world and get acquainted with the largest DX phone band. Twist the old dial among the broadcast, police, amateur, forest fire, broadcast pickup, experimental, and television stations to increase your log and aid immeasurably in classifying u. h. f. (ultra-high-frequency) receiving conditions.

As this is a totally new frequency area to most DXers it must first be understood that theoretically these waves have a quasi-optical range, but it now appears that a new DX band is being born and soon transmitters sharing the same frequency will be assigned new ones.

As you read this the ten-meter band is at its peak, so read over the station data to follow and give the ultra-high-frequencies a try.

Broadcast Stations

W6XKG, 25.95 mc., Los Angeles, California, operates 24 hours a day, seven days a week, simultaneously with

One of the "two-way" police radio cars of the Schenectady, New York, Police Department. General Electric equipment is employed. Patrolmen Semerad and Tooley at the controls



KGFJ. The transmitter is a composite job and the antenna in use at present is 2 quarter-wave verticals 2 wave lengths above the ground and fed with transposed feeders. The power is 100 watts. Outside of excellent coverage of the United States and Canada, reports have been received from England, Ireland, Scotland, Norway, Japan, Australia, New Zealand, Puerto Rico, Hawaii, and Alaska. Address: W6XKG, 1417 South Figueroa St., Los Angeles, California.

W9XOK, St. Louis, Mo., has been testing lately at 35.6 and 41.0 mc. with a power of 100 watts. These tests are conducted on eight radials, namely the 1, 2, 5, 10, 15, 20, 25 and 40 mile. The antenna is located on the Continental Life Building which is not only the highest building in that section of the city, but is on the highest elevation in the county. W9XOK was heard here twice testing on 35.6 mc. (R7,Q5,F6). Address: Radio W9XOK, St. Louis Star Times, St. Louis, Missouri.

W4XBW, has resumed operations on 31.6 mc. and now relays WDOD with 100 watts power. W4XBW was heard here at 8:30 p. m. (R6,Q4,F4). A report was sent but no verification or acknowledgment has been received. Address: Radio W4XBW, Hotel Patton, Chattanooga, Tenn.

W3XIR, a new WCAU outlet, is under construction and will probably be on the air about the last of January. It will be a 100 watt station operating on either 31.6, 35.6, 38.6, or 41.0 mc.

W9XHW, 31.6 mc., a 50 watt station is reported to operate on the following schedule: 7:15-11:00 a. m., 4 p. m.-12:30 a. m., Mondays, Wednesdays, and Fridays; 9:00-12:30 a. m., Saturdays and Sundays. Address: Radio W9XHW, c/o WCCO, Minneapolis, Minn.

W9XAZ, 26.4 mc. is now relaying WTMJ with 500 watts power. Schedule: 1-12:00 p. m. on weekdays, 1- 5:30 p. m. on Sundays. This frequency is a poor one for U. S. A., but it seems to put a strong signal into Australia. Address: Radio W9XAZ, The Journal, Milwaukee, Wisconsin.

W8XAI, 31.6 mc. is another station that is often heard in Australia. At present it is relaying WHAM from

The 142-foot mast of the ultra-high-frequency police radio station at Mount Vernon, N. Y., fed by a 50-watt Western Electric transmitter. The station provides complete coverage of the city.



7:30 to 12:05 a. m. with 100 watts power. Address: Radio W8XAI, Stromber Carlson Co., Rochester, New York.

W3XES is the only active station on 35.6 mc. at present. It now puts 300 watts into the ether from 9 a. m. to 5 p. m. Address: Radio W3XES, Monumental Radio Co., Baltimore, Md.

W8XWJ, 31.6 mc. the pioneer ultra-short wave station is nearing its second year of continuous operation. (see ALL-WAVE RADIO, May, 1936) Reports are still being received from all over the world on their fine 100 watt signal. Schedule: Weekdays, 10:30 a. m.-5:00 p. m. Address: W8XWJ, Detroit News, Detroit, Michigan.

W5XAU, 31.6 mc., the only ten-meter broadcaster in W5, is relaying WKY from 12:00-1:00 p. m. Address: W5XAU, WKY Radiotelephone Co., Oklahoma City, Okla.

W3XEY, 31.6 mc., is another consistent performer with its 100 watts. It relays WFBR from 4:00 p. m. to 12:00 a. m. Address: Radio W3XEY, Baltimore Radio Show, Inc., Baltimore, Md.

W9XPD, 31.6 mc., is for some unknown reason, the best heard 100-watt broadcaster. Last summer it was the only ten-meter station heard in our section and reports from Australia have it at R8 and Q5. Unfortunately a schedule could not be obtained, but from our own observations we conclude that it is on the air every day from 11 a. m. to 6 p. m. Address: Radio W9XPD, Pulitzer Publishing Co., St. Louis, Mo.

W1XEQ, 31.6 mc., Storrs, Conn., is reported to use its 100 watts daily from 3-9 p. m.

We are uncertain at present upon what frequency W2XDV operates. All sources seem to differ and we are unable to secure information from the station engineer.

W6XRE, 120.0 mc., has discontinued operations on this frequency. This station last spring and summer conducted tests in conjunction with W6XKG.

W4XCA, 31.6 mc., Memphis, Tenn., is another well-heard 250-watt N.B.C. station. It is now relaying WNC on a very irregular schedule. W4XCA was heard here at 4:00 p.m. (R6, Q4, F4). Address: Radio W4XCA, Memphis Commercial Appeal, Memphis, Tenn.

W8XH, 41.0 mc., is using a new turnstile antenna designed by Dr. G. H. Brown, of the RCA Victor Co. This horizontal polarization antenna consists of a 70-foot steel pole, whose maximum height above ground is 350 feet, which supports the turnstile array. The complete array is mounted on the Hotel Statler in Buffalo. We are unable at present to obtain a schedule of the transmissions. Address Radio W8XH, c/o WBEN, Buffalo, New York.

W9XJL, 31.6 mc. Telegram Building, Superior Mich., was heard here at 3:45 p.m. (R4, Q3, F4), when using a power of only 40 watts! This station has no regular schedule as far as we know. It relays the programs of WEBC, Duluth, and the power is now 80 watts. It is understood that W9XJL also transmits on 26.1 mc.

We have listed above a few of the most interesting or the most active of the u.h.f. broadcasters. It must be remembered that these stations are allotted four or more frequencies to be used at will, so schedules and frequencies are always subject to change.

"Forest Fire" Stations

After several hectic seasons with forest fires, the New Jersey Department of Conservation installed a complete two-way radio-phone transmitter in each of their fire towers, airplanes, and portable units. The system now totals over 25 separate stations operating on one of three frequencies. The "C" stations operate on 33.85 mc., while the B stations operate on 36.0 mc., except W3XBT, the Trenton control station, which operates near 39.0 mc.

Below is a list of the stations that are in operation:

Station	Location	Station	Location
W3XBT	Trenton	W3XCG	Wind Beam
W3XBU	Budd Lake	W3XCH	Beaufort
W3XBV	Butler	W3XCI	Cedar Bridge
W3XBW	Mt. Holly	W3XCJ	Farmingdale
W3XBX	Blue Anchor	W3XCS	Mizpah
W3XBY	Bridgeton	W3XCT	Edison
W3XBZ	Silver Lake	W3XCU	Lakehurst
W3XCA	Catfish	W3XCV	Maple Lake
W3XCB	Millville	W3XCQ	On any air-
W3XCC	Belle Plains		craft
W3XCD	Retreat	W3XCR	Airplane
W3XCE	Batso		Hangar
W3XCF	McKeetown	W3XD	Portable

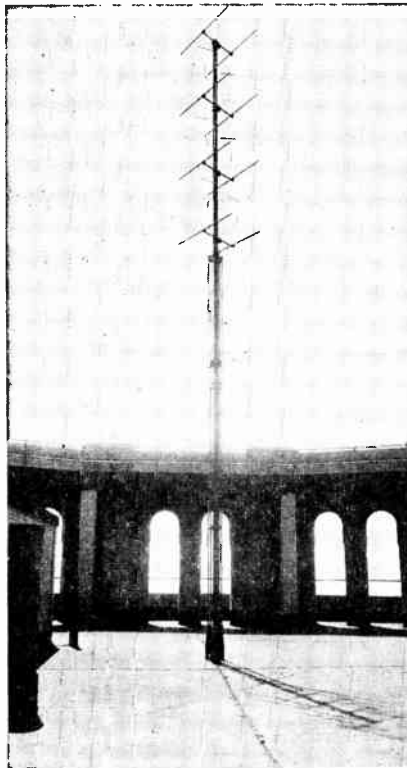

Turnstile antenna atop an office building in lower Manhattan for reception of ultra-short waves in the New York-Philadelphia facsimile circuit of RCA.

By tuning to W3XBX on 36.0 mc. the listener may hear all that goes on, as the Blue Anchor control station transmitter is left on all day. The service becomes quite interesting when a forest fire is under progress and the portable units are in the field.

Experimental Stations

If, when tuning through 55.0 mc. you hear a strange clicking sound, it's not

from Mars; it is only the u.h.f. weather balloon of the National Bureau of Standards. These balloons are freed occasionally to collect data on the upper atmosphere and send it by radio to automatic recording receivers. Many times these balloons—depending on their diameter—reach a height of 127,000 feet (24 miles).

W10XFZ, the N.B.C. portable transmitter operates on 40.6 mc., 34.6 mc., and 31.1 mc.

W1XAV, owned and operated by the Shepard Broadcasting Service, of Quincy, Mass., uses a frequency of 61.5 mc.

A new u.h.f. beacon system has been devised by the Bureau of Air Commerce. 75.0-mc. installations have been made at Newark, Chicago, Kansas City and Washington airports. All of the 91.0 mc. installations have been shut down because of mechanical difficulties.

Speaking of airplane beacons, a 500-watt Lorenz system has been installed at the Indianapolis airport. The large transmitter operates on 33.3 mc. while the markers operate on 38.0 mc.

W1XR, 53.0 mc., the Mount Washington Observatory station, has established a record for the most reliable u.h.f. circuit in operation; a total of four years. Address: Alexander A. McKenzie, Gorham, New Hampshire.

W1XW, 60.3 mc., the Blue Hill Observatory station, located 142 miles away, exchanges weather reports and other observations with W1XR from day to day. They also free radio-equipped balloons, operating on either

(Continued on page 664)

W8XWJ, the Detroit News ultra-high-frequency broadcast station which has stacked up quite a DX record.. C. H. Wesser at the controls.

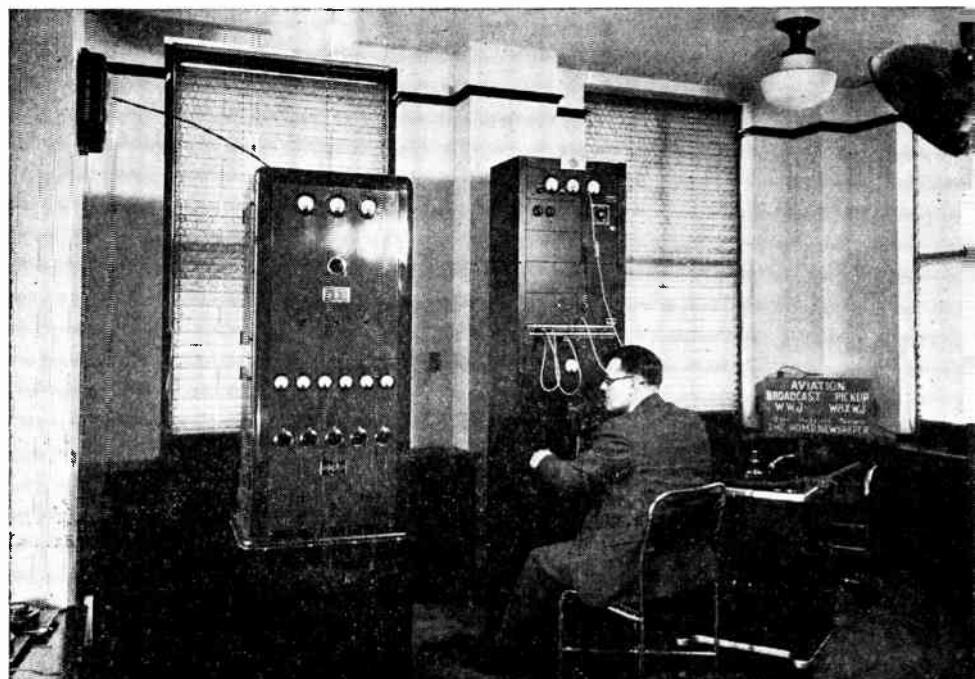

Globe Girddling

By J. B. L. HINDS

ZTJ, 9606 kc., 31.23 meters, Johannesburg, South Africa, sounds good to the ears of a DXer. ZTJ, 6097 kc. as listed, is still on the air. The latter frequency has long been the goal of all DX fans, but with its 500 watts power, and its close proximity to local short-wave stations which operated at the same hours, very little success was achieved by those in Eastern United States. But with its new 5 kw. transmitter its signal is a good R7 and holds up consistently the full hour it is heard from 11:45 p.m. to 12:45 a.m. These hours represent 6:45 to 7:45 a.m. in Johannesburg.

The station is first heard with its bugle call at the beginning of the physical exercises. At 12 a.m. are heard the clock chimes followed by the toll of 7 by the big Johannesburg clock. News items follow, band selections, another class of physical exercises, stocks and bonds, market reports, prices, etc., all being in English and repeated in the language of the Transvaal. They close with bugle calls as at the beginning. Other programs as scheduled under ZTJ, 6097 kc., are broadcast. The present signal has sufficient strength to override the prevailing static and electrical disturbances, and comes in with remarkable clearness,

BBC's 98 CLOCKS . . . HBO-HBL WINTER SCHEDULES . . . FINNISH TESTS . . . NEW CUBAN ZTG, JOHANNESBURG . . . MANCHUKUO SIGNALS UP . . . WARSAW TWINS . . . CT2AJ.

NEW STATIONS

KC.	Meters	Call	Location
41000	7.32	W2XHG	New York, N. Y.
38650	7.76	W2XDG	New York, N. Y.
31600	9.4	W2XDV	New York, N. Y.
11990	25.02	CB1199	Valdivia, Chile
11760	25.50	TGWA	Guatamala City, Guatemala
11700	25.64	CB1170	Santiago, Chile
11535	26.01	SPD	Warsaw, Poland
10370	28.93	Radio Nacionales	Salamanca, Spain
9685	30.98	TGWA	Guatemala City, Guatemala
9640	31.12	CXA8	Montevideo, Uruguay
9630	31.15	HJ7ABD	Bucaramanga, Colombia
9606	31.23	ZTJ	Johannesburg, South Africa
9590	31.28	W2XE	Wayne, N. J.
9510	31.55	HS8PJ	Bangkok, Siam
9505	31.56	HID	Ciudad Trujillo, Dom. Rep.
6900	43.48	T12RS	San Jose, Costa Rica
6072	49.41	OER2	Wien, Austria
5977	50.19	Radio Renascenca	Lisbon, Portugal

6042.3	HJ1ABG	6040.5
6007	Radio Burma	6097
5813	TIGPH2	T12H	5813
5146	PMY	5140
4900	HJ3ABH	6012
4880	HJ4ABP	6030
4860	HJ1ABE	9500
4740	HJ6ABC	HJ4ABC	6090
4660	HJ2ABJ	HJ1ABJ	6025

STATIONS DELETED

KC	Meters	Call	Reason
24380	12.3	CRCX	Not in service
6325	47.43	HH3NW	Not in service

NON-AUTHENTICATED STATIONS

Frequency	Call	Location
15650	JFZ	Japan (Oct.)
14010	VK5DI	Australia (Oct.)
10590	ZIK2	British Honduras (Dec.)
9580	OAX5C	Peru (Dec.)
9565	HP5S	Panama (May)
8900	COKC	Cuba (Dec.)
7600	HC1RJ	Ecuador (May)
7200	HC1AJ	Ecuador (May)
7100	...	Mexico (Nov.)
6600	H16H	Dom. Rep. (May)
6485	H11L	Dom. Rep. (Nov.)
6128	OAX7A	Peru (May)
6122	OAX4P	Peru (May)
6122	OAX6A	Peru (May)
6120	HP5Z	Panama (June)
6050	XEKM	Mexico (Nov.)
6000	OAX5A	Peru (May)
5835	YV5RR	Venezuela (Nov.)
4820	HJ7AB	Colombia (Dec.)

STATION CHANGES

New Frequency	New Call	Old Call	Old Frequency
15440	XEBM	15300
11435	COCX	11500
11801	OER3	OER2	11801
9516.6	HJ6ABH	HJ4ABH	9520
6325	YNLG	8505
6145	HJ4ABE	6097
6105.1	HJ6ABB	HJ4ABB	6110
6085.7	HJ5ABD	6085
6070.5	HJ3ABF	6170
6054.3	HJ6ABR	HJ4ABU	6150

which speaks well for the engineers of the station. And thus the United States gains another next-door neighbor

through the achievements of short-wave radio.

With the continual adding of new stations in nearly every country in the world, the rapid advance in the improvement of facilities, increases in power and the wonderful improvement in receiving equipment, short-wave radio is far from the point of being on its way out, in the opinion of the writer.

BBC's 98 Clocks

In their daily struggle to maintain the accuracy of program timings, the program officials at Broadcasting House, London, have the assistance of 98 clocks, twenty-two of which are in the studios and the remainder in the silence-rooms associated with the studios. All are controlled electrically from a "master" in the control-room on the eighth floor, the "master's" accuracy being checked with the Royal Observatory, Greenwich, several times a day.

Broadcasting House is connected with Greenwich by a telephone line, which carries the six "pips" of the Greenwich Time Signal on the first stage of its



Photo-veri from Praha, Czechoslovakia.. Call in red.

journey to listeners. The last of those "dot seconds," as they are technically known, indicates a point of time to a normal accuracy of one-twentieth part of a second.

Some of the studio clocks have been fitted with a red "sweep" hand which travels steadily round the clock-face, completing each cycle in sixty seconds. This makes possible, among other things, the calculating to the odd second of the time taken for fading a program in and out, the speed of a "fade" control being synchronized with the "sweep" hand of the clock.

Throughout rehearsals, however, a stop-watch is indispensable, for the running time of every number must be checked to the second. Even so, time is inevitably lost or gained when some programs are actually transmitted, and an over-run of one broadcast can seriously upset the timing of the next. If, for instance, a production has been timed to run for exactly sixty minutes, and the program that it follows over-runs by three minutes, the producer does not know that he will have to "cut" something or, if he does, how much, until the red light in the studio tells him that he is "on the air." Then he has to get each artist outside the studio as opportunity arises so that he can arrange a "cut". Afterwards he must send a note to the band to ensure that they will not play the wrong tune where the item has been deleted.

Recitals of phonograph records also demand split-second timing, especially if a complete opera, or some other big musical work, is being reproduced from several double-sided records. There must be no pause while records are being changed.

Radiophone and Experimental Stations

GBS, 12150 kc., Rugby, England, heard calling DON, 10128 kc., Germany at 4 p. m.

VLK, 10520 kc., Sydney, Australia, carried a program recently transmitted by GBP, 10770 kc., Rugby, England 2:30 to 3 p.m.

TYA2, 9037 kc., Paris, heard 2:17 to 2:28 p.m. broadcasting in French and English.

IRW, 19520 kc., Rome, Italy, heard working JVH, 14600 kc., Nazaki, Japan at 6:43 a.m.

LSL, 21160 kc., Buenos Aires, Argentina, heard calling Rio de Janerio at 5:49 p.m.

LSK-3, 10250 kc., Buenos Aires, heard talking with GCA, 9710 kc., Rugby, England at 6:35 p.m.

SUX, 7860 kc., Cairo, Egypt, heard testing with Europe between 4 and 5:30 a.m.

JCK, 9460 kc., Tripoli, Africa, heard

QRA
Polskie Radio Warsaw
5 Mazowiecka St.

SPW

Poland

THIS CONFIRM UR REPORT REG ON SCHEDULES:
MONDAYS, WEDNESDAYS, FRIDAYS

TNX QSL 73's

A beautiful veri from Poland. Colors black and blue (Who's the man on the horse?)

talking with Rome between 5:30 and 6:30 a.m.

FZE8, 17280 kc., Djibouti, French Somaliland, Africa, sends a musical broadcast 6:45-7:15 a.m. first Thursday of each month.

CFA5, 9630 kc., and CJA6, 6760 kc., Drummondville, Ont., Canada tests with Europe near 8 a.m.

CNR, 12830 kc. and 8035 kc., Rabat, Morocco, used in radio telephone service daily with France between 2:30 a.m. and 3:30 p.m.

YSL, 13410 kc., San Salvador, El

Salvador, heard testing 11:30-11:40 p.m. on about 10050 kc., and announcing call YSL. It is therefore possible that frequency has been changed.

Down-Unders

JDY, 9925 kc., Dairen, Manchukuo, is being heard in Eastern United States with excellent power and clarity. Their English period appears to be from 7:45 a.m. to sign off at 8 a.m.

JFAK is said by many listeners to be the call of a station in Japan on 9625 or 9630 kc., and its location to be Taihoku, Taiwan.

JZK, 15160 kc., and JZJ, 11800 kc., are still carrying the regular overseas programs and at the same hours as heretofore.

XGOX, 6820 kc., Nanking, China, is said to be off the air. A station with call of XGRX heard at 9590, 9625, and 9800 kc., but late reports indicate it is silent.

VK3LR, 9580 kc., Melbourne, Australia, advises that pending the provision of the new transmitter in Australia, an immediate improvement is being made by increasing the power of VK3LR to more than double that at which it is now operating.

The Postmaster General's Department, which handles the technical side of broadcasting in Australia, proposes to extend and improve the short-wave service by establishing a new transmitter in Victoria. No information was given as to the approximate date on which the new transmitter would be in operation.

PMY, Bandoeng, Java, is now on 5146 kc., instead of 5140 kc. Station is operated by the Bandoeng Radio Society, and has a new time schedule in this issue.

HS8PJ, 9510 kc., Bangkok, Siam, is

LAST-MINUTE FLASHES

TGWA, 9685 kc., Guatemala City, Guatemala, 19 kw. power. Sunday 7:15 to 10 p.m.; Monday, Tuesday, Thursday, 9-11 p.m.; Wednesday, 9:30 to 10:15 p.m.; Friday silent; Saturday 10 p.m. to 1 a.m.

TGWA, 11760 kc., 15170 kc. and 17800 kc. Monday to Saturday 12:45 to 1:30 p.m.; Sunday 12 noon to 2:45 p.m.

TGWA, 11760 kc., may be used on programs day or night.

XEBT, 6000 kc., Mexico D.F., will soon increase power to 1.5 kw.

HCI1PM, 5725 kc., Ecuador, temporarily off the air.

HILL, 6480 kc., Santiago de los Caballeros, Dom. Rep., in non-authenticated block is on the air. Address: Radioemisora Nacional "El Diario," Calle "Presidente Triunfo," No. 97, Altos.

SM5SX, 15155 kc., Stockholm, Sweden, on the air weekdays 11 a.m. to 5 p.m.; Sundays 9 a.m. to 5 p.m.

SBP, 11705 kc., Motala, Sweden, Monday to Friday, 1:20 to 2 a.m.; 6 to 9 a.m.; 11 a.m. to 1:30 p.m. Saturday, 1:20 to 2 a.m.; 6 a.m. to 1:30 p.m. Sunday 3 a.m. to 1:30 p.m.

SBO, 6065 kc., Motala, Sweden, daily, 1:30 to 5 p.m.

CSW, Lisbon, Portugal, now uses 11840 kc., 11040 kc. and 9940 kc. On the air 1 p.m. to 8 p.m. (Off air until Dec.)

CTIAA, Lisbon, Portugal, 9650 kc. New call reported as CS2WA.

ZIK2, 10600 kc., Belize, British Honduras, on air Tuesday, Thursday and Saturday 7:30 to 7:45 p.m.

TIPG, 6410 kc., San Jose, Costa Rica, being heard with improved signal on about 11980 kc. broadcasting as "The Voice of Costa Rica." Apparently changed frequency or transmitting simultaneously on two frequencies.



The new "Report of Reception" issued by the BBC. This is not a veri, but it's nice to have.

the new frequency being heard and reported by many as broadcasting on Mondays and Thursdays from 8 to 10 a.m. It is not yet known if broadcasts have been discontinued on 19020 and 9350 kc. Reports are being received that HS8PJ is still being heard on 9350 kc. on other days than Monday and Thursday. It is, therefore, possible that the service has been extended.

League of Nations

HBO, 11402 kc., and HBL, 9345 kc., Geneva, Switzerland, will be used on weekly League of Nations broadcasts this fall and winter, and the transmissions will occur on Friday nights instead of Saturday as formerly, which were sent over HBP, 7797 kc., and HBL, 9595 kc.

On account of the manner of stating these Friday broadcasts by the League, it is possible that those listed past midnight (GMT) will be heard in the United States on Thursday nights, unless the schedules really mean they are on Saturday morning, in which case they would be received here on Friday evening. However, subsequent revision can be made in later issue if incorrectly stated.

HBO, 11402 kc., and HBJ, 14535 kc., will continue to carry the broadcasts of the Swiss broadcasting authorities on Saturday nights from 6:45 to 8:30 p.m. as heretofore. The call "League of Nations Wireless," is not used on these Swiss transmissions. Reception reports for Swiss programs should be sent to address as shown under HBJ, 14535 kc. Those for League of Nations programs should be sent to address as shown un-

der HBL, 9345 kc. The League advises that the response to the League Assembly broadcasts was so favorable that they decided to use the same hours and frequencies on the Friday programs.

RNE, 12000 kc., Moscow, U.S.S.R., now has an English program daily from 10 to 11 p.m. in addition to its English broadcasts on Sunday and Wednesday. The station schedule shows RNE on 25 meters flat, which the writer figures is 12000 kc. The station comes in close to 12060 kc. Moscow insists it is on 25 meters, so must have a different method of converting kilocycles to meters! Education at long range is a trifle slow, so we will await developments.

RAN, 9600 kc., and RKI, 7520 kc., Moscow, are still broadcasting the English program daily from 7 to 9:15 p.m.

Europeans

The Minister for Posts and Telegraphs of the Irish Free State advises that the question of the erection of a short-wave broadcasting station is under consideration. It is proposed as a preliminary to install short-wave equipment of an experimental character at the Athlone High Power Station, but a decision has not yet been reached as to the frequency on which the station, if ultimately decided on, will transmit.

Radio Renascenca, or "Emissora Catolica Portuguesa" 5977 kc., Lisbon, Portugal, is now operating as shown in list. At present station has 250 watts power, but advises it will soon increase power to 2½ kw. No call letters or interval signals, but plays the hymn, "Our Lady of Fatima" at the opening and closing of transmissions.



COBX veri. Calls in red, sketch in green, the remainder in black. (Who's the woman in the hammock?)

PIIJ, Dordrecht, Holland, 7088 and 14164 kc., is not a broadcasting station, but an experimental one for educational and scientific purposes. Dr. Hellingman states, however, that they make regular tests on the scheduled hours as mentioned in this section in November, and transmit recordings of musical selections and give talks in Dutch, English and German.

2RO, Rome, if not found on 11810 kc., will be on 9635 kc., with same schedule as listed under the first mentioned frequency.

ORK, 10330 kc., Brussels, Belgium, is constructing a new building for the housing of its plant at Ruyssede, which will be completed in 1938. New modern equipment will be installed and power of station materially increased, which will insure more satisfactory transmissions.

TPA2-3-4, Radio Coloniale, Paris, do issue a veri card although not so attractive, and quite difficult to secure; persistence must be one of your traits to procure one.

CSW, 9940 and 11040 kc., Lisbon, Portugal, has been off the air for a time, according to reports, due to the installation of a new 10-kw. transmitter. It is not known if a change in frequencies will be made or not.

SPW, 13635 kc., and SPD, 11535 kc., Warsaw, Poland, are on the air simultaneously with 2-kw. power. The call of the latter frequency was given, heretofore, as SPB. While these stations have been broadcasting mostly from 6 to 7 p.m., it is not known as yet what the regular schedule will be or if the programs at the noon hour have been or will be discontinued. They are maintaining a much better signal although some code interference on both frequencies at times. They are employing antennas beamed to North and South America.

Six short-wave broadcasting stations are under construction in Rome. Two will use 100-kw. power, and three will operate with 50-kw., and the sixth is to transmit on ultra-short-waves with 2-kw.

OER2, Vienna, Austria, transmits on 6072 kc., and OER3, on 11801 kc. No advice has as yet been received as to the exact days each week on which these frequencies are used.

Radio Nacionales, 10370 kc., Salamanca, Spain, is the listing of the new Insurgent station being heard with good signal strength nightly on their English program from 9 to 9:45 p.m. A majority of the announcements indicate station is on 10370 kc. or 28.93 meters, although one listener reports hearing them announce 10410 kc. or 28.82 meters. They have been operating from 10370 to 10425 kc. It has not as yet been learned if Radio Nacionales takes the place of EAJ43.

Finland is testing daily from 10 a.m. to 4 p.m. and relaying the National Finnish programs from Lahti, through the short-wave transmitter at Helsinki (Helsingfors). Station said to be on 6135 kc., or 48.90 meters. No advice has as yet been received as to when the new 1-kw. transmitter will be in operation. The station mentioned above is reported as having 75 watts power. This information furnished by Ingvar Gullberg, Hedemora, Sweden, who advises the address of the station is Suomen Ylesradio Fabianink, 15 Helsinki, Finland. A listener on the West Coast recently reported hearing a Finnish station in afternoons and usually signing off at 4 and 5 p.m. Mention of the new transmitter was made in this department in October.

The report of a new short-wave station in Lithuania appears to be premature. The Director General of Posts and Telegraphs advises that the matter of erecting a short-wave transmitter is being given consideration but no definite information can be furnished as plans have not been completed.

At present two long-wave broadcasting stations, LYX and LYY, are in operation with 7 and 10-kw. power respectively.

South Americans

HJ4ABD, 6133, 5900, 5780 kc., Medellin, HKV, 8795 kc., Bogota, HJ1ABC, 6000 kc., Quibdo, HJ2ABC, 4790 kc., Cucuta and HJ2ABD, 5980 kc., Bucaramanga are not accounted for in the new list of short-wave stations issued by the Minister of Communications of Colombia as being in effect in November and on. The situation on the 31- and 49-meter bands has been relieved somewhat by the transfer of stations to the 60-meter band and the change of frequencies on the first two named bands, which are reflected in station changes, making it unnecessary to detail in this section. It will be noted that changes have been made in call letters of stations as well as in frequencies.

VP3MR, 6070 kc., Georgetown, British Guiana, wishes mention made that they do not verify reports unless the necessary return postage is included, usually in shape of Int. Reply Coupon or in coin. All reports, however, are acknowledged on the air on Saturdays in the weekly mail-bag at approximately 7:15 p.m. E.S.T.

HJ7ABB, 4820 kc., is a new station to be installed at Bucaramanga, Colombia, within six months from the date of license, August 20, 1937. It will transmit with 750 watts power and will be known as Radio Santander. Station owner, Senor Francisco A. Bueno.

HC2CW, 8404 kc., Guayaquil, Ecuador, reported heard near 8618 kc.

HJ7ABD, 9630 kc., Bucaramanga, Colombia, continues to broadcast ex-

MINISTÈRE DES POSTES
TÉLÉGRAPHES & TÉLÉPHONES

Paris, le 30 septembre 1937

DIRECTION de la RADIODIFFUSION
STATION RADIO-COLONIALE
DE L'ÉTAT FRANÇAIS
98 bis, Boulevard Haussmann, 72 bis
PARIS (8^e)

Monsieur,

J'ai l'honneur de vous accuser réception de votre lettre du 30-8-1937. Je vous remercie des renseignements que vous avez bien voulu me communiquer sur les résultats que vous avez obtenus dans l'écoute de la Station Radio Coloniale de l'Etat Français et en particulier : 28-8-1937 - 83 m 84

Nos émissions se font tous les jours sur les longueurs d'ondes ci-après : 19 m. 68, 25 m. 24, 25 m. 60.

Veuillez agréer, Monsieur, l'assurance de ma considération très distinguée.

Le Directeur du Service de la Radiodiffusion.

Not attractive, but authoritative, is this veri from "Radio Coloniale", France.

cellent programs and maintain a fine signal. Some listeners say that HJ7ABD broadcasts simultaneously with HJ2ABD, on 5980 kc. As the latter station was not listed in the late set-up of the Minister of Communications of Colombia, it may be that the above statement is incorrect.

CXA8, 9640 kc., Montevideo, Uruguay, is listed in this issue. It is understood to relay LR3, Buenos Aires, Argentina.

CB1170, 11700 kc., Santiago, and CB1199, 11990 kc., Valdivia, Chile, are listed in station list. It is reported that CB1170 was originally broadcasting on 11760 kc., but subsequently changed to 11700 kc., the call being likewise changed. CB1199 is same station which was transmitting near 12007 kc., when its location was thought to have been Santiago instead of Valdivia. Some report the call as "Emisora Valdivia," and the address, Casilla 731.

OAX5C, Radio Universal, Ica, Peru, reported by several listeners as heard recently on 9580 kc. It is not yet clear as to whether OAX5A on 11796 kc., is in operation as "Radio Universal" at Ica, and until such time as facts are available the listing will remain unchanged and the first mentioned station will be shown in the non-authenticated block.

CT2AJ, 4002 kc., Ponta Delgada, Island of St. Michael, Azores is the only station in the Azores which carries broadcasting programs for entertainment regularly, although not received often in the United States. CT2AJ has a small crystal-controlled transmitter assembled some years ago by a British engineer, and only 50 watts power. Station owned by Messrs. Joao Soares, Jr., and son, of Ponta Delgada. The son, Sr. Deodato Soares, is an expert in re-

pairing radios and electrical equipment of all sorts. He also acts as announcer at the broadcasting station.

C.A. and West Indies

Radio Fort de France, 9450 kc., Martinique, is not being heard. The Department of Commerce bulletin states that this station has an assigned frequency of 7000 kc., and power of 200 watts, and further adds that it is reported that station has ordered new 1-kw. equipment.

ZIK2, Beliza, British Honduras, heard testing and broadcasting close to 10590 kc., 7:09 to 7:33 p.m. recently. Musical program of local talent and recordings. Station announced they would be on the air again on Monday at 6:30 p. m.

HID, 9505 kc., Ciudad Trujillo, Dominican Republic, is the latest new station to be heard in that country. It broadcasts early evenings and signs with the National Anthem either at 8:40 or 9:40 p.m. Station is maintaining a fairly good signal.

HH3W, 9645 kc., Port-au-Prince, Haiti, uses 4 chime notes preceding station announcements each fifteen minutes. The siren heard is used only before one special advertisement, which is made every fifteen minutes.

HI1A, 6190 kc., Santiago de los Caballeros, Dom. Rep., has a new time schedule. On Thursdays and Sundays this station presents the Duarte Park Municipal band concert from 7:40 to 9:40 p.m.

The call letters and assigned frequency of the Mexican station operating near 7100 kc., has not yet been learned. For details available see page 578 November ALL-WAVE RADIO.

TGWA, 9450 kc., Guatemala City, Guatemala, is evidently out of the picture, as the new 10-kw. station is on the

air with a wonderful signal. They have tested and announced frequencies of 11760 kc., and 9685 kc. It is said that assigned frequencies are 9725, 11760, 15170 and 17080 kc., but this statement has not been verified. We have listed TGWA on 9685 and 11760 kc.

YSM, 11710 kc., and YSD, 7894 kc., San Salvador, El Salvador, now have regular schedule which is shown in station list. As no schedule was given for YSH on 9520 kc., it is assumed this station will be used irregularly. The transmitter in use is Western Electric 14-C, 400 watts output and half-wave antenna.

TG2, 6310 kc., Guatemala City, Guatemala, is still retained in station list on same frequency as no definite advice of its new frequency has been received.

YNRG, 6325 kc., Managua, Nicaragua mentioned in this section in November and in non-authenticated block in same issue, is probably YNLG, which has been changed from 8505 kc.

TI2RS, 6900 kc., San Jose, Costa Rica, is listed in this issue. Station known as "Radioemisora Athena" and operated by Rogelia Sotela, Proprietor.

HP5A, 11700 kc., Panama City, Panama, now has correct schedule of time on the air. Excellent programs are transmitted. Station employs a Collins transmitter with 600 watts instead of 500 watts as first reported.

COKE or COKC may be the call of the new Cuban station being heard from 8900 to 9000 kc. All seem agreed that its location is Havana. The interference from code is rather strong at this point, which makes it difficult to identify the station.

U. S. Stations

W4XB, 6040 kc., Miami, Florida, has not as yet been heard, at least no reports have been received, although the last report from station was to the effect it would again be on the air not later than September 15th.

W1XAL is transmitting its regular program material on 15250, 11790 and 6040 kc.

W2XE has a new frequency—9590 kc. This station is authorized to share time with W3XAU but frequency is not being used at the present.

W1XK, 9570 kc., Boston, advises that station does not issue verification cards, and, as a general statement, does not verify reception reports unless such reports are more or less outstanding, or from individuals who have, by their letters, given information which is of definite value. But from reports received verification cards have been issued and at late dates.

W2XDV, 31600 kc., 50-watt experimental ultra-high-frequency broadcast station, relaying the programs of WABC, Columbia Broadcasting System, has been added to list. W2XDV is located in the CBS Building, New York, N. Y. It is licensed also to operate on 35600, 38600 and 41000 kc., but is using only the 31600 frequency at present.

W2XHG, 41000 kc., and W2XDG, 38650 kc., ultra-high-frequency broadcast stations of the National Broadcasting Company have been added to station lists. These stations are located on top of the RCA Building in New York City with an elevation of approximately 830 feet. The power radiated is 100

DECEMBER ACE REPORTERS

- L. P. Ambrosius, Louisville, Ky.
- Paul J. Barter, Melrose, Mass.
- W. E. Blanchard, W3E1, Bangor, Maine
- T. G. Brawley, W9J6, Greenville, Ohio
- Ernest Curry, W4F9, Pittsfield, Mass.
- Frank R. Dryden, Houston, Texas
- Zygmunt Drega, W3F27, Ware, Mass.
- J. L. Everett, V37F3, Toronto, Ont., Canada
- G. C. Gallagher, San Francisco, Calif.
- Frank J. Gleeson, F12S1, New Orleans, La.
- E. G. Granger, W5F2, Syracuse, New York
- D. C. Greenwood, W3G13, East Longmeadow, Mass.
- Edgar H. Grossman, VE29A3, Vancouver, B. C., Canada
- R. Jones, W8J1, Coshocton, Ohio
- M. E. Leshner, W3F32, Lawrence, Mass.
- Arthur Maitland, New York City, N. Y.
- H. M. McIntyre, W11H28, Harvey, Ill.
- Anthony L. Okolish, Barberton, Ohio
- R. B. Oxrieder, W6H5, State College, Pa.
- John Pollack, Brooklyn, N. Y.
- J. A. Piechuta, W3G14, Meriden, Conn.
- J. W. Partner, W29C1, Tacoma, Wash.
- Harry G. Runyon, W4H38, Berneville, N. J.
- George C. Starry, W7J12, Derry, Penna.
- R. Simpson, VK3, Concord West, Australia
- Theodore C. Smith, Ogdensburg, New York
- Shiko Tahara, Compton, Calif.
- P. E. Thompson, New York City, N. Y.
- Harold I. Tucker, W4G20, West Point, New York
- W. J. Thomas, W5J4, Ashton, Md.
- J. M. Unkefer, W8H14, Minerva, Ohio
- A. Velasco, Mexico City, Mexico
- Roy Waite, W4F11, Ballston Spa, New York
- H. Wilson, Jr., Ithaca, New York
- Mr. & Mrs. R. E. Weikals, Pratt, Kansas
- C. R. Wilson, W3E3, Portland, Me.

Radiodifusora Maracaibo

(EX Y V 7 R M O)

Y V I R D	P. O. BOX	Y V I R D
6070a.	100	1153 Kc.

Maracaibo, Venezuela, S. A.

Agradecemos su caluroso reportaje de nuestro programa de
 -193- y gustosos verificamos su
 exactitud, rogándole se sirva reportarnos nuevamente.

YVIRD

We are glad to send you this QCC card verifying your appreciated report of our program dated January 30th 1937. We thank you and will be glad to receive new reports again.

Maracaibo: April 24th 1937

Luis Mantellini, hijo (L. reporter owner)

Radiodifusora Maracaibo veri. Call in red, printing in blue.

watts which gives a fairly good coverage over Metropolitan New York.

Canadians

CJRX, 11720 kc., and CJRO, 6150 kc., advise they are still operating simultaneously on these frequencies from the Royal Alexandria Hotel in Winnipeg, Manitoba, Canada. New time schedule in this issue.

VE9CA, 6030 kc., Calgary, Alberta, Canada, advises there is no change in schedule as listed. Radio VE9CA relays all the regular programs of long-wave station CF6N at Calgary.

CRCX, 6090 kc., Bowmanville, Ont., Canada states that at the present time
 (Continued on page 670)

Channel Echoes

By ZEH BOUCK

IT'S ABOUT time something were done concerning the inane laughter which provides additional pollution to so many of the programs featuring our so-called comedians. Doubtless many readers have wondered at the consistent collection of imbeciles which the broadcasters accumulate for studio audiences — congregations of morons who laugh uproariously at the most stupid *witlessism* . . . pale ghosts of jokes that leave you, in front of the loud speaker, with about as much inclination to laugh as a Green mask for Anguish. We hasten to assure you that this is no fault of the studio audience — except to the extent of following instructions. They laugh when the program director holds up a big sign that reads "LAUGH" — which he does every time the word "laugh" is written into the script.

This business started back around a decade ago when comedians were running short of gags. The jokes were so bad that the radio audience rightly kicked about the programs. The comedians tried to improve upon their lines — but as the majority of them were as stupid as they sounded (then and now) few of them could concoct a joke that really rippled the midriff. The professional gagmen, patterning their efforts on the past style of the comedians, were of little assistance. Finally some bright lad had the inspiration to revoke the then universal rule of silence on the part of the studio audience. In fact he went the old order one better and commanded the audience to laugh at all jokes. Appreciating that it would be very difficult to tell what was a joke and what wasn't, the elementary but effective sign system was devised.

It worked like magic. An irate listener who ordinarily would have written a scoriating bit of sarcasm to the station concerning the quality of humor on the Whoosis Baker's Wisecracker Hour was nicely subdued, figuring that when so many people went into hysterics over the joke, he himself might be the one out of step.

The system is insidious and malicious. It has lowered the never very lofty standard of radio humor until it is somewhat less elevated than a snake's

WANTED—A PROGRAM PICKET . . . PUGS AND PLUGS . . . SCIENTIFIC LOGGING

shadow. Aside from the decreased protest on the part of the radio audience, the laughter of the studio clique convinces the would-be comedian that he is good — despite the fact that he is of course aware that it is command laughter. He, his gagmen and script writers make no effort to improve upon his technique and gags. On the stage — before an unprompted audience — the utter silence of his listeners, except for an occasional groan, would promptly force him to revise both or go out of business.

What to do? ALL-WAVE RADIO will present a life subscription to anyone who will make an adequate protest. It can be done very easily, and with a reasonable amount of dignity. Simply attend a broadcast as a studio guest. We'll personally be glad to supply you with tickets for any broadcast you feel worthy of this special attention. Take a seat up front. When the sign is raised "LAUGH," just yell at the top of your voice, "I won't laugh." Don't indulge in profanity, no matter how great the urge. That would be a serious federal offense, and we'd much rather send ALL-WAVE RADIO to you at your own home. You will of course immediately be escorted from the studio. Go without physical protest—but get in as many "I won't

laughs" as you can on the way out. Drop a letter to each of your local newspapers, explaining that you were ejected from such and such a studio — and tell why. Then send us a clipping and ALL-WAVE RADIO is yours until death do us part — one way or the other. Or better yet, let us know beforehand just what program you are going to picket and we'll be in front of the loudspeaker all ears.

ECHOES . . . The Colliers Hour . . . first, and for many years foremost among the dramatic hours. The accompanying photograph shows this old classic being rehearsed back in 1923. TEASER FOR THE MONTH: A free subscription to the first satisfactory explanation as to why this is a rehearsal and not a broadcast. This is one for old timers.

AND WHILE SPEAKING of free subscriptions, one goes to Allan B. Shaw, 3449 79th Street, Jackson Heights, N. Y., who nominates the "Lucky Strike Hit Parade" as radiodor for the month. He writes: "I consider the type of advertising on this program the lowest thing in all the major broadcasts. You say that Boake Carter's technique is bad. If so, Lucky Strike's is blasphemous!"

(Continued on page 670)



Rehearsing the Colliers Hour—an old time radio thriller—back in 1923. There's a catch in this picture for sleuths who will take time to read the accompanying paragraph.

Night-Owl Hoots

By RAY LA ROCQUE

THEY'RE off! We mean the DXers entered in this season's ALL-WAVE RADIO Championship Contest. This year's entries include practically all the leading DXers of North America as well as the defending champions—the 1936-37 winners! There is still time to enter, if you have not already done so. Late entries will be able to participate by reporting 20 stations instead of 10 during each semi-weekly period of competition until they have reported the same number of times as the charter entries. No new teams will be formed, but late entries may get an opportunity to be placed upon a team as a substitute for some DXer who has found it impossible to keep step with the others. So, if you are interested in enjoying some fine competition among the cream of DXers, or if you merely want to have some good, clean fun, enroll now! The first scoring results will appear next month.

Monitor Verifying

The Chief Night Owl is in an argumentative mood, owlets—so it giffs an editorial. We simply want to take up the cudgel in defense of a few of the country's most prominent DXers, who have been accused, among other things, of ruining our favorite hobby. We refer to the unjust panning directed against the boys who are giving up much of their spare time in order to keep a log (or to

DX CONTEST UNDER WAY . . . MONITOR VERIES . . . CUBAN HETERODYNES . . . IDA STUNT . . . FCC FREQUENCY TEST PROGRAMS . . . AUSSIE AND ZEDDER CHANGES

New Stations		ZHL (IDA)	
—	Goerlitz, Germany 1231 kc. 5000	(1333)	-3000
—	Maridiaz, Colombia 1500 kc. —	(1080)	-100
—	El Poblado, Colombia 1370 kc. —	(670)	1000-7500
—	Saarbruecken, Germany	(1410)	100-500
—	1231 kc. 5000	(1440)	-100
—	22B (1120)	(1150)	200-1000
—	22B (1120)	(1120)	-1000
CBF	Vercheres, Quebec 910 kc. 50000	3BA (1320)	50-500
CMBL	Havana, Cuba 710 kc. 2500	3BO (970)	1000-200
CMCH	Havana, Cuba 1110 kc. 5000	3MB (1490)	-100
CMCM	Havana, Cuba 850 kc. 250	3HA (1010)	300-750
CMJQ	Camaguey, Cuba 1080 kc. 200	3YB (1210)	50-100
CMKS	Guantanamo, Cuba 960 kc. 60	3TR (1240)	500-100
YV5RS	Caracas, Venezuela 1300 kc. 2000	3SR (1260)	500-2000
3LK	Lubeck, Australia 1090 kc. 2000	3SH (1130)	50-100
4LG	Longreach, Australia 1100 kc. 300	3UL (1000)	100-200
4ZR	Roma, Australia 1450 kc. 100	4AY (860)	100-500
5DN	Adelaide, Australia 960 kc. 500	4MB (1060)	50-100
5SR	Adelaide, Australia 1340 kc. 100	4AK (1220)	1000-500
6PM	Freemantle, Australia 1390 kc. 100	4WK (1340)	50-100
7QT	Queenstown, Australia 900 kc. 100	5CL (730)	2000-4000
		5MU (1450)	200-100
		6KG (1210)	85-500
		7BU (660)	-100
		1-YX (880)	500-150
Frequency Changes		Location	
Gleiwitz, Ger.	2BH 1050-1060 kc.	—	(1195) Kaiserslautern to Freiburg, Ger.
1230-1231 kc.	2DU 1060-660 kc.	XELO	(670) Piedras Negras to Tiajuana, Mex.
Hamburg, Ger.	3AR 630-620 kc.	4ZC	(1280) Otago to Cromwell, N. Z.
900-904 kc.	3MA 900-1360 kc.		
Konigsburg, Ger.	3MB 1390-1490 kc.		
1348-1384 kc.	3YB 1270-1210 kc.		
CKY 910-960 kc.	4TO 1080-1160 kc.		
CMBC 850-640 kc.	4VL 1130-1430 kc.		
CMJ 1100-1110 kc.	4WK 1360-1340 kc.		
CMCU 1280-1290 kc.	5MU 1340-1450 kc.		
CMGF 1120-1150 kc.	7ZL 590-630 kc.		
CMHO 1070-1480 kc.	7NT 750-710 kc.		
CMK 640-730 kc.	7HT 1330-1080 kc.		
CRCM 910-1050 kc.	7BU 1390-660 kc.		
XEDP 610-1080 kc.	1-ZJ 1320-1310 kc.		
XELO 1110-670 kc.			
Power Changes		Delete	
Kassell, Ger.	(1195) 2000-500	CRCY (1420)	3HS (1370)
Konigsburg, Ger.	(1031) 10000-100000	2LV (880)	3YB (1060)
Magdeburg, Ger.	(1330) 2000-500	2TM (1490)	4GY (1420)
CMO (880)	2500-25000		
CMX (920)	1000-10000		
LS-11 (IDA) (1440)	700-60000		



Neat veri card from KWG, Stockton, California, sent along by Anthony C. Tarr to whom it belongs.

monitor as it is called) of certain stations maintaining a non-verifying policy. From these logs the boys are able to check reports that are submitted by DXers. Reports are then verified by means of an attractive card in which they have invested some of their spending money. That the boys ask a few pennies from the DXers to help defray this cost and the cost of postage is only fair. "A racket," someone has called it, but 'tis a darn poor paying racket, say we! If the boys do not spend twice the amount received, not to mention the time lost in performing this service, then we'll eat these words, letter for letter. We have only our noisiest jeers for a large broadcasting house (who refuse to spend any money or time on DXers themselves) that has publicly denounced these boys for trying to perform a service to DXers. They have tried to

stop them with threatening letters.

The fear that all DXers personally will try their hand at monitoring stations in order to make a little extra cash is just an unfounded one—for DXers still prefer to get their veries direct from the stations when possible. It is only in the case of non-verifying stations that the idea can be worked out and non-verifying stations on the broadcast band are too few to make the situation alarming. So we ask DXers and clubs to give a few cheers for these generous and helpful minded DXers—and to stand by them now as they stood by you when you needed that veri last season! Should we sit idling while our hobby is being controlled by a group of broadcasters who are not even mildly interested in the hobby and who have never contributed anything to its support? No says the chief. What do you say?

With the Night Owls

Choice selections from the Letters of the Month constitute the copy for this department. Instead of acknowledging all letters here, where space is valuable, the chief acknowledges all of them personally.

Richard Wright (W11H6), Chicago, Ill.: "Have heard XELO testing from Tiajuana on 670 kc. every morning about 1:30 a. m. WSIX now in Nashville is testing a new 250-watt xmitter." *Richard H. Cooper*, Kittanning, Penna.: "KSUN has long been among the stations that refuse to verify. I have recently arranged to furnish this station with a quantity of verification cards and they will now verify all correct reports that include a 3c stamp. Reports should be sent to David G. Karbach, the chief engineer at the station."

C. J. Cooper (VE29A2), Vancouver, B. C.: "The Canadian Broadcasting Commission's station CRCV has changed its call to CBR. Frequency—1100 kc.; power—5000 w.; schedule 8 a. m. to 11 p. m. They will verify correct reports."

Harry Honda, Los Angeles, Calif.: "Time on the air for the following Southwestern stations: XELO—670 kc. tests from 2 a. m. nightly. XEBG signs off at 1 a. m. daily."

Anthony C. Tarr, Seattle, Wash.: "Here's a new one: XEAU, 1310 kc., Tiajuana, Lower California, heard testing and requesting reports at 3:10 a. m. From the signals I would judge the power to be 250 or 500 watts."

Richard Wright (W11H6), Chicago, Ill.: "Recently heard a program over NBC-WENR in which there was an exchange of programs between TGW and NBC. Secretary of State Hull sent greetings to TGW and TGWA on completion of their new 10 kw. xmitter. Later I heard TGWA and they an-

nounced that TGW was operating on 1230 kc., not 1210 kc. as listed. I am compiling card catalog of transmitter locations. Anyone able to furnish information please forward to 2762 Harper Ave., Chicago."

Bill Stone, Toronto, Ontario: "CHWK, Chilliwack, B. C., 780 kc., will conduct a DX program for NNRC. According to arrangements between myself and the station this program will be conducted in the first Saturday of each month from 2:45-4 a. m."

Bill Stone, Toronto, Ontario: "You are mistaken regarding CRCT and CRCY not verifying. They both verified for me this week. CRCT sent back my own veri, CRCY sent one of theirs." (We're glad to know this, but are inclined to believe your veri is due entirely to local favoritism as they emphatically refused to check any contest reports last season and sent every one of them back without so much as com-

menting on them. Of course they may have changed their policy—we hope so.—The Chief.)

Isaac T. Davis, Elkhart, Texas: (Too late to be included in the regular forecast, come a few tips from Southwestern DXers from this correspondent.—The Chief) "XGOA—660 kc. should come in around R5, 5-7 a. m.; JOCK-1—730 kc., 4-7 a. m. R6; JOSK—740 kc., 4-7 a. m. R6; JOHK—770 kc., 4-7 a. m. R7; JOIK—810 kc., 5-7 a. m. R6.; JOBK—990 kc., 4-7 a. m., R6.; Munich, Germany—740 kc., 2-3 a. m., R6."

Kilocycling Around

It's mutiny, that's what it is! First the Cuban Radio Bureau flashes out the news of some important changes about to take place in Cuba—then the changes never materialize and we're stuck with them. CMBC was supposed to move from 630 to 850 kc., and CMK was to take over the 630 kc. channel leaving 730 kc. vacant. Before any changes take place a new one, CMCN, takes possession of 850 and both CMBC and CMK necessarily must remain on their original channels. Now what chance has the Chief of getting the Cuban listings correct, when press releases contradict each other as these do? . . . Here's one Cuban change which you can accept as authentic—it should be, as it was heard on the air over the stations concerned in the changes. The news is that CMQ's former transmitter is operating on 710 kc. under the call CMBL, the new CMQ with 25 kw. using the old 880 channel. These two stations, together with CLCQ, usually operate simultaneously as a local network . . . Another complicated situation has been cooked up in Cuba. A permit authorizes a Havana firm to operate a new station, CMCH, with 5 kw. on 1110 kc. CMCJ is now firmly entrenched on this channel and the Radio Bureau clearly (?) explains the situation by saying that the matter will have to be adjusted between the two stations. It's the Chief's opinion that CMCJ is not going to give up any of its money producing hours to a new station. The result will only be known by keeping tuned to 1110 kc. for the next few months.

A clipping sent to us by W. Hallgren (W31J6) of Santa Rosa, California, reveals the following method of airing news items used by the Santa Rosa *Press Democrat* and the Santa Rosa *Republican*. News flashes from both papers are relayed to Panama City and are broadcast over the air by announcer George Williams at HP5J. These programs occur every second and fourth Monday at 3:30 p. m. and the station's short-wave frequency of 9590 kc. enables the Santa Rosa residents to tune in on their local news via Panama! . . . By

ALL-WAVE RADIO'S Time Table of DX Programs (All schedules given in E. S. T.)

Specials

WEDNESDAY MORNING, DEC. 1	
WTOC Savannah, Ga.	1260 kc. 3:00-4:00
SATURDAY MORNING, DEC. 4	
CHWX Chilliwack, B. C. (NNRC)	780 kc. 2:45-4:00
SUNDAY MORNING, DEC. 5	
KOB Albuquerque, N. M. (IDA)	1180 kc. 3:00-4:00
WJBO Baton Rouge, La.	1120 kc. 2:00-4:00
THURSDAY MORNING, DEC. 9	
WHIS Bluefield, W. Va.	1410 kc. 2:30-3:30
WLLH Lowell, Mass.	1370 kc. 1:45-2:00
SUNDAY MORNING, DEC. 12	
CKWX Vancouver, B. C. (IDA)	1010 kc. 2:45-4:30
WFMD Frederick, Md.	900 kc. 2:00-5:00
THURSDAY MORNING, DEC. 23	
WJJD Chicago, Ill. (IDA)	1130 kc. 4:00-5:00
SUNDAY MORNING, DEC. 26	
WJBO Baton Rouge, La.	1120 kc. 2:00-4:00
WEDNESDAY MORNING, DEC. 29	
WTAM Cleveland, Ohio (IDA)	1070 kc. 3:00-4:00
FRIDAY MORNING, DEC. 31	
WEAU Columbus, Ohio	1050 kc. 5:30-6:00
WLLH Lowell, Mass.	1370 kc. 1:00-1:15
Regulars	
EVERY SATURDAY MORNING	
KRLC Lewiston, Idaho	1390 kc. 3:00-4:00
EVERY SUNDAY MORNING	
KMTR Los Angeles, Calif.	570 kc. 12:00-12:30
TGW Guatamala City, Guatamala	1230 kc. 12:00-6:00

the way, you'll notice many changes in Australia and New Zealand of late. Our thanks to G. E. Botts of New Zealand for furnishing us with a revised list. Besides those stations listed in the deleted section of the changes, the following commercial stations have been sold to the government and will undoubtedly be closed down: 4ZO (1010), 4ZR (1340), 2ZM (1150), 2ZD (1170), 2ZH (820), 2ZR (920), 2ZF (960), 2ZP (900), 3ZM (1470) and 3ZR (940) . . . If you miss the NNRC special broadcast from WFMD in Frederick, Md., on the 12th, then you can just about say you've missed the

best program of the year. It's to be another of those super-colossal specials put on by the Baltimore boys and they'll do everything from razzing the other chapters to singing Christmas Carols! The station will have its usual supply of recordings on hand, but once the boys get hold of the mike—it's the gate for those canned artists. Souvenirs will go to everyone reporting and prizes will be given so many. So, Night Owls, 'tis 900 kc. on the morning of December 12 for the potentially best program of the season!

Now that WCAL and WLB have obtained permission to move to 760 kc.,

WTCN will have full time privileges on 1250 kc. . . For the benefit of those who have asked and those who are wondering whether the FCC frequency test programs will count in the new contest this year—we reply very decidedly in the affirmative. Just in case you did not already know it, these tests are conducted during the second week of each month. Below we list the Monday and Tuesday morning tests. Tests for the rest of the week will appear in succeeding issues of AWR.

ALL-WAVE RADIO'S DX FORECAST FOR DECEMBER

EASTERN NORTH AMERICA

General Forecast: This is the month for Europeans. There may be a few TP's (very few) or more SA's, but efforts should be concentrated on the signals from across the Atlantic.

Specific Forecast

T.A. . . . 1st-31st, 12-3 a.m. and 5-7 p.m., R8. In short, don't be surprised at any signal that comes your way from this direction in December. Try every channel on which high-powered Europeans are located from midnight till 2:30 or 3 a.m. and from sunset till 6 or 7 p.m. Germans start at midnight, French and Italians around 1:45 or 2 a.m. 1st-31st, 5:30 to sunrise, R4 (maybe).

JOAK-2 870 kc. Our long shot prediction for this month. We pick the Jap over the Aussies and Zedders because the mid-winter months are not so favorable for reception from the down-under stations. The long nights make it easier for the signals to cover the distance from Nippon to the eastern shores. If you should wake up to find this Jap's signals, then also try for JOAK-1 (590), JBCK (850), and JOIK (810).

1070 kc. 1st-31st, 6-10 p.m., R8. We'll stick to last month's prediction and pick these other Argentines as well as LR1: LR3 (1070), LR4 (990), LR5 (830), LR6 (870), LS2 (1190), LRA (750). And you might also try LS-11 (1440) who have just increased power.

PRE8 980 kc. 1st-31st, 6-8 p.m. R6. Good reception in localities remote from KDKA.

YV5RA 960 kc. 1st-31st, 5:30-10 p.m., R6. Best before XEAW signs on. While in Venezuela try for YV5RQ (882); and a new one, YV5RS (1300).

CMQ 880 kc. 1st-31st, sunset till 1 a.m., R9. This Cuban has been completely blotting out everything on 880. You cannot miss the new CMQ if reception is half-way decent. Rhumbas can also be heard over the following: CMX (920), CMBS (770), CMCF (815), CMBY (970), CMCI (1110), CMCO (1200), CMBC (630), CMCM (850), CMCY (570), and CMCX (1050).

XEW 890 kc. 1st-31st, 12-2 a.m., R8. Border stations using high power are considered locals and are not listed. In interior Mexico try for XEP (1160), XEK (990), XEMO (860), XEU (1010). Searching will reveal many more than we can list here.

XEFO 940 kc. 1st-31st, 1-2 a.m., R8. Daily program in English for American listeners.

TGW 1230 kc. 5th, 12th, 19th, 26th, 12-6 a.m., R7. Beg pardon folks, sorry to have caused you to lose any sleep over this one, but TGW has slipped one over on us and changed to 1230 kc. If you do not find them there—we'll give up forecasting Guatemalan reception!

TIPG 625 kc. 1st-31st, 7-12 p.m., R5. A good catch. Try sneaking in between 620 and 630 kc.—both very much overcrowded channels.

WKAQ 1240 kc. 1st-31st, 6-7 p.m., R7. Best just after sundown before locals get too strong.

WESTERN NORTH AMERICA

General Forecast: Aussies and Zedders will drop in signal strength this month, but Japs will be stronger and a few European's may show up. Latin Americans should continue to come in well.

Specific Forecast

4YA 790 kc. 1st-31st, 4-6:30 a.m., R7. Other Zedders easily heard: 1YA (650), 3YA (720), 2YC (840), 2YA (570). Those listed first are strongest.

JOAK-2 870 kc. 1st-31st, 5-7, R7. This one should be easy in December as well as many other Japs scattered over the band. Easiest heard stations shown in East Forecast.

4BH 1380 kc. 1st-31st, 5-6:30 unless otherwise stated, R6. This station, though not of very high power, is reported to be the most consistent Aussie in the west. Others which may be heard are:—R5: 4QN (600), 2CO (670), 2NR (770), 2BL (740), 4QG (800), 3GI (830), 2GZ (990) (till 6), 2KY (1040), 4AK (1220), 2CR (550), 3KZ (1180), 2CH (1190). R4 or less: 4BU (1480), 3BA (1320) (on at 5:30), 3DB (1030), 2GB (870), 5CL (730), 7NT (710) (on at 6), 2WL (1430) (on at 5:30), 3LK (1000), 3LO (770), and 5CK (640).

KGU 750 kc. 1st-31st, 3-5 a.m., R6. Other Hawaiians: KHBC (1400) 3-4:30 a.m., R7-8. KGMB (1320) 4-5:30 a.m., R7-8.

Rennes 1040 kc. 1st-31st, 2-3 a.m., R5. On occasions when reception from the east is good this one may be heard. Try Normandie on 1113 also.

YV5RA 960 kc. 1st-31st, R6. Just before XEAW comes on the air. Seldom reaches Northwest.

LR1 1070 kc. 1st-31st, 2-3 a.m., R6. Heard on occasional tests.

PRE8 980 kc. 1st-31st, 7-9 p.m., R7. Only in Southwest.

TGW 1230 kc. 5th, 12th, 19th, 26th, R5, 12-6 a.m. See East. Northwest DXers need not be too expectant.

WKAQ 1240 kc. 8th only, 2:40-3 a.m., R8 (weaker in Northwest).

WNEL 1290 kc. 11th only, 3:20-3:40 a.m., R8 (weaker in Northwest).

HAL 546 kc. 1st-31st, 6-7 a.m., R4. Here's our long shot for the West coast DXers. This station reported early in season by Northwest DXers. Signal evidently travels over the North Pole or takes an easterly route via Asia judging from the hour of reception. 100-1 you will not hear it, but it's worth trying anyhow.

XEC 1150 kc. 1st-31st, 12-1 a.m., R6. Announcements in Spanish. Mickey Mouse mentioned frequently in Spanish.

Every Second Monday	Every Second Tuesday
2:00 WLNH 1310 kc.	2:00 WBAX 1210 kc.
WJBO 1120 kc.	2:10 WDAS 1370 kc.
2:10 WBRB 1210 kc.	2:20 WBBL 1210 kc.
WHBB 1500 kc.	2:30 WFBG 1310 kc.
2:20 WMAS 1420 kc.	2:40 WMBG 1210 kc.
WIOD 1300 kc.	2:50 WEBR 1310 kc.
2:30 WWRL 1500 kc.	3:00 KDAL 1500 kc.
WJBW 1200 kc.	WLVA 1200 kc.
2:40 WOKO 1430 kc.	3:10 KPAC 1260 kc.
WMBR 1370 kc.	WBTM 1370 kc.
2:50 WCAH 1200 kc.	3:20 WKRC 550 kc.
WOP1 1500 kc.	WHFC 1430 kc.
3:00 WMBO 1310 kc.	3:30 WNAD 1010 kc.
WMSD 1420 kc.	WMBC 1420 kc.
3:10 WOC 1370 kc.	WRAC 1370 kc.
WCAD 1220 kc.	3:40 KFVS 1210 kc.
WMFN 1210 kc.	WJAC 1310 kc.
3:20 KWLC 1270 kc.	3:50 WTAW 1120 kc.
WMBQ 1500 kc.	WBNB 1430 kc.
WNBR 1430 kc.	WBNY 1370 kc.
3:30 KFPW 1210 kc.	4:00 WCOL 1210 kc.
WMFF 1310 kc.	WBRE 1310 kc.
WDBO 580 kc.	4:10 KLPB 1240 kc.
3:40 KABC 1420 kc.	WPAP 1420 kc.
WQDM 1390 kc.	WPAY 1370 kc.
WSMB 1320 kc.	4:20 KRMD 1310 kc.
3:50 WFAS 1210 kc.	WOMT 1210 kc.
WHEF 1500 kc.	WSYR 570 kc.
4:00 KFDM 560 kc.	4:30 KGCA 1270 kc.
RLS 1280 kc.	WJAY 610 kc.
WCAP 1280 kc.	WNBF 1500 kc.
WAGF 1370 kc.	4:40 KTEM 1370 kc.
4:10 KCRJ 1310 kc.	KGBU 900 kc.
KMLB 1200 kc.	WGH 1310 kc.
KVOS 1040 kc.	4:50 KGVO 1260 kc.
4:20 KLUF 1370 kc.	KRLH 1420 kc.
KGDM 1100 kc.	WHK 1390 kc.
WDEV 550 kc.	WWSW 1500 kc.
WDNC 1500 kc.	5:00 KGCC 1450 kc.
4:30 KROC 1310 kc.	KRMC 1370 kc.
KGAR 1370 kc.	WSPD 1340 kc.
KALB 1210 kc.	5:10 KAST 1370 kc.
4:40 KOVC 1500 kc.	KNET 1420 kc.
KROY 1210 kc.	WAVE 940 kc.
WBNO 1200 kc.	5:20 KCMO 1370 kc.
4:50 KEUB 1420 kc.	KFFJ 1210 kc.
KRE 1370 kc.	WXYZ 1240 kc.
WLAK 1310 kc.	5:30 KIDW 1420 kc.
5:00 KBST 1500 kc.	KPO 1500 kc.
KIEM 1450 kc.	WGAR 1450 kc.
WFOY 1210 kc.	5:40 KFIO 1120 kc.
5:10 KDON 1210 kc.	KOV 1380 kc.
WMIN 1370 kc.	WLAT 1200 kc.
WTAL 1310 kc.	5:50 KCAH 1210 kc.
5:20 KTRH 1290 kc.	KORE 1420 kc.
KUMA 1420 kc.	6:00 KOOS 1200 kc.
WATR 1250 kc.	WLRI 900 kc.
5:30 KFGQ 1370 kc.	
KWG 1200 kc.	
WGCM 1210 kc.	
5:40 KGMB 1320 kc.	
5:50 KGIO 1210 kc.	
KVCV 1200 kc.	
6:00 KHUR 1310 kc.	

The above listing shows the commencement time for each broadcast. Tests are all of 20 minutes duration and station announcements are made every three minutes.

Cheers and Jeers

Three cheers to the IDA for their original "Programs of the Week" idea. During the DX season stations will conduct programs of high entertainment quality for all DXers and listeners regardless of club affiliations. At the close of the season a \$10.00 cash prize will be given to the DXer who verifies the

(Continued on page 661)

Hamfest

By W8QMR ex-2PI • LU4S

SOME months ago we made a note to remind us to comment in this department on the excellent operating characteristics on the 80-meter c.w. band—quick, snappy calls, break-in operation, intelligent use of abbreviations, excellent fists and fast operating—not to mention good, clean notes and other factors contributing to efficient transmission. We take most of it back. The 80-meter band is no better nor worse than the others.

A few nights ago we were listening to W2GCE working W2ENZ—hearing only GCE's end of the conversation. It appears that ENZ—on a busman's holiday—is a commercial operator recently returned from the tropics. GCE remarked that it was a pleasure to work a commercial operator, and that while there were some good ops on 80, he was sick of the average run.

We check with GCE—100%. And we're not necessarily kicking about the beginner—the lad whose speed just tops 13 words per and whose fist, from professional standards, is about as awkward as a toddling infant. We were each a beginner once—and more power to him, if that's the only thing that's wrong with him. What we are kicking about is just plain lack of intelligence—interminable calls, and, still worse, interminable signs, unnecessary calls before and fol-

OT'S AND LIDS . . . W2AD . . . QSL CARDITIS . . . QSO'S ON SHARES

lowing each transmission, (after the QSO is under way) rotten chirpy notes—and what have you. Of course the majority of these attributes of sloppy operating are perpetrated by beginners. But we're wondering if we old timers are not to some extent responsible for their sins???

It's not much fun working a lid—we grant you. But if we are selfish enough to leave them to themselves—lid working lid and no one else—they will never see the errors of their ways, bad practices will become mutually standardized, and the ultimate product will be that least admirable of all operators, the fellow who has plenty of speed and ability but who simply hogs the air without rhyme, reason or the faintest idea that he is doing other than what all good operators should do! We can do a lot for the lid by precept. Make it a practice to work two or three beginners at every session in the shack. And, with the exception of speed, employ exactly the same technique you would in working an old timer. Give a short call and a shorter sign. Encourage the lad to break in on you. Go back at him again and again

without a lot of preliminary calling and signing—and conclude each transmission in the QSO with a simple AR K (or perhaps HW?—as the occasion calls for) rather than with a peroration of calls and signs (excepting of course once every fifteen minutes or so to conform with the FCC rules).

WE'VE WRITTEN ABOUT Andy Sannella before—but not about W2AD. As we recall it we said some nasty things about one of the programs with which he was associated — Lucky Strike, Campbell Soup or Rexall Drug Stores—in a fan column in the *New York Sun* a good many years back. (Which of course was no reflection on Andy.) Andy, as most of you know, is one of our ranking radio stars and orchestra leaders, plays a mean Hawaiian guitar and saxophone, and, incidentally, is no second fiddle on the bug.

Concerning W2AD, (photo on this page) Andy tells his own story—"Became interested in amateur radio about ten years ago, and started out with a 150-watt transmitter using a pair of 852s in the final of a bread-board layout. I've had several other transmitters which were built by friends who were also amateurs. Last year I purchased my Temco one-kilowatt transmitter from Mort Kahn (W2KR) and certainly have enjoyed it. I operate mostly on 20 meters, using a compromise 20-75-meter doublet, center fed with Bassett concentric cable. Have also operated on 40, 75 and 160 as occasions called for it.

"As to the bug on the table, it is authentic, as I do enjoy pounding brass. I venture to say that I work code more than fone. Of course, being in the musical profession, the fone comes in very handy with my professional friends. For, believe it or not, though these friends are radio stars and make their living in front of a microphone, they get a tremendous kick out of operating a ham station." (Just another bunch of busmen. Wonder if they ever get mike fright at W2AD?)

(Continued on page 668)



Andy Sannella, orchestra leader par excellence, and owner and operator of amateur station W2AD, Hartsdale, New York.

A PROVING-POST REVIEW

The MB-100 C.W. KIT TRANSMITTER

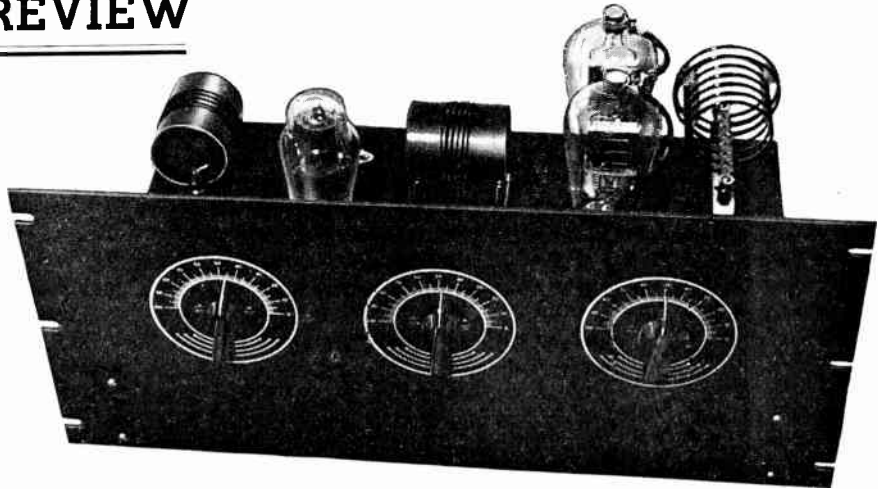

THE present reviewer does not have to delve very far back into memory to recall the days when 50 watts was considered reasonably good power and represented an outlay of about \$75.00 for the transmitter proper and about the same for a motor generator delivering some 1500 volts of

plate supply. The MB-100 does considerably better than that so far as power is concerned, and the cost, including tubes and crystal, should be under \$30.00. The power supply is extra, and the price will vary with the desired power output, which can be pushed to as high as 175 watts! For lower powers — in the neighborhood of 80 watts input

to the finals, such as was employed in the transmitter under test at the Proving Post—standard receiving parts can be used, and the cost of the power supply, complete with rectifier, should be under twelve dollars. Thus the MB-100 is an ideal recommendation for the beginner, who is usually somewhat limited in reference to the exchequer and who will have the advantage of considerably more power than that usually available to the amateur newcomer at no greater than the average cost for lower-power rigs. At the same time, the MB-100 is altogether adequate for the established amateur, and its low cost in no way affects the excellent manner in which it fulfills his exacting requirements. During the two months this transmitter was on test in the Proving Post, it was used consistently on 80 meters, operating on all schedules of the ENY net of the AARS, and provided one hundred per cent reliable service in traffic handling and drills. Reports were usually R7 and R8, occasionally R9, and always T9X.

A Kit Transmitter

The MB-100 is available in stripped kit form from the M & H Sporting Goods Company, Philadelphia, Pa. The kit includes a drilled chassis and all essential parts, less meters, tubes, crystal and power supply. It can readily be assembled in a few hours of pleasant labor. The transmitter received at this laboratory was equipped with a rack type panel which is nicely adapted to the beginner and the desirability of a commercial appearing job for the old timer. The rack and panel design provides for flexibility, and additional units — high power stage, modulator, etc. — can be added at a later date.

For the beginner, a wooden rack is

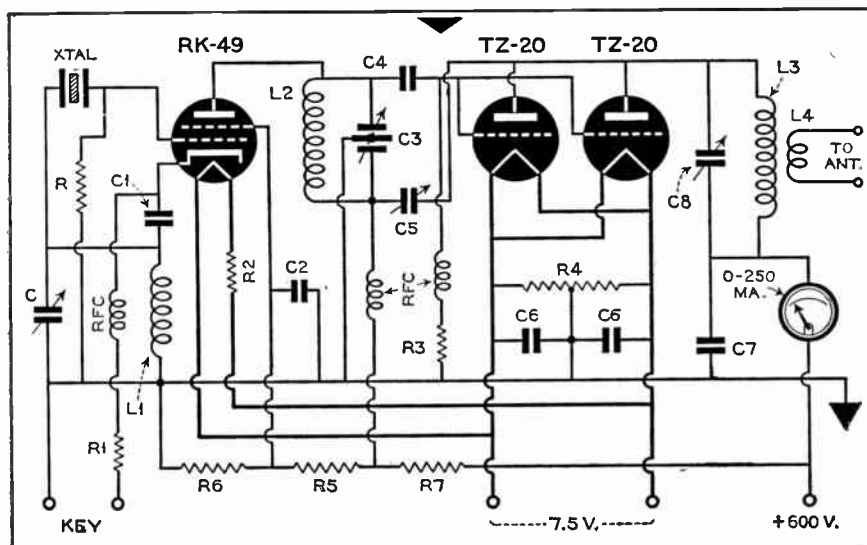

Fig. 2. Circuit diagram of the MB-100 transmitter. The TZ-20s are easily driven without use of a buffer stage.

KEY TO PARTS

R—25,000 ohms, 1 watt
R1—400 ohms, 2 watts
R2—1 ohm, 10 watts
R3—2000 ohms, 10 watts
R4—50 ohms, center tapped, 2 watts
R5—12,500 ohms, 10 watts
R6—17,500 ohms, 10 watts
R7—1500 ohms, 10 watts
RFC—(3 required) 2.5 mh.
C—150 mmfd.
C1—.002 mfd. 1000 volts
C2—.002 mfd. 600 volts
C3—100 mmfd. dual

C4—.0001 mfd.
C5—15 mmfd.
C6—(two required) .002 mfd.
C7—.002 mfd. 1000 volts
C8—100 mmfd.

Miscellaneous

6—large jack type feed-through insulators
6—small feed-through insulators
5—clip tite sockets
2—large plate clips
1—drilled chassis, 17 x 10 x 3 inches
1—8¾ x 19 inches relay rack panel
3—2¼ inch bar knobs
3—3½-inch dial plates

TABLE I

BAND	XTAL	COILS		
		Osc. Cath	Osc. Plate	Final
160	160	shorted	55 turns, 2"	160B*
80	80	shorted	29 turns, 2"	80B*
40	80	14 turns,	14 turns, 2"	40B*
40	40	shorted	14 turns, 2"	40B*
20	40	7 turns, 2"	7 turns, 2"	20B*
10	20	4 turns, 1½"	5 turns, 1½"	4 turns, 1½"

* Barker and Williamson type numbers.

suggested such as that shown in Fig. 1. The cost is negligible and it can be discarded later on when additional units are designed for standard relay rack mounting. The power supply sits on the table under the transmitter. While the most convenient power supply available was used at the Proving Post, it is suggested that the amateur construct his own on a rack panel, which can then be mounted directly under the transmitter on the same wooden rack. Logically and conveniently, the power supply panel can be dressed up a bit with the very essential plate milliammeter. (Plate current to the finals only. There is little necessity of a meter in the RK49 plate circuit as the bias resistor tends to keep the plate current constant, and there is relatively little dip at resonance.)

As will be observed in the wiring diagram, Fig. 2, the antenna is coupled to the tank coil without any special antenna coupling system. This is the easiest way of doing the job, and highly effective. A twisted transmission line is used — such as EO-1 cable, Lynch Giant-Killer, or Bassett concentric feeder. No condensers, transmission line spacers, or other complications are required.

However, the number of turns provided on the coupling coil, L4, may not be sufficient to load the TZ-20s which should draw from about 125 milliamperes up — depending upon the plate voltage. Under such circumstances, additional turns should be added to L4 which in the stock coil is a simple 2-turn link.

In adding these turns, some form of radiation indicator is desirable. A standard 115-volt, 75-watt lamp works out nicely, and with 80 watts input this will light up to a medium brilliancy. It should be disconnected (shorted) when the proper number of turns on L4 is determined and the tank condenser retuned slightly for maximum dip. The additional turns on L4 can be conveniently wound with No. 18 bell wire directly over the spaces in L3. Be sure to wind and connect in the same direction. Incidentally, no jacks were provided for the banana plugs on L4. The same holds for antenna posts. We used loose jacks and wired them with short lengths of

flexible wire to the stand-off insulators (antenna posts) on the side of the wooden rack. Only two of the three stand-offs are generally used — the third merely providing a connection to a radiation indicating device when employed.

The Circuit

The oscillator will be recognized as a slightly modified tri-tet. For harmonic operation, the cathode coil, L1, is tuned by condenser C. When operating on the fundamentals, C is shorted by turning to full capacity, the tip of a rotor plate being bent to scrape the stator. The RK-49 oscillator is a somewhat exalted 6L6G with an isolantite base. The oscillator tank coil, L2, is tuned with the split-stator condenser C3, the r. f. voltage being perfectly balanced to provide satisfactory neutralization to the TZ-20s in parallel through C5. In practice neutralization is constant and readily obtained with the usual neon lamp technique.

The zero bias TZ-20s are exceedingly easy to drive, and the output of the RK-49 is altogether adequate for this purpose.

Coil Data

While the transmitter on test was used exclusively on 80-meter c. w. there is no reason why comparable efficiency should not be secured on other bands. The recommended data is given in Table I.

The gauge of wire used to wind the coils is not critical. Enamel wire is preferred, and in general No. 26 may be used for 160 meters, No. 22 for 80 meters and No. 18 for the balance.

Efficiency, Output and Operating Voltages

The efficiency obtainable with this transmitter is excellent and varies from 70 to almost 90 percent, depending upon the plate voltage available and other operating conditions.

With a plate potential of 500 volts, 87.5 watts can be fed to the finals with an output of 63.75 watts. With 600 volts, the input is raised to slightly over 100 watts and the output to 75 watts. This is about as high as it is desirable to go with the zero bias TZ-20 tubes without some form of external bias. Employing self-bias across a 400-ohm resistor, the plate voltage can be raised to about 700, inputting 143 watts for a 100-watt output.

The efficiency rises with the plate potential, but at higher voltages battery bias is desirable if the oscillator is keyed. With a plate potential of 1040 volts and a fixed bias permitting 190 milliamperes to the finals, the input is 196 watts, the output 175 watts (we're getting into real power now) and the efficiency 87.5 percent.

As will be noted from the diagram, the transmitter is keyed in the oscil-

(Continued on page 661)

Fig. 1. An economical arrangement for an economy transmitter. Also both neat and effective. The wooden relay rack can be discarded later when additional units are built up.

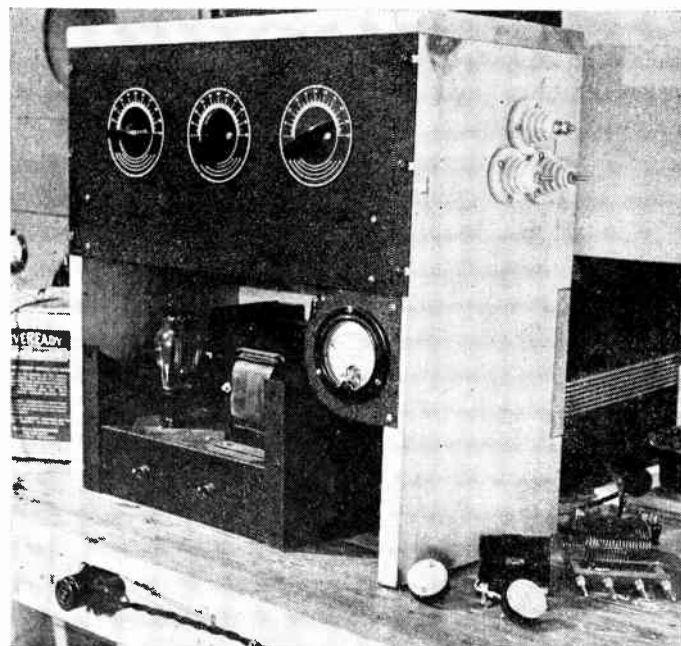

RADIO SIGNAL SURVEY LEAGUE NEWS

THE signal survey on station WANC terminates December 1st. All members who monitored this station and have not as yet sent in their reports are requested to do so as soon after this date as possible. As usual, reports should be sent to Sectional Managers, or direct to headquarters in the event no Manager has been appointed in your territory.

Communications

Sectional Managers, who serve the League without pay, are in some instances being put to unnecessary expense in handling letters from applicants. We greatly appreciate the endeavors of all members in obtaining recruits, but it is urgently requested that applicants be referred to headquarters rather than to the Sectional Manager in their locality. This procedure will ease matters considerably and at the same time expedite the handling of new applications.

Monitoring Station Identifications

C. D. Jaffe, W5L2, Algonquin Park, Norfolk, Va., and others, have brought up a point with regard to R.S.S.L. Monitoring Station "calls" that we believe should be aired and commented upon. As Mr. Jaffe points out; "Since the calls issued to individual members by the League do not correspond to the U. S. Amateur call areas or districts, they often prove confusing to foreign amateurs and others to whom signal reports are sent." For instance, Mr. Jaffe is located in the 3rd U. S. Radio District where amateur and experimental station calls carry the prefix W3. On the other hand, his R.S.S.L. Monitor Station Identification is W5L2 . . . the "W5" suggesting the 5th call area.

Mr. Jaffe suggests as a solution to the problem the changing of all R.S.S.L. Monitoring Station Identifications to coincide with the U. S. call areas, or use, in the case of the United States, the prefix W10.

The proposals are worthy of serious consideration, so let us review possible objections. First of all, numerous R.S.S.L. members have had cards printed carrying their Monitoring Station Identifications, and a change would require the scrapping of these cards or the imprinting of a new identification. Second, too close a similarity between amateur station calls and R.S.S.L. Monitoring Station Identifications would be just as confusing and rather unethical to boot.

The use of the prefix W10 is ruled out since this is assigned by the government to experimental stations, expeditions, etc. It might be explained again that the

Monitoring Station Identifications issued by the League have definite geographical significance. The first letter or letters, (Continued on page 666)

NEW R.S.S.L. MEMBERS

CALIFORNIA

Leslie Bud King, Arcadia—W29N8
Stanley L. Bruce, Burlingame—W31J14
William W. Cloud, Long Beach—W29N9
Elmer Patrick, Maywood—W29M28
Kenneth Knutson, Pasadena—W29M29
John A. Gilmont, Jr., San Francisco—W31J15
Myron Huebler, San Francisco—W31J16

CONNECTICUT

Louis Kuslan, West Haven—W4G22

IDAHO

LeRoy Earl Jones, Pocatello—W25G1

ILLINOIS

Clarence Streck, Belleville—W13L11
Wallace Grove, Chicago—W11H52
Norbert C. Fortman, Chicago—W11H51
Walter B. Roetter, Highland Park—W12H7
James Hall, Litchfield—W12K6
Peter J. Massey, Jr., River Forest—W12H8

INDIANA

Michael Gajdos, East Chicago—W11H53

IOWA

Henry C. Hendrickson, Jr., McGregor—W13G2

KANSAS

Dick Cahill, Salina—W17H1

KENTUCKY

Gilbert Everett Fuller, Ft. Mitchell—W10K14

LOUISIANA

J. I. Vaught, New Orleans—W12S2

MAINE

Eugene Howard Herrick, Rangeley Lakes—W3D1
Harold Cole, Saco—W3E9

MARYLAND

Bernard Farace, Baltimore—W5J19
Joseph Lenoir, Baltimore—W5J20
James Reed Coale, Baltimore—W5J21
Robert H. Willner, Baltimore—W5J22

MASSACHUSETTS

Preston Hicks, Belmont—W3F61
Cecil Kent Drinker, Jr., Brookline—W3F63
J. Gorham Underhill, North Attleboro—W3F62

MICHIGAN

I Herman J. Pfeiffer, Jr., Detroit—W9G16
James Brager, Jackson—W9J20
Paul J. Ambrose, Jackson—W10H14
Ralph Horton, Jackson—W10H15

MINNESOTA

Charles M. Johnson, Annandale—W15F3

MISSISSIPPI

Warren O. Parkerson, Indianola—W13P2

MISSOURI

Wallace W. Johnston, Kirkwood—W13L12
Charles A. Parrish, Jr., St. Louis—W13L13
O. C. Von Burg, St. Louis—W13L14

NEW JERSEY

G. Albert Rhoads, Jr., Haddon Heights—W4H163
Morgan T. Kennedy, Oaklyn—W4H162
Israel Sinofsky, Passaic—W4H153
John Csubak, Woodbridge—W4H168

NEW YORK

Sidney Wolkin, Brooklyn—W4H160
Bernard N. Gensler, Brooklyn—W4H155
Edward Badwick, Brooklyn—W4H154
Sam Horowitz, Brooklyn—W4H156
William Raymond Goetz, Brooklyn—W4H161
Wilson Walter Streeter, Brooklyn—W4H159
Max Levine, Brooklyn—W4H152
Charles F. Dieter, Jr., Brooklyn—W4H167
Curtis Nickerson, Binghamton—W5G4

Donald L. Williams, Jordan—W5F9
Theodore C. Smith, Ogdensburg—W5F8

OHIO

Lowell A. Dittmer, Dayton—W9J19
Robert Carlton Fleischman, Dayton—W9J18
Wilson R. Scott, Dayton—W9J17
Wilbur Neff Nungesser, Portsmouth—W9K2
Stanley B. Dickerson, Springfield—W9J21
Lee Kemberling, Toledo—W9H7
William Carl Noltemeyer, Trilby—W9H8

OKLAHOMA

R. M. Farnam, Ponca City—W17M4

PENNSYLVANIA

James Clifford Rill, Lancaster—W5H13
Jack Haberman, Philadelphia—W4H165
James Garfield Shock, Jr., Philadelphia—W4H169
Howard L. Dutkin, Philadelphia—W4H158
Marcella T. Dutkin, Philadelphia—W4H157
Rudolph R. Sutter, Philadelphia—W4H166
George F. Kline, Jr., Williamsport—W4H164

RHODE ISLAND

George Charles Onoyan, Cranston—W3G29

SOUTH CAROLINA

Larry S. Hatfield, Florence—W6N1

WASHINGTON

Dennis Fenno, Anacortes—W29B9
Robert Mack Bissell, Tacoma—W29C4

WYOMING

C. H. Johnson, Casper—W21G1

NEW FOREIGN MEMBERS

CANADA

Emanuel H. Manning, Edmonton, Alberta—VE24A9
Donald Gordon, Edmonton, Alberta—VE24A6
Harold Leslie Ray, Edmonton, Alberta—VE24A7
Paul A. Green, Edmonton, Alberta—VE24A8
William C. Buchanan, Sydney, Nova Scotia—VE1B1
James Pratt, London, Ontario—VE8G7

ENGLAND

William Isaacs, Bucks—G33
Norman Owen, Brighton, Sussex—G34
Laurence F. J. Hobden, Brighton, Sussex—G35
James Philip Barnes, Faversham, Kent—G36
William James Croft, Bristol, Glos.—G37
William Douglas Andrews, Chepstow, Monmouthshire—G38
Percy Keneally, Manchester, Lancashire—G39
John Terence Anglin, Grimsby, Lincolnshire—G40
Harold Willets, Bolton, Lancashire—G41
Percival Royston Dinham, Bristol—G42
George Ludkin, Chepstow, Monmouthshire—G43
Charles Frederick Biggs, Tottenham, London—G44
Ernest Wright, Liverpool, Lancs.—G45
Leonard Sidney Wright, Liverpool, Lancs.—G46
Stanley R. Price, Dorchester, Dorset—G47
Edward R. Crane, London—G48
Kenneth Bertram Michaelson, London—G49
Leonard James Marsh, Portsmouth, Hants—G50
George W. King, Liverpool, Lancashire—G51
Joseph George Christmas, Bristol—G52
Reginald McDonald, Plaistow, West Ham.—G53
Francis William Moore, Devon—G54
Roland Thomas Wiggins, Newbury Park, Essex—G55
Desmond Alimundo, Manchester—G56

SCOTLAND

Alan Owen, Inverness, Inverness-shire—G32

NOTES ON THE WIDE-RANGE SYSTEM

DETECTOR STABILIZATION • ADDING INVERSE FEEDBACK • BASS BOOST

AN unusual amount of interest has been shown in the articles by Watzel and Bohlen on Wide-Range Music for the Home, which appeared in the September and October issues of ALL-WAVE RADIO. Which naturally leaves the impression that "high fidelity" is far from being a dead issue. Moreover, the number of letters received, and their nature, suggest that additional notes on the system would be welcomed. Therefore we shall cover in this article the various points brought up by readers, and at the same time deal with a few simple alterations that can be made in the original job that will improve overall results.

The Tuner

Presumably some difficulty has been experienced in obtaining through the usual dealer channels the type 1501 antenna transformer, L, specified in the original article. This transformer may be replaced by the Aladdin type 502

which will function equally as well, and is carried by the average radio dealer.

Because the infinite-impedance detector introduces a negative resistance in its grid circuit, difficulty is apt to be experienced from oscillation. Moreover, as previously brought out by Watzel and Bohlen, hum may be introduced into the amplifier if the infinite-impedance detector tube has appreciable heater-cathode leakage. After some research it has been found that oscillation can be eliminated, and hum greatly reduced in a leaky tube, by the introduction of a filter in the plate circuit. This filter is shown in the accompanying schematic diagram and is composed of the resistor, R9, of 10,000 ohms value, in series with the plate circuit of the 6C5 detector tube, and the 0.1-mfd. bypass condenser, C8, connected from plate to chassis. It is recommended that this addition be made.

All other component values in the tuner remain the same as originally speci-

fied, but are repeated in the accompanying list of parts for your convenience.

The Power Supply

A type 80 rectifier was specified in the original article. This tube is satisfactory for the purpose, but considering subsequent alterations depicted in the accompanying schematic diagram, all of which are highly recommended, it is suggested that the 80 tube be replaced with a type 5Z3. The 5Z3 is interchangeable with the 80, so no circuit changes are required.

Condenser input was specified in the original article. With the addition of inverse feedback—to be explained presently—and the advantages of operating the amplifier at a slightly lower voltage, the input condenser, C17, in the original diagram can be put to better use.

It will be seen from the diagram on this page that choke input is employed.

(Continued on page 650)

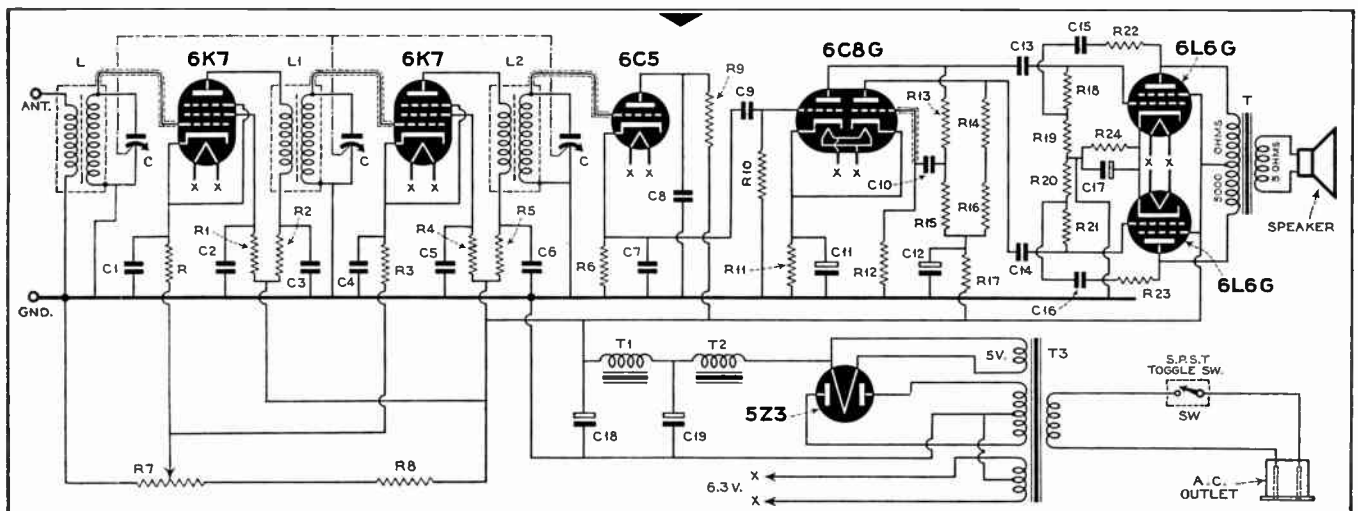

Revised schematic diagram of the Wide-Range System without volume expander, and including tone-compensated inverse feedback, balanced phase inverter and stabilized infinite-impedance detector.

- L —Aladdin type 502 ant. trans.
- L1 —Aladdin type 3001 interstage trans.
- L2 —Aladdin type 3001 interstage trans.
- T —UTC type LS-55 output trans.
- T1 —UTC type CS-301 filter choke
- T2 —UTC type CS-301 filter choke
- T3 —UTC type UH-6 power trans.
- R —IRC 350 ohms, ½ watt
- R1 —IRC 100,000 ohms, ½ watt
- R2 —IRC 2000 ohms, ½ watt
- R3 —IRC 350 ohms, ½ watt
- R4 —IRC 350 ohms, ½ watt
- R5 —IRC 2000 ohms, ½ watt
- R6 —IRC 100,000 ohms; ½ watt
- R7 —Yaxley 50,000-ohm pot.
- R8 —IRC 50,000 ohms, 1 watt
- R9 —IRC 10,000 ohms, ½ watt
- R10 —IRC 250,000 ohms, ½ watt

- R11 —IRC 1500 ohms, ½ watt
- R12 —IRC 50,000 ohms, ½ watt
- R13 —IRC 100,000 ohms, ½ watt
- R14 —IRC 100,000 ohms, ½ watt
- R15 —IRC 10,000 ohms, ½ watt
- R16 —IRC 10,000 ohms, ½ watt
- R17 —IRC 10,000 ohms, 2 watts
- R18 —IRC 75,000 ohms, ½ watt
- R19 —IRC 5000 ohms, ½ watt
- R20 —IRC 5000 ohms, ½ watt
- R21 —IRC 75,000 ohms, ½ watt
- R22 —IRC 50,000 ohms, ½ watt
- R23 —IRC 50,000 ohms, ½ watt
- R24 —Ward Leonard 200 ohms, 25 watts, wire wound
- C —Variable gang condenser, .000365 mfd.
- C1 —C-D .1 mfd., 400 v.
- C2 —C-D .1 mfd., 400 v.

- C3 —C-D .1 mfd., 400 v.
- C4 —C-D .1 mfd., 400 v.
- C5 —C-D .1 mfd., 400 v.
- C6 —C-D .1 mfd., 400 v.
- C7 —C-D .0001 mfd. mica
- C8 —C-D .1 mfd., 400 v.
- C9 —C-D .1 mfd., 400 v.
- C10 —C-D .1 mfd., 400 v.
- C11 —C-D 25 mfd., 25 v. elect.
- C12 —C-D 8 mfd., 475 v. elect.
- C13 —C-D .1 mfd., 400 v.
- C14 —C-D .1 mfd., 400 v.
- C15 —C-D .1 mfd., 400 v.
- C16 —C-D .1 mfd., 400 v.
- C17 —C-D 25 mfd., 25 v. elect.
- C18 —C-D 24 mfd., 475 v. elect.
- C19 —C-D 24 mfd., 475 v. elect.
- Loudspeaker—Cinaudagraph FY12-12

A PROVING-POST REVIEW

THE NEW SILVER MASTERPIECE VI



THE Masterpiece VI differs from its immediate predecessor, the Masterpiece V, in refinements rather than radical changes. The former model was characterized by a high degree of all-around excellence upon which it would be difficult to improve. However, the sum total of the refinements is such as to contribute to ease of operation, flexibility and superior operation under adverse conditions. The audio frequency curve has been flattened somewhat, both electrically and acoustically, by the use of inverse feedback and a new baffle arrangement of the "bass reflex" type. Independent automatic volume control has been applied to the r.f. circuits and to the intermediate-frequency amplifier, providing a superior degree of control. Similarly, selectivity is controlled in both the r.f. and i.f. circuits and four different bandwidths are provided instead of the "sharp" and "broad" adjustments available on the Masterpiece V. This change extends the fidelity admittance of the Masterpiece VI to 16,000-cycle sidebands. The tuning range has also been extended and now embraces the 56-megacycle ham band. Octal base glass tubes are used, instead of the metal tubes featured in the previous model. All important electrical features have been retained—volume expansion, independent bass and treble tone adjustments, etc.

The Masterpiece VI is similar in appearance to its immediate predecessor, but here again refinements are to be

noted. The secondary controls are grouped on two escutcheons, rather than being mounted with individual plates. The dial mechanism is unchanged and the large dial is very similar to that on the Masterpiece V. However, the vernier dial has been considerably improved to facilitate logging and relogging of short-wave stations. The set shield now fastens to the chassis.

Controls

The controls from left to right are:—

Fidelity: This control switches the audio system over to microphone or phonograph, as well as controlling the four degrees of bandwidth—4000, 8000, 12,000 and 32,000 cycles.

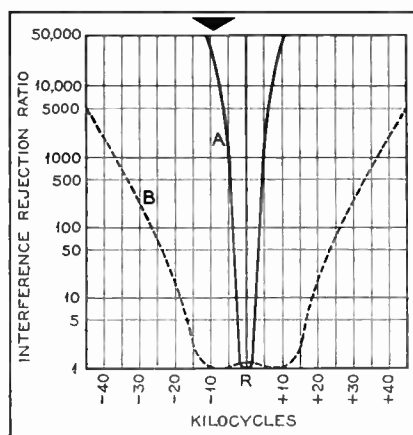

Fig. 2. Selectivity characteristics of the Masterpiece VI at maximum and minimum selectivity settings.

Volume Control: This is of the tone-compensated type maintaining a desirable balance between treble and bass response at different volume levels.

Expander: The degree of expansion is continuously variable.

Tuning Knob: Planetary type with two ratios—16 to 1 and 80 to 1.

Bass Tone Control: Makes possible the emphasis of low notes without affecting the treble tones.

Waveband Switch: Five bands, designated as A, B, C, D, E, are available and tune respectively from 140 to 450 kc., 550 to 1800 kc., 1800 to 575 kc., 5.75 to 18.5 mc. and from 17 to 65 mc. There are reasonable overlaps between all bands (except A and B) not necessarily indicated by numerals on the dial.

Treble Tone: Provides for emphasis of high notes without cutting down on the bass. The combined use of the bass and treble controls makes possible the compensation of any tonal range deficiencies encountered in present-day broadcasting and recording. Frequency discrimination characteristic of chain programs piped over land lines can be readily corrected. Turned completely counter-clockwise, the treble tone control connects in the beat-frequency oscillator for c.w. code reception, location of stations or precise logging (to zero beat).

Fidelity - Selectivity Control

The fidelity control is altogether independent of the audio-frequency tone control system, and, as we have already men-

tioned, operates independently on both the r.f. and i.f. amplifiers. Selectivity (or, inversely, the width of the admitted band) is controlled in two ways—by choosing the number of r.f. and i.f. stages, and by changing the type of transformer used in the intermediate-frequency amplifier. This last is an innovation, and was preferred by the designer to the more conventional method of varying the selectivity characteristics of a single type transformer.

In the wiring diagram, Fig. 1, the fidelity control switches ("I.F. Switch Gang") are shown running in row A, from 6 to 17. There are six of these switches ganged, and in the diagram they are in the 4-kilocycle fidelity position. At this adjustment all r.f. and i.f. tubes are employed, and the i.f. transformers in row C, T1, T2, T3, T4, are in the circuit. As the control is turned counter-clockwise, the original first i.f. tube, the

6K7G at C-10, is eliminated from the circuit, along with its associated i.f. transformers T1 and T2. The output of the first detector is now coupled to the second 6K7G through the transformer T5 at B-10. The remainder of the circuit remains unchanged. The bandwidth in this position is 8 kilocycles. Turning the control to the next point counter-clockwise, or to the 12-kilocycle position, eliminates the first radio-frequency amplifying stage but does not alter the i.f. circuit. In ordinary operation, with a simple L-type antenna, the "LONG ANT." post is connected to ground, and the lead-in connected to the "SHORT ANT." terminal. Thus, at the 12-kilocycle position, the antenna is shunted around, by the switch at A-7, and through condenser C1c to what ordinarily would be the plate coil of the first r.f. stage. The aerial is therefore coupled directly to the grid coil of the second

r.f. stage.

In the maximum fidelity position, with a bandwidth of 32 kilocycles, i.f. transformer T3 is eliminated and T6, at B-14, is substituted.

The extremes of selectivity which can be obtained with this system are indicated in the curves of Fig. 2, which show the 4- and 32-kilocycle characteristics. It will be observed that the interference rejection ratio is 1000 at 5 kc. off resonance, and that sidebands above 2000 cycles are very rapidly attenuated. Yet excellent tone quality can be obtained by means of treble tone compensation. The 32-kilocycle adjustment will rarely be used except within the local range of one of the few experimental high-fidelity stations.

The wave-band switch runs vertically in column 5-6. With the selectivity control in positions for 4- or 8-kilocycle bandwidths, it will be observed that the

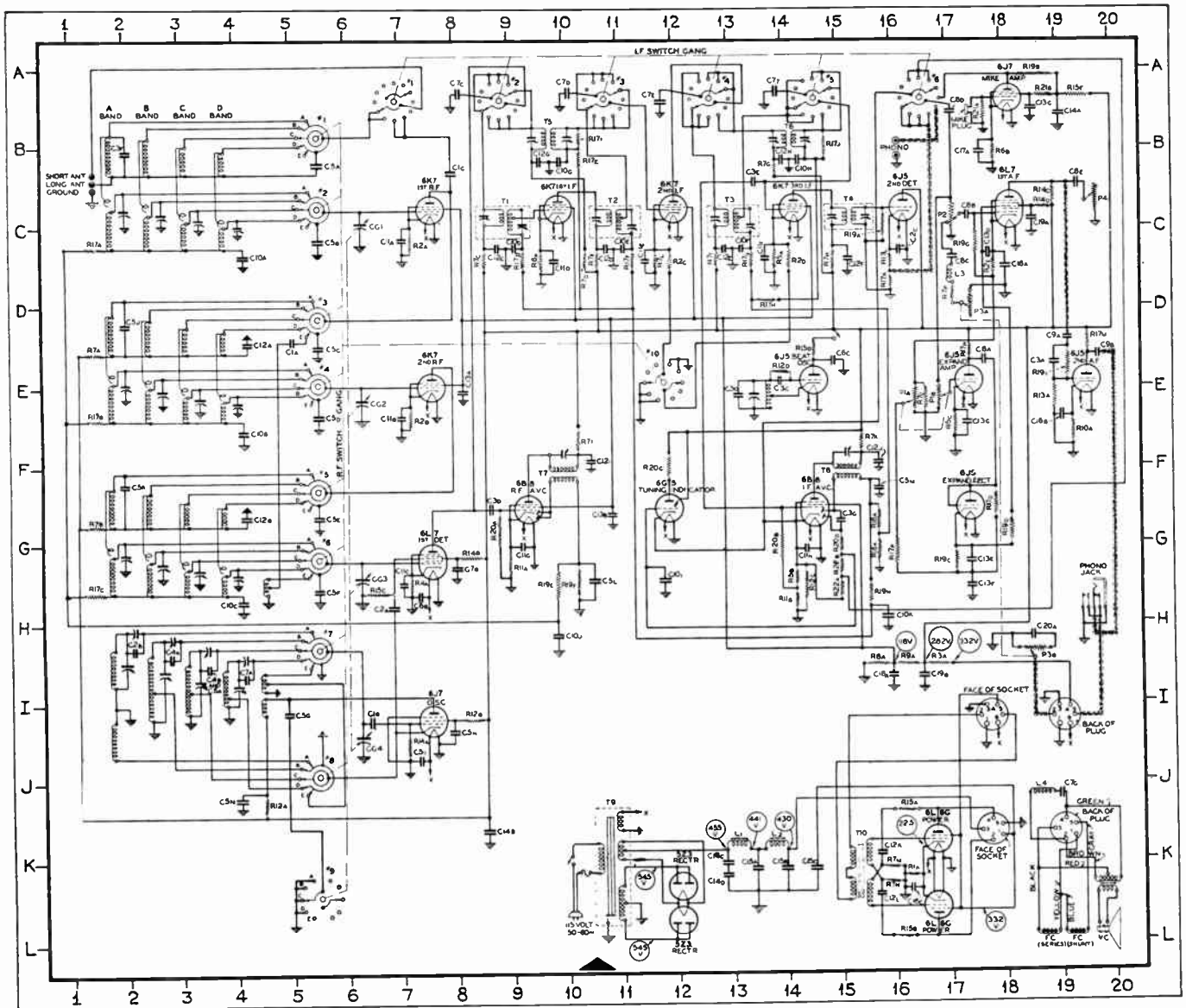

Fig. 1. Wiring diagram of the Silver Masterpiece VI. Though not indicated, "G" type tubes are supplied with the receiver.

two r.f. stages are employed on all bands excepting the extreme high-frequency band, E. When switched to band E, the two r.f. stages are eliminated and the antenna is coupled to the grid of the first detector through the auto-transformer located at G-4. To complete this circuit, the selectivity switch must be in the 12- or 32-kc. position. This is desirable as fairly broad tuning is essential on some of the higher frequency bands—particularly for amateur 5-meter reception. The switch at E-12 is ganged with the wave-change switches, and preserves optimum sensitivity in the i.f. amplifier on different bands by altering grid biases.

Two A.V.C. Amplifiers

Next in the order of the unusual in the Masterpiece VI is the use of two a.v.c. actions, one operating more or less conventionally on the i.f. amplifier, and the other on the r.f. circuits. The i.f. a.v.c. tube is at F-15, and receives its excitation in parallel with the 6K7G 3rd i.f. tube. The i.f. signal is amplified in the pentode section of the 6B8G, fed to transformer T8, and rectified in the diode section of the tube—the rectified output being applied through an appropriate resistor network, to the i.f. grids and to the magic tuning eye.

The r.f. a.v.c. tube is a similar 6B8G at F-9. It obtains excitation from the first detector tube to which it is impedance-coupled through condenser C3d. (The coupling impedance is the primary of the i.f. transformer in the first detector plate circuit.) Again the signal is amplified in the pentode section and rectified in the diode section. (The diode plates are tied together. In the case of the i.f. a.v.c. tube, one plate supplies rec-

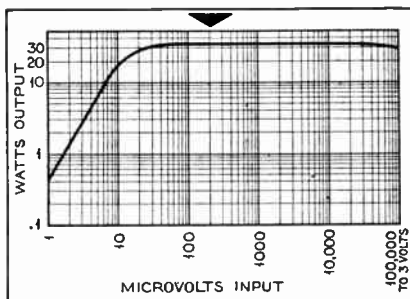

Fig. 3. Showing the a.v.c. control maintained by the dual system operating independently on r.f. and i.f. circuits.

tified current for the a.v.c. action, and the other for the tuning indicator.) The a.v.c. bias obtained is applied to all r.f. tubes including the first detector. The efficacy of this dual a.v.c. system is indicated in the curve of Fig. 3.

Second Detector

The second detector in the Masterpiece VI is of the infinite-impedance type, the main advantage of which is the tendency to cancel out harmonic distortion—to provide distortionless detection. This is accomplished by means of inverse feedback or degeneration. Instead of taking the output of the second detector from the plate of the tube by means of resistance, impedance or transformer coupling, it is obtained across part of the cathode resistor at D-16. This resistor is common to both grid and plate circuits, and the interaction results in degeneration. This is elementary and obvious. An increase in plate current will increase the negative bias applied to the grid, and this in turn will act to reduce the plate current. A very low value of cathode condenser—.0001 mfd.—

is used at C2c so that this effect will function at audio frequencies.

The Audio-Frequency System

When switched for radio reception, the output of the second detector is coupled to the 6L7G first a.f. tube at C-18 as described. Phono. input is coupled through the condenser C8d. When using a microphone, a pre-amplifier is automatically switched into the circuit. The tube is a 6J7G at A-18, which is resistance coupled to the regular first a.f. tube. This additional amplification makes it possible to employ a low sensitivity crystal microphone for p.a. work within the power capabilities of the amplifier and for amusement. The first a.f. tube is in turn resistance-coupled to the 6J5G triode second a.f. amplifier, which is transformer-coupled to the push-pull 6L6Gs. The amplifier is peaked for high frequencies, and treble tone control is obtained by the elementary bypass arrangement shown at B-20. The bass compensation is considerably more complicated and requires the ganged potentiometer and rheostat shown respectively at C-17 and D-17, the latter operating in conjunction with the indicated resistor, condenser and air-core audio choke L3.

The volume expander obtains its input in parallel with the first audio tube. It will therefore function on radio, phono. and mike. The output of the 6J5G expander amplifier (E-18) is rectified by the 6J5G at F-18 and the rectified current used to bias the second control grid of the first audio, 6L7G, and thus control the amount of amplification. The degree of control, or expansion, is adjusted by the double potentiometers at E-17.

By combining the actions of the fidelity control, bass and treble compensations, a variety of over-all audio-frequency characteristic can be secured, as will be noted from the graphs of Fig. 4. The pronounced dip at 10,000 cycles is due to the whistle trap—coil L4 and condenser C7g at J-19 in Fig. 1. This trap is tuned very sharply to 10 kc., to eliminate the heterodynes occasioned by our 10-kilocycle station separation system. The whistle, of course, will not be heard on the ordinary receiver which is incapable of reproducing frequencies of that order.

The rated output of the audio system is 34 watts with 2.5% total harmonic distortion. The output is distortionless at five watts which is ample for the average home reception, excepting perhaps fortissimo passages.

While at the present writing no sensitivity measurements have been made on the Masterpiece VI at this laboratory, its performance is such as to substantiate the manufacturer's claims for a very high order of sensitivity and a low noise level.

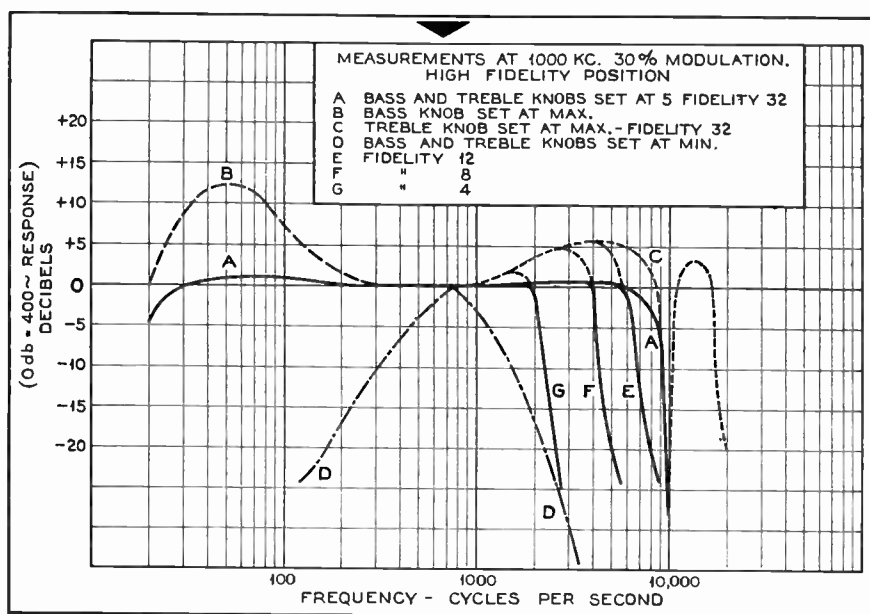

Fig. 4. Various overall a.f. characteristics which are obtained with different settings of fidelity, treble and bass controls.

Queries

Question No. 45: I have recently come across several references to "double superheterodynes" and should appreciate it if you would explain to me just what these receivers are and their advantages over the ordinary super.—*A. J. C., Leonia, N. J.*

Answer: The double super is exactly what its name implies—two superheterodyne actions in one receiver. These receivers are coming into more general use—Westinghouse and other manufacturers are featuring them.

In the double super the incoming signal is changed to a more or less conventional intermediate frequency—say 465 kilocycles—in the usual manner through a combination of local oscillator and first detector or mixer tube. This intermediate frequency is changed to a second intermediate frequency—say 100 kc.—by means of another oscillator and a second mixer or detector. (This second detector should not be confused with the familiar second detector in the conventional super. In the usual super, the second detector separates the audio-frequency component from the intermediate frequency—in the double super it merely changes one intermediate frequency into another intermediate frequency.) This second i.f. is now amplified in the usual way through one or more stages of intermediate-frequency amplification and passed on to the third detector which functions exactly as does the second detector in the ordinary super—that is, separates the audio or sound frequencies from the radio-frequency component for further amplification in the audio system.

When a short-wave converter is used in conjunction with the conventional super, the result is a double super. The converter converts the short-wave signal to an intermediate frequency in the

DOUBLE SUPERHETERODYNES . . . LOUDSPEAKER AS MIKE . . . THE ANSWER IS NO!

THE primary purpose of the Queries Department is to solve the technical and semi-technical problems of our readers who feel they require such assistance. However, questions, so long as they are related to radio, need not be of a technical nature. Every question will be answered personally, by mail. A self-addressed and stamped envelope should be included. In questions concerning specific apparatus, it will be of considerable assistance to our technicians if the inquiry is accompanied with a wiring diagram, original operating instructions, and all relevant literature. While it is the desire of this department to be of assistance in all possible instances, it should be borne in mind that the manufacturer will occasionally be in a position to give better advice concerning his own product, and usually maintains a technical department at the service of those who purchase his equipment.

standard broadcast band. The super then takes this frequency and converts it to the i.f. of the receiver.

There is no special advantage in the double super except in automatic frequency control circuits—which are responsible for its introduction in the commercial field. Automatic frequency control tends to correct tuning deficiencies. If the station is not correctly tuned, dis-

ortion is the result—as we all know. In automatic frequency control circuits, minor variations in tuning are compensated by the local oscillator which automatically changes its frequency so that the intermediate frequency is correct. This is accomplished by changes in the effective inductance in the oscillator circuit—the amount of change being automatically governed by the degree of off-resonance of the intermediate frequency. The variation in oscillator circuit inductance will be the same for a given number of kilocycles off resonance regardless of the frequency to which the receiver is tuned—long wave or short wave. However, the change in oscillator frequency for a given change in inductance will be considerably greater at high frequencies than on the broadcast band. Hence the compensation will not be the same at all wavelengths. The solution is to apply a.f.c. to an oscillator that remains practically constant in frequency regardless of the wavelength to which the receiver is tuned—and this can be accomplished in the double super.

Fig. 1 shows a block diagram of a double super. The first oscillator operates at a frequency of 465 kilocycles above the signal frequency. The frequency of oscillation will of course vary considerably on different bands. For instance, when tuning a signal of 5000 kc., the oscillator frequency will be 5465 kc. At 1000 kc., the oscillator frequency will be 1465 kc. At 20 megacycles the oscillator frequency will be 20465 kilocycles. Obviously such an oscillator is not suitable for automatic frequency control except on the long-wave band where its frequency change will be relatively limited—from about 1965 kc. (for 200 meters) to 965 kc. (for 500 meters). The output of the first detector tube will be practically constant in frequency at 465 kilocycles. This first intermediate frequency is immediately mixed with the second oscillator so as to produce a second intermediate frequency of 100 kc. This second oscillator will therefore always oscillate at a practically constant frequency (the only variations being the minor shifts caused by a.f.c. compensation) of 365 kilocycles—and can therefore be satisfactorily controlled by the a.f.c. circuit, regardless of the frequency to which the receiver is tuned. (A frequency of 565 kilocycles could of course

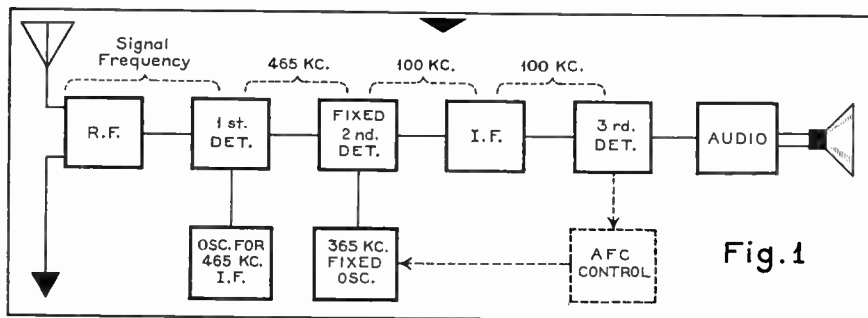

Block diagram explaining the action of the "double super." The connection of the a.f.c. circuit (the main reason for the double super) is shown by the dotted lines.

(Continued on page 667)

1160 KC			WMFN	Clarksdale, Miss.	100	WBEO	Marquette, Mich.	100
WOWO	Fort Wayne, Ind.	10000	WOMT	Manitowoc, Wis.	100	WBOW	Terre Haute, Ind.	100
WWVA	Wheeling, W. Va.	5000	WPAX	Thomasville, Ga.	250	WBRE	Wilkes-Barre, Pa.	100
1170 KC			WSAY	Rochester, N. Y.	100	WBRK	Pittsfield, Mass.	100
WCAU	Philadelphia, Pa.	50000	WSBC	Chicago, Ill.	100	WCLS	Joliet, Ill.	100
1180 KC			WSIX	Nashville, Tenn.	100	WCMJ	Ashland, Ky.	100
KEX	Portland, Ore.	5000	WSNJ	Bridgeton, N. J.	100	WDAH	El Paso, Texas	100
KOB	Albuquerque, N. M.	10000	WSOC	Charlotte, N. C.	100	WBRB	Buffalo, N. Y.	100
WDGY	Minneapolis, Minn.	1000	WTAX	Springfield, Ill.	100	WEMP	Milwaukee, Wis.	100
WINS	New York, N. Y.	1000	1220 KC			WEXL	Royal Oak, Mich.	100
WMAZ	Macon, Ga.	1000	KFKU	Lawrence, Kansas	1000	WFBG	Altoona, Pa.	100
1190 KC			KTMS	Santa Barbara, Calif.	500	WDFD	Flint, Mich.	100
KTAC	Visalia, Calif.	250	KTW	Seattle, Wash.	1000	WGHT	Newport News, Va.	100
WOAI	San Antonio, Texas	50000	KWSC	Pullman, Wash.	1000	WGTM	Wilson, N. C.	100
WSAZ	Huntington, W. Va.	1000	WCAD	Canton, N. Y.	500	WHAT	Philadelphia, Pa.	100
1200 KC			WCAE	Pittsburgh, Pa.	1000	WLAC	Johnstown, Pa.	100
KADA	Coeur d'Alene, Idaho	100	WDAE	Lakeland, Fla.	1000	WLAK	Lakeland, Fla.	100
KBTM	Jonesboro, Ark.	100	WREN	Lawrence, Kans.	1000	WLCB	Muncie, Ind.	100
KDNC	Lewiston, Mont.	100	1230 KC			WLNH	Laconia, N. H.	100
KFJB	Marshalltown, Iowa	100	KGBX	Springfield, Mo.	500	WMBO	Auburn, N. Y.	100
KFXD	Nampa, Idaho	100	KGGM	Albuquerque, N. M.	1000	WMFF	Plattsburg, N. Y.	250
KFXJ	Grand Junction, Colo.	100	KYA	San Francisco, Calif.	1000	WNBH	New Bedford, Mass.	100
KGDE	Fergus Falls, Minn.	100	WFBM	Indianapolis, Ind.	1000	WRAW	Reading, Pa.	100
KGEK	Sterling, Colo.	100	WNAC	Boston, Mass.	1000	WROL	Knoxville, Tenn.	100
KGFJ	Los Angeles, Calif.	100	WOL	Washington, D. C.	1000	WSAJ	Grove City, Pa.	100
KGHI	Little Rock, Ark.	100	1240 KC			WSGN	Birmingham, Ala.	100
KGSS	Southern Falls, S. D.	100	KTAT	Fort Worth, Texas	1000	WSJS	Winston-Salem, N. C.	100
KGVL	Greenville, Texas	100	KTFI	Twin Falls, Idaho	1000	WTAL	Tallahassee, Fla.	100
KMLB	Monroe, La.	100	WKAQ	San Juan, Porto Rico	1000	WTFL	Philadelphia, Pa.	100
KSUN	Lowell, Ariz.	100	WXYZ	Detroit, Mich.	1000	WTIS	Jackson, Tenn.	100
KVCV	Redding, Calif.	100	1250 KC			WTRC	Elkhart, Ind.	100
KVEC	San Luis Obispo, Calif.	250	KFOX	Long Beach, Calif.	1000	1320 KC		
KVOS	Bellingham, Wash.	100	KIT	Yakima, Wash.	250	KGHF	Pueblo, Colo.	500
KWG	Stockton, Calif.	100	KXOX	St. Louis, Mo.	1000	KGMB	Honolulu, Hawaii	1000
KWNO	Winona, Minn.	100	WAIR	Winston Salem, N. C.	250	KID	Idaho Falls, Idaho	500
WABI	Bangor, Me.	100	WDSU	New Orleans, La.	1000	KRNT	Des Moines, Iowa	1000
WAIM	Anderson, S. C.	100	WHBI	Newark, N. J.	1000	WADC	Akron, Ohio	1000
WAYX	Waycross, Ga.	100	WNEW	New York, N. Y.	1000	WORK	York, Pa.	1000
WBBZ	Ponca City, Okla.	100	WTCN	Minneapolis, Minn.	1000	WSMB	New Orleans, La.	1000
WBHP	Huntsville, Ala.	100	1260 KC			1330 KC		
WBNO	New Orleans, La.	100	KGVO	Missoula, Mont.	1000	KGB	San Diego, Calif.	1000
WCAT	Rapid City, S. D.	100	KHSL	Chico, Calif.	250	KMO	Tacoma, Wash.	1000
WCAX	Burlington, Vt.	100	KOIL	Council Bluffs, Iowa	1000	KSCJ	Sioux City, Iowa	1000
WCLO	Janesville, Wis.	100	EPAC	Port Arthur, Texas	500	WDRG	Hartford, Conn.	1000
WCPO	Cincinnati, Ohio	100	KRGV	Weslaco, Texas	1000	WSAI	Cincinnati, Ohio	1000
WDSN	Superior, Wis.	100	KUOA	Fayetteville, Ark.	1000	WTAQ	Green Bay, Wis.	1000
WEST	Easton, Pa.	100	WHIO	Dayton, Ohio	1000	KRIS	Corpus Christi, Tex.	500
WFAM	South Bend, Ind.	100	WNRX	Springfield, Vt.	1000	1340 KC		
WFTC	Kinston, N. C.	100	WTOC	Savannah, Ga.	1000	KDTH	Dubuque, Iowa	500
WHBC	Canton, Ohio	100	1270 KC			KGDY	Huron, S. D.	250
WHBY	Green Bay, Wis.	100	KGCA	Decorah, Iowa	100	KGIR	Butte, Mont.	1000
WBX	Utica, N. Y.	100	KOL	Seattle, Wash.	1000	KGNO	Dodge City, Kans.	250
WIL	St. Louis, Mo.	100	KVOR	Colorado Springs, Colo.	1000	WCOA	Pensacola, Fla.	1000
WIBC	Bloomington, Ill.	100	KWLC	Decorah, Iowa	100	WFOA	Manchester, N. H.	500
WIRL	Decatur, Ill.	100	WASH	Grand Rapids, Mich.	500	WSPD	Toledo, Ohio	1000
WIRW	New Orleans, La.	100	WFBR	Baltimore, Md.	500	1350 KC		
WIPO	West Palm Beach, Fla.	100	WJDX	Jackson, Miss.	1000	KIDO	Boise, Idaho	1000
WIRD	Tuscaloosa, Ala.	100	WOOD	Grand Rapids, Mich.	500	KWK	St. Louis, Mo.	1000
WKBO	Harrisburg, Pa.	100	1280 KC			WAWZ	Zarephath, N. J.	500
WLVA	Lynchburg, Va.	100	KFBB	Great Falls, Mont.	1000	WBNX	New York, N. Y.	1000
WMFR	High Point, N. C.	100	KLS	Oakland, Calif.	250	1360 KC		
WMPC	Lapeer, Mich.	100	WCAM	Camden, N. J.	500	KCRC	Enid, Okla.	250
WOLS	Florence, S. C.	100	WCAP	Asbury Park, N. J.	500	KGER	Long Beach, Calif.	1000
WRBL	Columbus, Ga.	100	WDOD	Chattanooga, Tenn.	1000	KLPM	Minot, N. D.	500
WSAL	Salisbury, Md.	250	WTNJ	Madison, Wis.	1000	WCSC	Charleston, S. C.	500
WTHT	Hartford, Conn.	100	WBIA	Worcester, Mass.	500	WFBL	Syracuse, N. Y.	1000
WTOL	Toledo, Ohio	100	WORC	Dallas, Texas	500	WGFS	Chicago, Ill.	500
WVAE	Hammond, Ind.	100	WRR	Trenton, N. J.	500	WQBC	Vicksburg, Miss.	1000
1210 KC			1290 KC			WSBT	South Bend, Ind.	500
KALB	Alexandria, La.	100	KDYL	Salt Lake City, Utah	1000	1370 KC		
KANS	Wichita, Kans.	100	KLCN	Blytheville, Ark.	100	KAST	Astoria, Ore.	100
KASA	Elk City, Okla.	100	KTRH	Houston, Texas	1000	KCMO	Kansas City, Mo.	100
KDLR	Devils Lake, N. D.	100	WATR	Waterbury, Conn.	250	KELD	El Dorado, Ark.	100
KDON	Del Monte, Calif.	100	WBOC	Superior, Wis.	1000	KERN	Bakersfield, Calif.	100
KFTI	Klamath Falls, Ore.	100	WIAS	Pittsburgh, Pa.	1000	KTOK	Boone, Iowa	100
KFOR	Lincoln, Neb.	100	WNBZ	Saranac Lake, N. Y.	100	KFJZ	Fort Worth, Texas	100
KFPF	Helena, Mont.	250	WNEL	San Juan, Porto Rico	1000	KGAR	Tucson, Ariz.	100
KFPW	Fort Smith, Ark.	100	1300 KC			KGFG	Oklahoma City, Okla.	100
KFRD	Longview, Texas	100	KALE	Portland, Ore.	500	KGFL	Roswell, N. M.	100
KFVS	Cape Girardeau, Mo.	100	KFAH	Los Angeles, Calif.	1000	KGKL	San Angelo, Texas.	100
KFXM	San Bernardino, Calif.	100	KFH	Wichita, Kans.	1000	KICA	Clovis, N. M.	100
KGLO	Mason City, Iowa	100	KFIR	Portland, Ore.	500	KIUP	Durango, Colo.	100
KGY	Olympia, Wash.	100	WBRR	Brooklyn, N. Y.	1000	KLUF	Galveston, Texas	100
KIRG	Oklmulgee, Okla.	100	WEVD	New York, N. Y.	1000	KMAC	San Antonio, Texas	100
KIUL	Garden City, Kans.	100	WFAB	New York, N. Y.	1000	KOBH	Rapid City, S. D.	100
KLAH	Carlsbad, N. M.	100	WFBC	Greenville, S. C.	1000	KOKO	La Junta, Colo.	100
KOCA	Kilgore, Texas	100	WHIAZ	Troy, N. Y.	500	KONO	San Antonio, Texas	100
KPPC	Pasadena, Calif.	100	WHBL	Sheboygan, Wis.	500	KRE	Berkeley, Calif.	100
KVSO	Ardmore, Okla.	100	1310 KC			KRKO	Everett, Wash.	50
KWTN	Watertown, S. D.	100	KAND	Corsicana, Texas	100	KRMC	Jamestown, N. D.	100
WATR	Zanesville, Ohio	100	KARM	Fresno, Calif.	100	KSLM	Salem, Ore.	100
WBAX	Wilkes-Barre, Pa.	100	KCKN	Kansas City, Kans.	100	KTEM	Temple, Texas	250
WBBL	Richmond, Va.	100	KCRJ	Jerome, Ariz.	100	KUI	Walla Walla, Wash.	100
WBLY	Lima, Ohio	100	KCFI	Dublin, Texas	1000	KVGB	Great Bend, Kans.	100
WBRB	Red Bank, N. J.	100	KFPJ	Oklahoma City, Okla.	1000	KVL	Seattle, Wash.	100
WCOL	Columbus, Ohio	100	KFXR	Lubbock, Texas	100	KWYO	Sheridan, Wyo.	100
WCRW	Chicago, Ill.	100	KPYO	Kallispeil, Mont.	100	WARY	Albany, N. Y.	100
WEHQ	Harrisburg, Ill.	100	KGEZ	Kearney, Neb.	100	WAGF	Dothan, Ala.	250
WEDC	Chicago, Ill.	100	KGFW	Watsonville, Calif.	250	WATL	Atlanta, Ga.	100
WEAS	White Plains, N. Y.	100	KHUB	Pampa, Texas	100	WRNY	Buffalo, N. Y.	100
WFOY	St. Augustine, Fla.	100	KPDN	Sherman, Texas	100	WRTM	Danville, Va.	100
WGBB	Freeport, N. Y.	100	KRUV	Lufkin, Texas	100	WCRM	Baltimore, Md.	100
WGCM	Gulfport, Miss.	100	KROB	Shreveport, La.	100	WDAS	Philadelphia, Pa.	100
WGNV	Chester Township, N. Y.	100	KROY	Rochester, Minn.	100	WDNS	Champaign, Ill.	100
WHBF	Rock Island, Ill.	100	KROA	Sacramento, Calif.	100	WEOA	Evansville, Ind.	100
WHBU	Anderson, Ind.	100	KSKO	Santa Fe, N. M.	100	WBK	Clarksburg, W. Va.	100
WIBU	Poynette, Wis.	100	KSUB	Santa Rosa, Calif.	250	WBFB	Hattiesburg, Miss.	100
WIBY	Gadsden, Ala.	100	KTSM	Cedar City, Utah	100	WGL	Fort Wayne, Ind.	100
WIEI	Hagerstown, Md.	100	KVOL	El Paso, Texas	100	WGRC	New Albany, Ind.	250
WITM	Lansing, Mich.	100	KVOS	Lafayette, La.	100	WHBQ	Memphis, Tenn.	100
WITN	Jamestown, N. Y.	100	KXRO	Moorehead, Minn.	100	WHDF	Calumet, Mich.	100
WIW	Akron, Ohio	100	WAML	Laurel, Miss.	100	WHLR	Virginia, Minn.	100
WKOK	Sunbury, Pa.	100				WIBM	Jackson, Mich.	100
WLMU	Middlesboro, Ky.	100				WILL	Lowell, Mass.	100
WMBG	Richmond, Va.	100				WMBR	Jacksonville, Fla.	100
WMFG	Hibbing, Minn.	100				WMFD	Wilmington, N. C.	100
						WMFO	Decatur, Ill.	100

WMIN	St. Paul, Minn.	100	KTRI	Sioux City, Iowa	100	WLAC	Nashville, Tenn.	5000
WOC	Davenport, Iowa	100	KUMA	Yuma, Ariz.	100	WMEX	Boston, Mass.	5000
WPAY	Portsmouth, Ohio	100	KWVG	Hutchinson, Kans.	100	1480 KC		
WPRA	Mayaguez, P. R.	100	KXKL	Portland, Ore.	100	KOMA	Oklahoma City, Okla.	5000
WRAC	Williamsport, Pa.	100	WACO	Waco, Texas	100	WHIP	Hammond, Ind.	5000
WRDO	Augusta, Ga.	100	WAGM	Presque Isle, Me.	100	WKBW	Buffalo, N. Y.	5000
WRJN	Racine, Wis.	100	WAPQ	Chattanooga, Tenn.	100	1490 KC		
WSAU	Wausau, Wis.	100	WAZL	Hazleton, Pa.	100	KFBK	Sacramento, Calif.	5000
KSVS	Buffalo, N. Y.	50	WCBS	Springfield, Ill.	100	WCKY	Covington, Ky.	5000
KVRS	Rocky Springs, Wyo.	100	WCHV	Charlottesville, Va.	100	1500 KC		
1380 KC			WEED	Rocky Mount, N. C.	100	KAWM	Gallup, N. Mex.	100
KOH	Reno, Nevada	500	WEHS	Cicero, Ill.	100	KBIX	Muskogee, Okla.	100
KQV	Pittsburgh, Pa.	500	WELL	Battle Creek, Mich.	100	KBST	Big Springs, Texas	100
WALA	Mobile, Ala.	500	WFAM	St. Cloud, Minn.	100	KDAL	Duluth, Minn.	100
WKBH	La Crosse, Wis.	1000	WGPC	Albany, Ga.	100	KDB	Santa Barbara, Calif.	100
WNBC	New Britain, Conn.	250	WHFC	Cicero, Ill.	100	KGFI	Brownsville, Tex.	100
WSMK	Dayton, Ohio	200	WILM	Wilmington, N. C.	100	KGKB	Tyler, Texas	100
1390 KC			WJBR	Gastonia, N. C.	100	KGKY	Scottsbluff, Nebr.	100
KLRA	Little Rock, Ark.	1000	WJMS	Ironwood, Mich.	100	KNEL	Brady, Texas	250
KRLC	Lewiston, Idaho	250	WKBI	Cicero, Ill.	100	KNOW	Austin, Texas	100
KOOS	Marshfield, Ore.	250	WLAP	Lexington, Ky.	100	KOTN	Pine Bluff, Ark.	100
KOY	Phoenix, Ariz.	500	WLEU	Eric, Pa.	100	KOVC	Valley City, N. D.	100
WHK	Cleveland, Ohio	1000	WMAJ	Springfield, Mass.	100	KPLC	Lake Charles, La.	100
WQDM	St. Albans, Vt.	1000	WMBC	Detroit, Mich.	100	KPLT	Paris, Texas	250
1400 KC			WMBH	Joplin, Mo.	100	KPO	Wenatchee, Wash.	100
KLO	Ogden, Utah	500	WMFJ	Daytona Beach, Fla.	100	KRNR	Roseburg, Ore.	100
KTUL	Tulsa, Okla.	500	WMSD	Sheffield, Ala.	100	KROD	El Paso, Texas	100
WBBC	Brooklyn, N. Y.	500	WNNY	Watertown, N. Y.	100	KSAL	Salina, Kans.	100
WEGL	Brooklyn, N. Y.	500	WPAD	Paducah, Ky.	100	KUTA	Salt Lake City, Utah	100
WHDL	Olean, N. Y.	250	WPAR	Parkersburg, W. Va.	100	KVOE	Santa Ana, Calif.	100
WIRE	Indianapolis, Ind.	1000	WPRP	Ponce, P. R.	100	KNO	El Centro, Calif.	100
WVFW	Brooklyn, N. Y.	500	1430 KC			KCNW	Brooklyn, N. Y.	100
1410 KC			KECA	Los Angeles, Calif.	1000	WDNC	Durham, N. C.	100
KFIM	Grand Forks, N. D.	500	KGNF	North Platte, Nebr.	1000	WGAL	Lancaster, Pa.	100
KGX	Wolf Point, Mont.	500	KINY	Juneau, Alaska	250	WHBB	Selma, Ala.	100
KGNC	Amarillo, Texas	1000	KSO	Des Moines, Iowa	500	WHEF	Kosciusko, Miss.	500
KMED	Medford, Ore.	250	WBNS	Columbus, Ohio	500	WIBK	Detroit, Mich.	100
WAAB	Boston, Mass.	500	WHEC	Rochester, N. Y.	500	WKAT	Miami Beach, Fla.	100
WACM	Bay City, Mich.	500	WHP	Harrisburg, Pa.	500	WKBB	East Dubuque, Ill.	100
WHIS	Bluefield, W. Va.	250	WMPS	Memphis, Tenn.	500	WKBY	Richmond, Ind.	100
WROK	Rockford, Ill.	500	WOKO	Albany, N. Y.	500	WKBY	Muskegon, Mich.	100
WSFA	Montgomery, Ala.	500	1440 KC			WKFEU	Griffin, Ga.	100
1420 KC			KDFN	Casper, Wyo.	500	WMBO	Brooklyn, N. Y.	100
KABC	San Antonio, Texas	100	KFLA	Centralia, Wash.	500	WNBF	Binghamton, N. Y.	100
KABR	Aberdeen, S. D.	100	KXYZ	Houston, Texas	1000	WNLC	New London, Conn.	100
KATE	Albert Lea, Minn.	250	WBIG	Greensboro, N. C.	1000	WOMI	Owensboro, Ky.	100
KBPS	Portland, Ore.	100	WCBA	Allentown, Pa.	500	WOPH	Bristol, Tenn.	100
KCMC	Texarkana, Ark.	100	WMBD	Peoria, Ill.	1000	WRDW	Augusta, Ga.	100
KEUB	Price, Utah	100	WSAN	Allentown, Pa.	500	WRGA	Rome, Ga.	100
KFIZ	Fond du Lac, Wis.	100	1450 KC			WKTD	Richmond, Va.	100
KGFF	Shawnee, Okla.	100	KIFM	Eureka, Calif.	500	WTSB	Rutland, Vt.	100
KGCC	San Francisco, Calif.	100	KTBS	Shreveport, La.	1000	WTMV	East St. Louis, Ill.	100
KGIV	Alamosa, Colo.	100	WGAR	Cleveland, Ohio	500	WWRL	Woodside, N. Y.	100
KHBC	Hilo, Hawaii	100	WHOM	Jersey City, N. J.	250	WWSW	Pittsburgh, Pa.	100
KIDW	Lamar, Colo.	100	WMBS	Uniontown, Pa.	250		El Paso, Texas	100
KIUN	Pecos, Texas	100	WSAR	Fall River, Mass.	1000	1530 KC		
KLBM	La Grande, Ore.	100	WAGA	Atlanta, Ga.	500	KXBY	Kansas City, Mo.	1000
KNET	Palestine, Texas	100	1460 KC			WBRY	Waterbury, Conn.	1000
KORE	Eugene, Ore.	100	KSTP	St. Paul, Minn.	25000	1550 KC		
KRBC	Ahilene, Texas	100	WJSP	Washington, D. C.	10000	KPMC	Bakersfield, Calif.	1000
KRLH	Midland, Texas	100	1470 KC			WQXR	Long Island City, N. Y.	1000
			KGA	Spokane, Wash.	5000			

NOTES ON THE WIDE-RANGE SYSTEM

(Continued from page 643)

In order to reduce hum to the absolute minimum, the capacities of the filter condensers C18 and C19 have been increased, each of these two being 24 mfd., or one of the Cornell-Dubilier KR-5888 units each of which is composed of three 8-mfd. sections in a single can. This accounts for two of the three large electrolytic condenser units used in the original amplifier, the third unit being used to bypass circuits in the volume expander. The fourth unit—which is a single 8-mfd. electrolytic condenser in a smaller container, is used to bypass the plate feed circuit to the two sections of the 6C8G tube, and is C12 in the accompanying diagram.

It might be added that two 24-mfd. filter condensers in the power-supply circuit are not essential; one can get along with a single 8-8-8 mfd. unit, using one section for C18, a second section for C19 and the third section for C12. But the higher capacities for C18 and C19 are advantageous.

The Phase Inverter

A minor change has also been made in

the output circuit of the phase inverter, this being the addition of a 10,000-ohm, ½-watt resistor, R16, in the plate circuit of the second section of the 6C8G tube. This places the same amount of resistance in both plate circuits—100,000 ohms and 10,000 ohms respectively—with the result that plate current is equal for both sections of the tube.

Originally a certain amount of de-generation was introduced in the phase inverter, but with the addition of inverse feedback in the output stage, and in the interests of balanced operation of the phase inverter, the cathode resistor, R11, is bypassed by a 25-mfd., 25-volt electrolytic condenser. Again, this condenser is by no means a necessity, but is a worthwhile addition.

Inverse Feedback

By far the most notable contribution to the original circuit is the addition of inverse feedback. To the best of our knowledge, no data has been published on the application of this system to a resistance-coupled push-pull amplifier, though there is nothing complex about

it. And the advantages of this system can be gained by the mere addition of four resistors and two fixed condensers. Anyone can add it in a few minutes of soldering and the improved results obtained make the addition extremely worth while.

The advantages gained through the use of inverse feedback are numerous. Most even harmonic distortion is balanced out in a push-pull amplifier stage, but odd harmonic distortion persists. The latter harmonics, which may be a product of distortion developed in earlier amplifier stages, are reduced appreciably by the function of inverse feedback. This is accomplished by feeding back to the grid circuits out-of-phase voltages which cancel out the original distortion, the amount of cancellation or equalization depending upon the percentage of feedback. This feedback reduces the gain or power sensitivity of the output tubes, the reduction also being dependent upon the percentage of feedback voltage, but this loss of gain can be readily compensated for by in-

(Continued on page 662)

SHORT-WAVE BROADCAST STATION LIST

BOLD NUMERALS: MEGACYCLES. LIGHT NUMERALS: METERS. DOT (•): STATION DOES NOT VERIFY. DIAMOND (◆): STATION NOT IN USE.

Abbreviations: O—Opening; C—Closing; I—Interval; S—Signal; I.R.C.—International Reply Coupon. Schedules in E.S.T.

41.000 W2XHG 7.32	National Broadcasting Co., 30 Rockefeller Plaza, New York, N. Y. Daily 9 a.m.-12 midnight.	15.370 HAS-3 19.52	Director Radio, Hungarian Post, Gyali St., 22, Budapest, Hungary. I: Musical Box Melody; O: Bells ringing; C: Lord Bless the Hungarian (national anthem). Sunday 9-10 a.m.	14.970 LZA 20.04	Director General, Telegraphs and Telephones, Sofia, Bulgaria. O: Racherutza-(Bulgarian Folk Dance). C: National Anthem and Hymn of His Majesty the King. Weekdays 5-6:30 a.m.; 12-2:45 p.m.; Sundays 12 a.m.-4 p.m.
38.650 W2XDG 7.76	New York, N. Y. (see 41.000 mc.) Daily 9 a.m.-12 midnight.	15.360 DZG 19.53	Zeesen, Germany (see 17.760 mc.) Irregular.	14.935 PSE 20.07	Rio de Janeiro, Brazil, (P) Phones LSL-WLK day irreg.; EDM-EHY 8 a.m. Broadcasts German program 4-4:10 p.m. Wednesdays (see 21.080 mc.)
31.600 W1XKA 9.4	Boston, Mass. (see W1XK 9.570 mc.) Daily 7 a.m.-1 a.m.	15.340 DJR 19.56	Zeesen, Germany (see 17.760 mc.) Daily 8-9 a.m.	14.600 JVH 20.55	Nazaki, Japan (see 21.520 mc.) Irregular.
31.600 W8XKB 9.4	Westinghouse Electric & Mfg. Co., Springfield, Mass. Daily 7 a.m.-1 a.m.	15.330 W2XAD 19.56	General Electric Co., 1 River Rd., Schenectady, N. Y.; O: Spark Discharge. C: Star Spangled Banner. Daily 11 a.m.-9 p.m.	14.535 HBJ 20.64	Radio Sulsse, S.A., 12, Qual de la Poste, Geneva, Switzerland. No opening or closing selection (see 1150 11.402 mc.) Saturdays 6:45-8:30 p.m.
31.600 W1XKB 9.4	Pittsburgh, Pa. (see W8XK 21.540 mc.) Daily 10 a.m.-12 Midnight.	15.320 OLR5B 19.58	Prague, Czechoslovakia, (see 21.450 mc.) Irregular (see 9.550-11.840 mc.)	14.480 DZH 20.75	Zeesen, Germany (see 17.760 mc.) Irregular.
31.600 W3XKA 9.4	Philadelphia, Pa. (see W3XAU 9.590 mc.) Daily 9 a.m.-10 p.m.	15.310 GSP 19.60	Daventry, England (see 26.100 mc.) Daily 4-6 p.m.; 6:20-8:30 p.m.	13.635 SPW 22.00	Polkskie Radio, 5, Mazowiecka St., Warsaw, Poland. Mon., Wed., Fri. 12:30-1:30 p.m. Sun. 11:30 a.m.-1:30 p.m. Daily 6-7 p.m.
31.600 W8XWJ 9.4	4465 Penobscot Bldg., Detroit, Mich. Daily exc. Sun. 10:30 a.m.-5 p.m.	15.300 YDB 19.61	Soerabaja, Java. Daily 7:30 p.m.-2 a.m. (see 15.150 mc.)	13.600 ZMBJ 22.06	TSS Awatea, Union Line S.S., Coy Head Office, Wellington, New Zealand. Daily 1-3 a.m., Sundays 6:40-7 p.m.
31.600 W2XDV 9.4	New York, N. Y. (see 21.520 mc.) Mon. to Fri. 6-11 p.m. Sat-Sun. 1:30-6 p.m.; 7-10 p.m.	15.290 LRU 19.62	Radio El Mundo, Malpu, 555, Buenos Aires, Argentina, S.A. O-C: English only. Daily 7-9 a.m.	12.500 HIN 24.00	Ciudad Trujillo, Dom. Rep., W. I. (see 6.243 mc.) Daily exc. Sun. 11:40 a.m.-1:40 p.m.; 7:10-9:50 p.m.
26.100 GSK 11.49	British Broadcasting Corp., Broadcasting House, London W1, England. Big Ben strikes the hour according to arrangement program. C: God Save The King. I. Bow Bells.	15.280 H13X 19.63	J. R. Saladin, Director of Radio Communications, Ciudad Trujillo, Dominican Republic. S: Bells. Weekdays 12:10-1:10 p.m.; Sundays 7:40-10:40 a.m.	12.300 CB615 24.39	Radio Service, Desmaras and Cia., Ltd., Casilla 761, Santiago, Chile, S.A. Daily 12-2 p.m. 5-8 p.m.
25.950 W6XKG 11.56	Washington Blvd. at Oak St., Los Angeles, Calif. Continuously 24 hours each day.	15.270 W2XE 19.64	Wayne, N. J. (see 21.520 mc.) Mon. to Fri. 1-6 p.m. 8:30 p.m.-12 a.m. Sat. & Sun. 2:30 p.m.-6 p.m. 8:30 p.m.-12 a.m.	12.235 TFJ 24.52	Icelandic State Broadcasting Service, P. O. Box 547, Reykjavik, Iceland. First half English. C: Icelandic National Orchestra and chorus voices. Sundays 1:40-2:30 p.m.
21.550 GST 13.92	Daventry, England. (see 26.100 mc.)	15.260 GSI 19.66	Daventry, England (see 26.100 mc.) Daily 12:30-3:45 p.m.	12.130 DZE 24.73	Zeesen, Germany (see 17.760 mc.) Irregular.
21.540 W8XK 13.92	Grant Bldg., Pittsburgh, Pa. O-C: Stars and Stripes Forever. Daily 6:45-9 a.m.	15.250 W1XAL 19.67	Boston, Mass. (see 21.460 mc.) Sun. 11 a.m.-12 noon. Daily 2:15-4 p.m.	12.000 RNE 25.00	Moscow, U.S.S.R. (see RKI; 15.040 mc.) Daily 10-11 p.m. Sun. 6-7 a.m.; 10-11 a.m.; 4-5 p.m.; Wed. 6-7 a.m.; 4-5 p.m.; Fri. 4-5 p.m. Casilla 642, Valdivia, Chile. Daily 6-11 p.m.
21.530 GSI 13.93	Daventry, England. (see 26.100 mc.) Daily 5:45-8:55 a.m.; 9:15 a.m.-10:30 a.m.	15.243 TPA-2 19.68	Minister des Postes, Boulevard Haussmann, 98, Bis., Paris, France. I: Three tones F in Morse. O-C: La Marseillaise; S: chimes ¼ hours. Daily 6-11 a.m. Prague, Czechoslovakia (see 21.450 mc.) Irregular.	11.990 CBI199 25.02	Ciudad Trujillo, Dom. Rep. (see 15.280 mc.) Tues. and Fri. 8:10-10:10 p.m. Sunday 7:40-10:40 a.m.
21.520 W2XE 13.94	485 Madison Ave., New York, N. Y. C: Star Spangled Banner. Mon. to Fri. 7:30-10 a.m. Sat-Sun. 8 a.m.-1 p.m.	15.230 OLR5A 19.70	Philips Radio, Hilversum, Holland. Tues. 4:30-6 a.m.	11.960 H12X 25.08	P. O. Box 2874, Mexico, D.F. S: 2 strokes cong. O-C: May Angels Guard Thee. Sun. 12:30-2 p.m. Mon., Wed., Fri. 3-4 p.m.; 9 p.m.-12 a.m.; Tues., Thurs. 7:30 p.m.-12 a.m.; Sat. 9 p.m.-12 a.m. (see 6.015 mc.)
21.520 JZM 13.94	Overseas Section, The Broadcasting Corp. of Japan, Tokyo, Japan. O-C: Kimigayo National Anthem. Musical chimes follow. (see 11.800-15.160 mc.)	15.220 PCJ 19.71	Pittsburgh, Pa. (see 21.540 mc.) Daily 9 a.m.-7 p.m.	11.900 XEW1 25.21	Prague, Czechoslovakia (see 21.450 mc.) Irregular (see 9.550-11.840 mc.)
21.470 GSH 13.97	Daventry, England. (see 26.100 mc.) Daily 5:45-8:55 a.m.; 9:15 a.m.-12 noon.	15.210 W8XK 19.72	Zeesen, Germany (see 17.760 mc.) Daily 12:05 a.m.-11 a.m.; 11:10 a.m.-12:25 p.m.; 4:50-10:45 p.m. Sunday 8-9 a.m.	11.895 XEXR 25.22	Departamento Autonomo de Propaganda y Publicidad, Mexico, D. F. Daily 6-11:30 p.m.
21.460 W1XAL 13.98	World Wide Broadcasting Corp., University Club, Boston, Mass. O: News Blaze Away. C: Star Spangled Banner. Irregular.	15.200 DJB 19.74	Hong Kong, China (see 9.525 mc.)	11.895 HP51 25.22	Emisora IIP51, Aguadulce, Panama. English—beginning and closing. I: three notes cong. thrice (9) ea. 30 mins. O-C: El Tabor de la Algeria. Daily 7:30-9:30 p.m. Verl cards free.
21.450 OLR6A 13.99	Radiojournal, Praha X11, Fochova Tr. 16, Praha, (Prague) Czechoslovakia. O-C: Melody New World Symphony and Cathedral chimes. I: 9 note trumpet call, repeated. Irregular (see 9.550-11.840 mc.)	15.190 ZBW-4 19.75	Moscow, U.S.S.R. (see RKI 15.040 mc.) Irregular.	11.885 TPA3 25.24	Pontoise, France (see 15.243 mc.) Daily 2-5 a.m. 12:15-6 p.m.
19.020 HS8PJ 15.77	Superintending Engineer, Post and Telegraph Dept., Technical Section, Bangkok, Siam. O: 3 chimes, English Mondays, 8:10 a.m.	15.183 RV96 19.76	Daventry, England (see 26.100 mc.) Daily 3:15-5:30 a.m., 5:45-8:55 a.m., 4-6 p.m.	11.880 XEXA 25.25	Secretaria de Educacion Publica, Mexico, D. F. O-C: March of the Toys. Weekdays 8:30-11 a.m. 2:30-4:30 p.m.; 7 p.m.-12 a.m.; Sun. 7 p.m.-12 a.m.
17.790 GSG 16.86	Daventry, England. (see 26.100 mc.) Daily 3:15-5:30 a.m., 5:45-8:55 a.m., 9:15-12 noon, 12:20-3:45 p.m.	15.180 GSO 19.76	Prague, Czechoslovakia (see 21.450 mc.) Irregular (see 9.550-11.840 mc.)	11.875 OLR4C 25.26	Prague, Czechoslovakia (see 21.450 mc.) Irregular (see 9.550-11.840 mc.)
17.785 JZL 16.87	Nazaki, Japan. (see 21:20 mc.) Irregular.	15.160 OLR5C 19.79	Mexico, D. F. (see 9.500 mc.) Daily 9 a.m.-12 midnight.	11.870 W8XK 25.26	Pittsburgh, Pa. (see 21.540 mc.) Daily 7-9 p.m.
17.780 W3XAL 16.87	30 Rockefeller Plaza, New York, N. Y. Daily 8:55 a.m.-6:45 p.m., 7-9 p.m.	15.160 JZK 19.79	Nazaki, Japan (see 21.520 mc.) Daily 12:30-1:30 a.m.; 8-9 a.m.; 3-4 p.m.; 4:30-5:30 p.m.	11.860 YDB 25.29	Soerabaja, Java (see 15.150 mc.) Daily 10:30 p.m.-2 a.m.
17.780 W9XAA 16.87	666 Lake Shore Drive, Chicago, Ill. S: 3 chimes each 15 minutes. O: Star Spangled Banner.	15.155 SM5SX 19.80	Royal Technical University, Stockholm, Sweden. Daily 11:00 a.m.-5 p.m.	11.860 GSE 25.29	Daventry, England. (see 26.100 mc.)
17.770 PHI 16.88	Philips Radio, Hilversum, Holland. Call: Seven languages. I: Metronome 80 beats per minute. C: National Anthem. Sun., 7:25-10:25 a.m., Mon., Tues., Thurs., Fri. 8:25-10 a.m., Sat. 8:25-10:30 a.m.	15.150 YDC 19.80	N.I.R.O.M., Koningsplein West 5, Batavia, Java, N.E.I. (Location-Soerabaja). Weekdays 5:30-10 a.m. (Sat. 11:30 a.m.) 6-7:30 p.m. 10:30 p.m.-2 a.m. Sunday 5:30-10 a.m. 7:30 p.m.-2 a.m.	11.855 DJP 25.31	Zeesen, Germany (see 17.760 mc.) Irregular.
17.760 DJE 16.89	German Short Wave Station, Broadcasting House, Berlin, Germany. I: 9 musical notes. Folk Song. C: National Horst-Wessel Lied and Duetschlandlied. Daily 12:05 midnight-11 a.m.; Sunday 11:10 a.m.-12:25 p.m.	15.140 GSF 19.82	Daventry, England (see 26.100 mc.) Daily 9:15 a.m.-12 noon, 4-6 p.m.	11.840 OLR4A 25.34	Prague, Czechoslovakia (see 21.450 mc.) Daily 2-2:15 p.m. Mon. & Thurs. 7-9:10 p.m.
17.760 W2XE 16.89	Wayne, N. J. (see 21.520 mc.) Daily 6:30-8 p.m.	15.121 HVJ 19.84	Stazione Radio HVJ, Citta del Vaticano, Vatican City. I: clock ticks 5 m. S: Bells. C: (spoken) Laudetur Jesus Christus. Weekdays 10:30-10:45 a.m.	11.840 KZRM 25.34	Erlanger and Galingner, Inc., Regina Bldg., David St., Manila, P. I. Daily 4-10 a.m. (see 9.570 mc.)
17.755 ZBW-5 16.90	Hong Kong, China. (see 9.525 mc.)	15.040 RKI 19.95	Radio Centre, Soliana 12, Moscow, USSR. Call: "This Is Moscow Calling." O-C: Internationale. Irregular. No I.R.C. required.	11.830 W2XE 25.36	Wayne, N. J. (see 21.520 mc.)
15.530 HS8PJ 19.32	Bangkok, Siam. (see 19.020 mc.) Occasional Mondays 8-10 a.m.				
15.440 XEBM 19.43	P. O. Box 50, Mazatlan, Mexico. Daily 9-10 a.m.; 1-2 p.m., 8-10 p.m.				

11.830 W9XAA Chicago, Ill. (see 17.780 mc.) Week days 9 a.m.-6 p.m., Sun 9-11 a.m., 1-5:30 p.m.

11.820 XEBR Apartado 68, Hermosillo, Con. Mexico. O-C: **Over The Waves**, Daily 1-4 p.m.; 9 p.m.-12 a.m.

11.820 GSN Daventry, England (see 26.100 mc.)

11.810 2RO-4 5 Via Montello, Rome, Italy. O: **Bells of Rome**. C: **Italian Royal March and Giovinetta**. I: bird call—black cap bird (see 9.635 mc.) Daily 6:43 a.m.-12:20 p.m. Skamleback, Denmark (see 6.060 mc.) Daily 5-10 p.m.

11.805 OXY Oster. Radioverkehrs A.G., Johannesgasse 4h, Wien 1, Austria. Call: "Hier Radio Wien." I: Metronome—60 beats per m. Weekdays 9 a.m.-5 p.m. Sat. to 6 p.m.

11.801 OER-3 Nazaki, Japan (see 21.520 mc.) Daily 8-9 a.m.; 3-4 p.m.; 4:30-5:30 p.m.

11.800 JZJ General Betancourt 51. (Playa) Mantanzas, Cuba. O-C: **Vals Diana**. Weekdays 1-4 p.m., 6-10 p.m. Sun. 9-10 p.m.

11.796 OAX5A Avenida San Luis, Ica, Peru. S.A. O: March, "Relator". C: "Estrelita." Daily 12-4 p.m. 7-11:30 p.m. Zeesen, Germany (see 17.760 mc.) Irregular.

11.795 DJO Boston, Mass. (see 21.460 mc.) Mon. to Fri. 4:45-6:30 p.m. Sat. 1:15-5 p.m. Sun. 3-6:30 p.m.

11.790 WIAXL Zeesen, Germany (see 17.760 mc.) Daily 10:40 a.m.-4:30 p.m.; 4:50-10:45 p.m.

11.770 DJD Guatemala City, Guatemala, C.A. (see 9.450 mc.) Evenings. Irregular.

11.760 TGWA Apartado 203, Monterey, Mexico. Daily 7-11 p.m.

11.760 OLR4B Prague, Czechoslovakia (see 21.450 mc.) Irregular (see 9.550-11.840 mc.)

11.750 GSD Daventry, England (see 26.100 mc.) Daily 3:15-5:30 a.m.; 10:45 a.m.-12 noon; 12:20-3:45 p.m.; 6:20-8:30 p.m.; 9-11 p.m.

11.740 HP5L Apartado 129, David, Chiriqui, Panama, C. A. Daily 4-7 p.m.

11.730 XETM Villahermosa, Mexico. Daily 6-11 p.m.

11.730 PHI Hilversum, Holland (see 17.770 mc.) Sun. 8-9 p.m.

11.729 CJRX Royal Alexandra Hotel, Winnipeg, Manitoba, Canada. Weekdays 6 p.m.-12 a.m. Sundays 5-10 p.m. Pontoise, France (see 15.243 mc.) Daily 6:15-8:15 p.m.; 10 p.m.-1 a.m.

11.718 CR7BH Lourenco Marques, Portuguese East Africa (see CR7AA, 6.137 mc.) Weekdays 4:30-6:30 a.m.; 9:30-11 a.m.; 12:30-4 p.m. Sundays 5-7 p.m.; 10 a.m.-12:30 p.m.; 2-4 p.m.

11.710 YSM Director of Comunicaciones, San Salvador, El Salvador, C. A. Daily 1:30-2:30 p.m.

11.710 Philco 211-213D Rue Catinat, Saigon, Indo-China. Daily 6:30-9:30 a.m. News in French 9-9:10 a.m.

11.710 XEWB Juarez 289, Guadalajara, Mexico. Daily 7-11 p.m.

11.710 VKSMI M.V. Kanibla, Mellwraith and McEacham, Bridge St., Sydney, Australia. 11 p.m.-8 a.m. and later.

11.705 SBP Chief Engineer, Motala, Sweden. Daily 6-9 a.m., 11 a.m.-4 p.m.

11.700 HP5A P. O. Box 954, Panama City, Panama, C.A. O-C: "Anvil Chorus". Daily 11:45 a.m.-1 p.m., 6-10 p.m. Sundays—open at 10 a.m. Thurs., Fri., Sat.—open at 5 p.m.

11.700 CB170 Broadcasting Populares, Santiago, Chile, S.A. Daily 6-11 p.m.

11.570 HH2T Societe Haitienne Radiodiffusion, P.O. Box 103, Port-au-Prince, Haiti, W.I. S: 4 tones gong 1-3-2-4. English and French O-C: **The Swan**. Special programs, irregular.

11.535 SPD Warsaw, Poland (see 13.635 kc.) Daily 6-7 p.m.

11.435 COCX P. O. Box 32, Havana, Cuba. S: 5 bells. English each ½ hr. O-C: **Pajarillo Barranqueno**. Daily 8 a.m.-1 a.m.

11.402 HBO Geneva, Switzerland (see IIBJ, 14.535 mc.) Mondays 12:40-1:40 a.m. Fridays 2-2:15 p.m. Saturdays 6:45-8:30 p.m.

11.040 CSW Emissora Nacional, Rua do Quelhas, No. 2, Lisbon, Portugal. Daily 2-6 p.m.

11.000 PLP J. Sanders, Chief Engr., Java Wireless Stations, Bandoeng, Java; D.E.I. Weekdays 4:30-10 a.m. (Sat. 11:30 a.m.); 6-7:30 p.m. 10:30 p.m.-2 a.m.; Sunday 4:30-10 a.m.; 7:30 p.m.-2 a.m.

10.960 JZB Nazaki, Japan. (see 21.520 mc.) Irregular.

10.740 JVM Nazaki, Japan (see 21.520 mc.) 4:30-7:30 a.m. Irregular.

10.670 CEC Cia Internacional de Radio, Casilla 16-D, Santiago, Chile. Daily exc. Sat. and Sun. 7-7:20 p.m. (see CED, 10.230 mc.)

10.660 JVN Nazaki, Japan (see 21.520 mc.) Daily 3-7:30 a.m.

10.370 Radio Nacionales, Salamanca, Spain. Daily 9-9:45 p.m.

10.370 EAJ43 Radio Club Tenerife, Apartado 225, Santa Cruz, Tenerife, C.I. Daily 2:15-3:30 p.m.; 6-7 p.m.; 7:10-9:30 p.m.

10.370 EHZ Tablero, Tenerife, C. I. Daily 3-4 p.m.; 6-8:15 p.m.

10.350 LSX Transradio Internacional, San Martin, 329, Buenos Aires, Argentina, S.A. C: **San Lorenzo March**. Irregular 5-8 p.m.

10.330 ORK Director of Communications, Bruxelles, Belgium. I: Carrillon. O: **Towards The Future**. C: **Brabanconne**. Daily 1:30-3 p.m.

10.290 DZC Zeesen, Germany (see 17.760 mc.) Irregular.

10.260 PMN Bandoeng, Java, D.E.I. (see PLP, 11.000 mc.) Weekdays 5:30-11 a.m. (Sat. 11:30 a.m.); 6-7:30 p.m.; 10:30 p.m.-2 a.m.; Sundays 5:30-11 a.m.; 7:30 p.m.-2 a.m.

10.230 CED Antofagasta, Chile (see CEC 10.670 mc.) Sat. and Sun. 7-7:20 p.m.

10.135 CQN Chief of Radio Station CQN, Post Office Bldg., Macao (Portuguese) China. O: **Maria de Fonte**. C: **National—A Portuguesa**. Mon. and Fri. 7-8:30 a.m.

10.042 DZB Zeesen, Germany (see 17.760 mc.) Irregular.

9.940 Lisbon, Portugal (see 11.040 mc.) Daily 6-9 p.m.

9.925 JDY Dalren, Manchukuo, Japan. Daily 7-8 a.m.

9.860 EAQ P. O. Box 951, Madrid, Spain. O: **La Verbena de la Paloma**. C: **Himno de Riego or Good Night Melody**, Sat. 1-3:30 p.m. Daily 5:15-9:30 p.m.

9.840 COCM Apartado 33, Havana, Cuba. Daily 8 a.m.-12 midnight.

9.750 COCQ Calle 25, No. 445, Havana, Cuba. Weekdays 6:55 a.m.-1 a.m.; Sundays 6:55 a.m.-12:01 a.m.

9.685 TGWA Guatemala City, Guatemala, C. A. (see 9.450 mc.) Evenings—Irregular.

9.685 Radio Martinique, P. O. Box 136. Port de France, Martinique, F.W.I. O-C: "La Marseillaise", Daily 6:30-7:50 p.m.

9.675 DZA Zeesen, Germany (see 17.760 mc.) Irregular.

9.670 TI4NRH Apartado 40, Heredia, Costa Rica, C.A. Daily 9-10 p.m.; 11:30 p.m.-12 a.m.; Sat. to 2 a.m.

9.666 CR6AA Caixa Postal 103, Lobito, Angola. Portuguese West Africa. I: 3 notes on piano; A-C-B. Portuguese, French and English. Wed. and Sat. 2:45-4:30 p.m.

9.660 LRX Buenos Aires, Argentina, S. A. (see LRU, 15.200 mc.) Daily 9:30 a.m.-11:30 p.m.

9.650 CTIAA Antonio Augusto de Aguair, 144 Lisbon, Portugal. I: Cookoo, 3 times. C:A Portuguese (national anthem). Tues., Thurs., Sat. 4-7 p.m.

9.645 HH3W P. O. Box A117, Port-au-Prince, Haiti, W.I. S: 4 chime notes and siren each 15 min. before announcements. Daily exc. Sunday 1-2 p.m.; 7-8:30 p.m.

9.640 CXA8 Director, Montevideo, Uruguay, S.A. Daily 6 p.m.-12 a.m.

9.635 2RO-3 Rome, Italy. Daily 12:30-6 p.m. Saturdays only 5:30 p.m. Am. hours M., W., F. 6-7:30 p.m. So. Am. Hrs. T., Th., S. 6-7:45 p.m. (see 11.810 mc.)

9.630 HJ7ABD Bucaramanga, Colombia, S.A. Daily 8-11 p.m.

9.616 HJIABP P. O. Box 37, Cartagena, Colombia, S. A. O-C: **Under The Double Eagle**. Daily 7-9 a.m.; 11 a.m.-1:20 p.m.; 6-11 p.m.

9.606 ZTJ Johannesburg, South Africa (see 6.097 mc.) 11:45 p.m.-12:45 a.m.

9.600 RAN Moscow, U.S.S.R. (see RKI, 15.040 mc.) Daily 7-9:15 p.m.

9.600 KEYU Universidad Nacional, Mexico, D.F. Daily 7-10 p.m.

9.600 CB960 Casilla 1342, Santiago, Chile, S.A. O: **Babes in Toyland**. C: **Someone who a Voice is Calling** (organ). Daily 11:30 a.m.-2 p.m.; 9:30 p.m.-12 a.m. **Veri Slow**.

9.595 HBL Geneva, Switzerland (see IIBJ, 9.345 mc.) Irregular.

9.595 YNLF Calle, 15 de Set No. 206, Managua, Nicaragua, C.A. Daily 8-9 a.m.; 1-3 p.m.; 6:30-10:30 p.m. **Veri—5c U. S. postage**.

9.590 VK6ME Amalgamated Wireless Ltd., Perth, West Australia. (Address 47 York St., Sydney, Australia). Daily exc. Sun. 6-8 a.m.

9.590 W2XE Wayne, N. J. (see 21.520 mc.) 31.28

9.590 W3XAU 1622 Chestnut St., Philadelphia, Pa. Daily 12 noon-8 p.m.

9.590 VK2ME Amalgamated Wireless, Ltd. 47 York St., Sydney, Australia. Clock strikes at hour, chimes ¼ hr. I: Kookaburra bird call. C: **God Save The King**. Sunday 1-3 a.m.; 4:30-8:30 a.m.; 9-11 a.m.

9.590 HPSJ Apartado 867, Panama City, Panama. C. A. News 6:30 p.m. O: **Black-horse Troop March**. C: **Discipline Honor and Abrogacion**. Weekdays 12-2 p.m.; 5-10:30 p.m. Sundays 10:30 a.m.-2 p.m.; 8-10 p.m.

9.590 PCJ Hilversum, Holland. (see 15.220 mc.) Sunday 2-3 p.m.; 7-8 p.m. Tues. 1:30-3 p.m. Wed. 8-10 p.m.

9.580 GSC Daventry, England (see 26.100 mc.) Daily 9-11 p.m.

9.580 VK3LR Australian Broadcasting Commission. G.P.O. Box 1686, Melbourne, Australia. O: Recording, song, Australian Lyre Bird. C: **God Save The King**. S—3 notes, gong; time signals and P.O. chimes. Sunday 3-7:30 a.m.; Mon. to Fri. 9:45 p.m.-2 a.m., 3:30-8:30 a.m.; Sat. 9:45 p.m.-2:30 a.m.; 3:30-9 a.m.

9.570 WIXK Westinghouse Electric and Mfg. Co., Boston, Mass. O-C: **Stars and Stripes Forever**. Weekdays 6 a.m.-1 a.m. Sunday 8 a.m.-1 a.m.

9.570 KZRM Manila, P. I. (see 11.840 mc.) Daily 4-10 a.m.

9.565 YV3RB Sr. Arturo Ramos Magi, Prop., Barquisimeto, Venezuela. Daily 11:30 a.m.-12:30 p.m.; 5:30-9:30 p.m.

9.562 OAX4T Radio Nacional, Peruvian Government, Av. Petit Thouars 447, Lima, Peru. Daily 11:30 a.m.-1:30 p.m.

9.560 DJA Zeesen, Germany (see 17.760 mc.) Daily 12:05 a.m.-11 a.m.; 4:50-10:45 p.m.

9.550 XEFT Av. Independencia 28, Veracruz, Mexico. S: Chimes, bugle calls or cookoo horn. English at closing. O-C: **Vals Poetico**. Weekdays 10:30 a.m.-4:30 p.m.; 7:30 p.m.-12:30 a.m.; Sundays 9 p.m.-12:30 a.m.

9.550 YDB Soerabaja, Java N.E.I. (see 15.150 mc.) Weekdays 5:30-10 a.m. (Sat. 11:30 a.m.) 6-7:30 p.m., 10:30 p.m.-2 a.m. Sun. 5:30-10 a.m. 7:30 p.m.-2 a.m.

9.550 HISE Sr. H. Chavez, Ciudad Trujillo, Dom. Rep., W. I. Irregular.

9.550 OLR3A Prague, Czechoslovakia (see 21.450 mc.) Daily 2:30-4:30 p.m.

9.545 HH2R Port-au-Prince, Haiti, W.I. (see IIBJ, 11.570 mc.) Special programs irregular.

9.540 VPD-2 Amalgamated Wireless, Ltd., Suva, Fiji Islands. C: **God Save The King**. Daily 5:30-7:00 a.m. No signals.

9.540 DJN Zeesen, Germany (see 17.760 mc.) Daily 12:05 a.m.-11 a.m.; 4:50-10:45 p.m.

9.535 JZI Nazaki, Japan (see 21.520 mc.) 4:30-7:30 a.m. Irregular.

9.530 W2XAF Schenectady, N. Y. (see W2XAD 15.330 mc.) Daily 4 p.m.-12 a.m. Ministers du Commerce, Administrateur des Telegraphes, Oslo, Norway. I: Piano motif Grieg's **Sigurd Jorsalfar**. C: **National—Yes, We Love This Country**. Daily 5-8 a.m.; 11 a.m.-5 p.m.

9.525 ZBW-3 Hong Kong Broadcasting Committee, P.O. Box 200, Hong Kong, China. I-O-C: none. Weekdays 11:30 p.m.-1:15 a.m., Mon.-Thurs. 4-10 a.m., Tues., Wed., Fri., 3-10 a.m., Sat., 3-11 a.m., Sun. 9 p.m.-1:30 a.m., 3-9:30 a.m.

9.524 FIQA Tananarive, Madagascar (see 6.000 mc.) Daily 12:30-12:45 a.m.; 3:30-4:30 a.m.; 10-11 a.m. simultaneously on 6.000 mc.

9.523 Radio Stato Operai, 25 Liberte, Paris, France. Daily 7-8 p.m. (see 7.380 mc.)

9.520 OZF Copenhagen, Denmark (see ONY 6.060 mc.) Daily 2-6:45 p.m.

9.516.6 HJ6ABH Armenia, Colombia, S.A. O-C: **The Spanish Soldiers**. S: Blows on Marimba. News 7-10 p.m. Weekdays 8-11 a.m.; 6-10 p.m. Sundays 7-10 p.m.

9.520 YSH San Salvador, El Salvador, C.A. (see 11.710 mc.) Irregular.

9.520 XEDQ Apartado 107, Guadalajara, Jalisco, Mexico. O-C: Mexican Dance—**Jarabe Tapatio**. Daily 12-4 p.m. 8 p.m.-12 a.m. Occasional **DX Sunday 2-4 a.m.**

9.510 GSB Daventry, England (see 26.100 mc.) Daily 3:15-5:30 a.m.; 12:20-3:45 p.m.; 4-6 p.m.; 6:20-8:30 p.m.; 9-11 p.m.

9.510 HJU 31.55	Buenaventura, Colombia, S.A. O-C: Palma , English each 5 mins. Mon., Wed., Fri. 12-2 p.m.; 8-11 p.m.	7.510 JVP 39.95	Nazaki, Japan (see 21.520 mc.) 3-7:30 a.m. Irregular.	6.482 HI4D 46.28	Ciudad Trujillo, Dom. Rep. W.I. Mon. & Sat. 11:55 a.m.-1:40 p.m.; 4:40-7:40 p.m.
9.510 HS8PJ 31.55	Bangkok, Siam (see 9.550-10.020 mc.) Mon. and Thurs. 8-10 a.m.	7.411 HCICE 40.48	Apartado 485, Quito, Ecuador, S.A. Thursday 9-10 p.m. Veri—5c U. S. postage.	6.480 EDR-4 46.30	Radio Poste, Palma de Mallorca, Balearic Islands. Daily 4:30-5:15 p.m.
9.510 VK3ME 31.55	Amalgamated Wireless Ltd., 167-9 Queen St., Melbourne, Australia. S: chimes and striking on hour. C: God Save the King . Daily exc. Sun. 4-7 a.m.	7.380 "Radio Liberte" 40.65	Paris, France (see 9.523 mc.) Daily 7-8 p.m.	6.479 H18A 46.30	Apartado 1312, Ciudad Trujillo, Dom. Rep., W.I. English each 15 mins. O-C: March General Alvaro Obregon . S: 2 strokes of bell. Daily 8:40-10:40 a.m.; 2:40-4:40 p.m.; Sat. 9:10-10:40 p.m.
9.505 HID 31.56	Director, Ciudad Trujillo, Dom. Rep., W.I. Daily 5:40 to 7:40 or 8:40 p.m.	7.380 XECR 40.65	Departamento Autonomo de Publicidad, Mexico, D.F. Sun 7-8 p.m. No signals or O-C selection.	6.450 HI4V 46.51	Santiago Francisco de Macoris, Dom. Rep., W.I. Daily 11:40 a.m.-1:40 p.m.; 6:40-9:15 p.m.
9.504 OLR3B 31.57	Prague, Czechoslovakia, (see 21.450 mc.) Irregular (see 9.550-11.840 mc.)	7.211 EA8AB 41.60	Radio Club Tenerife, Apartado 225, Santa Cruz, Tenerife, C.I. O-C: Lady of Spain . English on Saturdays only. Mon., Wed., Fri., Sat. 3:15-4:15 p.m.	6.445 YVQ 46.55	Gobierno de Venezuela, Maracay, Venezuela, S.A. 8-9 p.m. Saturdays.
9.501 PRF5 31.58	P.O. Box 709, Rio de Janeiro, Brazil, S.A. I: three-note gong. C: Brazilian National Anthem. (see PSE 14.935 mc.) Daily exc. Sun. 4:45-5:45 p.m.	7.203 EAJ-8 41.64	San Sebastian, Spain. (see 10.370 mc.) Daily 3-4 a.m., 8-10 a.m., 1:30-4 p.m., 5-7 p.m.	6.430 HIIS 46.66	P.O. Box 112, Santiago de los Caballeros, Dom. Rep., W.I. Daily 11:40 a.m.-1:40 p.m.; 5:30-7:40 p.m.
9.500 HI5G 31.58	La Vega, Dominican Republic, W.I. Daily 6:40-8:40 a.m.; 10:40 a.m.-2:40 p.m.; 4:40-8:40 p.m.	7.200 YNAM 41.67	A. Majewsky, Gerente, Managua, Nicaragua, C.A. Daily 7-10 p.m. Veri—5c U. S. postage.	6.420 YV6RC 46.73	Ciudad Bolivar, Venezuela, S.A. Daily 10:30 a.m.-1:30 p.m.; 4:30-9:30 p.m.
9.500 XEWW 31.58	Apartado 2516, Mexico, D.F. Daily 9 a.m.-12 midnight.	7.177 CR6AA 41.80	Lobito, Portuguese West Africa (see 9.666 mc.) Wed. and Sat. 2:45-4:30 p.m.	6.410 TIPG 46.80	Apartado 225, San Jose, Costa Rica, C.A. O-C: Parade of the Wooden Soldiers . Daily 7:30-9:30 a.m.; 12-2 p.m.; 6-11:30 p.m.
9.480 EAR 31.65	P. O. Box 951, Madrid, Spain. Daily 6:30-8:30 p.m.; 10-11 p.m.	7.100 FO8AA 42.25	Radio Club Oceanien, Alfred T. Poria, Pres. Papeete, Tahiti. Tues. and Fri. 11 p.m.-1 a.m.	6.400 YV5RH 46.88	Apartado 1931, Caracas, Venezuela, S.A. Weekdays 11 a.m.-1:30 p.m.; 4:30-9:30 p.m.; Sun. 9:30 a.m.-1:30 p.m.; 5-7:30 p.m.
9.450 "Radio Fort de France" 31.75	Edouard Boulanger Fils, Fort de France, Martinique. Daily 11:30 a.m.-12:30 p.m.; 6:15-7:15 p.m.; 8-9 p.m.	7.030 EA9AH 42.67	El Coronel Jefe de Estado, de las Mayor de las Puezas, Militares, Apartado 124, Tetuan, Spanish Morocco, Africa. Daily 4-4:25 p.m.; 12-2:30 a.m. Irregular.	6.375 YV5RF 47.10	Apartado 983, Caracas, Venezuela, S.A. C: Organ: Blue Danube . Daily 6:30-7:30 a.m.; 10:30 a.m.-1:30 p.m.; 4:30-10:30 p.m.
9.450 TGWA 31.75	Radiodifusora Nacional, Guatemala City, Guatemala, C.A. Daily exc. Sun. 12-2 p.m.; 8-9 p.m.; 10 p.m.-12 a.m.; Sun. 12-2 p.m.; 12 a.m.-6 p.m.; No I.R.C. necessary.	6.975 HCETC 43.01	Apartado 134, Quito, Ecuador, S.A. Sat. and Mon. 7:45-9 p.m. Veri—5c U. S. postage. Veri slow.	6.360 YV1RH 47.17	P. O. Box 261, Maracaibo, Venezuela, S.A. O: Jealousy . C: Er Weicht der Sonne Nicht —march Weekdays 5:45-6:45 a.m.; 10:30 a.m.-1:30 p.m.; 3:30-10:30 p.m. English 10-10:30 p.m. Sunday 8:30 a.m.-2:30 p.m.
9.440 HCODA 31.78	Guayaquil, Ecuador, S.A. Daily exc. Sunday 8-11 p.m. Veri—5c U.S. postage.	6.900 HI2D 43.48	Associated Cia Dominicana, Ciudad Trujillo, Dom. Rep., W.I. Daily 6:40-8:40 a.m.; 10:40 a.m.-2:40 p.m.; 4:40-8:40 p.m.	6.351 HRPI 47.24	Sr. Manuel E. Escota, Director, San Pedro Sula, Honduras, C.A. Weekdays 12-2 p.m.; 7:45-10 p.m. Veri—5c U. S. postage.
9.428 COCH 31.81	P.O. Box 41, Havana, Cuba. English each 15 mins. S: chimes 15 m. 2 blows gong adv. O-C: Organ: Maria My Own . Daily 8 a.m.-12 a.m.	6.850 TIOW 43.80	Sr. Rogelia Sotela, Prop., San Jose, Costa Rica, C.A. Weekdays 10-11:30 p.m.; Sun. 2-3 p.m.	6.340 HI1X 47.32	Ciudad Trujillo, Dom. Rep., W.I. (see 15.280 mc.) Weekdays 12:10-1:10 p.m.; Tues. and Fri. 8:10-10:10 p.m.; Sun. 7:40-10:40 a.m.
9.350 HS8PJ 32.09	Bangkok, Siam (see 19.020 mc.) Thursdays 8-10 a.m.	6.820 XGOX 43.99	Central Broadcasting Committee of Kuomintang, Nanking, China. Chinese except English 8:15 a.m. E.S.T. O-C No regular selections. Weekdays 5:30-8:30 a.m. Sun. 7-9 a.m.	6.330 JZG 47.39	Nazaki, Japan (see 21.520 mc.) Irregular.
9.350 COBC 32.09	Apartado 132, Havana, Cuba. Daily 7 a.m.-12:30 a.m.	6.800 HI7P 44.12	Calle Jose Reyes No. 35, Ciudad Trujillo, Dom. Rep. W. I. Weekdays 12:40-1:40 p.m.; 6:40-8:40 p.m.; Sun. 9:30-10:40 a.m.	6.330 COCW 47.39	Apartado 130, Havana, Cuba. Daily 7 a.m.-12 midnight.
9.345 HBL 32.10	Information Section, League of Nations, Geneva, Switzerland. Fridays 2:30-2:45 p.m.; 7:30-7:45 p.m.; 8-8:15 p.m.	6.788 PZH 44.20	Paramaribo (S u r i n a m), Dutch Guiana, S.A. Weekdays 2:45-4:45; 5:45-9:45 p.m. Sun. 9:45-11:45 a.m. Veri slow.	6.325 YNLG 47.43	Sr. Benjamin J. Guerra, L. Managua, Nicaragua. Daily 8-10 a.m., 1-3 p.m., 6 p.m.-12 a.m. Veri—5c U. S. postage.
9.340 OAX4J 32.12	Radio Internacional, Casilla 1166 Lima, Peru. C: Organ: Good Night Sweetheart . Daily 12:3 p.m.; 5 p.m.-1 a.m.	6.780 HIH 44.25	San Pedro de Macoris, Dom. Rep., W.I. Daily 12:10-1:40 p.m.; 7:40-9 p.m. Sun. 5:10-6:40 p.m. DX 2:40-3:40 a.m.	6.315 HIZ 47.51	Apartado 1092 and 771, Ciudad Trujillo, Dom. Rep., W.I. Weekdays 11:10 a.m.-2:10 p.m.; 4:40-9:40 p.m. Sundays 11:40 a.m.-2:40 p.m.
9.300 YNGU 32.27	Apartado 295, Managua, Nicaragua, C.A. Weekdays 12-2 p.m.; 5-6 p.m. Sun. 11 a.m.-12 noon. Veri—5c U. S. Postage.	6.750 JVT 44.44	Nazaki, Japan (see 21.520 mc.) 4:30-7:30 a.m. Irregular.	6.310 TG2 47.54	Director General of Electrical Communications, Guatemala City, Guatemala, C.A. Irregular. 11 p.m.-2 a.m. No I.R.C. required.
9.200 COBX 32.61	San Miguel #194, Havana, Cuba. Daily 8 a.m.-11:30 p.m.	6.730 HI3C 44.58	Sr. Roberto Palli, B., La Romana, Dom. Rep., W.I. English announcements regular. Weekdays 12:10-2:10 p.m.; 6:10-11 p.m. Sun. 12:10-2:40 p.m.	6.300 YV4RD 47.62	Sr. Luis Croquer, Prop., Maracay, Venezuela, S.A. Weekdays 11:30 a.m.-12:30 p.m.; 5:30-9:30 p.m.
9.125 HAT-4 32.88	Budapest, Hungary (see IAS-3, 15.370 mc.) Sun. and Wed. 7-8 p.m.; Sat. 6-7 p.m.	6.690 TIEP 44.84	Apartado 227, San Jose, Costa Rica, C.A. Daily 7-11 p.m.	6.280 COHB 47.77	P. O. Box 85, Sancti-Spiritus, Santa Clara, Cuba. Weekdays 9-10 a.m., 12-10 p.m. Sun. 10 a.m.-10 p.m.
9.090 COBZ 33.32	P.O. Box 866, Havana, Cuba. S-4 chimes. O-C: Record: "Popular Melodies" 7:45 a.m.-12:30 a.m. Sat. to 2 a.m.	6.668 HC2RL 44.99	P. O. Box 759, Guayaquil, Ecuador, S.A. O-C: Ecuadorian National Anthem . English each 15 mins. Sunday 5:30-7:30 p.m.; Tues. 9-11 p.m. Veri—5c U. S. postage.	6.280 HIG 47.77	Av. Jose Trujillo No. 50, Ciudad Trujillo, Dom. Rep., W.I. Daily 7:10-8:40 a.m.; 12:40-2:10 p.m.; 8:10-9:40 p.m.
8.840 ZMBJ 33.94	Wellington, N. Z. (see 13.600 mc.) Sun. 6:40-7 p.m.; daily 1-3 a.m.	6.630 HIT 45.25	Apartado 1105, Ciudad Trujillo, Dom. Rep., W.I. O-C: Anchors Aweigh . English. Daily exc. Sun. 12:10-1:40 p.m.; 6:10-8:40 p.m. DX 1st Sat. 11:10 p.m.-1:10 a.m.	6.275 OAX4G 47.81	Avda. Abancay, 915-923, Lima, Peru, S.A. C: Good Night Sweetheart . Daily 7-11:30 p.m.
8.831 HCJBI 33.97	Casilla 691, Quito, Ecuador, S.A. O: March Patria I: 4 blows on gong. C: Ecuadorian National Anthem . Daily exc. Mon. 7:30-8:45 a.m. 11:30 a.m.-2:30 p.m. 5-10 p.m. (to 7 p.m. on 4.107 mc.; after 7 p.m. on 4.107 and 8.831 mc.) Veri—5c U. S. Postage.	6.618 El Prado 45.33	Apartado 98, Riobamba, Ecuador, S.A. English ea. 15 mins. O: Bugle call. Thursday 9:15-11:15 p.m. Veri—5c U. S. postage.	6.270 YV5RP 47.85	P. O. Box 508, Caracas, Venezuela, S.A. Daily 6-11:45 p.m.
8.795 HKV 34.13	Ministerio de Guerra, Military Service, Bogota, Colombia, S.A. Mon. and Thurs. news 7-7:30 p.m.	6.580 "Radio Guardia Civil" 45.59	Tetuan, Spanish Morocco, Africa O: March of the Caliph. C: Spanish National Anthem. I and S: chimes . Daily 2-3 p.m.; 7-8 p.m.	6.250 YV5RJ 48.00	Sr. Edmundo Suegart, Prop., Caracas, Venezuela, S.A. Daily 5:30-9:30 p.m.
8.665 COJK 34.62	Finlay No. 3, Altos, Camaguey, Cuba. S—3 tone gong, each ¼ hr. English Ann. Each ½ hr. O: "Allegiance March" C—None. Week days 10:30 a.m.-12:30 p.m. 7-10:30 p.m., Sat. 11 p.m., Sun. 10 a.m.-12:30 p.m.	6.575 HCIVT 45.63	Ambato, Ecuador, S.A. Mon., Wed., Fri. 8-10:30 p.m. Veri 5c U. S. postage.	6.243 HIN 48.05	Calle Arzobispo Merino #97, Ciudad Trujillo, Dom. Rep., W.I. English each 15 mins. (see 12.500 mc.) Weekdays 11:40 a.m.-2:40 p.m.; 7:10-9:10 p.m. Sun. 11:10 a.m.-3:40 p.m.
8.580 YNIPR 34.97	A. Mejevsky, Gerente, Managua, Nicaragua, C.A. Daily 1-2:30 p.m.; 7:30-10:30 p.m. Veri—5c U. S. postage.	6.550 TIRCC 45.81	Apartado 1064, San Jose, Costa Rica, C. A. S: 4 notes on gong O-C: The Lost Chord—Organ . Tues., Thurs., Sat., 6-7 p.m. Religious Sundays 10 a.m.-7 and 8 p.m.; Thurs. 8 p.m.	6.240 HI8Q 48.08	Julio O. Garcia Alardo, Ciudad Trujillo, Dom. Rep., W.I. Daily 10:40 a.m.-1:40 p.m.; 4:40-8:40 p.m.
8.404 HC2CW 35.70	Casilla 1166, Guayaquil, Ecuador, S.A. O-C: Sangre Ecuatoriana . Weekdays 11:30 a.m.-12:30 p.m.; 7-11 p.m. Sun. 3-5 p.m. Veri—5c U. S. postage.	6.545 YV6RB 45.84	Apartado 34, Ciudad Bolivar, Venezuela, S.A. Daily 7:10 p.m.; Sun. 3-6 p.m.	6.235 HRD 48.11	Sr. Tulio Castaneda, Director, La Ceiba, Honduras, C.A. English on the hour. O: Solo Tuyo. C: Intermzzo No. 1 . Piano 10:58 p.m. Good Night Melody . No signals. Daily exc. Sun. 8-11 p.m.
8.110 ZPIO 37.00	Radio Prieto ZPIO, Asuncion, Paraguay, S.A. Daily 8-10 p.m.	6.535 YNIGG 45.91	Managua, Nicaragua, C.A. Daily 6-10 p.m.; Veri—5c U. S. postage.	6.230 YVIRG 48.15	Radio Valera, Valera, Venezuela, S.A. S: 1 bell O-C: Local March . Daily 11 a.m.-12:30 p.m.; 5:30-9:30 p.m.
7.894 YSD 38.00	San Salvador, El Salvador, C. A. (see 11.710 mc.) Daily 9-11 p.m.	6.520 YV4RB 46.01	Valencia, Venezuela, S.A. C: Bugle call, taps and off. Daily 11 a.m.-1:30 p.m.; 5:30-9:30 p.m.	6.200 COKG 48.39	Apartado 137, Santiago, Cuba. Daily 5-6 p.m.; 9:30-10:30 p.m.; Sundays 12:01-1 a.m.
7.854 HC2JBS 38.19	P.O. Box 805, Guayaquil, Ecuador, S.A. S: Gong. O-C: El Corcovado (Carloca fox). Daily 11 a.m.-2 p.m.; 4:30-11 p.m. Veri—5c U. S. postage.	6.500 HIL 46.15	Apartado 623, Ciudad Trujillo, Dom. Rep., W.I. Daily 12-2 p.m.; 6-8 p.m.	6.200 XEXS 48.39	Secretaria de la Economia Nacional, Mexico, D.F. Daily 7-11 p.m.
7.797 HBP 38.49	Geneva, Switzerland (see 9.345 mc.) Irregular.	6.500 YV1RN 46.15	Maracaibo, Venezuela, S.A. Daily 6-9:30 p.m.		
7.750 T18WS 39.74	Apartado 75, Puntarenas, Costa Rica, C.A. Weekdays 5-7 p.m.; 8:30-10 p.m. Sun. 4-5 p.m.				
7.520 RKI 39.89	Moscow, U.S.S.R. Daily 7-9:15 p.m. (see 15.040 mc.)				

6.190 H11A P. O. Box 423, Santiago de los Caballeros, Dom. Rep. W.I. 1: Gong C: Anchors Aweigh. Daily 6:40 a.m.-4:40 p.m.; Thurs. and Sundays, 7:40-9:40 p.m. Band concerts.

6.160 VPB Radio Club of Ceylon and So. India. P. O. Box 282, Colombo, Ceylon. S: Time on hour. 6 pips. I: Bow Bells, infrequently. Daily 6:30-11:30 a.m. Saturdays 12:30 p.m.

6.158 YV5RD Radio Venezuela, Caracas, Venezuela, S.A. I: 5 strokes of bell. O-C: Triunfo Aereo. Weekdays 6:30-7:30 a.m.; 10:30 a.m.-1:30 p.m.; 3:30-10 p.m. Sun. 8:30 a.m.-10:30 p.m.

6.150 CJRO Winnipeg, Manitoba, Canada (see CJRX, 11.720 mc.) Weekdays 6 p.m.-12 a.m. Sundays 5-10 p.m.

6.150 H15N Moca, Dom. Rep., W.I. Daily 6:40-8:40 a.m.; 10:40 a.m.-2:40 p.m. 4:40-8:40 p.m.

6.150 OAX1A Sr. J. Carlos Montjoy D., Casilla No. 9, Chichayo, Peru. Daily exc. Sat. 8-11 p.m.; Sat. 8 p.m.-12 a.m.

6.145 HJ4ABE Medellin, Colombia, S.A. I: Morse-letter "M" S: 4 chimes. Daily 9:30 a.m.-1 p.m.; 5-11:30 p.m.

6.140 W8XK Pittsburgh, Pa. (see 21.540 mc.) Daily 10 p.m.-1 a.m.

6.140 ZEB Bulawayo, Rhodesia, South Africa (see ZEC, 5.800 mc. for address). Sun. 3-5 a.m.; Tues. and Thurs. 1:15-3:15 p.m.

6.138 HJ4ABD Sr. Luis Emilio Mejia, Gerente, Medellin, Colombia, S.A. O-C: Part 4a William Tell (see 5.900-5.780 mc.) Weekdays 10 a.m.-2 p.m.; 4-11 p.m. Sun. 11 a.m.-3 p.m.; 7-11 p.m. Veri slow.

6.137 CR7AA P.O. Box 594, Lourenco Marques, Portuguese East Africa. O: A Maria de Fonte. C: A Portuguesa. Weekdays 12:15-1 a.m.; 4:30-6:30 a.m.; 9:30-11 a.m.; 12:30-4 p.m. Sundays 5-7 a.m.; 10 a.m.-12:30 p.m.; 2-4 p.m.

6.133 XEXA Mexico, D.F. (see 11.880 mc.) Weekdays 8:30-11 a.m.; 2:30-4:30 p.m.; 7 p.m.-12 a.m. Sunday 7 p.m.-12 a.m.

6.130 VP3BG Crystal Broadcasting Co., Philharmonic Bldgs., Georgetown, British Guiana, S.A. O: Serenade. C: Good Night My Love and God Save the King. Week-days 10:15-11:15 a.m. 3-7:45 p.m. Sundays 6:45-8:45 a.m.; 4:45-6:45 p.m. Veri slow.

6.130 ZGE Kuala Lumpur, Malaya States, S.S. Sun., Tues., Fri. 6:40-8:40 a.m.

6.130 LKJI Jeloy, Norway (see 9:530 mc.) Daily 11 a.m.-5 p.m.

6.130 COCD P.O. Box 2294, Havana, Cuba, English each 15 mins. O: In a Clock Store. C: Good Night. Weekdays 9 a.m.-1 a.m. Sundays 10 a.m.-8 p.m. (DX 1-3 a.m.)

6.130 VE9HX P.O. Box 998, Halifax, N.S., Canada. O-C: Oh Canada. Chimes 15 min. periods. Sun. 12 noon-10:45 p.m. Mon. to Fri. 7 a.m.-10:45 p.m. Sat. 11 a.m.-10:45 p.m.

6.125 CX44 Mercedes 823, Montevideo, Uruguay, S.A. Daily 8 a.m.-12 noon; 2-10 p.m.

6.122 HP5H Voice of the People, Panama City, Panama, C. A. Daily 7-10 p.m.

6.122 HJ3ABX Apartado 26-65, Bogota, Colombia, S.A. Weekdays 10:30 a.m.-2 p.m.; 5:30-11:30 p.m. Sundays 12-1:30 p.m.; 6-11 p.m.

6.120 XEFT Veracruz, Mexico (see 9.550 mc.)

6.120 W2XE Wayne, N. J. (see 21.520 mc.)

6.120 XEuz F. J. Stavoll, Chief Engr. Radio Nacional, Mexico, D. F. S: 5 bells (chimes) O-C: Marcha Dragona. Daily 10 a.m.-1 p.m.; 7 p.m.-2 a.m. DX 1-2 a.m.

6.115 OLR2C Prague, Czechoslovakia (see 21.450 mc.) S: Bells. Irregular (see 9.550-11.840 mc.)

6.110 GSL Daventry, England (see 26.100 mc.)

6.110 XEGW Enrique Arzamendi, Gen'l. Mgr., Mexico, D.F. O-C: Vail a didid Aztec-march. Daily exc. Mondays 11 a.m.-4 p.m.; 7 p.m.-12 a.m. Mondays 9 a.m.-14 p.m.

6.109 YUC 1 Garstin Place, Calcutta, India. S: none. C: God Save The King. Daily 8 a.m.-12:30 p.m. 11 p.m.-12:30 a.m.

6.105.1 HJ6ABB Apartado 175, Manizales, Colombia, S.A. Daily 11 a.m.-1 p.m.; 5-8 p.m. Veri slow.

6.100 YUA Director, Bureau Central de Presse, Belgrade, Yugoslavia. S: Short tune on flute. O-C: National Anthem. Daily 12:45 a.m.-6 p.m.

6.100 W9XF 20 N. Wacker Drive, Chicago, Ill. O-C: Star Spangled Banner. Daily 6-9:05 p.m.-1:05-2 a.m.

6.100 W3XAL Bound Brook, N. J. (see 17.780 mc.) Daily 9 p.m.-1 a.m.

6.097 ZTJ African Broadcasting Co., Inc., P.O. Box 4559, Johannesburg, South Africa. Physical session. O: Bugles—Reveille. C: Cook House. I: chimes. C: God Save The King. Sun. 4-5 a.m.; 12-15-3:15 p.m. Weekdays 12-12:45 p.m.; 3:15-5 a.m. and 9 a.m.-4 p.m. Daily 11:45 p.m.-12:45 a.m.

6.095 JZH Nazaki, Japan (see 21.520 mc.) Irregular.

6.090 CRCX Rural Route No. 4, Bowmansville, Ont., Canada. Weekdays 7:45 a.m.-5 p.m. Sunday, 10:45-5 p.m.

6.090 ZWB-2 Hong Kong, China (see 9.525 mc.)

6.090 XEBF Insurgentes 34, Jalapa, Mexico. Daily 7-11 p.m.

6.085.7 HJ5ABD Cali, Colombia, S.A. Daily 11 a.m.-2 p.m.; 6-11 p.m.

6.082 VQ7LO P.O. Box 777, Nairobi, Kenya, Colony, Africa. English used. C: God Save The King. Time signal 6 pips on hour. Daily exc. Sunday 5:30-6 a.m. Daily 11:15 a.m.-2:15 p.m. Tues. and Thurs. 8:15-9:15 a.m.

6.082 OAX4Z Lima, Peru (see OAX4T, 9.562 mc.) Daily 7-11:30 p.m.

6.080 W9XAA Chicago, Ill. (see 17.780 mc.) Weekdays 7:30-9 a.m., 6 p.m.-1 a.m. Sun. 11 a.m.-1 p.m., 6 p.m.-1 a.m.

6.080—ZHI Penang Wireless Society Headquarters, 40 Perak Road, Penang, S.S. O: Chimes. Vocal song, "Land of Hope and Glory". C: "God Save the King". Weekdays 6:40-8:40 a.m.

6.080 VE9CS 743 Davie St., Vancouver, B.C., Canada. O: O Canada: C: God Save The King. S: 3 strokes gong. Sun. 12 noon-1:30 a.m. Mon., Thurs., Sat. 9:30 a.m.-8:30 p.m. Tues., Wed., Fri. 9:30 a.m.-2:30 a.m.

6.080 HP5F Hotel Carlton, Colon, Panama, C.A. Weekdays 11 a.m.-1 p.m.; 7-10 p.m.; Sun. 10:45-11:30 a.m.-7-10 p.m.

6.080—XEWV Apartado 2516, Mexico D.F. Irregular (see 9.500 mc.)

6.079 DJM Zeesen, Germany (see 17.760 mc.) Irregular.

6.075 XECU Hidalgo 579, Guadalajara Jal., Mexico. O-C: Ojos Tapatiuous. I: Train in motion. Daily 9-11 a.m.; 1-4 p.m.; 8-11 p.m. or 12 a.m.

6.072 OER-2 Wien, Austria. (Alternates days with 11.801 kc.) Weekdays 9 a.m.-5 p.m. Sat. to 6 p.m.

6.070.5 HJ3ABF Apartado 317, Bogota, Colombia, S.A. C: Good Night Sweetheart. Daily 11 a.m.-2 p.m. 6-11 p.m.

6.070 YVIRO P. O. Box 100, Maracaibo, Venezuela, S. A. Daily 8 p.m.-12 a.m.

6.070 VP3MR 16, Robb and Hincks Sts., Georgetown, British Guiana, S.A. S: Time signals, studio clock. O: The Bond of Friendship. C: Ted Lewis' Goodnight Melody and God Save the King. Veries—I.R.C. or coin. Weekdays 4:15-8:15 p.m. Sundays 7:45-10:45 a.m.

6.070 CFRX 37 Bloor St., West, Toronto, Ontario, Canada. Week days 7:30 a.m.-12 midnight. Sunday 10:30 a.m.-12 midnight.

6.065 XEXR Departamento Autonomo de Propaganda y Publicidad, Mexico, D. F. Daily 6-11:30 p.m.

6.065 SBO Motala, Sweden (see 11.705 mc.) Daily 4-5 p.m.

6.060 W8XAL Crosley Radio Corp., Cincinnati, Ohio. Daily 6 a.m.-8 p.m., 10 p.m.-2 a.m.

6.060 W3XAU Philadelphia, Pa. (see 9.590 mc.) Daily 8-11 p.m.

6.060 OXY Stadsradionfonen, Heibergsgade 7, Copenhagen, Denmark. O: one gong stroke. C: There is a Windows land. Weekdays 1-6:30 p.m. Sun. 11 a.m.-6:30 p.m.

6.054.3 HJ6ABR Pereira, Caldas, Colombia, S. A. No English. Official March—El Hombre Payaso. C: Overture—Chorus Voices. No signals. Daily 9:30 a.m.-12 noon; 6:15-10 p.m.

6.050 GSA Daventry, England (see 26.100 mc.)

6.050 XEXF Secretaria de la Economia Nacional, Mexico, D. F. Daily 8 p.m.-12 a.m.

6.045 XETW Francisco I. Madero, 10, Tampico, Mexico. Daily 7 p.m.-12 a.m.

6.042.3 HJ1ABG Apartado 674, Barranquilla, Colombia S.A. S: 1 gong with chimes ea. ¼ H. O-C: National Anthem. Daily 11 a.m.-11 p.m.; Sun. 11 a.m.-9 p.m.

6.040 YDA Tandjong Priok, Java N. E. I. (see 15.150 mc.) Daily 7:30 p.m.-2 a.m.

6.040 W4XB Herald Bldg., Miami, Fla. Schedule not known.

6.040 WIXAL Boston, Mass. (see 21.460 mc.) Daily exc. Sat. 7-9 p.m.

6.030 OLR2B Prague, Czechoslovakia (see 21.450 mc.) Irregular (see 9.550-11.840 mc.)

6.030 HP5B P.O. Box 910, Panama City, Panama, English and Spanish. O-C: March, Panama. No signals or bells. Daily 11:30 a.m.-1 p.m.; 5-10 p.m.

6.030 VE9CA Toronto General Trust Bldg., Calgary, Alberta, Canada. C: Lights Out. S: None. Weekdays 9 a.m.-1 a.m. Thurs. to 2 a.m. Sun. 12 noon-12:30 a.m.

6.030 XEBQ Astillero 35, Mazatlan, Mexico. Daily 8-11:30 p.m.

6.020 DJC Zeesen, Germany (see 17.760 mc.) Daily 10:30 a.m.-4:30 p.m.; 4:50-10:45 p.m.

6.020 XEUW Av. Independencia 98, Veracruz, Mexico. S: Marimba. O: March Victoria. C: La Golondrina. Daily 8 a.m.-12 midnight.

6.015 H13U Apartado 23, Santiago de los Caballeros, Dom. Rep., W.I. O-C: Organ Maria My Own. Weekdays 7:10-8:40 a.m.; 10:40 a.m.-1:40 p.m.; 4:40-9:40 p.m. Sun. 10:40 a.m.-1:40 p.m. only.

6.015 XEWI Mexico, D.F. (see 11.900 mc.) Irregular.

6.010 VK9M1 M. V. Kanimbla, Sydney, Australia (see 11.710 mc.) 11 p.m.-8 a.m. and later.

6.010 COCO P.O. Box 98, Havana, Cuba. English and Cuban. Daily 8 a.m.-10 p.m.

6.010 OLR2A Prague, Czechoslovakia (see 21.450 mc.) Irregular (see 15.230-11.840 mc.)

6.007 Radio Burma Burma Independent Wireless, Rangoon, Burma C: God Save the King. Daily 9:10-9:40 a.m.

6.005 HP5K P.O. Box 33, Colon, Panama, C.A. S: 3 chimes, ea. 15 m. O-C: Merry Widow Waltz. Daily exc. Sun. 7-9 a.m.; 11:30 a.m.-1 p.m.; 6-11 p.m. Sun. 10 a.m.-12 a.m.

6.005 CFCX P.O. Box 1690, Montreal, Quebec, Canada. Weekdays 7:44 a.m.-1 a.m. Sundays 9 a.m.-11:15 p.m.

6.005 VE9DN Montreal, Quebec, Canada (see CFCX, 6.005 mc.) Sat. 11 p.m.-12 a.m. Fall, winter and spring.

6.000 CX42 Rio Negro, Montevideo, Uruguay, S.A. O: Voluntary Trumpeter. C: Good Night Melody. Daily 10:30 a.m.-10:30 p.m.

6.000 HJ1ABC St. Rafael Valencia Ibanez, Quibdo, Colombia, S. A. O-C: March, Relator. S: 2 blows Chinese gong. Sun. 3-5 p.m. Wed., Sat. 5-6 p.m. Daily 6-9 p.m.

6.000 XEBT P.O. Box 79-44 Mexico, D.F. I: 3 blasts on cookoo horn. Siren near closing. O: Las Mananitas. C: Liebertraum. Daily 10 a.m.-12:15 a.m.

6.000 FIQA Director of Posts and Telegraphs Tananarive, Madagascar. Daily 12:30-12:45 a.m.; 3:30-4:30 a.m.; 10-11 a.m.

6.000 RV59 Moscow, U.S.S.R. (see RKI, 15.040 mc.) No I.R.C. required.

5.980 HJ2ABD Calle 2 No. 1205, Bucaramanga, Colombia, S.A. Daily 11:30 a.m.-12:30 p.m.; 6-10 p.m.

5.977 Radio Our Lady of Fatima, I: none. Daily 2:30-4:30 p.m. Sunday and Thursday 6-7 a.m.

5.969 HVJ Vatican City (see 15.121 mc.) 2-2:15 p.m. Sun. 5-5:30 a.m.

5.955 HJN Minister of Education Nacional, Bogota, Colombia. Daily 11 a.m.-2 p.m.; 5-10:30 p.m.

5.940 TG2X De la Policia Nacional, Guatemala City, Guatemala, C.A. Daily 4-6 p.m. Mon., Thurs., Sat. 10-11:30 p.m. Sundays 1-2 p.m. No I.R.C. required.

5.930 PJCI Curacaoesche Radio Vereeniging, Willemstad, Curacao, N.W.I. O: Electrical song, 4 strokes and repeat 5 mins. O-C: National anthem. Weekdays 6:30-8:36 p.m. Sun. 10:36 a.m.-12:36 p.m.

5.930 YVIRL P.O. 247, Maracaibo, Venezuela, S.A. Weekdays 11 a.m.-1 p.m.; 4:30-9:30 p.m. Sun. 8:30 a.m., 2:30 p.m.

5.910 YV4RH Valencia, Venezuela, S.A. Daily 8-11:30 p.m.

5.910 HH2S Port-au-Prince, Haiti, W.I. (see 11.570 mc.) Daily 7-10 p.m.

5.905 TILS P.O. Box No. 3, San Jose, Costa Rica, C.A. S: none. O: Washington and Lee Swing. C: Adios Mi Chapparrita. Weekdays 12-3 p.m.; 6-11 p.m. Sundays Irregular.

5.900 ZNB Government Engineer, Mafeking, South Africa. Mon. to Fri. 1-2:30 p.m. Sun. 1:30-2:30 p.m.

5.900 HJ4ABD 50.85	Medellin, Colombia, S.A. (see 6.138-5.780 mc.) Weekdays 10 a.m.-2 p.m.; 4-11 p.m. Sun. 11 a.m.-3 p.m.; 7-11 p.m. Veri slow.	5.780 OAX4D 51.90	All American Cables, Ltd., Cailla 2336, Lima, Peru, S.A. Signs on and off Morse code. No signals. English and Spanish. Wed., Sat. 9-11:30 p.m.	4.841 HJ3ABD 61.97	Apartado 715, Barranquilla, Colombia. O: Parí Ti Rio Rita. C: Rio Rita and National Anthem. Weekdays 9 a.m.-2 p.m., 6 p.m.-12 a.m., Tues and Thurs. to 3 p.m. Wed. and Fri. begin 5:30 p.m.
5.885 H19B 50.98	P.O. Box 95, Santiago de los Caballeros, Dom. Rep., W.I. O-C: Piano Solo—Vals Evocation. Weekdays 7:25-8:40 a.m.; 11:55 a.m.-2:10 p.m.; 4:55-7:40 p.m. Sundays 11:40 a.m.-2:40 p.m.	5.780 HJ4ABD 51.90	Medellin, Colombia, S.A. (see 6.138-5.900 mc.) Weekdays 10 a.m.-2 p.m.; 4-11 p.m. Sun. 11 a.m.-3 p.m.; 7-11 p.m. Veri slow.	4.810 YDE2 62.37	Solo, Java, N.E.I. (see 15.150 mc.) Daily 5:30-11 a.m.; 5:45-6:45 p.m.; 10:30 p.m.-2 a.m.
5.880 YV3RA 51.02	Earquisimeto, Venezuela (see YV3RB, 9.565 mc.) Daily 11:30 a.m.-12:30 p.m.; 5:30-9:30 p.m.	5.758 YNOP 52.10	Radio Bayer, Managua, Nicaragua, C.A. Weekdays 8:30-10:30 p.m. Veri—5c U. S. Postage.	4.790 HJ2ABC 62.63	Sr. Pompilio Sanchez, Prop., Cucuta, Colombia, S.A. Daily 11 a.m.-12 noon, 6:30-9 p.m.
5.875 HRN 51.11	Tegucigalpa Honduras, C.A. C: Good Night Melody (Ted Lewis) Daily 7-10 p.m. Veris—10c U. S. cash. Veri slow.	5.755 YV2RA 52.13	San Cristobal, Venezuela. English each 15 mins. S: 6 strokes gonz. O-C: March, El Capitan. Weekdays 11:30 a.m.-12:30 p.m.; 5:30-9 p.m. Sun. 5:30-10 p.m.	4.780 HJ1ABB 62.76	Apartado 715 Barranquilla, Colombia, S.A. I: 3 chimes. S: 1 chime between advertisements. C: La Golondrina 7-9 a.m. 11-1 p.m., 5:30-10 p.m.
5.865 H11J 51.15	Apartado 204, San Pedro de Macoris, Dom. Rep., W.I. O-C: Waltz, Sweet Remembrance. English very seldom. S: none. Daily 11:40 a.m.-1:40 p.m.; 5:40-9:40 p.m.	5.725 HC1PM 52.40	P.O. Box 664, Quito, Ecuador, S.A. O-C: La Marcha de Aida. Saturdays 9-11 p.m.	4.740 HJ6ABC 63.29	Ibague, Colombia, S.A. Daily 6-11 p.m.
5.850 YV1RB 51.28	P.O. Box 37, Maricao, Venezuela, S.A. English and Spanish. O-C: Strike Up The Band. Daily exc. Sun. 10:45 a.m.-12:45 p.m.; 4:45-9:45 p.m. Sun. 8:45 a.m.-9:45 p.m.; Mon., Wed., Fri. 5:45-8:15 a.m. Tues., Thurs., Sat. 5:45-9:45 a.m.	5.713 TGS 52.51	Casa de Presidencial, Guatemala City, Guatemala, C.A. Sun., Wed., Fri. 6-8 p.m. No. I.R.C. necessary.	4.660 HJ2ABJ 64.38	Santa Marta, Colombia, S.A. Daily 11:30 a.m.-2 p.m.; 5:30-10:30 p.m.
5.830 TIGPH 51.46	Apartado 800, San Jose, Costa Rica, C.A. C: Good Night Melody (Ted Lewis). Weekdays 8-11 p.m.	5.713 TGS 52.51	Casa de Presidencial, Guatemala City, Guatemala, C.A. Sun., Wed., Fri. 6-8 p.m. No. I.R.C. necessary.	4.600 HC2ET 65.22	P.O. Box 824, Guayaquil, Ecuador, S.A. I: 12 chimes, Wed. and Sat. 9:15-10:45 p.m. Veri—5c U. S. postage.
5.813 TIGPH-2 51.61	Apartado 800, San Jose, Costa Rica, C.A. C: Good Night Melody. Daily 7-11 p.m.	5.146 PMY 58.30	Bandoeng Radio Society, Nillmy Bldg., Bandoeng, Java, N.E.I. O: March, Le Rene Passe. C: On chimes. Good Night and National Anthem. Sun. 6:30 p.m.-1:30 a.m. 4-10:30 a.m. Mon. to Fri. 5:30 p.m.-2:30 a.m. 4-10:30 a.m. Sat. 5:30 p.m.-2 a.m. 4-11:30 a.m.	4.420 ZMBJ 67.87	Wellington, N. Z. (see 13.600 mc.)
5.800 YV5RC 51.72	P.O. Box 2009, Caracas, Venezuela, S.A. I: 4 chimes. O-C: Official IBB March. Bugles, whistles before closing. Weekdays 7-8 a.m. 10:30 a.m.-1:45 p.m. 3:45-10:30 p.m. Sundays 8:30 a.m.-10:30 p.m.	4.900 HJ3ABH 61.22	Apartado 565, Bogota, Colombia, S. A. I: 3 chime notes. Weekdays 11:30 a.m.-2 p.m. 6-11 p.m. Sunday 12-2 p.m.; 4-11 p.m.	4.273 RV15 70.21	Radio Committee, Khabarovsk, U.S.S.R. English, 2 a.m., EST and at announcements. Daily exc. 6th 12-18-24-30th 3 p.m.-8 a.m. On 6-12-18-24-30th 7:10 p.m.-8 a.m. English programs start at 2 a.m. No I.R.C. necessary.
5.800 ZEC 51.72	P.O. Box 792, Salisbury, Rhodesia, South Africa. Sun., 3-5 a.m.; Tues. and Fri. 1:15-3:15 p.m.	4.880 HJ4ABP 61.48	Emisora Claridad, Medellin, Colombia, S. A. Daily 8 a.m.-11 p.m.	4.107 HCJB-2 73.05	Quito, Ecuador, S.A. (see 8.831 mc.)
		4.860 HJ1ABE 61.73	Apartado 31, Cartagena, Colombia, S. A. O: Organ—Song of the Islands. English each hour; clock strikes the hour. C: Aloha Oe. Weekdays 11 a.m.-1 p.m. 6-10:30 p.m. Sun. 9 a.m.-3 p.m.	4.002 CT2AJ 75.00	Ponta Delgada, Island of St. Michael, Azores. Wed. and Sat., 5-7 p.m.

TOOLS FOR THE HOME WORKSHOP

(Continued from page 625)

plied. Use a solder with a minimum of rosin in the core for best work. Both Kester and Berry's solder have been found satisfactory. Where the surfaces to be soldered cannot be tinned with rosin-core solder a dab of Nokorode soldering paste on the joint will do the trick. This is usually the case when wires are soldered into the prongs of coil forms.

Short-Nose Pliers: These are indispensable to the constructor in wiring, also in many other operations. They can be used to skin the insulation off many types of wire and will bend the wire into any desired shape to fit the wiring requirements. Also, when a wire is being soldered into place it should be held near the joint with these pliers. This will not only aid in securing a solid joint but will eliminate burnt fingers.

Diagonal Pliers: These are used for removing certain kinds of insulation from wire that cannot be easily removed with the pliers. A little experience will indicate which tool to use for skinning a particular piece of wire.

One valuable use of these "side cutters" is in snipping off the small ends of wire left after a wire is soldered into place. An ordinary pair of cutting pliers will not get into many places that a pair of side cutters will. The experienced wirer uses them continually for this purpose.

Knife: A knife is a tool of many uses in radio construction work. It is used, chiefly, in skinning and cleaning insulated

wires, in conjunction with either the pliers or side cutters. A knife is also useful in drilling operations. It will cut aluminum burrs off cleanly and easily. It will, as a matter of fact, even cut steel burrs. If you don't spend over a quarter or so for the knife you won't mind nicking it up a bit.

Adjustments

Several tools are useful in making various adjustments when the receiver or other piece of equipment is completed and under test. Most useful, perhaps, are the various sizes of screw drivers. Most intermediate-frequency transformers, for instance, are adjusted with this tool.

When the adjustment is made by means of a nut the Spintite type of wrench is generally necessary. There is, incidentally, a type of Spintite wrench, not illustrated, which will go "around corners." It is constructed the same as the type shown but has the end bent at right angles to the handle.

Insulated Adjuster: These are usually known as "neutralizing" tools. In certain types of adjustments the metal mass of an ordinary screw driver will, by its capacity to the hand, make it almost impossible to attain the proper adjustment. The "neutralizing" tool consists of a long insulating rod with only a very small piece of metal in the end. Thus the effect of the tool and hand on a "hot" adjustment screw is negligible.

"Resonator": This handy gadget, put out by Aladdin, is not, strictly speaking, a tool. It consists of a length of flexible rubber. In one end is inserted a small iron core, while a brass core is inserted in the other end. Inserting the iron end into the field of a coil will raise its inductance, while the brass end will lower it. In this way the experimenter may determine which way to adjust a receiver coil in order to make it "track" with other coils. In cases where no trimmer condensers are employed across the coils that is the only way in which the tuning of the circuit may be checked for resonance.

All the above tools are procurable at any hardware store, or radio supply house. Sometimes an auto accessory or "5-and-10" store will provide the best "buys" in some of these tools, as in the case of the open-end wrenches.

Vise Advice

An accessory that is very useful in conjunction with these tools is the vise. A small one can be purchased for around half a dollar or so which will clamp easily to any projection and is large enough for radio construction work. Don't clamp it on a good piece of furniture, however, unless you wish to start a domestic war. The appearance of these tools in any location other than the cellar will probably invoke such a conflict, anyway, so you might as well make it worth while.

Backwash

COMMERCIAL CODE

Editor: Just a line to inform you how much your magazine is appreciated here in Vancouver.

Was much interested in the letter by A. Shaw in "Backwash," October issue. Believe me, there are more fellows interested in logging commercial c.w. than is popularly supposed. I took up this phase of radio DXing a couple of years ago but owing to the lack of station addresses was unable to send reports and secure verifications. I do believe you would be encouraging a worthwhile side of the SWL game should you decide to devote a page a month to readers' c.w. reports and station addresses.

Incidentally, with the new "Code Reader" on the market, I am of the opinion that it would be to your advantage to publish such a list. I am certain you would not be at a loss for reports as many readers would be only too glad to cooperate.

At the present time I am minus a receiver, a situation which must be remedied at all costs; hi! Will be pleased to give you any possible assistance with this new department as soon as I can get an s.w. receiver on the air. Have been an enthusiastic SWL for several years; am Canadian correspondent for "West Australia Wireless News" and ex-member of ISWC and BSWL. Before closing allow me to express my appreciation of the articles by Mr. Hinds. I have had the pleasure of several interesting chats by letter with this gentleman, and a more accurate authority on s.w. matters would be hard to find.

BOB MORRISON,
VANCOUVER, B. C., CANADA

(You win, along with the many others who have expressed a desire to see space devoted to commercial code stations; we are reviewing the subject and will have something definite to offer in the very near future. A list will be forthcoming at any rate—possibly a department devoted to code stations.—Editor.)

CODE LISTENERS

Editor: The readers' letters and your comments on commercial c.w. in the October number of your magazine interested me very, very much. It would please me greatly to see you devote an entire page to commercial c.w. and the various aspects of c.w. reception throughout the entire radio spectrum. You would be the "one and only" magazine giving the non-transmitting listener a real "break."

HAROLD BLINN,
ARKANSAS CITY, KANS.

(Okay—we'll give you a "real break." But it would seem advisable to prepare the

way for the potential code listener with an article dealing with the ins and outs of commercial radio telegraphy, lest some poor soul gets "the law" on him for "divulging the contents of messages."—Editor.)

MORE ON C.W.

Editor: I noticed in Backwash of the October AWR that other SWLs are interested in commercial c.w. I am 15 years old and own a Sky Buddy receiver. My speed in code is about 10 words per minute. I think it would be great if you would have a separate page for this c.w. commercial list.

One of the main things we are interested in is whether these commercials will verify or not. It is important to me and other SWLs, I guess, to have the wall papered with QSL cards.

I would like to know something about these commercials; what they are good for. All I ever hear is "V.V.V. de" and the call. They all come in fine and they are real DX. So how about some dope on the commercials?

EDWARD WESTCOTT, W11M1,
NASHVILLE, TENN.

(A commercial c.w. station list, or something amounting to the same thing, is forthcoming. As a rule commercial c.w. stations do not verify reception reports, unless the transmitter is used for occasional broadcasting as well. The stations you hear using their V-wheels do handle traffic, which you'll discover if you listen long enough. More on this in a forthcoming article.—Editor.)

PAGE MR. BOUCK!

Editor: Month after month I have picked up copies of AWR and read through them with pleasure, more or less. First of all, I want to congratulate you on such an interesting publication. I fully agree with everyone who requests a commercial c.w. station list; a fairly complete one would be more than appreciated. Mr. J. B. L. Hinds' column is the backbone of the magazine from my viewpoint, a DXer's. Ray La Rocque's department couldn't be omitted, but Zeh Bouck's wouldn't be missed if omitted.

Personally, I imagine he is a crank, grouchy and pessimistic critic. Never a word is mentioned about the excellence of some programs but condemnation reigns over all he listens to.

Working on a recollection, I dug through radio magazines until my search stopped at an October 1934 issue of *Short-Wave Radio*. Now, if you'd care to follow me, get the May 1937 issue of AWR; open it to "Channel Echoes" and read, in the

third column, Mr. Bouck's discourse on his personal opinion concerning "veries." He makes it clear he isn't interested in veries, has never written for one, and wouldn't pay a cent for one. So much for the 1937 version of Bouck.

Referring back to J. B. L. Hinds' column in the '34 magazine we find, under the caption "Page Mr. Bouck," an item that is very interesting. It seems that Mr. Bouck wrote a rather good article in the *New York Sun* on his interest in radio and verification cards. Mr. Hinds is obliging enough to divulge the contents of said article, naming Bouck's own reasons, among which was "his interest in receiving veries." (Perhaps it never passed that stage and remained only an interest.) But if Mr. Bouck can write so convincingly on verifications that Mr. Hinds is impressed (imagine!) as he states himself, then just three years later emphatically deny ever being interested in veries, we're inclined to turn our thumbs down and the page over.

Perhaps his vehement criticisms have something to do with his memory. We wouldn't doubt it. We sincerely hope this self-appointed nemesis of putrid advertising and advertisers would pass on to other material, anything! Perhaps the literary angle of servicing.

JOSEPH A. PIECHUTA, W3G14,
MERIDEN, CONN.

(That ought to hold Bouck, unless he has a good comeback—which he usually has. Come on, W8QMR, Zeh it!—Editor.)

AWR AT SEA

Editor: Am a commercial operator and enjoy your magazine very much. It helps me to keep abreast of modern radio, even during the days that I am at sea.

BYRON L. FRIEND,
RADIO OPERATOR, S. S. SANDCRAFT,
NEW YORK, N. Y.

(Pleased to know AWR meets your requirements. We have heard it is seen in the radio rooms of numerous ships docking at New York.—Editor.)

WORLD S.W. STATION LIST

Editor: Hinds has done it again! The World Short-Wave Station List in its new form is the best that exists today. It could be no better as far as material is concerned.

You might do one thing, however—place markers in for the various bands. A line, or bold-face type, would suffice.

C. M. WHELAN,
MEMPHIS, TENN.

(When ALL-WAVE RADIO was first published the various bands in the short-wave station list were marked much in the manner you suggest. Readers didn't seem to like the idea, so we dropped it. What is the opinion now?—Editor.)

SUPER CONVERSION

(Continued from page 623)

first audio stage so that the bias can be adjusted above the cut-off point. When handling traffic from stations having an S8-S9 signal the bias can be adjusted so that background noise drops out. Weak signals or static below the threshold level of the first audio stage are not amplified and consequently annoying frying sounds are largely eliminated—the set simply goes dead between the dots and dashes. It is best to use a high- μ tube for this application in order to secure a sharp cut-off with low bias. In this circuit we used half of a 53 tube (6.3 v. equivalent is the 6A6 or 6N7) which proves to be more than satisfactory. The other half of the 53 is reserved for the beat-frequency oscillator.

Beat-Frequency Oscillator

In making a receiver conversion there is one tube which must always be added—the beat-frequency oscillator. There being no extra socket space on the chassis, we used a 53 dual triode and killed two birds with one stone. One-half of the 53 serves as the b.f.o. tube, the other as the high- μ triode for the first audio stage. Other than combining two tubes in one envelope there is no particular advantage or disadvantage to this combination.

The beat-frequency oscillator transformer, B.F.O., consists of a single tapped coil and is intended to be used in an electron-coupled oscillator circuit. In this application it is necessary for the cathode of the dual triode tube to be grounded, so that a series Hartley circuit is used instead. A .0001 mfd. mica condenser is connected across the b. f. o. coil, so that with the added capacity, the b.f.o. tunes to one-half the intermediate frequency, or 232 kc. By using the second harmonic to provide the beat note all tendency towards interlocking is eliminated, and the higher "C" oscillator circuit provides remarkable stability and freedom from drift.

Coupling between the beat-frequency oscillator and the diode second detector is accomplished by means of a "gimmick" — a small capacity formed by twisting two pieces of hook-up wire together. This capacity should be adjusted for best results — insufficient capacity will result in a poor beat-note on strong signals, while excessive capacity will lower the sensitivity of the receiver. About $\frac{3}{4}$ " of twisted length will give very satisfactory results.

I. F. Selectivity

For broadcast reception a broad-nosed

frequency response curve is desirable to secure reasonable fidelity of reproduction. This broad-nosed effect is usually obtained by over-coupling the coils. Therefore one of the first steps to take in converting a broadcast superheterodyne for communication work is to check the selectivity of the i. f. transformers. The easiest way of doing this is to line up the receiver, using an oscilloscope, oscillator and frequency wobbler.

If after being lined up the response curve is broad-nosed, or double-humped, increase the separation of each pair of coils in the i. f. transformers by $\frac{1}{4}$ ", realign and try again. The gain will not go down much (it may actually increase) and the selectivity will improve considerably. To increase the spacing of the coils will require disassembling the i. f. units. In some instances the coils are wound directly on a wood dowel, while in other cases the winding is made on a cardboard tube which is slipped over the center dowel. When a cardboard tube is used, sever the section between the coils with a sharp knife or razor blade. Then hold the coil assembly close to the hot end of an electric soldering iron until the wax softens. When the coils are mounted directly on a wooden dowel rod, there are two ways by which the coils can be loosened. One way is to drill a hole lengthways into the dowel, insert a piece of copper rod, and heat the end of this until the impregnation softens. Or, the dowel rod can be cut in two between the coils and a small spacer added. Use a wooden pin to hold this in place—a brass or iron screw will increase the losses of the circuit.

Voltage Distribution

In making a superheterodyne conversion it may be practical to leave the present voltage distribution system intact. In many instances, however, it will be found that the resistors have aged so that they are noisy and their resistance values are no longer accurate. Also if B- is not off ground potential by 15 or 20 volts it will not be practical to install the manual squelch system for suppressing background noise. Consequently an outline of the voltage distribution system used in our receiver will be given.

The filter circuit consists of a condenser input filter, C24, of 16 mfd. plus a choke in the positive lead of the power supply. This is followed by C25, a second 16 mfd. condenser, and the speaker field in the negative lead. By placing the speaker field in the negative lead the voltage drop through this may be utilized to supply the various bias voltages required by the receiver. The output of the filter is terminated by a third 16 mfd. condenser, C26. While the capacities indicated are considerably larger

Use
YAXLEY
APPROVED RADIO
PRECISION PRODUCTS

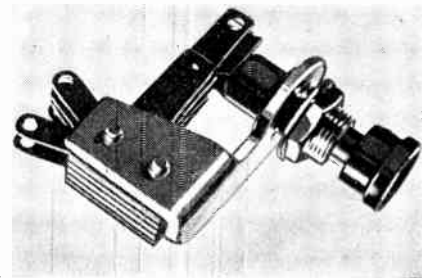

YAXLEY Push-Button Switches

We haven't said much about them but you will find Yaxley Push-Button Switches in almost every station. They are ideal for meter shunt service, as well as for set analyzers, tube checkers and other test equipment.

Mallory Push-Button Switches have numerous outstanding features, such as:

1. Accurate workmanship.
2. Nickel-plated phosphor bronze springs.
3. Coin silver contacts.
4. Heavy cadmium-plated frame.
5. Self-wiping contact action.
6. Hot tinned soldering lugs.

Available in both locking and non-locking types with a large variety of spring contact arrangements. See Yaxley Push-Button Switches at your distributor's.

P. R. MALLORY & CO., Inc.
INDIANAPOLIS INDIANA

Cable Address — PELMALLO

Use
MALLORY
APPROVED RADIO
PRECISION PRODUCTS

ON THE MARKET

ALADDIN "PRE-TUNED" OSCILLATOR UNIT

RECOGNIZING THE potential demand for pre-tuned units for automatic tuning in radio receivers, Aladdin Radio Industries, Inc., have developed a multiple oscillator, aligned with Polyiron cores, and contained in a compact housing, measuring 3" wide, 2" high and 2" deep.

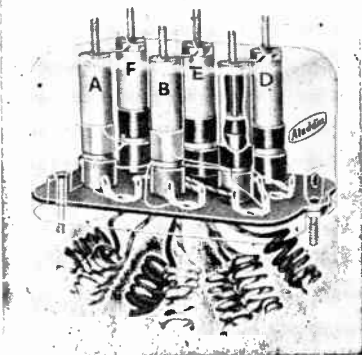

The unit will accommodate six pre-selected stations. There are six separate coils, each having its own iron core, adjustable from the top, as shown in the accompanying illustration. The following ranges are obtained with the individual coils which cover the standard broadcast band:

A coil	1520 to 830 kc.
B coil	1520 to 830 kc.
C coil	1250 to 670 kc.
D coil	1220 to 670 kc.
E coil	870 to 580 kc.
F coil	770 to 540 kc.

The stability afforded by the Polyiron method of alignment, as against the usual compression type trimmer condenser method, makes this composite coil invaluable in those systems where oscillator frequency drift is a critical factor.

The coil unit is designed for use with an i.f. amplifier peaked at 465 kc. ALL-WAVE RADIO.

NEW HAMMARLUND NEUTRALIZING CONDENSER

ANOTHER NEW condenser for transmitting has just been developed in the laboratories of the Hammarlund Manufacturing Com-

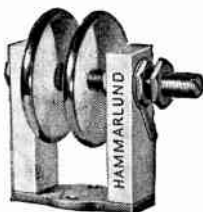

pany, Inc. It is a neutralizing condenser and is called the "N-10." This newest addition to the Hammarlund transmitting condenser family is exceedingly compact and designed for horizontal adjustment.

It has heavy aluminum round edged plates, polished over all surfaces, which are mounted on a pair of strong Isolantite bars. These bars are so mounted that they will not shift or pull out of position. The movable plate of this condenser is controlled by a finely threaded screw, allowing micrometer control. A positive locking nut permits extremely accurate settings. The special design of the adjusting screw prevents any possibilities of plate touching or short circuits. The capacity range of the "N-10" is from 2 to 10 mmfd., while the air gap can be varied from 1/16" to 5/8". At the minimum spacing, the peak voltage rating is 3000. The base is drilled for 2-hole base mounting. The condenser is only 2 5/8" high x 1 13/16" deep. ALL-WAVE RADIO.

NEW HICKOK SIGNAL GENERATOR

THIS NEW HICKOK Instrument—Model PSG-15—has the output calibrated in microvolts. This calibrated output together with power level meter gives more measurements than any other signal generator now available, it is said. Sensitivity, gain per stage and selectivity are standardized by a self-contained vacuum-tube voltmeter.



Output ranges are as follows: R.F.—1/2 microvolt to 100,000. A.F.—0 to 2.0 volts. There are three decibel ranges: -10 to +6; +6 to +22; +22 to +38.

Radio-frequency ranges are calibrated directly, from 85 kc. to 28 mc.

Complete built-in power supply consists of transformer, rectifier and filter system. Case is 13" x 10" x 7"—made from steel with etched aluminum panel.

The many other features of this instrument may be learned from the maker, The Hickok Electrical Instrument Co., Cleveland, Ohio. ALL-WAVE RADIO.

BRUSH VIBRATION PICKUPS

THE BRUSH DEVELOPMENT Company recently announced its complete line of vibration pickups. These devices are of typical piezo-electric Rochelle salt crystal design,

and are applicable to the study of noises and vibrations in various industrial applications. Three types known as VP-1, VP-5 and DP-1 are now available. Characteristics of the various pickups are such that they cover the complete frequency range. Literature describing these crystal devices is available upon request. ALL-WAVE RADIO.

JOHNSON TRANSMITTING TUBE SOCKETS

WAFER-TYPE sockets molded from Alsimag 196, and especially designed for use in transmitter tube positions, are new items produced by the E. F. Johnson Co., Waseca, Minn.

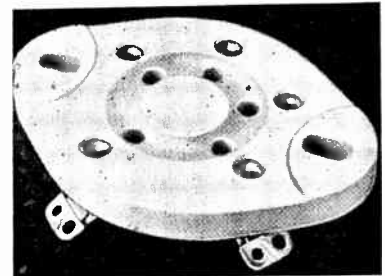

Contacts are of cadmium-plated phosphor bronze, recessed in the form to prevent movement. All metal parts are countersunk to permit mounting on metal surfaces without shorting.

The sockets are 1 5/8" wide and 2 3/8" long. Mounting holes are slotted to permit mounting centers between 1 11/16" and 1 27/32" inclusive.

The sockets are available in the following types: 4, 5, and 6-prong; 7-prong small and large! octal, and acorn. ALL-WAVE RADIO.

SWEEP-EXPANDING AMPLIFIER

THE WAVE-EXPANDING feature as incorporated in the latest DuMont 5-inch all-purpose oscillograph, is valuable in the study of complex waves where it is desirable to spread a small portion of the wave for detailed study. Furthermore, it allows expansion of waves of much higher frequency than the fundamental frequency of the sweep. Million cycle waves can be observed with good detail, and the return trace eliminator, a regular television principle, permits the waves to appear only on the forward linear portion of the sweep.

The action of the sweep-expanding amplifier is quite startling. Four 1000-cycle waves, for instance, may be normally packed closely together, occupying the center section of the cathode-ray screen. A slight adjustment of the sweep-expanding control and these waves instantly spread
(Continued on page 660)

than commonly used for filter circuits, the added cost for the extra capacity is amply compensated for by the extreme quietness of operation.

Voltage distribution is made by means of two adjustable vitreous resistors, R18-R19, of the 50-watt size. Resistors of this rating are not necessary for the application, but are used to provide sufficient linear length so that intermediate voltage adjustments will not be excessively critical.

Circuit Isolation

The schematic diagram Fig. 4 shows a total of five r. f. chokes. Whether or not these may be required for your particular conversion can only be determined by experiment. For those not familiar with the action of the described circuit, it should be stated that the r. f. choke on the first detector screen lead, and the r. f. choke in the oscillator plate supply were necessary to prevent an apparent interlock between the sensitivity and regeneration controls. The addition of these chokes stopped all tendency of the i. f. amplifier to oscillate when the first detector regeneration control was advanced excessively. The balance of the r. f. chokes were necessary to secure complete stability of the i. f. amplifier.

Selection of Components

In choosing the components for your receiver, select the best quality tuning condensers for the detector and oscillator. The tuning condensers should be of rugged construction and preferably should have ceramic insulation to prevent r. f. losses and to insure the absolute rigidity to prevent oscillator drifting. Some losses can be tolerated in an i. f. amplifier since this merely means a loss of gain, but losses in a detector circuit cannot be made up by subsequent amplification. The i. f. amplification is limited by the tube noises which are generated in the first detector circuit.

Filter condensers and paper r. f. bypasses should also be selected with care. Avoid so-called bargain condensers — nothing is harder to locate than trouble caused by a poorly constructed paper bypass condenser or a high power factor electrolytic, and a single defective condenser will ruin the performance of the best receiver.

Mounting Parts

To eliminate the necessity of taping joints, and to provide support for resistors and condensers, the little Mallory AO16 Terminal Connectors were used throughout the conversion. This terminal connector consists of a small strip of bakelite upon which are fastened three double soldering lugs and a mounting bracket. In addition to improving the appearance of the wiring,

constructors will find the AO16 is a real time and effort saver.

Coil Specifications

Standard large size 4-prong coil forms, 1½" diameter and 27⁄8" long (Hammarlund SWF-4), were used for winding the 160, 80 and 40 meter coils. Midget coil forms 1" in diameter and 1½" long

(National XR-1) were used for the 10-meter coils. The 20 meter coils were made on both sizes of forms, and exactly equivalent results were obtained. The Coil Specification Table lists both types. The use of smaller forms for the higher frequency bands permit a greater number of wire turns to be used.

(Continued on page 661)

YES THERE IS A Santa Claus

YOUR RADIO PARTS DISTRIBUTOR



He's YOUR Radio Parts Distributor, serving you every day of the year. Your Radio Parts Distributor cheerfully gives his time and attention to YOUR problems. His stock of excellent radio gear makes his store a veritable sleigh load of values. Yes sir, he's an honest-to-gosh Santa Claus to every Ham who knows him. We are as proud of our Distributors as you are. They represent the cream of the industry. We acknowledge their acclaims, and the praise of all amateurs, who know Taylor Tubes' "More Watts Per Dollar" value. Taylor Tubes and Taylor policies are built on customer satisfaction and four square dealing. We sincerely appreciate the compliment of top sales that you, the amateur, and our mutual friend, your Distributor, have given us during 1937. Our hats are off, as are those of the Amateur, to the Amateur Radio Parts Distributor — *Long may he serve.*



TAYLOR TUBES EXTENDS HEARTIEST
★ SEASON'S GREETINGS ★

Warren Taylor Frank Hajek, W9ECA Rex Munger, W9LIP

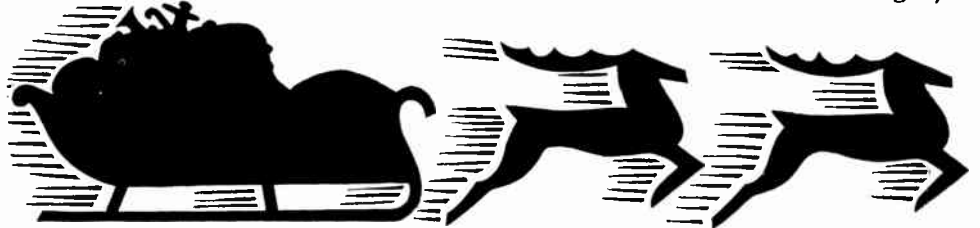

"More Watts Per Dollar"

Taylor HEAVY CUSTOM BUILT DUTY Tubes

TAYLOR TUBES, INC., 2341 WABANSIA AVE., CHICAGO, ILLINOIS

out to fill the entire screen. A further adjustment and just one complete cycle is left on the screen, greatly stretched out for critical study.

The new feature is included, among other standard and novel features, in the 5-inch all-purpose Type 168 DuMont oscillograph now offered by the Allen B. DuMont Laboratories, Inc., of Upper Montclair, N. J. ALL-WAVE RADIO.

RCA TYPE 809 TRANSMITTING TUBE

RCA RADIOTRON has announced the RCA-809, a three-electrode tube of the high- μ type for use as a radio-frequency amplifier, oscillator, or Class B modulator and a.f. amplifier. Because of its high permeance, the 809 can be operated at high plate efficiency with low driving power.

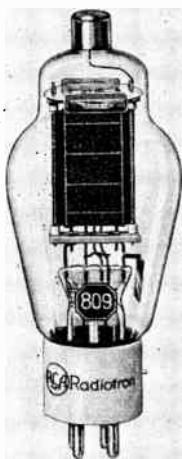

The plate connection is brought out through a separate seal at the top of the bulb to provide high insulation. The internal structure of the tube permits operation at the maximum ratings at frequencies as high as 60 megacycles. The maximum plate dissipation is 25 watts for Class C telegraph and Class B services. A ceramic base is used.

The filament is operated at 6.3 volts and draws 2.5 amperes. The amplification factor of the tube is 50. Grid-plate capacity is 6.7 mmfd., grid-filament, 5.7 mmfd., and plate-filament, 0.9 mmfd. Maximum plate voltage is 750. ALL-WAVE RADIO.

HARDWARE ASSORTMENTS

A COMPLETE LINE of small-hardware assortments, intended for electrical, radio and automotive service shops and for home use by amateur craftsmen, has been brought out by the Insuline Corporation of America, 25 Park Place, New York, N. Y. The parts are supplied in indestructible flat metal boxes having hinged lids and twelve individual compartments, the following assortments being available: master screw and nut assortment, all purpose radio hardware and equipment, insulated washers and grommets, and master miscellaneous assortment, consisting of rivets, lugs, washers, etc.

Insuline also announces a line of square-type glass jars with screw caps, filled with

individual hardware items such as screws, nuts, washers, rivets, etc. A total of 81 different items is available. These jars stack neatly on shelves and keep their con-



tents clean and free of dust. For counter display purposes, dealers are furnished gratis with a decorative metal rack holding 36 of these jars. ALL-WAVE RADIO.

NEW RAYTHEON DATA CHART

OFF THE PRESS last week, was Raytheon's 11th edition of their tube characteristic data chart. More complete than ever before, the new edition contains all and every characteristic data necessary to the interests of good servicing—facts that will be extremely valuable to distributor's salesmen, dealers, and servicemen. A free copy can be obtained from a Raytheon jobber or by writing direct to Raytheon Production Corp., 420 Lexington Avenue, New York City. ALL-WAVE RADIO.

SOLAR TRANSMITTING CAPACITORS

SHOWN IN THE accompanying illustration is one of the new line of "Transoil" Capacitors recently placed on the market by the Solar Mfg. Corp., 599-601 Broadway, New York, N. Y.—a rugged oil capacitor for special use in transmitting services.

The complete family consists of "Transoil," "Transmica," and "Solarex," each line of the highest quality and designed to be "reliable in every climate," to quote the manufacturer.

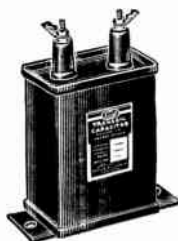

For the benefit of amateurs, engineers and servicemen, and the Solar distributors, this company has published a complete catalog, No. 2-X, describing its lines of Transmitting Capacitors in full. Copy available if you write Solar. ALL-WAVE RADIO.

YAXLEY MATCHED DIAL PLATES

IT IS NO LONGER necessary to laboriously make and hand-calibrate dial plates. You can purchase Matched Dial Plates for all standard Yaxley Controls, Rheostats and Potentiometers which will insure the accuracy of your equipment and give that desired expensive, professional appearance.

These new Dial Plates are marked in 100 divisions of the active rotation, and are calibrated numerically from 1 to 10. The rotation covered by the terminals and the switch short out is clearly marked so that it is easy to set the plates in their proper position on the panel. The new Yaxley Matched Dial Plates are 2¼" in diameter and are finished with polished aluminum markings against a satin black background.

If the control is of the linear type (Yaxley No. 4 taper), a setting of "5" on the Matched Dial Plate indicates that one-half of the resistance is in the circuit. A setting of "1" indicates that one-tenth of the resistance is in the circuit, etc. When a Yaxley Matched Dial Plate is used with a tapered Control (Yaxley No. 1 or No. 2 tapers) in the proper circuit, the calibration is in proportion to the audible intensity of the signal—thus a setting of "5" would indicate 50% volume as heard by the ear.

You can obtain Yaxley Controls, Rheostats and Potentiometers with Matched Dial Plates from your most convenient Mallory-Yaxley Distributor. ALL-WAVE RADIO.

"WIDE RANGE" I.F. TRANSFORMERS

A NEW LINE of standard i.f. double-tuned transformers has recently been placed on the market by the Meissner Mfg. Company. They are known as the "Wide Range" line.

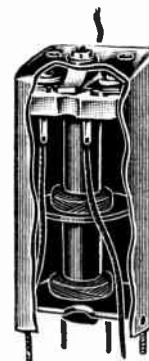

The unusual feature of these transformers is the wide range that the transformers can be tuned to. A serviceman can with only four standard wide-range transformers tune to any i.f. frequency required from 121 to 650 kc. without skip. They are available in either air-core or iron-core types. 1500-kc. and 3000-kc. units are also available for the amateur. ALL-WAVE RADIO.

NEW PRECISION RESISTORS

OHMITE MANUFACTURING Company announces the new Riteohm "71" a vitreous enameled 1% accurate, precision resistor of 1-watt rating. Riteohms are ideal for use as voltmeter multipliers, in laboratory equipment, radio and electrical test sets and in many similar applications.

By this achievement, it is said, Ohmite thus brings, for the first time, the permanent protection of vitreous enamel against moisture and atmospheric corrosion to all except the highest resistances in the compact 1 watt, 1% accurate, precision re-

(Continued on page 672)

Notes Regarding Oscillator Coils

(Continued from page 659)

If because of the availability of other wire sizes it is desired to alter the coil constants indicated in the Coil Specifications Table, the following suggestions will be of help:

1. The number of tickler turns (L3) should be just sufficient to insure strong oscillation with the condensers tuned to the lowest frequency of the coil range. Excessive tickler turns will cause a motor-boating effect at the high-frequency end of the band, apparently caused by the oscillator trying to operate simultaneously as a T. P. T. G. and Armstrong circuit.
2. The use of small diameter wire for the tickler coil is recommended since the use of such wire will give the tickler coil a poor "Q" and lessen the effect described in the preceding paragraph.
3. The wire size of the grid tank (L2) may be increased somewhat, but should not be decreased, or the efficiency of the coils will suffer.

MB-100 XMTTR

(Continued from page 641)

lator, making possible break-in operation on one's own frequency. This is highly desirable, and was of course necessary in operating on the AARS net frequency. The keying is instantaneous, even at high speeds, and chirpless. Clicks and thumps are equally conspicuous by their absence. In other words, the Proving Post definitely approves of this transmitter, and recommends it to lid and OT alike—to the impecunious and the opulent ham.

NIGHT-OWL HOOTS

(Continued from page 638)

greatest number of programs of the week. IDA programs of the week are marked (IDA) in the DX Time Table.

Our jeers again have to go to the Canadian Broadcasting Commission. Perhaps they shouldn't be tossed very strongly as this offense is not a serious one. We merely cannot understand why Canada cannot abide by the international agreement and use calls which are within its own assignment. Canada's calls are supposed to commence with a prefix between VAA and VGZ or CFA and CKZ. Instead they are now to use a prefix rightly belonging to Chile for their new network stations—CB. Formerly

THE MB-100 XMTTR KIT

(100 WATTS)

\$16⁹⁵ (LESS TUBES)
DRILLED CHASSIS.
EASILY BUILT!

Described elsewhere in this issue, this rig uses an RK49 Tritet and a pair of TZ20s in the amplifier. Quickly and easily assembled.

Also, now exclusive distributor of TEMCO Xmitters in Phila.

AND A FULL LINE OF AMATEUR BARGAINS . . .

THE KENYON SPECIALS POWER TRANSFORMERS

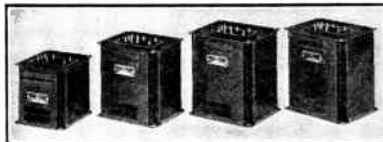

	Net Price
D-200 750-1000 each side of center at 300 mills D.C.	\$5.25
D-201 1000-1250-1500 each side of center at 300 mills D.C.	6.80
D-202 1500-2000-2500 each side of center at 300 mills D.C.	11.00
D-203 1000-1250-1500 each side of center at 500 mills D.C.	11.00
SMOOTHING CHOKES	
D-100 20 henries—200 MA.	\$1.50
D-102 20 henries—300 MA.	2.90
D-104 20 henries—400 MA.	3.50
D-106 20 henries—500 MA.	5.00

SWINGING CHOKES

	Net Price
D-101 5-25 henries—200 MA., 2500-Volt Insulation	\$1.50
D-103 5-25 henries—300 MA., 2500-Volt Insulation	2.90
D-105 5-25 henries—400 MA., 5000-Volt Insulation	3.50
D-107 5-25 henries—500 MA., 6000-Volt Insulation	5.00

NEW THORDARSON HAM UNITS PLATE TRANSFORMERS

	Amateur Net Price
T-16P00 D.C. volts 650 or 500 @ 200 M.A.	\$3.88
T-16P01 D.C. volts 1250 or 1000 @ 300 M.A.	7.64
T-16P02 D.C. volts 1250 or 1000 @ 500 M.A.	12.35
T-16P03 D.C. volts 1800 or 1450 @ 300 M.A.	11.17
T-16P04 D.C. volts 2500 or 2000 @ 300 M.A.	13.67

CHOKES—Input

T-16C20 5-20h—200 ma 2000 v ins.	2.20
T-16C21 5-20h—300 ma—3000 v ins.	2.94
T-16C22 5-20h—500 ma—3000 v ins.	5.28
Smoothing	
T-16C25 12h—200 ma—2000 v ins.	2.20
T-16C26 12h—300 ma—3000 v ins.	2.94
T-16C27 12h—500 ma—3000 v ins.	5.28

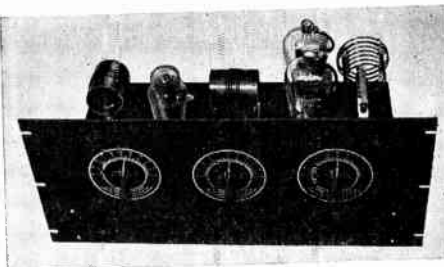

NEW 1938 SUPER SKY RIDER
with MAXIMUM USABLE BAND SPREAD . . . plus a new high order of selectivity for greater station separation. In stock . . . \$99.00

NEW NATIONAL 80X
ten tubes, crystal filter, controllable selectivity from 200 to 15,000 cycles, automatic coil shifting, frequency coverage from 95% to 600 meters, self-contained power pack, 4M speaker, calibrated mechanical band spread. Complete with tubes, crystal and speaker chassis. Net Price \$88.00

XMITTING FILTER CONDENSERS

Cap. Mfds.	Volts	Price
1	1000	\$1.08
2	1000	1.47
4	1000	\$1.96
1	1500	1.42
2	1500	1.96
1	2000	1.71
2	2000	2.40
4	2000	4.56
1	3000	2.45
2	3000	4.85
2 Mfd., 1000 Volts, oil-filled filter condensers98c		



ALL THE NEW TAYLOR TUBES IN STOCK

TZ 20 zero bias triode 20 watt pl. dis. . . . \$2.45
T125 high frequency triode 125 pl. dis. . . . \$13.50

Isolanite Base RK49 Raytheon Tubes (6L6G) \$2.10
BRAND NEW SYLVANIA 211-C

Designed for high frequency use. Two of these in class B will deliver 200 watts of audio. Regular price \$17.50 Our price \$6.75

FILAMENT TRANSFORMERS

Open style sub or top panel mounting—115 volt, 60 cycle primaries.	Volts 2,000 2.06
T-16F17 6.3 Volts C.T. @ 3 Amps. Insulation	T-16F17 6.3 Volts C.T. @ 3 Amps. Insulation 1.03
T-16F08 2.5 Volts C.T. @ 5.25 Amps. Insulation	T-16F13 7.5 Volts C.T. @ 4 Amps. Insulation 1.18
Volts 2,00088	T-16F14 7.5 Volts C.T. @ 10 Amps. Insulation 1.76
T-16F09 2.5 Volts C.T. @ 10 Amps. Insulation	T-16F15 10 Volts C.T. @ 4 Amps. Insulation 1.76
Volts 2,000 1.03	T-16F16 10 Volts C.T. @ 8 Amps. Insulation 2.35
T-16F16 2.5 Volts C.T. @ 10 Amps. Insulation	T-16F15 10 Volts C.T. @ 4 Amps. Insulation 1.91
Volts 2,000 1.18	T-16F16 10 Volts C.T. @ 8 Amps. Insulation 2.35
T-16F11 5.25 volts C.T. @ 4 Amps. Insulation	T-16F12 5.25 Volts C.T. @ 13 Amps. Insulation 2.35
Volts 2,000 1.76	
T-16F12 5.25 Volts C.T. @ 13 Amps. Insulation	

M & H SPORTING GOODS CO.

512 MARKET STREET PHILA., PA.
ATLANTIC CITY BRANCH 1709 ATLANTIC AVENUE

HUM Is Expected

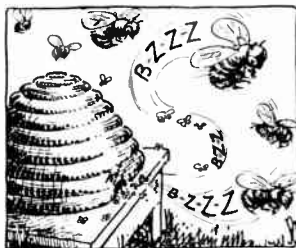

Hum is expected around bee hives but should not be tolerated in audio design.

Kenyon Hum Bucking Transformers are priced as low as \$2.40.

Catalogs describing the various Kenyon audio and power components obtainable from your local dealer.

Kenyon Transformer Co., Inc.

840 Barry St.

New York, N. Y.

TEMCO

TRANSMITTERS
Are Now Demonstrated
And Sold By
LEADING DEALERS

The consistently superlative performance of Temco Transmitters has led many Amateurs to believe that such quality was beyond their financial means. But today many leading dealers chosen by Temco can tell you how you may purchase a Temco on liberal time payment plan to meet your budget requirements.

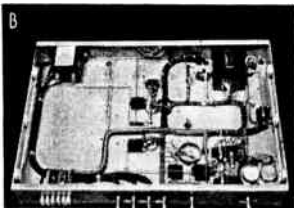
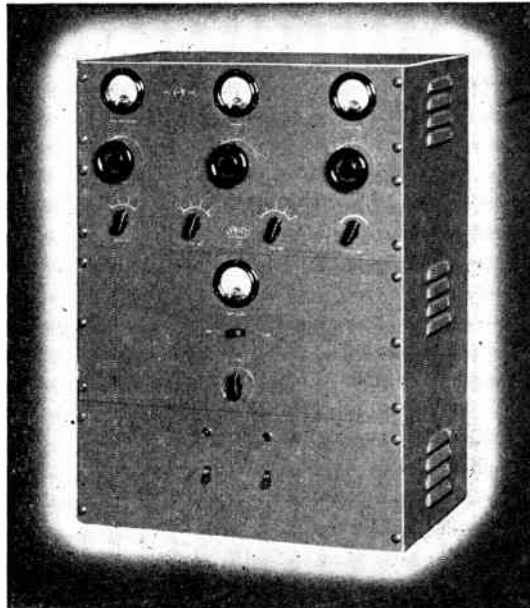

Above: Front view of Temco 100. B—Under-side view of intermediate and power amplifier chassis of model 600 illustrating the superlative wiring details and careful mechanical construction which is typical of all Temco Transmitters.

Temco advanced engineering which includes band switching exciter units, automatic plug-in chassis, high fidelity audio response, efficiency over entire wave length range, etc., brings all the advantages of ultra-modern transmitter design which insure the user against the hazards of premature obsolescence. See your Dealer now for complete details or write today to—

TRANSMITTER EQUIPMENT MANUFACTURING COMPANY
130 CEDAR STREET • NEW YORK, N. Y.

they were using a prefix assigned to Portugal—CR, and still farther in the past they used CN which was assigned to Morocco. It seems sort of silly that the Commission should go into some other country's assignment for calls when there are plenty of available combinations in Canada's assignment to accommodate many times the number of stations existing in that country today.

Address all communications for this department and for the Championship DX Contest to Ray La Rocque, *note address change*, 28 Aetna St. Worcester, Mass.

WIDE-RANGE NOTES

(Continued from page 650)

creasing the gain of earlier stages in the amplifier. However, there is sufficient overall gain in the original Wide-Range system, and in the circuit accompanying this article, to make up for the slight loss in gain in the power stage.

By the same token, inverse feedback will reduce or eliminate hum which may be present in the amplifier or introduced into the circuit from an external source. Moreover, poor power-supply regulation has less effect on amplification when inverse feedback is employed.

The application of inverse feedback in an output stage—and particularly when beam power tubes such as the 6L6G are used—also tends to reduce the effective a.c. resistance of the tubes so that, though they still function with the desirable characteristics of the pentode, are given the desirable low plate-resistance characteristics of the triode. The application of inverse feedback therefore permits adequate damping of the loudspeaker which eliminates what is commonly referred to as "speaker hangover."

Automatic Tone Compensation

The inverse feedback circuit also provides a highly efficient means of compensating for tone deficiencies present in an amplifier, or for accentuating certain audio frequencies to compensate for aural deficiencies. In other words, bass or treble can be boosted at will and without any difficulties from phase shift. And the compensation can be made to function automatically!

In order that you may appreciate this method of attaining automatic tone compensation, let us first examine the manner in which inverse feedback is applied to the Wide-Range amplifier. Referring to the accompanying circuit diagram, the feedback circuit for the upper 6L6G tube is composed of R22, C15, and R19, and for the lower 6L6G, R23, C16 and R20.

Pardon us . . .
if we say nothing about this
AMPEREX HF-100

We're not bashful . . . but at the same time, we hate to be accused of boasting.

Ask any amateur who is operating HF-100's . . . He'll tell you OUR story in his own words.

You'll thank him . . . and when you do, thank him for us, too . . . please . . .

\$12.50 at your favorite distributor

AMPEREX
ELECTRONIC PRODUCTS, Inc.
79 WASHINGTON STREET • BROOKLYN, NEW YORK

These may be looked upon as voltage-divider circuits, and the degree of inverse audio voltage developed across the resistors R19 and R20 is at the same time the amount of inverse voltage impressed on the grids of the 6L6G tubes.

Generally speaking, the percentage of feedback voltage impressed on the grids of the 6L6G tubes is dependent upon the values of R22 and R19 in the one case and R23 and R20 in the other case. Since the same percentage of inverse feedback is desired for both tubes, the respective values for the four resistors are identical. In this case R22 and R23 are 50,000 ohms, and R19 and R20 are 5,000 ohms.

However, we are dealing with audio voltages, and therefore the value of the condensers C15 and C16 also have a bearing on the percentage of feedback. If the reactance of these condensers to a given frequency is high, the percentage of feedback will be reduced, whereas if their reactance is low the feedback voltage developed across the resistors R19 and R20 will be high.

A bit of speculation on this point will make it clear that if condensers of comparatively high capacity are used in the inverse feedback circuits, their reactance to both low and high frequencies will be comparatively low and the percentage of feedback will be substantially uniform over the entire frequency range. On the other hand, if C15 and C16 are of low capacity—say in the vicinity of .05 mfd. or less—their reactance to low frequencies will be substantially greater but still be small to the higher frequencies. The result is, in this instance, that the percentage of inverse feedback at the higher frequencies will be substantially greater than at the low frequencies, and since the greater the percentage of feedback the less the gain in the power stage, it stands to reason that bass notes will be amplified to a greater extent than the treble—and the action will be entirely automatic.

The action is similar to volume expansion in the sense that the gain of an amplifier stage is automatically controlled, but in this instance the control factor is the frequency of the signal rather than its relative amplitude.

The degree of bass boost that can be obtained in this manner is limited by the gain differential created by the introduction of inverse feedback, but is sufficient for most purposes. The Wide-Range amplifier has adequate bass response without such compensation, and for that reason the condensers C15 and C16 are given a value of 0.1 mfd. If more boost is desired, these values may be reduced to as low as .01 mfd. or less, but the best way to determine values suitable to your own requirements is by experiment.

If you wish to control the amount of automatic bass boost to meet varying pro-

HAVE YOU A COMPLETE FILE OF ALL-WAVE RADIO?

CIRCUIT - DIAGRAMS • FORMULAE • CONSTRUCTIONS • TABLES • LISTS • QUESTIONS - ANSWERS • ETC.

COMPLETE AN INVALUABLE REFERENCE LIBRARY NOW!

A Limited Number of the Following Issues are available (First Come—First Served)

1935 Sept., Nov., Dec.
1936 Jan., Feb., March, April, May, July, Aug., Sept., Oct., Nov., Dec.
1937 All issued to date.

15c EACH

8 for \$1.00

POST-PAID

ORDER FROM ROOM 601, 16 EAST 43rd ST., NEW YORK, N. Y.

Super-Sensitivity

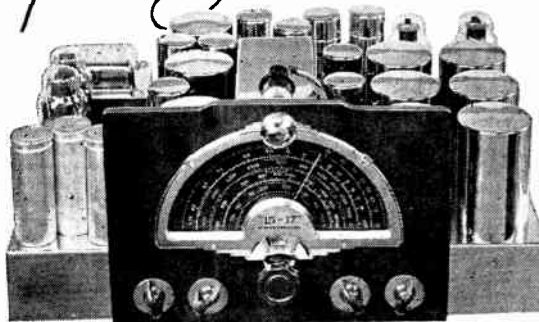

★ Here, in a new and straight forward circuit, is the super-sensitivity that make McMurdo Silver MASTERPIECE V's the exclusive choice of VE1IN, the Bowdoin-Kent Island Expedition now in the Arctic. This same super-sensitivity comes to you in the new "15-17". With it you can listen with pleasure to broadcast and short wave stations from near and far, for the "15-17" measures better than 3:1 signal to noise ratio at one-half microvolt absolute sensitivity.

This is made possible by its exclusive stabilized regenerative tuned r. f. stage, which equals two ordinary tuned r. f. stages, and its exclusive new TRI-BAND i. f. amplifier. Imagine such super-sensitivity coupled with your instant choice of razor sharp 3 kc., general purpose 8 kc., and full throated 16 kc. high fidelity selectivity, double action a.v.c. eliminating both fading and overload, dual control of that truly MASTERPIECE tone which radio editors praise and musicians choose, and you have the "15-17".

Band spread is inches, not just a few degrees, on all short wave bands, wave length range is 530 to 32,000 kc. (yes, the "15-17" is "hot" on 10 meters, as it is all over all bands). Finish is polished chromium—construction is MASTERPIECE throughout—but if you want the story of this really superb all wave, high fidelity receiver, you'd better mail the coupon.

29

IMPORTANT FEATURES

Besides new sensitivity, there are 29 additional reasons why you want a "15-17" receiver custom-built for you. It has the performance and features you would expect only at triple its extremely low cost. 15 tubes performing 17 functions before a Jensen-Silver 15 inch Giant speaker, housed in a hand customed, solid and heavy Bifarian (bass-reflex and peri-dynamic) console, acoustically perfect. "15-17" is radio's greatest value today, bringing MASTERPIECE quality to every home.

When the best costs less and you can buy it for only \$28.00 down — it pays to investigate. Mail the coupon below for free particulars and our introductory Offer.

Individual Custom Built Radio

McMURDO SILVER
MASTERPIECE

McMURDO SILVER CORP.,
2900-B South Michigan Blvd.
Chicago, Illinois

Send me full "15-17" details.

Name _____

Address _____

**NO HUM
NO BUZZ
NO "BACKTALK"
FROM**

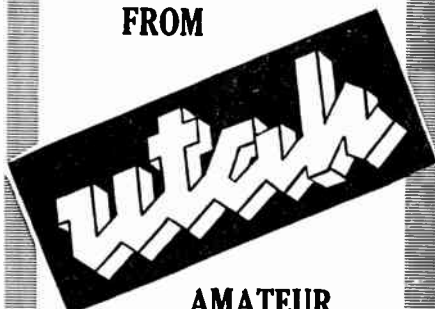

**AMATEUR
TRANSFORMERS**



Maybe you are accustomed to feed-back from output transformers in a class B circuit. Try UTAH transformers and hear the big difference. They don't "talk back"! In addition, UTAH transformers have lower eddy current losses, greater magnetic field efficiency, unusually high safety factors and are positively sealed against humidity.

There's a properly designed UTAH transformer for every radio tube on the market. Take advantage of UTAH's 16 years of making good radio parts better. You can do it so easily! Just say UTAH to your jobber. He has a COMPLETE line.

SPECIFY UTAH PARTS

- SPEAKERS
- TRANSFORMERS
- CHOKES
- VOLUME CON. TROLS
- TONE CON. TROLS
- VIBRATORS
- RESISTORS
- PLUGS
- JACKS
- JACK
- SWITCHES
- PUSH-BUTTON SWITCHES
- CONTROL MOTORS

UTAH RADIO PRODUCTS CO
CHICAGO, U. S. A.

TORONTO ONTARIO, CANADA BUENOS AIRES UCOA RADIO PRODUCTS CO.

"16 YEARS OF LEADERSHIP"

gram or record response, it would be a simple matter to employ banks of condensers, controlled by a dual switch, so that the proper values for any condition could be thrown into circuit.

If high-frequency boost is desirable, this may be obtained automatically by shunting low-capacity condensers of equal value across the grid resistors R19 and R20. These would have high reactance to low frequency voltages but comparatively low reactance to high-frequency voltages. Consequently such condensers would reduce considerably the high-frequency voltages developed across R19 and R20 but have little effect on the low-frequencies—result: less high-frequency inverse voltage impressed on the 6L6G grids and therefore greater gain.

Obviously, one can take advantage of both bass and treble boost in the manner outlined, but we doubt the value of the latter in the Wide-Range amplifier. High level treble can be downright objectionable, but for those who wish to try it we suggest values from .0001 mfd. to .0005 mfd. or higher for the two condensers used to shunt the resistors R19 and R20.

With the inverse feedback arrangement in use, we suggest the addition of a bypass condenser across the cathode resistor R24. This condenser, labeled C17 in the diagram, is a 25-mfd., 25-volt electrolytic. It is not necessary, but tends to equalize a mismatch of the output tubes, should it exist.

Conclusion

The diagram accompanying this article suggests the best arrangement where volume expansion for recorded music is not desired, which is the case with many of our readers who wish the equipment for radio program reproduction only. Even so, there is sufficient gain available for full output from a good phonograph pickup feeding the input control grid of the 6C8G. This tube, incidentally, should be shielded, unless 6L6s are used in place of the 6L6Gs. The latter develop a strong field and are apt to cause motor-boating in the amplifier if the 6C8G is not protected.

ULTRA-HIGH

(Continued from page 629)

frequency, to aid their observations. Address: Albert S. Sise, Milton, Boston, Mass.

Television Stations

As there are no television receivers on the market, in the United States, the listener will probably be more interested in the sound portions of television transmissions than in the sight portions.

There is listed below ten stations that are making the most progress and are most frequently heard, exclusive of foreign stations.

- W2XAX New station under construction, to be installed in the Chrysler Building, New York. Power 30,000 watts.
- W6XAO The Los Angeles, Don Lee station. Uses 150 watts on 45.0 mc. for sound.
- W3XPF The new Philo-Farnsworth station at Philadelphia, Pa. Power 1,000 watts. 66.0 mc. sound, 62.75 mc. sight.
- W9XAL The First National Television station at Kansas City, Mo. Uses 300 watts on sight and 150 watts on sound.
- W2XBS } RCA, New York station. Uses 12 kilowatts on 49.75 mc. for sight and 15 kilowatts on 52.0 mc. for sound.
- W2XF }
- W3XE The Philco station at Philadelphia, Pa. Uses 250 watts on 54.25 mc. for sound.
- W2XDR Radio Pictures, Inc., of Long Island City, New York. Uses 500 watts for sound.
- W3XEP The RCA station at Camden, N. J. Operates on 46.0 mc. with 30 kw.
- W8XAN Sparks-Withington station at Jackson, Mich. Uses 100 watts for both sight and sound.

There are a number of other stations in operation but at present we have no information as to their progress.

RCA recently demonstrated a new high-speed facsimile circuit between New York and Philadelphia. The system is a multi-channel one and engineers are very anxious to increase power, install new filters, and automatic typewriters able to carry 12,000 words per minute in both directions. The circuit uses four stations to bridge the gap between the two cities. They operate on six different frequencies; 89,500 kc., 90,000 kc., 94,500 kc., 95,000 kc., 99,500 kc., and 104,000 kc. As the range of each station is virtually quasi-optical they are selected to provide a distant horizon. In New York and Philadelphia, therefore, the antennas are located atop tall buildings which have a 30 and 25 mile horizon respectively, leaving only 36 miles between Arneys Mount, N. J. and New Brunswick, N. J. The equipment itself is a modern marvel, making ultra-high-speed facsimile a sensation on the u.h.f.

Also doing notable work on facsimile is W9XAF, 41.0 mc., The Journal Co., and W2XBH, 86.0 mc., Radio Pictures Inc.

A little surpassing the advances in American television are the foreign performers. In England, France, Germany, and Holland receivers are being marketed so that many a family now spends a quiet evening by the television.

In England, Baird and Marconi-E.M.I. are broadcasting from the Alexandra Palace, London. Frequencies employed are 45.0 mc., for sight and 41.5 mc. for sound. In the Netherlands, The Philips Co. are experimenting in the 43.0-mc. channel. In Germany, the powerful Berlin transmitters operate on 43.0 and 44.0 mc. French receivers are being widely publicized as in the near future a 30,000-watt transmitter will be put in operation.

Mutual Telephone Co. Stations

These stations are the real pioneers in ultra-high-frequency work, as several years ago they were installed for inter-island communication. The six stations listed below employ 200-watt transmitters.

Station	Location	Frequency
KGXC	Oahu, T. H.	37.4 mc.
KGXJ	Ulupalakua, T. H.	40.7 mc.
KGXO	Kapela, T. H.	46.2 mc.
KGXB	Manawahua, T. H.	47.3 mc.
KGXK	Waikii, T. H.	49.5 mc.
KGXH	Ulupalakua, T. H.	48.4 mc.

Police Radio Stations

If you are looking for the extraordinary in police reception, the four ultra-high-frequency bands are the places to try. Already a dozen new stations have been put in operation since the publication of the police lists in the August, 1937 issue of ALL-WAVE RADIO. Unfortunately these lists are very misleading as only headquarters stations are included, district stations and portable units being absent. As a matter of fact, two-way transmission between five radio cars is the average. So the u.h.f. stations have the short-wave police radio stations outnumbered three to one.

Police Notes: Philadelphia will probably drain off all of the W3 experimental call letters when its fifty cars and substations are commissioned. They have been testing lately on 40.1 mc.

W3XIZ, 37.1 mc., Pleasantville, N. J., operating in conjunction with W3XF, 37.1 mc., and W3XEB, 37.1 mc., have installed two-way units in their respective dog catcher trucks! (*Calling car 28, calling car 28—pick up dangerous pekingnese at 2-- Fra--- St.*)

W6XMW is using its fifty watts on 33.1 mc.

Also reported, or heard here, on 33.1 mc. are: W6XEH, W5XB, W8XAU, W4XAN, W4XR, W4XI, W3XBD, W3XBP, and W6XHE. Heard here on 30.1 mc. were W6XFE, W8XGY, and W2XEM. Operating on 40.1 mc. is W9XEC which is experimenting with concentric feeders. The above stations state that they have only "local coverage" but already several stations have interfered with each other though they were 2,500 miles apart.

Amateur Phones

If you want to hear the stations that you generally wouldn't hear on other bands, the ten-meter amateur band is the place to listen.

After the moving of the American phone band to 28,500-30,000 kc., it leaves the foreign phones in a separate band 28,000-28,500 kc., but following the American moving day many of the foreign stations also changed frequency, putting our lists temporarily in a cloud.

Knowing ten meters as we do, we are sure many of the stations listed below

will return to the new band and bring others with them.

Country	Calls	Time Heard (E.S.T.)
Alaska	K7PQ, K7FDE	11:00 am.-7:00 pm.
Argentina	LU9AN, LU7BC, LU7AZ	4:00-7:30 pm.
Australia	VK3YP, VK7KV, VK4WH, VK2GU, VK2XP	10:30 pm.
Bermuda	VP9R, VP9G	1:00-5:00 pm.
Canal Zone	NY2AE, K5AG, K5BJ, K5AT	2:30-6:00 pm.
Cayman Islands	VP5PZ	3:30 pm.
Colombia	HK1JB	7:15 pm.
Dominican Rep.	H15X, H17G	8:00 am.-4:00 pm.
Egypt	SU1RO, SU1SG	7:45 am.-4:30 pm.
France	F8MG, F8RR, F8VS, F3HL	7:55 am.
Germany	D3AAN, D3LSR, D4DLC, D4KJP, D5AF, D6MV	3:45-4:30 pm.
Great Britain	G2HX, G2QB, G2ZY, G5DJ, G5RI, G5BM, G5BJ, G5QF, G5RH, G5KH, G5JW, G5SY, G5WP, G5AU, G6GS, G6BW, G6GF, G6LK, G6WN, G6GO, G6RG, GW2UL, G5KF	7:30 am.-4:00 pm.
Hawaii	K6MVB, K6OGS	10:00 am.-6:30 pm.
Honduras	HR4AF	6:30 pm.
India	VU2CQ, VU2AU, VU2EB	9:55 pm.
Ireland	EI2L, EI2J, EI7F	8:00 am.-3:45 pm.
Japan	J2CF, J2CB, J2IN, J2DC, J2LU, J2IS, J3FK, J3FJ, J3FZ	10:30-11:20 pm.
Jugoslavia	YT7MT	7:45 am.
Latvia	YL2BB, YL2CD	8:00 am.-3:00 pm.
Martinique	FM8AA	9:00 am.
Mexico	XE2N, XE2AG, XE1GE, XE3R	12:00-4:30 pm.
Morocco	CN8AM, CN8AB	12:45-2:00 pm.
Malaya	VS2AJ	6:45 am.
New Zealand	ZL1CD, ZL4SW, ZL4AL	10:00-11:30 pm.
Porto Rico	K4DDH, K4SA, K4EJE, K4EPO, K4EIL, K4ETP	7:30 am.-6:00 pm.
Portugal	CT1KH	1:00 pm.
South Airica	ZU6P, ZU1C, ZE1JR, ZE6AJ, ZT2G, ZT6Y, ZT2U, ZE1J, ZE1JU, ZT6AY	10:00 am.-4:00 pm.
Reunion	FR8VX	12:30 pm.

Notings

As the listener can easily determine from this article, definite reform was needed on the ultra-high frequencies. Consequently, beginning October 13, 1938, the F.C.C. will place all of the ultra-high frequencies under control and reassign frequency channels.

For the police 75 channels between 41,020 kc. and 43,980 kc. will be allotted. For the broadcast relay stations 16 channels between 30,830 kc. and 39,820 kc. will be allotted. The television stations will be given frequencies between 44,000 kc. and 108,000 kc. For airport traffic control, the commission made provision for 6 channels between 129,000 kc. and 130,000 kc. and 11 channels for radio telephone service with aircraft in service flights between 132,000 kc. and 144,000 kc. For persons authorized to carry on research work the Commission assigned frequencies between 30,000 kc. and 40,000 kc., and between 132,000 kc. and 140,000 kc. (to be shared).

We wish to extend our thanks to those who have helped to make this article possible. We especially appreciate the letters of R. V. Hamilton and Ben S. McGlashan.

We will render all assistance possible

RACO CRASHES THROUGH WITH NEW S-W VALUES



UNIVERSAL CLIPPER

Uses the new 25L6 low voltage beam power tube which makes possible high power output with an inexpensive A.C.-D.C. power supply. Here is the famous CLIPPER circuit. The same smooth, non-critical tuning; combined regeneration and super-regeneration; separate bandspread and ultra-high frequency tuning condenser; 5 inch dynamic speaker; 3 to 555 meter tuning range; automatic earphone jack; in fact, all of the splendid features which make the CLIPPER circuit a tremendous success.

ASK THE MAN WHO OWNS A CLIPPER—LOOK AT HIS LOG!

COMPLETE KIT WITH ALL PARTS ASSEMBLED and wiring diagram; less only tube and cabinet, unwired \$12.40

Black crackle finish cabinet 1.80
Matched set of five tubes 3.20
Wiring 2.90

UNIVERSAL CLIPPER—COMPLETE, with black crackle cabinet (20" x 10" x 9 1/2"); five tubes; 6K7, 2-6J5G, 25L6, 25Z6G; ready to operate, and one-year guarantee. Special Complete Price \$19.50

THE NEW RANGER

3-TUBE UNIVERSAL A.C.-D.C.

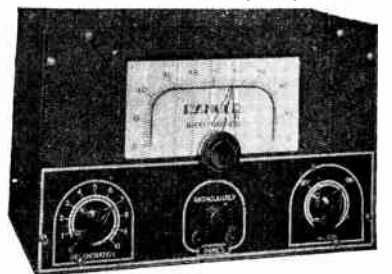

AMAZING VALUE IN THIS SPLENDID ALL-WAVE SET! You will be astounded at the way it brings foreigners rolling in. Yes, and separates them too! Uses super-sensitive electron coupled regenerative circuit giving smooth tuning and perfect regeneration control over its entire wave-length range. Tunes from 15 to 550 meters with positively no skips.

RANGER 3-TUBE UNIVERSAL A.C.-D.C.—complete kit, assembled but not wired, including wiring diagram and broadcast coil but less cabinet and tubes \$4.50

3 additional coils (15 to 200 meters)50
Crystallized metal cabinet90
Set of three tubes (2-6J5G; 1-6A7) 1.35
Wired and tested 1.40

SPECIAL COMPLETE PRICE with all coils, cabinet and tubes, wired and tested, with one-year guarantee 8.25

FREE Catalog!

Kits, receivers, converters, valuable antenna information—everything you'd expect to find in a complete short-wave catalog—at prices astoundingly low. Write today for RACO'S LATEST SHORT-WAVE CATALOG. Address Dept. AWR-1237.

RADIO CONSTRUCTORS LABORATORIES
136 LIBERTY ST., NEW YORK, N.Y.



- Hams! Here's your answer to those over-crowded amateur bands. A directional receiving antenna instantly aimed at any desired transmitter.
- Makes virtually a single-signal receiver out of your set, without drawback and expense of I.F. crystal.
- Employs two separate doublets 90° apart, special downlead, selector switch box and coupling transformer. In handy kit.
- Merely turn selector switch to any point of the compass. That "beams" your receiver. Wonderful results.

DATA: Send for technical details on this latest development by our antenna engineers. Ask your jobber to show you the handy kit.



TECHNICAL APPLIANCE CORP.
17 East 16th St., New York City
In CANADA: 414 Bay St., TORONTO

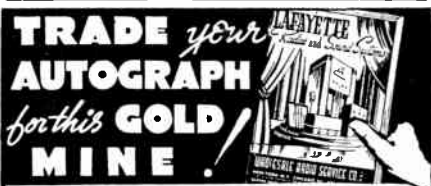

Don't miss this sensational gift offer—a radio "goldmine" 180 pages deep . . . new finds on every page. It's yours for the asking—absolutely FREE! Just send in the coupon with your name.

"HAM HEADQUARTERS"

Here at WHOLESALE you'll find Ham Headquarters. No waiting for popular equipment—take your pick from every nationally advertised line. Consult with our ham staff in person—or by mail—they're at your service. In the catalog you'll find a complete section on "ham" equipment. And, of course, LAFAYETTE Radios, public address systems, test instruments. All indexed for easy reference. Full story on our Easy Time Payment Plan and 30 DAY FREE TRIAL.



Here is a 40 page guide to your Xmas shopping. Lists nationally advertised electric trains, toys, home appliances, etc. at unbeatable prices. Mail coupon

WHOLESALE RADIO SERVICE CO. INC.
NEW YORK, N.Y. • CHICAGO, ILL. • ATLANTA, GA.
100 SIXTH AVENUE • 301 W. JACKSON BLVD. • 430 W. PEACOCK ST. N.W.
BOSTON, MASS. • BRONX, N.Y. • NEWARK, N.J. • JAMAICA, L.I.

WHOLESALE RADIO SERVICE CO., INC.
100 SIXTH AVENUE, NEW YORK, N.Y.

Rush FREE 1938 Catalog No. 69—10M7
Rush FREE Xmas Catalog No. 70—10M7

Name.....
Address.....
City.....State.....

PASTE COUPON ON PENNY POST CARD

in relation to inquiries of a technical or non-technical nature. (The author conducted several tests last winter with various types of receiving antennas, and will gladly send a summary of the results to those who may wish it.) Address all letters to Perry Ferrell Jr., Linwood, New Jersey, enclosing a stamped self-addressed envelope if you desire a reply.

GLOBE GIRDLING

(Continued from page 634)

they have no veri cards on hand and have not been advised that cards will be supplied at some future date. This in answer to a request for information, the report being received that cards were to be printed for CRCX.

It is reported that the Canadian Broadcasting Corporation have under active consideration the proposal for the erection of a powerful 50-kilowatt short-wave transmitter, with equipment which will enable the Dominion to participate in world broadcasting. No definite plans have been made as yet, however.

Amateur Phones

The following is a list of 20-meter amateur phone stations not previously reported or listed:

Country	Frequency	Calls	Time Heard
Australia	LF	VK2ADT-AFQ	7 & 1:24 a.m.
Australia	HF	VK3XJ	2 a.m.
Australia	LF	VK3DC	8 a.m.
Azores	HF	CT2AB	5 p.m.
Belgium	HF	ON4PV	8 p.m.
Belgium	LF	ON4MD	7:20 p.m.
Chile	LF	CE3CO	7:28 p.m.
Cuba	LF	CO8JB	8:33 a.m.
Cuba	LF	CO2HF-2RF	6:07&7:18 p.m.
England	LF	G6RH	3:20 a.m.
France	LF	F3NF-3LR	2-3 a.m.
Java	LF	PK3GD	7 a.m.
Jamaica	LF	VP5PZ	6:20 p.m.
Labrador	HF	VO6JO	9 p.m.
Mexico	LF	XE1DT	8 p.m.
Portugal	LF	CF1QG	6:30 p.m.
Trinidad	LF	VP4TH	7 a.m.
Uruguay	LF	CX1AA	6 p.m.
Venezuela	LF	YV4RX-5AK	6:53&7:26 a.m.

Moscow reports UPOL, 14410 kc., Soviet air base near North Pole on the air daily 2 to 9 p.m. except those days when no winds prevail in the polar basin. Short-wave listeners should report reception to Central Council of Aviation and Chemical Defense Society, U.S.S.R., Moscow. Prizes will be awarded for the best reports, it is stated.

OX2QY, 14368 kc., Reindeer Point, Greenland, MacGregor Arctic Expedition. Steamer frozen in for the winter. Radio operator is A. G. Sayre, W2QY, whose address is Storm King School, Cornwall-on-Hudson, New York. Reception reports should be sent to latter address. Station operates with 400 watts power. Reindeer Point is near Etah, 40 miles from Ellsmere Island and 600 miles from North Pole.

It is noted that the reportings for the 20-meter section are decreasing and some of those reporting are not giving sufficient information. This block was started upon the request of many interested listeners, and it is our desire to maintain it if enough are still interested. In reporting kindly send stations heard which have not been listed, and for each station show the date received, time of day or night received, location, whether on the low-frequency end or high-frequency end of American band, marking each station "LF" or "HF" as the case may be. If within the limits of the American band please mark "AB".

It affords us much pleasure to acknowledge and thank the many readers for their numerous letters and reports, for it is by these reports that we are enabled to improve the section. Each one, therefore, can assist by sending information of value to the readers, such as new stations heard, changes in frequencies, time schedules, and items of interest.

It is always our pleasure to reply to your inquiries and assist wherever possible with regard to the identity of unknown stations, reception and station matters in general and to exchange information with all.

Address your letters to Mr. J. B. L. Hinds, 85 Saint Andrews Place, Yonkers, New York, enclosing self-addressed stamped envelope if you desire reply.

All questions of a technical nature should be forwarded to Queries Editor, ALL-WAVE RADIO, 16 East 43rd Street, New York, N. Y.

R.S.S.L. NEWS

(Continued from page 642)

as the case may be, indicate the country in which the Monitoring Station is located. The numbers and letters immediately following the prefix provide the key to the exact location of a Monitoring Station. We have at headquarters a series of large maps each of which is broken up into square areas representing approximately 100 miles in each direction, or 10,000 square miles. Each intersection is represented by a letter or a number, similar to a road map, and it is therefore possible to locate with considerable rapidity any R.S.S.L. Monitoring Station.

This system is required in analyzing signal surveys, although experience along these lines indicates that a given survey would be accurate enough for all purposes were we to employ larger subdivisions—say states and provinces only, or possibly radio districts.

In any event, our methods of operation are sufficiently flexible that alterations

can be made in Monitoring Station Identifications if the majority of members approve. It should be practical, for instance, to use standard prefixes indicating country and area—such as W4 or VE3, etc., followed by a single letter to indicate a state or province, and two numbers for a headquarters key. W5L62 as an example.

If any such change is to be made, it should be done immediately, as membership renewal cards will be issued beginning the first of the year. Consequently we request that all present members let us have their opinions and suggestions at the earliest possible moment. Jot them down on a postcard today and mail to headquarters.

Membership Renewals

The new R.S.S.L. Official Membership cards for the year 1938 have reached us from the printer. The new card is a buff color and the printing in black. Otherwise it is similar to the 1937 card.

Letters will go forward to all present members before the first of the year regarding the manner in which renewals can be obtained. However, no 1938 cards will be issued until it has been determined what form of station identification is to be used in the future.

New members will receive 1938 cards, so if you recently applied for membership in the R. S. S. L. please be patient. It is too near to the end of the year to issue any further 1937 cards.

QUERIES

(Continued from page 647)

be used for this second oscillator. However, as this frequency falls within the broadcast band, complications would necessarily result.)

Question No. 46: I have heard that an ordinary loudspeaker can be used as a microphone and should like to know how to connect it up for this purpose.—*R.O.N., San Juan, Porto Rico.*

Answer: Yes—a loudspeaker of the magnetic type can be used very readily as a microphone. It is only necessary to connect the leads to the grid circuit of the detector tube—when the detector circuit is suitable. This, however, is not usually the case in modern receivers employing

SWITCH-O-MATIC

ALL WAVE ANTENNA KIT

Clarifies reception for thousands of satisfied customers. No. 375 All-Wave Antenna List ea. \$4.25.

BIRNBACH RADIO CO.

145 HUDSON ST. BIRCO. NEW YORK, N. Y.



ALL WAVE

"8" Kit



Four Bands—7.5 to 555 meters (no skip). Using the Meissner Multi Wave Air Tuned All Wave Assembly.

Essential kit furnished contains All Wave Assembly, All necessary i.f. etc. coils, chokes, calibrated dial, tuning condenser, and complete detailed instructions and prints.

Kit No. 7508A . . . list price \$34.50

FREE—Write to department F-2 for our complete 32 page coil catalog including 20 modern receiver kits.

MEISSNER MFG. CO.

Mt. Carmel Illinois

RAYTHEON

AMATEUR TUBES

RECOMMENDED BY LEADING PARTS JOBBERS



manufactures the MOST COMPLETE LINE OF RADIO TRANSFORMERS IN THE WORLD . . . Ask your local jobber for our new catalog No. P.S. 401.

MAKE LEEDS

your Christmas gift source of supply

Complete Stock of

Communication Receivers, Transmitters, Tubes, Microphones, Amateur Parts and Equipment.

Featuring

All parts necessary for the construction of transmitters and receivers described in this and other magazines.

The parts required may be obtained individually or in Kit form at

LEEDS

No matter what you require LEEDS HAS IT!

Service - Quality - Price

THE HEADQUARTERS STORE FOR AMATEURS

LEEDS

The House of Radio

45A Vesey Street
New York City

Tel. COrtlandt 7-2612 Cable Address: "RADLEEDS"

From near & far!

AMATEURS ACCLAIM
CORNELL - DUBILIER
UNIVERSAL MOUNTING
DYKANOL CAPACITORS

Type TJ-U

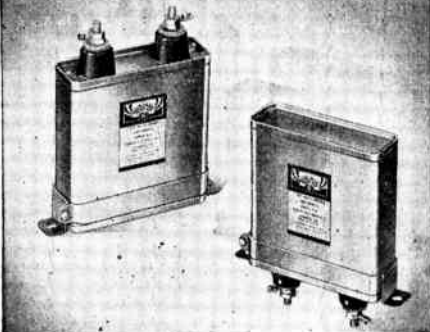

NEW ADJUSTABLE BRACKETS SIMPLIFY MOUNTING

This new mechanical feature—at no extra cost—makes C-D type TJ-U high voltage filter capacitors THE outstanding "buy" of the year! Type TJ-U capacitors are filled with DYKANOL in hermetically sealed containers. Available in a complete capacity range from 600 to 25,000 volts. The original oil capacitor. Don't be satisfied with imitations—demand the finest! Write to:

1002 Hamilton Bldg., So. Plainfield, N. J.

CORNELL - DUBILIER

ELECTRIC CORPORATION

South Plainfield, New Jersey

READ SEND CODE

LIKE AN EXPERT
Learn Quickly at Home—Get Real SPEED

It's easy, fascinating, to become a good op with the NEW ALL ELECTRIC MASTER TELEPLEX CODE TEACHER to help you. Only instrument ever produced which records your sending in visible dots and dashes—then sends back to you at any speed you desire. Also sends practice work, recorded by an expert. That is why so many schools teaching code prefer Master Teleplex. That is why thousands agree this method is surest, quickest—Teleplex has been teaching the code for many years—longer than anyone else. We furnish Complete Course, lend you the All Electric Master Teleplex, give you personal instruction with a MONEY-BACK GUARANTEE. Low cost. Send today for booklet AW 12, no obligation.

THE "HAM" SPECIAL

Standard Teleplex—a highly efficient code teacher using heavy specially prepared waxed paper tape, having two rows of perforations. Write for Free folder W 12. We are the originators of this type instrument

TELEPLEX CO.

72-76 Cortlandt St. New York City
TELEPLEX—The Choice of Those Who Know

WHO SAID WE MODERNS AREN'T RUGGED!

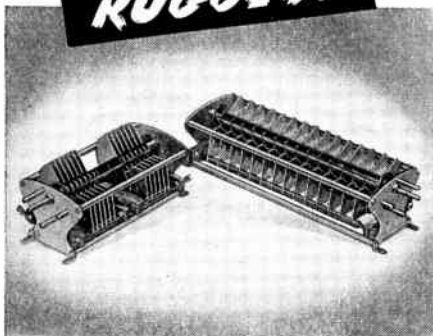

We've got polish, sure—but it takes more than good looks to work in today's modern circuits. Trust Bud variable condensers! They're built to "take it"!

BUD midjet variable condensers for receivers and low powered transmitters have been popular among s.w. fans for years. They know that BUD Products stand up best, yet cost considerably less!

Visit the Bud Authorized Distributor Nearest You or Write Direct for FREE Descriptive Catalog No. W-1238.

BUD RADIO, INC.
5205 CEDAR AVE. CLEVELAND, O.

diodes and double diodes. Obviously there is no grid available in some of these detectors. A variety of possible connections is suggested in Fig. 2. In the instances of the 55, 6R7, 85, 2A6, 6Q7, 75, 1F6, 2B7, 6B7 and 6B8, it will usually only be necessary to remove the grid cap and connect the speaker between the control grid and ground or chassis. In other tube arrangements, where the control grid (or single grid in the case of a triode) is brought out to a base prong, a connection will have to be broken.

Where a receiver is equipped with a jack or posts for phonograph connection, it will often be possible to operate the magnetic speaker as a microphone merely by connecting it to this circuit—exactly as you would a phonograph pickup. The volume will usually have to be turned up a bit higher than when using the phono pickup.

In cases where a magnetic speaker may not be available, fairly good results can be obtained by using a single head phone. Quality may not be quite so good and more amplification will be needed. If a dynamic speaker is used it will be necessary to employ a transformer. A regular output-to-voice-coil transformer will be satisfactory. Connect the voice coil to the usual terminals. If the transformer is designed for push-pull tubes, disregard the center tap.

In Fig. 2 we show a variety of possibilities. A, B and C are respectively a magnetic speaker, headphone and dynamic speaker. (If the last named is of

other than the permanent magnet type, field supply must be provided.) Terminals X and Y should be connected to the phono pickup jacks or to the circuits indicated in D, E and F—respectively a grid leak detector, bias detector and duplex diode.

Wright DeCoster makes a microphone designed on these principles and which can be used in the circuits shown. Improved sensitivity and quality will be had with this device than with the average speaker.

Question No. 47: My friend and I live on different floors of an apartment house. We both have superheterodyne receivers, and we have discovered that when tuned a certain way we can both hear a squeal from the other's receiver. We are very much interested in code and would appreciate it if you could tell us how to insert a key in the receiver circuit so that we could communicate with each other by means of the "squeal."—R. E. B., Portland, Me.

Answer: This would be a very easy thing to do—but supplying you with the information might render us an accomplice and make us both liable to two years in a federal penitentiary plus a ten thousand-dollar fine. Your receiver can squeal all it wants to and radiate to the other end of the earth—and there is no law against it. But if you key that squeal, for the transmission of intelligence, even though only to the floor above, it is a violation of our Basic Communications Act, and the violator is liable to the penalties mentioned above. Besides you would probably be transmitting off-frequency which would make you liable to an additional \$500 fine for each day of offense.

Better get a license and a crystal-controlled transmitter on an amateur band!

HAMFEST

(Continued from page 639)

As will be observed, the receiver at W2AD is a Hammarlund Super Pro. AD's present QTH is Hartsdale, N. Y., but he expects to move the rig to New York City as soon as the power company runs in the special lines for the Temco.

INCIDENTALLY, PHOTOS of ham rigs are always welcome in this department. Following publication we'll be glad to make the rig owner a present of the cut, which can be used on QSL cards, stationery, etc. Which brings up the subject of QSL cards, and we protest mildly against the stereotyped character of the vast majority of these vehicles of acknowledgment. Ninety-nine out of a hundred consist mainly of the station call letters sprawled out across a piece of

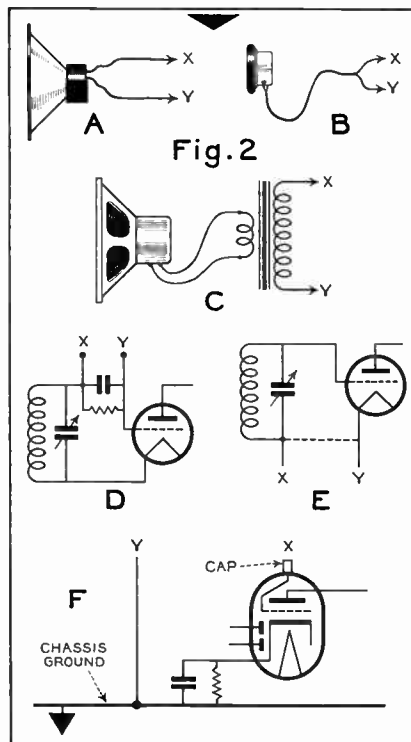

Fig. 2. Showing various ways of using loudspeakers or headphones as microphones. The easiest way is to connect in place of a phonograph pickup.



QSL card with pictorial note, from U.S.S.R.

cheap cardboard—a work of art completely minus one iota of originality.

We're looking for original—different—QSL cards, and shall be glad to publish outstanding examples in this column. While the accompanying Russian card, recently received at W8QMR, is pretty well standardized in the U.S.S.R., it has a pictorial note that could well be adapted over here. The printing is in red and black on buff. VO1Y, St. John's, Newfoundland, acknowledged a QSO with a distinctly original card, bearing appropriately a half-tone reproduction of a Newfoundland dog. Carrying out the barnyard theme, W8QCQ's card sports a crowing rooster. Any more animal crackers?

WIIGN is the first feminop we've worked who can really handle the bug. Her name is Doris—which shortens quite relevantly to "Dot." Grease up the cans some night and give her a buzz. Her QRG is 3670 kc.

ONE OF THE MAIN thoughts behind our recommendation of a couple of months ago that all transmitters be taxed (read the September and October issues before you jump on us!) was that part of the funds so collected could be turned over to the FCC so that they could render some sort of service other than determining what time the sun sets in Kalamazoo. It is practically impossible for the individual amateur to secure even vital information from the FCC. Half the time you will receive no answer at all. At other times your letter will be returned with a notation that refers you to some section in the rules and regulations. But the unfortunate fact is that at present the full rules and regulations cannot be bought, stolen or borrowed from the FCC or the

Government Printing office! It is simply out of print, and so far as we have been able to find out it has not been available for many moons.

And if the FCC ever does get around to answering a question without referring you to something you can't get hold of, they go the Delphic oracle considerably better. We actually did elicit a response from the Commish a few weeks back replying to a very simple question. Boiled down to its essentials, the answer was "yes and no."

THE INCREASING practice of sharing QSOs is an excellent idea. It saves a lot of CQs, insures a lot more dx—and last but not least, it is a friendly gesture. The system is simple and merely consists of inviting some other station to participate in a dx schedule. For example, the other night, when working W2PF on our regular 1000p sked, he mentioned that he had a schedule with VE1ER in Nova Scotia at eleven and asked us if we'd care to hang around. We said yes, and PF gave us the VE's freq. When he finished with VE1ER, PF gave him our frequency. We clicked perfectly, and a half minute later had established a QSO that would have taken a month of CQs to set up.

FOR THE BENEFIT of some second-district station who may care to check his log (and anyone else whom the shoe fits), we tell a sad tale. At 1217a, October 28th, we sent a short CQ. This second-district station came right back, and we tried to bk him—but to no avail. While he was calling we jotted down his RST as 569x, looked up his QTH, lit a cigarette, let the cat out, lit another cigarette. We pulled the switches and made our final entry in the log—"Called too long—couldn't wait."

(Continued on page 670)

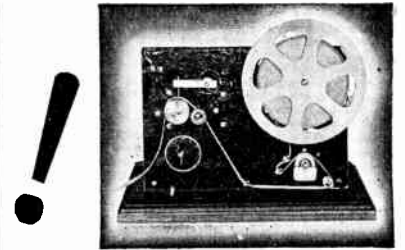

Now YOU CAN SEE IT DEMONSTRATED AT YOUR DEALERS

AMERICAN CODE READER

Now that the first rush of orders has been taken care of we want to take a deep breath and say: "Thanks!"

To you Hams who have waited actually to see the Code Reader before buying, we say: "Go to your Jobber today." He has it on demonstration. You'll see how efficiently the Code Reader takes all speeds up to 125 words per minute. You'll see how the beginner can use it in conjunction with the American Audio Oscillator to permit him to see and hear his fist at the same time . . . thus enabling him to improve it.

You'll see also how to make personal tape recordings when the Code Reader is connected in series with a key and 4.5 dry cell. Yes, sir, just walk into your Jobber today and walk out with the Code Reader. The list price, less tube (1-76) . . . \$20.00
Americode Tape, 250 ft. roll . . . each 25c

AMERICAN COMMUNICATIONS CORP.

1650 Broadway Dept. AW-12 New York, N. Y.

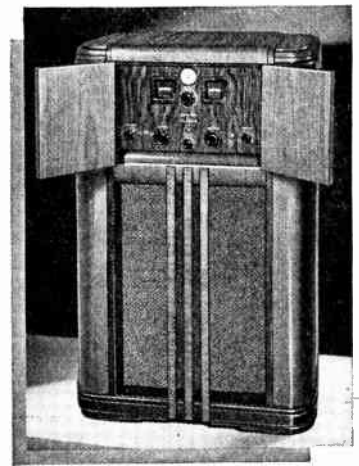

For Quality Reception

Use the new "Super-Pro" in its new distinctive console with the special sealed sound chamber offering, for the first time, professional efficiency and striking acoustical reproduction. Enjoy the superior features of the new "Super-Pro" which has been designed for the professional who demands the best for his critical air activities. Console models for 7½ to 240, 15 to 560, or 15 to 2000 meters. Mail coupon below for special illustrated bulletin.

HAMMARLUND MFG. CO., INC. AW-12
424-438 W. 33 St., N.Y.C.

() Please send me "Super-Pro" console bulletin

Name

Address

City

State

HAMMARLUND



TRANSOIL

for transmitting

**HIGHEST QUALITY
OIL CAPACITORS**

Ask for new complete
Transmitting Catalog
describing

TRANSOIL—SOLAREX—TRANSMICA

SOLAR MFG. CORP.  599 BROADWAY
NEW YORK CITY

JOBS in RADIO-TELEVISION

If you are seriously ambitious to make this fascinating, well-paying field your life work—if you have fair ability and are willing to train for success—write us. We'll tell you how we train men—how we fit them for good jobs, and help them get the jobs—how we qualify them to take exams for two Gov't. Licenses—how we prepare them for the glamorous future of television. A home-experiment course—with equipment furnished by us—followed by experience-training in our modern laboratories. The only independent school with 441-line electronic television equipment. Affiliated with Columbia basic network station KMBC. Address MIDLAND TELEVISION, INC., 114-N, Power & Light Bldg., Kansas City, Mo.

Free RADIO Catalog



See the latest sensational radio development in ALLIED'S new 1938 Radio Catalog! 61 new Knight Radios at amazingly low prices: 12,000 radio parts: 32 new Build-YOUR-OWN kits. Amateur gear: P.A. Systems, new test equipment, books, tools, etc. Write today for your FREE copy!

ALLIED RADIO CORP.
833 W. Jackson Blvd., Chicago Dept. 4-M8



Designers and manufacturers of radio parts in steel, brass, copper, Mycalex, Ameroid, bakelite. Be sure you have our catalog of over 2000 parts!

AMERICAN
RADIO HARDWARE COMPANY, INC.
476 Broadway, New York City

Ask your **JOBBER**
for the NEW



"HAMANUAL"

New Tubes . . . New Circuits

16 NEW TRANSMITTERS
5 WATTS TO 1000 WATTS

STANDARD TRANSFORMER
CORPORATION
850 BLACKHAWK STREET, CHICAGO

WHICH BRINGS US to an old friend — "Dear QMR: What's the idea of ur mag telling everyone tt they've got to hv a license to transmit regardless of pwr and dx? Tts hooley. Do incinerators need licenses? . . . diathermy machines? . . . smoke precipitators? Naw, Why? Because they don't transmit intelligence. Out of the 47,000 hams, 30,000 don't need tickets. Yrs — HI."

CHANNEL ECHOES

(Continued from page 635)

The Rye-Krisp program featuring Marion Talley isn't much better. Luckies are kind to the throat and Rye-Krisps are "kind to your waist-line" — but as radio programs they're both of a kind — kinda punk.

ALSO FROM THE letter box — G. L. S., of Grosse Point Farms, Mich., writes: "About the Louis-Farr fight broadcast . . . Knowing that the B. B. C. would carry the festivities, it didn't take much ballyhoo to make me switch from a local to London short waves. An English commentator reported the fight in a matter-of-fact way—even apologizing for excessive enthusiasm and possible prejudice in favor of Farr. His opinion tallied with the verdict given later, and he seemed dumbfounded by Louis's being booed, because he thought the decision was just. Quite refreshing to get away from all the ballyhoo and hysterics!"

JAPAN, ACCORDING to a recent announcement by the Nippon Hoso Kyokai, now broadcasts in six different languages. Well — we suppose that comes in handy when one has a lot of explaining to do.

THE SHORT-WAVE channels are replete these days with unlisted broadcasting stations as well as listed stations well off the usual broadcasting bands. The large majority of these stations broadcast only in foreign tongues and must be identified by checking against an accurate frequency list. (Listings of new stations will usually appear in AWR shortly after they first make their appearance on the ether). Of course, for stations located within a few dial divisions of the more popular bands—15 mc., 11-12 mc. and 9.5-9.6 mc., an unknown station can often be correctly located in reference to frequency by a precise check on the dial against a known station. The number of dial divisions between two fairly adjacent known stations (not more than two hundred kc. apart) should be accurately measured, and this figure divided into the kc. separation. This will give you the kc. variation per dial

READY FOR DELIVERY!



The Brand New AWR Binder

Custom built to accommodate 12 issues of ALL-WAVE RADIO, this excellently constructed binder embodies the following "up-to-the-minute" features:

- Handsome Maroon Simulated-leather Covering!
- Gold-embossed "ALL-WAVE RADIO" on Front Cover and Backbone.
- Sturdy, Rigid Covers!
- No Mutilation of Magazines with New Patented "SNAP-IN" Binding!
- Simple but Secure!
- Magazines Bound Individually!
- May be Removed Individually!
- Lies FLAT When Open!

\$1.25

Postpaid

Protect copies from tearing or possible loss and keep them handy for reference by ordering the handsome, new, AWR BINDER TODAY!

ALL-WAVE RADIO Dept. 11-B
16 E. 43 St., New York, N. Y.
Enclosed please find \$1.25 in Stamps
 M.O. Check for which please
RUSH one of the new ALL-WAVE RADIO
BINDERS to:

Name:

Address:

City: State:

STATEMENT OF THE OWNERSHIP, MANAGEMENT, CIRCULATION, ETC., REQUIRED BY THE ACTS OF CONGRESS OF AUGUST 24, 1912, AND MARCH 3, 1933

Of ALL-WAVE RADIO Magazine, published monthly at New York, N. Y., for Oct. 1, 1937. State of New York } ss. County of New York }

Before me, a Notary Public in and for the State and county aforesaid, personally appeared Edwin W. Lederman, who, having been duly sworn according to law, deposes and says that he is the Business Manager of ALL-WAVE RADIO Magazine and that the following is, to the best of his knowledge and belief, a true statement of the ownership, management (and if a daily paper, the circulation), etc., of the aforesaid publication for the date shown in the above caption, required by the Act of August 24, 1912, as amended by the Act of March 3, 1933, embodied in section 537, Postal Laws and Regulations, printed on the reverse of this form, to wit:

1. That the names and addresses of the publisher, editor, managing editor, and business manager are: Publisher, Manson Publications Corp., 16 East 43rd St., New York, N. Y.; Editor, Maurice L. Muhleman, 300 Gramatan Ave., Mt. Vernon, N. Y.; Managing Editor, Maurice L. Muhleman, 300 Gramatan Ave., Mt. Vernon, N. Y.; Business Manager, Edwin W. Lederman, 12 East 86th St., New York, N. Y.

2. That the owner is: (If owned by a corporation, its name and address must be stated and also immediately thereunder the names and addresses of stockholders owning or holding one per cent or more of total amount of stock. If not owned by a corporation, the names and addresses of the individual owners must be given. If owned by a firm, company, or other unincorporated concern, its name and address, as well as those of each individual member, must be given.) Manson Publications Corp., 16 East 43rd St., New York, N. Y.; Edwin W. Lederman, 12 East 86th St., New York, N. Y.; Maurice L. Muhleman, 300 Gramatan Ave., Mt. Vernon, N. Y.

3. That the known bondholders, mortgagees, and other security holders owning or holding 1 per cent or more of total amount of bonds, mortgages, or other securities are: (If there are none, so state.) None.

4. That the two paragraphs next above, giving the names of the owners, stockholders, and security holders, if any, contain not only the list of stockholders and security holders as they appear upon the books of the company but also, in cases where the stockholder or security holder appears upon the books of the company as trustee or in any other fiduciary relation, the name of the person or corporation for whom such trustee is acting, is given; also that the said two paragraphs contain statements embracing affiant's full knowledge and belief as to the circumstances and conditions under which stockholders and security holders who do not appear upon the books of the company as trustees, hold stock and securities in a capacity other than that of a bona fide owner; and this affiant has no reason to believe that any other person, association, or corporation has any interest direct or indirect in the said stock, bonds, or other securities than as so stated by him.

5. That the average number of copies of each issue of this publication sold or distributed, through the mails or otherwise, to paid subscribers during the twelve months preceding the date shown above is — (This information is required from daily publications only.)

EDWIN W. LEDERMAN,
Business Manager.

Sworn to and subscribed before me this 28th day of September, 1937.

(Seal.) EDWARD H. SNYDER,
Notary Public.
(My commission expires March 30, 1938.)

See Your Distributor for Sheets
Listing New Micamold Products

Micamold

**MICAMOLD PRODUCTS
CORP.**

Flushing and Porter Ave. Brooklyn, N. Y.

IMPROVE PERFORMANCE

**JEFFERSON
TRANSFORMERS**

For Radio Catalog No. 372 R—
write JEFFERSON ELECTRIC
COMPANY, Bellwood, Illinois

division. It is then an easy and obvious matter to determine the frequency of an unknown station by measuring the number of dial divisions separating it from the nearest station of known frequency. This is best done only when the known station is on the air — rather than from its previously logged position — because the calibration of the receiver will vary considerably at different temperatures. Of course the shift can be checked against any known station (logged when the receiver was thoroughly warmed up). It goes without saying that all stations used as markers should be logged after the receiver has been on for several hours, excepting when a practically simultaneous check is going to be made on an unknown station.

Unfortunately when hunting is best for unknown DX stations, convenient marker stations are not available. Also, as we have mentioned, many unknown stations are too far away from known stations to determine the frequency accurately by reference to the marker station. This is due to the fact that the rate of kilocycle change per dial division is not the same over different portions of the dial. For instance, on our own receiver, W3XAL, 17780 kc. is located at exactly 143 on the dial — at which point frequency changes at the rate of 30 kc. per dial division, and the dial can be read to tenths of one division. An unknown Spanish-speaking station was located at 169.4. As W3XAL was the nearest station on our log, this was used as a marker, which placed the unknown at 26.4 degrees higher up. At 30 kc. per degree, this made a difference of 792 kc., or placed the unknown at 18572 — or 18570 kilocycles. However, suspecting the accuracy of this long-distance check (over 26 dial degrees) we checked against a crystal-controlled oscillator and found that the correct frequency of the unknown was 18630 kilocycles — 60 kc. higher. (So far we have not seen this station listed.)

The serious short-wave fan should equip himself with a piezo-electric calibrator. It is really essential for accurate logging twenty-four hours out of the day and on isolated portions of the dial. A commercial model can be had for less than thirty dollars, and supplies harmonics, 100 kilocycles apart, way down to about ten meters. In addition, there is a marker signal every 1000 kilocycles. The accuracy is better than 100 cycles at 15 mc., which is better than seven thousandths of one per cent.

RAY E. CHESHOLM, RSSL Station W10-H2 of Jackson, Michigan, writes concerning an interference problem recently discussed in the *Queries Department*—concerning interference caused by a

THE STANDARD

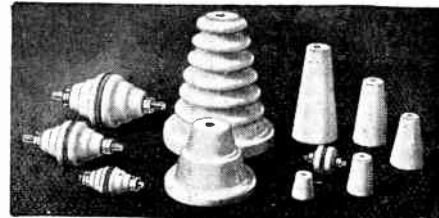

The Johnson line of Stand-Off and Thru-Panel Insulators originated more than ten years ago with a single unit. In these ten years the line has grown until it now includes 45 different insulators, 11 of which are illustrated.

Discriminating radio men have standardized on Johnson Insulators . . .

BECAUSE . . . there is a better Johnson insulator for every application.

BECAUSE . . . Johnson insulators combine effective insulation with high mechanical strength, without excess bulk.

BECAUSE . . . exclusive Johnson features offer the most in utility and convenience.

BECAUSE . . . Johnson insulators cost no more than substitutes.

Include the *Standard* in your equipment. For complete information on these and other Johnson products, ask your jobber or write for Catalog 964L.

E. F. JOHNSON COMPANY

Waseca, Minnesota, U.S.A.

Export Office: 25 Warren St., New York

Cable: "SIMONTRICE"

Par-Metal

RACKS • PANELS • CABINETS
For
TRANSMITTERS • RECEIVERS
PORTABLES

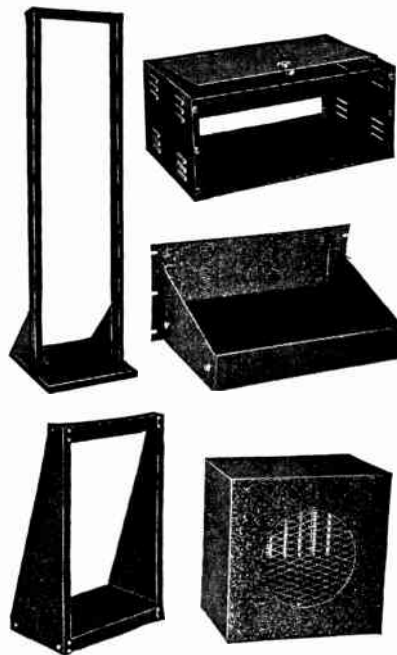

Write for our FREE Catalogue No. 37
PAR-METAL PRODUCTS CORP.
3529 41st ST., LONG ISLAND CITY, N. Y.

The ONE Complete LINE



plus

- Each AEROVOX condenser and resistor is fully guaranteed. Don't gamble your time and effort assembling uncertain components.
- AEROVOX units last longer by actual test. Check their service records for yourself, if you want proof.
- Conservative ratings have always been the AEROVOX practice. AEROVOX stresses "working" rather than "test" voltage.
- To aid you do still better radio work, AEROVOX issues practical, helpful literature, including the monthly RESEARCH WORKER.
- Lastly, your AEROVOX JOBBER has been carefully selected because of his ability to carry an adequate stock and to serve you best.



Ask for DATA

Latest catalog lists the most extensive line of condensers and essential resistors yet offered. Ask your jobber—or write us direct—for your copy.



smoke precipitator at a smelting plant. Mr. Chesholm asks can the FCC do anything about it.

We've had a bit of one-sided correspondence with the FCC lately, and have been unable to secure an answer from them—let alone a commitment—to our letters. But as far as we have been able to find out, the Federal Communications Commission can do nothing about interference unless the interfering signal is conveying intelligence. It is for this reason that the FCC has been unable to take action against diathermy machines, x-rays and other radiating devices. So long as there is no intelligence concerned it seems to be quite okay—which is probably the reason the FCC can't do anything about our average commercial broadcast programs.

ON THE MARKET

(Continued from page 660)

sistor field. Riteohms up to 50,000 ohms are only $1\frac{3}{4}$ " x $\frac{3}{8}$ " and $\frac{7}{16}$ " x 2" up to 100,000 ohms.

The Riteohm "71" is single-layer wound with special alloy wire, on a ceramic tube. The ends of the wire are mechanically locked and brazed to the copper lugs providing permanent connection. Easily soldered tinned copper wire leads make installation convenient. The resistor is covered with special Ohmite vitreous enamel, which rigidly holds, insulates and protects the accurately space-wound wire.

Because of their small size, single-layer construction and relatively few turns, the resistors have low inductance and distributed capacity. They are very conveniently used in many kinds of circuits.

Bulletin 108 describing the Riteohm "71" and other precision resistors may be had from the Ohmite Manufacturing Company, 4835 W. Flournoy Street, Chicago, Ill. ALL-WAVE RADIO.

SELECTIVE BEAM ANTENNA

THE TECHNICAL APPLIANCE CO., 17 East 16th St., New York, N. Y., announces a recently developed multi-directional receiving antenna.

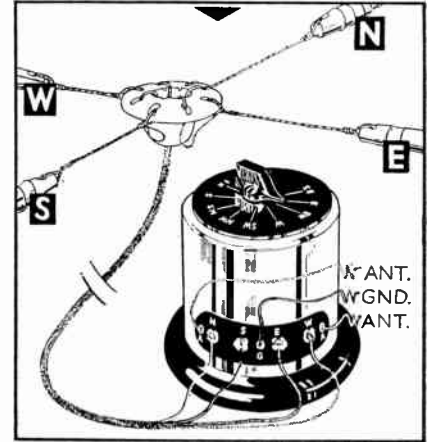

The antenna employs two separate doublets, 90 degrees apart, special down lead, selector switch box and coupling transformer, all in a handy kit. The antenna is "beamed" in any desired direction by merely turning the selector switch to any point of the compass. ALL-WAVE RADIO.

NEW JEFFERSON TRANSFORMER CATALOG

TO FACILITATE easy selection of radio transformers and chokes, Jefferson Electric Company, Bellwood, Illinois, has just published a complete catalog of 16 pages—augmented also by a similar number of pages on public-address system amplifiers, diagrams and equipment. This catalog—No. 372-R contains data on all types of transformers, and filter, swinging and plate chokes. Tables are included also giving dimensions for radio replacement power transformers with a guide giving transformer requirements for nearly 2000 receiver sets. Copies of the catalog are free to those interested in radio. ALL-WAVE RADIO.

INDEX TO ADVERTISERS

Aerovox Corporation	672	Micamold Manufacturing Co.	671
Allied Radio Corporation	670	Midland Television, Inc.	670
American Communication Corp.	669	National Company, Inc.	Third Cover
American Radio Hardware Co.	670	Par-Metal Products Corp.	671
Amperex Electronic Products	662	Radio Constructors Laboratories	665
Birnbach Radio Company, Inc.	667	Raytheon Production Corp.	667
Bud Radio Company	668	Silver, Inc., McMurdo	663
Cornell Dubilier Corporation	667	Solar Manufacturing Corp.	670
Hallicrafters, Incorporated	Back Cover	Standard Transformer Corp.	670
Hammarlund Manufacturing Co.	669	Taylor Tubes, Inc.	659
Jefferson Electric Company	671	Technical Appliance Corp.	666
Johnson Company, E. F.	671	Teleplex Company	668
Kenyon Transformer Company	661	Transmitter Equipment Mfg. Co., Inc.	662
Leeds	667	United Transformer Corp.	667
M & H Sporting Goods Company	661	Utah Radio Products Corp.	664
Mallory & Co., Inc., P. R.	657	Wholesale Radio Service Co., Inc.	666
Meissner Manufacturing Co.	667		

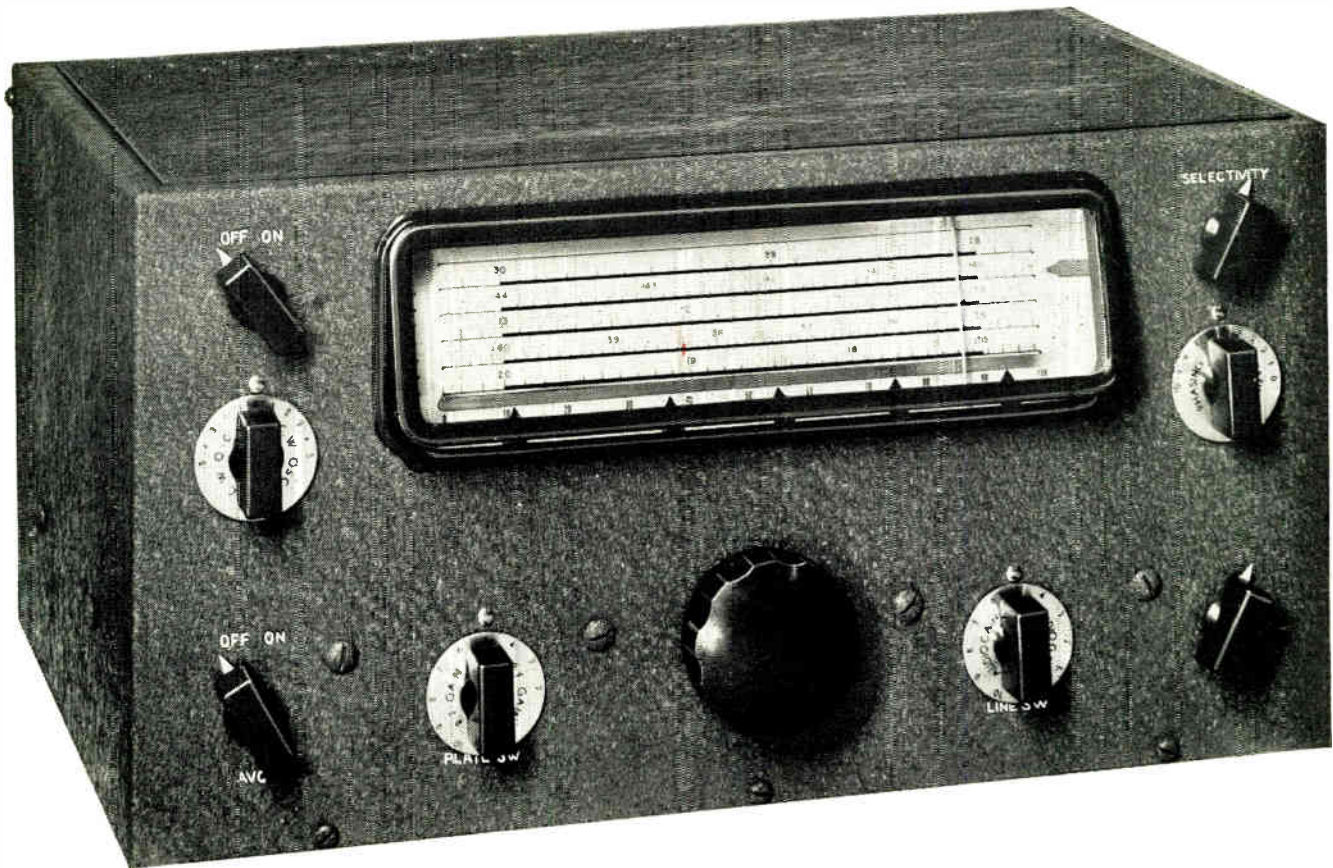

The NATIONAL NC-80X

See the new National NC-80X at your dealers. It embodies basic new improvements that for the first time make it possible to design a high-performance communication receiver at a low price. A new crystal filter circuit provides continuously variable selectivity from 400 cycles to 5 kilocycles, and wide phasing range. By its use, noise and interfering signals are reduced enormously. A high IF frequency (1560 KC) separates image frequencies by so great a span that they are readily rejected. These features make it practical to eliminate preselector stages. Use of new tubes designed for very low plate voltages allow AC-DC operation without sacrifice in performance. Thanks to such refinements, it has been found possible to engineer this new receiver with the high quality of the NC-100X, including the famous Movable Coil Tuning Unit, and yet achieve the remarkably low price of \$88.00 Net, complete with speaker, tubes, and power supply. Two models are available, the NC-80X with coverage from 550 KC to 30 MC, and the NC-81X Amateur Model (illustrated) covering five amateur bands with extreme bandspread. The new National Catalogue No. 270 describes this fine receiver in detail.



NATIONAL COMPANY, INC., MALDEN, MASS.

UNITY OF INTERMEDIATE FREQUENCY AMPLIFIER AT 465 KC 1000

WIDE RANGE VARIABLE

Selectivity



RAZOR SHARP
TO BROAD HIGH FIDELITY

SELECTIVITY important in a communications receiver, is highly developed in the 1938 Super Sky-rider. New, improved iron core I. F. transformer circuits allow Wide Range Variable Selectivity, from "razor-sharpness" to broad "High Fidelity" (8.7 KC to 20.0 KC at 100 time down). With crystal in circuits, selectivity is better than one KC, providing a variable selectivity ratio of over 30 to 1, and offering true communications receiver performance. Write today for descriptive bulletin on the New 1938 SUPER SKYRIDER.

All Hallicrafters Receivers now available on Liberal Time Payments.

the hallicrafters inc.

2605 Indiana Avenue, Chicago, Ill. • Cable Address "Hallicraft" Chicago
World's Largest Manufacturer of Amateur Communications Equipment