

October 31, 1970

\$1.00

# Cash Box

**Trade Reporting: A Credo (Ed)...Columbia 'Playback' Opens Consumer Dialog...Chicago Court Grants Anti-Piracy Decisions...TRO & Carlton Team In Disk-A/V Venture...Lowy Heads Mediarts Pubs...1st US Teldec Shown...Festival Gets Island/Invictus In Australia**

THE CARPENTERS: ONLY JUST BEGUN

ART AND RECORDINGS DEPARTMENT



# VIC DANA'S MUSIC HAS A NEW LABEL.

## COLUMBIA.

Vic Dana is no stranger to the charts. And now, with his new label, more people will be paying attention to Vic's music than ever before.

Vic's new single, "You Gave Me A Reason (To Believe)," will have Columbia Records on it. As well as behind it.

**Welcome, Vic Dana, to Columbia Records** 

"You Gave Me A Reason (To Believe)" (4-45261)

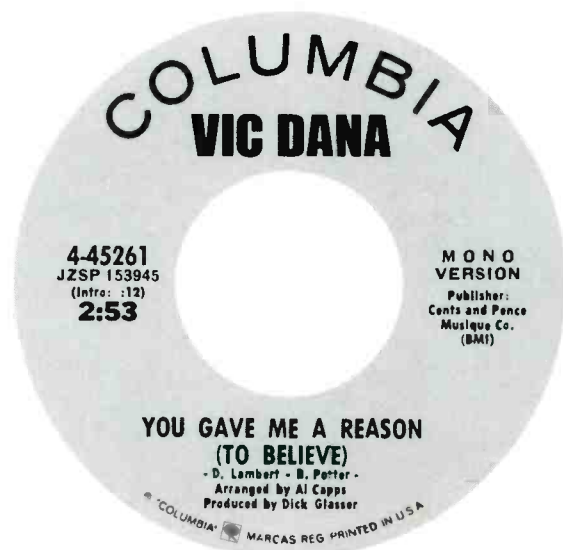

GEORGE ALBERT  
*President and Publisher*  
MARTY OSTROW  
*Vice President*  
IRV LIGHTMAN  
*Editor in Chief*

EDITORIAL

MARY GOODMAN  
*Assoc. Editor*

ED KELLEHER  
ERIC VAN LUSTBADER  
KENNY KERNER

EDITORIAL ASSISTANTS

MIKE MARTUCCI  
ANTHONY LANZETTA  
MARK HODES

ADVERTISING

STAN SOIFER  
*Advertising Manager*

ACCOUNT EXECUTIVES

ED ADLUM, New York  
HARVEY GELLER, Hollywood  
WOODY HARDING  
*Art Director*

COIN MACHINE & VENDING

ED ADLUM

*General Manager*

JON RAND, Assistant  
CAMILLE COMPASIO, Chicago  
LISSA MORROW, Hollywood

CIRCULATION

THERESA TORTOSA, Mgr.

HOLLYWOOD

HARVEY GELLER  
6430 Sunset Blvd., Hollywood, Calif. 90028  
Phone: (213) 465-2129

NASHVILLE

JUANITA JONES  
806 16th Ave. South, Nashville, Tenn. 37203  
Phone: (615) 244-2898

CHICAGO

CAMILLE COMPASIO  
29 E. Madison St., Chicago, Ill. Phone: (312) FI 6-7272

ENGLAND

DORRIS LAND  
3 Cork Street  
London W1  
Tel. 01-7342374

GERMANY

CHRISTIAN TOERSLEFF  
2 Hamburg 56  
Leuchtturmeg 30  
Tel: 34-91-94-86

BRAZIL

PEDRO FRAZAO  
DE VASCONCELOS  
Rua Frei Caneca, 11, Apt. 13  
Sao Paulo, S.P., Brazil  
Tel: 257 15 58

ARGENTINA

MIGUEL SMIRNOFF  
Belgrano 3252, Piso 4 "B"  
Buenos Aires, Argentina  
Tel: 89-6796

CANADA

WALT GREALIS  
RPM  
1560 Bayview Ave.  
Toronto 17, Ontario  
Tel: (416) 89-2166

FRANCE

FRANC G. LIPSIC  
32 Rue Du Moulin Joly  
Paris XI  
Tel. 023-90-06

SPAIN

JOAQUIN MERINO  
Presidente Carmona, 11  
Madrid 20, Spain  
Tel. 270-2915

ITALY

BRUNO POZZA  
5, Corso Europa  
Milan  
Tel: 704691

HOLLAND

PAUL ACKET  
Theresiastraat 59-63  
The Hague  
Tel: 837700

BELGIUM

ETIENNE SMET  
Postbus 56  
B-2700 Sint-Niklaas  
Tel. (03) 76.54.39

AUSTRALIA

PETER SMITH  
40 Winters Way  
Doncaster 3108  
Victoria, Australia

MEXICO

SALVADOR ARREGUIN  
ANTONIO SENS  
Tiber 100 — 7 y 8 Pisos  
Mexico 5, D.F.  
Tel: 525-39-52 11-62-96

JAPAN

Adv. Mgr.  
SACHIO SAITO  
1-11 2-Chome Shinbashi  
Minato-Ku, Tokyo  
Tel: 504-1651

Editorial Mgr.  
FUMIYO TACHIBANA  
1-11 2-Chome Shinbashi  
Minato-Ku, Tokyo  
Tel: 504-1651

SUBSCRIPTION RATES \$30 per year anywhere in the U.S.A., Published weekly at 10 McGovern Avenue, Lancaster, Pa. by Cash Box, 1780 Broadway, New York, N.Y. 10019. Second class postage paid at Lancaster, Pa. 17604 U.S.A.

Copyright © 1970 by The Cash Box Publishing Co., Inc. All rights reserved. Copyright under Universal Copyright Convention.

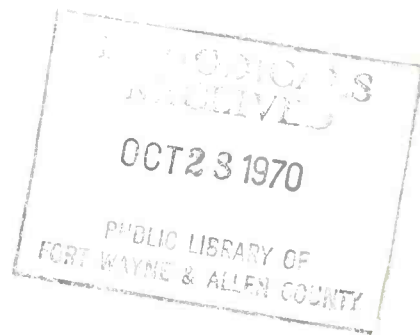

## Trade Reporting: A Credo

"Have you heard . . ." or "we have heard . . ." is music to the ears of a reporter. For it may set in motion the follow-up to a good trade story that may not only inform the trade, but prove to be an exclusive piece as well. While exclusive coverage of trade developments in **Cash Box** is a nice thing to have, the rumor-that-could-be-true call carries with it certain responsibilities that are, surely, more important than the possible exclusive.

Reporter initiative is fine, but it should mean an awareness that comments **off-the-record** remain off limits to his typewriter. When a member of the trade informs a reporter that what he is saying is not for print, and that desire is not adhered to, it constitutes a breach of journalistic ethics. When to the best of his ability and the circumstances involved a reporter fails to check out a rumor to its ultimate source of confirmation or fails to get both sides of comment, it is a breach of one's concern for the trade, since the "exclusive" story with the facts all messed-up can result in the termination of an important industry deal and with it the loss of a great deal of money.

We, as part of the trade press, not only want a good story when we can

offer legitimate reason for its use, we also want the industry to prosper and be well served, two good reasons for trade papers to exist in the first place.

This piece is not intended to be a primer on "how to handle a possible exclusive." For we all feel that industry developments occur without the direct initiative of a trade reporter. A journalism professor once told an astounded class that he estimated that 90% of all news coverage is the result of handouts, including important political and social news. **Cash Box** feels that the fact that it receives an important news item directly from the individual or company involved does not automatically relegate it to obscurity in favor of the "exclusive" with minor trade importance. If these releases are not press-time rushes, there should be an attempt to dig and make evaluations on the "hand-out." But, even with superficial re-write based on the time element, a major trade development is major whether or not it's going to be read Monday morning in all the trades.

"Responsibility," then, is the key word in reporting, any kind of reporting. **Cash Box** attempts to honor its commitment to a better industry through responsibility.



# Cash Box TOP 100

Cash Box — October 31, 1970

<b>1</b>	<b>I'LL BE THERE</b> The Jackson Five-Motown 1171	<b>1</b>	<b>2</b>	<b>35</b>	<b>(I KNOW) I'M LOSING YOU</b> Rare Earth-Rare Earth 5017 (Dist: Motown)	<b>18</b>	<b>8</b>	<b>68</b>	<b>STAND BY ME</b> David & Jimmy Ruffin-Soul 35076	<b>80</b>	<b>—</b>
<b>2</b>	<b>WE'VE ONLY JUST BEGUN</b> Carpenters-A&M 1217	<b>2</b>	<b>4</b>	<b>36</b>	<b>CLOSER TO HOME</b> Grand Funk-Capitol 2877	<b>27</b>	<b>31</b>	<b>69</b>	<b>LOVE UPRISING</b> Otis Leaville-Dakar 620 (Dist: Atlantic)	<b>73</b>	<b>80</b>
<b>3</b>	<b>ALL RIGHT NOW</b> Free-A&M 1206	<b>4</b>	<b>5</b>	<b>37</b>	<b>DO WHAT YOU WANNA DO</b> 5 Flights Up-Ta 202 (Dist: Bell)	<b>29</b>	<b>32</b>	<b>70</b>	<b>ONE LESS BELL TO ANSWER</b> Fifth Dimension-Bell 940	<b>76</b>	<b>87</b>
<b>4</b>	<b>INDIANA WANTS ME</b> R. Dean Taylor-Rare Earth 5013 (Motown)	<b>5</b>	<b>6</b>	<b>38</b>	<b>SWEETHEART</b> Engelbert Humperdinck-Parrot 40054 (London)	<b>38</b>	<b>41</b>	<b>71</b>	<b>FRESH AIR</b> Quicksilver-Messenger Service-Capitol 2920	<b>78</b>	<b>84</b>
<b>5</b>	<b>GREEN EYED LADY</b> Sugarloaf-Liberty 56183	<b>6</b>	<b>7</b>	<b>39</b>	<b>YELLOW RIVER</b> Christie-Epic 10626	<b>50</b>	<b>60</b>	<b>72</b>	<b>I NEED HELP</b> Bobby Byrd-King 6323	<b>—</b>	<b>—</b>
<b>6</b>	<b>FIRE &amp; RAIN</b> James Taylor-Warner Bros. 7423	<b>7</b>	<b>15</b>	<b>40</b>	<b>HEED THE CALL</b> Kenny Rogers & First Edition-Reprise 0953	<b>52</b>	<b>61</b>	<b>73</b>	<b>BE MY BABY</b> Andy Kim-Steed 729 (Dist: Paramount)	<b>—</b>	<b>—</b>
<b>7</b>	<b>CRACKLIN' ROSIE</b> Neil Diamond-Uni 55250	<b>3</b>	<b>1</b>	<b>41</b>	<b>AND THE GRASS WON'T PAY NO MIND</b> Mark Lindsay-Columbia 45229	<b>46</b>	<b>50</b>	<b>74</b>	<b>JERUSALEM</b> Herb Alpert & Tijuana Brass-A&M 1225	<b>81</b>	<b>86</b>
<b>8</b>	<b>LOLA</b> Kinks-Reprise 0930	<b>8</b>	<b>14</b>	<b>42</b>	<b>I JUST WANNA KEEP IT TOGETHER</b> Paul Davis-Bang 579	<b>47</b>	<b>57</b>	<b>75</b>	<b>INDIAN LADY</b> Lou Christie-Buddah 192	<b>82</b>	<b>89</b>
<b>9</b>	<b>SOMEBODY'S BEEN SLEEPING</b> 100 Proof-Hot Wax 7004 (Dist: Buddah)	<b>14</b>	<b>19</b>	<b>43</b>	<b>PART TIME LOVE</b> Ann Peebles-Hi 2178 (Dist: London)	<b>56</b>	<b>66</b>	<b>76</b>	<b>SIMPLY CALL IT LOVE</b> Gene Chandler-Mercury 73121	<b>88</b>	<b>—</b>
<b>10</b>	<b>LOOK WHAT THEY'VE DONE TO MY SONG MA</b> New Seekers-Elektra 45699	<b>10</b>	<b>—</b>	<b>44</b>	<b>AS YEARS GO BY</b> Mashmakhan-Epic 10634	<b>49</b>	<b>54</b>	<b>77</b>	<b>CAROLINA IN MY MIND</b> Crystal Mansion-Colossus 128	<b>79</b>	<b>85</b>
<b>11</b>	<b>IT'S ONLY MAKE BELIEVE</b> Glen Campbell-Capitol 2905	<b>12</b>	<b>13</b>	<b>45</b>	<b>SO CLOSE</b> Jake Holmes-Polydor 14041	<b>54</b>	<b>63</b>	<b>78</b>	<b>LOSERS WEEPERS</b> Etta James-Cadet 5676	<b>85</b>	<b>91</b>
<b>12</b>	<b>STILL WATER (LOVE)</b> Four Tops-Motown 1170	<b>13</b>	<b>17</b>	<b>46</b>	<b>5-10-15-20 (25-30 YEARS OF LOVE)</b> Presidents-Sussex 207 (Dist: Buddah)	<b>57</b>	<b>67</b>	<b>79</b>	<b>NO MATTER WHAT</b> Badfinger-Apple 1822	<b>89</b>	<b>92</b>
<b>13</b>	<b>IT DON'T MATTER TO ME</b> Bread-Elektra 45701	<b>16</b>	<b>21</b>	<b>47</b>	<b>TIME WAITS FOR NO ONE</b> Friends of Distinction-RCA 0385	<b>48</b>	<b>51</b>	<b>80</b>	<b>THIS IS MY LOVE SONG</b> Intruders-Gamble 4007	<b>86</b>	<b>—</b>
<b>14</b>	<b>EL CONDOR PASA</b> Simon & Garfunkel-Columbia 45237	<b>11</b>	<b>12</b>	<b>48</b>	<b>UNGENA ZA ULIMWENGU (UNITE THE WORLD)</b> Temptations-Gordy 7102	<b>30</b>	<b>34</b>	<b>81</b>	<b>WOODSTOCK</b> Assembled Multitude-Atlantic 2764	<b>84</b>	<b>78</b>
<b>15</b>	<b>I THINK I LOVE YOU</b> Partridge Family-Bell 010	<b>34</b>	<b>52</b>	<b>49</b>	<b>I AM SOMEBODY</b> Johnnie Taylor-Stax 0078	<b>70</b>	<b>83</b>	<b>82</b>	<b>KING OF ROCK &amp; ROLL</b> Crow-Amaret 125	<b>94</b>	<b>100</b>
<b>16</b>	<b>SUPER BAD</b> James Brown-King	<b>24</b>	<b>33</b>	<b>50</b>	<b>MONGOOSE</b> Elephants Memory-Metromedia 182	<b>53</b>	<b>56</b>	<b>83</b>	<b>I'M BETTER OFF WITHOUT YOU</b> Main Ingredient-RCA 0382	<b>87</b>	<b>—</b>
<b>17</b>	<b>GOD LOVE &amp; ROCK &amp; ROLL</b> Teegarden & Van Winkle-Westbound 170 (Janus)	<b>19</b>	<b>24</b>	<b>51</b>	<b>SNOWBIRD</b> Anne Murray-Capitol 2738	<b>26</b>	<b>10</b>	<b>84</b>	<b>STONED LOVE</b> Supremes-Motown 1172	<b>—</b>	<b>—</b>
<b>18</b>	<b>SEE ME, FEEL ME</b> Who-Decca 32729	<b>23</b>	<b>30</b>	<b>52</b>	<b>SHARE THE LAND</b> Guess Who-RCA 0388	<b>77</b>	<b>90</b>	<b>85</b>	<b>GROOVE ME</b> King Floyd-Chimneyville 435 (Cotillion/ATL)	<b>—</b>	<b>—</b>
<b>19</b>	<b>LUCRETIA MAC EVIL</b> Blood Sweat & Tears-Columbia 45235	<b>22</b>	<b>27</b>	<b>53</b>	<b>LET ME BACK IN</b> Tyrone Davis-Daker 621 (Dist: Atlantic)	<b>55</b>	<b>58</b>	<b>86</b>	<b>STONEY END</b> Barbra Streisand-Columbia 45236	<b>90</b>	<b>98</b>
<b>20</b>	<b>OUR HOUSE</b> Crosby, Stills, Nash & Young-Atlantic 2760	<b>21</b>	<b>25</b>	<b>54</b>	<b>JULIE, DO YA LOVE ME</b> Bobby Sherman-Metromedia 194	<b>32</b>	<b>22</b>	<b>87</b>	<b>WHERE DID ALL THE GOOD TIMES GO</b> Dennis Yost & The Classics IV-Liberty 56200	<b>98</b>	<b>—</b>
<b>21</b>	<b>THE TEARS OF A CLOWN</b> Smokey Robinson & Miracles-Tamla 54199	<b>40</b>	<b>55</b>	<b>55</b>	<b>LET'S WORK TOGETHER</b> Canned Heat-Liberty 56151	<b>65</b>	<b>76</b>	<b>88</b>	<b>TIME TO KILL</b> Band-Capitol 2870	<b>93</b>	<b>96</b>
<b>22</b>	<b>DEEPER, DEEPER</b> Freda Payne-Invictus 9080 (Dist: Capitol)	<b>25</b>	<b>28</b>	<b>56</b>	<b>I DON'T WANNA CRY</b> Ronnie Dyson-Columbia 45240	<b>66</b>	<b>77</b>	<b>89</b>	<b>SUNSET STRIP</b> Ray Stevens-Barnaby 2021 (Dist: Epic)	<b>—</b>	<b>—</b>
<b>23</b>	<b>STAND BY YOUR MAN</b> Candi Staton-Fame 1472	<b>28</b>	<b>36</b>	<b>57</b>	<b>IT'S A SHAME</b> Spinners-V.I.P. 25057 (Dist: Motown)	<b>43</b>	<b>37</b>	<b>90</b>	<b>THE TAKER</b> Waylon Jennings-RCA 9885	<b>95</b>	<b>—</b>
<b>24</b>	<b>CRY ME A RIVER</b> Joe Cocker-A&M 1200	<b>31</b>	<b>38</b>	<b>58</b>	<b>IF YOU WERE MINE</b> Ray Charles-ABC Tangerine 11271	<b>69</b>	<b>82</b>	<b>91</b>	<b>SOMETHING</b> Shirley Bassey-United Artists 50698	<b>97</b>	<b>—</b>
<b>25</b>	<b>OUT IN THE COUNTRY</b> 3 Dog Night-Dunhill 4250	<b>9</b>	<b>9</b>	<b>59</b>	<b>CHAINS &amp; THINGS</b> B. B. King-ABC 11280	<b>68</b>	<b>—</b>	<b>92</b>	<b>VALLEY TO PRAY</b> Arlo Guthrie-Reprise 0951	<b>—</b>	<b>—</b>
<b>26</b>	<b>HEAVEN HELP US ALL</b> Steve Wonder-Tamla 54200	<b>36</b>	<b>53</b>	<b>60</b>	<b>I JUST DON'T KNOW WHAT TO DO WITH MYSELF</b> Gary Puckett-Columbia 45240	<b>63</b>	<b>74</b>	<b>93</b>	<b>HUM ALONG &amp; DANCE</b> Temptations-Gordy 7102	<b>—</b>	<b>—</b>
<b>27</b>	<b>MAKE IT EASY ON YOURSELF</b> Dione Warwick-Scepter 12294	<b>33</b>	<b>40</b>	<b>61</b>	<b>WHEN YOU GET RIGHT DOWN TO IT</b> Delfonics-Philly Groove 163 (Dist: Bell)	<b>41</b>	<b>44</b>	<b>94</b>	<b>GET INTO SOMETHING</b> Isley Bros-T Neck 924 (Dist: Buddah)	<b>96</b>	<b>—</b>
<b>28</b>	<b>ENGINE #9</b> Wilson Pickett-Atlantic 2765	<b>37</b>	<b>48</b>	<b>62</b>	<b>FOR THE GOOD TIMES</b> Ray Price-Columbia 45178	<b>64</b>	<b>70</b>	<b>95</b>	<b>MR. BOJANGLES</b> Nitty Gritty Dirt Band-Liberty 56197	<b>—</b>	<b>—</b>
<b>29</b>	<b>EXPRESS YOURSELF</b> Watts 103rd St. Rhythm Band-Warner Bros. 7417	<b>17</b>	<b>18</b>	<b>63</b>	<b>AFTER MIDNIGHT</b> Eric Clapton-Atco 6784	<b>72</b>	<b>81</b>	<b>96</b>	<b>IT'S IMPOSSIBLE</b> Perry Como-RCA 0387	<b>—</b>	<b>—</b>
<b>30</b>	<b>THAT'S WHERE I WENT WRONG</b> Poppy Family-London 1139	<b>20</b>	<b>20</b>	<b>64</b>	<b>SEEMS LIKE I GOTTA DO WRONG</b> Whispers-Soul Clock 1004 (Dist: Canyon)	<b>74</b>	<b>88</b>	<b>97</b>	<b>SPECIAL MEMORY</b> Jerry Butler-Mercury 73131	<b>100</b>	<b>—</b>
<b>31</b>	<b>MONTEGO BAY</b> Bobby Bloom-MGM/L&R 157 (Dist: MGM)	<b>39</b>	<b>46</b>	<b>65</b>	<b>ONLY LOVE CAN BREAK YOUR HEART</b> Neil Young-Reprise 0958	<b>—</b>	<b>—</b>	<b>98</b>	<b>I CAN'T BELIEVE THAT YOU'VE STOPPED LOVING ME</b> Charlie Pride-RCA 9902	<b>—</b>	<b>—</b>
<b>32</b>	<b>GYPSY WOMAN</b> Brian Hyland-Uni 55240	<b>42</b>	<b>59</b>	<b>66</b>	<b>OUR WORLD</b> Blue Mink-Phillips 40686	<b>67</b>	<b>73</b>	<b>99</b>	<b>EASY RIDER</b> Iron Butterfly-Atco 6782	<b>—</b>	<b>—</b>
<b>33</b>	<b>CANDIDA</b> Dawn-Bell 903	<b>15</b>	<b>3</b>	<b>67</b>	<b>I'M NOT MY BROTHER'S KEEPER</b> Flaming Ember-Hot Wax 7006 (Dist: Buddah)	<b>83</b>	<b>—</b>	<b>100</b>	<b>DETROIT CITY</b> Dean Martin-Reprise 0955	<b>99</b>	<b>—</b>

### ALPHABETIZED TOP 100 (INCLUDING PUBLISHERS AND LICENSEES)

After Midnight (Viva—BMI)	63	Green Eyed Lady (Claridge—ASCAP)	5	Julie, Do Ya Love Me (Lucon/Sequel—BMI)	54	Something (Harris Songs—BMI)	91
All Right Now (Irving—BMI)	3	Groove Me (Malaco/Roffig/NRC—BMI)	85	King Of Rock & Roll (Hastings—BMI)	82	Special Memory (Butler/Chappel—ASCAP)	93
And The Grass Won't Pay No Mind (Stone-bridge—ASCAP)	41	Gypsy Woman (Curton—BMI)	32	Let Me Back In (Julio Brian—BMI)	53	Stand By Me (Tro—BMI)	68
As Years Go By (Markham-Blackwood—BMI)	44	Heaven Help Us All (Stein & Van Stock—ASCAP)	26	Let's Work Together (Mozella—BMI)	55	Stand By Your Man (Al Gallico—BMI)	23
Be My Baby (Trio/Mother Bertha—BMI)	73	Heed The Call (Quill—ASCAP)	40	Lola (Hill and Range—BMI)	8	Still Water (Love) (Jobete—BMI)	12
Candida (Pocket Full of Tunes—BMI)	33	Hum Along & Dance (Jobete—BMI)	93	Look What They've Done To My Song Ma (Kama Rippa/Amelaine—ASCAP)	10	Stoned Love (Jobete—BMI)	84
Carolina In My Mind (B. Cockerwood-Country Road—BMI)	77	I Am Somebody (Grovesville—BMI)	49	Love Uprising (Julio Brian—BMI)	78	Stoney End (Tuna Fish—BMI)	86
Chains & Things (Pamco c/o—ABC)	59	I Can't Believe (Blue Crest/Ludix)—BMI	98	Lucretia Mac Evil (Blockwood-Bay—BMI)	20	Sunset Strip (Ahab—BMI)	89
Closer To Home (Storybook—BMI)	36	I Don't Wanna Cry (Betabin—BMI)	56	Make It Easy On Yourself (Famous—BMI)	69	Super Bad (Cried—BMI)	16
Cracklin' Rosie (Prophet—ASCAP)	7	I Just Don't Know What To Do With Myself (U.S. Songs/Blue Seas/Joel/Belinda—ASCAP)	60	Mongoose (Pocket Full of Tunes—BMI)	20	Sweetheart (Casseroles—BMI)	38
Cry Me A River (Joe Cocker—ASCAP)	24	I Just Wanna Keep It Together (Wed 4—BMI)	42	Montego Bay (Unart—BMI Chessburger—BMI)	27	That's Where I Went Wrong (Gone Fishin—BMI)	30
Deeper, Deeper (Gold Forever—BMI)	22	I Need Help (Cried—BMI)	72	Mr. Bojangles (Cotillion/Danel—BMI)	50	The Tears Of A Clown (Jobete—BMI)	21
Detroit City (Cedarwood—BMI)	100	I Just Wanna Keep It Together (Wed 4—BMI)	42	No Matter What (Apple—ASCAP)	31	The Taker (Combine—BMI)	90
Do What You Wanna Do (Brig and Tiny Tiger—ASCAP)	37	I Think I Love You (Screen Gems/Columbia—BMI)	15	One Less Bell (Blue Seas—ASCAP)	79	This Is My Love Song (Assorted—BMI)	80
Easy Rider (Marlu—ASCAP)	99	If You Were Mine (Tangerine—BMI)	58	Only Love Can Break (Broken Arrow/Cotillion—BMI)	70	Time To Kill (Quicksilver—BMI)	88
El Condor Pasa (Charing Cross—BMI)	14	I'm Better Off Without You (Clarama—BMI)	83	Our House (Giving Room—BMI)	65	Time Waits For No One (Kirshner—BMI)	47
Engine #9 (Assorted—BMI Gamble Huff)	28	I'm Not My Brother's Keeper (Gold Forever—BMI)	67	Our World (MRC—BMI)	21	Ungena Za Ulimwengu (Unite the World) (Jobete—BMI)	48
Express Yourself (Warner-Tamerlane & Wright Gerst—BMI)	29	Indian Lady (Sleepy Sun—BMI)	75	Part Time Love (Gireco—BMI Escort—BMI)	66	Valley To Pray (Howard Beach—ASCAP)	92
Fire & Rain (Country Road Blackwood—BMI)	6	Indiana Wants Me (Jobete—BMI)	4	Part Time Love (Gireco—BMI Escort—BMI)	43	We've Only Just Begun (Irving—BMI)	2
5-10-15-20 (25-30 Years of Love) (Van McCoy Interior—BMI)	46	(I Know) I'm Losing You (Jobete—BMI)	35	See Me, Feel Me (Track—BMI)	18	When You Get Right Down To It (Screen Gems/Columbia—BMI)	61
For The Good Times (Buckhorn—BMI)	62	I'll Be There (Jobete—BMI)	1	Seems Like I Gotta Do Wrong (Wally Roker—BMI) c/o Canyon	64	Where Did All The Good Times Go (Low Sal—BMI)	87
Fresh Air (Quicksilver—BMI)	71	It Don't Matter To Me (Screen Gems/Columbia—BMI)	13	Share The Land (Dunbar—BMI)	52	Woodstock (Siquomb—BMI)	81
Get Into Something (Triple Three—BMI c/o Buddah)	92	It's A Shame (Jobete—BMI)	57	Simply Call It Love (Cashand—BMI)	76	Yellow River (Noma—BMI)	39
God, Love & Roc: & Roll (Bridgeport—BMI)	17	It's Impossible (Sunbury—ASCAP)	96	Snowbird (Beechwood—BMI)	51	You Don't Have To Say You Love Me (Miller—ASCAP)	34

# PART TIME LOVE Ann Peebles

*A gigantic hit from Memphis...  
on ALL charts!*

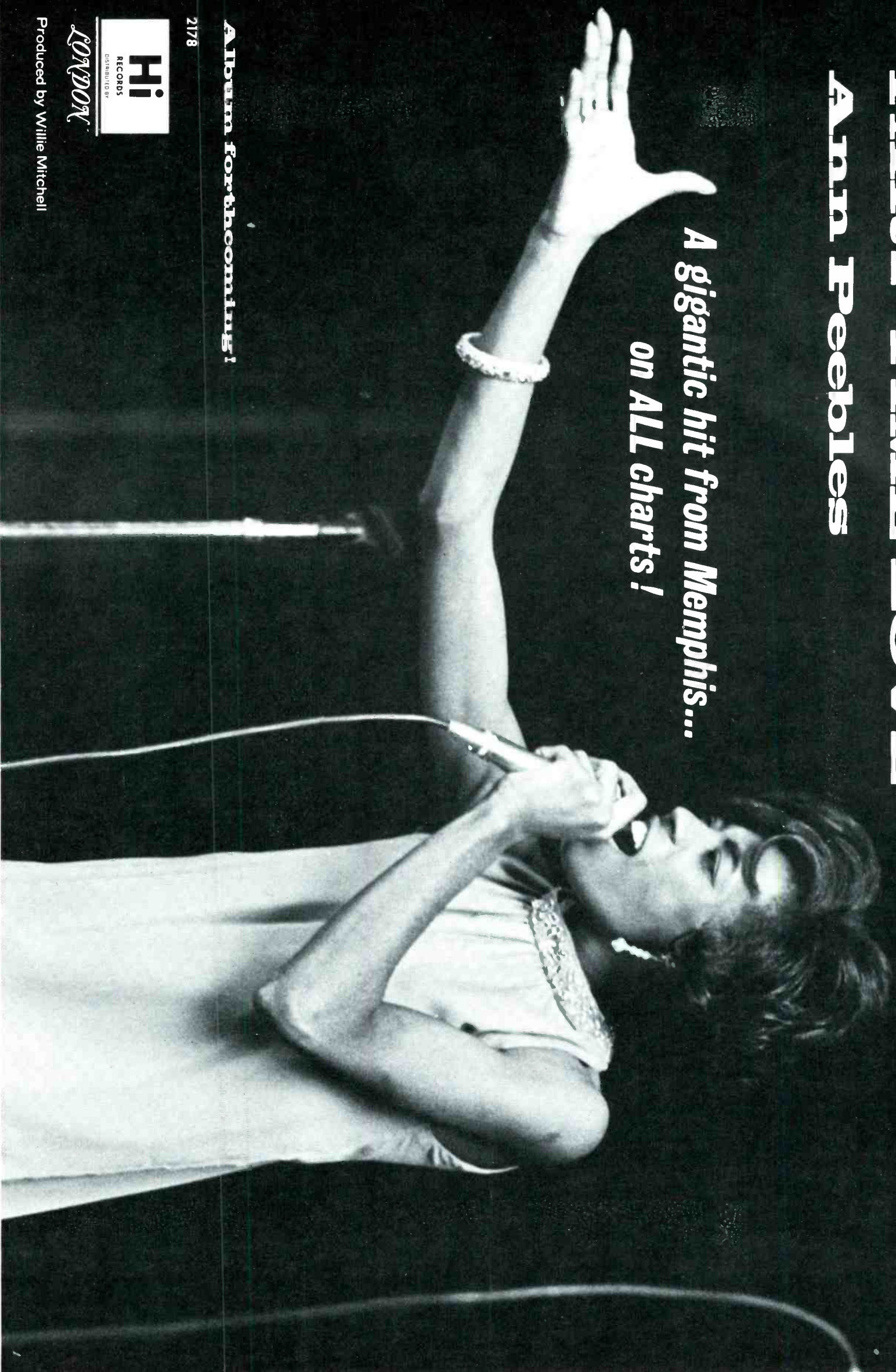

**Album forthcoming!**

2178



*LONDON*

Produced by Willie Mitchell

---

MGM

---

WISHES TO CONGRATULATE

---

**ERIC BURDON  
AND WAR**

---

AND

---

**PRODUCER JERRY GOLDSTEIN**

---

ON THEIR GOLD SINGLE

---

"SPILL THE WINE" #K14118

---

AND THEIR GOLD ALBUM

---

"ERIC BURDON DECLARES WAR" SE-4663

---



## Jay Lowy Named GM For Mediarts Publ.

HOLLYWOOD — Former vp and A&R director at Dot Records, Jay Lowy has become general manager of Mediarts' publishing operations. Appointed last week by Mediarts execs Alan Livingston and Bob York, Lowy will take charge of the company's Mediarts Music (ASCAP) and Mayday Music (BMI) firms. He will be headquartered at the firm's Los Angeles offices.

Chicago-born, Los Angeles raised, Lowy entered the industry in 1954 as a local promotion man with London Records. After two years, he left to form his own promotion firm, retaining the London account. In 1959 he joined the west coast promotional staff with Big Three (Robbins, Feist & Miller). He later moved to New York with the company to serve as general professional manager. During this tenure, he developed a series of campaigns, among them work on the score from "Dr. Zhivago," and the theme from "The Sandpiper," "The Shadow of Your Smile."

He joined Paramount Pictures' music division in 1967 as general professional manager of the publishing wing. There his projects included the "Romeo & Juliet" score before his elevation to the Dot/Paramount A&R staff.

## FRONT COVER:



Just like their namesake, the Carpenters have become known for their quality craftsmanship. The A&M brother-sister team have consistently been in the top ten since the national breakout of their "Close To You," smash, which, incidentally was the major factor in selling their first album, "Offering," even though that cut was not on the LP. The team is certainly multi-talented. Both Karen and Richard Carpenter sing and, in addition, Richard plays keyboards, arranges all the material, and writes the original songs, while Karen plays drums and bass. Now with "We've Only Just Begun," near the apex of the Top 100 and their second album on release, the Carpenters have finished the foundation and are in the process of building their first story of hits.

## INDEX

Album Reviews	34, 36
Basic Album Inventory	32
Coin Machine News	53-68
Country Music Section	40-46
Insight & Sound	33, 36
Looking Ahead (Singles)	18
New Additions To Playlist	26, 28
Radio Active Chart	12
Radio News Report	14
R&B Top 60	37
Single Reviews	24
Talent On Stage	20
Tape News	22
Top Hits Of The Year	37
Top 100 Albums	31
Vital Statistics	38, 39

# Illinois Courts Award Landmark Anti-Piracy Decisions

## Columbia And Capitol Win Cases; Appellate Reverses Lower Case

NEW YORK—A pair of landmark decisions involving tape piracy were delivered by Illinois courts last week, both involving the same defendant, Gary Spies, who operates the Tape-A-Tape Sound Reproduction Co. in Chicago. Decisions stem from suits brought against him and his firm by the CBS and Capitol record corporations seeking to enjoin the piracy of their records and tapes by Spies' firm.

In the Capitol case, the Appellate Court of Illinois reversed a lower court ruling that had denied Capitol an injunction to restrain Tape-A-Tape from pirating its records and tapes. The Columbia case in the Circuit Court of Cook County granted an injunction against Tape-A-Tape from duplicating Columbia's products without authorization.

The Recording Industry Association

of America hailed both decisions as another victory in the fight it had launched with the cooperation of its member companies and other segments of the industry against record and tape piracy and counterfeiting.

In both cases, Tape-A-Tape had relied heavily on two Supreme Court decisions (the "Sears" and "Compeco" cases) in which the court had ruled that copying articles that were not patentable did not constitute unfair competition. Tape-A-Tape had contended that since recordings were not currently included under Federal Copyright Laws, they were subject to copying under those Supreme Court decisions.

### Argument Rejected

The Appellate Court of Illinois, however, rejected this argument stating "... we hold that the Sears and Compeco decisions do not apply to the case at bar. Evidence reveals that Spies was not merely copying unpatented or uncopyrighted arti-

cles, but that he was actually taking and appropriating Capitol's product itself—the actual sounds recorded on the album. Spies was then relieved of the necessity of contracting with various performers so that he might produce a recording; he needed only to wait until a particular rendition produced by Capitol became popular and then was able to take advantage of the existing market. It seems evident that the Supreme Court in Sears and Compeco did not intend to condone this form of unfair competition."

In granting an injunction to CBS against Tape-A-Tape, the Circuit Court of Cook County took a similar position. It also rejected a contention by the defendant that the piracy of CBS products was not unfair competition because all of the pirated tapes bore the legend: "no relationship of any kind exists between Tape-A-Tape and the original recording company, nor between this recording and the original recording artist. This tape is not produced under a license of any kind from the original recording company nor the recording artist(s) and neither the recording company nor artist(s) receives a fee or royalty of any kind from Tape-A-Tape. Permission to produce this tape has not been sought or obtained from any party whatsoever."

With reference to that disclaimer the court said: "his bald admission of what he is doing no more insulates him from the plaintiff's action here than does the proclamation by a thief that he has committed a theft vitiate his criminal act."

The Court also noted "the common law always has and always will protect against intentional and admitted outright theft of another's creation." It called the practice of piracy one that "cries out for censure and prohibition, and the courts of equity historically have dealt with that which does violence to our fundamental principles of fair play."

Though the decisions handed down in Illinois are too new to have shown their influence, additional piracy and counterfeiting suits are currently pending with Columbia as plaintiff in the states of California, Maryland and Virginia. Columbia stated that investigations are also proceeding on a national basis in cooperation with RIAA, NARM, the Harry Fox Agency and the Federal Bureau of Investigation as well as other law enforcement agencies.

## 'Playback' Title of Columbia's Dialog Service with Consumers

NEW YORK — The constant search for new avenues through which the record company can reach the consumer with information about its forthcoming musical and recording ventures has inspired Columbia to offer an inventive new service called "Playback." Although it was originally discussed with distributors and promotion personnel at the company's convention last July at the Kings Inn in Freeport, first notice of the availability of the "Playback" offer was on the inner sleeve of the Santana "Abraxas" LP.

In a nutshell, the "Playback" service offers any consumer (who notices the offer on the inner sleeve of a Columbia or Epic LP) ten "Playback" Sampler records "during the coming year" as well as a "Playback" newsletter with "little known, interesting information" about upcoming product for only \$3.00. The offer also suggests that the consumer will have an open line with the company's A&R staff, through "Playback," to discuss the rapidly changing music scene. (A copy of the form

(Cont'd. on P. 20)

## Video Disc Demonstrated By Teldec For 1st Time In U.S.

NEW YORK — The Video Disc is here. And with it come all of the questions: Will it be the leading configuration in the audio-video field? What are its advantages? Etc.

London Records of America hosted the first demonstration of this audiovisual concept on behalf of A.E.G.-Telefunken and Teldec (Telefunken-British Decca) at a series of showings held in the Pierre Hotel last week. The presentations were emceed by D. H. Toller-Bond, president of London Records, Inc.

The big plus factors of this method of recording audio and video material is low cost. Since the records are stamped on a very thin, almost paper thin plastic (about 1/25th of an inch thick), and do not have to be molded, the company can produce approximately 12,000 disks in one hour on one machine, keeping the cost of the discs extremely low.

Secondly, the low cost of the playback equipment, which is expected to range between \$150 and \$300, and which can hook up to the TV antenna poles of any of today's TV sets, makes it extremely attractive. Although all demonstrations were in black and white the company expects everything to be available in color when it debuts its hardware and records in 1972. The black and white picture reproduction was excellent at the screening this reporter attended.

Other than ease of mass production, other advantages highlighted by the company include: random access of required passages; ease of handling, operation and storage, as well as stop-frame and short sequence repeat facilities.

The Video Disc was first premiered in Berlin on June 24, 1970.

Each of the flexible plastic disks, that float on a cushion of air (no moving turntable) and revolve at a speed of 1,500 rpm, offers twelve minutes of playing time for a 12 inch disk. And it is expected that video-discs the equivalent of an LP will cost approximately the same as one LP. The gentleman operating the turntable of the playback unit, picked

up the turntable while it was in operation and rocked it back and forth without even a flicker of the sound or the picture resulting.

This is one of the primary characteristics of the playback unit. Since a twelve inch disk offers only twelve minutes of music, a changer mechanism, with a very short change time, is almost a necessity. Although everyone of the spectators seemed to think in terms of a stack of records on a changer, it was intimated that the records might conceivably be stored vertically, since the stream of air keeps the record against the stylus.

The prime negative factor about the Teldec system appears to be the inability to do home recording on the system while the SONY system of video-tape plans to offer such facilities. However, the Teldec people seem to feel the low cost of the disk makes their configuration more attractive. Even though it was suggested that both configurations might very well

(Cont'd. on P. 20)

## Ornato RCA Manager For Southern Europe

NEW YORK — Guiseppe Ornato has been named manager of the southern European region, by RCA Records.

The announcement was made by Rocco Laginestra, president of RCA Records, who called the appointment a step in his general restructuring of RCA Records throughout the world. Laginestra said that Ornato would continue as president of RCA Italy and additionally has been named chairman of the board of RCA Spain and RCA France.

Ornato joined RCA Italy in 1956 as manager, in 1960 was named general manager, and in 1964, president.

The firm entered music publishing nine years ago, and now is one of the major publishers in Italy. It also was the first firm in Europe to begin production of Stereo 8 cartridge tapes, for which it now has the largest manufacturing facility in Europe.

## Sight & Sound Are Prime Aspects For TRO-Carlton Firm

NEW YORK—Organic Productions, Inc., a company teaming the music publishing firm of TRO/The Richmond Organization with veteran record producer and administrator Joseph Carlton has been formed. The new company will focus its attentions on the independent production of records and videocassette films.

According to Carlton, who will serve as the company's vice-president and general manager, "The emphasis of Organic can be identified by the name of our new operation. The advent of sight-and-sound technology and the sweeping changes coming for the entire record industry in the years ahead, make the demand for enlightened creativity almost unlimited. We will be concerned with music and artists that hold validity for contemporary life.

"What we are seeking are the talented young people who actually live and feel their new sounds and musical statements. We can and will provide much international power and expertise, but the basic approach whether as songwriter or artist must be authentic and natural, in a very real sense—organic."

Carlton's experience with CBS special products in the creative production of filmstrips, 16mm motion pictures and slides for the retail, educational and premium trade was considered an important factor in helping the new company move into the visual cartridge and cassette markets.

Muhammad Ali - Jerry Quarry

Curtis Mayfield

**Fight on!**

There's a reason Curtis was asked to sing the national anthem at the Muhammad Ali vs. Jerry Quarry fight.

There's a reason Curtis was asked to write and sing the Miss Black America theme song. Curtis is America--talking about his thoughts, his love, his frustrations; talking about life. People are listening to Curtis.

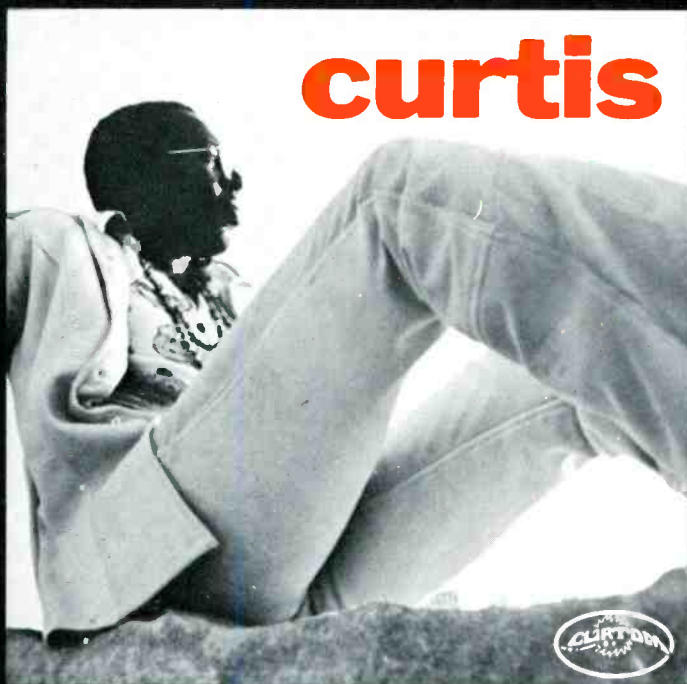

Just released as a single from the new Curtis album:  
"(Don't Worry) If There Is a Hell Below, We're All Gonna Go."

CR-1955



DISTRIBUTED BY BUDDAH  RECORDS



## London Adds Drive To Stones & '1812' Album Promotions

NEW YORK — London Records is currently in the midst of a sizeable publicity campaign geared to heavily advertise two of its newest LP releases, "Get Yer Ya Ya's Out," by the Rolling Stones, and the recently issued "1812 Overture" by Tchaikovsky.

London has printed 25,000 deluxe full color posters of the Stones which will be distributed to retail disk outlets across the country. Additionally, AM and FM stations will carry ads promoting the album. "Get Yer Ya Ya's Out" is currently in the top 10 on all the record charts, and is soon expected to receive certification from the RIAA as a million seller.

Tchaikovsky's "1812 Overture" performed by Zubin Mehta and the Los Angeles Philharmonic is also being bolstered by an all out promo and merchandising campaign. Full advertising coverage is planned in many underground papers as well as ads in High Fidelity Magazine. Special browser back-up cards are also being distributed to retailers.

## Clapton Produces

LONDON — Eric Clapton flew to Atlantic Records studios in Miami earlier this month to produce his first album for Buddy Guy and Junior Wells. The arrangements were made when Clapton jammed with Buddy Guy, Junior Wells and the Rolling Stones at the Stones' Paris concert.

Commenting on the Guy-Wells LP Clapton said "I am very excited about the whole idea. It's something I've wanted to do for some time, and it couldn't have been with better people. I won't be playing on the sessions, with a guitarist like Buddy, what could I add?"

Clapton is currently touring the United States with his new band, Derek and the Dominos. Atlantic is readying their debut album "Layla," for release Oct. 28.

## Goody Opens Ninth Store

NEW YORK — Sam Goody, Inc. announced the opening of its Ninth Retail Store in the King's Plaza Shopping Center in Brooklyn, New York. King's Plaza is the largest and most modern shopping center in Brooklyn and the first mall-type center in New York City. It is expected to draw its customers from a large surrounding area which includes parts of Queens and Nassau counties. The new Goody Store carries a full line of records, tapes, audio equipment and accessories and is organized, stocked and staffed to give maximum service to the area.

In announcing the opening, Mr. Sam Goody, president, noted that the company's tenth unit would be located in a large shopping center under construction in Woodbridge, New Jersey, which is scheduled for completion sometime in February, 1971.

In addition to its operation of a chain of nine retail audio and record stores, Sam Goody, Inc., through subsidiaries, is also reaching college campuses and the wholesale market.

For the twelve months ended June 30, 1970, the company reported sales of \$19,176,651 and earnings of \$636,073, or \$.95 per share.

Sam Goody, Inc. common stock is traded in the over-the-counter market.

## Wallichs At Toshiba Meet

HOLLYWOOD—Glenn E. Wallichs, chairman of the board and chief executive officer of Capitol Industries, left last week (Oct. 22) to attend a Board meeting of Toshiba Musical Industries, Ltd. The meeting is scheduled for Friday, Oct. 30, in Tokyo.

Wallichs will make a further stop in Hong Kong before returning to the Capitol Tower in Hollywood on Nov. 16.

## Sunbury/Dunbar Looks To Doubled Performances In '71 Says Teifer

NEW YORK — "Solid progress in its third full year of operation" was the description delivered last week by Gerald Teifer, president of the Sunbury and Dunbar Music firms.

Citing solid hits, growth of catalog and emergence of many new and important song writers, Teifer said the RCA Records' publishing subsidiary had enjoyed the best year of operations since its establishment in 1967. The present sharply improved competitive position within the industry would, he predicted, more than double 1970's performance in 1971.

"Although Sunbury/Dunbar is one of the last publishing operations formed by a major recording company, its track record over the last year indicates it has become a positive force," he said.

Alluding to the successful philosophy behind Sunbury/Dunbar, Teifer said "choosing to build rather than to buy, we have built a catalog which includes such outstanding songs as "Who Will Andwer?" "Yesterday I Heard the Rain," "L. David Sloane," "These Eyes," "Tonight I'll Say a Prayer," "Laughing," "American Woman," "No Sugar Tonight," "One," "Hand Me Down World," "Free," "Undun," "Rainmaker," "I Guess the Lord Must Be in New York City," "10 Little Indians," "Polly High," "Maybe," "Together," "Changing, Changing," "Think About Your Troubles," "Daddy's Song" and "Wailing of the Willow."

## Brother-EMI Complete Foreign Deal

HOLLYWOOD — Brother Records has concluded a deal for foreign distribution of Brother product through the EMI Group. The arrangement takes effect immediately.

Under terms of the deal, negotiated by Brother Records business manager Nicholas Grillo and EMI group director for records Len Wood, EMI will act as distributor for Brother product in all countries except the United States and Canada. This includes product by The Beach Boys, which is distributed in North America by Warner-Reprise. The Beach Boys, are currently riding the crest of enormous sales in the United Kingdom and on the continent, with their single, "Cottonfields," and an album, "Beach Boys Greatest Hits." Also part of the deal, upon agreement between EMI and Brother, will be product by The Flame whose "See the Light" is distributed in the U. S. and Canada by Starday-King.

The first Brother release to be distributed by EMI will be "Sunflower," the latest album by The Beach Boys.

The EMI version of "Sunflower" will include one cut not found on the

## Columbia Recording Rothschilds LP

NEW YORK—"The Rothschilds" original cast album has been recorded by Columbia Records on Sunday (25). The musical, with a score by Jerry Bock and Sheldon Harnick, opened at the Lunt-Fontanne Theatre on last Monday (19).

## Aretha's Gold Is Ahmet's

NEW YORK — Aretha Franklin earned her ninth gold single last week when the RIAA certified "Don't Play That Song" as a million seller. She has also been awarded three gold records for best-selling albums.

Aretha's award also means a gold award for Atlantic prexy Ahmet Ertegun, the writer of "Don't Play That Song." Ertegun penned the tune back in 1962 for Ben E. King who made it a smash hit. Ertegun produced the Ben E. King version. Atlantic execs Jerry Wexler, Tom Dowd and Arif Mardin produced Aretha's version.

"Our success has come as a result of a number of people and situations. Naturally, we're grateful to the artists, record companies and producers who have aided us, but our major tribute must still go to writers such as Randy Bachman, Burt Cummings, Harry Nilsson, Sammy Cahn, Sheila Davis, Gene Lees, Curt Winter, Sid Wayne, L. E. Aute Armando Manzanero, Tony Rennis, Modungo, Billy Charne, Doyle Marsh and Bob Allen."

Teifer said the firms had just signed Randy Bachman exclusively. Bachman is responsible for such smash hits as "These Eyes," "Laughing," "Undun," "No Time," "American Woman" and "No Sugar Tonight." Other writers just signed include Jeff Morrow, David Martin and Chris Arnold pacted by English Sunbury Ltd., and Simon Caine and the Mongrels signed as writer-artist-group in Canada.

### TV/Broadway Activity

In other areas of activity, Teifer said the firm was involved with an up-coming 90-minute ABC-TV cartoon special titled "The Point," which will have narration by Dustin Hoffman and songs by Harry Nilsson. He also said Sunbury/Dunbar had published scores and songs from a number of Broadway and off-Broadway shows during the year, and that the production arm, Sunbar Productions has been quite active.

North American pressings, the single "Cottonfields."

### European BB Tour

The Beach Boys have been firming up plans for a tour of England and Europe in connection with their "Sunflower" album. The record will be released by EMI in early November.

## Miller Signs RCA Indie Prod. Deal

NEW YORK — Rocco Laginestra, president of RCA Records announced that an independent production agreement has been reached to allow producer Jimmy Miller to bring new talent to the label and to independently produce artists currently on the RCA Records' roster.

Miller has racked up rock hits with such groups as the Rolling Stones, Blind Faith, Bonnie & Delaney, Traffic, Spooky Tooth and Led Zepelin.



Laginestra, Miller

## Kinney Talking Acquisition With Simon & Schuster

NEW YORK — Steven Ross, president of Kinney National Service, Inc., and Leon Shimkin, president of Simon & Schuster, Inc., disclosed last week that their companies are now engaged in negotiations toward the possible acquisition by Kinney of Simon & Schuster, Inc.

## Capitol Shows Loss For 1st Fiscal Qtr.

HOLLYWOOD — The annual meeting of Capitol Industries, Inc., was told by president Stan Gortikov that the companies showed a net loss of \$809,000 for the first fiscal quarter (ended Sept. 30). This contrasts to the firm's \$1.3 million profit a year ago.

Attributing the decline primarily to the declining economy which has resulted in a general slackening of record purchases, Gortikov also pointed out that the tight money is causing retailers to cut back on new product orders and to accelerate exchanges and returns.

The turnaround from last year's prosperity was accented, Gortikov noted, because the label had no success that could match the four-million sales of "Abbey Road" from the Beatles. Since the news of the foursome's disbanding, no product had been issued by them, and Capitol, he said, "will not have Beatle product in the foreseeable future."

Gortikov noted that Capitol is already moving toward a return to profitability for the total fiscal year, however, his prediction included the note that the gains would be unlikely to surpass the level of fiscal '69-'70.

Other business conducted at the shareholders' meeting included approval of an increase in the number of authorized common shares to 6.5 million. The current share figure is 5.5 million.

## BMI Seeks Damages From SW Concerts

NEW YORK—Broadcast Music, Inc. and several of its affiliated publishers have instituted action against Arthur Squires' Southwest Concerts, Inc., alleging their copyrighted songs were performed during the Tom Jones Concert at the Convention Center Arena, San Antonio, Texas last July without authorization and in violation of the U. S. Copyright Act. Squires presents live musical attractions in public facilities through Southwest Concerts, Inc.

Songs involved in the suit are "Proud Mary" (Jondora Music); "Cabaret" (Sunbeam Music); "Can't Take My Eyes Off Of You" (Saturday Music and Season's Four Music); "More" (Edward B. Marks Music); "Spanish Harlem" (Progressive Music and Trio Music) and "Green, Green Grass Of Home" (Tree Publishing).

In the complaint, the plaintiffs seek statutory damages together with attorneys' fees and court costs. The suit was filed in the United States District Court for the Southern District of Texas last week (21).

## Merrick PR Company Relocates To L.A.

NEW YORK — The Mike Merrick Company will relocate its personal headquarters from New York to Los Angeles commencing October 26. This move is part of a general expansion program of the west coast offices of the public relations company, founded by Merrick in 1958 in New York City.

Marilyn Reiss, vice president of west coast operations since 1966, will continue in that capacity, supervising all facets of the daily publicity operation with Merrick concentrating on client relations, new business and the growth of the company. The New York offices will continue to function under the direction of Nancy Love.

## ASCAP Membership Meeting Set This Week

NEW YORK—The semi-annual East Coast membership meeting of the American Society of Composers, Authors and Publishers will be held this Wednesday, (28) at 2:30 PM in the Empire Room of the Waldorf Astoria Hotel in New York.

Reports will then be given by the president Stanley Adams and other officials of the Society.

## Farrell Forms Euphoria

NEW YORK — Wes Farrell, president of the Wes Farrell Organization, has announced the formation of Euphoria Productions, Inc. to encompass the development and production of properties for motion pictures, television and the theatre.

"Conspiracy", the contemporary, off-Broadway musical which Farrell currently has in preparation for a November opening, will now become a part of the activity of Euphoria Productions.

## Tomorrow/Today Bows; 'Everything' Agency Formed By Candy Leigh

NEW YORK — Tomorrow/Today—The Everything Agency has been formed with offices in New York and Los Angeles. According to Candy Leigh, the founder, "Everything" will include "a new concept in industry-wide public relations under the auspices of a to-be-announced advisory board; a new concept in creative services and a new concept in special services geared to specific needs of the industry."

One such special service offered by the agency is personalized corporate Christmas shopping. Miss Leigh has acquired a staff of gift counselors who will see the gift-giving through to its last detail.

Miss Leigh has been in the entertainment field for nine years, most recently as director of artists relations for Gerard W. Purcell Associates and his GWP Records. Before that, she was director of eastern activities for Tertragrammation Records and v.p. of their subsidiary, the Sutton Public Relations Co.

Today/Tomorrow will headquarter in New York at 150 E. 52nd, phone number 753-7962 and will have an office in Los Angeles at 6269 Selma Ave., phone HO-6-4439.

## Chrysalis Clamps \$5.50 Top On Jethro Tull U. S. Rock Concerts

NEW YORK — To counteract the tendency of musical groups to escalate ticket prices and to aid concert promoters in holding down costs, Chrysalis Management last week announced that a top price of \$5.50, wherever possible, has been set for all forthcoming engagements for Jethro Tull.

Terry Ellis, head of the British-based management company, said that Jethro Tull's current month-long U. S. tour will hold the \$5.50 price

line, except in three situations where previous contracts were drawn with a \$6.00 top.

Ellis said that advance reservations were outstanding even before the price line was established.

### Tight Economy Demands

"Rock groups have been pricing themselves out of the market," Ellis said. "Today's tight economy demands that we think and act accordingly. Someone has to do something or we will drain the market dry."

"I hope our action with Tull will be followed by other groups and their management representatives. We hope that this move will enable those fans who want to see their favorite groups perform to do so at realistic prices."

The Reprise act has, on this tour, played the Forum in Los Angeles; Swing Auditorium, San Bernardino; Oregon State Univ., Arena, Seattle. Future dates include East Town Theatre, Detroit (28); Civic Arena, Pittsburgh (30); War Memorial, Syracuse (31); Richmond Mosque, Virginia (Nov. 1); Paramount Theatre, Wilkes-Barre, Pa. (3); Carnegie Hall, N. Y. (4); St. Anselms College, N. H. (6); Michigan State University (7); Opera House, St. Louis (8); Ohio Theatre, Columbus (9); Kleinhus Auditorium, Buffalo, (11); Union College, Schenectady, (13); War Memorial, Rochester (14); and Plattsburgh, N. Y. (15).

## Goldstein To Head Morris Operations

NEW YORK — Sidney Goldstein has been named director of international operations of the Edwin H. Morris Music Publishing Company, according to "Buddy" Morris, president.

Goldstein has been active in the music business for 12 years before joining the Edwin H. Morris Company in 1950. He has acquired many copyrights that have developed into major standards and was instrumental in building the foreign catalogues of Edwin H. Morris.

The publishing company remains the industry's largest independent music operation and Morris indicated other executive announcements will be named to handle the widening scope of the firm's activities.

## Gomprecht's Daughter Dies

NEW YORK — The industry was shocked at the tragic passing of the 16-year-old daughter of Irv Gomprecht, head of the J. M. Zamoiski Company in Baltimore. She died as a result of hepatitis.

## Government Decision Spurs Orders On Seale LP

NASHVILLE — Certron's first spoken record, "Gagged and Chained", a re-creation of Bobby Seale's contempt of court citation, was given added impetus last week when a government request was revealed asking that Judge Julius Hoffman drop conspiracy charges against Seale. Seven other defendants were found innocent of conspiracy charges by the same jury earlier this year.

With the news of Judge Hoffman's decision, orders started pouring into the sales office here for the Seale double-LP. David Ward, publicity director of Certron, said that "we have had to go into our second pressing since our initial pressing of 50,000 is nearly exhausted".

## Lenz Merchandising Post For Chappell's Publications Div.

NEW YORK — With the expansion and growth of Chappell & Co.'s publication and sales departments, Jacques Chabrier, President, has announced the appointment of Harold Lenz as merchandising director of the publishing company.

Position was created in response to increased volume of sales in 1970 due to Chappell's greater activity in the field of contemporary music, and its increasingly heavy schedule of publications in the educational area.

Lenz will work closely with both the sales and publications departments, coordinating activities of both, in addition to developing new sales methods in the areas of packaging, design and merchandising. He will work with printed product in all fields, creating new sales areas including heavy concentration on tie-in promotions. He will report directly to Norman Weiser, vice-president and general manager.

Lenz will begin work immediately on Richard Rodgers' new musical "Two By Two", opening on Broadway, Nov. 10. He will also be working with other publications currently in release including Rod Stewart's "Gasoline Alley" folio, the score from the film "Joe", the current Ronnie Dyson hit "Why Can't I Touch You", Chappell's exciting new Thunderrock Marching Band Series and the new Kenny Rogers hit "Heed The Call", as well as a wealth of contemporary music from the vast Chappell catalogue. He will also be involved with Chappell's background music library, Sonaura, and its rental library.

## Bourdain Now Dir. Of Col's Masterwork LP's

NEW YORK — Pierre Bourdain has been promoted to the position of director of merchandising, Masterwork Albums, Original Cast and Soundtrack Catalog, Columbia Records. In announcing the appointment, Bruce Lundvall, veep of the label's merchandising and advertising department.

In his new capacity, Bourdain will be responsible to Lundvall for directing the creation of merchandising programs and materials for the Masterwork and Odyssey catalogs, and Columbia Original Cast and Soundtrack recordings, including monitoring the development of packaging. In addition, he will provide Masterworks and Columbia A&R staff with marketing guidance in their production of classical product.

Bourdain joined Columbia in 1967 as associate manager of Classical Albums Merchandising.

"Be My Baby"

Produced by  
Jeff Barry

Andy Kim

1 Week after release  
and already on...

ST-729

**STEED**

WLS	Chicago
WDRC	Hartford
WKNR	Detroit
KIMN	Denver
WOKY	Milwaukee
WMAK	Nashville
CKLW	Detroit
KOL	Seattle
KJR	Seattle
WRIT	Milwaukee
WCFL	Chicago

Distributed Nationally by Paramount Records



**SENSATIONAL**—Exclusive Notable Music writers Wally Harper and Paul Zakrzewski soon to be represented with their off-Broadway musical "Sensations," have just become new members of ASCAP. Shown (l. to r.) are David Combe, head of membership at ASCAP, Eric Colodne, g.m. of Notable, Harper and Zakrzewski.

# NEW PRODUCT MADE FOR PILES

*James Gang  
Rides Again  
ABC 8-711*

**James  
gang  
rides  
again**

*Pharoah Sanders  
Summun Bukmun  
Umyun  
AS-9199*

*B.B. King  
Indianola  
Mississippi  
Seeds  
ABC 8-713*

*The best of  
John Coltrane  
His Greatest Years  
AS 9200-2*

*Beverly Sills sings  
Mozart & Strauss  
ABC-AT&S-2004*

**Beverly Sills  
Mozart  
Strauss**

ALDO CECI

ALDO CECI

**Blues Magoos - Gulf Coast Bound**

**B.B. King**

**the best of John Coltrane**

**his greatest years**

**Tommy Roe  
& Can Make Music**

**ABC 8-714**

**ABC/DUNHILL RECORDS**



# Buddah Distributes Skye

NEW YORK — The Buddah/Kama Sutra group of labels has entered into a domestic distribution agreement with the Skye Recording Co., Ltd., whereby Buddah will distribute all Skye LP and single product in the United States, subject to existing contracts with Philips, GRT and Ampex for tape and foreign distribution. The Skye distributed product will appear on the Buddah label. The announcement was made by Art Kass and Neil Bogart, co-presidents of the Buddah/Kama Sutra Group, and Norman Schwartz, president of Skye Records.

The Skye catalog contains albums by Gary McFarland, Bob Freedman, Cal Tjader, Armando Peraza, Gabor Szabo, Wendy & Bonnie Flower, Grady Tate, Ruth Brown and Lena

## Cooper Opens Umbrella

LOS ANGELES — Bill Cooper of Artist Management and Development Co. has formed Umbrella Record Production Co. First artists on the label will be the Seeds, also on the label will be The Insects. Cooper is also negotiating with European movie star Andrej Garn, who is now in Hollywood.

Horne. The label won a Grammy Award in 1969 for cover design and is seeing considerable success with their latest package, "Lena/Gabor", a collaboration between Szabo and Lena Horne.

In making the announcement, Bogart said the Skye label "was originally formed as a venture to overcome what the Skye people felt were the limitations imposed on creative artists by record labels. Buddah's policy, exemplified by our many successful distributing agreements, has always been to let the artist do his own thing creatively, while we do our thing in promotion, sales and marketing. That is the basic understanding between Buddah and Skye, and we're glad to welcome them as the newest member of the Buddah family.

First Buddah/Skye product is scheduled for release in early November.

## Edwards Hand, Cut By Martin, Is Act On RCA

HOLLYWOOD — Edwards Hand, the first group which George Martin has produced since the Beatles, will be given a major exploitation campaign by RCA, which is working with the group's managers, International Management Combine (IMC) on introducing the act in America.

The band, which has had its first album cut in London, will be in the U. S. in mid-Nov., according to Lenny Poncher, co-owner of IMC. Martin and the two leaders of the band, Rod Edwards and Roger Hand, worked on the LP five months. Martin and the two leaders arranged the songs together.

Their first RCA LP is called "Stranded" and features original songs by Edwards and Hand who have been playing together in England for six years. Martin's musical and electronic understanding are evident in his production work.

One side of the LP is titled "Death of a Man" and the other side is called "America." Edwards and Hand use the concept LP to express their opinions on the world and society around them. They use six men on the record date.

Edwards and Hand are the first British act which IMC has had complete management control over. IMC is presently determining which booking agency it will sign the band with. The intention is to get major rock concert dates rather than a string of one nighters in nightclubs.

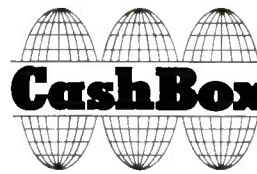

## CashBox Radio Active

A survey of key radio stations in all important markets throughout the country to determine by percentage of those reporting which releases are being added to station play lists this week for the first time and also the degree of concentration combining previous reports. Percentage figures on left indicate how many of the stations, reporting this week have added the following titles to their play list for the first time. Percentage figures on right include total from left plus the percentage title received in prior week or weeks.

	TITLE	ARTIST	LABEL	% OF STATIONS ADDING TITLES TO PROG. SCHED. THIS WEEK	TOTAL % OF STATIONS TO HAVE ADDED TITLES TO PROG. SCHED. TO DATE
1.	Be My Baby	Andy Kim	Steed	70%	82%
2.	Stoned Love	Supremes	Motown	37%	57%
3.	He Ain't Heavy, He's My Brother	Neil Diamond	Uni	30%	30%
4.	Patch It Up	Elvis Presley	RCA	27%	39%
5.	Sweet Sweetheart	Bobby Vee	Liberty	27%	27%
6.	You Don't Have To Say You Love Me	Elvis Presley	RCA	26%	97%
7.	Who Needs You	Steppenwolf	Dunhill	26%	26%
8.	I Don't Wanna Cry	Ronnie Dyson	Columbia	26%	26%
9.	One Less Bell To Answer	Fifth Dimension	Bell	23%	46%
10.	I'm Not My Brother's Keeper	Flaming Embers	Hot Wax	22%	52%
11.	So Close	Jake Holmes	Polydor	21%	86%
12.	I Just Don't Know	Gary Puckett & Union Gap	Columbia	20%	79%
13.	Chains & Things	B. B. King	ABC	19%	19%
14.	Me About You	Turtles	White Whale	16%	26%
15.	Does Anybody Really Know What Time It Is	Chicago	Columbia	15%	24%
16.	No Matter What	Badfinger	Apple	14%	93%
17.	King Of Rock & Roll	Crow	Amaret	14%	32%
18.	Call Me Super Bad	James Brown	King	12%	83%
19.	Only Love Can Break Your Heart	Neil Young	Reprise	11%	21%
20.	Domino	Van Morrison	Warner Brothers	11%	11%
21.	Carolina In My Mind	Crystal Mansion	Colossus	10%	61%
22.	Cherry Cherry	Jonathan King	London	10%	10%
23.	You Can Get It	Desmond Decker	Uni	10%	10%
24.	Little Wheel Spin Spin	Chakra	Mediarts	10%	10%
25.	It's All In My Mind	Clarence Carter	Atlantic	10%	10%
26.	Maggie	Redbone	Columbia	9%	9%
27.	Steel River	Ten Pound Note	Evolution	9%	9%
28.	Sunset Strip	Ray Stevens	Barnaby	8%	25%
29.	Where Did All The Good Times Go	Classics IV	Liberty	8%	25%
30.	After Midnight	Eric Clapton	Atco	7%	95%

Where  
The Music  
and  
Entertainment  
People  
Meet  
To See  
and  
Be Seen

**Spindletop**

IDEAL FACILITIES FOR ARTIST'S  
PROMO PARTIES

CALL YOUR HOST  
**VAN RAPOPORT**  
254 W. 47 ST. CI 5-7326

**ERIC SAYS:**



**WAR  
IS  
BIG  
BUSINESS**

# SOUND TRACK OF THE YEAR!

AN AVCO EMBASSY FILM

## Sunflower

ORIGINAL MOTION PICTURE SOUND TRACK  
MUSIC COMPOSED AND CONDUCTED BY

# Henry Mancini

SOPHIA LOREN & MARCELLO MASTROIANNI AND A MAGNIFICENT SCORE BY HENRY MANCINI



AVAILABLE ON  
AMPEX STEREO TAPES  
8 TRACK • CASSETTE •  
OPEN REEL

  
AVCO EMBASSY  
STEREO AVE-0-11001

SUNFLOWER WILL BE BACKED BY AN EXTENSIVE MERCHANDISING CAMPAIGN\*

\*SUNFLOWER WINDOW DISPLAY CONTEST

**WIN AN ALL EXPENSE PAID TWO WEEK TRIP TO ITALY FOR TWO**

**WIN AN AMPEX STEREO MUSIC CENTER CONSOLE VALUED AT OVER \$600. RETAIL.**

CONTACT YOUR AVCO EMBASSY RECORD DISTRIBUTOR FOR DETAILS.

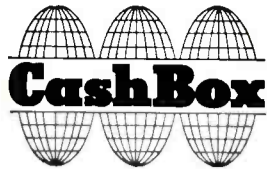

## Tuning In On...

# The Gavin Meet Radio, Where's It Going?

With approximately one month to go, the Fifth Annual Radio Program Conference is already shaping up as a must event of the broadcasting and recording industry. The conference, often referred to as the Gavin Convention, is scheduled for Nov. 20-22 at the Century Plaza Hotel in Los Angeles.

This week it was announced that one of broadcasting's most controversial figures, Federal Communications Commissioner Nicholas Johnson, would open the conference with an address on "The Social Impact And Opportunity Of Radio." Johnson's will be the only formal presentation during the three-day non-profit event, and will be followed by a question and answer period.

It seems likely that many broadcasting executives who have expressed disagreement with Johnson in the past will be on hand to confront him directly. Johnson, no stranger to direct criticism (he was recently blasted by Vice President Spiro Agnew for "permissiveness"), is expected to reply in kind.

All other sessions will utilize an "encounter" format calling for full audience participation on topics related to the inter-relation of radio and recorded music, in keeping with the theme of the conference, "Radio, Where Do We Go From Here?"

One of the more interesting "encounter" sessions should be the one devoted to FM progressive radio, which will be moderated by Willis Duff, v.p. and general mgr. of KSAN-San Francisco.

"Resource" people assembled by Duff and confirmed to date include Tom Donahue, now with Warner Brothers Films, who is considered the father of underground radio because of his pioneering efforts at KMPX-San Francisco.

Also set: Allen Shaw, vice president for ABC-FM stations, New York; John Detz, manager, WABX-FM, Detroit; Matt Ash, manager, KMET, Los Angeles; and Augie Blume, independent record promotion man specializing in FM product. Blume was honored at last year's Conference as Record Promotion Man of the Year.

Session moderators announced by Gavin include Dave Klem national promotion director, Blair Radio; Willis Duff; Ken Dowe, national director of operations, The McLendon Stations; Al Bell, executive vice president, Stax/Volt Records; and Joe Smith, executive vice president, Warner Bros. Records.

Also, Bill Summers, vice president and general manager, WLOU-Louisville; Mark Blinoff, assistant program director, KMPC-Los Angeles; Ralph Emery, WSM-Nashville.



**FAMILY SHOW** — David Cassidy of Bell's Partridge Family guested on the Larry Kane Show on KTRK-Houston and was interviewed by Kane. The artist also performed his current chart single, "I Think I Love You." After twelve years in Houston, the Kane Show goes into syndication in January through Bing Crosby Productions.

## STATION BREAKS:

Jack Lescoulie inked a new long-term contract with Avco Broadcasting... WMIL-Milwaukee will become an affiliate of ABC News Network on Jan. 1. Station is currently with Mutual Radio Network... Dick Henby has joined WWDC-Washington, D. C. to do production work and host a weekend show; he was formerly with WQMR-Silver Spring, Md.

Latest addition to KHJ-AM, Hollywood air staff is Jerry Butler, lately of WRKO-Boston. He'll hold down the nine to midnight slot... Jack Sellmeyer has been named chief engineer of WGAR and WNCR-FM, Cleveland... Jock Bob Foster has joined KFRC-San Francisco from KIMN-Denver. He'll take charge of the nine to midnight slot, while, at same station, Mike Phillips moves into the 3-6 p.m. period.

Martin Perlich joins the staff of WNCR-FM, Cleveland and will host nightly show from 9 p.m. to 1 a.m. . . . Congrats to KPIX-TV, San Francisco, which copped seven of twelve awards given by San Francisco Press Club... KDKA-Pittsburgh celebrating 50th birthday, by airing 50 of most memorable broadcasts of all time.



**KNOCK ON WOOD** — Dropping by the studios of WOR-FM, New York this week were A&M's The Carpenters, Karen and Richard. On hand to welcome the duo were Gail Sicilia, the station's music director and Sebastian Stone, WOR program director.

## FORE Urges NATRA 'Keep It Together'

**HOLLYWOOD** — The Fraternity Of Recording Executives (FORE) has made public a letter from its interim chairman Aki Aleong to Lucky Cordell, executive secretary of NATRA, the National Association Of Television and Radio Announcers. In it the FORE executive "reiterates the impregnable bonds" between the organizations and pledges support for NATRA, while calling attention to the fact that "we at FORE are concerned primarily with the record industry, whereas NATRA's primary priority is in broadcasting."

During the recent NATRA convention, held in Houston, there were repeated rumors of major disagreements between officers of the two organizations. During that meet, Aleong took office, succeeding Warren Lanier, who stepped down abruptly from the position of FORE president.

In the letter, Aleong stresses the need to "keep it together before it's too late" and enumerates the various ways in which FORE plans to be of service to its members.

## Yurdin Joins ABC-FM As Production Dir.

**NEW YORK** — Larry Yurdin, who conceived and executed the Alternative Media Conference at Goddard College earlier this year, has joined the staff of ABC-FM. He will be responsible for all production involving the ABC-FM Owned Group (seven stations: New York, Los Angeles, Chicago, San Francisco, Houston, Detroit, Pittsburgh). His area of activity will involve public service announcements, commercials, promo's, presentation tapes, and other special programming projects.

Additionally, special presentations will salute the fiftieth anniversary of commercial radio. Gavin's annual "Men of the Year" Awards, voted by radio and record executives, will be revealed during a banquet program on Friday evening, Nov. 20.

A 40-member advisory committee has developed this year's Conference.

## ERIC SAYS:



# WAR IS BIG BUSINESS



**EVERYTHING IS STILL BEAUTIFUL** for Barnaby recording artist Ray Stevens who recently appeared at San Francisco's Fairmont Hotel. During his engagement there, Stevens was visited by a delegation from KLIF. Left to right, Michael O'Shea, KLIF program director and his wife; Stevens; Ken Dowe, station's operations mgr., and Mrs. Dowe; Norm Ziegler, regional director of Columbia Records; Don Williams, Barnaby Records.



A Hit Single

# Lee Dorsey

Lee Dorsey has a new sound. Call it pure swamp funk and call his new single, YES WE CAN—PART ONE, another smash in the Lee Dorsey tradition. Lee has been happening since 1958 when he showed up on American Bandstand and knocked everyone out. Since then his hits have included DO RE MI, RIDE YOUR PONY, WORKING IN A COALMINE and the underground hit, GET OUT OF MY LIFE WOMAN. Lee's new swampy single was penned by his friend and personal songwriter Allen Toussaint and says that all the peace in the world is inside, you just have to find it. The single has been out less than a week and it's already happening. Big. Just like all those other Lee Dorsey singles.

**We've only just begun.**

## YES WE CAN PART ONE

(PD 2-14038)

From his forthcoming album:



YES WE CAN (24-4042)



Polydor Records, Cassettes and 8-Track Cartridges are distributed in the USA by Polydor Inc; in Canada by Polydor Canada Ltd.

# cash box/talent on stage

## Raphael

ROYAL BOX, AMERICANA, NEW YORK — International recording star Raphael is a dynamic entertainer with a thoroughly beautiful, marvelously-controlled, velvet voice. He has fantastic range from the forceful deep tones to high falsettos, and he uses them in almost every song. He has long hair, is very much a "today" performer with exciting hand-motions in the Tom Jones style, wears very hip clothing (he wore a perforated shirt and a jump suit all in black opening night) and sings in Spanish and English with a beat.

The opening night audience was loaded with Spanish speaking people who came to see and hear their idol. They ran up to take photos, presented him with a painting of himself, threw rose petals and flowers at him, and screamed at every sexy motion or stare he offered.

He tore onto the stage with a galloping "Hallelujah" number (also his closer) sang "Goin' Outta My Head" in English and Spanish, belted "Something" and "I Believe" in English, "Ghost Riders" in Spanish, a medley of his hits in Spanish, "La Bamba," "Hava Nagilah" and a dramatic "Pagliacci" number that seemed to tear his throat apart. Raphael gives his all. How he can do two a day with such force and volume is beyond belief.

Nothing seemed to satisfy the audience more than when he sang "Carnival" (or "The Day In The Life Of A Fool") in Spanish and Portuguese. This is where he excelled, and everyone loved it. Because it was the only number that was not delivered with an over-dramatized technique.

Because so much of the program (we think too much) was in English, the Spanish speaking people were

constantly screaming "Sing in Spanish." "En Espagnol" was a repeated cry. And because so much of what he sings in English is done phonetically, Americans, judging from the reactions around the table, sensed that he didn't understand the meaning of many of the lyrics he was chanting. When you hear the "Wonder Of You" pronounced the "Gwonder of You" and the line in a dramatic reading of "I Believe" pronounced "every TINE I hear a new born baby cry" the mood is broken and the performance is hurt.

And there is the constant problem so common in performers from the Continent of making every song a dramatic event or major tragedy. So superb was Raphael with his medley of hits in his native tongue and with "Carnival" that we couldn't help but feel that he would have been that much stronger if he had stuck with songs in Spanish, and sung more soft, mood material that would display his velvety voice and its beautiful curls and tremors to greatest advantage.

The one English bit that really flipped us was Raphael's delicate piece of special material at which time he hands a lady in the audience (while he croons his love to her) a cute little pink stuffed doll as souvenir of the evening they spent together. Raphael's material is available on Liberty/UA in the U.S.

## James Anderson

ELECTRIC CIRCUS, NASHVILLE, TENN.—It's still great fun being in on the embryonic days of a talent who could be a giant in a matter of months. That's the kick we had last week.

Gerry Wexler, exec v.p. of Atlantic Records, brought James Anderson up to Cash Box last week to play us some super cuts of an LP that Huey Meaux, the man who discovered Jim, had recorded. We flipped on a "Mama Mama" cut and fell in love with a ballad piece (as well as a number of others) in the LP. Jim has a fantastic range, can dip down to the Brook Benton depths, has superb phrasing with a soul lyric, and sings with the texture of Sam Cooke. That's what we got from the record.

When Gerry was asked, how Jim was on stage, Gerry said he never saw him perform but signed him for his vocal ability on the tapes and Meaux's comment about his talents.

Hearing that he was appearing that same evening (as the office visit) in Nashville, and since we were heading down there that same day for the Country Convention, we stopped in to see Jim work at this new discotheque. And much to our surprise, this soft-spoken lad is a wild man on stage, and he's got it all.

Working with a pick-up band (Jim has no band of his own yet and the club was opened only just six days earlier) he tore the place apart with "Easy To Be Hard," a wild version of Chicago's "Wake Up Sunshine," Delaney & Bonnie's "Soul Shake" and closed the set with Sly's "I Wanna Take You Higher."

James Anderson is absolutely torrid, with body motions, James Brown type leg work, microphone girations and the like. He's a natural. Unfortunately we couldn't get any soft stuff from the stage because the atmosphere of swinging beer-drinkers called for heavy rock. And that's what Jim gave 'em.

The combination of so beautiful a sound on disks and such wild enthusiasm on stage, plus facial bone structure that reminds one of Mike Jagger, suggests the birth of a major talent.

Keep the name James Anderson in mind. You'll probably be hearing a great deal from this lad. His material will be made available on Cotillion.

## Jackson 5

MADISON SQUARE GARDEN, NYC — What does it take to satisfy the musical tastes of 15,000 people; people between the ages of four and forty, black people and white people, the rich and the poor? It takes something extra special, something that's energetic and totally captivating. It takes five youngsters; the new kings of soul. It takes the Jackson 5.

The Jackson 5 are the most dynamic, energetic, and professional group in show business. They turned Madison Square Garden into complete chaos by merely walking on stage, and when they began to perform, it was obvious that they deserved every bit of recognition they got. The 5 are super stars; the new kings of soul replacing James Brown and the Temptations. Their songs are brilliant, and their voices-golden. They are a new sensation as were Presley and the Beatles in their time. They are America's hottest group in terms of record sales.

The Jackson 5 can sing, dance, perform, and generate enough excitement to completely overwhelm an audience. You name it, and the Jackson 5 can do it better than anyone in the business, period.

k.k.

## The Munchkins

VILLAGE GATE, NYC—The Munchkins are three young men from Pennsylvania who play a blend of music which incorporates good old rock and roll with some of the more electronically contemporary sounds—the latter of their own composition. The trio was on view all too briefly last week at the Gate; still they hung around long enough to show they are one of the more exciting and musically proficient of the new groups.

Guitarist Craig Bolyn, late of the Nazz, led the charge for the major portion of the Munchkins' sets. He has a commanding instrumental style and a voice particularly well suited to the blues. Along with associates Larry Morris on bass and Renaldo Smith on drums, he did up "Theme From A Pirate Opera," a fine extended piece; an irrepensible "Bovine Blues" and the perennial "School Days."

The Munchkins are new and still evolving. Before very long, an enterprising record company will undoubtedly enable them to put their sound before a large section of the people.

e.k.

## The World's Fare

PLAYBOY CLUB/LAKE GENEVA, WIS.—A fresh and very entertaining new group, billed as The World's Fare featuring Jan Brenner, debuted recently in the Playmate Room of the Lake Geneva Playboy Club.

The group was formed about a year ago in Dayton, Ohio and consists of Jim LaMonica (drums), Sandy Allen (Piano), Phil Pierria (bass)—three very accomplished musicians showcased during a brief but effective warm-up session of jazz music—Danny Nelson (lead singer & congo drums) and vocalist Jan Brenner.

When performing as a whole, the group's material is largely contemporary with an oldie or two thrown in. Their acappella reading of "Somewhere Over The Rainbow" proved a showstopper and, in contrast, "Something's Burning," "59th St. Bridge" and "Carnet Man" were also outstanding and very pleasing to the audience. Miss Brenner's soft, deep voice and very winning stage personality compliments the group nicely.

An excellent lounge act. The 'Fare' are solidly booked through February of next year and are currently weighing several disk offers.

c.c.

## David Ackles

FORTUNE THEATER, NYC—About five weeks ago, a phenomenon occurred on the West Coast. Elton John made his American debut. On the bill with him was David Ackles. When I met Elton in New York shortly after, I mentioned to him that I thought both his and David's work displayed the same kind of sensitivity. "You know, it's funny," he said. "David doesn't seem to be as well known here as he should. In Britain he's a huge star and could sell out any theater he chose to play in. We think he's incredible."

Somewhere, if you chose to look hard enough, there's a musical link between Elton and David. It's enough for me to know that the feeling is there.

David must be the most intense single performer when he takes the stage. Listening to him, as he sings, hunched over his upright piano, is somewhat like sitting in on group therapy. His songs are astoundingly clear portraits of people—their personalities and relationships, and places. Dark bars, crusty men whose minds are inhabited by frighteningly real phantasms that often determine their lives and the lives of those who touch them, cities uncontrollably belching evil chemicalized air, and the unmatched, crippling hurt that one human being inflicts on another, these are the subjects of David's musical poems.

And when, at the end of the set, after the superb "Downriver," encore (a classic of modern songwriting), you leave the theater, it's as if your mind has been cleansed, your lungs and veins purged of accumulated poisons. A great weight seems to have been lifted. David Ackles is the sauna of the soul.

e.v.l.

## Dick Jensen

WESTSIDE ROOM, CENTURY CITY, CALIF. — Jensen, who hails from Honolulu, has worked many of L. A.'s lesser bistros in the last few years and is currently getting a star buildup with a recent stint at the Landmark in Vegas and the Copa in N. Y.

In this, his first major club appearance in town, he more than lives up to billing as "Hawaii's Only Active Volcano." It's an explosive, orgasmic act and, if some of the mannerisms are borrowed from Elvis Presley, Tom Jones and Bobby Darin, there are enough variations to make his act palatable. Jensen isn't unique. But he is thoroughly entertaining.

Vocally, one is tempted to compare him with Dean Martin on pop ballads and David Clayton Thomas on rhythmic, soulful sounds. But this is unfair to Jensen — his voice is rugged, robust and readily identifiable.

Despite his comment that "the older folks probably wonder what I'm doing out here," it is a compromise act which succeeds in bridging the generation gap. A few chart and standard titles are sandwiched between the harder rock songs ("Everything is Beautiful," "Try A Little Tenderness," "My Way," "Pearly Shells" and "Spinning Wheel" are several of the more recognizable titles establishment fans). Arrangements, mostly by Don Costa, are nearly magnificent. But somehow they too smack of parrotism, echoing Chicago and Blood Sweat and Tears. The Al Pelligrini Band offers them with proper abandon and the Duncan Sisters (Phyllis and Helen) offer both soul and inspiration to the proceedings.

Jensen recently signed an exclusive contract with Screen Gems and word is out that he'll be starring in his own musical TV series next season.

h.g.

## ATTENTION NEW BOOK

LISTS EVERY CHARTED RECORD

- |                  |                                    |                  |
|------------------|------------------------------------|------------------|
| 1<br>9<br>5<br>5 | ★ Date record first hit chart.     | 1<br>9<br>7<br>0 |
|                  | ★ Highest position reached.        |                  |
|                  | ★ Total weeks on chart.            |                  |
|                  | ★ Record label and number.         |                  |
|                  | ★ Listed by artist alphabetically. |                  |

Over 10,000 records and 2,200 artists are listed.

Compiled from Billboard Magazines "Top 100" Charts, this exciting new book lists every "45" RPM record to hit every "Top 100" chart from November, 1955 to January, 1970.

Everyone interested in or associated with the record music industry will find this informative book to be an absolute must!

Don't miss out on your personal copy of this valuable and informative reference book.

What some of the nations leading radio stations are saying:

"Most fantastic tool we've ever seen."

"Out of sight."

"A godsend to the music business."

Now available for immediate shipment.

Order Now! \$50<sup>00</sup> postpaid



8447 Lloyd (414) 251-5408  
Menomonone Falls, Wisc. 53051



Dear who ever,

On the Record "Timothy"  
it's the talk of the school every  
~~body says~~ some people has a different  
story just left Timothy in the  
mine, some say he was eaten by  
Joe was killed when it caved  
in then they ate him will you  
please send me the words of  
the song and tell me what it  
means!

Thank you

Stacie Schiller

**THE BUOYS**

Hit Single

**TIMOTHY**

SCE 12275

Produced By Michael Wright



## Kapralik Dismayed At Boston Action On Sly Cancellation

LOS ANGELES — The decision of Boston's Mayor Kevin White to revoke the promoter's license for Sly and the Family Stone to perform at Boston Gardens last week was cited as an "illogical act" by the group's manager, Dave Kapralik.

Kapralik said that the mayor's decision was based on "mis-information and one without investigating all aspects of the situation."

"Over the past two years," Kapralik said, "Sly and the Family Stone have performed on numerous occasions for Boston audiences without that occurrence."

"In addition," he continued, "Mayor White's reference to the recent Chicago riots and his allegations that Sly and the Family Stone was a cause of those riots shows that he is not aware that Mayor Daley of Chicago announced in the press that the group was in no way responsible for that occurrence."

"Sly was on his way to the Chicago concert in a limousine with the head of the department of parks when the police requested that they turn around since the riot was already developing."

## 'Madron' Track To Quad

LOS ANGELES — The soundtrack from "Madron," the Four-Star/Excelsior motion picture, has been scheduled as the first album to be released by Quad Records, Four-Star's label. MGM will distribute the LP.

The soundtrack album contains ten tracks, all written by Riz Ortolani, composer of "More." Music is being published by BNP Music Publishing Co. (ASCAP), the publishing subsidiary of Four-Star.

The "Madron" involvement is the first motion picture venture for BNP.

## Atlantic Promo Staff Expands

NEW YORK — Henry Allen, Atlantic's vice-president in charge of national promotion has disclosed plans for the label's expanding its promotional staff and adjusting its promotional activities. New promotion men to be added by the firm will concentrate on regional areas, specifically to give Atlantic's labels: Atlantic, Atco & Cotillion extra coverage in these areas.

Currently reporting to Allen are Atlantic's full promotion staff, including LeRoy Little, Richard Mack, Bill Staton, Dick Kline, Gary Johnson, Mario Medious, Dick Wooly, Vince Faraci, Vic O'Gilvie, Bob Gaiters, George Furness, John Minkove, Ray Evans and Gunter Hauer. Working closely with Allen are Jerry Greenberg, newly appointed vice-president in charge of product & operations and the firm's sales and marketing chiefs.



DEBUT — Peter Nero is shown conducting orchestra and chorus in the debut performance of his original musical work, "Anne Frank: The Diary of A Young Girl." The concert was presented in Temple Beth El in Great Neck, New York, Sunday, September 27th. As a result of the success of this first performance, Nero currently is negotiating for a TV special featuring his work, in addition to bringing it into Manhattan for a concert at Philharmonic Hall.



## LOOKING AHEAD

- 1 **DREAMS**  
(No Exit—BMI)  
Buddy Miles (Mercury 73119)
- 2 **CATHY CALLED**  
(Damian-Virtu-Schoogiebueg—BMI)  
Eddy Holman (ABC 11276)
- 3 **WORKIN' TOGETHER**  
(Unart—BMI)  
Ike & Tina Turner (Liberty 56207)
- 4 **I LOVED YOU LIKE MY VERY LIFE**  
(Pocketful of Tunes—BMI)  
Carla Thomas (Stax 0080)
- 5 **LUCY**  
(Mee-Moo—BMI)  
Crabby Appleton (Elektra 45702)
- 6 **GAMES**  
(Dimension—BMI)  
Redeye (Pentagram 204)
- 7 **STONED COWBOY**  
(Unart—BMI)  
Fantasy (Liberty 56190)
- 8 **SPIRIT IN THE SKY**  
(Great Honesty—BMI)  
Dorothy Morrison (Buddah 196)
- 9 **YOUNG MAN**  
(Jazz Edition—BMI)  
The Who (Decca 32737)
- 10 **TO THE OTHER MAN**  
(Klondike—BMI)  
Luther Ingram (Koko 2106)
- 11 **AMOS MOSES**  
(Vector—BMI)  
Jerry Reed (RCA 9904)
- 12 **HEY GIRL**  
(Screen Gems/Columbia—BMI)  
Lettermen (Capitol 2938)
- 13 **I GOTTA LET YOU GO**  
(Jobete—BMI)  
Martha Reeves & Vandellas (Gordy 7103)
- 14 **WHO NEEDS YOU**  
(Trousdale—BMI)  
Steppenwolf (Dunhill 4261)
- 15 **ONE LIGHT, TWO LIGHTS**  
(Tattersall/Lan-Tastic—BMI)  
Satisfactions (Lionel 3205)
- 16 **THE BEST YEARS OF MY LIFE**  
(East/Memphis—BMI)  
Eddie Floyd (Stax 0077)
- 17 **FROM ATLANTA TO GOODBYE**  
(Geo. Pincus—ASCAP)  
Manhattans (Deluxe 129)
- 18 **RUN, WOMAN, RUN**  
(Algee—BMI)  
Tammy Wynette (Epic 10653)
- 19 **MONEY MUSIC**  
(Greyhound/Dorafl—BMI)  
Boys in the Band (Spring 106)
- 20 **THIS WORLD**  
(Sunbean—BMI)  
Sweet Inspirations (Atlantic 2750)
- 21 **GOOD TIMES ARE COMING**  
(April/Barwin/Jac—ASCAP)  
Mama Cass (Dunhill 4253)
- 22 **SWEET SWEETHEART**  
(Screen Gems/Columbia—BMI)  
Bobby Vee (Liberty 56208)
- 23 **A WOMAN'S WAY**  
(Moonsong/Cotillion—BMI)  
Rozetta Johnson (Clintone 1001)
- 24 **I CAN'T GET NEXT TO YOU**  
(Jobete—BMI)  
Al Greene (HI 2182)
- 25 **THAT'S THE WAY I WANT OUR LOVE**  
(Cape Ann/Jabee—BMI)  
Joe Simon (Soundstage 7 2667)
- 26 **EMPTY PAGES**  
(Irving—BMI)  
Traffic (United Artists 50692)
- 27 **CHERYL MOANA MARIE**  
(Rosebridge—BMI)  
John Rowles (Kapp 2102)
- 28 **THE MAN, THE WIFE & LITTLE BABY DAUGHTER**  
(Greyhound—BMI)  
Phil Flowers (Bell 928)
- 29 **MORNING**  
(Show Biz—BMI)  
Jim Ed Brown (RCA 9909)
- 30 **ME ABOUT YOU**  
(Chardon—BMI)  
Turtles (White Whale 364)

## Big Three Sets Keith PR Drive

NEW YORK — Big 3 Music's talent acquisition drive directed by executive vice president Allen Stanton is currently focused on Barbara Keith.

Her composition "Free The People" has already been recorded in several versions according to Big 3 general professional manager Wally Schuster and because of the widespread reaction to the tune, A&M Records has just rush released Barbara Keith's own version. An album featuring "Free The People" is also in preparation by Miss Keith.

Big 3 is now embarked on a campaign designed to further develop Miss Keith's talents on all levels. Her engagement at Fillmore East was followed with appearances on Canadian Television with Ian and Sylvia, as well as local TV guest shots in the States. A series of college concerts is also in the works for the artist who has already built up a substantial underground reputation by way of her first Verve LP.

## 'Colette' Mio's Caster

NEW YORK — Mio International Records has acquired the original off-Broadway cast of "Colette." Album is scheduled for release within the next several weeks and will be issued on Mio's 3000 Series label which carries a suggested list price of \$5.98.

"Colette" originally opened off-Broadway last May at the Ellen Stewart Theater. Starring Zoe Caldwell, who received the New York Drama Desk Award for her performance. "Colette" ran until Miss Caldwell's August departure because of a prior commitment.

Mio's album will feature Miss Caldwell and members of the cast in excerpts from the show, along with incidental music played by Harvey Schmidt who, in collaboration with Tom Jones, composed the music.

## Bloom to Europe

NEW YORK — L&R/MGM Records artist Bobby Bloom has departed for Hamburg, Germany to begin a series of television and promotional appearances throughout Europe. Bloom's debut single "Montego Bay," a cut from his first LP, "Bobby Bloom" is at #31 this week. Currently the record is #28 in Holland; #14 in Belgium and #2 in England. Bloom's recordings are released on L&R/MGM in the United States and on Polydor throughout Europe.

Included on Bobby Bloom's schedule is an appearance on Germany's "Four, Three, Two, One" to be aired November 7. Holland's pop program "Eddy Ready Do" will host Bobby Bloom on its October 28 segment, and in Paris, Bloom will join Georgie Fame on the color TV series "Du Sur La Deux" on November 2nd.



ON THE LEWIS AGAIN—Ramsey Lewis has re-signed with GRT Records Group according to Len Levy, president of the company. A major all-market promotion, advertising, and publicity campaign will help celebrate Lewis' fifteenth year as a recording artist. Shown at the pacting are (l. to r.) Len Levy, Joe Gowan, veep of administration for GRT and (seated) Ramsey Lewis.

# CITIZENS This Is Your

Rick  
Ely  
V  
On RCA  
L  
U  
TV series  
I  
On ABC TV  
N

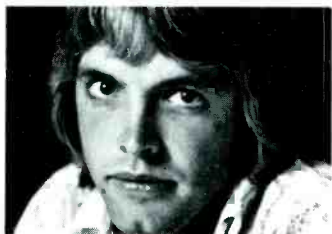

**RCA** Records  
and Tapes

THE RICK ELY REVOLUTION STARTS  
WITH "CIRCLE GAME"  
FROM HIS FORTHCOMING ALBUM.

# We laughed when they sat down at the kazoo.



Official Mungo Jerry Kazoo

We were still laughing when Mungo Jerry played IN THE SUMMERTIME.  
By the time they finished we were hysterical. A few weeks later  
IN THE SUMMERTIME had sold over a million singles. That really got us.  
Now, we laughingly introduce another Mungo Jerry single.  
This one, like the other one is from the album and it's called JOHNNY B. BADDE.  
And it sounds mighty goode.

## MUNGO JERRY Johnny B. Badde

(J-128)

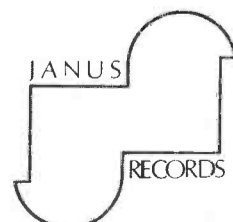

An Affiliate of GRT Corporation  
1700 Broadway, New York, New York.

**ie Produces B. J.**

SHVILLE — Scepter recording artist B. J. Thomas is currently spending time in Atlanta recording next single at the Studio One recording facility of Buddy Buie, who handling the production chores of Thomas single. The sessions represent the first production efforts by the Scepter artist whose hits include "Raindrops Keep Falling On My Head" & "I Just Can't Help Believing."

Buie is the producer of such hits "Cherry Hill Park", "Traces", "Booky", "Stormy", "Every Day With You Girl", and "Where Did All the Good Times Go?", as recorded by Dennis Yost and the Classics IV and Billy Joe Royal.

**comano Joins SESAC Exec Staff**

SHVILLE — Alice Prager, executive vice president and managing director of SESAC, Inc., has appointed Nicholas Arcomano as operations administrator, effective immediately.

For some ten years prior to his accepting his new assignment at SESAC, Arcomano had been assistant director of operations for CAP. With SESAC, he will work directly with the licensing firm's vice president and executive administrator, Sal Candilora.

Arcomano is a graduate of Fordham University and holds an L.L.B. degree from Albany (N. Y.) Law School. He is a member of the Copyright Society of the U. S. A., the Fordham University and Albany Law School Alumni Associations, the Gospel Music and Country Music Associations.

**campbell To Brunswick**

NEW YORK — Irving Wiegman, secretary-treasurer of the Brunswick Record Corporation, has named Anita Campbell administrative director of the firm's copyright and royalty department. Miss Campbell spent the last six years with Decca Records.

**GRT Releases First Albums**

NEW YORK — GRT Records announced three albums in the label's initial release: "Dixie Belle" by Stan Hitchcock, "Come To My Garden" by Minnie Riperton, and "Podipto" by Podipto.

The albums, which feature product directed toward the country, soul and underground audiences, will be supported by an extensive promotion, advertising and publicity campaign. Trade and consumer ads, radio spots, and local promotion co-ordinated with personal appearances will be utilized.

**Schwartz Up At NMC**

OCEANSIDE, N. Y.—NMC Corp. has promoted Gertrude Schwartz to corporate secretary with the additional responsibility for directing the recently reorganized budget department of the corporation.

Tom White, vice president of finance and administration stated that the promotion of Mrs. Schwartz to her new position will enable the company to broaden its internal reporting and forecasting techniques and allow management to better channel its efforts on corporate investment.

**Lebowsky Named MD For 'Exodus' On Broadway**

NEW YORK — Stanley Lebowsky has been set as musical director by producers Ken Gaston and Leonard Goldberg for "Ari," the musicalization of Leon Uris' novel, "Exodus," which goes into rehearsal next Monday for a January 24th premiere at the Mark Hellinger Theatre. Philip J. Lang will do the orchestrations, while Peter Howard will create the dance and incidental music arrangements for the Walt Smith score.

With David Crver and Constance Towers in the starring roles, "Ari" will open a 3 week pre-Broadway engagement at the Shubert Theatre in Philadelphia on November 30th.

**Teldec's U. S. Video Disc Showing (from p. 7)**

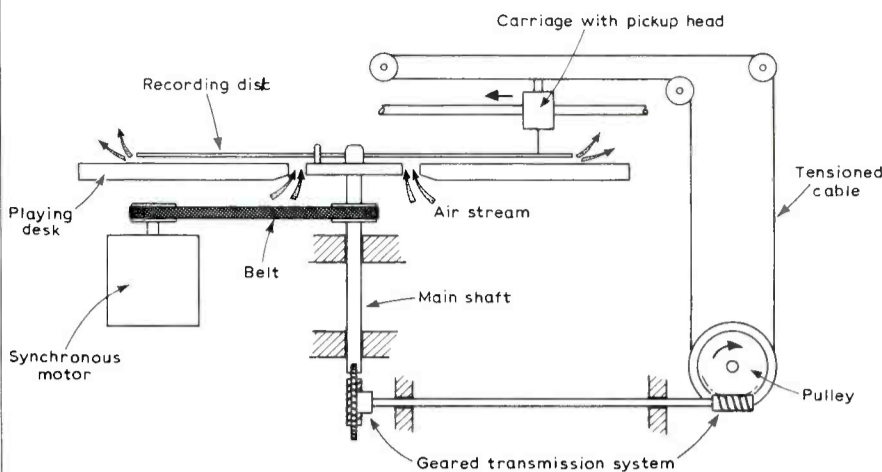

Principle of the video disc reproducer mechanism.

survive along side one another. One of the few questions the panel



Shown in the photo are (l. to r.) Lloyd Gellison classical publicity dir. of Polydor, Scott Mampe, in charge of classical products for Mercury Records, Tom Manoff and Harris Danziger of the Settlement.

THE THIRD STREET MUSIC SCHOOL Settlement was recently found to be in dire need of money and equipment to assist in its teaching programs. Their operating budget is so limited it denied them the ability to purchase a record player or develop a record library.

Harris Danziger, director of the School received, as a memorial to John P. Gula formerly of Heliodor Records, a stereo phonograph with FM receiver and cassette unit and basic collateral equipment as a personal gift from friends. The nucleus of a small record and cassette collection was contributed by Deutsche Grammophon and Mercury.

The seventy-five year old school provides youngsters who would otherwise be on the streets of the lower East Side with an alternative, music. Any kind of music. It keeps them involved and enables them to participate with a goal and opportunity for development they often cannot obtain within their home environment.

It would be a small matter Danziger said, if each record company with a classical label were to place the Third Street Music School Settlement on its promotional mailing list, as has been done by Mercury and Deutsche Grammophon. The records and cassettes would be a minor gift by the record manufacturers, but multiplied in receipt by the Third Street Music School Settlement could be a bonanza. This sort of contribution could help alleviate one need.

A similar participation of the part of music publishers, and publishers of books of a musical nature would satisfy another hunger. Also the school needs equipment. Students are being trained in recording techniques with the generous loan of some basic units by instructor Tom Manoff. The recording studio he has built with the aid of his students in the basement is a feat of ingenuity.

To aid the project, Irwin H. Steinberg, president of Mercury Records, and Jerry Schoenbaum, president of Polydor Incorporated, Deutsche Grammophon's U. S. parent, have also contributed a scholarship to the school through Harris Danziger. Third Street Music School Settlement, 55 East 3rd Street, New York.

**Tim Gayle Dies**

LOS ANGELES—Services were held this past week for Tim Gayle (57), songwriter, artist, manager and record publicist for the past twenty-five years. He died of a heart attack.

of inventors and execs did not want to comment on at this session was at what speed the records were recorded. Another was the effect this would have on contract negotiations with artists for video rights.

The lack of response brought to mind infinite possibilities such as what one might do with an artist the likes of an Andy Williams, assuming his contracts were originally negotiated before the advent of the audio-visual recording technique. Since Andy is a Columbia recording artist, a division of CBS, and has a video agreement with NBC, related to RCA, if provisions for this eventually were not made in advance, which of these companies would have the rights to Audio-Visual recordings.

When Leo Hofberg, director of special projects for London Records was discussing and displaying the various potential uses of the A-V Disc (musical entertainment, educational, sports, films, in advertising, or have the disc on a sheet in a newspaper or magazine supplement) infinite problems of rights to record in the A-V configuration came to mind.

The educational aspects of the A-V disc seem limitless. This was obvious when Hofberg suggested that as many as 50 TV sets could be fed by a program from one single record.

On hand for the presentation, in addition to D. H. Toller-Bond and Leo Hofberg, were the system's inventors, H. Redlich and G. Dickopp as well as W. Berger, who reviewed the development of the Video Disc and K. Thorne, of British Decca who handled the question and answer session.

**Columbia 'Playback' Plan**

(Continued from p. 7)

on the inner sleeve is shown below.) It is understood that the A&R department is desirous of finding out how the consumer feels about material it plans to release, etc.

The form does not suggest the size or the speed of the sample disk that will be sent out ten times a year.

Other side of the sleeve offers a series of posters, mostly of Columbia artists for \$1.50 each as well as an assortment of six jigsaw puzzles of familiar Columbia and Epic LP covers for \$2.00 each.

Hear the new sounds—new groups—new discoveries—from Columbia and Epic Records some before they've ever been released!

GET 10 "PLAYBACK" SAMPLER RECORDS sent to you during the coming year plus

THE "PLAYBACK" NEWSLETTER

... with little known, interesting information on your favorite artists, and their latest releases. "PLAYBACK" invites you to share your opinions with us. For one year you can be directly involved with what's happening in the record business!

All this—10 Samplers, 10 Newsletters and an open line of communication with our A&R department—for just \$3.00, to help us cover the costs of production and mailing.

Mail this coupon with check or money order (payable to Columbia Records), to "Playback," P.O. Box 872, Radio City Station, New York, N.Y. 10019.

NAME \_\_\_\_\_  
 ADDRESS \_\_\_\_\_  
 CITY \_\_\_\_\_  
 STATE \_\_\_\_\_ ZIP \_\_\_\_\_

'Playback' Mailer Form

Cash Box — October 31, 1970

**"Be My Baby"**

Produced by Jeff Barry

**Andy Kim**

**1 Week after release and already on...**

ST-729

**STEED**

WLS	Chicago
WDRC	Hartford
WKNR	Detroit
KIMN	Denver
WOKY	Milwaukee
WMAK	Nashville
CKLW	Detroit
KOL	Seattle
KJR	Seattle
WRIT	Milwaukee
WCFL	Chicago

Distributed Nationally by Paramount Records

**A new hit single**  
**Stand By Me,**  
 (S35076)  
*The Ruffin Brothers*



**charting  
 out of the  
 album!**

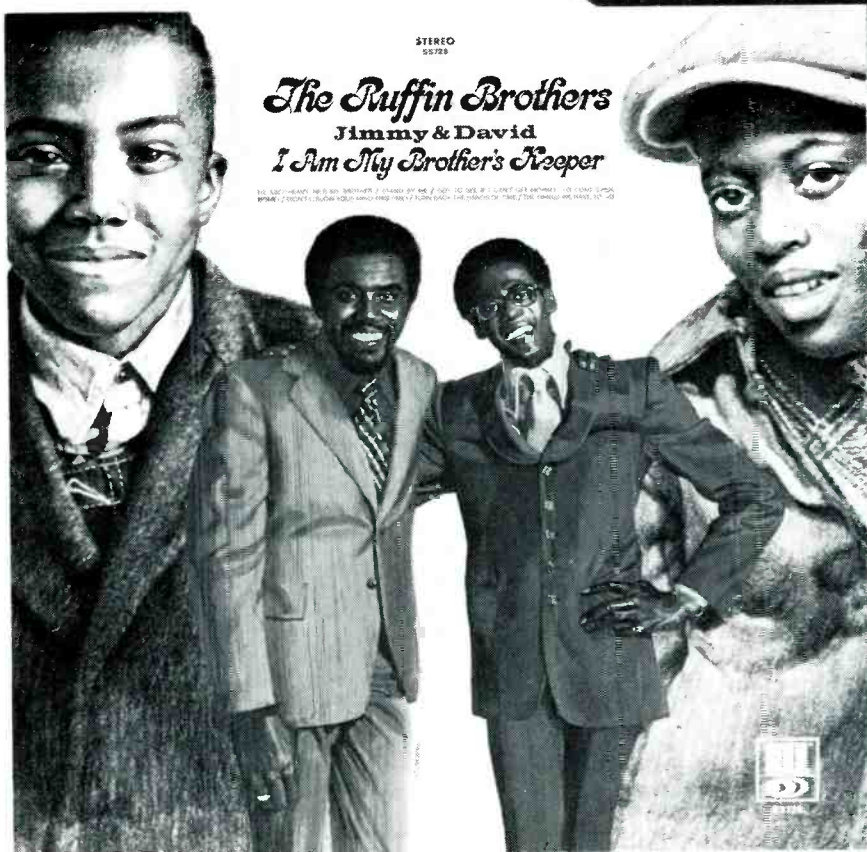

- LOLA  
KINKS ..... REPRISÉ  
Noma Music  
Hi-Count Music
- YELLOW RIVER  
CHRISTIE ..... EPIC  
LEAPY LEE ..... DECCA  
Noma Music
- I JUST DON'T KNOW WHAT TO  
DO WITH MYSELF  
GARY PUCKETT ..... COLUMBIA  
CISSY HOUSTON ..... JANUS  
Ann-Rachel  
U.S. Songs  
Jac Songs  
Blue Seas
- STAND BY ME  
DAVID & JIMMY RUFFIN ..... SOUL  
Hill & Range  
Trio Music  
ABT Ent.
- PATCH IT UP  
ELVIS PRESLEY ..... RCA  
Elvis Presley  
S-P-R Music
- DO I LOVE YOU  
DILL DEAL & RHONDELLS ..... POLYDOR  
Hill & Range  
Mother Bertha
- I CAN'T BELIEVE THAT  
YOU'VE STOPPED LOVING ME  
CHARLIE PRIDE ..... RCA  
Hill & Range  
Blue Crest
- TINKER TAILOR  
THE OUTSIDERS ..... KAPP  
BUTTERMILK BOTTOM ..... POLYDOR  
Noma Music  
Inquiry Music
- I GOT A WOMAN  
AL KOOPER ..... COLUMBIA  
Hill & Range
- GONE  
BILL MEDLEY ..... MGM  
Hill & Range  
Dallas Music
- DON'T PLAY THAT SONG  
ARETHA FRANKLIN ..... ATLANTIC  
Hill & Range

**THE ABERBACH GROUP**  
241 West 72 Street, New York, N.Y.

## Film Technicians' Rep Proposes Payment Scale From TV Cassette Use

HOLLYWOOD—The first formula for negotiations under which Hollywood film crafts would benefit from the proceeds of the television cassette industry was proposed recently by Don Haggerty, business representative of Film Technicians Local 683, IATSE.

In a letter to IATSE international president Dick Walsh, Haggerty sought immediate bargaining with producers who have indicated their intentions of making available to video cassettes their theatrical and television films.

Haggerty's formula would include 10 per cent of the gross revenue (sales and rental) of domestically-produced theatrical features from their use in television cassettes; 10 per cent of the gross from cassette use of all domestically-made theatrical short subjects and subjects made originally for television broadcast, and 20 per cent of the gross from those theatrical pictures of American interest made abroad and so used.

Haggerty proposed that the proceeds from the cassettes be used to bolster the health and welfare fund and the pension plan of Hollywood craftsmen, as well as provide supplemental unemployment benefits to the jobless. He said that the funds have been hard hit by lack of employment in motion picture and telefilm production, and that thousands, including many industry veterans have lost their benefits.

Haggerty, one of the two union officials who attended the three-day International Symposium of TV Cassettes here, said, "The cassette field is amazing in its potential and that the unions and guilds should be on the alert to protect the interests of their members." He also claimed that the guilds and unions lost millions of dollars by not being reimbursed for the television exhibition of the older motion pictures.

## Smith Named EVR V.P. for Marketing; Former G.E. Exec

NEW YORK—The naming of Harry E. Smith as Vice President, Marketing, for the CBS Electronic Video Recording Division was announced by Robert E. Brockway, Division President. "Proliferation of both individual and industry-wide opportunities for creating EVR packages to solve education, industrial and enrichment problems has opened up this position earlier than anticipated," Brockway said.

Smith came to CBS after some twenty years with General Electric. In his last four years with G.E., he was concurrently responsible for general management of its Closed Circuit Television business section, and for all marketing activities of its Visual Communications Products Department. Mr. Smith held a variety of posts with G.E. Schenectady operations between 1950 and 1962, then moved to G.E. operations in Syracuse.

## 'Goldie' Awards

Dick Martin (l) and Dan Rowan (r) stars of the "Laugh-In" television show are pictured with the first Golden Cassettes presented to the comedians by the International Symposium of TV Cassettes. Pictured with the two is Frederick Ford, former national Cable TV President and FCC Commissioner. Rowan and Martin were honored for their "pioneering accomplishments in the production of films for the television cartridge medium" through their ARM Productions.



## Motorola Forms Center for TV Cassette Programming

NEW YORK—Motorola, Inc., recently announced formation of a new organization, the Motorola Teleprogram Center, termed "Another step in our determination to take a commanding lead not only in the hardware part of the new medium of Cartridge TV but in programming as well" by Elmer Wavering, vice-chairman and chief operating officer.

The new organization will operate

as part of the education and training products unit, which also is in charge of sales and marketing of the Motorola "Teleplayer" device which permits playing CBS-developed EVR cartridges through any television set.

The Motorola Teleprogram Center, according to Lloyd Singer, vice president of Motorola Systems Inc., has formed advisory groups to assist in the selection of programming for conversion to the EVR format to satisfy specific needs of major industrial/institutional markets including education, business and industry, health, public safety, religious institutions, cable TV, and the home consumer.

He said its other functions are: Obtaining rights to program material and arranging for conversion to EVR and, in the future, to other Cartridge TV formats; Maintaining an inventory of cartridges which will help to give producers the opportunity to create special programs in the new medium and to be assured of distribution; Merchandising the Cartridge TV concept to new markets through Motorola divisions, or combination distributors. (A combination distributor is one who markets both the "Teleplayer" unit and programming as a package for specific audiences.)

Another function is the investigation of other markets and applications for the program material the Motorola Teleprogram Center will have available. Singer said a number of independent producers already have worked with the company since announcement of its entry into programming, and Motorola expects this trend to grow.

Singer said the center will also play a role in providing programming for the home consumer market, but only after extensive research to determine the public's needs and how they can be effectively coupled with the new medium.

## Towne, Aucoin to Address Videotape Production Assn. 2-Part New York Meeting

NEW YORK—On Monday, October 26 at 6:30 p.m., the Videotape Production Assn. will hold a two-part meeting at Eastern Video Studios, 423 East 90th Street here. The first half of the meeting will consist of a talk by Howard Towne, manager of product development at Ampex. Towne will speak on the subjects of "high speed duplication" and two-inch videotape cassettes. The presentation will be both technical and non-technical and will include slides.

During the second half of the meeting, director for Tele-Tape Productions, Guillaume Aucoin will discuss the techniques he employed while directing the closed circuit television videotaping of "Oh! Calcutta!" Aucoin winner of six Clio awards, three Art Direction awards and a Hollywood Reporter award, is presently working on an Enzo Stuarti Special and a festival concert for The Rolling Stones in London. At his presentation, segments of "Oh! Calcutta!" will be screened.

## Dolphin Produces Films Of Bahamas Regattas

NEW YORK — Dolphin Productions, in the first announcement of specific titles, has committed two films for distribution in the home video cassette market. Allan Stanley, president of Dolphin, a division of Computer Image Corp., is presently negotiating release with major firms who will both manufacture the cassettes and supply video programming "software".

Dolphin, a producer of television commercials as well as industrial and educational films, has recently begun production of computer-generated animation on film. This will be combined with the live action of the two films, now in the can, for the final version released to the cassette market.

The two films, both produced and directed by Stanley, are the first "special interest" titles announced.

"The Bermuda Race"—a half-hour sports action portrait of the famous Newport-to-Bermuda blue-chip classic. Color-filmed by a Dolphin production crew aboard the "Stormvogel," one of the contenders in the race, the picture is narrated by Bill Robinson, editor of "Yachting" magazine and author of the book "Berth to Bermuda".

"Out Island Regatta" is a half-hour record of a different kind of sailing, with the carnival-like atmosphere of this regatta, open to the inter-island schooners and fishing craft of the Bahamas Out Islands.

Stanley plans to combine computer-generated animation with live action in the production of additional films for the home video cassette market and is meeting with several companies now who seek instructional, informational and special interest programming for cassette distribution.

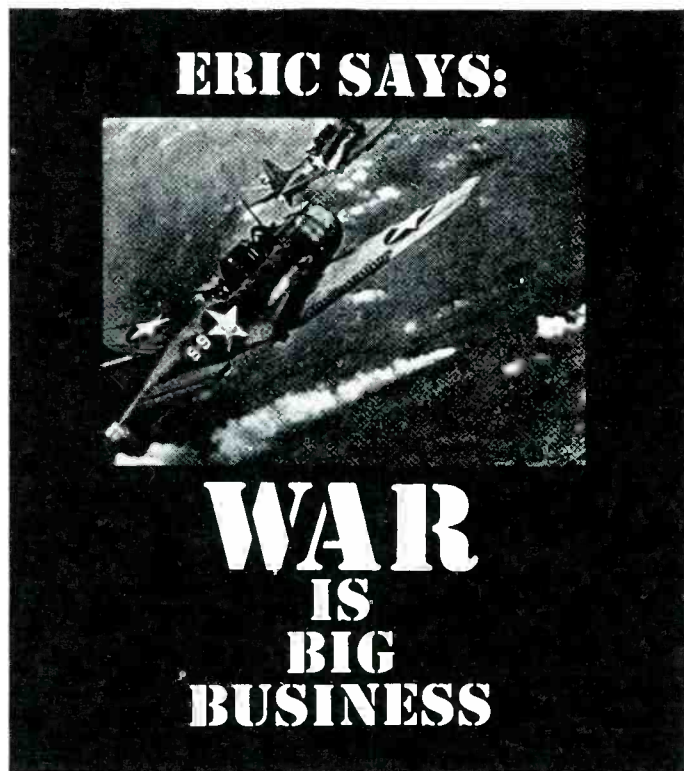

# 8-TRACK STEREO CARTRIDGES FOR THE PRICE OF RECORDS



There are over 10,000,000 tape cartridge players in the U. S. But up until now, people had to pay around \$7 for cartridges. Which tempted them to make do with as few as possible.

So Vocalion is introducing cartridges that list for \$3.98. That's a price the public is used to. They've bought billions of records at it. Vocalion cartridges feature Peggy Lee, Sammy

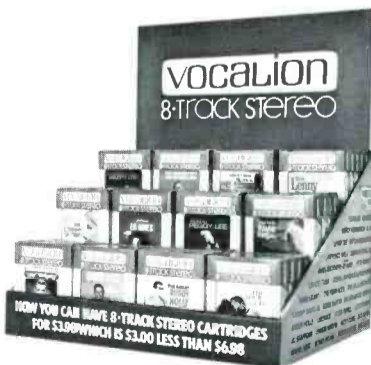

Davis, Jr., Steve & Eydie, Buddy Holly, The Ames Brothers (featuring Ed Ames), Lawrence Welk, The Mills Brothers, Earl Grant, Pete Fountain, Jo Stafford, The Ray Charles Singers, Skitch Henderson, Jack Jones and many others. At \$3.98, you won't have to push these cartridges. All you have to do is ask for our new counter display. And then try to keep it filled.

**VOCALION**  
**RECORDS AND TAPES**  
A PRODUCT OF MCA, INC.

## Picks of the Week

### THE SUPREMES (Motown 1172)

**Stoned Love** (2:49) (Jobete, BMI—Wilson, Semoht)

A breath of the original motor city sound supercharges this new Supremes side. Track is "Baby Love" come of age with a full power that enhances the dance drive and sparkles behind the team's mighty vocal performance. One more giant on the roster. Flip: "Shine on Me" (3:59) (Jobete, BMI—Wilson)

### CLARENCE CARTER (Atlantic 2774)

**It's All in Your Mind** (2:31) (Fame, BMI—Jackson, Moore)

Yet another chapter in the life story of Clarence Carter finds the man of "Patches" come of age and meeting his first lover's setback. The insight of the material and Carter's superior delivery add up to another powerful sales entry. Flip: "Till I Can't Take it Anymore" (3:05) (Eden, BMI—Otis, Burton)

### NEIL DIAMOND (Uni 55264)

**He Ain't Heavy . . . He's My Brother** (3:59) (Harrison, ASCAP—Russell, Scott)

Turning, as he only infrequently does, to other authors' material, Neil Diamond follows his "Cracklin' Rosie" with a reprise of the Hollies hit of last year. The material's magnetism is well suited to Diamond's moody style and should prove a powerful outing. Flip: no info.

### NEIL DIAMOND (Bang 580)

**Do It** (2:18) (Tallyrand, BMI—Diamond)

And from his own catalog, Diamond doubles up with this issue of an early-in-his-career coupling track. Side is more rhythmic and an even more top forty tailored track that should continue to sustain his dual hit string. Flip: "Hanky Panky" (2:47) (T.M., BMI—Barry Greenwich) Remember?

### STEPPENWOLF (Dunhill 4261)

**Who Needs Ya** (2:47) (Trousdale, BMI—Byrom, Kay)

Smoothed out sound that makes Steppenwolf sound like an almost different act turns this new single into a surprising offering. The track has already gained exposure advantage and looks like one of the brightest from the group in a long while. Flip: "Earschplittenludenboomer" (Trousdale, BMI—Byrom)

### CHAIRMEN OF THE BOARD (Invictus 9081)

**Pay to the Piper** (3:06) (Gold Forever, BMI—Perry, Johnson, Dunbar, Bond)

Pulsing rhythmic power and once again vocal fireworks touch off musical explosions for the Chairmen of the Board. Team blazes with a winning effort that is bound to boom into R&B sales ranks and catch top forty attention. Flip: "Bless You" (2:59) (Gold Forever, BMI—Johnson, Dunbar, Bond)

### THE MOMENTS (Stang 5017)

**All I Have** (3:20) (Gambi, BMI—Kerr, Robinson)

Having dipped into the oldie bag, the Moments route their attention on a new piece that presents a gleaming new hit for the act. Smouldering ballad fare with the team's characteristic brilliance to highlight the song. Excellent blues with top forty potential too. Flip: no info.

### CHICAGO (Columbia 45264)

**Does Anybody Really Know What Time it Is?** (2:53/3:17) (Aurelius, BMI—Lamm)

Two versions of the song from their first album presents the Chicago Transit Authority with a flourish in top forty time. Team's exciting arrangements and superb material add up to an aural outburst that should blossom as a flowering chart entry.

### MUNGO JERRY (Janus 128)

**Johnny B. Badde** (3:00) (Our Music/Don Kirshner, BMI—Dorset)

Washbasin rag from the "In the Summertime" crew links their good-feeling flavor with an almost-hoe-down flair to come up with a frolic that should whet top forty appetites. Charm and rhythm offered with a twinkle. Flip: "My Friend" (2:36) (Same credits)

### ARCHIE BELL & THE DRELLS (Atlantic 2768)

**Wrap it Up** (2:40) (East/Memphis/Pronto, BMI—Hayes, Porter)

One of the second magnitude hits in the Sam & Dave catalog, "Wrap It Up" is revisited by Archie Bell in a session that should reap fiery results among teen listeners on the blues and rock sides. Powerful dance side for the performers. Flip: "Deal With Him" (2:40) (Cotillion/Orellia, BMI—Bell)

### BOBBY BLAND (Duke 464)

**Keep on Loving Me** (2:32) (Groovesville, BMI—Wilson)

Breaking into a bright new surge, Bobby Bland comes on with a strength that hasn't been achieved in earlier singles. New side has a production plus that is bound to turn this into one of B.B.'s best sellers among blues and many top forty audiences. Flip: no info.

### LITTLE MILTON CAMPBELL (Checker 1236)

**A Mother's Love** (3:06) (Big Bee, BMI—Adpt: Bass)

Finding the soft approach a means of sizeable sales, Little Milton turns to an easy delivery once more with this blues drenched adaption of the classic "A Mother's Love." Tender, but with a vocal strength that should excite listener reaction. Flip: "Many Rivers to Cross" (3:00) (Irving, BMI—Cliff) Third version of this marvel.

### TAMIKO JONES (Metromedia 197)

**Blossom** (2:11) (Blackwood/Country Road, BMI—Taylor)

Working with a tune from one of the hottest writers in the current picture, Tamiko Jones adds a hypnotic vocal sound that turns the session into pure magic. Especially good for both top forty and mixed adult audiences, the side could well jump into the best seller circuit. Flip: "Please Don't Tell Me" (2:52) (Ruler, BMI—Quillen, Smith)

### LITTLE SISTER (Stone Flower 9001)

**Somebody's Watching You** (2:46) (Daly City, BMI—Stewart)

Unmistakable material tinged by the Sly Stewart stroke gives Little Sister a new vehicle for top forty/blues reception. Side is not as raucous as the first hit from the act, but has a simmering rhythmic flash to assure solid response. Flip: no info.

### EDWARD BEAR (Capitol 2955)

**You Can't Deny It** (3:43) (Eeyor, Marks)

Having showed their softer side in "You, Me & Mexico," Edward Bear roars out of Canada again with rhythmic fangs bared. Pulsing top forty side that has the impact to create sales action on the teen level. Flip: no info.

### BETTY EVERETT (Fantasy 652)

**I Got to Tell Somebody** (2:20) (Wally Roker, BMI—Ervin)

Returning after a brief absence, Betty Everett takes hold of a bright ballad entry and turns it into a sprightly moderately-paced rhythm offering. Side is bound to stir up R&B notice and could gain the momentum to break top forty. Flip: "Why Are You Leaving Me" (3:30) (Parabut, BMI—Butler, Blumberg)

## Newcomer Picks

### RIISING SIGN (Scepter 12295)

**Together Again** (2:54) (Larry Weiss, ASCAP—Weiss)

The label that brought us "Raindrops Keep Fallin'" comes up with another enchanting ballad in that vein, this time from the Rising Sign. Charming material and arrangements give the group that extra thrust to win a spotlight place across the pop/rock board. Flip: "Hey Don't Hurt Yourself" (2:59) (Same credits)

### THE STRANGE BROS. SHOW (Sire 4120)

**Right On** (3:14) (Doraflo/Greyhound, BMI—Feldman, Gottehrer)

The expression of the day is fitted into a power percussion background to make "Right On" a rapid-fire top forty side. Choral sparkle and a lyric tailor made for teen audiences assure this effort a quick trip into the best seller picture. Flip: "Shakey Jakes" (2:40) (Same credits)

## Choice Programming

Choice Programming selections are singles which, in the opinion of our reviewing staff, are deserving of special programmer consideration.

### JACKIE JASON (Pip 99)

**The World is Coming to a Start** (2:32) (Mourbar, ASCAP — Udell, Geld) A series of blues stations have begun to expose this bright-lyric ballad which is heightened by a perking bass line. Could spring into the sales running and turn top forty too. Flip: "Please Mr. Sun" (2:44) (Weiss & Barry, BMI — Getsov, Frank)

### AD LIBS (Capitol 2944)

**Love Me** (3:15) (Belwin Mills, ASCAP — Murphy, Elbert) Attractive blues material is dressed up with a performance that could create spill-over interest on the top forty side. Flip: "Know All About You" (2:55) (Belwin Mills, ASCAP — Perricone)

### BEAT HOVEN (Wizdom 1981)

**A Medley of My Hits** (3:02) (Trajames, ASCAP — Wisner) Bright piano medley of melodies including the chorale, "Ode to Joy" which should make it interesting MOR fare. Flip: "A Jab to the Jaw" (3:23) (Same credits)

### DESMOND DEKKER (Uni 55261)

**You Can Get it if You Really Want** (Irving, BMI — Cliff) Mild reggae in his patented style brings Desmond Dekkar back, this time polished for added top forty impact. Flip: "Perseverance" (Irving, BMI — Dacres)

### LYNN ANDERSON (Columbia 45252)

**Rose Garden** (2:52) (Lowery, BMI — South) Written by Joe South, the biggest single version of "Rose Garden" was aimed at R&B. Now, a country hit-in-the-making, Lynn Anderson's stands a powerful chance of going top forty and MOR as well. Flip: no info.

### RAY RIVERA ORCH. (MGM LAT 3005)

**Hard Hats** (2:35) (Belwin-Mills, ASCAP—) Chuckling instrumental side with guitar and organ to rouse teen change-of-pace play and blues thought. Flip: "Guava" (2:20) (Same credits)

### BURL IVES (Bell 930)

**Roll Up Some Inspiration** (3:04) (J. L. S., ASCAP — Meyer) Fine old-fashioned sing along kind of material and a rousing interpretation from Burl Ives make this a strong shot for across the board play. Flip: "Real Roses" (2:06) (Magic, ASCAP—Maraine)

### DEEP PURPLE (Warner Bros. 7405)

**Black Night** (2:58) (HEC), — Blackmore, Gillan, Glover, Lord, Paice) Power material harkening back to earlier days boils over on the new Deep Purple venture. From G. B.'s best seller lists and aimed top forty/FM. Flip: "Into the Fire" (3:35) (Same credits)

### STEVE MILLER BAND (Capitol 2945)

**Steve Miller's Midnight Tango** (2:38) (Sailor, ASCAP — Sidran) Soft side from the band for a change gives them a pretty pop outing with FM prospects. Flip: "Going to Mexico" (2:23) (Sailor, ASCAP — Miller, Scaggs)

### FREE DESIGN (Project Three 1387)

**Don't Cry, Baby** (2:59) (Almitra/Record, ASCAP — Dedrick) A group that can always be counted on for an out of the ordinary performance, the Free Design weaves a subtle vocal ballad that might spring into the MOR and top forty showcases. Flip: "Time & Love" (2:49) (Celestial/Cherry River, ASCAP — Nyro)



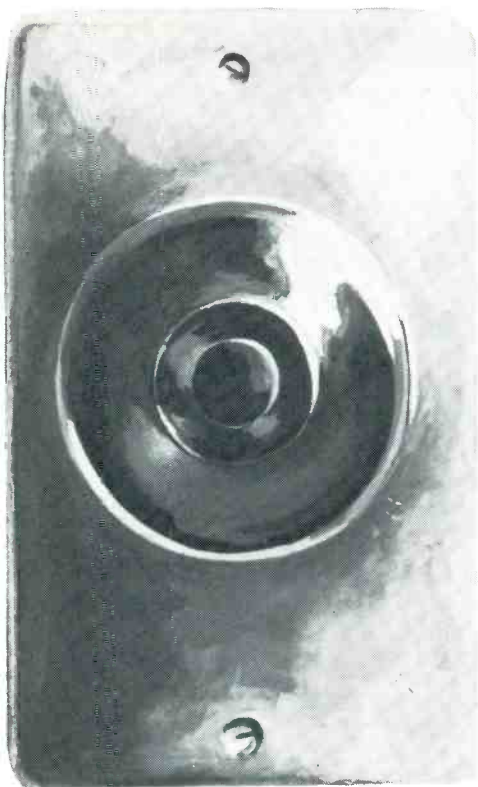
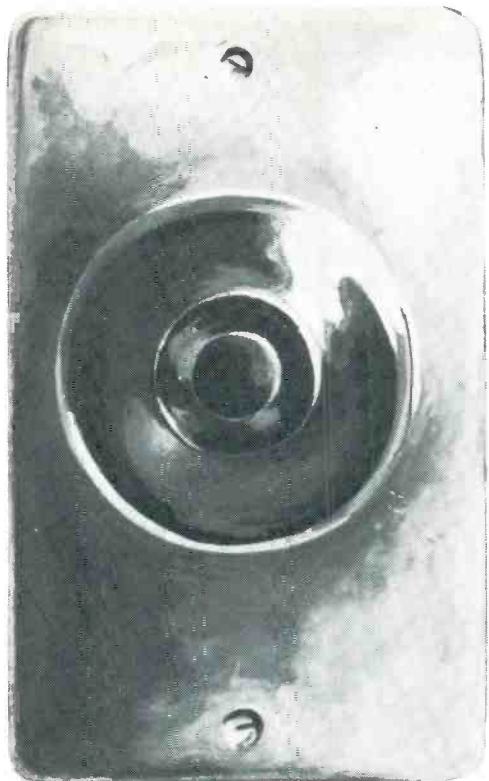

**“ONE  
LESS  
BELL”**

**ONE MORE  
BELL HIT!**



# **THE 5<sup>TH</sup> DIMENSION**

**“ONE LESS BELL TO ANSWER”**  
on Bell #B-940

Written by  
**BURT BACHARACH & HAL DAVID**  
Production & Sound by  
**BONES HOWE**

BELL RECORDS A Division of Columbia Pictures Industries, Inc.



# New Additions To Radio Playlists — Primary Markets

A broad view of the titles many of radio's key Top 40 stations added to their "Playlists" last week.

## WKBW—Buffalo

Engine #9—Wilson Pickett—Atlantic  
Little Will Spin And Spin—Chakra—Mediarts  
King Of Rock—Crow—Amaret  
Unite The World—Temptations—Gordy  
5-10-15-20—Presidents—Sussex

## WQAM—Miami

Heaven Help Us All—Stevie Wonder—Tamlia  
Engine #9—Wilson Pickett—Atlantic  
Let's Work Together—Canned Heat—Liberty  
Share The Land—Guess Who—RCA

## WTIX—New Orleans

It Don't Matter—Bread—Elektra  
Unite The World—Temptations—Gordy  
Montego Bay—Bobby Bloom—L&R/MGM  
Heaven Help Us All—Stevie Wonder—Tamlia  
Mama Mama—James Anderson—Cotillion

## WABC—New York

So Close—Jake Holmes—Polydor  
I Think I Love You—Partridge Family—Bell  
5-10-15-20—Presidents—Sussex  
Still Water—4 Tops—Motown  
LP: Carol—Rolling Stones—London  
LP: Immigrant Song/Bron-y-aur-Stomp—Led  
Zeppelin—Atlantic

## WLS—Chicago

Tears Of A Clown—Smokey Robinson—Tamlia  
Engine #9—Wilson Pickett—Atlantic  
Stand By Your Man—Candi Staton—Fame  
Heaven Help Us All—Stevie Wonder—Tamlia  
Be My Baby—Andy Kim—Steed  
Cry Me A River—Joe Cocker—A&M  
See Me Feel Me—The Who—Decca



**TONY BENNETT**

Starring At

**LONDON PALLADIUM**

October 26th—November 14th

## WQXI—Atlanta

Let's Work Together—Canned Heat—Liberty  
See Me, Feel Me—The Who—Decca  
Maggie—Redbone—Columbia  
Cry Me A River—Joe Cocker—A&M  
Share The Land—Guess Who—RCA

## WFIL—Philadelphia

After Midnight—Eric Clapton—Atco  
Engine #9—Wilson Pickett—Atlantic

## WDGY—Minneapolis

Tears Of A Clown—Smokey Robinson—Tamlia  
Heaven Help Us All—Stevie Wonder—Tamlia  
He Ain't Heavy—Neil Diamond—Uni  
Do It—Neil Diamond—Bang  
LP: Black Magic Woman/Gypsy Queen—  
Santana—Columbia

## CKLW—Detroit

Super Bad—James Brown—King  
See Me, Feel Me—The Who—Decca  
Deeper Deeper—Freda Payne—Invictus  
Heed The Call—Kenny Rogers—Reprise

## WIXY—Cleveland

Sweetheart—Engelbert Humperdinck—Parrot  
Tears Of A Clown—Smokey Robinson—Tamlia  
You Don't Have To Say—Elvis Presley—RCA  
I Don't Wanna Cry—Ronnie Dyson—Columbia  
Heaven Help Us All—Stevie Wonder—Tamlia  
I Am Somebody—Johnny Taylor—Stax

## WMPS—Memphis

Man Wife And Little Baby Daughter—Phil  
Flowers—Bell  
Stoned Love—Supremes—Motown  
It's All In My Mind—Clarence Carter—Atlantic

## WSAI—Cincinnati

Cry Me A River—Joe Cocker—A&M  
You Don't Have To Say—Elvis Presley—RCA  
5-10-15-20—Presidents—Sussex  
I Do Take You—Three Degrees—Roulette  
Heed The Call—Kenny Rogers—Reprise

1650  
BROADWAY  
Corner 51st Street

NOW AVAILABLE  
A FEW DESIRABLE  
AIR CONDITIONED OFFICES

**THE  
DILLIARD  
CORPORATION**

Miss E. Kunzman  
Plaza 7-4400

## WOKY—Milwaukee

No Matter What—Badfinger—Apple  
Be My Baby—Andy Kim—Steed  
Still Water—4 Tops—Motown

## KXOK—St. Louis

Yellow River—Christie—Epic  
You Don't Have To Say—Elvis Presley—RCA  
Hum Along And Dance—Temptations—Gordy  
Part Time Love—Ann Peebles—Hi  
I Am Somebody—Johnny Taylor—Stax  
Chains And Things—B. B. King—ABC

## WMAK—Nashville

It Don't Matter—Bread—Elektra  
Stand By Your Man—Candi Staton—Fame  
Patch It Up/You Don't Have To Say—Elvis  
Presley—RCA  
Sunset Strip—Ray Stevens—Barnaby  
See The Light—The Flame—Brother

## WEAM—Washington D.C.

Stoned Love—Supremes—Motown  
Brothers Keeper—Flaming Ember—Hot Wax  
No Matter What—Badfinger—Apple  
Who Needs You—Steppenwolf—Dunhill  
So Close—Jake Holmes—Polydor

## WMEX—Boston

Stoned Love—Supremes—Motown  
He Ain't Heavy—Neil Diamond—Uni  
Stand By Your Man—Candi Staton—Fame  
Me About You—Turtles—White Whale  
Steve Miller's Midnight Tango—Steve Miller  
Band—Capitol  
Grass Won't Pay—Mark Lindsay—Columbia

## WHB—Kansas City

I Don't Wanna Cry—Ronnie Dyson—Columbia  
King Of Rock—Crow—Amaret  
Who Needs You—Steppenwolf—Dunhill  
Easy Rider—Iron Butterfly—Atco  
This Is My Love Song—Intruders—Gamble  
Pick: Simply Call It Love—Gene Chandler—  
Mercury  
Pick: Don't Know—Gary Puckett—Columbia

## KILT—Houston

Pick: Be My Baby—Andy Kim—Steed  
Engine #9—Wilson Pickett—Atlantic  
Sweet Sweetheart—Bobby Vee—Liberty  
Chains And Things—B. B. King—ABC

## WRKO—Boston

Does Anybody Really Know What Time It Is—  
Chicago—Columbia  
Stand By Your Man—Candi Staton—Fame  
See Me, Feel Me—The Who—Decca  
Be My Baby—Andy Kim—Steed

## WKNR—Detroit

Tears Of A Clown—Smokey Robinson—Tamlia  
Now That I Have Found You—Santos—  
Evolution  
Be My Baby—Andy Kim—Steed  
No Matter What—Badfinger—Apple  
I Am Somebody—Johnny Taylor—Stax

## KQV—Pittsburgh

For The Good Times—Ray Price—Columbia  
Don't Matter—Bread—Elektra  
5-10-15-20—Presidents—Sussex  
Cry Me A River—Joe Cocker—A&M  
We Gotta Get You A Woman—Runt—Ampex

## WAYS—Charlotte

Sweet Sweetheart—Bobby Vee—Liberty  
Do It—Neil Diamond—Bang  
Stoned Love—Supremes—Motown  
Who Needs You—Steppenwolf—Dunhill  
Scratch My Back—Tony Joe White—Monument  
Heaven Help Us All—Stevie Wonder—Tamlia  
I Am Somebody—Johnny Taylor—Stax

## KFRC—San Francisco

Heaven Help Us All—Stevie Wonder—Tamlia

## KHJ—Hollywood

Stoned Love—Supremes—Motown  
I Think I Love You—Partridge Family—Bell  
Engine #9—Wilson Pickett—Atlantic  
Do It—Neil Diamond—Bang

## KYA—San Francisco

Tears Of A Clown—Smokey Robinson—Tamlia  
Domino—Van Morrison—Warner Bros.  
Montego Bay—Bobby Bloom—L&R/MGM  
Stand By Your Man—Candi Staton—Fame  
You Don't Have To Say—Elvis Presley—RCA

## KJR—Seattle

You Don't Have To Say—Elvis Presley—RCA  
No Matter What—Badfinger—Apple  
Be My Baby—Andy Kim—Steed  
Sweetheart—Engelbert Humperdinck—Parrot

## KXOA—Sacramento

Patch It Up—Elvis Presley—RCA  
Rose Garden—Lynn Anderson—Columbia  
Be My Baby—Andy Kim—Steed  
Sweet Sweetheart—Bobby Vee—Liberty  
Stony End—Barbra Streisand—Columbia  
Endlessly—Sonny James—Capitol  
Stand By Your Man—Candi Staton—Fame  
It's Impossible—Perry Como—RCA  
Still Water—4 Tops—Motown  
One Less Bell To Answer—5th Dimension—Bell

## KGB—San Diego

Still Water—4 Tops—Motown  
Domino—Van Morrison—Warner Bros.  
Stoned Love—Supremes—Motown

## WCAO—Baltimore

I Don't Wanna Cry—Ronnie Dyson—Columbia  
Stoned Love—Supremes—Motown  
I Gotta Let You Go—Martha Reeves—Gordy  
Let's Work Together—Canned Heat—Liberty  
I Just Don't Know—Gary Puckett—Columbia  
So Close—Jake Holmes—Polydor  
Heed The Call—Kenny Rogers—Reprise  
Share The Land—Guess Who—RCA  
Sweetheart—Engelbert Humperdinck—Parrot

## WAPE—Jacksonville

Indian Lady—Lou Christie—Buddah  
He Ain't Heavy—Neil Diamond—Uni  
You Don't Have To Say—Elvis Presley—RCA  
Brothers Keeper—Flaming Ember—Hot Wax  
5-10-15-20—Presidents—Sussex  
This World—Sweet Inspiration—Atlantic  
Rock Me In The Cradle—Glory Roads—Courtney  
Pick: Be My Baby—Andy Kim—Steed

## WIBG—Philadelphia

Grass Won't Pay—Mark Lindsay—Columbia  
After Midnight—Eric Clapton—Atco  
Help Me Find A Way—Little Anthony—U.A.

## KLIF—Dallas

Still Water—4 Tops—Motown  
Tears Of A Clown—Smokey Robinson—Tamlia  
You And I—Hunt & Hodges—Carla  
For A Friend—Bugaloos—Capitol  
Somebody's Been Sleeping—100 Proof—  
Hot Wax  
So Close—Jake Holmes—Polydor  
He Ain't Heavy—Neil Diamond—Uni  
Girl I've Got News For You—Mardi Gras—  
Map City  
See Me, Feel Me—The Who—Decca  
Mama—James Anderson—Cotillion

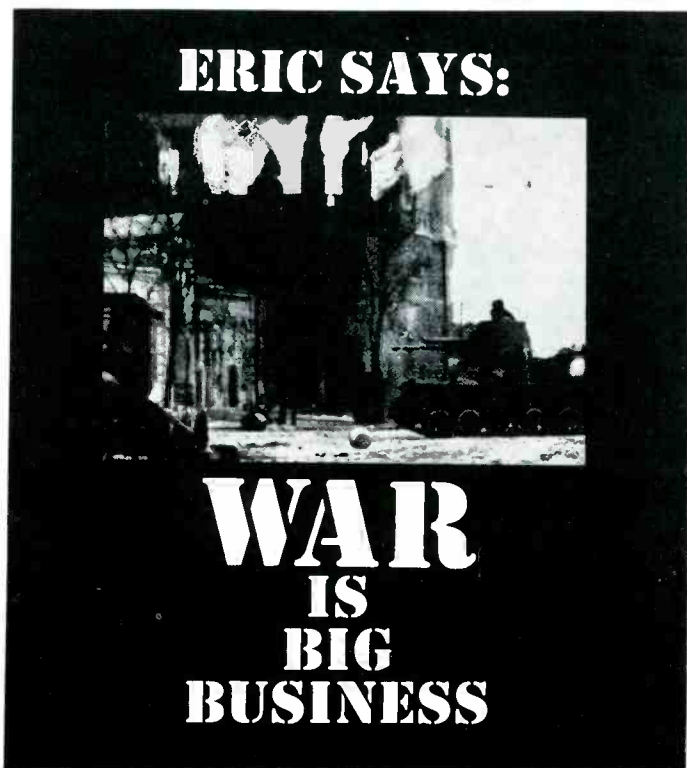

# Going somewhere in your mind???



## Stop off in Carolina.

Only James Taylor can sing a James Taylor song!

**WRONG!**

Have you heard the Crystal Mansion sing a James Taylor song? A lot of other people have. CAROLINA IN MY MIND broke out on seventy-six new stations this week. Are you one of them? Bill Gavin's reporters are calling CAROLINA IN MY MIND by the Crystal Mansion a hit. It's beautiful.

# CAROLINA IN MY MIND

## Crystal Mansion

C-128



Colossus Record Corporation,  
a division of Metro-Goldwyn-Mayer Inc.  
A presentation of Jerry Ross Productions, Inc.  
1855 Broadway, New York, N.Y. 10023.

# New Additions To Radio Playlists — Secondary Markets

A broad view of the titles many of radio's key Top 40 stations added to their "Playlists" last week.

**KIOA—Des Moines, Iowa**  
Share The Land—Guess Who—RCA  
Gypsy Woman—Brian Hyland—Uni  
You Don't Have To—Elvis Presley—RCA

**WPOP—Hartford, Conn.**  
So Close—Jake Holmes—Polydor  
He Ain't Heavy—Neil Diamond—Uni  
Only Love—Neil Young—Reprise  
Chains & Things—B. B. King—ABC  
Stoned Love—Supremes—Motown  
Carolina In My Mind—James Taylor—Warner Bros.  
Does Anybody Really Know—Chicago—Columbia  
Super Star—Cher—Atco  
Think About Your Children—Mary Hopkin—Apple

**KLEO—Wichita, Kansas**  
Tears Of A Clown—Smokey Robinson—Tamla  
The Juicer—Sweet—Paramount  
Sweet Sweetheart—Bobby Vee—Columbia  
Shape I'm In—Band—Capitol  
Heaven Help Us—Stevie Wonder—Tamla

**WKLO—Louisville, Ky.**  
Engine #9—Wilson Pickett—Atlantic  
Cry Me A River—Joe Cocker—A&M  
Let's Work Together—Canned Heat—Liberty  
Heed The Call—Kenny Rogers—Reprise  
Somebody's Been Sleeping—100 Proof—Hot Wax

**WHLO—Akron, Ohio**  
Heaven Help Us—Stevie Wonder—Tamla  
Share The Land—Guess Who—RCA  
Patch It Up/You Don't Have To—Elvis Presley—RCA  
I Don't Wanna Cry—Ronnie Dyson—Columbia  
PICK: Back To The River—Damnation Of Adam Blessing—U.A.

**WPRO—Providence, R.I.**  
Be My Baby—Andy Kim—Steed  
You Don't Have To—Elvis Presley—RCA  
5-10-15—Presidents—Sussex  
Jacobs Ladder—Doris Troy—Apple  
Easy Rider—Iron Butterfly—Atco  
We All Sung Together—Grin—Epic

**WING—Dayton, Ohio**  
Montego Bay—Bobby Bloom—MGM/L&R  
One Less Bell—5th Dimension—Bell  
You Don't Have To—Elvis Presley—RCA  
Share The Land—Guess Who—RCA  
King Of Rock & Roll—Crow—Amaret  
Heaven Help Us—Stevie Wonder—Tamla  
All In Your Mind—Clarence Carter—Atlantic  
Green River—Kenny Roberts—Starday—King

**WCOL—Columbus, Ohio**  
After Midnight—Eric Clapton—Atco  
Steel River—10 Pound Note—Evolution  
Be My Baby—Andy Kim—Steed  
My Brother's Keeper—Flaming Embers—Hot Wax  
King Of Rock & Roll—Amaret  
Me About You—Turtles—White Whale  
He Ain't Heavy—Neil Diamond—Uni  
Carolina In My Mind—Crystal Mansion—Colossus

**WGLI—Babylon, N.Y.**  
Cherry Cherry—Johnathon King—London  
I Was A Boy When You Needed A Man—Michael Allan—MGM  
Be My Baby—Andy Kim—Steed  
Chains & Things—B. B. King—ABC  
After Midnight—Eric Clapton—Atco  
Gypsy Woman—Brian Hyland—Uni  
Indian Lady—Lou Christie—Buddah  
So Close—Jake Holmes—Polydor  
Only Love—Neil Young—Reprise

**WKIX—Raleigh, N.C.**  
Heed The Call—Kenny Rogers—Reprise  
Montego Bay—Bobby Bloom—MGM/L&R  
Be My Baby—Andy Kim—Steed  
You Don't Have To—Elvis Presley—RCA  
No Matter What—Badfinger—Apple

**WDRC—Hartford, Conn.**  
Let's Work Together—Canned Heat—Liberty  
Does Anybody Really Know—Chicago—Columbia  
Engine #9—Wilson Pickett—Atlantic  
So Close—Jake Holmes—Polydor  
Be My Baby—Andy Kim—Steed  
One Less Bell—5th Dimension—Bell  
Who Needs You—Steppenwolf—Dunhill

**WJET—Erie, Pa.**  
All The Good Times—Classics IV—Liberty  
Super Bad—James Brown—King  
Let's Work Together—Canned Heat—Liberty  
Stand By Me—David & Jimmy Ruffin—Soul  
No Matter What—Badfinger—Apple  
One Less Bell—5th Dimension—Bell

**WFEC—Harrisburg, Pa.**  
Fresh Air—Quicksilver—Capitol  
Be My Baby—Andy Kim—Steed  
Only Love—Neil Young—Reprise  
Games—Redeye—Pentagram  
Carolina In My Mind—Crystal Mansion—Colossus  
Cathy Called—Eddie Holman—ABC

**WROV—Roanoke, Va.**  
You Don't Have To—Elvis Presley—RCA  
Share The Land—Guess Who—RCA  
Be My Baby—Andy Kim—Steed  
The Taker—Waylon Jennings—RCA  
Ten Pound Note—Steel River—Evolution  
LP CUTS:  
Take Me To The Pilot—Elton John—Uni  
All Right In The City—Dunn & McCashen—Capitol  
Country Road—James Taylor—Warner Bros.  
Southern Man—Neil Young—After The Gold Rush—Reprise  
Bus Rider—Guess Who—Share The Land—RCA

**WKWK—Wheeling, W. Va.**  
I Believe In Love—Kent Russell—Capitol  
My Brother's Keeper—Flaming Embers—Hot Wax  
Don't Stop Loving Me—Steam—Mercury  
Top 40 Love—Cashboard, Billbox & Young—Heritage  
Come With Me—Utopia Pkwy—U.A.  
Listen Here—Brian Auger—RCA  
I Still Got My Heart—Tony Burrows—Bell  
Little Wheel Spin—Chakara—Media Arts

**WTRY—Albany, Schenectady, Troy, N.Y.**  
I Think I Love You—Partridge Family—Bell  
PICKS: Me About You—Turtles—White Whale  
You Don't Have To—Elvis Presley—RCA  
Be My Baby—Andy Kim—Steed

**WLOF—Orlando, Fla.**  
Sweet Sweetheart—Bobby Vee—Columbia  
Me About You—Turtles—White Whale  
21st. Century Man—Johnny Winter—Columbia  
Who Needs You—Steppenwolf—Dunhill  
Sugarlady—Jordan Bros.—Jamie  
Maggie—Redbone—Epic

**WCRV—Washington, N.J.**  
Be My Baby—Andy Kim—Steed  
I Just Don't Know—Gary Puckett—Columbia  
The Secret—Yellow Brick Road—Laurie  
Me About You—Turtles—White Whale

**WIRL—Peoria, Ill.**  
Carolina In Your Mind—Crystal Mansion—Colossus  
Cry Me A River—Joe Cocker—A&M  
Heaven Help Us—Stevie Wonder—Tamla  
Montego Bay—Bobby Bloom—MGM/L&R  
Mongoose—Elephant's Memory—Metromedia  
LP: Partridge Family—Bell

**WLAV—Grand Rapids, Mich.**  
Patch It Up/You Don't Have To—Elvis Presley—RCA  
See Me Feel Me—Who—Decca  
Share The Land—Guess Who—RCA  
Make It Easy—Dionne Warwick—Scepter  
Now That I've Found You—Larry Santos—Evolution  
He Ain't Heavy—Neil Diamond—Uni

**KEYN—Wichita, Kansas**  
Spirit In The Dark—Dorothy Morrison—Buddah  
Silk Stone Mountain—Beautiful Day—Columbia  
Better Times—Reivers—Elektra  
Let's Work Together—Canned Heat—Liberty  
Going To Mexico—Steve Miller—Capitol  
If You Ever Leave Me Now—Maralyn Brown—Roulette

**WNHC—New Haven, Conn.**  
Cherry, Cherry—Johnathon King—London  
You Can Get It—Desmond Decker—Uni  
Stand By Your Man—Candi Staton—Fame

**WBAM—Montgomery, Ala.**  
Be My Baby—Andy Kim—Steed  
Little Wheel Spin—Chakara—Media Arts  
Burning Bridges—Mike Curb—MGM  
Me About You—Turtles—White Whale  
Mama Mama—James Anderson—Atco

## Elton John To U.S.; Second Album Near

NEW YORK — Elton John begins a national tour of the U. S. this week with performance dates slated for Boston, Providence, Philadelphia and Baltimore beginning Oct. 29. He will then move west for shows in San Francisco and Santa Monica, return for a weekend at Fillmore East in NYC and complete the tour with an Anaheim show, Dec. 4.

During the final week of his jaunt, Uni has scheduled release of his second LP, "Tumble Weed Connection." This will be the follow up to his current best seller, "Elton John."

## Yes 2nd LP Promo

NEW YORK — Brian Lane, chief executive with Hemdale, Ltd., will arrive in the United States on November 2 on the first leg of a special promotion tour to kick off "Time And A Word," the second album by Yes to be released in this country next week on Atlantic.

Lane will visit major radio stations throughout the country. The purpose of his trip is to aid both Atlantic and Yes in the promotion drive on their new album.

Additionally, plans are being made for Yes to tour England and Europe with the Iron Butterfly early next year.

## Band Tours

NEW YORK — After a long absence from the concert stage, Capitol recording artists The Band will embark on a fall tour beginning with concert dates at the University of Alabama on Oct. 30, and Ellis Auditorium, Memphis, on Oct. 31.

Their six-week tour of the southern circuit will be completed with the following concert dates: December 2—Austin, Texas Memorial Auditorium; Dallas Memorial Auditorium (4), Houston Music Hall (5), New Orleans, The Warehouse (6), Georgia Tech Coliseum (10), Jacksonville Civic Auditorium (11), Miami Beach Auditorium (12).

Preceding the southern jaunt, The Band will play the Spectrum in Philadelphia on November 8. The Coliseum in Madison, Wisc., (13), and the Syrian Mosque in Pittsburgh on (15).

## Scarbury To Lionel

Joey Scarbury, a 15 year old singer, has signed with Lionel through Bob and Jimmy Webb's Canopy Productions. Scarbury's first release on the label is "Mixed Up Guy".

## 3rd Boy To Lundvalls

NEW YORK — Kay and Bruce Lundvall, he's Columbia's vice president of merchandising, had their third boy last week. His name is Kurt Anders Lundvall, the baby brother of Eric and Tor.

## Announcing Bill Gavin's



## 5TH ANNUAL RADIO PROGRAM CONFERENCE

A Series of In-Depth 'Encounter' Discussions

November 20-21-22, 1970

Century Plaza Hotel  
Los Angeles, California

Principal Address:  
Commissioner Nicholas Johnson,  
Federal Communications Commission

Participation Information:  
Radio Program Conference  
114 Sansome Street, San Francisco 94104  
(415) 392-7750

(The Conference is a non-profit event; net proceeds are contributed to deserving public service organizations.)

a new album

# JOHN MAYALL



"Sugarcane" Harris  
Violin



Larry Taylor  
Bass Guitar



Harvey Mandel  
Lead Guitar

John Mayall is one of our most important artists not only in terms of sales but in terms of talent as well. USA-UNION is John's new album. Here's the story behind it in John's own words: "As there was a panic on at Polydor to come up with a new LP, I had to get on the telephone and pretty quickly round up a new band. I was very fortunate in that the three musicians I wanted were available. I was equally as excited because this would be the first time working with a band made up entirely of American musicians. The album was recorded on the nights of July 27th and 28th and the following 2 nights were spent in mixing and putting it all together to hand over to Polydor who breathed a sigh of relief in New York." John Mayall

## USA-UNION

(24-4022)



Polydor Records,  
Cassettes and 8-Track Cartridges  
in the USA by Polydor Inc.  
in Canada by Polydor Canada Ltd.

# RAYA

1. A BEAM OF LIGHT OR OTHER RADIANT ENERGY.

2. A MORAL OR INTELLECTUAL LIGHT.

3. THE ORIGINAL MUSICAL SUPER-STAR.

THE NEWEST RAY OF PURE GOLD...  
"IF YOU WERE MINE" ABC 11271

# RAY CHARLES

FROM HIS HIT ALBUM "LOVE COUNTRY STYLE" ABCS 707  
AN EXCLUSIVE TANGERINE RECORDING ARTIST  
DISTRIBUTED BY ABC/DUNHILL RECORDS



A PRODUCT OF  
TANGERINE RECORDS

ABC/DUNHILL RECORDS





# TOP 100 Albums

BOTTOM NO. INDICATES 8 AND 4 TRACK AND CASSETTE

- **ABRAXAS**  
SANTANA (Columbia KC 30130) 2  
(CA 30130) (CT 30130)
- 2 COSMO'S FACTORY**  
CREEDENCE CLEARWATER REVIVAL (Fantasy 842) 1
- **3 THIRD ALBUM**  
JACKSON 5 (Motown MS 718) 6  
(M8 1718) (M75 718)
- **4 SWEET BABY JAMES**  
JAMES TAYLOR (Warner Bros./7 Arts WS 1843) 5  
(8WM 1843) (CWX 1843)
- **5 LED ZEPPELIN III**  
(Atlantic SD 7201) 13  
(TP 7201) (CS 7201)
- **6 CLOSE TO YOU**  
CARPENTERS (A&M 4271) 8  
(8T 4271) (CS 4271)
- 7 A QUESTION OF BALANCE**  
THE MOODY BLUES (Threshold 3) 3
- **8 GET YER YA-YA'S OUT**  
ROLLING STONES (London NPS 5) 10  
(M72 176) (M57 176)
- 9 WOODSTOCK**  
ORIGINAL SOUNDTRACK (Cotillion SD3-500) 7  
(TP 33-500) (CS 33-500)
- 10 MAD DOGS & ENGLISHMEN**  
JOE COCKER A&M (SP 6002) 4  
(8T 6002) (CT 6002)
- 11 AFTER THE GOLD RUSH**  
NEIL YOUNG (Reprise RS 6383) 9  
(8RM 6383) (CRX 6383)
- 12 NEIL DIAMOND GOLD**  
(UNI 73084) 11  
(8-73084) (2-73084)
- 13 CHICAGO**  
(Columbia KSP 24) 12  
(18 BO 0858) (16 BO 1858)
- 14 STAGEFRIGHT**  
THE BAND (Capitol SW 425) 14  
(8XT 425) (4XT 425)
- 15 TOMMY**  
THE WHO (Decca DXSW 7205) 17  
(6-2500) (73-2500)
- 16 DEJA VU**  
CROSBY STILLS, NASH & YOUNG (Atlantic SD 7200) 16  
(TP 7200) (CS 7200)
- **17 FIRE AND WATER**  
FREE (A&M 4268) 22  
(8T 4268) (CS 4268)
- 18 HISTORICAL PERFORMANCES  
RECORDED AT THE MONTEREY  
INTERNATIONAL POP FESTIVAL**  
OTIS REDDING & THE JIMI HENDRIX EXPERIENCE (Reprise RS 2029) (8RM 2029) (CRX 2029) 18
- 19 TEMPTATIONS GREATEST HITS  
VOL. II**  
(Gordy GS 854) (G8 954) (T75 954) 20
- 20 CLOSER TO HOME**  
GRAND FUNK (Capitol SKAO 471) 23  
(8XT 471) (4XT 471)
- 21 BLOOD SWEAT & TEARS 3**  
(Columbia KS 30090) 21  
(CA 30090) (CT 30090)
- 22 SUGARLOAF**  
(Liberty LST 7640) 24
- 23 LIVE AT LEEDS**  
THE WHO (Decca DL 7975) 19  
(6-9175) (73-9175)
- 24 JOHN BARLEYCORN MUST DIE**  
TRAFFIC (United Artists UAS 5504) 27
- 25 STILL WATERS RUN DEEP**  
FOUR TOPS (Motown MS 704) 28  
(MS 1704) (MS 704)
- 26 ECOLOGY**  
RARE EARTH (Rare Earth RS 514) 26  
(R8 1514) (R75 514)
- 27 DIANA ROSS**  
(Motown MS 711) 15  
(M8 1711) (M75 711)
- **28 SHARE THE LAND**  
THE GUESS WHO (RCA LSP 4359) 39  
(P8S 1590) (PK 1590)
- 29 JAMES GANG RIDES AGAIN**  
(ABC ABCS 711) 29  
(8022-711 V) (5002-711 M)
- 30 ON THE WATERS**  
BREAD (Elektra EKS 74076) 31  
(ET8 4076) (TCS5-4076)
- **31 ELTON JOHN**  
(UNI 73090) 41  
(8 73090) (2 73090)
- **32 (UNTITLED)**  
THE BYRDS (Columbia G 30127) 40  
(CA 30127) (CT 30127)
- 33 THE GLEN CAMPBELL  
GOODTIME ALBUM**  
(Capitol SW 493) 37  
(8XT 493) (4XT 493)
- 34 SPIRIT IN THE DARK**  
ARETHA FRANKLIN (Atlantic SD 8265) 30  
(TP 8265) (CS 8265)
- **35 JAMES TAYLOR**  
(Apple SKAO 3352) (8XT 3352) (4XT 352) 48
- 36 CHAPTER 2**  
ROBERTA FLACK (Atlantic 1569) 33  
(TP 1569) (CS 1569)
- 37 LEFTOVER WINE**  
MELANIE (Buddah 5066) 25  
(M 85066) (M 55066)
- 38 THE SESAME STREET  
BOOK & RECORD**  
ORIGINAL TV CAST (Columbia CS 1069) 34  
(18 10 1069) (16 10 1069)
- 39 WAR & PEACE**  
EDWIN STARR (Gordy GS 948) 32  
(G8 1948) (G5 948)
- 40 SIGNED, SEALED, DELIVERED**  
STEVIE WONDER (Tamia TS 304) 35  
(T8 1304) (T75 304)
- 41 ERIC CLAPTON**  
(Atco SD 33-329) 38  
(TP 33-329) (CS 33-29)
- 42 JUST FOR LOVE**  
QUICKSILVER (Capitol ST 498) 42  
(8XT 498) (4XT 498)
- **43 U.S.A. UNION**  
JOHN MAYALL (Polydor 4022) 54  
(8F 4022) (F 4022)
- 44 HENDRIX BAND OF GYPSYS**  
JIMI HENDRIX (Capitol STAO 472) 49  
(8XT 472) (4XT 472)
- 45 ABC**  
JACKSON 5 (Motown MS 709) 50  
(M8 1709) (M75 709)
- 46 THE ISAAC HAYES MOVEMENT**  
(Enterprise ENS 1010) 53  
(ENE 1010) (ENC 1010)
- **47 WITH LOVE, BOBBY**  
BOBBY SHERMAN (Metromedia KMD 1032) 58  
(8090 1032) (5090 1032)
- 48 ABSOLUTELY LIVE**  
THE DOORS (Elektra EKS 9002) 36  
(T8 9002) (CT2 9002)
- 49 METAMORPHOSIS**  
IRON BUTTERFLY (Atco 339) 51  
(TP 339) (CS 339)
- 50 GET READY**  
RARE EARTH (Rare Earth RS 507) 52  
(R8 1507) (R75 507)
- 51 MUNGO JERRY**  
(Janus JXS 7000) 55
- 52 SEX MACHINE**  
JAMES BROWN (King KS 7-1115) 57
- **53 BEAUCOUPS OF BLUES**  
RINGO STARR (Apple SMAS 3368) 64  
(8XT 3368) (4XT 3368)
- 54 SNOWBIRD**  
ANNE MURRAY (Capitol ST 579) 60
- **55 THE PARTRIDGE FAMILY ALBUM**  
ORIGINAL TV CAST (Bell 6050) 77  
(8 6050) (5 6050)
- 56 THE BEST OF PETER, PAUL & MARY**  
(Warner Bros. BS 2552) 43  
(8WM 2552) (CWX 2552)
- 57 LET IT BE**  
BEATLES (Apple 3400) 46  
(8XT 3400) (4XT 3400)
- 58 NEIL DIAMOND'S GREATEST HITS**  
(Bang 219) 59
- 59 NEW WAYS BUT LOVE STAYS**  
SUPREMES (Motown M720) 62  
(M8 1720) (M75 720)
- **60 CURTIS**  
CURTIS MAYFIELD (Custom CRS 8005) 71
- 61 DON'T CRUSH THAT DWARF  
HAND ME THE PLIERS**  
FIRESIGN THEATRE (Columbia C30102) 63  
(CA 30102) (CT 30102)
- 62 SHILO**  
NEIL DIAMOND (Bang 221) 66
- 63 LOOKING IN**  
SAVOY BROWN (Parrot PAS 71042) 70  
(M79 842) (M79 642)
- 64 THE LAST POETS**  
THE LAST POETS (Douglas 3) 47
- 65 CHARLEY PRIDE'S 10th ALBUM**  
(RCA LSP 4367) 61  
(P8S 1593) (PK 1593)
- 66 FUTURE BLUES**  
CANNED HEAT (Liberty LST 11002) 68
- 67 WHY CAN'T I TOUCH YOU?**  
RONNIE DYSON (Columbia C 30223) 67  
(CA 30223) (CT 30223)
- **68 INDIANOLA MISSISSIPPI SEEDS**  
B. B. KING (ABC ABCS 713) 82
- 69 TO BONNIE FROM DELANEY**  
DELANEY & BONNIE & FRIENDS (Atco SD 341) 72  
(TP 341) (CS 341)
- 70 GYPSY**  
(Metromedia M2D 1031) 75  
(8090 1031M) (5090 1031)
- **71 WASHINGTON COUNTY**  
ARLO GUTHRIE (Reprise RS6411) (M86411) (M56411)
- 72 WORLDWIDE 50 GOLD AWARDS  
HITS, VOL. 1**  
ELVIS PRESLEY (RCA LPM 6401) 73  
(P8S 6401) (PK 6401)
- 73 SELF PORTRAIT**  
BOB DYLAN (Columbia C2X 30050) 79  
(C2A 30050) (C2T 30050)
- 74 BRIDGE OVER TROUBLED WATER**  
SIMON & GARFUNKEL (Columbia KCS 99-14) 81  
(18 10 0750) (14 10 0750) (16 10 0750)
- 75 THE BEGETTING OF THE PRESIDENT**  
ORSON WELLS (Mediarts 41-2) 45
- 76 HOT TUNA**  
(RCA LSP 4353) 44  
(P8S 1630) (PK 1630)
- 77 CACTUS**  
(Atco SD 33-340) 65  
(TP 33-340) (CS 33-340)
- 78 IN THE WAKE OF POSEIDON**  
KING CRIMSON (Atlantic 8266) 56  
(TP 8266) (CS 8266)
- **79 TELL IT ALL BROTHER**  
KENNY ROGERS & FIRST EDITION (Reprise RS 6412) 89  
(8 6412) (5 6412)
- **80 BLACK SABBATH**  
(Warner Bros. WS 1871) 92  
(CWX 1871) (8WM 1871)
- 81 MORE GOLDEN GRASS**  
GRASS ROOTS (Dunhill DS 50087) 87
- **82 EVERYBODY KNOWS THIS  
IS NOWHERE**  
NEIL YOUNG & CRAZY HORSE (Reprise RS 6349) 94  
(8 RM 6349) (CRX 6349)
- 83 McCARTNEY**  
PAUL McCARTNEY (Apple STAO 3363) 85  
(8XT 3363) (4XT 3363)
- 84 CLOSE TO YOU**  
JOHNNY MATHIS (Columbia C 30210) 69  
(CA 30210) (CT 30210)
- 85 WORKINGMAN'S DEAD**  
GRATEFUL DEAD (Warner Bros. WS 1869) 93  
(8WM 1869) (CWX 1869)
- **86 FOR THE GOOD TIMES**  
RAY PRICE (Columbia C 30106) (CA 30106) (CT 30106)
- 87 BLUE**  
MICHAEL PARKS (MGM SE 4717) 90
- 88 THE DELFONICS**  
(Philly Groove PG 1153) 80
- 89 GARY PUCKETT & THE UNION GAP'S  
GREATEST HITS**  
(Columbia CS 1042) 83  
(18 10 1042) (16 10 1042)
- 90 PATCHES**  
CLARENCE CARTER (Atlantic SD 8267) 97  
(TP 8267) (CS 8267)
- 91 SILVERBIRD**  
MARK LINDSAY (Columbia C 30111) 78  
(CA 30111) (CT 30111)
- 92 DEFROSTED**  
FRIJID PINK (Parrot PAS 71041) 98  
(M 79 841) (M79 641)
- 93 BAND OF GOLD**  
FREDA PAYNE (Invictus ST 7301) 74  
(8XT 7301) (4XT 7301)
- 94 BARREL**  
LEE MICHAELS (A&M 4249) 100  
(8T 4249) (CT 4249)
- 95 IT AIN'T EASY**  
THREE DOG NIGHT (Dunhill 50078) 76  
(8023-50078 V) (5023-50078 M)
- 96 THEM CHANGES**  
BUDDY MILES (Mercury SR 61280) 95
- 97 GULA MATARI**  
QUINCY JONES (A&M SP 3030) 101  
(8T 3030) (CS 3030)
- 98 ALONE TOGETHER**  
DAVE MASON (Blue Thumb BTS 19) 91  
(8075-19M) (5075-19M)
- 99 IF**  
(Capitol 539) (8XT 539) (4XT 539) 84
- 100 THE FIFTH DIMENSION  
GREATEST HITS**  
(Soul City SCS 33900) 88

# Basic Album Inventory

A check list of best selling pop albums other than those appearing on the CASH BOX Top 100 Album chart. Feature is designed to call wholesalers' & retailers' attention to key catalog, top steady selling LP's, as well as recent chart hits still going strong in sales. Information is supplied by manufacturers. This is a weekly revolving list presented in alphabetical order. It is advised that this card be kept until the list returns to this alphabetical section.

## LONDON GROUP

Tom Jones	It's Not Unusual	PAS 71004
Tom Jones	What's New Pussycat	PAS 71006
Tom Jones	Green, Green Grass Of Home	PAS 71009
Tom Jones	Funny, Familiar, Forgotten Feelings	PAS 71011
Engelbert Humperdinck	Release Me	PAS 71012
Willie Mitchell	Soul Serenade	SHL 32039
Ace Cannon	Incomparable Sax Of Ace Cannon	SHL 32043
Bill Black's Combo	Bill Black's Beat Goes On	SHL 32041
Procol Harum	A Whiter Shade Of Pale	DES 18008
Ten Years After	Ten Years After	DES 18009
Moody Blues	Days Of Future Passed	DES 18012
Engelbert Humperdinck	A Man Without Love	PAS 71022
Moody Blues	In Search Of A Lost Chord	DES 18017
Engelbert Humperdinck	The Last Waltz	PAS 71015
Tom Jones	Help Yourself	PAS 71025
Tom Jones	Fever Zone	PAS 71019
Ten Years After	Ten Years After Undead	DES 18016
Tom Jones	A-Tom-Ic Jones	PAS 71007
Tom Jones	Tom Jones Live!	PAS 71014
Engelbert Humperdinck	Engelbert	PAS 71026
Bill Black's Combo	Soulin' The Blues	SHL 32047
Willie Mitchell	On Top	SHL 32048
Moody Blues	Question of Balance	THS — 3
Tom Jones	Tom	XPAS 71037
Tom Jones	I Who Have Nothing	NPAS 71049
Engelbert Humperdinck	We Made It Happen	XPAS 71038
Savoy Brown	Raw Sienna	PAS 71036
Frijid Pink	Frijid Pink	PAS 71033
Frijid Pink	Defrosted	PAS 71041
Savoy Brown	Lookin' In	PAS 71042
Ten Years After	Cricklewood Green	DES 18038
Willie Mitchell	Robbins Nest	SHL 32058

## MACE

Othmar Schoeck	Concerto in B-Flat Major	
	Op. 21 for Violin and Orch./Concerto	
	Op. 65 for Horn and String Orch.	MCM/MCS 9047
Mozart	Piano Concerto No. 14 in E-Flat Major	MCM/MCS 9048
	Double Chorus Motets Of The Old Masters	MCM/MCS 9054
Helmut Walcha	Harpichord-Six French Suites Vol. 1	MCM/MCS 9072
Handel	Three Concerti	MCM/MCS 9063
Paul Hindemith	Sonata Op. 11, No. 4 for Viola & Piano	
	Sonata Op. 25, No. 1 for Viola, Unaccompanied	MCM/MCS 9075
Trio Sonatas of Bach	Elliott Rosoff: Violin; Andrew Lolya: Flute; Sally Babstansky: Cello; Roy Eaton: Piano	MCM/MCS 9076
Paganini	Sonata Concerta For Violin & Guitar	
	Marga Baml, Guitar/Walter Klasinc, Violin	M 9025
J. S. Bach	Six English Suites Vol. 2	MCM/MCS 9036
F. J. Haydn	Concerto in C-Major For Oboe And Orch. & Others	MCM/MCS 9040

## MAINSTREAM

Morganna King	With A Taste of Honey	6015
Featuring the Oud of John Berberian	Expressions East	6023
Carmen McRae	Second To None	6028
Lightning Hopkins	The Blues	6040
Oud Artistry Of John Berberian		6047
Sonny Terry & Brown McGhee	Home Town Blues	6049

Miss Morganna King		6052
Maurice Jarre-		
Orig. S.T.	The Collector	6053
Nono Rota-Orig. S.T.	Juliet Of The Spirits	6062
Clark Terry	Mumbles	6066
Jerry Goldsmith-		
Orig. S.T.	A Patch Of Blue	6068
Elmer Bernstein-		
Orig. S.T.	Walk On The Wild Side	6083
Carmen McRae	Alfie	6084
Gordon Jenkins & Orch.	Soul Of A People	6093
Big Brother & Holding Co.		
The Best Of		6099
Morganna King		6109
Amboy Dukes	Journey To The Center Of The Mind	6112
The Best Of Pete Jolly		6114
Amboy Dukes	Migration	6118

## MERCURY

Encore of Golden Hits	The Platters	SR60243
George Jones' Greatest Hits	George Jones	SR60621
Spanky and Our Gang	Spanky & Our Gang	SR61124
The Ice Man Cometh	Jerry Butler	SR61198
Spanky's Greatest Hits	Spanky & Our Gang	SR61227
Ice on Ice	Jerry Butler	SR61234
The Rod Stewart Album	Rod Stewart	SR61237
Taos	Taos	SR61257
Live At Sing Sing	Moms Mabley	SR61263
The Best Of Roy Drusky	Roy Drusky	SR61266
The Best of Faron Young	Faron Young	SR61267
The Best of Dave Dudley	Dave Dudley	SR61268
You and Me	Jerry Butler	SR61269
The 4 Seasons' Gold Vault of Hits	The 4 Seasons	PHS600-196
One Stormy Night	The Mystic Moods	PHS600-205
2nd Vault of Golden Hits	The 4 Seasons	PHS600-221
Blooming Hits	Paul Mauriat	PHS600-248
Dark Shadows	Original TV Music	PHS600-314
Blue Cheer	Blue Cheer	PHS600-333
Midnight Cowboy/Let The Sunshine In	Paul Mauriat	PHS600-337
Half and Half	The 4 Seasons	PHS600-341
Stormy Weekend	The Mystic Moods	PHS600-342
Edizone D'Oro (Gold Edition)	The 4 Seasons	PHS2-6501
Missa Luba	Les Troubadours du Roi Baudouin	PCC606
The Umbrellas Of Cherbourg	Michel Legrand	PCC616
Misa Criolla	Los Fronterizos	PCC619
Misa Flamenca/Misa Mozarabe	Various Artists	PCC623
Golden Hits	Roger Miller	SRS67073
She Even Woke Me Up To Say Goodbye	Jerry Lee Lewis	SRS67128
The Best of Jerry Lee Lewis	Jerry Lee Lewis	SRS67131
Black Orpheus	Original Soundtrack	SRF67520
Je T'Aime	Jane Birkin and Serge Gainsbourg	SRF67610

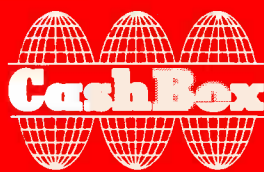

# TOP 100 Albums

101 TO 140

101	SUSAN SINGS SONGS FROM SESAME STREET (Scepter SPS 584)
102	LOVE COUNTRY STYLE Ray Charles (ABC-S 707) (8022-707v) (5022-70m)
103	STEPPENWOLF LIVE (Dunhill DSD 5075)
104	GASOLINE ALLEY Rod Stewart (Mercury SR 61264)
105	LIVE AT LONDON'S TALK OF THE TOWN Temptations (Gordy GS 953) (G8 1953) (G75 953)
106	MOUNTAIN CLIMBING Mountain (Windfall W-4501)
107	ERIC BURDON DECLARES WAR (MGM SE 4663)
108	NUMBER 5 Steve Miller Band (Capitol SKAO 436) (8XT 436) (4XT 436)
109	JOHNNY WINTER AND (Columbia C 30221) (CA 30221) (CT 30210)
110	CANDLES IN THE RAIN Melanie (Buddah BDS 5060) (M 85060) (M 55060)
111	DOWN HOME Seals & Crofts (T.A. 5004) (Bell) (8 5004) (5 5004)

112	JOE COCKER (A&M SP 4224) (BT 4224) (4T 4224) (CS 4224)
113	MY WOMAN, MY WOMAN, MY WIFE Dean Martin (Reprise RS 6403) (8RM 6403) (CRX 6403)
114	ON STAGE—FEBRUARY 1970 Elvis Presley (RCA LSP 4362) (P8S 1594) (PK 1594)
115	HERE COMES BOBBY Bobby Sherman (Metromedia 1028) (8090-1028 M) (5090-1028 M)
116	HAIR Original Cast (RCA Victor LSO 1150) (085-1038) (OK-1038)
117	MASHMAKHAN (Epic E 30235)
118	CHANGING TIMES Four Tops (Motown 721) (M 8-1721) (M 75-721)
119	LADIES OF THE CANYON Joni Mitchell (Reprise RS 6376) (8RM 6376) (CRX 6376)
120	MAKE IT EASY ON YOURSELF Burt Bachrach (A&M SP 4188) (8T 4188) (CT 4188)
121	NANCY'S GREATEST HITS Nancy Sinatra (Reprise RS 6409) (8 6409) (5 6409)

122	MUSIC FROM "DUTCH CASSIDY AND THE SUNDANCE KID" Burt Bachrach (A&M SP 4227) (8T 4227) (CT 4227)
123	REFLECTIONS The Lettermen (Capitol ST 496) (8 XT 496) (4 XT 496)
124	WILSON PICKETT IN PHILADELPHIA (Atlantic SD 8270) (TP 8270) (CS 8270)
125	ABBEY ROAD Beatles (Apple So 383) (8XT 383) (4XT 383)
126	JOE SOUTH'S GREATEST HITS (Capitol ST 450) (8 XT 450) (4XT 450)
127	DEEP PURPLE IN ROCK Warner Bros. WS 1 77) (8WM 1877) (CWX 1877)
128	BEFOUR (P&S 1600) (PK 1600) Brian Auger & The Trinity (RCA LSP 4372)
129	MAGNETIC SOUTH Michael Nesmith & First National Band (RCA LSP 4371) (P8S.....) (PK .....
130	SILK PURSE Linda Ronstadt (Capitol ST 407) (8 XT 407) (4 XT 407)

131	SOMETHING Shirley Bassey (UAS 6765)
132	WE MADE IT HAPPEN (Engelbert Humperdinck (Parrot XPAS 71038) (M 79838) (M 79638)
133	YARDBIRDS Yardbirds (Epic EG 30135) (EGA 30135) (EGT 30135)
134	OPEN ROAD Donovan (Epic E 30125) (A 30125) (ET 30125)
135	LAY A LITTLE LOVIN' ON ME Robin McNamara (Steed STS 37007) (ST8-37007) (STC 37007)
136	AMERICAN WOMAN The Guess Who (RCA RS 4266) (P8S 1518) (PK 1518)
137	RICK SINGS NELSON Decca DL 75236) (6 5236) (73 5236)
138	DINOSAUR SWAMP Flock (Columbia C 30007) (CA 30007) (CT 30007)
139	BITCHES BREW Miles Davis (Columbia GP 26) (18 BO 0908)
140	TOM Tom Jones (Parrot XPAS 70037) (M 79837) (M 79637)



# insight&sound



## NEW YORK — RICHARD NADER: ROCK 'N ROLL IS HERE TO STAY

The year is 1970, the place, Anywhere, USA. Seventeen year old Norman Noone turns on his favorite radio program and hears a few cuts from the new Led Zeppelin album—great! great! Following Zeppelin are the Beatles, the Who, a controversial Stones' LP cut, Creedence Clearwater Revival, and a new Beach Boys single. What an array of talent. Such creativity and imagination.

you don't remember me, but i remember you  
'twas not so long ago, you broke my heart in two

The year is 1953, the place, Anywhere, USA. Norman Noone was born. He doesn't have a favorite radio program, and the word "music" is as difficult for him to comprehend as the word "mama." Had Norman been able to intellectually comprehend music during his first years, he would have been introduced to the artists who are responsible for the very existence of our top rock acts today, in 1970.

i said the joint was rockin  
going round and round  
yeah, reelin and a rockin  
what a crazy sound  
and it never stopped rockin  
till the moon went down

Richard Nader is 29 years old. He too had a favorite radio program in 1953, and he knows who is responsible for starting rock 'n roll. He knows the truth about our rock acts today. He knows how original and creative they all—or aren't!

On Oct. 30, Richard Nader will produce his fourth successful Rock 'N Roll Revival. On that night, 18,000 people between the ages of 15 and 40 will come to Madison Square Garden to pay tribute to the founders of rock 'n roll. The youngsters come as curiosity seekers determined once and for all to find out what it's all about. The over 25 crowd comes because they know, and want for just another moment or two, a return, a pause, a time to reflect.

Nader takes his business seriously, and well he should. Many people feel that he has been reviving washed up groups so that he can capitalize on them, but anyone capable of putting together a show that leaves 18,000 people dancing and screaming in the aisles of Madison Square Garden, deserves a minimal reward for his efforts. Had it not been for Nader's honesty and determination,

(Cont'd on page 36)

## HOLLYWOOD—CLAP HANDS, HERE COMES CHARLIE

His name isn't Charlie. But we'll use it because it fits the headline. Also because he might be embarrassed by the publicity. Charlie is a songwriting friend of ours who used to make his living as a group therapist. He did get a song cut once (in '62) but it was never released. That's a whole other story. Almost as sad as this. Anyway, for a very brief interlude and due to one of those nutty flukes that can happen only in show biz, Charlie was a star sideman, a hit maker of major proportions.

His first date was with Sam Cooke and it was an historical event. Charlie had just happened to drop in with us at the old RCA studios on Sunset and Vine and Cooke was cutting a song about a "Saturday Night Party." Were there any hand-clappers in the studio, the A&R man asked. Nicholas Venet, also visiting the session, was willing. And Charlie said he'd like to try.

It turned out to be one of the most compelling hand-clap sides of all time. Some of the credit, of course, should go to Venet. But Charlie was inspired. The record, you may recall, raced to #1 on all the charts.

Word got around about Charlie's capabilities. Within a week he was rushed into a Dot session with Wink Martindale on vocal. This time Charlie was teamed with Joe Saracino, one of the better clappers in town. The song was titled "Big Building." You say you never heard of it? Well it was a really fine song and the arrangement was O.K. But it didn't sell five copies.

Was Charlie a one shot artist? Had he lost his touch? That's what the trade said. He hasn't worked a session since.

We lost track of Charlie over the years. Occasionally we'd run into guys who knew him. They said he had given up his therapy practice in favor of working night and day, perfecting his hand-clap craft. Hoping for a come-back.

The other day he dropped by our office, looking fifteen years older. His clothes were worn and dirty and he had a sty in his right eye. We couldn't help but notice that his hands were red, worn and chapped. Well, we just happened to be spinning the new Merry Clayton album as he entered. After the preliminary "hellos," we asked if he'd mind joining in on the second chorus of "Gimme Shelter." He was reluctant at first. Eventually, he agreed. His sty lit up and his hands went to work and I wish you could have been here. Maybe it's the acoustics in our office. But we could swear that he's better than ever; more relaxed, more self-assured, more compelling.

We're not musically informed enough to comment on whether Charlie is ready for the bigtime again. That's up to an A&R man with a heart. If there are any out there who could utilize Charlie's epidermoidal brand of genius, please get in touch with us.

It would be nice—on your next date—to have Charlie on hand.

**4 ACES, ONE QUEEN**—Our West Coast Girl of the Week is Patti Deutsch who, along with Michael Mislove, George Terry, Bill Saluga and Fred Willard makes up the Ace Trucking Company, the five accomplished lunatics found each week on the Tom Jones TV show. Michael is from Philadelphia. More important than that, he claims, is the fact that he got out. George Terry started in music by stealing instruments from his buddies. Bill Saluga is a former actor who made one film—a stag. "It was so terrible that it is surprising that it made it to 42nd Street." Fred Willard is a graduate of Second City. Patti has reddish hair and an indescribable voice. She hails from Pittsburgh, attended Carnegie Tech, wrote and starred in her revue (in Pittsburgh), wrote a sequel, said good-bye to school and arrived in N.Y. "I came to N.Y. in a revue that went into the Bon Soir. We closed

(Cont'd on page 36)

Richard Nader  
Humble Pie  
Patti Deutsch

## Pop Picks

### GREATEST HITS—Sly & The Family Stone—Epic KE 30325

Seems like there's been a Sly Stone Greatest Hits album around the corner for months on end, but no one seemed to know why it wasn't being released. But then when it comes to Sly nobody really knows what's happening next. Be that as it may with Sly 'G.H.' means: "I Want To Take You Higher," "Stand!," "Everyday People," "Hot Fun In The Summertime," "Everybody Is A Star," "M'lady," and so on. Gonna be a big one.



### WASHINGTON COUNTY—Arlo Guthrie—Reprise—6411

Arlo Guthrie who has amassed an incredible underground following since his "Alice's Restaurant" album, turns in another bright performance on this, his latest LP release. Over the past year, Arlo has emerged as a fine songwriter as well as a masterful singer. His haunting voice is most effective on "I Could Be Singing," "I Want To Be Around," "Valley To Pray," and Dylan's "Percy's Song." This new release by Arlo is his finest to date as record sales will soon indicate.



### STAINED GLASS MORNING—Scott McKenzie—Ode 70SP—77007

It's going to take quite a bit of doing for Scott McKenzie to overcome the broken promise of his first album. It's been a long time since we've heard from him but if that time was used in constructing this second LP then it was time well spent. Super producer David Anderle, responsible for the mystical, creeping production of the premier David Ackles set, has here allowed Scott much room to breath (something that was lacking in the first over-produced LP) and therefore "Stained Glass Morning" succeeds in letting us, for the first time, get a good, clear look at Scott's talent. The tone is sometimes country but only in the most eclectic way. A happy surprise and, by the way, the cover photography is splendid.

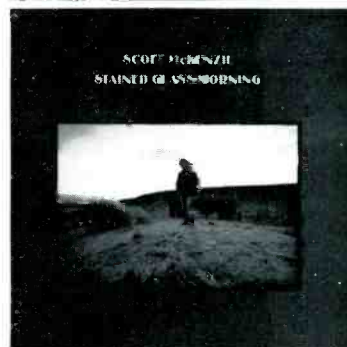

### NEW FEELIN'—Liza Minnelli—A&M—SP 4272

Liza Minnelli, sounding more like mom every day, puts together a beautiful package of standards guaranteed to warm your heart. Among the classics are "Stormy Weather," "Come Rain Or Come Shine," "Lazy Bones," "The Man I Love," "God Bless The Child," and "How Long Has This Been Going On." Liza belts them out from beginning to end on this, her most impressive album.

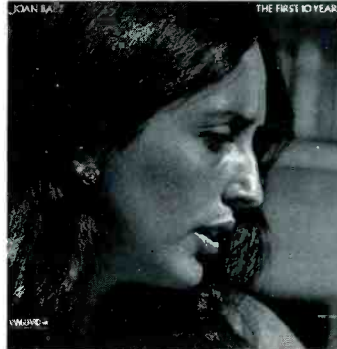

### THE FIRST TEN YEARS—Joan Baez—Vanguard 6560/1

With PP&M's first ten years already on sale can Joan's be far behind? Yet somehow, even though we grew up with these artists growing with us, this recounting of Joan's career 'til now is vastly more nostalgic. For whatever we think of Joan personally, with such songs as "Silver Dagger," "Love Is Just A Four-Letter Word," "There But For Fortune," "Carry It On," "Will The Circle Be Unbroken," and "Te Ador," reverberating one after another on this two-record set we can, on a grand scale, hear and feel Joan's total commitment to music and to life. This, then, is what it's about: American and British (with a touch of Portuguese folk music sung by one of the stellar talents of our time.

### WHOSE GARDEN WAS THIS—John Denver—RCA 4414

How nice to find an album that doesn't hit you over the head with noise or pseudo philosophy! This is far from John Denver's first LP, but it does represent an artist in flux and what emerges is a delicious set of relaxing songs far above the maddening crowd. "Whose Garden Was This," a Tom Paxton tune of warmth and grace has just been released as a single. "Eleanor Rigby" has been given a driving, superbly evil arrangement by Milt Okun and John's glowing vocals prove to be a perfect counterpoint to this: the Eternal Champion battling Chaos and Death. And Jaques Brel's "Old Folks" is splendidly rendered. A set of surpassing beauty.



### A POCKET FULL OF MIRACLES—Smokey Robinson and the Miracles—Tamla TS 306

Twelve soulful tracks highlight this new package from the Miracles. They've been around for a long time, but the Miracles are one of those groups that seem to get better with each new album release. "Flower Girl," "Get Ready," "Bridge Over Troubled Water," "Wishful Thinking," "Something/Something You Got," and "Who's Gonna Take The Blame," and six others comprise this delightful LP.

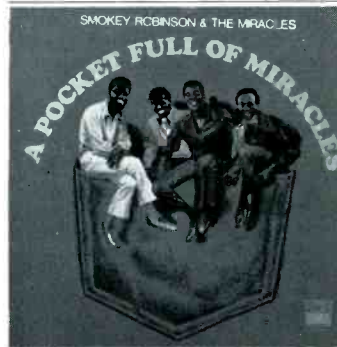

### DR. FOUNTAIN'S MAGICAL LICORICE STICK REMEDY FOR THE BLUES—Pete Fountain—Coral—CRL 757513

Pete's got the answer. A new formula to cure all your ills—well, maybe just your musical ones at that. Included along with the title tune are "Mississippi," "Licorice Stick Rag," "Sulphur And Molasses," "Everything Is Beautiful," "Passport To The Future," and five others which together make this Pete's best album to date.



### STEALING IN THE NAME OF THE LORD—Paul Kelly—Happy Tiger 1015

After the single which is the title track here, comes Paul Kelly's first album. It turns out to be far more than a followup to the hit. It immediately becomes an important release because it introduces both a singer and a writer of great merit for today and of tremendous potential for the future. Here is a man who is comfortable in both the single and album media. Pick up early on this one because Paul promises to be one of the finest talents to emerge this year. The entire LP is filled with moving commercial material sung with love and conviction. Yea! Score one for the good guys!



## Newcomer Picks

### FROM HERE TO MAMA ROSA — Chris Farlowe—Polydor 24-4041

Chris Farlowe's career has been, and still is, one of the most enigmatic of anyone in or out of rock music. Originally discovered by Mick Jagger, he was one of the initial signings to Andrew Loog Oldham's famous, but now defunct Immediate label, the first major independent rock label in Britain. Mick produced a number of his singles and albums and, with Keith Richard, wrote some songs especially for Chris, most notably "Ride On Baby." But because the musical ideas were too advanced even for Britain, he never really sold after his "Out Of Time" smash. Here then is a transitory stage in Chris' career. His voice is incredible: desperate and power-packed. It's like no one else. Chris has joined Colosseum now. Woosh!



## Pop Best Bets

### FABULOUS BROADWAY—Arthur Fiedler and the Boston Pops—Polydor—24—5003

Arthur Fiedler and the Boston Pops have played together for 41 seasons. This, however is their first album for their new label, Polydor; and it's a great one. On this magnificent new release, Fiedler combines selections from the scores of four classic Broadway plays, "Hair," "Company," "Fiddler On The Roof," and "Man Of La Mancha." The choice of these selections keeps Fiedler in the realm of contemporary music. Not bad for a 75 year old man!

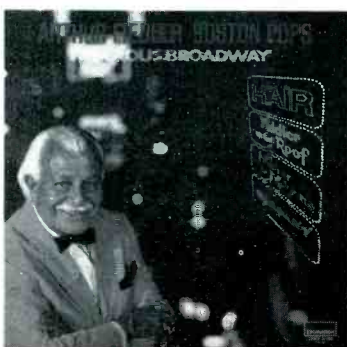

### A LITTLE BIT OF PAUL DAVIS—Paul Davis—Bang—BLPS 223

On the liner notes to this album, Jeff Barry wrote, "If you never get to meet Paul, this album is second best because it's all him..." Of the 10 tracks on the LP, seven were written by Paul, and the remaining three, "A Little Bit Of Soap," "Sally's Sayin' Something," and "Who's Gonna Love Me Tomorrow," are classics. Paul's voice is sharp and biting on all the tracks, and as a result, we find ourselves wanting a bit more.

# Lowery Presents 2nd Gold Clef Awards; Mary Tallent Named Group's Vice Pres.

NASHVILLE — Excitement greeted last Tuesday's (20) "Second Annual Gold Clef Awards" presentation by the Lowery Group of music publishing companies in Atlanta. From the moment Wade Pepper, national country promotion director for Capitol Records, introduced Bill Lowery, president of the Group, a crowd of several hundred music industry guests and friends applauded enthusiastically for the presentation of seven custom designed gold clefs, a special anniversary award for Tommy Roe, and the announcement of the appointment of Mary Tallent to the position of vice president and assistant to the president for the Lowery Group.

New custom designed clefs, created by the firm of Josten's Inc., were presented to song writers Joe South, Tommy Roe, Freddy Weller, Bill Gilmore, Robert Nix, and Ray Whitley for tunes placed in the top thirty on the nation's popularity charts during the previous twelve months. Grammy Award winner South was the only double clef recipient of the evening as he received the honors for "Walk A Mile In My Shoes" and "Don't It Make You Want To Go Home." Whitley received a Gold Clef for "What Kind Of Fool Do You Think I Am?" recorded by Bill Deal and the Rhondels. Roe and Weller received awards for their joint writing efforts on Roe's million-selling success, "Jam Up and Jelly Tight." Billy Joe Royal's Columbia recording of "Cherry Hill Park," brought writers

Robert Nix and Bill Gilmore clefs for their efforts.

A special feature of the evening's program was the presentation of a special plaque, commemorating the anniversary of Tommy Roe's ten years in the music industry. Lowery's award to Roe read in part: "A decade and 13 million records later, we honor and pay due respect to your unparalleled accomplishments in the music field."

A special surprise was sprung by BMI president Ed Cramer who made a special flight into Atlanta to not only attend the celebration, but also to personally deliver three awards to Lowery and his music group. The presentation cited the Lowery organization on three separate prizes for "outstanding contributions to the fields" in country, pop and "rock & roll" music.

## Tallent Appointment

Mary Tallent also received recognition when the announcement was made that she had been appointed vice president and assistant to the president of the Lowery Group of Music Publishing Companies. Mrs. Tallent has been with president Bill Lowery since his days as a disk jockey and voice of the Georgia Tech "Yellow Jackets" football network on WGST Radio in Atlanta. When he left radio to build his Atlanta music empire, Mrs. Tallent was his first employee.

## 10 Yrs. After Sets Nov. Dates

NEW YORK — Britain's Ten Years After, returning to the U. S. for a short tour of large arenas in major cities have set some of their November concert dates.

The popular group fly directly to Detroit to start their tour, November 11th & 12 at the East Town Theater and then fly to New York to play the main arena at Madison Square Garden (13). The scheduled dates are as follows: The Spectrum in Phila., Pa. (14), Southern Methodist in Dallas on the (16), Municipal Auditorium in San Antonio (17), Sam Houston Coliseum in Houston (18), Georgia Tech (19), the Syndrome in Chicago (20), Berkley Community Theater, (21), HIC Arena in Honolulu (22), The Arena in Seattle (25), and the San Diego Sports Arena (29).

## 'Abraxas' Golden

NEW YORK — Columbia recording group, Santana, have achieved a RIAA Certified Gold Record for their Columbia LP, "Abraxas," less than four weeks after the album's release, making it the second million-dollar-seller for the group. Their first Columbia LP, "Santana" was certified Gold last December, seven weeks after it was released.

## Cap Integrates Depts.

HOLLYWOOD — Dave Lawhon, v.p. of manufacturing and engineering of Capitol Records, has announced the integration of two formerly separate departments within Manufacturing.

Systems & Procedures and Manufacturing Data Processing are being combined into Manufacturing Data Processing & Systems; this move will result in increased efficiency and significant cost reduction.

Mark Lee, Manager of the former Systems & Procedures Department, will direct the new combined operation.

Lee's office is located at the Los Angeles plant and he will report directly to Dave Lawhon.

## Friel Joins Jerden Board

SEATTLE — Gerald Dennon, president of Jerden Industries, has announced that Richard Friel, former v.p. in charge of marketing for the Gates Learjet Corp., has joined the Board of Directors of Jerden Industries effective immediately.

Friel joins Robert Flick, Robert Ager and Dennon on the Jerden Board. Flick is a member of the world famous Brothers Four singing group and Ager is a Seattle attorney.

**ERIC SAYS:**

**WAR IS BIG BUSINESS**

## Klowns Are Coming Via RCA Promotions

NEW YORK — A major nationwide promotion campaign has been launched by RCA Records to introduce the first album and single by a new group, The Klowns, which will be introduced nationally when ABC-TV airs a special of the same name sponsored by Canada Dry on November 15.

The single, released this week, is "Lady Love" and "If You Can't Be a Clown," and the album is "The Klowns."

The group came to RCA Records via a production deal involving Irvin Feld, president of Ringling Brothers and Barnum & Baily Circus, and producer Jeff Barry. Barry produced all the music for The Klowns for the TV special with Sammy Davis, Jr., Jerry Lewis and Juliet Prowse.

RCA Records and Ringling Brothers and Barnum & Baily will host Klowns parties in Chicago, Detroit and Cleveland in conjunction with the opening in those cities of the Ringling Brothers and Barnum & Baily Circus. RCA Records will host additional parties in New York and Atlanta.

Announcement was made by Joe D'Imperio, Division Vice President of Popular Music, RCA Records.



**GOLDEN RAYS**—Larry Uttal (standing l.) president of Bell Records, presents a Gold disk for a million in sales to the writing/production team of "Candida" by Dawn. Standing next to Uttal (l. to r.) are Toni Wine and Irwin Levine co-writers and producer Phillip Margo. Seated are David Apple, Hank Medrass, Norman Bergen, and Jay Siegel.

**"Be My Baby"**

Produced by  
**Jeff Barry**

**Andy Kim**

**The Following Stations  
have added Andy's Smash**

ST-729

WFUN—Miami  
KILT—Houston  
WRKO—Boston  
WAYS—Charlotte

Distributed Nationally by Paramount Records

## Pop Best Bets

### ONLY FOR THE LONELY—Mavis Staples—Volt—VOS 6010

Mavis Staples is a brilliant songstress with an incredibly powerful voice. Listening to her perform on an album, one cannot help but feel that she is in fact performing live in your living room. "I Have Learned To Do Without You," "Endlessly," "Since I Fell For You," and "It Makes Me Wanna Cry," are among the more impressive cuts, but each is a gem in its own right. For Mavis, it's the second release in a bright, shining career.



### FEELING IS BELIEVING—Erroll Garner Mercury—SR 61308

Erroll Garner's fresh and creative piano style is captured superbly on his new Mercury LP release, "Feeling Is Believing." There are 10 tracks on the album, five of which were penned by Erroll himself. "For Once In My Life," "The Look Of Love," "Paisley Eyes," "The Loving Touch," and "Spinning Wheel," are among the more outstanding cuts.

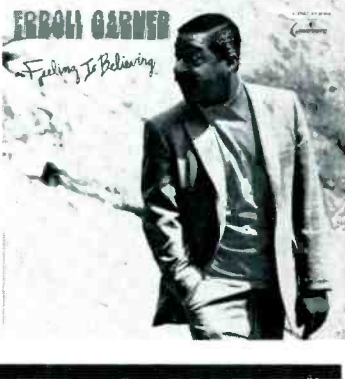

## Classical Picks



### THE COPLAND ALBUM—New York Philharmonic/Bernstein—Columbia MG 30071

The happiest release in Columbia's specially-priced double album series is "The Copland Album." There is literally no one to touch Leonard Bernstein's interpretation of that most American of composers Aaron Copland. "Appalachian Spring," "Billy The Kid," "El Salon Mexico," "Rodeo," and Dance from "Music For The Theater," are served up in splendid form. Here is where Bernstein shines, because there seems to be an emotional link between him and Copland which transforms the music into stellar sound. A must for any music collection.



### BOULEZ CONDUCTS BEETHOVEN—New Philharmonia Orch./John Aildis Choir—Columbia M 30085

It is already becoming apparent that the former enfant terrible of conducting, is well on his way to becoming one of the most renowned conductors of our time. He is now one of the most sensitive. As part of the Beethoven Bicentennial, this new release includes the Fifth Symphony, and the first stereo recording of the "Calm Sea and Prosperous Voyage," Cantata. Boulez proves with this recording that a Gallic soul can understand the Germanic spirit. A new Boulez recording is always a cause for joy, and this is no exception.



### THE BACH ALBUM—Philadelphia Orch./Ormandy—Columbia MG 30072

Part of a series of specially-priced albums (two LP's for little more than the price of one) this package includes Ormandy's fantastic version of Bach's "Tocatta and Fugue in D Minor," which he transcribed for orchestra from the original organ manuscript. Also included are "Sheep May Safely Graze," "Air On A G String," "A Mighty Fortress Is Our God," and the long "Tocatta, Adagio, and Fugue in C Major," also transcribed by Ormandy. Set is superb.



### PRIMA DONNA VOLUME 3—Leontyne Price—RCA LSC-3163

Subtitled "Great Soprano Arias from Gluck to Poulenc," this third set of arias by the phenomenal soprano Leontyne Price is just beautiful. Highlights of the package includes Gluck's "Aliceste: Divinites du Styx," Mozart "Don Giovanni: Non mi dir," Flotow "Martha: The Last Rose of Summer," Wagner "Die Walkure: Du bist der Lenz," Bizet "Carmen: Je dis que rien ne m'epouvante." Excellent selection for many a collection.

NEW YORK (Cont'd from page 33)

it." She has also done closed circuit TV. "They weren't meant to be closed circuit, but that's as far as they got." there would be no revivals, no tributes, and most important, no truth about our music today. No known roots; no starting point.

Many of the acts on previous Nader revival shows hadn't performed together in 15 years. Some were walking the streets, and others were pumping gas on the west coast. But Nader was determined to make it happen, and he did—in a big way. So great was the reaction to earlier Nader revivals, that a 28 city tour was planned with the very same artists that in earlier months couldn't find any work at all.

Nader is not an oldie—but goodie. He is completely atop the contemporary music scene, and just recently he produced Eric Burdon and War at the Felt Forum. He worked (between 1966-68) as a major booking agent for Premier Talent, handling Mitch Ryder, Herman's Hermits, Wayne Fontana and the Animals. He was later promoted to head the east coast division.

Today, because of Nader's determination, many of the revival acts are enjoying the best and most productive years of their lives. Most of them have received new recording contracts and already have albums on the market. They are beginning to guest on prime time television shows, and their concert booking price has just about quadrupled. In many instances, the revised booking prices have become so astronomical that, in a matter of time, Nader himself won't be able to book the very acts he brought back to life.

In short, Richard Nader has created a monster. But basically a friendly monster that is in many ways responsible for our Joe Cocker, Delaney and Bonnie, and Creedence Clearwater Revival, to name only a few. For this, we thank him. And thanks from Chuck, and Bo, and Richard, and Jackie, and Anthony, and . . .

kenny kerner

### HUMBLE PIE: SUCKING ON THE SWEET VINE

It was a rather blue Thursday, (sky wise) as we sat, legs crossed, passing cigarettes and cokes through the smoke filled room. No one spoke a word. Only vacant glances were apparent on our faces. Humble who?—I thought. What a strange name! Then the conversation began. . . .

"We've toured America before, but this is the first time everything was properly arranged" . . . "The audiences have really been beautiful, they really liked us." . . . "Touring is hectic, sure, but once you make time for everything, it's not so bad . . ."

Greg Ridley, Jerry Shirley, Peter Frampton, and Steve Marriott are Humble Pie. Their only concern as musicians is to make good music that lots of people will enjoy. Humble Pie was formed in 1968 when Frampton (then with The Herd) and Marriott (of The Small Faces) became disappointed with their groups and were on the lookout for something new and different. Enter, Jerry Shirley and Greg Ridley. Welcome, Humble Pie!

Humble Pie is not a hard rock group; nor are they an acoustic group. Rather, they blend the hard and the soft, the country and the folk, into their own unique style.

"It's hard to sit through an entire album of all rock music or all folk music, because after a while, it all begins to sound the same. You have to diversify the album to interest more people. . . ."

And so, with their own philosophy of music, and the release of their third album, Humble Pie continues on hoping to firmly implant their names in the minds of music lovers the world over.

HOLLYWOOD (Cont'd from page 33)

Patti is married to Donald Ross, one of the writers on the Tom Jones Show. "Ask me what it's like being the only girl among four guys?" "What's it like being the only girl among four guys?"

"As I think about it, I have renewed respect for Snow White."

QUICKIES—Jack Jones, in between his Chicago Palmer House engagement, sped into N.Y. for two days to cut two RCA sides—Teddy Randazzo's "I Didn't Count on Love" and Earl Wilson, Jr.'s song from Universal's "The Adding Machine," "How Small We Are, How Little We Know." . . . Chairman of the Board made their west coast nightery debut this past week at P.J.'s . . . Three Dog Nite travels to London this week for a performance at Royal Albert Hall—group's fifth LP due any moment . . . Johnny Farrow notes from Vegas that he has two songs in the new Mills Bros. LP—"I'm Sorry I answered the Phone" (which he wrote with George Goehring) and "No Turnin' Back," a Bee Walker-Nancy Leeds song published by Johnny . . . Farrow is repping music pubs in Vegas on an indie basis. He may be contacted at 3569 Sand Hill Rd., Las Vegas, Nevada 89109. Phone # is (702) 737-8752 . . . Composer Dave Grusin invited by the Brazilian Government to be one of the panel judges repping the U.S. at the Brazilian Song Festival, currently being held in Rio . . . Bobby Stevens and the Checkmates signed for a two week engagement at the Cal-Neva Lodge in Lake Tahoe, beginning this week . . . Miel Saan, former assistant publicity director on the west coast for Columbia Records, has joined Public Relations Associates (PRA).

harvey geller

CHICAGO—MGM's Michael Allen was a CB visitor last week, squired by Bob Ruttenberg of Royal Disc Dist. Michael has just begun a 72 city tour (this was his fourth stop!) to expose his new MGM single "I Was A Boy When You Needed A Man". His hectic Chicago schedule included a complete tour of the radio-TV circuit; an appearance at the MGM booth during the Music Operators of America convention in the Sherman House, and a performance at the MOA banquet show. Shortly after the first of the year he'll begin working on his first MGM album, to be recorded in England with Johnny Harris, who also produced and arranged the single . . . Marv Stuart of State & Madison Management (whose clients include the Impressions) announced the signing of two new groups: BGR from Toledo, Ohio and Seven, featuring Sandi, Susan and Greg Guidry. BGR have already waxed their first single for Scepter Records, produced by Marv and Curtis Mayfield. The Impressions, meanwhile, are in the midst of a three month tour of the south, which will include a November 25-29 engagement with Jerry Butler. They'll head back to Chicago 12/26 for an Auditorium Theater concert. Curtis Mayfield does the Auditorium on November 20 . . . Liberty-UA's Paul Diamond says the Shirley Bassey single "Something" is one of his biggest items . . . The Tones, local-based vocal instrumental group, have been held over for an unlimited stay at The Apartment in Elmwood Park.

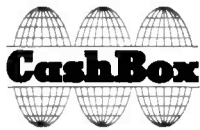

# Top 60 In R & B Locations

1	<b>I'LL BE THERE</b> Jackson 5 (Motown 1711)	1	31	<b>CHAINS &amp; THINGS</b> B. B. King (ABC 11280)	43
2	<b>CALL ME SUPER BAD</b> James Brown (King 6329)	7	32	<b>STAND BY ME</b> David & Jimmy Ruffin (Soul 35076)	40
3	<b>STAND BY YOUR MAN</b> Candi Staton (Fame 1472)	2	33	<b>A MESSAGE FROM THE METERS</b> Meters (Josie 1024)	21
4	<b>ENGINE #9</b> Wilson Pickett (Atlantic 2765)	12	34	<b>MAKE IT EASY ON YOURSELF</b> Dionne Warwick (Scepter 12294)	—
5	<b>STILL WATERS (LOVE)</b> Four Tops (Mowtown 1170)	3	35	<b>GET INTO SOMETHING</b> Isley Brothers (T-Neck 924)	35
6	<b>UNITE THE WORLD</b> Temptations (Gordy 7102)	9	36	<b>I'M NOT MY BROTHER'S KEEPER</b> Flaming Embers (Hot Wax 7006)	42
7	<b>I NEED HELP</b> Bobby Byrd (King 6323)	8	37	<b>BIG LEGGED WOMAN</b> Israel Tolbert (Waren 106)	—
8	<b>PART TIME LOVE</b> Ann Peebles (Hi 2178)	10	38	<b>I CAN'T GET NEXT TO YOU</b> Al Green (Hi 2182)	52
9	<b>DEEPER &amp; DEEPER</b> Freda Payne (Invictus 9080)	11	39	<b>MONEY MUSIC</b> Boys In The Band (Spring 106)	34
10	<b>I DO TAKE YOU</b> Three Degrees (Roulette 7088)	6	40	<b>LEAD ME ON</b> Gwen McCree (Columbia 4-45214)	59
11	<b>5-10-15-20-(25-30 YEARS OF LOVE)</b> Presidents (Sussex 207)	18	41	<b>THIS WORLD</b> Sweet Impressions (Atlantic 2750)	39
12	<b>SOMEBODY'S BEEN SLEEPING</b> 100 Proof (Hot Wax 71004)	4	42	<b>I DON'T WANNA CRY</b> Ronnie Dyson (Columbia 45240)	47
13	<b>EXPRESS YOURSELF</b> Watts 103rd St. Band (Warner Bros. 7417)	5	43	<b>DON'T PLAY THAT SONG</b> Aretha Franklin (Atlantic 2751)	28
14	<b>IF YOU WERE MINE</b> Ray Charles (ABC-Tangerine 11271)	16	44	<b>YOU GOTTA PUSH</b> Jody Gayles (Thomas Th 808)	—
15	<b>ONE LIGHT, TWO LIGHTS</b> Satisfactions (Lionel 3205)	22	45	<b>ACE OF SPADES</b> O. V. Wright (Back Beat 615)	56
16	<b>HEAVEN HELP US ALL</b> Stevie Wonder (Tamla 54200)	29	46	<b>TO THE OTHER MAN</b> Luther Ingram (Koko 2106)	51
17	<b>FUNKY MAN</b> Kool & Gang (De-lite 534)	19	47	<b>I DID IT</b> Barbara Aklin (Brunswick 55440)	50
18	<b>(BABY) TURN ON TO ME</b> Impressions (Curtom 1954)	13	48	<b>I WANT TO BE YOUR BABY</b> Jive 5 (Decca 32736)	49
19	<b>WHEN YOU GET RIGHT DOWN TO IT</b> Delphonics (Philly Groove 163)	14	49	<b>THIS IS MY LOVE SONG</b> Intruders (Gamble 4007)	—
20	<b>TIME WAITS FOR NO ONE</b> Friends of Distinction (RCA 0385)	24	50	<b>HEART ASSOCIATION</b> Emotions (Volt 4045)	53
21	<b>I STAND ACCUSED</b> Isaac Hayes (Enterprise 9017)	15	51	<b>LOSERS WEEPERS</b> Etta James (Cadet 5676)	37
22	<b>I AM SOMEBODY</b> Johnny Taylor (Stax 0078)	27	52	<b>FROM ATLANTA TO GOODBYE</b> Manhattans (Deluxe 129)	54
23	<b>THE TEARS OF A CLOWN</b> Smokey Robinson & Miracles (Tamla 54199)	36	53	<b>POURING WATER ON A DROWNING MAN</b> Otis Clay (Cotillion 44068)	—
24	<b>LOVE UPRISING</b> Otis Leavilli (Dakar 620)	17	54	<b>I JUST DON'T KNOW WHAT TO DO WITH MYSELF</b> Ciss Houston (Janus-J-131)	55
25	<b>LET ME BACK IN</b> Tyrone Davis (Dakar 621)	30	55	<b>MR. PREACHER MAN</b> Bobby Adams (Hometown 102A)	46
26	<b>LET ME TRY</b> Odds & Ends (Today 1001)	25	56	<b>WHEN LOVE CALLS</b> Darrow Fletcher (55244)	57
27	<b>AIN'T NO MOUNTAIN HIGH ENOUGH</b> Diana Ross (Mowtown 1169)	20	57	<b>CAN'T GET OVER LOSING YOU</b> Donnie Elbert (Rare Bullet 101)	60
28	<b>SEEMS LIKE I GOTTA DO WRONG</b> Whispers (Soul Clock 1004)	23	58	<b>KEEP ON LOVING ME</b> Bobby Bland (Duke 464)	—
29	<b>IF I DIDN'T CARE</b> Moments (Stang 5016)	25	59	<b>HELP ME FIND A WAY</b> Little Anthony & The Imperials (United Artists 50720)	—
30	<b>THAT'S THE WAY I WANT OUR LOVE</b> Joe Simon (Sound Stage 7-2667)	38	60	<b>YES WE CAN</b> Lee Dorsey (Polydor PD 14038)	—

# TOP HITS OF THE YEAR

PUBLICATION OF THE YEAR'S BIGGEST HITS TO DATE

Title of Song	Artists	Record Co.	Total
1	Spirit In The Sky—Norman Greenbaum—Reprise		141
2	ABC—Jackson 5—Motown		141
3	Band Of Gold—Freda Payne—Invictus		140
4	Get Ready—Rare Earth—Rare Earth		138
5	War—Edwin Starr—Gordy		137
6	Bridge Over Troubled Waters—Simon & Garfunkel—Columbia		135
7	Venus—Shocking Blue—Colossus		135
8	American Woman—Guess Who—RCA		134
9	Which Way You Goin' Billy?—Poppy Family—London		129
10	Let It Be—Beatles—Apple		129
11	Mama Told Me Not To Come—Three Dog Night—Dunhill		127
12	Ball Of Confusion—Temptations—Gordy		127
13	Spill The Wine—Eric Burdon—War—MGM		127
14	The Love You Save—Jackson 5—Motown		125
15	Raindrops Keep Falling—Scepter—B. J. Thomas		124
16	Close To You—Carpenters—A&M		120
17	Looking Out My Back Door—Creedence Clearwater Revival—Fantasy		120
18	Hey There Lonely Girl—Ed Holman—ABC		120
19	(Lay Down) Candles In The Rain—Melanie & Edwin Hawkins Singers—Buddah		118
20	Aint No Mountain High Enough—Diana Ross—Motown		117
21	Instant Karma—John Ono Lennon—Apple		117
22	No Time—Guess Who—RCA		116
23	Make It With You—Bread—Elektra		115
24	Signed, Sealed, Delivered I'm Yours—Stevie Wonder—Tamla		115
25	Patches—Clarence Carter—Atlantic		114
26	Everything's Beautiful—Ray Stevens—Barnaby		113
27	Something's Burning—Ken Rogers & First Edition—Reprise		113
28	Thank You—Sly & The Family Stone—Epic		112
29	Ride Captain Ride—Blues Image—Atco		111
30	In The Summertime—Mungo Jerry—Janus		111
31	Reflections Of My Life—Marmalade—London		110
32	Up Around The Bend—Creedence Clearwater Revival—Fantasy		110
33	I Want You Back—Jackson 5—Motown		110
34	Turn Back The Hands Of Time—Tyrone Davis—Dakar		109
35	Julie, Do Ya Love Me—Bobby Sherman—Metromedia		109
36	Love Grows—Edison Lighthouse—Bell		109
37	Rapper—Jaggerz—Kama Sutra		108
38	Long Winding Road—Beatles—Apple		105
39	O-O-H Child—Five Steps—Buddah		105
40	The Letter—Joe Cocker—A&M		105
41	House Of The Rising Sun—Frijid Pink—Parrot		103
42	Tighter & Tighter—Alive & Kicking—Roulette		101
43	Psychedelic Shack—The Temptations—Gordy		101
44	Come And Get It—Badfinger—Apple		101
45	Easy Come Easy Go—Bobby Sherman—Metromedia		100
46	Vehicle—Ides Of March—Warner Bros./7 Arts		99
47	25 Or 6 To 4—Chicago—Columbia		98
48	For The Love Of Him—Bobbi Martin—U.A.		96
49	Without Love—Tom Jones—Parrot		96
49	Cecilia—Simon & Garfunkel—Columbia		96

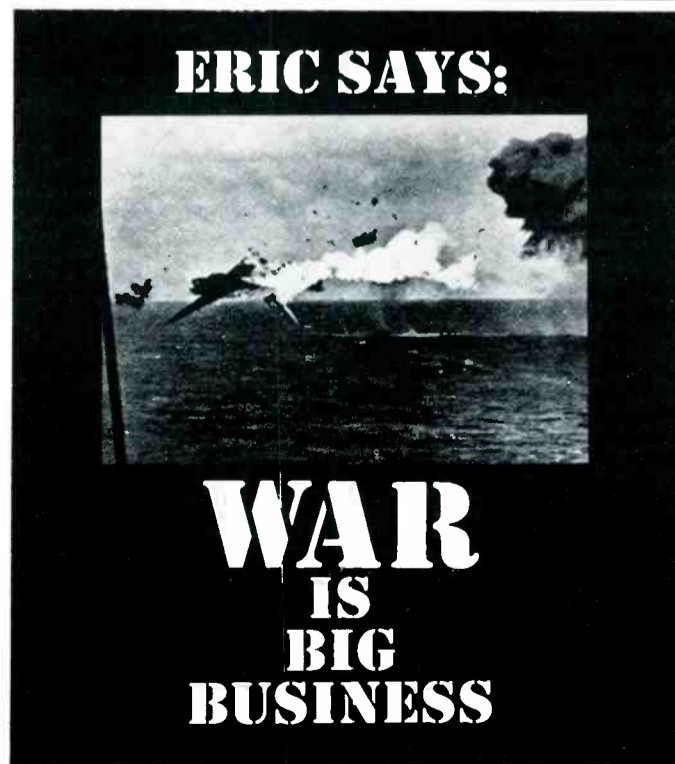

# Vital Statistics

DETAILED INFORMATION ABOUT TITLES ON THE CASH BOX TOP 100 THIS WEEK

- \* New To The Top 100**
- #1**  
**LL BE THERE (3:35)**  
Jackson Five-Motown 1171  
2457 Woodward Ave., Detroit, Mich.  
PROD: Hal Davis c/o Motown  
PUB: Jobete BMI (same address)  
WRITERS: B. Gordy Jr.-B. West-W. Hutch-H. Davis  
ARR: B. West FLIP: One More Chance
- #2**  
**WE'VE ONLY JUST BEGUN (3:04)**  
Carpenters-A&M 1217  
416 N La Brea, Hollywood, Calif.  
PROD: Jack Dougherty c/o A&M  
PUB: Irving BMI (same address)  
WRITERS: Paul Williams-Roger Nichols  
ARR: Richard Carpenter FLIP: All Of My Life
- #3**  
**ALL RIGHT NOW (4:14)**  
Free-A&M 206  
416 N La Brea, Hollywood, Calif.  
PUB: Irving BMI c/o A&M  
WRITERS: A. Fraser-P. Rogers  
FLIP: Mouthful Of Grass
- #4**  
**INDIANA WANTS ME (2:53)**  
Dean Taylor-Rare Earth 5013  
2457 Woodward Ave., Detroit, Mich.  
PROD: R. Dean Taylor c/o Rare Earth  
PUB: Jobete BMI (same address)  
WRITER: R. Dean Taylor  
ARR: David Van De Pitte-R. Dean Taylor  
FLIP: Love's Your Name
- #5**  
**GREEN EYED LADY (5:58)**  
Sugar Loaf-Liberty 56183  
2920 Sunset Blvd., Hollywood, Calif.  
PROD: Frank Slay (Liberty)  
PUB: Claridge-ASCAP  
PUB: 362 Hollywood Blvd., Hollywood, Calif.  
WRITERS: Jerry Corbetta, J. C. Phillips  
David Riardan  
FLIP: West Of Tomorrow
- #6**  
**FIRE AND RAIN (3:20)**  
James Taylor-Reprise 7423  
4000 Warner Blvd., Burbank, Calif.  
PROD: Peter Asher c/o Warner Bros.  
PUB: Blackwood BMI/Country Road BMI  
650 Bway, NYC.  
WRITER: J. Taylor FLIP: Anywhere Like Heaven
- #7**  
**CRACKLIN' ROSIE (2:47)**  
Neil Diamond-Uni 5520  
8255 Sunset Blvd., L.A. Calif.  
PROD: Tom Catalano 16715 Chermel Lane,  
Pac. Pal., Calif.  
PUB: Prophet ASCAP c/o Tom Catalano  
WRITER: N. Diamond ARR: Don Randi  
FLIP: Lordy
- #8**  
**LOLA (4:06) Kinks-Reprise 0930**  
4000 Warner Blvd., Burbank, Calif.  
PROD: Ray Davies c/o Reprise  
PUB: Hill & Range BMI 241 W 72 St., NYC.  
WRITER: R. Davies  
FLIP: Mindless Child Of Motherhood
- #9**  
**SOMEBODY'S BEEN SLEEPING (2:46)**  
100 Proof-Hot Wax 7004  
c/o Buddha 1650 Bway, NYC.  
PROD: G. Perry 2601 Cadillac Tower, Detroit,  
Mich.  
PUB: Goldforever BMI c/o G. Perry  
WRITERS: G. Perry-G. Johnson-A. Bond  
FLIP: I've Come To Save You
- #10**  
**LOOK WHAT THEY'VE DONE TO MY SONG (3:18)**  
New Seekers-Elektra 45699  
15 Columbia Circle, NYC.  
PROD: Dave McKay-Leon Henry Prod. Ltd.  
PUB: Kama Ripa/Amelaine ASCAP  
1650 Bway, NYC.  
WRITER: Melanie Safka  
FLIP: It's A Beautiful Day
- #11**  
**IT'S ONLY MAKE BELIEVE (2:21)**  
Glen Campbell-Capitol 2905  
1750 N Vine, L.A., Calif.  
PROD: Al DeLory c/o Capitol  
PUB: Marielle BMI 110 E 59 St. NYC.  
WRITERS: C. Twitty-J. Nace ARR: Al DeLory  
FLIP: Pave Your Way Into Tomorrow
- #12**  
**STILL WATER (LOVE) (2:58)**  
Four Tops-Motown 1170  
2457 Woodward Ave., Detroit, Mich.  
PROD: Frank Wilson c/o Motown  
PUB: Jobete BMI (same address)  
WRITERS: W. Robinson-F. Wilson  
ARR: Jerry Long-Jerry Roach  
FLIP: Still Water (Peace)
- #13**  
**IT DON'T MATTER TO ME (2:46)**  
Bread-Elektra 45701  
15 Columbus Circle, NYC.  
PROD: David Gates-Griffin-Rover c/o Elektra  
PUB: Screen Gems/Columbia BMI 711 5th Ave  
NYC.  
WRITER: D. Gates FLIP: Call On Me
- #14**  
**Simon & Garfunkel-Columbia 45237**  
**EL CONDOR PASA (3:06)**  
51 W 52 St. NYC.  
PROD: Simon & Garfunkel-Roy Halle  
c/o Columbia  
PUB: Charing Cross BMI 521 5th Ave, NYC.  
WRITER: Paul Simon ARR: Paul Simon  
FLIP: Why Don't You Write Me
- #15**  
**I THINK I LOVE YOU (2:28)**  
Partridge Family-Bell 910  
1776 Bway, NYC.  
PROD: Wes Farrell 3 E 54 St., NYC.  
PUB: Screen Gems/Columbia BMI 711 5th  
Ave, NYC. WRITER: Tony Romeo  
ARR: Billy Strange  
FLIP: Somebody Wants To Love You
- #16**  
**SUPER BAD Pt. 1 & Pt. 2 (4:04)**  
James Brown-King 6329  
1540 Brewster Ave., Cinn., Ohio  
PROD: James Brown c/o King  
PUB: Crited BMI (same address)  
WRITER: J. Brown  
FLIP: Super Bad Pt. 3
- #17**  
**GOD, LOVE ROCK AND ROLL (2:47)**  
Teegarden and Van Winkle-Westbound 170  
c/o Janus 1700 Bway, NYC.  
PROD: J. Cassily & Teegarden & Van Winkle  
14643 Joy Rd, Detroit, Mich.  
PUB: Bridgeport BMI c/o J. Cassily  
WRITERS: S. Knappe-D. Teegarden  
FLIP: Work Me Tomorrow
- #18**  
**SEE ME, FEEL ME (3:22)**  
The Who-Decca 32729  
445 Park Ave, NYC.  
PROD: Kif Lambert 58 Old Compton St. London  
W1 Eng.  
PUB: Track BMI 200 W 57 St. NYC.  
WRITER: Townsend  
FLIP: Overture From Tommy
- #19**  
**LUCRETIA MAC EVIL (3:05)**  
Blood Sweat Tears-Columbia 45235  
51 W 52 St. NYC.  
PROD: Bob Colomby-Roy Halle c/o Columbia  
PUB: Blackwood-Bay BMI 1650 Bway, NYC.  
WRITER: D. C. Thomas ARR: B. Halligan  
FLIP: Lucretia's Reprise
- #20**  
**OUR HOUSE (2:59)**  
Crosby Stills Nash Young-Atlantic 2760  
1841 Bway, NYC.  
PROD: Crosby Stills Nash Young c/o Atlantic  
PUB: Giving Room BMI 55 Liberty St., NYC.  
WRITER: Graham Nash FLIP: Deja Vu
- #21**  
**THE TEARS OF A CLOWN (2:56)**  
Smokey Robinson & Miracles-Tamla 54199  
2457 Woodward, Detroit, Mich.  
PROD: Henry Cosby-Smokey Robinson c/o  
Tamla PUB: Jobete BMI (same address)  
WRITERS: Cosby-Robinson-Wonder  
FLIP: Promise Me
- #22**  
**DEEPER, DEEPER (3:17)**  
Freda-Payne-Invictus 9080  
2601 Cadillac, Detroit, Mich.  
PROD: Holland-Dozier-Holland  
c/o Invictus  
PUB: Goldforever BMI (same address)  
WRITERS: N. Toney-R. Dunbar-E. Wayne  
FLIP: Unhooked Generation
- #23**  
**STAND BY YOUR MAN (2:43)**  
Candi Staton-Fame 1472  
1750 N Vine, L.A. Calif.  
PROD: Rick Hall c/o Fame  
PUB: Al Gallico BMI 101 W 55 St. NYC.  
WRITERS: B. Sherrill-T. Wynette  
FLIP: How Can I Put Out The Flame  
(When You Keep The Fire Burning)
- #24**  
**CRY ME A RIVER (3:50)**  
Joe Cocker-A&M 1200  
1416 N. La Brea, L.A., Calif.  
PROD: Denny Cordell-Leon Russell for Tarantula  
c/o A&M  
PUB: Saunders ASCAP 119 W 57 St., NYC.  
WRITER: Arthur Hamilton  
FLIP: Give Peace A Chance
- #25**  
**OUT IN THE COUNTRY (3:08)**  
3 Dog Night-Dunhill 4250  
8255 Bev. Blvd., L.A., Calif.  
PROD: Richard Podlor c/o Dunhill  
PUB: Irving BMI 1416 N La Brea, L.A., Calif.  
WRITERS: P. Williams-R. Nichols  
FLIP: Good Time Living
- #26**  
**HEAVEN HELP US ALL (3:07)**  
Stevie Wonder-Tamla 54200  
2457 Woodward Ave. Det. Mich.  
PROD: Ron Miller-Tom Baird (same address)  
PUB: Stein Van Stock ASCAP (same address)  
WRITER: R. Miller FLIP: I Got To Have A Song
- #27**  
**MAKE IT EASY ON YOURSELF (3:32)**  
Dionne Warwick-Scepter 12294  
254 W 54 St., NYC.  
PROD: Blue Jac 527 Mad. Ave., NYC.  
PUB: Famous BMI 1 Columbus Circle, NYC.  
WRITERS: B. Bacharach-H. David  
ARR: Larry Wilcox  
FLIP: Knowing When To Leave
- #28**  
**ENGINE #9 (2:46)**  
Wilson Pickett-Atlantic 2765  
1841 Bway, NYC.  
PROD: Staff for Gamble Huff 250 S. Broad St.  
Phila., Pa.  
PUB: Assorted BMI c/o Gamble Huff  
WRITERS: Gamble-Huff ARR: Bobby Martin  
FLIP: International Playboy
- #29**  
**EXPRESS YOURSELF (3:15)**  
Watts 103rd St. Rhythm Band-Warner Bros. 7417  
4000 Warner Blvd, Burbank, Calif.  
PROD: Chas. Wright  
PUB: Warner-Tamerlane BMI 6290 Sunset Blvd.  
PUB: Wright-Gerstl BMI 6321 Gilday Dr. H'wood  
Calif.  
WRITER: C. Wright  
ARR: C. Wright-Ray Jackson-Gabe Fleming  
FLIP: Living On Borrowed Time
- #30**  
**THAT'S WHERE I WENT WRONG (2:32)**  
Poppy Family-London 139  
539 W 25 St. NYC.  
PROD: Terry Jacks c/o London Records  
190 Graveline St. Laurent, Que. Canada.  
PUB: Gone Fishin BMI  
WRITER: T. Jacks  
FLIP: Shadows On My Wall
- #31**  
**MONTEGO BAY (2:53)**  
Bobby Bloom-MGM/L&R 157  
322 W 48 St., NYC.  
PROD: Jeff Barry c/o Unart  
PUB: Unart BMI 729 7th Ave., NYC.  
Cheezburger BMI c/o B. Bloom  
430 Pk Ave. S., NYC.  
WRITERS: J. Barry-B. Bloom  
FLIP: Try A Little Harder
- #32**  
**GYPSY WOMAN (2:32)**  
Brian Hyland-Uni 55240  
8255 Sunset Blvd., L.A. Calif.  
PROD: Del Shannon c/o Uni  
PUB: Certom BMI 79 W Monroe St. Chicago, Ill  
WRITER: C. Mayfield FLIP: You And Me (11)
- #33**  
**CANDIDA (3:02)**  
Dawn-Bell 903  
1776 Bway, NYC.  
PROD: Tokens & Dave Appell  
c/o Bright Tunes, 1697 Bway, NYC.  
PUB: Pocket Full Of Tunes & Jillbern BMI  
c/o Bright Tunes  
WRITERS: T. Wine-I Levine ARR: Norm Bergen  
FLIP: Look At
- #34**  
**YOU DON'T HAVE TO SAY YOU LOVE ME (2:29)**  
Elvis Presley-RCA 9916  
1133 Ave of the Americas, NYC.  
PUB: Miller ASCAP 1350 Ave of the Americas,  
NYC.  
WRITERS: Wickham-Napier Bell-Donaggio-  
Pallavianni  
FLIP: Patch It Up
- #35**  
**(I KNOW) I'M LOSING YOU (3:38)**  
Rare Earth-Rare Earth 5017  
c/o Motown 2457 Ave. Detroit, Mich.  
PROD: Norman Whitfield c/o Motown  
PUB: Jobete BMI (same address)  
WRITERS: Grant-Holland-Whitfield  
FLIP: When Joannie Smiles
- #36**  
**CLOSER TO HOME (5:30)**  
Grand Funk-Capitol 2877  
1750 N Vine, L.A., Calif.  
PROD: Terry Knight c/o Capitol  
PUB: Storybook BMI 720 5th Ave, NYC.  
WRITER: Mark Farner FLIP: Aimless Lady
- #37**  
**DO WHAT YOU WANNA DO (2:25)**  
5 Flights Up-TA 202  
c/o Bell 1776 Bway, NYC.  
PROD: John Florez c/o TA  
4024 Radford, Studio City, Calif.  
PUB: Brig-Tiny Tiger ASCAP 1619 Bway, NYC.  
WRITER: J. B. Bingham ARR: Ernie Freeman  
FLIP: Black Cat
- #38**  
**SWEETHEART (2:59)**  
Engelbert Humperdinck-Parrot 40054  
539 W 25 St. NYC.  
PROD: Peter Sullivan for Gordon Mills  
24-25 New Bond St. London W1 Eng.  
PUB: Casserole BMI 221 W 57 St. NYC.  
WRITERS: M. Gibb-E. Gibb  
FLIP: Born To Be Wanted
- #39**  
**YELLOW RIVER (2:40)**  
Christie-Epic 10626  
51 W 52 St., NYC.  
PROD: Mike Smith c/o Epic  
PUB: Norma BMI 241 W 72 St., NYC.  
WRITER: J. Christi  
FLIP: Down The Mississippi Line
- #40**  
**HEED THE CALL (3:17)**  
Kenny Rogers & The First Edition-Reprise 0953  
4000 Warner Blvd, Burbank, Calif.  
PROD: Jimmy Bowen-Kenny Rogers  
6565 Sunset Blvd, H'wood, Cal.  
PUB: Quill ASCAP 6565 Sunset Blvd, H'wood,  
Cal. WRITER: K. Vassy ARR: K. Rogers  
FLIP: A Stranger In My Place
- #41**  
**AND THE GRASS WON'T PAY NO MIND (3:16)**  
Mark Lindsay-Columbia 45229  
51 W 52 St., NYC.  
PROD: Jerry Fuller c/o Columbia  
PUB: Stonebridge ASCAP 350 5th Ave, NYC.  
WRITER: M. Diamond ARR: Artie Butler  
FLIP: Funny How Little Men Care

**Be My Baby**

Produced by  
Jeff Barry

**Andy Kim**

**The Following Stations  
have added Andy's Smash**

ST-729

WFUN—Miami  
KILT—Houston  
WRKO—Boston  
WAYS—Charlotte

STEED

Distributed Nationally by Paramount Records

# Vital Statistics

DETAILED INFORMATION ABOUT TITLES ON THE CASH BOX TOP 100 THIS WEEK

## \*New To The Top 100

**#42**  
JUST WANT TO KEEP IT TOGETHER (2:30)  
Paul Davis-Bang 579  
1650 Bway, NYC.  
PROD: Chips Moman 827 Thomas, Memphis, Tenn.  
PUB: Web IV BMI 1650 Bway, NYC.  
WRITER: P. Davis FLIP: Pollyana

**#43**  
PART TIME LOVE (2:48)  
Ann Peebles-Hi 2178  
539 W 25 St., NYC.  
PROD: Willie Mitchell c/o Hi  
PUB: Cireco BMI 855 Treat Ave., San Fran., Cal.  
Escort BMI 5613 57th Ave B., St. Petersburg, Fla.  
WRITER: C. Hammond FLIP: I Still Love You

**#44**  
AS YEARS GO BY (3:06)  
Mashmakhan-Epic 10634  
51 West 52 Street, NYC.  
PROD: Billy Jackson c/o Columbia  
PUB: Makhham BMI 1396 St. Catherine St. W  
Montreal, Can.  
WRITER: P. Senecal ARR: P. Senecal  
FLIP: Days When We Are Free

**#45**  
SO CLOSE (3:26)  
Jake Holmes-Polydor 14041  
1700 Bway, NYC.  
PROD: Eliot Mazer c/o Polydor  
PUB: Out Of Business Ltd-ASCAP  
c/o D. Wincor 745 5th Ave, NYC.  
WRITER: J. Holmes ARR: Ted Irwin  
FLIP: Django & Friend

**#46**  
5-10-15-20 (25-30 YEARS OF LOVE) (3:00)  
Presidents-Sussex 207  
c/o Buddah 1650 Bway, NYC.  
PROD: Van McCoy (same address)  
PUB: Van McCoy-Interior BMI (same address)  
WRITERS: T. Boyd-A. Powell ARR: Van McCoy  
FLIP: I'm Still Dancing

**#47**  
TIME WAITS FOR NO ONE (2:49)  
Friends Of Distinction-RCA 0385  
1133 Ave of the Americas, NYC.  
PROD: Cork, Jr. c/o RCA H'wood Calif.  
PUB: Kirshner BMI 655 Mad. Ave. NYC.  
WRITERS: Sedaka-Greenfield ARR: R. Cork, Jr.  
FLIP: New Mother Nature

**#48**  
UNGENA ZA ULIMEVENYU (Unite The World)  
Temptations-Gordy 7102  
2457 Woodward Ave., Det., Mich.  
PROD: Norman Whitfield (same address)  
PUB: Jobete BMI (same address)  
WRITERS: N. Whitfield-B. Strong  
ARR: David Van Dee Pitte

**#49**  
I AM SOMEBODY—2 (3:18)  
Johnnie Taylor-Stax 0078  
926 E. McLemore, Memphis, Tenn.  
PROD: Don Davis c/o Stax  
PUB: Groovesville BMI 19767 Ardmore, Det.,  
Mich.  
WRITER: A Snider FLIP: I Am Somebody—I

**#50**  
MONGOOSE (4:47)  
Elephant's Memory-Metromedia 182  
1700 Bway, NYC.  
PROD: Ted Cooper 3 #54 St. NYC.  
PUB: Pocket Full of Tunes BMI c/o Ted Cooper  
WRITERS: R. Frank-S. Bronstein  
FLIP: I Couldn't Dream

**#51**  
SNOWBIRD (2:08)  
Ann Murray-Capitol 2738  
1740 N Vine, L.A. Cal.  
PROD: Bryan Ahern c/o Capitol  
PUB: Beechwood BMI c/o Capitol  
WRITER: Gene MacLellan  
FLIP: Just Bidin' My Time

**#52**  
SHARE THE LAND (3:53)  
Guess Who-RCA 0388  
1133 Ave of the Americas, NYC.  
PROD: Nimbus 9 for Jack Richardson  
PUB: Dunbar BMI 1650 Bway, NYC.  
Cirrus BMI 131 Hazleton Ave, Tor. Ont. Can.  
Expressions BMI 41 Valley Brk. Dr. Don Mills,  
Ont. Can. WRITER: Cummings ARR: Winter  
FLIP: Bus Rider

**#53**  
LET ME BACK IN (2:40)  
Tyrone Davis-Dakar 621  
1841 Bway, NYC.  
PROD: Willie Henderson c/c Dakar  
PUB: Julio Brian BMI 445 Pk Ave, NYC.  
WRITER: Jean Dollison  
ARR: Tom Tom Washington-W. Henderson  
FLIP: Love Bones

**#54**  
JULIE, DO YA LOVE ME (2:52)  
Bobby Sherman-Metromedia 194  
1700 Bway, NYC.  
PROD: Jackie Mills 6430 Sunset Blvd. H'wood,  
Cal. PUB: Lucon/Sequel BMI c/o Jackie Mills  
WRITER: T. Bahles ARR: Al Capps  
FLIP: Spend Some Time Lovin' Me

**#55**  
LET'S WORK TOGETHER (2:45)  
Canned Heat-Liberty 56151  
6920 Sunset Blvd., L.A. Calif.  
PROD: Skip Taylor-Canned Heat c/o Liberty  
PUB: Mozzella BMI 58 W 58 St., NYC.  
WRITER: Wilbert Harrison FLIP: I'm Her Man

**#56**  
I DON'T WANNA CRY (3:00)  
Ronnie Dyson-Columbia 45240  
51 W 52 St. NYC.  
PROD: Billy Jackson c/o Columbia  
PUB: Ludix BMI 10 E 44 St. NYC.  
Befabim BMI 1271 6th Ave, NYC.  
WRITERS: L. Dixon-C. Jackson  
ARR: Jimmy Wisner FLIP: She's Gone

**#57**  
IT'S A SHAME (2:57)  
Spinners-V.I.P. 25057  
c/o Motown 2457 Woodward Ave, Det. Mich.  
PROD: Stevie Wonder c/o Motown  
PUB: Jobete BMI (same address)  
WRITERS: Wonder-Garret-Wright ARR: Paul  
Riser  
FLIP: Together We Can Make Such Sweet Music

**#58**  
IF YOU WERE MINE (2:49)  
Ray Charles-ABC/Tangerine 11271  
8255 Beverlv Blvd., L. A. Calif.  
PUB: Tangerine BMI 2107 W. Washington, L.A.,  
Calif.  
WRITER: Irving Lewis  
FLIP: Till I Can't Take It Any More

**#59**  
CHAINS AND THINGS (3:27)  
B. B. King-ABC 1280  
3255 Bev. Blvd. L.A. Cal.  
PROD: Bill Szymczyk c/o ABC  
PUB: Pamco c/o ABC BMI Sounds of Lucille BMI  
1414 Ave of the Americas, NYC.  
WRITERS: B. B. King-Dave Clark  
FLIP: King's Special

**#60**  
I JUST DON'T KNOW WHAT TO DO WITH  
MYSELF (2:57)  
Gary Puckett-Columbia 45249  
51 W 52 St. NYC.  
PROD: Richard Perry c/o Columbia  
PUB: 6121 Sunset Blvd. H'wood, Cal.  
PUB: U.S. Songs ASCAP 1619 Bway, NYC.  
Blue Seas/Jac ASCAP 15 E 48 St. NYC.  
Belinda Ltd. ASCAP  
WRITERS: Hal David-Burt Bacharach  
ARR: Artie Butler FLIP: All That Matters

**#61**  
WHEN YOU GET RIGHT DOWN TO IT (2:48)  
Delfonics-Philly Groove 163  
c/o Bell 1776 Bway, NYC.  
PROD: Stan & Bell Prod. c/o Bell  
Pub: Screen Gems/Columbia BMI 711 5th Ave,  
NYC.  
WRITER: B. Mann ARR: Thom Bell  
FLIP: I Gave To You

**#62**  
FOR THE GOOD TIMES (3:48)  
Ray Price-Columbia 45178  
51 W 52 St. NYC.  
PROD: Don Law 2016 Terrace Pl. Nashville, Tenn.  
PUB: Buckhorn BMI 806 16th Ave. S. Nashville,  
Tenn. WRITER: K. Kristofferson ARR: Cam Mul-  
lins FLIP: Grazin' In Green Pastures

**#63**  
AFTER MIDNIGHT (3:15) Eric Clapton-Atco  
6784  
1841 Bway, NYC.  
PROD: Delaney Bramlett by Robt. Stigwood  
London, Eng.  
PUB: Viva BMI 6922 H'wood Blvd. H'wood,  
Cal.  
WRITERS: John J. Cole ARR: D. Bramlett  
FLIP: Easy Now

**#64**  
SEEMS LIKE I GOTTA DO WRONG (2:45)  
Whispers-Soul Clock 1004  
c/o Canyon 1242 N Highland Ave, H'wood,  
Cal.  
PROD: Ron Carson c/o Canyon  
PUB: Wally Roker BMI c/o Canyon  
WRITERS: D. Ervine-Lynn Farr ARR: Art Freeman  
FLIP: Needle In A Hay Stack

**#65\***  
ONLY LOVE CAN BREAK YOUR HEART (3:13)  
Neil Young-Reprise 0958  
4000 Warner Blvd. Burbank, Cal.  
PROD: N. Young-David Briggs-Ken Dalltasio  
c/o Reprise BMI: Broken Arrow/Cotillion BMI  
1841 Bway, NYC. WRITER: N. Young FLIP: Birds

**#66**  
OUR WORLD (4:04)  
Blue Mink-Philips 40686  
35 E Wacker Dr., Chicago, Ill.  
PROD: Morgan Music Prod., London, England  
PUB: MRC BMI 110 W 57 St., NYC.  
WRITERS: Flowers-Pickett  
FLIP: Respects To Mr. Jones

**#67**  
I'M NOT MY BROTHER'S KEEPER (2:55)  
Flaming Ember-Hot Wax 7007  
c/o Buddah 1650 Bway, NYC.  
PROD: William Weatherspoon-Raynard Miner  
c/o Buddah  
PUB: Goldforever BMI 2601 Cadillac Tower, Det.,  
Mich.  
WRITERS: W. Weatherspoon-R. Miner-R. Dunbar  
FLIP: Deserted Village

**#68**  
STAND BY ME (3:20)  
David & Jimmy Ruffin-Soul 35076  
2457 Woodward Ave, Det. Mich.  
PROD: Frank Wilson c/o Soul  
PUB: Tro BMI 10 Col. Circle, NYC.  
WRITERS: King-Glick  
ARR: Willie Shorter-Tom Braid  
FLIP: Your Love Was Worth Waiting For

**#69**  
LOVE UPRISING (2:38)  
Otis Leavill-Dakar 620  
1841 Bway, NYC.  
PROD: W. Henderson c/o Dakar  
PUB: Julio Brian BMI 445 Pk Ave, NYC.  
WRITER: Eugene Record ARR: Tom Tom  
Washington  
FLIP: I Need You

**#70**  
ONE LESS BELL TO ANSWER (3:29)  
5th Dimension-Bell 940  
1776 Bway, NYC.  
PROD: Bones Howe 8833 Sunset Blvd. L.A. Cal.  
PUB: Blue Seas/Jac ASCAP 15 E 48 St. NYC.  
WRITERS: Burt Bacharach-Hal David  
ARR: Bob Alcivar-Bill Holman-B. Howe  
FLIP: Feelin' Alright

**#71**  
FRESH AIR (5:20) Quicksilver Messenger  
Service  
Capitol 2920  
1750 N Vine, L.A. Cal.  
PROD: John Paladino c/o Capitol  
PUB: Quicksilver BMI 221 W 57 St. NYC.  
WRITER: Jesse Oris Farrow  
FLIP: Freeway Flier

**#72\***  
I NEED HELP (I CAN'T DO IT ALONE) (3:55)  
Bobby Byrd-King 6323  
1540 Brewster Ave, Cinn. Ohio.  
PROD: James Brown c/o King  
PUB: Crited BMI (same address)  
WRITER: Teddy Brown FLIP: I Need Help  
(I Can't Do It Alone) Pt. 2

**#73\***  
BE MY BABY (2:59)  
Andy Kim-Steed 729  
Gulf & Western Bldg. 1 Col. Cir. NYC.  
PROD: Jeff Barry 137 W 52 St. NYC.  
PUB: Trio BMI 1619 Bway, NYC.  
Mother Bertha BMI 9130 Sunset Blvd. L.A. Cal.  
WRITERS: Barry-Greenwich-Spector  
FLIP: Love That Little Woman

**#74**  
JERUSALEM (2:30) Herb Alpert & Tijuana Brass-  
A&M 1225  
1416 N La Brea, H'wood, Cal.  
PROD: H. Alpert-J. Moss-Larry Levine c/o A&M  
PUB: Almo ASCAP c/o A&M  
WRITER: H. Alpert ARR: H. Alpert  
FLIP: Strike Up The Band

**#75**  
INDIAN LADY (3:00)  
Lou Christie-Buddah 192  
1650 Bway, NYC.  
PROD: Stan Vincent 300 W 55 St. NYC.  
PUB: Sleeping Sun BMI c/o Buddah  
WRITER: S. Vincent ARR: S. Vincent  
FLIP: Glory River

**#76**  
SIMPLY CALL IT LOVE (2:35)  
Gene Chandler-Mercury 73121  
35 E. Wacker Dr., Chi., Ill.  
PROD: Gene Chandler c/o Mercury  
PUB: Cashand BMI  
WRITERS: J. Thompson-E. Dixon  
ARR: Tom Washington  
FLIP: Give Me A Chance

**#77**  
CAROLINA ON MY MIND (3:20)  
Crystal Mansion-Colossus 128  
1855 Bway, NYC.  
PROD: David White-Crystal Mansion c/o  
Artie Kaplan  
PUB: Blackwood BMI 1650 Bway, NYC. Country  
Road BMI WRITER: James Taylor  
ARR: A. Gorgoni FLIP: If I Live

**#78**  
LOSERS WEEPERS (2:56)  
Etta James-Cadet 5676  
1301 Ave. of the Americas, NYC.  
PROD: G. Barge-R. Bass 320 E 21st St., Chi., Ill.  
PUB: Heavy BMI WRITER: L. D. Bonds  
ARR: Gene Barge FLIP: Weepers

**#79**  
NO MATTER WHAT (2:57)  
Badfinger-Apple 1822  
1700 Bway, NYC.  
PROD: Mal Evans c/o Apple  
PUB: Apple ASCAP 110 E 59 St. NYC.  
WRITER: Peter Ham FLIP: Carry On Till  
Tomorrow

**#80**  
THIS IS MY LOVE SONG (2:55)  
Intruders-Gamble 4007  
1650 Bway, NYC.  
PROD: Gamble Huff 250 S Broad St., Phila, Pa.  
PUB: Assorted BMI c/o Gamble Huff  
WRITERS: K. Gamble-L. Huff ARR: Bobby Martin  
FLIP: Let Me In Your Mind

**#81**  
WOODSTOCK (2:15) Assembled Multitude-  
Atlantic 2764  
1841 Bway, NYC.  
PROD: Bill Buster-Tom Sellers c/o Atlantic  
PUB: Siquomb BMI 55 Liberty St. NYC.  
WRITER: Joni Mitchell ARR: Tom Sellers  
FLIP: Mr. Peppercorn

**#82**  
KING OF ROCK AND ROLL (2:29)  
Crow-Amaret 125  
1717 N Highland, H'wood Cal.  
PROD: Bob Monaco c/o Dunwich 25 E. Chestnut,  
Chi, Ill.  
PUB: Hastings BMI 7165 Sunset Blvd. H'wood  
Cal. WRITER: Jeff Thomas FLIP: Satisfied

**#83**  
I'M BETTER OFF WITHOUT YOU (3:07)  
Main Ingredient-RCA 0382  
1133 Ave of the Americas, NYC.  
PROD: Sylvester-Simmons-McPherson  
Buzz Willis c/o RCA  
PUB: Clarara BMI 37 W 57 St. NYC.  
WRITERS: Sylvester-Simmons-McPherson  
ARR: Bert Decoaux  
FLIP: Need Her Love (Mr. Bugler)

**#84\***  
STONED LOVE (2:49)  
Supremes-Motown 1172  
2457 Woodward Ave, Det. Mich.  
PROD: Frank Wilson c/o Motown  
PUB: Jobete BMI (same address)  
WRITERS: F. Wilson-Y. Samoht ARR: David  
Van Pitte FLIP: Shine On Me

**#85\***  
GROOVE ME (3:04)  
King Floyd-Chimneyville 435  
c/o Atlantic 1841 Bway, NYC.  
PROD: E. Walker for Malaco c/o Malaco  
PUB: Malaco BMI P.O. Bx 1552 Jackson, Miss.  
Roffignoc BMI WRITER: King Floyd  
ARR: Wardell Quezergue FLIP: What Our  
Love Needs

**#86**  
STONE END (2:57)  
Barbara Streisand-Columbia 45236  
51 W 52 St. NYC.  
PROD: Richard Perry c/o Columbia, H'wood,  
Cal.  
PUB: Tuna Fish BMI 555 Mad. Ave, NYC.  
WRITER: Laura Nyro ARR: Gene Page  
FLIP: I'll Be Home

**#87**  
WHERE DID ALL THE GOOD TIMES GO (2:34)  
Dennis Yost & The Classics IV-Liberty 56200  
6920 Sunset Blvd., L.A. Cal.  
PROD: Buddy Buie P.O. Bx 9687 Atlanta, Ga.  
PUB: Low Sal BMI c/o Buddy Buie  
WRITERS: Buie-Cobb ARR: Larry Goss  
FLIP: Ain't It The Truth

**#88**  
TIME TO KILL (3:58) The Band-Capitol  
2870  
1750 N Vine, H'wood, Cal.  
PROD: John Paladino c/o Capitol  
PUB: Canaan ASCAP 75 E 55 St. NYC.  
WRITER: Robbie Robertson  
FLIP: The Shape I'm In

**#89\***  
SUNSET STRIP (3:35)  
Ray Stevens-Barnaby 2021  
51 W. 52 St. NYC.  
PROD: Ray Stevens for Ahab  
PUB: Ahab BMI Route 7 Meadowgreen Dr.  
Franklin, Tenn. WRITER: R. Stevens  
FLIP: Islands

**#90**  
THE TAKER (2:28) Waylon Jennings-RCA 9885  
1133 Ave of the Americas, NYC.  
PROD: Danny Davis c/o RCA Nashville, Tenn.  
PUB: Combine BMI 530 W. Main St.,  
Hendersonville, Tenn.  
WRITERS: Kris Kristofferson Shel Silverstein  
FLIP: Shadow Of The Gallows

**#91**  
SOMETHING (3:31) Shirley Bassey-U. A. 50698  
6920 Sunset Blvd., L.A. Cal.  
PROD: Johnny Harris-Tony Colton c/o U. A.  
PUB: Harris Songs BMI 1700 Bway, NYC.  
WRITER: Geo. Harrison-ARR: Johnny Harris  
FLIP: What Are You Doing The Rest Of Your Life

**#92\***  
VALLEY TO PRAY (2:47)  
Arlo Guthrie-Reprise 0951  
4000 Warner Blvd. Burbank, Cal.  
PROD: Lennie Warnaker-John Pilla c/o Reprise  
PUB: Howard Beach ASCAP 200 W 57 St. NYC.  
WRITERS: D. Coutson-J. Pilla-A. Guthrie  
FLIP: Gabriel's Mother Hyway Ballad #16 Blues

**#93\***  
HUM ALONG AND DANCE (3:15)  
Temptations-Gordy 7102  
2457 Woodward Ave, Det. Mich.  
PROD: Norman Whitfield c/o Gordy  
PUB: Jobete BMI (same address)  
WRITERS: N. Whitfield-B. Strong  
FLIP: Unite The World

**#94**  
GET INTO SOMETHING (3:51)  
Nesky Bros.-T. Neck 929  
c/o Buddah 1650 Bway, NYC.  
PROD: R. O. & R. Isley c/o Buddah  
PUB: Triple Three BMI c/o Buddah  
WRITERS: R. O. & R. Isley  
FLIP: Get Into Something II

**#95**  
MR. BOJANGLES (5:15)  
Nitty Gritty Dirt Band-Liberty 56197  
6920 Sunset Blvd. L.A. Cal.  
PROD: Wm. E. McEuen c/o Liberty  
PUB: Cotillion BMI Danel BMI 1841 Bway, NYC.  
WRITER: Jerry Jeff Walker ARR: Nitty Gritty  
Dirt Band FLIP: Uncle Charlie's Interview/  
Spanish Fandango

**#96\***  
IT'S IMPOSSIBLE (3:12)  
Perry Como-RCA 0387  
1133 Ave of the Americas, NYC.  
PROD: Ernie Altschuler  
PUB: Sunbury ASCAP c/o RCA  
WRITERS: S. Wayne-A. Manzanero ARR: Marty  
Manning FLIP: Long Life, Lots Of Happiness

**#97**  
SPECIAL MEMORY (3:08)  
Jerry Butler-Mercury 73131  
35 E. Wacker Dr., Chi., Ill.  
PROD: Jerry Butler-Billy Butler c/o Mercury  
PUB: Butler/Chappell ASCAP 609 5th Ave, NYC.  
WRITERS: J. Butler-B. Butler-L. Wade  
ARR: Don Hathaway FLIP: How Does It Feel

**#98\***  
I CAN'T BELIEVE THAT YOU'VE STOPPED  
LOVING ME (3:06)  
Charlie Pride-RCA 9902  
1133 Ave of the Americas, NYC.  
PROD: Jack Clement c/o RCA Nashville, Tenn.  
PUB: Hill & Range BMI 241 W 72 St., NYC.  
Blue Crest BMI P.O. Bx 162 Madison, Tenn.  
WRITERS: A.L. Doodle "Owens" Dallas Frazier  
FLIP: Time "You're Not A Friend Of Mine"

**#99\***  
EASY RIDER (3:05)  
Iron Butterfly-Atco 6782  
1841 Bway, NYC.  
PROD: Richard Podolar c/o Atco  
PUB: Marlu ASCAP  
ARR: Iron Butterfly-R. Podolar  
WRITERS: Iron Butterfly-Robt. Woods Edmonson  
FLIP: Soldier In Our Town

**#100**  
DETROIT CITY (3:45) Dean Martin-Reprise 0955  
4000 Warner Blvd., Burbank, Cal.  
PROD: Jimmy Bowen c/o Amos  
6565 Sunset Blvd., L.A., Cal.  
PUB: Cedarwood BMI 815 16th Ave S. Nashville,  
Tenn.  
WRITERS: Davie Dill-Mel Tillis ARR: Billy Strange  
FLIP: Turn The World Around



## Editorial:

# CMA'S LOSS

The Country Music Association has done so much for Country Music since its inception.

Imagine what it could have done were it not bogged down by constant politics, in-fighting, harmful by-laws and the like.

The original concept of CMA, when it was formed, was to benefit Country Music as a whole. All in the Association and on the Board were asked to disassociate themselves from company affiliations and personal benefit, and think in terms of the how all of Country Music would be improved by any decision, appointment, expenditure and the like.

Unfortunately, it seems as though too many people in the association have lost sight of its original principles and goals and are involved in personal power struggles and politicking either for their own selfish desires or to prevent more deserving business competitors from getting into a position whereby their work for the improvement of country music might be detrimental to their day-to-day business activities.

We saw vivid evidence of the politics and games CMA people play at the annual CMA election of directors in Nashville last week . . . especially in our own "Publications" category.

After three deserving candidates desirous of working hard for Country Music were nominated from the publications field at a board meeting a few months ago, and were put onto the ballot for all to scrutinize and think about, a last minute move was made by a large block-voting member of the publication field to elect a dark horse, nominated just before the secretary closed nominations, giving no one time to investigate who the individual was, whether he was qualified, or whether his election was in the best interest of Country Music. As a matter of fact a number of the members in our vicinity were overheard asking "who is he?" . . . Did you ever hear of him? . . . and fearful of exhibiting ignorance mumbled, "I never heard of that publication" or "I never knew it was involved in Country music."

Why wasn't this nomination to such an important job made months ago like the others. So it too could be examined by members. Why was it saved for the very last second, for Country Music Week, when Nashville goes thru the turmoil and confusion caused by over population and a schedule of events that makes one desirous of "getting done quickly" with such things as nominations and elections so he can get to his next bit of business on an overloaded schedule of events.

Needless to say, the big block vote of the one publication, which, each year, seems to have more votes than all the other publications combined (a situation very unlike our constitutional approach to things that gives Delaware as many Senators as New York has in Congress) pushed through its favorite son, depriving CMA of anyone of the three previously nominated candidates who would have given so much to the Association.

This editorial may smack of sour grapes. But it's not that. It's just the result of years of frustration that sees worthy people, who want to serve, (a rare breed in this day and age) prevented from doing so by politics. It's unfortunate that a block vote of the membership of one company, that could include the firm's window washers, receptionists or mail-room clerks, can control an election. And keep, possibly more deserving people who might pose a business threat, out of the limelight.

For its own benefit, we advise the CMA Board to re-examine its by laws and consider a more constitutional election process before we find an editor from "Facist Party Daily" or some sexy girly magazine nominated and elected to the Board before anyone realizes it has happened.

## Winners Circle



**THE TAKER** — Kris Kristofferson, takes time out to pose for a picture with BMI president Edward Cramer, left, Fred Foster, and Bob Beckham. Kris (second from right) was on hand when his "Me And Bobby McGee" was honored as one of the BMI award winning country songs. The awards were presented in Nashville on Oct. 13.



**GOOD SHOW** — Recipients of ASCAP's Country Music Songwriters Awards held in Nashville October 14th are: (l-r) Rick Hall, producer for Bobbie Gentry's million-seller, "Fancy"; Mr. & Mrs. Frank Russell accepted on behalf of their son, Bobby Russell, who won two awards for "Better Homes and Gardens" and "Then She's A Lover"; Wesley Rose publisher (Milene Music) for "Pull My String and Wind Me Up", written by James L. White; William P. Gallagher, president of Famous Music; and president of ASCAP Stanley Adams who presented the awards. Thirty one songs were cited.

# SESAC Country Awards Presented In Nashville

NASHVILLE — The 1970 SESAC Country Music Awards were presented at the Woodmont Country Club in Nashville, on Thursday evening, October 15th. The occasion was the Sixth Annual SESAC Awards Banquet, held annually in conjunction with the week-long celebration of the WSM "Grand Ole Opry" anniversary and the Country Music Festival. More than 250 top artists, writers, publishers and recording company executives were in attendance.

Following a festive "black-tie" dinner, the 1970 Awards presentation got underway, hosted by Ralph Emery, WSM deejay whose syndicated "Ralph Emery Show" is currently aired on close to 100 radio stations coast-to-coast. Music was provided by Nashville's own Boyce Hawkins and his orchestra.

Awards in the "artist" category were presented to Faron Young, Warner Mack, Webb Pierce, George Jones, Jack Greene, Bobby Lord, Conway Twitty and Loretta Lynn. SESAC's "Ambassador of Country Music" award for 1970 was presented to Johnny Cash, and a special trophy was awarded to America's singing cowboy, Roy Rogers, for "Multi-Media Country and Western Excellence."

For the second consecutive year, Ted Harris was selected as "Country Music Writer of the Year", while Betty Walker was chosen "Most

Promising Country Music Writer of the Year". Both writers are affiliated with Contention Music. Ten-year old Kerry McLean, author of "That's What Life Is All About", recorded and released by Warner Mack on Decca, received a special tribute as "Youngest Country Music Writer of the Year." Other awards in the "writer" category went to Warner Mack, Webb Pierce, Eddie Noack and Raymond Smith.

In the field of "publisher" awards, Page Boy Publications, Wandering Acres Music Inc., Raydee Music Company, Contention Music and Peach Music copped all honors. Owen Bradley, Decca; Pappy Daily, Musicor; Jerry Kennedy, Mercury; and Bob Thompson, MTA Records were singled out for A&B Producer recognition.

Each year, SESAC awards trophy to the person or organization who, in the opinion of the licensing firm, has contributed most to the promotion and betterment of country music. The 1969 award was given to the Country Music Association and, this year, it was presented to Chet Atkins, RCA Victor.

SESAC, long a leader in the international promotion of its publisher affiliates' works, this year presented for the first time award to Sage and Sand Music, Inc., for its song "Burning Bridges", sub-published and released on numerous occasions throughout the world.

# Harold Hitt Reports CMA Progress 1970

NASHVILLE — Harold Hitt, president of the Country Music Association opened the 12th Annual CMA Membership Meeting last week by reflecting upon the recent achievements made by country music during the past year. Following, are excerpts from Mr. Hitt's speech:

"The year of 1970 has been a year when Country Music has attained its well deserved place in American society, the world and even the cosmos.

Your board of directors, at their own expense, has carried the banner of country music into many different sections of our continent this year. Our first meeting, in January, was held in Hawaii, the second in Atlanta, where significant gains in membership from this active area in country music was accomplished, our third meeting was in Toronto, Canada, with 29 top executives from this country sharing ideas with our neighbors to the North. To show the strength of your board, I would like to point out that we have 41 executives from the west coast, the southeast, the mid-west, and the New York City area. With this caliber of persons and broad regional support, your country music association will continue to be a sounding force in the industry.

Membership records have been set during this 1970 year with 157 lifetime members, (including Pete Conrad, our moon-walking astronaut), 186 organizational members, and 2,516 individual members. This gives us a total membership of 2,859, a gain of 423 during the past year. Membership chairman Ralph Emery and his weekly meeting committee, and Margaret Beeskau, CMA Membership Director, deserve a special vote of

thanks for their devotion to the cause, and those of you who have brought new members into our fold are to be congratulated and commended for your efforts in this area.

TV has become, and is becoming each day, a more important medium for displaying our product to the nation. After the highest audience rating yet, (a 40 percent share) for our annual Kraft Awards Show, the Madison Avenue executive has truly become aware of Country Music in the industry. More talent has been presented on network TV this year than ever before in the history of the industry. The high ratings of the Johnny Cash Show, The Hee-Haw Show, and the Glen Campbell Show have brought interest from such prominent personalities as Ed Sullivan, Lawrence Welk, Andy Williams, Dean Martin, Merv Griffin, Joey Bishop, Mike Douglas, David Frost, Flip Wilson, Dick Cavett, Lennon-Durante, Donald O'Connor and Bob Hope as well as the Kraft Music Hall. Both The Cash Show and Hee-Haw are rated in their networks among the top five programs. In the ten major cities of the east coast, both shows are rated two and three in the top five of their networks. Recently, a variety magazine survey shows that these country shows rate with the public as family entertainment, variety shows, comedies, and musicals, all rolled into one.

(cont. on pg. 42)



# ASCAP Honors Country Music Award Winners

NASHVILLE — A record number of songwriters, publishers, record producers and music stars have won ASCAP country music awards at the largest ASCAP Awards Luncheon in Nashville's history.

Over 700 music business leaders, including the biggest names in the country music world, attended the program in which ASCAP president Stanley Adams presented plaques to the writers, publishers, producers and artists of 31 award-winning songs.

Among the multiple winners were Billy Edd Wheeler ("Blistered", "River Bottom" and "Son of a Coal Man"), Bobby Russell ("Then She's a Lover" and "Better Homes and Gardens"), and the songwriting team of Jerry Foster and Bill Rice ("Call Me Gone" and "Heaven Everyday").

Among other writers receiving awards were Vaughn Horton for "Big Wheel Cannonball"; Hoover ("All That Keeps Ya Goin'"); Jerry Smith ("Drivin' Home"); Bobbie Gentry ("Fancy"); Richard Ross ("Hum a Song"); James Peterik ("Vehicle"); Jan Deckard and Jimmy Henson ("Sugar in the Flowers"); Van Trevor and Ron Peterson ("Sittin' in Atlanta Station"); Edwin Hawkins ("Oh Hapiy Day"); Vance Bulla and Steven J. Allen ("Partly Bill"); Darrell Statler ("Put Your Lovin' Where Your Mouth Is"); James L. White ("Pull My String and Wind Me Up"); Jimmy Webb ("MacArthur Park"); Cy Cohen ("Johnny Cash and Charley's Pride"); Bob Dylan ("I'll Be Your Baby Tonight"); and Don Robertson for "I Can't Seem to Say Good-bye".

Other award songs were "Are You From Dixie", "House of Blue Lights", "I'll Never Be Free", "I'm Going Home", "Marry Me", "My Cup Runneth Over", "Seven Lonely Days", and "There Wouldn't Be a Lonely Heart in Town."

A total of 124 awards were presented to three winners.

In welcoming remarks, ASCAP president Stanley Adams commented, "During the past year, a record number of publishers and writers have been elected to ASCAP through the Nashville office. From last November through last month, a total of 193 songwriters from the southern region were elected to ASCAP membership. A record number of music publishers, seventy, were elected to ASCAP membership during this same period."

Country music stars Stan Hitchcock, Mac Curtis, and John Wesley Ryles provided entertainment for the luncheon.

Among the producers receiving awards were Jack Clement, Chet Atkins, Buzz Cason, George Richey, Bob Johnston, Glenn Sutton, Owen Bradley, Rick Hall, Jim Vienneau, Bob Montgomery, Sam Phillips, Norris Wilson, Ken Nelson, Scotty Turner, Danny Davis, Pete Drake, Al DeLory, Slim Williamson, Don Law, Henry Hunt, Larry Butler, Felton Jarvis, Cliff Williamson, Joe Allison, Bob Destocki, Jerry Wexler, Tom Dowd, and Arif Mardin.

## Williams To Radio KBBQ

Dudley Williams, one of the most popular air personalities in the Los Angeles area for the past decade has "moved to the country."

Williams, who has been heard in the mid-day slot (10-33) on KGIL for the past thirteen years, has left that station to take over the morning slot (6-10) on KBBQ, the 24 hour country music station, KBBQ, owned and operated by George Cameron Communications, Inc., emanates from "Beautiful Downtown Burbank" with a signal span that covers the San Fernando Valley and the greater Los Angeles area.

Dudley broke into radio on country music stations in the southwest. His last job prior to moving to California and the San Fernando Valley in 1958 was in Lubbock, Texas. His warm, friendly style has brought him a large following of loyal listeners, and recognition from radio critics.

Williams' voice is familiar to radio listeners all over the country, although unidentified. He has voiced commercials for Marlborough Cigarettes, Paquin Lotion, Downey Flake Corporation, and Copper Penny Restaurants, among others.

ASCAP Awards also went to such renowned recording stars as Johnny Cash, Tompall and the Glaser Brothers, Jerry Reed, Bobby Russell, Dick Curless, Stan Hitchcock, Jerry Smith, Bobbie Gentry, Mel Tillis, Earl Richards, Jerry Lee Lewis, Claude King, Johnnie and Jonie Mosby, Bobby Lewis, Mac Wiseman, Waylon Jennings, Johnny Bush, Glen Campbell, Lawanda Lindsey, Carl Smith, Peggy Little, Johnny Darrell, Jean Shepard, Nat Stuckey, Del Reeves, Anthony Armstrong Jones, Roy Clark, the Ides of March, and Lulu.

## The Wheel Of Glaser

NASHVILLE—With the announcement of the opening of the newest recording facility in Music City, Tompall, Chuck and Jim have completed the formation of their wheel called Glaser.

The newly completed studio features the latest advances in electronics as applied to recording. The "T" shaped control room offers a 20-channel board with 16-track tape machines and is designed for quadra-sonic 4-channel stereo sound.

The control room, presided over by chief engineer Claude Hill, is adjusted by elekracoustics and equipped for perfect response. The studio, consisting of three separate rooms is designed to give better separation, or composite sessions, and was built primarily for the use of Glaser Productions artists and writers use at their most productive point. The studio is also available for custom work and is fully equipped with a synthesizer, possibly Moog, on the way.

The many spokes to the wheel called Glaser includes three publishing companies, and booking, recording and production companies. Owners of the copyright, "Gentle On My Mind", Glaser Publications has received the citation of achievement as Most Performed Song from BMI for the years 1968, '69 and '70, in both the pop and country fields, with the first Robert J. Burton Award received at the recent BMI banquet.

Working as the vocal group "Tompall and the Glaser Brothers", they were awarded in 1970 1st Place by CMA, Billboard, Record World (3rd year), Music City News (3rd year), KBT Fan Clubs (2nd year), with an Award of Merit from ASCAP.

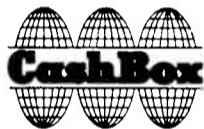

## Country Roundup

Prissy Mitchell and Jerry Reed (in private life Mr. and Mrs. Jerry Hubbard) proud new parents of a baby girl born in Nashville on October 20th . . . Brian Collins, a 19-year discovery of RPM, Inc. president Brad McCuen, has inked a recording contract with Mega Records, a division of RPM. McCuen said the young Texan's initial dinking for the label is due for release Nov. 2 and features "Your Kind Of Man" b/w "Walkin'," a song penned by Collins. McCuen said the original and all future sessions on the young artist will be produced by Collins' personal manager, Billy Carr and added that an album will be forthcoming.

Patsy Sledd, whose latest for United Artists is "Bring Your Love Back To Me," is looking forward to an Hawaiian tour Nov. 6-15 and will be at the Silver Dollar in Las Vegas Nov. 16-17. This is the first trip to either Hawaii or Vegas. The Hawaiian tour is being coordinated through the Hubert Long Agency and D. J. Productions of Hawaii.

Carl Perkins, a writer for Cedarwood, has done something that is not exactly unheard of, but it's not the usual either. He has recorded a Cedarwood song not written by Carl Perkins. Ronnie Self penned Carl's latest dinking, "What Every Little Boy Ought To Know."

The Merle Haggard convention, or so it seemed, ended here October 17 and during the week when deejays from across the country converged on the country music mecca, Capitol's "Okie From Muskogee" captured four major CMA awards, male vocalist of the year, entertainer of the

year, album of the year and single of the year.

The CBS (Channel 5) TV Hee-Haw Show to resume taping in Music City the latter part of October . . . On November 9th Jeannie C. Riley will fly to Europe where she will tape an appearance on an Ed Sullivan Show tribute to the American armed forces. Arranged in conjunction with the program's sponsor, Bristol-Meyers, her appearance is slated for telecasting early in '71. On the 22nd of November, the artist will also be a part of Sullivan's salute to composer Richard Rodgers, taped at the Hollywood Bowl for CBS airing. Coinciding with the release of her latest single and LP for Plantation, Miss Riley recently wound-up a tour of record breaking fair dates, a return appearance on the Grand Ole Opry, and television guest appearances on Hee-Haw and the Tom Jones Show before readying to depart for the European commitments.

Durwood Haddock says, "I gotta think of something real good . . . now what is it?" . . . Lynn Anderson and husband Glenn Sutton are planning to move in the near future to a beautiful new country estate south of Nashville . . . Billy Deaton, Faron Young's manager, reports that Faron, along with his Country Deputies, will open the Pensacola State Fair, in Florida, on the 22nd of October, also on Sunday, the 25th Faron and his Deputies will be performing at one of the largest prisons in the United States, the Huntsville State Prison Rodeo in Huntsville, Texas.

Local writer-singer-guitarist Kris Kristofferson has been signed for the

lead role in "The Dealer" movie, a Columbia production which begins shooting November 2nd in Hollywood . . . Representatives for Tony Joe White refute rumors of his signing with any record company as yet. But he has had talks with Atlantic, Capitol, Columbia, and Warner Brothers. TJW will be on the Johnny Cash Show November 11.

Decca Records were more valuable than booze to thieves who broke into the Decca Hospitality Suite during the recent Grand Ole Opry celebration. The thieves took 42 single records, and four albums, leaving 3½ cases of liquor intact . . . Our sympathy to Hubert Long, talent agent and publisher, whose father recently died after a lengthy illness.

Duane Dee recorded at Woodland Sound Studios for Cartwheel Records with Ron Chancey producing . . . Sonny Throckmorton recently put the finishing touches to his new single release for Vintage Music . . . Two of Woodland Sound's Engineers, Jim Pugh and Rick Horton handled the sound for the BMI Awards Dinner . . . Frank Gorshin, who now records for King Records recently in Nashville to do final overdubbing for his single release on the King label. Upcoming TV-wise is a "Virginian" series and also a Kraft Music Hall Show to be aired November 12th.

One of Faron Young's Country Deputies, Dave Hall, has a new release out on RCA entitled, "We Can Work It Out" . . . Billy Deaton just signed with Buck Owens to represent his Blue Book Music in Nashville, Tenn.

Certron Corporation Music Division hosted last Thursday night

(15th) what was termed by the Sheraton staff as the "biggest dinner and party ever held at the Nashville hotel." Certron artists Ronnie Dove, Merv Shiner, and Elton Britt entertained the estimated crowd of 2500 persons with interludes of square dancing by the Rutherford County (Tenn.) Cloggers. Earl Norwood, caterer for the free Beer 'N BBQ, said that 1000 people were served in the first hour. The menu consisted of country food, BBQ, spareribs, chicken, catfish, ham, slaw, black-eyed peas, sweet potatoes, baked beans, and fruit pies. An interesting sidelight to the event, reported in the local papers, was the beer truck that had to be brought in for the event. Norwood said the truck pumped (and served) 750 gallons of beer.

Brad McCuen, prexy RPM/Mega Records announced the signing of Ronnie Prophet to the label during Convention week. Canadian born Prophet is a fabulous blend of singer, musician and comedian. He has been in Nashville for the past two years appearing nightly in a famed Printer's Alley club.

Pick the side on Webb Pierce's new release on Decca. Will it be "The Way We Were Back Then" or "Showing His Dollar" . . . One of Nashville's prettiest Libras, Jeannie C. Riley, became the proud new owner of a white 1971 Corvette on her birthday, October 19. Her surprise gift gathered more than a few "second looks" as it sped out towards Jeannie's suburban home in time for the celebration; it was surrounded by a huge blue ribbon and bow.



## CashBox Country LP Reviews

### SINGER OF SAD SONGS — Waylon Jennings — RCA — LSP 4418

Waylon Jennings currently holding down the number one position on the country and western singles chart with his version of "The Taker," should do as well with his "Singer Of Sad Songs" album. The LP features Waylon's magnificent rendition of "Honky Tonk Woman" as well as "No Regrets," "If I Were A Carpenter," "Ragged But Right," and seven other brilliant tunes.



### SKID ROW JOE — DOWN IN THE ALLEY — Porter Wagoner — RCA — LSP 4386

This new album by Porter basically concerns itself with songs dedicated to or written to depict the tragic life of people who are down in the dumps. There are many references to wine, and drinking, as evidenced by "Here's A Toast To Mama," "The Town Drunk," "When I Drink My Wine," and "Bottle Of Wine." and "The Alley," further substantiate the point. The album is absolutely brilliant and will become a country landmark.

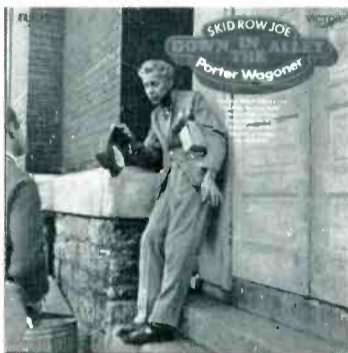

### DOWN HOME IN THE COUNTRY — George Hamilton IV — RCA — LSP 4435

Here's the newest and perhaps most interesting album by George. It contains 11 tracks all done in brilliant country and western fashion. The cuts on the LP are mixed; some old, some very recent—but all are performed expertly. George performs two Kristofferson tunes, "Me And Bobby McGee," and "Sunday Mornin' Comin' Down," which have already become classics. On "Everything Is Beautiful," he performs with Skeeter Davis, but the entire album is a masterpiece.



### ALL WRAPPED UP IN CASH — Nashville Fiddles — Certron — 7006

Subtitled "Johnny Cash's Greatest Hits," this album by the Nashville Fiddles is just that. The package contains 10 Cash classics all performed beautifully by the Fiddles. "Ring Of Fire," "Jackson," "I Walk The Line," "A Boy Named Sue," "Folsom Prison Blues," "Don't Take Your Guns To Town," just to name a few.

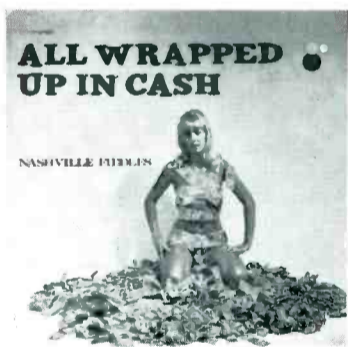

**MONEY CAN'T BUY**—Roy Rogers holds SESAC award presented to him for "Multi Media Country and Western Excellence" at the Woodmont Country Club in Nashville, Oct. 15. His Capitol album, "The Country Side of Roy Rogers" is steadily climbing the charts, while his single, "Money Can't Buy Love," has already established itself as a hit.



## CashBox Top Country Albums

1	<b>THE FIGHTIN' SIDE OF ME</b> Merle Haggard (Capitol ST 451)	1	16	<b>REMOVING THE SHADOW</b> Hank Williams Jr. & Lois Johnson (MGM 4721)	19
2	<b>LIVE AT THE INTERNATIONAL, LAS VEGAS</b> Jerry Lee Lewis (Mercury SR 61278)	2	17	<b>THE GREAT WHITE HORSE</b> Buck Owens & Susan Raye (Capitol ST 558)	15
3	<b>HELLO DARLIN'</b> Conway Twitty (Decca DL 75209)	3	18	<b>COUNTRY FAIR</b> Various Artists (Capitol SWBB 562)	18
4	<b>ONCE MORE</b> Porter Wagoner & Dolly Parton (RCA LSP 4388)	5	19	<b>ONE MORE TIME</b> Mel Tillis (MGM SE 4681)	20
5	<b>FOR THE GOOD TIMES</b> Ray Price (Columbia C 30106)	7	20	<b>TAMMY'S TOUCH</b> Tammy Wynette (Epic BN 26549)	16
6	<b>CHARLEY PRIDE'S 10TH ALBUM</b> (RCA LSP 4367)	4	21	<b>I NEVER ONCE STOPPED LOVING YOU</b> Connie Smith (RCA LSP 4394)	22
7	<b>NO LOVE AT ALL</b> Lynn Anderson (Columbia C 30099)	9	22	<b>I'M ALRIGHT</b> Lynn Anderson (Chart 1037)	27
8	<b>I NEVER PICKED COTON</b> Roy Clark (Dot DLP 25980)	6	23	<b>IT'S HARD TO BE A WOMAN</b> Skeeter Davis (RCA LSP 4382)	25
9	<b>GLEN CAMPBELL GOODTIME ALBUM</b> (Capitol SW 493)	11	24	<b>WONDERS OF THE WINE</b> David Houston (Epic BN 30108)	29
10	<b>THE FIRST LADY</b> Tammy Wynette (Epic 30213)	17	25	<b>MY LOVE/DON'T KEEP ME HANGIN' ON</b> Sonny James & The Southern Gentlemen (Capitol ST 479)	21
11	<b>SNOWBIRD</b> Anne Murray (Capitol ST 579)	14	26	<b>THE BEST OF JERRY LEE LEWIS</b> (Smash SRS 6/131)	23
12	<b>ME &amp; JERRY</b> Chet Atkins — Jerry Reed (RCA LSP 4396)	13	27	<b>A TRIP IN THE COUNTRY</b> Roger Miller (Mercury SR 61297)	30
13	<b>MY WOMAN, MY WOMAN MY WIFE</b> Marty Robbins (Columbia CS 9978)	8	28	<b>YOUR SWEET LOVE LIFTED ME</b> Ferlin Husky (Capitol ST 591)	—
14	<b>A REAL LIVE DOLLY</b> Dolly Parton (RCA LSP 4387)	10	29	<b>COUNTRY SIDE OF</b> Roy Rogers (Capitol ST 594)	—
15	<b>THE POOL SHARK</b> Dave Dudley (Mercury SR 61276)	12	30	<b>THIS IS BARE COUNTRY</b> Bobby Bare (Mercury SR 61290)	24

## Harold Hitt Reports CMA

Cont'd from page 40)

Radio has also made a tremendous contribution in the exposure of our country music people. During the past year, the numbers of full-time country music broadcasters has grown to over 650 stations with approximately 1,300 additional stations broadcasting some country music during the day, ranging from 2 to 19 hours daily. DJ's across the nation have increasingly utilized the visiting artists to do live interviews on the air. Across the nation, it is intriguing to note that, since our first radio station survey in 1961, there has been a 150 percent increase in the numbers of stations broadcasting some, or all, country music, and approximately 750 percent increase in full time country music broadcasting. Roughly, one-third of all stations in the United States and Canada air some country music, and an increasing number of FM stations are getting in on the act.

For the first time, in 1970, country music stars were given special international recognition by the Country

Music Association of Great Britain at their first annual Awards last May. Again, CMA officials and other United States executives were there to help strengthen country music's position.

The Capitol, MCA, and RCA tours of Europe and England have a positive effect on the acceptance of Country Music in those markets, and those who were connected with the tours are to be congratulated. European countries becoming increasingly strong for country music include—England, Belgium, Ireland, Germany, and the Scandanavian countries. Did you know that there is a country music association of Norway? And one in Sweden? Representatives of these organizations are attending this convention.

In closing, we in the Country Music Association are most happy to be a part of the Grand Ole Opry's birthday celebration. WSM and the Grand Ole Opry continue to be a dynamic force in the industry, and the future promises continued success with the construction of the 21 million dollar complex called Opryland, and the total involvement of Irvin Waugh and WSM in the Country Music field insures a very bright future, indeed, for those of us in the industry."

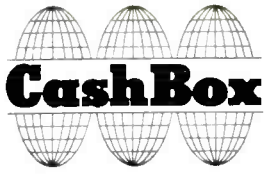

# CashBox Country Top 65

1	<b>RUN, WOMAN, RUN</b> Tammy Wynette (Epic 10653) (Algee—BMI)	1	33	<b>SOUTH/DON'T WE HAVE THE RIGHT</b> Roger Miller (Mercury 731C2) (Pixrus—ASCAP)	23
2	<b>IT'S ONLY MAKE BELIEVE</b> Glen Campbell (Capitol 2905) (Marielle—BMI)	4	34	<b>MORNING</b> Jim Ed Brown (RCA 9909) (Show Biz—BMI)	42
3	<b>SUNDAY MORNING COMING DOWN</b> Johnny Cash (Columbia 45211) (Combine—BMI)	3	35	<b>LET'S THINK ABOUT WHERE WE'RE GOING</b> Lawanda Lindsey & Kenny Vernon (Chart 5090) (Yonah—BMI)	36
4	<b>I CAN'T BELIEVE THAT YOU'VE STOPPED LOVING ME</b> Charlie Pride (RCA 9902) (Blue Crest—BMI)	7	36	<b>RIGHT BACK LOVING YOU AGAIN</b> Del Reeves (United Artists 50714) (Passkey—BMI)	39
5	<b>JOLIE GIRL</b> Marty Robbins (Columbia 45215) (Bujo—BMI)	6	37	<b>YOUR SWEET LOVE LIFTED ME</b> Ferlin Husky (Capitol 2882) (Al Gallico—BMI)	32
6	<b>THE TAKER</b> Waylon Jennings (RCA 9885) (Combine—BMI)	2	38	<b>PATCHES</b> Ray Griff (Royal American 19) (Gold Forever—BMI)	41
7	<b>FIFTEEN YEARS AGO</b> Conway Twitty (Decca 32742) (Peach, SESAC)	10	39	<b>HOW I LOVE THEM OLD SONGS</b> Carl Smith (Columbia 45225) (Acuff-Rose—BMI)	47
8	<b>THERE MUST BE MORE TO LOVE THAN THIS</b> Jerry Lee Lewis (Mercury 73009) (DeCapo, Varla, Chimneyville—BMI)	5	40	<b>MONEY CAN'T BUY LOVE</b> Roy Rogers (Capitol 2895) (Cedarwood—BMI)	44
9	<b>THANK GOD AND GREYHOUND</b> Roy Clark (Dot 17355) (Window—BMI)	12	41	<b>COAL MINER'S DAUGHTER</b> Loretta Lynn (Decca 32749) (Sure-Fire—BMI)	50
10	<b>I CAN'T BE MYSELF/ SIDEWALKS OF CHICAGO</b> Merle Haggard (Capitol ST 451) (Blue Book—BMI) (Tree—BMI)	14	42	<b>I WAKE UP IN HEAVEN</b> David Rogers (Columbia 45226) (Window—BMI)	45
11	<b>ALL MY HARD TIMES</b> Roy Drusky (Mercury 73111) (Lowery—BMI)	13	43	<b>I WOULDN'T LIVE IN NEW YORK CITY</b> Buck Owens & The Buckaroos (Capitol 6042) (Blue Book—BMI)	53
12	<b>ANGELS DON'T LIE</b> Jim Reeves (RCA 9880) (Acclaim—BMI)	9	44	<b>DIXIE BELLE</b> Stan Hitchcock (GRT 23) (Jack & Bill—ASCAP)	46
13	<b>ENDLESSLY</b> Sonny James (Capitol 2914) (Vogue—BMI)	25	45	<b>SHE GOES WALKING THROUGH MY MIND</b> Billy Walker (MGM 14173) (Forrest Hills—BMI)	55
14	<b>AFTER CLOSING TIME</b> David Houston & Barbara Mandrell (Epic 10656) (Algee—BMI)	16	46	<b>SOMETHING TO BRAG ABOUT</b> Charlie Louvin & Melba Montgomery (Capitol 2915) (Tree Int'l—BMI)	48
15	<b>SNOWBIRD</b> Ann Murray (Capitol 2738) (Beechwood—BMI)	8	47	<b>TYING STRINGS</b> June Stearns (Decca 32726) (Wilderness—BMI)	43
16	<b>THE GREAT WHITE HORSE</b> Buck Owens & Susan Raye (Capitol 2871) (Blue Book—BMI)	11	48	<b>FROM HEAVEN TO HEARTACHE</b> Eddy Arnold (RCA 9889) (Shelby Singleton—BMI)	37
17	<b>LIVE FOR THE GOOD TIMES</b> Warner Mack (Decca 32725) (Page Boy—SECAC)	18	49	<b>WAXAHACHIE WOMAN</b> John Deer Co. (Royal American 21) (Elan—BMI)	52
18	<b>HOW I GOT TO MEMPHIS</b> Bobby Bare (Mercury 73097) (Newkeys—BMI)	15	50	<b>EARLY IN THE MORNING</b> Mac Curtis (GRT 26) (Post Music—ASCAP)	54
19	<b>LOUISIANA MAN</b> Connie Smith (RCA 47-9887) (Acuff-Rose—BMI)	20	51	<b>NICE 'N EASY</b> Charlie Rich (Epic 10662)	—
20	<b>WAKE ME UP EARLY IN THE MORNING</b> Bobby Lord (Decca 32718) (Contention—SESAC)	22	52	<b>COWBOY CONVENTION</b> Buddy Alan & Don Rich (Capitol 6025) (Peer Int'l—BMI)	56
21	<b>WONDERS OF THE WINE</b> David Houston (Epic 10643) (Algee—BMI)	21	53	<b>I'M ALRIGHT</b> Lynn Anderson (Chart 5098) (Stallion—BMI)	57
22	<b>GOIN' STEADY</b> Faron Young (Mercury 73112) (Central Songs—BMI)	29	54	<b>HE'S EVERYWHERE</b> Sammi Smith (Mega 0002) (Two Rivers—ASCAP)	34
23	<b>I CRIED (THE BLUE RIGHT OUT OF MY EYES)</b> Crystal Gayle (Decca 32721) (Sure-Fire—BMI)	24	55	<b>OH LONESOME ME</b> Stonewall Jackson (Columbia 45217) (Acuff-Rose—BMI)	59
24	<b>IT'S A BEAUTIFUL DAY</b> Wynn Stewart (Capitol 2888) (Return—BMI)	26	56	<b>IT AIN'T NO BIG THING</b> Tex Williams (Monument 1216) (Central—BMI)	61
25	<b>SO SAD</b> Hank Williams Jr. & Lois Johnson (MGM 14164) (Acuff-Rose—BMI)	31	57	<b>SUNSHINE</b> Earl Richards (United Artists 50704) (Acuff-Rose—BMI)	62
26	<b>YOU'VE GOT YOUR TROUBLES (I'VE GOT MINE)</b> Jack Blanchard & Misty Morgan (Wayside 015) (Mills—ASCAP)	28	58	<b>WHISKEY SIX YEARS OLD</b> Norma Jean (RCA 9900) (Tree—BMI)	64
27	<b>STEPPIN' OUT</b> Jerry Smith (Decca 32730) (Papa Joes—ASCAP)	27	59	<b>ALL FOR THE LOVE OF SUNSHINE</b> Hank Williams, Jr. & Mike Curb Cong. (MGM 14152) (Hastings—BMI)	38
28	<b>WHERE HAVE ALL YOUR HEROES GONE</b> Bill Anderson (Decca 32744) (Stallion—BMI)	33	60	<b>PREACHER &amp; THE BEAR/ AMOS MOSES</b> Jerry Reed (RCA 47-9904)	—
29	<b>LOOK AT MINE</b> Jody Miller (Epic 10641) (Welbeck—ASCAP)	19	61	<b>FOREVER YOURS</b> Dottie West (RCA 9911) (Husky—BMI)	60
30	<b>JIM JOHNSON</b> Porter Wagoner (RCA 9895)	30	62	<b>GONE GIRL</b> Tompall & The Glaser Bros. (MGM-K-14169)	—
31	<b>BACK WHERE IT'S AT</b> George Hamilton IV (RCA) (Acuff-Rose—BMI)	17	63	<b>DOWN YONDER</b> Danny Davis & The Nashville Brass (RCA 9905) (La Salle—ASCAP)	63
32	<b>TOO LONELY, TOO LONG</b> Mei Tiliis (Kapp 2103) (Sawgrass—BMI)	35	64	<b>FOR THE GOOD TIMES</b> Ray Price (Columbia 45178) (Buckhorn—BMI)	49
			65	<b>MAMA CALL ME HOME</b> Bob Dalton (Mega 0003) (Dunbar—BMI)	65

Continuing  
the good times  
with another  
#1 hit for  
**ROY DRUSKY**



**"ALL MY HARD TIMES"**



73111



The  
Lowery  
Group  
of Music Publishing  
Companies

**FLI** HUBERT LONG AGENCY  
A DIVISION OF HUBERT LONG INTERNATIONAL

**WHERE HAVE  
ALL OUR HEROES  
GONE?**

A GREAT NEW HIT BY  
**BILL ANDERSON**

DECCA 32744



**Thanks Record World**

**THE SOUL YOU  
NEVER HAD**

**THE GREAT BALLAD SOUND OF  
JAN HOWARD**

DECCA 32743



**for voting us no. 1 duet**



# C & W Singles Reviews

## Picks of the Week

**LYNN ANDERSON** (Columbia 4-45252)  
**Rose Garden** (2:52) (Lowery Music, BMI—J. South)  
 Highlighted by a catchy melody, and brilliant lyrics, Lynn delivers this beautiful Joe South tune in excellent fashion. "Rose Garden" could very well become the next number one country single. Flip: (No Information Available)

**JERRY LEE LEWIS** (Sun 1119)  
**Waiting For A Train** (1:37) (Peer Int, BMI—J. Rodgers)  
 This new single release finds Jerry a thousand miles away from home, waiting for a train. As usual, his strikingly unique piano style is sure to make this one an instant success. Flip: (No Information Available)

**BILLIE JO SPEARS** (Capitol 6050)  
**I Stayed Long Enough** (2:12) (Al Gallico Music, BMI—T. Wynette)  
 Written by Tammy Wynette, and cut as a single from Billie Jo's "Country Girl" LP, this record can't miss. This emotional story of how two lovers meet will soon become a favorite. Flip: "Come On Home" (2:23) (Central Songs, BMI—J. Rhodes, G. Richey)

**TOMMY CASH** (Epic 5-10673)  
**The Tears On Lincoln's Face** (2:28) (Al Gallico Music, BMI—G. Sutton, H. X. Lewis)  
 Tommy Cash makes his new entry a patriotic one. Will be in strong contention for a top chart position. Flip: (No Information Available)

**WAYLON JENNINGS AND JESSI COLTER** (RCA 47-9920)  
**Suspicious Minds** (3:42) (Press Music, BMI—M. James)  
 Unable to go on together with "Suspicious Minds," Waylon and Jessi prove, with this fine ballad, that honesty is the best policy. Flip: "I Ain't The One" (2:13) (Baron Music, BMI—M. Eddy)

**BUCK OWENS' BAKERSFIELD BRASS** (Capitol 6014)  
**Buckaroo** (1:54) (Blue Book, BMI—B. Morris)  
 Revitalizing the smash single of many years ago, the Bakersfield Brass should be equally successful on the charts. Flip: "Okie From Muskogee" (2:15) (Blue Book, BMI—Haggard, Burris)

**THE YATES** (Capitol 2970)  
**I'm Only Country** (2:04) (Beechwood Music, BMI—L. Yates)  
 A great record depicting the philosophy of country folks. Destined to become a giant country classic. Flip: "Shoe Leather Alley" (2:56) (Beechwood Music, BMI—B. Yates)

## Best Bets

**HAROLD LEE** (Mega 615-0009)  
**Ten O' Clock Train** (3:07) (Ramblin Rose Music, ASCAP-H. Lee) Barbara's comin home on the ten o'clock train, and Harold prepares for the occasion, record changes pace in mid stream which adds to overall interest and emotionalism. Flip: "Funerals Ain't Funny" (3:01) (Two Rivers Music, ASCAP-B. Graves)

**BOBBY GEORGE** (Capitol 6048)  
**Old Shep: The Dog's Side Of It** (4:02) (West Par Music, BMI-E. George) Here's the timeless story of man and his best friend told from the dog's point of view. An interesting new twist. Flip: "Just Because We Care" (2:02) (Freeway Music, BMI-B. George)

**JIM "SPIDER" WEBB** (Select 100)  
**Biggest Coward Of The West** (3:05) (Coby Music, BMI-J. Webb) Jim Webb challenges all of Dodge City to a showdown, until Marshal Dillon saves the day. Soft piano highlights the recitation. Flip: "When You Snooze, You Loose" (2:25) (same credits)

**DENNY MYRICK** (D 1285)  
**From Table To Table** (2:13) (Raydee Music, SESAC-E. C. Davenport, I. Wagoner) A beautiful up tempo tune highlighted by Denny's powerfully exciting vocal interpretation. Flip: "Sometimes You Just Can't Win" (2:52) (Glad Music, BMI-Smokey Stover)

**JOE HUDGINS** (Clark 524)  
**Wild And Wicked World** (2:43) (Acuff Rose, BMI-J. D. Miller, G. Sherry) A beautiful fiddle background sets the mood for this tale of lost love. Flip: "Pull Down The Shades And Lock The Door" (2:20) (Tree, BMI-J. Hudgins)

**KENNY BRIGGS** (Jamboree USA 1001)  
**Chasing Rainbows** (2:26) (Sawgrass Music, BMI—J. Owen) A new pre-occupation with love finds Kenny suddenly chasing rainbows. This one should be big in the weeks to come. Flip: "Enough To Go Around" (2:50) (Basic Wheeling Music, BMI—K. Briggs)

**FREDDY CARR** (Jamboree USA 1003)  
**Maybe She'll Find Out** (2:18) (Last Straw Music, BMI—A. L. Owens) A beautiful single that could come out of left field to capture the attention of country lovers. Flip: "The Name Of The Game" (2:25) (Window Music, BMI—H. Crockett)

**JIM MCGRAW** (Happy Tiger 565)  
**Just A Girl I Met Along The Way** (2:30) (G. B. Music, ASCAP—R. Hanna) A tremendous outing by Jim that should immediately start to climb the country charts. Flip: "I Don't Know Me Anymore" (1:50) (Glaser, BMI—D. Pate)

**LESTER FLATT** (Nuggett 1056)  
**Drink That Mash & Talk That Trash** (2:35) (Big Country Music, BMI-P. Warren, G. Miles) Sounding a bit like Ernie Ford's "16 Tons," Lester comes on strong with a fine new country release. Flip: "The Sunny Side Of The Mountain" (2:50) Hill and Range, BMI-H. McCalluf)

**KOSSI GARDNER** (RCA 47-9919)  
**Oh Lonesome Me** (2:14) (Acuff-Rose, BMI-D. Gibson) Pulled from his "Organ-Nashville Style" LP, this classic Gibson tune is done again in fine instrumental fashion by Kossi. Flip: "Funny Bones" (1:43) (Hindu Music, ASCAP-Gardner)

**CHARLIE LOUVIN** (Capitol 6056)  
**Sittin' Bull** (2:23) (Sure Fire Music, BMI-L. Allen, L. Lynn) "Old Sittin' Bull ain't gonna take it sittin down" exclaims Charlie on this novelty record written by Lorene Aleen and Loretta Lynn. Flip: "It Ain't No Big Thing" (2:16) (Central Songs, BMI-N. Merritt, A. Joy, S. Hall)

**TONY DOUGLAS** (Paula 1234)  
**No Joy In My World** (2:05) (Su-Ma, Cochise Music, BMI—M. Scott, T. Douglas) A sad ballad by Tony that is highlighted by some excellent steel guitar work. Flip: "Man" (2:15) (Kay Day, BMI—D. Popowick, D. Logan)

**THE KOUNTRY KOUSINS** (Lark 1134)  
**Pretty Red Wine** (2:12) (Dooms Music, BMI—M. W. Cave, Jr.) The Kountry Kousins are spending all their money on pretty red wine. Naturally, victims of a broken heart. An excellent record all around. Flip: "Resting On A Little Band Of Gold" (1:53) (same credits)

**LARRY JOE WRIGHT** (Wright 1051)  
**Till Love Grows On A Tree** (2:48) (Lomzo, Oscar Music—BMI—D. Marsh) Larry offers a beautifully written and excellently performed love ballad that should be attracting a lot of attention. Flip: "Bring Your Love Back To Me" (2:40) (Lair Music, BMI—C. Trantham)

**TOMMY GAEBLER** (Trip Universal 8031)  
**If I Loved You More** (3:14) (Blender Music, ASCAP—D. Haddock) A tender ballad sung by Tommy to his lover. "If I loved you more, I would be more than one man." Flip: "You Ever Need My Love" (2:23) (Riverboat Music, BMI—M. Wilson, L. Leigh)

**THE COUNTRY MUSIC REVIVAL** (Ashley 35005)  
**Happy Loving You** (2:22) (Ashley Music, BMI—Ashley, Singleton) This bouncy country and western tune done in fine sing along fashion should catch on in a hurry. Flip: (No Information Available)

**RAY COBB** (Ashley 35004)  
**Why Tell Me Why** (1:50) (Ashmar Music, BMI—Ashley, Singleton) Interesting lyrics set the mood for a story of a man who is never quite satisfied. A fine recording. Flip: (No Information Available)

**BUD CURTRIGHT** (Jamboree USA 1002)  
**I'll Wait For Heaven** (2:23) (Basic Wheeling Music, BMI—B. Curtright) A great new ballad. "Waiting For Heaven" could do it for Bud. Flip: "F.O.B. Chicago" (2:23) (Same Credits)

**AL HOMBURG** (Panorama 1008)  
**Teacher's Lament** (2:30) (American Music, BMI—M. Travis, C. Ram) Here's "16 Tons" all over again, but this time around with a different set of lyrics, and a more contemporary subject. Flip: "Soldier Joe" (Pano, ASCAP—S. Rowley, A. Homburg)

**CHERYL POOLE** (Paula 1232)  
**With You** (2:30) (Central Songs, BMI—C. Roberts, S. Turner) Cheryl does a fine job with this soothing love song highlighted by deep bass lines and a soft piano. A fine record. Flip: "Kansas City" (2:25) (Lais, BMI—J. Leiber, M. Stoller)

**LORNE GREENE** (GRT 32)  
**Daddy (I'm Proud To Be Your Son)** (3:52) (Al Gallico Music, BMI—G. Fischhoff) Lorne Greene narrates the sad tale of a young man who goes off to college to study, but suddenly gets caught up in violent demonstrations and is killed. A touching story beautifully done by Lorne. Flip: "I Love A Rainbow" (2:29) (Lorne Greene Music, BMI—B. Sherrill, G. Sutton)

***If you are reading someone else's copy of***  
**CashBox**  
***why not mail this coupon today!***

**CASH BOX**  
**1780 BROADWAY**  
**NEW YORK, N. Y. 10019**

Enclosed find my check.

\$30 for a full year (52 weeks) subscription (United States, Canada, Mexico)

\$50 for a full year (Airmail United States, Canada, Mexico)

\$60 for a full year (Airmail other countries)

\$40 for a full year (Steamer mail other countries)

NAME .....

FIRM .....

ADDRESS .....

CITY ..... STATE ..... ZIP # .....

**Please Check Proper Classification Below**

MY FIRM OPERATES THE FOLLOWING EQUIPMENT:

JUKE BOXES .....

AMUSEMENT GAMES .....

CIGARETTES .....

VENDING MACHINES .....

OTHER .....

**Be Sure To Check Business Classification Above!**

# *cash box*

INTERNATIONAL MUSIC SECTION



A consistent movie box office attraction, Sandro is following in records to expand his fame throughout the world. The Argentine artist is now extending his CBS wax showing with recordings for Europe to add the Continent to string of successes in the Spanish speaking areas. In addition to recording, Sandro's business interests include writing, publishing and management.

October 31, 1970



# France

Stuart Reid from Chappell London was in Paris to meet Michel Larmand at Chappell's pop division new offices: "4 rue d'Argenson," Paris. Also in Paris Ron Randall, general manager for Europe of Acuff Rose to meet Paulin du Besset before leaving for the States...

Alain de Ricou, "Editions Pathe Marconi," signed the Leonard Cohen catalogue for France and also the Bobby "Little Green Apples" Russel catalogue... "Les editions Tutti" have the latest hits by Johnny Hallday "Le Monde Entier Va Sauter" and Sylvie Vartan "J'ai deux mains, j'ai deux pieds." Also: "Wonderful World, Beautiful People" covered in France by Claude Francois after the Jimmy Cliff hit. "Gimme Dat Dink" the Pipkin's hit covered in French by top Deejay Patrick Topaloff. Tutti also has the new Otis Redding single: "Give Away None Of My Love" and "Snatch A Little Piece"...

"Les Editions Continental" have the cover version by Herbert Leonard of Candida, the Dawn hit. An LP by Ache and also Ten Wheel Drive's latest hit: "Morning Much Better"... Maurice Buisson manager of the biggest record shop in Paris, the famous "Lido Musique" is making a trip to New York with one of his collaborators to visit Harlem in New York and buy as many independently produced records as possible. Maurice Buisson and Jacques Jembla feel that there may be a great number of records released only in Harlem that might interest the French public. They will also bring back many "3-track cartridges" to be sold in his shop...

Pathe releases this week the Richard Harris single "Fill The World With Love" coupled with "A Man Called Horse"... Claude Ebrard, former managing director of Stigwood France, is now the CBS disques international department manager

(foreign products) export and international promotion and coordinator of A and R local products...

April Music inform us of the latest songs they are publishing: "La Vie" by Rika Zarai (co-published with Chappell). "Silver Bird" by Kenny Young covered in French by Herbert Leonard. "Play With Me" recorded by Nicole Croisille...

Fernandel will be guest at a party given for him after his 2,000,000th record sold... Jacques Helard is keeping his effort to import American and British records as fast as possible for Pathe Marconi. To even make these importation more efficient he has sent Richard Peisac to the States to meet several executives of various record companies.

Among the latest best sellers are Deep Purple. Pink Floyd and "Beaucoups Of Blues" by Ringo Starr. At the same time Pathe Marconi is making a top job of improving the quality of local records. Quality of French records has been getting better and better. To promote this point Jacques Helard will launch a massive promotion campaign to draw the attention of the general public on the top quality of their products. This quality matter has always been one of Francois Minchin biggest concern.

Big Joe Turner will undertake an impressive tour of France which will take him in almost all the main towns of France... Juliette Greco in Japan for several concerts. Then she will go in Scandinavia... Nana Mouskouri will fly to Canada to give a total of 45 concerts. Michele Torr in Rio for the Festival. Pierre Henry also touring France to perform among other things: "Ceremony"... Patrick Taton met Johnny Reimar, production manager of Nordick Polyphon AK, to talk about Ache, a Danish group whose first LP has just been released by Phillips.

# Great Britain's Best Sellers

This Week	Last Week	Weeks On Chart	Artist/Title
1	1	5	Band Of Gold—Freda Payne—Invictus—Gold Forever
2	2	5	*You Can Get It If You Really Want It—Desmond Dekker—Trojan—Island
3	6	3	*Black Night—Deep Purple—Harvest—Hec
4	4	4	Montego Bay—Bobby Bloom—Polydor—United Artists
5	14	3	*Paranoid—Black Sabbath—Vertigo—Essex International
6	10	3	Ain't No Mountain High Enough—Dianna Ross—Tamla Motown—Jobete/Carlin
7	7	4	Which Way You Goin' Billy?—Poppy Family—Decca—Burlington
8	5	4	Give Me Just A Little More Time—Chairman of The Board—Invictus—Gold Forever
9	16	2	Close To You—Carpenters—A & M—Carlin
10	3	9	Tears Of A Clown—Smoke Robinson & Miracles—Tamla Motown—Jobete/Carlin
11	18	2	*Me And My Life—Tremeloes—CBS—Gale
12	13	4	*Strange Band—Family—Reprise—Dukeslodge
13	17	4	Don't Play That Song—Aretha Franklin—Atlantic—Carlin
14	8	7	*Love Is Life—Hot Chocolate—Rak—Rak
15	—	1	Black Pearl—Horace Faith—Trojan—Rondor
16	9	6	Make It With You—Bread—Elektra—Screen Gems
17	12	13	The Wonder Of You—Elvis Presley—RCA—Leeds
18	11	7	Mama Told Me Not To Come—Three Dog Night—Stateside—Schroeder
19	—	1	Ball Of Confusion—Temptations—Tamla Motown—Jobete/Carlin
20	15	8	*Wild World—Jimmy Cliff—Island—Freshwater

\*Local Copyrights

### Top LP's

- 1 Get Yer Ya Yas Out—Rolling Stones—Decca
- 2 Bridge Over Troubled Water—Simon & Garfunkel—CBS
- 3 Question Of Balance—Moody Blues—Threshold
- 4 Paranoid—Black Sabbath—Vertigo
- 5 Cosmo's Factory—Creedence Clearwater Revival—Liberty
- 6 Deep Purple In Rock—Deep Purple—Harvest
- 7 Led Zeppelin 2—Led Zeppelin—Atlantic
- 8 Beach Boys Greatest Hits—Capitol
- 9 Paint Your Wagon—Soundtrack—Paramount
- 10 Something—Shirley Bassey—United Artists

# Name a country.

Leaving aside the Iron Curtain areas we doubt that you could name a country of any size where EMI records aren't high up in the sales charts. With 5,000 other companies battling for the business it's EMI's unique international know-how, its gigantic resources in plant and people — and of course the world's greatest names on its labels — that enables it to graph-up sales currently running at one fifth of the total world market. With 30 Companies and a score of licensee Organisations spaced around the globe (and with more to come) we are thoroughly equipped not only to meet this astronomical demand but to stimulate it.



THE GREATEST RECORDING ORGANISATION IN THE WORLD

Electric & Musical Industries Limited (EMI) London, England.





## Southern Signs For All Polish Popular Music

WARSAW — After almost three years of negotiations, the Southern Music group has now concluded possibly the most important deal in the history of Polish music.

Southern has now obtained exclusive rights in the entire Western world for all Polish music other than classical works. Under the deal, Southern has a six month option on all new light and pop music from Poland.

The deal has been concluded principally due to the initiative of Southern Music's U. K. managing director Bob Kingston who has made two visits to Poland in the course of negotiations.

The preliminary groundwork was done at the 1968 MIDEM in Cannes. Representing Poland in the deal was the Polish Authors Agency.

## Peer Professionals Meet In London

NEW YORK — The Peer Southern Organization, world-wide music publishing complex, is to hold a meeting for European branch office managers Oct 26th through Oct. 28th. The meeting, hosted by Robert Kingston, managing director of PSO's London office and European professional manager, will be held at the Mayfair Hotel in London.

In attendance are to be Monique I. Peer, president of the Peer Southern Organization and Denny Diante, professional manager of the Hollywood office. Representing the organization's European offices will be Han Dunk and Elbert van Zoeren of PSO Holland; Rolf Marbot, Paris; Lennart Hanning, Sweden; Manuel Salinger and Ramon Farran, Spain; Alberto Carisch, Italy and Pat Seeger and Michael Karnstedt of Germany. Representing the London office with Kingston will be T. H. and T. F. Ward, Dennis Berry, Derek King and officers of the London professional, production copyright and trade departments.



**FOLLOWING UP** — Having established its network in July of this year, the Imudico publishing firms have already completed their first comprehensive meeting. Held in Stockholm at the start of the month, representatives of the arms of Imudico gathered to discuss inter-office relationships and iron out working difficulties that had arisen. Attending the conference were (from left): John Rasmussen, general manager of the Danish Imudico; Bengt Sundstrom, g.m. of the Swedish affiliate; Einar Jemtland, professional manager for Norsk Imudico A S; Risto Backman, P. M. in Finland; and Leif Karlsson, P. M. in Sweden.

## Festival Gains Rights To Island, Invictus & Hot Wax In Australia

LONDON — Allan Hely, managing director of Festival Records, Australia's major indie, has completed contracts which will bring to the Australian and New Zealand markets through Festival the catalogs of the Island Records (UK), Invictus (USA) and Hot Wax (USA) labels.

At a recent meeting in London, Chris Blackwell who has made Island Records a heavily sought-after independent label, and Allan Hely renewed the existing contract which will now see the Island product merchandised under its own logo for the first time in Australia and New Zealand. Initial releases on Island currently on promotion include 6 albums and 3 singles by Britain's Traffic, Spooky Tooth, Free, Quin-

tessence and Fotheringay among others.

The new American Invictus label which has recently reached No. 1 both in the U.S.A. and U.K. will also be merchandised on its own logo. First singles (to be followed by album product) will feature Freda Payne, Chairmen Of The Board, The Glass House, Ruth Copeland and others. This label has fast become a major force under supervision of Holland, Dozier & Holland.

Finally, Hot Wax will feature artists such as The Honey Cone, Flaming Ember, 100 Proof (Aged In Soul) etc. The company is currently signing up new talent and plans are complete for a heavy release programme for 1970-71.

## Doraflo/Bleu Disque Publ. Group Starts German/Australian Firms

NEW YORK — The Doraflo/Bleu Disque group of publishing companies, an affiliate of Sire Records, have just opened their own branch publishing companies in Germany and Australia. These new firms will represent all catalogs controlled by the group including; Doraflo (BMI), Bleu Disque (ASCAP), Pandora (BMI), Geordie (ASCAP), and several smaller firms.

Doraflo Musikverlag GmbH, which will operate in Germany, Austria, and Switzerland, is a jointly owned venture between Doraflo/Bleu Disque group and E.R.P. Music of Germany. The company will headquarter in Munich at 2/11 Franz-Joseph Strasse, and will be under the direction of E.R.P. chief, Eckart Rahn.

Doraflo Music (Pty.) Ltd. of Australia is a joint venture between the group and Angle Music, an independent down under firm headed by Roger Savage and David Mackay. Mackay, incidentally, is the producer of the current international success, "Look What They've Done To My Song," by the New Seekers.

The Doraflo/Bleu Disque group have since 1969 represented Angle of Australia in the U.S.A. and Canada through a jointly owned firm, Right Angle Music (ASCAP). The group has recently begun to represent E.R.P. Music here and have just

started a new ASCAP pubbery to house these copyrights.

### Sire's Stein Visits European Partners

Seymour Stein, head of the Doraflo/Bleu Disque group, left for a three week European swing. First stop is London, where Stein will confer with Richard and Mike Vernon, his partners in the high successful British indie label, Blue Horizon. Stein will then head for the continent to tie up publishing deals for the Dora/Bleu Disque group in Benelux, Scandinavia, and Spain, and to confer with Blue Horizon and Sire distributors in Europe.

## Ace Trucking To London

NEW YORK — The Ace Trucking Company, weekly regulars on ABC-TV's The Tom Jones Show, have left New York for London to complete taping the remaining shows of the season.

## King Biscuit Boy Leaves Crowbar

TORONTO — King Biscuit Boy (Richard Newell) has decided to quit Crowbar to concentrate on writing material for his third album. He is currently enjoying top chart action on both his single, "Corinna Corinna" and the album from which it was culled, "Official Music." They have also become one of the most in-demand groups in Upper Canada. Much of this popularity, in view of their chart successes.

Love Productions' president Frank Davies, who made the announcement of the split, had just recently completed negotiations with Paramount for a recording deal with Biscuit Boy and Crowbar involving \$250,000. This is one of the biggest deals ever made for a Canadian group. Advance U. S. orders on the group's initial album release has been reported as "large." Their second album, "Gooduns" is in its final mastering stages and should be released by the first part of next year. Another single is expected to precede this release.

Crowbar will continue to fill bookings which includes the sharing of the bill at Toronto's Massey Hall (15) with Van Morrison. The group will release their first album by mid-November.

King Biscuit Boy is expected to return to the p.a. scene the early part of next year at which time he'll tie-in with Paramount for a large-scale U. S. tour.



**TOUCHING DOWN** — Two of the leaders of the G.P.G. (Philips DGG) Group are shown landing at the start of a whirlwind South American tour. C. Solleved, president of the G.P.G. and J. Van Der Velden, financial and administrative director of the group, here arrive in Argentina for the first of a series of meetings with affiliates of the Philips and Deutsche Grammophon labels in Chile and Brazil.

## James Gang Ends European Tour

NEW YORK — The James Gang has just completed touring Europe appearing with the Who. Dates played thus far include the Speakeasy; Sophia Gardens, Cardiff; Free Trade Hall, Manchester; Purley; Newcastle; Birmingham; Leeds; Trentham Gardens, Stoke; East Anglia University, Norwich; Odeon, Lewisham; ABC Cinema, Stockton; Greens Playhouse, Glasgow; Sheffield University in Sheffield; and the Empire Theater in Liverpool.

The group returns to the United States for the October 30 weekend at the Jai Alai Fronton in Miami, and November dates beginning the 6th at the Westbury Music Fair and continuing with Nov. 10, Reflections in Cincinnati; Nov. 11, Shippensburg College, Shippensburg, Pa.; Nov. 12, Thiel College, Greenville, Pa.; Nov. 13, University of Virginia, Charlottesville; Nov. 14, Alfred University in Alfred, New York; and winding up the tour at the Fillmore West, November 19-22.



During their recent 3-day stay in Holland, the Rolling Stones were presented a Golden Disk for "Let It Bleed" by Decca Records' Anton Witkamp. The Rolling Stones did the last concert of their 6-weeks European tour in Amsterdam. The RAI Hall was fully booked up—holding over 20,000 enthusiastic youngsters. Decca Records is now building sales for the "Get Yer Ya-Ya's Out" album. Pictured with the Golden Disks are (l. to r.): Charlie Watts, Mick Taylor, Mick Jagger, Keith Richard and Bill Wyman.

## Japan's Best Sellers

This Week	Last Week	
1	1	Tegami—Saori Yuki (Express/Toshiba) Pub/All Staff
2	5	Kyoto No Koi—Yuko Nagisa (Toshiba) Pub/Taiyo Ongaku
3	9	Hashire Koutaroo—Sorutei Sugar (Victor) Pub/Nichion
4	2	Inochi Azukemasu—Keiko Fuji (RCA Victor) Pub/Green Music
5	3	Uwasa No Onna—Hiroshi Uchiyama & Cool Five (RCA Victor)
6	—	Ginza No Onna—Sinichi Mori (Victor) Pub/Watanabe
7	10	X + Y = Love—Naomi Chiaki (Columbia) Pub/Watanabe
8	12	Shiseikatsu—Mari Henmi (Columbia) Pub/Watanabe
9	—	Mandom—Lovers of the World—Jerry Wallace (Liberty-Toshiba) Sub-Pub/
10	8	Mr. Monday—Original Cast (Bell) Sub-Pub/
11	7	Kibou—Youko Kishi (King) Pub/All Staff
12	4	El Condor Pasa—Simon & Garfunkel (CBS/Sony) Sub-Pub/
13	11	Otoko To Onna No Ohanashi—Mimi Hiroshi (Victor) Pub/JCM
14	6	Ai Wa Kizutsuki Yasuku—Hide & Rossanna (Columbia) Pub/Fuji
15	19	Ai No Kizuna—Ritsuko Abe (King) Pub/
16	14	Yellow River—Christies (CBS/Sony) Sub-Pub/
17	—	Futari No Kankei—Hide & Rossanna (Columbia) Pub/Fuji
18	—	Que Sera, Sera—Mary Hopkin (Apple/Toshiba) Sub-Pub/Folestar
19	—	Toki Wa Nagareru—Jun Mayuzumi (Express/Toshiba) Pub-Ishihara
20	20	Let It Be—The Beatles (Apple/Toshiba) Sub-Pub/Toshiba

### Top LP's—Catch

This Week	Last Week	
1	2	Onna No Blues/Enka No Hoshi, Fuji Keiko (RCA)
2	1	Bridge Over Troubled Water—Simon & Garfunkel (CBS)
3	4	Sound Of Music/Sound Track (RCA)
4	5	Tom Jones/Live In Las Vegas (King/Longon)
5	3	Uwasa No Onna—Hiroshi Uchiyamada & Cool Five (RCA)

## Argentina's Best Sellers

This Week	Last Week	
1	1	Soolaimon (Melograf) Neil Diamond (RCA); Malcolm (Odeon); Georgette y Jose (Music Hall)
2	4	*Las Cosas Que Me Alejan De Ti (Fermata) Hector Cabrera (Music Hall); Gian Franco Pagliaro (Odeon)
3	2	La Distancia Es Como El Viento (Relay) Domenico Modugno (RCA)
4	3	Pequeño Bolso Verde George Baker Selection (Philips)
5	7	*Te Quiero Ver Bailar (Melograf) Los Naufragos (CBS)
6	5	Rio Amarillo (No Comprendes) (Melograf) Bob Christian (Music Hall); Christie (CBS)
7	13	120 . . . 150 . . . 200 Km Por Hora Roberto Carlos (CBS)
8	8	Buen Dia Paz Blue Mink (Philips)
9	17	Haciendo Dedo (Hitchin' A Ride) Pintura Fresca (Disc Jockey); Vanity Fare (Fermata)
10	6	*Y Peguele Fuerte (Relay) Solvente (RCA)
11	9	*Mamarracho (Relay) Iracundos (RCA)
12	11	*Viejas Fotos (Kleinman) Santiago Elizalde (Music Hall)
13	15	Son Cosas Que Pasan (Melograf) Sergio Denis (CBS)
14	10	Arrontate (Get Ready) Rare Earth (RCA); Pacific Gas & Electric (CBS)
15	—	Yo . . . Uno De Tantos (Smart) Tom Jones (Odeon)
16	12	Dum Dum Kingston Karachi (RCA)
17	14	Neanderthal Man Idle Race (EMI); Hotlegs (Philips); Vision 70 (Odeon)
18	20	*Juan Camelo (Kleinman) Septima Brigada (Disc Jockey)
19	19	Ese Tierno Sentimiento Pickettywitch (Music Hall)
20	—	*Hoy No Puedo Dormirme (Melograf) Leonardo Favio (CBS)
20	—	*Ternura Roberto Vicario (EMI)

(\*) Local

### Top LP's

This Week	Last Week	
1	1	Muchacho Sandro (CBS)
2	2	Sotano Beat A Todo Color Selection (RCA)
3	3	Cosmo's Factory Creedence Clearwater Revival (Liberty-EMI)
4	4	Super Selection (Music Hall)
5	5	Todos Juntos Selection (Disc Jockey)
6	10	Domenico Modugno Domenico Modugno (RCA)
7	—	Caliente Vox Dei (Disc Jockey)
8	7	Woodstock Selection (Atlantic)
9	9	Victor Manuel Victor Manuel (Philips)
10	8	Alain Debray Alain Debray (RCA)

## Holland's Best Sellers

This Week	Last Week	
1	5	To My Father's House (The Les Humpries Singers/Decca) (Sikorski-Basart/Amsterdam)
2	2	Wild World (Jimmy Cliff/Island) (Dayglow/Hilversum)
3	1	Lola (Kinks/Pye) (Belinda/Amsterdam)
4	8	Paranoid (Black Sabbath/Vertigo)
5	3	Back Home (Golden Earring/Polydor) (Dayglow/Hilversum)
6	4	The Tears Of A Clown (Sm. Robinson & Miracles/Tamla-Motown) (Impala Basart/Amsterdam)
7	10	Flash (The Duke Of Burlington/Pink Elephant)
8	—	Peace Will Come (Melanie/Buddah)
9	9	Amsterdam (Buck Owens/Capitol)
10	6	Suicide Is Painless (The Mash/CBS) (Altona/Amsterdam)



## Spain

Columbia announced some internal changes: From now on Mr. José Luis Yzaguirre will do Adv. & Promo for Spain, replacing Mr. Gerhard Haltermann, who has become overseas P. R. & Promo man, and Mr. Gabriel González, working formerly for the adv. & promo, department, is heading the radio department.

According to Hispavox, "Tú y Yo," the new song by Karina, just released here, will be coupled with "Colours Are Changing," for a world-wide release by this artist.

By the way, Spanish TV is changing the formula used during the last couple of years for choosing the Spanish Eurovision Song Contest entry, and a new program called "Pasaporte to Dublin," produced by Fernando Garcia de la Vega and Valerio Lazarov, will introduce to the Spanish tele-viewers, for eleven running weeks, the ten candidates for them to choose. Karina will be one of them, and she has possibly the biggest chances. Many people felt disappointed in 1969 and 1970 because she was not selected to represent Spain in Madrid and Amsterdam respectively. Karina is a very pretty and innocent-looking girl who would be extremely well endowed—when the Contest reaches the usual two hundred million of European viewers—to break the language barrier and warm the hearts of European housewives . . . as well as those of their husbands and sons.

Spanish TV has just announced its music programs for the new season. Apart from "Passport To Dublin," people will be able to watch "Golden Voices," a program made with a selection of the best foreign TV shows, put together by means of an original script; the Happy Seventy, produced by Ricardo Arias; and Fourth Continent, introduced by José Luis Uribarri, with a series of Latin-American folk songs. On October 10, as a foreword to all these musical programs, Spanish TV offered the very special show filmed by Lazarov at the Osaka Fair with Karina, Miguel Ríos (Hispavox), Massiel (Novola) and Julio Iglesias (Columbia). RCA is releasing a remarkable L.P. by Child, a group, as they say, "that is born and dies with this unique L.P. we are proud to introduce to the Spanish market in view of its outstanding quality." They also claim they are releasing it in Spain as a "musical European scoop."

Cold-weather has descended on Madrid after a long and hot summer, cold weather which is affecting also, it seems, the Spanish overall economy, rather deflated and a bit gloomy. Prices are stepping up and wages are not, and the official credit restrictions are affecting many firms. The record world, however, has come definitely of age and decided to live and lead its own life with an optimistic outlook. On the other hand, the consumers and consumers-to-be, have reacted favorably to this attitude

and are buying records with such an eagerness that there is no sign of crisis in the record market. The singles' sales have weakened, but the L. P.'s are booming with a strength nobody could have guessed just one year ago. The "pioneer" of this trend was Joan Manuel Serrat (Novola), whose "Dedicado A Antonio Machado, Poeta," must have passed the 75,000-copies-mark, and now it is Simon & Garfunkel's turn. We are watching an unbelievable boom for the duo here, and their "Bridge Over Troubled Water" has already passed the 50,000 copies mark and remains solidly on top of the L. P.'s charts.

In view no doubt of this L. P.'s market explosion—and more specifically of the success they are having here with Simon & Garfunkel—CBS has released three double albums by Chicago, Bob Dylan and the Everly Brothers, to a reasonable retail price: 500 pesetas (around \$7) each. Hispavox has accepted the challenge and launched simultaneously "Hits & Soul," the outstanding Atlantic L. P. by some of the finest soul performers, as well as other albums by Joan Baez, Family and Joni Mitchell. Movieplay has just released another three albums: La Mosca (The Fly), produced by Alfonso Sáinz and performed by the "re-born" Pekenikes, John Rowles and Moloch, and Novola has launched the first album by Basilio.

According to Columbia, "Notas Magicas," their publishing concern, which was founded just one year ago, is signing an agreement with Burlington Co. Ltd. to create a new company based in Spain. It is an easy guess to forecast that the new firm will be "Spanish Burlington," or "Burlington of Spain" which was an old project of Mr. John Nice. "Notas Magicas" has also signed with Ivan Mogull and is starting a Spanish Ivan Mogull's operation. The Spanish Group of the International Federation of the Phonographic Industry is meeting here today. Some vital issues will be discussed, and we shall inform you of them in the next chronicle.

A new recording firm is born. It is called "Discográfica Talar, S. A." and will have its headquarters in Barcelona (Bori y Fontestá, 19). Its president is Mr. A. Talarewitz, and it has two vice-presidents: E. Talarewitz and J. L. Gomariz. Other executives are Mr. A. M. Martinez Sovedia, marketing manager; and Mr. Carlos Sanmartin, adv. & promo. Mr. Sanmartin held formerly the same position with Diskos Vergara. They are releasing the product of several foreign concerns: C. T. I. (U. S.), B & C Records and Zel Records (U. K.), Supertone (Netherlands). King Records (Japan) and National General (U. S.), and they have so far the following Spanish artists: Las Madres del Cordero, Eddie Lee Mattison, Nuevos Tiempos, Gong, Lady March, Gualberto, Estratagama and H20.

## Belgium's Best Sellers

This Week	Last Week	
1	1	Comme J'ai Toujours Envie D'aimer (Mark Hamilton—Carrère—Apollo Music).
2	2	Tears Of A Clown (Smokey Robinson & The Miracles—Tamla Motown).
3	7	My Way (Samantha Jones—Penny Farthing).
4	3	Sweetheart (Engelbert Humperdinck—Decca—Primavera).
5	6	Wild World (Jimmy Cliff—Island—Primavera).
6	11	Paranoid (Black Sabbath—Vertigo).
7	13	Look What They've Done To My Song Ma (The New Seekers—Philips).
8	19	Cherry Cherry (Jonathan King—Decca).
9	8	Lola (The Kinks—Pye—Primavera).
10	4	Sex Machine (James Brown—Polydor).

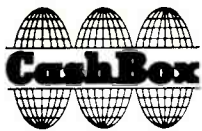

# Holland

Robin McBride of Mercury's Chicago office visited Holland for a Mercury meeting and talks with execs of P.P.I. Baarn and N. V. Phonogram Amsterdam. N. V. Phonogram has the no. 1 and 2 records on the national Dutch charts. Topping the charts is "To My Father's House" by the Les Humphries Singers (Decca), while Jimmy Cliff's "Wild World" (Island) is no. 2. Penny Farthing Records have a first giant hit in Holland with Samantha Jones' version of "My Way," which is currently no. 17 on the charts. Avro-television transmitted the first Engelbert Humperdinck TV-show with guest-stars Blue Mink.

Within short time, the English group Black Sabbath established itself as one of the top acts in Holland. The group's single "Paranoid" is currently no. 4 on the charts, while the "Paranoid" album is no. 9 on the LP-charts (Vertigo). N. V. Phonogram rush-released a first Philips album by the Anita Kerr Singers, called "The Simon and Garfunkel Songbook." The album was presented to national press and disk-jockey's during a special reception in Amsterdam. It is no. 20 on this week's LP-charts.

Last concert of the Rolling Stones European concert-tour took place in Amsterdam for a capacity audience of more than 20,000. Promotors were SBA and the Paul Acket Agency.

Negram/Delta from now on will represent and distribute the Ember-label with famous artists such as Desmond Dekker and Julie Rogers. The first hit for Negram on the Ember-label will be "You Can Get It If You Want It" by Desmond Dekker. Negram has released an album by the "Kabouter"-movement, entitled "Kabouter-chismus." For the press-meeting were invited a.o. the admiral of the Royal Navy, the burgomaster of Amsterdam and even Prince Consort Bernhard. Q 65 and After Tea, two of the most famous groups in Holland, gave a free-concert in The Hague this week to introduce their albums for Negram. "Afghanistan" and "After Tea." The concert was followed by a press meeting. As a follow up to their hit single "Tickatoo" the Dizzy Man's Band released

on the Indigo-label "Young Love," which is about to enter the national Top-40. Latest Tee Set recording, "She Likes Weeds" already entered the charts.

Neil Young's album for Reprise, "After The Goldrush" is a bestseller in the Top 10 album chart. Also "Weasels Ripped My Flesh," the album by Frank Zappa and the Mothers Of Invention is selling very well.

Most famous singing bar-keeper of Amsterdam, Bolle Jan, recorded for single the song "Zierikzeese Marie," composed and writtzn by Ellis de Liefde, which entered the charts lately. Bolle Jan's LP "Vize Verze" sold over 30,000 copies and "Zierikzeese Marie" will be his first hit-single.

Barclay Dominique Dussault visited Holland last week and recorded her "Un Grand Bateau" for the "Cabaret Jos Brink" tv-show which will be broadcasted December 31st.

Melanie's third LP "Candles in the rain" sold over 25,000 copies in our country. For this Melanie will receive her 3rd. golden record. The new Edwin Hawkins album "More happy Days" has also got a Dutch title "Praise him." By the way this Budah choir is visiting Amsterdam on October 31st. as first town on their European trip.

The German brass band "Die Egerländer Musikanten" visited the southern part of our country two times: Roermond and Gulpen. This Telefunken band just received its seventh golden album for total sales over seven million.

CNR started October with the campaign "album of the month." This month "the Soupe ouvertures" by the USSR radio-symphonic orchestre conducted by Rozhdestvensky. This Melodia record will be sold for \$2 —only in October—instead of \$3.50. The campaign is supported by advertisements, showcards and mobiles. Famous Russian violinist David Oistrakh gave concerts in Holland the last two weeks for promoting the lp with the Bach violinconcert in a and W. A. Mozarts violinconcert nr. 3 KV 216. This promotion album costs only \$2.50. On October 18th. Dutch television broadcasted a tv-appearance from French trumpet-player Maurice Andre. The film was recorded in the Haarlem St. Bavo cathedral.



# Mexico

Jose R. Bustillos, CBS top exec and president of the Federación Latinoamericana de Productores Fonográficos (Latin America Federation of Disk Producers), is back in Mexico from Montevideo, Uruguay where he attended the assembly of the Comité Ejecutivo de la Asociación Latinoamericana de Libre Comercio (Permanent Executive Committee of ALALC).—"The agreements reached by the Committee will be, in the near future, of great importance for the local industry," Lic. Bustillos reported.

"Volveremos" by Roberto Cantoral is the selected product to be sung by Marco Antonio Muñoz as Mexican representative in the forthcoming Río de Janeiro Festival. The selective group in the TV contest series consisting of newsmen. Dee Jays, radio programers and the public, gave the unanimous vote to "Volveremos."

"Te Dejo La Ciudad Sin Mi" with Mario Garena (1st. place in the New York Latinamerican Song Fest.) was launched on Polydor by Diskos Universales, S. A.

Cesar Costa's "Negra Paloma," "En La Soledad" and "Un Vaso De Vino" on Diskos Capitol de Mexico, are making the charts in Ecuador.

Napoleon is the name of a new and

promising chanter/composer about to be launched by Diskos Musart.

"La Zandunga" with Raphael is the most aired number in México. This version of the old time mexican "La Zandunga" may be Raphael's come back to the mexican public's favor.

"Y Volveré" with Los Angeles Negros is reported as a smash hit all over the Country. Diskos Orfeon will soon release the author's, original version.

We have received from Alberto Cortéz, in Spain, a promotional Hispavox single with his latest numbers "Distancia" and "Como El Girasol." The record was produced by Rafael Trabucchelli with arrangements by Cesar Gentili. In México it will be released by Diskos Gamma.

All sorts of comments among the industry's people, for Guillermo Infante's resignation from RCA. Infante, as we reported last week is now heading Diskos Orfeon.

Dekalafe, brazilian songstress well known here since her successful appearance in the 1969 Festival de la Canción Latina, is back in México for a two week stand at Hotel Alameda's Bamerette, and to star a new TV show. Her manager, Celia Macedo, is taking action to assure Dekalafe's permanent stay in México.

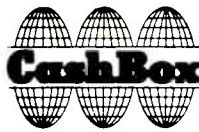

# Argentina

CBS is starting its Annual Sales Convention, including all the representatives from this country, and premiering the new LP's to be marketed in the Summer Season. The LP's include local artists like Los Naufragos and International stars like Bob Dylan. The diskery is currently expecting strong sales from the new Pedro y Pablo single, "Marcha De La Bronca," which gave this duo the winning post at the recent Festival de Musica Beat held at the Pueyrredon Theater.

Mario and Norberto Kaminsky, heads of Microfon, are departing in a couple of weeks to the States, where they will visit Los Angeles and New York, and also Mexico and a couple of other Latin American cities. Microfon has been expanding strongly in the budget priced market, and has representation agreements, both ways in several other Latin markets.

On October 30 and 31 the First Argentine Song Festival will take place at the Luna Park, which will be aired directly and by satellite by Channel 13. Thirty songs have been selected for the event, and will be presented by artists like Hugo Marcle, Fedra y Max, Violeta Rivas, Robert Livi, Salako, Piero, Juan y Juan, Carlos Bisso and others. The orchestra will be directed by Horacio Malvicino, Lucio Milena and three other arrangers, and strong public attendance and TV ratings are expected. The artists belong mostly to CBS and RCA, the two diskeries that refused to participate at the Buenos Aires Song Festival, organized last month by Ciro Dante and Aldo Fabre, also at the Luna Park.

There is a new single by Riz Ortolani's Orchestra, "Con Cuanto

Amor," another single by Paul Slate and one by Catherine Spaak; there is also one by Ornella Vanoni (L'Apuntamento) and one more version of "Borsalino," the Belmondo-Delon film currently shown here, this time by Le Gang.

Music Hall is following its policy of building a strong local rock music catalog, and has released an album by Luz de Mercurio and another one by Trocha Angosta. The first LP by Rolando Percy, who took part at the Song Festival held in Latin New York last month, is also under way. On the sales side, the diskery is profiting strongly from the "Super" LP, which features the current strong pop artists, both local and International.

RCA has released a new album by folk chanter Carlos Di Fulvio, who had two strong hits in the near past with "Canto Monumento" and "La Conquista Del Desierto." It is preparing also the first LP by the rock group Manal, who recently signed with RCA after being associated to Mandioca Records; their first single, "Dona Laura," is already running well. Folk chanter Jose Larralde is also preparing a new album, while his "El Sentir . . . Vol II" has been a very consistent seller during several months.

Phonogram's Bentivoglio reports that the diskery is re-releasing Beethoven's Nine Symphonies, in a new package; a plan of Classical music releases is also being fulfilled.

On the pop side, there is a new LP by Melanie, plans for the third volume by Led Zeppelin, and in the release of the album by Blue Mink, whose single is one of the highest items at the local charts, at this moment.

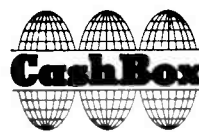

# Japan

Mr. Minoru Suzuki, executive director of King Records, one of the major record companies in Japan, got back from a 35 day tour in Europe and U.S.A. on October 3.

At Tokyo Airport, he said as follows; "I visited 20 record companies and talked with about 200 people in Europe and America. The purpose of his tour was to attend the A&M meeting in London and observe the movement of video disk and talk with companies which we have contracted."

"The focus of the meeting, 35 people attending from companies in Germany, Mexico, Canada, America and other countries, was on the Japanese Market. I explained our market for 30 minutes in English, during 7 days

meeting."

"We exchanged opinions about video disk with the companies including Decca Records. A&M has made contracts of license systems with every company except the ones in Britain and Canada, and it seemed they didn't plan the joint venture with Japan."

"I flew into America on September 19, and contracted with new record company. 'Jazz and Pops', in New York. This company, originally issued weekly magazines, started its life as a record company. Their main contents will be jazz. They will release 4 albums by Elvin Jones and other artists early in next year. This Jazz and Pops is run by Phollin Riveri."

## Mexico's Best Sellers

1	1	In The Summertime—Mungo Jerry—Gamma
2	5	Y Volvere—Los Angeles Negros—Capitol
3	2	*Sufrir—Los Solitarios—Peerless
4	3	*La Banda Dominguera—Imelda Miller—RCA
5	4	Celoso—Roberto Lutti—Gamma
6	9	Cottage Cheese—Crow—Gamma
7	6	Soolaimon—Neil Diamond—Orfeon
8	7	Run To Her—The Beeds—Buddah
9	10	Yo Se Que No Es Feliz—Leo Dan—CBS
10	—	*Un Vaso De Vino—Cesar Cosita—Capitol

## Australia's Best Sellers

1	1	*In The Summertime—The Mixtures—Essex—Fable
2	3	I've Lost You—Elvis Presley—Belinda—R.C.A.
3	4	Spill The Wine—Eric Burdon & War—Control—Polydor
4	5	*Yellow River—Jigsaw—Castle—Fable
5	8	Big Yellow Taxi—Joni Mitchell—Control—Reprise
6	9	Lookin' Out My Back Door—Creedence Clearwater Revival—Palace—Liberty
7	—	*Old Man Emu—John Williamson—July—Fable
8	7	Close To You—Carpenters—Control—A & M
9	6	Drivin' Home—Jerry Smith—Sydney Tree—M.C.A.
10	2	Make It With You—Bread—Screen Gems—Astor

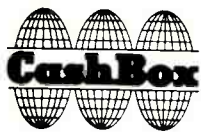

# Germany

The top organization of the German record firms, about 98% of the record manufacturers are members, determined on its annual meeting to call themselves in the future "Bundesverband Schallplatte." President is Dr. L. Veeder of EMI-Electrola, vice presidents are Kurt Richter (Teldec), Richard Busch (Deutsche Grammophon) and Friedrich Schmidt (Ariola).

The world sales agreement between Resono, Cologne, and Deutsche Vogue Records has been signed at GroBkoenigsdorf. It was said already that Deutsche Vogue is to enlarge its catalog by contracts with different production firms. Thus the ratification of the Resono contract took place now. The following artists are to be heard on Resono records: Ulla Norden, Marc Andre, Eva Pflug, Joe Raphael, Gardy Claus, The End, Nicolai, Ralph. On the Resono label a long-playing record rendering original reports of the world's championship in football between Germany-England and Italy-Germany has been released a few days ago. Immediately after having published this record it can already be marked on top of the Resono sales charts.

Ariola/Eurodisc, in Munich, expands its combine. They concluded a contract with Essex music, London, and from now on, all records of the groups Move (latest hit "Brontosaurus"), *Tirannosaurus Rex* (biggest hit "By The Light Of The Magical Moon") and Procol Harum ("A Whiter Shade Of Pale") will be distributed in Germany, Austria and Switzerland by Ariola. This recording appeared in England on the by Essex music new founded label, Fly. First new releases of Move are a single "When Alice Comes Back To The Farm" and an LP, and new *Tirannosaurus Rex* single, "Ride A White Swan." The Fly label will be expanded. Until now the distribution of this label was by Polydor.

Four months ago the annual German hit competition was arranged and telecasted by the German TV. The first balance of the until September sold records with the festival titles shows a good result. Of the conqueror title "Das Schoene Maedchen Von Seite 1" by Howard Carpendale on Electrola until now 225,000 singles were sold. Together with the other 11 festival titles a total turnover of about 700,000 copies was reached.

An inquiry by the Federal Republic has shown that 56 per cent of all homes have a record-player. A third have tape recorders, a fifth, stereo plants and 10 per cent have a cassette-recorders. The difference between the age groups are: of the young people between 15 and 30, 74 per cents have records. These constitute three-quarters of the interviewed persons of this group. The 50-year-olds, only 37 per cent. Dr. Werner Vogelsang, managing director of Phonogram (Philips) explained that 30-40 per cent of the pop LP turnover in Germany are composed of progressive and underground music from England and the USA. The explanation of this fact is the generation problems. Nearly each second German (that means also record-buyer) is less than 25 years old. This impor-

tant fact must be noted in the future by all record firms.

Professor Leopold Ludwig, general music director, held a press conference in Hamburg before he flew to New York on the 16th of October. In New York Professor Ludwig will start with auditions for a new "Parsifal-production" at the Metropolitan opera. Premiere will be on November 14.

Jeffrey S. Kruger, chairman and managing director of Ember Records Ltd. of London and Jimmy Henney, director of promotion and creative services were on a whistle-stop tour visiting Munich and Berlin. The Ember executives spent a few hours in Munich visiting Nobby Varenholz, international head of Ariola, who distribute the Ember label in Germany. Ember is also partners in the Sparta Florida Music Group Limited and visited Hans Wewerka of Musikverlage Hans Wewerka for discussions concerning the future of this publishing combine, which is currently hot worldwide with recordings by The Moody Blues, The Foundations, Dusty Springfield, Desmond Dekker and many others.

Radio Luxemburg has finished its preparations for the big music producer festival "Grand Prix RTL International" which will take place in Luxemburg on October 28. At this competition, producers from Germany, Austria, Switzerland, Great Britain, Ireland, France, Belgium, Netherlands and Luxemburg will take part. The names of the interpreters of the twelve final titles are: Haide Hannson, Peter Rubin und Gigliola Cinquetti; Richard Barnes, Picketwitch and Julie Rogers; Serge Priset, Frida Boccara and Mike Brant sowie Monique Nelson, The Conventions und Greenfield & Cook. The special prize for the national program of Radio Luxemburg will be awarded to Joe Dassin, Freddy Quinn, Joe Dolan, Dalida and the Shocking Blue. The Second German TV will telecast this recording of the finale in color on the 5th of November.

A great day for the German record trade will be the 15th of November. On this day German TV will telecast the "Gala Evening Of The Record - Classical." This show - a co-operation between the record industry and TV - takes 135 minutes, is produced in color and will be taken over by the Eurovision for other countries. This arrangement has three parts: (1) Symphony concert - the recording of a Beethoven concert with the Wiener Philharmoniker, (2) the secret of the black disk - a report about the production of classical music records and (3) scenes from operas - a studio production with prominent opera stars as Nicolai Gedda, Wolfgang Windgassen, Ingeborg Hallstein and others. Until now 14 European countries will take over this mammoth telecast.

In the middle of 1971 the videocassett will enter the German market. The main customers are expected to be the 6,000 discotheques in Germany. The first program will be offered by the Video Tape-Program Company (the Bosch combine is participated with 25 per cent) in co-operation with Radio Luxemburg and the German Disk-Jockey Organization.

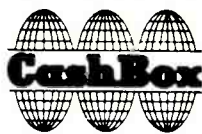

# Belgium

Humo's top 5 LP's are: 1. "Corrie & De Rekels" (11 Provincien), 2. "Cosmo's Factory" by Creedence Clearwater Revival (Liberty), 3. "Led Zep-pelin III" (Atlantic), 4. "Paul Severs" (Start) and 5. "Beach Party" by James Last (Polydor).

Vogue has a hit with Mungo Jerry's "Maggie," a track from their LP "In The Summertime." Cardinal has this week's pick of the week with "Good love & rock 'n roll" Teegarden & Van Winkle. Inelco released a cut-price Christmas LP by Elvis Presley. Fonior released the LP "Yo Canto" (Julio Iglesias) and the single "That's Were I Went Wrong" (Poppy Family). Enormous success for both the single "To My Father's House" and the LP "I believe" by the Les Humphries Singers. A well deserved feather in Etienne Smet's cap, the man responsible for this success. CBS-Artone released a new LP by Percy Faith and a double set "This is Donovan" on Epic. A great plugging for Diana Kolby's "Holy Man." Also a new series cut-price Artone LP's by Dutch artists. Polydor has a hit with Bobby Bloom's "Montego bay."

Polygram's Flemish stars Marva and Jimmy Frey have new hits. Marva's newest is entitled "Nieuwe liefde, Nieuwe Dromen/Darlidarlada." Jimmy Frey's is entitled "Waar De Zon Schijnt," the Flemish version of "Let The Sunshine In," written by the famous duo Hazlewood/Hammond." "Go North" is the new single by Richard Barnes, the British entry in the Grand Prix RTL. Big success for the Samantha Jones version of "My Way," number three in the BRT National top 30. Much played is "Roly Poly" by Stampford Bridge on Penny Farthing. New Polygram LP's are "Jimmy Campbell" on Vertigo and "Hits A Go Go" (Peter Covent).

Gramophone's public relation man Yves De Vriendt's pick of the week is "Dancing In The Moonlight" by Boffolongo on the United Artists label. A hit for Deep Purple and "Black night." Dimitri Van Toren, more popular in Flanders than in Holland due to the promotion of Gramophone-Belgium, has a new record in country-pop style entitled "Suzan" (HMV). In the series "The best of . . ." there are new LP's by Timi Yuro, Merle Haggard, martine Bijl and Nat King Cole en Espagne. A second solo LP for Ringo Starr and "Beaucoups Of Blues." Newly released Tamla Motown singles are

"Still Water" (The Four Tops) and "Give Me Just A Little More Time" (Chairmen of the Board). "Time To Kill" is the new single by The Band, a track from their LP "Stage Fright." Gramophone does a great promotion for its own recording Cantor Yeoshua Lerer accompanied by The Choir of the Great Synagogue in Antwerp. This is a double LP with Jewish songs. Gramophone, His Master's Voice records and Eagle Productions invited the press to a cocktail on the occasion of Francois Glorieux' new LP with the works "Mouvements-Effects-Rites." His first LP is sold very well. Gramophone does also a great promotion for the Irish group The Tymes.

Editions Basart-Belgium news: Samantha appeared in the TV-show "Binnen En Buiten" with her hit "Helikopter US Navy 66." Peggy has a new LP. She performs her new single "Cinderella/Aan De Piano" in the same "Binnen En Buiten" show. "Bella bella donna" by the Valantino's entered Radio Veronica's top 40. "April fools" by Pop Corn Corners entered the German hitparade. A new LP for Tony Corsari. The company tries to get the Les Humphries Singers to Belgium. Their LP and single are an edition Basart Belgium.

After "Caroline," "Holy Holy" and "Soolaimon" Ardmore & Beechwood got the rights of the new Neil Diamond single "Cracklin' Rosie." John Terra recorded the Flemish version "Parking Rosie" on Parlophone. Flipside is entitled "O Heer, O Heer." Lize Marke recorded the Flemish version of "Menningen" on Columbia. Ardmore & Beechwood control the singles "Ne Joue Pas" (Claudia Sylva) and "Een Dag Zonder Jou" (Benny Frank) in the whole world. "Justine" (The Tate Gallery) is controlled in several countries.

Hebra Records released the record "The Monks And Nuns From Temele." It is an original recording very popular in several countries. "Medley For You" is a new record by Roland Thyssen. R.K.M. news: The Belgian representative for the R.T.L. contest is the R.K.M. production and R.K.M. copyright "Alone." The group is The Convention and it was their first record produced with R.K.M. They will attend the contest in Luxemburg as the Belgian representative.

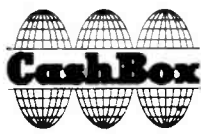

# Australia

The Federation of Commercial Broadcasters and the Phonographic Performance Company of Australia Limited, have agreed on a basis of settlement of their record dispute. The dispute, in operation for the past five months, has been over the terms on which commercial radio stations should be entitled to air certain records under the control of members of the PPCA. It arose out of the cancellation by the manufacturers of an earlier agreement whereby stations granted advertising time to manufacturers for the right to broadcast records. In a joint statement the Federation and the PPCA (manufacturers) announced that they had reached agreement on the basic principles of an equitable settlement. The parties have confirmed their intention of meeting quickly to work out details; in the meantime the ban on all English and most Australian recordings continues.

Back for another stint in Sydney, beautiful Lainie Kazan currently wowing audiences at the Chevron Hotel.

The double LP set featuring top name artists at a special budget price has become a boom for the Austral-

ian Record Company. ARC have three such sets in their new release; Bitches Brew by Miles Davis, The World Of Ray Price, and "Fill Your Head With Rock," a sampler of CBS performers including Santana, Chicago, Blood Sweat And Tears, and Laura Nyro. ARC's general sales manager Mr. Ray Bull said that while some performers had their doubts initially, they've now been dispelled by the popularity of the sets as the public realizes the great value it gets in this kind of buying. ARC promotion man Des Steen is currently touring America.

Cash Box congratulates Sydney-based entrepreneur Harry M. Miller, who for the second year running, won the Cobb & Co. Major Award for the greatest single contribution to the Australian entertainment industry. Miller was responsible for bringing the Musical "Hair" to this country.

RCA Records here have announced a reduction in the price of 7" EP records. Most extended-play disks sell at around \$1.55, but RCA has dropped back to \$1.19 in an effort to increase sales. (The retail price of singles is \$1.00)

## France's Best Sellers

- 1 Comme J'ai Toujours Envie D'aimer (Carrere) Marc Hamilton
- 2 In The Summertime (Vogue) Mungo Jerry
- 3 Girls I've Got News For You (Disc'AZ) Mardi Gras
- 4 L'Amerique (CBS) Joe Dassin
- 5 Gloria (Disc'AZ) Michel Polnareff
- 6 El Condor Pasa (CBS) Simon & Garfunkel
- 7 C'est De L'eau, C'est Du Vent (Philips) Claude Francois
- 8 Neanderthal Man (Philips) Hot Legs
- 9 Looking Out My Back Door (Musidisc) Creedence Clearwater Revival
- 10 No No No (Vogue) Voices Of East Harlem
- 11 Dirladada (Sonopresse) Dalida
- 12 Deux Amis Pour Un Amour (Philips) Johnny Hallyday
- 13 Tante Agathe (Philips) Rika Zarai
- 14 Never Marry A Railroad Man (Disc'AZ) Shocking Blue

## EDITORIAL: The Best Yet!

Trade paper writers have a penchant for dubbing every industry exposition a "success". Commenting on this year's MOA convention is a breeze in that regard. It was not only a success . . . it was in every respect the **very best yet**.

Attendance was up—2,355 this year registered, as compared to 2,037 in 1969. Better, the percentage of "pure operator" personnel was well over the 50% range this year, with the rest composed of the exhibitor personnel and their dealers. What this means in a nutshell is that this show put machine manufacturers and their salesmen in face to face contact with their customers, and even better, had a wealth of brand new merchandise right there to talk about.

The 1970 Expo was again unique in the type of operator personnel who turned out to view the exhibits, attend the business meetings and exchange ideas with their contemporaries. It seemed that every operator brought along at least one of his servicemen. The exhibitors loved it. They had a chance to talk about the technical and location merits of their machines with the route guys instead of just price with the operator. They could and did hit on all bases.

Operators got a lot off their chests at the show. They hit the exhibitors on pricing, mechanical points, game ideas. The factories in turn had an invaluable chance to explain why prices go up and could show the electronic breakthroughs they engineered into the new equipment which pushed that price up . . . breakthroughs which also pushed up the coin box take on location.

The trade show was basically knowledgeable people asking knowledgeable questions and getting straight answers. It was a show where business was written in private rooms and hospitality suites after the show each day. And even tho it's against the rules, we bet there was plenty of dealing going on right on the trade show floor.

Why do we stress the success of the trade show rather than of the whole convention itself? Well, for one thing, MOA as an organization proved itself to be an outstanding and continuing success several years ago . . . no contest. Its own services and achievements are on record and its new activities are duly reported on in this issue. But the trade show—the exposition of machines—was of singular interest to all in the industry this year . . . an industry which in Fred Granger's words "looked to the Expo for that shot in the arm to move away from the soft and back to the boom."

We feel if any event could and did give us that boost it was Expo Seven-O. Everyone let it all out . . . the gripes the great ideas. Personal confrontations were all over the place the first day but friendships were renewed by show's close. The frustrations of dealers, welling up from a really telling business slump, were soothed, not only with orders but with the promise of continuing orders. And not out of any operator's good heart but from his head, as he saw, absorbed and acted to get the best equipment back into his route locations for the best collections the public can yield.

## Montooth Assumes MOA Presidency at Expo 7-0; Williams Amendment Feared Likely to Pass Senate

CHICAGO — Les Montooth, Peoria, Ill. operator, formally accepted the presidency of MOA for 1970-71 at the general membership meeting held here Oct. 17 during Expo Seven-O. Montooth, who succeeds Lou Ptacek, Bird Music Co., Manhattan, Kan., as association president, was elected by the MOA's nominating committee at MOA's mid-year board meeting in San Francisco.

The MOA's new treasurer is John Trucano, Black Hills Novelty Co., Deadwood, S.D. Trucano has just completed his 1969-70 term as the association's treasurer. Taking over as treasurer is Harlan Wingrave, Emporia Music Service, Inc., Emporia, Kan. Wingrave has just completed a term as an MOA vice president and served as a co-chairman of Expo Seven-O.

While the meeting was generally marked by applause for incoming and outgoing association officials and award recipients, controversy was aroused by the legislative report of Nick Allen, MOA's Washington attorney and lobbyist. Allen reported that the Williams Amendment, as unfavorable addition for operators to the Copyright Revision Bill, was likely to be passed by the U. S. Senate during the upcoming session.

The Bill, as passed by the House of Representatives in 1967, provides that operators pay an annual flat fee of \$8.00 to compensate persons on the creative side of records played on jukeboxes. The Williams Amendment would increase that yearly fee to \$9.50 with a provision for review after five years. The original \$8.00 fee was the result of an agreement arrived at between legislators and MOA representatives.

Operator George Pappas made a motion that the bill be now fought in its entirety because federal legislators have reneged on the original compromise and there is no longer



The changing of the guard is signified by a plaque of appreciation presented to outgoing MOA president Lou Ptacek (left), by his successor Les Montooth.

any reason for the MOA to comply with the Bill.

Outgoing vice president Tom Greco, Jr., seconded the motion, maintaining that the \$9.50 figure would merely represent a "foot in the door" by the performance rights societies and that efforts would be made to further increase that figure.

Allen then returned to the podium and suggested that the MOA stick to its current position and that members begin pressuring their legislators since the Bill must return to the House for a vote even if passed by the Senate.

Allen said that the MOA has struck a bargain and would behave in bad faith to back out of that bargain. "If we fight," he said, "the scramble starts all over again." He said that if the debate begins anew, the per-

(cont. on p. 55)



Eight of 10 outgoing MOA directors display the certificates of appreciation they received during the MOA's general membership brunch meeting held during Expo Seven-O. Standing (left to right) are Harry Witsen, Cannon Coin Machine Co., Haddonfield, N.J.; Harry Schaffner, Schaffner Music Co., Alton, Ill.; Pat Storino, S & S Amusement Co.; L. M. Smith, Capitol Music Co., Jackson, Miss. and outgoing MOA president Lou Ptacek, Bird Music Co., Manhattan, Kan. Seated (left to right) are Jim Mullins, Mullins Amusement Co., Miami, Fla.; Leonard Leonard, Leonard Amusement Co., Adrian, Mich.; Garland Garrett, Sr., Cape Fear Music Co., and Ray Barker, Wayland's Amusement Co., Shirley Center, Mass. Absent from the photo are Joe MacQuivey, Mac's Machines, South Bend, Ind. and Bill O'Connor, O'Connor Dist. Co., Dallas, Texas.

Seeburg's more-play phonograph with an all new look

# musical Bandshell



The Seeburg Musical Bandshell — its elegant bandshell arc breaks with traditional design to offer the most dramatic coin phonograph available anywhere! With Exclusive 10 button Digital Selector • Exclusive “All Coin Accumulator” lets customers buy music with nickels, dimes, quarters and half dollars in any combination with bonus incentives • Exclusive Micro-log circuitry • New Seeburg Stereo Sound System • New pull-out servicing feature that’s up front and on top!

The Seeburg Sales Corporation • 1500 North Dayton St. • Chicago

**SEEBURG**

# Bally's Scheer Scores Ops' Attitude Toward Distributors at Expo Seminar



Participating in the Expo-Seven-O opening day panel seminar on "New Vistas in the Amusement Game Industry" are Mort Secore, sales manager of Chicago Dynamics Industries; Marty Johnson, sales manager of Nutting Industries; Ross Scheer, director of marketing for Bally Mfg. Corp.; Gene Lipkin, sales manager of Allied Leisure Industries; Leonard Nakielny, Williams Electronics, and Dave Ralstin, sales manager of Nutting Associates. Moderating the panel discussion was Fred Collins Jr. (center photo), Collins Music, Greenville, S.C.

CHICAGO — "The distributor in today's music and games business is being unjustly maligned by the operator," asserted Bally Mfg. Corp. marketing director Ross Scheer, during his address at Expo Seven-O's Friday (Oct. 16th) industry seminar. "Operators have an attitude toward their local dealers which just plain makes me mad," he stated. "Instead of considering the dealer as some kind of

necessary evil, the operator should see his dealer as a positive force in this industry. Be advised that we at the games factory's consider our dealers as an indispensable part of our marketing programs. We have no intention of getting into the distributing business ourselves by taking over dealers. We simply could not do the effective job that our existing dealers are doing, so operators had

better look at the distributor for the true job he is doing for them in equipment supply, parts supply service and financial help."

The opening day seminar at the 1970 MOA discussed the broad subject "New Vistas in the Amusement Game Industry". While it frankly did not measure up to the expectations of many visiting operators, who expected to gain more information on procedures for finding and exploiting new locations with the newer electronic games, it did offer some clear indication by the games factories' on how they think the operating trade is or isn't taking advantage of the "promise of the sight and sound machines."

The seminar began with a series of short speeches by panel members Scheer, Marty Johnson, sales manager of Nutting Industries; Dave Ralstin, sales manager of Nutting Associates; Mort Secore, sales manager of Chicago Dynamics Industries; Gene Lipkin, sales manager of Allied Leisure Industries, and Leonard Nakielny of Williams Electronics. Panel moderator was Fred Collins Jr. of Collins Music, Greenville, S. C.

Discussing the distributors' situation, Scheer said, "There is a cloud to his future at this very moment. He makes less money than anyone else in the trade."

He said the distributor's basic problem is an inability to sell enough new machines to operators who really need them. Scheer said that 75 per cent of amusement games on location are more than five years old. He added that the distributor's well-being hinges on the foresight and innovativeness of the factories. "The distributor lives and dies with our winners and losers," he said.

Reacting indignantly to a trade magazine survey in which one operator termed distributors, "liars, thieves and competitors," Scheer asserted that the distributor is "one of the operator's best friends." He added, "I have heard that operators are nothing more than collectors," and said that if some distributors competed with operators for locations, it was because the operators were doing an inadequate job and weren't capable of holding those locations.

Scheer also mentioned the service school efforts by distributors as valuable to operators.

Lipkin spoke about the newer games recently produced and maintained that audio-visual games benefit the operator, resulting in "more income, more locations and a greater turnover in equipment."

Nakielny discussed the components of the new games, emphasizing the increased use of electronics parts in the newer games. "The use of electronics parts in our equipment," he said, "is not only feasible, but practical."

Referring to the new locations that have been opened up by the newer machines, Ralstin quoted a trade magazine survey that reported 35 per cent of operators have placed games in the newer locations. He encourag-

ed operators to pursue the new locations and encouraged distributors to devote the bulk of their time toward servicing the innovative operators.

"If I were a distributor," he said, "I would spend 90 per cent of my time with those 35 per cent of the operators, because one day those 35 per cent will own the other 65 per cent."

Secore emphasized the need for diligent machine maintenance, reasoning that play at locations and the willingness of location owners to do business with operators is greatly encouraged by the appearance of machines that are kept in good condition.

Progressive per-play pricing was the theme emphasized by Johnson, who pointed out the need for quarter play to help the operator adjust to an economy that has been taking its toll on other businesses.

During a provocative question and answer session, Harry Goldner of Silco Automatic Vending Co. explained his firm's serious problems with vandalism and asked why the factories do not make an effort to install effective security devices in their machines. "Security would be a big selling point," he said.

John Bilotta, president of Bilotta Enterprises, answered Goldner by saying that operators are not ready to pay for security devices that would obviously increase the costs of machines.

Millie McCarthy, president of the New York State Coin Machine Assn., replied, "We're ready to pay for it."

The basis of the controversy appeared to be over the severity of the vandalism problem throughout the nation. If security devices were placed on machines, all operators would have to pay for them whether or not vandalism problems were acute in their respective areas.

In the general area of machine components, Abe Weisberg of Abraham Weisberg Service Co. asked what the factories were doing cooperatively to offer interchangeability of machine parts to alleviate the operator's service problems. He was told that the problem has not yet been attacked on an industry-wide basis.

The seminar was followed by convention guest speaker Dr. G. Herbert True (See separate story).

## 110 Ladies Attend Luncheon

CHICAGO — A highlight of Expo Seven-O was the ladies luncheon held at Maxim's, one of the most exclusive restaurants here.

MOA chartered special buses to transport 110 ladies from the Sherman House Hotel to the Astor Towers where the restaurant is located. A French meal was served, complete with wine and dessert.

The luncheon's climax was a fur fashion show at the conclusion of lunch, sponsored by Saks Fifth Avenue. All present "ooh'd" and "aah'd" over the elegant array of furs.

## Montooth New MOA President; 4 Vice-Presidents, 10 Directors Installed at Expo Membership Meeting

Con't. from page 53

formance rights societies are likely to demand substantially higher payments than those currently proposed.

Pappas' motion was amended to a motion that the MOA stick to its \$8.00 agreement and go no further. It was not specified what action would be taken if the Senate passes the Williams Amendment and then returns it to the House for a possible passage into law.

The legislative report was preceded by the treasurer's report during which Trucano reported the Association's assets as \$129,886.12 for MOA's last fiscal year, adding that the convention would cost about \$30,000.

Four outgoing association vice presidents were presented with plaques and 10 outgoing directors received certificates to underscore their service to the Association.

The outgoing vice presidents honored were Greco of Greco Bros. Amusement Co., Glasco, N. Y.; Russ Mawdsley, Russell-Hall, Inc., Holyoke, Mass.; Hal Shinn, Star Amusement Co., Gaffney, S. C., and Wingrave.

New vice presidents installed were Bob Walker, Capital Music & Vending, Helena, Mont.; Ted Nichols, Automatic Vending, Inc., Fremont, Ned.; Ray Barker, Wayland's Amusement Co., Shirley Center, Mass.; and Garland Garrett, Cape Fear Music Co., Wilmington, N. C.

Eleven new directors were elected by the membership, one of whom will complete an unexpired term. They are Clayton Norberg, C & N Sales Co., Mankato, Minn.; Dike Hawes, Peach State Music Co., Macon, Ga.; Wes Lawson, Lawson Music Co., Winter Haven, Fla.; Bob Rooney, State Novelty Co., Baton Rouge, La.; James Stevens, J. Stevens Amusement Co., Grafton, W. Va.; Wayne Hesch, A. H. Entertainers, Inc., Arlington Heights, Ill.; Maynard Hopkins, Honkins Music & Vending, Inc., Galion, Ohio; Arnold Taksen, D & L Coin Machine Co., Harrisburg, Pa.; Clem Arceneaux, Service Music Co., Jackson, Miss.; Fred Zemke, Zemke Operated Machines, Ann Arbor, Mich., and Gil Sonin, Gil Music, Brooklyn, N. Y. Sonin is completing an unexpired term and will remain eligible for a director's post in 1971, when his current term expires.

Stepping down as directors were Barker, Garrett, Leonard Leonard, Leonard Amusement Co., Adrian, Mich.; Joe MacQuivey, Mac's Ma-



Outgoing MOA president Lou Ptacek (right) presents a Merit Award to Phil Mason, Allied Vending Corp., Washington, D.C., for his cooperation with the Washington Star newspaper in the research of the feature, "The Beloved Jukebox", which appeared earlier in the year as the cover story in the Star's Sunday supplement.

chines, Inc.; Jim Mullins, Mullins Amusement Co., Miami, Fla.; Bill O'Connor, O'Connor Distributing Co., Dallas, Tex.; Harry Schaffner, Schaffner Music Co., Alton, Ill.; L. M. Smith, Capitol Music Co.; Pat Storino, S & S Amusement Co., Toms River, N. J., and Harry Witsen, Cannon Coin Machine Co., Haddonfield, N. J. Storino now replaces Walker as MOA sergeant-at-arms.

A Merit Award was presented to Phil Mason, Allied Vending Corp., Washington D. C. for his efforts in cooperating with the Washington Star in a Sunday supplement cover story entitled "The Beloved Jukebox." A Merit Award was previously presented to former MOA president Howard Ellis at a recent quarterly meeting of Coin Operated Industries of Nebraska.

The membership meeting also included a report by MOA executive vice president Fred Granger, who discussed the immediate future of the Association. Granger said that the MOA is now moving into a new role, one more inclusive than that of an administrator. "We must provide vision, leadership and some guidance," he said.

## Little L. P.s Reviving, Says Gold-Mor Head

ENGLEWOOD — The "Little L.P. revival" is proceeding at a healthy pace, according to Bernie Yudkofsky, president of Gold-Mor Distributing here, who exhibited at the recent Expo Seven-O in Chicago.

Yudkofsky, who distributes Little L.P.s nationally reports that operators at Expo were enthusiastic about his product. "I'm very happy with the operators' reaction," he said, "and now our main task is to get our message across to the one-stops."

He said that the larger one-stops have been receiving large demands for Little L.P.s, but that many one-stops do not yet have them in stock. Yudkofsky added that he expects one-stops will pick up on orders, however, as operators continue to ask for the product. "The final guy who gets it wants it," Yudkofsky maintains.

He further explains that the Little L.P.s must avoid duplication of material already included on singles. Such duplication, he said, would cut down on orders from operators who already have the singles material on their machines and would detract from the image of Little L.P.s as a fresh product.

Yudkofsky began his distributing effort with nine Little L.P.s and has since received four new L.P.s from Capitol Records and currently has four in the production stage from Columbia. The forthcoming L.P.s are by Johnny Mathis, Errol Garner, Tammy Wynette and Harry James.

The Gold-Mor president said he expects to continue expanding his inventory and also expects to maintain the adult location-oriented bent of his product.

A Full Line of  
Coin Operated  
Recreational  
Tables from

*American*  
**SHUFFLEBOARD COMPANY**  
210 PATERSON PLANK ROAD  
UNION CITY, NEW JERSEY

"The House That  
Quality Built"

**U.S. MARSHALL**

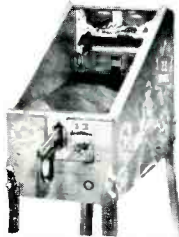

**J.F. FRANTZ MFG. CO.**

1940 W. Lake St.  
Chicago, Ill. 60612  
Tel. TAYlor 9-2399

**WANTED:  
Williams  
4 Aces**

Contact:  
**(212) 377-0788**



# CashBox Location Programming Guide

THIS WEEK'S TOP RECORD RELEASES FOR COIN PHONOGRAPHS

## Pop

STONED LOVE (2:49)

**THE SUPREMES**

Shine On Me (3:59) Motown 1172

DOES ANYBODY REALLY KNOW  
WHAT TIME IT IS? (2:53)

**CHICAGO**

Part 2 (3:17) Columbia 45264

IT'S ALL IN YOUR MIND (2:31)

**CLARENCE CARTER**

Till I Can't Take It Anymore (3:05) Atlantic 2774

JOHNNY B. BADDE (3:00)

**MUNGO JERRY**

My Friend (2:36) Janus 128

PAY TO THE PIPER (3:06)

**CHAIRMEN OF THE BOARD**

Bless You (2:59) Invictus 9081

HE AIN'T HEAVY . . . HE'S MY BROTHER (3:59)

**NEIL DIAMOND**

No Flip Info. Uni 55264

DO IT (2:18)

**NEIL DIAMOND**

Hanky Panky (2:47) Bang 580

## R & B

ALL I HAVE (3:20)

**THE MOMENTS**

No Flip Info. Stang 5017

WRAP IT UP (2:40)

**ARCHIE BELL & THE DRELLS**

Deal With Him (2:40) Atlantic 2768

KEEP ON LOVING ME (2:32)

**BOBBY BLAND**

No Flip Info. Duke 464

## C & W

ROSE GARDEN (2:52)

**LYNN ANDERSON**

No Flip Info. Columbia 4-45252

WAITING FOR A TRAIN (1:37)

**JERRY LEE LEWIS**

No Flip Info. Sun SI-1119

THE TEARS ON LINCOLN'S FACE (2:28)

**TOMMY CASH**

No Flip Info. Epic 5-10673

## Dr. True Combines Comic Routine With Sound Business Advice In Expo Presentation; Stresses Need for Trade Professionalism

CHICAGO — Combining sound business advice with the routine of a stand-up comic, convention guest speaker Dr. G. Herbert True delighted a full house of Expo Seven-O visitors Oct. 16 in the Louis XVI Room of the Sherman House Hotel.

Dr. True, a research psychologist and former university professor, discussed "Salesmanship and Public Relations." Striding onto the floor blowing a whistle and dressed in a football referee's uniform, True proceeded to explain to operators the factors that cause man's behavior and emphasized the need for the music operator to adopt an attitude of business professionalism.

"You're either an amateur or a professional," he reiterated, explaining that the professional has a thor-

ough understanding of his business and an understanding of the needs and goals of those he seeks to serve.

When the competition is equal in an industry, he said, the individual businessman must be better than that competition. He stressed the need to operators for improved interpersonal communication with customers through distinctive calling cards, name tags for salesmen and a forthright, friendly approach.

True's talk was accompanied by an imaginative slide presentation that illustrated the operator's business associates and problems in a humorous light. He received a standing ovation at the conclusion of his speech.

True's talk was preceded by a panel discussion on "New Vistas in the Amusement Game Industry."



Dr. True at Expo



## New Rock-Ola Phono Line Includes 3 Models;

### 'Low-Boy' Console Features Furniture Look

CHICAGO — Rock-Ola Manufacturing Corp. recently introduced a com-



Rock-Ola's new 160-selection Model "444" phonograph contains many of the features of its predecessor, the "442", and offers several new features, which include the digital read-out "record-now-playing" indicator and improved service accessibility.



The Rock-Ola "445" is the 100-selection counterpart to the "444", including the same features such as swing-out components for in-unit on-location service and an electric "total play counter".



Rock-Ola's new Model "446" furniture style low-boy console has been designed to gain entrance into locations with decor considered incompatible with a standard type of jukebox. The "446" offers 160 selections and contains the identical features of the "444" phonograph.

plete new line of coin-operated phonographs to its distributor organization at the Grand Hotel in Point Clear, Alabama, on October 4.

The phonograph line was publicly shown to all operators attending the recent MOA Show at the Sherman House here and was also shown to operators throughout the country by Rock-Ola distributors during "Open House Week" the week of Oct.

The phonograph line consists of a new 160-selection, traditional console; a 100-selection traditional phonograph, and a new furniture style console, which also offers 160 selections.

The 160-selection model "444," while carrying over several features from its predecessor, the Model "442" has many new added features. Among the new features, according to Ed Doris, executive vice president of Rock-Ola Manufacturing Corp., is the "compute-a-flash" digital read-out "record-now-playing" indicator. This record indicator provides animation and information as it prints out the record number in gleaming progressions.

Another new feature is the angle of the program holder, which has been slanted forward for perfect alignment of the record number and tune titles. The entire program holder and shroud has been tinted light blue to cut down on glare and improve the visibility of the title strip.

For operator service, the entire program holder assembly "flips-down" for accessibility for cleaning the inside of the upper dome glass and a spring-loaded counter-balance mechanism has been added for ease in lifting the upper dome.

Other features include the snap-out, indestructible cycolec front grille; swing-out components for in-unit on-location service; stand-up programming for eye level reading of the title strips and integrated circuits to provide ease in servicing, and the elimination of the pre-amplifier chassis.

Other features are the addition of an electric "total play counter," new turntable motor featuring specially hardened shafts, and jet-age lubrication for extra long life. A new locked cash box provides greater storage and collection security and is an optional piece of equipment. Two-for-a-quarter pricing is standard on the Model "444."

The 100-selection counterpart of

## Six New Jukeboxes Presented by Rowe Intl.

### In Attempt at Widespread Location Appeal

WHIPPANY — Rowe International has introduced a 1971 line of six new phonographs. No major changes were made in the phonograph mechanism which is the same in all models, but the exterior cabinetry of each is different.

Continuing with the wood-front styling introduced last year, Rowe now has two models with the furniture look, the "Californian" and "New Orleans". Two other models, "Cathedral" and "Tiffany", feature leaded-glass type fronts, designed to complement the stained glass decor of many locations. Two additional models, the "Playgirl" and "Beauty", depict beautiful girls.

The new models all have a profile five-inches lower than the "MM-4" of last year. Illuminated framing around the selector panel and the larger selector buttons provide a "human engineered" design which makes it convenient for the customer to play.

The title strip safety glass cover is tempered for strength, and the title strips are front-illuminated rather than back-lighted.

The basic mechanism design has been in use for 10 years, and evolutionary refinements have been incorporated, including centered gold contact points for longer life and three fewer cam switches. All bearing surfaces now use dry lubricant materials, such as teflon, dalbon and emralon, and Rowe offers a 5-year guarantee on all moving parts.

Rowe's "stereo round" sound system has been improved with the addition of a second heavy duty bass speaker in the duct-tuned sound chamber. The two-six inch side speakers have been repositioned for improved tone balance.

The Rowe AMI phonograph also uses hybrid amplifier—solid state for the pre-amp and easy-to-service tubes for the power output. The standard amplifier is rated 68 watts (IHF) and there is available as an option an amplifier rated at 136 watts for large installations.

The MM-5 "Presidential" line is available for 100, 160 or 200 record selections, and play mixed 45 and 33 1/2 r.p.m. stereo disks. The dollar bill acceptor is optional, as are many other accessories, including the "PhonoVue."

the Model "444" is the new Model "445." According to Doris, the Model "445" has all the features of the Model "444" except that a quarter pricing kit is optional equipment on the "445."

The new addition to the Rock-Ola line of phonographs is the Model "446" — the furniture style low-boy console. This machine, according to Doris, was designed to fit into the type of location, the decor of which would not fit the traditional type of juke box. The Model "446" is a 160-selection phonograph and all features are identical to the 160-selection Model "444." When not in use, the lid of the Model "446" can be lowered and becomes a contemporary piece of furniture.

The Model "444" is presently in production; the Model "445" is scheduled for production towards the end of November, and the Model "446" is scheduled for production in December.



Rowe design and engineering executive Walter Koch explains the design of the "New Orleans" model, one of six new phonographs in the firm's "Presidential" line.

Other continued features include full front door servicing, single key operation, one hand spring-assisted door opening, flip-out title strip racks, plug-in components, complete picing flexibility, and a service control center. A special switch puts the phonograph back into operation by closing the door.

This year Rowe is also offering a break-in/vandalism insurance policy for each Rowe phonograph on location that is equipped with Rowe's optional burglar alarm.

In announcing the program, Joe Barton, vice-president of Rowe's marketing & distribution stated that the insurance covers the loss or damage to the phonograph and contents as the result of the theft, fire, attempted burglary and vandalism.

BUY  
**Bally**  
**SPACE FLIGHT**  
FOR  
**TOP EARNINGS**  
IN  
**EVERY TYPE OF LOCATION**  
EVERYWHERE

**NUTTING INDUSTRIES LTD.**

salutes its distributor and friend

**JOHN BILOTTA**

on his selection as

**1970 Citizen of the Year**

by the Newark, N.Y. Chamber of Commerce

We're proud of you, John!

# Cash Box Snaps from MOA Expo Seven-O



Honored dais of MOA officers and directors assemble at opening of gala banquet Sunday evening. Banquet brought out an SRO attendance of ops, wives, employees, plus manufacturer and dealer reps, to enjoy ceremonies and elaborate floor show.

MOA brass, all decked out in their banquet finery, gather for snapshot. They include past president Howard Ellis, new treasurer Harlan Wingrave, outgoing president Lu Ptacek and executive vice president Fred Granger.

Up at the well-populated A.C.A. hospitality suite in the Bismarck, the food and liquid refreshment flowed freely, as did compliments for the new NSM Prestige 160-B jukebox on display in the room, as well as on the trade show floor.



Mondial Commercial Corp's sales exec Aspet Varten (left) joins Allied Leisure Industries' chief engineer Ron Haliburton and ALI prexy Boh Braun at their display in the games room. Mondial distributes ALI's Wild Cycle in overseas markets.

SEGA's Jet Rocket, one of this fall's sales sensations, was center of attention at their exhibit. Firm chairman Dave Rosen (left) with Cash Box's Ed Adlum try turning it into a two player version.

Bill Anderson (left) and Tommy Greco (right) think Clint Pierce needs a little more bubbly and aren't about to take no for an answer at the gala banquet.

Mutoscope president Larry Galante, with well-versed machine demonstrator, talked up the games which A.C.A. imports into the states at that firm's second exhibit in the games room.



Johnny Bilotta (left) shakes hands with Juke Records' prexy Tommy Wills and Mrs. Wills at the latter's exhibit. Tommy makes and markets 45's exclusively for jukebox operators.

Hoping wives don't get to read the Cash Box, here's a rather representative photo of the hail-fellow-well-met at the various hospitality suites.

Can't figure it out, but we only know the guys with drinks in their hands. Left to right, are: Hank Leyser, a non-drinker, Larry Galante, Lou Northrup and Al Scalora.

Sumner Segall of Kiddietime pulls a funny out of Ed Winn's file at the Cash Box booth. Left to right are Jon Rand of Cash Box, Sumner, Ed Adlum of Cash Box and Alex Kress of Cortlandt Amusement.



West Virginia guys and gals get together at the banquet, reminiscing about the closing convention and looking forward to next year's event.

U.S. Billiards execs and customers surround firm's brand new and feature-packed Aristocrat coin timer table, among them: Dick Simon, Al Simon, Len Schneller and Al D'Inzillo.

Doing the evening thing at another hospitality suite, we find many familiar faces (and a bunch we don't know). Among this august assemblage are Larry Kaghan, Joe Gino, Fred Granger, Bob Rooney and Fred Collins.

# Cash Box Camera Snaps From MOA Expo Seven-0



Atlas Music of Chicago prexy Eddie Ginsburg (center) and Rowe International market service exec Jimmy Newlander (right) strike proud stance at the Rowe exhibit, and why not . . . brand new Presidential juke line was on national display for first time, and the trade gave it a grand reception.

Happy group at the Rock-Ola pent-house hospitality suite Friday evening is (left to right) Mrs. Ed Zorinsky of H. Z. Vending, Omaha, Eddie, Lucky Coin's Bob Nims and Mr. and Mrs. Johnny Trucano of South Dakota's Black Hills Novelty Co. Bob and Ed are Rock disribs and the Trucano's are good customers.

Empire International's Murph Gordon, with cutie-pie helpmate, manned the really popular Empire exhibit where the Phonograph Equipment-Ruffler & Walker games line was on display for first time at MOA. Clearly most popular of the PRW games was the Flying Circus which should be shipping by end of this year.

Seeburg of Chicago president Bill Adair (left) with firm's vending division chief Bob Breither were on hand at Seeburg's exhibit to render advice on and accept compliments for their brand new Musical Bandshell phonograph. Local dealer showings were held prior to the MOA, but many conventioners viewed spectacular juke for first time at the Expo.



Cash Box's Ed Adlum (left) meets good friend Jack Mitnick at the Irving Kaye Co. exhibit over Irv's prototype of the Bing Bang Bo. Jack was at Expo to sing the praises of his new Electro Billiard Ball Polisher machine.

Gale Records' artist Harold Braun (between glamorous firm staffers) gets ready to autograph sample 45's for New Jersey op Paddy Storino (center) and Nick Roco of Kiddie-time in Mass.

Fischer Mfg. Corp. coin division manager Frank Schroeder (right) holds poster pointing down to interior table view of firm's brand new burglar alarm mech, which made a hit with security-minded ops. To Frank's right is Fred Blaes, with prexy Charlie Bailey in center.

A bunch from West Virginia pause on entering the exposition floor area for a snapshot. Left to right are Gene Wallace, Leoma Ballard and George Pappas.



The gang was definitely all there (and enjoying it) at the All-Tech display with (left to right) Carl Novy, Sol Mollengarden, Mel Blatt, Aaron Goldsmith and a pair of unidentified ops.

Williams-United veteran Billy DeSelm, one of the few guys who enjoys instant recognition by the trade at every MOA, shows Ed Adlum the in's and out's of firm's soon-to-release Straight Flush pin.

Taking advantage of the benefits at the MOA directors cocktail party Thursday night are: (left to right) Bob Rondeau of Empire, Mrs. Maire Pierce, her well-known husband Clint and Jim Stansfield.

The prime movers at American Shuffleboard's popular display, proudly showing off their new coin-op Golden Eagle shuffleboard, are: (left to right) Dick DelFino, Nick Melone, Sol Lipkin and Mike Bozza.



Valley Mfg. Corp's exhibit displayed current coin and home table line, plus their own-manufactured selection of cue sticks. Firm president Earl Feddick (to right) chats with customer.

"Gimmie that pipe and take this cue" jokes D&R's Lynn Ruber (left) to Illinois op Bernie Lazare (right) while Dick Utanoff looks on

At long last, the machine everybody heard about but few saw made it to MOA. The phenomenal multi-sensory Sensorama Simulator console did it's fantastic thing at Expo Seven-0 and inventor Mort Heilig (right) enjoyed the commotion.

As if it were necessary to promote Rock-Ola's perennially popular pent-house party, George Hincker gave all a reminder anyway. Next to George is Rock-Ola's Lowboy 446 stereo console.



ROCK-OLA



The coin operated phonograph industry is very mature. That means that everybody is producing an excellent product and the operators in the field have a great choice of equipment. Great. But there are differences and a careful choice of the best phonograph can still mean increased profits.

With all this in mind, we'd like to announce the new Rock-Ola 444 phonograph for 1971. A phonograph, we feel, that surpasses even the present standards of the industry. In design, service, durability, and ease of operation.

To begin with, the 444 is a blaze of monochromatic purples. Just like the fashion industry this year.

We've got a new program holder shroud that drops down for improved cleaning. Flip-down title strip holders for changing ease. And a spring loaded dome with a new counter balance mechanism that your wife could lift with one finger.

We've added advanced, integrated circuitry and a computerized selection indicator that prints out the "Record-Now-Playing" number in glittering progressions. 160 selections.

Tempered glass. A new coin box security system. A modular approach to getting at the guts. And a lot of other features that you've been wanting. We're not saying that the other phonographs aren't good, but we think that this year's Rock-Ola 444 is a little better. And in our industry, a little better is a lot. Try it. You'll like it.



IT'S HARD  
TO BE  
BETTER  
WHEN  
EVERYBODY  
ELSE IS SO  
GOOD

ROCK-OLA  
THE SOUND ONE

800 North Kedzie Avenue  
Chicago, Illinois 60651

# Cash Box Snaps From MOA Expo Seven-0



Twas the age of Aquarius, and of Taurus and Gemini for that matter, at the Wurlitzer Co. display as firm bowed gorgeous new Zodiac juke. Out front (left to right) are Nat Hochman, identified customer, Ralph Cragan and Bob Bear.

Between a couple of their dozen coin and home tables, friends of the Irving Kaye Co. give us a photo. Left to right are Kaye sales manager Howard Kaye, Active's Frank Ash and Kaye production chief Arnold Kaye.

A.C.A. Sales and Service held forth with an extremely well-attended hospitality suite in the Bismarck every night of the show. Firm dealers for NSM phono line above at the suite are (left to right) Tom Greco, Len Leonard, Mickie Greenman, Ron and Larry Kaghan.

Bernie Yudkofsky, president of Gold-Mor Distributing, enjoyed brisk activity at his display of little LP's which he found much to the operator's liking.



Center of attention at the ACA exhibit is the brand new Prestige 160-B phonograph. Flanking the juke are ACA president Hank Leyser (left) and NSM factory exec Herbert Nach, with four marvelous machine demonstrators.

Fresh for the show and a real hit with ops with bowling alley locations is Nutting Industries' Learn-O-Matic machine, with audio-visual (coin-op) instructions on how to throw the ball. Left to right are Dave Nutting, Johnny Bilotta (always learning) and Marty Johnson.

Brand new for Expo at the Midway Mfg. Corp. display is the Invaders target game. Showing it off are (left to right) Midway's Larry Berke, model Donna Rae Wood and Bally marketing chief Ross Scheer.

Anxiously waiting for the "show" to start above are (left to right) Sugarman's Hans VanDenDop, Tom Greco and Myron Sugarman.



Dave Ralstin (left), Nutting Associates' sales manager, chats with quiz machine ops at that firm's display.

Prominent coin machine exporter Vic Haim of Belam (left) was joined by son Marc at the Expo this year. We snapped them at the MOW association booth in the registration area.

U.S. Billiards sales manager Len Schneller (right) congratulates winners of firm's 8-ball tournament, Greg Oliver (first place) and Mike Mosebacher (runner-up) with U.S. salesman Sy Lipp at right.

The Brunswick Corp. exhibit was very popular during the show, with ops checking out the CB coin-op table series and registering for prize drawing. Billiard pro Joe Balsis (right) joins firm's product chief Mac Makenny in presenting Nancy Garrett with rod and reel.



Back to Nutting Industries we find well-known Philly dealer Joe Ash (left) with Nutting sales manager Marty Johnson and Cash Box's Ed Adlum.

A real big hit at this year's convention was Johnny Bilotta's Sweepstakes penny pitching game. That's John showing us novices how it's done, with Mike Steingass and Pat Button looking on.

Plenty of new prototypes, and current games, were on display at Bally's wide display. Plenty of dealers and customers there too.

Gordon Murrey (right) of Murrey & Sons coin and home table factory in California, with sales staffers, presented their lineup to the MOW for first time this year.

# Of the eleven new jukeboxes being introduced this year, we make six.



**Beauty**



**New Orleans**



**Tiffany**



**Cathedral**



**Playgirl**



**Californian**

For the first time ever, we're introducing a line of jukeboxes. The Presidential Line.

Why are we doing it? To give you more than a one style, "take-it-or-leave-it" selling story. To make it easier for you to place our machines. To make money for you.

And, in the long run, to give you a higher resale value.

But looks aren't everything new with our Presidential line. The sound is new, too. It's the best sound in the industry. Our

patented stereo round has been expanded, and we've added another speaker to our duct tuned sound chamber.

Is a line of jukeboxes a better idea? Well, all we can say is that last year we introduced a line of changeable front panels. And we improved our market penetration. Nobody else did.

So, get on the Rowe bandwagon. And let us hand you a line.

**rowe international, inc.**

A SUBSIDIARY OF TRIANGLE INDUSTRIES, INC.

75 TROY HILLS RD., WHIPPANY, N.J. 07981, TEL.: (201) 887-0400, Cable: ROVEND

From the first line of jukeboxes.

**Cathedral**



One of the 6 in the  
**Presidential Line** from **Rowe**

See it now at:

**Southern Amusement Co.**

628 Madison Ave. Memphis, Tenn.  
(901) 525-3609

From the first line of jukeboxes.

**New Orleans**



One of the 6 in the  
**Presidential Line** from **Rowe**

See it now at:

**BANNER**

1508 Fifth Avenue  
Pittsburgh, Pa. 15219

**Trimount Holds Rowe 'Presidential' Showing**

DEDHAM — Trimount Automatic Sales Co. was host Oct. 11 for a showing of the new Rowe "Presidential" phonograph line that includes six models, the "Beauty," "New Orleans," "Tiffany," "Cathedral," "Play-girl" and "Californian."

According to Irwin Margold, vice president of Trimount, "This was one of the most successful showings ever

held in many years as a distributor." Many New England area operators attended the showing and guests included Harry Martin, president of Rowe and Joe Barton, Rowe vice president in charge of marketing.

The showing, held at Trimount's new facilities at 888 Providence Highway in Dedham, also marked the first formal showing held at the new showroom.



Irwin Margold (left), vice president of Trimount Automatic Sales Co., surveys the busy scene during Trimount's showing of the new Rowe "Presidential" phonograph line, attended by operators throughout the New England area.

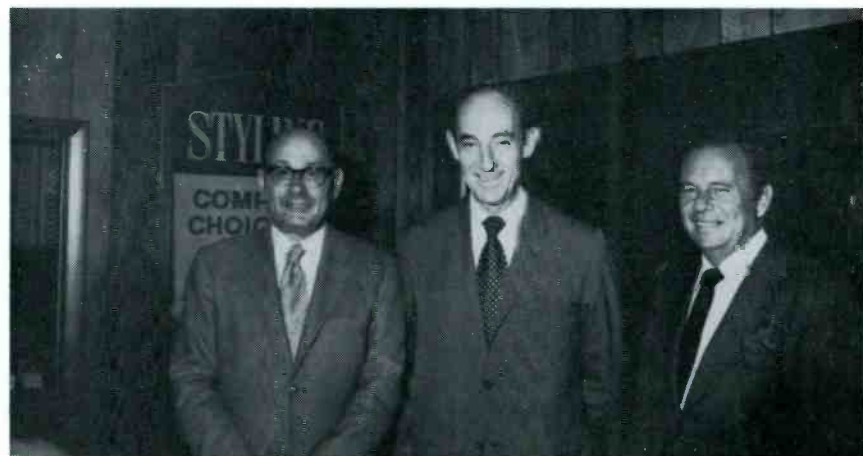

Joining the open house activities at Trimount are (left to right) Margold, Rowe president Harry Martin and Rowe vice president in charge of marketing Joe Barton. The two factory representatives spent much of the day speaking with operators, asking for their reaction to the new machines and explaining the features of the six new models.

**Runyon Displays Rowe Line at Open House**



Runyon Sales Co. held an open house showing of the new Rowe "Presidential" line Oct. 22 at its New York branch. Sampling the wide variety of sandwiches and phonographs were (left to right) Steve Hodge, operator of Atomic Music; Jack Lamm, Runyon mechanical engineer; Sid Gerber, parts department manager; Irving Green, general manager; Lou Wolberg, sales staffer, and sales manager Irv Kempner. The center of attention was of course the new phone line that includes the "New Orleans" model (left, photo right) and the "Cathedral".



# cash box / Round The Route

## EASTERN FLASHES

**ON THE AVENUE**—"One more show and I think I'm gonna go away for a long rest," joked a distributor rep who will remain nameless, after returning from the MOA Expo and plunging right into his own jukebox showing down on Tenth. But really, this has been an exciting time of year for those of us who got into the thick of the machine shows. All the new jukes and plenty of new games are out now and are creating quite the fuss. One new music box is so startling, we've heard one good comment which went "you either love it or hate it" but that's the kind of stuff around these days. We personally love it, and all the pieces on the market since the close of MOA.

About the MOA, we regrettably report that not that many lads from the city turned out this year. Oddly enough, the Sherman House was packed to the rafters with ops, their wives and service guys from all other parts of the country. Sure, the regulars were there: Al Denver and Max, Benny Chicofsky, a couple of the Herman brothers, Al Elowitz and Goldsmith from the arcades, and others, but really not too representative. Jersey showed strong with all the dealers and big ops like "Jukebox" Harry, Paddy Storino and Harry Witsen. Upstaters included Al Kress of the Westchester Assn., Lindy Nardone and his Missus, Joe and Anne Grillo, Knobby, Millie and son Vic with Ginger, and of course a big entourage from Bilotta Enterprises. Johnny Bilotta, incidentally, got the surprise of his life the night of Oct. 13th while attending a dinner meeting of the Newark, N.Y. Chamber of Commerce when he was named the 1970 Citizen of the Year. Of all the awards Johnny's received over these 42 years in business, this was the best, mainly because it was given by the folks he likes best, the folks in his own community. As Johnny's daughter Pat told us while at the MOA, "this was great because you know it's toughest to get recognition in your own back yard." MOA itself is so public relations minded that they were passing out Xerox copies of the front page stories devoted to John by several upstate New York papers. Fred Collins came up to the Cash Box booth to tell us to show the award in print. We told Fred we've got one key on our typewriter that prints "Bilotta" all by itself and he smiled, saying, "I seem to recall y'all mentioning him from time to time."

**NOTES FROM THE SHOW**—Mickie Greenman worked his . . . off at the show, shooting from the A.C.A. exhibits to their hospitality suite and back again to talk up the new Prestige 160-B with customers. Lighter moment for Mick came when his son Jon showed up Saturday at the show, taking the trip from his nearby school. Had the best time of the show up in the Greco Brothers' suite in the Sherman (where else). Walked in in the middle of a joke telling contest between Myron Sugerman, Tommy and Joe Grillo and thought we'd never catch our breath. This on top of a gorgeous hangover from the night before, starting with Rock-Ola's party in the penthouse (and a spirited conversation with Mrs. Les Rieck about hippies), to the A.C.A. suite for some imported German beer (Henry's got class), to Wurlitzer for some more refreshment and memorable anecdotes from A. D. Palmer, to Peach State's place in the Bismarck for a drink with Dennis Yost and Billy Whitcomb and . . . then we forget. Got in around 4:30 A.M. after scouring the loop district for an open mill and failing. Chicago's a great town but bring a bottle with you if you intend on drinking to excess.

Met Wes Lawson, newly-elected president of the Florida association, who brought along association director Bob Reinhart. Wes, we learn, is one of the most astute operators in the business and should do well for that group. Speaking of Florida, we and we guess everyone else missed Sol Tabb at the show. He's always there, why not this year? . . . The trade show was also unique for the number of cute models demonstrating the equipment, plus a lot of other promotional jazz which really livened the place up. The guys from Allied Leisure from Hialeah had a real cutie named Paulette something, who ran a dart game with a weekend in Miami, plus super bowl tix for two, as prize. Mort Secore at ChiCoin had a super-loaded Harley Davidson motorcycle at his exhibit and a cameraman taking photos of conventioners on the bike with a model riding the rear. Cycle, obviously, was to punch up their Motorcycle game. Incidentally, ChiCoin previewed a new target game called Night Bomber which should be on the market shortly . . . The Brunswick Corp. had a unique attraction. Joe Balsis, pocket billiards pro, was to take one shot and whoever numbered spot on the felt he landed, would cop a set of golf clubs. Harry Goldner of Silco got the clubs, Garland Garrett's wife Nancy was runner up and won a fishing rod and reel . . . Len Schneller and Sy Lipp ran their popular 8-ball tourney, and a Fischer rep, of all people, took top prize of a home table. Fischer president Charlie Bailey was watching his boy play and took it good-naturedly. Good spirit at the show.

Abe Weisberg, metro New York indie serviceman, made some waves at the industry seminar when he asked the manufacturer reps on the panel why they couldn't standardize some parts on games thru some agreement among themselves. Would hurt in competition, he was answered . . . Seminar also got into the security problem with the usual questions and answers but no concrete solutions. Some ops are willing to pay extra for super-secure machines and others would prefer that their games were easy to break into in order to cut down on damage repairs afterward. Gil Sonin was named to fill out the unexpired directors term of George Holtzman, who's sold his route and left the business. Gil couldn't make the convention but will certainly make a great MOA director.

While at the show we learned that Myron Sugerman is expanding his coinbiz activities with plans to go to Nigeria, Africa and distribute the Bally games line. Hans VanDenDop, Sugerman vet and a minority principle under Myron, will take over top administrative duties at the giant Hillside, N.J. machine emporium while Myron's overseas establishing Bally in that most populous of African nations. It's definitely business as usual for Hans and the rest out in Hillside and after the MOA order taking, will be a very busy lad next couple of months.

From the first line of jukeboxes.

New Orleans



One of the 6 in the  
Presidential Line from Rowe

See it now at:

**DAVID ROSEN Inc.**

*Exclusive Rowe AMI Distributor*

*Ea. Penn./So. Jersey/Delaware/Maryland/District of Columbia*

**N. BROAD ST. • PHILADELPHIA, PA. 19123**

**(215) CE 2-2900**

From the first line of jukeboxes.

Tiffany



One of the 6 in the  
Presidential Line from Rowe

See it now at:

**Runyon Sales Co.**

**Route 22/Fadam Rd. 593 10th Ave.  
Springfield, N.J. New York, N.Y.  
(201) 376-8720 (212) 564-1880**

From the first line of jukeboxes.

**New Orleans**



One of the 6 in the  
**Presidential Line** from **Rowe**

See it now at:

**trimount automatic sales co.**

888 providence highway dedham, Massachusetts 02026  
(617) 329-3456 cable: tricoin dedham

From the first line of jukeboxes.

**Cathedral**



One of the 6 in the  
**Presidential Line** from **Rowe**

See it now at:

**Bush International, Inc.**

OFFICES:

Miami—Jacksonville—Tampa  
Richmond—New Orleans

## CHICAGO CHATTER

Attendance figures of 2,355 for this year as against 2,037 for '69 gives credence to the pre-convention predictions that MOA Expo Seven-O would, in fact, break a few records! It did just that! The 1970 conclave was by far one of the most successful (if not the most successful) in the association's history! . . . Special recognition is due the many individuals, not the least of whom are **Fred Granger** and his assistant **Bonnie York**, whose tireless efforts, weeks of planning and just plain hard work, contributed immeasurably to the success of Expo! . . . First casualty of note was Bonnie's voice which had quite a work-out during the show and decided on a brief respite. As of last Wednesday she was still whispering! . . . Empire Int'l., recently appointed exclusive sales agent in the U.S. for PRW (Phonographic) London, premiered four of the firm's latest releases during MOA—"Flying Circus", "Attack", "Super Sniper" and "Tank Assault". All were very well received, according to **Joe Robbins**! Joe also informed us that Empire has already set up a distributor network in the U.S. Delivery schedules will commence sometime in December . . . Booth #112, where the new Rock-Ola phono models were prominently displayed, attracted plenty of attention during Expo. **Alfred W. Adickes**, who came in from Germany to visit with the Rock-Ola people prior to the show, also made the trip to the Sherman House to attend the MOA . . . Had a post-convention chat with ChiCoin's **Mort Score** about "Night Bomber" which made its debut during Expo. Factory will commence production in a few weeks or so—right now "Motorcycle" continues to be the top priority item! Mort was one of the many who told us how pleased he personally was with the entire show—one of the biggest, he says! . . . Spotted **Hymie Zorinsky** of H. Z. Vending & Sales in Omaha on the exhibit floor. He and son, **Eddie** (who stopped by the CB booth) never miss a show . . . Said a quick hello to Seeburg prexy **Bill Adair**. Big attraction at the Seeburg display, of course, was the beautiful new "Musical Bandshell" phonograph! . . . Can't ignore the fact that the showing of the new model phonographs by all the manufacturers (a first this year) contributed much to the total success of Expo! . . . Never did get a chance to talk to **Bill DeSelm**. He was pretty much surrounded by people at the Williams booth most of the time. The Williams exhibit spotlighted "Palos Verde", "Bonanza", "Ringer", "Strike Zone", the new single player "Straight Flush" and the add-a-ball version "Three Jokers" . . . **Larry Berke** was kept pretty busy at the Midway Mfg. Co. booth where the stellar attractions were "Sea Devil" and the newly debuted "Invader From Outer Space". Production on the latter item has not commenced as yet . . . A steady flow of operators and visitors were noted at the Bally Mfg. Corp. booth. The Bally exhibit housed such items as "Space Flight", "Trail Drive", "Zip A Doo" and a new 4-player which will go into production shortly called "See-Saw" . . . Just prior to Expo, MOA's **Bonnie York** dropped a note to **Roy Leonard** of radio station WGN advising him of the show and the juke box awards to be given. Bonnie included a copy of the juke box story with her note. Result was, Mr. Leonard devoted a lengthy segment of his Monday morning (19) show to, not only the convention itself, but a brief history (with quotes from the booklet) of the industry. He also programmed the award winning "Raindrops Keep Falling" tune as well as recordings by **Creedance Clearwater Revival** and **Johnny Cash**. He passed on many favorable and interesting bits of information about the industry to his listeners. Might be a good idea to seek this kind of exposure in other areas of the country.

## CALIFORNIA CLIPPINGS

We were told to pass on the following quote from Eastern Novelty's Los Angeles branch manager **Sol Mollengarden**: "My thanks to Dave Forman for pirating away by best salesman." . . . **Bob Portale** returned from the 1970 MOA show with the happy news that he's taken on the PRW games line for this area. The British super-games are now imported exclusively by Empire International in Chicago, and Bob's one of many regional dealers Empire appointed for the line. Of the many games Empire showed at the Expo, the clear-cut favorite among operators was the Flying Circus game. They also showed the Attack target game which is already popular on U.S. arcade locations . . . **Buddy Lurie** at the Expo, meeting old pals at Williams and taking California ops over to see the Bandshell phonograph at the Seeburg exhibit . . . A.C.A.'s **George Muroaka** took his wife to the Expo this year, we hear. That'll show you how clean-cut our conventions are. No? . . . **Walt Merila**, a consultant to the Moffitt Vending routes, tells us he moved from his old address at 1745 Orange Dr. in Hollywood and until he establishes new offices, can be reached at Moffitt in San Clemente.

## MILWAUKEE MENTIONS

Local coin people were unanimous in their praise of the recent MOA Expo Seven-O convention held at the Sherman House Hotel in Chicago October 16-17-18. A record number from Milwaukee and various areas throughout the state of Wisconsin made the trip to Chicago to participate in the big event. As a matter of fact there were quite a few who stayed over following the banquet show on Sunday night and didn't resume normal business activities until Tuesday morning.

MOA board member **Bob Rondeau**, who marked his tenth convention this year, says Expo Seven-O was by far the biggest and most successful he's even attended. Bob's celebrating ten years with Empire Dist., by the way . . . **Paul Jacobs** of United, Inc. made the convention scene on Saturday morning and, of course, spent a great deal of time at the Wurlitzer booth.

Said a quick hello to **Joel Kleiman** of Pioneer Sales & Services as he was departing the exhibit floor after touring the area and visiting the Rowe display . . . **Jack Hastings** and **Willy Bohrer** (Hastings Dist. Co.) stopped by the Cash Box booth for a few minutes on Saturday and then headed for the display area. Would you believe, in all the excitement we forgot to ask Jack how the Hastings bowling team is doing.

Caught a glimpse of **Clint Pierce** on the convention floor but never got a chance to say hello . . . The Stansfields, **Jim Sr.** and **Jr.** were very much involved in Expo activity. **Jim Sr.** was on duty at the registration desk much of the time.

# cashbox/ Round The Route

## HOUSTON HAPPENINGS

H. A. Franz & Company presented Seeburg's 1971 model phonograph, "Musical Bandshell," to Houston trade area coinmatic population with a super showing Oct. 13-14 in firm's display hall, 606 Dennis at Smith, Houston. Showing topped all previous attendance records despite its two days duration instead of the three days as has been custom during the past several years. Every city and town in this territory was represented.

H. A. (Hoddy) Franz, owner Franz Company, planned and piloted the affair. Those active in hosting the show, including Hoddy of course, were: salesman Wade Gibson, Hershel Hamlin, Larry Twardowski, David Brown, Dave Beasley; Servicemen Cliff Haynes and Bud Wright; receptionist Shirley Buchanan and versatile office clerk D. W. Lester. Barbecue luncheon was served with beer, coffee and soft drinks served long and liberally both days. Considerable activity noted in sales closing office too.

John E. Williams, ABC Music, well known statewide as well as locally, in hospital recovering nicely from major surgery. . . . Another widely known coinman, L. R. Gardener, owner Gardener Sales Corp., lately out of hospital. Pretty weak but made a new model showing with aid of a wheel chair chauffeured by Mrs. Gardener. . . . K. Harold Handkins, 15 years with Rowe factory and presently general mgr. of The Texas group of Rowe distributors, recently moved to Texas. Early this fall he purchased a home in Houston.

Raymond Fickey and gracious wife Alice own and operate the F. & F. Vending Service, Inc., Bryan, Tex. Alice returned a short time ago from an extended visit to Honolulu, Hawaii. Said the trip was enjoyable beyond description. Her comments and description, all favorable, on scenery and people were extremely interesting but too numerous to enumerat here. She pictured Honolulu as a world crossroads; populated by people from Australia, New Zealand, Great Britian, U.S.A. and lesser known nations.

Richwood Music Company, a comparatively new music and games operation on Trenton St., is owned and run by H. Lee Sherwood. . . . Another new operator in City is Robert Elam who has not as yet selected a name for his operation. . . . W. L. (Bill) Gainer, Jr. and charming wife Bernadine, owners Bill's Novelty Co., mentioned that most of their cigaret, music and novelty game operations were in Beaumont.

Bill Williamson, owner Williamson Music Co. on 22nd St. in Huntsville, Tex. said his business so far was above average. Huntsville, in East Texas, is more widely known nationwide each year on account of "Inside The Walls Prison Rodeo" held each Sunday of October at Texas State Penitentiary, located in that city. Average paid attendance exceeds 30,000 and many of those linger in town a spell waiting for bumper-to-bumper highway traffic to thin out.

## UPPER MID-WEST

The Lieberman Music Co. had the showing of the new 1971 "Seeburg Musical Bandshell" in its showroom Wednesday and Thursday Oct. 14-15. Stan Jarocki, representing the Seeburg Corp., was there for the showing and was overwhelmed with the tremendous response from operators attending the show. The new "Bandshell" was accepted as the most outstanding Seeburg phonograph in years.

Twin City operators attending the show were Jack Deming, Don Carmichael, Phil and Jeff Smith, Greg and Harold Theisen, Ken Aheren, Dick Couch, Bob Leonard, Marv Huber, Fred Gross, Jim Chakaris, Marv Doer, Fred & Dan Dahlin, Eddie, Ben, Lloyd Bischel, Stan Hennes, Kenny Anderson, Arnold & Mabel Tessmer, Frank Kuntz, Dick Benson, Walter & Gary Witt, Harold & Don Awe, and Les Bruning.

Out of town guests were Mr. & Mrs. Dar Hofzman, Big Fork, Jack Godfrey, Chaska, Mr. & Mrs. Noel Hefte, George Berquist, Ironwood, Clayt Norberg, Bob Keese, Johnny Galep, Gerald Brickley, Lloyd Williamson Jr., Leo Friedel, Gettysburg, Ike Sundem, Mr. & Mrs. Loren Daniel, St. Cloud, Mr. & Mrs. Lawrence Sieg, Mr. & Mrs. Vern Ness, Don Hazelwood and Hazelwood Jr., Mr. & Mrs. Gordon Runnberg, Herb Peterson, Mr. & Mrs. John Trucano, Deadwood; stopping off on their way to the MOA. . . .

H. H. Krueger, J. C. & Darrel Weber, Morris Anseau, Bob Lucking, Con Kaluza Jr., Al Eggermont Sr., Charley Sersen, Dick Hawkins, Dick Schroeder, Ron Scheuble, Bill Bregel, Willmar, Terry Boerger, Ralph Sanders, Joe Topic, Bill Hunder, Wheaton, Darwin Leslie, Arndt Peterson, Don Hanson, A. E. Cluseau, Mr. & Mrs. Lawrence Sanford, Andy Theisen, Eina Carlson and Bill Smilonvich.

From the first line of jukeboxes.

Cathedral



One of the 6 in the  
Presidential Line from Rowe

See it now at:



Cable:  
ATMUSIC—Chicago

ATLAS MUSIC COMPANY

2122 N. WESTERN AVE., CHICAGO, ILL. 60647. ARmitage 6-5005

From the first line of jukeboxes.

Tiffany



One of the 6 in the  
Presidential Line from Rowe

See it now at:

Miller-Newmark Dist. Co.

3767 E. 28th St.  
Grand Rapids, Mich.  
616 949-2030

310 Livernois  
Ferndale, Mich. 48202  
(313) 399-7600

Proven Profit Maker!

SENSATIONAL!  
CHICAGO COIN'S

motorcycle



REALISTIC  
RACEWAY  
DRIVING...  
ACTION...  
SOUNDS!

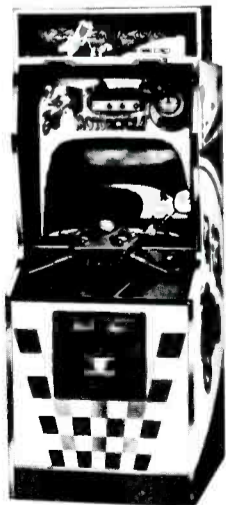

Mrs.  
of  
PROVEN  
PROFIT MAKERS  
Since  
1931

CHICAGO COIN MACHINE DIV

CHICAGO DYNAMIC INDUSTRIES, INC.

1725 W. DIVERSEY BLVD CHICAGO, ILL. 60614

# CLASSIFIED ADVERTISING SECTION

## COIN MACHINES WANTED

WANTED TO BUY OUT SELLING STOCKS OR two years old Jennings slot machines Wurlitzer juke boxes and Pinball games two or four players, make an offer to AUTOMATTJANST N STORGATAN 19 BJUV, SWEDEN.

WANTED: Midway Red Balls, Joker Balls and Joker's Wild Any Condition. Contact AMERICAN MUSIC CO., 219 First Ave. South Great Falls, Montana. (406) 452-7301.

WANT — Pool Tables, Personal music equipment, Scopitone film, 69 - 68 model Phonographs new and used, Phonovue attachments, Distribution of allied products. Write stating make, model, condition and best cash price. ST. THOMAS COIN SALES, 669 TALBOT ST., ST. THOMAS, ONTARIO, CANADA. AREA 519-631-9550.

OLD BALL GUM OR PEANUT MACHINES, table model games of skill or chance from 1950 & earlier, early arcade machines, slots, any quantity or condition. SACKIN, 318 E. 70 St., N.Y.C., N.Y. 10021 — 212-628-0413.

WE ARE ALWAYS INTERESTED IN USED AND BRAND new phonographs, pinballs, bingos, guns, arcade, kiddie rides, slot machines, etc., all makes, all models. QUOTE FOB SEA VESSEL TO HOLLAND BELGIE EUROPE, SPRL., 276 AVENUE LOUISE, BRUSSELS.

WANTED BALLY BINGOS, 6 CARD GAMES, SLOTS, uprights, flippers for export. Also late models AMI, Rock-Ola, Seeburg, Wurlitzer. All late flipper games. Write or call BOB JONES for best prices. ROBERT JONES INTERNATIONAL, 19 Brook Road, P.O. Box 181, Needham Hrs., Mass. 02194. (617) 449-3330.

WANTED TO IMPORT: BINGOS — CAN CAN, LIDO, Bikini, Roller Derby, Circus Queen, Bigwheel, UPRIGHT — Super Treble Chance, Super Jumboree, MIDWAY — Joker Ball, Red Ball, ROTAMINT — Bingeroyal, SLOT — Vest Pocket, Mini-Sega, SYDNEY BEACH, SKILL PARADE, any other PAYOUT gaming device, offer KAY A. CHIBA, Port P.O. Box 111, Yokohama, Japan.

WANT FOR EXPORT, BINGOS, UPRIGHTS, CONSOLES, Slots. Late model Pingames and Music. Immediately available — complete list of Arcade games, Guns, pins, Music, etc. Write or call Bob Jones ROBERT JONES INTERNATIONAL, 19 Brook Rd., P.O. Box 181, Needham Heights, Mass. 02194. (617) 449-3330.

## COIN MACHINES FOR SALE

FOR SALE: Model 14 Auto Photo, EXCELLENT condition. Call or Write. New in original cartons. Hollywood Driving Range. 15 ball golf fame. Closeout \$295 ea. CLEVELAND COIN INTERNATIONAL, 2025 Prospect Avenue, Cleveland, Ohio. Phone (216) 861-6715.

FOR SALE: Jukeboxes, pinballs, arcade, guns, base balls, Kiddie rides European football machines. For Export. Uprights, bingos, consoles, slots and punchboards. Contact: MYRON SUGERMAN INTERNATIONAL, 140 Central Ave., Hillside, N.J. (201) 923-6430.

FOR SALE: SEEBURG LSI-\$775, 480-\$495, LPC1-\$450, Wurlitzer 3000-\$495, 2910-\$375, 3010-\$415, 2710-\$275, AMI JBM-\$375, BIRD MUSIC DISTRIBUTORS INC., P.O. Box B Manhattan, Kansas 66502, or Phone 913-778-5229.

ALL TYPES OF COIN-OPERATED ARCADE EQUIPMENT for sale — guns, Helicopters, pinballs, etc.; Auto-Photo machines. Write for equipment list and prices. ROCK CITY DISTRIBUTING CO., INC., 615 Murfreesboro Road, Nashville, Tenn. 37210.

FOR SALE: Keeney Black Dragons, Wild Arrow, Twin Dragons, Flaming Arrows and Mountain Climbers. Also Bally Slot Machines, Triple Bells, Draw Bell and Buckley Track Odds. Want Old Slots. SASKATCHEWAN COIN MACHINE CO., 1025-104th St., North Battleford, Saskatchewan, Canada. Phone 445-2989 — Area Code 306.

## CLASSIFIED AD RATE 20 CENTS PER WORD

Count every word including all words in firm name. Numbers in address count as one word. Minimum ad accepted \$5.00. CASH OR CHECK MUST ACCOMPANY ALL ORDERS FOR CLASSIFIED ADVERTISING. If cash or check is NOT enclosed with order your classified ad will be held for following issue pending receipt of your check or cash.

NOTICE — \$82 Classified Advertisers (Outside USA add \$52 to your present subscription price). You are entitled to a classified ad of 40 words in each week's issue for a period of One Full Year, 52 consecutive weeks. You are allowed to change your Classified Ad each week if you so desire. All words over 40 will be billed at the rate of 20¢ per word. Please count words carefully. Be sure your Classified Ad is sent to reach New York publication office by Wednesday, 12 noon, of preceding week to appear in the following week's issue.

### Classified Ads Close WEDNESDAY

Send all copy to: CASH BOX, 1780 Broadway, N.Y., N.Y. 10019

BINGOS AND 6 CARD GAMES AVAILABLE INCLUDING Silver Sails and Golden Gates. These games are shipped! Call WASSICK NOVELTY at (304) 292-3791 Morgantown, West Virginia.

FOR EXPORT: Late games, Phonos, Vending. Write for our latest listing. ADVANCE DISTRIBUTING COMPANY, 2820 North Grand Blvd., St. Louis, Missouri 63107 — (314) 652-1600.

FOR SALE: SEGA BASKETBALL \$250, MIDWAY Basketball \$250, Williams Derby Day \$275, Student Prince \$425, Casanova \$265, Jolly Roger \$395, Hayburner-II \$350, Beat Time \$495, Shangri La \$325, Spook Gun \$495 Operators Sales, Inc., 4122 Washington Avenue, New Orleans, Louisiana, 70125. (504) 822-2370.

ALL TYPES COIN OPER AMUSE MACHINES, NEW AND RECONDITIONED. Ready for location. Write for latest listings. Fuel line and parts and supplies. MUNVES CORP., Dept. BC — 577 10th Avenue, New York, N.Y. 10036 Phone 212-279-6677.

FOR SALE/EXPORT: NEW BACKGLASSES FOR COUNTRY Fairs, Sea Islands, Roller Derbys, Can Cans, Bikinis, Lite Lines, Cypress Gardens, Ballerinas, Black Dragons. Numerous used BACKGLASSES. Complete bingo games include County Fairs, Lagunas, Lidos, Circus Queens. MUSIC VEND DISTRIBUTING, 100 Elliott West, Seattle. Phone 206-284-7740.

FOR SALE 6-CUE RACK, MAHOGANY, BUILT BY JUNIOR ACHIEVEMENT, top quality and finish, send \$6.95 for sample, quantity discount—help put our youth to work. Budge Wright's WESTERN DISTRIBUTORS, 1226 SW 16th, Portland, Oregon 97208-7565.

FOR SALE/EXPORT — USED SLOTS: BALLY Standard, 3 Line Pay, Multipliers, Quick Draws, Assorted Mills, Electric Payout Jennings, Space Jet Bell; Segas, Assorted Bally Bingos, "Games" Upright Multipliers. Write for particulars THOMAS TRADING COMPANY, 2622 Westwood Drive, Box 15391, Las Vegas, Nevada 89114 (702) 734-8818 Cable — VEGAS.

STEREO PICK-UPS "SMC" FOR SEEBURGS "B" through "201", \$20 "WMC" for Wurlitzer Cobra, \$10. SOUND & SIGNAL SERVICE, Box 10052, Albuquerque, N. Mex. 87114.

FOR SALE 3 SPEED QUEEN BY BALLY — Boats \$275 each, 3 Elephants by Tusko — \$275 each. CENTRAL MUSIC CO., P.O. Box 284, 407 E. Ave. D, Killeen, Texas 76541.

FOR SALE 12-RCA-16 MM PANORAMS, PEEP shows wt. timers mint cond. Also film girle nudes b & w used \$8.00 Color \$25. App. 400 ft. each. Money makers RICHTER, 1063 Market St., San Francisco, Calif. Z 94103.

FOR SALE LIKE NEW SPEEDWAY, MOTORCYCLE, Wild Cycle, Bally Space Flight, SAMI, late flipper games. Phone or write BALLY DISTRIBUTING COMPANY, Box 7457, Reno, Nev. 89502. (702) 323-6157.

FOR SALE: SKIPPERS \$450, STUDENT PRINCES \$375, Deluxe Fun Cruises \$275, Space Flights write, Strippers write, Mini Soccer \$125, Midway White Lightnings \$325, Sea Raiders \$520, SEGA Basketballs \$250. Also stock of bingos, NEW ORLEANS NOVELTY COMPANY, 1055 Dryades Street, New Orleans, La. 70113. Tel. (504) 529-7321 Cable. NONOVCO.

FOR SALE RECONDITIONED BARGAINS — BALLY DISCOTEK (2 pl) \$145, Rocket III (1 pl) \$195, Mini-Zag (1 pl) \$295, Wiggler (4 pl) \$325, King Tut (1 pl) \$395, Gallahad (2 pl) \$445, Rock-Ola 404 (100 sel) \$295, Seeburg DS 100-H (100 sel) \$245, Wurlitzer 2150 (200 sel) \$95, 2304 \$95, MICKEY ANDERSON AMUSEMENT CO., 314 East 11th St., Erie, Pa. 16503 Phone (814) 452-3207.

FOR SALE: Large selection used Pin Games to choose from, write for price list. BIRD MUSIC DISTRIBUTORS, INC., Manhattan, Kansas, Box B, or Phone 778-5229.

FOR SALE: WILLIAMS Spooks Gun \$425, MIDWAY Flying Saucer \$350, MIDWAY Space Gun \$315, MIDWAY Monster Gun \$225, MIDWAY 1 Million B.C. Gun \$395, Tusco Horse \$300, BALLY Champion Horse \$350 UNITED DISTRIBUTORS, INC., 902 W. Second, Wichita, Kansas 67203.

FOR SALE PANORAMS — NEW — WITH OR WITHOUT sound. Write or call URBAN INDUSTRIES INC., P.O. Box 31, Louisville, Kentucky 40201. (502) 969-3227.

NEVADA FRUIT (SLOT) MACHINES PRESENTS THE Raven Electronics Solid State line of Fruit (slot) Machines, Kenos and Mini-Bingos, 150 Mills Front. Opening, stands included as NEW \$200.00 Ea. 310 Bally Bingos, all models. Write or Call anytime — P.O. Box 5734, Reno, Nevada 89503. (702) 329-3932.

FOR SALE: CLOSE OUT — READY FOR LOCATION GOTT Royal Guard, Crosstown, Ice Revue, North Star, Buckeroo, (2 pl) Paradise, Flying Circus, (4 pl) Dancing Lady, WMS, Apollo, Full House, Moulin Rouge, Alpine Club, Riverboat, Beat the Clock, SEEBURG 3W1 D Wallboxes D & L COIN MACHINE CO., 414 Kelker Street, Harrisburg, Pa. 17105. Phone: (717) 234-4731, 234-2235.

BINGOS FOR EXPORT: BIG WHEELS, LAGUNA BEACHES Can Cans, Golden Gates, Circus Queens, Bikinis, Bountys, and Border Beauty. All types of pin balls available D & P MUSIC, 27 E. Philadelphia Street, York, Pa. Phone (717) 848-1846.

ALL TYPES OF COIN-OPERATED EQUIPMENT: ADD A-Balls, shuffles, guns, computers, etc. All types of phonographs; large selection on hand. Vending machines, from cigarette to candy to can drink, etc. all kinds, shipped to perfection. Write or call FLOWER CITY DIST CO., 389 Webster Ave., Rochester, N.Y. 14609 Tel: (716) 654-8020 and ask for JOE GRILLO.

50 ROWE 2700 CIGARETTES COMPLETE — OFF LOCATION. As-is condition. Make offer. THE MACKIE COMPANY, Central Pennsylvania, 1201 South 20th Street, Harrisburg, Pennsylvania 17104 717-238-1768 Manny Silvia.

FOR SALE: Two Panoram peep show machines with optional 25¢ or 50¢ coin chute. Continuous reel that holds 1,000 ft. of 16mm film. Operated with a time unit. PHIL GOULD, 224 Market Street, Newark, N.J. Tel: 201 — Market 4 3297.

POOL TABLES — Large selection of all makes and models available. Completely reconditioned or in "as is" condition for immediate shipment at very attractive prices. Also large selections of pin games, shuffles, guns and music — Phone or write EASTERN NOVELTY DISTRIBUTORS, INC., 3726 Tonnele Avenue, North Bergen, New Jersey 07047 — (201) 864-2424.

FOR SALE: Bingos, Orient, Zodiac, Bahama Beach, Follies Bergere, Beauty Beach, Sho Gal, All others. Late 4 & 2 Player Flippers, AMI J-200 \$215, K-200 \$225, JAL \$200, JEL \$225. Photomatic & Arcade Machines: Buckley Track Odds — CROSSE DUNHAM & CO., Tel. 504-367-4365, 225 Wright Ave., Gretna, La. 70053.

30 BRAND NEW AUTOMATIC SHOESHINE machines available in factory cartons. \$325 ea. FOB New Jersey. Call (212) W17-5659.

FOR EXPORT: BRAND NEW MADE IN JAPAN JUKE Box, Kiddie Rides, Arcade, Gun, SUB-ROC SUPERROAD-7, CLAY GUN, now obtainable DISTRIBUTORSHIP, contact to KAY A CHIBA, Port P.O. Box 111, Yokohama, Japan.

FOR SALE: MINI CYCLES \$480, SPIN WHEELS \$310, Mibs \$350, Sing-Alongs \$195, Wild Wild West \$410, Jive Times \$425, Student Princes \$375, Deluxe Fun Cruises \$225, SEGA Duck Hunts \$400, SEGA Missiles \$550, SEGA Basketballs \$250, Chicco Super Circus Guns \$550. Also Stock of Bingos NEW ORLEANS NOVELTY CO., 1055 Dryades St., New Orleans, La. 70113. Tel (504) 529-7321. CABLE. NONOVCO.

## HUMOR

DEE JAYS! 11,000 hilarious classified one-liners, \$10. Or send \$15 for above plus 7,500 additional "Clever Remarks!" Unconditionally guaranteed. You must be delighted or we'll refund your money. Comedy catalog free on request. Edmund Orrin, Boyer Road, Mariposa, Calif. 95338.

## EMPLOYMENT SERVICE

BINGO MECHANICS WANTED: Legal territory of Nevada, 5 day, 40 hour work week. MUST have past Bingo experience. State age, references, past experience. Send photo if possible. Write or phone UNITED COIN MACHINE CO., 2621 South Highland, Las Vegas, Nevada. Phone (702) 735-5000.

MECHANICS WANTED FOR MUSIC AND PINS. SALARY commensurate with ability. Time and half for over forty hour week. Liberal fringe benefits plus vehicle. Contact AMUSE-A-MAT CORP., 123 E. Luzerne St., Philadelphia, Pa. 19124. Telephone (215) 329-5700.

WANTED EXPERIENCED JUKE BOX AND GAME Mechanic. Good working conditions. Paid Vacations, sick leave, time and one half for overtime to reliable man. Call Mr. Anderson Collect person to person. Telephone 237-1563, Coin Music, Inc. 710 R St., Fresno, California.

EXPERIENCED MECHANIC, MUSIC AND GAMES wishes to relocate out West. Non-drifter, non drinker, good health. Reply to Box 1302, Landover, Maryland 20785.

## RECORDS-MUSIC

ATTENTION COLLECTORS: A NEW OLDIES SHOP has opened. Thousands of rare R & B, rock, pop 45's, 78's, LP's. ALL ORIGINAL LABELS. Mail orders accepted. Roy's Memory Shop, 2312 Bissonet, Houston, Texas 77005. 713-526-5819.

DISCOGRAPHY OF OVER 1500 COUNTRY & WESTERN Artists, containing over 40,000 singles and LP's. \$2.00 per artist will get you our complete discography on any artist you request. R. Ford, 34 Sadowski, Decatur, Illinois 62521.

WANT RECORDS, 45'S AND LP'S SURPLUS RETURNS, overstock cut-outs, etc. Call or write HARRY WARRINER at KNICKERBOCKER MUSIC CO., 453 McLean Ave., Yonkers, New York 10705 (914) GR6-7778.

FOR THE SERIOUS COLLECTOR WE OFFER THOSE hard-to-find rare oldie albums. Rock 'n' roll and rhythm & blues albums no longer available in the stores. A & G Oldie Albums, Suite 1412 1860 Broadway, New York City 10023. Call for week night or Saturday appointment 212-243-1548 or 212-253-3712.

USED 45 RPM RECORDS ALL TYPES AS THEY RUN, right off the route. No sorting or picking. We pay freight from anywhere in U.S.A. Standing order available for regular shippers. JALEN AMUSEMENT CO., 1215 S. HOWARD STREET — BALTIMORE MARYLAND 21230.

FREE CIRCULAR — HARD TO FIND NEW COUNTRY record albums and 8 track tape cartridges, Fiddle tunes, waltzes, blue grass, etc. Such artists as Mac Wiseman, Hylo Brown, the legendary J.E. Mainer, others. UNCLE JIM O'NEAL, Box AC, Arcadia, California 91006.

LEADING TAPE WHOLESALER WILL SELL HIGHEST chart tapes at lowest prices. Send for current list. CANDY STRIPE RECORDS, 17 Alabama Ave., Island Park, N.Y. 11558.

WE SELL 45s, LPs TO RECORD DEALERS, COLLECTORS, one stop, foreign — Send free catalogue, \$7.00 per hundred, \$63.00 per thousand. We need 45s, lps, Disk Jockey copies, surplus, overstock, cutouts, CAPE INTERNATIONAL, Box #74, Brooklyn, N.Y. 11234, Phone (212) 253-5916-5917.

ATTENTION RECORD OUTLETS, WE HAVE THE LARGEST selection of major label albums at promotional prices. Write for our complete listings of Jazz, Rock, Soul, Folk, Blues, Spirituals, etc. International Orders Welcome. SCORPIO MUSIC DISTRIBUTORS, 6720 Broad Street, Philadelphia, Pa. 19126.

WANTED TO BUY — OPEN REEL TAPES, WHY TIE UP capital investment in slow-moving reel tape department? We will buy complete inventories — large or small. Send detailed lists and quantities. VARIETY AUDIO PRODUCTS, 170 Central Avenue, Farmingdale, N.Y. 11735 516-293-5858.

## COIN MACHINE SERVICES

ACE LOCKS KEYED ALIKE. SEND LOCKS AND THE key you want them mastered to \$1.00 each less 10% lots of 50 or more. RANDEL LOCK SERVICE, 61 ROCKAWAY AVENUE, VALLEY STREAM, N.Y. 11580. TEL: 516-VA 5-6216. OUR 35th YEAR IN VENDING.

SPEED UP YOUR COIN COLLECTIONS — New portable coin sorting, counting and packing machine, combined as one unit — hand operated — portable — weighs 18 pounds — with automatic stops and tubes for different sizes. Apply SEIFERT MACHINERY CO., Box 3421, Philadelphia, Pa. 19122.

FLOATING FUN BALLOON VENDING MACHINE, DOES NOT have to be attended. Space Age Memory Control Panel, 25¢ vend. Literature at your request. Dukane Ski n Skore and Grand Prix parts available. NOVEMBER CORPORATION, 1351 W. Grand Ave., Chicago, Illinois 60622. (312) 733-2988.

APRONS: FOR VENDORS — COIN CHANGERS YOU have it we will make it. Uniforms, work clothes and emblems. E & M SUPPLY CO., 2090 Pacific Blvd., Atlantic Beach, N.Y. 11509.

STAMP-A-SPOT ON YOUR POOL TABLE. ELIMINATES curled spots, high spots, replacements. Stamp it on and forget it for the life of the cloth. Send your order and check for \$6.95 to-day to: P. O. BOX 69, Inwood, N.Y. 11696.

## CLASSIFIED POWER!

### CLASSIFIED AD RATE 20 CENTS PER WORD

Got machines to sell? Is there something you're looking to buy? Maybe you'd like to move some used 45's or need a route mechanic? For every coin machine need, use the Cash Box Classified.

Type Or Print Your Ad Message Here:

### Classified Ads Close WEDNESDAY

Send all copy to: CASH BOX, 1780 Broadway, New York, N.Y. 10019

We've got a

# HIT

on our hands!

Talk about a rousing reception... the WURLITZER ZODIAC made a sensational debut during M.O.A. and at every National Wurlitzer Week showing.

No question about it. We've got a hit on our hands!

The quicker you get Zodiacs out of our hands and into your top spots the sooner you'll see results on your routes that will astound you.

See your Wurlitzer Distributor on the double. The ZODIAC might even do *that* for your earnings.

The Wurlitzer Company  
North Tonawanda, N.Y. 14120

# WURLITZER ZODIAC



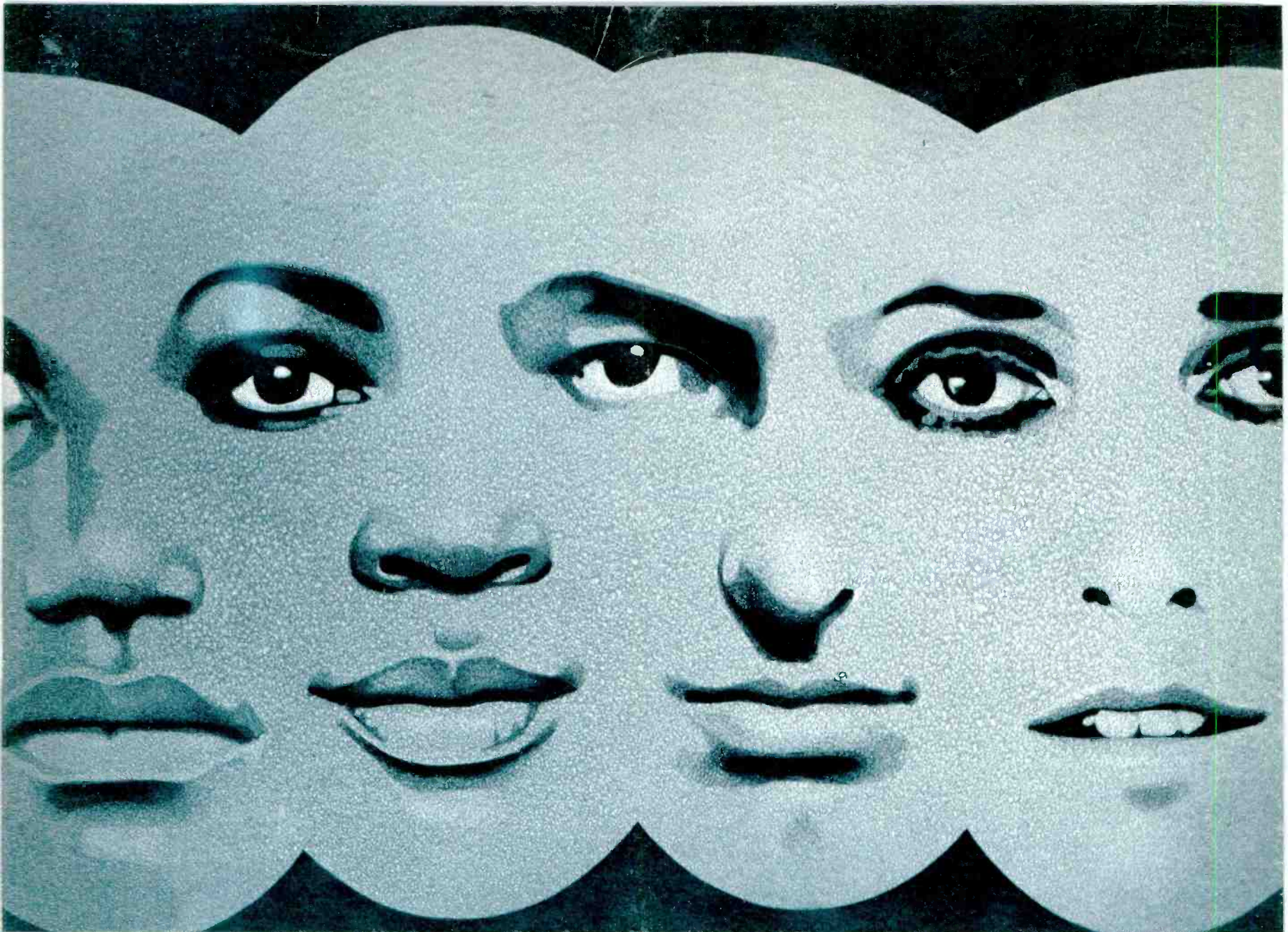

**Predictably, The Main Ingredient's new single makes it for everyone who's hearing it.**

There's no doubt about it now. "I'm Better Off Without You" has not only broken out—but it's crossing over as well.

Heavy reorders as expected.

**"I'm Better Off Without You"**

#74-0382

It's in their new album

**"Tasteful Soul"**

LSP-4412



**RCA** Records and Tapes

2115 #

