

CATJ is a Copyright © 1982 by the Community Antenna Television Association, Inc. All rights reserved. Quedan reservados todos los derechos. Printed in U.S.A. Permission to reprint CATJ published material must be given by CATA, prior to republication.

# CATJ

Vol. 9 No.1

CATJ, The Official Journal for the Community Antenna Television Association is published as a service for Association Members and others providing services to the industry.

## OFFICERS

Ben D. Campbell, Chairman of the Board  
Ben V. Willie, President  
Peter Athanas, Vice President  
G. H. Dodson, Secretary/Treasurer

## DISTRICT DIRECTORS

One Clarence Dow (Maine)  
Two Ed Smith (New York)  
Three David Fox (West Virginia)  
Four Pat McConnell (Florida)  
Five Joe Bain (Oklahoma)  
Six Wayne Sheldon (California)  
Seven Carl Schmauder (Oregon)  
Eight Neil Webster (Iowa)  
Nine Peter Athanas (Wisconsin)  
Ten Jim Hays III (Kentucky)

## VICE DIRECTOR

Jim Garvalia (Wisconsin)  
Lee Holmes (Guam)

## ASSOCIATES' DIRECTORS

Raleigh B. Stelle III, Texscan/Theta Com  
Ernie Larson, Larson Electronics

## DIRECTORS EMERITUS

Gene Edwards (Ohio)  
Chuck Kee (Oregon)  
William Ridsen (Kentucky)

## CATJ STAFF

President and Publisher  
G. H. Dodson

Business and Managing Editor  
Celeste Rule

Executive Assistant To The Editor  
Diane Howard

Subscriptions/Ed. Assistant  
Rose Capshaw

Contributing Editors  
S. J. Birkill, Stephen Effros,  
Ralph Haimowitz

Art Director/Marketing  
Phyllis Crumpler

Production Assistant  
Dianna Johnson

## OFFICES

National Headquarters  
CATA/CATJ  
Celeste Rule, Managing Editor  
4209 N.W. 23rd, Suite 106  
Oklahoma City, Okla. 73107  
(405) 947-7664; 947-4717

CATA (Washington Office)  
Stephen R. Effros, Executive Director  
3977 Chainbridge Rd.  
Fairfax, Va. 22030  
(703) 691-8875

CATA (Engineering Office)  
Ralph Haimowitz, Director  
518 S. W. 21st Street  
Vero Beach, Florida 32960  
(305) 562-7847

The Community Antenna Television Association, Inc. is a nonprofit organization formed under Chapter 19, Title 18 of the Statutes of the State of Oklahoma. As such, no part of its assets or income shall be the property of its members, such assets and income shall be devoted exclusively to the purposes of the Corporation.

The Community Antenna Television Journal (CATJ) — ISSN-0194-5963 — is published monthly by TPI, Inc., 4209 N. W. 23rd, Suite 106, Okla. City, OK 73107. Subscription price: \$18.00 per year, \$22.00 per year Canada, Mexico, and foreign. Second class postage paid at Oklahoma City.

POSTMASTER: Send address changes to 4209 N. W. 23rd, Oklahoma City, OK. 73107.

## on the inside...

### FEATURES

- CABLE SYSTEM VALUES: BASIC CONSIDERATIONS (PART II)** — J. Patrick Michaels of Communications Equity Associates continues his series on cable television properties ..... **6**
- SWEEP DOUBLER** — S. K. Richey, Azle, Texas, describes how to build a simple and inexpensive passive frequency doubler ..... **12**
- IF TRAP ADJUSTMENT FOR OPTIMUM INTERFERENCE REJECTION IN THE FILTERED EARTH STATION (PART #5)** by Glyn Bostick, Microwave Filter Co., Inc. .... **38**

### DEPARTMENTS

- CATA-TORIAL** — Discussion of the elimination of the compulsory license and the copyright compromise by CATA President, Ben Willie ..... **4**
- STEVE J. BIRKILL ON EXPERIMENTAL TERMINALS** — This month Mr. Birkill discusses Polarization Tilt: Why, and How Much? ..... **20**
- HAIMO-WITS** — Interested in the 1982 Technical Training Schedule and locations? Also a report on a recent meeting Mr. Haimowitz attended as well as a letter questioning scrambling of satellite signals included in the November 1981 article and the reply ..... **28**
- ASSOCIATES' SHOWCASE** ..... **42**
- ASSOCIATES' ROSTER** ..... **46**
- CLASSYCATS** ..... **48**

## on the outside...

The January cover highlights 1982 as it surges forward with the changes and the challenge that it holds for the cable industry

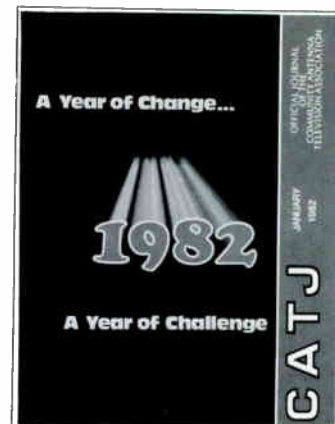

# catatorial

Ben V. Willie,  
President of CATA

It has never been a secret that the Community Antenna Television Association and the National Cable Television Association differ on our perspective of copyright. CATA has always taken the position that the Copyright Law, like any other law, is supposed to benefit the general public, not just the selected industry representatives that happen to be the loudest lobbying voices because they have the most money. We have never agreed with those who argue that the best way to reach a solution to what some perceive as a **"copyright problem"** is to get all the industry representatives together and create a **"compromise"** agreement.

This difference, not only between the NCTA and CATA, but between us and most of the other parties involved, including the key Congressmen dealing with the issue, has resulted in CATA's always being seen as the **"outsider"** in these fights — **outside** in that we are not made an integral party to the negotiations in the back rooms — **outside** in that we are with all the rest of the people, the public, our subscribers — on the **outside** looking at the process in awe, and sometimes in anger as we see **"deals"** being made that have very little relationship to reality as we know it, and deals that certainly do not take into account either our interests, or those of our subscribers.

How do these **"deals"** start? How is it that the public can be so ignored in a process that is supposed to be of benefit to them? Well, it all seems to start with a **"perception"**. That is, the Congressmen and the various lobbyists who talk to each other all the time get together and agree that there seems to be some **"movement"** on this issue or that. In our case it was copyright. So there was **"movement"**. That, in Washington short-hand, meant that the relevant Subcommittee members had apparently solidified their positions to the point that a vote on the issue of copyright might have resulted in something other than a stalemate.

Of course a **"stalemate"** is exactly what CATA was hoping for, since we saw, and, still see, no reason to change the current law. There has been no new evidence, no new startling factors, no massive change in the relative positions of the groups involved — including the viewing public, that would justify a change. But, nevertheless, there was an image of **"movement"** and some Congressmen and lobbyists took advantage of that to create the impression that the Kastenmeier Copyright Subcommittee was about to do something — possibly something drastic, and therefore it was time to retire to the back rooms and compromise.

The threat that has always been hanging over the head of the cable industry is that the compulsory license which is now a part of the law would be eliminated, and that in turn would mean a drastic change in the business we now call cable television. Whether anything as drastic as elimination of the compulsory license was really in the offing is not really important, that the impression was created is enough. And the impression was certainly

created.

Why would anyone want to create that impression? Well, there are as many reasons as there are parties. The Subcommittee is interested in getting a bill adopted — **any bill**. Without substantial agreement from the heavy hitters, there is little chance that a bill would go through. The various industries all have enough power to stop a bill if they really want to. The Motion Picture Association saw the need to put pressure on the NCTA to get a compromise. They, too, knew that there was little chance of them getting through a bill that eliminated the compulsory license, but if they presented that image, maybe the NCTA would cut a deal, and that deal could then be adopted.

Remember, too, that the MPAA has other fish to fry right now — they have a big problem on Capitol Hill with the issue of home video tape recording. They can't afford to spend too much time right now on the cable issue. What better way to get it out of the way than to reach a **"compromise"**? And of course the NAB doesn't really have much to do with copyright at this point anyway. They get less than five percent of the copyright royalty pool. They, for the most part, are not copyright holders. So why are they a part of this deal? Well, they shouldn't be. But they saw the possibility of getting something out of it for themselves. They saw a way to include the **"must carry"** issue in the law, so they participated in the **"sky is falling"** charade of telling the public and most cable operators that we were about to lose the compulsory license.

Finally, we get to the biggest questionmark; why would the NCTA participate in this little show? Why would the largest representative of the cable television industry tell its own membership that it had been totally ineffective in stopping a drive to eliminate the compulsory license, and therefore it was necessary to negotiate an agreement? And what happens now if we do not get a good agreement? To begin with, we must all recognize that the NCTA is representing the broadband, vertically integrated companies, not the cable television operators around the United States. These are the companies that are not only trying to build the big cities, which do not need distant television signals any more, but they are also the companies that are producing programming that they are trying to sell to the rest of us.

These companies have a very different view of what is needed to succeed. They are having problems at the moment because they cannot sell as much programming as they would like since there is channel scarcity in the cable industry. They would not mind at all if a few channels, such as the superstations, were knocked off the satellite, and thereby taken off most cable systems. They would ultimately benefit from such a plan. Further, they do not want to pay any copyright in the big cities where they don't carry distant signals, so any deal that will result in saving them one or two percent or more of their gross revenues is a good deal indeed. That is part of the

reason that the NCTA participated in the charade about the imminent loss of the compulsory license.

Another reason, I suspect, is purely tactical. As most lawyers learn early in their careers, if you spell out the worst case analysis to your client and then come away with anything better than that, you will be considered a hero.

The NCTA wanted to be a hero. It is a lot easier to do it that way than to fight for what you believe to be right for the industry and possibly not get everything you were fighting for. Then you are seen as "losing" something instead of "winning" something. The NCTA had "lost" one recently, and was looking for a "win". So they participated in the game. The major operators wanted in that way anyway, and since they pay the bills, what difference does it make if the rest of the industry disagrees? After all, only a small segment belongs to CATA, and the rest of the NCTA membership would be in total disarray since they would have no one to represent them! It almost worked.

What none of the parties to the agreement counted on was the resourcefulness of the cable television operators around the country. They forgot that we are not only independent thinkers — both CATA and NCTA members, but also that we understand the power of politics, and the power of our subscribers. So things have changed. A new "compromise" has been proposed, and there will probably be more. Now that we have forced this agreement out into the public, and it is clear what the impact of it will be, changes are being made to protect the public — which is what was supposed to have been done in the first place. The CATA coalition has won

round one. But there is trouble ahead. And the problem is in the lasting impression that was created by the various groups, all for their own reasons, that led up to the compromise. You remember, the impression that said all this activity had to take place because, if it didn't, the Subcommittee would vote to get rid of the compulsory license.

A lot of folks still believe that, and the danger is that it may become a self-fulfilling prophecy. What happens if the "compromise", and the "son of compromise" and all the other "deals" finally fall through? What happens if we force the issue of the rights of the public to the point where the "back room boys" simply can no longer cut a deal? Then what? It may be that everyone has convinced themselves that the only other step is to adopt legislation that would propose the elimination of the compulsory license! That would be foolish, but a lot of people have a tendency to believe their own press releases, and that could be very dangerous.

**The warning I am sounding here is very simple:** we not only must fight, but we must be careful not to allow our adversaries to be blinded to the many options open in this entire area. Naturally CATA maintains the position that no legislation is needed at this time. But, as we have made very clear in proposals to Congress and full explanations on these pages, there are lots of alternatives to the present law also. And those alternatives do not necessarily take the shape of the current "compromise" or the elimination of the compulsory license.

Join CATA in this fight; if you're not already a member, use the application blank and join with the independent thinkers in CATA. □

## CATA MEMBERSHIP APPLICATION

Please enroll my CATA system(s) in the COMMUNITY ANTENNA TELEVISION ASSOCIATION (CATA). I understand that we have the right to cancel our membership at any time. Please see that I receive all of the initial CATA material.

System Name \_\_\_\_\_  
System Address \_\_\_\_\_  
City \_\_\_\_\_ State \_\_\_\_\_ Zip \_\_\_\_\_  
Individual Authorizing Membership \_\_\_\_\_  
Telephone(\_\_\_\_\_) \_\_\_\_\_

### About Your System—CONFIDENTIAL— For CATA use Only

1. Number of current subscribers (FCC count) \_\_\_\_\_  
Projected number of subscribers \_\_\_\_\_
2. Number of homes in franchise area \_\_\_\_\_  
 Top 50 Market (35 mile zone)  
 Second 50  
 Smaller TV Market  
 Outside All Markets
3. Channel capacity \_\_\_\_\_  
System start-up date \_\_\_\_\_
4. Do you plan to build a TVRO earth station?  Yes  No
5. Congressional District \_\_\_\_\_

### ABOUT YOUR CATA DUES STRUCTURE

SURCHARGE scale is \$5.00 for systems with subscribers up to 500; \$10.00 for systems with subscribers between 500 and 3500; \$15.00 for systems with more than 3500 subscribers. The surcharge, PLUS 3 cents per subscriber per month determines the monthly dues charge.

Numbers of Subs \_\_\_\_\_  
X .03 \_\_\_\_\_  
Sub Total \_\_\_\_\_  
+ Surcharge \_\_\_\_\_  
Total \_\_\_\_\_

PLEASE ATTACH CHECK FOR THAT AMOUNT WITH APPLICATION.

### Note on Corporate Membership:

Dues for systems or MSOs with more than 16,666 subscribers are established with a dues limitation of \$5,000 annually.

**Personal memberships for those in related industries are available at \$50.00 annual dues.**

CATJ SUBSCRIPTION RATE FOR CATA MEMBERS IS \$1800 per year.

If you are not presently a subscriber and wish a new subscription, enclose \$18.00 for you CATJ magazine.

# Cable System Values:

(PART II)

By J. Patrick Michaels, Jr.  
Communications Equity Associates  
Tampa, Florida

## BASIC CONSIDERATIONS

In Part I of this series, we examined the nature of the current acquisition market for cable television properties. Almost everyone who owns an interest in a cable television property or who is in an active role in the industry is well aware of the present intensity of the "seller's market," which has existed since 1979, and the fact that until recently, very few cable systems were actively on the market. In spite of this awareness, there is generally only a vague consciousness on the part of most operators as to what value to place on their system and/or franchises.

The simple fact is most people in the industry develop their concepts of valuation from a mosaic of trade press announcements, industry scuttlebutt and conversations with brokers at trade shows. The fact is that it is very unusual for the price of details of acquisitions to be published. Even if a price were to be announced, without having the structure of the deal, it is impossible to utilize that price information for comparative purposes. Even though most acquisitions in the industry are developed at a relatively sophisticated level, conversations about acquisitions at almost all levels tend to rely on antiquated rules of thumb. Although these generalizations have valid historical roots, the employment of these concepts is generally very misleading and can, when put in practice, result in disappointing miscalculations of true market value.

How many times have you heard relatively sophisticated and industry-wise persons seriously discussing values in terms of dollars per subscriber, multiples of cash flow or multiples of gross revenues? Who has not argued whether or not a pay subscriber should be valued at the same price as a basic subscriber? This jargon has become coin of the realm, and even sophisticated individuals find themselves translating complex transactions into these simplified terms.

In order to better understand why these rules of thumb have persisted, it is interesting to examine their historical context. For example, the "\$300 per subscriber" figure, which predominated industry thinking from 1968 to 1976, had its basis in classic cable systems, which were highly saturated and cost \$5,000 or less per mile to construct. These types of systems generally had a maximum primary monthly rate of \$6.00 (\$72.00 per annum). With an average of fifty subscribers per mile, the system would gross approximately \$3,600.00 per mile per annum with operating costs, exclusive of interest, depreciation and amortization, of fifty percent or \$1,800.00 per mile per annum.

Based on a \$300.00 per basic subscriber price, this hypothetical system would be valued at \$15,000 per mile; three times the cost of construction, or approximately eight times cash flow.

Unfortunately, when one deals with a hypothetical situation or model, it rarely can be found in reality. The reader will recognize that the standard hypothetical model used here would apply to very few of the nation's 4,000 cable TV systems. The basic underlying and fundamental principle is that each acquisition opportunity is an entity unto itself, which will require extensive analysis within the framework of certain criteria. In actual fact, the bottom line is really a discounted rate of return on invested equity; or perhaps, since cable television is basically a cash flow business with some tax sheltering benefits, one could look at the income stream as it relates to tax sheltered cash flow. In times of very high inflation, such as the nation is currently experiencing, the discounted cash flow analysis method is critical, particularly when related to debt service. If seller financing is involved or if non-compete and/or consulting agreements are utilized, it is also necessary to look at the present value of the financing package structured.

The market value of a cable system or franchise is in essence a perishable item, since the number of buyers and sellers is in a constant state of flux and the "unique characteristic" which makes a potential purchase a highly desirable property can change, and differs among purchasers. Obviously, the most efficient way of valuing a cable property is to retain an independent appraiser with the substantial experience in valuing cable television systems and franchises. It is also essential to employ a well-qualified consulting firm to assist the buyer in analyzing the market potential status and quality of existing operations, franchise considerations and the technical quality of the systems. Even buyers with in-house capability should consider obtaining a third party view. If, in fact, you are giving serious consideration to either acquiring or divesting, it is very important to utilize professional assistance, particularly in the area of analyzing tax consequences. Since some of the basic tax considerations and structuring will be addressed in Part III of this series, we will focus on some of the basic non-tax criteria and considerations utilized by buyers in today's market in this Article.

Another factor which is essential is having the ability to accurately analyze financial statements of the seller. Until recently, cable has had no standardized accounting procedures. Close attention must be given to accounting procedures of the seller, even those with audited financial statements.

# How to own an original and not a copy.

## Look for proven satellite receiver design.

Hughes has pioneered nearly every major advancement in satellite technology. In fact, we introduced the separate downconverter/receiver two years ago. Other manufacturers are now copying this idea. But will they get it right?

## Look for technically secure design.

Hughes dual conversion receivers use interface frequencies that are free of interference from local UHF broadcasters. We use the latest industry standard frequencies to reduce the risk of undesirable intermodulation products. Don't get stuck with an incompatible, non-standard frequency.



## Look for money saving features.

Hughes downconverters can be mounted at the antenna and each can feed as many as 12 low-cost receivers as you expand. And they use low-cost trunk cable instead of expensive 4 GHz cable. Our diplexers allow sharing of your existing cable.

## Look for 24 channel agility.

Hughes has always believed that built-in channel agility with threshold extension is the life insurance policy of a satellite receiver. Satellites do fail. Channels do get reassigned. And with Hughes all you have to do is push a button on the front panel. You can even do it by remote control.

**Look for "Hughes" on the name plate.** It's your guarantee of all the above, and more. Hughes

ultra-reliable microwave integrated circuits and built-in test and alignment circuits mean much less down time, easier maintenance. Complete your system with our unique expandable antenna.

## Check out our 2 year warranty.

Because our system has been field-proven for many years, we have the confidence to offer a full 2-year warranty, backed by a 48-hour exchange program.

For more information write or call:  
Hughes **MICROWAVE™  
COMMUNICATIONS  
PRODUCTS**

P.O. Box 2999, Torrance, CA 90509  
(213) 517-6233 or toll free outside  
of California (800) 421-5748.



There is a marked dichotomy when one compares the relative value of cable television properties presently owned by public companies vis-a-vis individuals, partnerships or closely held corporations. This same valuation criteria often applies equally to acquisitions. In spite of the widespread enthusiasm for publicly-held cable stocks, prices are still somewhat below liquidation value of the systems and franchises on the "private market," or the potential value on a merger basis. This results primarily from the differences in tax considerations, concern for earnings versus cash flow, different accounting policies, etc. It may be more appropriate for public companies to consider valuing cable properties on a capitalization of income basis.

To some degree, the tax benefits which might be gained from the acquisition and/or construction of a cable property, as well as through operations, are generally more significant to the private investor. The absence of standardized accounting practices in the industry has resulted in wide variations in accounting policies. This "flexibility" has generally enhanced the sheltering capacity of cable investments for the private investor. The combination of a sheltered cash flow, tax deferral, rapid appreciation and availability of reasonable leverage and the conversion of ordinary income to capital gains, all contribute to the growing popularity of cable as an investment opportunity for individuals through a Subchapter S or limited partnership vehicle.

Generally paramount in the private investor's mind is the ultimate goal of capital gain; while the public companies have an orientation of growth of corporate earnings, as well as increasing the value of the corporation's shares. While the tax benefits available to individuals, partnerships and/or closely held companies can be very significant, allowing these groups to, in some cases, pay higher prices for systems and for franchises, the public companies have the substantial advantage of having access to more favorable debt financing, as well as the advantage of having the ability to do acquisitions on a tax-free exchange of shares basis where appropriate.

Public companies should be cognizant of the likely possibility that a large cable acquisition may, in fact, have a negative impact on earnings for some time. Hence, it is necessary to have well-reasoned corporate goals and long-range planning before contemplating a major expansion program in cable.

While public companies and private investors may have somewhat different considerations and investment goals, it should be strongly pointed out that any sophisticated investor will not only examine the tax considerations, income stream, cash flow leverage, available debt financing, but also the many other important variables involved in evaluating a cable television property as an **operating business**. It is difficult, within the scope of this article, to discuss in detail all of the variables which should be considered; however, there are certain basic considerations which should be carefully noted.

## I

**Growth.** Cable TV is a cash flow business, and if one examines a mature property with little or no growth internally through marketing or increase in available homes passed, one would be buying only existing cash flow, with only limited ability to increase rates to overcome inflation. It may be possible in some instances, to significantly improve the cash flow of a mature property through the addition of innovative services, such as tiered pay; however, systems with growth, either internal or through economical extension of plant, are more valuable than a mature, older system where subscribers have been generally resistant to innovations such as pay. It is also advisable to ascertain what additional franchising opportunities may be available in areas nearby the prospective acquisition and to realistically assess the competition. Moreover, one should also consider what other acquisition opportunities might exist in adjacent areas, since the economics of scale in operating larger complexes can make small acquisitions more viable than to a third party purchaser who would have to operate the smaller property as a stand-alone investment.

## II

**Condition of System.** Most older mature systems are almost completely depreciated, and, of course, some of this depreciation is real. This is particularly true since technological obsolescence in recent years has been substantial. It is imperative to have an engineering evaluation of a property to determine not only the cost of immediate capital improvements which may be required, but also ongoing capital costs. Consideration must also be given to the type and condition of converters utilized, if any, in the system, as well as the seller's maintenance policy. Newer state-of-the-art systems, in good repair, are worth considerably more than older systems.

## III

**Rates and Rate Regulations.** Obviously, since a system's rate structure relates directly to income and cash flow, rates are a major consideration. If the purpose of the appraisal is to assess market value, then there are four major considerations involving rates:

(A) If the system has no rate regulation (or favorable regulation), then this is a plus factor, since the purchasing party can create additional cash flow by raising the rates. Generally, most of the increase would flow to the bottom line since operating costs in mature systems are relatively fixed.

(B) If the system has an unusually high rate, then a purchaser must consider that **since demand is to some degree, price elastic**, it would probably be difficult to demand a higher rate in the short term and run the risk of an adverse impact on subscribers. Secondly, if the rates are regulated, it would be unlikely that the regulatory body would grant an increase which would offend the public, unless it could be demonstrated by the company that a new service or other

# USED EQUIPMENT

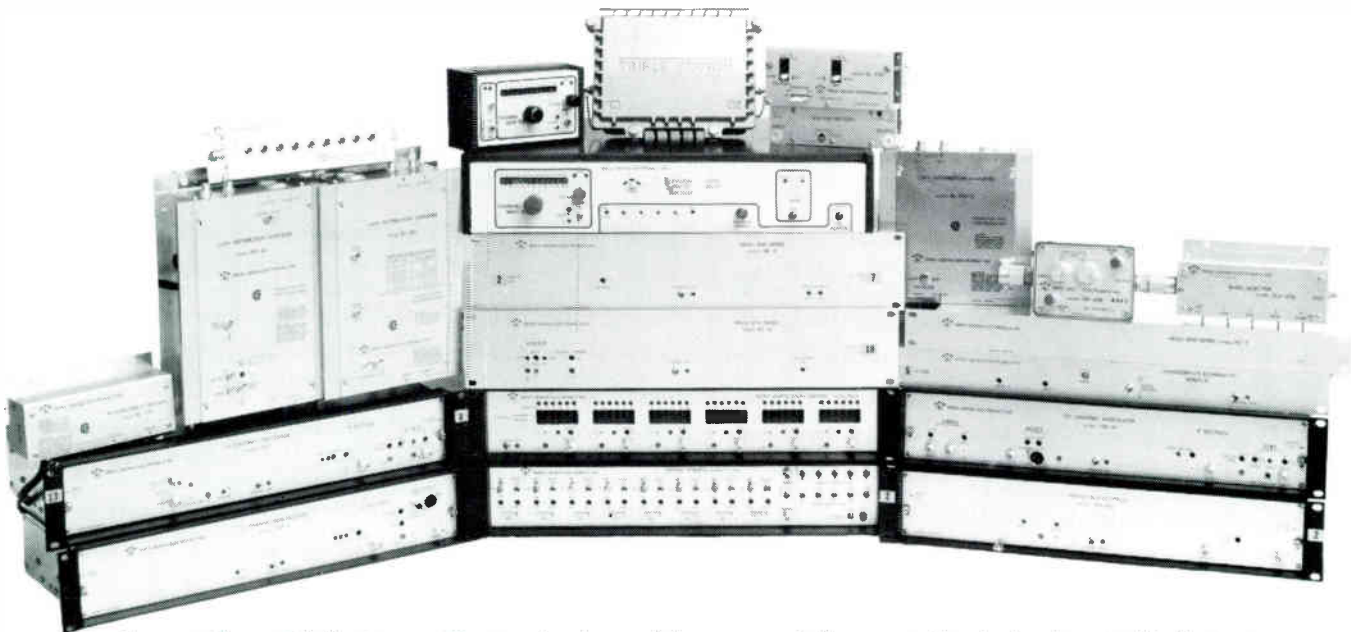

Equipment from Triple Crown Electronics is used by some of the most discriminating Multiple System Operators, Engineering Consultants, CATV Equipment Manufacturers and Small System Operators in the world.

We supply TV Channel Modulators and Processors, Test Equipment, RF Amplifiers and TVRO Receivers.

**WE LIKE TO BE USED!**

## TRIPLE CROWN ELECTRONICS SALES AND SERVICE ORGANIZATIONS

### HEAD OFFICE

Triple Crown Electronics, Inc.,  
42 Racine Road,  
Rexdale, Ontario, M9W 2Z3, (416) 743-1481.

### QUEBEC/MARITIMES

Incospec Electronics,  
4050 Rue Charleroi Street,  
Montreal-Nord, Quebec, H1H 1S6, (514) 322-5540.

### WESTERN CANADA

Techcom Sales Inc.,  
5349 Imperial Street  
Burnaby, British Columbia, V5J 1E5, (604) 437-6122.

### UNITED STATES

B.E. Duval Company,  
29619 South Western Avenue,  
San Pedro, Calif., 90732, (213) 833-0951.

TR Pitts Company,  
P.O. Box 57, 458 West Sanborn Street,  
Winona, Minn., 55987, (507) 452-2629.

Ind. Co. Cable TV., Inc.,  
P.O. Box 3799, 755-23rd Street,  
Batesville, Arkansas, 72501, (501) 793-4174.

d/B CATV Supply,  
Millstone Professional Plaza,  
RD #2, Box 95C,  
Englishtown, N.J., 07726, (201) 446-3612.

### MEXICO

Fag S.A.,  
Calle 15 #81,  
San Pedro De Los Pinos, Mexico, (905) 516-1075.

### EUROPE

HF Transmissie Techniek B.V.,  
P.O.B. 385, De Smalle Zijde 8,  
3900 AJ Veenendaal, Holland, 08485-17231.

### U.S. REPAIR

Lee Dorman Repair Service,  
Tressler Street,  
Pleasant Gap, Pa., 16823, (814) 359-3161.

Superior Electronics Center, Inc.  
2010 Pine Terrace  
Sarasota, Florida 33581, (813) 922-1511

capital improvements realistically made the increase necessary. Thus, acquiring a property with a high rate usually means a "top dollar price", since such purchase price is not likely to be effectively reduced in the immediate future through an increase in rates, and correspondingly, the system's cash flow.

(C) Rate regulation itself is most important. Systems located in a few states which regulate cable through the Public Service Commission or a cable TV regulatory commission may not be as attractive as other opportunities, since the time and cost of obtaining increases is generally quite high. Additionally, there is always the threat of "rate of return" regulation, whereby public utility accounting methods for calculating rate of return would be applied to cable, which is, of course, in almost all cases, a "risk" business.

(D) It is necessary to analyze the history of increases. For example, a system that started in 1970 and has a current rate of \$5.00, with no increase in the past decade, is considerably more valuable from a rate prospective than a system that just implemented an increase six months ago.

(E) Because of the rapid development of tiered services and pricing, it is becoming increasingly important to develop a sophisticated analysis of both produce offering and pricing in relation to the number of services offered.

#### IV

**Franchise Considerations.** Any unfavorable franchise provisions can diminish the value of a cable property. Some of the principal considerations are:

(A) **Term.** If a franchise has a short time remaining before expiration, this could be a serious problem for a potential buyer, since most lenders will not lend money beyond the term of the franchise. Secondly, in spite of a near perfect record of the cable industry for renewing franchises, there can be no assurance that a franchise can be renewed or renewed on a favorable basis. Recently, there has been an increasing number of competitors seeking to apply at the time of franchise renewals. While it is fortunate that most operators with reasonable track records are obtaining renewals, there is the unfortunate problem that, in a competitive situation, the operator's offer must match unrealistic promises made by competitors. Also, some systems operate under "licenses," which are renewable annually. Obviously, it is more opportune to operate under a long-term franchise agreement.

(B) **Rate Regulations.** Although there are no federal regulations which require that franchising authorities regulate cable TV rates, the majority of cable systems are regulated in terms of rates by franchising authorities. Rate increase hearings are usually highly political in nature and tough franchise requirements can be a problem.

(C) **Service Territory.** Some franchises contain requirements for expansion to areas that are economically unfeasible to service (e.g., low density areas, downtown commercial areas which are prohibitively expensive to construct, industrial areas, etc.).

(D) **Percentage of Gross.** Some franchises granted prior to 1972 have ridiculously high percentages of gross payable to the franchising authority, even ranging as high as 33%! Unless a buyer has an opportunity of reducing a high franchise fee payment prior to closing, this can be a substantial negative.

(E) **Technical Standards.** Some franchises contain unreasonable requirements. If, in fact, the cable system was not meeting these requirements, even though the franchising body may not have complained, a buyer could face future problems up to and including a possible revocation of the franchise, if the buyer did not make very expensive capital improvements to bring the system into full compliance.

(F) **Access Requirements.** Some franchises contain absurd access and lease channel requirements, which can be costly to administer. Even though the recent Supreme Court ruling on public access should reduce this problem, the fact that these requirements exist can create problems, unless the franchise is amended.

(G) It is imperative in appraising a property to carefully examine the franchise and **the system's compliance with its terms.** Franchises, licenses and/or permits are critical to the appraisal process, since **the valuation of a cable TV property must be as an on-going business,** since the value of the assets in terms of salvage is generally negligible. Unless the prospective buyer has the capability and experience to analyze this situation, it is well worth the expense to engage a professional for assistance.

(H) Most importantly, because of increasing demands by franchising authorities for cable operations to keep pace with the industry's promises in urban areas, as well as the growing competition in refinancing, franchises are no longer the monopolies which they once enjoyed. Hence, of equal concern is the ability of the seller to transfer the franchise to the buyer on favorable conditions. Most franchises require the permission of the franchising authority to transfer. The transfer process can be absolutely critical, particularly if the buyer is also seeking an extension of the term. In addition to the legal consideration, it is mandatory to ascertain the political climate of the franchising authority before attempting to obtain a transfer and/or extension.

#### V

**FCC Regulation and State Regulations.** Cable TV is a heavily regulated industry, hence, it is imperative to determine whether or not the systems being appraised is in substantial compliance with both FCC and state

(continued on page 34)





---

**WANT TO BUILD A SIMPLE AND  
INEXPENSIVE PASSIVE FREQUENCY DOUBLER?**

# Sweep Doublers

by S. K. Richey  
Teltran, Inc.  
Azle, Texas

---

One of the most frustrating experiences when you need to sweep a piece of equipment is to find that the frequency range of your sweep system does not go high enough in frequency. The easiest and simplest way to solve this problem is to build a simple and inexpensive passive frequency doubler. This device, when connected between your sweep generator and the equipment under test, will convert your in-

puts to twice their operating frequencies while attenuating the fundamental by as much as 30dBc (dB relative to carrier), and all of this happens with only a 12dB Insertion Loss.

## TRANSFORMERS

Begin construction by twisting a pair of number 32 magnet wires into a tight twist (approximately

16 twists per inch). You will need about 3 or 4 inches of this wire, and an easy way to make it is to place the end of the wire into an electric drill and hold onto the free ends of the wires while the drill is running. After you have completed twisting the wires together, run them 4 times through the center of a small RF Shielding Bead (Ferroxcube 56590 65 4B or any small bead you may find in any used CATV

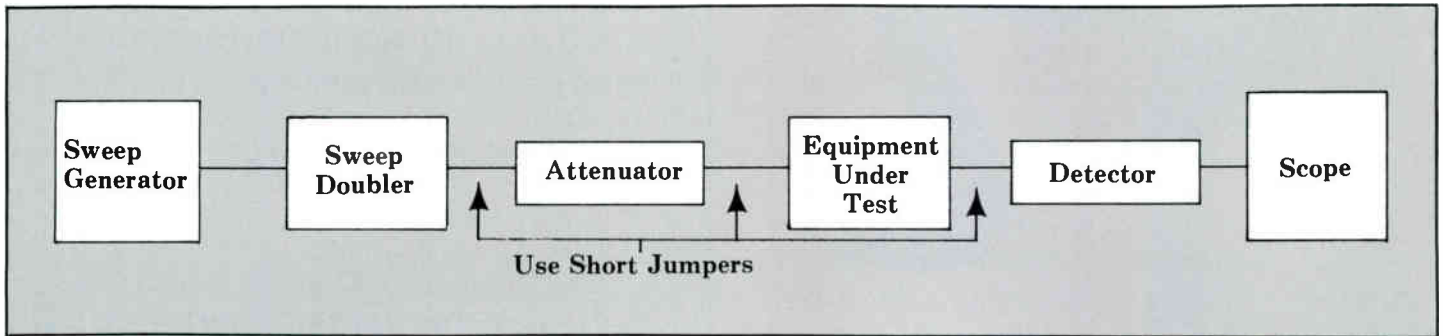

equipment). NOTE: This runs the wires 4 times through the center of the bead, but it will only be

around the outside of the bead 3 times. Separate the wires, tin them with a little solder, and, using an ohmmeter to identify both

ends of each wire, cut the ends off each side of one of the twisted

(continued on page 16)

# CWY Apartment Security Boxes

At CWY we take great pride in producing the highest quality product at the lowest possible cost. Our new apartment security boxes are no exception.

Although all our apartment boxes have a heavy, welded on, wedge shaped hasp lock which is virtually impossible to remove, they also have a knock-out for an optional key lock. This lock is also available from CWY.

There are variable 7/8" and 1 3/4" knock-out holes on the bottom of these products — two on the 5" x 8" x 6" box and three on all the others.

**Features include:**

1. Zinc rich primer with heavy baked-on enamel finish.
2. Reinforced front cover.
3. All welded, weather proof construction.
4. 1/2" plywood mounting board on back.
5. Knock-outs on the bottom.
6. Heavy hasp lock.
7. Knock-outs for optional key lock.
8. Heavy gauge steel.

Salt spray tests are available on request.

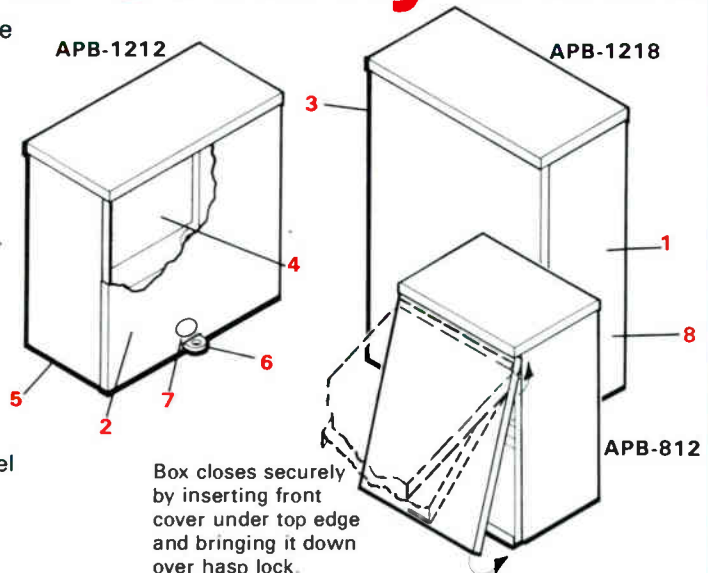

**CWY**  
 CWY Electronics  
 405 N. Earl Avenue  
 Lafayette, Indiana 47904-2898  
 Call Toll Free 1-800-428-7596  
 Indiana 1-800-382-7526



# PUTS TIMES TECHNOLOGY TO WORK FOR YOU

To deliver the superior dielectric performance you need, Times' Cable Television Division harnessed the latest advances in polymer chemistry and molecular engineering to create T4: a new generation of gas-injected dielectrics for trunk, feeder and drop cables.

T4 is a unique system of high-performance polymers and innovative process technology. It culminates a two-year program of research and development by Times' team of material scientists to produce a hard, tightly-structured foamed dielectric with outstanding strength and long-term durability.

*What are Times' four T4 secrets? Proprietary nucleating agents, controlled adhesion, tailored polyethylene resins, and new rheological extrusion processes.*

We put them together and now we have it! T4—Times' answer to your need for superior performance in total bandwidth systems.

---

## ***Controlled Bonding for Long Life***

---

T4 provides an improved barrier between the center conductor and dielectric for long-life moisture protection. T4 also provides controlled adhesion for superior strippability.

---

## ***Tough and Durable Foam Structure***

---

T4 high-strength resins and tight cell structure create a harder, tougher foam dielectric for easier handling, more reliable installation, and improved resistance to kinking and deformation.



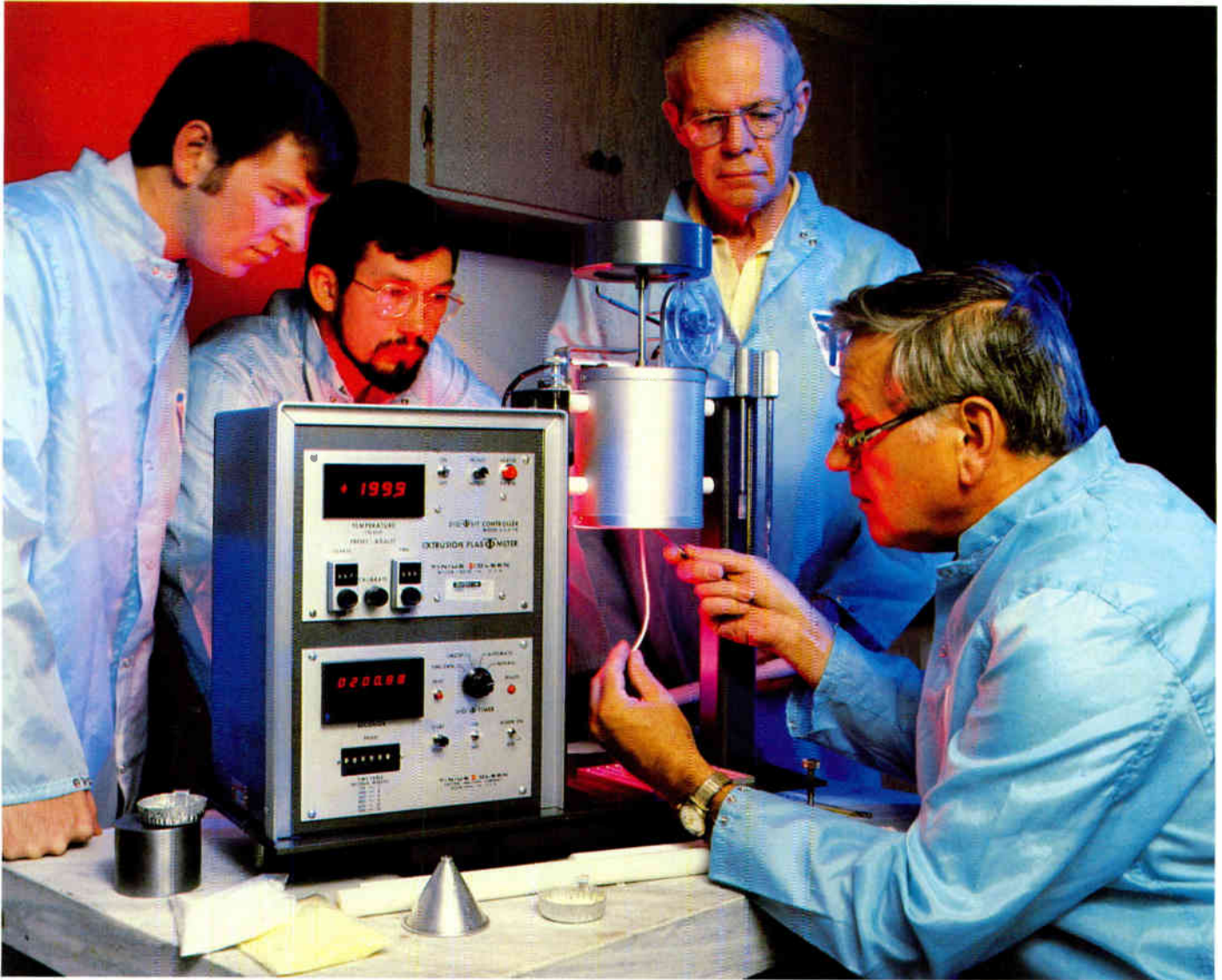

---

## ***Outstanding Electrical Performance***

---

T4 provides a more uniform cell structure to give you improved structural return loss and outstanding attenuation performance.

---

## ***Total Product Line***

---

The T4 foam dielectric system is available in Times' full line of coaxial trunk, feeder and drop cable, ready now for specification on your next build.

To find out more about how this new dielectric can help you, call your Man From Times today. You can also contact us at 358 Hall Avenue, Wallingford, CT 06492, telephone (800) 243-6904.



**TIMES FIBER COMMUNICATIONS, INC.**  
**CABLE TELEVISION DIVISION**

An  Company

pair a little shorter than the other wire for identification.

## DIODES

The diodes we used are a matched quad set of Hewlett-Packard 5082-2800 (Hot Carrier) diodes. However, a set of four IN4148 matched (use an ohmmeter to measure the back resistance and select the four that match the closest) diodes may be used instead. Start construction by taking two of the diodes and twisting the banded end leads together forming a "V". Make sure that the ends of the diodes are as close together as possible

as lead lengths are very critical. Make a second "V" by twisting the unbanded leads of the remaining two diodes together. Remember, to keep lead lengths as short as possible. Now, bring the open leads of the diodes together to form a "diamond".

## HOUSING

In a small box, such as a BUD MOO, cut a piece of copper clad circuit board to fit in the bottom of the box and drill two holes 3/8 inches in diameter and 1 1/8 inches apart. The holes must go through both the copper clad and the box.

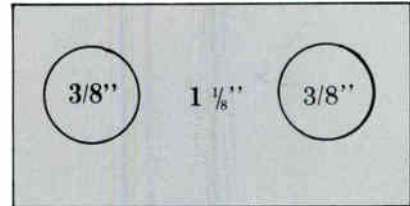

Install two "F" female chassis fittings (F-61-AS) in the box with the copper clad foil side exposed and tightened securely.

## RF CHOKES

On small beads, such as Ferroxcube 56 590 65 4B, wind six turns of number 32 magnet wire. Make two of these RF Chokes.

## FINAL ASSEMBLY

Take the diode "diamond" and solder the junction that does not have any bands to one of the female "F" chassis fittings. Solder one of the RF Chokes from that same "F" chassis fitting to ground (the copper side of your copper clad board). Solder the opposite ends of the diode ((diamond)) (the end with two banded ends) and solder it to ground with very short leads. Solder one end lead of your transformer to the other "F" (INPUT) female chassis fitting and connect the other end of the transformer to a point on the diode "diamond" that has both a banded and an unbanded end. Connect your last RF Choke to this same point on the diode "diamond" and solder. Solder the other end of the RF Choke to ground. Solder one end of the remaining transformer wire to ground and the other end to the last unused junction point on the diode "diamond". This completes the assembly of your Sweep Doubler.

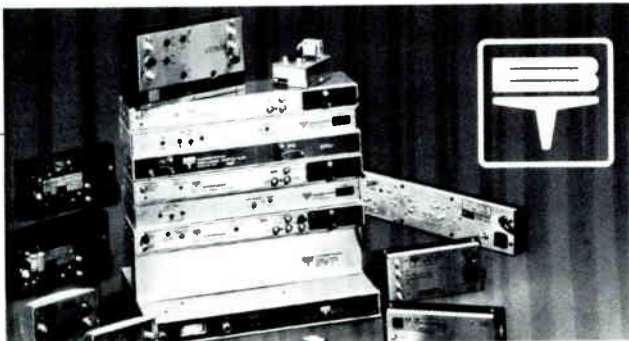

## Look to us for high quality B-T no-wait CATV equipment.

We have it in stock for immediate delivery. Or pick-up.

Blonder-Tongue stock items include: antennas, amplifiers, modulators, converters, filters, headend accessories, traps, processors, preamps, and more. Call us for what you need.

## Davco, Incorporated

America's Oldest CATV Distributor

- Same day shipment
- Help when you need it
- Everything you need in one stop
- In business since 1949!



Authorized  
Blonder-Tongue  
Stocking  
Distributor

P.O. Box 2456

Batesville, Arkansas 72501

(501) 793-3816

# WITHOUT THE INDEX VOLUME, YOUR LIBRARY IS INCOMPLETE

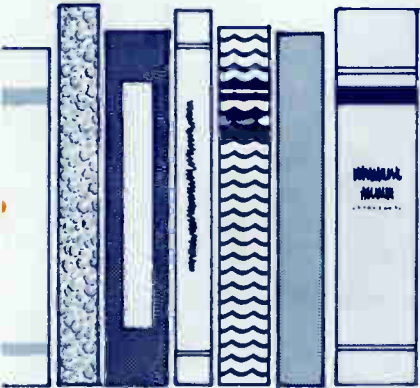

The 1981 Supplement to CATJ's INDEXED VOLUME is now available!  
Included in this group are the articles on:

- UPGRADING YOUR SYSTEM
- CATV BILLING AND FINANCING
- 3 METER ANTENNAS
- AML DISTRIBUTION
- INTERFERENCE STUDIES AND SATELLITE
- STATION FREQUENCY COORDINATION
- PREVENTIVE MAINTENANCE OF SYSTEM
- DEGRADATION
- SMALL OPERATOR SURVIVAL AND HELP FOR
- THE RURAL SYSTEMS
- SATELLITE COMMUNICATION
- CONVERTERS
- AND . . . the regular monthly
- STEVE BIRKILL ARTICLES and
- WASHINGTON UPDATE

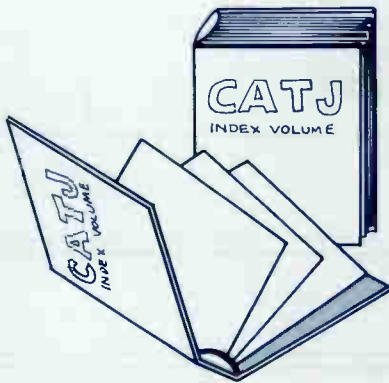
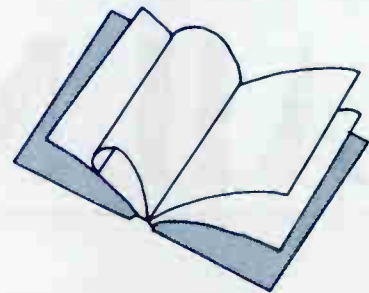

Separated by subject matter, this addition is designed to fit into the tabbed sections of the INDEXED VOLUME, a compilation of the major articles since the inception of CATJ (May 1974 through 1979). Completing this library, the 1980 CATJ Supplement is still available. If you don't have your INDEXED VOLUME and the 1980 and 1981 SUPPLEMENTS, your library isn't complete. Order today!!

**A  
VALUABLE  
WORKING  
REFERENCE**

**YES!**

I WANT TO  
KEEP UP WITH  
THE CURRENT INNOVATIONS  
IN THE FIELD!  
SEND ME:

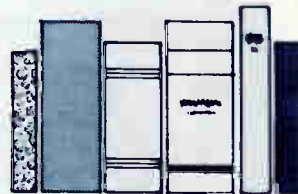

| No. of Sets | Item                                     |       |
|-------------|--|-------|
| _____       | Index Volume with 1980 & 1981 supplement | \$150 |
| _____       | Index Volume with 1980 supplement        | \$120 |
| _____       | Index Volume                             | \$100 |
| _____       | 1981 supplement                          | \$ 30 |
| _____       | 1980 supplement                          | \$ 30 |

I am enclosing a check for \$ \_\_\_\_\_ for the items marked above.

Name \_\_\_\_\_

Address \_\_\_\_\_

City \_\_\_\_\_ State/County \_\_\_\_\_ Zip \_\_\_\_\_

MAIL TO: CATJ, 4209 N.W. 23rd Suite 106 Okla. City, Okla. 73107

# KEEP PACE with the Industry All New 1982

subscribe

Name

Address

City

State

Zip

CATA MEMBER

NON-MEMBER

\*  \$14.00 enclosed for 1 year

\$18.00 enclosed for 1 year

\*  \$40.00 enclosed for 3 year

\$50.00 enclosed for 3 year

NOTE: CANADA/MEXICO SUBSCRIBERS: Add \$4.00 per year to rates given above. All other Foreign Countries add \$7.00 per year to rates given above. Special handling arranged upon request. U.S. CURRENCY ONLY.

\* MUST FURNISH SYSTEM NAME:

WorldRadioHistory

# CATJ



NOTE: Complete parts kits at \$25.00 each, including postage available from:

Teltran, Inc.  
Rt. 2, Box 220B  
Azle, Texas 76020

### CHECKOUT AND USE

Connect the output of your Sweep Generator to the input of the Sweep Doubler, and turn the gain of the sweep generator up to maximum output signal level (at least +55dBmV). Connect the

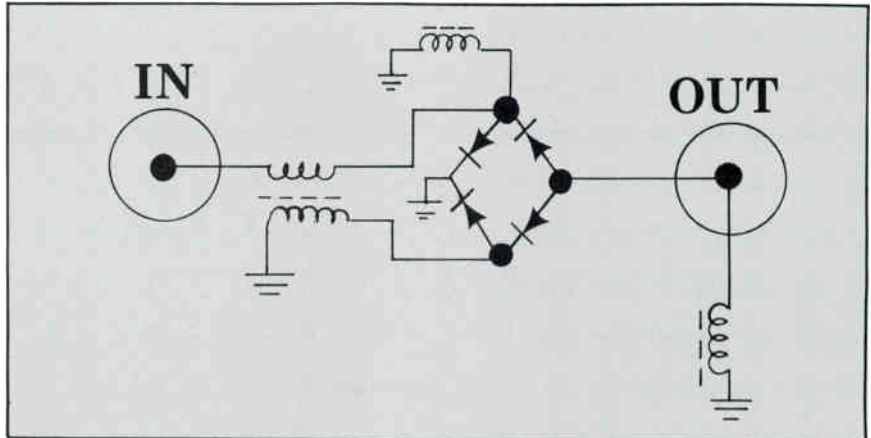

### PARTS LIST

| QTY. | ITEM                     |
|------|--------------------------|
| 1    | MOO Bud Box              |
| 2    | F-61AS Chassis Fitting   |
| 3    | 56-590-65-4B Core        |
| 4    | 5082-2800 Matched Diodes |
|      | #32 Magnet Wire          |
|      | G-10 Copper Clad         |

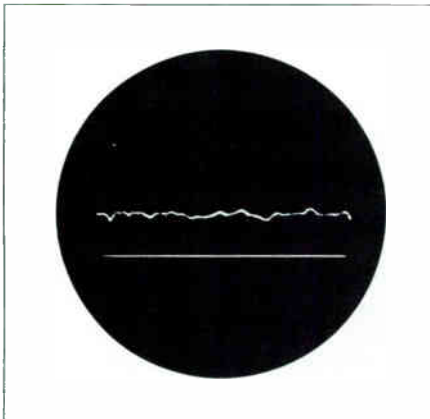
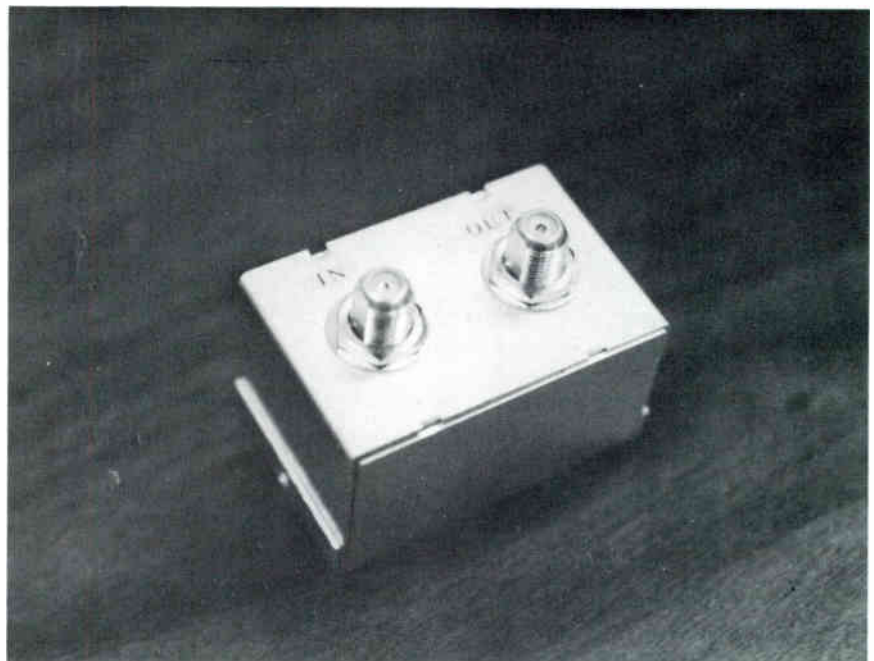

Photo 1

output of the Sweep Doubler with a short jumper cable to your Detector, and connect the detector output to your oscilloscope. The trace that you will see on your scope will be twice the output frequency from the sweep generator (See Figure #1).

(continued)



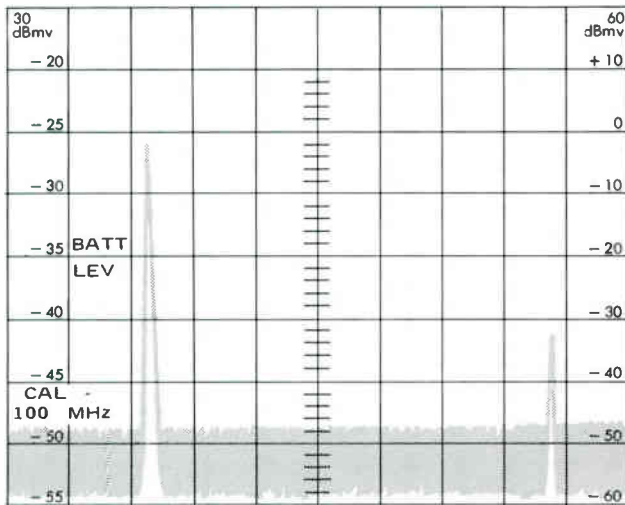

Photo 2

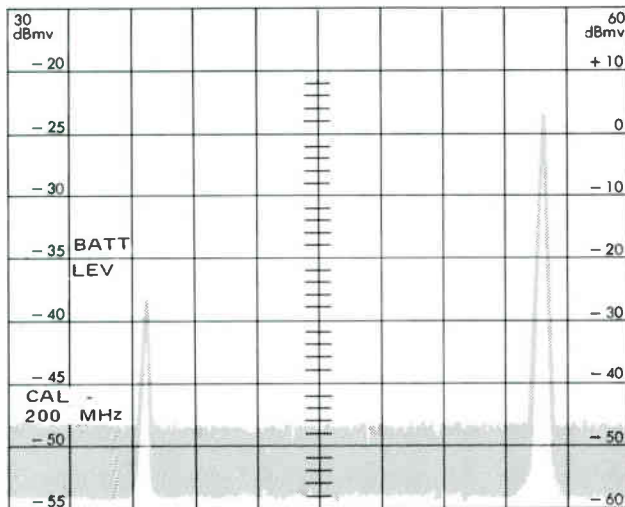

Photo 3

NOTE: Any internal markers you use in your sweep system will also double in frequency and a 50MHz marker will become a 100MHz marker, and so on. Figure #2 shows a 100MHz output signal from the sweep generator into the sweep doubler on a spectrum analyzer. Figure #3 shows that same sweep generator output signal after it has been passed through the Sweep Doubler at 200MHz with the resultant attenuation of the fundamental.

When using the Sweep Doubler you must keep your sweep generator at maximum output. To measure gain and/or loss in the equipment under test, you will need to add a variable attenuator between the sweep doubler and the detector with short jumper cables and use it for all measurements.

Good Luck on building your sweep doubler. It is nice to be back in CATJ and I hope to have many interesting articles and construction projects for you in the months to come. If you have any questions concerning construction of this sweep doubler, you may contact me at the address above. □

# ...fantastic isolation...

These are the words of Bill Turner, from the office of his West Virginia system, the Welch Antenna Co. But the isolation he's really talking about is the "... fantastic isolation ..." available with our RF Sensing Coaxial Relay.

You see, he takes the RF out of 2 processors in conjunction with a real-time clock to handle his signal switching. From Welch, W.VA., he relies on our Relay to switch from satellite, to local, to land based microwave, to off-air, or back to space again.

The RF/IF Coaxial Relay is just one of our family of models, such as Video Sensing (with a variety of options) and the Standard (using manual and/or impulse manipulation). And they'll work for your system — no matter how large, how small, or how isolated.

We think Bill Turner's kind of isolation is rather fantastic, too!



*An Employee Owned Corporation*  
**COMSONICS<sup>®</sup>, INC.**

P. O. Box 1106 Harrisonburg, Virginia 22801

**1-800-336-9681**

IN VA., 703-434-5965 COLLECT

**If you're into Cable Communications, We're Into Your World.**

# Steve J. Birkill On Experimental Earth Terminals

Steve J. Birkill  
Real-World Technology  
128 Cross House Road  
Grenoside, Sheffield S30 3RX England

© 1982 CATJ

## Polarization Tilt:

# WHY, & HOW MUCH?

Frequency re-use on the current 4 GHz domestic 24-channel birds is achieved by overlapping two groups of twelve channels each, with orthogonal polarizations. Orthogonal means at right angles, referring to horizontal versus vertical, but it can also be applied to opposite senses of circular polarization. A correctly adjusted linear feed will “peak” on one direction of polarization while producing a “null” 90 degrees of rotation away. Similarly, a perfectly set up feed for a right-hand circularly polarized wave will have zero response to a signal with

left-hand rotation. The definition of polarization refers to the direction of the electric field vector of the wavefront. So, a vertically polarized wave has its “E”-plane aligned up-down and its “H”-plane aligned left-right. And a right-hand circular wave has an electric field vector which rotates in a clockwise direction along its direction of propagation. And so on.

Because of this orthogonal property of wave polarization, it can be used to provide a measure of isolation between two indepen-

dent streams of information sharing the same chunk of spectrum. Two signals which would otherwise interfere with each other can be kept separate. In practice, isolation of about 30 dB (1000 times power ratio) can be achieved with care. Small errors in alignment, antenna pointing, or weather conditions along the path can degrade the figure to only 20 dB (100 times) so the channel frequencies are arranged with a half-channel offset, so the highest-energy region of a horizontal channel falls in the

(continued)

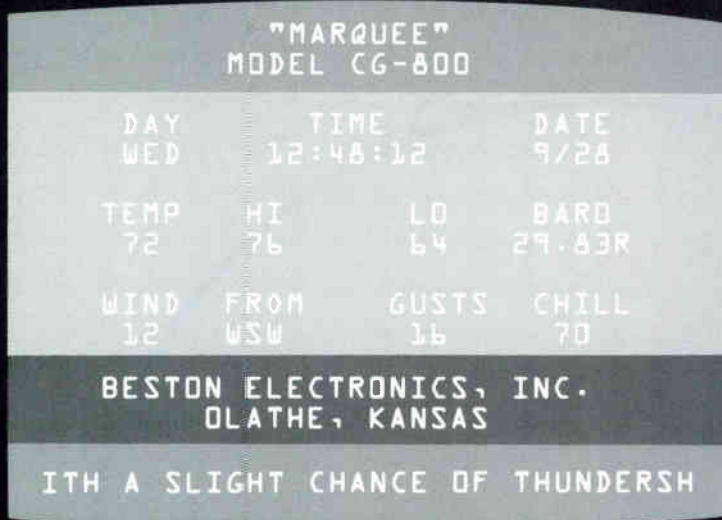

Only  
\$4,225<sup>00</sup>

◀ ONE PAGE LIKE THIS!

▼ THREE PAGES LIKE THIS!

(with 8 line messages on each page)  
Expanded to 16 pages for only \$300.

Crawl line is standard with keyboard entry, optionally interfaced to NOAA. ▶



# COLOR DIGITAL WEATHER / MESSAGE

AFFORDABLE BY DESIGN

Only \$4,225<sup>00</sup> COMPLETE: Including the cost of a factory wired and tested HEATHKIT WEATHER COMPUTER!

BEI has interfaced the CG-800 "Marquee" to the Heathkit digital weather computer for a low cost color digital weather and message channel.

CHECK THESE STANDARD FEATURES:

- Keyboard.
- Four message pages.
- Crawl line with 1000 characters.
- RS-170 Color Sync System.
- Color background generator.
- Automatic centering.
- Page by page display time.
- Random page display.
- AND MORE!



P.O. Box 937-Olathe, Kansas 66061  
Toll Free 1-800-255-6226  
In Kansas 913-764-1900  
TWX 910-749-6401

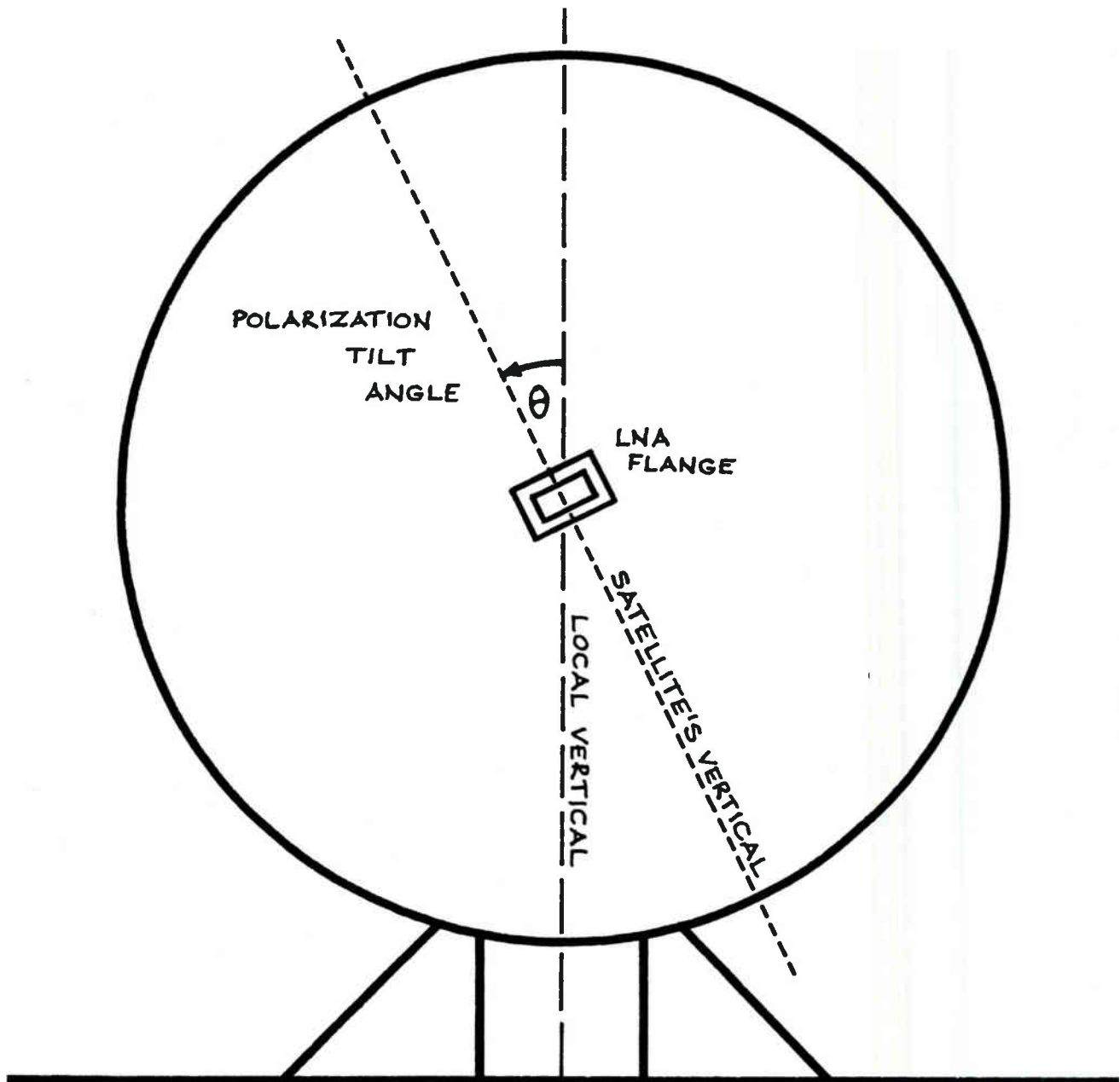

FIGURE 1 TVRO antenna showing definition of tilt angle.

low-energy region between two orthogonal vertical channels, and vice versa. This means that, most of the time, interference is no problem.

Now if someone comes along and tells you he's designed a feed which will respond fully and equally to both directions of polarization simultaneously, **don't believe him**. You can keep both of them separate, or you can com-

bine them with 3 dB (half-power) loss to each, but the laws of physics don't permit combining them without loss. To position the feed probe at 45 degrees to the "horizontal" and "vertical" directions will certainly give you a mixture of the two, but carrier/noise ratio for each will be degraded by 3 dB, before you can even consider the effects of the mutual interference. It might be a

handy method of scooting through all the transponders on a bird to see what's where, but you can't hope to achieve anything like perfect picture quality unless: 1. you "up" the antenna gain by 3 dB (which means increasing its aperture by a factor of 1.4) and 2. you use a rather clever demodulator which can cancel out the unwanted half-channel in-

(continued)

**Wishing  
You and Yours  
A Prosperous and  
Happy New Year!**



**from the staff at  
CATJ**

formation in each half of the wanted channel.

Still, I speak glibly of “horizontal” and “vertical”. No doubt you do too. But we all know that our feed probes are very seldom aligned anything like horizontally or vertically. The “H” and “V” we refer to are those defined at the satellite itself, which looks down at the earth and stabilizes itself so that its pitch axis is aligned north-south, its roll axis is aligned along its direction of orbital motion, that is east-west, and its yaw axis points towards the earth’s center. Having done that, it calls north-south “vertical” and east-west “horizontal”. Usually

anyway — there are some exceptions, for instance Europe’s Orbital Test Satellite defines vertical as the direction five degrees clockwise of the north-south line. The North American satellites align their polarization with the north-south axis, so we’ll just consider those here.

This means that, if the receiving terminal is on the same meridian as the satellite, it will agree with the satellite’s definitions of “H” and “V”. But elsewhere it will not. Because of the curvature of the earth, a satellite to east or west of the terminal’s meridian

will appear to have its polarization axes tilted. So that we are in no doubt about direction of tilt; look at **Figure 1**. This shows the receiving antenna as seen by the satellite. We are looking at the front of the dish, and seeing the LNA/feed assembly pointing away from us, looking into the dish. From this viewpoint, the signal polarization is tilted counter-clockwise, relative to local (terminal) horizontal and vertical, for a satellite to the west of

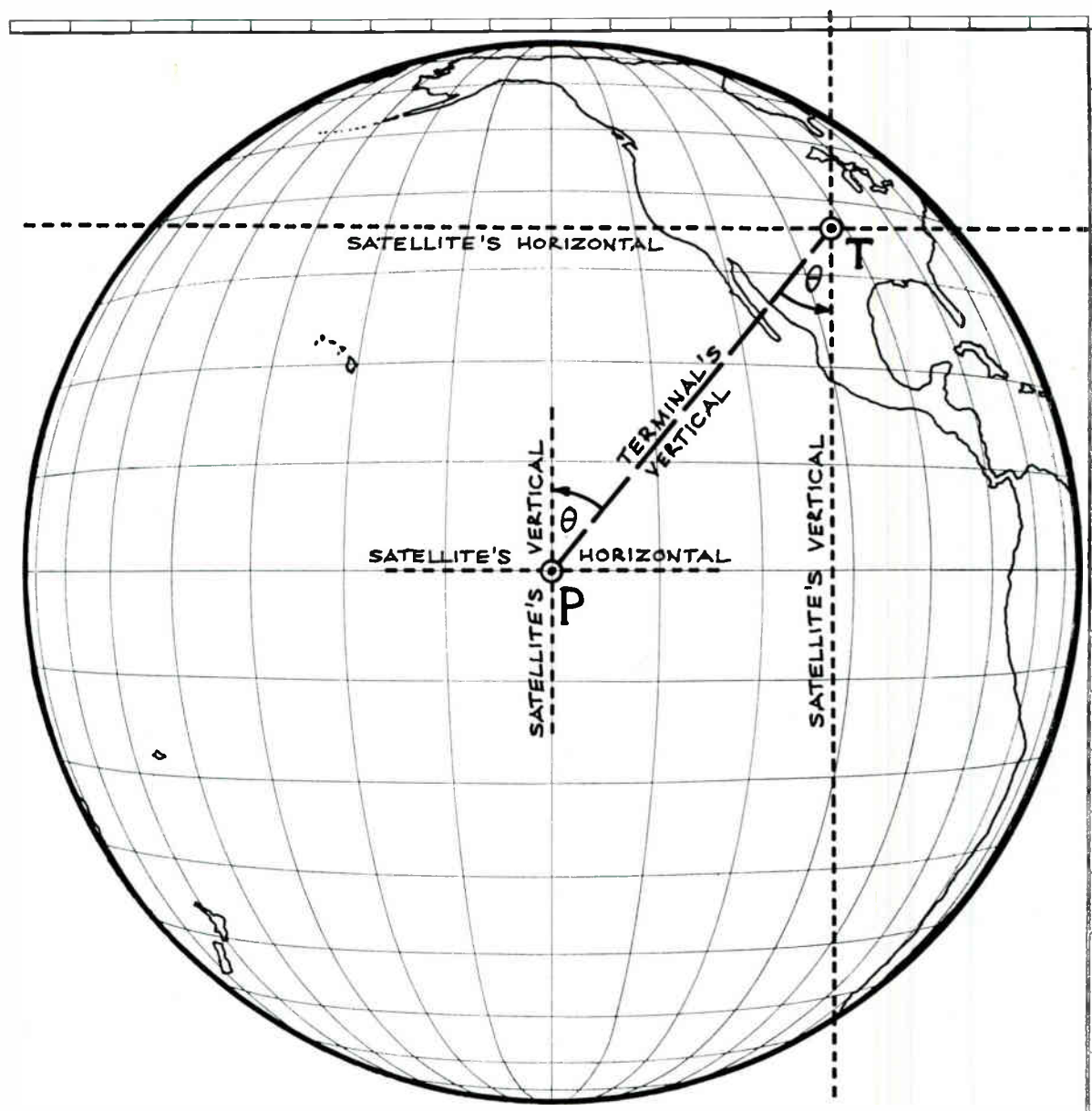

**FIGURE 2** The earth as seen by a geostationary satellite at 135°W



us. For satellites to our east, the tilt is of course the other way. And all this applies to the northern hemisphere. Terminals south of the equator change north for south and east for west to define direction of tilt.

To arrive at a value for theta, the angle of tilt, consider first **Figure 2**. This shows the earth as seen from the satellite, showing the distortion of the familiar coastlines as they wrap around the curved surface of the globe.

From this viewpoint, all horizontal lines are parallel to the satellite's own horizontal, defined at the sub-satellite point P, and likewise all verticals are parallel to the north-south line on the satellite's meridian. But at the terminal T, vertical is the line joining T to the earth's center, a point directly in line behind P, as seen by the satellite. So angle theta is the angle between the line PT and the satellite's vertical using this projection.

**Figure 3** shows the same situation in a three-dimensional representation. We know the values of **angle lambda**, the difference in longitude between terminal and satellite, and **angle phi**, the latitude of terminal T. We also know the earth's radius **r**, though this doesn't affect the result. **Triangle TRQ** is in a plane perpendicular to line **OQPS** between the satellite and the center of the earth, and TR is parallel to the earth's axis. From simple trigonometry,

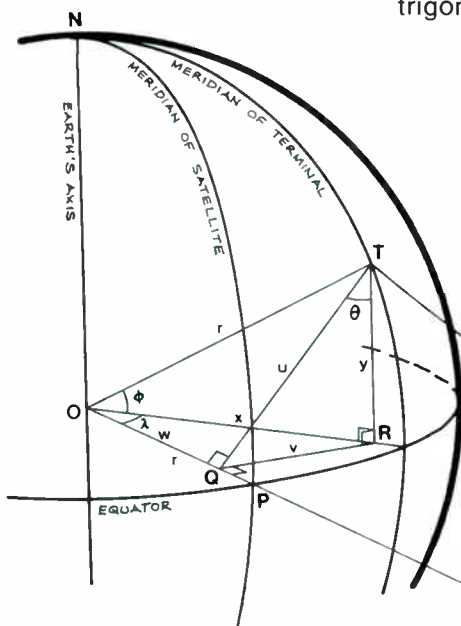

**FIGURE 3**  
Geometrical derivation of tilt angle

$$y = r \sin \phi$$

$$x = r \cos \phi$$

$$v = x \sin \lambda$$

$$= r \cos \phi \sin \lambda$$

Now in triangle TRQ,

$$\tan \theta = \frac{v}{y}$$

$$= \frac{r \cos \phi \sin \lambda}{r \sin \phi}$$

$$= \sin \lambda \cot \phi$$

$$\text{So } \theta = \tan^{-1} (\sin \lambda \cot \phi)$$

This simple relationship defines polarization tilt angle, independent of earth radius or satellite altitude. And it gives us an excuse to plot some more lines on our old USA map. **Figure 4** shows contours of constant polarization angle for a satellite at 135°W. The contours are in fact curved, though this particular map projection makes them look like straight lines. Similar maps could be plotted for any satellite, though the formula is simple enough to apply to each satellite of interest at the terminal site in question. It must be stressed though that, accurate as these results are, the best method for trimming feed probe orientation is by nulling the cross-polarized signal. That is to say you find the true direction of "horizontal" by tuning to a vertical channel and rotating the LNA/feed assembly for a minimum — a very sharply defined position. The maximum is poorly defined and should not be used for setting up.

All very straightforward when  
(continued)

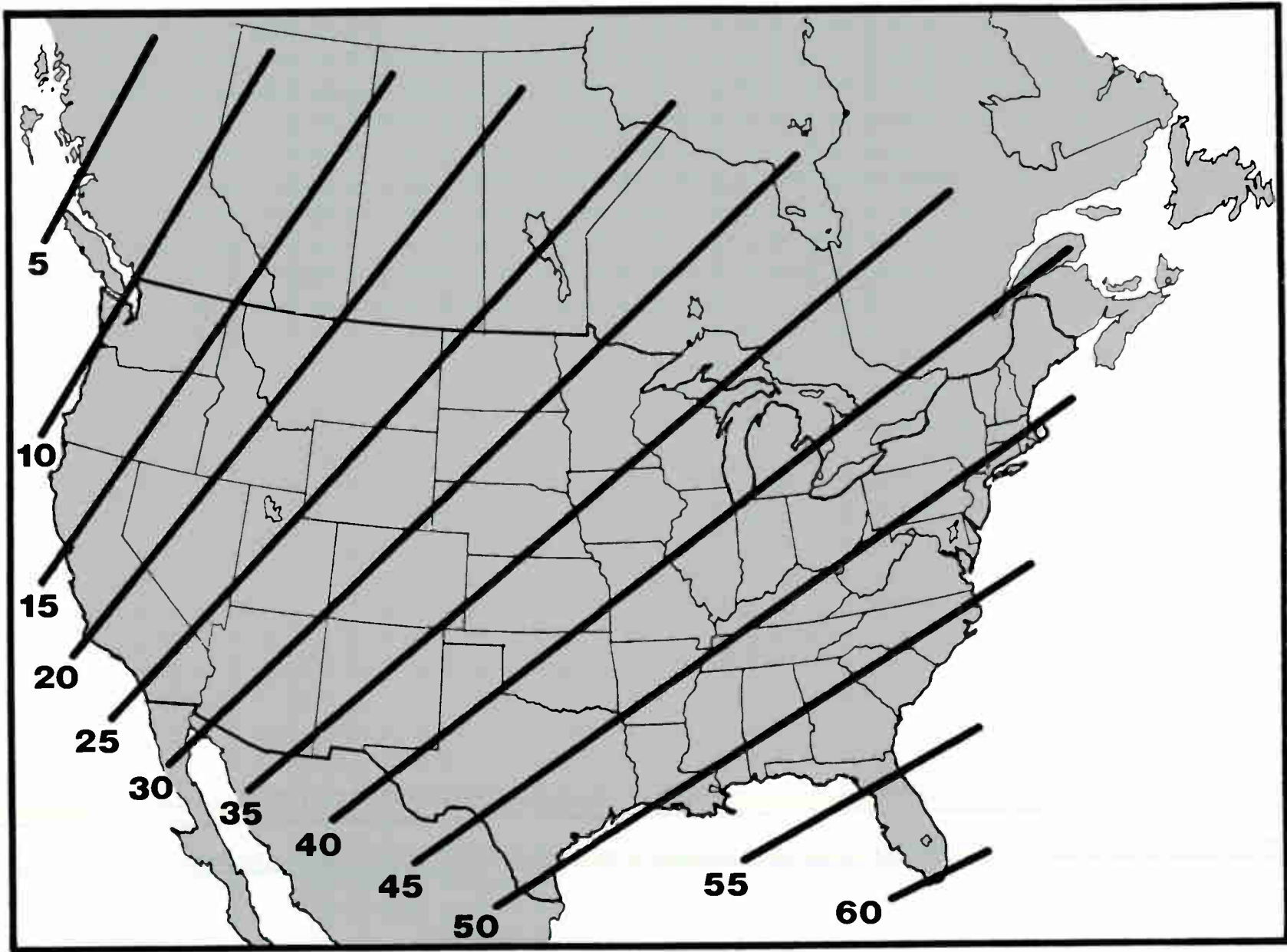

FIGURE 4

Tilt angle contours from 135°W to mainland USA

considering a single satellite! But increasingly the TVRO installation is a steerable one, capable of acquiring any one of maybe a dozen birds in the domestic belt. Such a steerable installation has either an orthocoupler feeding two LNAs, or switched to one LNA, or a switchable ferrite rotator in the waveguide, or a 90 degree rotatable feed and LNA assembly. How does this pre-set 90 degrees keep track of the polarization tilt angle differences for each of the satellites as the

antenna scans along the arc? Well, if the antenna mount is az/el, the feed rotation has to be programmed along with the look angle. But if the antenna uses the modified polar mount, it transpires that polarization tilt is automatically taken care of as the dish turns about the polar axis, to an accuracy limited only by the axis offset angle (the amount the polar axis is inclined away from the direction of the earth's axis), which is everywhere less than 0.7 degrees, as we shall see next

month when we analyze the modified polar mount.

Spacecraft buffs will have noticed an error that appeared in November's piece. On page 38, the captions to the two satellite photographs somehow became transposed. The TV screen shot shows the earthward face of OTS, with its five dish antennas. The other bird, with its assortment of round and square horns and orange-peel reflectors around a large dish, is of course the Soviet Gorizont. □

## **NEW** **Unscramble** **Your** **Installation!**

Fast and easy identification of your basic drops and pay levels is now possible with "Label Locks" from CWY. Our new Label Lock model has extra length to accommodate the latest style (F) connector. It comes in six distinctive colors that can be used in hundreds of combinations. Colorfast to withstand inclement weather, Label Locks are easily seen from the ground, eliminating extra climbing and giving you years of easy audit.

Attachment of the Label Lock is quick and permanent. They simply snap together and must be destroyed to be removed. This prevents tampering or tag changing. As an added feature any Label Lock may be attached to the junction of a Vitek trap or drop cable, serving as a label and security device.

Label Locks come in two sizes and will fit any drop cable or Vitek trap. Each has an area especially made to be written on.



405 N. Earl Avenue  
Lafayette, Indiana 47904

Call Toll Free 1-800-428-7596  
Indiana 1-800-382-7526

**NOW**

# SPECTRUM ANALYZERS

for monitoring, service and testing communication equipment  
100 kHz - 2 GHz

The Model 632B-1 is well suited for wide range distortion and noise measurements, test

equipment calibration, EMC tests, and other frequency domain applications up to 2.0 GHz.



Send for our new catalog.



polarad polarad polarad

Polarad Electronics, Inc. 5 Delaware Dr., Lake Success, N.Y. 11042 TEL 516-328-1100 TWX 510-223-0414

# 19 CATA S SCHE

Many have inquired what the schedule for the CATA technical training seminars would be for 1982, and below you will find that schedule. Also, you will notice that the curriculum has been divided into two sections and we will have one schedule for the installer category (a three-day course), and the other for the more experienced chief technician type with the three days' lectures and two for hands-on experience.

We have had many that have requested the more basic training for the newer personnel in the cable industry; therefore, the shorter, three-day teaching program was developed to accommodate those requests. Again, this is an example of how CATA is seeking to provide the technical training and assistance to the cable system operator that he needs to operate his system more efficiently. We would suggest that as soon as you make a decision on whether to attend one of these yourself or to send one of your people, you request registration information from CATA and secure a spot, because, as before, space will be limited.

## 1982 CATA SEMINARS

### CATA Advanced Technical Training Seminars

An advanced technical seminar on system concepts and design, system problems and catastrophic features, system tests and measurements, and FCC technical requirements and tests. Includes two days of hands-on test equipment laboratory.

## FOR UNDERGROUND HOUSE DROPS

Discover what compact performance can mean to you!!

NO TRAILER NO LAWN DAMAGE

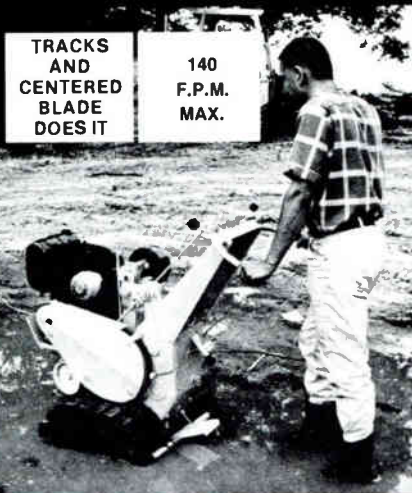

The Line-Ward L-1 Cable-Line Layer "Explodes" the Myth "Big is Better" & Outperforms Units 3 Times its Size Only 24½" Wide

Mud or Fine Lawns (It Will Go Where The Others Will Not)

157 Seneca Creek Rd. Buffalo, N.Y. 14224

**LINE WARD CORP.**

Phone 716-675-7373

# 82 EMINAR DULE

March 8-12  
New Orleans, La.

May 3-7  
Albany, N.Y.

Aug. 30-Sept. 3  
Phoenix, Az.

Oct. 4-8  
Indianapolis, In.

Dec. 6-11  
Orlando, Fl.

## CATA Basic Technical Training Seminars

This basic technical seminar covers how a cable system works, from the signal sources to the subscribers TV set. Teaches coaxial cable, subscriber installation techniques, proper use of field strength meters, trouble shooting techniques of the distribution system, and diagnosing common cable system problems. Classroom and hands-on laboratory training.

April 5-7  
Oklahoma City, Ok.

June 7-9  
Winston-Salem, N.C.

Aug. 2-4  
Boise, Id.

Nov. 1-3  
Hot Springs, Ark.

Contact CATA Engineering of-  
fice for information.



Checking response flatness?

It's easy with Sadelco's  
SC 450 Spectrum Calibrator

**1/4 dB**  
**ACCURACY**  
**4.5-450 MHz**  
MHz Ratio: 100 to 1

Covers the complete  
CATV range, present  
and future.



Checking signal levels?

do it accurately with Sadelco's  
FS 3D-VS Signal Level Meter

**450 MHz**  
**52 Channels**

PLUS . . .  
the FS 3D-VS Professional SLM  
has Built-in Quality Features . .

- $\pm 1.0$  dB Accuracy
- Electronic Auto. Shut-off
- New High-Impact case  
with Accessory storage
- AC/Battery Operation:  
3 types of Battery Options;  
Nicads, Alkaline or  
Carbon Zinc

Call or Write for Free Color Brochure

**Sadelco, Inc.** 75 West Forest Ave., Englewood, N.J. 07631 201-569-3323  
General Rep. for Europe: Catec AG Luzern/Switzerland, Habsburgerstr 22, Tel. 041-23-90-56 Telex: TELFI 78168

### Distributors in U.S.A.:

**ANIXTER PRUZAN**  
Alaska:  
Anchorage 907-274-8525  
Fairbanks 907-456-1815  
California:  
Los Angeles (Irvine) 714-556-6270  
Colorado:  
Denver (Englewood) 303-741-2900  
Georgia:  
Atlanta 404-449-6533  
Illinois:  
Chicago (Elk Grove Village)  
312-540-1156  
Skokie (Headquarters) 312-677-2600  
New Jersey:  
Wharton 201-328-0980  
Missouri:  
St. Louis 314-423-9555  
Oregon:  
Portland 503-285-2245  
Texas:  
Houston 713-674-8035  
Washington:  
Seattle 206-251-6760

**CABLE TV SUPPLY CO.**  
California:  
Los Angeles 213-204-4440  
Georgia:  
Decatur 404-981-9220  
Illinois:  
Addison 312-543-9800  
Massachusetts:  
Woburn 617-938-1221  
New Jersey:  
Cinnaminson 609-829-0100  
Ohio:  
Brecksville 216-526-0919  
Texas:  
Grand Prairie 214-988-1841  
Houston 713-681-6141

**DAVCO ELECTRONICS CORP.**  
Arkansas:  
Batesville 501-793-3816

**ELECTROTEx**  
Texas:  
Houston 713-526-3456

**GULF ELECTRONIC SUPPLY INC.**  
Florida:  
Miami 305-592-6583

**HURLEY ELECTRONICS INC.**  
California:  
Inglewood 213-678-7644  
Long Beach 213-537-5375  
Oceanside 714-722-7694  
San Bernardino 714-885-0721  
San Diego 714-235-6245  
Santa Ana 714-971-2203  
Van Nuys 213-781-8410

**KLUNGNESS ELECTRONIC SUPPLY**  
Michigan:  
Iron Mountain 906-774-1755

**MIDWEST CATV SYSTEMS**  
West Virginia:  
Clarksburg 304-622-4700

**MIDWEST CORP.**  
Florida:  
Miami 305-592-5355  
Indiana:  
Indianapolis 317-251-5750

Kentucky:  
Lexington 606-277-4994  
Louisville 502-491-2888  
Maryland:  
Lanham 301-577-4903  
Michigan:  
Troy 313-689-9730

Ohio:  
Cincinnati 513-651-1904  
Cleveland 216-871-3116  
Columbus 614-476-2800  
Virginia:  
Virginia Beach 804-464-6256  
West Virginia:  
Nitro 304-722-2921

**NELSON ELECTRIC SUPPLY CO.**  
Texas:  
Dallas 214-741-6341

**S. A. L. COMMUNICATIONS**  
California:  
Chatsworth 213-341-9100  
Georgia:  
Decatur 404-981-0050  
Indiana:  
Indianapolis 317-244-2477  
New York:  
Melville 516-694-7110

**TELE-WIRE SUPPLY CORP.**  
Florida:  
Sarasota 813-371-3447  
Michigan:  
Three Rivers 616-273-9534  
Pennsylvania:  
Simpson 717-282-2340  
Texas:  
Grand Prairie 214-492-2898

**TONER CABLE EQUIPMENT**  
Pennsylvania:  
Horsham 215-675-2053

**TVC SUPPLY CO. INC.**  
Pennsylvania:  
Hershey 717-534-4982

### Distributors in Canada:

**ANIXTER PRUZAN**  
Montreal, Quebec 514-637-3511

**INCOSPEC ELECTRONICS, INC.**  
Montreal-Nord, Quebec 514-322-5540

**R. F. COMMUNICATIONS LTD.**  
Ontario 416-495-1030

**TECH COMM SALES, INC.**  
Burnaby, British Columbia 604-437-6122

---

---

# Haimo Wits cont.

---

---

Women In Cable has recently held several local chapter meetings to premier HBO's documentary special, "She's Nobody's Baby". What made these gatherings unique, at least the South Florida Chapter of Women In Cable premiere that I attended, was that this was not just a regular membership meeting, but a well planned, social gathering of both men and women from the cable industry that had the opportunity to share their thoughts and feelings about a very special program.

I was quite pleased when I received my very own printed invitation to this event — not just included on Patti's — which made me feel that Women In Cable wanted me there as a representative of CATA and as an individual participant from the cable industry, not just the spouse of a chapter member.

The South Florida event began with champagne cocktails and hors d'oeuvres, with a pleasant hour of conversation with members of Women In Cable and their invited guests, about 100 people total. I was pleased to see several other men among the guests, most of whom I have known from my years in cable in the Florida area. It was dis-

appointing, however, to learn that only a small percentage of those men who received invitations actually came to this program, and I hope that it was not Monday Night Football that kept them away. Those who did attend certainly enjoyed the evening and were made to feel right at home.

Suzanne Levine, managing editor of *Ms. Magazine* and producer of the show, told the audience some of the "behind the scenes" people and events that went into the making of "She's Nobody's Baby", and some of the problems they encountered in obtaining film clips. "It was a revelation how limited documentation of women in real life was. Where was there footage of a day spent at the laundromat", said Ms. Levine.

If you haven't seen "She's Nobody's Baby", then you have missed an excellent program that is not only entertaining, but is also historical and educational. Some of the documented information shown, particularly the segments of government propaganda films during the beginning and right after World War II, are real eye openers. In short, the production is an honest and open program about the American women and, if you did not get the chance to see it on HBO, I would suggest that you write to HBO to

bring it back again for an encore.

I know that many people in this industry feel that cable television is far ahead of many other industries in hiring women not only in the office but as installers, and, in some instances, technicians. We even have a few women in high level management. For the most part, I am afraid, that women in cable are looked upon as the "girl who answers the phone, and writes up the work orders". There are many women though who are quite capable of handling the job of installers, technicians, and even engineers in the cable industry. Perhaps some of the reluctance is based upon fear that a women might do a better job. That could be a terrible blow to man's ego so, if they aren't given the job then we can insure job security.

If it appears that I am on a soap box again, it is for a very good reason. The women who work in our industry today are intelligent, capable, and hard working members of our industry. They deserve the same opportunities and pay that we men have. Let's be perfectly honest, we could not enjoy the success that cable has had without our women in cable. Let's all do our part to see that they receive the appreciation and rewards that they have earned. □



**CHARLES L. GREENE**  
*President*

## **AMCOM, INC.**

Building E Suite 200  
5775 Peachtree-Dunwoody Road, N.E.  
Atlanta, Georgia 30342  
(404) 256-0228

***Cable TV Brokerage***

**THANK YOU!** Your requests for extra copies of our **Customer Relations Brochures** have been fantastic. For those who have yet to order — a few copies are still available for **\$2. each.**

a fragile road



# Second Edition WTFDA TV STATION GUIDE

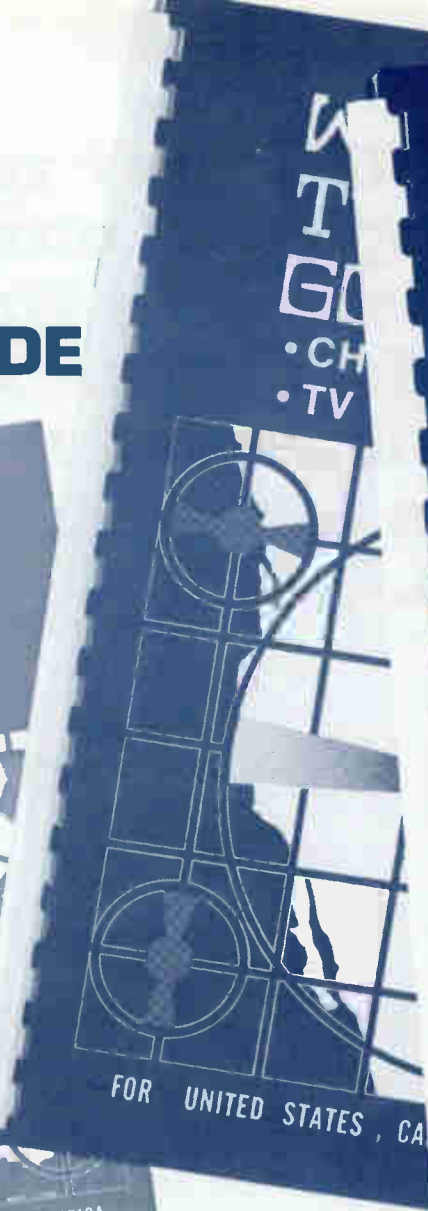
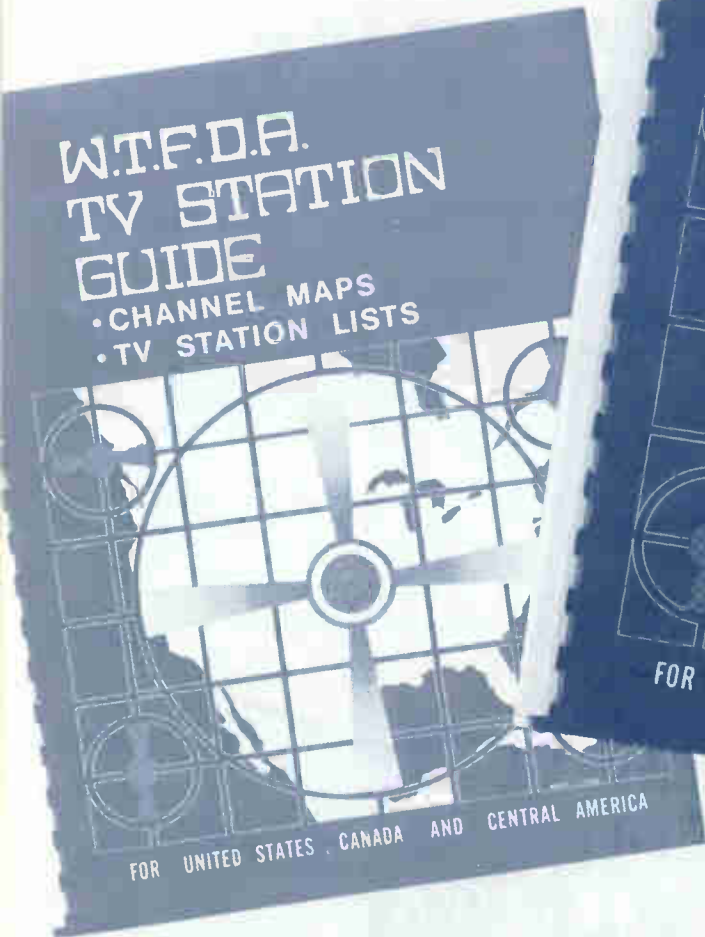

CATJ is proud to offer to its readers the Second Edition of the WTFDA TV STATION GUIDE, developed by the Worldwide TV-FM DX Association. CATJ appreciates their cooperation in providing these guides.

Recognized as an invaluable reference

The 63-page book covers TV stations in the United States, Canada, and Mexico with the station directory pages covering such details as call letters, network affiliation or programming format, station locations, effective radiated power, and antenna height. The channel maps pinpoint station location and indicate call letters, network, offset frequency and local time zone. Another channel map section covers Central American TV stations operating on channels 2-6.

A new feature in the WTFDA TV STATION GUIDE is the inclu-

source, the guide is arranged by channel and features maps opposite complementary directory pages. It also features special sections covering TV satellite transponder frequencies and program source data, private microwave TV frequencies, and a directory of receiving

equipment supplier.

Designed primarily for long distance TV reception enthusiasts (TV-DXers), this second edition is expected to provide needed material for communications professionals, and become as popular a tool as their first edition.

sion of television satellite transponder information. Channel-by-channel listings detail operating frequency, polarization, programming originator and subcarrier services for three major US satellites. Information is also featured on Canadian and Russian satellites.

CATJ is offering these guides, available immediately, for \$10.00 per copy (\$12.00 for Canadian orders in U.S. currency) and will be sent first class mail upon receipt of your order.

A limited amount of these guides are available; order yours

Please RUSH \_\_\_\_\_ copies of the WTFDA TV STATION GUIDE I am enclosing \$10 for each copy ordered. (Canadian customers please add \$2. for each book)

Name:

Address:

City

State

Zip



# IN THE COMING MONTHS IN 1982...

## **More Technical Articles**

**Continuation of Rick Michael's Series on  
Financing Cable Systems and Tax Considerations**

## **More Birkill**

**Up to Date Information on the Washington Scene  
and the Copyright Fight**

## **Articles on Kit Construction**

**Information and Registration for Cata's CCOS '82  
Scheduled in Nashville (July 3-6, 1982)**

## CWY Cable TV Pedestals

Built in our tradition of quality workmanship, CWY is proud to introduce our new security pedestals. There is no other pedestal on the market today that offers this kind of heavy gauge, built-to-last, welded construction at a more reasonable price.

### **Consider these features:**

1. Rectangle design for maximum use of space and ease of installation.
2. Hinging system that allows cover to come completely off and yet is easy to open and close.
3. Knock-outs in the back for simple installation. (Large unit has multiple knock-out holes for added flexibility.)
4. Silk screened warning signs for safety and your protection.
5. Finish that has a zinc-rich primer and then heavy baked enamel to withstand years in the elements.
6. Heavy hasp lock for complete security.
7. Attractive light green color for good appearance in residential areas.
8. Finger hold for convenient, easy opening.
9. Heavy screened louvres in large pedestal only.

### **Stakes S-24**

Stakes are all painted an attractive light green to match pedestals and have multiple holes for easy installation no matter what the height requirement.

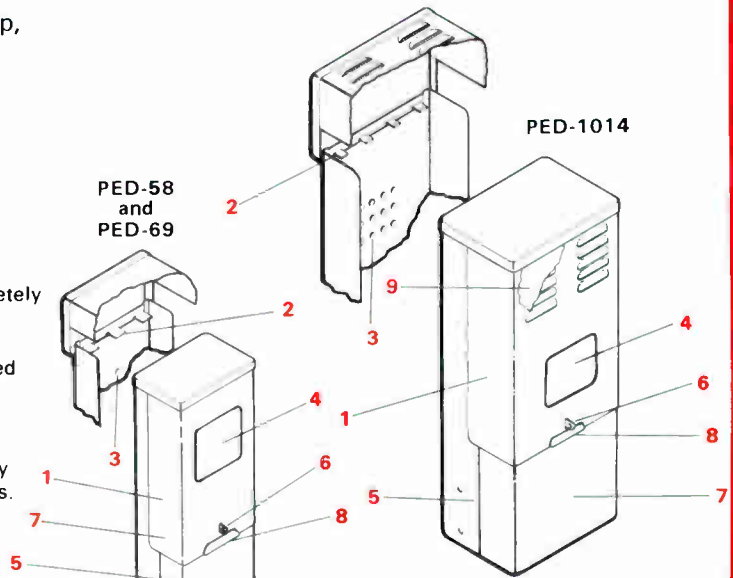

Salt tests available on request

**CWY**  
CWY Electronics  
405 N. Earl Avenue  
Lafayette, Indiana 47904-2898

Call Toll Free 1-800-428-7596  
Indiana 1-800-382-7526

regulations. If there is a major problem, for example, a legal challenge to the signals carried by the system, this could be a significant problem. Also, there is some evidence that the market price of systems located in certain states which are heavily regulated have somewhat lower selling prices. Since there is a real cost of this regulation, it would, in any case, directly infringe upon the cash flow of the system, and hence, the value to some degree. An example would be the State of Vermont, which regulates cable through the Public Utilities Commission. The PUC refuses to analyze rate increase requests based on a return on investment of a purchase price, but rather bases the increase on a return on the depreciated value of the equipment. Another example would be Hawaii, which regulates cable through a State Cable Commission. Hawaii gives preference to systems owned by Island residents and has been very hesitant to approve transfers to companies which do not have at least 50% resident ownership of the system license being transferred.

## VI

**Penetration.** If a system is "undersaturated" in relationship to similar markets or adjacent properties, or if a substantial number of customers can be added by providing new channels via microwave, satellite, etc., these are positive factors to a potential buyer. Also, it is very important to consider the marketing history of a property. If it has a low penetration and has been heavily

promoted and sold, this could indicate that the real remaining internal growth may not be attractive; hence, a lower value would be required.

## VII

**Pay Cable.** Without getting into substantial details on how one evaluates the pay cable potential of an existing property, it is mandatory to take this factor into consideration of the price of a cable TV property which has not yet implemented pay service. On a comparative basis, any new system **without** pay cable on a single tier is considerably more valuable in terms of future pay revenues than an older classic system in a rural area on a comprehensive revenue producing basis. If pay has been implemented, then one must assess the penetration, marketing history, churn factor, **real** costs of operation, capital costs, actual or potential competition from MDS, STV, number and type of services offered, etc.

## VIII

**Churn Factor.** It is my opinion that it is extremely important to examine the subscriber history of any property, its growth pattern and its "churn factor" (connects, disconnects and reconnects). A system with a high churn factor, such as a large urban market, military base, college town, resort community, etc., generally has high operating costs. It is also very important to examine the number of inactive taps and relate this to reconNECTIONS as a measure of capital costs when forecasting install capital. A high degree of churn, pay and/or basic, is a negative factor in terms of valuing a property.

## IX

**Number of Head Ends.** Considerable attention should be given to the number of head ends, both for reasons of increased operating and capital costs, and because of multiple regulatory bodies. Single head end properties are generally more valuable than multiple systems of comparable size.

## X

**Major Market vs. Classic Market.** Until 1976, major market properties, particularly those with problems and low penetration, were almost impossible to sell, except at very discounted prices — sometimes below book value. With the advent of satellite delivered channels, high acceptance of pay cable, more favorable FCC regulations, etc., as well as lower resistance to rates and tiered pricing, there has been a surge of interest, particularly on the part of MSO's. The increasing demand for attractive major market situations, in general, has made them considerably more valuable than the mature classic systems. Some buyers also perceive that the "electronic highway of tomorrow" will emerge first in the metropolitan areas.

## XI

**Size.** Generally, larger system sell at competitively higher prices than comparable smaller properties. There

# HARD TO BELIEVE?

- ⚡ A MODULATOR WITH THE MOST REQUESTED FEATURES?
- ⚡ ONE TO MEET YOUR REQUIREMENTS?
- ⚡ AUDIO PHASE-LOCKED TO VIDEO?
- ⚡ SAW FILTER BANDPASSING?
- ⚡ LOWBAND, MIDBAND AND SUPERBAND CAPABILITIES?
- ⚡ RELIABILITY AND STABILITY OF THE SAW FILTER?

ALL THIS AND QUALITY TOO?  
**BELIEVE IT!**

AND IT'S AVAILABLE  
FOR ONLY \$714<sup>00</sup> AT

**ELECTRON CONSULTING ASSOCIATES**  
VHF • UHF • MICROWAVE

TONY R. BICKEL  
P. O. DRAWER 2029  
GROVE, OKLAHOMA 74344  
(918) 786-5349



are a number of reasons for this, but there are four very basic reasons:

(A) Greater operating efficiencies may lead to a higher operating cash flow margin.

(B) Pay cable has been generally more successful in the larger properties, particularly in urban and suburban markets. Economies of scale with regard to cost, etc., result in higher profits.

(C) Larger systems are more likely to increase in relative population in terms of gross numbers of households. For example, a 10% increase in a 2,000 home system yields 200 new homes while the same 10% increase in a 20,000 home market yields 2,000 new homes.

(D) Larger systems are traditionally more densely populated and frequently urban or suburban in nature. These areas tend to be more receptive to innovative changes and consequently, would be better areas to implement new services on an economically viable basis.

## XII

**Type of Community.** It is very important to consider the socio-economic structure of the community served. Is it gaining population? Is employment strong? Is it a one-industry town? Is there a record of labor unrest, strikes, large layoffs? Does it have a base in cyclical industries? Is there a large low income population? Does the community depend heavily on seasonal income? Is it a resort, military base, university town? Is it a progressive community? Is it rural, suburban or urban in nature? What is the long-term outlook for growth, both population and economic? A realistic evaluation of the community is one of the most important factors in appraising a cable TV property. It should also be pointed out that a cable system serving an urban area is generally more valuable if the cable company also has franchises for the adjacent suburban communities and unincorporated areas. Additionally, sun belt properties (Florida, Texas, California and Arizona) are commanding much greater premiums than in other areas of the country.

## XIII

**Management and Personnel.** One of the industry's most significant current problems is the lack of qualified, experienced personnel and competent management. A great deal of attention should be given to this basic consideration. The lack of qualified and competent personnel should be given serious consideration in regard to the availability of such personnel and the time and expense of training new people. One of the most difficult tasks arising from the acquisition of a poorly managed system is overcoming the negative image in the community.

## XIV

**Contracts, Leases, Obligations.** It is imperative that any buyer carefully review, with the assistance of legal  
(continued)

# Power-Passing Splitters, Directional Couplers Power Inserters & Equalizers 5 to 400 MHz



Housing  
Dimensions  
4.80" L  
X 4.50" W  
X 2.25" H

### Features:

**Zinc die-cast housing** with excellent weather-resistant properties.  
**Stainless-steel inserts** prevent thread damage to cable entry ports and provide a shoulder for heat-shrink tubing.  
**Environmental seal and RFI/EMI integrity** provided by a Duosil gasket. **Corrosion-resistant** chromate and thermo-setting acrylic finish meets or exceeds military spec No. 5507 and the 96 hour, 5% salt-spray test. **Captive, stainless-steel bolts** on cover plate eliminate bolt-loss and prevent bolt rusting.



Three-Way Splitter  
Three-Way  
Directional Coupler



- TAPS
- FILTERS
- COUPLERS
- SPLITTERS
- SPECIAL AMPLIFIERS
- SWITCH-TRANSFORMERS

## ELECTROLINE Television Equipment Inc.

8750, 8th Avenue . St-Michel  
Montreal, Que. H1Z 2W4

or phone **collect**  
(514) 725-2471

Representatives across  
Canada and the U.S.A.

counsel, all contracts, leases, union contracts, easements, billing agreements, pension and profit sharing plans, employment agreements, pole rental contracts or any other corporate obligation.

### XV

**Litigation.** Although a purchase and sale agreement would normally contain standard warranties, covenants, indemnities, etc., their strength is only as good as the financial strength of the seller. Should any litigation be threatened or pending, it should be very carefully reviewed, even if the acquisition contemplated is to be on an asset basis.

### XVI

**Real Estate.** Very few cable television acquisitions involve a significant amount of real estate; nevertheless, if, in fact, the contemplated transaction involves real estate to any significant degree, this should be considered, in the case of an asset sale, separately. In many cases, it is more prudent to refinance the real estate using traditional financing. It is also important to obtain a separate appraisal for real property.

### XVII

**Local and State Taxes.** In analyzing any acquisition, it is necessary to carefully evaluate local and state tax laws

as may be applied to operating a cable system — personal property taxes, and ad valorem taxes, state franchise tax, sales tax on cable services, state and local corporate income taxes, property taxes on real property, sales tax on equipment, etc.

### XVIII

**Utility Relations.** In addition to carefully examining the company's agreement with utility companies, it is important to interview utility company officials to ascertain if any major public relations problems exist.

### XIX

**Political and Community Relations.** In addition to franchise considerations already discussed, poor political and community relations can be a serious problem. It is particularly difficult to reverse years of poor image, and generally, these "turnaround" opportunities take a substantial amount of time and effort. These types of situations should not be attempted unless the buyer has a substantial amount of experience and working capital to carry the company through the turnaround period.

### XX

**Financial Statements.** Obviously, one of the essential items is a careful analysis of historical and current financial data. Since there are no standard accounting

# First In Reliability

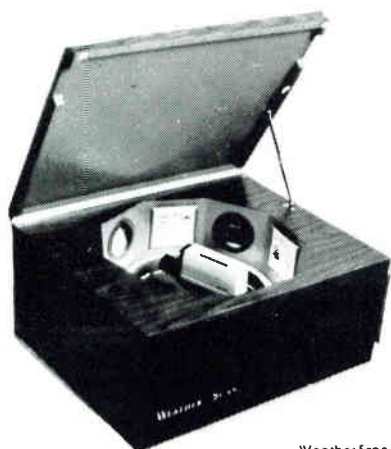

Weather Scan III

**Impressive quality . . . surprisingly low price. Just \$3295 for the most reliable unit available (at any price!).**

We have been in the cable television business for 23 years . . . and providing weather information systems for the past 16 years. We know what you need and we know how to manufacture it. For reliability and performance.

The Weather Scan III comes complete with Sony AVC-1400 camera with separate mesh vidicon and 2:1 interlace sync. Includes Time, Temperature, Barometric Pressure, Wind Velocity, Wind Direction, plus four card holders. Compact cabinet is just 28" wide, 23" deep and 14" high. For complete information call or write.



## Weather Scan, Inc.

An R.H. Tyler Enterprise

Loop 132 and Throckmorton Hwy. Olney, Texas 76374 Ph. 817-564-5688

practices in the industry, a buyer would be advised to seek the assistance of a certified public accounting firm, preferably one with experience in cable television, such as one of the "Big 8" firms, to provide technical assistance in this regard. This is particularly true if the company lacks audited statements.

There are many items of concern which could be the subject of an entire article. Some of the most basic are:

(A) **Capitalization vs. expense.** A clear understanding of the selling company's assumptions regarding these items is extremely important and critical to the ascertainment of cash flow. For example, a limited partnership or Subchapter S corporation will, no doubt, be expensing as many items as possible, while a public company may be capitalizing as much as possible to preserve losses for the future and reduce the impact of the losses on corporate earnings.

(B) **Non-operating expenses.** Many family-owned businesses in corporate form will have built-in large salaries, family autos, life insurance, director's fees, medical reimbursement plans, pension and profit sharing plans, high legal and accounting fees, "questionable" arms-length transactions and heavy travel and entertainment expenses, etc., which may not apply to a buyer.

(C) **Non-operating Revenues and Discounts.** Generally, revenues from non-operating sources, such as investment revenue, real estate leases, etc.,

are relatively easy to spot; however, it is not uncommon to find revenues from unrelated businesses, such as services provided to co-owned properties being included. This could include interest on intercompany debt, which is not uncommon in smaller MSO's.

Of equal importance is the necessity to ascertain what subscriber fee discounts are being applied, and how such discounts are being carried. The bad debt write-off policies of the company must also be carefully analyzed when examining the receivables.

(D) **Depreciation.** In the purchase of stock the buyer inherits the depreciation schedule of the company. What has been the seller's policy? In the event one is considering the purchase of assets or buying the stock with a subsequent liquidation in mind, it is really necessary to carefully examine past federal income tax returns to ascertain the true recapture.

These are simply a few of the principal items to be considered. Unless the buyer has a high degree of sophistication, as well as experience in cable television acquisitions, it would be wise to seek out professional assistance from one of the nationally recognized cable television consulting or investment banking firms. This is in addition to specialized legal and accounting assistance.

The next article in this series will examine some of the basic tax considerations involved in acquiring cable television systems and/or franchises. □

## THE SYSTEM SAVERS

*Filters from the Compleat Trapper*

### VHF - UHF CATV



1 Week Delivery

- Channel Deletion
- Channel Clean-up
- Adjacent Channel
- RF Offenders

- Co-channel
- Full Transponder Band
- Single Transponder BPF
- IF-BPF 70 MHz  
820 MHz  
1200 MHz

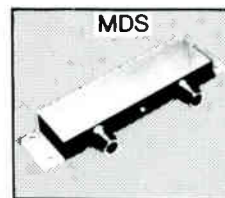

1 Week Delivery



72 Hour Delivery

Ask for CATV catalog C/80 and Earth Station catalog MTV/81.

**MFC**  
MICROWAVE FILTER COMPANY, INC.  
6743 Kinne St. East Syracuse, NY 13057



1 Week Delivery

U.S.  
Toll Free 1-800-448-1666

NY/Hawaii/Alaska/Canada  
Collect 1-315-437-3953

TWX  
710-541-0493

In Switzerland CATEC 041/23 90 56, Europe: Holland HF TRANSMISSIE TECHNIEK B.V., Telex 45046 Tel. 08385-17231  
In Canada: INCOspec, Montreal-514-322-5540, COMMUNICATIONS EQUITY, Ontario-416-495-1030, TECH COMM SALES, INC., Burnaby, B.C. V5J1E5, Tel: 604-437-6122

IF Trap Adjustment for Optimum Interference Rejection in –

# THE FILTERED EARTH STATION

By: Glyn Bostick  
Microwave Filter Co., Inc.

**More On IF Trapping . . .**

Let's return to the IF interference traps (at 60 Mhz and 80 Mhz) for the most common IF: 70 Mhz. We do this to pick up some additional pointers on installing and adjusting them for optimum performance. This additional information was developed during interference analysis on about 50 earth stations during the past few months.

**60 Mhz, 80 Mhz, or Both?**

Recall from the **August and September 1981 issues of CATJ** that these traps combat the microwave telephone carriers right in the earth station band:  $\pm 10$  Mhz relative to the center frequencies of the transponders. This  $\pm 10$  Mhz offset will be preserved in downconversion, and the interference will be seen at 60 and/or 80 Mhz at IF.

(continued)

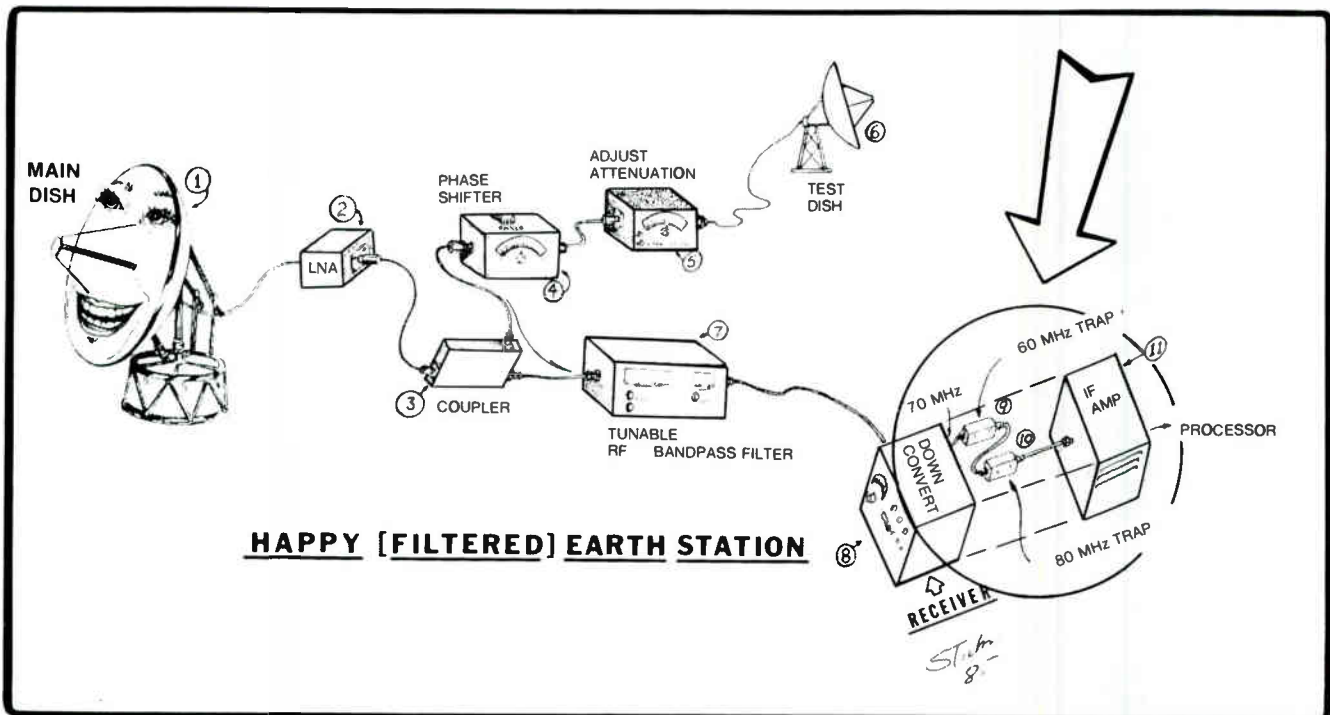

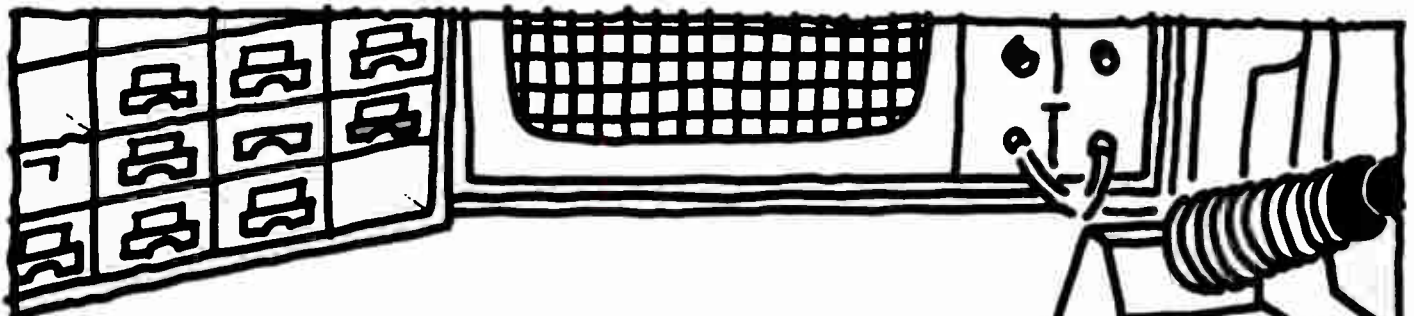

# Why do the top Cable Systems Operators have their name on our Repair List?

## Here's Why!

### EXPERIENCE

We have more of it than any other independent repair firm. In combined years it's 150.

### KNOW HOW

Our technicians are kept up to date on a scheduled training basis, both factory conducted and in-house.

### TECHNOLOGY

All repair and refurbishing is done by highly qualified technicians and engineers.

Using the latest test equipment, they can repair everything from AEL to Zenith.

We can repair your time base corrector, your spec-

trum analyzer and your video cassette recorder — it only follows that we can handle your line equipment too.

### SERVICE

We offer a multi-level service program to allow you to select the "service tailored to your needs."

- Repair any and all faults, make to meet or exceed original specifications, replace high-failure parts, add surge protection.
- Repair of any and all faults, testing and alignment to specifications.
- Repair as instructed at minimum cost and return.

ComSonics now operates TWO shifts to improve turn around time.

And for those special situations, our Field Services team will provide on site repair and FCC Testing.

### VIDEO REPAIR

We are qualified to handle B/W & color cameras, control units, video tape recorders/players, monitors, test

equipment and switcher-faders. We're also an Authorized Panasonic Repair Center.

### WARRANTY— RETURN SHIPPING

We consider the quality of our workmanship and parts worth offering you a 90-day warranty on both. Every item is returned in a sealed bag with moisture-absorbing dessicant.

### TURN AROUND

For normal repair and testing, two weeks is average, based on parts inventory of high failure items and access to those requiring less frequent replacement; TWO DAY emergency service available at extra cost.

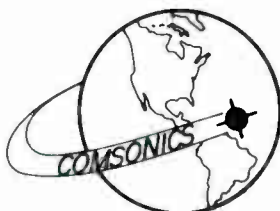

# COMSONICS<sup>®</sup>, INC.

P. O. Box 1106 Harrisonburg, Virginia 22801 (703) 434-5965  
An Employee Owned Corporation

## 1-800-336-9681

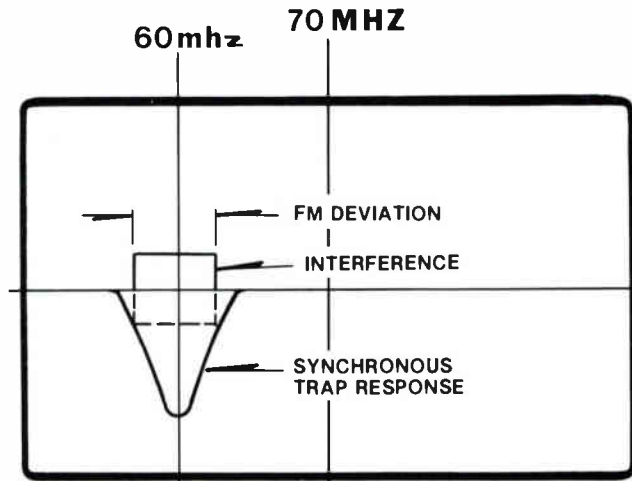

(a) Trap suppresses FM deviation

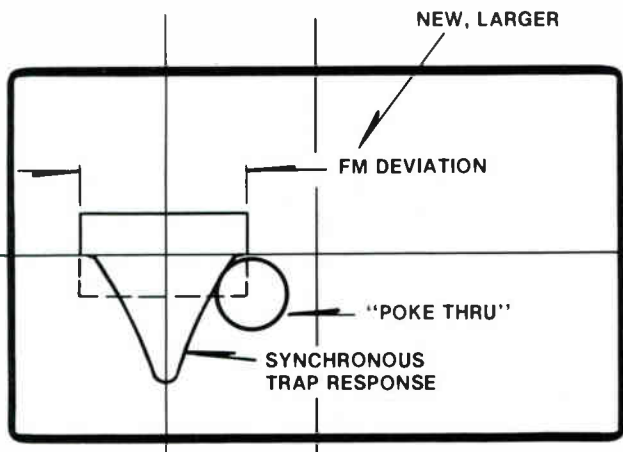

(b) Deviation widens, resulting in untrapped interference

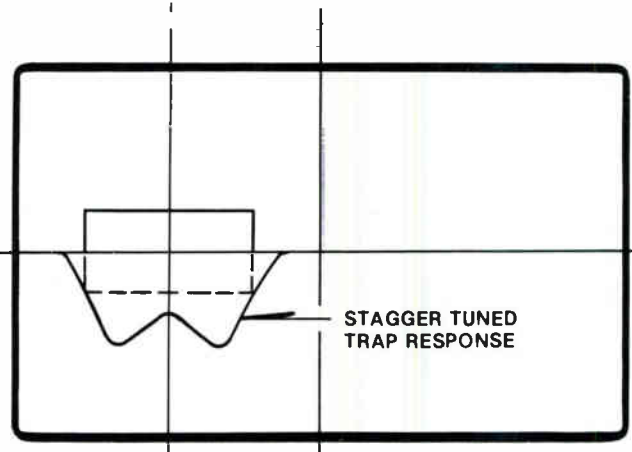

(c) Trap is stagger tuned to cover full, new deviation

FIGURE 1. Interference seen at IF. Trap stagger tuning to suppress wide FM deviations.

A nearby microwave telephone relay station may handle several frequencies (we've seen as many as six) spaced a minimum of 80 MHz apart. Polarization is usually vertical. If the interference is mild (the "sparklies" are merely a nuisance!), only odd number channels will be affected, because they are of the same polarization as the interference. For stronger interfering signals, both even and odd

channels will be affected with more trouble on the odd ones, of course.

Where only **one** interfering carrier is present, you may need only **one** trap (60 or 80 MHz): the undesired signal is always midway between an odd and even channel and is most likely to affect the odd one.

A 60 MHz, or 80 MHz trap may suffice, depending on whether the interference is + 10 MHz or - 10 MHz



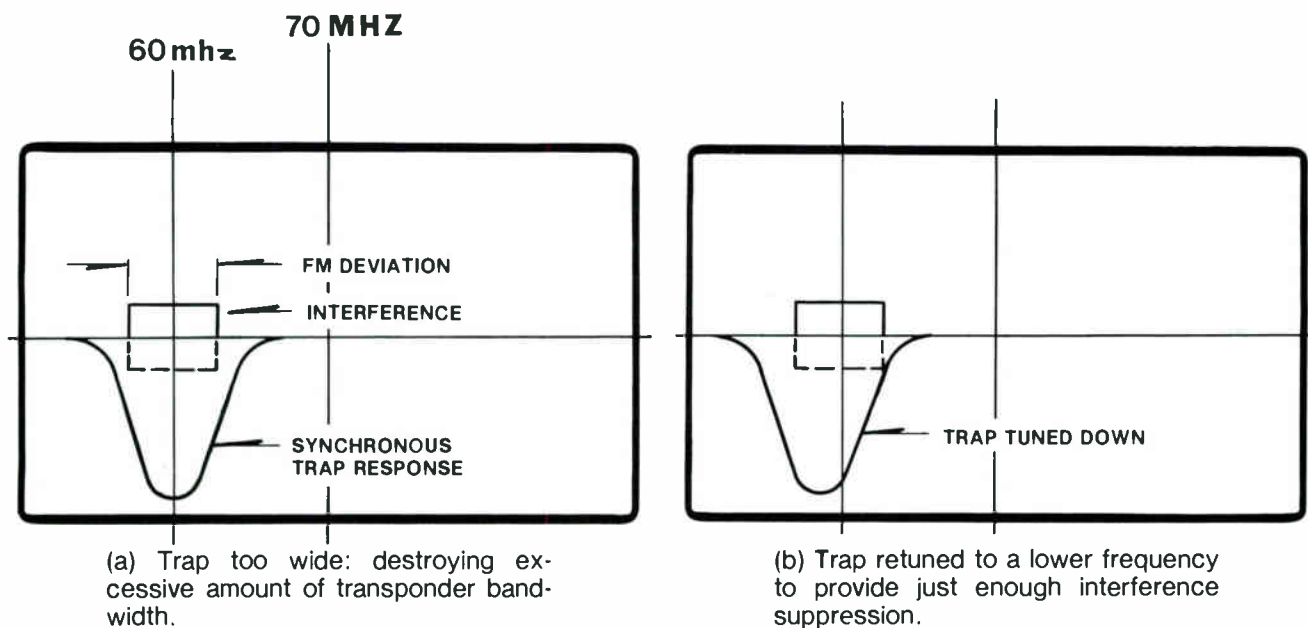

FIGURE 2. Trap retuning, to minimize spectrum destruction.

with respect to the nearest odd transponder. As the number of offending signals increase, the chances of getting away with only trap goes down. So, one should insert the traps one at a time to test the sufficiency of one trap.

Since the trap destroys a portion of your spectrum, the **fewer** you can get away with — **the better!**

In many cases of mild interference, the standard practice of inserting both 70 and 80 Mhz traps while eliminating the interference can reduce the quality more than necessary.

#### Stagger-Tuning The Trap

When traps are installed and interference is eliminated, or reduced to an acceptable level, picture clarity may deteriorate at certain times — at night particularly. This appears to be due to increased traffic on the undesired carrier at these times. Increased traffic requires a wide FM deviation, and it could be that it is breaking out of the trap envelope. If the trap branches are separately tunable, the wider FM deviation can be covered by stagger tuning the trap, as illustrated in Figure 1. This operation should be done when interference is at its worst, so you can do it once and then forget it!

#### Retune Wide Traps

Sometimes the available trap is too wide. Although it suppresses the interference, it destroys an excessive amount of transponder bandwidth. If so, the trap can be retuned (Figure 2) to provide just the amount of suppression required. This is done while watching the picture to reach the best compromise.

#### Switchable Traps

Traps in place remove a portion of your transponder bandwidth, and this decreases picture quality. While this decrease is usually acceptable on affected transponders (in lieu of the interference), it is unwelcome on other transponders, which have no interference. If possible, the traps should be arranged for easy removal (**ideally by a switch**) when tuning the receiver to channels unaffected by interference.

#### Next Installment

We'll examine the "**ABOMINABLE SNOW MAN**" — the in-band interfering signal so strong that it disables the mixer and renders traps ineffective. Some or all channels are "snowed out". So we must keep IF from reaching the down converter. **BUT HOW? That's to come!!** □

# SHOWCASE!

## SCIENTIFIC-ATLANTA INTRODUCES BROADBAND DATA MODEM FOR DISTRIBUTION OF BUSINESS COMMUNICATIONS VIA CABLE TELEVISION SYSTEMS AND 36-CHANNEL SET-TOP CONVERTER

Scientific-Atlanta, Inc., has introduced its Model 6400 Broadband Data Modem, the first in a series of business products that will launch the CATV industry into the data transmission business. The modem translates high-speed voice and data for transmission over the local cable system. Broadband cable offers businesses the advantages of lower cost and greater capacity for communication within a city. It also provides for transmission across town to the common carrier uplink for communication by satellite between cities.

The Model 6400 Broadband Data Modem is bandwidth efficient. Spectrum currently not being used for CATV entertainment can be leased by businesses to transmit and receive high-speed data. CATV systems with institutional "B" cable can now fully utilize this secondary system as a business communications network.

Unique to the 6400 Modem is its frequency agility. The customer need not specify frequency upon ordering the unit, but can manually adjust both transmit and receive frequencies at the business site.

The 6400 Modem is tailored for the CATV application and represents the first in a series of products designed by Scientific-Atlanta to facilitate the growing demand for alternative methods of distributing high-speed data.

Scientific-Atlanta has expanded its cable TV set-top product line by introducing its Model 6780 36-channel set-top converter. The new converter is designed for CATV systems with input frequencies ranging from 54 to 300 MHz. The Model 6780 converter is designed for use in systems where traps secure premium channels.

The Model 6780 converter meets FCC requirements and is UL approved. The exterior is molded plastic with dark brown, simulated woodgrain finish. It is designed to blend well into a home setting. The new converter takes an input signal ranging from 0 dBmV to +20 dBmV, with a minimum gain of 2 dB and maximum gain of 8 dB. Noise figures average less than 12.5 dB, with a maximum of 14 dB.

For additional information contact: Communications Products Group at Scientific Atlanta, One Technology Parkway, Box 105600, Atlanta, Georgia 30348; Telephone 404 441-4000.

## SCIENTIFIC-ATLANTA INTRODUCES LOW-SPEED BROADBAND DATA MODEM FOR DISTRIBUTION OF BUSINESS COMMUNICATIONS VIA CATV SYSTEMS

Scientific-Atlanta, Inc., has introduced its Model 6410 Broadband Data Modem for point-to-point data communications via cable television systems. The 6410 low-speed modem, coupled with Scientific-Atlanta's Model 6402 high-speed modem, broadens the company's line of business communications products that translate data for transmission over coaxial cable. Broadband cable offers business the advantages of low cost and greater capacity for communications within a city. It also provides for transmission across town to the common carrier uplink for communication by satellite between cities.

The Model 6410 modem enables cable operators to lease spectrum currently not being used on the entertainment network for point-to-point data communications. CATV systems with institutional "B" cable can now fully utilize this secondary system as a business communications network.

The Model 6410 Broadband Data Modem is a low-to-moderate speed modem offering superior flexibility. The modem can be manually adjusted to any data format or mode of operation the customer might require at any speed between 110 bits per second to 19.2 kilobits per second.

Scientific-Atlanta has published a comprehensive product support catalog for its cable communications products. The new 110-page catalog features descriptions and prices of replacement components, accessories, printed circuit boards and subassemblies available from S/A on an off-the-shelf delivery basis. The catalog also provides an overview of equipment rental, field services, project management, and factory and service center repairs. This catalog is available by writing to Scientific Atlanta, Inc., Box 105027, Department A/R, Atlanta, Georgia 30348. □

## DROP SHOP INTRODUCES PALADIN VOLTAGE & CONTINUITY TESTERS AND UTILITY LIGHT

The Drop Shop introduces a new line of "Paladin" voltage and circuit continuity testers. The line consists of three units: The PA 1751, PA 1752 and PA 1755.

The PA 1751 is a durable voltage tester with LED indicator which measures voltage from 6v to 440v AC or DC as polarity. The PA 1752 is a battery

operated continuity tester with LED indicator which measures up to 10 Ohms of resistance as well as voltage detection from 4.5v to 440v AC or DC. The PA

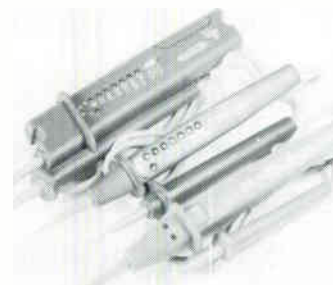

1755 continuity/voltage tester combines all the functions of far more expensive tools. This unit features continuity and voltage testing as well as an audible tone for assurance test.



Also being marketed is a hand held fluorescent utility light. The light may be carried in a vest pocket, pouch, or glove compartment and weighs only 7 ounces. The utility light with hanging strap and mounting bracket is used to throw a condensed beam of florescent light into dark narrow crawl spaces, attics, head end rooms, etc. This versatile light may be used in many other practical applications. For further information call their knowledgeable sales staff at (800) 526-4100 or call collect at (201) 241-9300.

## CATEL AND TOMCO MERGE

Catel and Tomco Communications, Inc., two leading manufacturers of processing equipment for CATV and CCTV, have been merged under the banner of United Scientific Corporation, a subsidiary of Data Design Laboratories (DDL). DDL is traded over the counter.

Tomco, founded in March, 1970 by Tom Olson, is best known for the development of standby and backup systems for CATV and Pay TV. The company was purchased by DDL in October, 1981.

Catel, started in 1968, and managed by Frank Genochio, is the leading manufacturer of equipment for the coax trans-

mission of video, audio and data using FM techniques. It has been a Division of USC since 1971.

Initially, both Catel and Tomco will market their products through a combined sales network, but retain separate brand names. □

#### HUGHES OFFERS TVRO POST AMPLIFIER FOR USE WITH 1/2-MILE-AWAY ANTENNA

A new post-amplifier, for use in satellite video receiving terminals where the TVRO antenna must be located at significant distance (up to 1/2 mile) from the receiver electronics, has been introduced by **Hughes Aircraft Company's Microwave Communications Products**.

The new unit, designated Model IFLA 463, operates over a frequency range from 950 to 1450 MHz, has 40 dB gain, and a noise figure of 5 dB. It is available as a single unit or as part of a dual/redundant panel with single or redundant power supply.

Model IFLA 463 is compatible with Hughes' Model SVR 463 receiver and other block downconversion receivers using the industry standard 1 GHz interface. Unit price of the amplifier is \$600, and delivery is from stock. For further information, including an application note, contact **Hughes Microwave Communications Products**, P.O. Box 2999, Torrance, Calif. 90509, phone (213) 517-6100. □

#### UNITED VIDEO REVEALS INNOVATIVE ELECTRONIC PROGRAM GUIDE

**United Video, Inc.** unveiled its newest satellite service **EPG—Electronic Program Guide**—for cable television, an innovative and totally unattended hour-by-hour cable television programming schedule prior to the opening of the Western Cable Convention.

The 24-hour service will be supported by local, regional and national advertising, and low-cost weekly fees to subscribing systems. New technology allows a personalized schedule for each system from a central computer located at United Video's headquarters in Tulsa, Oklahoma.

Network, local independent and specific satellite programming schedules are fed into the computer along with an individual system's origination and advertising information. The data is then relayed to United's uplink facility near Chicago and satellite transmitted to respective cable systems.

A one-piece mount demodulator and character generator provided free to

each subscribing system by United Video is the only system headend equipment required, and takes less than 30 minutes to install. The transfer of information from central computer to a cable subscriber's screen is automatic and unattended. An entire day's programming takes less than a minute to deliver to a system via satellite.

**United**, featuring more satellite services on one transponder than any satellite user, utilizes the vertical interval portion of their transponder 3 signal on RCA's Cable Network 1, (Satcom I) for uninterrupted signal delivery. Each system can be updated for local origination advertising or preemptions by calling the computer center and providing EPG personnel with information.

Network, satellite and common listings to cable systems are provided by Associates Corporations while individual system schedule requirements are gathered by **EPG** personnel allowing the computer to automatically sort and continuously provide error-free information to each system.

Program schedules appear on a viewer's screen letter-by-letter, one line at a time from the bottom, and then scroll upward. This method of presentation was found to be the most acceptable to viewers according to scientific eye movement and readability studies. Each segment of programming, such as from 5 p.m. to 5:30 p.m., appears in a contrasting color to the time slots above and below it. The **EPG** system displays the current 30 minutes and the next 2½ hours of programming every two to three minutes. The total schedule advances every 30 minutes. The primary attraction to **EPG** for cable systems is the opportunity to make a tremendous amount of money while providing an unmatched subscriber service.

Each system's schedule and advertising can be personalized. This means that local and regional advertising can appear right along with national advertisers.

**EPG** allows room for three areas of advertising. The primary area is a scrolling three-line slot that appears with the programming schedule. Ads are presented in the scroll so that the viewer automatically reads the ad as he reads the schedule. A maximum of 48 advertising slots are available per week, and each ad will appear 420 times.

One-line stationary ad spaces are available at the very top and very bottom of the screen, and can be changed on command to more readily match programming or cable system promotions.

It was explained that **EPG** already has a national sales force at work selling ads on a national basis, and will be entering regional markets as systems begin using **EPG**. Local ad sales can be covered by

the individual system or **EPG** will eventually provide assistance in that area.

If a system sells an advertising slot, it keeps 65% of the revenues, Price explained. If **EPG** sells the space, the system gets 20% of the revenues. Based on a simple inventory availability ad rate schedule beginning at \$50 for a week's slot, a system can pay for the **EPG** subscription rate with only two system-sold ads or five **EPG**-sold slots.

**EPG** will charge each system a flat rate of \$125 per week plus \$4 per channel in excess of 14 channels.

Based on selling 50% of the available time for a week, a system's annual income would be more than \$60,000, or 31¢ per subscriber per month if you had a 15,000 sub system.

Plus, a system has no equipment costs, programmers, or staff to worry about unless an advertising representative is added. This means **EPG** adds a first class system service while creating a source for new profits.

National advertisers are interested in **EPG** because they can put their message in a near subliminal concept, surround it with "demand" viewing, localize or regionalize it if needed, and at ad rates that are extremely conservative.

United Video had the **EPG** system working in test systems, at various locations, and all are successful. **EPG** marketing will be handled through United Video's marketing staff. The company also is the common carrier for and markets Chicago's SuperChannel featuring independent WGN Television, WFMT fine arts stereo radio through Satellite Music Network.

More information about **EPG** is available by calling Robert Price or Joan Rickett at United toll free 1-800-331-4806, or in Oklahoma 918-749-8811. □

#### GARDINER EXPANDS CHANNELCUE ADDS COMMERCIAL INSERTION AND ANNOUNCES LOW-COST ADDRESSABILITY

Insertion of commercial text is the newest function of Channelcue, **Gardiner Communications Corporation's** programmable video switcher, and will be available early in 1982.

"This new capability is an add-on for any Channelcue system now in service," said Clifton H. Gardiner, GCC president. "By utilizing either an existing or a new auxiliary rack, special modules and a character generator designed to access instantly any of up to 110 pages of memory, commercial messages can be inserted on time or tone command," Gardiner said.

"At the same time we introduce this

# showcase!

new feature. we are adding another auxiliary rack specifically designed for RF or IF switching. Syndicated exclusivity observance will require this capability in most cable systems."

"Channelcuc has proven its value and reliability in video switching. These additions are logical and are timed to meet the growing need for commercial insertion and to protect cable operators from copyright violations."

Gardiner is also introducing low-cost addressability for smaller cable systems, also available in 1982. This is designed for 20 channel systems with up to 10,000 subscribers and these devices do not require two-way system capability. The hardware for each subscriber will cost less than \$40. The computer control can be configured to provide billing and accounting functions. Individual access to any of the eight mid-band channels can be controlled for individual subscribers. Special events can be programmed on a pay-per-view basis, and the entire converter can be turned on and off.

For more information on the above new services and products from Gardiner, contact them at 1980 South Post Oak Road, Suite 2040, Houston, Texas 77056 or call (713) 961-7348. □

## STATION BUSINESS SYSTEMS INTRODUCE NEW "COLLECTION" FEATURE

Credit managers at cable TV companies can now have greater control over delinquent subscriber accounts thanks to an exciting, new computer capability that was introduced at the Western Cable Show recently. The new "Collections/Write-Off" module will be offered as an option to the Subscriber Business System 2000, Station Business System's automated management reporting and control product for cable television operators.

The highly flexible new system takes over where routine computerized accounts receivable functions leave off by alerting credit managers to subscriber accounts that are seriously overdue, and by recommending an appropriate action for each account. These actions are steps that can be taken to generate payment; for example, a dunning notice, a phone call, or a disconnect order. The cable operator determines both the specific actions and the criteria that apply to each.

The system maintains records of all collection actions that are taken for any subscriber and, should an amount prove to be uncollectable, the credit manager can automatically generate the necessary transactions to write-off the

amount in the accounts receivable system. All details are stored in a special write-off file and, should a subscriber attempt to re-order service, a warning will flash automatically on the terminal screen during the order entry process.

Station Business Systems, a division of the Control Data Corporation, also provides billing, accounting and traffic systems and a computerized newsroom system to the broadcasting industry. For more information contact Station Business Systems at 600 West Putnam, Greenwich, Connecticut 06830 or call (203) 622-2400. □

## GENERAL CABLE INTRODUCES 11.5mm (.450") FUSED DISC® M-III COAXIAL CABLE

General Cable Company, a division of GK Technologies, Incorporated, today announced the introduction of a new size coaxial cable for the cable television industry. This latest addition is 11.5mm (.450") Fused Disc M-III coaxial cable. In mid-1981, General Cable Company's CATV Division developed the advanced Fused Disc M-III product line, featuring metric sizing and 450 MHz bandwidth. M-III cables, applied in aerial, buried and submarine environments, are now available in the new 11.5mm (.450") size, as well as in 13.0mm (.500"), 14.5mm (.570"), 16.5mm (.660"), 19.0mm (.750") and 25.0mm (1.00") sizes.

In regard to the new cable and compared with competitive designs, **Fused Disc M-III** cables offer a significant cost-cutting choice, thus reducing system cost. Cables of equivalent size and cost can be selected to achieve a performance-edge in amplifiers, power supplies and operating cost; smaller cables that cost less and are electrically equivalent to competitive designs can also be selected. These cables can plug into existing system designs without modification. Most important, you can gain a cost edge on cable and connectors. The new 11.5mm (.450") size is designed for present users of competitive .500" cables.

11.5mm (.450") cables are available for immediate delivery. These cables will be offered in a full range of bare, jacketed and armored constructions.

In addition to General Cable's diversified lines of wire, cord, cable and associated installation and maintenance equipment, GK Technologies manufactures and sells electronic and electric circuit components through its Sprague Electric Company subsidiary. For more information, contact **General Cable** at (201) 636 5500 or CATV Division, Woodridge Center, Woodridge, N.J. 07095.

## SADELCO ANNOUNCES SECOND GENERATION DIGITAL SIGNAL LEVEL METERS

Sadelco is introducing its second generation of Digital Signal Level Meters. The **Model Digit-Level-200** features a dual tuner system; one VHF and one Super-Band tuner, each operated independently. The extra large LED, three digit readout is combined with a complimentary analog meter which provides the user with fast and accurate signal information.



The DL-200 Series feature  $\pm 1$  dB accuracy, a programmed attenuator, 0.1 dB resolution, a built-in speaker, an automatic electronic shut-off and ni-cad battery/AC operation (adaptor-charger included).

Two models are available, the DL-200-VS (VHF/Superband) and the DL-200-VU (VHF/UHF). The DL-200-VS has 450 MHz -60 Channel capability. An optional adaptor is available for the 5 - 45 MHz portion of the spectrum. These units are lightweight, portable and are housed in a deluxe foam filled carrying case.

For additional information please contact: **Sadelco Inc.**, 75 West Forest Avenue, Englewood, N.J. 07631 (201) 569-3323. □

## BELDEN INTRODUCES NEW DUOBOND PLUS™ CATV DROP CABLES

A new line of CATV drop cables, called Duoband Plus™, has been introduced by **Belden Corp.'s Electronic Division**. The three-shield 75-ohm design offers improved shield effectiveness values over a 5-450 MHz range, assuring higher levels of protection against interference and

leakage than other drop cable configurations presently available.

Comparative tests indicate that Duobond Plus drop cables are superior to competitive foil/braid/foil/braid configurations, and achieve shielding performance suitable for use in high-density multi-channel TV reception areas where EMI/RFI problems are most severe. All Duobond Plus cables are 100% sweep tested with a minimum return loss of 23 dB for RG-59 types and 26 dB for RG-6 types. High shielding effectiveness also helps CATV systems comply with FCC signal leakage regulations.



The new shield design incorporates 1) an aluminum foil-polyester film bonded directly to the cellular polyethylene dielectric, 2) a medium- to high-coverage aluminum braid, and 3) an outer Aluminum foil shield specially folded to form a closed conductive layer around the two interior shields.

The Duobond Plus line covers 16 styles in Rg-59/U-type, RG-6/U-type, and RG-11/U-type configurations. Braid shield coverage includes 67%, 77%, and 95% options for RG-59; 60%, 77%, and 95% for RG-6, and 77% for RG-11. Messengered versions as well as flooded burial constructions (59/U-type and 6/U-type) also are available.

Jacket material is black PVC, with black polyethylene used in flooded burial constructions. All use standard F connectors, available off the shelf, for quick termination and installation.

Standard one-piece putups are 1,000 ft. including a selection of non-messengered styles packaged in Belden's Unreel® dispenser carton.

For additional information, write Sales Manager, CATV Products, Belden Corp., P.O. Box 1980, Richmond, Ind. 47374.

#### NEW FROM COMSONICS, INC.

ComSonics now offers a "Modular System" of Coaxial Switching Relays. Carefully selected purchasing of this improved format allows you to build and expand your systems switching capability to meet the demands of your particular system. Constructed of quality components to exacting technical standards, each relay uses highly reliable RF Coaxial Reed Assemblies. Reliable performance is provided by PC Board design.

#### THE STANDARD COAXIAL RELAY

This basic unit is triggered by command switching voltage and permits selective interconnecting for maximum channel allocation, eg, the sharing of one channel among multiple programming sources. From this point you begin building the relay to the specs and demands of your system.

#### THE VIDEO SENSING RELAY

(Standard with Video Sync Sensor added)

The model VSCR automatically manipulates switching of baseband video signals which can originate from a variety of sources. The VSCR will provide your system with automatic back-up video signal insertion and/or channel pre-empting. But you can build your switching capability further yet.

#### THE RF SENSING RELAY

(Standard with RF/IF Sensor added)

This unit like the others extends to a frequency of 450MHz. Sensing video modulated signals, it can provide automatic RF/IF and Video switching capability. Sensing of signal change due to carrier or modulation signal completion or failure, it switches between PRIMARY and SECONDARY input ports. The sig-

nals may original from any of several sources. Each relay offers proven reliability, flexibility and performance. They feature High Isolation and the passive design eliminates third order distortion.

In addition, ComSonics offers:

- (1) a Carrier Modulation Sensor - a unit which will indicate presence or failure of TV modulated carrier; or TV modulation signal (on the carrier);
- (2) a Video Sync Sensor - the unit will sense video presence or failure;
- (3) a Power Supply - a rack mounted type (12 or 24Vdc) which will power and allow for the mounting of several relays.

**HBO  
LAUNCHES 24-HOUR DAILY FORMAT  
IN 1982 WITH MORE CHILDREN'S  
AND ORIGINAL PROGRAMMING,  
SPORTS, AND MOVIES.**

Beginning in January 1982, Home Box Office will unveil its 24-hour-a-day, seven-day-a-week schedule, which will include more ambitious sports and original programming and differentiation of major motion picture titles.

In the early morning hours, when there is a large children's audience the programming will feature attractions appealing to that age group. In addition to a wide roster of family-type movies, HBO will present four new 13-part half-hour serials and a lineup of half-hour features aimed at the children's market.

The children's series will include adventure serials and provide a variety of quality family entertainment featuring stories of exciting international scenes.

In addition to the above, HBO will expand its documentary series with the development of four subjects. MONEY MATTERS, THAT FABULOUS YEAR, WHAT ON EARTH? and FLASHBACK. All these represent the continuing effort to present informational programming in an entertaining format.

# Happy New Year 1982

# ASSOCIATE ROSTER

Alpha Technologies, 1305 Fraser St. D-G, Bellingham, WA 98225 (M9, Standby Power Supplies) 206—671-7703  
AMCOM, Inc., Bldg. E, Suite 200, 5775 Peachtree-Dunwoody Rd., N.E., Atlanta, GA 30342 (S9, Brokering & Consulting) 404—256-0228  
Anixter-Pruzan, Inc., P.O. Box 88758, Tukwila Branch, Seattle, WA 98188 (D1) 206—251-6760  
The Associated Press, 50 Rockefeller Plaza, New York, NY 10020 (S9 Automated News SVC) 212—262-4014  
B E I (Beston Electronics, Inc.), P.O. Box 937, Olathe, KS 66061 (M9 Character Generators) 913—764-1900  
Belden Corp., Electronics Division, P.O. Box 1980, Richmond, IN 47374 (M3) 317—966-6661  
Broadband Engineering, Inc., P.O. Box 1247, Jupiter, FL 33458 (D9, replacement parts) 1-800-327-6690  
Broadcast Equipment Leasing, 7 Wood Street, Pittsburgh, PA 15222 (S3), 412—765-0690  
Budco, Incorp., 4910 East Admiral Place, Tulsa, OK 74115, (D9, Security & Identification Devices), 800-331-2246  
CATEL-Division of United Scientific Corp., 1400-D Stierling Rd., Mountain View, CA 94043, 415—969-9400  
C-COR Electronics, Inc., 60 Decibel Rd., State College, PA 16801 (M1, M4, M5, S1, S2, S8) 814—238-2461  
CBS Cable, 1211 Avenue of the Americas, 2nd Floor, New York, NY 10019 (S4) 212—975-1766  
CCS Hatfield/CATV Div., 5707 W. Buckeye Rd., Phoenix, AZ 85063 (M3) 201—272-3850  
CRC Electronics, Inc., 2669 Kilihau St., Honolulu, HI 96819 (M9 Videotape & Headend Automation Equipment) 808—836-0811  
CWY Electronics, 405 N. Earl Ave., Lafayette, IN 74904 (M9, D1) 317—447-4617  
CableBus Systems Corporation, 7869 S.W. Nimbus Avenue, Beaverton, OR 97005, (M1) 503—543-3329  
Cable TV Supply Company, 5933 Bowcroft Street, Los Angeles, CA 90016 (D1, D2, D3, D4, D5, D6, D7, D8, M5, M6) 213—204-4440  
Century III Electronics, Inc., 3880 E. Eagle Drive, Anaheim, CA 92807 (M1, M3, M4, M5, M7, M8, S1, S2, S8) 630-3714  
Capscan, Inc., P.O. Box 36, Adelphia, NJ 07710, (M1, M3, M4, M5)  
Channel Master, Div. of Avnet, Inc., Ellenville, NY 12428 (M2, 3, 4, 5, 6, 7) 914—647-5000  
Collins Commercial Telecommunications, MP-402-101, Dallas, TX 75207 (M9, Microwave) 214—690-5954  
Comm/Scope Company, Rt. 1, Box 199A, Catawba, NC 28609 (M3) 704—241-3142  
Communications Equity Associates, 651 Lincoln Center, 5401 W. Kennedy Blvd., Tampa FL 33609 (S3) 813—877-8844  
Communications Supply/Communications Construction, Inc., 319 J Westtown Rd., P.O. Box 1538, West Chester, PA 19380, (D1, 3, 4, 5, 6, 7, 8, 9, S1, 2, 8, 9) 800—345-8286  
Compucon, P.O. Box 401229, Dallas, TX 75240 (S8, S9-CARS-Band Planning, Earth Station Site Selection and Coordination) 214—233-4380  
Computer Video Systems, Inc., 3678 W. 2105 S. Unit 2, Salt Lake City, UT 84120 (M9) 801—974-5380  
ComSearch Inc., 7633 Leesburg Pike, Falls Creek, VA 22043 (S8, S9, Earth station placement frequency coordination) 703—356-9470  
ComSonic, Inc., P.O. Box 1106, Harrisonburg, VA 22801 (M8, M9, S8, S9) 703—434-5965  
DF Countryman Co., 1821 University Ave., St. Paul, MN 55104 (D1, S1, S8) 612—645-9153  
Davco, Inc., P.O. Box 861, Batesville, AR 72501 (D1, S1, S2, S8) 501—793-3816  
Ditch Witch, P.O. Box 66, Perry, OK 73077, (M9), 405—336-4402  
The Drop Shop Ltd., Inc., Box 284, Roselle, NJ 07203 (M9, Plastics, D5, 6, 7) 201—241-9300  
Durnell Engineering Inc., Hwy 4 So. Emmetsburg, IA 50536 (M9) 712—852-2611  
Eagle Com-Tronics, Inc., 4562 Waterhouse Rd., Clay, NY 13041 (M9 Pay TV Delivery Systems & Products) 313—622-3402 and 800-448-7474  
Eales Comm & Antenna Serv., 2904 N.W. 23rd, Oklahoma City, OK 73107 (D1, 2, 3, 4, 5, 6, 7, S1, 2, S7, 8) 405—946-3788  
Eastern Microwave, Inc., 3 Northern Concourse, P.O. Box 4872, Syracuse, NY 13221 (S4) 315—455-5955  
Electroline TV Equipment, Inc., 8750-8th Ave., St. Michel, Montreal, Canada H1Z 2W4 (M4, 5, 7, 9, D7, 9) 514—725-2471  
Electron Consulting Associates, Box 2029, Grove, OK 74344, (M2, D1, S1, 8) 918—786-5349  
Entertainment and Sports Programming Network, 319 Cooke St., Plainville, CN 06062 (S9) 203—747-6847  
Ferguson Communications Corp., P.O. Drawer 1599, Henderson, TX 75652 (S1, 2, 7, 8, 9) 214—854-2405  
Franey & Parr of Texas, Inc., (Formerly Doherty & Co.), One Turtle Creek Village, Suite 524, Dallas, TX (S9, Insurance) 214—528-4820  
GTE Products Corp., Sylvania CATV Trans. Systems, 10841 Pellicano Dr., El Paso, TX 79935 (D7, M4, M5, M6, S4, S8) 800—351-2345  
Gardiner Communications Corp., 1980 S. Post Oak Rd., Suite 2040, Houston, TX 77056 (M9 TVRO Packages, S1, S2, S8) 713—961-7348  
General Cable Corp., 1 Woodbridge Center, P.O. Box 700 Woodbridge, NJ 07095 (M3) 201—636-5500  
Gilbert Engineering Co., P.O. Box 23189, Phoenix, AZ 85063 (M7) 1-800-528-5567, TWX 910-951-1380  
Harris Corporation-Satellite Communications Division, P.O. Box 1700, Melbourne, FL 32901 (M2, M9, S2) 305—724-3401  
Heller-Oak Communications Finance Corp., 105 W. Adams St., Chicago, IL 60603 (S3) 312—621-7661  
Hoarty & Raines Assoc., Inc., 8637 O'Neal Rd., Raleigh, NC 27612 (S7, S9 Consultants) 919—781-1734  
Home Box Office, Inc. 7839 Churchill Way—Suite 133, Box 63, Dallas, TX 75251 (S4) 214—387-8557  
Hughes Microwave Communications Products, 3060 W. Lomita Blvd., Torrance, CA 90505 (M9) 213—517-6233  
Jerry Conn Associates, Inc., P.O. Box 444, Chambersburg, PA 17201 (D3, D4, D5, D6, D7, D8) 717—263-8258  
KMP Computer Services, Inc., 555 Totavi, Los Alamos, NM 87544, (S4, 5) 505—662-5545  
Karnath Corporation, 2001 Westridge, Plano, TX 75075 (S1, 2, 8, 9) 214—422-7981 or 7055  
Katek, Inc., 134 Wood Ave., Middlesex, NJ 08846 201—356-8940  
Klungness Electronic Supply, P.O. Box 547, 107 Kent Street, Iron Mountain, MI 49801 (D1, D8, S2, S8) 906—774-1755  
LRC Electronics, Inc., 901 South Ave., Horseheads, NY 14845 (M7) 607—739-3844  
Larson Electronics, 311 S. Locust St., Denton, TX 76201 (M9 Standby Power) 817—387-0002  
Lemco Tool Corporation, Box 330A, Cogan Station, PA 17728 (M6, 9 Tools) 717—494-0620

| Distributors                | Manufacturers               | Service Firms             |
|-----------------------------|-----------------------------|---------------------------|
| D1—Full CATV equipment line | M1—Full CATV equipment line | S1—CATV contracting       |
| D2—CATV antennas            | M2—CATV antennas            | S2—CATV construction      |
| D3—CATV cable               | M3—CATV cable               | S3—CATV financing         |
| D4—CATV amplifiers          | M4—CATV amplifiers          | S4—CATV software          |
| D5—CATV passives            | M5—CATV passives            | S5—CATV billing services  |
| D6—CATV hardware            | M6—CATV hardware            | S6—CATV publishing        |
| D7—CATV connectors          | M7—CATV connectors          | S7—CATV drop installation |
| D8—CATV test equipment      | M8—CATV test equipment      | S8—CATV engineering       |
| D9—Other                    | M9—Other                    | S9—Other                  |

Lester Kamin & Company, 2020 North Loop West, Suite 111, Houston, TX 77018 (S9 Brokers, Consultants) 713—957-0310  
Lindsay Specialty Products, Ltd., 50 Mary Street West, Lindsay, Ontario, Canada, K9V 4S7 (M1, 2, 4, 5, 7, 9) 705—324-2196  
Magnavox CATV Division, 100 Fairgrounds Drive, Manlius, NY 13104 (D4, 5, 7, M4, 5, 6, 7, S3, 8) 315—682-9105  
McCullough Satellite Systems, P.O. Box 57, Salem, AR 72576 (M2, 9, D3, 4, 6, 7) 501—895-3167  
Microdyne Corporation, 471 Oak Road, Ocala, FL 32672 (M9 Satellite TV Receivers) 904—687-4633  
Microwave Associates Communications Co., 777 S. Central Expwy., Suite 1G, Richardson, TX 75080 (M9 Microwave Radio Systems) 214—234-3522  
**Microwave Filter Co.**, 6743 Kinne St., Box 103, E. Syracuse, NY 10357 (M5 Bandpass Filters) 315—437-4529  
Midwest Corp., CATV, Divn., P.O. Box 226, Clarksburg, W. VA. 26301 (D1, 2, 3, 4, 5, 6, 7, 8) 304—624-5459  
Miralite Corp., 1012 Brioso, Suite 201, Costa Mesa, CA 92627 (M2) 714—851-9000  
Modern Cable Programs, 5000 Park St. N., St. Petersburg, FL 33709 (S4)  
National Com-Service, Inc., 2255-E Wyandotte Rd., Willow Grove, PA 19090 (D1, 2, S8, 9 repair service) 215—657-4690  
National Screen Service Corp., 1600 Broadway, New York, NY 10019 (M9) 212—246-5700  
North Supply Company, 10951 Lakeview Ave., Lenexa, KS 66219 (D1, 2, 3, 4, 5, 6, 7, 8) 913—888-9800  
Northern CATV Sales, Inc., 115 Twin Oaks Dr., Syracuse, NY 13206 (D1) 315—463-8433  
Oak Industries Inc/CATV Div., Crystal Lake, IL 60014 (M1, M9 Converters, S3) 815—459-5000  
Power and Telephone Supply Company, Inc., 530 Interchange Drive N.W., Atlanta, GA 30336 (D1) 404—691-6813  
Prodelin, Inc., 1350 Duane Avenue, Santa Clara, CA 95050 (M2, M3, M7, S2) 408—244-4720  
Pyramid Industries, Inc., P.O. Box 23169, Phoenix, AZ 85063 (M7, 8) 602—269-6431  
Q-BIT Corporation, P.O. Box 2208, Melbourne, FL 32901 (M4) 305—727-1838  
**RMS CATV Division**, 50 Antin Place, Bronx, NY 10462 (M4, M5, M6, M7, M9), 212-892-1000  
Reuters, 1212 Avenue of the Americas, 16th Floor, New York, NY 10036 (D9) 212—730-2715  
Rockwell International, Collins Transmission Systems Division, M.S. 402-101, Dallas, TX 75207 (M9, Microwave/Satellite) 214—996-5954  
S.A.L. Communications, Inc., P.O. Box 794, Melville, NY 11747 (D1) 516—694-7110  
Sadelco, Inc., 75 West Forest Ave., Englewood, NJ 07631 (M8) 201—569-3323  
Scientific Atlanta Inc., 3845 Pleasantdale Rd., Atlanta, GA 30340 (M1, M2, M4, M8, S1, S2, S3, S8) 404—449-2000  
Shafer Associates, Inc., 9501 Briar Glen Way, Gaithersburg, MD 20760 (S9, consultant) 301—869-4477  
Showtime Entertainment Inc., 1633 Broadway, NY 10019 (S4) 212—708-1600  
Sky Skamp, Box 277, Riceville, IA 50466 (M9) 515—985-2078  
Southern Satellite Systems, Inc., P.O. Box 45684, Tulsa, OK 74145 (S9) 918—481-0881  
Station Business Systems, 600 West Putnam, Greenwich, CT 06830 (S4, 5, 9) 203—622-2400  
T.E.S.T., Inc., 16130 Stagg St., Van Nuys, CA 91409 (M9 Encoders & Decoders) 213—989-4535  
TV Guide, Radnor, PA 19088 (D9) 215—293-8500  
TV Tempo, P.O. Box 5443, Athens, GA 30604 (S9, Program Guide) 404—546-8458  
TeleCom Systems, Inc., P.O. Box 5214, Charlotte, NC (S1, 2, 7, 8, 9) 704—332-6064  
Tele-Wire Supply Corp., 122 Cutter Mill Rd., Great Neck, NY 11021 (D1, 2, 3, 5, 6, 7, 8, 9) 516—829-8484  
**Texscan Corp.** 2446 N. Shadeland Ave., Indianapolis, IN 46219 (M8 Bandpass Filters) 317—357-8781  
**Theta-Com CATV**, Division of Texscan Corporation, 2960 Grand Avenue, Phoenix, AZ 85061 (M1, M4, M5, M7, M8) 602—252-5021  
**Times Wire & Cable Co.**, 358 Hall Avenue, Wallingford, CT 06492 (M3) 203—265-2361  
Tocom, Inc., P.O. Box 47066, Dallas, TX 75247 (M1, M4, M5, Converters) 214—438-7691  
Tomco Communications, Inc., 1145 Tasmin Dr., Sunnyvale, CA 94086 (M4, M5, M9)  
**Toner Cable Equipment, Inc.**, 969 Horsham Rd., Horsham, PA 19044 (D2, D3, D4, D5, D6, D7) 800—523-5947, In Penna. 800—492-2512  
Triple Crown Electronics Inc., 42 Racine Rd., Rexdale, Ontario, Canada, M9W 2Z3 (M4, M8) 416—743-1481  
Turner Communications Corp. (WTBS-TV) 1050 Techwood Dr., Atlanta, GA 30318 404—898-8500  
USA Network, 208 Harristown Rd., Glen Rock, NJ (S4) 201—445-8550  
United Press International, 220 East 42nd St., New York, NY 10017 (S9 Automated News Svc.) 212—682-0400  
United States Tower & Fab Co., P.O. Drawer "S", Afton, OK 74331 (M2, M9) 918—257-4257  
United Video, Inc., 5200 S. Harvard, Suite 4-D, Tulsa, OK 74135 (S9) 918—749-8811  
VU-TV, Inc., 4201 N. 16th St. #250, Phoenix, AZ 85016 (S4) 602—277-8888  
Van Ladder, Inc., P.O. Box 1557, Spencer, IA 51301 (M9, Automated Ladder Equipment) 712—262-5810  
Video Data Systems, 40 Oser Avenue, Hauppauge, NY 11787 (M9) 516—231-4400  
Vitek Electronics, Inc., 4 Gladys Court, Edison, NJ 08817 201—287-3200  
Warner Amex Satellite Entertainment Corporation, 1211 Avenue of the Americas, New York, NY 10036, (S4) 212—944-4250  
**Wavetek Indiana**, 66 N. First Ave., Beech Grove, IN 46107 (M8) 317—783-3221  
Weatherscan, Loop 132, Throckmorton Hwy., Olney, TX 76374 (D9, Sony Equip. Dist., M9 Weather Channel Displays) 817—564-5688  
Western Communication Service, Box 347, San Angelo, TX 76901 (M2, Towers) 915—655-6262/653-3363  
Winegard Company, 3000 Kirkwood Street, Burlington, IA 52601 (M1, M2, M3, M4, M5, M7) 319—753-0121

Note: Associates listed in bold are Charter Members.

# classycats

Classy-Cat advertising is offered as a service by CATA for its membership. ANY member of CATA may advertise in the Classy-Cat section FREE of CHARGE (limit of 50 words per issue - 3 issues per year.)

- CATA offers three types of memberships:
- 1.) Systems - paying regular monthly dues based on number of system subscribers.
  - 2.) Associate Members - pay an annual fee.
  - 3.) Individual Members - pay an annual fee.

NON MEMBERS may also use the Classy-Cat section at the rate of 50 cents per word with a minimum charge of \$20.00. Add \$2.00 for blind-box. Non-members should include full payment with the ad insertion.

Deadlines for all Classy-Cats is the 1st of the month for the following month's issue.

Address all Classy-Cat material to: CATJ, Suite 106, 4209 NW. 23rd, Oklahoma City, Okla. 73107.

**JIM YOUNG & ASSOCIATES, INC.**  
Leader In The Placement Of  
Cable Television Professionals

Needed Immediately Engineers, Chief Technicians, Technicians and System Managers for permanent assignments. Located in sunbelt.

JIM YOUNG & ASSOCIATES, INC.  
P.O. BOX 79089  
FT. WORTH, TEXAS 76179  
IN TEXAS CALL (817) 236-7187

## IRS TAX TIPS

### For Working Couples

■  
If you pay for the care of your children or disabled dependents so you can work, you may be able to claim a tax credit of up to \$800. See free IRS Publication 503, *Child and Disabled Dependent Care*.

■  
If you paid for insulation or other energy-saving devices in your home, you may be able to claim a credit for these expenses. See IRS free Publication 903, *Energy Credits for Individuals*.

■  
If either you or your spouse held more than one job during the year and either of you earned more than \$29,700, you may have paid too much Social Security tax which can be applied to the income tax you owe.

A public service message from  
the Internal Revenue Service

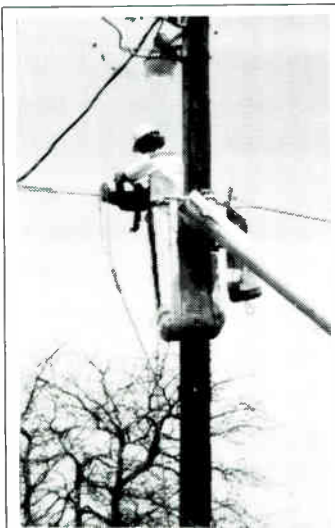

## ATTENTION!

### SYSTEM MANAGERS — TECHNICIANS NEEDED

Excellent opportunity for system managers and technicians for our systems in Colorado, Texas, and Oklahoma. Need qualified personnel for these Southwestern locations; good working conditions and opportunity for the right people who want to work and stay actively involved in the cable business. These systems have good equipment to work with and offer excellent situations to grow in the cable business. If interested, send resume to the box number indicated below.

Box 71080  
c/o CATJ  
4209 N.W. 23rd  
Suite 106  
Okla. City, OK 73107

## All You Should Know About SLM's...

...Is covered completely in the new NCTI 28-minute Video Cassette, **Signal Level Meters: Use, Care and Maintenance**. Train on the job about the purpose, design, use and care of SLM's. Write today for full information on this effective new educational tool.

**NATIONAL CABLE  
TELEVISION INSTITUTE** P.O. Box 27277  
Denver, CO 80227  
(303) 697-4967

## A great way to spread the word

Good news travels fast when you advertise in the Classifieds! It's the best way to get your message to the right person



# ADD UNLIMITED PAY CHANNELS TO YOUR SYSTEM WITHOUT LOSING YOUR INVESTMENT IN CONVERTERS.

## Now, That's The Ticket!



If you're like most cable systems, you've spent almost \$225,000 on converters. Don't throw away that investment! With Eagle's Descrambler, you can add 15 tiers of service and unlimited channels to your system using your present converter.

### Write Your Own Ticket!

Whether you're adding one pay channel, 15 pay channels, or 15 tiers of service with 120 channels, Eagle's Descrambler can handle it all. Select only what you need. In the future, channels can be added to the headend scrambler with our simple plug-in module. The headend unit integrates with all manufacturer's modulators and processors and is compatible with all Standard/HRC/ICC configurations.

### The Best Show In Town

Eagle's Descrambler is compatible with all single channel output converters and is factory tuned for channel 2, 3, or 4. The descrambler

has no information on the audio making it ideal for AML transmission.

### Private Audiences Only

There are no subscriber controls with Eagle's Descrambler and our unique sync suppression scrambling insures maximum security. In addition, we've developed a tamperproof identification matrix to eliminate concerns about theft of service.

### Future Attraction

Addressability? It's coming. Eagle's Descrambler will be ready for addressability when you are . . . and the descrambler will be perfectly compatible with our addressable unit. Across the board, we're working to protect your investments.

Add pay channels . . . maximize your converter investment . . . prepare for addressability . . . Eagle's 15 Tier Descrambler. Now, That's The Ticket!



OFFICE ADDRESS: 4562 Waterhouse Road, Clay, N.Y. 13041 (315) 622-3402  
 MAIL ADDRESS: P.O. Box 2457, Syracuse, N.Y. 13220  
 IN CANADA: Deskin Sales • Montreal • Toronto • Vancouver (416) 495-1412  
 77D Steelcase Road West, Markham, Ontario L3R2M4

CALL TOLL FREE TO ORDER World Radio History 800-448-7474

