

**Pay Radio**

Canada considers subscription radio services, including Eureka-147 terrestrial broadcasting.

Page 17

**Six for 6 Million**

Six watts of IBOC for 6 million people? KPCC(FM) and NPR wondered if it was possible.

Page 8

# Radio World



\$2.50

The Newspaper for Radio Managers and Engineers

August 11, 2004

**INSIDE**

**HD RADIO**

▼ Robert Reams on 5.1 implementation in the real world.

Page 12



**ENGINEERING**

▼ Supply Side: Pulsecom PCAU.

Page 19

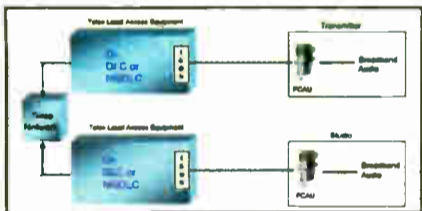

▼ Fun and learning with codecs.

Page 20

**STUDIO SESSIONS**

▼ Star Case: U-build-'em studio racks.

Page 31



**OPINION**

▼ Alan Heil Jr. says a congressional investigation of the IBB and its oversight of VOA is overdue.

Page 16

▼ Frank McCoy asks why not give listeners the option of uncensored digital?

Page 38

## Someone Out There Is Listening

*Verification Technology Springs Up to Serve Advertisers, PDs, Licensing Groups*

by Randy J. Stine

**BERWYN, Pa.** The monitoring companies at the forefront of bringing "audio watermark" and "digital fingerprint" technology to new applications in broadcast say their spot verification processes are replacing older manual methods and that broadcasters and advertisers will benefit from using their media tracking services.

However, more-accurate spot detection will place pressure on radio traffic departments to improve reporting and eliminate discrepancies, advertising industry sources say.

Most radio networks and major advertisers at one time relied exclusively upon affiliate commercial clearance reports or costly, labor-intensive manual methods for spot verification. But since the mid-1990s, technology has developed allowing for real-time spot verification, reporting and

See VERIFICATION, page 3 ►

## Clear Channel Embraces IBOC

by Leslie Stimson

**SAN ANTONIO, Texas** Clear Channel Radio's plans to convert 1,000 stations to digital sends a strong message about its confidence in the technology, IBOC experts say.

Digital proponents believe this is a major step in radio's efforts to improve its audio quality and add new services. The decision also is expected to provide a boost in business for companies involved in producing digital radio transmission and receiver equipment.

Clear Channel plans to spend more than approximately \$100 million over the next decade to implement HD Radio.

Most IBOC experts interviewed by Radio World predicted that other radio groups

would follow Clear Channel's lead and begin to transition a substantial number of stations.

"The fact that the nation's largest broadcast group is going to be delivering HD Radio in every major market in the country will certainly stimulate deployment across the board," said Mike Bergman, vice president of new digital technologies for Kenwood USA.

Transmission equipment makers are ecstatic about Clear Channel Radio's plans to convert 1,000 stations to digital. Harris and Broadcast Electronics representatives say they have been receiving requests for equipment price quotes from engineers at Clear Channel stations.

See CLEAR CHANNEL, page 23 ►

## Networks Get on the Election Bus

Page 6



Photos © 2004 ABC Inc./Steve Fenn

## Networked Audio from Harris? You Betcha!



Want to maximize your facility and studio capacity? Leverage your existing equipment to do more for your talent, station — and bottom line? You can with the power of VistaMax™ from Harris.

VistaMax is a digital audio management system that lets you network your audio studios together. With universal access to all of your resources simultaneously you increase productivity and quality while decreasing maintenance. You can smoothly migrate from a dedicated analog studio to a digital networked infrastructure with this distributed approach — on your timeframe. Benefits include:

- Autonomous console operation, when needed
- Easily share resources to gain economies of scale

- Quickly reconfigure your facility when program or format changes occur
- Reduce installation time and cost for any reconfiguration

As a natural extension of our BMXdigital™ expertise, VistaMax is built on field-proven technologies such as familiar user interfaces without the complexity of a PC.

Empower your audio management with VistaMax. Contact Harris today.

1 800.622.0022 | www.broadcast.harris.com



Sign Up For NewsBytes Weekly Digest at [www.rwonline.com](http://www.rwonline.com)

# ◆ NEWSWATCH ◆

## Clear Channel To Cut Spot Load, Clutter

**SAN ANTONIO** Clear Channel is "actively" encouraging other radio groups to follow its lead and cut commercial clutter.

Addressing issues of low spot rates, high inventory and on-air clutter, the radio group will limit its spot load and promotional announcements beginning in January 2005.

"Clutter is a major issue in our industry and our decision to limit the

amount of commercial time and length of breaks, while reducing promotional interruptions, will benefit listeners, advertisers and the industry as a whole," stated Clear Channel Radio CEO John Hogan.

Under the new rules, no Clear Channel station would run more than 15 minutes of spots per hour and no spot break would run longer than 4 minutes or contain more than six ads.

In addition to reducing commercial capacity, Clear Channel Radio will reduce and limit the amount of promos beginning Oct. 1.

A recent study from J.P. Morgan found some radio stations air up to 22 minutes

of spots per hour, and that 10 to 13 minutes per hour was considered the norm for radio a decade ago.

Clear Channel hopes reduced inventory will drive up revenue. It's also hoping the change will retain younger listeners, and keep them from abandoning radio for on-demand music media.

"Despite radio's great underlying listener trends, and the fragmentation in other media, radio is still discounted relative to other media," Hogan states. "We're taking this step to close that gap and make radio more competitive, compelling, effective and valuable. And we actively encourage the rest of the industry to do the same."

## Infinity, Stern, Clear Channel In Legal Fight

**NEW YORK** It's Clear Channel Communications vs. Infinity Broadcasting Corp. and its shock jock Howard Stern in federal court. At issue is whether Clear Channel had the right to drop Stern's show from six markets earlier this year.

Stern's production company One Twelve Inc. and his distributor, Infinity Broadcasting Corp., sued Clear Channel in June for \$10 million claiming breach of contract.

Clear Channel countersued in July for \$3 million, seeking indemnification of the \$495,000 fine that Clear Channel paid as part of a \$1.75 million settlement with the FCC, as well as damages for lost advertising revenue from the show's cancellation and attorney fees. The amount also includes a refund of monies paid to Infinity and One Twelve while the show was suspended between February and April.

Clear Channel pulled the Stern show due to indecency complaints and said it had a right to do so because Infinity and Stern "refused to assure us that future programs would conform to the law," according to the company's chief legal officer Andrew Levin. Clear Channel alleges that the contracts with One Twelve and Infinity stipulated that Clear Channel could not change the show in any way.

Clear Channel had "to broadcast those programs immediately upon receipt from a satellite feed in their entirety, without alteration." It says it could not "preview, edit or alter" the Stern show.

In June, Infinity added Stern to its stations in the six markets where Clear Channel had dropped the program, plus

See NEWSWATCH, page 7 ►



The Wheatstone GENERATION-5  
has the POWER and FEATURES  
Stations Demand the MOST

# LOTS More!

**Our Generation-5** provides your operators with a straightforward traditional control surface coupled with all the benefits of digital technology. It gives you the flexibility of system-wide source, mix and destination control (any signal anywhere), a powerful mix-minus section and a complete event store, name and recall system. One wire from this surface can control THOUSANDS of wires in your technical operations center.

And while the G-5 feels like an analog console, its DSP-based mixing engine keeps your digital sources digital while converting analog sources to switched digital, eliminating crosstalk and noise. It can furnish remote and telcom functionality on any input fader without fear of feedback—a real plus in back-to-back

daily operations. Its built-in graphic displays keep operators on top of things with just a glance. And since the entire system is software based, you can accommodate any format with a press of a button.

Like all our Generation Series consoles, the G-5 has complete failsafe options available, such as automatic fail-over DSP and CPU cards and redundant power supplies. We can even provide scheduling software and studio mounted satellite cages that can be configured to mix independently from your main routing system.

At WHEATSTONE we've built and sold over a thousand digital audio consoles. The G-5 is a culmination of all that experience. Benefit from our expertise—choose WHEATSTONE!

 **Wheatstone**

600 Industrial Drive, New Bern, North Carolina 28562  
252-638-7000 / [www.wheatstone.com](http://www.wheatstone.com) / [sales@wheatstone.com](mailto:sales@wheatstone.com)

copyright © 2004 by Wheatstone Corporation

## Index

### NEWS

Someone Out There Is Listening	1
Clear Channel Embraces IBOC	1
NewsWatch	2
From the Editor	4
End the Double Standard for LPFM	5
Networks Get on the Election Bus	6

### HD RADIO NEWS

HD Radio and a Low-Power Application in Los Angeles	8
5.1 Implementation in the Real World	12
Public Ponders Skywaves, Digital LP	14

### FEATURES

<b>Workbench: Condition Air Without Losing Your Hair</b>	15
<b>Voice of America Imperiled</b>	16
<b>Rethinking DAB North of the Border</b>	17
<b>Supply Side: Pulsecom</b>	19
<b>Fun and Learning With Codex</b>	20
<b>Teach an EAS Class at Your Station</b>	23

### STUDIO SESSIONS

Audio Interfaces for Computers	25
Star Case Racks: U-Build-Em Studio Racks	31

### OPINION

HD Radio Can Fix Obscenity Issue	38
Engineers, It's Up to You	38

# Verification

► Continued from page 1  
data collection via the Web and virtual private networks.

Monitoring companies such as Media Monitors Inc., Audible Magic Corp., ConfirMedia and Mediaguide track content of radio stations nationwide via remote listening stations and then report when a commercial ran and whether it was the right version.

Some companies use audio watermarking, which requires the participation of advertising clients and broadcasters to encode material with a "watermark," a unique and inaudible code in radio commercials. Other companies are using audio recognition technology, known as fingerprinting, which requires no encoding and uses only tiny bits of identifying audio features that are mapped and coded for comparison.

## Accountability

The progress in monitoring technology has coincided with a spot verification initiative launched in 2003 by the American Association of Advertising Agencies to address growing concern within the advertising community with what it calls "verification discrepancies."

Gary Fries, president and CEO of the Radio Advertising Bureau, stated, "Accountability is a huge issue with advertisers who have to answer to their CFOs and accountants how and where every dollar is spent. This puts pressure on agencies and ultimately the media to verify that the spot ran when it was supposed to."

The efforts of major radio groups and rep firms to move into electronic data invoicing, or EDI, will go a long way toward changing the perception among advertisers, Fries said.

George Searle, CEO of Mediaguide, said radio "certainly delivers many benefits, but it is the most fragmented and most difficult of the media to measure, data-wise."

Searle said Mediaguide collects data that allows advertisers and their agencies to understand the return on their investment and why it is worthwhile.

Mediaguide's passive monitoring technology checks audio from 2,000 radio stations in approximately 200 markets, typically without them knowing they are being monitored, Searle said.

Mediaguide has unmanned workstations with racks of electronics equipment in data centers across the country, Searle said. The company's headquarters in Berwyn, Pa., is the main hub for the spot verification system.

"The first step is content fingerprinting. That happens prior to broadcast (in Berwyn) during content registration. Clients send us the spot and we create a uniquely robust fingerprint ... preserving important characteristics to make identification."

That data is uploaded to the remote listening stations, Searle said, joining millions of other audio fingerprints that Mediaguide has in memory.

Searle said computers in the data centers record continuous broadcast audio and scan content for the digital fingerprints that match with ones already stored in its memory without having to encode the content.

"As a station is monitored, creative is recognized in seconds. We log the time, date and station of the detection. That

data is shipped over a virtual private network to Berwyn where we aggregate all of the codes for our reports," Searle said.

Arbitron began using Mediaguide's broadcast monitoring technology for its RADAR radio network ratings service this spring. Searle said Arbitron had used a manual process to monitor about 600 stations. The sample has increased to more than 1,200 stations since the switch, he said.

ASCAP, the performing rights organization, and ConneXus Corp. formed Mediaguide in 2002 to develop a service for better tracking of ASCAP member performances and airplay on TV and radio, Searle said. "Spot monitoring has been an offshoot of that," he said.

## Truly third-party'

Monitoring services say the results help broadcasters and radio networks maximize revenues by tracking client spots on competitors and determining what buys they are missing. The data also give broadcasters the ability to show clients exactly when their spots aired.

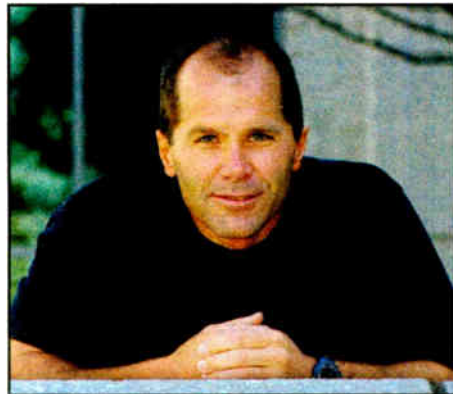

Mediaguide CEO George Searle

Media Monitors Inc., a subsidiary of RCS, inked a deal in June with broadcaster Radio One Inc., to provide same-day data via its AirCheck product.

Radio One COO Mary Catherine Sneed stated, "Being able to see spot breaks on key stations in a market helps us create better sales strategy and provide our advertisers with verification that their spots ran."

With automated listening stations in the top 25 markets, Media Monitors uses a secure virtual private network to transport data from listening sites to its data center in White Plains, N.Y., said President Philippe Generali.

"We believe the only viable technology is fingerprinting technology. We do not have to ask anyone's help. Not the broadcasters, not the advertiser or the creator of the spot. This is truly third-party spot verification," Generali said.

AirCheck uses software that summarizes the audio signal from a radio station at each listening post, and according to the cut's characteristics, creates a matrix of sorts. By saving only key parts of each element, an entire day's worth of identifiable audio typically amounts to less than 2 MB, Generali said.

The only manual part of the process is when a commercial is heard for the first time and cannot be identified by the company's computer software, Generali said.

"When a brand-new commercial is heard and we can't identify it, we have individuals in our data center who lift the broadcast signature or fingerprint of a spot. We therefore can go back and determine how much it has played in the past. We have a library of millions of fingerprints," Generali said.

Several monitoring companies, including ConfirMedia, use digital audio watermark technology. The embedding of

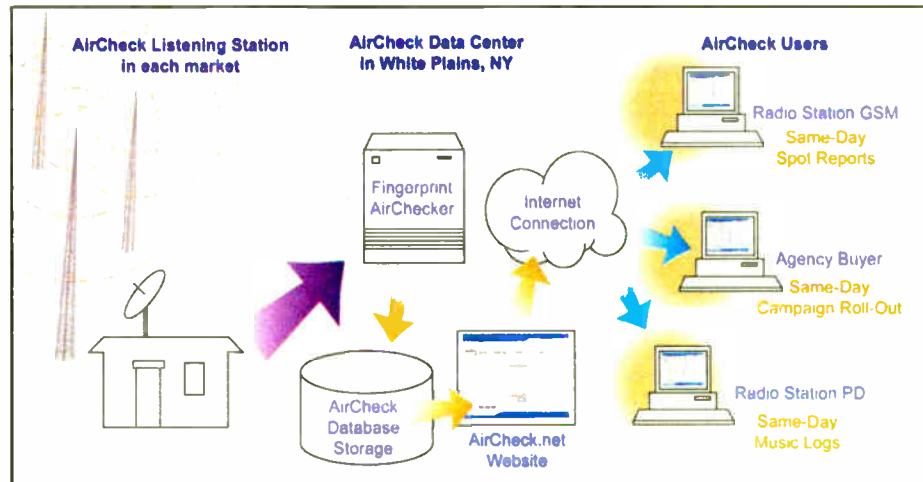

Media Monitors, which sells the AirCheck system, is part of RCS.

unique and inaudible codes in commercials is performed directly into an audio waveform by introducing minute alterations to the waveform that are transparent to the user, according to the company.

AudioAudit, which offers cable and television spot monitoring, is in the development stages of a radio verification service, said Richard Alcott, executive vice president of marketing for AudioAudit. The company plans a late 2004 launch of its radio monitoring software.

"We have been quietly testing within the radio industry. There is a need on the part of our clients to answer the question, 'Did the broadcaster air what they were supposed to air?'"

Alcott said the monitoring company would introduce both a watermark and an

audio recognition fingerprint technology by the end of the year.

Another company ready to enter the radio spot verification business is Mediabase, a division of Premiere Radio Networks. It monitors radio record airplay on 1,100 radio stations in 140 markets.

"We are well into the test phase of a product for identifying spots. While it is relatively easy to monitor national and network spots, the challenge is to include important local advertisers in the data," said Rich Meyer, president of Mediabase.

Meyer declined to identify the technological underpinnings and infrastructure of Mediabase's monitoring system, saying they are confidential. He would only say Mediabase uses a three-way monitoring system with built-in redundancies.



## Reduce Your Work Load Save Time and Money With SCMS!

- ❖ 28 Years of Personal Service
- ❖ Extensive Rental Fleet
- ❖ Experienced Technical Staff
- ❖ Rep for 600+ Companies
- ❖ New & Rebuilt Audio & RF
- ❖ Trade-ins Welcomed

Mid-South Sales:  
**Bob Mayben**  
Voice: 877-391-2650

Central Sales:  
**Bernie O'Brien**  
Cell: 731-695-1714

West Coast Sales:  
**Doug Sharp**  
Sales: 866-673-9267

Mid-West Sales:  
**Mary Schnelle**  
Sales: 1-800-245-4307

South-Atlantic Sales:  
**Art White**  
Sales: 770-632-1295

North-East Sales:  
**Jim Peck**  
Sales: 315-623-7655

**CORPORATE SALES OFFICE**  
Pineville, N.C.

Call: **BOB, MIKE, ERNIE or MATT**

Toll FREE 1-800-438-6040  
1-704-889-4508

Fax 1-704-889-4540  
e-mail sales@scmsinc.com  
www.scmsinc.com



# Finally, Radio Invests in Itself

Clear Channel's commitment to an aggressive rollout of HD Radio is a huge boost to radio's hopes of retaining its listeners and relevancy. (Some would say "and attracting *new* listeners," but let's start by keeping the ones we've got.)

Radio's biggest group owner already was an investor in the technology through Ibiquity; but the super-sized radio company had been holding back on taking the big IBOC step. Two years ago this month, Bill Suffa, Clear Channel's top capital investment guy, told our News Editor Leslie Stimson on the front page of this newspaper that "the whole IBOC thing is one of economics ... from a financial basis, it's very difficult to justify going to IBOC at this time ... We're talking about return on investment."

Things have changed; and when the company in late July issued its announcement of an "advanced technology initiative" and a commitment to install HD Radio in 95 percent of its top 100 markets within three years, Stimson stuck her head into my office and said, "I guess they found their ROI."

## Market forces

Indeed, return on investment is what this is all about. And it's good news — *great* news — that the big pooch in radio's dog pound is thinking about how to make radio better.

I don't want to make too much out of one corporate decision. However, I do like what I'm seeing and hearing on several fronts from Clear Channel lately. And don't think for a minute that other companies aren't paying close attention.

For too long, radio has been content to milk its lucrative market position without investing in improving itself. While new media have sprung up around us, many leaders in radio felt secure believing that nothing could threaten our supremacy with listeners trapped in the car or the workplace.

As a result, ad clutter proliferated. Programming innovation plummeted. Groups looked for every way to squeeze out the "inefficiencies" in the marketplace — inefficiencies that, some people feel, gave radio its market-by-market identity.

lite radio, the 2-by-4 upside the head that really got the donkey's attention. Satellite is a competing medium that reached right into the center of our home turf and showed us that listeners not only want interesting programming with fewer commercials, they'll

**I**t's great news that the biggest pooch in radio's dog pound is thinking about how to make radio better — and not just regarding audio.

Meanwhile, many rosy-outlook types parroted the old line that "radio will survive, it always has," as though our medium is invincible thanks to some sort of magic invincibility cloak.

My friends at NAB and some other broadcasters will argue with me about this; they've said that radio has never been *more* diverse and listener-oriented than it is today. But they are ignoring the elephant in the room on this issue.

"Localism" has come to be viewed by cynics as a naïve concept. Stations sound the same, market to market to market. Even the most ardent radio fans have felt (and I have written) that market forces were at work to make homogenization of our product inevitable.

But guess what? Market forces are now working to make radio better. Smugness has been replaced by concern that radio's place in the American media pantheon is *not* inviolable. Along came Internet radio, MP3s and iPods, cellphones, Wi-Fi — and satel-

lite radio.

Thanks, XM. You did what many of us in radio could not.

## More than toothpaste

Meanwhile, the past year has seen several welcome initiatives at Clear Channel. Someone — and I suspect it's John Hogan — has succeeded in getting the company to tone down its "we're just toothpaste salesman" rhetoric.

The company's localism initiatives, efforts to curb indecency and apparent renewed appreciation for its image in the communities in which it operates are, of course, driven by business concerns, not altruism; but I welcome them, because I equate good radio practices with good business.

Clear Channel has been a more responsible corporate citizen of late, responding to critics who felt it was paying little heed to the quality of its programming. (Compare this to Infinity's pugilistic attitude toward regulation and content.)

And few announcements, even this

## From the Editor



**Paul J. McLane**

IBOC news, could be as welcome to me as Clear Channel's stated commitment to fixing the problem of ad clutter.

I am proud that Radio World has been one of the most vocal industry voices on this topic over the years, including a pointed editorial in our Feb. 11 issue, in which we wrote, "Ad buyers must sense that if their commercial is deeper than the second or third ad played in a stop set, a huge chunk of the audience has tuned out mentally or switched channels ... yet the paradigm persists. ... Radio needs to reinvent the way commercials are presented."

I am encouraged to find that a big industry can in fact do better when it puts its mind to a problem.

Digital radio's audio quality is a plus; and some major news coverage of the Clear Channel announcement focused on that aspect. But my gut tells me Clear Channel ultimately made the decision it did because it believes that the data and multicasting possibilities represent a major potential increase in the value of the spectrum it occupies. A company like Clear Channel does not spend \$100 million over 10 years unless it does indeed see the ROI.

Radio has a real chance here to win back listeners and make the radio experience exciting again. Improvements to radio's fundamental services are in our enlightened self-interest. I'm glad Clear Channel took this step. 🌐

**...SCROLL WITH IT...**

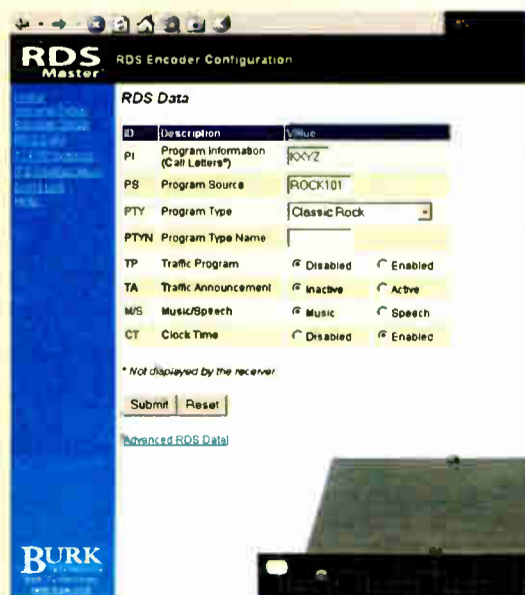

**RDS Master™**  
RDS ENCODER

The RDS Master sets the standard for RDS datacasting. It delivers powerful user features, like Web-based setup menus and TCP/IP access for changing your settings on the fly. Scrolling RDS displays artists and song titles, and you can update messages as often as you want. You can even integrate the RDS Master with your remote control.

Visit [www.burk.com/rds](http://www.burk.com/rds) and learn more about the easiest to use and most versatile RDS encoder available today.

Scroll with it. You'll see the difference.



**BURK**  
TECHNOLOGY

800-255-8090 (Main Office)  
800-736-9165 (Kansas City)  
[www.burk.com](http://www.burk.com)

## GUEST COMMENTARY

# End the Double Standard for LPFM

by Don Schellhardt

Most readers know about the Mitre Corp. report to the FCC, which found no evidence of substantial interference from low-power FM stations.

I take a paternal interest in the report. That's because the Amherst Alliance — a citizens' advocacy group of which I am president, and that I manage and represent as a subcontractor — helped to give birth to the report, or more precisely, to its arrival in the public domain.

In May of 2003, the Amherst Alliance led a group of 19 parties who filed a Freedom of Information Act for release of the long-overdue Mitre report. In response to this multi-party FOIA Request and certain related correspondence, the report finally was released to the general public in July of last year.

Mitre concluded in the report that no significant interference would result if Congress lifts the current statutory mandate for third-adjacent-channel spacing of all LPFM stations.

The FCC then solicited public comments on the report, in FCC Docket 99-25, and sent a Report to Congress in February of this year. In that report, the FCC endorsed both the technical findings of the Mitre study and its recommendation that Congress should repeal the existing channel spacing requirements for LPFM stations.

In June, Senate Commerce Committee Chairman John McCain, R-Ariz., introduced legislation to accomplish this goal, S. 2505. Joining him as co-sponsors were Sen. Patrick Leahy, D-Vt., ranking minority member of the Senate Judiciary Committee, and Senator Maria Cantwell, D-Wash., from the Commerce Committee. In late July the measure passed out of committee to the full Senate.

Amherst has urged five leaders of the House Energy and Commerce Committee to introduce and support comparable legislation. The committee members were Chairman Joe Barton, R-Texas; Ranking Minority Member John Dingell, D-Mich.; Communications Subcommittee Chairman Fred Upton, R-Mich.; Communications Subcommittee Vice Chairman Cliff Stearns, R-Fla.; and Communications Subcommittee Ranking Minority Member Edward Markey, D-Mass.

## Legislative action?

Radio World, in a recent editorial, also called for action to repeal the channel spacing restrictions on LPFM stations.

Further, in a Jan. 14 editorial on a related issue, Radio World called for FCC action to reform translator station policies. These policies led to a translator filing window, in March of 2003, that Radio World called "a Wild, Wild West free-for-all that resulted in more than 10,000 applications for new translators. A couple of organizations filed for thousands of individual translator applications each."

This massive invasion of long-distance translator applications has caused great distress in the LPFM community. Under current rules, many of these applications can now claim "squatters' rights" for frequencies that could be used more productively by locally based, locally-focused LPFM stations, or by truly local FM translators, as opposed to the ubiquitous

"satellators."

To address this situation, Radio World urged the FCC to "consider a reasonable numerical limit on applications from individual stations," adopt "a reasonable standard to prevent applications that proposed translating unbuilt stations (such as construction permits) or stations located

rather comparative levels of radio interference.

Much technical criticism of the Mitre report has turned on whether or not radio interference from LPFM stations was accurately demonstrated to be zero, or at least meaningless on a functional level. This is the wrong question to ask.

## Professional broadcast engineers are not necessarily the best technical evaluators.

many states away" and "strictly enforce the requirement that all translators be able to receive an off-air signal from the station being translated."

After years of ignoring the growing need for translator reform, the FCC finally has issued a Notice Of Inquiry on broadcast localism that solicits public comment on translator station policies and ideas for encouraging the growth of LPFM. The deadline to file comments in Docket 04-233 is Sept. 1.

These proceedings, perhaps buttressed by public input to the FCC's Localism Task Force ([www.fcc.gov/localism](http://www.fcc.gov/localism)), might lead to meaningful reforms late this year or early next year.

Hopefully, S. 2505, or other LPFM channel spacing reform legislation can be enacted before Congress reaches its target adjournment date of Oct. 1. However, the NAB and other parties have criticized the Mitre report and opposed adjacent-channel-spacing reform for LPFM.

## Disinterested parties

The criticisms of the Mitre report reveal the most in what they *don't* say. Professional broadcast engineers are not necessarily the best technical evaluators.

Some critics of the report have asked why it was prepared by scientists and technicians hired from outside the broadcasting industry, instead of by professional broadcast engineers. (Radio World itself asked this question in editorializing on the Mitre situation.) What the critics *haven't* asked is whether the FCC could have found a single professional broadcast engineer in the whole country, outside of the FCC itself, who doesn't actually or potentially derive some, most or all of his or her income from full-power broadcasters with a vested interest in the results of this report.

You don't look for "independent" technical judgments by turning to people who work, or want to work, for one or more parties with a financial stake in the test results. Even if there were no actual conflict of interest, within the minds of those consulted, their judgments automatically would be suspect. In hiring independent evaluators, the FCC chose to avoid not only actual impropriety but also the appearance of possible impropriety.

The standard for LPFM should not be absolute levels of radio interference, but

dards for similarly situated parties, the mandatory standard for acceptable interference from LPFM should not be reaching absolute purity, but rather attaining (or exceeding) the same norms that other broadcasters are expected to meet. Most everyday Americans would consider this a matter of fundamental "fair play."

Once the issue has been rephrased in these terms, it is clear that low-power FM has been subject to an unexplained and irrational "double standard" from the very beginning of the modern LPFM debate.

The FCC's technical staff has already verified, back in 1999, that LPFM does not pose significant interference problems.

Before the final rule to establish LPFM was issued, the FCC's technical staff had already concluded, and assured the full commission, that LPFM stations would not cause interference problems if only second-adjacent-channel spacing were required. Consequently, the FCC's final rule on LPFM incorporated second-adjacent-channel spacing requirements.

Indeed, the FCC's proposed rule envisioned a requirement for only primary-adjacent-channel spacing. The FCC's shift to secondary-adjacent-channel spacing was a concession to the cautious instincts of some, rather than a response to compelling technical evidence.

## Triple-tested'

In a uniquely intrusive action, it was Congress, not the FCC, that mandated third-adjacent-channel spacing — pending the outcome of the same independent

See LPFM, page 18 ▶

networks and the Internet. Now... Broadcast Quality, Live, Audio Over IP networks and the Internet. Now... Broadcast Quality, Live

# LIVE AUDIO OVER IP NETWORKS AND THE INTERNET. NOW.

Studio-Transmitter Link (STL)  
Programme Distribution  
Ad-Hoc & Permanent Audio

using

Broadband Internet  
LAN/WAN, ADSL, Cable  
Wireless Networks  
T1/E1, ATM, Satellite

AudioTX Communicator is a broadcast-quality, robust and reliable IP network codec.

Communicator works over any IP network - whether a private, dedicated, network or the Internet.

From LANs and WANs to ATM or a Satellite link, T1/E1 or over the internet using Broadband ADSL, DSL, Cable Modem or other high speed connection.

The availability of new Satellite Broadband services means you can use Communicator to get live, audio absolutely anywhere.

Communicator includes everything you need for robust, broadcast-quality audio. It includes auto-fallback/reconnect to an alternate IP network, or via ISDN, in case of network failure.

Communicator is also an ISDN codec, with MPEG Layer 2 & 3 and G.722 coding plus G.711 telephony and is compatible with virtually all other manufacturers' units for outside broadcasts, studio links, voice-over work, reporting and news-gathering, using studio PCs or existing reporter Laptops.



# Networks Get on the Election Bus

by Naina Narayana Chernoff

**WASHINGTON** Radio networks are fine-tuning equipment systems for the remaining weeks of intense presidential campaign coverage and the GOP convention, to begin Aug. 30.

Operations vary from remote setups such as those of NPR and Westwood One, to newsgathering equipment that captures audio shared by an outlet's radio and television staff, as is the case for C-SPAN Radio. Whatever the setup, numerous broadcast organizations are poised to provide coverage of the presidential campaign.

Approximately 15,000 members of the press were expected to cover each of the big political conventions, the Democrats in Boston and the Republicans in New York.

At a time when FCC Chairman Michael Powell and Sen. John McCain, R-Ariz., are challenging radio and television broadcasters to expand reportage of the upcoming election, some news organizations and networks have pledged to boost political coverage.

Other broadcasters are maintaining the same level of coverage but cutting back on how they cover the stories because of economic realities. For example, NPR expects to save almost a quarter-million dollars this year by scrapping plans for its usual skybox and trailers at the Democratic and Republican conventions, said Andrea Gewirtz, NPR's technical director for the 2004 campaign coverage.

The staff tested the plan at the New Hampshire primary, she said, and it worked well.

"We're trying something radically different than in past years," she said. "We're not getting the fundraising dollars we were getting prior to Sept. 11 and it's prompted a new, sleek way of doing things."

Although NPR has undertaken a \$15 million news expansion based in part on interest from the \$225 million bequest of Joan Kroc, that money is separate from its engineering budget. A major portion of the approximately \$11 million annual engineering budget for the network is devoted to getting news on the air, an NPR spokeswoman said.

For each convention, NPR expected to set up a workplace at a hotel near the

convention location, including a remote broadcasting studio.

The studio will contain a Mackie Onyx compact mixer, computers and TI connection to enable employees to file reports with the main NPR newsroom in Washington. Gewirtz planned to have two Musicam USA RoadRunner ISDN Codecs available to serve as backup for feeding news spots and reports for the seven reporters and seven producers on site.

NPR planned to have a presence in the small space at each arena from which radio outlets will be broadcasting. From these spaces, NPR reporters would be able to feed audio back to Washington and broadcast live using the RoadRunner units, Gewirtz said. The network also planned to have space in the press tents at each convention, where the reporters and producers will have an ISDN line to Washington as well as laptops equipped with audio editing program Cool Edit.

For the arena locations, Gewirtz planned to purchase a Mackie Onyx mixer with 16 channels, smaller than the 24x24 system NPR owns, as well as 10 new laptops equipped with audio editing.

With all of the connections to its headquarters studios, Gewirtz said she believes the turnaround time will be short for reporters and producers to get edited audio back to the studios and then put on the air from conventions and the campaign trail. "At the conventions, we have four different places to send audio home," she said.

On the campaign trail, some reporters also will use laptops equipped with Verizon Wireless PCMCIA cards to connect with their cell phones for an Internet wireless connection to send audio to Washington via NPR's FTP site.

Planning for election night coverage has not begun and won't "until after the Republican convention." The presidential debates in October will require serious planning, which the team will conduct in coming weeks, she said.

Despite cutbacks for the convention, Gewirtz doesn't anticipate the same situation for election night coverage. "Just like in past years, we will create a newsroom in Studio 4A," she said. "Everyone seems to get a kick out of it."

NPR's flagship broadcasting space,

Studio 4A, is a 1,800-square-foot, two-story studio that has hosted election night coverage, town hall meetings and orchestras.

## One at a time

Westwood One, too, had not finalized plans for election night coverage in July, but expects preparations that are less frantic compared to the summer conventions.



The radio audio mix area in the ABC bus is in a converted bathroom.

"Between the conventions and the Olympics" — to which the program provider has broadcasting rights — "election night is still pretty far away now," said Conrad Trautmann, senior vice president of engineering for the network. "We won't have as many resources devoted to election night as the conventions because it doesn't require us to be as complex with remote locations."

At the Republican convention, Westwood One planned to set up broadcast centers at three skyboxes with editing and broadcasting capabilities, the same arrangement it planned to have at the Democratic convention. The team also will set up a trailer with two more editing and broadcasting positions and a quiet place for interviews.

For New York-based Westwood One, the proximity of the 2004 Republican National Convention at Madison Square Garden is beneficial, said Trautmann. At the Democratic National Convention, the

network was to employ a Harris Intraplex TI system to carry the programming live, as well as several Dell computers equipped with VoxPro from Audion Laboratories, a digital audio editor, and QuickPix, from OMT Technologies. QuickPix is a virtual cart machine that allows reporters to stack up audio bites for quick broadcast.

Reporters on the road use a variety of methods to capture sound and edit it for the air, he said. Depending on their location, the reporters use a Comrex Matrix audio codec, a system capable of being used for POTS, ISDN or wireless transmission; or they record into their computers, edit audio using Cool Edit or its successor software, Adobe Audition, and send it back to Westwood One via its FTP site.

Westwood One has a plan to cover the campaign in all types of situations. When coverage of an election event is pooled by the networks, Trautmann said, Westwood One shares resources with the CBS TV network. The programmer, which distributes CBS Radio News, shares connectivity with the TV side.

Trautmann declined to comment on the size of Westwood One's equipment budget for the election, but said, "Because we do this a lot, we have the resources in place. We came up with a master plan and went through our inventory of remote gear."

## Reallocating funds

ABC News' budget did not spike dramatically for its radio coverage of the elections, said Tony Gatto, the news network's general manager of radio operations, who declined to provide budget figures. Rather, funds were reallocated to cover the events, he said.

The network did not purchase new equipment specifically for the election, Gatto said, adding that he simply planned for having more news reporters in the field and offering more services for ABC affiliates.

Gatto, in charge of special events coverage and new technology, said ABC offered affiliates at both conventions spaces along "ABC Talk Radio Row," custom on-site studio facilities at each convention hall where local affiliate hosts can broadcast directly from the convention. ABC planned to set up spaces for 15 talk shows hosts from around the country at each convention, including hosts from Infinity Broadcasting and Clear Channel

See ELECTION, page 7 ▶



For each one of these you own...  
(rack or portable)



...we'll give you one of these...  
\*OK, we'll send you a check, not real \$500 bills



...when you buy one of these.

## The Great Comrex Update-Rebate!

(For Comrex HotLine owners only)

Act Now!  
Offer Ends  
Aug 31, 2004

To show our appreciation for your being a Comrex HotLine pioneer, we are going to make it easier for you to put today's technology to work for you. Comrex's current POTS codecs offer twice the audio quality and a more robust modem technology that improves reliability and stability. For each BlueBox, Matrix or Matrix Rack you purchase, Comrex will send you a \$500 rebate for each HotLine

you already own, purchased before Jan 1, 2004 (you get to keep your HotLines!). After getting a great value from your favorite Comrex dealer, just contact Comrex or fill out the on-line form at [www.comrex.com](http://www.comrex.com) so we can get your rebate check quickly processed. Cash in your pocket and the best sounding remotes. Two more reasons to put Comrex on the line!

**COMREX**

Toll Free: 800-237-1776 • [www.comrex.com](http://www.comrex.com) • e-mail: [info@comrex.com](mailto:info@comrex.com)  
19 Pine Road, Devens, MA 01434 USA • Tel: 978-784-1776 • Fax: 978-784-1717

# Election

► Continued from page 6

Radio, as a revenue-generating venture.

For example, at the Democratic National Convention, ABC News expected to provide 10 positions with ISDN lines for live broadcasting for ABC affiliates.

"It's a tremendous service for them. Local stations just love it," Gatto said. "They get to go right to the story." His team sets up local talent with press credentials, guests to interview and the technical equipment such as microphones, codecs, mixers and a team of engineers ready to troubleshoot any transmission problems for the remote broadcasts.

ABC News began offering the service to affiliates at the New Hampshire primary four years ago and also at the ceremonies marking the first anniversary of the Sept. 11 terrorist attacks.

## On the bus, Gus

ABC News believes it will set itself apart from other news organizations with its use of three campaign busses it began using during the primaries last winter.

The busses are equipped with mobile radio and television studios. Reporters can produce and file reports as well as conduct interviews from the vehicles. The vehicles are equipped with seven digital audio workstations, computers and Voice Over Internet Protocol connections. Also available for reporters is a compact radio studio, a small room in what used to be a bathroom.

Reporters at the conventions and on the campaign trail most commonly use VoIP to get their reports on the air, Gatto said. Using codecs by AudioTX, a product line of MDOUK in the United Kingdom, reporters can plug their microphones into their laptops and send reports via the wireless connection. Reporters will be equipped with a laptop featuring Cool Edit and will send their reports back to ABC's New York studio via its FTP site ([abcspotdepot.com](http://abcspotdepot.com)) for quick broadcast.

Reporters will also have access to four Inmarsat satellite phones manufactured by Nera to get sound back to the New York studio, Gatto said. To give reporters in the field another option, his team was testing GSM codec performance using Comrex and Tieline products to determine whether to use them for the conventions, said Jeff Fitzgerald, assistant director of news operations.

At both conventions, ABC News planned to use a skybox and set up a trailer with broadcasting equipment. The trailer will be equipped with a master control system as well as Dalet digital audio workstations for editing and producing reports, Fitzgerald said.

On the convention floors, Gatto and Fitzgerald planned to set up three locations for ABC reporters to broadcast live and make available headsets and RF transmitters to broadcast from any location.

Like other news organizations, Gatto and Fitzgerald said planning for election day and night coverage will begin after the Republican convention and will come as a welcome relief. "As far as technical operations, we set up two to three locations," he said. "On an operational level, it's so much easier." ●

► continued from page 2

three additional markets, bringing the total number of markets that carry Stern to 45, including 27 Infinity O&Os.

## Canada's CHOI to Lose License

**OTTAWA-GATINEAU** Quebec station CHOI(FM) is due to lose its license Aug. 31 over several programming complaints. This would be only the sixth Canadian station to have its license pulled, according to experts here.

The Canadian Radio-television and

Telecommunications Commission denied a renewal application by Genex Communications Inc.

At the same time, it called for applications for a new French-language FM in Quebec for the former CHOI frequency.

The CRTC said that since Genex acquired CHOI in 1997, the station's programming had been the subject of several complaints, including "personal attacks and harassment."

"The commission considered that offensive comments made by the hosts over the station's airwaves tended or were likely to expose individuals or groups of individuals to hatred or contempt on the basis of mental disability, race, ethnic origin, religion, color

or sex. The commission also considered, among other things, that the station's hosts were relentless in their use of the public airwaves to insult and ridicule people."

In 2002, the CRTC renewed the station's license for two years, rather than the maximum seven, due to complaints, and made the renewal subject to certain conditions.

At a public hearing on the complaints in February of 2002, the CRTC said Genex "denied that a problem existed."

The CRTC termed Genex' behavior "inflexible" and stated the owner demonstrated a lack of commitment to fix the problems.

Genex intends to fight the decision, according to published accounts.



### Matrix Portable:

Delivering the sound of the gun going off to listeners around the world is as simple as pressing a button. The Comrex Matrix, equipped with our optional GSM Module, combines an integrated mobile phone and an advanced Comrex codec to deliver broadcast quality 7kHz audio over standard cellular connections (15kHz over POTS). The results? Your listeners hear the wind in the rigging – the sound of a half-a-boat-length victory with detail that's unprecedented.



### Matrix Rack:

Sure all the action is in the field (or off shore...), but a great remote needs a great home base. And there's nothing better than the Matrix Rack. It's compatible via POTS and ISDN with ALL Comrex codecs as well as those from nearly everyone else. Perfect for receiving those GSM calls from the field. Make the Matrix Rack the center of communications for ALL your remotes.



Grab your audience by the ears and give them the full experience – not just a story.

Doing a remote? Put Comrex on the line.

**COMREX**

Toll Free: 800-237-1776 • [www.comrex.com](http://www.comrex.com) • e-mail: [info@comrex.com](mailto:info@comrex.com)  
19 Pine Road, Devens, MA 01434 USA • Tel: 978-784-1776 • Fax: 978-784-1717

# HD Radio News

Radio World

Covering Radio's Digital Transition

August 11, 2004

FIRST PERSON

## HD Radio and a Low-Power Application in Los Angeles

by Ed Hollis

**LOS ANGELES** Six watts of in-band, on-channel digital audio broadcasting covering more than 6 million people? KPCC(FM) and National Public Radio wondered if this was possible, and with the help of Broadcast Electronics and Shively Labs we set out to test a low-power IBOC signal in Los Angeles.

The FM broadcast band is crowded in Southern California. KPCC, of which I am chief engineer, broadcasts a 600-watt ERP analog signal to cover 4,000 square miles of metropolitan Los Angeles from high on top of Mt. Wilson. We doubted that a digital signal, operating with a power lower than that of other digital installations, would cover the same area as our FM analog.

Six watts IBOC is KPCC's calculated digital ERP to be 20 dBc below the analog carrier. We know of no other IBOC tests that have been conducted at such lower power levels.

KPCC and NPR were impressed with the coverage of this 6-watt IBOC signal. Our measurement team drove the freeways of Southern California for several days making signal strength and reception quality measurements.

Where the digital signal was weak and the Kenwood receiver dropped the

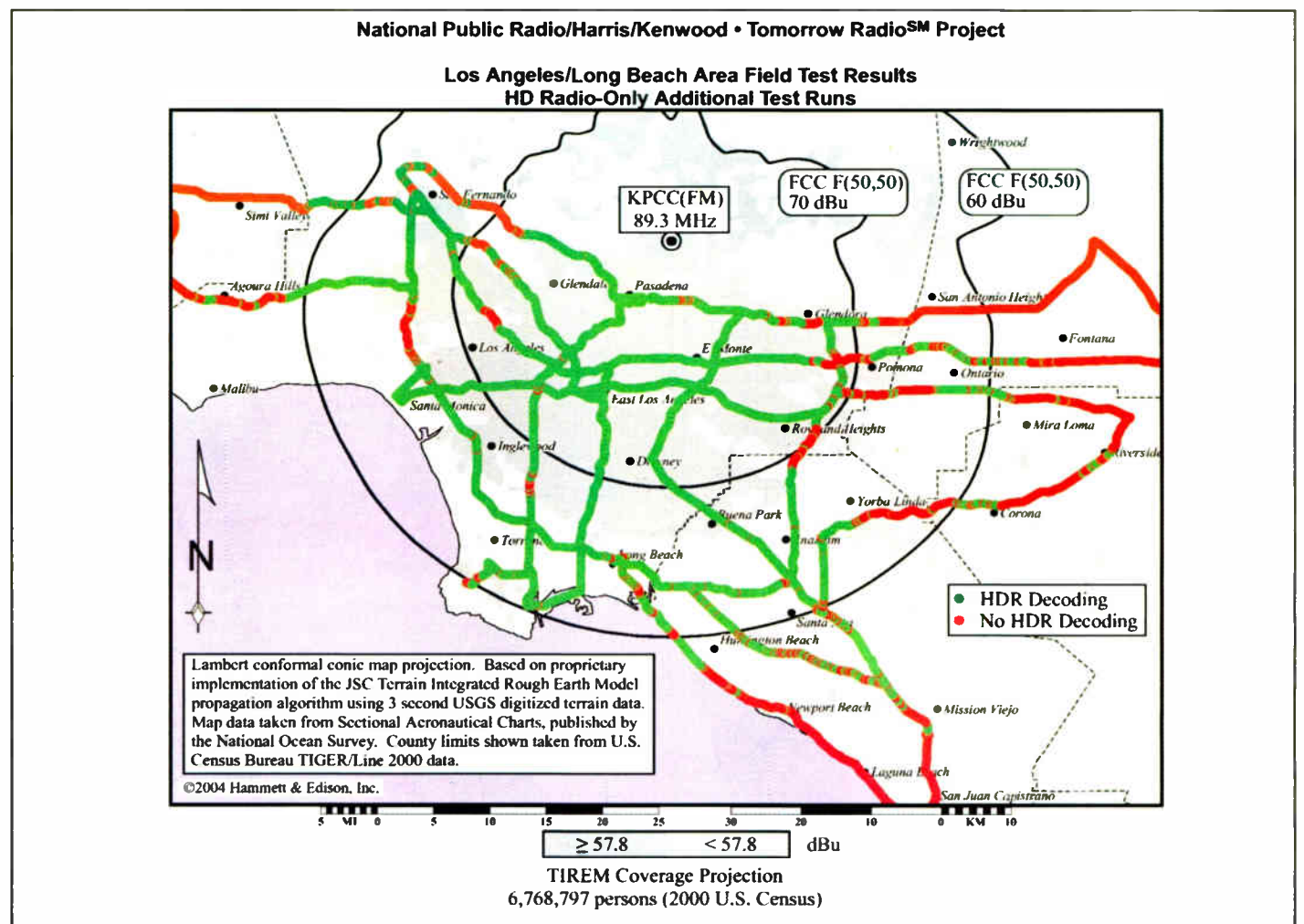

Fig. 1: KPCC coverage map showing digital signal.

Just because its **compact** doesn't mean it has less **impact**. You're reading this aren't you?

**DSPX**, the 1RU sized **FM-IBOC-HD-NET processor** from **BW**. Small box, small price, **BIG** sound.

Now available from broadcasters general store.  
For more info or to arrange a demo contact BGS on 352-622-7700

**ANALOGUE**

LEFT INPUT, RIGHT INPUT, LEFT OUTPUT, RIGHT OUTPUT

**DSPX**

SCA INPUT, MPX OUTPUT, PLOTT OUT

**DSPX DIGITAL AUDIO BROADCAST PROCESSOR**

4 band rms agc · 4 band dynamic limiters · dual use outputs · lookahead limiting · distortion controlled clipping · composite processing · bass enhancement · rs232 and IP control real time clock for scheduling · remote trigger port · factory and user presets · dual screens · digital and analog I/O · flash upgradable · much much much more.

www.dsp-x.com

digital signal and reverted to the analog signal, the analog signal was noisy, also. See the coverage map above.

### Background

This test of HD Radio, in a low-power application, took place in February with the help of fellow radio engineers. The weather was cold, rainy and overcast. Mt. Wilson was covered with 6 inches of snow.

Mt. Wilson consists of an antenna farm with a changing population of several television and radio stations and business-band repeaters. The mountain is 5,780 feet above sea level and the tower on which KPCC's antenna sits another 100 feet above that. At 5,880 feet above sea level, it's easy to understand why KPCC's signal covers the Los Angeles area so well.

Two people encouraged and financed this report: Don Creighton, senior vice president of technology at Minnesota Public Radio, and Mike Starling, vice president of engineering and technology of NPR. Broadcast Electronics and Shively Labs provided the HD Radio equipment.

KPCC's analog and IBOC signals are weak from the get-go. Yet, both the FM and IBOC modulation methods

See LOW POWER, page 10 ▶



# The routing switcher gets a new twist.

(About five twists per inch, actually.)

**Everybody needs to share audio.** Sometimes just a few signals — sometimes a few hundred. Across the hall, between floors, now and then across campus. Routing switchers are a convenient way to manage and share your audio, but will your GM really let you buy a router that costs more than his dream car? Unlikely.

If you need a routing switcher but aren't made of money, consider Axia, the Ethernet-based audio network. Yes, Ethernet. Axia is a *true network*. Place our audio adapter nodes next to your sources and destinations, then connect using standard Ethernet switches and Cat-6. Imagine the simplicity and power of Ethernet connecting any studio device to any other, any room to any other, any building to any other... you get the idea.



Routers are OK... but a network is so much more modern. With Axia, your ins and outs are next to the audio, where they belong. No frame, no cards, no sweat.

### Scalable, flexible, reliable... pick any three.

An expensive proprietary router isn't practical for smaller facilities. In fact, it doesn't scale all that well for larger ones. Here's where an expandable network really shines.

Connect eight Axia 8x8 Audio Nodes using Cat-6 cable and an Ethernet switch, and you've got a 64x64 routing switcher. And you can easily add more I/O whenever and wherever you need it. Build a 128x128 system... or 1024x1024... use a Gigabit fiber backbone and the sky's the limit.

### Are you still using PC sound cards?

Even the best sound cards are compromised by PC noise, inconvenient output connectors, poor headroom, and other gremlins. Instead, load the Axia IP-Audio Driver for Windows® on your workstations and connect *directly* to the Axia audio network using their Ethernet ports. Not only will your PC productions sound fantastic, you'll eliminate sound cards and the hardware they usually feed (like router or console input modules). Just think of all the cash you'll save.

**Livewire**



<...> 100/1000

There's a better way to get audio out of your PC. No more consumer grade 1/8" connectors — with Axia your digital audio stays clean and pristine.



Put an Axia Microphone Node next to your mics and send preamplified audio anywhere you need it, over Ethernet — with no line loss or signal degradation.

### Put your preamps where your mics are.

Most mainframe routers have no mic inputs, so you need to buy preamps. With Axia you get ultra-low-noise preamps with Phantom power. Put a node in each studio, right next to the mics, to keep mic cables nice and tight, then send multiple mic channels to the network on a single Cat-6 cable. And did we mention that each Mic Node has eight stereo line outputs for headphones? Nice bonus.

### Put your snake on a diet.

Nobody loves cable snakes. Besides soldering a jillion connectors, just try finding the pair you want when there's a change to make. Axia Audio Nodes come in AES/EBU and balanced stereo analog flavors. Put a batch of Nodes on each end of a Cat-6 run, and BAM! a bi-directional multi-channel snake. Use media converters and a fiber link for extra-long runs between studios — or between buildings.



An Axia digital audio snake can carry hundreds of channels of digital audio on one skinny CAT-6 cable. We know you're not going to miss soldering all that multi-pair...



Scott Studios



Axia is already working with some great companies. Like Enco Systems, Scott Studios, Radio Systems, Balsys Technology Group, and of course Telos and Omnia. Check [AxiaAudio.com/partners/](http://AxiaAudio.com/partners/) to find out who's next.

### With a little help from our friends.

A networked audio system doesn't just replace a traditional router — it *improves* upon it. Already, companies in our industry are realizing the advantages of tightly integrated systems, and are making new products that reap those benefits. Working with our partners, Axia Audio is bringing new thinking and ideas to audio distribution, machine control, Program Associated Data (PAD), and even wiring convenience.

### Would you like some control with that?

There are plenty of ways to control your Axia network. For instance, you'll find built-in web servers on all Axia equipment for easy configuration via browser. PathfinderPC® software for Windows gives you central control of every audio path in your plant. Router Selector nodes allow quick local source selection, and intelligent studio control surfaces let talent easily access and mix any source in your networked facility.



Control freaks of the world, rejoice: intelligent Axia mixing surfaces give talent complete control of their working environment. Reconfigure studios instantly and assign often-used sources just where they're most useful.



**"This sounds expensive."** Just the opposite, really. Axia saves money by eliminating distribution amps, line selectors, sound cards, patch bays, multi-pair cables, and tons of discrete wiring — not to mention the installation and maintenance time you'll recover. And those are just side benefits: our hardware is about half the cost of those big mainframe routers. That's right... *half*. Once you experience the benefits of networked audio, you will never want to go back. [AxiaAudio.com](http://AxiaAudio.com) for details.



© 2004 IIS Corp. All rights reserved. Axia, the Axia logo, Livewire, the Livewire logo, Telos, and the Telos logo are trademarks or registered trademarks of IIS Corp. All other trademarks and logos are the property of their respective owners.

## Low Power

► Continued from page 8

covered Los Angeles and parts of Riverside, San Bernardino, Ventura and Orange Counties amazingly well. Building penetration of KPCC's analog signal is poor and has always been a problem.

Ethan Torrey, chief of research and development for Minnesota Public Radio, and Jan Andrews, senior engineer NPR, drove the freeways of Southern California. They assembled Kenwood HD Radio receivers with specialized test and measurement gear to map and plot the low-power IBOC coverage.

Two model FM 1.5A Broadcast Electronics analog transmitters provide redundant service in an alternate/main configuration.

The plant is plumbed in 1-5/8-inch rigid transmission line to a motorized coaxial switch. From this point, gassed Heliac completes the run to the half-wave-spaced Jampro JMPC-2D two-bay antenna. A Broadcast Electronics FMI 31 provided the digital IBOC signal. Shively Labs provided a 5526 HD Radio Digital Injector to combine the analog and IBOC signals.

The installation process was simple. The injector was placed on top of the center equipment rack. The injector's analog input and combined output were plumbed in 1-5/8-inch rigid cop-

per. LDF4-50 1/2-inch Heliac was used to plumb the IBOC input and reject output. The reject port fed a 5 kW load placed on the floor behind the transmitters.

The measured injector performance results were as follows: Analog to digital isolation, -30.8 dB; analog in to combined out, -0.5 dB; digital in to combined out, -9.6 dB. The normal TPO for the analog transmitter was 1,060 watts.

The desired digital ERP of 6 watts (-20 dBc) required a 10.6 watts digital signal after the injector. The 97.3 watts at the injector's digital input compensates for the 9.6 dB coupling loss. Similarly, increasing the analog transmitter TPO to 1,191 watts compensated for the 0.5 dB analog inser-

tion loss. Minimal line loss in the LDF-50 was compensated for resulting in a digital TPO of 100 watts from the FMI 31. Similarly, the injector analog insertion loss was compensated for and yielded an analog TPO of 1,191 watts.

After the hardware installation was completed, the IBOC injection level was measured and adjusted. Broadcast Electronics recommended a method to set the IBOC injection level. A -53 dB slug was used in the sample section.

The sample fed an HP 8591E spectrum analyzer.

The HP Spectrum Analyzer was set to a span of 2 MHz per division, resolution bandwidth was set to 1 kHz, video bandwidth was set to 3 kHz and we turned on video averaging. This method of IBOC measurement is problematical on several counts, but the desired result of -20 dBc IBOC can be confirmed by other methods. However, the issue of peak IBOC power measurement remains unanswered.

### Markers

The first step in the process was to obtain a reference measurement of the unmodulated analog carrier. This measurement yielded a value of 8.8 dBm.

Next, the analog carrier was turned off. Leaving the analyzer settings as is, we turned on the digital transmitter.

Markers were placed on each of the two Orthogonal Frequency Division Multiplexing carrier families. The marker values should show -43 dBc relative to the unmodulated analog carrier.

In KPCC's case, the desired value was -34.2 dBm (8.8 minus 43).

The desired result was to inject a digital signal at -20 dBc. This means that with half of that power in each of the two IBOC groups, each group should have a total channel power of -23 dBc.

Lyle Henry, CPBE, performed SCA noise measurement tests from the IBOC signal in SCA channels. Noise measurements were made to both 67 and 92 kHz SCAs with a Belar SCA monitor.

At 10 percent SCA injection, both 67 and 92 kHz SCAs' noise increased 2.5 dB with the application of the IBOC signal. At 5 percent injection, 67 kHz noise measured 4.1 dB while the 92 kHz SCA noise measured 1.5dB.

Also, Henry performed an SCA radio listening test. He used two SCA receivers: one of good quality and one of average quality. He reports, "Neither of these radios showed any increase in noise on the SCA channels at either 10 or 5 percent injection when IBOC was on."

The coverage map produced by Andrews and Hammett & Edison, Consulting Engineers (Fig. 1) demonstrates how well 6 watts ERP of IBOC signal covered the greater Los Angeles area. As the Kenwood HD Radio receiver's digital signal faded to analog in fringe areas, the analog signal was just about ready to fade out as well.

Building penetration by the 6-watt digital signal was not possible. KPCC's analog signal at 600 watts ERP often fails to penetrate buildings within its general coverage area.

Ed Hollis, CBRE, CBNT, is chief engineer of KPCC(FM), Los Angeles. ●

# Sabre Towers



Sabre offers a complete line of towers, monopoles and tower components. In the tower industry for more than 25 years, Sabre towers are engineered with experience. Offering everything in guyed towers from a 12" face tubular lightweight tower

to an 84" face solid leg knock down tower. Sabre has a tower for nearly all broadcast applications. Committed to customer service, Sabre offers quality products at competitive prices with the shortest lead times.



800-369-6690 • [www.sabrecom.com](http://www.sabrecom.com)  
2101 Murray Street • PO Box 658 • Sioux City, IA 51104

# Powerful Automation from BSI



**Series 110**  
**\$9,999**

**Purchase a system from BSI with the confidence that you're buying years of research into what makes an automation and hard-disk play out system reliable, powerful and versatile. Dell Computers with 3-year on-site warranty, professional AudioScience multi-output sound cards and BSI software make a great combination.**

**Our team of broadcast professionals installs and configures your software and hardware so that everything is ready to run out of the box. We also include telephone training to help you get started and the Series 110 comes with a full year of standard telephone support and software upgrades. For added piece of mind, software mirroring synchronizes the two machines so that changes made on one computer are reflected on the other.**

**BSI systems are used in stations across the US and around the world.**

**Thousands of users have discovered how easy and versatile BSI software really is. Test and try before you buy.**

**Broadcast Software International**  
1925 Bailey Hill Road, Suite A, Eugene, OR 97405  
www.bsiusa.com 888-BSI-USA1 (888-274-8721) info@bsiusa.com

**Para el español, llamada Felipe Chavez, Distribuidor de los E.E.U.U.**  
(916) 368-6332 fchavez@ommedianet.com



## GUEST COMMENTARY

# 5.1 Implementation in the Real World

by Robert Reams

There has been a recent flurry of press regarding the efficacy of surround sound, rather, surround sound for digital radio. For those in the know, this is not news. It appears that there are a vocal few who have suddenly realized something that has been painfully obvious for many, many years: *Consumers really like surround sound.*

What a revelation! Perhaps it's appropriate to focus upon real-world application challenges and solutions that are being adopted and applied to now for 2005-06 release home and auto products and broadcast appliances.

## Background

Broadcasting 5.1 audio over a digital radio infrastructure posts several major challenges:

- The lack of popular radio content produced in 5.1;
- The lack of a 5.1 production and broadcast infrastructure;
- The incompatibility of lossy codecs with traditional surround schemes; and
- The multitude of automotive playback configurations.

## Scarcity of 5.1 music

Although the availability of 5.1 original recordings is growing, the dominant configuration for distribution of music is stereo. Most content in "heavy rotation" is delivered in stereo, or "2.0" in spatial jargon.

It has been known for years that stereo is more than two channels; rather, stereo is a "spatial" or two-dimensional format. The 5.1 design is also a 2-D format.

So, it would seem that the only thing separating 2.0 and 5.1 (other than the subwoofer LFE channel) is the number of "origins" in the content production and the number of loudspeakers through which it is produced. That being said, it is plausible that both formats could be represented within the "unified" or common denominator of 2-D which requires two discrete fine

structures.

All content could be handled using the existing 2.0 infrastructure. The 2.0 content could be interspersed with 5.1 original source station ID tags and commercials. As the 5.1 content became available, more and more content would transition to 5.1 ... all without any discontinuities.

Of course, legacy 2.0 content will always be around, so the methodology for storing, broadcasting and receiving it would continue to exist in perpetuity.

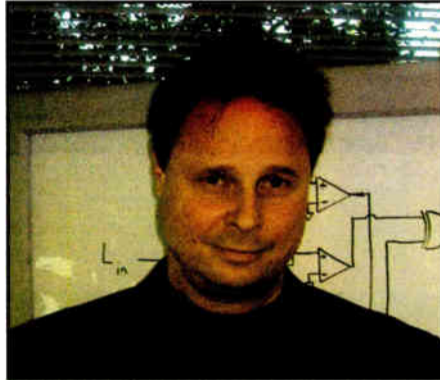

Robert Reams

Consumers with receiver systems employing Neural's Spatial Environment Engine (SEE) will enjoy 2-D stereo using the same number of loudspeakers used for 5.1 playback. Experience with this methodology has proven successful within the HDTV industry.

Consumers respond positively to discrete 5.1 interspersed with 5.1 rendered stereo. These same consumers respond *negatively* to discrete 5.1 interspersed with two-channel stereo. Imagine how your radio listeners will respond in a car.

## Lack of 5.1 production and broadcast infrastructure

Neural Audio and Harris have developed and are deploying the 5225 surround appliance. The 5225 makes possible the creation of original 5.1 content as well as down-mixing and watermarking original 5.1

music recordings (with confidence monitoring) for broadcast over existing two channel broadcast infrastructures.

All 5.1 music, commercial and ID tag content on the broadcast side may be "down-mixed" (via 5225) and stored or archived along with Lt/Rt (matrixed encoded stereo) and stereo content on existing 2.0 carts, editors (yes! you can edit it!) and servers, regardless of the compression algorithm. No modification is required. You may "cart" your 5.1 anywhere on anything, even a well-behaved analog recorder/reproducer. Just treat it as "content."

## Lossy codecs are incompatible with traditional surround

The economic value proposition for any digital audio broadcast is based on low data rate audio codecs. Unfortunately, the combination of unpredictable content pedigree with lossy codecs used in broadcast results in incompatibility with spatial rendering as demonstrated by their interaction with traditional matrix decoder schemes.

In order to limit unnatural or hostile artifacts, spectral extension and image fine structure must be manipulated to minimize the audibility of said artifacts. Many broadcast stations therefore apply an additional proprietary Neural Audio process called Parametric Image Reparsing to address this issue.

Parametric Image Reparsing allows for spatial "reassignment" of spectra to alternate portions of the image. This reduces the coding of perceptually recessive image elements and reduces the occurrence of "zero-quantizing."

Parametric Image Reparsing is processor-intensive and application-specific, so it is best accomplished within the Harris Neustar before encoding the 2-D content for broadcast.

In addition to the critical process of Parametric Image reparsing, it can also not be overemphasized how much attention to detail in producing or processing the content can influence the performance of digital audio broadcast. Neural processors apply de-humming, de-noising and image management to improve the content's "codability" and make the result more pleasing and listenable regardless of the playback environment, be it stereo, matrix or discrete 5.1.

## Automotive playback

How do you render the 2-D content (regardless of how many channels the original source consisted of) to a pre-determined number of loudspeaker channels — be it 5.1, 4.1 or 2.0, on the consumer side?

Upon reception or input at the receiver end, the content is selectively and automatically post-processed and "up-mixed" by the Neural Audio Spatial Environment Engine (SEE) to the available number and type of loudspeaker elements in their "real-world" location in the automotive environment.

While the nature of this mechanism is hotly discussed, the need is sorely noticed as demonstrated by the plethora of spatial coding schemes. This is not to say that these technologies are without merit. It's just that they don't address many practical implementation issues on the broadcast, as well as, consumer side.

The newer "discrete" 5.1 formats don't seem offer a complete solution to the automotive environment designer, as they are "fixed" and require the automotive environment to conform to the specification of the

audio system, not the other way around.

There are many possible, and often necessary, permutations of the automotive "spatial environment" as well as all of the possible sources (hard, soft and broadcast) of content.

Choices for loudspeaker number and placement are seldom ideal and always driven by budget and aesthetics.

This is where SEE resolves the problem with flexible rendering (from two to 256 channels) of the common spatial denominator.

SEE is easy for the designers to use and portable to various DSP environments. As such, the spatial rendering is flexible and allows for limited "customization" to achieve the best performance possible within the limitations of driver number and speaker placement in the automotive environment.

This is not to say that SEE has no application within the consumer home theater environment. Many clever designers may see this as a closed solution for simplifying existing content compatibility issues for consumer electronics including satellite, cable and terrestrial broadcast.

## SEEDS

In order for automotive engineers to test and design their audio systems effectively around these powerful new concepts of "surround broadcast," Neural Audio is making available a Spatial Environment Engine Development System developing tool.

SEEDS is a multi-channel audio DSP box that can process up to eight analog audio channels inputs to eight analog audio channels out. It may be placed between any two-channel receiver, CD or cassette transport and the amplifiers.

SEEDS is flexible and may be configured for any number of speaker configurations compatible within the given spatial environment.

## Our task

There are a lot of challenges with transitioning broadcast from 2.0 to 5.1. We must modify our thinking of "changing 2.0 to 5.1" to "planning for 2.0 and 5.1 interoperability." There is much more to it than building a 5.1 "pipe" and calling the problem "solved."

Let's learn a lesson from HDTV audio and emulate what has worked for it:

- Content producers must be left free to produce their content in any spatial environment they wish;
- Distribution channels must remain backward-compatible;
- The technology must be beneficial to legacy content; it must function compatibly with the status quo of content production and distribution as well as the upgrade. OEM and aftermarket manufacturers for consumer products only make products that benefit them *now*; and
- Most important, the image rendering must meet consumers' expectation of what is considered "surround."

Any technology that ignores these requirements creates insurmountable barriers to the artist, distributor, broadcaster and the consumer and guarantees a soft reception by all.

Robert Reams has authored several white papers and articles on related topics. To obtain copies, visit [neuralaudio.com](http://neuralaudio.com).

Reams is co-founder and chief technology officer of Neural Audio. Reach him via e-mail to [robert@neuralaudio.com](mailto:robert@neuralaudio.com).

RW welcomes other points of view. 

## Bigger, Bolder, Brighter!

THIRD-GENERATION "DAVID" PROCESSING...  
SMOOTH AND EXCEPTIONALLY COMPETITIVE!



Improved AGC, 3-band Spectral Loading™ processing, and our proprietary PIPP™ limiter... new features we've merged with the 'elegant simplicity' that characterizes the "DAVID" FM-airchain legacy. The result is performance that rivals processing systems costing several times the DAVID-III's modest price. Your listeners will hear music with dynamics and 'punch,' and live-announce that's natural and non-abrasive.

The DAVID-III is easy to set up and easy to use. It employs quasi-digital PWM processing circuitry, digital synthesis of the FM baseband signal, and it never requires routine calibration. Component parts are common and available worldwide.

Ask your preferred distributor for a demonstration of the DAVID-III at your station.

 **Inovonics**  
1305 Fair Ave. • Santa Cruz, CA 95060  
TEL: (831) 458-0552 • FAX: (831) 458-0554  
[www.inovon.com](http://www.inovon.com) • e-mail: [info@inovon.com](mailto:info@inovon.com)

**DAVID-III - \$2200**

Visit [www.inovon.com](http://www.inovon.com)  
for full technical details

# Leading POTS Codecs Compared.

	Comrex Matrix	Tieline Commander	Zephyr Xport
Audio Bandwidth @ 24 kbps @ 19 kbps	14 kHz 11.2 kHz	15 kHz 9 kHz	15 kHz 15 kHz
<u>Direct</u> Internet Software Updates	No	No	Yes, via Ethernet port
Digital PC Audio Input	No	No	Yes, via Ethernet port and supplied driver
Audio Metering (XMIT/RCV)	Transmit only	One-at-a-time	Simultaneous
Audio Processing	None	Simple AGC	Digital multi-band AGC with look-ahead limiter by Omnia
Remote Control	No	RS-232 and dedicated computer	Ethernet via Web browser
Auto Dial Storage	19 Numbers	50 Numbers	100 Numbers
Frequently-Used Settings Storage	none	none	30
Standards-based POTS Codec	No - Proprietary	No - Proprietary	Yes - aacPlus (MPEG HEAAC)
Transmit-Receive Quality Display	No	Yes	Yes
Contact Closures	2	2	3
Display Resolution	120x32 LCD	120x32 LCD	128x64 LCD
Analog Cell Phone Interface	Optional	Standard	Standard
Mixer Inputs	1 mic, 1 mic / line	2 mic / line	1 mic, 1 line
Phantom Power	No	No	Yes - 12 volt
Automatic Voice-Grade Backup	No	No	Yes
Power Supply	External	External	Internal auto-switching
Local Mix Audio Outputs Headphone Line Level	Yes Yes	Yes No	Yes Yes
Direct Receive Audio Output	No	Yes	Yes
Uses ISDN at the Studio Side for More Reliable Connections	No	No	Yes - your Zephyr Xstream becomes universal POTS and ISDN codec.
Available ISDN Option	\$850.00 (adds MPEG L3 & G.722)	\$850.00 (adds G.722)	\$495.00 (adds G.722 & state-of- the-art AAC-LD for high fidelity and low delay)
List Price:*	\$3,700.00	\$3,650.00	<b>\$2,495.00</b>



The world's most advanced POTS codec  
is also the world's lowest priced POTS codec.

*Telos*  
AUDIO | NETWORKS

\* Refers to base MSRP without ISDN option as of 5/1/04. The Telos logo, Zephyr, Zephyr Xstream, Zephyr Xport are all registered trademarks of TLS Corporation, © 2004. aacPlus (TM) Coding Technologies. Comrex, Tieline and associated trademarks are property of their respective owners. Product specifications quoted from manufacturer's most current published documentation at time of printing.

# Public Ponders Skywaves, Digital LP

**WASHINGTON** This is the third in a series of articles sampling public comments filed with the FCC in the proceeding to develop final authorization rules for IBOC. Here we excerpt observations about digital recording, AM nighttime skywave service, digital LPFM and data applications.

*Microsoft Corp. wrote:*

"(W)e specifically encourage the commission to promote the public interest by allowing multicasting and permitting multiple datacasting transports in digital radio signals. ...

"Microsoft believes that consumers will be encouraged to transition to DAB if the service offers a greater variety of content than is currently available, both via multicasts of audio streams and via a range of datacasting systems. ...

adoption of Ibiqity's digital *datacasting* architecture, which is still early in development, as an exclusive datacasting standard."

*Public Knowledge, Consumers Union and Consumer Federation of America wrote:*

"The Consumer Group Coalition supports the commission's goal of promoting digital audio broadcasting and believes that attractive DAB services can expand the radio marketplace. Precisely because we support this goal, we argue here that the commission must forbear from imposing copy-protection/content-protection technologies on free over-the-air radio broadcasting and/or on consumer devices built to receive such broadcasts.

"There is no case for saddling digital radio broadcasting with technological

wise legal devices and lawful home recording. As such, this request centers on copyright law and policy, which are beyond the jurisdiction of the commission. To put the matter plainly, the commission has no authority to halt activities that Congress and the courts have established as lawful. Nor does the commission have the jurisdiction to mandate that copy controls be built into DAB devices.

"Properly, this proceeding should focus on digital audio broadcast standards and development; it should not be diverted by misconceived fears of copyright infringement."

*Leonard Kahn, president of Kahn Communications Inc., wrote:*

"It is the opinion of the undersigned that this decade-long Rulemaking as it pertains to AM broadcasting should be expeditiously terminated and the commission should permit the awesome power of free competition to complete the job. ...

"The basic conclusion of this submission is that the FCC should immediately issue an order permitting all AM stations to implement any form of improvement they believe will permit them to better compete with FM, with a single limitation, that said improvements do not create additional interference to other licensees.

"Without the commission seriously considering a single competitive IBOC system, the commission has encouraged AM broadcasters and radio receiver manufacturers to adopt the patented IBOC system "under investigation" (IBOC-ui), that has only been tested on a handful of stations, (only 30 AM stations, some of which have turned the system off after a few days of operation), all of these stations cannot work after sundown and all of them create enormous co- and adjacent

will not eliminate either groundwave or skywave analog broadcasts. (Ibiqity) tests indicated that there is a potential for an impact to groundwave analog service outside a station's primary coverage area; however, this should not have a significant impact on the majority of a station's listeners. The potential impact on analog skywave service is somewhat harder to predict due to the variable nature of skywave service. The tests indicate that nighttime AM IBOC may reduce the availability of the analog skywave signal but it will not eliminate the service. ...

"Ibiqity has licensed every entity that has sought a license to manufacture a product incorporating HD Radio technology. ... Based on Ibiqity's existing licensing process, it would be extraordinary and unnecessary for the commission to take any action on this topic. ...

"Ibiqity agrees with the commission's concern that the digital signal for stations with low analog power may fall below the noise floor. Particularly in areas with terrain obstructions or high noise levels, the extremely low power of the digital signal may limit digital coverage.

"Ibiqity recommends that the commission implement procedures to authorize digital operations at levels exceeding 20 dB below the analog signal where needed to overcome coverage limitations. Any increase in digital power levels, however, may raise concerns about the impact on adjacent channel stations.

"Because there has been insufficient field work completed on higher digital power levels and any potential increase in adjacent channel interference, Ibiqity believes it would be difficult for the commission to establish a minimum power level for the digital signal at this time. Instead, Ibiqity recommends that the commission allow stations to adopt higher digital power levels upon an adequate showing that the proposed power level will not cause incremental harmful interference to adjacent channel operations.

## AM IBOC may reduce the availability of the analog skywave signal but it will not eliminate the service.

— Ibiqity Digital

"(T)o enhance multicasting options, the commission should afford broadcasters the flexibility to assign data rates between main and supplemental audio services as appropriate.

"This will give broadcasters the freedom to develop and deploy a range of digital audio services and to adapt those services in response to consumer interest and demand. In addition, the commission should permit the deployment of alternative audio codecs (in addition to Ibiqity's HD Radio "HDC" codec) for the transmission of supplemental audio services.

"Microsoft further agrees that the commission generally should 'adopt a flexible policy permitting radio stations to produce and distribute any and all types of datacasting services.' The adoption of the Ibiqity IBOC transmission and coding architecture for digital *audio* service does not necessitate

restrictions. Furthermore, unnecessary restrictions on DAB technologies will harm the development of innovative DAB products and delay consumer adoption of the technology.

"Although the Consumer Group Coalition respects the commission's desire to conduct a preliminary investigation of any possible problems associated with DAB and copyright infringement, we argue here that there is no evidence that radio broadcasts are a significant source of infringement. Nor is there evidence that DAB poses any threat to the music industry distribution model. Thus, there is no support for the claim that DAB presents a problem requiring a copy-protection technology mandate, or any content-related technology mandate. ...

"The RIAA request for regulation seeks what would effectively be a ban on other-

## This proceeding should focus on digital audio broadcast standards and development; it should not be diverted by misconceived fears of copyright infringement.

— Public Knowledge,

Consumers Union and Consumer Federation of America

channel interference during the day. ...

"KCI has commitments with a number of public-spirited broadcasters to accept Cam-D equipment temporarily absent the high fidelity (8 to 15 kHz extended audio response) so that they and the listeners they serve do not have to wait for the development of a new integrated circuit which, at best, will take 8 to 10 months to get into full production. This will permit the mass production of 8 kHz limited radios with 10 data channels; three of the channels will be devoted to homeland security service, and the remaining 7 channels for scrolling news, road conditions, identification of the station and the name of the music being played, etc. ...

The name of this new AM system will be PTA-Cam-D System which stands (optimistically) for Pre-Type Approved Cam-D System."

*Ibiqity Digital Corp. wrote:*

"The introduction of AM IBOC at night

"This will allow the commission to assess geographic separation, terrain and other factors that may decrease concerns about adjacent channel interference. ... Ibiqity also recommends that these authorizations be implemented as part of the station license rather than as experimental or special temporary authorizations. ...

"LPFM stations should have the option to convert their operations to digital broadcasts.

"HD Radio system equipment can operate at the power levels authorized for LPFM service. In the case of 10-watt stations, however, the extremely low power level of those stations may make digital broadcasts infeasible. ...

"In the case of a 100-watt LPFM station, it is more likely that the digital signal will be recovered by a receiver. Because these LPFM stations are required to comply with the commission's adjacent-channel interference restrictions, the introduction of digital broadcasts by these stations should not create harmful new interference." 

### Control Solutions

#### Model RFC-1/B Remote Facilities Controller

- control transmitter from any telephone
- 8-64 channels of telemetry and control
- programmable control by date and time
- optional printer and modem adapters
- programmable telemetry alarms
- integrated rack panel



#### Model RAK-1 Intelligent Rack Adapter

- parallel printer interface
- internal modem for data transfer
- front panel status indicators
- battery backed power supply
- rack mountable chassis
- accessory package for RFC-1/B



 Sine Systems, inc.

615.228.3500

more information: [www.sinesystems.com](http://www.sinesystems.com)

# Workbench

Radio World, August 11, 2004

Past columns are archived at [www.rwonline.com/reference-room](http://www.rwonline.com/reference-room)

## Condition Air Without Losing Your Hair

by John Bisset

Here's an inexpensive add-on that will help you sleep at night and enjoy long weekends without the panic call of a flood in the studio.

Winland Electronics was founded in the early 1970s manufacturing sensors and alarms for Minnesota farmers and businesses. The company has grown to 120 employees and is known among the security industry as the "environmental security specialist."

When a film of water forms a bridge between the sensor contacts, the unit triggers the alarm output. Fig. 2 shows the contacts on the bottom of the WaterBug.

The unit will not false trigger on condensation or high humidity. If you need to monitor those parameters, Winland Electronics builds a different sensor. You can read about these products on its Web site, [www.winland.com](http://www.winland.com).

The WaterBug can warn of a leaking roof or water ingress past a door. Place one

in San Antonio tells about a little episode.

Seems he was moving a little 5 kW transmitter to another site. The one-inch conduit that contains the three-phase power needed to be removed as well. The conduit led from an 8x8 duct about four feet above the floor. The conduit went up the wall, close to the 10-foot ceiling. It ran horizontally at this point for about 12 feet, then down about five feet to the top of the transmitter — basically your standard elec-

side. The penetrations are mated to conduit that leads to a transformer and his emergency generator transfer switch.

As it turns out, the path is a nice "air duct" leading into the transmitter room. Near the ceiling, about two feet from the conduit, is a ceiling-mounted air conditioner. The duct was blowing very cold air directly on the one-inch conduit.

The result was the interior of the conduit "breathes" very humid San Antonio air, which in turn was condensed by the air conditioner. The conduit sagged a little and filled with water. Paul had no indication of moisture in the top of the transmitter.



Fig. 1: The WaterBug warns of leaks by connecting to your remote control.

Among the company's products is the WaterBug, electronic water detection at its best. Bill Bracken at Infinity Boston's WBCN(FM) has one tied to his remote control in his transmitter room.

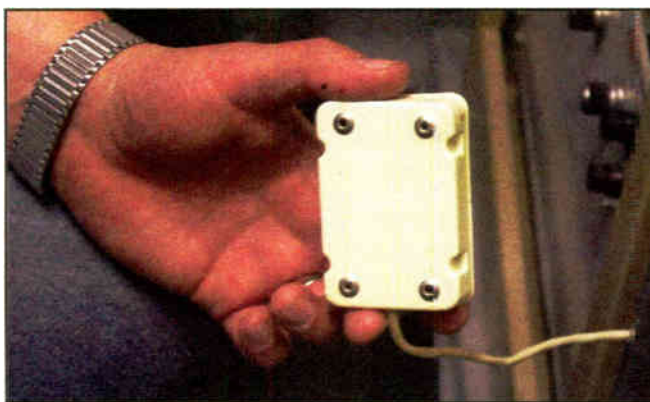

Fig. 2: Four contacts sense the presence of water and trigger the system alarm.

in the condensate drip pan of your air conditioner to warn of a condensate drain stoppage, as shown in Fig. 3. Add a WaterBug and you're doubly protected; the pan catches any leaking water, while the WaterBug alerts you to the problem.

Thanks to Bill Bracken for sharing this idea.

\*\*\*

While we're on the subject of air conditioning, Paul Reynolds with the Cox clus-

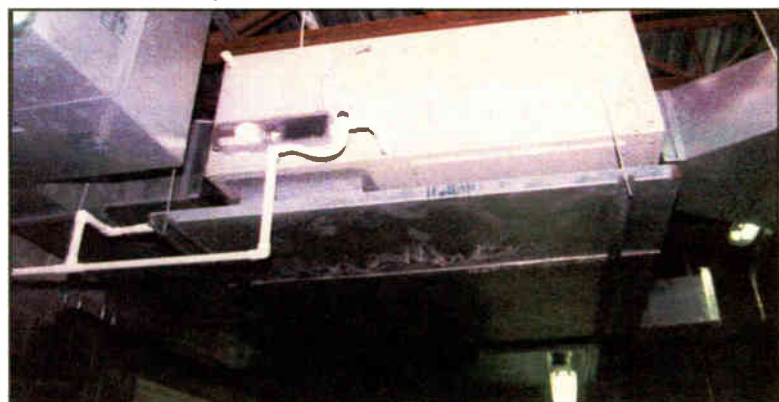

Fig. 3: A pan beneath the air handler guards against condensate drain overflow.

trical conduit run.

As Paul was removing the conduit adapter and a coupling, he got a surprise. About a quart of ice-cold water started running down his arm! Fortunately, all power was off.

Keeping in mind that both ends of the conduit were open, Paul couldn't imagine where the water was coming from.

After some investigation, Paul noticed that the 8x8 trough is on an outside wall, and that there were a couple of two-inch penetrations through the wall to the out-

The lesson learned here is to beware of what cold and humid air will do when they meet. Thanks, Paul, for sharing this unusual problem.

Paul Reynolds can be reached at [paul.reynolds@cox.com](mailto:paul.reynolds@cox.com).

John Bisset has worked as a chief engineer and contract engineer for more than 30 years. He is the northeast regional sales manager for Dielectric Communications. Reach him at (571) 217-9386, or [john.bisset@dielectric.spx.com](mailto:john.bisset@dielectric.spx.com).

NEW!

PREVENT LIGHTNING DAMAGE!  
IMPROVE RELIABILITY!  
STAY ON THE AIR!

**NEW!** PowerClamp surge suppressors prevent lightning-induced AC spikes and surges from damaging your equipment!

PowerClamp virtually eliminates the transients, surges, and waveform distortions that cause transmitter and studio gear failures, computer lockups, and unexplainable malfunctions.

PowerClamp will protect your investment and keep you on the air!

For user testimonials and detailed information, visit [www.henryeng.com](http://www.henryeng.com) or contact any Henry Engineering dealer.

**POWERCLAMP**  
Tel: 626-355-3656

GUEST COMMENTARY

# Voice of America Imperiled

by Alan L. Heil Jr.

*"Radio, if it is to serve and survive, must hold a mirror up to the nation and the world. The mirror must have no curves, and be held with a steady hand."*

— Edward R. Murrow

Murrow's statement as warclouds gathered over Europe in the late 1930s, might well apply today to the nation's largest overseas network, the Voice of America. The situation at the Voice is deteriorating quickly, despite steadfast efforts on the part of its professional staff to retain its place as a globally respected source of news and information about Middle East, U.S. and world events.

VOA News Director Andre de Nesnera was transferred from his position to senior diplomatic correspondent of VOA July 1 by VOA Director David Jackson. This was no routine personnel move. De Nesnera is an award-winning journalist who had been a steadfast shield against efforts of the politically-appointed director over the past two years to second-guess VOA news copy, particularly on Iraq. No VOA chief executive has taken such a hands-on approach to the newscasts in at least half a century.

De Nesnera's removal occurred just four days before 450 employees of the Voice (managers, journalists, producers and engineers, about half its staff) circulated a peti-

tion on Capitol Hill calling for an investigation of the Voice's oversight board, the U.S. Broadcasting Board of Governors.

## Shadow of itself

The BBG since 2002 has:

Closed VOA Arabic and replaced it with Radio Sawa, a 24/7 pop music service aimed at youth, rather than intellectuals, government leaders, educators and movers and shakers in Arab society;

The inevitable consequence of these reductions (some of which were made to reprogram funds for the Board's new Radio Sawa and Alhurra TV services) is to weaken significantly the Voice of America's reach around the world.

In technical as well as programming terms, VOA is being reduced to a shadow of its former self — especially in the Middle East.

Board member Norman J. Pattiz, chair-

## Small wonder that the VOA staff has called for a congressional investigation of the Board and its oversight of the Voice.

Reduced VOA's global English service from 24 to 19 hours a day, with more cuts to come next October on the eve of the U.S. presidential election. VOA can barely be heard in the Middle East in English as a result of these cuts and it will get worse: there will be only 14 hours on the air daily next winter.

Abolished 10 VOA language services to central and eastern Europe last February 14: Estonian, Latvian, Lithuanian, Polish, Hungarian, Romanian, Bulgarian, Czech, Slovak and Slovene.

man of its Middle East subcommittee, wasted no time after Sawa went on the air on March 20, 2002 in ordering reallocation of VOA frequencies in the region to enhance his pet project. He directed the powerful 500 kW Kuwait and Rhodes medium-wave relay stations to serve only Sawa in Arabic, 24/7. That meant that VOA English, Persian and Kurdish had to rely solely (at least for nearly a year) on less accessible shortwave transmissions to reach their listeners. This was also the case on the Kuwait facility for RFE/RL's Persian Service and its in-depth Arabic language program, Radio Free Iraq.

In 2003, however, a much weaker medium-wave transmission (105 kW) was added in Kuwait to broadcast parts of VOA Persian, VOA English and Radio Free Iraq.

## No more RFI

The Board, meanwhile, abolished RFE's widely listened to Persian Service (Radio Azadi) on Dec. 1, 2002, and replaced it with a Persian-language pop music sibling of Radio Sawa named Radio Farda. Farda also was given a place on the weaker Kuwait medium-wave frequency, and has gradually been able to increase its substantive news content. But unlike the old RFE Persian Service, it was given a 24/7 schedule on shortwave which still consists of about two-thirds music.

trial FM facilities in the Arab world to get Sawa's signals out there in FM and medium-wave — much more popular among listeners than shortwave.

VOA Arabic was on the air 7 hours a day. Sawa is on 24/7. VOA Arabic cost the taxpayer \$4 million in its final year; Sawa cost \$34 million in its first year.

Most surprisingly, perhaps, Pattiz insisted on the reallocation of many of those "scratchy shortwave" frequencies to Sawa, which devotes about three-quarters of its airtime to pop music. The Board also negotiated a contract for a 500 kW medium-wave transmitter in Cyprus, greatly enhancing Sawa's reach during nighttime hours into Egypt. (Egypt, unlike Jordan, Kuwait, Morocco, Djibouti and many of the Gulf emirates, so far has refused to permit Sawa to broadcast on a local FM frequency.)

## Time for action

In terms of expenditures, though, these radio initiatives are dwarfed by Pattiz's investment in U.S.-originated satellite TV in Arabic.

The Board launched Alhurra TV last Feb. 14, entering a field of more than 170 mostly indigenous channels in the Arab world. The first year cost of Alhurra ("The Free One," in Arabic) exceeds \$100 million, including \$40 million from a Department of Defense supplemental. Thus, in the current budget year, the Board is spending more than a fourth of its total budget for worldwide broadcasting on Sawa and Alhurra-TV.

The early returns on Alhurra are mixed. Although e-mails and some surveys have been favorable, there also have been criticisms of its professionalism in the region and in the West.

As one Lebanese-American editor in Washington noted, "The training wheels came off when Alhurra carried cooking and fashion shows during live coverage by Al Jazeera, Al-Arabiya and others of violence in Fallujah and during the Israeli assault on Rafah.

"It's ridiculous," the editor added, "and Alhurra was not being taken seriously during a recent visit I made to the region. There's nothing worse than not being taken seriously when you are a journalist."

Small wonder, then, that the VOA staff has called for a congressional investigation of the Board and its oversight of the Voice. That seems overdue. In the post-9/11 world, with anti-American sentiment at its peak, the nation has not a moment to

## Radio Free Iraq, the U.S. government's last really substantive radio voice in Arabic to the Arab world, will go off the air on Sept. 30.

(The Board decided, in launching Farda, to retain VOA Persian, but only three hours daily — strengthened a year ago with daily hour-long TV transmissions including call-in programs to Iran.)

Now, the Board is abolishing Radio Free Iraq, the U.S. government's last really substantive radio voice in Arabic to the Arab world. RFI will go off the air on September 30, at a time of great uncertainty in Iraq's transition and three months before the deadline for holding the first elections there.

It is true that VOA Arabic used to be on what Pattiz has called "scratchy shortwave" as well as medium-wave facilities before the service was abolished in 2002. The big (and costly) innovation has been in leasing terres-

lose in getting its international broadcasting to the Arab and Muslim worlds right. It can do so by reinforcing, rather than destroying, the time-honored principles of timely, accurate, objective and comprehensive reportage and programming to reformers in those countries yearning for a brighter day.

The author is a former VOA deputy director and author of "Voice of America: A History" (Columbia University Press, 2003). This text appeared on the Web site "Informed Comment: Thoughts on the Middle East, History, and Religion," www.juancole.com, and is reprinted with permission.

RW welcomes other points of view.

EXPECT MORE FROM YOUR AM TRANSMITTER



Armstrong Transmitter X-1000B

1KW HD Radio ready AM Transmitter for under \$10K

Built with dual hot-swappable 600 Watt RF modules capable of 150% modulation, X-1000B can bring that major market sound to your radio station. Engineered with the latest technological innovations, X-1000B offers high reliability, built-in redundancy and it is HD Radio ready.

Best of all, our customers tell us that the money they save running the X-1000B pays for itself with savings in electricity and

maintenance costs over an older transmitter ...and as a bonus they get exceptional reliability and that major market sound for free.

But, don't take our word for it. Talk to our customers already on-the-air with the X-1000B. Call or email for a users list and decide for yourself why owning this transmitter is a no-brainer.

**ARMSTRONG**  
TRANSMITTER CORPORATION

Tel 315-673-1269 / sales@armstrongtx.com / www.armstrongtx.com

HD Radio is a registered trade mark of iBiquity Digital Corporation.



# Rethinking DAB North of the Border

## The Big Picture

*Canada Considers Subscription Radio Services, Including Eureka-147 Terrestrial Broadcasting*

by Skip Pizzi

Canada has been a long and strong supporter of the Eureka-147 DAB format for its transition path to digital radio. The country's plan has been to replace AM and FM broadcasting eventually with an equivalent number of Eureka channels in the international L-band DAB allocation of 1452-1492 MHz.

Deployment has been steadily implemented over the last several years, and DAB operations now serve several major metro areas across the country with simulcasts of selected local AM and FM channels. (At last count, there were 25 active DAB channels in Toronto, 15 in Vancouver, 12 in Montreal, six in Windsor and four in Ottawa.)

The Canadian experience has been little different from other countries taking a pure simulcast approach, however. Despite substantial marketing efforts and on-air promotion, DAB has not been a strong seller to Canadian consumers to date, even though Canada has perhaps the lowest-cost DAB receivers available anywhere (<\$100 CDN, or ~\$75 US). As a result, DAB radios are not widely available, either at retail or as automotive options.

Canadian Satellite Radio or CSR, a joint venture of Canadian entrepreneur and former Toronto Raptors owner John Bitove Jr. and XM Satellite Radio Holdings. The other was submitted by the national public broadcast organization of Canada, the Canadian Broadcast Corp. (CBC/Radio Canada), in partnership with Sirius Satellite Radio and Standard Radio Inc. The latter is the Canada's largest commercial radio station group, with approximately 50 radio stations plus TV, online and program syndication properties.

Both the CSR and CBC proposals would leverage existing S-band (2320-2345 MHz) digital radio satellite services — XM's and Sirius', respectively — repackaged for Canadian audiences with somewhat different channel lineups than those currently offered by the two services in the United States.

CSR's proposes 101 channels, four of which would be produced in Canada, for a monthly fee of \$12.99 Canadian. CBC proposes 78 channels, with four produced by CBC, for a \$12.95 CDN monthly charge. In each case, the other, non-Canadian produced channels included in the

See DAB, page 18 ▶

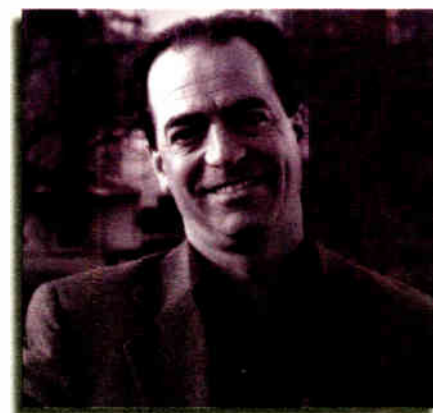

Photo: Gary Hayes, BBC

by Skip Pizzi

**By next year, digital radio in the Americas will likely have another important new aspect.**

Meanwhile, a significant gray market has developed for U.S. satellite radio receivers in Canada. Because over 75 percent of the Canadian population lives within 200 miles of the U.S. border, XM and Sirius satellite radio services have reasonable potential access to the market. For Canadian residents living within this spillover coverage area, all that is required to obtain either service is a U.S. billing address and a receiver.

**A proactive solution path**

In December 2003, Canada's Radio-television and Telecommunications Commission (CRTC, the Canadian regulatory equivalent of the U.S. FCC) issued a call for applications for multichannel subscription radio services. This was not so much in response to the lagging uptake of DAB as it was to unsolicited satellite radio proposals from U.S. satellite radio operators and some Canadian partners. (A policy aimed at thwarting growth of gray-market satellite radio usage was probably also involved.)

So it came as no surprise that once the CRTC issued this call, two proposals were soon received. One of these came from a newly formed company called



## AudioVAULT: Because you wouldn't drink from the other guy's mug.

Just because you sit in the same chair, it doesn't mean you have to work on the same screen as the other talent. Whether you're left- or right-handed, left- or right-brained, the latest AudioVAULT lets you create a custom interface that matches your workstyle. AudioVAULT enhances automation and content management with a second-generation CD ripper, true IP networking, enhanced quick-start pallets, and other new benefits including RDS and HD Radio data service integration. Now is the time to get serious about stepping up to the reliability of AudioVAULT.

Already own AudioVAULT? Contact BE for upgrade details.



Broadcast Electronics, Inc. • 4100 North 24th Street, P.O. Box 3606, Quincy, Illinois 62305-3606 U.S.A.  
Telephone: (217) 224-9600 • Fax: (217) 224-9607 • E-Mail: [bdcast@bdcast.com](mailto:bdcast@bdcast.com)

Broadcast Electronics, the BE logo and AudioVAULT are registered trademarks of Broadcast Electronics, Inc. HD Radio is a registered trademark of iBiquity Digital Corporation.

# DAB

► Continued from page 17

Canadian package would come from the regular menu of XM's or Sirius's offerings. Meanwhile, the Canadian-produced channels could also be offered to U.S. subscribers. Like much of Canadian radio, those services would include both English- and French-language content.

Canada's more northerly location would provide Sirius with some relative advantage, given its satellites' highly elliptical orbit (HEO) configuration, but the population distribution noted above would likely not significantly disadvantage XM beyond its performance in the northern tier of U.S. states. (Note also that the most highly populated part of Canada is actually *south* of the northernmost areas in the "lower 48.")

Current Canadian spectrum allocations will also allow terrestrial repeaters to use the approximately 9 MHz of spectrum they currently occupy within the 2320-2345 MHz band in the United States, without relocation of other services.

## A surprise late entrant

A third and final applicant for a Canadian subscription radio license is CHUM Ltd., another major Canadian commercial broadcaster (with 30 radio and eight TV stations), which submitted its proposal for CHUM Subscription Radio Canada (CSRC) in February 2004. In stark contrast to the other proposals, CSRC would use Eureka-147 terrestrial DAB for its service, adding conditional access and providing a 50-channel service initially — with plans for subsequent growth to 100 channels — for a \$9.95 CDN monthly subscription.

All of CSRC's content channels would be produced in Canada (the proposal is unique in its having no American partner involved), and because regular broadcast spectrum would be used, the service would be subject to the rule that all

Canadian terrestrial broadcasters must follow, which requires that approximately 35 percent of all mainstream music channels' content to be of Canadian origin. The satellite services are not subject to this rule, although the CRTC has solicited public comment on this and other policy matters for its upcoming rulemaking process for Canadian subscription radio.

## This approach could give Canadian radio broadcasters and consumers the best of both worlds.

Also unlike satellite systems, CSRC's service area would be more gradually scaled, starting in five major markets, and growing to 25 markets by the end of the first license term (10 years), which represents about 60 percent of total Canadian population.

Although CSRC is based on the standard Eu-147 format, with substantial reliance on single-frequency networks (SFNs) for efficient spectrum reuse, there are several variations contemplated.

First, the conditional access system might or might not be a standardized algorithm, but the addressable receivers used by CSRC would still pick up regular (free) DAB channels. CSRC radios might also include a card slot for adding removable memory for recording, as well as a RAM cache for live-pause and replay features.

But to achieve the service density required to allow a 50- or 100-channel subscription service to coexist with the current Canadian DAB plan for AM and FM service replacement, other changes are proposed by CSRC.

The least radical involves changing the current Canadian practice of using conservative data compression ratios in DAB (typically ~256 kilobits per second for stereo music services) to the current U.K. approach, in which about twice as much compression is used (~128 kbps for stereo). This is arguably about the lower

limit of acceptable quality for the DAB-standard's MPEG-1 Audio Layer 2 codec (although some observers feel it exceeds such tolerances). This change would be required at a minimum in order to achieve the 50-channel service level.

For the full 100-channel service, CSRC proposes either the use of a second, more advanced codec for subscription services

ly be granted licenses by the CRTC. But it is unclear whether market-size limitations or political considerations will cause the CRTC to eschew such full approval and select from among the proponents.

Another approach that has not been loudly voiced in Canada, but is clearly on at least some broadcasters' minds there, would involve the use of L-band DAB for terrestrial subscription services similar to the CHUM proposal, but instead of also using the band for AM/FM replacement, to shift that process to an IBOC solution.

This would allow homegrown Canadian subscription services to use existing DAB allocations without requiring increased compression, new codecs or spectrum extensions, and meanwhile provide a migration path for Canadian digital AM/FM replacement congruent to the process now beginning in the U.S. (Meanwhile, Canadian customers could also avail themselves of S-band satellite radio, either via continuing gray market access, or officially sanctioned processes.)

This approach could give Canadian radio broadcasters and consumers the best of both worlds — free and subscription, Eureka and IBOC — in North American digital radio. The party line in Canada is still overtly anti-IBOC, but numerous Canadian broadcasters nevertheless keep a watchful eye on IBOC proceedings in the United States.

In any event, by next year digital radio in the Americas will likely have another important new aspect.

*Skip Pizzi is contributing editor of Radio World.*

(similar to those used by satellite radio, which would provide another approximate doubling of spectral efficiency), and/or the allocation of a "modest amount" of additional spectrum beyond the current 1452-1492 MHz DAB band.

The CSRC proposal also implies an arrangement between CHUM and one or more telecom partners for use of broadband signal paths and towers to manage distributed L-band DAB transmitter networks across Canada.

## Next steps

The CRTC has closed the filing period for proposals, but continues to accept public comment until Sept. 15, 2004. It will hold a hearing on the subject Nov. 1, and may issue rules and license(s) in 2005. Because the three proposals are not mutually exclusive on a technical basis, all three could potential-

# LPFM

► Continued from page 5

technical study that has now been completed by Mitre and released by the FCC.

Even before Mitre initiated independent testing of alleged LPFM interference, other independent technical experts had concluded that third-adjacent-channel spacing is unnecessary. Notably included among these independent technical experts was Dr. Theodore Rappaport of Virginia Polytechnic Institute, who testified during hearings before the House Telecommunications Subcommittee in February of 2000.

Now, of course, Mitre Corp.'s testing has verified what the other independent technical experts, and the FCC's technical experts, had concluded earlier. Thus, LPFM is now a uniquely "triple tested" commodity.

There is still more evidence of a double standard for LPFM. Even during the FCC's earliest deliberations on LPFM, well before Congress became involved, "short spacing" of LPFM stations was never "on the table." Yet "short spacing" of full-power radio stations is common. The risk of interference is evidently considered too great for "short spacing" of LPFM stations, operating at 100 watts or less; but the risk is apparently considered acceptable for "short spaced" stations operating at thousands of watts. Why?

In the same legislation that mandated third-adjacent-channel spacing for LPFM, Congress mandated the independent study that is now contained in the Mitre report. Yet the same new statute also required that, even if no significant interference were found (which has now happened), the commission still could not

lift third-adjacent-channel spacing requirements on its own authority.

The most the FCC was allowed to do was prepare recommendations to Congress (which it has now done). This statutory requirement is yet another unprecedented intrusion into the FCC's discretion on technical matters, making LPFM the only form of broadcasting for which the FCC's authority has ever been restricted in this manner. Why?

In October of 2002, the FCC authorized "interim" broadcasts for IBOC digital radio. This action was taken despite public acknowledgements by FCC commissioners and staff, at the meeting that approved the order, that IBOC digital radio (or at least Iboquity Digital's version of it) can cause interference with some existing radio stations. This acknowledged risk of interference, as an inherent tradeoff for the asserted benefits, did not stop the FCC from approving IBOC swiftly and unanimously, with no negative reaction from Congress. Yet mere allegations of interference were enough to delay LPFM for years, after which it remained uniquely restricted. Why?

The Mitre report and the FCC's resulting recommendations offer Congress an opportunity to end the double standard that has hindered LPFM. This discrimination has been "arbitrary and capricious": unexplained, unjustified, unconstitutional and undeniable.

This year: Let's clear the air by playing fair.

*The author is an attorney, writer and president of Schellhardt Advocacy Services, which provides government relations advocacy and ghostwriting services. He is president of The Amherst Alliance and vice president for government relations and membership development with the National Antenna Consortium.*

*RW welcomes other points of view.*

## MEASURING THE DIFFERENCE in Digital Audio Cable Performance...



The critical link in digital audio interfacing, Gepeco 110Ω twisted-pair and 75Ω coax feature exacting impedance, bandwidth, and attenuation specifications to deliver low-jitter, minimal pulse rounding, and exceptional performance in high-resolution, digital audio systems.

- Precision 110Ω or 75Ω Impedance
- 25MHz Bandwidth for 192kHz Sampling Rates
- Low-Jitter
- Minimizes Pulse-Rounding
- Multi-pair Designs up to 24 Pairs



**GEPACO**  
INTERNATIONAL, INC.

TRANSMITTING CLARITY

www.gepeco.com email: gepeco@gepeco.com

800.966.0069

**SUPPLY SIDE**

**Pulsecom**

"Supply Side" is a new series of articles about radio broadcast suppliers you don't know, and facts you don't know about companies you do. This Q&A is with Pulsecom's Director of Marketing Dave Corp.

**What does your company do?**

Since 1963, Pulsecom has designed and manufactured telecommunications equipment for many of the world's largest phone companies. Some of our equipment is used to provide the link between telco buildings and businesses to support voice and data services. However, until we teamed with APT in 2001, Pulsecom did not offer high-quality "Program Audio" equipment that's been used by telcos for radio station applications.

While APT's apt-X algorithm was in widespread use, telcos continued to offer antiquated analog amplifiers and J.41 compression equipment. What was lacking was a product that could take advantage of apt-X quality and yet "fit" within the existing telco network. The APT/Pulsecom Program Channel Access Unit, or PCAU, is the first such product. The result has permitted stations to dramatically improve quality of studio-to-talent and STL links, and enabled telcos to provide Program Audio to sites that could not be reached in the past.

**What do engineers ask about it?**

Frankly, the unit's pretty transparent. We are asked "What's the compression scheme?" Invariably, engineers are pleased when they learn it's apt-X. Engineers also ask how to order PCAU-based service from their telco, which can sometimes take a few days to track down. It's an important question, though, because if stations don't ask for the PCAU, telcos may economize by re-deploying existing J.41 gear.

**You have a stereo version?**

"Phase matching" between left and right channels assures optimum audio quality, as Radio World readers are no doubt aware. For example, the ANSI T1.505 spec requires that left and right channels be phase matched to within 3 degrees to assure excellent stereo broadcast quality.

Earlier technologies used by telcos for program channel circuits assumed left and right channels would be transmitted through the same equipment ("channel banks") and, in addition, that the routing of left and right channels through the network would be identical. There was lots of opportunity to build up a 3 degree phase difference.

PCAU's used for left and right stereo channels are linked with a special stereo synchronization cable and incorporate digital buffering circuitry to lock the channels together to help assure public network topologies won't degrade stereo performance.

**What would an STL setup cost?**

A very interesting question! To the best of my knowledge — certainly for all of this year — Pulsecom has only sold PCAUs for telephone company use. That means stations don't generally need to buy the PCAU, just order digital program service from their telco. The telco would purchase the required PCAUs and bill the station the tariffed rate for program channel service.

It's similar to ordering a regular phone line; the phone company buys and owns the equipment as well as the telephone wire or fiber optic cable facilities required to make a phone interface connection available at a premise.

**Stations among early users?**

WQXR(FM) in New York and a number of Clear Channel locations.

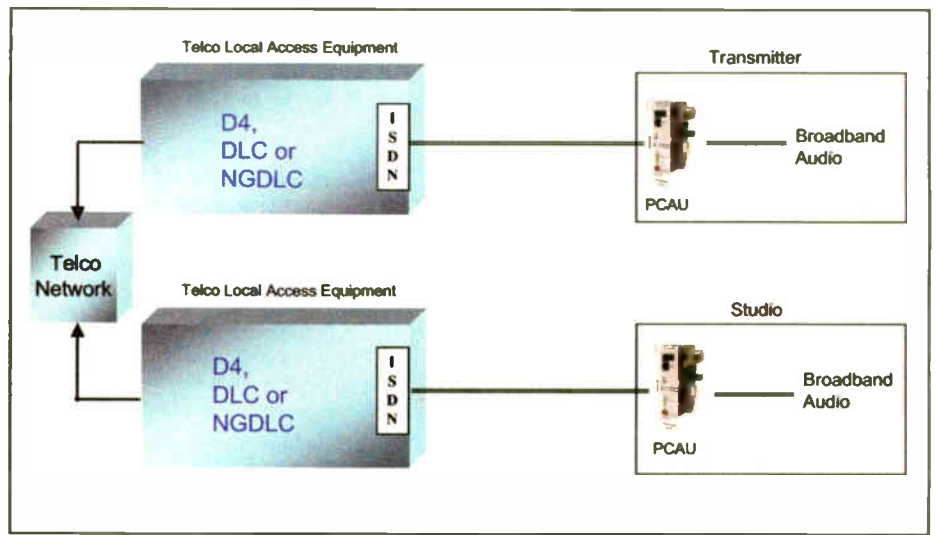

A typical network application is shown.

"Logitek gives me the capabilities I want."



- First Broadcasting Console Configurations**
- 2 Logitek Audio Engines, networked
  - 6 analog I/O cards  
72 inputs & outputs
  - 4 digital I/O cards  
32 stereo inputs & outputs
  - 2 SharcAttack multi-DSP processing cards for EQ, dynamics processing and more
  - 2 Numix-12 consoles

*"For audio consoles, I always choose the Logitek Audio Engine with the Numix control surface."*

I believe it's a product that gives a lot of bang for the buck. Its mix-minus capabilities and ease of use make it a real winner, and it looks great. We have used this board in both on-air and production rooms in many radio, TV and Webcasting facilities in two states, and I have never had any off-air time, EVER!"

— Jay Rose, CE  
JRBE Inc.

Logitek Electronic Systems, Inc.  
5622 Edgemoor  
Houston, TX 77081 USA 713.664.4470 800.231.5870 www.logitekaudio.com

**Logitek**  
Console Router Systems

©2004 Logitek Electronic Systems, Inc.

**Info**

Company: Pulsecom  
Headquartered: Herndon, Va.  
Employees: ~100  
Ownership: Subsidiary of Hubbell Inc. (NYSE: HUBB)  
To learn more: www.pulse.com or Dave Corp at (703) 471-2908

## TECH TIPS

# Fun and Learning With Codecs

by Stephen Poole

Most of what has been written about digital broadcasting has focused on things like RF power level and coverage area. Rather than rehash all that, I'd rather have some fun. Let's use our ears and some free files from the Internet to make some important points about digital audio in general.

Fire up the Web browser and head first to [www.vorbis.com](http://www.vorbis.com). Download the Ogg-Vorbis tools. Next, head over to [flac.sourceforge.org](http://flac.sourceforge.org) and download the Free Lossless Audio Codec. Your last stop will be [www.speex.org](http://www.speex.org), where you'll snag the Speex voice codec. Finally, you'll need some Plain Jane, non-compressed WAV files from your audio workstations.

Standard non-compressed WAV files are bit-for-bit representations of the original audio. If you encode a WAV with one of these tools, then decode back to a WAV and listen to the final result, you'll get a direct idea of what might be "lost" in the process. You can do this at any desktop computer with a decent sound card and speakers.

## Misperceptions

Your first experiment will prove that it's a bad idea to compress the audio excessively across several stages in an airchain.

Encode and decode various WAVs with Vorbis and Speex. Take the results and encode/decode them again, then a third time. This can happen when files

are, say, stored in MP3 to the hard drive, then re-compressed over an STL, then encoded one final time in an IBOC transmitter. The final result at the listener's end will not sound very good.

But on the other hand, many engineers seem to think that any kind of size or bandwidth compression automatically results in a loss of fidelity. That's not so, and you can prove it with FLAC — the Free Lossless Audio Codec. The output is identical to the original, even though the compressed file may be several times smaller.

To get really aggressive compression, though, we do have to discard some information, using a so-called "lossy" codec. This is where more misinformation has been promulgated.

Many engineers seem to believe that a lossy codec can't possibly sound as good as the original. That may be true from a purely technical standpoint; but the fact is, most people cannot hear the difference with a very good lossy codec like Vorbis or AAC.

It doesn't help that false and misleading information has been circulated about

stereo signal, ignoring the weaker channel for that instant. The codec can degrade the softer channel for a very brief moment to save bandwidth.

Incidentally, that last one raises an interesting possibility. Suppose a satellite provider sends two separate programs down the same channel, one on the left, the other on the right. (A common thing, is it not?) If he uses a lossy stereo codec, he's going to get masking. A hollering preacher on the left channel could cause a severe degradation in the right channel! Things like this have to be kept in mind; for example, you'd choose a "Dual Mono" setting on your Zephyr Xstream for something like this, rather than true stereo.

To prove this one, use an audio editing program to create a stereo WAV with one channel much louder than the other. Encode with Speex or Vorbis, then decode and play it back. Listen to each channel separately. The "softer" channel will sound worse.

Now for one final experiment. You'll need a few WAV files in identical mono and stereo versions. Encode these with Vorbis and look at the encoded file sizes. Don't be surprised that the mono files are larger; stereo gives the codec more opportunities for masking, as just discussed.

Have fun with these tools and come up with some experiments of your own.

For example, while you need a special test rig to do this properly, you can get an idea with a very good audio editing program. Line up the original waveform with the encoded-decoded waveform in two different tracks. Make one of them out of phase with the other track. Carefully position them and adjust the amplitude so that they cancel out as much as possible. If you could do it perfectly, whatever you heard would be the changes introduced by the codec.

One thing is for sure; even after several generations of encode/decode using any decent codec, it'll never begin to approach 92 percent.

*The author is chief of Crawford's Birmingham, Ala., cluster, with 25 years of experience as an engineer.*

*This was adapted from an article that appeared in Crawford Broadcasting's Local Oscillator newsletter.*

Let's use our ears and some free files from the Net to make important points about digital audio.

How do lossless codecs work? The complete answer would fill a textbook, but to give you an idea, Kurzweil pioneered one approach back in the 1980s with his delicious-sounding music synthesizers. A waveform can be approximated with a stored formula, with corrections applied on playback. Other methods use standard tables — "play waveform #3 with these corrections, followed by waveform #37 with this modification."

You can also save on size by only sending the changes from one moment to the next, rather than absolute values. Variable bit rates can be used, too.

lossy codecs. For example, in this very publication a few months ago, one writer said something like "compressing a file down to 8 percent of its original size means that we're throwing away 92 percent of the original." That's just not true!

We can prove this with the Speex tools on some voice files. That's what it's optimized for and it's amazing. Even with the default settings, you can compress a WAV voice file by as much as 30 times(!). When you decode and play it back, you'll be surprised at how good it sounds. Nowhere near "92 percent of the original" has been lost, even though it may have been compressed to less than 5 percent of the original size.

## Make your own

What gets the audiophiles in an uproar is the use of "psychoacoustics" by lossy codecs; but this, too, is often misunderstood. Some errors can be masked by adding a brief, small amount of noise. The codec also can take advantage of the fact that your ears will tend to focus on a very loud sound in one channel of a

## STATION/STUDIO SERVICES

BACK-TO-SCHOOL SAFETY • SHOP HOMETOWN MERCHANTS • FARM SAFETY WEEK • MORE!

WE PROVIDE *Ready-to-Air* Business BOOSTERS. YOU PRESENT THEM TO CLIENTS....



...AND BUSINESS GETS BETTER!

Something New to Sell Every Month!

HOLIDAYS • SEASONAL EVENTS • FRESH IDEAS!  
RETAIL SALES BOOSTERS • SAFETY CAMPAIGNS

30- and 60-second features

GRACE BROADCAST SALES  
Toll-free 1-888-472-2388  
Sound Ideas for Building Business™

FREE DEMOS & SALES TIPS!  
[www.gracebroadcast.com](http://www.gracebroadcast.com)

# 9/11

## WE WILL NOT FORGET.

FREE FEATURES AVAILABLE NOW

[www.gracebroadcast.com](http://www.gracebroadcast.com)

### 100% Royalty-Free Commercial Production Music

Buy any single CD for \$39.  
Get any 4 for \$99.  
Get 8 for \$169.  
Get all 16 for \$299.

Complete track listings and demos are online at [www.radio-mall.com](http://www.radio-mall.com) or call 1-800-759-4561

## ATTENTION PROVIDERS!

Promote your services to **Radio World's** readers. Reach Radio Station and Recording Studio owners/managers and engineers with your message.

For information on affordable advertising call **Simone** at 1-703-998-7600, ext. 154.

## Cool Commission

Radio World Editor Paul McLane and Associate Editor John Casey visited the FCC to present a Radio World "Cool Stuff" Award to Wireless Telecommunications Bureau Chief John Muleta, Deputy Chief Jerry Vaughan and FCC staff. Award judges gave the commission an honorable mention for its informative and fun booth at the spring NAB convention.

From left: David Solomon, Ruban Marchiani, Dorothy Conway, Cecilia Sulhoff (obscured), Linda Sanderson, Jerry Vaughan, Ruby Hough, Pat Rinn, Debra Klein, Robert Ratcliffe, Robert Somers, George Dillon, Tom Nessinger, Steve Markendorff, John Chudovan, Will Carroll, Brian Carter, Paul McLane, Ronnie Wauls, John Muleta, Dan Rumelt, Bobby Brown, John Casey.



Photo by Bob Kovacs

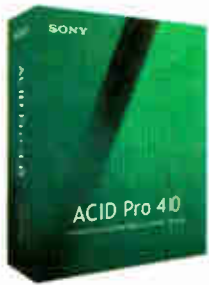

# GET GEAR HERE



**CALL TODAY. TALK TO A PRO.**



**800-356-5844**

MICROPHONES HEADPHONES MIXERS CD PLAYERS DIGITAL RECORDERS SIGNAL PROCESSING AMPLIFIERS SPEAKERS KEYBOARDS GUITAR EFFECTS VIDEO LIGHTING STANDS CASES CABLES SOFTWARE AND MUCH, MUCH MORE

VIDEO LIGHTING STANDS CASES CABLES SOFTWARE AND MUCH, MUCH MORE



# WANNA TRADE?

**\$500** TRADE-IN CREDIT on ANY CONSOLE  
TOWARDS an AUDIOARTS R-90\*

\* Larger \$\$\$ Trade Credit on Select Models - Call SCMS for Details

## Audioarts R-90 - The Streamlined Audioarts Console

### FEATURE LIST:

- dual phone caller support
- Wheatstone's reliable SimplePhone® circuitry
- true modular construction
- electronic switching throughout
- LED illuminated switches throughout
- extensive control room monitoring
- dual studio support
- dual headphone support
- external power supply
- failsafe power option
- 23 input/accessory positions
- one master module position
- two monitor module positions
- digital timer (manual and auto restart)



- digital clock (reads ESE time code)
- cue speaker with built-in amplifier
- conductive plastic faders and monitor pots
- connectorized faders and channel ON/OFF switches
- steel construction
- concealed headphone jacks
- countertop installation

**CORPORATE  
SALES OFFICE  
Pineville, N.C.**

**Call: BOB, MIKE  
ERNIE or MATT**

**Toll FREE 1-800-438-6040  
Fax 1-704-889-4540**

e-mail [sales@scmsinc.com](mailto:sales@scmsinc.com)  
[www.scmsinc.com](http://www.scmsinc.com)

Mid-South Sales:  
**Bob Mayben**  
Voice: 877-391-2650

West Coast Sales:  
**Doug Tharp**  
Sales: 866-673-9267

South-Atlantic Sales:  
**Art White**  
Sales: 770-632-1295

Central Sales:  
**Bernie O'Brien**  
Cell: 731-695-1714

Mid-West Sales:  
**Mary Schnelle**  
Sales: 1-800-245-4307

North-East Sales:  
**Jim Peck**  
Sales: 315-623-7655



# Teach an EAS Class at Your Station

by Clay Freinwald

*The author is the SBE EAS Committee Chair.*

When was the last time you taught an EAS class at your station?

If your facility is like most, the answer is likely to be seldom or never. Consider the following:

EAS is often poorly understood (a warning sign);

EAS is about saving lives (something we should all be interested in);

EAS is a hot-button item when it comes to FCC inspections (remember the Boy Scout motto).

If you are not in "Tornado Alley," where the EAS is used perhaps all too often, EAS is in many ways like fire drills and CPR training: If you don't teach it and have regular refreshers, the knowledge base will slowly dwindle away.

Consider, then, establishing a routine of teaching EAS to new hires and offering a refresher course to your engineering and programming staff on a regular basis.

Following are some guidelines that will help you with your course:

## Materials

**Part 11 of the FCC Rules** — It's a good idea to thoroughly read these prior to teaching your class. Make sure there is a set handy for reference.

**FCC EAS Checklist** — This is the one that an FCC inspector might use; also great for checking your ability to pass the next inspection.

**Your State EAS Plan** — This describes how your state EAS system works, as well as how the local areas fit into the big picture.

**Your Local EAS Plan** — How local, county or city authorities can utilize EAS.

**Your Monitoring Assignments** — This is a list of sources of EAS messages that you need to have connected to your EAS decoder. These "assignments" are usually created by your SECC and may well be part of an FCC inspection.

**EAS Operating Handbook** — This is the FCC book dealing with EAS procedures; you should edit the text in this to make it more applicable to your location/station.

**Custom Instructions** — These are readily-available written instructions for dealing with EAS, whereby anyone would be able to understand what to do in the event of receipt of EAS messages and/or tests when there is no one around to ask.

Go through the materials and explain how each item relates to the operation of the EAS at your facility and, for future reference, where the materials can be found. (It's a good idea to have these in clearly labeled binders on a shelf where all can find them)

## Major course outline items

**Purpose** — Explain how EAS has two facets:

FCC required — national level participation, presidential messages, etc.

Voluntary — state, local and weather messages

**Priorities** — How the national level is #1, etc.

**Sources** — How EAS messages are generated by a governmental entity whose responsibility it is to issue a public warning message

**Distribution** — How the EAS messages get from their sources to your station:

National level distribution, PEP stations, etc.

State relay network

Local relay network

NOAA weather radio

**Your Connections** — Whom you are monitoring and what their role is in getting the various sources of EAS messages to your station

**Broadcasters' Role** — To relay the EAS message from their governmental source to your listeners (not generate messages)

**Event Codes** — The different events or situations where EAS could be used. Be sure to cover the important ones, explaining your stations actions for each. For example:

EAN — Emergency Action Notification, the required national use of EAS

EVI — Evacuation Immediate, a life-saving message

CEM — Civil Emergency Message

TOR — Tornado Warning

CAE — Child Abduction Emergency/Amber Alert

There are many other event codes that may be used in your state or area. Check the list in Part 11 of the rules to see which ones are applicable to your area.

**Operating During an Emergency** —

How a national level activation "takes over" your programming

How other EAS uses are voluntary

**Decoder Programming** — What event codes your EAS equipment is programmed to respond to and which ones it will ignore. (Note: this may well require a meeting with management or programming prior to the class to establish a company/station policy for dealing with each event.) Pay close attention to unattended operation periods.

**Participation Policies** — What your station will do upon receipt of an EAS message, a review of written procedures. It's important that all understand that each station can choose how it wishes to deal with various event codes and therefore each station may well be different.

**Repeat or Relay** — Which events your station must relay (for the benefit of others downstream) and which you may simply use as information inserted into your normal programming

**Equipment Operation** — How the EAS encoder/decoder works. There are several makes and models of EAS equipment; each is different. Plan on spending time demonstrating how the equipment works for each of the events that your station will be dealing with.

**Testing** —

RMT — Required Monthly Test, where it comes from and how it must be forwarded

RWT — Required Weekly Test, the test of your encoder

DMOs and other tests — How other tests are used to verify the performance of the system.

**Logging** — The importance of logging EAS activity, specifically RMTs, RWTs,



as well as real EAS Messages

The EAS is becoming an increasingly vital element in our nation's public warning system. It's not enough to just install the required equipment; a well-trained staff is needed as well. This is where you come in. Feel free to customize this outline to fit your situation, it is only meant as a starting place.

Good luck with your class. Let me know how it goes.

*The author, a corporate engineer with Entercom based in Seattle, is chair of the National SBE EAS and Washington State EAS Committees. He travels the country speaking about EAS and will be in Colorado Sept. 13 with his class "Beyond Part 11: Making EAS Really Work."*

E-mail him at k7cr@wolfenet.com.

## Clear Channel

► Continued from page 1

"They will begin to buy equipment quickly and we will get a portion of that business," said Tim Bealor, vice president of RF systems.

Ibiquity has licensed 300 stations for its HD Radio technology. Roughly 126 were on-air as of July.

Harris' new Radio Transmission Business Unit is showing a "significant increase in FY '05 numbers" in anticipation of selling more digital radio equipment this year, said Tom Jones, director of radio transmission products. "It's a huge boost to us and we're excited."

Clear Channel is also considering HD Radio equipment from Nautel.

Jeff Littlejohn, vice president of engineering for Clear Channel Radio, said the company hopes to convert 50 stations by the end of this year. It's focusing on the top 100 markets, and hopes to have 95 percent of those conversions completed within three years.

The company is not dedicating a special roving team to conversions; rather, its 10 regional vice presidents of engineering likely would each be responsible for 10 station conversions.

"They'll be in charge of making sure the right products are ordered. In most cases, they'll do the work" of the install, Littlejohn said.

The company is still deciding which stations to convert. It has nine stations on the air with a digital signal now: KIOI(FM), San Francisco; KIIS(FM), Los Angeles; KKSJ(FM), San Francisco; KOST(FM), Los Angeles; WDTW(FM), Detroit; WNUA(FM), Chicago; WIZE(AM), Dayton, Ohio; WSAI(AM), Cincinnati; WPOC(FM), Baltimore; WVAZ(FM), Oak Park, Ill.

Clear Channel is considering converting stations in markets where it

already has digital stations, as well as markets in which it does not. Minneapolis, Portland, Austin, Seattle and San Diego are among the possibilities, Littlejohn said. He expected the company would publicize specifics at a later date.

## Now is the time

The timing of Clear Channel's digital conversion plan was interesting, coinciding with its announcement that it plans to cut spot breaks and ad clutter, as well as its continuing indecency-related programming decisions.

Though Clear Channel is an investor in Ibiquity Digital Corp., the HD Radio developer, until now sources close to the big broadcast group had maintained in comments to Radio World that Clear Channel had concerns about digital's AM nighttime performance.

Now those concerns appear to have been eased although, as of late July, the FCC had yet to give final approval to the use of HD Radio on AM at night.

Littlejohn stressed that both AM and FM stations are part of the conversion plans.

"It's the right thing to do to increase the audio quality, reduce the multipath and add in the digital data that comes along with it. This is the right way to make the move and we'll do it in a big way.

"We're ready to move forward with it. Any interference that happens, we'll deal with it," said Littlejohn. "Bottom line, we think the enhancement for the quality of the audio for the majority of our listeners is a reasonable tradeoff for the loss of some fringe skywave coverage."

He and Ibiquity agree that AM skywave coverage may be affected in certain situations but that in no way will skywave become unusable or disappear as a result of AMs going digital at night.

See CLEAR CHANNEL, page 24 ►

# Clear Channel

Continued from page 23

Littlejohn agrees with NAB's suggested AM nighttime interference mitigation procedures, but he would like the commission to go further into detail and make them part of the IBOC authorization rules. He would like the FCC to spell out what constitutes unacceptable interference.

The company will focus on the top 100 markets and plans to have 1,000 conversions completed within three years. Littlejohn hopes the conversions will go faster once employees gain experience with the installs. Equipment makers say they're prepared to meet the demand for production of equipment.

In addition to IBOC exciters and trans-

mitters, he and other engineers in the company are studying further equipment needs, including STL gear for conversions in which

studios and transmitters are not collocated. The average conversion price has been about \$100,000, Littlejohn said.

start the industry's conversion. At press time roughly 100 stations were transmitting analog and digital signals.

President/CEO Robert Struble said of the Clear Channel digital conversion plan, "It's a big deal. It's a clear statement about the importance of the technology and why they are doing it. It's a major milestone to get infrastructure in place to get deep (station) coverage."

"This gets radio back on a growth curve and Clear Channel is in a great position to do it," said Struble. He expects more radio groups will follow Clear Channel's lead and transition substantially more stations.

Terms of the deal were not disclosed. Clear Channel had to license the technology from Ibiqity for the stations. Struble said Ibiqity provided the broadcaster with "incentives" to move the rollout along. He said his company also is talking to other radio groups along similar lines.

**The enhancement for the quality of the audio for the majority of our listeners is a reasonable tradeoff for the loss of some fringe skywave coverage.**

— Jeff Littlejohn

So far, conversion prices per station have

Ibiqity Digital Corp. has been nudging stations groups for a while to jump-

# ONE DIGITAL SYSTEM STANDS OUT



The same way our red apple stands out from a group of green ones, savvy air talent knows Scott's SS32 stands out from other digital systems.

Scott Studios' is the easiest to use. Also, SS32 has many capabilities the others don't. Scott cart walls are so intuitive that anything you want is effortlessly on the air in a second or two.

When jocks are thinking creatively, Scott's SS32 touchscreen enhances the flow and adds to the show.



Shown above is K-Love morning host Jon Rivers at his SS32 with musical guest Michael W. Smith. K-Love is a national network of 250 Christian stations.

Scott Studios' systems are simple to use, yet powerful. Jocks can color code labels, play Hot Keys at a touch, find anything fast on Cart Walls, and preview anything at any time—even audition the ending while the same cut is on the air.

### Fast phone editor

If a jock works alone, editing great phones is as fast as a flash! If air talent works with a producer or co-host, one can edit while the other takes calls. Share cuts on as many screens as you want.



### Voice Tracker

Scott's Voice Tracker via Internet doesn't require corporate or duplicate music libraries. Our Voice Tracker stations sound better than live.

### Internet control and remote

SS32 auto-imports digital audio from wireless PDAs, laptops, weather services and MP3s.

### Hook promos

Promos with hooks—short clips of upcoming songs—are easy to build in SS32.



### New look...new features

With Scott Studios, nothing is static. Our 4,600 client stations give us new ideas we add as updates.

### Free logging software

The FCC is likely to require all stations to archive broadcasts. New customers get free logging software you can run on any office computer. Why pay extra?

### Not proprietary

SS32 works with *any* computers and sound cards. You only pay for the software features you'll use, so it's in *your* price range. You also can add modules at very low cost.

These are just a few reasons why more stations choose Scott than the second and third ranked vendors combined. For details, call 1-888-GET-SCOTT.

### Lockhart: Clear Channel's New Digital Data Guru

**OGALLALA, Neb.** Clear Channel is covering all its bases on the digital front. It has hired Kevin Lockhart, former president of its Prophet Systems business, as a digital data guru. Officially, his title is senior vice president of technology development; Lockhart reports to Clear Channel Radio CEO John Hogan.

Lockhart said his job is "to identify new technologies or ways to enhance current technologies to increase listenership." Clear Channel will look at ways to take advantage of the potential data services digital radio offers, plus multiple channels and surround sound as possible ways to broaden its listener base, he said.

The company eventually may apply these suggestions about software enhancements to hardware to make new consumer products; it could use the data capabilities of HD Radio to send its signals to personal devices other than traditional radios, he said.

He's also looking at what the company's doing to enhance its analog signals, such as its use of RDS.

Lockhart's job is a new position. Dick Wooden, formerly in charge of business development for Prophet Systems, is working with him at Clear Channel, he said. He expects his department to eventually expand with more employees.

Prophet has split the president's job between Chip Jellison and Tim Gieschen, Lockhart said. Jellison is co-president of technology and Gieschen is co-president for operations, sales and finance.

Lockhart will remain in Nebraska, rather than move to Clear Channel's San Antonio headquarters. He said he will be working with Prophet employees frequently. "Prophet Systems will still provide the backbone of the technology."

Lockhart and his father Ray founded Prophet in 1989 to develop automation equipment and service to run their radio stations. The company was purchased in 1997 and is now an independent business division of Clear Channel Communications.

— Leslie Stimson

**1-888-GET-SCOTT**

Some features described are optional. Systems are tailored to needs and budgets.

**Scott Studios**  
13375 Stemmons Freeway, Suite 400  
Dallas, Texas 75234 USA



## Audio Interfaces for Computers

*Various Formats Exist for Recording and Editing Audio Using PCs and Macs*

by Bruce Bartlett

Computers are great tools for recording, editing and mixing spots and documentaries. To get audio into and out of the computer, an audio interface does the job. It comes in several formats: sound card, I/O breakout box, two-channel and multi-channel.

To help you decide which will work best for your station, we will explain the features of each type.

### Sound advice

The simplest form of interface is a sound card, which plugs into a PCI slot on the motherboard. Low-cost sound cards have unbalanced 1/8-inch phone

to eight balanced TRS connectors or XLRs on cables. Examples include sound cards by AudioScience; Digigram; Digital Audio Labs; Frontier Design; SEK'D; Lynx Studio Technology; Echo Digital Audio; Midiman; Turtle Beach and RME Hammerfall. A digital-only sound card is a low-cost choice if you work only with digital signals. A sound card comparison is at [www.pcavtech.com/soundcards/compare/index.htm](http://www.pcavtech.com/soundcards/compare/index.htm).

A more convenient setup than a sound card is an outboard audio interface or I/O breakout box (like the model shown in Fig. 1), in which all the connectors are in a common chassis. Because the mic preamps are outside of the computer, they tend to pick up less computer electrical noise than analog sound cards.



Fig. 1: M-Audio FireWire 410

jacks for mic, line in and line out. Generally, the sound quality and connectors of a low-cost card are not up to professional standards. Don't use the noisy mic input in sound cards; use a line input fed by a mic preamp or mixer.

The next step up is a sound card with two

All breakout boxes accept line-level signals from a mic preamp or mixer. Some have mic preamps built in. A few have a high-impedance (hi-Z) 1/4-inch input jack for an electric guitar.

Some interfaces also are controllers: they have faders, knobs and switches that

adjust the DAW's virtual controls you see on screen. Every outboard interface includes input and output connectors, and most offer MIDI connectors, level controls and meters.

with more microphones. Some interfaces come with XLRs; other use 1/4-inch TRS or 1/8-inch phone jacks.

**Analog outputs** — These outputs can feed a power amp or powered speakers for monitoring.



Fig. 2: MOTU Audio 896HD

I/O breakout boxes are made by Axia Audio; Radio Systems Studio Hub; I/One Connects; Aardvark; Digidesign; M-Audio; Echo; Metric Halo; PreSonus; Creative Labs; Tascam and MOTU (Fig. 2), among others. Typical prices are \$200 to \$2,495.

### Checklist

When deciding which interface to purchase, here are some features to look for:

**Analog inputs** — First decide how many inputs you need. If you are recording one source at a time, or are recording only in stereo, two mic or line inputs might be enough. You can overdub more parts using the same two inputs each time. Four-to-eight inputs cost more but let you record

**Computer interface format** — The interface has a connector to send digital audio to the computer. This data can be transferred by PCI, USB or FireWire formats. PCI is a common format of slots on a computer motherboard, used for sound cards. USB and FireWire are protocols for transferring digital data quickly from one device to another. For example, they transfer digital audio from an audio interface to a computer.

Outboard interfaces with the USB format are convenient: they plug into a USB port on the outside of your computer, so you don't need to open up the computer to install the interface.

Running at 400 megabits per second, See INTERFACE FORMATS, page 27 ▶

**ALTRONIC RESEARCH INC.**  
Performance By Design

**MANUFACTURER OF RF COAXIAL LOAD RESISTORS. DUMMY LOADS FROM 1 KW TO 1500KW, AVAILABLE IN AIR, WATER OR SELF-CONTAINED HEAT EXCHANGERS. HIGH POWER NON-REACTIVE CERMET RESISTORS FROM 1 OHM TO 20 MEGOHMS.**

**ALTRONIC RESEARCH INC.**

P.O. Box 249 • Yellville, Arkansas 72687 870-449-4093 • Fax: 870-449-6000  
E-mail: [altronic@mtnhome.com](mailto:altronic@mtnhome.com) Web Site: <http://www.altronic.com>

# Wish you had more

up top?



## Announcing Omnia-6EX.

There's a lot of buzz about the new HD Radio codec. We've heard it and agree with the many others who like it and say it's now time to get on with radio's transition to digital.

Because HD Radio can transmit audio frequencies up to 20kHz, listeners will finally be allowed to hear the full CD spectrum – if their radio stations choose the right on-air processor. On this point, you should know something important: Some “HD” processors simply hack off everything above 15kHz... robbing listeners of the full HD Radio experience and keeping our industry in a fidelity backwater.

The new Omnia-6EX won't short-change your listeners. We've built Omnias with sampling rates of 48kHz and higher from the start. All along, we've needed the sampling headroom to keep analog FM audio grunge-free. Now it's essential for HD Radio. Even if some listeners wouldn't notice the missing high frequencies, there's a fair chance they would hear a sharp 15kHz low-pass filter operating within HD Radio's codec range.

Omnia-6EX is also full of processing enhancements that result in yet more bass punch, yet more voice clarity, than the original Omnia-6. A sound so powerful and free of artificial constraints, you'll crave it for your station the first time you hear it.

More than 50% of the US' Top 100 FM stations have already upgraded to Omnia. Maybe you're next?



*The new Omnia-6EX has enhanced processing for analog FM, and is ready for HD Radio with a second limiter section and digital output. Both FM and HD limiters and outputs are included as standard.*

**Omnia**  
A Telos Company  
omniaaudio.com

## Interface Formats

► Continued from page 25

FireWire 400 is faster than USB 1.1 but about equal to USB 2.0 high-speed (480 Mbps). FireWire 800 runs at up to 800 Mbps (100 MBps). A FireWire card that plugs into a computer PCI slot costs about \$35, and some sound cards and computers have a FireWire port built in.

USB and FireWire devices are hot-swappable; you can insert or remove the connector while the computer is on. Both formats are compatible with Mac or PC.

Both ports also are available in PCMCIA cards and CardBus cards, which fit into laptops. A PCMCIA card is a credit-card-size memory card or I/O device that connects to a slot in a computer. CardBus is an advanced PCMCIA card with faster speed due to its Direct Memory Access (DMA) and 32-bit data transfer.

**A** more convenient setup than a sound card is an outboard audio interface or I/O breakout box. Because the mic preamps are outside of the computer, they pick up less computer electrical noise.

**Digital I/O** — Some interfaces have digital inputs and outputs as well as analog. If you have a digital mixer or an outboard A/D converter, a digital-only card may be all you need. Four digital formats are available:

- **S/PDIF** — a coaxial cable with RCA plugs, or an optical connection. Used with DAT recorders and digital mixers.

- **AES/EBU** — a XLR connection used with DAT recorders and digital mixers.

- **ADAT Lightpipe** — an optical connection to Alesis ADAT recorders. Transfers eight channels of audio at once.

- **Tascam TDIF** — a D-sub connection to Tascam multitrack recorders. Transfers eight channels of audio at once.

**Sampling rates** — Available rates are 32 to 192 kHz. Of course, recordings made with higher sampling rates give better sound quality but consume more hard-drive space.

**MIDI ports** — Some interfaces have MIDI ports so you can send MIDI signals from a keyboard to your computer sequencing software. If your interface has a MIDI port, you don't need a separate MIDI card in your computer.

**Word Clock I/O** — Some interfaces offer Word Clock connectors, which control the timing of digital signals. To reduce jitter, it's best to use a single Word Clock to drive all the digital devices in your studio with a common clock signal.

**Driver support** — An audio driver is a program that allows recording programs to transfer audio to and from an audio interface. Interfaces are usually sold with several types of drivers. Be sure that your interface has drivers that your recording software requires.

Look for a driver with low latency (less than about 5 msec). Latency is the signal delay through the driver and interface to the monitor output. This can be a problem in overdubbing, in which the monitored signal in the sound source you're overdubbing is heard later than the

pre-recorded tracks.

The most popular audio driver formats are ASIO, DAE, Direct I/O, GSIF, MAS, SoundManager, Wave and WDM.

Here is a brief description of each driver format:

- **ASIO** — (Mac, PC): Audio Streaming Input and Output. A popular driver developed by Steinberg. Allows multiple channels of simultaneous input and output, and low latency with software synthesizers.

- **DAE** — (Mac, PC): Used only with Digidesign audio interfaces. It's a multi-channel driver that runs with a compatible host such as Pro Tools, Logic and Digital Performer. Using DAE lets you use RTAS and/or TDM plug-ins in a host application.

- **Direct I/O** — (Mac, PC): Works with Digidesign interfaces as a multi-channel driver only. Does not let you run RTAS or

TDM effects.

- **GSIF** — (PC): Permits low latency when playing samples from hard disk with TASCAM's GigaStudio software sampler.

- **MAS** — (Mac): Developed by Mark of the Unicorn. Offers resolutions up to 24/96 and multiple simultaneous input and output channels. It's also a plug-in format for real-time audio effects.

- **SoundManager** — (Mac): Macintosh's standard audio driver. It lets you record and play mono and stereo files up to 16-bit and 44.1 kHz. Has a moderate amount of latency.

- **Wave** — (PC): The PC standard audio driver. Wave can be used with a variety of audio interfaces (like Sound Blaster-type sound cards) to record and play mono or stereo audio. Has a moderate amount of latency.

See INTERFACE FORMATS, page 29 ►



## WHAT'S YOUR DATA DILEMMA?

- Adding RDS?
- Installing a remote server?
- Changing remote control/telemetry?
- Need security and surveillance?

Lanlink is a bi-directional Ethernet and RS-232 serial data link operating in the license-free 900 MHz ISM band.

And it is so close to the 950 MHz STL band you can duplex into your existing antenna system.

Network your processing and even add Internet and email at the transmitter site too!

Let the digital STL experts at Moseley help you solve your data dilemma.

# LANLINK

LANEXTENDER/DATALINK

### CALL FOR MORE INFORMATION:

Dave Chancey 805-968-9621 ext. 213

Bill Gould 978-373-6303

**Moseley**  
www.moseleysb.com

# Products & Services SHOWCASE

## 79,507 SIZES...IN STOCK!



**A New "Patent Pending" Rack Design**  
**Assemble Any Size Rack Using Only 3 STOCK Parts**  
 3 precisely engineered parts when connected together form Wiggle-Free equivalent strength and integrity of fully assembled welded rack enclosures. Choose any width, depth, & height of dual-tapped E.I.A. rack rail from one of 43 sizes in 1-3/4" rack unit increments.  
 Ships knocked-down in 3 small cartons. Build all kinds of neat stuff!

**4 RU 13" Deep - \$159.85**  
**43 RU 30" Deep - \$264.85**  
**Shop Online**  
[www.starcas.com/rack.htm](http://www.starcas.com/rack.htm)  
**(800)822-STAR (7827)**  
**(800)782-CASE (2273)**

raduga automation

Automate Your Station in Minutes  
 ...No Degree Required

**NEW! Just Released v3.8**

- Extremely Easy To Use & Understand
- For All Stations, All Formats
- Schedule Spots, ID's, Build Rotations
- Plays All Audio File Formats
- Complete Automation Systems Available
- AirList Music Scheduling Software Only \$259
- Music Libraries Available

...Did we mention **FREE SUPPORT**

Raduga Software



Download your **FREE Demo Today**  
[www.raduga.net/rw.htm](http://www.raduga.net/rw.htm)  
 (513) 887-0714

**Low as \$149\* Buyout**

## DIGITAL ANTENNA MONITORS

In-Stock-Available for  
 Immediate Delivery



Price US\$2700.00 2 Towers  
 Will operate with any remote control equipment.

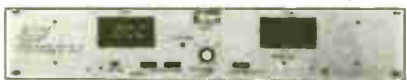

Price US\$2100.00 2 Towers  
 For AM directionals with studio located at transmitter site.

These monitors are state-of-the-art instruments of unequalled accuracy (.5% or better on ratio and .5° or better on phase) and stability. With typical modulation the true ratio readout of these monitors is a factor of 10 more stable than instruments that measure normalized amplitude, and their phase readouts are rock solid. Phase sign is automatic, no extra operation. In addition to the analog DC outputs for remote control the Model CMR has a multiplexed BCD digital output which can be used to drive the Remote Indicator Model CMR-1. RF inputs have dual protection. Gas discharge tubes across the sample line terminations plus relay protection.

**GORMAN REDLICH MFG. CO.**  
 257 W. Union St. Athens, Ohio 45701  
 Phone 740-593-3150 • FAX 740-592-3898  
[www.gorman-redlich.com/jimg@gorman-redlich.com](http://www.gorman-redlich.com/jimg@gorman-redlich.com)

## AM Antenna Solutions



LBA Tunipole™  
 Folded Unipole Systems



RF Components



Vacuum Capacitors



Diplexer, Triplexer and  
 Phasor Systems



LBA Technology, Inc. is your proven supplier of innovative, digital-ready AM antenna systems. Our products include tuning units, phasing systems, multiplexers, AM/wireless isolation systems and components for every power level. We help hundreds of broadcasters in the USA and worldwide to --

**Reach further –  
 sound better!**

**LBA Technology, Inc.**



3400 Tupper Drive, Greenville, NC 27834

800-522-4464 / 252-757-0279 / Fax 252-752-9155 / Email [Lbatech@Lbagroup.com](mailto:Lbatech@Lbagroup.com) / [www.Lbagroup.com](http://www.Lbagroup.com)

**LBA**  
 Since 1963

**STA-2A · STICK-ON**  
**DUAL HIGH GAIN LINE AMPS**  
 BALANCED OR UNBALANCED HIGH OR LOW Z  
 INPUT A OUTPUT INPUT B OUTPUT 24 VDC PWR + -

**STA-2A Dual High Gain Line Amps**  
 It's true! The best things do come in small packages.

- Up to 24 dB of Gain in Audio Lines
- Conversion from Unbalanced to Balanced
- Conversion from High to Low Impedance
- Low Impedance, High Current Line Drivers
- Dual-Channel Line-Level Preamplifiers
- High Gain, High Output, High Performance
- RDL® SupplyFlex™ Power Input Configuration

READ ABOUT IT!  
<http://r7.stickons.com>

**RDL**  
 International Sales: (805) 684-5415  
 United States Sales: (800) 281-2683  
 European Sales: (31) 20-6238-983

**The Simple Cell Phone Interface Solution**  
**FJ-500 FlipJack**  
 CELL PHONE INTERFACE

Connect To Standard Telephone In-Event Of Poor Cell Phone Connection

**CONEX ELECTRO-SYSTEMS**

Call For More Info  
 800-645-1061  
[www.conex-electro.com](http://www.conex-electro.com)

**Problem Solvers For You!**

CircuitWerkes makes control and interface solutions including: telephone couplers, powerful DTMF operated controls and encoders, subaudible decoders & encoders, sophisticated and simplified relay expanders, and more. Our product line is growing monthly and we keep stuff in-stock for instant delivery. Call us or visit our website to see how we can help you at a surprisingly affordable price!

**NEW From CircuitWerkes:**

**The GENr8 DTMF Tone Generator / Encoder**

- ▶ Generates all 16 DTMF tones & Elite, user defined, DTMF sequences.
- ▶ Balanced audio Input for mixing & Balanced output at up to +17dBm.
- ▶ Generate tones or sequences with contact closures.
- ▶ Program or control via serial port with our free software.

See our **MANY** new problem solvers online at [www.circuitwerkes.com](http://www.circuitwerkes.com)

## Interface Formats

► Continued from page 27

• **WDM — (PC):** A multi-channel driver. Allows low latency with WDM-compatible audio hardware and DXi software instruments. Also, DirectX audio effects can be used live on input signals, not just during playback. This lets you monitor and record effects in real time as you're recording.

**Caution:** If you have multiple drivers installed, they may conflict. Then the computer might crash or the recording software might not access the audio interface. Delete unused drivers.

**Other options —** Listed are several features that some interfaces offer, along with a brief description of each.

• **ProTools compatible:** the interface works with ProTools recording software and hardware.



Fig. 3. Tascam FW-1884

• **Built-in control surface (Fig. 3):** Has faders, switches and knobs that adjust the "virtual controls" you see on screen when using a recording program. Easier to use than a mouse, but adds cost. Make sure it is compatible with your recording software.

• **Motorized faders:** The faders in the control surface are motorized, so they move like the virtual faders on screen.

• **Stand-alone mixer mode:** You can use the control surface as a regular mixer.

• **Footswitch jack:** Accepts a footswitch for punch-in/out. The footswitch works only if your recording software supports this function.

• **Surround sound:** Provides 5.1 or 7.1 surround sound monitoring.

• **Powered by FireWire bus or USB bus:** The FireWire or USB connection powers the interface; you don't need another power supply.

• **Battery powering:** This makes the interface portable for on-location recording.

• **192 kHz playback:** Playback can be at a very high sampling rate of 192 kHz for state-of-the-art sound quality.

• **Aux send/return:** Allows you to connect an external analog signal processor.

• **Supplied recording software:** The interface is packaged with recording software, so you might not need to buy other software.

• **A/D/A converter mode:** The interface can act as a real-time analog-to-digital and digital-to-analog converter.

• **SMPTE sync:** The interface will synchronize with a SMPTE time code signal.

• **Insert jacks:** An insert jack in series with each channel's signal allows you to plug in an analog compressor.

• **MIDI routing and merging:** Allows control of MIDI signals.

As we've seen, there are a range of features and connectors among different interface models. A good interface is well worth the price because of its top-quality sound, convenient connections and easy control of audio signals.

*Bruce Bartlett is a technical writer/mic engineer for Crown International, a recording engineer and an audio journalist.*

### PRODUCT GUIDE

## Tascam CD-RW750 Offers CD Text Support

Tascam debuted its 2 RU rackmountable CD-RW750 CD recorder at NAB2004, including upgrades to its predecessor, CD-RW700, such as CD Text support, A-B repeat and single playback. The unit retains features of the original model including 24-bit digital converters, CD-R and CD-RW support and S/PDIF digital I/O.

The functions enable the user to record CDs in the format of choice, record to standard CD-R and CD-RW media and offer low-noise digital conversion. Because of the input monitor function, the CD-RW750 can be used as an A/D or

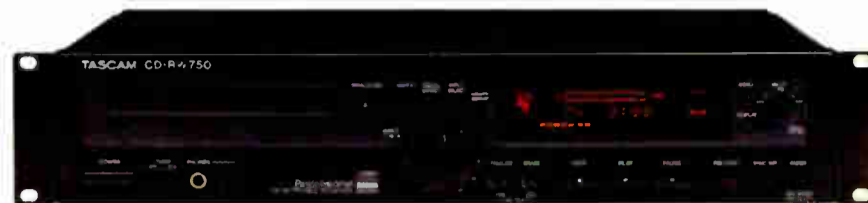

D/A converter or to monitor the source before recording. CD Text support enables each track to be read as well as the programming of a title for the disc. The RC-RW750 wireless remote is included.

The company touts applications such as professional recording, where a mix can be recorded to CD for distribution, mix checking or backup; installed systems; church market; and post-produc-

tion, where finished projects can be recorded to CD for output, as well as voiceovers.

For more information, including pricing, contact Tascam in California at (323) 726-0303 or visit [www.tascam.com](http://www.tascam.com).

## "State of the art technology in digital consoles and routers for radio and TV"



### BC2000 D Digital Console

- Cost effective and flexible design.
- Multipoint intercommunication and easy multi-studio management capabilities.
- Flexible inputs and outputs allocated to faders.
- Design adaptable to digital and analog environments with all basic broadcasting functions built-in.
- Enhanced interconnectivity between engines through MADI multi-channel links.
- Modular surface control with motorized faders; positions stored on pages.



### BC2000 D Router

The same router used by the BC 2000D console works as a stand-alone router, with 2048 inputs and outputs, summing and processing, with a scalable and modular architecture.

For more information on the BC 2000D Digital Console visit our Web Page

### AEQ also offers excellent communications and audio equipment

- Stationary and portable ISDN audio codecs and telephone hybrids.
- Advanced multi-channel talk show system.
- Multiplexers, analogue mixing consoles, AD converters, monitors and digital commentary system for large sport events.

### AEQ

Phone: 866-817 9745  
954-581 7999

Fax: 954-581 7733  
e-mail: [sales@aeqbroadcast.com](mailto:sales@aeqbroadcast.com)  
url: [www.aeqbroadcast.com](http://www.aeqbroadcast.com)

# Products & Services SHOWCASE

## ATI Live at 5



If you have watched any live news coverage on television lately, chances are you've heard ATI.

ATI mixers are known for their outstanding audio quality, rugged compact housings and field tested durability, making them the mixer of choice in ENG and SNG trucks as well as for semi-fixed field installations.

With their extremely low noise front-ends, the ability to cram up to 11 channels into 1 rack space and flexible power options, it's no surprise that AEC, CBS News and NBC News, CNN, 30/20 and 80 Minutes have all chosen ATI mixers.

Hear why more Engineers and Sound Professionals are specifying ATI. Give us a call or drop us an email and get your copy of the new ATI catalog.

### NANOAMP Series



Mono and Stereo Production Mixers

Audio Technologies Incorporated  
Telephone +215-443-0330  
Facsimile +215-443-0394

www.ATIaudio.com

Celebrating 33 Years of Innovation

## Ready for lightning?



### TS-1 Transient Voltage Surge Suppressor

Telephone lines give lightning a direct path to your broadcast equipment. Protect your investment with the TS-1 surge suppressor. Built for broadcast.

**BURK**  
TECHNOLOGY

800-255-8090 / sales@burk.com / www.burk.com

ELECTRONICS RESEARCH, INC.

## iBOX Hybrid Combiners



**ERI** Your Single Source for Broadcast Solutions

Sales@ERInc.com | +1 (812) 925-6000 | www.ERInc.com

## Maximize your FM Station!

Success Starts with **rflInvestigator V2.5**  
The software that works as hard as you do.

**rflInvestigator V2.5** is our *most flexible* program yet.

Display Audemat-Aztec Navigator 100 & Navigator 007 field surveys.  
Export propagation jobs for display in other mapping programs.  
Import contour information from other programs for your use.  
One set of TOPO! Maps is included with the program.

### Display and Printing Improvements

Set colors and line weights for easier to read maps  
Invert colors easily for faxing  
Create your own map labels  
Variable job scan range  
Display ESRI Shape Files

### "DA Design Tool" Improvements

Completely redesigned to work faster  
Set your own antenna design limits  
New booster designer

### PL-SERVER

With this advanced module you can create path-loss files for propagation analysis in **rflInvestigator**.

### DO-BUILDER

is a "behind-the-scenes" utility program that downloads data from the FCC website and creates databases for our various products. **Never buy** another database!

**Audemat-Aztec** *New!*

**rflSoftware** is an Audemat-Aztec dealer.

Visit [www.rflsoftware.com](http://www.rflsoftware.com) today!

Call 352-336-7223 for information.

On-site Training Available

**rflSoftware, Inc.**

innovative engineering tools

## Broadcasting to the World

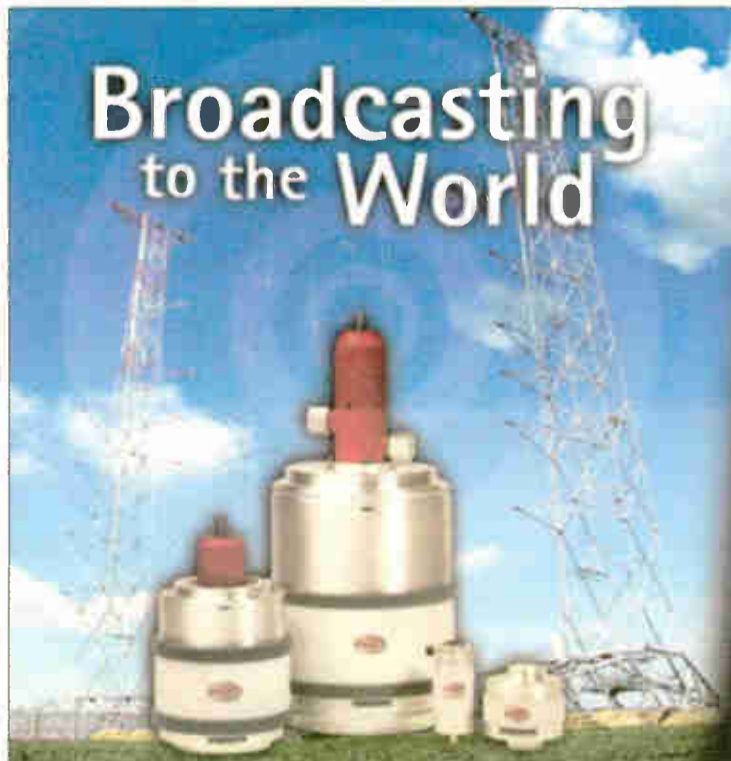

### COMET NORTH AMERICA

421 Wards Corner Road  
Cincinnati, Ohio 45140  
Ph: (513) 831-5000  
F: (513) 831-7889  
www.cometna.com

- Full range of broadcast equipment for processing
  - FM/AM Modulators
  - Stereo Wave Encoders
- Standard equipment for all types AM & SW Transmitters
- Professional TV test equipment for reliable reception
- Trained in North America with European Labs to provide engineering expertise in manufacturing



**Kentmore Labs, Inc.**  
144 Pleasant Drive Road  
Bridgeton, NJ 08304  
Ph: (856) 876-0141  
F: (856) 876-4224  
www.kentmore.com



May we present...

## YOUR AD



### RADIO WORLD'S

Products and Services Showcase provides a perfect medium for marketing your products and services.

For more information, call Simone at 703-998-7600, ext. 154 to request a media kit.

## PRODUCT EVALUATION

## Star Case Rack: U-Build-Em Studio Racks

by Alan R. Peterson

Okay, it's a rack.

Maybe it's not the latest whizbang audio processor or the newest and most expensive piece of gear your station absolutely cannot live without. There certainly are enough of those to go around every month here in Studio Sessions.

It's... a... rack!

It's the thing into which you put all those whizbang components.

Notice however I did not say it's just a rack. To do so would be doing an injustice to the Star Case Mfg. Co. Inc. and the Star Case Rack, an innovative assemblage of rails, brackets and secure steel corners that come together in configurations and sizes that you choose for your own purpose.

The rollout of the Star Case Rack means no longer having to choose between a massively overbuilt server-style steel behemoth or one of those knockdown flakeboard music store numbers when you need to rack up only a few pieces. You pick only the size you need.

Measure out all the components you want to mount, pick a few rail sizes and get busy with your power screwdriver. You get a sturdy and secure equipment rack and you don't pay a ton for it. Nineteen-inch width racks range in price from \$159.85 for the 4 RU x 13-inch deep size, to \$264.85 for a unit that is 43 RU and 30-inches deep.

**Right at home**

To begin with, you have to like a company that set down roots in a town called Munster, Ind. If only Butch Patrick were their spokesperson...

The Star Case Rack is what you wish those gray, bendy steel shelves from the home improvement store were built like. In fact, putting one together may remind you of the last storage shelf you built: steel rails screwed down at the corners, along with a couple of crossbraces to hold it all together.

If you have built one or two of those in the past, forget all about it right now.

The corner braces on the Star Case Rack are heavy and serious, and screw directly into the 10-32 tapped screw holes in the rails — not into a set of hex nuts that can go loose.

Those optional crossbraces are not for show. Under fairly heavy loads, these add stability against bowing or twisting, unlike those home improvement shelves that bend like pipe cleaners under a single can of paint.

What you are going to like is the selection of rail sizes offered. Sure, it's a good bet you will be constructing a typical EIA 19-inch equipment rack, but at what depth?

Do you want to mount a cassette deck, a digital reverb and other shallow, lightweight components? Or do you have a need to go ultra-deep, as on a CRT monitor or (shudder) one of the old Scientific Atlanta satellite receivers?

Star Case Rack dimensions are cataloged as A (width), B (depth) and C (height), so when figuring out your best configuration, simply size up the steel rails that will work best for you. Need to go deep? Order the proper rails.

Need to add more vertical space? Star Case Racks can be stacked by nesting the

corners of two or more frames vertically, then bolting them together.

Are you more interested in mounting computer units or creating a LAN workstation? You already know 19-inch racks are not the best choice for PCs and monitors, which is why Star Case Rack rails can also be ordered in 25-inch widths.

In fact, just how big a rack do you need? Sales literature from Star Case shows a large custom configuration nearly 80 inches on all sides. If it came with walls, it could almost qualify as a vocal booth!

**Hole in one**

Here is something I wish everybody did. Star Case etched the rails with lines every 1-3/4 inches to show you the exact point to mount components. How many times have we attempted to mount something new in a rack, only to find we didn't line the item up with those dopey holes? Each mark shows the mounting point of a typical 1 RU component.

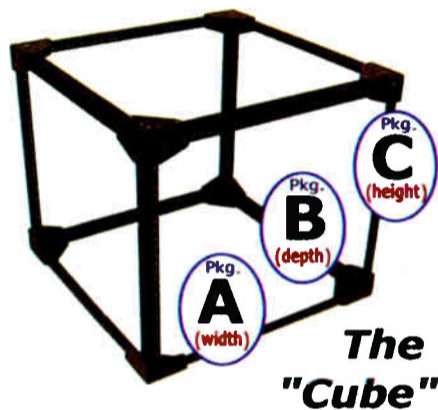

ARP likes how Star Case etched the rails of its racks with lines every 1-3/4 inches to show the exact point to mount components.

Because the same holes exist on the height and depth rails as well as on the face rails, we have plenty of places to insert nylon cable ties to run those pesky cables. We shouldn't, but we do.

When ordering a Star Case Rack, it comes with a Master Pack consisting of corners, screws, a set of nylon levelers and four 17 1/2-inch width rails, which give you the necessary 19 inches after being assembled to the corners.

You also need to order a Package B and C to set the depth and the height necessary. You may go as deep as their standard 30 inches, and as tall as 78 1/2-inches.

Options? Sure. Side handles, cross braces, adjustable shelves, and also drawers, top and bottom steel cover panels, PVC plastic side panels and casters. A fully-loaded rack unit can take on about 400 lbs. worth of gear before you have to buy another one and bolt them side-by-side.

**Summary**

The Star Case Rack is a utility type rack. It does not have any decorative panel options, which means this would not be your first choice for prettifying up the main on-air studio.

No, this rack begs for the brawny jobs. Bolt one together and mount your mobile RPU unit, Zephyr and a CD deck in it for the station promo vehicle.

Mount the console power supply and mic processors in one of the smaller units, away from the wandering fingers

of curious jocks. Gang two or three together and fill it with RAID's and a few rackmount CPUs.

With a set of casters, a Star Case Rack becomes a wheelaround unit you can pack with sound reinforcement gear, like an amp or two, a crossover and an EQ, then cap the whole thing off with a small mixer on rack ears mounted face up. It does not offer any side impact protection like a road case will, but they offer a 1/8-inch cosmetic enclosure side panel option made of attractive PVC as well as rigid steel top and bottom cover panels, and all components stay where you want them.

Similarly appealing as an option would be a bolt-on power strip, whether offered by Star Case or OEM'd from an established manufacturer of same.

But for now, if you are setting up a home studio or adding on to the rackmount needs at your station, the Star Case Rack makes it easy, affordable and totally unlike the cheap lumber panels we are all but resigned to buy right now.

It is hard to get jazzed about a rack, probably the least glamorous item in your

**Product Capsule:**  
Star Case Mfg. Co.,  
Star Case Rack

**Thumbs Up**

- ✓ Flexible design lets you create only what you need
- ✓ Robust steel construction
- ✓ 1RU mounting markers

**Thumbs Down**

- ✓ Hard to get excited about a rack, but this comes close

Price: \$159.85 - \$264.85

For information, contact the company in Indiana at (800) 822-STAR (7827) or (800) 782-CASE (2273), or visit [www.starcase.com/rack.htm](http://www.starcase.com/rack.htm)

studio. But I think you will appreciate what you get out of the Star Case Rack.

Alan Peterson is the assistant chief engineer for the Radio America network in Washington D.C., and a longtime RW writer and columnist.

## PRODUCT GUIDE

## Lynx Debuts OSX Drivers For Use With Apple G5s

Lynx Studio Technology released the OSX Core Audio drivers for its LynxTwo, L22 and AES16 products, enabling the units to use Apple Computer's core Audio protocol and operate with G5 model computers.

The driver is integrated into the OSX Kernel, facilitating clock management. The user has the freedom to manage the clock from the application or from the Lynx software mixer.

Other highlights include the ability to store and recall mixer scenes and settings; real-time metering and volume control using the Lynx mixer; monitoring with no latency; and mixing and routing capabilities using the Lynx mixer.

The OSX Core Audio driver is shipping with AES16, LynxTwo and L22 interfaces. Current owners can download the driver for free from the Lynx Web site.

For more information, contact Lynx Studio Technology at (949) 515-8265 or visit [www.lynxstudio.com](http://www.lynxstudio.com).

## Mackie dXb 200 Console Ships

Mackie is shipping its dXb 200 digital production console. The dXb 200 features a 72x72 channel I/O matrix (36x36 at 192 kHz) or 64 channels with DSP at 96 kHz (32 channels with DSP at 192 kHz). Channel DSP includes compressor/limiter, gate/expander and four-band parameters. Both models of the dXb platform, dXb 200 and dXb 400, share architecture and footprint, including a dual touchscreen interface, 96 kHz operation (optional to 192 kHz), automation and DSP and 25 100 mm Penny+Giles touchfaders.

A UAD-1 Powered Plug-ins card can be installed in the dXb 200 as an option.

For more information, contact Mackie at (425) 487-4333 or visit [www.mackie.com](http://www.mackie.com).



## Russ Bassett Offers Media Storage Systems

Russ Bassett Corp. says its ProMedia media storage systems organize clutter and optimize floor space for media studios. Its Gemtrac design features an overhead track system, and can be locked if security is threatened.

The ProMedia line accepts media such as CDs and DVDs, and magnetic tapes such as VHS, Beta, D2, DVC Pro and DV-Cam. More than 12,000 CDs can be stored within 25 square feet of space. Each storage system features a steel-welded frame and panel construction. The series also includes cabinets, adjustable shelving and Slidetrac in-line rolling shelving for high-capacity filing in shallow-depth areas.

Metal surfaces feature a powder-coated finish and are available in 12 colors. Drawer dividers, adjustable back stops, bookend supports and other options are available.

For more information, contact Russ Bassett Corp. at (800) 350-2445 or visit [www.russbassett.com](http://www.russbassett.com).

## PRODUCT GUIDE

## NTI Adds Acoustilyzer To Minstruments Line

NTI is accepting orders for its AL1 Acoustilyzer handheld acoustics analyzer, and its functional extension STI-PA for speech intelligibility analysis.

The company says the Acoustilyzer expands its MLI Minilyzer analog audio meter, both part of the Minstruments series of handheld test equipment. It features integrated sound pressure level measurements, repeatable short-time LEQ and sound exposure level test capabilities for event monitoring. The audio spectrum and the chart view of the SPL/LEQ history are visualized without interrupting ongoing sound level measurements, and measurement results may be

logged to the internal memory.

The real-time spectrum analyzer features selectable 1/1 and 1/3-octave bandwidth, and permits relative sound spectrum measurements against previously stored references. Stored spectra may be averaged or combined by using AL1's mathematical functions. The "Max-Min" display finds dominant room modes and characterizes listening areas.

Features include investigation of the frequency response, reverberation time measurement and propagation delay time measurement, which is conducted between the electrical input of the AL1 and its microphone.



The NTI Acoustilyzer

NTI's STI-PA analyzer option enables speech intelligibility measurement within 15 seconds. A detailed view of modulation indices and individual band level results is provided, along with the single value STI or CIS test results. Acquired measurements may be referenced to previously estab-

lished background noise level spectras with recalculation of the STI values.

Call the company in Oregon at (503) 639-3737 or visit [www.nti-instruments.com](http://www.nti-instruments.com).

## How to Submit Letters

Radio World welcomes your point of view on any topic related to the U.S. radio broadcast industry.

Send letters via e-mail to [radioworld@imaspub.com](mailto:radioworld@imaspub.com), with "Letter to the Editor" in the subject field; fax to (703) 820-3245; or mail to Reader's Forum, Radio World, P.O. Box 1214, Falls Church, VA 22041.

# SH SHOWCASE SE

**UNLEASH THE POWER OF BEXT**

"A Bext transmitter has been our main stay since August 29th, 1988" (WDZN FM)

**BEXT**  
Transmitters from 10W to 35kW  
Digital / Analog STLs Translators  
Antennas, Filters & Combiners

1 888 239 8462  
[www.bext.com](http://www.bext.com)

**Eimac** Maintaining the Standard...

**Innovative features in Eimac products include:**

- Rugged grids made with proprietary Y3™ wire
- Advanced cooling fin design
- Low noise and high efficiency
- Laser-cut pyrolytic graphite grids
- 100% made in USA in the 300,000 sq. ft. San Carlos, CA facility
- ISO9001:2000 certified

Richardson Electronics is Eimac's authorized stocking distributor

- Over \$6 million in Eimac inventory...in stock!
- Product available from 33 global warehouses
- Same day shipments for orders placed by 4 PM CST
- Emergency 24/7 & Next Flight Out (NFO) service
- Complete & timely warranty support
- Large supply of accessories, sockets, etc.

and Maintaining Your Standards... **Richardson Electronics**  
Engineered Solutions

Turn to the names you can trust —  
EIMAC and Richardson Electronics

800-882-3872 • 630-208-2200 • [broadcast.rell.com](http://broadcast.rell.com)

## Mini Mix 8A

Proven...Affordable...  
Reliable

**AUTOGRAM**

800.327.6901  
[www.autogramcorp.com](http://www.autogramcorp.com)

## CircuitWerkes Control Solutions

**DR-10 Dial Up Controller & Remote Broadcast Interface**

- ▶ The DR-10 is a Dial-Up remote control with telephone audio input and output for remote broadcasting.
- ▶ If your automation works with satellite networks, you can use the DR-10's relay outputs to fire commercials, liners, etc.
- ▶ Use the DPDT relays to insert the phone audio directly into the program path when necessary, especially for emergencies.
- ▶ When used with our Silencer Option, the DR-10 is the **ONLY** product available that will completely remove DTMF control tones from the audio path for extra clean remotes.

**pREX Programmable Relay Multiplier & Converter**

- ▶ 12 optocoupled inputs and 16 CPU-controlled relay outputs.
- ▶ Control any output or a group of outputs from a single contact or from a group of GPIs using logic modes like AND, OR, XOR, NOR, NAND, NXOR, Interlocked, etc.
- ▶ Output modes include: Momentary, Toggled, Leading or Trailing Edge, Pulse Stretching up to 45 hours, Input Debounce, Maximum OnTime, Minimum OnTime and more.
- ▶ Program or control the relays by serial port using terminal or GUI.

**GENr8 Programmable DTMF Tone Encoder**

- ▶ The GENr8 is a powerful, yet inexpensive DTMF Generator that can produce either single DTMF tones or can record and play DTMF sequences up to 20 digits.
- ▶ Active, balanced, audio input and output lets you mix DTMF and program material without an external mixer.
- ▶ Program or control the GENr8 by serial port using terminal or our free GUI.
- ▶ Optically isolated inputs work with external contact closures to send tones or program the GENr8.

Learn how you can take control at [www.circuitwerkes.com](http://www.circuitwerkes.com)

CircuitWerkes, Inc. - 2805 NW 6th Street, Gainesville, Florida 32609, USA 352-335-6555



2-for-1 Registration — NAB Members-only!  
**Register Today!**

# Charting

Radio's Future

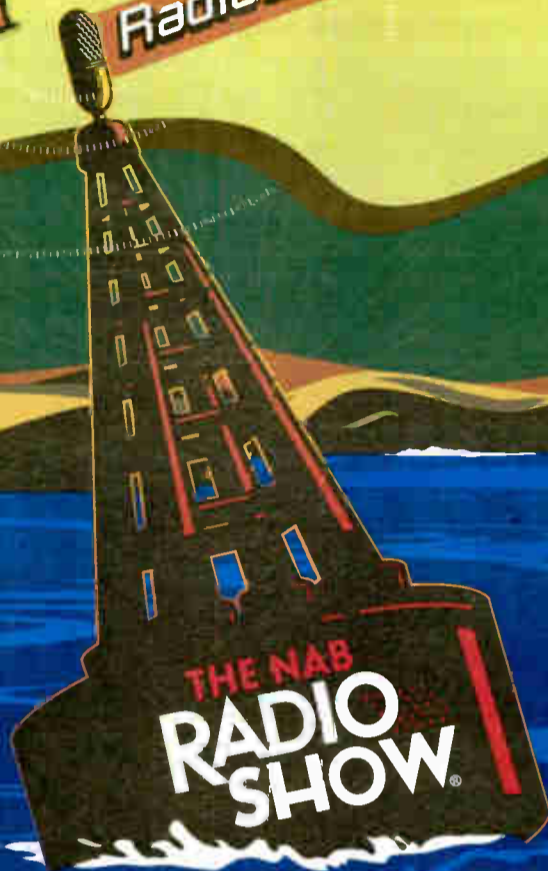

If you're in radio, this is your show!  
 The NAB Radio Show® is a once-a-year opportunity to network with thousands of your peers from stations of all formats and market sizes. No other media reaches the audiences that radio can deliver — and no other event drives that message home like The NAB Radio Show®.

## Navigating New Waters Together

Thursday / October 7  
**FCC Breakfast**

Sponsored by:



**Jonathan Adelstein**  
 FCC Commissioner



**Kevin Martin**  
 FCC Commissioner

Thursday / October 7  
**Group Executive Session**

Group Executives Include:



**Judy Ellis**  
 Citadel  
 Communications  
 Corporation



**Chesley Maddox-Dorsey**  
 Access.1  
 Communications



**Mark Mays**  
 Clear Channel  
 Worldwide



**Peter Smyth**  
 Greater Media Inc.



**Jay Mitchell**  
 Small Market  
 Radio Newsletter



**Tom Taylor**  
 Inside Radio

Co-Moderators:

Sponsored by:



Thursday / October 7  
 NAB Marconi Radio Awards  
 Reception, Dinner & Show

Hosted by:  
**Bob & Tom**



The Bob & Tom Show  
 Premiere Radio Networks



Friday / October 8  
**Breakfast with  
 Charlie Cook**

Political Analyst



Sponsored by:



Friday / October 8  
 Radio Luncheon  
 NAB National Radio  
 Award Recipient  
**Clarke Brown**

Jefferson-Pilot Communications



Sponsored by:



**October 6-8, 2004**  
 Manchester Grand Hyatt, San Diego, CA

visit [www.nab.org/conventions/radioshow](http://www.nab.org/conventions/radioshow)

# BROADCAST BROADCAST BROADCAST

## Equipment Exchange

"Broadcast Equipment Exchange" accepts no responsibility for the condition of the equipment listed or for the specifics of transactions made between buyers and sellers.

### ACOUSTICS

#### Want to Sell



Full product line for sound control & noise elimination.

[www.acousticsfirst.com](http://www.acousticsfirst.com)

### AMPLIFIERS

#### Want to Buy

Shively Labs 6810-6R-DA antenna. This antenna is tuned to 92.5FM with a gain of 6.09 and db of 7.85. This was originally installed in 1986 and removed from service back in November. System also included raydoms for ice protection and is 20 dbk max. Pictures are available so e-mail [Mraley@bbradio.org](mailto:Mraley@bbradio.org) for the full scoop. Asking \$20,000. buyer responsible for pick-up and delivery. This system is located in Alert, NC.

### ANTENNAS/TOWERS/CABLES

#### Want to Sell

Reliable, On-time Installation  
Quality Workmanship  
Ground System Evaluation  
and Repair  
[www.amgroundsystems.com](http://www.amgroundsystems.com)  
1-877-766-2999

Andrews Coax HCC-300. 900' already on the spool waiting to be picked up by buyer. This line was installed in 1982 and removed from service back in November. Just like the antenna I listed it is located in Alert, NC awaiting it's new owner. Asking \$2500. Email [Mraley@bbradio.org](mailto:Mraley@bbradio.org) for pictures.

**Why Buy a Used Antenna. When you can Buy a New Antenna for about the Same Price contact Benny Springer 800/696-7919 Superior Broadcast Products Factory Direct Prices to you**

Cablewave CP-1000-2, 2-bay, FM transmit antenna with radomes. 2000 watt power capacity, brand new, still in factory sealed cartons, complete antenna, does not include transmission line, \$1250/BO. Ray Knudson, KNXK, 1229 Park Ave, La Crosse WI 54601. 608-782-2254.

**PROMOTE YOUR BUSINESS! ADVERTISE!**

For more information, call Simone Fewell at 703.998.7600, ext. 154.

### AUTOMATION EQUIPMENT

#### Want to Sell

Smartcaster Live Assist, can run 24/7, 8 decks, computer and rack, great condition, \$2300 +shpg. John Wilsbach, WMSS, 214 Race St, Middletown PA 17057. 717-948-9136.

### COMPLETE FACILITIES

#### Want to Sell

NEW OR USED COMPLETE PACKAGES  
STUDIO/STL/TRANSMITTER/ANTENNA OR ANY COMBINATION OF ABOVE.  
-LEASE OPTIONS-  
-EMERGENCY RENTALS-  
-REMOTE BROADCAST RENTALS-  
SCMS, Inc. (800) 438-6040  
"You Know We Know Radio"

### CONSOLES

#### Want to Sell

LPB S-13 console, Signature 3, 8 pot, 24 input. Excellent condition, taken out of service in June 04, \$900. Jim Travis, Family Life Network, POB 506, Bath NY 14810. 607-776-4151 ext 222.

#### Want to Buy

Small, solid state, stereo console, any condition. David Johnson, 970-309-3623 or email: [remix9@comcast.net](mailto:remix9@comcast.net).

### LIMITERS/AUDIO PROCESSING

#### Want to Sell

CRL SEP-800, \$600. Robert Leembruggen, 808-383-4054 or email: [Robert@mauisound.com](mailto:Robert@mauisound.com)

dbx 160X compressor/limiters (2), excellent condition, rack mount, \$125 +shpg each. Joel Block, The Production Block Studios, 3811 North Lamar Blvd, Austin TX 78705. 512-472-8975.

Eventide Harmonizer, Model H3000, in excellent condition, \$500. Joel Block, The Production Block Studios, 3811 North Lamar Blvd, Austin TX 78705. 512-472-8975.

Inovonics David 715 stereo generator, used on high school FM station, great condition, \$1000 +shpg. John Wilsbach, WMSS, 214 Race St, Middletown PA 17057. 717-948-9136.

Yamaha SPX 90 II audio processor (reverb, delay, etc) in excellent condition, \$125 +shpg. Joel Block, The Production Block Studios, 3811 North Lamar Blvd, Austin TX 78705. 512-472-8975.

### Want to Buy

Teletronix LA-2A's, UREI LA-3A's & LA-4's, Fairchild 660's & 670's, any Pultec EQ's & any other old tube compressor/limiters, call after 3PM CST, 972-271-7625.

### MICROPHONES

#### Want to Buy

RCA 77-DX's & 44-BX's, any other RCA ribbon mics, on-air lights, call after 3PM CST, 972-271-7625.

### MISCELLANEOUS

#### Want to Sell

ROTRON BLOWERS AND PLATE BLOCKERS, new & rebuilt for Elcom, Harris, CCA, CSI, McMartin. Goodrich Ent. 11435 Manderson St. Omaha, NE 68164 402 493 1886 FAX 402 493 6821

Proteck 20 MHZ Spec. analyzer (A-3502). Make a decent offer. Call Michael Raley (704) 523-5555 or e-mail [Mraley@rrb.org](mailto:Mraley@rrb.org).

### BAY COUNTRY BROADCAST EQUIPMENT

BUY - SELL - TRADE  
Your #1 Source For Quality Used Radio Broadcast Equipment  
View The Latest List On Line At: <http://www.baycountry.com>  
Or Call And We Will Fax It To You  
7117 Olivia Rd., Baltimore MD 21220  
Toll Free: 877-722-1031 • FAX 443-596-0212 • E-mail: [info@baycountry.com](mailto:info@baycountry.com)  
Member of BBB

### Want to Buy

Noncommercial community station needs several Texas Instruments TIL-308 or TIL-309 seven segment displays, as used in Moseley MRC-1. Believe they were also used in some Kenwoor or Yaesu ham gear. Marc Sophos, WDFH-FM, 914-674-0900; [marc@wdfh.org](mailto:marc@wdfh.org).

Seeking San Francisco radio recordings from the 1920's through the 1980's. Stations like KYA, KSFO, KPO, KWBR, KTAB, etc. Formats in r-r, 16" radio transcription disc, cassette, etc. I'll pay to have copies made for me. Write or call: Ron Tamm, 140 Linden Ln #127, Mill Valley CA 94941. 415-383-6216.

### PATCHBAYS

#### Want to Sell

ADC Pro-Patch, 7 units, \$100 each. Robert Leembruggen, 808-383-4054 or email: [Robert@mauisound.com](mailto:Robert@mauisound.com).

### RECORDERS

#### Want to Sell

Marantz professional dual well cassette recorders, Model PMD-520 (4), low hours, excellent condition, rack mount, \$95 each. Joel Block, The Production Block Studios, 3811 North Lamar Blvd, Austin TX 78705. 512-472-8975.

Otari MX5050-BII r-r, good condition, includes manuals, BO. Andrew Skotdal, KRKO, 425-304-1381 or email: [Andrew.skotdal@krko.com](mailto:Andrew.skotdal@krko.com).

Tascam BR-20 r-r, low hours, excellent condition, \$650 +shpg. Also Tascam DA-88 with SY-88 timecode care, \$150 +shpg. Joel Block, The Production Block Studios, 3811 North Lamar Blvd, Austin TX 78705. 512-472-8975.

### REMOTE & MICROWAVE

#### Want to Sell

WE RENT FOR LESS  
Blueboxes FM Exciters  
Zephyrs FM Power Amps  
POTS Codacs STLs  
RF/Audio Gear Test Equipment  
If we don't have it, we will get it!  
SCMS, INC. (800) 438-6040  
"You Know We Know Radio!"

CDQ-Prima 120 + NT1 interface, very good condition, ISDN quality for your studio or network, \$2300/BO. Andrew Skotdal, KRKO, 425-304-1381 or email: [Andrew.skotdal@krko.com](mailto:Andrew.skotdal@krko.com).

Comrex Nexus ISDN remote unit, \$1150/BO, good condition. Andrew Skotdal, KRKO, 425-304-1381 or email: [Andrew.skotdal@krko.com](mailto:Andrew.skotdal@krko.com).

Comrex Nexus ISDN remote unit, \$1250/BO, very good condition. Andrew Skotdal, KRKO, 425-304-1381 or email: [Andrew.skotdal@krko.com](mailto:Andrew.skotdal@krko.com).

TFT reciter, great condition, \$7500. Robert Leembruggen, KAOI Radio Group, 808-244-9145.

MAC+ & MiniMAC+  
THE MOST FLEXIBLE SECURE-IP  
REMOTE MONITORING SYSTEMS  
ON THE MARKET  
COMLAB INC.  
2300, Leon-Harmel, Suite 220  
Quebec, QC, G1N 4L2  
Tel: 418.682.3380 Fax: 418.682.8996  
E-mail: [sales@comlab.com](mailto:sales@comlab.com) Web: [www.davicom.com](http://www.davicom.com)

**SPACE IS AVAILABLE!**  
To advertise, call Simone at 703-998-7600, ext. 154.

#### Want to Buy

Noncommercial community FM station seeks Moseley MRC-1 for parts. Looking particularly for Texas Instruments TIL-308 displays used in the MRC-1 or TIL-308 or TIL-309 displays from other gear. Several needed. Marc Sophos, WDFH-FM, 914-674-0900 or [marc@wdfh.org](mailto:marc@wdfh.org).

Noncommercial community FM station seeks transmitter remote control system (Moseley MRC series or Burk preferred). Donation to 501¢(3) or reasonable price if possible. Will pay shipping. Marc Sophos, WDFH-FM, 914-674-0900, or [marc@wdfh.org](mailto:marc@wdfh.org).

### SATELLITE EQUIPMENT

#### Want to Sell

MPEG-2 Satellite Receivers, LNBs, C & Ku Band Equipment. [www.daveswebshop.com](http://www.daveswebshop.com), 479-997-2230.

STARGUIDE AUDIO CARDS REPAIRED! \$83 per card, includes return shipping. Email: [nf4a@knology.net](mailto:nf4a@knology.net) for more information.

Buying used equipment?  
Selling used equipment?  
**YOU'RE IN THE RIGHT PLACE!**  
Radio World  
Broadcast Equipment Exchange  
For more information, call Simone Fewell at 703-998-7600, ext. 154

Wegner DN 86 Digital Audio Receiver 3944.1 MHZ - \$100.00 "as is" plus shipping and handling - Call Michael Raley @ (704) 523-5555 for more information or e-mail [Mraley@rrb.org](mailto:Mraley@rrb.org) for a picture.

New Dawn LNB Part # CLNB20-PL10, \$150. Herman Gibbs, WCWS, Box C-3177, College of Wooster, Wooster OH 44691. 330-263-2212.

**Radio World**  
5827 Columbia Pike, 3rd Floor Falls Church, VA 22041  
PHONE: 703-998-7600 • FAX: 703-671-7409

### Classified Advertising Rates Effective January 1, 2004

	1x	6x	13x	26x
1-9 col inch (per inch)	\$105	100	95	90
10-19 col inch (per inch)	\$90	80	70	60
Distributor Directory	\$130	125	120	115
Professional Card	\$100	95	90	85
Station/Studio Services	\$195	165	140	119
Classified Line Ad	\$2/word			
Blind Box Ad	\$15 additional			

Call Simone Fewell, Ext. 154, Classified Ad Manager, to reserve space in the next issue. Use your credit card to pay, we now accept VISA, MASTERCARD and American Express.

**STUDIO EQUIPMENT (WTS) Cont.**

TFT 713 AM Frequency and Modulation Monitor. Cost \$3,400.00 new but will sell for \$1000.00 plus S&H. Needs re-calibration. Call Michael Raley at (704) 523-5555 or e-mail [Mraley@rrb.org](mailto:Mraley@rrb.org) for a picture.

Two RTS 416 Distribution Amplifiers. Has slight problem pushing +4. Cost \$1,173.00 new but will take \$300.00 for each unit plus S&H. Call Michael Raley at (704) 523-5555 or e-mail [Mraley@rrb.org](mailto:Mraley@rrb.org) for a picture.

CSIT-25-FA FM Transmitter. Recently removed from service in Savannah, GA after 18 yrs of solid operation. Includes Relay interface for remote control and Low Pass filter but not the exciter. This is a three-phase box tuned to 89.5 FM. TPO is 25k with an efficiency of .73. This also includes a CSI T-3 which drives the final. We have the manuals for both. Asking \$13,000 plus buyer arranges shipping. Give me a call at 704-523-5555 or e-mail [Mraley@bbradio.org](mailto:Mraley@bbradio.org).

**OFF THE AIR?**  
Emergency Back-up Rentals

FM Exciters - STLs -  
FM Pwr Amps - Antennas -  
Studio & Test Equipment

SCMS Inc (800) 438-6040  
"You Know We Know Radio"

[www.fivonine.com](http://www.fivonine.com)

**TRANSMITTERS**

**Want to Sell**

McMartin BF-5K, 5kW FM. Factory rebuilt in perfect, like new condition, includes new tubes, tested & tuned on your frequency. Guaranteed, fully adjustable from 0 to 5.5 kW. Goodrich Enterprises Inc, 402-493-1886.

**Radio World**  
Equipment Exchange

QEI FMQ series 6.0 to 9.6FM. This xmitter did a tour of duty in Argentina but some goofy laws in this country made it impossible to permit the station to operate at this power. To make a long story short it was only in operation no more than four months. Will let this go for \$18 ,000.00. Call Mike Raley at (704) 523-5555 or E-mail [Mraley@rrb.org](mailto:Mraley@rrb.org) for pictures.

**Why Buy a Used Transmitter. When you can Buy a New Transmitter for about the Same Price contact Benny Springer 800/696-7919 Superior Broadcast Products Factory Direct Prices to you**

RCA BTA1S 1000/500 watt broadcast transmitter with new matched pair of 400-C power tubes in transmitter plus spares. AM crystal oscillator at 1300 in transmitter with manuals, \$3000. Donald De Rosa, WAMF, 315-593-1300 or email: [WAMF1300@alltel.net](mailto:WAMF1300@alltel.net).

**BEXT**  
From the tall to the small  
[WWW.BEXT.COM](http://WWW.BEXT.COM)  
**888 239 8462**  
Transmitters & Antennas

To advertise,  
call 703-998-7600,  
ext. 154  
or e-mail:  
[sfewell@imaspub.com](mailto:sfewell@imaspub.com).

**CCA HELP**

- Rotron Blowers ▪ Rebuild Plate Blockers ▪ Tubes
- Tube sockets/parts ▪ most all transmitter parts
- rebuild tuning line assemblies

Goodrich Ent. Inc  
402-493-1886  
[www.goodrichenterprises.com](http://www.goodrichenterprises.com) [cgoodrich@tconl.com](mailto:cgoodrich@tconl.com)

**Broadcast Equipment Exchange**

"BEE" in the habit of selling your used equipment here!

Call Simone for details at  
**(703) 998-7600, Ext. 154.**

**TRANSCOM CORP.**  
Serving the Broadcast Industry Since 1978

Fine Used AM & FM Transmitters and Also New Equipment

USED FM TRANSMITTERS		
1KW	1998	Harris Quest Solid State
1.5KW	1987	BE FM1.5A
3.5KW	1988	BE FM3.5A
3.5KW	1992	Harris HT3.5
10/12KW	1980	CCA 12,000E
20KW	1978	Collins 831G2
25KW	1980	CSI T-25-FA (Amplifier Only)
25KW	1982	Harris FM25K
30KW	1986	BE FM30A
50KW	1982	Harris Combiner w/auto exciter-transmitter switcher

USED AM TRANSMITTERS		
1KW	1982	Continental 314R-1
1KW	1987	Harris SX1A Solid State
2.5KW	1999	Harris "Gales 2" Solid State
10KW	1986	Harris MW10B
50KW	1985	Continental 317C2
50KW	1985	Harris MW50C3
50KW	1986	Nautek AMPFET 50 Solid State

NEW TV TRANSMITTERS ANALOG AND DIGITAL	
VHF AND UHF (10 W to 10KW)	TV Antennas TV STL

USED TV TRANSMITTERS	
1KW UHF	1992 Acrodyne
10KW UHF	1999 Itelco T614C (Like new-60 hrs. of use)

USED EXCITERS	
Harris DIGIT. 2002	BE FX 30
Continental 802B	

USED MISC. EQUIPMENT	
Audio Amplifiers:	BGW 85
	Crown D-75
	Audiometrics Stereo Distribution Amplifier
	Belar AMM3 Modulation Monitor
	Harris AMS-G1 AM Stereo Generator
	Inovonics AM Stereo Audio Processor
	Kirtronics 50kw AM RF Switch
	Moseley remote controls
	Polomac Phase Monitor AM19 w/sampler
	Polomac Phase Monitor 1901 Digital 2Twr
	Sola Voltage Regulator 60hz 1KVA s-phase

AND MUCH MORE

CALL US FOR A QUOTE!

2655 Philmont Ave #200, Huntingdon Valley, PA 19006  
800-441-8454 • 215-938-7304 • FAX No. 215-938-7361  
VISIT OUR NEW INTERNET SITE: [www.fmamtv.com](http://www.fmamtv.com)  
SEND YOUR E-MAIL REQUESTS TO: [transcom@fmamtv.com](mailto:transcom@fmamtv.com)

**CONSULTANTS**

**Consulting Communications Engineers EMC Test Lab**

- FCC Applications and Field Engineering
- Frequency Searches and Coordination
- AM-FM-CATV-ITFS-LPTV
- EMC Test Lab-FCC and European (IEC)

**OWL ENGINEERING, INC.**  
**651-784-7445** Fax (651) 784-7541  
5844 Hamline Ave. N., Shoreview, MN 55128 \*Member AFCCE\*

**EVANS ASSOCIATES** Consulting Communications Engineers

FCC Applications • Design • Field Engineering • Tower Detuning Upgrade & Relocation Studies • AM Directional Array Tuning & Proof

EXPERTS IN:  
TV • DTV Transition • FM • Directional Antennas • RF Exposure

210 S. Main St., Thiensville, WI 53092. (262) 242-6000, FAX (262) 242-6045  
<http://www.evansassoc.com> Member AFCCE

**Communications Technologies, Inc.**

Radio Frequency / Broadcast Engineering Consultants

AM FM TV LPTV Cellular/PCS Site Analysis

P.O. Box 1130 / Marlton, NJ 08053  
Tel: 856/985-0077  
Fax: 856/985-8124  
web: [commtechrf.com](http://commtechrf.com)

Clarence M. Beverage  
Laura M. Mizrahi

**GRAHAM BROCK, INC.**

BROADCAST TECHNICAL CONSULTANTS

Full Service From Allocation to Operation AM/FM/TV/AU X Services; Field Work; Antenna and Facilities Design

Over 35 years engineering and consulting experience

**912-638-8028**  
**202-393-5133**  
[www.grahambrock.com](http://www.grahambrock.com)

**FASTER... MORE ACCURATE RADIO COVERAGE**

- Real Time 3-D Displays
- Interference calculations
- Cost effective mapping
- Fully integrated databases
- Used by the FCC
- Latest standards built-in

**RADIO SOFT**

Visit us on the web at [www.radiosoft.com](http://www.radiosoft.com)  
101 Demarest Sq., #E, Demorest GA - 706-778-8811

**System One Communications**

Broadcast Constructors & Consultants  
Houston, Texas  
**888-625-5649**

- AM-FM Site Construction Specialists
- Complete Tower Service
- Antenna & Transmission Line Diagnostics

**Structural Analysis**

**ERI**

Electronics Research, Inc.  
7777 Gardner Road  
Chandler, IN 47610  
(812) 925-6000  
[www.ERInc.com](http://www.ERInc.com)

**REGISTERED PROFESSIONAL ENGINEERS**

**STRUCTURAL ANALYSIS**

ERI Incorporated 1943

**TOWER REINFORCING**

**M Celenza**

Communications Consultants

FM-AM-TV-LPTV-LPFM Applications, Amendments, Upgrades, Frequency Searches, Directional Antennas

Field Work (Station Inspections)  
**631-965-0816 or 516-429-8340**  
[celenza@prodigy.net](mailto:celenza@prodigy.net)

41 Kathleen Crescent, Coram N.Y. 11727

**Doug Vernier**

Telecommunication Consultants

Broadcast Engineering Consulting

AM/FM/TV/LPTV/DTV Custom mapping service  
Frequency searches  
Propagation prediction  
FCC application preparation

**VSoft**  
Software for your PC

**(800) 743-3684**  
[www.v-soft.com](http://www.v-soft.com)

**dataworld**

Market Analysis  
Engineering Software  
Ethnic/Demographic Data  
Custom Full-color Mapping  
Sales Marketing Packages

[www.dataworld.com](http://www.dataworld.com)  
800-368-5754

[info@dataworld.com](mailto:info@dataworld.com)  
fax: 301-656-5341

**David C. Schaberg**

Allocation Specialist

FM & AM Frequency Searches: Move-ins, upgrades, allocations  
Maximization of signals

"I do the tough ones!"

Contract engineering in the Midwest; build-outs across the country and equipment repairs.

**517-393-1037**  
[www.starradio.net](http://www.starradio.net)

**MULLANEY ENGINEERING, INC.**

Consulting Engineers

- Design & Optimization of AM Directional Arrays
- Analysis for New Allocation, Site Relocation, and Upgrades
- AM-FM TV LPTV Wireless Cable (MOS/MMDIS/ITFS/OFS)
- Environmental Radiation Analysis
- Field Work
- Expert Testimony

9049 Shady Grove Court  
Galthersburg, MD 20877  
Phone: (301) 921-0115  
Fax: (301) 590-9757  
email: [mullengr@aol.com](mailto:mullengr@aol.com)

**DISTRIBUTOR DIRECTORY**

The following distributors serving the broadcast industry would be glad to help you with any of your requirements.

**CORNELL-DUBILIER MICA CAPACITORS**

FROM STOCK

**JENNINGS VACUUM CAPACITORS**

FROM STOCK

**JENNINGS VACUUM RELAYS**

**SURCOM ASSOCIATES**  
2215 Faraday Ave., Suite A  
Carlsbad, California 92008  
(760) 438-4420 Fax: (760) 438-4759  
e-mail: [link@surcom.com](mailto:link@surcom.com) web: [www.surcom.com](http://www.surcom.com)

**SPACE IS AVAILABLE!**

**Are You a Distributor?**

**ADVERTISE HERE!**

Space is available.  
Call 703-998-7600, ext. 154.



POWER TUBES  
REBUILT  
-----  
1/2 THE COST  
OF NEW!

# ECONCO

TEL: 800-532-6626  
INTL: +1-530-662-7553  
FAX: +1-530-666-7760  
www.econco.com  
SE HABLE ESPAÑOL



**TUBES & COMPONENTS**  
Want to Sell

**FOR THE BEST PRICE**  
& 24 Hr service on transmitting tubes & sockets/parts, new & rebuilt call Goodrich Ent. at 402-493-1886 day or night, www.goodrichenterprises.com.



The Choice of Successful Broadcasters Since 1934

**NEW POWER TUBES**  
Triodes  
Tetrodes  
Pentodes

**NEW SOCKETS & REPLACEMENT PARTS**

Worldwide Availability

Made in U.S.A.

CALL 800-414-8823  
Int'l (650) 592-1221  
Fax (650) 592-9988

Visit our Web Site at  
www.eimac.com



**RF PARTS CO.**  
From Milliwatts to Kilowatts  
EIMAC • TAYLOR • ECONCO • SVETLANA  
Motorola • Toshiba • SGS • Thomson & Mitsubishi Semiconductors  
Se Habla Español **800-737-2787** We Export  
760-744-0700 Email: rfp@rfparts.com Web: www.rfparts.com

Check out the web site!  
**www.rwonline.com**

**D And C Electronics**  
An International Distributor of RF Components  
**Tubes**  
NEW & REBUILT  
TRANSMITTERS, STUDIO EQUIPMENT, STLS, ANTENNAS,  
RADIO DATA SYSTEM (FOR CAR RADIO DISPLAY)  
EXCITERS-TRANSMITTERS, TRANSLATORS, MIXERS-CONSOLES, RADIO LINK  
RPU, MOSFETS, VACUUM CAPACITORS, SOCKETS

**EIMAC** **Pro-Tek®**  
**SVETLANA** **OMB** **EEV**  
USA DISTRIBUTOR

**BEST PRICES** To Order: **FROM OUR STOCK**  
1-800-881-2374  
Outside U.S. (352) 688-2374  
Se Habla Español

3089 Deltona Blvd. 352-688-2374  
Spring Hill, FL 34609 Fax 352-683-9595  
BEST SERVICE Website: www.dandcelectronics.com

# EMPLOYMENT

**HELP WANTED**

**STUDER**  
professional audio equipment  
Regional Sales Manager -- Los Angeles based

As a leading supplier of digital audio mixing systems to the Post Production and Broadcast markets, Studer USA is seeking a Western Regional Sales Manager to assist in the continued expansion of the brand.

Reporting directly to the National Sales Manager, you should already be familiar with the audio side of both the Post and Broadcast industries. Ideally you will have a minimum of a Bachelors degree in an associated discipline or a minimum of 5 years experience within the audio side of Broadcast sales. Consideration may also be given to an individual with a strong technical background who is looking to break into sales.

As part of the Harman International Group of companies, you will receive a benefits package, including 401K and healthcare, commensurate with this level of position.

If interested, please email your resume to [projobs@harman.com](mailto:projobs@harman.com) quoting # STSELW.06 in the subject line or fax direct to: 818-893-1531

Harman is an equal opportunities employer.

Hispanic rookie on task in looking for that special station to call home. Bilingual and ready to travel. Ike (Mad Mexican) Soliz, 214-339-1336.

Rob, "The Music Man" or "Razorback Rob" with the sports, either way dependable, exciting, hard working and always with something to say. Rob, 405-672-8978.

Rookie in need of a start. I'm motivated & proficient in DRS and Cool Edit 2000. Willing to travel. Stephen Smith, 817-451-8441 or [consy2001@yahoo.com](mailto:consy2001@yahoo.com).

**Radio World**  
Equipment Exchange

Since 2003 Paris Vaughn has lit up the airwaves on KABS. She's precocious, aggressive, ambitious and on fire. If interested, call 917-754-1304.

Smart, witty, warm and fuzzy DJ, producer, board op, newscaster, Nicholas Del Toro is the man you want to get the job done right. 940-458-7245 or [Nicky\\_Del\\_Toro78@yahoo.com](mailto:Nicky_Del_Toro78@yahoo.com).

Strong male voice seeks Dallas area position. ABS graduate with 8 years professional digital audio experience. 972-240-6233. Listen to aircheck online at <http://bill.snoeck.home.comcast.net>.

The best in pure talent, energetic, enthusiastic, funny and down to earth. Available to make your station number 1 in all areas. Hezekiah, 405-412-5471.

**POSITIONS WANTED**

Are you seeking proficiency, professionalism, extensive knowledge of digital production, on-air domination and a willing to relocate? Contact Dony, 405-818-7973 or [leed302002@yahoo.com](mailto:leed302002@yahoo.com).

Ebonee Dymond, a highly conscientious, multi-tasked driven, self-motivator willing to achieve organizational objectives for deadlines and time goals. Carlene, 405-641-3076.

Creative ABS graduate bursting with enthusiasm seeks OKC area radio station/ad agency. Copywriting, voicing, production, news writing, music programming. Kelly, 405-602-3193 or [Kreativejuices@cox.net](mailto:Kreativejuices@cox.net).

Recent ABS grad looking for her place on the radio. Energetic, hardworking and willing to relocate. Barbie, 405-819-2283 or [brmaguire@mahaffeygore.com](mailto:brmaguire@mahaffeygore.com).

Creative! Energetic! Unique! Tell me what you think! Production, copywriting and on-air too, put me at your station and see what I can do! Lekeytha, 405-924-1407.

# ACTION-GRAM

**EQUIPMENT LISTINGS**

Radio World's Broadcast Equipment Exchange provides a FREE listing service for radio stations only. All other end users will be charged. This FREE service does not apply to Employment Help Wanted ads or Stations For Sale ads. These are published on a paid basis only. Send your listings to us by filling out the form below. Please be aware that it takes one month for listings to appear. The listings run for two consecutive issues and must be resubmitted in order to run again. Thank you.

Please print and include all information:

Are you currently a subscriber to Radio World?  
 Yes  No

Signature \_\_\_\_\_ Date \_\_\_\_\_

Contact Name \_\_\_\_\_  
Title \_\_\_\_\_  
Company/Station \_\_\_\_\_  
Address \_\_\_\_\_  
City/State \_\_\_\_\_  
Zip Code \_\_\_\_\_  
Telephone \_\_\_\_\_

Brokers, dealers, manufacturers and other organizations who are not legitimate end users can participate in the Broadcast Equipment Exchange on a paid basis. Line ad listings & display advertising are available on a per word or per inch basis.

WTS  WTB  Category: \_\_\_\_\_  
Make: \_\_\_\_\_ Model: \_\_\_\_\_  
Brief Description: \_\_\_\_\_  
Price: \_\_\_\_\_

WTS  WTB  Category: \_\_\_\_\_  
Make: \_\_\_\_\_ Model: \_\_\_\_\_  
Brief Description: \_\_\_\_\_  
Price: \_\_\_\_\_

\*Closing for listings is every other Friday for the next month's issue. All listings are run for 2 issues unless pressed for space or otherwise notified by listee.

**Broadcast Equipment Exchange**

PO BOX 1214, Falls Church, VA 22041 • Tel: 703-998-7600 • Fax: 703-998-2966

# ADVERTISER INDEX

This listing is provided for the convenience of our readers. Radio World assumes no liability for inaccuracy.

PAGE	ADVERTISER	WEB SITE URL
29	AEQ	www.aeqbroadcast.com
25	Altronic Research	www.altronic.com
16	Armstrong Transmitters	www.armstrongtx.com
30	ATI	www.atiaudio.com
5	audioTX Communicator	www.audiotx.com
32	Autogram Corporation	www.autogramcorp.com
32	Bext	www.bext.com
17	Broadcast Electronics	www.bdcast.com
11	Broadcast Software Int'l (BSI)	www.bsiusa.com
8	Broadcast Warehouse	www.dsp-x.com
4	Burk Technology	www.burk.com
30	Burk Technology	www.burk.com
28	Circuit Werkes	www.circuitwerkes.com
32	Circuit Werkes	www.circuitwerkes.com
30	Comet North America	www.cometna.com
6	Comrex	www.comrex.com
7	Comrex	www.comrex.com
28	Conex Electric Systems	www.conex-electro.com
30	Electronics Research Inc.	www.eriinc.com
21	Full Compass	www.fullcompass.com
18	Gepco International	www.gepco.com
28	Gorman-Redlich Mfg. Co.	www.gorman-redlich.com
20	Grace Broadcast Sales	www.gracebroadcast.com
1	Harris	www.broadcast.harris.com
15	Henry Engineering	www.henryeng.com
12	Inovonics	www.inovon.com
28	LBA Technology	www.lbagroup.com
19	Logitek	www.logitekaudio.com
27	Moseley Associates	www.moseleysb.com
26	Omnia, a Telos Company	www.omniaaudio.com
28	Radio Design Labs	www.rdlnet.com
28	Raduga Automation	www.raduga.net
30	rSoftware, Inc.	www.rsoftware.com
32	Richardson Electronics	www.broadcast.rell.com
3	S.C.M.S.	www.scmsinc.com
28	S.C.M.S.	www.scmsinc.com
10	Sabre Communications	www.sabrecom.com
24	Scott Studios	www.scottstudios.com
14	Sine Systems	www.sinesystems.com
28	Star Case Mfg. Co, Inc.	www.starcase.com/rack.htm
9	Telos Systems	www.axiaaudio.com
13	Telos Systems	www.telos-systems.com
2	Wheatstone	www.wheatstone.com
39	Wheatstone	www.wheatstone.com
40	Wheatstone	www.wheatstone.com
20	www.radio-mall.com	www.radio-mall.com

## ◆ READER'S FORUM ◆

Radio World, August 11, 2004

### Obscenity

► continued from page 38  
standards" line for a community somewhere, and so would be deemed obscene. Yet these movies are seen nightly by a national audience. How?

The loophole seems to be that XM and HBO are transmitted as scrambled subscription services. Even though federal law (Title 18, Section 1468) includes an obscenity prohibition for subscription services, the "community standards" test doesn't really make sense when the community of viewers paid to see the stuff. Politically, this seems unlikely to change. Even if congressmen can't understand Arbitron ratings, their consultants can.

And attempts to censor where the audience fully expects obscene content have usually fallen flat, like Chicago's WSNS(TV), which once aired adult videos that required a decoder for viewing. Cases involving rape videos or snuff films, such as were sold by Garry and Tamara Ragsdale before their 2003 con-

as something of an inconvenience.

Meanwhile, broadcasters are responding to the obscenity concerns by installing profanity delay systems. By combining these two initiatives into one, Ibiquity can solve our obscenity problem.

#### Informed consent

What if the Ibiquity audio stream was branded as "uncensored and uncut," and the existing analog FM signal was subject to profanity bleeps? By choosing to enable Ibiquity reception, the listener is granting informed consent. Cross-media promotion, such as outdoor and TV, should make clear that the Ibiquity digital stream is uncensored and uncut.

The mechanisms would be easy to implement and jocks could even "self-censor" using a button like the old cough switch right in the studio. If station management seeks a second level of control, another censor could control content using a traditional profanity delay. The key difference is that the program would remain uncensored for the Ibiquity stream.

**W**hat if the Ibiquity audio stream was branded as 'uncensored and uncut,' and the existing analog FM signal was subject to profanity bleeps?

viction for mailing obscene material, were the exception. The key to avoiding trouble is to provide a path to "informed consent" on the part of the listener.

Unfortunately, our medium has no provision for "scrambling" the signal, like XM and HBO — at least not until now.

#### HD scramble

Many FM stations are in the process of implementing Ibiquity HD Radio, our FCC-approved digital radio technology. One of the necessary processes in the Ibiquity system is called interleaving, which is a kind of "scrambling" of the digital audio stream. Without the correct reciprocal unscrambling process at the listener end, the Ibiquity audio is unrecognizable.

Ibiquity requires that listeners buy a whole new radio, for the same reasons your old turntable won't play a CD. And the radio will almost certainly allow the listener to disable the Ibiquity and listen to ordinary analog FM. The conscious decision on the part of the listener to switch on Ibiquity and listen to the digital audio represents consent.

Interestingly, the Ibiquity scrambling process takes time. Audio goes into the Ibiquity encoder and comes out seconds later. Because it is intended that the Ibiquity digital audio and the plain old FM arrive at the same time, a separate time delay must be applied to the analog FM to match the built-in delay of Ibiquity. Until now, this has been viewed

For those stations wanting still another level of regulatory comfort, promotions involving retailers of Ibiquity receivers could include listener registration. By creating an impression that listeners must sign up for Ibiquity (even if the registration fee is "waived" or given to charity) those who do not register forfeit their right to complain, because the complaint will be about a service that has been "stolen."

With such a solution, our listener, driving to an unsatisfying job and working for a jerk of a boss, will once again be able to enjoy living vicariously through the Howard Sterns of our medium. The listener will once again enjoy a chuckle thanks to clever but irreverent hosts who butcher the sacred cows of mainstream sensibility.

In an era when radio has been criticized for universal bland sameness, isn't the commuter entitled to assert individual taste, and choose the desired flavor of escape from reality radio provides?

Frank McCoy is vice president of American Media Services, a firm that upgrades radio stations.

#### Correction

The story about pirate radio in the June 16 issue contained a typo in WCEE(FM)'s power level. The station in Melbourne, Fla., has an ERP of 43 watts.

**Radio World.**  
The Newspaper for Radio Managers and Engineers

**Our readers have something to say**

*"Every issue has something of interest. I love the articles on engineering, especially John Bisset's column, as well as stories by Scott Fybush and Paul McLane. Radio World is true radio people doing a magazine for radio people."*

Charlie Slezak, Engineer  
Delmarva Broadcasting  
WDEL-WSTW-WXCY  
Wilmington, Del.

## GUEST COMMENTARY

# HD Radio Can Fix Obscenity Issue

The Author Argues That We Can Give Listeners the Option of Uncensored Digital or Censored Analog FM

by Frank McCoy

With the Congress and the FCC on our case, fines and possible license revocation are a reality for stations that get nailed for saying naughty things. Most of us are just one Morning Zoo slip-up from trouble — and possibly three slip-ups from disaster. The crusade to stamp out broadcast obscenity seems to be reported more often in the financial section of the newspaper, an indication of where journalists think this story leads. If you weren't scared before, you probably are now.

We also face a possible talent exodus, right into the waiting arms of XM and Sirius. And with them will go valuable listeners — listeners from the MTV generation who are likely to adopt new technology like satellite radio. High-profile, established air talent is just what XM and Sirius need to get a foothold.

The good news is that there is a technical solution to this problem. It is a one-size-fits-all idea, and requires minimal operational changes.

The solution I'm proposing would allow listeners to choose whether or not to hear edited (some might say censored) broadcasts. It'll settle down the spooked air talent before they head for the door, and will solidify our place with the tech-savvy younger demos.

And this solution is already FCC-approved.

## Heretofore

In case you were wondering how we got to this point ...

From time to time, usually during contentious political periods in Washington, the content of broadcast media comes to the attention of the FCC and sometimes other parts of government. In the 1970s, the FCC was used as a police department by the White House, for Nixon and his aides felt that network news coverage was slanted and wanted to take action.

In one such instance, according to former CBS News reporter Bob Schieffer in his book "This Just In," FCC Chairman Dean Burch personally called CBS, NBC and ABC demanding transcripts of news commentary aired after a Nixon speech.

The intent was to intimidate, as the networks knew that the FCC had the power to revoke licenses.

After Nixon, the target moved from offensive news to offensive entertainment, with the focus on nudity on TV and dirty words on the radio. The FCC and the courts established in *Miller vs. California* (1973) that obscene material enjoys no First Amendment protection, and that local community standards would dictate what was considered obscene. We ended the 1970s with the famous FCC vs. Pacifica case about George Carlin's monologue "Filthy Words" that aired in New York.

For the most part, the FCC took enforcement action only when the offensive material could be reproduced, either through playback of a recording or reading of a transcript. Throughout most of the 1980s and 1990s, the FCC required complaints to be accompanied by a tape or transcript before undertaking any investigation. Even today, the FCC's Web site states:

*"The Commission does not independently monitor broadcasts for indecent material. Its enforcement actions are based on documented complaints of indecent or obscene broadcasting received from the public. Given the sensitive nature of these cases, it is important that the Commission be afforded as full a record as possible to evaluate allegations of obscene or indecent programming."*

So, for those that have attributed this dust-up to election year political grandstanding, you are partly right.

## Easy copies

I can remember working at stations in the 1980s that threw out their "logging" recorders — clunky old machines with names like Soundscribe. These devices were tossed because, in the absence of a recording and without a transcript, everything that was aired was deniable. Any station that kept a permanent record of what it broadcast risked having to produce a copy if demanded by the FCC.

Nowadays, almost every high-profile radio program should assume it is being

## Engineers, It's Up to You

Technological changes are affecting the broadcast industry at an ever-quickening pace. Engineers can never be 100 percent "caught up." But over time, they stand to become less relevant if they don't anticipate larger trends and prepare themselves by learning as much as possible.

The list of potential topics is long, but here are three important ones to consider as we go about maintaining today's broadcast plants and learn IT systems installation, repair and admin skills:

**Telematics:** Communications and computer technologies are merging. Already applications exist that benefit the broadcaster's bottom line. The combining of automotive on-board navigation systems with the broadcaster's traffic reporting technologies is right around the corner. The new Microsoft Smart Watch delivers customizable Web-based services to subscriber wristwatch displays via FM subcarriers. The underlying SPOT (Smart Personal Objects Technology) platform can deliver customized information to a range of devices.

**Pervasive computing and networking:** In the not-too-distant future, most devices will have some sort of computing capability, and will be connected to the Internet. Already, many broadcast devices have their own TCP/IP connection; but this is only the beginning. New networking technologies such as Sun Microsystems' Jini envision an infrastructure in which devices can attach themselves to the network, advertise their services and remove themselves when they fail, all with little or no human intervention.

**Information Visualization:** Finding ways to understand and interpret the burgeoning amount of data at our fingertips is another hot topic. The future seems to lie in alternatives to the traditional text and numeric representations of metadata.

Media asset management systems, for example, store a wealth of audio, text, video and graphic files, but it can be difficult to find what you're looking for using conventional representations. Applications such as monitoring and controlling a large number of transmitter sites also could benefit from a visually-enriched user interface. Info viz has been under development for several years, and gradually is finding commercial applications.

Increasingly, knowledge workers need to take responsibility for their own continuing education. There are a number of ways to stay informed. You may want to research an emerging technology for a presentation at your local SBE chapter. If public speaking isn't your thing, consider writing an article for Radio World or other technical journals.

You also can avail yourself of the wealth of online course materials from university engineering and information science programs.

Sometimes the future can seem like a frightening place. Taking the time to learn about even a small piece of it can do a little to ease stress, and a lot for your job security.

— RW

recorded. John Garziglia, a lawyer with the Washington-based communications law firm Womble Carlyle, attributes part of our present dilemma to the Apple iPod and similar devices. Inexpensive, long-running digital recorders make it possible to easily archive multi-hour radio shows. Well-meaning fans post the most edgy clips on Web sites. A Google search of "Stern aircheck" yielded 224 hits. Even the stations' Web sites make digital copies available.

Today, it is easier than ever to document an obscenity complaint with a verifiable recording right from the Internet. No matter what your feelings are about broadcast obscenity, the enforcement

consequences are a serious problem that is here to stay.

## Scrambled signals

Why can Howard Stern go to XM? Doesn't XM use the airwaves?

Yes, and federal law (Title 18, Part 1, Chapter 71, Section 1464) prohibits broadcasting obscene material over XM.

It also prohibits obscene material on HBO. But HBO routinely shows uncut movies with R ratings. Such movies always contain enough senseless violence, nudity and offensive language to guarantee Hollywood a return on investment. Most would cross the "community

See OBSCENITY, page 37 ▶

## —EDITORIAL STAFF—

Paul J. McLane	ext. 117	Editor
Leslie Stimson	ext. 129	News Editor/Wash. Bureau Chief
Kelly Brooks	ext. 136	Associate Editor
Thomas R. McGinley	—	Technical Adviser
Alan Peterson	—	Technical Adviser
John Bisset	—	Contributing Editor
Skip Pizzi	—	Contributing Editor
T. Carter Ross	ext. 120	Editor-in-Chief (International)
Marguerite Clark	—	Editor (International), Milan
Rogelio Ocampo	ext. 121	Latin America Editor in Chief
Karina Gerardi	ext. 137	Latin America Editor
Teresa Geary	ext. 126	Assistant Editor (International)
Terry Hanley	ext. 130	Editorial Assistant & Listings Coordinator
Peter Finch	—	Editorial Assistant, Milan

## —EDITORIAL CONTRIBUTORS—

W.C. Alexander, Bruce Bartlett, Frank Beacham, Naina N. Chernoff, Harry Cole, Troy Conner, Vince Dittingo, Mark Durenberger, Charles Fitch, Ty Ford, Scott Fybush, Harold Hallikainen, Jeff Johnson, Craig Johnston, Paul Kaminski, Peter King, Mark Lapidus, Mark Persons, Sharon Rae Pettigrew, Michael LeClair, Carl Lindemann, Frank R. Montero, Ted Nahil, Tom Osenkowsky, Ken R., Rich Rarey, Randy Stine, Travis the VIO Guy, Barry Umansky, Tom Vernon.

## Radio World

Vol. 28, No. 17 August 11, 2004

Telephone: (703) 998-7600 • Business Fax: (703) 998-2966 • Editorial Fax: (703) 820-3245  
E-mail: radioworld@imaspub.com • Web site: www.rwonline.com

## —ADVERTISING SALES REPRESENTATIVES—

US East: John Casey	330-342-8361	Fax: 330-342-8362	e-mail: jcasey@imaspub.com
US West: Dale Tucker	916-721-3410	Fax: 815-352-1698	e-mail: dtucker@imaspub.com
Product Showcase & Classified Ads: Simone Fewell	703-998-7600 x154	Fax: 703-671-7409	e-mail: sfewell@imaspub.com
European Sales Mgr., Africa, Middle East: Raffaella Calabrese	+39-02-7030-0310	Fax: +39-02-7030-0211	e-mail: rcalabrese@imaspub.com
Japan: Eiji Yoshikawa	+81-3-3327-2688	Fax: +81-3-3327-3010	e-mail: callmsn@msn.com
Asia/Pacific: Wengong Wang	+86-755-5785161	Fax: +86-755-5785160	e-mail: wwg@imaschina.com
Latin America: Alan Carter	703-998-7600 x111	Fax: 703-671-7409	e-mail: acarter@imaspub.com

## NEXT ISSUE OF RADIO WORLD SEPTEMBER 1, 2004

For address changes, send current and new address to RW a month in advance at P.O. Box 1214, Falls Church, VA 22041. Unsolicited manuscripts are welcomed for review: send to the attention of the appropriate editor.

## —ADMINISTRATION & PRODUCTION—

Stevan B. Dana	President/CEO
Carmel King	VPI Group Publisher
Marlene Lane	Editorial Director/COO
Chuck Inderrieden	CFO
Eric Trabb	Sales & Marketing Director
John Casey	Associate Publisher
Annette Linn	Production Director
Melissa SE Robertson	Production Publication Coordinator
Kathy Jackson	Ad Traffic Manager
Milagros Castañeda	Classified/Product Showcase Layout
Robert Green	Circulation Manager

Radio World (ISSN: 0274-8541) is published bi-weekly by IMAS Publishing (USA), Inc., P.O. Box 1214, Falls Church, VA 22041. Phone: (703) 998-7600, Fax: (703) 998-2966. Periodicals postage rates are paid at Falls Church VA 22046 and additional mailing offices. POSTMASTER: Send address changes to Radio World, P.O. Box 1214, Falls Church VA 22041. REPRINTS: Reprints of all articles in this issue are available. Call or write Ermmily Wilson, P.O. Box 1214, Falls Church, VA 22041; (703) 998-7600 ext. 148; Fax: (703) 998-2966. Copyright 2004 by IMAS Publishing (USA), Inc. All rights reserved.

—Printed in the USA—

# D-8000

## Digital Radio Console

**ADVANCED TECHNOLOGY!** WHEATSTONE'S fourth generation digital console has what you need: dual-domain input modules that accept both analog and digital sources; built-in router integration with 8-character displays; a choice of features like auxiliary sends, equalization, dynamics control and event memory/recall—all without the aid of an external computer. The D-8000 is an all-modular design with no active components mounted inside. And best of all, it uses Wheatstone's exclusive VDIP® setup software, letting you easily configure individual console modules, logic modes and automatic functions. **Contact Wheatstone—the digital audio people!**



sales@wheatstone.com  
tel 252-638-7000

www.wheatstone.com  
copyright © 2004 by Wheatstone Corporation

# GENERATION-8: The On-Air Control Surface for High-Traffic Studios

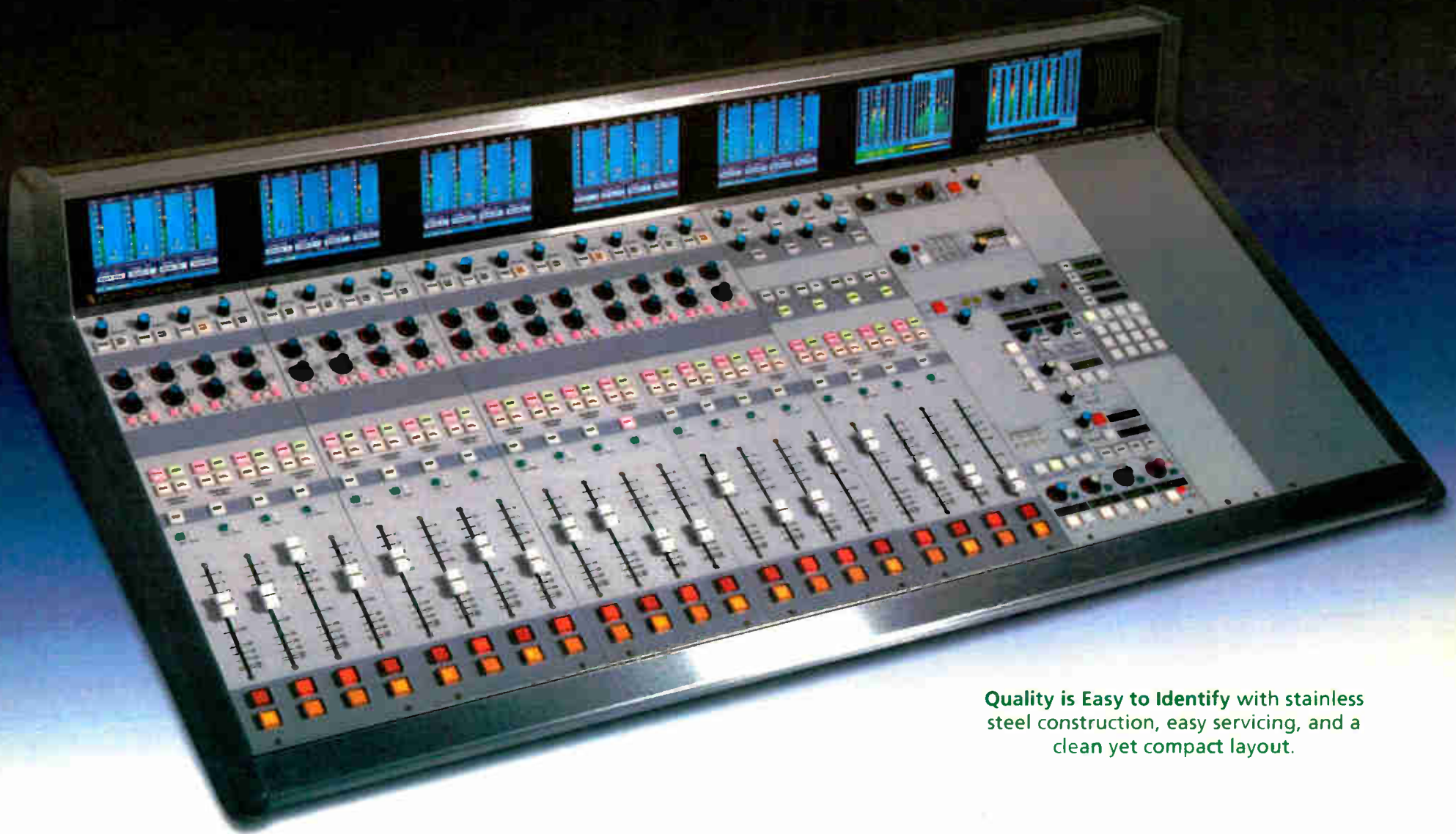

Quality is Easy to Identify with stainless steel construction, easy servicing, and a clean yet compact layout.

## The **POWER** of a Network Surface with the **FEEL** of a Traditional Console!

ONE CAT-5 WIRE conveys all the control from this surface to Wheatstone's Bridge System. You can bring any system source (inputs or mixes) to any console fader or monitor pot (source visibility software controlled). You can set destinations for mixes, aux sends and MXMs to anywhere in your facility. For example, you could allow (or software disallow) your news console to go to your on-air chain, or feed any mix desired to a talent or remote position.

THIS MAJOR MARKET CONSOLE can handle all the call-ins and remotes you'll encounter. Four faders dedicated specifically to phone segments provide errorfree interface to four callers or remotes, each with independent caller and fader feeds, user

selectable talkback communication and adjacent channel linking. A dedicated LCD display screen keeps the operator informed and in control.

YOU CAN STORE AND NAME switch and fader settings for each operator's task and recall them by simply spinning an encoder and hitting a TAKE button. And like our larger G-9, the G-8 has 12 user programmable switches for salvos and intercoms plus additional programmable TALK buttons for IFB functions. And with full color LCD display screens the operator will know for certain that his signal is clean, his sources correct, and his preset signal is ready and waiting. *The G-8 has the layout and features to let your operators work fast and accurately!*

 **Wheatstone**

600 Industrial Drive, New Bern, North Carolina, USA 28562  
tel 252-638-7000 / fax 252-635-4857 / sales@wheatstone.com

the digital audio leaders

[www.wheatstone.com](http://www.wheatstone.com)



Made in USA

Copyright © 2004 by Wheatstone Corporation