

DIGITAL STORAGE/PLAYBACK
Check out Technology Breakthroughs,
in our expanded NAB coverage, pp. 14-22

Radio World®

Vol 15, No 11

Radio's Best Read Newspaper

June 12, 1991

WARC Filings Prefer L-Band

by Judith Gross

WASHINGTON As the FCC prepared to set World Administrative Radio Conference (WARC) policy, the last round of comments on its Notice of Inquiry (NOI) still supported L-band as the most likely

part of the spectrum to place a DAB service.

Comments and replies on a supplemental notice to the second WARC NOI, however, urged co-primary status between terrestrial and satellite DAB and cautioned that the U.S. should seek to have the maximum flexibility going into WARC, slated for next February in Spain.

The short timetable is due to the need to have all position papers in by the end of this summer, according to the FCC.

L-band still the best

The WARC NOI's mapped out four possible spectrum slices for DAB, or BSS (sound), as it is called on the WARC agenda. These areas fell in the UHF-TV, 1500 MHz (L-band), and 2300 MHz (S-band) regions.

UHF-TV was treated by most commenters as being off limits, based on plans to locate HDTV in that frequency. This was restated in the Association for Maximum Service Television (MSTV)'s reply comments asking the Commission to "remove the UHF-TV band from
(continued on page 3)



British Airwaves:

The BBC moves into newly refurbished U.S. radio studios. For more details, see p. 13.

Indecency Ban Lifted

by Charles Taylor

WASHINGTON The U.S. Court of Appeals here has shot down a 24-hour ban of "indecent" over the airwaves.

The ban, which was passed by the FCC in 1988—but never enforced pending the court's examination—was deemed unconstitutionally vague.

The Commission's ruling followed a recommendation from Congress in September 1988 that directed the FCC to prohibit indecent broadcasts 24 hours a day.

Within months, the FCC established a hard line on the issue when it acted on 95 public complaints of "indecent." As a result, the FCC fined four radio stations a total of \$20,000 and issued inquiries to four others.

The NAB and major networks were quick to react, however, citing that a 24-hour ban of "constitutionally protected speech" is contrary to federal law. The groups took issue with the idea that it was wrong to assume that children are in the broadcast audience at all times of the day and night.

"Our view has been all along that the decision of what children should see and hear is up to the parents. A blanket cannot be justified," said an attorney for the groups.

In light of the groups' protests, the U.S. Court of Appeals postponed the effective date of the 24-hour ban, pending a review of the rule's constitutionality. That review resulted in the Court of Appeals decision in May.

FCC Chairman Al Sikes said he is "disappointed in the outcome" of the court decision. "We will continue to study the court's opinion and will be discussing any future action with the Solicitor General's office."

FCC Eyes Ownership

by Arthur Cole

WASHINGTON Despite reservations by three members, the FCC issued a

notice of proposed rulemaking aimed at increasing the multiple ownership limit as a way to jump-start the sagging radio industry.

In a unanimous decision at its May meeting, the Commission asked for comments on a number of ownership scenarios, all of which would increase the ownership limits. Currently, single entities can own up to 12 AM, 12 FM and 12 TV stations.

Among the proposals the Commission is seeking comment on are whether to:

- Raise the numerical restrictions on ownership. Specific proposals include raising or eliminating the cap on AM ownership while retaining the FM and TV limits, or possibly allowing additional AMs to be purchased, provided a total station limit is not exceeded. For example, if the total station limit is 30 and the FM limit is 12, a broadcaster could own 22 AMs, but only eight FMs.

- Base ownership rules on audience or market rank. The Commission suggested establishing a national audience reach percentage that a multiple-station organization cannot exceed, or to eliminate restrictions in the top markets if there are at least 30 competitors in the market.

- Relax the duopoly rule to allow ownership of more than one station per broadcast region. Again, ownership of stations in the same geographical area would be subject to numerical caps or market share or audience level limits.

- Encourage joint ventures and cooperative

(continued on page 10)

SUMMER STUDIO SALE

50% OFF LIST PRICE ON

BROADCAST AUDIO
DIVISION OF FIDELIPAC

Series VI and Series IV Consoles
with purchase of
Dynamax® CTR94 Recorder/Reproducer
and two CTR92 Reproducers.

Complete packages from under \$10,000.



Call Fidelipac for details and the name of your authorized Broadcast Audio dealer.

Fidelipac Corporation • PO Box 808 • Moorestown, NJ 08057 USA • Tel: 609-235-3900 • Fax: 609-235-7779

This offer may be withdrawn at any time without prior notice.

AM Station Cited for Unlit Towers

by John Gatski

JACKSON, Miss. The FCC is very serious about its get-tough policy on unlit broadcast towers, judging by its recent action to cite the owner of AM station WOKJ.

The station, which has been dark since July, 1990, faces a possible \$250,000 fine for multiple violations, including unlit towers and failure to turn in the

station's license after ceasing operation.

Following a six-month investigation and several repeated attempts to contact station owner David R. Price, the FCC has issued a show cause hearing and notice of forfeiture.

If Price is found to be in violation following the show cause hearing, he will not only be fined and lose the station license, but the Commission

also could dismantle the six-array towers that threaten air safety when unlit.

FCC Mass Media Spokeswoman Amy Zoslov said the \$250,000 fine is not a FCC recommendation, but is the statutory maximum forfeiture limit the administrative judge can set.

She emphasized, however, that the magnitude of WOKJ's violations is very serious.

"I think that this case is prob-

ably the most serious case involving tower lights we have ever had," Zoslov said.

Serious charges

The FCC stepped up its tower light enforcement in 1989 following several near collisions of aircraft with towers and a death involving a helicopter collision with a cellular telephone tower.

The Commission's action in the WOKJ case is based on frus-

tration in trying to alleviate the air hazard for several months. On July 20, 1990, the FAA issued a warning to aircraft in the Jackson area because the station's six 390-foot antennas, located 2.5 nautical miles from a nearby airport, were unlit; the power company had shut off the electricity for nonpayment.

The FAA notified the FCC about the unlit towers on August 8. The FCC tried unsuccessfully to reach Price by phone, resulting in the Field Operations Bureau (FOB) sending a certified letter to Price on August 22. The letter directed him to address the air hazard within three days.

Trying to sell

Price responded to the FCC a few weeks later, saying he was trying to sell the station and "hoped" the new buyer would restore the tower lights.

According to the FCC, the air hazard was not addressed and the FOB tried several more times to contact Price. The Commission said that if action was not taken it would dismantle the towers.

In late December, the FCC convinced Mississippi Power and Light Company to restore power to the towers to reduce the air hazard if Price agreed to make payment arrangements to pay off his bill. Price agreed and the power was restored. As of May 15, the tower lights were still on.

Besides the tower violations, the severity of the citations also is based on Price's apparent disregard for FCC procedure, including not turning in his license and failure to respond to FOB inquiries and directives. FCC rules require a station to return a license within three days after cessation of broadcasting.

Give Your Production People Some POWER!

THE SP-6 IS LOADED WITH FEATURES! Like a powerful equalizer section that gives your talent greater creative freedom; four auxiliary sends that can be used for special effects, headphone feeds, or IFB mixes; both 8-track and stereo bus assigns for multi-track and dubbing work; plus a choice of mono mic/line or stereo input channels. And, to keep things fast and productive, it even includes full machine control logic, control room and studio mutes, plus tally systems—just like you'd expect on an on-air console. The SP-6 provides independent headphone, control room and multiple studio monitors, and (of course) an automatic stereo cue/solo

system. Our unique track monitor section will speed your production pace, allowing simultaneous stereo mixdown during the multi-track bed session.

A powerful group of accessory modules will increase your production control, like a 7-station intercom module that links this console with other Wheatstone consoles and talent stations throughout your complex; a full-function tape recorder control panel; an 8-position source selector to enhance input capability; additional studio modules to accommodate multi-studio installations; and finally, a digital event timer and a precision clock.

So contact Wheatstone, the company with the integrity and experience you can count on.



INDEX

Expanded NAB Coverage:	14-22
Technology Breakthroughs	16
New On-Air Choices	
by Mel Lambert	21
Computers Find Niche in Radio	
by Barry Mishkind	22
Workbench	23
How to Select the Right Mic	
by John "Q" Shepler	27
CD Recorders:	
A Format Reborn	
by Mel Lambert	29
Keeping on Top of Paperwork	
by Barry Mishkind	30
A History of Licensing And Rule Compliance	
by Harold Hallikainen	32
Remote Offers	
Ski Resort a Lift	
by Dee McVicker	34
Cellular Solutions for Remotes	
by Bruce Bartlett	36

Wheatstone® Corporation

6720 V.I.P. Parkway, Syracuse, NY 13217 (tel 315-455-7740/fax 315-454-8104)

Circle 60 On Reader Service Card

FCC Filings Support L-Band Use

(continued from page 1)

consideration for a domestic or international allocation for DAB."

MSTV noted that no other country is considering locating DAB in the UHF-TV band.

Companies that manufacture microwave equipment for other industries, including microwave ovens, filed reply comments noting the impracticality of sharing that band due to interference concerns.

Cornell University also opposed S-band because its astronomical observatory makes use of that band for research.

Satellite CD Radio noted the objections to S-band in its reply comments and said an L-band allocation is "preferable to an allocation anywhere in the S-band." But its comments called S-band a "second-best alternative" to L-band.

In-band DAB

Satellite CD Radio also noted that if not enough spectrum can be found at L-band to accommodate both terrestrial and satellite DAB interests, "the best solution would be to have terrestrial systems located in the existing AM and FM bands."

Afrispac, with plans to launch a satellite audio service into Africa, took Satellite CD Radio's statement about S-band being second best to heart and concluded that "it would appear to be a largely foregone conclusion that U.S. BSS (sound) will occur in 2360-2410 MHz." Afrispac urged a multiband approach to a U.S. WARC policy, citing both S-band and L-band.

A letter from National Public Radio also urged flexibility as systems are developed, noting that "at this time neither the L-band nor the in-band DAB technologies have been demonstrated to be fully acceptable." NPR said a request for L-band would help ensure a flexible position.

In its reply comments, NAB conceded that DAB improvement, as had been stated in positions by others in earlier

comments, was only a "marginal improvement" to the current U.S. radio service. But NAB asked for the right to make that improvement on behalf of all broadcasters.

The association reaffirmed its belief that L-band is the place to locate a DAB service and said that S-band is not feasible.

S-band not desirable

"If the only DAB allocation made at the upcoming WARC is for S-band, then the chances for prompt domestic implementation of DAB would either be greatly reduced or perhaps even eliminated," NAB stressed.

General Motors also reaffirmed its support of L-band, and asked for at least a 50 MHz allocation "for the sake of the American driving public." GM supports a satellite DAB system augmented by terrestrial repeaters.

GM also took the opportunity to express concern about in-band DAB, saying "the risks inherent in relying on the ability of an in-band DAB system to meet the needs of the American motoring public are just too high."

GM's technical concerns about in-band systems include the worry that the digital signal may degrade the analog by reducing the rejection of an undesired station from 55 dB of protection to only 25-30 dB protection. GM noted that such interference would fall outside a station's coverage contour but argued that listeners would still want service in "fringe" areas.

GM also worried that in-band may be inferior to a system (like Eureka or Stanford Telecom) designed specifically for a mobile environment; specifically, that multipath, which is frequency-selective (with delay greater than 5 microseconds), could reduce the analog signal energy and leave the digital modulation present as noise in the analog signal.

GM also voiced concern over instances of flat fading, which Gannett and Stanford

Research, in developing Acorn Digital, maintain only occurs in about 2 percent of all listening environments.

The Aerospace & Flight Test Radio Coordinating Council (AFTRCC) filed reply comments strongly opposing any allocation of L-band for DAB, calling such requests "without merit."

AFTRCC noted that the additional S-band request for flight testing telemetry was not prompted because L-band is not needed; rather, because the L-band is too crowded.

Concerning proposals to relocate flight testing to S-band, AFTRCC noted, "It

has taken hundreds of millions of dollars and some 20 years to equip the L-band." AFTRCC harshly criticized NAB's position, saying "NAB's temerity is exceeded only by its lack of competence" in such matters as determining what would be entailed in relocating flight testing to the S-band.

AFTRCC also cited in-band systems in development as a solution for where to locate a DAB service and warned that "the U.S. should feel under no pressure to accept BSS (sound) (from WARC) at the expense of flight test allocation."

Satellite Quality Audio...

COMREX, the leader in remote audio broadcast transmission via standard telephone lines, now sets the pace with satellite-quality audio transmission using standard dial phones or digital circuits. Since 1961, Comrex has been consistently delivering the most reliable equipment and personalized response to broadcasters world-wide.

COMREX gives you a choice of options:

- 1, 2 or 3 line frequency extenders with up to 8 KHz bandwidth on dial telephone service
- Digital Audio Codec systems for ISDN
- Plus . . . a full range of telephone interface products including couplers, hybrids and portable mixers

Performance so good, we invite you to try it before you buy it. Hear the difference for yourself.

by Telephone.

COMREX
Specialists in Remote Broadcast Audio Transmission

Comrex Ltd.
75 The Grove, Ealing, London, W5 5LL, UK
081-579-2743 / FAX: 081-840-0018

Comrex Corporation
65 Nonset Path, Acton, MA 01720 USA
(508) 263-1800 / FAX: (508) 635-0401

WHAT DO AIR-TALENT REALLY WANT ?

IT SEEMS WE SPEND A LOT OF OUR VALUABLE TIME TRYING TO DETERMINE JUST THAT. ONE THING IS CERTAIN: WHETHER THEY'RE PRESIDING OVER A HOT MORNING ZOO, AN EARNEST POLITICAL DEBATE OR A RAUCOUS SPORTS CALL-IN, THEY WANT GOOD PHONES. DECENT AUDIO. SIMPLE, INTUITIVE OPERATION. IN A WORD, TELOS. YOU AREN'T KEEPING IT FROM THEM -- ARE YOU? ARE YOU?

1729 SUPERIOR AVENUE
CLEVELAND, OH 44114
(216) 241-7225

The Ins and Outs of In-Band DAB

by Judith Gross

FALLS CHURCH, Va. Here's a new one for you. How about **DAB in-band**, but on the **UHF-TV band**? What will those **Eureka** folks dream up next?

Seems it's a possibility, and it's being looked at **right now** in Europe. For one thing, it gives you **6 MHz** to fool around



in, so the **Eureka** folks feel **more confident** about using the signal reflections to **cancel multipath** than, say, in the **200 kHz** of an FM station.

It's all **highly preliminary**, but would probably be designed to go with the **6 MHz** of **NTSC**, not the extra six for **HDTV**.

Can't see as it would **help radio**, though. For starters, how would it work? **Lease space** from your friendly neighborhood **TV affiliate**? And would there be **enough to go around**?

But will there be enough of **anything** to go around? Before you read this (but after I write it) the **FCC** will have come out with some sort of **game plan** for **WARC**. The **ugly gossip** from the grapevine envisions **nobody** walking away happy in a true **Machiavellian compromise**. Let's see what happens.

★★★

It's getting more and more obvious that **digital interfacing** is the **manufacturer's headache** of the '90s. Seems everybody is doing it a bit differently. So how the heck do you **connect** all that studio-through-the-transmitter gear together?

I'm wondering why everybody has to **reinvent the wheel**, here. Last time we had a situation like this was way back when everybody had a different type of

endless loop cartridge for audio playback. Well the **NAB** got involved and **Eureka!** (oh, excuse me, I got carried away; I meant *voila!*) we had one of the best examples of **standards in action**.

Now **Harris-Allied**, **QEI** and a few others are scratching their heads saying, well, howzit all going to join together? So how 'bout it **NAB**, you're a **believer in standards**, right? How about one for **digital interfaces**?

Had a heckuva good time down in **N'Awlins**, speaking to the engineers and finding out what's hot in public radio at the **Public Radio Conference**. That thing is growing, and the sessions were especially timely.

RDS may be big for public (as well as commercial) radio, particularly if it becomes a factor in a new **emergency alerting network**. Watch for the **FCC** to come out with its **NOI on EBS**, if it hasn't by now. One plan would call for **RDS** to replace **EBS**.

Heck, everybody knows **EBS isn't working now**. How about a plan to make **public stations** the emergency alerting stations? Well, I think we'd need more of them if that flies.

★★★

Also had another glimpse at the latest in **source coding**, or compression, from Mr. Compression himself—**Larry Hinderks** from Corporate Computer Systems. Now **CCIR** has decided to test algorithms—**ISO** wasn't enough for them. This time they'll look at **broadcast applications**, including multiple coding, or "chaining."

And the arguments still rage over **ASPEC** and **MUSICAM**. **Ted Schober** of American Digital Radio/Radiotechniques and **Bill Spurlin** from Christian Science Monitor Radio take issue with my cavalier dismissal of the need to have a system that sounds good at **64 kbps**.

Hey, guys, I'm only telling you: what I hear most engineers say. Those who can

stomach any kind of compression at all can't hear a difference in **MUSICAM** and **ASPEC** at **128 kbps** and don't seem to be much interested in any more scrunching down. That's not to say that it won't be im-



Yeah, but which is Click and which is Clack?

portant some day. But when do we go from "good idea" to "shipping next week?"

I really see the whole old **AM stereo argument** rearing its ugly head. As **Yogi (Berra, not the Bear)** said, "It's déjà vu all over again." We can **argue indefinitely** about the **technical merits** of one system over another. And maybe the one we all adopt **won't be** the most technically superior (or maybe it will).

It's what happens when the **chip companies** have to weigh the **costs and complexities** and make a decision they can live with *now* that really separates the **major from the minor** leagues, the big dogs from the pups, the tough guys from the . . . oh, you get the idea.

Technical arguments only go so far.

Loved **Larry Hinderks'** characterization of what compression algorithm and psychoacoustic engineers do when they want to **talk tough**. He says they punch each other in the shoulder and start bragging about their **global masking thresholds**. They must have some wild cocktail parties. Did you really used to shoot **solder flux** to get a buzz, Larr?

Then how about **Ron Strother's** characterization about all these **sessions on DAB** springing up every time two or more engineers gather: "a technology chasing a conference pursued by an industry."

Ron and his lovely wife gave a bunch of us a taste of some **real southern hospital-**

ity in his home in **Hammond**, not far from **N'Awlins**. The crawfish were great, Ron; sorry we couldn't stop discussing **DAB**. We're real fun at parties, too, I guess.

★★★

Also at **PRC**, I got to meet my idols: **Click and Clack**, the Tappet brothers. You know, the guys who do **Car Talk**? Here they are in a rare serious moment. They have a book out guaranteed to help any **dummy** understand what goes on under



Gotta stop those late nights on Bourbon St.

your basic hood of your basic car.

Real helpful stuff, but **every chapter** led me to the **same conclusion** about my jalopy: It's going to cost me. Why don't I just pour my **paycheck** into the master cylinder and **eliminate the middleman**?

Some **PRC** attendees had a **better time** than others. Check out the other picture. But hey, that's normal for the **French Quarter**.

I also spent some time at the **Voodoo Museum**. Did you know **jazz** started out as voodoo ritual music? There was a certain aura about the place. I could almost see **into the future**—ah, yes . . . years from now . . . the world is a garden of **digital delights** . . . and we're all in agreement on a **DAB system**. Which one is it? I'll never tell.

Heard a juicy tidbit? *Spill your guts to Earwaves by faxing JG at 703-998-2966 or writing to P.O. Box 1214, Falls Church, VA 22041. What, no mug? We'll see.*



Unattended operation helps you operate your station profitably. All it takes is a satellite or automation program source, a good transmitter control system, and a way to handle **EBS**.

You take care of the program source... We'll help with the rest.

A transmitter control system from **Burk Technology** relieves you of the need to keep someone at the station just to take transmitter readings. Add our exclusive **Studio I/O** and we'll run **EBS** for you, too.

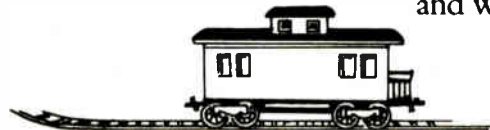

Burk gives you the flexibility to run your station the way you want, and in full compliance with **FCC** rules.

Call us now. We'll show you a new way to run a railroad.

TOLL FREE 1-800 255-8090

BURK
TECHNOLOGY

7 Lomar Drive, Pepperell, MA, 01463 (508) 433-8877

Circle 126 On Reader Service Card

World Radio History

READERS FORUM

If you have comments for *Radio World*, call us at 800-336-3045 or send a letter to Readers' Forum (Radio World, Box 1214, Falls Church VA 22041 or MCI Mailbox #302-7776). All letters received become the property of Radio World, to be used at our discretion and as space permits.

UL clarifies its role

Dear RW,

A recent letter to the RW Readers Forum questioned the significance of Underwriters Laboratories Inc. (UL) in the safety investigation of equipment used in broadcasting. We would like to address some of the issues raised by that letter.

The evaluation of professional broadcasting equipment is a relatively new area of product safety investigation and certification for UL. Since the submittal of products for investigation by UL is voluntary on the part of manufacturers, UL became involved in this work as a direct result of industry and manufacturer requests for assistance.

In the case of professional broadcasting equipment, UL has investigated and listed a number of professional broadcasting products. Clearly, some manufacturers have foreseen the value of product safety certification of their products by a nationally and internationally recognized third-party organization with a record of nearly 100 years of excellence.

Also, jurisdictional authorities look for a third-party certification mark as an indication that a product complies with nationally recognized safety requirements

and/or is compatible with the requirements of the National Electrical Code and other national installation codes and standards. Some jurisdictional authorities are now calling for a product safety certification mark on professional broadcasting equipment because concerns have been raised about:

- 1) the suitability and safety of electrical connections between pieces of equipment from different manufacturers;
- 2) the temperature which may be generated by densely packed equipment installed in racks and consoles; and
- 3) the environmental abuses to which professional broadcasting equipment is often subjected.

Another point for your consideration—the recent letter to RW argues, among other things, that the broadcasting industry should not pursue UL certification of professional broadcasting equipment because there's no marketplace advantage and the safety record of this equipment does not justify such investigations.

However, a careful review of available information on this matter indicates increasing interest and participation of jurisdictional authorities and manufacturers in the product safety certification of professional broadcast equipment. This information simply does not support the arguments presented in the letter to RW.

It appears that despite the concerns expressed to date, investigation and certification of professional broadcasting equipment by third-party organizations other than UL would apparently be acceptable to the writer. Needless to say, we find these views contradictory.

We would be happy to see that any questions your readers may have about UL investigation of professional broadcasting equipment are promptly answered by our engineering staff.

Donald Mader, VP Engineering
Underwriters Laboratories Inc.
Northbrook, Ill.

Editor's note: Readers interested in contacting Underwriters Laboratories can call 708-272-8800, FAX: 708-272-8129; or write to UL at 333 Pfingsten Road, Northbrook, Ill., 60062-2096.

Requiem for an AM

Dear RW,

I really got a charge out of the AM certification mark story in the April 24 RW. At this rate, it's going to be close—will there be any AMs on the air if or when any NRSC radios hit the market to "save AM?"

I know that WDME-AM was born, lived 20-plus years, and died without ever having been heard on NRSC radio. I know because I just shut down and helped load the Gates BC1G onto a truck. I doubt our one thousand watts ever tickled anything but an envelope detector.

In management's view, the AM revenue (we were 90 percent simulcast) was less than the fixed utility and insurance costs to keep it on. There was also the fear of this mandatory stereo movement. We'd be in the unique situation of being FM mon-

NAB conventions are exhausting. Not to mention how hard it is walking all over the trade show floor in search of new products, the sheer volume of information from manufacturers exhibiting new broadcast equipment is overwhelming. It's hard to keep all the facts straight.

RW always brings its readers timely, comprehensive coverage of every NAB convention in a special issue following the show. But the massive quantity of digital equipment introduced this year was startling—new products spilled into many halls besides those of the main convention center.

Clearly, the importance of so many product introductions required more than a single-issue wrap-up.

That's why in this issue, and for the next four issues, RW is presenting *Technology Breakthroughs*, a spotlight on new products displayed for the first time at the NAB convention in Las Vegas.

Break On Through

This issue focuses on professional digital record and replay devices: hard disk-based storage systems, DAT products, recordable CDs and more, presented in a brief but comprehensive section. Along with an overview by digital expert Mel Lambert on what it all means to the industry, *Technology Breakthroughs* is intended as a means of keeping track of what's out there.

But it doesn't stop just with record and replay gear. Whether it's digital processing; transmission gear; trends in STL, remote and telco products or digital audio workstations, each installment of *Technology Breakthroughs* will provide a quick understanding of the latest new products—with an overview by one of RW's authorities on the subject.

The facts, a photo, and contact information—essential information for busy broadcasters. *Technology Breakthroughs* can be an at-a-glance product organizer, crib notes for future purchases or a way to stay on top of equipment news for those who had to miss the show but don't want to miss the boat.

Use RW's *Technology Breakthroughs* all summer long as a way to keep the facts straight on new products. Then sit back, take a deep breath and get ready to start the convention craziness all over again—Radio '91 is only three months away.

—RW

ophonic and AM stereo!

After all, the forced NRSC costs didn't improve AM here—there's no first or second adjacent channels worth talking about and three other co-channels in Maine on 1340 kc/s. I can now selectively pick up one or two of them.

I also got a kick out of the Armstrong Transmitter piece: "In countries like South Africa—many cars have only AM radios." Rural Maine is right up there with South Africa. The humble WDME engineer's car has AM only.

It was really surprising to see how many first generation AM transistor radios are in use as the only home radio. I saw this in person traveling our area with station owner Fred Hirsch, giving out new free AM/FM radios to those who would otherwise have no local radio coverage.

I agree 100 percent with Don Stepka's letter (RW, April 24): There's no point broadcasting AM over 5 kc/s with 10 kc/s channel spacing. There are also valid reasons to run FM in monophonic.

AM is dead. Let's save FM.

Sidney Marshall, CE
WDME-FM
Dover-Foxcroft, Maine

Integrity of transparency

Dear RW,

I was disappointed to read in *Earwaves* that you don't believe that digital audio compression below 128 kHz is important. Let me tell you why I feel that it is essential to establish CD quality digital audio at 64 kbps or possibly at 56 kbps rates.

Today's best digital audio compression coding can be made transparent at 128 kbps per channel. I believe that we can agree on this based upon the ISO data, and the many "Golden Ears" who haven't been able to identify encoded

source at this rate. This appears to be so for both MUSICAM and ASPEC.

Neither system remains transparent after successive coding, decoding, recoding and final decoding, particularly if the coding systems are not identical.

Broadcast programs must be delivered from the source (remote, satellite, network, etc.) to the station. The telephone network and most CDMS satellite systems work in submultiples of 64 kbps (or 56 kbps). These resources are purchased as used; for example, four T-1 frames or five switched 56 lines would be required to multiplex a stereo pair using present 128 kbps technology, whereas only two frames or two switched 56 lines would be required at the lower rate.

If the integrity of transparency is to be maintained, it is essential that the source material not be coded more than once. The coding must be done once—at the source. ADR is working on methods to permit decoding and recoding by the same algorithm with no loss, thereby permitting editing, etc. to take place, but we haven't figured out how to make a program that has gone through MUSICAM sound good after recoding with ASPEC, or vice versa.

The U.S. government recognizes that each Hz-square kilometer of the radio spectrum has value as a resource. Spectrum auction, or at least spectrum fees will generate BILLIONS of dollars annually for the government. It makes sense that if it takes half the spectrum to transmit a program, then the fees to the FCC would be halved.

I hope that I have shown why it is important that we use digital audio compression coding that provides the spectrum efficiency which will be shortly available.

Ted Schober, President
American Digital Radio, Inc.
Haddon Heights, N.J.

Radio World
Vol 15, No 11 June 12, 1991

Editor, Alex Zavistovich
Editorial Consultant, Judith Gross
International Editor, Alan Carter
Associate Editor, Charles Taylor
News Editor, John Gatski
Reporters, Benn Kobb, Frank Beacham/L.A.
Editorial Assistant, Debra Green
Technical Editor, John Bisset
Technical Advisor, Tom McGinley

Production Director, Kim Lowe
Julianne Stone, Lisa Roach, Lisa Stafford
Ad Production Coordinator,
Regan Deatherage

Publisher, Stevan B. Dana
Associate Publishers, Arthur Constantine
Carmel King
Marketing Consultant, Albert Leon

Ad Coordination Manager, Simone Mullins
Circulation Manager, Tiana Hickman
Accounts Receivable, Valerie Mason

Advertising Sales Managers:

Eastern U.S., Art Constantine
800-336-3045, Fax: 703-998-2966
West & Midwest U.S., Jack Ducart
916-962-2240, Fax: 916-962-2194

Radio World (ISSN: 0274-8541) is published semimonthly by Industrial Marketing Advisory Services, Inc., 5827 Columbia Pike, Suite 310, Falls Church, VA 22041. Phone: 703-998-7600, Fax: 703-998-2966.

Second-class postage rates is paid of Falls Church VA 22041 and additional mailing offices. POSTMASTER: Send 3579 forms and address changes to Radio World, P.O. Box 1214, Falls Church VA 22041. Copyright 1991 by Industrial Marketing Advisory Services, Inc. All rights reserved.

Free subscriptions are available upon request to professional broadcasting and audiovisual equipment users. For address changes, send current and new address to RW a month in advance of the above address. Unsolicited manuscripts are welcomed for review; send to the attention of the appropriate editor.

Next Issue
Radio World
June 26, 1991



AUDISK: IT'S A "WALK AWAY" HIT!

WHAT MAKES AUDISK THE HOTTEST DIGITAL STORAGE/AUTOMATION SYSTEM IN RADIO?

AUDISK doesn't just sound better, it works better

- Digital automation *and* digital audio storage in one compact, convenient, easy-to-use system.
- For satellite formats, live-assist or any combination.
- Easy to use: A computer novice can schedule an entire weekend of commercial stopsets in 15 minutes or less.
- Optional traffic system software interface.

AUDISK makes real financial sense

- Costs less than cart-based automation, yet does much more.

AUDISK gives you 7 full days of "walk away" time.

- Longer storage capacity than any cart-based system at lower cost.
- Holds your entire commercial inventory online, plus PSAs, liners and IDs, and more.

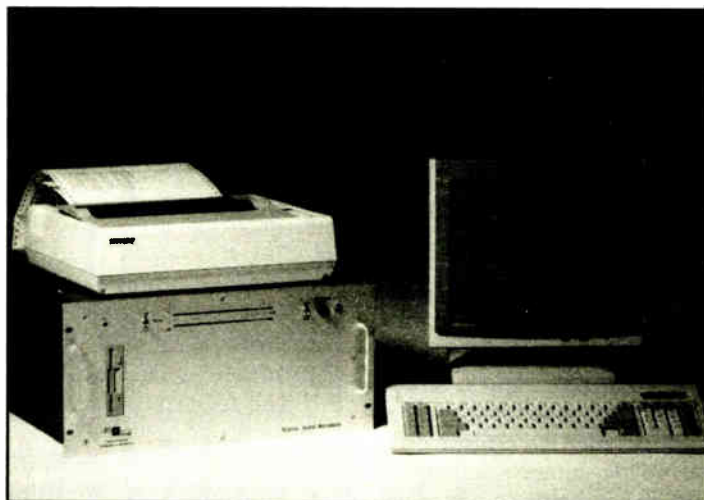

- "Smart audio" software automatically switches ID calls in time with satellite jocks, plays liners and IDs in random rotation, substitutes PSAs for past-killdate commercials, etc.

AUDISK continues to innovate

- Audisk now achieves variable length audio files without disc fragmentation.
- Now with time commands.

- Jog editing now standard.
- Color work stations for on-air live assist.

AUDISK is designed by radio people for radio people

- Balanced inputs and outputs, opto-isolated remote contact closures, even the optional traffic system interface, all fit right into your station.

AUDISK owners are supported by the full resources of Harris Allied

- Including service, installation support and custom configurations through Harris Allied Systems.

"Get hot" with AUDISK — the total solution in digital automation.

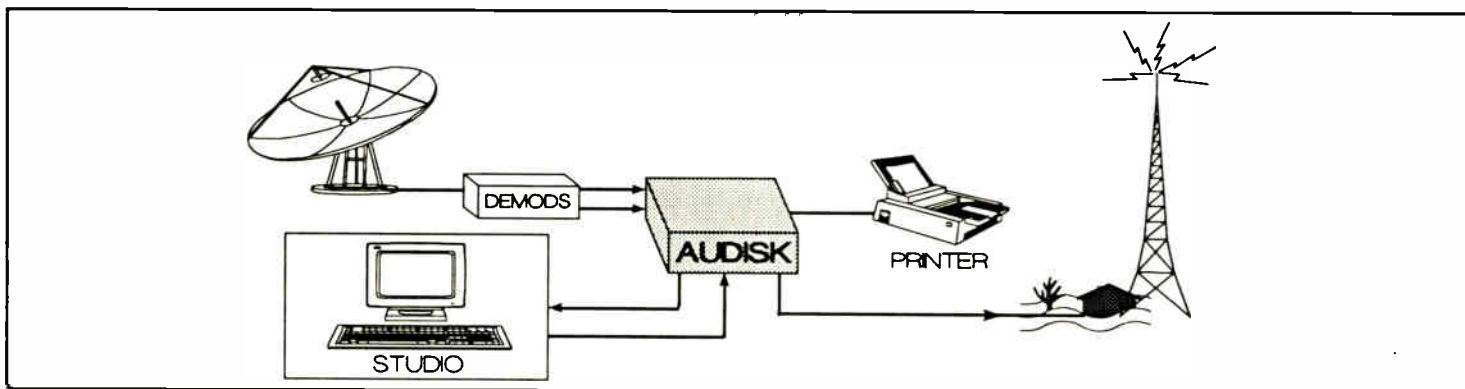

Call the Harris Allied Broadcast Resource Center today for full information.



FAX 317-966-0623

800-622-0022

IN CANADA 800-268-6817

WARC Group Endorses L-Band

by Arthur Cole

WASHINGTON The industry working group overseeing recommendations to next year's World Administrative Radio Conference (WARC) has recommended the L-band for Digital Audio Broadcasting (DAB).

In its final report to the Industry Advisory Committee (IAC), which will make final WARC recommendations to the FCC in the coming months, Ad Hoc Group B of Informal Working Group 2 said L-band, particularly the 1493-1525 MHz range, "is the only band among those under consideration that is well suited to both satellite and terrestrial DAB."

Specifically, the group recommended a 60 MHz band within the 1435-1525 MHz range.

"Strong, violent opposition"

Ben Fisher, chairman of the Industry Advisory Committee's (IAC) Informal Working Group, said that while "very strong, violent continuing opposition" to L-band still exists, differences of opinion were outweighed by the need for a uni-

fied DAB approach at WARC.

"The reality was that the proponents of satellite sound realized that they all had to get together to support the (recommendation) and settle their differences later," he said. "You have to get a playing field before you can play the game."

Ad Hoc B also recommended the spectrum be allocated on a co-primary basis for Broadcast Satellite Service (BSS) and terrestrial broadcasting.

Although the report stated that co-frequency reception would "probably not be achievable," channels for satellite and terrestrial delivery could be provided in the same band.

The group also recommended DAB service be implemented internationally and domestically as soon as possible.

Multiband back-up

Should the WARC negotiations fail to establish a worldwide DAB allocation, the group recommends a back-up plan in which the U.S. should push for two or three frequency allocations to allow countries to choose their own

band. That plan, however, would most likely require more than 60 MHz of spectrum.

In recommending L-band, the group rejected using locations in the 2300 MHz to 2600 MHz range, arguing that interference from microwave ovens as well as the added cost of transmitting at that level (due to higher power needed) make it a poor choice.

The Bush administration has offered to release the 2360-2390 MHz band which is currently used for telemetry purposes to BSS. The group has asked the White House to donate an equivalent amount of spectrum in the telemetry band below 1525 MHz and phase in the use of higher-band telemetry equipment over a number of years.

"If the (FCC) and the executive branch could accept this proposal, it would appear to accommodate the needs of both the BSS and Aeronautical mobile telemetry," the report stated.

The Air Force has already expressed an unwillingness to give up its lower-frequency telemetry spectrum.

"The 1400 band is best suited and

more acceptable for terrestrial use," Fisher said. "We feel the Commission should revisit this issue. Let DAB have the L-band, where it will work most effectively."

Air force resistance

One problem with the selection of L-band, however, is the fact that it is presently being used in many countries for terrestrial broadcast. In those cases, a power flux density (PFD) limit would have to be established to reduce interference, the report said.

The group recommends a PFD limit in the 2500-2690 MHz range.

Compression "Bake-Off" Set

by Judith Gross

WASHINGTON The CCIR has decided to hold a second round of audio compression algorithm "bake-offs," which would be aimed at broadcast applications. The tests are slated to take place this fall in Ottawa.

Several participants have confirmed that U.S. companies—including those who manufacture coding scheme equipment—and agencies have had a se-

ASPEC supporters have rallied for additional ISO tests . . .

ries of preparatory meetings aimed at helping define test parameters.

Last summer, the International Standards Organization (ISO) conducted tests to determine a worldwide coding scheme standard. Listening tests showed that two of the four compression systems tested—the European-developed MUSICAM and AT&T-developed ASPEC—were virtually the same, indistinguishable at 128 kbps.

But the ISO tests said that MUSICAM was less complex to implement and called for the two systems to combine features to become the published ISO standard.

Since that time, ASPEC supporters have rallied for additional ISO tests and a bitter emotional battle between proponents of various coding schemes has raged.

Since then, the compression systems began showing up in studio gear, specifically in digital mass storage and playback systems; engineers have begun to wonder what happens if audio is subjected to multiple source coding—

otherwise known as "chaining."

For example, audio could be subjected to one coding scheme in digital record/play gear, go through a second one through a digital STL, and then a third coding scheme for DAB transmission. Engineers wonder when a "break-down" in audio quality might occur.

Now the CCIR is going to try to answer those specific questions with the Canadian tests. The BBC has already done similar tests, but will not go public with the results. The BBC, however, will provide the materials for these new tests.

Expected to be included in the tests, which will take place this fall, are the ISO standard (MUSICAM/ASPEC); Dolby's AC-2; Scientific-Atlanta's proprietary SEDAT scheme; a system developed by Hughes Aircraft; a Japanese scheme, and perhaps the British apt-x system.

One problem that needs to be ironed out concerns the full disclosure requirements of CCIR standards setting. Some companies are not eager to reveal proprietary features of their algorithms, for fear their competitors may adapt them for their own use.

Emph'asize it!



WITH THE

Emph'asizer™ AUDIO PROCESSOR

- DJ Personality Processor
- Production Tape Processor
- Gated Recovery Compressor
- Four Parametric Equalizers
- Phone Line EQ and Noise Suppressor
- Room Equalizer and Gated Mike Control
- Unobtrusive Background Noise Gate
- Mike and Line Level Inputs and Outputs

Free Detailed Brochure Available



AUDIO TECHNOLOGIES INCORPORATED
328 Maple Avenue, Horsham, PA 19044 • (215) 443-0330
Fax: 1-215-443-0394



For Excellence In Antennas

- A complete line of TV and FM Broadcast Antennas
- Modern 7,000 ft. test range facilities
- Innovative Engineering Careful construction
- Two Year Warranty on Product and Workmanship

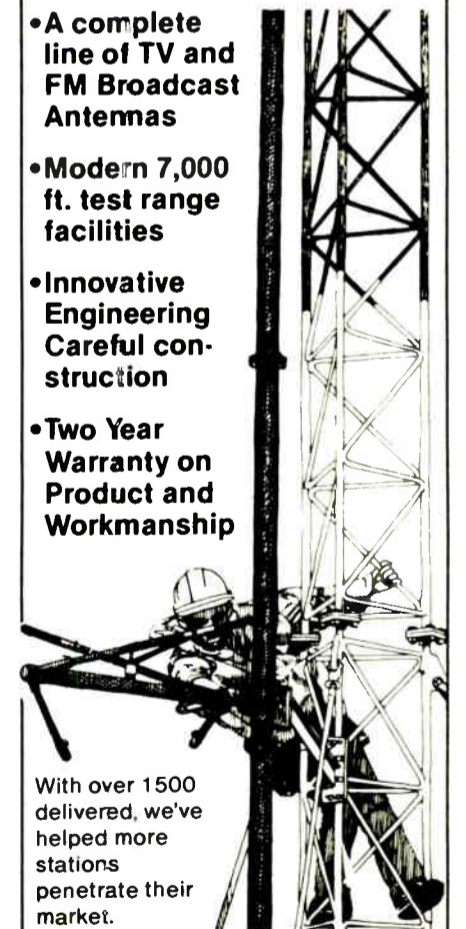

With over 1500 delivered, we've helped more stations penetrate their market.

FCC Directionals
Pattern Studies
Multi-Station Arrays
Full Scale Measurement

JAMPRO ANTENNAS, Inc.
6939 Power Inn Road
Sacramento, CA 95828
(916) 383-1177 TELEX 377321

FCC OKs Strother Test Plan

Broadcaster Receives Permission to Test DAB In Washington and Boston on UHF Frequencies

by Judith Gross

WASHINGTON Strother Communications has moved several important steps closer to becoming the "independent test authority" for DAB systems with two recent FCC decisions.

Despite objections by D.C. public TV station WETA and the Association for Maximum Service Television (MSTV), the Commission granted Strother two UHF-TV channels—channel 40, here, and channel 15 in Boston—for experimental tests of DAB.

The FCC also OK'd an experimental license for MDS service provider Shannondale Wireless of Fairfax, Va., to test DAB on its wireless cable frequencies in S-band (2150-2160 MHz). Shannondale has an agreement with Strother to conduct those tests (see sidebar).

This gives Strother the potential to test all DAB systems in in-band FM and AM, through his agreement with WPGC radio, here; to test in UHF-TV frequencies; and to test at S-band while his application for L-band and satellite experimental authority are pending.

Objections have no merit

It took the FCC nearly a year to respond to Strother's original request for four UHF-TV channels (two in D.C. and

two in Boston) to test DAB.

At one point, approval seemed imminent until "petitions to deny" were

The FCC said it had concluded that granting the two channels "is in the public interest". . .

filed against the Strother plan by WETA and MSTV. The FCC said, in granting approval for two UHF channels, that the arguments were treated as informal objections, since no provision exists for petitions to deny experimental requests.

The FCC said it had concluded that granting the two channels "is in the public interest" and conditioned its grant on the experiments not causing problems to adjacent channel land mobile operations.

The Commission noted that experimental authority has a built-in safeguard which calls for the ceasing of any operation that causes interference.

While noting that D.C. channel 40 is the sound image taboo channel for WETA (channel 26), the Commission

called interference unlikely and said that Strother's plans to limit the bandwidth to the lower 4 MHz of channel 40, use vertical polarization with no transmitted energy on channel 40 at the sound carrier frequency, and operate from an established facility with only 1 kW of power eliminates the potential for interference with WETA's signal.

MSTV criticized

The FCC, however, took the opportunity to level harsh criticism at MSTV's objections—many of which, the FCC noted, were unsupported by engineering statements or based on incorrect assumptions.

As to MSTV's argument that Strother's request to test on UHF-TV channels sets an undesirable precedent and would lead to DAB proponents seeking UHF-TV spectrum on a permanent basis, the FCC said "we find unpersuasive MSTV's concerns."

The Commission asked Strother to file a report describing his actual operation before the tests begin and to complete construction within one year from the approval. It concluded by saying, "We believe that the contributions to be made to the advancement of the broadcast art by this proposal outweigh any slight potential for interference."

All systems, all frequencies

Strother's original proposal called for testing the Eureka 147 DAB system on the UHF-TV channels. But with NAB's endorsement and pursuit of licensing of Eureka, Strother has expanded his test plans to include all DAB systems.

He said the UHF-TV channels would be suited to testing both Eureka and Stanford Telecom's (not to be confused with Stanford Research and Acorn) DAB systems, which can be used for terrestrial or satellite systems.

Strother said he is putting together an advisory group to define a test outline and hopes to test all systems and all possible frequencies. He also is working on a possible agreement with the Committee for Digital Radio Broad-

SCI Gets FCC Nod

WASHINGTON Strother Communications will be able to test DAB systems in S-band (2150-2160 MHz) over channels MDS 1 and MDS 2A operated as a "wireless cable," or multipoint distribution service by Shannondale Wireless.

Shannondale Wireless has signed an agreement with Strother and recently received an experimental license (KF2XJR) from the FCC. The service transmits from The Blue Ridge Mountain into Virginia's Shenandoah Valley and portions of West Virginia.

Shannondale noted that the variety of terrain including flat, mountainous and rolling hills make it an ideal test facility.

Strother Communications President Ron Strother said he is interested in testing the Eureka 147 and Stanford Telecom DAB systems in S-band, and is seeking experimental authority to test via satellite as well as terrestrial.

"Economically, it appears that S-band would be better suited to satellite than to land-based DAB," Strother noted.

Shannondale Wireless already has experience with S-band propagation characteristics. But, the company noted, even if S-band proves uneconomical for DAB on a wide scale, it may be suitable for a pay-per-listen or subscription digital audio service.

casting (CDRB), which may include an independent DAB testing facility.

Eureka has already been tested extensively in Europe, but Strother said, "We need an independent and unbiased test facility and not just results produced by the proponents themselves."

"The quicker we get this data in hand, the quicker we can move forward with this technology in the U.S.," he added.

NEW!

LEVEL A 0.59 dBm LEVEL B 0.47 dBm PHASE A-B 0.1 deg

-15.00 dBm AUTORANGE 15.00 dBm

PORTABLE ONE

AUDIO PRECISION QUALITY IN A PORTABLE TEST SET

PORTABLE - AFFORDABLE - EASY TO USE

Just press a button and take a measurement!

- amplitude
- phase
- two-channel level
- noise
- frequency
- amplitude ratio
- THD + N
- wow & flutter
- crosstalk
- IMD*
- generator load
- AC mains check

The Portable One—a two-channel analyzer at the price of single channel competitors!

\$4,000*

Audio precision

PO. Box 2209, Beaverton, OR 97075
503/627-0832 1-800/231-7350
FAX: 503/641-8906, TELEX: 283957 AUDIO UR

Circle 65 On Reader Service Card

SUBSCRIPTION/READER SERVICE FORM

Radio World

June 12, 1991 Issue Use until September 12, 1991

FREE Subscription/Renewal Card

I would like to receive or continue receiving **Radio World** FREE each month. YES NO

Signature _____ Date _____

Please print and include all information:

Name _____ Title _____

Company/Station _____

Address _____

City _____ State _____ ZIP _____

Business Telephone () _____

Please circle only one entry for each category:

I. Type of Firm

D. Combination AM/FM station F. Recording studio
A. Commercial AM station G. TV station/teleprod facility
B. Commercial FM station H. Consultant/ind engineer
C. Educational FM station I. Mfg, distributor or dealer
E. Network/group owner J. Other _____

II. Job Function

A. Ownership D. Programming/production
B. General management E. News operations
C. Engineering F. Other (specify) _____

III. Purchasing Authority

1. Recommend 2. Specify 3. Approve

Reader Service

Please first fill out contact information at left. Then check each advertisement for corresponding number and circle below. NOTE: Circle no more than 15 numbers, otherwise card will not be processed.

001 023 045 067 089 111 133
002 024 046 068 090 112 134
003 025 047 069 091 113 135
004 026 048 070 092 114 136
005 027 049 071 093 115 137
006 028 050 072 094 116 138
007 029 051 073 095 117 139
008 030 052 074 096 118 140
009 031 053 075 097 119 141
010 032 054 076 098 120 142
011 033 055 077 099 121 143
012 034 056 078 100 122 144
013 035 057 079 101 123 145
014 036 058 080 102 124 146
015 037 059 081 103 125 147
016 038 060 082 104 126 148
017 039 061 083 105 127 149
018 040 062 084 106 128 150
019 041 063 085 107 129 151
020 042 064 086 108 130 152
021 043 065 087 109 131 153
022 044 066 088 110 132 154

FCC Cites EBS Abuse

by Frank Beacham

WASHINGTON On the heels of levying a stiff \$25,000 fine to a Missouri radio station for dramatizing a fake nuclear attack, the FCC has issued a stern warning to all broadcasters not to alter the weekly Emergency Broadcasting System (EBS) test or air any musical rendition of the system's warning tones.

In a Public Notice issued May 15, the FCC made it clear it will not tolerate alterations that "would undermine the serious nature of the (EBS) system."

An FCC spokeswoman said the statement was designed to give the EBS "a higher profile" in light of the what the Commission viewed as a serious violation by KSHE-FM, an Emmis Broadcasting station that serves the St. Louis area.

The FCC fined KSHE the maximum penalty for violating its rule against airing false or deceptive emergency warnings. At issue was a dramatization by disc jockey John Ulett. On Jan. 29, Ulett broadcast a phony skit that the United States was under nuclear attack, an episode that frightened some listeners because it occurred during the Persian Gulf War.

EBS tones abused

According to the FCC, Ulett used "bleep" tones in the mock announcement which were mistaken by many listeners as the two-tone EBS alert sig-

nal. The fake attack alert was aired at 7:35 a.m. but listeners were not informed it was a hoax until 9:30 a.m., nearly two hours later, the FCC noted.

In its statement to broadcasters, the FCC said broadcasting of false or deceptive emergency warnings is a serious violation of a licensee's fundamental obligation to serve the public interest.

"KSHE's use of tones popularly mistaken for the EBS Attention Signal tones, undermined the integrity of the EBS," the FCC said. "It also conflicted with the clear intent of the Commission's EBS rules which are designed to deal with true national, state and local emergencies.

"The Commission is warning broadcasters not to alter the weekly EBS test or air any musical rendition or alteration of the test script as outlined in the EBS Checklist," the notice stated.

The FCC noted that use of prerecorded (taped) EBS encoder tones is not in compliance with Sections 73.940 or 73.906. The EBS encoder should be used to generate the tones, the notice said.

FCC EBS engineer Frank Lucia said commission members felt that for such an incident to occur in a time of a war was "in their minds a bad violation. There have been people who have done skits but it was immediately recognized as a comedy thing," Lucia said. "But this was not like that. It gave the general impression that we (the United States)

(continued on page 12)

Ellason E250 Color Radar

Real-time local radar coverage for your entire audience.



- Detects snowfall as well as rain and thunderstorms.
 - Five selectable ranges up to 200 miles.
 - Operator selection of antenna tilt, receiver gain, two separate graphic overlays, and automatic operations.
 - Optional larger antenna to provide better snow detection.
 - Picture storage to determine weather changes.
- For complete information, call 314/532-3031, or write Ellason Weather Radar, 747 Spirit of St. Louis Blvd. Chesterfield, MO 63005.

1-800-727-2327



ELLASON WEATHER RADAR

First Choice...

...For Durability



At stations around the world, you'll find that one brand of cart dominates the library—"true blue," genuine original Audiopak. Why? Because no "copycart" can copy our reputation for proven longevity.

When you pull a cart from the library, you want that song, spot or promo *for sure*—without dropouts, bias fluctuations or phase problems. With specially developed oxide formulations and proprietary back-coatings, blue Audiopak AA-4s, AA-3s and black A-2s deliver—time after time, cart after cart.

...For Consistency



One thing you *don't* want from a cart is surprises. That's why Audiopak is the first choice of more stations around the world.

When you push the Start button, you know "true blue" Audiopak AA-4s, AA-3s and A-2s will deliver consistent bias, phase and frequency response and dropout-free performance—cart after cart after cart. Our proven performance record is something no "look-alike" cart can match.

...For Reliability



The last thing you want from a tape cart is on-air failure. That's why the one cart more stations count on is Audiopak.

Whether you use carts for music, spots or special effects, Audiopak AA-4s, AA-3s and A-2s deliver "true blue" mechanical performance—spot after spot, song after song, cart after cart. Yet another record no "look-alike" cart can match. No wonder demanding broadcasters have made Audiopak the best-selling cart worldwide. After all, why would you trust your signal to anything less? Make sure your new carts are the real thing. Look for the molded-in Audiopak logo and our Quality Assurance seal on every cart.

audiopak
BROADCAST CARTRIDGES



P.O. Box 3100
Winchester, VA 22601
Tel: (800) 522-CART
or (703) 667-8125
Fax: (703) 667-6379

Ownership NPRM Proposed

(continued from page 1)
arrangements between stations. Proposals include fostering a system of shared advertising revenues, technical facilities and formats, provided separately-owned stations maintain their editorial identities. The Commission also called for proposals regarding time brokerage rules, but offered none of its own.

Minority rules

The Commission also will examine a proposal submitted by the NAACP and three other minority organizations that would raise minority ownership from 14 of each broadcast service to 20.

While the Commission proposals are all aimed at raising the number of AM ownership possibilities, the FCC also is seeking comments on whether the rules should apply to FM ownership.

Similar proposals for TV ownership are currently in the works and are expected to be presented to the Commission later this year.

Although the notice was approved unanimously, Commissioners James Quello, Andrew Barrett and Ervin Duggan expressed reservations about relaxing the rules, saying the move could reduce the diversity of the broadcast markets and actually work to stymie the financial gains it is designed to achieve.

"Frankly, some of these solutions disturb me," Duggan said. "Increasing the local or national ownership limits and encouraging time brokerage could diminish marketplace diversity by rewarding station owners with the deepest pockets at the expense of those who can best serve their local communities.

"Minorities, women, small station owners and rural broadcasters—those who provide the diversity we value so highly—may have difficulty acquiring a broadcast license or keeping a struggling station alive in such a market," he said.

Major concerns

Quello was disturbed by the duopoly and minority proposals.

"Local broadcasters may be faced with

increased competition from dominant group owners who may own two or more AM stations and an FM outlet within a community," he said. On the minority issue, he added, "The numerical ownership proposals in the notice pertain to ownership in general, not just ownership by minorities. (They) could, in fact, reduce the number of stations available for minority ownership."

Commissioner Barrett expressed similar concern. "I question the elimination or substantial relaxation of the multiple ownership rules without some potential public interest benefit," he said. "Without full consideration of the impact of increasing the maximum number of stations a party may own, the Commission could undermine our diversity and minority ownership goals."

The commissioners supported looking into time brokerage rules, but not with the intent to expand them.

Duggan said time brokerage "may tacitly permit consolidation without any

change in our ownership rules."

"I believe the Commission should take a serious look at this issue—especially the extent to which stations in the same community might use time brokerage arrangements to simulcast some programming 24 hours a day," Duggan said. "Even more troublesome would be evidence that major market stations use this practice to extend their reach into neighboring smaller markets."

Commissioner concern

Quello said: "We should examine the proliferation of time brokering requests. The growth of such arrangements either could be an indication of the financial condition faced by local radio broadcasters, or an opportunity to maximize profits at the expense of serving the public interest."

The commissioners also were concerned that now may not be the best time to overhaul the ownership rules, particularly since technological advancements such as DAB could produce major changes in the broadcasting arena in the next few years.

The proposed rulemaking was met with enthusiasm by the NAB, with President Edward Fritts saying the move is "clearly in order."

Japan Taps C-QUAM

by Alan Carter

WASHINGTON The selection of C-QUAM as the AM stereo transmission standard in Japan comes at a volatile time in U.S. radio, but broadcasters hope

for a positive effect in the States—in particular, the development of home receivers.

The Ministry of Post and Telecommunications recommended Japan use Motorola-developed C-QUAM. According to Yasuo Suzuki, counselor for economic affairs at the Japanese Embassy in Washington, his country's 50 AMs should begin broadcasting in stereo by 1992.

Suzuki warned, however, that exporting potential doesn't play a role in what products Japan develops. Rather, consumer demand is key, Suzuki said.

A waiting market

"The listener is eager to hear stereo and broadcasters want to improve the quality of broadcasting," he said.

From a U.S. broadcaster perspective, Japan could not have picked a better time to choose a standard, according to Ted Snider, president of Snider Corp. in Little Rock, Ark., and chairman of the NAB AM Receiver Manufacturer Liaison Task Force.

The production of AM stereo receivers in Japan should "dovetail beautifully" with the AM receiver certification campaign that the NAB and Electronic Industries Association (EIA) are orchestrating, he said. (See separate story, this issue.)

"It is my hope that Japan's adoption will mean they include AM stereo on a lot of the home receivers," Snider said. "That means more (home receivers) should be available to the U.S."

Currently, the majority of AM stereo radios are in automobiles, he noted.

In the U.S.

While the FCC has refused to set an AM stereo standard in the U.S., C-QUAM is considered the "de facto" standard. The FCC is considering requiring AM stations that broadcast in stereo but is not singling out C-QUAM or its rival, the ISB system developed by Leonard Kahn.

According to Motorola, about 700 U.S. (continued on page 14)

Fishing For A Phone Number?

Catch it in

1991 Radio World Directory Issue

— The Industry Source for Manufacturer, Supplier, NAB and FCC Phone Listings, as well as Product Information, Company Profiles, Buyers Guide Reprints, RW's 1990 Editorial Index, Reference Material, and More...

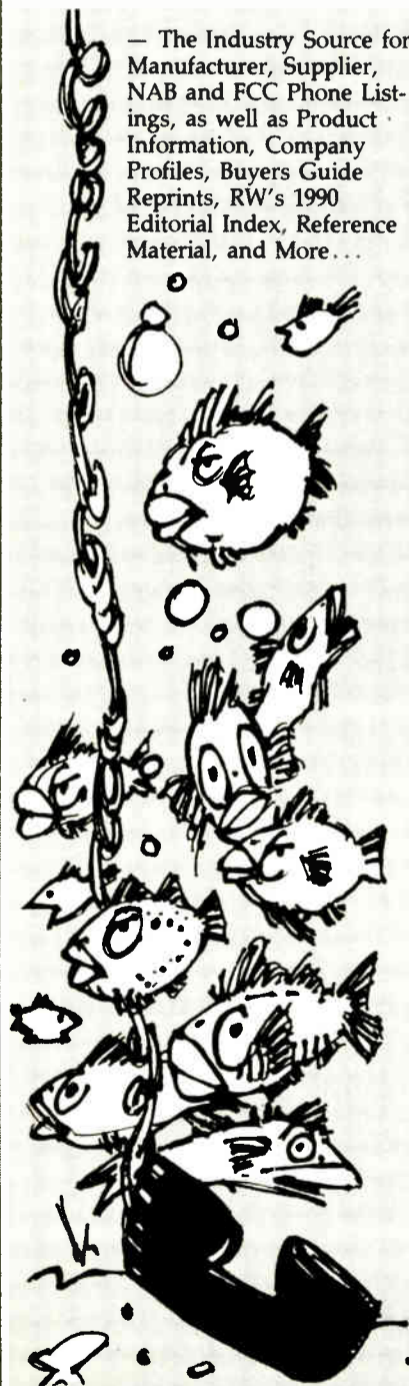

Send \$14.95 for each copy to
RW 1991 Directory Issue
P.O. Box 1214
Falls Church, VA 22041



Harris DX Series Digitally Modulated Solid State AM Transmitters

What makes DX Series transmitters the first choice of competitive AM broadcasters around the world? Simplicity, reliability, ruggedness—and significant performance breakthroughs in AM technology. No other AM transmitter offers all these DX Series features:

- Patented Digital Modulation delivers the strongest, cleanest AM signal yet: Over 135% positive peak capability, plus the lowest THD and IMD ever
- RF/AC ratio of 86% for lowest power costs of any AM transmitter
- ColorStat™ front panel signal flow diagram with red/green LEDs shows status at a glance
- Harris power supplies are designed for continuous duty operation with 100% sine wave modulation
- Modular construction with readily available FET output devices
- Bandpass filter and output matching network for effective lightning protection
- 100% solid state design totally eliminates tube replacement costs and reduces maintenance costs sharply
- Output impedance matching controls provide tuning flexibility for non-standard or changing loads

AM stations around the world have already discovered the competitive advantage of DX Series transmitters in 10, 25, 50 and 100 kW power levels*. Isn't it time you did too? Call Harris Allied today at 800-622-0022 for more information on digitally modulated DX Series AM transmitters.

* Contact us for applications to 500 kW and beyond.

© 1991 Harris Corporation

HARRIS ALLIED

Harris Allied Broadcast Equipment
Radio RF Sales • P.O. Box 4290
Quincy, IL USA 62305-4290



SYSTEM 12



SYSTEM 16



SYSTEM 20

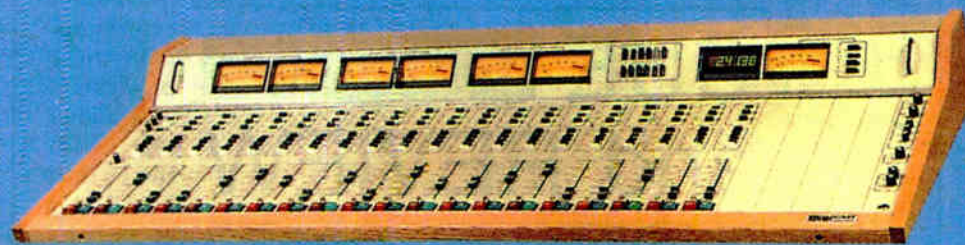

SYSTEM 24



SYSTEM 8

Broadcast Audio Series VI Dependable, Affordable, Practical

Broadcast Audio consoles sound great, are easy to use and employ proven reliable electronics for absolute dependability. What's more, they offer blue chip value at new economical list prices with an extended warranty.

Top quality construction is a hard and fast rule. Double-sided ground plane motherboards assure minimum noise and cross-talk as well as superior RFI immunity. Premium Penny & Giles faders are standard. VCA's are not used. Ribbon cables aren't used for audio signal paths. The no-nonsense design doesn't cut corners.

All mixer modules can be interchanged freely

because console logic is not programmed on the module and each module is switchable between mic and line levels. Mixers and output amplifiers can be removed or inserted with power on. Additional flexibility is provided by three stereo busses and a mono mix-minus bus which are standard in all units. In short, high-grade construction and audio performance are uncompromising.

Broadcast Audio consoles are installed in every one of the 50 states in the USA. During the past 13 years, over 1,400 consoles have been delivered and virtually every one remains in use today. A 5-year warranty is provided on all new units.

Call Fidelipac for the name of your authorized Broadcast Audio dealer.



Fidelipac Corporation □ P.O. Box 808 □ Moorestown, NJ 08057 U.S.A. □ TEL 609-235-3900 □ FAX 609-235-7779

A Max Is New Tag For AM Cert Mark

by John Gatski

WASHINGTON The Electronic Industries Association (EIA) has agreed to work with the NAB on setting an AM receiver certification mark that will designate high quality AM receivers.

The mark will be known as AMax and was agreed upon by both associations, according to EIA Executive Director of Legislative Affairs David Poisson.

"We are in the process of registering the name," Poisson said.

According to the agreement, EIA will elicit support of receiver manufacturers to produce high quality AM receivers, while NAB will embark on a promotion campaign through its station members, to advise the public that such equipment will be manufactured.

Despite recent developments in new technologies such as DAB, NAB Staff Engineer Stan Salek said there is still interest in quality AM receivers and the AM certification mark is a way to get better products.

"I think AM receiver manufacturers are listening, but they still haven't made it a priority," he said. Salek said the certification mark program will increase manufacturer, broadcaster and consumer interest.

EBS Abuse

(continued from page 9)

were under attack. The phone lines at the station were flooded with people calling. It wasn't a good situation. And they let it lay there without a disclaimer for about two hours."

Station may appeal the fine

Lucia said the rule on distress signals in the Communications Act is simple: "False distress signals are a big no-no!"

Emmis Broadcasting Radio Division President Doyle Rose called the station fine "excessive" and said a decision will be made soon whether or not to appeal. The station has 30 days to ask the FCC for reconsideration of its action.

Rose said the mock attack was staged without advance management knowledge and said Ulett had been suspended without pay for one week following the incident. But he defended Ulett as having an excellent record with the station.

"It was certainly an error in judgment on the announcer's part," Rose said. "His intention was well-meaning. His judgment was not good in terms of not coming out of it right away and explaining what he did."

Rose acknowledged that some listeners thought the attack was real and called the station. "What made a bigger deal out of this than anything else was the timing—because of the war. Everybody was hyped during that time and I think that's where the judgment (error) came in on the announcer's part."

The mark is to be based on the National Radio Systems Committee (NRSC) voluntary AM receiver standard, "Audio Bandwidth and Distortion Recommendations for AM Broadcast Receivers."

The standard recommends a receiver bandwidth of 10 kHz with at least 50 Hz to 7.5 kHz frequency response and distortion at two percent or less. The standard also calls for circuitry that attenuates the 10 kHz adjacent carrier by 20 dB with NRSC pre-emphasis I on, or 30 dB without the pre-emphasis.

Additional recommendations include external antenna connection, noise blanking, switchable wide/narrow bandwidth and addition of the 1605 kHz-1705 kHz expanded band, which many manufacturers have already added to their AM sections.

AM stereo would not be required to meet the mark, according to Poisson, but there will be a separate designation for high quality receivers with AM stereo, perhaps AMax Stereo or a similar derivative.

Although high hopes were held for an AM certification mark two years ago, lack of a consensus left its future uncertain until the NAB gave the EIA an ultimatum last winter.

The NAB told the EIA last January that either the latter group agree to jointly promote an AM receiver standard within 30 days or the broadcasters' organization would pursue a standard on its own.

The EIA tentatively agreed to study the AM certification mark, and the NAB extended its deadline for a decision until the EIA conducted its Consumer Electronics Group (CEG) spring meeting.

CDs' Golden Rule?

by John Gatski

WASHINGTON Some time ago, a co-worker asked me about what I thought about CD rot. "CD what?" I shot back. "C-D R-O-T," my colleague repeated.

"Is this a commentary on the music or some kind of fungal infestation?" I asked.

The person assured me that it was a real phenomenon that results in the erosion of a CD's precious inner core, resulting in eventual CD player silence. At the time, I was skeptical of this claim. Perhaps it was just another rumor planted by one those "LPs Forever" folks.

Anyway, I didn't think any more about the subject until a Denon

press conference at NAB '91, where company officials were explaining their new professional CD recorder. In discussing the recordable write-once CDs, a 10-year shelf life was mentioned.

Now wait a minute, I thought. Here goes that shelf life stuff again. I've always thought that one of the supposed virtues of CDs over LPs was increased resistance to degradation. I thought CDs were supposed to last forever unless you use them as mini-Frisbees or let your kids play with them in the sandbox.

Radio stations already have a hard enough time with a CD's surface because of rough handling by DJs. Now we have to worry about the inside?

Apparently, there are varying opinions on the subject. Some believe

that if modern manufacturing processes are used, CDs will last many years. Others have said that conventional materials used in CDs can result in eventual error-prone playing.

Critics of conventional CD production methods said the problem stems from the aluminum used as the reflective layer. Studies have suggested that pinholes in a CD's protective plastic surface can allow the aluminum to oxidize, causing audible bit errors.

According to Mobile Fidelity, the California company that has been issuing audiophile remasters of LPs and CDs for many years, using other

materials can eliminate these problems.

In a joint test with the U.S. Naval Air Develop-

ment Center and a Japanese petrochemical company, Mobile Fidelity concluded that coating the reflective layers with gold eliminates pinhole and oxidation problems.

The testing also indicated that after extreme temperature and humidity testing, gold CDs were "playable" while most of the aluminum-coated CDs were not, the company said.

It should be noted that Mobile Fidelity sells an expensive line of gold-coated discs, the ULTRADISC. These remasters of acclaimed releases do sound great, but it remains to be seen whether they will last longer than properly manufactured aluminum-coated discs.

In addressing CD shelf life, Denon's Laura Tyson said the company's write-once CDs (which also have a gold-

(continued on page 13)

CUE and REVIEW



INTRODUCING THE SHURE FP410, THE "HANDS OFF" MIXER THAT DELIVERS PERFECT SOUND AUTOMATICALLY.

The new Shure FP410 is not just another pretty face. It's a whole new concept in portable mixing; one that forever solves the nagging problems of multiple open microphones. By automatically keeping unused microphones turned down, the FP410 dramatically improves your audio quality.

The secret: Shure IntelliMix — the patented operational concept behind the revolutionary FP410. It thoroughly shatters existing standards for portable mixer performance and ease of operation.

Just set your levels and flip the switch to "Automatic." Shure IntelliMix does the rest.

□ Its Noise Adaptive Threshold activates microphones for speech but not for constant room noise, such as air conditioning.

Set It And

BBC Renovates U.S. Studios

by Mary C. Gruszka

WASHINGTON News almost always happens at the most inconvenient time.

But as world events turned out, the British Broadcasting Corp. moved into its upgraded and refurbished radio news studios here just in time.

Completed in late October and in use during November, the facilities allowed the world-renowned organization to easily handle all of the news that came out of Washington during the Persian Gulf War.

The war coverage really put the staff and facility to the test. Just the phone patch system alone allowed easy access to and from all incoming lines, some of which were activated for only a few minutes.

"It would have been impossible to cover the war with the old facility," said Beth Miller, a BBC Radio Producer for the past nine years.

A full schedule

Located on the sixth floor at 2030 M Street in Washington—an area commonly known as the communications corridor with CBS next door and National Public Radio across the street—BBC Radio News is responsible for producing news and current affairs programming for the four major domestic networks in the United Kingdom.

Miller said both short form and long form programming is produced here, ranging from news reports and features to half-hour specials and live studio discussions.

With so much activity to cover in Washington and with so many programs to produce, the 10-year-old, single-studio facilities were no longer adequate. The BBC contracted with A.F. Associates of Northvale, N.J., for the systems design and equipment integration and Cooper-Lecky Associates of Washington for the architectural design.

AFA worked closely with BBC Engineering to develop the overall design within tight budget constraints. "A combination of new and existing equipment was used," said Scott Griffin, project engineer at AFA and project manager for the job. "In addition, the facility was designed to be easy to operate and to require little or no maintenance since there is no engineer on-site."

The project was completed in approximately four months, which included demolition. The technical areas include a studio, two control rooms and an equipment rack room.

Offices for radio and TV correspondents, a bureau manager, a radio news-gathering area, a future TV edit room and an insert stage also were built.

A new studio

The studio, approximately 400 square feet, contains a Cranford round table that can seat up to six people. The table, specified by the BBC, has an acoustically treated surface to minimize reflections and includes a cable access section for headphone amps and microphones.

The main control room has visual contact with the studio and also with an adjacent second, self-operational, studio/control room. While the main control room is normally used with the studio, the self-op room can control it as well. A connector panel in the studio allows the mics to be easily routed into either room.

The main control room, approximately 240 square feet, is outfitted with a Soundcraft SAC 200 audio console with 24 mono inputs. The console has both stereo and mono outputs, and a monitor selector panel that allows a mono mix to be sent to the left speaker and cue to the right speaker.

"Everything was designed for stereo capability," Griffin said. "But the programming is primarily in mono."

Equipment includes four Studer PR-99MKIII two-track tape decks, one

Yamaha C300 two-track cassette deck, one Technics SL-1200MK2 turntable, one Tascam CD-401 CD player, one Panasonic AG-1240 VHS VCR, three Gentner SPH-5 telephone hybrids, three Audi-Cord cart machines, Crown D-75 power amps, Rogers loudspeakers (reused), Eddor HA-8000C headphone amps, and one Anchor MS-1000C powered loudspeaker for cue.

The self-op room has a smaller Soundcraft SAC 200 console with a 16-input frame that is loaded with 12-input modules. The equipment selection is the same as the main control room, but here there are two, two-track audio tape recorders and one telephone hybrid.

Both rooms have an AutoPatch 4X-DM 16x16 router, microphones, and jackfields. An I/O connector panel in each room allows the connection of a future four-track tape machine.

Custom work

Griffin designed, and AFA built, a custom relay chassis interface to convert the console's ECL logic fader start/stop outputs to contact closures. The extensive fader start system controls such devices as the tape machines, CD player, turntable, and telephone hybrids.

In addition to internal equipment, the rooms receive direct-line feeds from sites such as the White House, the State Department, the Pentagon, CBS, WAND (Washington Audio News Distribution), NPR, and leased lines to the correspondents' homes.

There are two routers used throughout the plant, one for in-house monitoring of a variety of audio feeds, and the other for remote control from London or New York.

The in-house router, called the Audio Ring Main, was a custom mechanical router that the BBC specified for maintenance ease. Each of the studio and control rooms, plus correspondents' offices and news area, has a Ring Main selector panel, a custom-built unit made by AFA. A rotary switch on the panel routes the

selected feed to a built-in Aurotone speaker.

The remotely controlled router, a 16x4 Glen Sound NCA unit, was reused and allows London and New York to access feeds from the Washington bureau.

In the machine room, four fully-loaded equipment racks house the terminal equipment. Two racks hold the Avitel audio and video distribution amplifiers, and a QC section for each.

Another contains the heart of the existing Basys system, which is an interactive database that the newswriters and producers use to generate their stories. Connected to London and New York, the system also interfaces with news services such as Reuters and Associated Press. Terminals are provided throughout the facility.

The outline

The transmission rack contains the headend equipment of the RF distribution system that includes feeds from other news organizations plus internal TV tuners that are fed to TV monitors throughout the facility. The remote controlled router also is located here.

The transmission rack also contains the DOWTY KMX-8800 telephone multiplexer, which combines one output plus control from the NCA router, the plant telephone key system, and control for the Basys system into one 64 kilobit line. This signal plus another primary NCA output then goes into an IDB TDM-150 T1 multiplexer that feeds a lease line to New York.

Gold CDs

(continued from page 12)

coated reflective surface, with a special green dye) will last as long as well-made consumer CDs.

But, she said, CD rot is real. It is, however, a phenomenon associated with older aluminum CDs when manufacturing processes were not as refined as today's. A quality control manager for a Denon CD pressing plant in Georgia confirmed that periodic, accelerated-aging tests reveal no premature failure of aluminum-coated discs manufactured under current production methods.

Audio expert Len Feldman, who conducts professional and consumer equipment testing from his lab in Great Neck, N.Y., does not believe that CD rot, whether due to pinholes or use under extreme conditions, is a serious problem, either.

He said he has conducted temperature extreme tests on consumer CDs and concluded that they hold up quite well.

The CD rot theory probably stems from problems within laser discs, in which two halves are bonded together with an adhesive, according to Feldman. If the seal is not complete, the aluminum could oxidize, he said.

Since CDs are not made the same way, he noted, they are likely to last a very long time under normal to even more stringent use, he said.

I suppose that if CD rot ever became a vast problem, a new service could be created to deal with it—perhaps CD recycling. I can see it now. Audiophiles sorting through defective discs and placing them in the appropriate recycling containers so the CD recycling truck can come by and pick them up once a month.

Let's see. How would they be separated? Rock, country, classical, discs with white labels, black labels . . .



FP410 Mixer shown actual size.

Forget It.

□ Its MaxBus limits the number of activated microphones to one per talker.

□ And its Last Mic Lock-On keeps the most recently activated microphone open until a newly activated microphone takes its place.

With Shure IntelliMix, you'll get a "seamless" mix that's as close to perfect as you'll find. Providing the cleanest, clearest sound you've ever heard from a portable mixer. And freeing you from the tedious

task of turning microphones on and off.

For a closer look at the world's first portable automatic mixer, call for more information including the article "Why Use An Automatic Mixer?"

We think you'll agree: The Shure FP410 is automatically a classic.

Call 1-800-25-SHURE. The Sound Of The Professionals®..Worldwide.

SHURE

Overseas Firms Flock to Vegas

by Alan Carter

LAS VEGAS Not only did international attendance impact the 1991 NAB show, but exhibitors from overseas had a stronger presence than ever.

At its first NAB, Italian manufacturer Elenos highlighted its line of transmitters and a new remote control software package called R.F. Diagnostic.

R.F. Diagnostic is a telemetry and remote control system for tube-type power transmitters and the transmitting site. The parameters needed to prevent malfunctions are displayed on an IBM PC, and the computer screen will reproduce the front panel, including all meters.

Spain's AEQ showed its Systel-3000 digital multi-hybrid telephone system. Among the fea-

tures of the digital signal hybrid systems are: microprocessor control via standard RS-232 or RS-422 interface; up to eight telephone lines in full multiplex communication due to the internal mix-minus bus structure; no preliminary adjustment or line measurement; and a control module either as a small dedicated console or a standard PC. AEQ also offered the MP-10

portable mixer that allows two- or four-wire communication; the TH-02 single or dual digital hybrid; and the IN-02 digital echo suppressor intercom.

Barco-EMT showed the EMT 460 cart recorder and EMT 461 cart player, all part of the company's BEDAS digital audio storage system.

The 460 cart recorder is a digital cartridge unit used for record-

ing, editing, copying and playing spots. The 461 cart player is designed for playing spots from digital cartridges.

Another Italian company, AEV, displayed its complete range of products including mixers, telephone hybrids, audio digital samplers, audio processors, automation system, clock system, stereo generators, and RDS generators.

Other international exhibitors included SIRA, also from Italy, with its line of FM and TV antennas and combiners, and Plasmec of Surrey, England, which showed its new Mosses and Mitchell flex-patch audio jack-

For information from Elenos, contact the U.S. distributor, Bext in San Diego, Calif.: 619-239-8462; FAX: 619-239-8474, or circle Reader Service 16.

For information from AEQ, contact Javier Lizuain in Spain: 34-1-686-1300; FAX: 34-1-686-4492, or circle Reader Service 134.

For information from Barco-EMT, contact the company's U.S. office in Georgia at telephone: 404-590-7900; FAX: 404-590-8042, or circle Reader Service 79.

For information from AEV, contact Giuseppe Vaccari in Italy: 39-51-950249; FAX: 39-51-950201, or circle Reader Service 111.

For information from SIRA, contact the North American distributor, Comad, in Canada: 613-969-1465; FAX: 613-969-0541, or circle Reader Service 45.

For information from Plasmec, contact Penny & Giles in Santa Monica, Calif.: 213-393-0014; FAX: 213-450-9860, or circle Reader Service 31.

C-QUAM

(continued from page 10)
stations are AM stereo, with all but between 24 and 30 using C-QUAM.

Frank Hilbert, manager of Motorola's Modulation Systems Laboratory, said Japan should lead the way for other countries in the lucrative Pacific Rim radio market to go AM stereo.

This latest boost for AM stereo comes as the radio world develops the next generation of radio technology—digital audio broadcasting (DAB). DAB would change radio as it is known today, creating a new transmission standard and requiring new receivers.

But many believe DAB will not be a setback for AM improvements.

"I don't think any AM improvement is rendered moot because of DAB," NAB Science and Technology Senior VP Michael Rau said. "DAB remains a promise and AM radio exists today and has to be dealt with."

Snider agreed. "Nearly everybody I talk to says DAB is eight to 10 years away," Snider said. "AM stereo is a fact, it just hasn't been adopted. The problem is the lack of receivers."

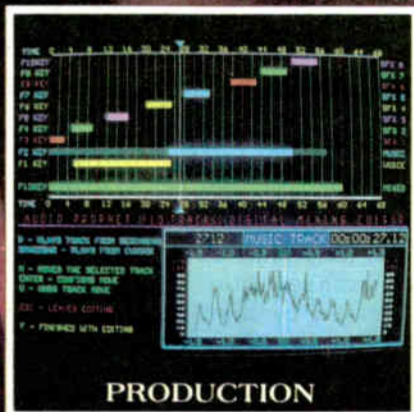
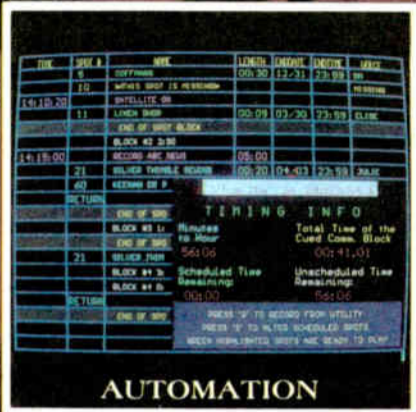

THE
UNLIMITED
DIGITAL
BROADCAST
SYSTEM

WELCOME TO THE FUTURE

LIVE

SATELLITE

1-800-658-4403 (308) 284-3007

Big Things Come In Small Packages

Henry Engineering products take up very little room in your studio, yet are some of the most important products you can own. Each unit is a mini problem solver providing the vital interface between the major components you rely on daily. Take advantage of this special pricing and find out why so many broadcasters trust Henry Engineering and BSW to solve their equipment problems.



MIXMINUS PLUS

MixMinus Plus is a differential summing amplifier designed to add a "Mix-Minus" output to a broadcast audio console for proper set up of call-in talk shows.



MATCHBOX

The most trusted unit for interconnecting "HI FI" or semi-pro equipment with professional studio gear. The Matchbox is a bi-directional, stereo input/output interface.



TWINMATCH

Twinmatch is a four channel, "one-way", level and impedance interface that's ideal for a pair of consumer grade CD players or four-channel tape deck output.

Your Choice Only ~~\$~~159.00

BSW®

BROADCAST SUPPLY WEST

America's Full-Time Broadcast Supplier

Call Toll Free 800-426-8434 Or FAX 206-565-8114

Circle 25 On Reader Service Card

World Radio History

DISK-BASED AUTOMATION SYSTEMS



Digi-Link

The Digi-Link from Arrakis Systems can be configured for manual, live-assist, satellite and automated operation from a single screen display.

Users can choose between normal 16-bit PCM audio record/replay, or 2:1/4:1 data compression for enhanced storage capacity; adaptive differential PCM is the compression scheme used. Sampling rates are 44 kHz, 32 kHz, 22 kHz or 16 kHz, jumper select. Stated frequency response is 10 Hz-20 kHz, ± 0.5 dB.

The system processor for the Digi-Link is an Intel 80286, using an operating system of MSDOS 3.0 or higher. Base systems are available with up to 10 hours of stereo audio storage, extending to 140 hours with add-on hard drives.

The Digi-Link controller comes complete with a DSP board and SCSI controller and Arrakis' "Wavelink" stereo production software.

For information, contact Harris-Allied at 800-622-0022, or **circle Reader Service 52**.



Digital Commercial System

Computer Concepts Corporation showed an entry-level version of its disk-based Digital Commercial System at the NAB. The entry-level DCS system includes a 386SX PC with 2 Mbyte RAM, 1.2 MByte floppy drive and Tracball.

The system also features a 180 Mbyte hard drive capable of holding up to 170 minutes of mono audio, data compressed using Audio Processing Technology's apt-X 100 4:1 codec.

The DCS is coupled with the firm's Traffic System to provide on-screen display of a station's broadcast schedule, with complete audit capability.

According to the company, an entry-level DCS can play an entire day's or even weekend's worth of commercial, jingles, promos, PSAs and liners automatically. Commercials are pulled from the DCS hard disk, placed in a queue for each break and played automatically.

For more information, contact Greg Dean at Computer Concepts Corporation: 800-255-6350, FAX: 913-541-0169, or **circle Reader Service 70**.

TECHNOLOGY BREAKTHROUGHS



DIGITAL ON-AIR RECORD AND REPLAY DEVICES

Audio Prophet

Prophet Systems' Audio Prophet combines production, traffic and billing functions together in a hard disk system that offers 16 kHz audio over a 32 kHz sampling rate. Automatic stereo and mono switching is possible within a group of spots currently playing.

The Audio Prophet also features 10-track recording, editing and mixing capabilities. The unit is designed to control up to 16 audio sources to mix with a satellite feed.

A Hewlett-Packard 676 Mbyte SCSI drive—expandable to 9.6 Gbyte—is used for the Audio Prophet. The processor is



an Intel 486, running at 33 MHz, with an on-board math co-processor. The system offers 150 minutes of uncompressed stereo or 338 minutes of compressed stereo audio storage.

For more information, contact Ray Lockhart at Prophet Systems: 800-658-4403, FAX: 308-284-3517, or **circle Reader Service 76**.

UDS Ultimate Digital Studio

The UDS Ultimate Digital Studio from TM Century is now being configured around the DigiCart Bernoulli/hard-drive unit from 360 Systems, to provide up to 20.8 hours of mono audio file storage, using Dolby AC-2 data compression.

The system will also directly control Pioneer PDM435 and Sony CDK-006 CD players for music playback.

For more information, contact Dave Scott at TM Century: 214-934-2121; or **circle Reader Service 112**.



DigiForm

International Tapetronics Corporation's DigiForm Digital Audio Operating Platform will provide control of up to two recorders and three playback units (or 32 automated multi-source changers). The ITC unit offers integrated live-assist, satellite automation, program automation and traffic/accounting capabilities.

Production and Programming modes of the DigiForm include touch screen and keyboard control; On-Air mode is via touch screen with minimal operator controls. An internal 330 Mbyte hard drive provides 27 minutes of stereo record/replay; an optional 1.2 Gbyte external drive adds 98 stereo minutes of playback capacity.

Hardware for the DigiForm is an 80286 CPU. Audio specifications for the system include frequency response of 20 Hz-20 kHz, ± 0.5 dB (sampled at either 44.1 or 48 kHz). Signal to noise is at least 85 dB, at +6 dBm output level.

For more information, contact Larry Lamoray at ITC: 800-447-0414, FAX: 309-828-1386, or **circle Reader Service 88**.

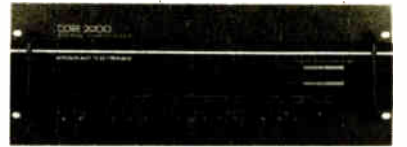

AudioVAULT and CORE 2000

The Broadcast Electronics AudioVAULT is based around Stacks and Playlists that mimic, via icons, the normal operations of conventional analog cart machines. Stacks holding up to eight "carts" can be pre-loaded in the system's cueing mechanism, and triggered via contact closures from a satellite decoder.

Up to eight audio inputs (four stereo pairs) are fully addressable as a digitized signal capable of being routed to any of four stereo outputs.

The hardware section of the system is a 386 or 386SX PC-compatible CPU; the software platform utilizes Microsoft Windows 3.0.

The CORE 2000, also new from BE, is a PC-based program control system that allows for applications in full automation, live assist and satellite formats. CORE 2000's program display screen indicates the event menu, on-air readout, location and status. Event progress is noted with a countdown timer of on-air events; real-time status of all upcoming events is also displayed on-screen.

The unit is addressable for up to 36 source inputs, each with flexible machine control. Each input allows "smart source" interfaces, with capability for both parallel and serial I/Os.

For more information, contact Ted Lantz at BE: 217-224-9600, FAX: 217-224-9607, or **circle Reader Service 130**.



Audisk

The Audisk system from MacroMedia now offers multi-user/multi-tasking functionality, for simultaneous inload/replay and housekeeping between various interlinked systems around a station, as well as full control of all system functions from any local or remote PC station.

The Audisk system processor is an Intel 8088; the system employs 4:1 split-band adaptive differential PCM for compression. Sampling rates for the unit are 44.1 kHz, 32 kHz, 22.05 kHz and 16 kHz, made via jumper selection. At 32 kHz, frequency response for the Audisk is 5 Hz to 15 kHz, ± 0.2 dB.

The Audisk is available with storage times beginning at 180 minutes, mono or stereo.

For technical information, contact Tim Valley at MacroMedia: 507-645-5970. For sales information, contact Harris-Allied at 800-622-0022, or **circle Reader Service 37**.

Sentry Systems DS-1

The new Sentry Systems DS-1 hard disk system is compatible with existing controller units. It offers up to 90 minutes of stereo audio storage with an optional 700 Mbyte disk; up to seven hours of 12 kHz mono audio can be stored using ADPCM compression.

Three operational modes—live assist, fully automated and satellite insertion—are available with the DS-1.

For more information, contact Mike Bettelli at Sentry Systems: 206-728-8651, or **circle Reader Service 94**.

"Not So Hard Disk"

Wheatstone's "Not So Hard Disk" utilizes a dedicated Disk Playback Console to control cue selection and replay functions, in conjunction with existing console start/stop buttons.

The system is divided into an on-air disk playback terminal and a production room record terminal. The disk playback terminal gives the air talent access to only the playback functions of the system.

Scheduled to be made available by early summer, Wheatstone's Not So Hard Disk system allows up to 40 hours of apt-x 100-encoded audio to be recorded to disk for storage.

For more information, contact Mike Shane at Wheatstone: 315-455-7740; FAX: 315-454-8104; or **circle Reader Service 110**.

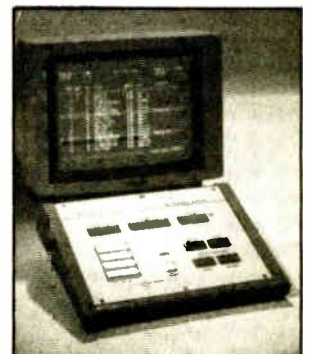

UNCOMPROMISING QUALITY SUPERIOR PERFORMANCE



ESL-V Eraser/
Splice Locator

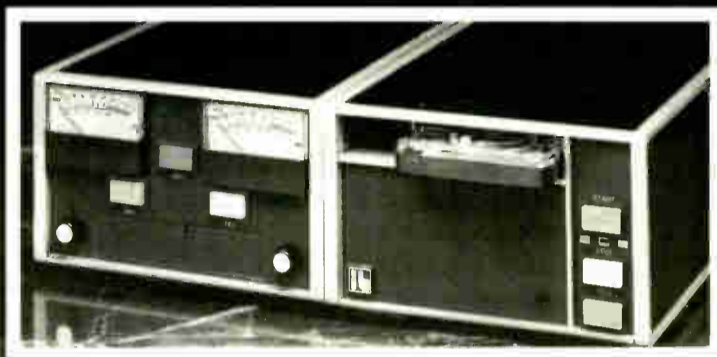

99B Series Recorder/Reproducer



DELTA I Reproducer, DELTA III Triple-Deck Reproducer,
DELTA IV Record Amplifier



Series 1 Reproducer

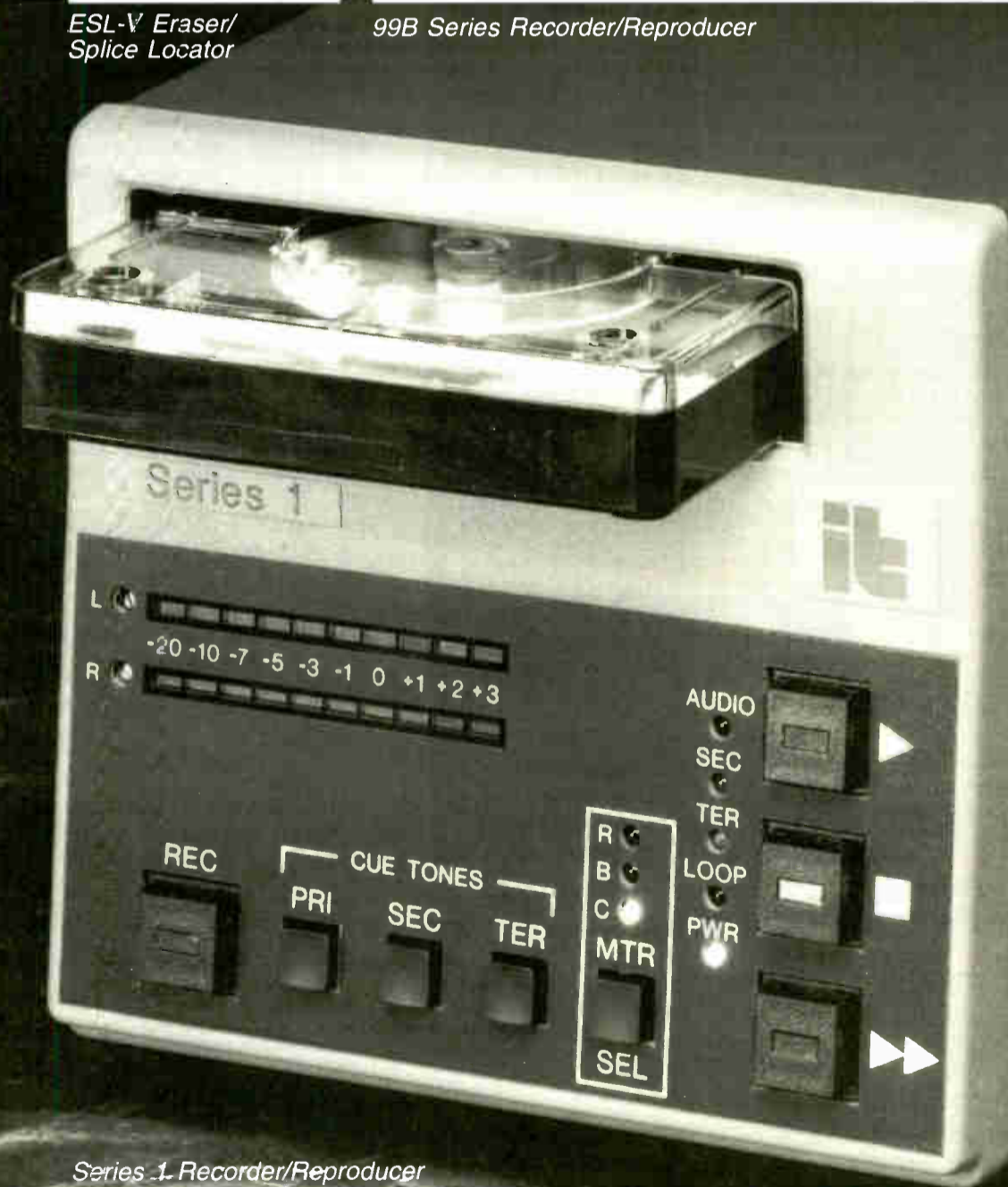

Series 1 Recorder/Reproducer

Whatever your needs or budget, there's an ITC machine to suit your requirements. From the world standard 99B Series, to the popular Delta Series, to the new and innovative Series 1. Each built to ITC's uncompromising standards of quality and performance.

For more information:

Allied Broadcast Equipment	800-622-0022
Audio Broadcast Group	800-999-9281
Broadcast Services Company	800-525-1037
Broadcast Supply West	800-426-8434
Northeast Broadcast Lab	518-793-2181

In Canada:

Maruno Electronics Ltd.	416-255-9108
-------------------------	--------------

For 21 years, ITC has set the standards for cartridge machine quality and performance, providing over 67,000 machines to broadcasters worldwide.

International Tapetronics Corporation

P.O. Box 241
Bloomington, IL 61702-0241
TEL: 800-447-0414; 309-828-1381
FAX: 309-828-1386



Circle 63 On Reader Service Card

World Radio History

TECHNOLOGY BREAKTHROUGHS

DIGITAL ON-AIR RECORD AND REPLAY DEVICES

DAWN

Gentner's Digital Audio Workstation Network ("DAWN") is LAN-based. The system links such station functions as traffic, programming, accounting, promotions into a master control system.

The DAWN workstation uses MUSICAM data compression to store audio on hard disk, providing what the company says is a minimum of 400 minutes stereo, with a compression ratio of 6:1.

Frequency response of the DAWN system is 20 Hz-15 kHz, ±0.1 dB. Total harmonic distortion plus noise is less than 0.3 percent at 6:1 compression.

For more information, contact Chuck Leonhardt at Gentner: 801-975-7200; FAX: 801-977-0087; or circle Reader Service 54.

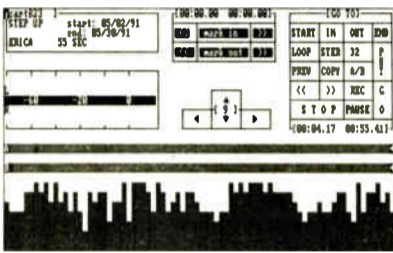

DIGITAL CART RECORDERS

DigiCart

The 360 Systems DigiCart is a random access, 16-bit linear cart-style recorder. It utilizes standard Bernoulli disks for storage, and is also available with several system options for enhanced storage capacity.

The HD-200 and HD-400 SCSI-equipped hard drives offer 40 and 100 minutes of mono storage at 44.1 kHz sampling frequencies; several units can be daisy-chained for additional on-line storage.

Recording options include variable sample rates of 48 kHz, 44.1 kHz, 32 kHz or 22.05 kHz, compressed or linear, in stereo or mono. The optional Dolby AC-2 data compression extends record/play-

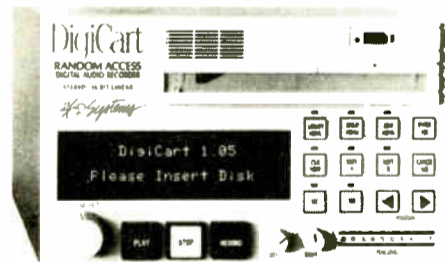

DigiSpot

Digital Broadcast Associates' DigiSpot system uses standard 20 Mbyte floppy diskettes to store up to two minutes of uncompressed stereo music or jingles, with front-panel readout of cut title. In addition to standard operator controls and back-panel interfaces, the system also features an RS-232 serial port for external computer control.

Digital input for the DigiSpot is 16-bit, with delta-sigma A/D converters and digital anti-aliasing filtering; digital output is also 16-bit, with an 8x interpolation filter and 64x delta-sigma DAC.

Both record/play and play-only models of the DigiSpot will be available by fall.

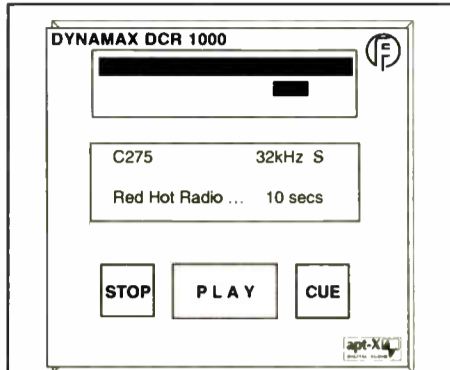

Dynamax DCR1000

The Dynamax DCR1000 Digital Cartridge Recorder from Fidelipac allows up to 120 seconds of apt-X 100-compressed stereo audio to be recorded onto 4 Mbyte floppies (74 seconds at 44.1 kHz sampling). Sampling rates for the DCR 1000 can be selected from 44.1 kHz, 32 kHz, 24 kHz and 22.05 kHz. Ten minutes of stereo will also be available, from 20 Mbyte disks.

A Record Module provides analog-to-digital conversion, while stand-alone Master Players handle replay functions. An optional keyboard allows diskette titling, length marking of recording, placement and movement of cue tones, end checking and mode select.

Additional DCR1000 Sub-Players can also be connected to Players for daisy-chained playback via a single D-to-A converter. A front-panel, two-line by 25-character LCD shows running time, title, cart number and other information.

For more information, contact Scott Martin at Fidelipac: 609-235-3900; FAX: 609-235-7779; or circle Reader Service 11.

back times by a factor of 6:1—a fully-configured system now offers up to 80 hours of mono file storage.

Controls include secondary and tertiary cues, remote control from closures, and replay lockout. Automation systems can interface with DigiCart by EIA-422 or BCD ports.

For more information, contact Don Bird at 360 Systems: 818-342-3127; FAX: 818-342-4372; or circle Reader Service 123.

For more information, contact Ron DeBry at Digital Broadcast Associates: 818-567-2873; FAX: 818-567-2917; or circle Reader Service 138.

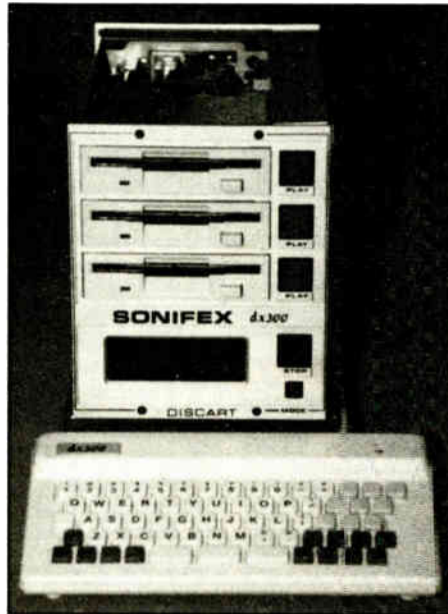

DISCART

The Sonifex DX Series DISCART system is a "triple-stack" floppy disk recorder/player. Using apt-X 100 data compression, the DISCART can store up to 5.5 minutes of 16-bit digital stereo audio on EHD floppy disks. The recording interface is a keyboard with simple single-stroke execute commands and LCD user prompts. An RS232 port is also available.

Additional slave units can be added to a recorder/player or player unit for additional capacity. A touch screen interface with hard disk is also available for extended functionality.

For more information, contact Paul Brooke at Sonifex: 011-44-933-650-700; FAX: 011-44-933-650-726; or circle Reader Service 43.

RECORDABLE CDs/ CD PLAYERS



Audiometrics CD cart player

The Audiometrics CD10 is a "second generation" CD cart machine, according to distributor Harris-Allied. The unit has features including Autolock to prevent accidental removal of discs in play, a programmable End of Message indicator to keep track of playing time and signal when a cut nears its end, and a linear tracking system for start times of less than 200 milliseconds.

For more information, contact Harris-Allied at 800-622-0022, or circle Reader Service 34.



Denon DN-770R

Denon's DN-770R CD cart recorder features AES/EBU and SPDIF digital I/Os, plus an optional Audio Interface Unit for connection to analog sources.

Sixteen-bit, 44.1 kHz digital recording is possible with the DN-770R; standard recording time is 63 minutes. A maximum of 99 tracks and 99 index numbers can be placed on a disc. An optional Multi-Unit Interface allows up to 10 machines to be chained together.

For more information, contact Laura Tyson at Denon: 201-575-7810; or circle Reader Service 24.



Studer D740

The Studer D740 CD recorder offers full compatibility with other disc players once the table of contents is written. Included are AES/EBU and SPDIF digital I/Os and a PQ Editor, which automatically generates a table of contents including track numbers and exact running times.

The Write Once (WORM) optical media used with the Studer D740 will be stocked at all the company's regional offices.

For more information, contact Sandra Hale at Studer Revox: 615-254-5651; FAX: 615-256-7619; or circle Reader Service 67.

Yamaha YPDR601

A write-once unit, the Yamaha YPDR601 allows partially recorded discs to be played back before the disc is full. A full table of contents can be written to disc either before or after recording. Track numbers are written automatically by pressing either the Stop or Pause keys; manual entry of track numbers is also possible.

The Yamaha recorder has AES/EBU and SPDIF digital I/Os; analog connections are via balanced XLRs.

Up to seven YPDR601 can be controlled simultaneously using the RC601 remote controller. The YPDR601 can record three-inch as well as five-inch discs.

For more information, contact Gerald Tschetter at Yamaha Corp. of America: 714-522-9011; FAX 714-739-2680; or circle Reader Service 102.



DIGITAL AUDIO TAPE (DAT)

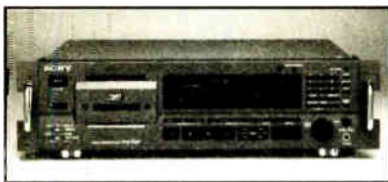

Sony PCM-2700

Sony Corporation unveiled the new PCM-2700 Pro-DAT. One-bit pulse digital-to-analog conversion and LSI circuitry are employed in the design of the PCM-2700, which also features four heads for read-after-write capabilities.

Other features include a digital fader and a four direct-drive motor mechanism in the transport.

For more information, call 1-800-635-SONY ext. 103, or circle Reader Service 108.

Yamaha DTR2

Yamaha's new DTR2 DAT machine is available with wired remote and coaxial/optical digital I/Os. A front panel switch selects between analog and digital inputs, and when recording from an analog source, another front panel switch selects either 44.1 kHz or 48 kHz sampling frequency.

The unit's A/D converters utilize Yamaha Delta-Sigma 1-bit conversion technology (with 16-bit PCM output). Signal to noise in analog performance is 92 dB, with total harmonic distortion of 0.003 percent. Digital performance is 103 dB S/N ration and THD of 0.0025 percent.

For more information, contact Gerald Tschetter at Yamaha: 714-522-9011, or circle Reader Service 26.

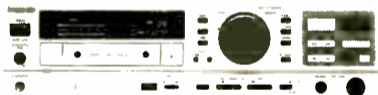

Panasonic SV-3900

Panasonic's SV-3900 Pro-DAT recorder has a selectable 44.1 kHz/48 kHz sampling rate, via analog or digital inputs. AES/EBU-format and IEC 958/SPDIF digital I/O ports carry Start and Skip ID information. The unit has balanced inputs and outputs, using XL-type connectors.

The SV-3900's standard nine-pin serial port can be switched to ES-Bus or P-2, making it compatible with a wide range of editing controllers and automation systems. A full-function remote controller, the MK390, is available for the SV-3900.

Panasonic also unveiled a Software Developer's ToolKit for the SV-3900 at the NAB. The package was designed to simplify the writing of ES-Bus serial control software for automation controllers and workstations. Custom-designed C and Pascal utilities are used in the ToolKit.

For more information, contact Panasonic at 714-373-7277, or circle Reader Service 144.

Otari R-DAT

Unnamed at press time, the new professional R-DAT recorder from Otari is planned for release in the fall of 1991. The machine will feature SMPTE/EBU time code record/reproduce capability. Other features include AES/EBU digital interface, 8x oversampling, RS422A serial remote control port and 37 pin parallel interface.

For more information, contact John Carey at Otari: 415-341-5900; FAX: 415-341-7200, or circle Reader Service 47.



Eventide VR240 Audio-Logger

The VR240 Digital Audio-Logger allows 170 hours of data-compressed audio from up to 24 channel sources to be recorded onto a single 60-meter DAT cartridge (270 hours from a 90m tape).

A high-capacity data buffer for continuous taping is featured in the VR240. All events are date-and-time stamped for simplified playback search. A built-in uninterruptible power supply enables safe transition to generator power.

A dual-transport version of the Eventide Audio-Logger includes automated switching for doubled record time.

For more information, contact Gil Griffith at Eventide: 201-641-1200; FAX: 201-641-1640; or circle Reader Service 83.

Through the next four issues, **RW** will spotlight a particular aspect of the new technology that emerged at this year's NAB trade show. Coming up in our June 26 issue: digital processing.

Put your jingles on CD

Frankford Wayne can transfer your jingles, IDs and sounders to CD.

Get CD quality, permanence and convenience of handling for a lot less than you might think.

Call today for a quote!

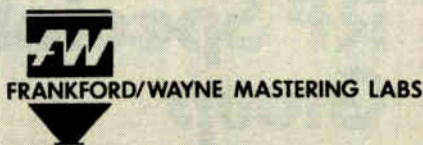

1697 Broadway, New York, NY 10019
(212) 582-5473

Circle 3 On Reader Service Card

Something Very Good Just Got Better!



John Schaab

John Schaab joins Broadcast Services/EME as Vice President/Sales

John comes to us from ITC, where his latest position was Digital Product Specialist. In his 19 years with ITC, John also served as a Regional Sales Manager, and Account Representative for video products. He can be reached at 800/525-1037.

Tony Mezey heads West Coast Sales Office



Tony Mezey

With over 22 years experience in broadcasting, Tony's most recent position was with Harris Allied in their Burbank office.

Prior to that, he also worked with CRL and Cetec. Tony is joining us as Field Sales Representative, with primary responsibility for the West Coast region. Working with Tony will be Sarah Shankland, who is also familiar to many broadcasters on the West Coast. She too comes to us from Harris Allied, and is joining us as Field Sales Coordinator for the West Coast office.



Sarah Shankland

We're pleased that these experienced professionals have chosen to join us. With their able assistance, we will continue to build an organization dedicated to bringing you complete satisfaction. Their confidence in what we are doing is a prime example of why we are...

The Preferred Source



The Davis Communications Group, Inc.

West Coast Office

Tony Mezey
Sarah Shankland **800/523-1037**

Southeast Office

Cindy Edwards **800/525-1037**

Middle Atlantic Office

Keith Arnett **800/345-7112**

Video Sales Office

Dennis Ford
Bill Gordon **800/942-6005**

Circle 122 On Reader Service Card

**We Don't Just
Sell Equipment...**

**We Know
How the
Pieces Fit
Together!**

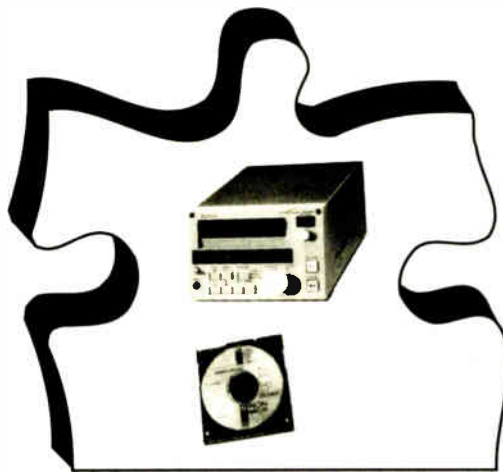
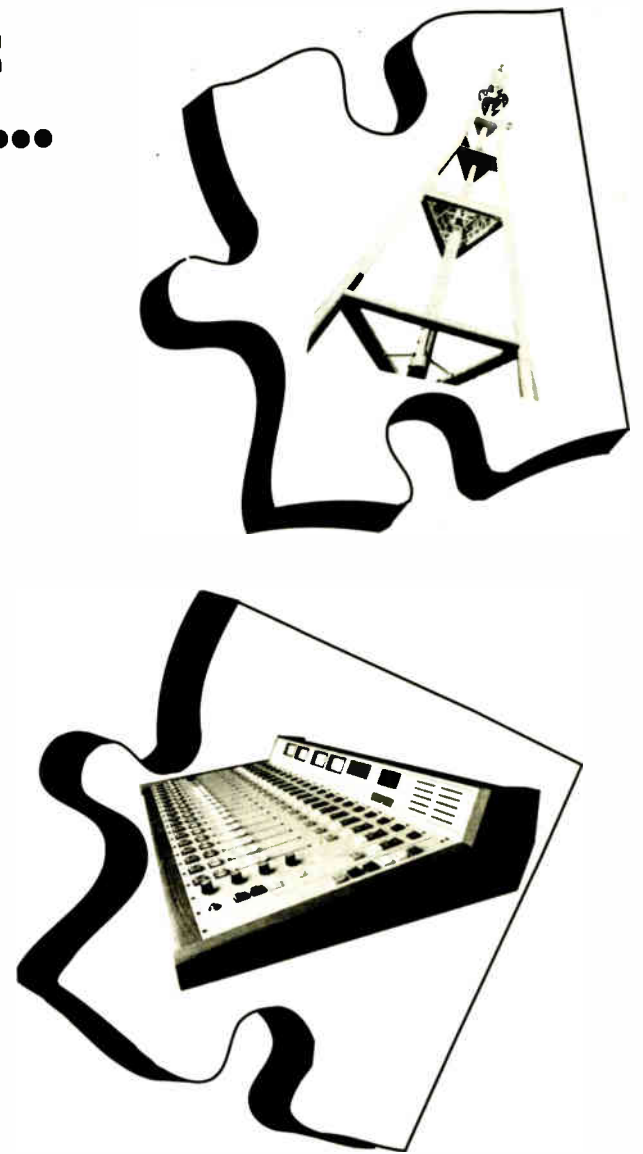
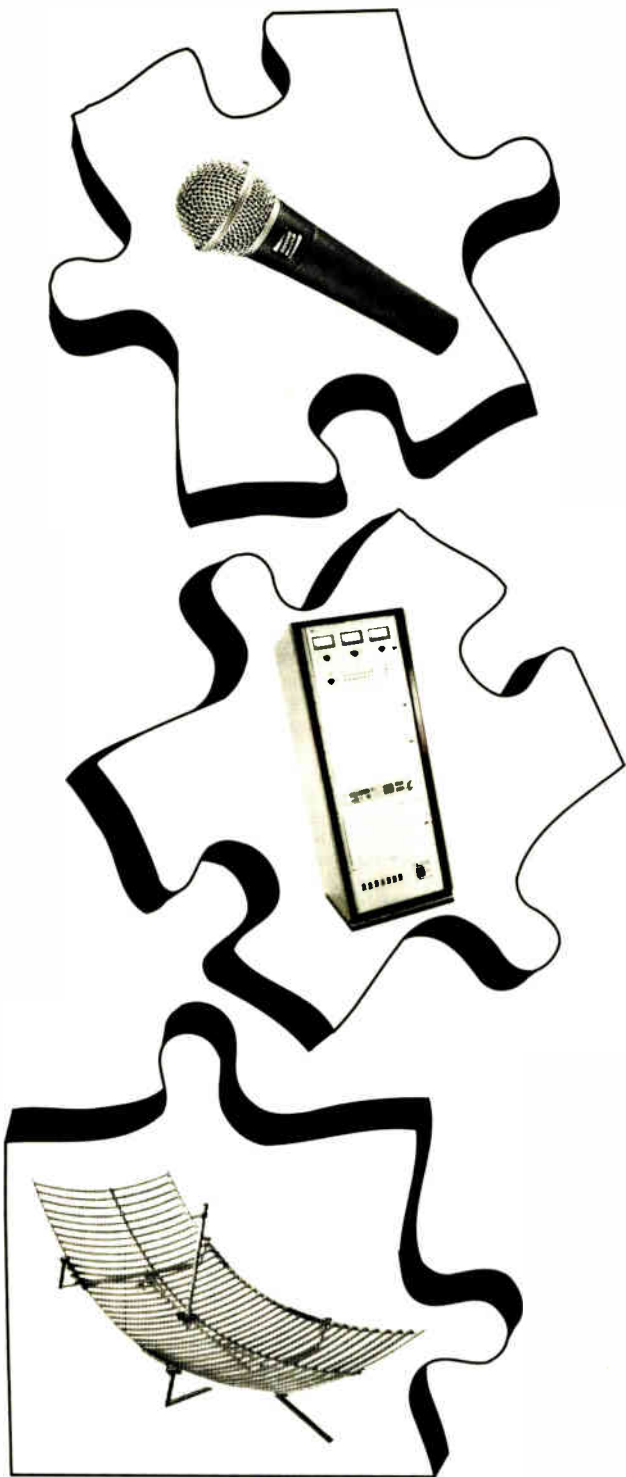

NORTHWEST
Seattle, WA
(206) 546-6546
FAX: (206) 546-2633

WEST COAST
Santa Barbara, CA
(805) 682-9429
FAX: (805) 682-5170

MIDWEST
Kearney, MO
(816) 635-5959
FAX: (816) 635-4508

NORTHEAST
Pittsburgh, PA
(412) 733-1994
FAX: (412) 327-9336

SOUTHEAST
Niceville, FL
(904) 678-8943
FAX: (904) 729-2744

SOUTHWEST
Amarillo, TX
(806) 372-4518
FAX: (806) 373-8036



Puzzled by new technology, or a tight engineering budget? We're not. Nor are we puzzled by innovative RF systems, resourceful studio designs, or even the FCC regulations that govern your station.

We're knowledgeable equipment suppliers. We're The RF Specialties Group.

- **RF and Audio Equipment.**
- **Over 120 Product Lines.**
- **Competitive Pricing.**
- **The Largest Number of Full Service Offices Nationwide.**
- **Specializing in System Design.**



**RF Specialties®
Group**

—Each RF Specialties Office Independently Owned and Operated—

Circle 71 On Reader Service Card

World Radio History

STUDIO CITY, Calif. As was very apparent from the technology unveiled during the recent NAB Convention in Las Vegas, digital continues to impact the broadcasting community.

From modest compact disc players, through sophisticated hard-disk automation systems, to the STLs and satellite trunks that carry the programming to its audience, digital is revolutionizing the quality we can deliver. Digital also offers enhanced creativity and flexibility in the realization and programming of the myriad source materials that comprise the broadcasting day.

During the NAB Convention, it became abundantly clear that some hard decisions face the radio broadcaster in the first half of the '90s. For a music station, making the transition from analog to digital replay sources can mean a sizeable investment in replacement media. Although NAB cartridges have a finite lifetime, and should be routinely refilled and then retired from service, it cannot be denied that the transition has a significant financial impact.

To be weighed against that start-up cost—the price of “buying into digital,” if you will—is the accompanying long-term quality increase and operational flexibility. And, as was evident from the NAB Convention, the spectrum of cost-effective record/replay formats is increasing dramatically. Recordable Compact Disc, which allows custom CDs of commercials, IDs, jingles and so on to be prepared very easily in the air or production studio, will allow existing hardware to gain a new lease on life.

Improved and new

At least three innovative firms showed very elegant CD-R units in Las Vegas that will find immediate applications in situations where CD replay is the preferred format for a station. Where an automation system based on CD “jukeboxes”—including several new, high-speed systems unveiled during the exhibition—is the preferred implementation, recordable CD can allow practi-

TECHNOLOGY BREAKTHROUGHS



DIGITAL ON-AIR RECORD AND REPLAY DEVICES

by Mel Lambert

Digital Gear Means New On-Air Choices

cally limitless flexibility.

Turning to DAT hardware, my feeling is that the format has finally come of age. In terms of fast inload—simply replacing a two-hour cassette with a new play list, for example, or a commercials package—the newer generation of remote-controllable DAT players offer a great deal of programming flexibility.

High-speed cueing to within a DAT frame (3 msec) provides random-access to any location within the tape, while machine interrogation allows the master automation controller to check machine status, error rates and a host of diagnostic data from several dozen machines connected on a serial network. And for enhanced replay time from an automated satellite delivery service, for example, at least one company unveiled a DAT multi-player that allows libraries of DAT tapes to be loaded into one of two master playback transports.

One of the most interesting developments shown in Las Vegas were several disk recorders that utilize data compression to provide up to two minutes of stereo replay from high-capacity, 3.5-inch 4-Mbyte floppies—10 minutes from 20-Mbyte drives is just around the corner.

As a *direct* replacement for existing analog cart machines, I expect such systems are more immediately familiar than hard-disk formats. While there can be no denying that a fully integrated hard-disk system offers unrivaled storage capacity and replay freedom, its design overlooks one fundamental human requirement.

Entering the comfort zone

NAB cartridges allow an operator to select the cut he or she wants from a rack, and then manually load it into the next available replay slot. A simple eye-hand link adds a great deal of security to the selection and loading process, and if the result of pressing the start button is silence, it's easy to simply select another source.

This user familiarity and inherent “comfort zone” will mean more than just a quality enhancement as we move from analog to digital. By providing what a broadcasting colleague of mine refers to as a “token”

that offers much-needed manipulative security, floppy-based technology will be more readily acceptable in a variety of applications. Of course, once people adapt to the new technology of hard disk-based systems, the transition to such systems will be all the more rapid—and inevitable.

In terms such technologies, I would suggest that the NAB trade show represented something of a watershed.

It is now possible to record a source to floppy, Bernoulli or hard disk, and then remain within the data-compression domain through hard-wire or satellite delivery and STL to the FM/AM transmitter.

With an established user base beginning to expand and stretch the technology in ways we could only dream of just three years ago, an increasing number of broadcasters are working with manufacturers to customize hard-disk systems in several interesting dimensions.

Bedazzled to familiar

In other words, now that hard-disk systems have become pretty much a way of life for live-assist and satellite-based formats, we can move from the initial “bedazzled” stage to a situation where the technology becomes an inherent and transparent (read: “familiar”) part of a station's *modus operandi*.

After all, a fully-configured PC-based system can handle more than just record/replay of music, IDs, jingles and other audio sequences. From order entry to client billing, in addition to programming days, weeks, months ahead, the data-manipulation capabilities of such formats are not to be overlooked.

During the show, time and time again I was impressed with the intuitive user interface, sort and cross-indexing available from some of the top-end automation systems.

For extended record/replay capacity, a

number of firms are now offering either built-in or optional digital audio data compression. Squeezing more than two hours of stereo audio onto a 320-Mbyte drive allows stations to extend their music selections from existing hardware, or increase the walk-away period in time-critical situations.

In addition, mirroring of each hard drive to provide 100 percent redundancy becomes more affordable. In the near future, the advent of cost-effective, removable magneto-optical drives for automation systems will further enhance their usefulness in a variety of radio formats.

Data compression is also finding its way into a wider spectrum of hardware. In fact, it is now possible to record a source to floppy, Bernoulli or hard disk, and then remain within the data-compression domain through hard-wire or satellite delivery and STL to the FM/AM transmitter. Although these sources cannot be mixed with one another, nor edited (at least for now!), there is no denying that we have more links

in the broadcasting chain than even before.

On a related topic, I would offer that the radio community should also make itself more familiar with the operational features of each of the half-dozen or so competing compression techniques, if only so that they become familiar with their basic quality and technical differences. Encoding delay, asynchronous operation, stereo imaging, generational losses, auxiliary data capacity, compatibility with existing PCM systems, pre-echo within decoders, immunity to random/sequential errors, and the simplicity of hardware implementation are just some of the parameters we need to establish while auditioning systems.

All in all, the recent NAB convention demonstrated (to this observer, at least) that digital technology has come of age for the radio broadcast. We do indeed live in exciting times.

■ ■ ■

Mel Lambert has been intimately involved with the production and broadcast industries on both sides of the Atlantic for more than a dozen years. Now principal of Media&Marketing, a consulting service for the professional audio industry, he can be reached at 818-753-9510.

CENSUS '90



CDS's On-Line

POPULATION COUNT 1990

program now uses the latest U.S. Census Data required for FCC Filings. Call today to set-up an On-Line account.

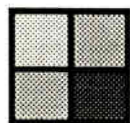

Richard L. & Richard P. Biby, Principals

Communications Data Services, Inc.

(703) 534-0034 • (800) 441-0034

Circle 17 On Reader Service Card

MATCH IT! IF YOU CAN

Audio Level and Impedance Interface



- Top Quality Specifications
- Bi-directional Interface
- Front Panel Gain Adjustments and Power Indicator
- Rugged, All Metal Enclosure
- Single or Dual Rackmount
- Internal Power Supply

\$179



ES-244



PRACTICAL SOLUTIONS FOR 19 YEARS

142 SIERRA ST., EL SEGUNDO, CA 90245 • (213) 322-2136

Circle 125 On Reader Service Card

Computers Find Niche in Radio

by Barry Mishkind

LAS VEGAS Over the past decade, computer usage in radio stations has steadily moved on from traffic and billing to a whole spectrum of uses.

At the 1991 NAB convention in Las Vegas, there was quite a diversity of programs and services shown that were broadcast-specific. Coverage contour services were the rage this year.

On-line services

Dataworld and Communications Data Services (CDS) are two firms offering on-line mainframe services to clients as well

as custom produced reports.

Whether you are desirous of finding out the HAAT (Height Above Average Terrain) of a potential site, the predicted coverage area, or a complete report on a frequency (and what options are available for a facility on the channel), these companies can provide it. Costs depend on the type and number of reports desired.

A new service featured by Dataworld was a "Received Signal Level" map. Utilizing the Longley-Rice computer model, Dataworld can produce maps up to 44" x 34", detailing the received signal strength throughout the station's service area.

CDS also was showing off its Real World

Propagation™ studies. CDS says that by using observations gained by field work, they have modified the Longley-Rice for higher accuracy.

Another of the real strengths of Dataworld and CDS are their on-line databases of all stations, permits and allocations. These databases are updated regularly to reflect the filings and actions at the FCC. Further, proprietary databases are available that are sometimes more accurate than the FCC database.

All of this information can be immediately accessed from your own computer via modem, or you may order by phone and have the reports mailed to you.

And if you're thinking of upgrading and need to be kept current on filings, or just want to know what is going on in your market, these companies can provide regular reports automatically.

Fixed cost reports

If the type of data you need doesn't change very often, you may find that one of the program packages from companies like EDX Engineering will serve you well.

These programs, like CVR™, a coverage calculation and plotting program, load right into your own computer, and allow you to do a lot of "what if" work without further costs. CVR lets you create custom coverage maps, as well as enabling you to "see" the effect of changing power or antenna height for a station.

Among other EDX programs are those that do frequency searches, path analysis and directional patterning. Several now feature a redesigned user interface with easier-to-navigate menus.

One of the attractions of stand-alone programs like these is that you only buy the data you need, and update it when necessary. While the downside is having your data on other facilities in your market become dated, if you're simply interested in terrain studies and coverage contours, this approach can save a lot of money.

NAB91 LAS VEGAS

If you have multiple stations in your company, or do work in a number of locations, EDX offers the terrain database for the country on CD ROM.

INTERCHK, shown by Doug Vernier, is a program that is of special interest to non-commercial and directional FM stations. Designed to duplicate the FCC FMOVER program, it runs interference studies for FM stations. This allows you to find the optimum location and power level for any facility.

Vernier has a full line of such programs that he sells to consultants and others, including COUNTPOP, providing population and demographic data from the 1990 census. In addition to the technical filings, this information can also be used for marketing.

Look, Ma—it's 3-D

Radiosoft's HT3D program, reviewed in the April 24 RW, continues to evolve. New features displayed at the NAB show include coverage plots overlaid on the 3-D terrain display.

The benefits of 3-D display become obvious when trying to choose sites for maximum coverage. Being able to "see" the terrain obstructions speeds the process.

Two other companies showed programs that help control the proliferation of equipment and wiring that causes many engineers to pull out their remaining hair while trying to find where something is or where it goes.

VidCad© and AudCad© from VDP are add-ins to the AutoCad™ from Autodesk. They provide a fast and accurate way to produce drawings for new studios.

Starting with flow diagrams, VidCad and AudCad allow the designer to move equipment around for best location. The studio design literally can be seen from whatever viewpoint is necessary and changes can be made without needing to deal with a single carpenter.

Even better, all the necessary wiring can be displayed on-screen, documented, and output as labels to be used on the individual wires. With this kind of documentation available to be updated as equipment is installed or moved, maintenance of even the most complex facility can be sped up significantly.

Speaking of maintenance, BCAM by Computer Assisted Technologies is a complete package that can be used to create inventory and maintenance records for any size facility.

One feature of BCAM that large facilities will like is the warranty status feature, which instantly tells whether a piece of equipment is still in warranty or not.

Other features include a database that locates each item, lists its maintenance history, provides identification tags, stores repair "tips," produces a list of parts to order, and more.

Barry Mishkind, aka RW's "Eclectic Engineer," is a consultant and contract engineer in Tucson. He can be reached at 602-296-3797, via MCI Mail #325-9883 or on FidoNet 1:300/11.

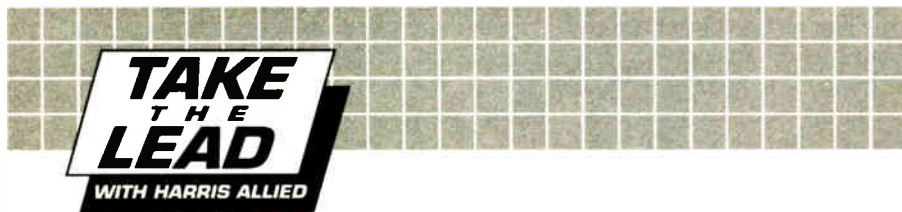

Upgrade Your Station Economically

Our deals are simply too hot to pass up and we're ready to help you get your station going strong for the '90s. Our broadcast veterans guarantee you the most knowledgeable broadcast assistance the industry has to offer. We accept trade-ins on buys of new equipment and we sell used and new broadcast equipment (demos and scratch & dents). We also selectively buy used radio equipment. Give us a call today so we can get started upgrading your station. We'll do it for you economically.

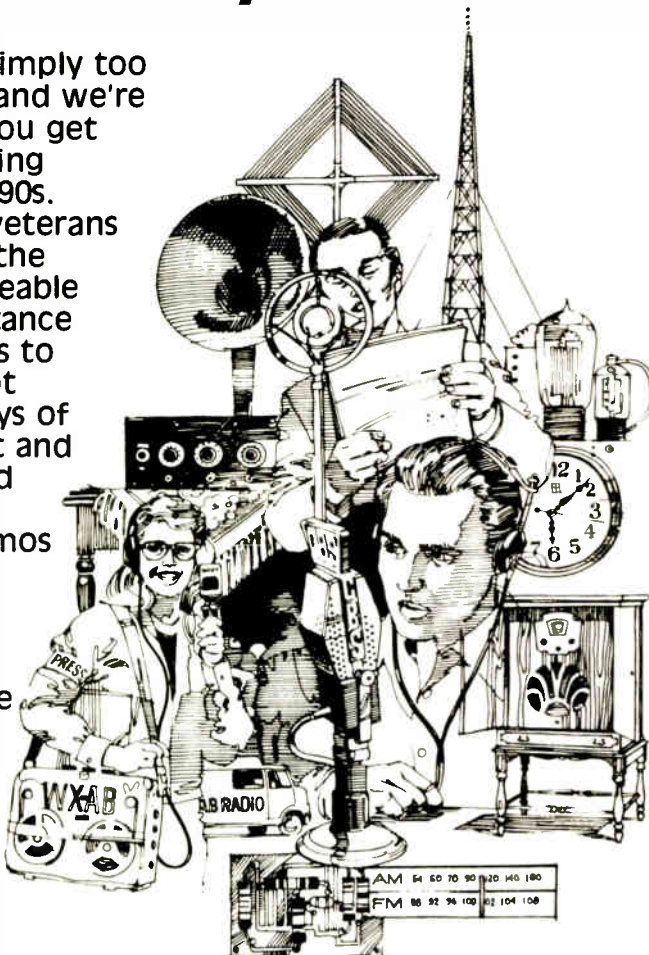

Our Used Equipment Exchange can stretch your equipment budget — it's just one of the ways that Harris Allied gives you more. We've expanded to put more people and more resources to work for you: That's what we mean by taking the lead.

HARRIS ALLIED
EQUIPMENT EXCHANGE

FAX 317-966-6321

317-962-1471

BUY—SELL—TRADE

With expanded staff and services... our lead keeps on growing!

HARRIS ALLIED ©1991

SINE SYSTEMS

DIAL UP REMOTE CONTROL

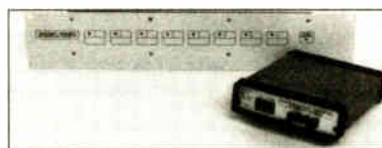

- ★ Up to 64 Channels of Status, Control & Metering
- ★ User Programmable Dial Out Tolerance or Status Alarms on Six Channels
- ★ FCC Legal
- ★ One Year Warranty
- ★ User Friendly
- ★ COMPLETE 8 CHANNEL SYSTEM STARTS AT LESS THAN \$1,400!

Call Your HE Sales Engineer Today!

HE HALL
Electronics
(804) 974-6466
1305-F Seminole Trail
Charlottesville, VA 22901

Circle 68 On Reader Service Card

World Radio History

WORKBENCH

Digging for Gold at NAB

by John Bisset

LAS VEGAS Remember the saying, "Good things come in small packages"? Well, that phrase certainly can be applied to the NAB.

There is no question that the larger exhibits had plenty to show, but so did a number of the smaller exhibitors that may have gotten overlooked in the crush of glamorous, splashy new technology. This installment of *Workbench* will look at some of these clever, lower-profile gadgets.

First, there was Harris' T.H.E. 1 FM exciter—now there's Modulock's T.H.E. Rack. The Total Height Expansion Rack is a new patent-pending design for the mounting and transport of 19-inch EIA rack-mount equipment. Ideal for remote broadcasts, T.H.E. Rack has a casted base, a top with locking rolltop doors and a series of interlocking sidebar pairs that form the vertical walls of the unit.

The beauty of the system is that the height of the rack grows with your requirements. Each piece of rack equipment is screwed into its own sidebar panels. The sidebar panels then are stacked and locked in place. This multipoint interlocking scheme means that components can be easily removed or added as your requirements change. Hand slots on the sides make for easy lifting of the rack. T.H.E. Rack is constructed using a bump resistant polypropylene. For more information, circle Reader Service 91.

Omnitronix of Pennsylvania offered a contract engineer's dream come true—a 10 W FM exciter with built-in stereo generator and audio processor for \$2,500. The FM10X has some interesting features. There's a Bessel test point for both modulation and frequency calibration using an inexpensive short-wave receiver.

The internal audio processor has switch-selectable pre-emphasis and uses precision analog multipliers. The stereo generator boasts 15.2 kHz, eighth-order elliptical switched capacitor low-pass filters. The exciter even has SWR and overcurrent protection. For more information on the FM10X, circle Reader Service 115.

You may have heard of Jonathan Manufacturing, but if not, the chances are good that you've used the company's products and not even known it. Jonathan Manufacturing Corp. builds the rack slides used nearly exclusively by broadcast equipment manufacturers. Available in aluminum or steel, one particular model really caught my eye. The Model 150QDP combines a full ball-bearing chassis slide (with a 200-pound load rating) with a chassis tilting provision.

Designed originally for VCR maintenance, the tilt slide facilitates maintenance or inspection of any rack-mount equipment. The tilt feature allows the equipment to be rotated either up or down in 45 degree increments. Priced at \$60 a pair in small quantities, you can receive more information by circling Reader Service 8.

With the thunderstorm season approaching, your thoughts may turn to AC

surge suppression. Northern Technologies in Spokane, Wash., displayed a full line of surge suppression systems. Its products are two-stage protection devices consisting of silicon avalanche diodes as the primary suppressors, backed up with standard MOV devices.

Unlike MOVs, which can degrade under stress, the avalanche diodes provide tighter clamping action than the MOVs, as well as

being faster reacting. The power protection devices are modular, which means simple repair in the field.

In addition to the full range of transient control systems, Northern Technologies also displayed some unique protection boxes. Each uses the silicon avalanche diodes. These boxes have input and output jacks to permit telephone protection (RJ-11 or RJ-45), coaxial line protection (using either F, N or BNC connectors) and even data circuit protection (using a 25-pin DB connector). For more information on the power protection products from Northern

Technologies, circle Reader Service 133. ***

What's new in the world of SONEX? Try ceiling tiles. Forget stuffing insulation atop your studio to deaden sound. Instead, try the two-inch-thick ceiling panels. The panels will fit in existing ceiling grids, are Class 1 fire rated, and permit track lighting to be mounted in the supporting grid. For more information on Sonex products, circle Reader Service 85.

If you do a lot of remotes, you may want to invest in a set of Armadillo Cable Pro- (continued on page 28)

PURE DIGITAL.



Bottom Line Orientation.

Creating a "sound" that attracts and holds the largest possible audience is the bottom line in the radio business. And the new OPTIMOD-FM Digital 8200 is a technological breakthrough with bottom line impact.

Digital Makes the Best Even Better.

The power of digital propels the 8200 to new levels of performance and functionality. OPTIMOD-FM 8200 is a *true* digital audio processor—the audio is digitized and all control functions are digital.

What is the value of digital processing and control? In addition to a better sound, digital makes the OPTIMOD-FM more user-friendly, more programmable, more flexible. Simply put, because the OPTIMOD-FM is easier to adapt to a station's programming needs, it will produce more benefit, more of the time.

The Processor with Multiple Personalities.

With most conventional processors, multiple processing configurations require multiple boxes. With the 8200's Multiple Variable Processing (MVP) architecture, processing configurations can be

changed with the push of a button—select the protection MVP for total transparency, or the two-band MVP for an improved version of the traditional open, bright and natural OPTIMOD-FM sound which helped make thousands of stations successful. Choose the optional multi-band MVP and meet the challenge of competitive major-market processing with selectable speeds to match any format.

Power. Potential. Profitability.

Take advantage of the power, potential and profitability of the OPTIMOD-FM 8200. Call your dealer now for a personal, hands-on evaluation of the 8200.

The OPTIMOD-FM 8200 is a technological breakthrough with bottom line impact. The power of OPTIMOD— in pure digital.



A Division of AKG Acoustics, Inc.
1525 Alvarado Street
San Leandro, CA 94577 USA
Tel: (415) 351-3500
Fax: (415) 351-0500

© 1991 AKG Acoustics, Inc.
Orban and Optimod are registered trademarks of AKG Acoustics, Inc.
AKG is a registered trademark of Akustische U. Kino-Geräte Ges.m.b.H. Austria.

NEW NEW NEW

SERIES CONSOLES

S - \$6,499 /18 CHANNELS - \$8,893



224-2248

FEATURES

- Totally Modular Console-Input modules, Output modules, Option modules
 - Ease of Service
 - Ease of Installation
 - Ease of Expansion
- Three Mainframe Sizes-8 channels, 18 channels, 28 channels
 - Full Metering
 - Timer on All models
 - Talkback to "2" studios
- Ultrahigh Quality Construction and design
 - Penny and Giles 3000 Series slide faders
 - VCA's
 - ITT Schadow switches
 - Gold connectors-IC's socketed-regulated power supply
- 3 Stereo Output Buses
- 2 Internal Mix-minus Buses for 'Telephone'
- Option Modules-D.A.'s, Mono Mixes, Remote Selectors, Etc.
- Comprehensive Logic system
 - Start and stop sources by isolated internal reed relays
 - Remote channel On and Off control with Tally lamps for turrets
 - Flashing OFF switches for cart machine status
 - Three muting buses for Control room and two studios
 - Timer reset selectable on each module
 - Monitor DIM function during cue and talkback



arrakis
SYSTEMS, INC.

**NEW
NEW
NEW
NEW
NEW**

NEW NEW NEW

USERS. COMMENTS.

Ingenious, Affordable, Well Documented, High in Value,
Totally Satisfying -- RS-Series consoles.

Quality of board versus cost is phenomenal.

JEFFREY L. FLYNT, C.E.
WSGY, Tifton GA

A breeze to set up! After years of working w/terminal blocks and molex plugs this was a pleasure - We had it on the air the day after it arrived.

BOB BURNHAM, C.E.
WHBT, Jackson MI

Very pleased! Very adaptable. Ingenious design.

JOE TALBOT, C.E.
KXXZ, Barstow CA

THE AFTER SALE TECHNICAL SUPPORT AND INFO ARE THE MAJOR REASONS FOR OUR PURCHASING A SECOND UNIT. I HAVE WORKED WITH MORE EXPENSIVE CONSOLES BUT HAVE NEVER SEEN A BETTER VALUE / COST SYSTEM. MANUALS ARE GREAT AND LAYOUT IS EXCELLENT.

ED CORN, C.E.
George Mason University, Fairfax VA

This console is one of the Best(!) Investments I've made. I WAS IN THE MARKET FOR A NEW CONSOLE FOR TWO YEARS, AND Found your console to be the BEST for PRICE - QUALITY AND flexibility. I am very happy with my purchase. THANKS

MICHAEL BALTOUMAS, President
Michael B. Productions, Lowell MA

** WE SAVED OVER FOUR HUNDRED DOLLARS BY PURCHASING THIS PRODUCT OVER ANOTHER, AND GOT A BETTER BOARD!!
* RADIO SYSTEMS STAFF IS TOP NOTCH!*

BILL GEORGE, G.M.
WXIN, Providence RI

I think I appreciate the tech manuals more than anything else - You can learn to live with any inconvenient design plan but proper, complete information is very important.

MICHAEL MALLORY, Contract Engineer
WBKI, Breaman GA

This is a great console. Probably the best console for the money currently available. Our air persons find it easy to use and have no complaints. I'm only sorry that I didn't buy the 18 channel unit.

JOHN J. DAVIS, President
KROR, Sierra Madre CA

I LOVE IT!
RICHARD LONG, Asst. Professor of Broadcasting
Northwestern College, St Paul MN



RADIO SYSTEMS INC.
Manufacturers of Professional Broadcast Equipment

110 High Hill Road • P.O. Box 458 • Bridgeport, NJ 08014-0458 • 609/467-8000 • 800/523-2133 • FAX 609/467-3044

How to Select the Right Mic

by John "Q" Shepler

ROCKFORD, Ill. Great sound complements great programming. An important part of that great audio is the bright, clear voices that mix with the music and effects to produce a compelling air sound. Those bright, clear voices start with a bright, clear microphone.

Microphones have personalities just like people. Some mics are crisp, nearly abrasive. Others are mellow to the point of monotony. You need to pick a mic that complements the air sound you want to achieve, not necessarily the favorite of each announcer.

Why pick a common mic for everybody rather than let them choose their own from a menu? Consistency. Having a dozen different mics gives you the same consistency problems as sequencing between CDs and old 45s. You need predictably good tonal balance on every announcer and every commercial. If the tonal variation between announcers is driving you crazy, you should correct that with consistent mic techniques and perhaps a touch of processing.

Which to pick?

It's hard to go wrong with a well-made unidirectional dynamic. These are the mics of choice for most studio work because they go for years without changing characteristics, don't need batteries or DC power—and they have the right connec-

tors and signal levels to drive any board, mic processor or recorder. They help reduce feedback and hollow studio reverbs and produce a natural sound.

Q-TIPS

Dynamics are built like loudspeakers in reverse. A very thin diaphragm moves a coil through a magnetic field. Most of the sound characteristics are determined by the design of the case, with tubes and ports to feed audio to the diaphragm. The major classes of design are directional and non-directional, which mean just what they say. The non-directional mics have smoother frequency response, but they pick up everything in the room.

The directional mics also are called cardioids because the pick-up pattern looks a little like a heart. There are two types of directional designs: single D and variable D. The D has to do with the acoustical design of the mic and affects the response of the mic when you are talking closely. A single D mic sounds bassier when you are up close.

Overdo the effect

Some announcers like the extra bass, but they overdo the effect trying to sound big-time. They wind up with heavy, muddy vocals. The variable D mics don't

change characteristics so dramatically as you move closer and farther away.

Plan to spend a couple hundred up to five hundred dollars per mic. This is going to become a big outlay because you'll need the same mic for every studio and your remote pickup van. That's right, you have to purge the station of every other mic or they'll destroy your consistency.

Since this is a major purchase, take your time. My advice is to get a variety of mics on loan and have on-air runoffs. Try a crisp mic like the Sennheiser MD-421, something more mellow like the Shure SM-7, a general performer like the SM57,

a clear sound like the ElectroVoice RE20 and perhaps a Neumann condenser, just so you know how cruel flat response can be to most announcers. AKG, beyerdynamic and Sony also make fine lines of professional mics.

With each mic, you'll get a frequency response chart. A popular sounding responderises a bit at the higher frequencies to give a crisp sound. As you compare mics, try to correlate the sound of each mic against the response curves. This gives you an idea of what characteristics produce the desired effect.

Five hundred dollar mics are wasted on announcers who work with the mic pointed at the top of their heads as they read copy on the table. Any mic sounds best when there is a straight line of six inches to a couple of feet between the front

(continued on page 28)



Right now, this person is running the hottest station in town.

With the Digital Commercial System (DCS) from Computer Concepts, 100% walkaway is a money-saving reality. You can program a day, weekend or weeks of commercials, jingles, promos, PSAs and local color liners with perfect integration into your satellite format.

Your listeners will hear a tight, seamless, great-sounding broadcast that attracts audience, builds ratings. DCS puts at your fingertips CD-sound quality, precise digital recording,

retrieval and queuing with overlapping program capability to commercials and other locally generated inserts. You avoid dead air, any sound differential between programs and breaks and the "canned" presentation that's sometimes associated with satellite broadcasts.

If all this sounds good to you, contact us. Write or FAX for a list of our DCS customer stations and a copy of our FREE demo disk which shows all the things DCS can do.

FREE DEMO DISK!

Computer Concepts CORPORATION

8375 Melrose Drive, Lenexa, KS 66214 FAX: 913-541-0169

Represented in Australasia by Techtel Pty. Ltd. and in Europe by Audio & Design Ltd.

Circle 9 On Reader Service Card

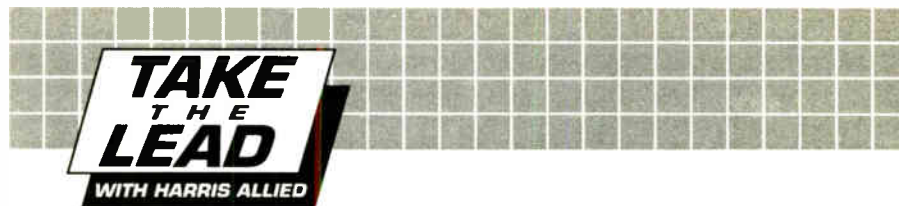

Supreme Satellite Subcarrier...



Model 450 Dual FM Subcarrier

The Tectan 450 is a frequency agile, synthesized FM subcarrier designed specifically for narrow band multi-channel applications. Each unit (1 rack unit high) contains two completely independent transmitters or receivers for stereo applications over terrestrial microwave, satellite or analog fiberoptic facilities.

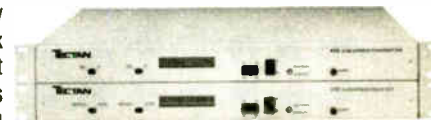

Model 454 Multifunction Subcarrier Transmitter/Receiver

The Tectan 454 is a frequency agile, synthesized FM subcarrier designed for satellite audio reception with ultra low distortion. Both channels are digitally synthesized and frequency agile from 1 MHz to 9.99 MHz.



Model 455 Composite Subcarrier System

The Tectan 455 composite subcarrier system is engineered to provide a transparent path for the complete MIS/BISC composite signal over any video microwave system.



Now more than ever, no one gives you more choices in satellite equipment — or more help making the *right* choices — than Harris Allied. More people; expanded resources: That's what we mean by taking the lead.

HARRIS ALLIED
SATELLITE EQUIPMENT

FAX 317-962-8961

317-962-8596

IN CANADA 800-268-6817

With expanded staff and services... our lead keeps on growing!

HARRIS ALLIED ©1991

"Call me, I'm interested." Circle 53.

"Send me literature." Circle 75.

Digging for Gold at NAB

(continued from page 23)

tectors. These molded polyurethane shields are designed to protect your cables, as well as your audience. Wire channel size ranges from 7/8-inch to three inches. For more information, contact Armadillo, a Draper Co., by circling **Reader Service 141**.

While we're on the subject of neat cables, do you remember those little woven tubes you played with as a kid, called "Chinese Handcuffs"? Tekflex has expanded the idea to serve as a wire harness. The woven monofilament sleeves expand to slip over connector ends, then pull tight to form a protective yet flexible sleeve.

Of particular interest at Tekflex was a new product—Flexo-Wrap. This is the same sleeving material but with a velcro closure. The velcro can be easily opened to add or subtract wires. In an equipment rack, the Flexo-Wrap can easily organize cabling chaos, yet permit quick removal of wires by simply unzipping the velcro. For more information on the Tekflex cable harnessing sleeves, circle **Reader Service 73**.

★★★

Benchmark displayed some slick interface products. Priced at less than \$60, these products consist of an amplifier board mounted on an XLR connector. Differential input amplifiers, differential output amplifiers and even a differential output

mixer that allows a zero loss mono sum without compromising crosstalk were shown. The specs are great and the compact size makes installation simple. For more information, circle **Reader Service 40**.

Can an XLR be improved? Switchcraft thinks so and displayed its "advanced" version of the A3M and A3F XLR connectors. The advanced connector uses one screw instead of three and the solder cups

have been repositioned for easier access. Both the industry standard "A" series and the new "AA" advanced series will be offered by Switchcraft and its distributors. For more information on the Switchcraft connectors, circle **Reader Service 2**.

◆◆◆

John Bisset, a principal with Multiphase Consulting, a contract engineering company, can be reached at 703-379-1665.

Selecting the Right Mic

(continued from page 27)

of the mic and your mouth. Directional mics lose both dynamic range and frequency response when you don't speak directly into them.

Varying microphone techniques causes more inconsistency at most stations than differences among mics. Watch your announcers and keep after them to use the mics properly. Sometimes people just don't like the straight-on sound of the mic through their headphones. Everyone's voice sounds much richer to their own ear than through a microphone. You can help this situation by putting an equalizer in the headphone feed so the announcers can make the mic sound more like "themselves."

Pop filters

Pop filters are a useful accessory. Yes, you can save \$15 or \$20 by making your own out of sponges, but they don't sound the same. Acoustical foam is much more transparent to audio frequencies. Spend the money and buy a few extras. Some announcers like to

have their own personal windscreen.

Mic processing in the form of compression and some equalization helps to stabilize levels, provides power to punch through the music and generally makes everyone sound more consistent. For most stations, a pre-set processor makes each mic a "power mic."

An advanced step is to provide individual adjustments for each announcer. If you have the commitment to do this right, you can improve the sound of every announcer by picking the right EQ and compression that complement the individual voice. Start in the production studio with raw voice tapes and find the settings that make everyone sound good, but also sound like they are working through the same mic without enhancement. Your goal is to add clarity and fix tonal problems, without adding an obvious mechanical sound. Go light on the adjustments.

◆◆◆

John Shepler is an engineering manager, broadcast consultant, writer and longtime RW columnist. He can be reached at 815-654-0145.

Take a turn for the better!



Studio-Pro 2 Speed Deluxe

Buy a RUSSCO Pro Turntable and you'll probably never need another.

The smart buyer knows dependability pays off. Russco all metal turntables just keep running while the Japanese brands are in the shop! The simple, smooth operation and quick starts make them a joy to use. These heavy-duty workhorses are the industry standard.



DA2816 Distribution Amp

16 Channels of Versatile Distribution!

Use the RUSSCO 2816 for stereo or 2 mono sources. A total of 16 adjustable channels feed from 2 balanced outputs. It guards against accidental feeds and gives you an honest 16dBm on a 600 Ohm line. Just what you need!

Match up a CD player CHEAP!

Save money with RUSSCO's CD100 impedance matching amplifier that interfaces inexpensive CD & cassette players to your console. Your Best Buy at only \$79.

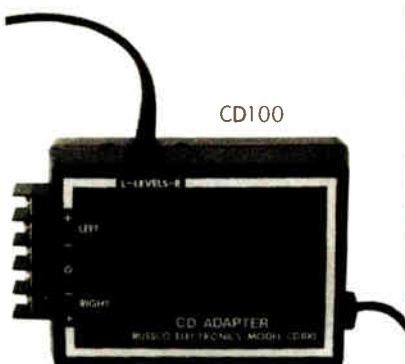

● Call us for our Catalog at (209) 291-5591

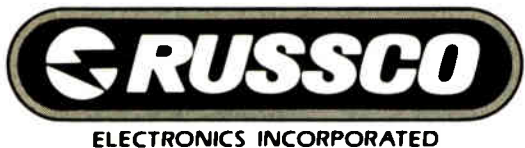

ELECTRONICS INCORPORATED

5690 E. Shields Ave., Fresno, CA 93727 • FAX (209) 291-9601

MIXERS • AMPLIFIERS • PREAMPS • TONE ARMS
AND A WHOLE LOT MORE!

Circle 10 On Reader Service Card

MAKE YOUR JINGLES

JINGLE AND YOUR SPOTS SPARKLE

at

Omega Studios' School of Applied Recording Arts and Sciences

**Comprehensive Certificate Programs in
Audio Recording Techniques, Electronic Music/MIDI
and Music Business**

Learn console and tape machine operation, digital editing, signal processors, voice-over production, microphone techniques, mixing and more at one of the East Coast's largest 4-studio music recording facilities.

Call (301) 230-9100 for a **FREE** Brochure.

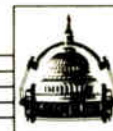

RECORDING STUDIOS

5609 Fishers Lane, Rockville, Maryland 20852

The Omega Studios' School is Approved by the Maryland Higher Education Commission and is Approved for Veterans' Training.

Circle 62 On Reader Service Card

CD: A Format Reborn

by Mel Lambert

STUDIO CITY, Calif. For stations that have made a major commitment to compact disc playback, the new generation of recordable CD units may be just what the doctor ordered.

CDs have suffered from one major drawback: A station couldn't record its own jingles, IDs, commercials and other non-music items. Sure, there were (and still are) CD manufacturing plants that handle small runs, but because of high mastering costs and other factors, the use of such a service for limited runs of less than several hundred CDs is hardly cost effective.

Against this background, the recent introduction of recordable CD decks is going to open up a great deal of opportunities for radio stations. Several firms now are offering units that will record analog/digital audio onto special media that can be played back on any conventional CD player.

Definitions

By way of background, some definitions might be in order. After a great deal of deliberation, several years ago Sony and Philips—co-developers of the CD format—released various documents that defined the physical and electrical characteristics of the "standardized" compact disc medium, and the features and functions that CD players would offer. This

document, referred to as "The Red Book," has been supplemented in recent years with "The Orange Book."

Recordable CDs are coated in a special photosensitive dye whose reflectivity is

DIGITAL DOMAIN

permanently modified by a recording laser beam of a higher intensity than the normal reading beam. (The recording beam also functions at a different wavelength of light, but that's neither here nor there.)

This action forms "bumps" on the dye surface of the recordable media, which can be read by conventional, Red Book-standard CD players. The media often is referred to as "WORM," or write-once/read-many, which succinctly describes what happens within the CD-R unit.

It should be remembered, however, that traditional CDs also contain information above and beyond the 70 odd minutes of 16-bit stereo audio. Additional data tells the CD player how many cuts are recorded onto the CD, where each track begins and ends, plus other timing and indexing information. On a conventional CD, this data is laid onto the inner section of the CD, and is supplied to the manufacturing

(continued on page 33)

RECORD YOUR OWN CD?

YES!



D740 CD Recorder

Produce custom CDs in your own facility for jingles, demos, sound effects, commercials, music libraries, studio refs, archiving, and mastering. The D740 is the first fully integrated "one box" CD Recorder. Orders now accepted.

A727 Professional CD Player - \$1,995*

This versatile and reliable On-Air model provides very quick access times, autocue, synchronized clock, comprehensive remote functions and superb audio quality for broadcasting and studio applications.

A730 Professional CD Player - \$2,995*

The top-of-the-line A730 is fully loaded with the most powerful features available in the pro audio market including cue wheel for frame-accurate cueing, cue memory, automatic recognition of up to 100 CDs, built-in monitor speaker and separate monitor output—all this and more at an excellent price/performance ratio.

A728/A729 CD System Controllers

Control multiple CD Players from any location! Convenient, fast and versatile the A728/A729 controllers can handle complicated tasks for creative program design, On-Air operation and spot production.

For friendly sales information or to order, call toll free 800-776-3833.

STUDER

Studer Revox America, Inc. • 1425 Elm Hill Pike • Nashville, TN 37210 • Tel: 615/254-5651 Fax: 615/256-7619
New York 212/255-4462 • Los Angeles 818/780-4234 • Studer Revox Canada Ltd., Toronto 416/510-1347

*U.S. List Price

© 1991 Studer Revox America, Inc.

There's a lot of life left in your old PR&E console. Let us remanufacture it to look like new.

PR&E

consoles are built to last for decades of "normal use". But if one of yours has suffered "beyond-normal" abuse over the years, why not send it back to the factory for remanufacturing? We'll rebuild it to look, sound and function like new—and we'll back it with a new console warranty! It's the next best thing to a brand new PR&E console, and the cost is very reasonable. In fact, when replacing an old PR&E console with a new one, many stations have us remanufacture their old unit for installation elsewhere in the facility, or the group. (It's like getting two PR&E consoles for little more than the price of one!) Another reason why Pacific Recorders consoles are your best buy for the long run. For more information, call us direct at 619-438-3911.



Pacific Recorders & Engineering Corporation
2070 Las Palmas Drive Carlsbad, CA 92009
Tel 619-438-3911 • Fax 619-438-9277
© Pacific Recorders & Engineering Corp 1991

Circle 50 On Reader Service Card

World Radio History

Circle 77 On Reader Service Card

Keeping on Top of Paperwork

by Barry Mishkind

TUCSON, Ariz. Paperwork. The milk of bureaucracy. Just the mention of it brings heavy sighs from the broadcast engineer. Lots of trees have given their lives to keep the paperwork mill going.

True, we no longer have to log the transmitter readings within *two minutes of every half hour*. In fact, other than the tower light and EBS monitoring, daily logs are more a reflection of a station's needs than the FCC requirements.

Maintenance logs also have changed over the years. The range and detail of the recorded data vary widely from station to station.

Which leads us to documentation. Some stations keep quite complete records of every license, wire and connection, with equipment manuals and maintenance history on hand for all items. Again, other stations know there is a cart machine *some-where* in the building.

On hand at most stations is a copy of the FCC Rules and Regulations. Whether acquired from the Government Printing Office or one of the commercial suppliers, the Rules are essential for knowing whether the station is operating legally.

Still, there is one more part of a station's paperwork pile that is quite often neglected. This is the instruction manual for the operators.

Every station is required to have a training program for its restricted permit oper-

ators, as well as step-by-step instructions for the operation of the transmitter.

However, sometimes all you'll find is a sheet posted by the remote control unit with rather simple instructions: "1. To go on the air, press the on button; 2. To turn transmitter off, press the off button."

CONTRACT ENGINEER

While this may suffice in some circumstances, we all know that, according to Murphy's Law: "If something can go wrong, it will—at the most inconvenient time possible."

Hence, most of the engineering community has received the dreaded 3 a.m. phone call from the new disk jockey at one time or another. This is the phone call that starts out, "We're off the air, now what do I do?"

My favorite variation is when there is a power failure. After the DJ finds a flashlight, he calls to say he's off the air and can't see anything. Invariably, asking the DJ if he had called the power company gets the response that he hadn't thought of it.

The most obnoxious type of call is the "one of our cart machines isn't working" kind. Usually made by the part-timer hired at the last minute by the PD, the caller rarely does it a second time after being educated by a drowsy but rather angry engineer.

Now, before going on, it's important for you to know that my manuals always included complete step-by-step instructions on what to do in such cases.

Over the years I've tried to keep track of all the things that can go wrong and how to best attack the problem. We defined what was an emergency, what was not, and how to handle each. My goal was to minimize downtime.

I found this is where a well thought out manual and training program can really pay off.

For example, by having the DJ call the power company first, we often saved a lot of time in getting a repair truck dispatched. With the appropriate phone numbers in the control room, the operator could get help rolling fast, and then call me.

By using clear instructions and flowcharts to pinpoint the problem, we not only saved time in getting back on the air, but often were able to direct the operator to the solution without having to call and wake me at all.

It's easy to see how important it is to keep such information up to date, with current dispatcher numbers for the utilities. If equipment changes in the control room, instructions usually require updating.

There have been times where DJs have damaged equipment by using old instructions to handle problems with new gear. But, perhaps the most annoying result of not keeping the list up to date is the 3 a.m. call received by the station's

previous engineer.

I recently got such a call. And, yes, it was really 3 a.m. when I heard the voice say, "We're off the air. What should I do?"

Mumbling with the caller, I discovered he was from a station I had left more than two years earlier. The current CE had never bothered to update the operator's manual. It really took restraint to keep from instructing the operator how to disconnect the remote control wiring.

So, if you've not done so recently, take the time to carefully check out your station's paperwork from top to bottom, including the operator instructions. You'll have trouble calls handled more quickly and efficiently. You'll also avoid unnecessarily antagonizing your predecessor.

And why not encourage the local engineering community to do so, too? If everyone does it, it could even prevent your getting the dreaded 3 a.m. false alarm.

■ ■ ■

Barry Mishkind is a consultant and contract engineer in Tucson. He can be reached at 602-296-3797; FidoNet 1:300/11; or on MCI Mail #325-9883.

BBS Update

Ray Vaughan has started a national SBE conference with emphasis on technical matters. The home board for this conference is Telcom Central, 305-828-7909. It also is being picked up and carried on a number of other BBSs, including NSN at 303-949-3253, Dallas SBE at 214-647-0670 and The Lighthouse at 517-321-0788.

EXPERIENCE COUNTS . . .

Continental Electronics Installations At Master Antenna Facilities.

LOXLEY TOWER SITE Mobile, Alabama 3 OF 3 STATIONS

WBLX 27.5 kW
WGCX 27.5 kW
WJLQ 27.5 kW

TELETOWER PROJECT Houston, Texas 2 OF 2 STATIONS

KLTR 27.5 kW / 21.5 kW (Aux)
KMJQ 50 kW

BRODIE LANE TOWER SITE Austin, Texas 2 OF 2 STATIONS

KHFI 35 kW
KPEZ 21.5 kW

SUMMIT TOWER PROJECT Atlanta, Georgia 2 OF 3 STATIONS / 4 OF 5 TRANSMITTERS

WSTR 35 kW (2)
WVEE 40 kW

LOADSTAR TOWER PROJECT Ft. Lauderdale, Florida 2 OF 2 STATIONS

WJQY 40 kW
WKQS 50 kW

LOADSTAR TOWER PROJECT New Orleans, Louisiana 4 OF 4 STATIONS

WEZB 35 kW
WLNG 35 kW
WMXZ 35 kW
WQUE 35 kW

GANNETT TOWER PROJECT Miami, Florida 8 OF 10 STATIONS

WEDR 50 kW
WHQT 25 kW
WLVE 25 kW (2)
WPOW 25 kW
WQBA 21.5 kW
WSHE 25 kW
WTMI 25 kW (2)
WZTA 25 kW (2)

MILLER TOWER SITE Dallas, Texas 6 OF 6 STATIONS

KKDA 40 kW
KLTY 40 kW
KLUV 40 kW
KOAI 45 kW
KZPS 40 kW
WRR 40 kW

LOADSTAR TOWER PROJECT Orlando, Florida 3 OF 3 STATIONS

WJHM 25 kW
WJYO 55 kW
WOCL 55 kW

LOADSTAR TOWER PROJECT Jacksonville, Florida 3 OF 4 STATIONS

WAIV 40 kW
WFYV 27.5 kW
WQIK 35 kW

OLDSMAR TOWER PROJECT Tampa, Florida 2 OF 2 STATIONS

WKRL 40 kW
WUSA 40 kW

SHOREVIEW TOWER PROJECT Minneapolis, Minnesota 6 OF 8 STATIONS

KDWB 25 kW
KEEY 25 kW
KLXK 25 kW
KQRS 25 kW
WLLO 25 kW
WLTE 25 kW (2)

SENIOR ROADS TOWER GROUP Houston, Texas 7 OF 12 TRANSMITTERS

KFMK 27.5 kW (2)
KIKK 27.5 kW (2)
KKBQ 27.5 kW
KLLO 27.5 kW

MONTGOMERY TOWER PARTNERS Montgomery, Alabama 4 OF 4 STATIONS

WBAM 35 kW
WHHY 35 kW
WLWI 35 kW
WSYA 35 kW

BITLOW TOWER PROJECT Orlando, Florida 3 OF 3 STATIONS

WHTQ 50 kW
WSSP 50 kW
WSTF 50 kW

WEST TIGER MOUNTAIN TOWER SITE Seattle, Washington 6 OF 9 TRANSMITTERS

KBSG 50 kW
KMPS 50 kW
KRPM 50 kW

When experience counts you can count on Continental transmitters.

This track record reflects the quality of Continental transmitters and our commitment to the broadcaster.

May we assist you in planning your new facility around a new Continental transmitter?



Continental Electronics Corporation

P.O. BOX 270879 DALLAS, TEXAS 75227-0879 214-381-7161 TELEX: 73-398 FAX: 214-381-4949

You Get What You Pay For...



Sennheiser MD421U

Only **\$319.00**



...And What You Don't Pay For!

Sennheiser HD450

FREE! with purchase of MD421U

BSW and Sennheiser are offering you a deal that's hard to beat. Buy the popular Sennheiser MD421U for the special price of only \$319.00 and receive a pair of equally popular HD450 headphones absolutely FREE. That means you save \$249.00 off of the combined list price of these items.

Offer is good for limited time only so call today to order yours.

BSW

BROADCAST SUPPLY WEST

America's Full-Time Broadcast Supplier

Call Toll Free 800-426-8434 Or Fax 206-565-8114

Circle 48 On Reader Service Card

World Radio History

QEI QEI QEI QEI QEI QEI QEI QEI QEI QEI

Bring your station into the 90's with CAT-LINK—the digital STL/TSL.

"It's a dream system—we get specs like the microwave wasn't even there. CAT-LINK has completely eliminated the STL delay."

Jeff Andrew, WGCI-FM, Chicago

"CAT-LINK solved all our problems in 4 minutes—2 minutes to install each end. Performance has been impeccable."

Paul Christensen, WIVY-FM, Jacksonville, FL

"CAT-LINK makes money for us, and it improves the sound of the station."

Mike Callaghan, KIIS-FM, Los Angeles CA

"CAT-LINK has held up through extreme heat, a hostile RF environment and nasty summer lightning storms."

Dick Byrd, WZGC-FM, Atlanta GA

Two-way multi-channel communications

CAT-LINK digitizes the entire composite signal with no data compression, so you can run the stereo generator and processing at the studio, where they really belong. At the same time, CAT-LINK sends and receives up to four customized auxiliary channels with no crosstalk—SCAs, control channels, voice communications, RS232 data, AM audio, transmitter readings and satellite or remote program feeds. What's more, CAT-LINK gives you extra capabilities like transmitter building surveillance via closed circuit TV and an analog telemetry channel.

Transparent digital transmission

CAT-LINK encodes the fully processed composite signal, then decodes it at the transmitter. You always get full stereo separation, without the phase or amplitude variations that plague two-channel STLs. Dynamic range is up to 84 dB, and your processed composite signal can use virtually all of it. You hear clear, clean, undistorted audio—all the time.

No audible delays

CAT-LINK's real-time digital encode/decode process doesn't introduce audible delays as data compression can. Jocks can monitor on-air without problems.

Flexible signal path options

• 23 GHz

Stations across the country are avoiding 950 MHz problems by using 23 GHz with CAT-LINK. They've stopped worrying about frequency congestion and interference, repeater-induced signal degradation, and fresnel zone clearance fading. 23 GHz dish sizes also reduce wind loading and tower space requirements.

• DS1 (T1) Data Line

CAT-LINK is cutting phone bills for stations that don't have a clear microwave path. With CAT-LINK, a single bidirectional DS1 line replaces multiple Class A telco lines, providing multi-channel STL and TSL over the same link. Already available virtually anywhere, DS1 service is getting cheaper every day.

• Fiber Optic

CAT-LINK and its optional fiber optic modem provide direct connection to discrete fiber.

• Twisted Pair

CAT-LINK will drive up to 5000 feet of twisted pair wire without repeaters. Four wires provide full two-way multi-channel capabilities.

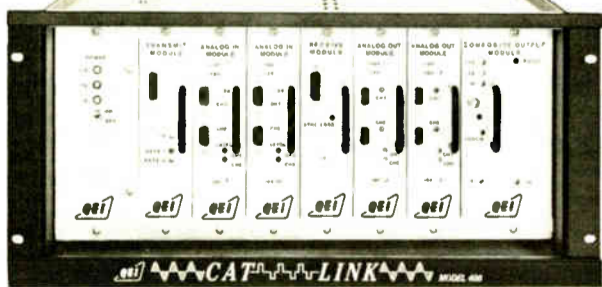

Turn the weak link in your signal chain into one of the strongest.

Call QEI toll-free at 800-334-9154 for more information on CAT-LINK—the digital STL/TSL for the 90's...and beyond.

QEI CORPORATION
ONE AIRPORT DRIVE • P.O. BOX 805 • WILLIAMSTOWN, N.J. 08094

24 HOUR SERVICE HOTLINE (609) 728-2020
TEL (800) 334-9154 • FAX (609) 629-1751

QUALITY • **E**NGINEERING • **I**NNOVATION

Circle 18 On Reader Service Card

A History of Licensing And Rule Compliance

by Harold Hallikainen

SAN LUIS OBISPO, Calif. The May 8 issue of RW contained an article describing the FCC's current efforts at establishing a "compliance baseline" for all FCC-regulated services.

I spoke with Jeff Young of the FCC Field Operations Bureau. Along with complaint-initiated inspections, the Commission is conducting random inspections to determine the general level of compliance. Complaint-initiated inspections may tend to have a higher frequency of violations as compared to the overall "population."

An increase in technical violations could be attributed to several changes over the past several years. These include a reduction in operator license requirements, a reduction in logging requirements, a reduction in frequency of station inspections (the FCC is now doing about 300 broadcast station inspections per year, so expect one in the next 30 years), an influx of station licensees new to broadcasting and the current economics of broadcasting (especially AM).

From World War II until 1979, FCC thoughts on operator licensing have varied. Prior to the war, a First Phone license was required to operate a broadcast transmitter. During the war, there was a shortage of First Phones, so, with certain restrictions, the FCC authorized holders of Restricted Permits (RP) to operate broadcast transmitters of 100 W or less. After the war, the First Phone was again required.

By 1953, the FCC authorized RP holders to operate non-directional AM stations of 10 kW or less. Such stations were required to have one or more First Phones to supervise the operation.

By 1963, the FCC found an excessive number of violations at broadcast stations. Apparently, the First Phones that were required to supervise the RP holders were not doing a sufficient job. The FCC estab-

lished the broadcast-endorsed Third. The broadcast-endorsed Third authorized operation of nondirectional AMs to 10 kW and FMs to 25 kW.

Stations using endorsed Thirds were required to have a First Phone to supervise the operation. The FCC "took back" some of the responsibility for determining the qualifications of an operator by establishing the exam for this license.

INSIGHT ON RULES

In 1968, the FCC gave the First Phone responsibility for the technical operation of a station, to certify to the FCC that the operator was properly trained. The FCC would issue a Provisional certificate for the endorsed Third.

The Provisional was good for one year, during which it was expected the operator would travel to the FCC field office and take the endorsed Third exam.

In 1972, the FCC authorized endorsed Thirds to operate all radio stations except critical arrays, if the station had a First Phone employed (or under contract for non-directional stations 10 kW or under and FM stations under 25 kW). The chief operator was to review the station logs daily.

In 1976, the FCC released a Notice of Inquiry regarding operator licensing. It considered several questions.

Should the "service operator" requirements be maintained? Was the FCC written test a valid test of competency in servicing transmitting equipment? Could the FCC issue a valid test (perhaps including a hands-on demonstration of technical competence)?

The FCC generally has held the station licensee responsible. If the FCC required a chief operator to be responsible for the training of routine duty operators, was the FCC exam for the broadcast-endorsed Third redundant?

What about "memorization schools?" Should the FCC issue a "learner's permit" to those who had passed a written exam but did not have hands-on experience? This would be similar to the experience requirement on the First Class Radiotelegraph license. The FCC received more than 500 responses to the Notice of Inquiry.

In 1977, the FCC contracted with the Georgia Institute of Technology to study broadcast service regulation. Based on the resulting report and the responses from the Notice of Inquiry, the FCC authorized, in 1977, the operation of all broadcast transmitters by RP holders. High power or DA stations using RP operators were required to designate a chief operator (who still needed a First Phone).

In 1980, the FCC found it still was issuing 53,000 Third Class licenses each year, yet only 2 percent of those licenses were needed (typically for marine radio). So, they endorsed the Third Phone to prohibit broadcast operation.

Finally, in 1981, the FCC eliminated the requirement that a chief operator hold a First Phone (an RP was sufficient). The FCC left the determination of the qualifications of all operators to the

(continued on next page)

WIRELESS CABLE DATABASE

(ITFS - MDS - MMDS - OFS
A1 Thru H3 Plus 1, 2 & 2A)

CURRENT
ALL 50 STATES
ON-LINE
24-HOUR ACCESS
CALL NOW!

dataworld
A Service of DW, Inc.

P.O. Box 30730, Bethesda, Maryland 20814

FAX (301) 656-5341

(301) 652-8822 (800) 368-5754

Circle 32 On Reader Service Card

A History of Radio Licensing

(continued from previous page)

station licensee. All stations were required to designate a chief operator, who was to help the station licensee ensure the station operated as expected.

I asked Jeff Young of the FCC whether the Commission would consider reinstating operator exams if it found a substantial increase in violations. He had not heard such a proposal and thought the operator licensing division would not be able to handle the workload.

It is still the responsibility of the station licensee and the chief operator to hire qualified transmitter operators. The FCC is not going to "prequalify" them for you.

With the increase in the number of stations and services (the FCC has been doing a lot of CATV inspections) and decreases in funds available, the FCC has substantially decreased the frequency of inspection at each station. The lack of inspection may tempt some stations to "temporarily" put off fixing problems.

Often these temporary problems are still there when the FCC inspects after 10 years. Random inspections, substan-

tial fines and publication of the details (not necessarily the names, but the circumstances) may encourage station licensees to pay more attention to the rule requirements.

Many new station licensees got into broadcasting as an investment and are not aware of the various FCC technical requirements. These licensees then have a difficult time hiring a qualified chief operator.

AM stations in particular are having a difficult time. Directional AM stations require close observation and continual maintenance to keep the operation within FCC requirements. Often, these stations—which may require the greatest maintenance expenditures—are the ones making the least money. Something gets set aside for later—until the FCC inspector shows up.

Some consultants offer "mock inspection" services. These can serve several purposes.

They, of course, catch the violations so you can fix them before the FCC finds them. Also, a mock inspection that gener-

ates a glowing report may impress your boss (and get you a raise?).

Finally, I'd like to thank Michael V. Chiarulli, manager of RF engineering and operations at Capital Cities/ABC for pointing out an error in my March 13 column.

The RF exposure limits are imposed on any six-minute window. If we are exposed to RF for one minute—that is, six times the

ANSI limit—there must be five minutes on each side of the exposure that are radiation free. I appreciate the feedback. Let's keep this a discussion instead of, "Harold says . . ."

■ ■ ■

Harold Hallikainen is president of Hallikainen & Friends, a manufacturer of transmitter control and telemetry systems. He also teaches electronics at Cuesta College, San Luis Obispo. He can be reached at 805-541-0200. He can also be reached on Internet at ap621@cleveland.freenet.edu or hhallika@pan.calpoly.edu

CDs: A Format Reborn

(continued from page 29)

plant in the form of PQ code tracks.

For CD-R, however, the situation becomes a shade more complicated (which explains why this separate Orange Book standard needed to be drawn up). While recording a series of commercials to CD-R, for example, you may not know how many 15-, 30-, 45- and 60-second cuts the CD may eventually hold, or you might even decide at a later date that some cuts should be blocked from use.

Table of contents

In these circumstances, a temporary Table of Contents (TOC) is built by the CD-R deck in a pre-defined (and reserved) section of the disc, and is updated or modified whenever a new track is recorded or a cut needs to be "erased." Because of this (and other reasons), the TOC for normal Orange Book CD-R discs is incompatible with Red Book-standard CD players.

CD-R decks therefore offer the function of converting an Orange-standard CD—that can normally only be replayed on a CD-R deck—into a normal Red-standard CD for use in the air studio. This process is one-time only—once the temporary TOC has been re-recorded as Red-Book format, in the correct location, then it cannot be removed nor modified.

In terms of the currently available hardware, they fall loosely into two main categories. The first units on the scene from Gotham Audio and Sonic Systems were based upon a workstation-plus-recorder format, with a PC/Mac controller handling the various timing information and PQ code preparation.

The newer generation of hardware is designed for stand-alone operation, and resembles little more than a conventional CD unit with additional push buttons for controlling the various record and directory functions. They all feature a choice of analog and digital inputs/outputs (AES/EBU and "SPDIF" via coaxial and often optical connectors), with full remote control.

Both the Denon DN-770R CD Cart Recorder and the Yamaha YPDR601 Profes-

sional Disc Recorder also will record "temporary" Orange Book discs that can be replayed on normal CD players, which means that partially filled CD-R media can be used until the time comes to add more material. (As soon as the disc is full, it can be modified with a new TOC to full Red Book standards.)

The YPDR601 can be set to Mode 1, which allows sequential recording and auditioning of material to Orange Book, and then a one-time conversion to Red Book; or Mode 2, which pre-formats the disc to hold either 10- or 30-second sound segments (soon to be augmented with 40- and 70-second divisions). It is this latter mode that allows a partially-recorded CD-R disc to be replayed on normal players, utilizing the temporary TOC files.

And last, the Studer D740 CD Recorder allows partially completed discs to be auditioned, and then converted permanently to Red Book Standards; intermediate discs cannot be used on traditional CD players, however.

As another component in the all-digital radio facility of the very near future, I'm convinced that CD-R decks can and will fulfill a very viable role within a variety of on-air and production-studio applications.

■ ■ ■

Mel Lambert has been intimately involved with the production and broadcast industries on both sides of the Atlantic for more than a dozen years. Now principal of Media&Marketing, a consulting service for the professional audio industry, he can be reached at 818-753-9510.

Oh-Oh!

Call
CORTANA

For Affordable Lightning Protection
505-325-5336

P.O. Box 2548, Farmington, N.M. 87499
FAX 505-326-2337

Circle 56 On Reader Service Card

THE BIGGEST PENNY PINCHER IN RADIO SINCE JACK BENNY.

Mr. Benny certainly knew a great bargain when he made one. And we think he'd appreciate the brilliance of the bargain-priced Tascam BR-20 Broadcast Production Recorder.

The BR-20 is built to do one thing—broadcast production—and to do it exceedingly well. It's a rugged, reliable 2-track with features that make every job easier and more efficient. Like independent reel-size selection. Splice block. Built-in monitor speaker. Independent L/R record for monitoring on one track while recording in sync on the other for overdubs and voiceovers. Fader start. And Quick Cue with Auto-Repeat.

The \$2,299* BR-20. It's got everything you need in a broadcast production recorder. Including a price even your station manager can live with.

Come see it today at your nearest Tascam dealer.

TASCAM®



© 1990 TEAC America, Inc., 7733 Telegraph Road
Montebello, CA 90640 213/726-0303.
*Manufacturer's Suggested Retail Price.

Circle 120 On Reader Service Card

Remote Offers Ski Resort a Lift

by Dee McVicker

BLOSSOM MOUNTAIN, Idaho In an ambitious remote, KVNI-AM's signal made the 42-mile commute from Silver Mountain to Blossom Mountain, Idaho, every day for a week. Engineer Jim Bjornstad and morning show host Dick Haugen also made the commute to Silver Mountain, which was an hour by car and another 20 minutes by ski gondola car.

Why? Because, as KVNI Operations Manager Steve Sibulsky explained, the new ski resort atop the 6,200-foot mountain needed advertising support. Once known for silver mining, but no longer

able to turn a profit due to plummeting silver prices, Silver Mountain had been redressed for recreational skiing in order to bring tourism to the county surrounding the town of Kellogg, Idaho.

KVNI-AM, located in nearby Coeur d'Alene, was just the station to broadcast the message. "What we target to do is to serve the people of Kootenai County," Sibulsky said.

Across the border

With the Spokane, Wash., metropolitan area just across the border, and some 17 of its stations "breathing down our neck," he added, KVNI-AM has to stay involved

in the community—and stay innovative.

In addition to the remote broadcasts regularly scheduled for town hall meetings and local high school games, it was decided that KVNI would do its most innovative remote broadcast yet—one that would take the station's morning show some 6,200 feet above sea level.

Even with such high expectations, however, there was initial doubt that the remote could be done: The stretch between the station's repeater on 4,400-foot Blossom Mountain and the resort on Silver Mountain was long, with an obtrusive mountain and more than 40 miles between them.

There also was the eight-mile stretch between Blossom Mountain and KVNI's studio—another leg of the journey that had to be factored in.

Bjornstad realized early on that the remote would probably require an antenna gain on the order of at least 10 dB to boost the station's 25 W remote transmission. The antennas typically used for KVNI remotes were not likely to make the hop; a 6 dB gain was the best Bjornstad could find.

In checking with two-way communication consultants, Bjornstad was told that a Phelps-Dodge corner reflector antenna might offer the gain—as well as the narrow beam—needed to make the 42-mile leap. Bringing in the antenna on loan, Bjornstad made the trip up to Silver Mountain to find out.

Bjornstad reported good news: The corner reflector's 12 dB gain gave the 450 MHz Marti transmitter ample boost for the signal to make the 42-mile hop between mountaintops. Kellogg Peak, the 6,000-foot

obtrusive mountain that had caused Bjornstad initial concern, was equally cooperative.

"Our signal virtually went right along that sidehill and we had a clean shot to our repeater site," Bjornstad said. On the cloudless day, the test signal was as clear as the winter sky.

OFFBEAT RADIO

With tests confirming good news, up the mountain went the station's morning show for a week-long remote that would air from six to nine o'clock in the morning during Kellogg's Winter Games festival. Also up the mountain went KVNI's trusted 450 MHz Marti, which works year-long in all of the station's remotes, as well as the corner reflector antenna and a wireless microphone.

The remote crew also packed in two mini studios. A portable editing setup, with mixer and cassette decks, was packed into Haugen's motel room in Kellogg, where he stayed during the week-long remote. Lifted onto the gondola car for the 20-minute ride up Silver Mountain was the other portable studio, comprised of two cassette decks, two CD players, a wireless microphone receiver and a small console.

This editing studio was kept in a closet at the ski resort during off hours, along with the Marti and the Phelps-Dodge antenna.

The first day of the remote, problems surfaced. A 10 kW daytime that drops power to 1 kW directional at night, KVNI-AM was scheduled to increase its power

(continued on page 36)

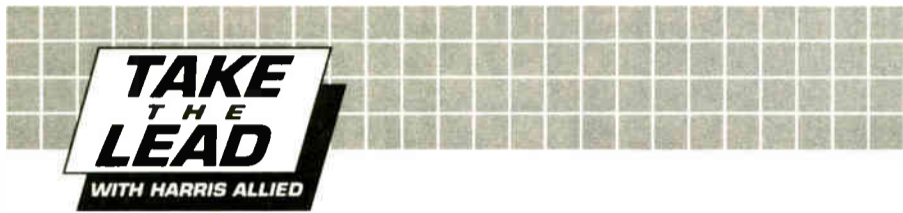

NEW WORLD STANDARD

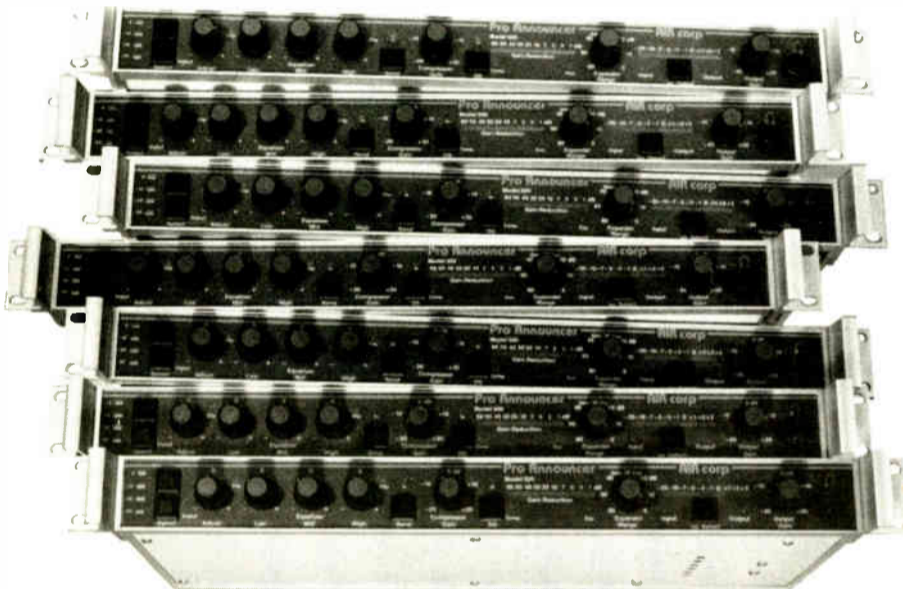

AirCorp 500 ProAnnouncer Mic Processor

WHY?

Similar products simply don't have the extra features AirCorp has taken the trouble to build into the 500.

Those special features are far too numerous to list here. But, if you'll call us at the number listed below, we'll tell you every one.

**AIRCORP 500
THE WORLD'S CLASS MIC PROCESSOR**

**HARRIS
ALLIED
BROADCAST EQUIPMENT**

FAX 317-962-8961

800-622-0022

IN CANADA 800-268-3817

With expanded staff and services... our lead keeps on growing!

HARRIS ALLIED ©1991

"Call me, I'm interested." Circle 39.

"Send me literature." Circle 61.

World Radio History

TECHNOLOGY MANAGEMENT FOR RADIO...

SESSIONS

- ★ DAB: Sound of the Future
- ★ New Technology for AM and FM Radio
- ★ Transitions to DAB
- ★ New Technical Regulations and Your Responsibilities
- ★ 23rd Directional Antenna Seminar
- ★ 4th Digital Radio Station Seminar
- ★ Gain Extra Income by Leasing Space on Your Tower
- ★ Plus—additional sessions on new technology



For information and to register, call the Radio 1991 toll-free hotline —

800-342-2460

National Association of
NAB
BROADCASTERS®

Fortunately for us, most radio engineers look before they leap.

You've always been an analytical bunch, so we're sure you know that our MX-55NM 2-track not only gives you the features you need, but that it's also priced several thousand dollars below its nearest competitor.

We know you're not about to overlook *major* features, like HX-Pro™ bias optimization, or gapless seamless punch-in punch-out, or that famous Otari sound. However, here's some fine points to examine as you do your "apples-to-apples" with our competitors.

For example, the MX-55NM incorporates a printed-circuit capstan motor (like that used on our MX-80 multitrack machine).

This not only gives you low wow and flutter right out of the chute, but very fast start times.

It's also worth noting that EQ selection and Reference Fluxivity values can

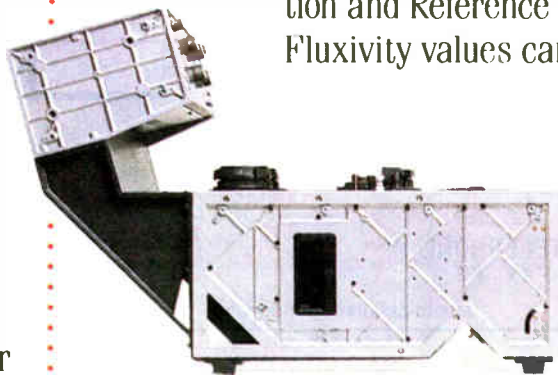

A 1.5" cast alloy deckplate, plus cast side frames give the MX-55NM the rigidity and ruggedness you've come to expect from Otari. (Do our competitors show you the inside of their machines?)

be changed with a flip of a switch. And as you put the deck



Three cue locations and a zero memory can be accessed via the MX-55NM's built-in locator.

through its paces, notice that the vari-speed control

provides 0.01% step resolution. This means you can make precise changes, and perhaps more importantly, you can repeat a change *exactly* when necessary.

For your convenience, an optional voice editing module maintains normal pitch at twice normal speed. And the meter-bridge keeps knobs and switches out of the way while you're editing.

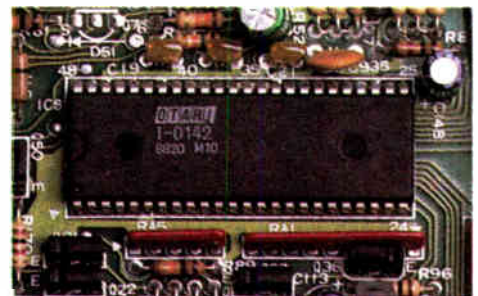

Because we know how hard you use our machines, we use a double-sided glass epoxy transport circuit board, and we silkscreen both sides of our PCBs so you can locate the components easily.

In the Otari tradition, we make the MX-55NM easy to service. Only four screws get you into the transport electronics. And when you get there, all servicing can take place with wiring intact. We also hinge all service panels, and use locking cable interconnects.

The specs? Why not call your nearest Otari dealer, or Otari at (415) 341-5900 and check them out. Like everything else, you'll find them "right on the money."

OTARI

Circle 36 On Reader Service Card

Cellular Solutions for Remotes

by Bruce Bartlett with
Jenny Bartlett

ELKHART, Ind. You're doing a remote at the scene of a flood. Suddenly the phone lines go down. But you stay on the air, thanks to the cellular wireless telephone network.

LINE OUT

Using frequency modulation near the UHF band, your cellular transceiver transmits to a nearby cell site (antenna/tower location). The reception area around each tower—about 30 to 40 miles in diameter—is called a cell. As you drive your mobile unit between cells, the system transfers your call to the next available cell.

At each cell site, the received signal is sent to the ground, where it goes to the Mobile Telephone Switching Office (MTSO). The MTSO processes the calls, manages call traffic and "hands off" calls from one cell site to another.

From the MTSO, your signal is fed two ways: to the public telephone network, and back to the cell site tower where it is retransmitted.

If the phone lines go down, or if the phone company's central office fails, you still can transmit from one cellular transceiver to another. This is a backup to the

standard land line phone network.

The FCC permits two cellular service providers in each service area. Each cellular system functions like an alternative local and long distance telephone network, and is fully interconnected with the public telephone network. This means that cellular users can place calls to or receive calls from anywhere in the world.

My comments in a recent column regarding cellular's unreliability drew some response. A leading manufacturer of cellular equipment sent me literature showing that cellular can be as trustworthy as a

provided in every license area by major telephone communications companies. They build equipment designed to withstand hurricanes, earthquakes, and central office (CO) failures.

For example, following San Francisco's devastating earthquake, approximately 91 out of 100 cells in the area continued to operate. And while Hurricane Hugo raged in the Carolinas and Puerto Rico, their cellular services kept on working.

How do you interface cellular with your audio mixer? First you need a telephone coupler such as those made by Comrex.

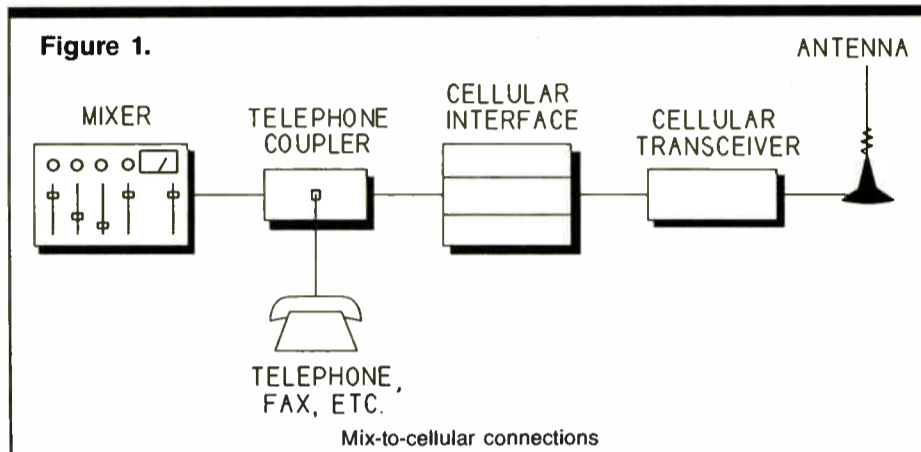

land line and maybe more so. In permanent installations at least, cellular transmission is said to have excellent quality.

To ensure reliability (and competition), multiple cellular services typically are

This device connects your mixer to the telephone line by transformer coupling, and holds that line.

In the coupler is an audio connector for your mixer's signal and two telephone jacks for a telephone and the phone line.

Now you've converted your audio to a telephone signal. In order to interface this telephone signal with cellular radio, you need a cellular interface like those made by Telular.

According to the manufacturer, Telular interfaces let you use any standard telephone equipment—fax, modem, telephone, audio-mixer telephone coupler—and send the signal via cellular radio. The interface allows your telephone products

to be used normally, as if they were connected into the wire line network.

With this equipment, you have an advantage wherever cellular service is available: If phone lines have failed or don't exist, you still can use your telephone equipment. You have a backup communications link independent of the regular phone lines.

Telular's interfaces provide one, four or 28 lines of cellular dial tone. Installation is easy: You plug into AC (or use internal batteries) and connect to your desk phone, coupler or other telephone equipment.

If you already have a cellular phone, Telular recommends using its Celjack cellular interface for mobile applications. The Celjack provides a standard RJ11c wall jack connector for any device you might connect to the phone line—coupler, modem, fax machine, answering machine, pay phone and so on. It couples these devices to your cellular transceiver while permitting use of the handset.

For fixed installations, if you already have a cellular transceiver, Telular recommends its Maxjack Universal Telephony Interface. It does not permit use of a cellular handset, but it is more flexible in coupling standard wire line telephone products to the transceiver.

If you also need a cellular transceiver, the CPTE-1 (Customer Premise Telular Equipment) interface is a good choice for fixed installations. This device includes a Maxjack interface with a standard RJ11c telephone jack, cellular transceiver (3 W, 832 channels) and battery backup. After adding an MA1000 800 MHz Magnet Mount Antenna, you're ready to transmit.

Your studio also requires a cellular transceiver if you want a backup system independent of the phone lines.

You can reach Telular Inc. at 708-256-8000. Telular, Maxjack, Celjack, and CPTE are registered trademarks of Telular Inc. Next time: Comrex remote broadcast equipment.

■ ■ ■

Bruce Bartlett is a microphone design engineer and technical writer for Crown International. Jenny Bartlett is a technical writer. Bruce can be reached at 219-294-8388.

Remote Offers a Lift

(continued from page 34)

at 7 a.m. The morning remote, however, was scheduled to start at 6 a.m., a scheduling oversight that meant that the morning show's first hour of broadcast could not be monitored off-air by the remote crew.

Bjornstad went in search of better receivers for the crew, hoping to find radios that would be able to pick up the weak, 1 kW signal at Silver Mountain. It looked hopeless. Compounding the problem was the signal's deep null, protecting a Minneapolis station due east—the direction of Silver Mountain. But by the start of the next day's show, Bjornstad had found the receiver he was looking for—at a Radio Shack in a nearby town.

Unreliable phone signal

Still, the remote had another communications problem. Communications between the remote location and the studio were being carried out on a cellular telephone to cue commercial breaks and news inserts. The cellular phone was unreliable and would fade out whenever the remote crew wandered away from the outside deck of the restaurant, where they had the antenna set up.

With the nearest cell on Blossom Mountain, explained Sibulsky, "the phone was trying to make the same 42-mile hop (as the remote)." Unfortunately, he commented, "it wasn't as reliable" or as successful at stretching the long distance as the Marti and Phelps-Dodge combination.

Despite the problems in communications, every morning, Sibulsky said, "a portable mast with the 450 transmit antenna and the 170 MHz wireless receive antenna were hauled onto a deck outside the ski resort's restaurant." From there, morning personality Haugen, as well as Bjornstad, would wander the resort, interviewing guests and covering events for the morning show.

The most memorable event covered by the station, said Bjornstad, was the notable First Annual Turkey Bowl. In this event ski patrons gathered around Pepsi bottle bowling pins, cheering on bowlers who slid 10-pound turkeys down the lanes in hopes of making a strike.

This event alone, said Bjornstad, was worth the 6,200-foot hike up Silver Mountain.

■ ■ ■

Dee McVicker is a free-lance writer and regular contributor to RW. To inquire about her writing service, call 602-899-8916.



100%
HARDWARE

CCA TRANSMITTERS
P.O. Box 426 • Fairburn, GA 30213
(404) 964-3530 • FAX: (404) 964-2222



SYSTEM - 3000

DIGITAL MULTI-HYBRID TELEPHONE SYSTEM

- Digital signal processed hybrid system.
- Microprocessor controlled via standard RS-232 or RS-422 interface.
- Up to eight telephone lines in full multiplex communication, due to the internal MIX-MINUS bus structure.
- No preliminary adjustment or line measurement is required; simply connect it and work!
- Easy to use: the control module can be either a small dedicated console or a standard PC or compatible.
- Line functions and controls are independent for each input module; the technician's job is made easier than ever, even in the software version.
- The switching section handles up to eight telephones, plus the control telephone and the studio telephone.
- Each input module includes:
 - Superb 60 dB sidetone rejection.
 - 128 steps digital adaptive filter.
 - 24 bits coefficients.
 - 16 bits sigma-delta A/D converters.
 - Switched-capacitor antialiasing filter, with 80 dB rejection.
 - Line inputs safety protected against line transients and discharges, according to CCITT regulations.
- Some of the functions included on the digital processed section are:
 - Digital AGC included in the self-adaptive filter.
 - Doubletalk detection, without influence in the adaptive procedure.
 - Noise reduction procedure, using a white noise generator applied in the digital domain.
 - Noise free line switching, using stand by signal timing.
 - Supervisory function of line status, with detection of dialing tones and signalling (busy line, hanged, etc.).

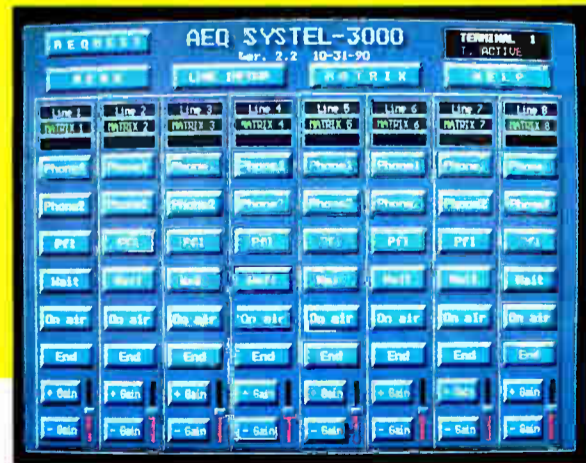
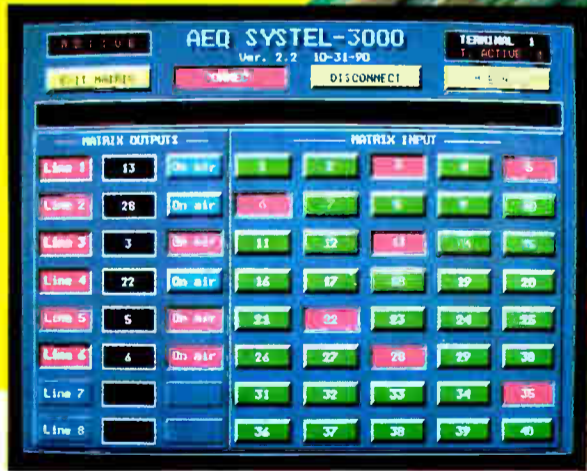
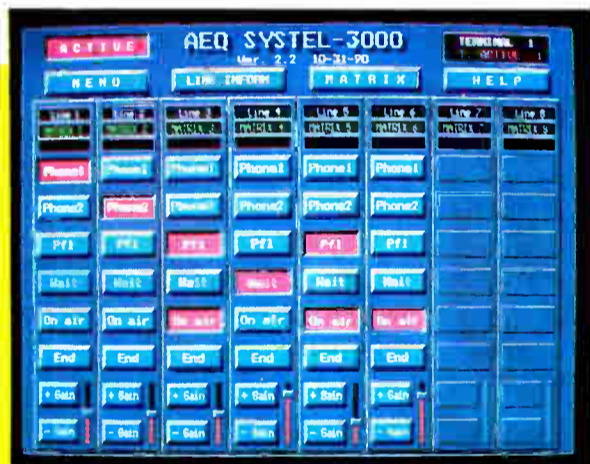

THE *Digital* SPECIALIST ON *Analog* TELEPHONE LINES

APLICACIONES ELECTRONICAS QUASAR, S.A

CENTRAL OFFICE: P.I.Leganés. c/Rey Pastor, 36 - 28914 LEGANES. MADRID. (SPAIN). Tel. 011-34-1-686 13 00 - Fax: 011-34-1-686 44 92

Circle 92 On Reader Service Card

World Radio History

Broadcast Equipment Exchange®

"Broadcast Equipment Exchange" accepts no responsibility for the condition of the equipment listed or for the specifics of transactions made between buyers and sellers.

AMPLIFIERS

Want to Sell

Harris program amp, monitor amp, stand alone, as new, \$150 ea. C Porter, WEAZ, POB 498, Carthage IL 62379. 217-357-3128.

RCA BA-33 program amps (5), mostly for parts, some working. H Kneller, WKII, 3151 Cooper St, Punta Gorda FL 33950. 813-639-1112.

McIntosh MC-2500, silver, \$2575/BO; black MC-2500, fact sealed, \$3575/BO; (2) MC-240, \$975 ea/BO; (3) MC-40, (2) MC-225, \$575 ea/BO; PS Audio 200C, \$975/BO. R Katz, Allegro Sound, 15015 Ventura Blvd, Sherman Oaks CA 91403. 213-859-5543.

Leak Point One stereo vacuum tube hi fi preamp, made in England, excel sound, \$195. J McLane, ODD-E-Q, 115 W Gutierrez, Santa Barbara CA 93101. 805-963-3941.

Hafner DH-500, 255 Wchnl, rack mount, factory performance checked recently, vgc, \$400+shipping; Crown IC-150 stereo audio preamp, 2 phono inputs, 2 tape inputs & several aux inputs, rack mountable, gd cond, \$60+shipping. Bill, DeFelice Prod, 93-2R Fowler St, New Haven CT 06515. 203-397-2595.

Ramko Primus P-8S/16M distribution amps (8), w/meter and headphone option, never used, \$400 ea. M Sadacca, KCKC-KBON, 740 W 4th St, San Bernardino CA 92410. 714-882-2575.

Carvin FET 900 Mosfet stereo pwr amp, 200 Wchnl at 8 ohms, sub and ultrasonic switches, variable compressors, bridge mode switch, 3 rack space, 35 lbs, like new, \$400. B Fisher, KPOK, POB 477, Bowman ND 58623. 701-523-3883.

McCurdy DA-504 1x12 amps and PS (6), vgc, rack mount, \$550; RCA BA 44 utility amps, vgc w/connector tray, \$70. B Kuhar, 1543 Eaton Ave, Bethlehem PA 18018. 717-645-8814.

Magnecord CM6K tube mon amp, 10 W, rack mount, rebuilt, \$35; Ramko 1x6 mono DA on rack panel, cln & wrkg, \$75. E Davison, 135 N Illinois, Springfield IL 62702. 217-787-0880.

Auditronics AUD-1100DAGLCL distr amps, \$50 ea; Auditronics AUD-1100-MF 10-input mainframe, \$250; Auditronics AUD-PS60 RM external pwr supply, \$210; Henry USDA 3, \$70 ea; all used 6 mnths. B Lord, Lord Brcdstg, 13313 SE 208th St, Kent WA 98042. 206-631-2374.

Crown PL-1 pwr amp (2), black, rack mount, 19" w/handles, 150 W-RMS, 3-yr guarantee, \$300. C Keith, 9 Roxbury, Keene NH 03431. 603-352-8460.

Ampex 602 octal plug-in Nuovistor mic preamps 96440-01, (2), \$35 ea; (2) Altec 1588C octal plug-in mic preamps w/xlr & phantom, \$20 ea; (2) Altec 1588B octal plug-in mic preamps w/xlr, \$10 ea. J Newman, Box 1211, Newport RI 02840, 401-847-0455.

Bryston 4B 400 W pwr amp, excel cond, 3 yrs old, \$900. R Tiegen, Plum Sound, 335 Merrimac St, Newburyport MA 01950. 508-465-5653.

Want to Buy

Sansui B-2301, BA-5000, C-2301; Luxman M-4000, M-4000-A, M-6000. R Katz, Allegro Sound, 15015 Ventura Blvd, Sherman Oaks CA 91403. 213-859-5543.

Altec Lansing 287F or 287W, any cond; any amps by Western Electric. D deForrest, 7441 Wayne Ave #10-D, Miami Beach FL 33191. 305-866-5401.

RCA OP-5, OP-6, OP-7, BN-2, 80 Series, etc. tube amps & remote mixers. B Davies, Virgo Prods, 5548 Elmer Ave, N Hollywood CA 91601. 818-761-9831.

HE HALL Electronics

THE BEST DEALS ON QUALITY REBUILT & BRAND NEW BROADCAST EQUIPMENT

We BUY & TRADE equipment too! Please phone or send for our latest flyer.

10:00AM-6:00PM EST

804-974-6466

1305-F Seminole Trail

FAX 804-974-6450

Charlottesville, VA 22901

Circle 64 On Reader Service Card

Altec 287-F/287-W, any cond; WE amps; Marantz, Ampro, Westrex vacuum tube audio amps; cutter amps; Marantz 1, 2, 3, 6, 7, 8, 8-B, 9, 10, 10-B. D deForrest, 7441 Wayne Ave #10-D, Miami Beach FL 33141. 305-866-5401.

Andrew MDS antenna, horz polarized, freq 2150-2163 MHz, w/200' 5" W/G, connectors & hardware, \$3500/BO. D Hill, KXAL, POB 1393, MI Pleasant TX 75455. 903-572-6536.

Jampro 8-bay w/brackets & radomes on 99.1. Was replaced for a no airtime lost xmr move. Also, (1) 6' Mark dish, 950 MHz, mdl P-9A72G. Don Patrick, 501-646-6142.

ANTENNAS & TOWERS

Want to Sell

RCA FBC-8C 8-bay high pwr w/de-icers, tuned to 102.3 MHz, excel cond, BO; RCA BFA-4A, 4-bay hor pol high pwr on 102.3 MHz, BO. T Edmison, WDKN, 106 E College, Dickson TN 37055. 615-446-0752.

CSP/Vector Tech 4-tower AM phasing unit wall phasing controls & Potomac Inst antenna monitor, currently on 1360 kHz, mint cond, BO. R Wright, 1208 N Locust Ave, Lawrenceburg TN 38464. 615-762-6200.

EIA Flanges 3 1/8" rigid coax line, (55) 20' pieces, 50 ohm, stored indoors, \$200 ea. L Bruce, WROR, 3 Fenway Plaza, Boston MA 02215. 617-236-6841.

LIGHTNING PROTECTION

Why Be Content

...with only a partial protection package when you can have a complete, low cost, proven system from LIGHTNING ELIMINATORS & CONSULTANTS? We can provide:

SPLINE BALL IONIZERS® — to significantly reduce the risk of a strike but "fall" as a 100% effective lightning collector. Use of multiple SBI's can eliminate the risk of a strike.

CHEM-RODS® — chemically activated ground rods for establishing very low resistance and low surge impedance earth connections.

SURGE PREVENTORS — to prevent the passage of power line surges or transients regardless of their source or energy level.



Lightning Eliminators & Consultants, Inc.

8687 Arapahoe Road
Boulder, Colorado 80303
(303) 447-2828 FAX (303) 447-8122

The company with nineteen years experience providing total protection systems.

RCA BFC6B 6-bay FM antenna w/deicers, tuned to 88.5 MHz, w/(5) spare bays, located at US Twr Frederick MD, \$2800/BO. M Byrnes, WAMU, American Univ, Washington DC 20016. 202-885-1069.

Gates FMC-7A 7-bay FM antenna, working when removed, extra heaters, 103.1 MHz. J Goeman, KJAM, Box D, Madison SD 57042. 605-256-4514.

EG&G 4-level, 3 flash boxes/level w/top AOL & controller, gd cond, TOP AOL in new cond, \$22500. M Pollock, WFXG-TV, POB 204540, Augusta GA 30917. 404-650-0054.

Dielectric IM-2400 dehydrator, \$1500; Cable-wave 920167-004 angle member adaptor kits (25 of 10 ea), \$30/kil. G Liebisch, WPTF/WQDR, Box 29521, Raleigh NC 27626. 919-790-6315.

Rigid feedline, (20) 20' sections w/end terminations, (4) 90° elbows & (6) assorted short pieces, alal 1-5/8 rigid feedline, just taken out of service, BO. J Bisset, Multiphase Consulting, 703-379-1665.

Atlas 160' self-supporting twr, 18' at base, all drawings, excel cond, you disassemble & transport, \$995. M DeClue, KOKI-TV, Tulsa OK 74145. 918-622-2300.

RCA isocoupler, tuned to 97.7, can retune, 1 5/8 EIA flange. G Fuller, WKFR, Box 2329, Opelika AL 36801. 205-745-4656.

Phelps Dodge CFMHP-5 5-bay FM, 3 1/8" line, 96.1 MHz, all hardware, like new, \$7000; Rohn 55 100' galvanized twr w/guy wires, top and bottom plates, turnbuckles, hardware, anti-twist arms, vgc, \$3000; 60' 1 5/8 air dielectric coax xmission line w/flanges on each end, \$750. Lonnie, KCMB, 1009-C Adams Ave, LaGrande OR 97850. 503-963-3405.

Harris/ERI Sky-Gain FMWH-1AE 1-bay FM antenna, gd cond, used 2 yrs, tuned to 92.7 MHz, \$500, buyer pick up. M Gollub, WMJS, Box 547, Prince Frederick MD 20678. 301-535-2201.

Radio Systems CP-15 couplers (12), wired w/6' 3-phase cable and disconnect plug, excel cond. R Rossman, WEHR, 103 Daniel Bldg, 2766 W College Ave, State College PA 16801. 814-865-9568.

Rohn 25 base insulator, never used, \$300/BO+shipping; LAPP 14855 base insulator, never used, \$300/BO+shipping. B Crusier, WJRX, 20-6 Jamestowne, Toms River NJ 08753. 908-286-0411.

Collins 37CP 6-bay antenna tuned to 97.1, 1 bay needs repairs, \$150. B Gagne, KTCZ-FM, 100 N 6th, Minneapolis MN 55110. 612-339-0000.

Phelps Dodge CFM-HP-8 8-bay antenna on 93.3, BO. C Springer, KLMR, POB 890, Lamar CO 81052. 719-336-2206.

Phasemaster T-14000-A rotary phase converter, input 230 V, output 230 V, idle amp 30, used 9 months. L Wayne, WVOD, POB 2059, Manteo NC 27954. 919-473-1993.

Kintronica 25 W isocoupler tuned to 92.0, \$1500. N Hunter, KTGL, 3201 Pionems Blvd, Lincoln NE 68502. 402-483-6814.

ARCO rotary 3-phase converter, 208/230 V, will support 3 kW xmr, excel cond, \$275. D Heinan, KYKA-FM, 1214 W Lincoln Ave, Yakima WA 98902. 509-452-7997.

CP antenna 3-bay tuned to 93.9, 200' 1 5/8" coax, solid dielectric, BO. D Jordan, WDTM, POB 3417, Jackson TN 38503. 901-668-1153.

Aeromator 17" face, 195' on ground, ready for pickup, gd cond, w/all hardware & some insulators, \$1500. T Edmison, WDKN-FM, 106 E College St, Dickson TN 37055. 615-446-0752.

Dummy loads, FM oil cooled, several to choose from, 1, 2.5, 5 kW; Also 75 kW AM, 4 port motorized RF switch, 3-1/8", 76 port patch panel 3-1/8". Goodrich Ent, 11435 Manderson St, Omaha NE 68164. 402-493-1886.

FM ANTENNAS

1 BAY	\$1,500
2 BAY	2,300
3 BAY	3,150
4 BAY	4,000

MORE BAYS AVAILABLE All warranted, tuned and tested

ARMSTRONG TRANSMITTER CORP.
5046 Smoral Road (315) 488-1269
Syracuse, NY FAX (315) 488-1365

Rohn towers (8), 11 yrs old, excellent condition. Models 55 G-65 G-80 & (2) S.S.V. towers. Also 300' insulated tower. Erection also available. Direct inquiries to Micro Tower, Inc., 712-258-4968.

Want to Buy

Transmission line dehydrator unit, all types. P Salois, KPCR, Box 1, Bowling Green MO 63334. 314-324-2263.

Want Cablewave LP 12 bay circular polarized FM antenna, need immediately. K Kichel, KTJC, 1207 Louisa St, Rayville LA 71269. 318-728-5852.

Christian station needs 12 bay L pwr FM circ polarized antenna between 91.5 and 93.5 MHz, also need 1 5/8" air coax 160-180' w/or without connectors. K Diebel, KTJC, 1207 1/2 Louisa St, Rayville LA 71269.

Jampro, Shively, ERI 3-bay FM tuned to 106.3 w/ w/out deicers/radomes, capable of 7500 W. L Maierhofer, WTGC/WUNS, 101 Armory Blvd, Lewisburg PA 17837. 717-523-3271.

AUDIO PRODUCTION

Want to Sell

Travel trailer 14' mod for remote studio use, 8 chnl SS console w/moon amp & spkrs, 5' rack, gd cabinet, \$4000. J Sellmeyer, Rt 1 Box 270, McKinney TX 75069. 214-542-2056.

Shure M68 (3), & level lock, all mounted in custom wood cabinet w/sliding doors, excel cond, \$300+shipping. C Easlick, MES Co, 2233 Cumberland, Lansing MI 48906. FAX 517-321-1900.

dbx 150 type 1 NR (2), rack mount, balanced in/out, excel cond, \$100 ea; Aphex Aural Exciter broadcast model, rack mount, balanced in/out, excel cond, \$500/BO. M Byrnes, WAMU, American Univ, Washington DC 20016. 202-885-1069.

Gentner pre-wired patch panels, 6' cables to punch blocks, panels are 14", 26 across (13 stereo) w/monitor row at bottom, sell/trade. B Harris, KXLT, 5350 S Roslyn St #210, Englewood CO 80111. 303-741-5654.

Rolling Radio remote van, '87 Toyota, 68,000 miles, w/console, 100 W speaker amp, cellphone. S Griffin, WYAY/WYAI-FM, 200 Galleria Pkwy #900, Atlanta GA 30339. 404-955-0106.

dbx 157 2-chnl rack mount, \$150. Tiki Recording Studios, 195 S 26th St, San Jose CA 95116. 408-286-4091.

dbx 900 series rack w/(2) 942 Type II 2-chnl decoder & (2) 411 Type II encoder/decoder, BO; Eventide H910 Harmonizer, not working, BO. K Stokes, WKJN, 3029 Sherwood Forest #200, Baton Rouge LA 70816. 504-292-9556.

Wells Cargo Super Roving Radio w/eqp rack and cabinets, \$18,000. D Denton, KFRC-FM, San Francisco CA. 415-362-8800.

Delta Lab DL-4 space rack mount effects processor w/variable delay, flange, double and echo effects and more, \$200/BO; Aphex Type C aural exciter, single rack space, variable controls add brightness and audio intelligibility, unbalanced 1/4" and RCA connectors, excel cond, \$175/BO. B Fisher, KPOK, POB 477, Bowman ND 58623. 701-523-3883.

Lycrc TIM 4 tape timer, 15 ips, \$50. P Cibley, Cibley Music, 138 E 38 St, NY NY 10016. 212-986-2219

FM - ANTENNAS

Designed and built for your frequency. Choose from 1 to 12 bays and five power levels. Financing available. Call Jimmie Joynt at S.W.R. 800/279-3326

Jampro JHPC-5, 5-bay FM antenna, tuned to 104.3 MHz, unused, \$8000 FOB. D Peluso, KJUL-FM, 2680 E Flamingo Rd #E, Las Vegas NV 89121. 702-732-2200.

Phelps Dodge CFM-LP-4 4-bay antenna, 94.3 MHz, radomes on tower, \$2000; 490' 1 5/8" coax on tower, 2 yrs old, excel cond, connectors incl, \$5ft. B Brewer, KOKL, 410 W 6th, Okmulgee OK 74447. 918-756-3646.

PETER DAHL CO.

Save \$\$

Heavy Duty Replacement Transformers, DC Filter chokes and capacitors for AM & FM transmitters manufactured by: AEL, CCA, CSI, COLLINS, CONTEL, CONTINENTAL, BAUER, GATES, GE, HARRIS, ITA, McMARTIN, RAYTHEON, RCA, SINGER, SINTRONIX, WILKINSON. Many other models also available.



FAST Delivery and FREE Technical support.

—Write For Free List—

5869 WAYCROSS AVENUE, EL PASO, TEXAS 79924
(915) 751-2300 FAX: (915) 751-0768



Circle 81 on Reader Service Card

AUDIO . . . WTS

Ramko Primus RS-1616 audiodata routing switchers (2), never used, remote cntrl avail, \$1000 ea. M Sadacca, KCKC-KBON, 740 W 4th St, San Bernardino CA 92410. 714-882-2575.

Orban 424A stereo complimenter/de-esser/noise gate, excel vocal processor, brdcst quality, \$650; Orban 674A para-graphic cross-EQ, \$850; both new cond. Jeff, 15106-A Frederick Rd Box 309, Rockville MD 20850. 301-340-0466.

UREI 813B studio mons, \$2200. R Tiegen, Plum Sound, 335 Merrimac St, Newburyport MA 01950. 508-465-5653.

Pultec EQ's, (1) EQP1R; (1) EQH2; (2) MEQ5's. RCA mic preamps BA21A. Call Mark, evenings, 718-387-2620.

Want to Buy

Symetrix 528A mic processors, gd to excel cond only, buy/trade. B Harris, KXLT, 5350 S Roslyn St #210, Englewood CO 80111. 303-741-5654.

Burwen TNE-7000, state price and cond. A Reis, REIS Inc, 308 Eastgate Ct, New Lenox IL 60451.

Teac AN60, AN80, AN100 Dolby noise reduction unit. R McDonald, Mission Rdring, 5231 Horton, Mission KS 66207. 913-722-2677.

Tube limiters, compressors and EQs: Fairchild 660/670; Teletronix/UREI LA2A, LA3A; Pultec; MAVEC; Lang; API; etc.; also, other tube signal processing equip. J Kreines, DelMott/Kreines Films, 5330 Kennedy Ave, Millbrook AL 36054. 205-285-6179.

Burwen TNE7000A or comparable. T Young, Bible Brcdstg Network, 1300 N Battlefield Blvd, Chesapeake VA 23320. 804-547-7376.

TFT EBS Syst, complete, on-air & prod 58/80 chnl audio console, FM mod mon & SS unit, (2) flanges for 1 5/8 Celwave cable, gas port & gas barrier, limiter, solid state. Spanish Cultural Network, WNZN-FM, Carr Vieja del Vigia #83, Ponce PR 00731. 809/840-1588.

Ham radio operators looking for surplus audio processors, mixers & mics, as well as other inexpensive gear that could help bdcst engrs play radio at home among enthusiasts for vintage AM. Please write wofferings, WA3WJB, Box 73, West Friendship MD 21794-0073.

AUTOMATION EQUIP

Want to Sell

MEI MP-1000, 8-source sequencer, 3 yrs old, excel cond, alone or w/custom wall cabinet w/(4) Ampex 445 decks w/pre-amps & tone detectors, \$4500 complete, you ship. H Kneiler, WK11, 3151 Cooper St, Punta Gorda FL 33950. 813-639-1112.

SMC Carousel 350-RSB, perf cond, ready to go on air, \$1200/BO/trade; SMC Carousel 250-RS (2), recently rebuilt, plus (1) for parts, \$500/BO/trade. S Callahan, WF1T-FM, 1120 Pinellas Bayway #103, Tiem Verde FL 33715. 813-866-3544.

Schafer 903E, gd cond, all but R-Rs, w/spare parts inventory, \$5500/BO, we pay half shipping. K Browall, KTRZ, Box 808, Riverton WY 82501.

BE Control 16X audio source cards (4), \$40 ea; BE live-assist remote control panel, new, never used, \$175. G Jones, SW Mediast, 110 Sierra Rd, Kerrville TX 78028. 512-367-4587.

SMC System, (6) 350 RS Carousels, (3) 250 RSC Carousels, (6) racks, DP-1, AS 20, currently on air, \$3500. E Dulaney, KYKK, 619 N Turner, Hobbs NM 88240. 505-397-4969.

IGM EC System, complete, BAI, 3 Carousels, 3 carts, 2 new racks, Otari ARS-1000, new '88, BO. J Phillips, WZOM, 409 Clinton, Defiance OH 43512. 419-782-8591.

SMC 350RSB, Carousel, rack, pwr supply, DS-20 switcher, RP1000 brain & assorted parts, BO. D Dunsmoor, KRRZ/KZPR, 216 S Bdwy, Minot ND 58702. 701-852-4646.

Autogram double Carousel random control, built into drawer w/pins, basic but cheap & complete, \$50; SMC 581-A double play cart, breaks or time announcer, missing one card, like new, \$200. D Jack, Mountain Media, POB 1826, Boise ID 83701. 208-286-7676.

IGM Go Cart 24 (2), Carousels in excel cond, 5 yrs old, \$2000 ea/\$3800 both. R Graiff, WPUT, Box 1055, Patterson NY 12563. 914-878-3307.

Harris System 9000 w/event controller for 12 sources, source cards, all system computer cards, pwr supply, cables for (4) Otari ARS-1000 stereo reel decks, (4) Carousels, data entry CRT workstation, (2) standard system equip racks; controller fully operational when removed, BO, buyer ships. K Eibert, KWED, 609 E Court St, Seguin TX 78155. 512-379-2234.

Complete automation system for satellite network, (2) 48 tray Instacarts, format Sentry FS12B, working when removed from service. B Umberger, WMTZ/WHBO, 18167 US 19 N #500, Clearwater FL 34624. 813-536-9600.

Harris 9000 controller, (5) Otari ARS-1000 R-R, (5) SMC 350 Carousels, \$5500. S King, KATP, 7701 I-40 W Ste 660, Amarillo TX 79160. 806-359-5999.

SMC ESP2, (6) Otari reels, (2) Carousels, (4) racks, control system, dual play cart and printer, excel cond, 2 yrs old, BO. L James, KYQQ-FM, POB 650, Wichita KS 67201. 316-265-1065.

Gates SP-10 auto system w/dialer; (2) Gates SC48 seq auto controllers; (2) switchers/mon panels; Carousel 252; (2) Gates 55 stack cart players, one for parts; all BO. M McDaniel, WBTO, Linton IN 47441. 812-847-9830.

Scully 255 FT (3), new heads, gd cond, \$700; Criterion R/P; FAT wire phone system, BO. R Remington, KMTX, 516 Fuller Ave, Helena MT 59624. 406-442-0400.

Cetec/Schafer 90Z I/O cards and cables (5), for Revex A77 reel PBs, \$75 ea/\$300 all. B Spitzer, KKLK/KMKM, Box 460, Rapid City SD 57701. 605-343-6161.

Harris System 90, 7-day clock, (2) 48 tray mono Instacarts, (2) 750 ITC clear text log, on air, BO/all or part. G Fuller, WKKR, Box 2329, Opelika AL 36801. 205-745-4656.

Schafer 901 Brain, (3) Audiofiles, (5) Carousels, (5) racks. R Hull, KCOL-KIMN, 1612 W Laporte Ave, Ft Collins CO 80521. 303-482-5991.

Sono-Mag DP-1, complete system, on air, (5) Carousels, (4) reels, delay news rcrdr, (5) racks, logger, printer, CRT mon, remote control, Audicord stereo cart rcrdr w/tones, \$10,000. M Rhoades, KTKT, POB 1232, Lebanon MO 65536. 417-588-1435.

SMC system, (6) 350 RS Carousels, (3) 250 RSC Carousels, (6) racks, DP-1, AS 20, on air and wrkg, \$3500. E Dulaney, KYKK, 619 N Turner, Hobbs NM 88240. 805-297-4969.

SMC DP-1 mono, w/programmer, AS-16 switcher, (7) 250RS Carousels, (2) Twintape P/Bs, wrkg when removed, sell whole/part, \$1500/BO. B Holtan, KVOX, Box 97 Country Rd 75, Moorhead MN 56561. 218-233-1522.

Conex CS-25 dual 25 Hz tone sensor w/manual, excel cond, \$300. B Watson, KSAK, 1551 E Amhr, W Covina CA 91792. 714-946-6249.

SMC DS-20 automation switcher, as is, \$250. E Stanley, KBTO, Box 12, Bottineau ND 58318. 701-228-2483.

BPI RS-50 random cntrlr for SMC 250 Carousel, \$60; SMC PDC-3 automation clock, cond unknown, \$250. E Stanley, KBTO, Box 12, Bottineau ND 58318. 701-228-2483.

SMC MSP-1 2,000 event cntrlr, USI-1 satellite interface, (4) SMC 450 Carousels, (3) sngl-play decks, in (2) rolling racks, \$13,500. D Kelly, KWPN, Box 84, West Point NE 68788. 402-372-5423.

Format Sentry FS12C, compl 24-chnl w/computer, 1 yr old, (4) 350B Carousels, (3) Otari ARA1000 reels, (2) SMC 700 series dual-tray cart machines, BO. Z Huffmaster, KSCC, POB 191, Berryville AR 72616. 501-521-0104.

Schafer 901/902, (2) Carousels, (3) R-R, (3) racks, fair cond, needs minor repairs, \$4500+shipping. R Huckleby, KJLF, 973 N Main St, Butte MT 59701. 406-723-4006.

CAMERAS (VIDEO)

Want to Sell

RCA TK760 studio color camera (2), w/CCUs, 151 Angenieux, paint boxes, cables & cases, \$4500/both. C Potorti, 10005 Lacy Ave, Morrisville PA 19067. 215-945-3990.

Sony BVP-30 camera w/CA3 adaptor, Fujinon 14x9 lens w/2x extender, beta back avail, excel cond, \$8500. Roman, World Video, 10625 Scripps, San Diego CA 92131. 619-695-1045.

Panasonic AK-7150 3-tube brcdst ENG camera head (2), case, no lens or VF, \$400 ea; Sony DXC-1200 Trinicon color cam compl studio pkg (2), \$450 ea; Hitachi 3-tube; Ampex 3-tube; (2) Norelco PC-70 compl. J Krepol, 7 Dustin Dr, Wilmington DE 19703. 302-798-4076.

JVC KY-1900, AC pwr & chrgr, 10x1 zoom, vy lw hrs, \$940; JVC GX-5700, sgl tube, 10x1 zoom, batt chrgr, \$570. K Schmidt, Bristol Prod, 2401 Bristol Ct SW, Olympia WA 98502. 206-754-4260.

Sony M2 3-tube MF Saticon camera, 12x lens, new, very lw hrs, \$2600/BO. R Jensen, Telecabre Prod, 5812 21st St, Radue WI 53406. 414-632-3131.

CART MACHINES

Want to Sell

BE 1070, 2-stereo play, 1 stereo RP, numerous modules for ATC Criterion I, \$350; cue amps, pgrm amps, pwr supplies, etc, \$25 ea. H Kneller, WK11, 3151 Cooper St, Punta Gorda FL 33950. 813-639-1112.

ITC RP R/P cart machine, 3 tone stereo, excel cond, \$1100+shipping; Harris Criterion 80 PBK, 3 tone, mono, gd cond, \$350ea+shipping; ITC SP, 3 tone, mono, like new, \$800. J Sellmeyer, Rt 1 Box 270, McKinney TX 75069. 214-542-2056.

Audicord E Series, 3 PB, 1 R/P, BO. J Phillips, WZOM, 409 Clinton, Defiance OH 43512. 419-782-8591.

Harris Criterion 80 & 90 Series (10), play or record, mono or stereo, \$300-350ea; Harris 90-3 triple deck mono, \$750. G Liebisch, WPTF/WQDR, Box 29521, Raleigh NC 27626. 919-790-6315.

ITC SP stereo PB w/ndy audio card installed (2), \$700 ea; ITC R/P w/SWA playback card, \$850. D Irwin, KJAZ, 1131 Harbor Bay Pkwy, Alameda CA 94501. 415-769-4800.

Sparta, (4) decks w/(3) tones PB, spare deck, \$800. L Beigel, On-Cue Rcrding, POB 85042, Los Angeles CA 90072. 800-726-9813.

Harris 994-7995-001, mono, \$250/BO. L Fuss, WDTL, POB 159, Fayetteville GA 30214. 404-460-6159.

EMPLOYMENT

To place ads in this section, use the ActionGram form. To respond to box numbers, write Radio World, PO Box 1214, Falls Church, VA 22041, Attn: _____

POSITIONS WANTED

Rock jock looking for F/T slot, if you're sick of liner card stiffs & dead air, call me. S Dunaway, 5 Evergreen Dr, Conway AR 72032. 501-327-7587.

CE w/30 yrs exper in AM-FM willing to relocate anywhere. F Shields, POB 194, Hunt TX 78024. 512-238-4334.

Veteran eng avail, temp or permanent, very exper in studio, satellite, automation, RF facilities from translators through 50 KW AM-DA, construction, budgeting, mngmnt, On-Air news, computers & TV. Radio World, POB 1214, Falls Church VA 22041. ATTN: 91-04-02 RW.

CE, 14-year pro, wants radio or AM/FM/TV in med to lrg market, prefer Midwest, family man, stable, inquire now to: Radio World, POB 1214, Falls Church VA 22041. ATTN: Box 91-04-01.

News/talk stations: radio's best producer avail to upgrade your programming, can write news, anchor & production too. P Dro, POB 76098, St Pete FL 33734. 813-922-5303.

Exper announcer seeks FT in SW US, England, Australia, Guam or English countries, 2 yrs as news director, does color in sports, morning drive. Bobby, 909 W Hester Dr, Silver City NM 88061. 505-388-4804.

Burning desire to be #1, 30-ish male seeks air shift, humorously ironic, irreverent, silent majority opinionated, 2 yrs exper volunteer newscasts, money unimportant, opportunity in NY-NJ-PA area. J Benson, 17 W Main St #5, Mdtm NY 10940. 914-343-9184.

Volunteer, no salary req'd, willing to learn all phases of brcdstg, production studio, news & sales, avail FT in Rockland NY-Westchester CT-N Bergen County NJ area. Mark, 914-357-2424 (days).

20 yrs exper in all phases incl engineering, programming, business & talk radio, seek position which includes talk. Jim, 717-373-1484.

Chicago metro area DJ w/2 yrs exp seeking major market slot, nights, FM, AOR, AC, will relocate anywhere, will express mail resume/tape. B Dohm, 534 E 37th Ave #31, Hobart IN 46342. 219-962-3392.

Radio newsmen/anncr seeks FT position in N Indiana, 16 yrs exp, done it all; references, tape & resume avail. T Murray, RR 3 Box 385, Rochester IN 46975. 219-223-4496.

CE w/bg production voice & over 15 yrs hands-on eng exper seeks eng position w/production in competitive top 100 market. G Morgan, 704-563-8676.

Entry lvl w/small brcdster, prefer N Eng area, On-Air exper, DJ, exper musician, bandleader, vast personal library. P Nash, 13 Custer St, Brockton MA 02401. 508-584-6056.

CE, 15 yrs exper, excel in RF, digital and FCC applications, KY, IN, TN and MO only. C King, KMMU/KATP, 13310 Cisco Dr, Amarillo TX 79111. 806-335-1954.

Engineer, 20+ yrs exper, seeks sm market on Gulf Coast/US CA. G Edwards, 30 Buckner Br Rd, Bryson City NC 28713. 704-488-9301.

Engineer w/24 yrs exper in all phases of radio, looking for DOE/CE position, EE degree, let's talk. T BonDurant, 1604 Endenderry Ct, Garner NC 27529. 919-779-6540.

Eng or combo, 18 yrs eng-PD-AT exper, west only, N CA or OR preferred. Tim, 2946 Amanecer Pl, Escondido CA 92027. 619-741-1054.

Annrcr/DJ w/14 yrs oldies exper seeks pos w/oldies AM/FM, have compl library of oldies on CD and record. Jimmy, 704-463-7626.

Announcer w/20 yrs exper seeks community station pos in N/W AR or SE OK, sales, production, news, network station exper. T Hohrend, 831 Cherry Ln, Malvern AR 72104.

Creative air talent, over 6 yrs exper, skills incl programming, operations mgt, production, copy/script writing, promo, voices, more. Randy, 704-596-4864.

Air personality seeks FT pos in E, 1 yr exper in AC, will work T-40/AC/SC. C Partridge, WNSI, 2629 1/2 S French Ave, Sanford FL 32773. 407-323-5279.

Announcer w/country, B/EZ, CHR, multi-trk and show producer exper seeks pos w/upward potential in markets 50-70. Tony, 14216 Shaner NE, Cedar Springs MI 49319. 616-696-1631.

Radio vet, 23 yrs exper, seeks On-Air C & W or AC in S GA, gd refs. B Rachels, 516 Colton, Thomasville GA 31792.

Design eng/proj mngnr, 8 yrs exper in network & local radio, articulate & committed, will travel anywhere. Engineer, POB 303, Avenel NJ 07001.

Tech school degree, interest sound eng, seeking compensated training A/V prod eng, studio recording/mixing, university radio, film prod or electro-mechanical servicing in CT. J Addison, 8 Thorne Rd, W Hartford CT 06110. 203-581-4534.

Main eng seeks FT, P/T, contract work, CET, FCC licensed, radar endorsement, NABRE, NARTE certified, experienced. M Rakoff, 114-41 Queens Blvd #148, Forest Hills NY 11375. 718-591-3859.

MSEE eng, SBE AM/FM cert, exper incl: teaching, troubleshooting, budgeting, mngmnt, construct, computers, rcrding & live brcdst. W Freeman, POB 125, Castleton VT 05735.

HELP WANTED

Chief Engineer: WEZG/WXRA. FM upgrade, AM directional. Resumes to Bob Wood, GM, 7900 Davis Rd North, Clay NY 13041.

IMMEDIATE OPENING for a hands-on Chief Engineer, maintenance oriented, for a Class C FM facility. Call Paul Duffer at 408-735-7094. EEOE.

Great Lakes State Group - people oriented company w/excellent reputation, looking for Director of Engineering to oversee technical operations of five stations. Successful applicant has proven administrative and technical skills and hands on work as well as travel within the state. Responsibilities include overseeing facility improvements and involvement in budgeting process. Pay/benefits exceed industry norms. EOE. Send resume/references to: Jim Jensen, President, Liggett Broadcast Inc., 160 E Grand River Ave, Williamston MI 48895.

Chief Engineer needed for AM/FM combo. Also qualifications with experience in SMR & paging, especially with 800 trunked phone systems, both interconnect & dispatch. Above \$30,000 for right person. Jerrill Shepherd, Box 430, Moberly MO. 816-263-5800.

EMPLOYMENT SECTION

HELP WANTED: Any company or station can run "Help Wanted" ads for \$1.50/word or buy a display box for \$55/column inch. Payment must accompany insert, use your MasterCard or VISA; there will be no invoicing. Blind box numbers will be provided at an extra charge of \$10. Responses will be forwarded to listee, unopened, upon receipt. Call 800-336-3045 for details.

POSITIONS WANTED: Any individual can run a "Position Wanted" ad, FREE of charge (25 words max), and it will appear in the following 3 issues of Radio World. Contact information will be provided, but if a box number is required, there is a \$5 fee which must be paid with the listing (there will be no invoicing). Responses will be forwarded to the listee, unopened.

Mail To: BROADCAST EQUIPMENT EXCHANGE PO Box 1214, Falls Church, VA 22041

PHONE: 703-998-7600 FAX: 703-998-2966



Call Simone Mullins, Classified Ad Manager, to reserve space in the next issue. Use your credit card to pay, we now accept VISA and MASTERCARD.

Radio World 5827 Columbia Pike, Ste 310 Falls Church, VA 22041

Ad deadlines are the first Friday of each month for the following month's issue

Select from these categories for best ad positioning:

- Amplifiers, Antennas & Towers & Cables, Audio Production (Other), Automation Equip., Brokers, Cameras (Video), Cart Machines, Cassette & R-R Recorders, CATV-MATV Equip., CD's, CD Players, Computers, Consoles, Disco-Pro Sound Equip., Financial Services, Limiters, Microphones, Miscellaneous, Monitors, Movie Production Equip., Receivers & Transceivers, Remote & Microwave Equip., Satellite, Software, Stations, Stereo Generators, Switchers (Video), Tapes, Carts & Reels, Tax Deductible Equip, Test Equipment, Transmitters/Exciters, Tubes, Turntables, TV Film Equip., Video Production Equip., Video Tape Recorders, Positions Wanted, Help Wanted

Classified Advertising Display Rates Effective January 1, 1991

Table with 4 columns: Ad Type, 1x, 3x, 6x, 12x. Rows include 1-9 col inch (per inch), 10-19 col inch (per inch), Distributor Directory, Professional Card, Classified Line Ad, Blind Box Ad.

To compute ad costs: Multiply the number of ad inches (columns x inches) by the desired rate schedule for your per unit cost. Example: a 3" ad at the 1x rate is \$165, at the 3x rate \$159, at the 6x rate \$150, at the 12x rate \$147, etc.

CART . . . WTS

ITC SP stereo cart reproducers (3), w/Straight Wire Audio elec, \$1000 ea/\$1950 all; Audicord DL series cart rcrdr/reproducer stereo, 1 yr old, w/manual, \$1000. B Shannon, WKZA, 5158 Countryside Dr, McKean PA 16426. 814-476-7426.

Tapemaster 700-P PB, \$100/BO; Harris 90-1 R/P, \$600/BO; Criterion PB, \$150/BO. M McDaniel, WBTO, Linton IN 47441. 812-847-9830.

ITC SP, mono, \$200; (2) ITC SP, mono & stereo, w/out cards or heads, \$50 ea; ITC RP, mono, \$250; ITC RP, mono, w/out case or cue detect card, \$175. P Walkowiak, WWWW, POB 167581, Oregon OH 43616. 419-255-1470.

Sony TC228 8-trk R/P w/16 blank carts, cin & wrkg, \$50; WE KS19522L1 recorder/coupler, auto answer interface between cart machine & phone line, new, \$50. E Davison, 135 N Illinois, Springfield IL 62702. 217-787-0880.

Audi-Cord CS26, BO. NW Ariz Brdcast Eng, 602-753-1995.

BE 3000A delay R/P, mono, rack mount, brand new, \$1900; BE 3000, (1) R/P, (2) PB only, mono, excel cond, new heads & pinch rollers, R/P for \$1500, PB for \$1000 ea; Harris Criterion 90 mono cartridge R/P, \$500; Audi-Cord A Series mono R/P, gd cond, on air, \$1000. D Kelly, KWPN, Box 64, West Point NE 68788. 402-372-5423.

Audicord A-21 R/P, \$300. G Milstien, WTYN-AM, 1241 E Lakeshore Dr, Landrum SC 29356. 803-457-3568.

Fidelipac CTR12 stereo play (4), \$1442 ea; Fidelipac ESD10 erasersplice finder, never used, in box, \$900. K Fink, WZLI-FM, POB 106, Toccoa GA 20577. 404-886-7106.

Want to Buy

Tapemaster RP & P in poor cond or need repairs. A Ishkanian, 9723 Riggs Rd, Adelphi MD 20783. 301-439-7222.

Stereo record head for Gates Criterion or IGM 92 record center. R Fess, WLRB/WKAS, 119 W Carroll St, Macomb IL 61455. 309-833-5561.

Complete rack mount adaptor for ITC 3D cart machine. F Kelly, WRZQ, POB 690, Columbus OH 47201. 812-378-1073.

CASSETTE & REEL-TO-REEL RECORDERS

Want to Sell

Otari MX5050 BQII, rack mount, manual, sold mechanically, some head wear, \$1300. P Thompson, Moonlight Sound, 4763 WCR 32, Longmont CO 80504. 303-535-4748.

EXPERT REVOX REPAIRS
Fast Turnarounds - Competitive Rates
15 ips mod. for A&B77's \$350
Rebuilt A77's \$750, guaranteed.
JM TECHNICAL ARTS
30 Music Sq. W. #5
Nashville, TN. 37203 (615) 244-6892

ITC 770, (4) PB & (1) R/P, gd cond, all w/new heads, 1 has 25 Hz detector, will consider pckg deal, \$500 to \$800. P Lierman, KCSP, 601 W Collins Dr, Casper WY 82601. 307-265-5414.

SOUND YOUR BEST ON THE AIR!
—optimize your audio quality—

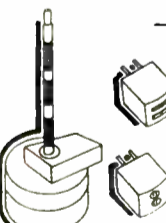

CART MACHINE SERVICES:
CART MOTORS REBUILT to quiet flutter-free perfection—shafts resurfaced
CART HEADS RELAPPED guaranteed to perform like new

Replacement heads and motors available

REEL TO REEL SERVICES:
HEADS RELAPPED and precise digital/optical
ASSEMBLY ALIGNMENTS performed for maximum response & head life
CAPITAN & REEL MOTORS REBUILT for MCI, OTARI and more.

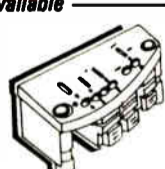

For peak performance from your recording equipment, call The Audio Magnetic Professionals.

AMP SERVICES

224 Datura Street, Suite 614, West Palm Beach, FL 33401
Call 1-800-826-0601 for "Same Day Service" in Florida 407-659-4805
Authorized Parts Dealers for: MCI • OTARI • TEAC/TASCAM

Technics 2-trk 1500 w/remote & rack mount, \$850. D Gold, Gold Star Rec, 11434 Ventura Blvd, #102, Studio City CA 91604. 818-986-2911.

Nakamichi 1000-ZXL computer-controlled cassette deck, w/NR-100 Dolby C, rack mount w/rosewood case, low hrs, excel cond, \$1575/BO/trade. R Katz, Allegro Sound, 15015 Ventura Blvd, Sherman Oaks CA 91403. 213-859-5543.

Ampex 350 mono, tube elect, complete, gd appearance, \$200. D Jack, Mountain Media, POB 1826, Boise ID 83701. 208-286-7676.

Ampex, ITC, Scully Reel-to-Reel Tape Recorder Spare Parts, Accessories, Motor Remanufacturing.

VIF INTERNATIONAL
PO Box 1555
Mtn View CA 94042

Direct order line (800) 848-4428
in area code 408
dial 739-9740
Telex 62922869 ESL UD
FAX: 1-408-739-0809

Nakamichi MR-1 cassette deck, gd cond, \$400; (2) Ampex 350 mono w/Novonics elect in cabinet, \$350 ea; Scully 280B 4 trk 1/2" cabinet, \$950; (2) Scully 280 mono, no cabinet, \$250; (2) ITC 750 stereo playback decks, \$300 ea. G Liebisch, WPTF/WQDR, Box 29521, Raleigh NC 27626. 919-790-6315.

Revox PR99 1/2 trk, 7 1/2 & 15 ips, new cond, \$1600. D Furhey, Audio Center, 1812 Brim, Toledo OH 43613. 419-474-4301.

Otari ARS-1000 stereo reproducers (8), new heads, excel cond, \$900 ea/(2) or more \$800 ea. R Graiff, WPUT, Box 1055, Patterson NY 12563. 914-878-3307.

TEAC C3RX 3-head, rack mount, \$275; Ampex MM1000 8-trk, 1", grt shape, sell all or parts, \$2600. Tiki Recording Studios, 195 S 26th St, San Jose CA 95116. 408-286-4091.

SCULLY TAPE RECORDERS —PARTS— and Service

SEQUOIA ELECTRONICS

1131 Virginia Ave
Campbell CA 95008
(408) 866-8434

Tascam wired remote control for 80-8 & similar Tascam/Teac reel decks, \$50+shipping. Bill, DeFelice Prod, 93-2R Fowler St, New Haven CT 06515. 203-397-2595.

Otari 5050 floor stand/roll around stands (3), black metal tubing w/rcrdr tilting mounts, never used, \$150 ea. R Bersani, Talk Info Ctr, 130 Enterprise Dr, Marshfield MA. 617-834-4400.

Otari 5050B-II 1/2 trk, 14", brand new in box, \$2350. A de Freitas, WJHU-FM, 2216 N Charles St, Baltimore MD 21218. 301-338-9548.

Tape-A-thon open reel tape players, bi-directional 3 3/4 ips, half trk, (2) portable 7" & 10 1/2", (1) 10 1/2" rack mount, all working, \$50 ea. E Davison, 135 N Illinois, Springfield IL 62702. 217-877-0800.

Ampex AG440-C audio tape rcrdr, 2-trk stereo, w/(2) Inonovics 370 elect, Rustang console, excel cond, \$1500. R Barwig, Barwig Recording, 5254 W Agatite Ave, Chicago IL 60630. 312-283-2820.

Studer HS-77 Mk IV special fact order FT mono, 15/7.5 ips, 10 hrs use, wood case, excel cond, \$475/BO/trade. R Katz, Allegro Sound, 15015 Ventura Blvd, Sherman Oaks CA 91403. 213-859-5543.

Technics 1500 stereo 2-trk, \$850; Revox A-77 stereo reel, \$450; Revox A-77 stereo reel w/o rec amp, \$200. R Chambers, KSUE AM/FM, 315 Johnstoneville Rd, Susanville CA 96130. 916-257-2121.

Panasonic SV-250 port DAT rcrdr, mint cond, BO. R Kaufman, Pams Prod, POB 462247, Garland TX 75046. 214-271-7625 (after 3PM).

Studer port case for A77 w/mom spkrs & pwr amps, excel cond, \$275. R Katz, Allegro Sound, 15015 Ventura Blvd, Sherman Oaks CA 91403. 213-859-5543.

Postek A-8 LR 14" 8-trk rcrdr/reproducer, new cond, \$850. R Simmons, Stonewall Brdcast, POB 50124, Austin TX 78763. 512-476-5200.

Scully 270 mon 2-trk, auto-reverse, 3 3/4 or 7 1/2, \$1000. R Evans, Cable Music Network, 156 Prospect St, Wilkes-Barre PA 18702. 800-743-1221.

Tascam T-2640MS and T-2640/2S dupl, forms 8x3 slave duping system, vgc, recently serviced. R Robinson, 203-269-4465.

Scully C-100 series 16-trk 2" tape w/meter bridge and tape counter, \$4500. A Tedecocli, Vault Studios, 106 N Page Ave, Endicott NY 13760. 607-748-4762.

Revox B-77 open reel rcrdr, 7.5 and 15 ips 1/2-trk, w/direct-input and tape-edit modification, improved output amp, remote cntrl, var-speed cntrlr, hrd fiber travel case, excel cond, \$1150/BO; Revox B-77, 7.5 and 15 ips 1/4-trk, direct-input mod, improved output amp, hrd fiber travel case, excel cond, \$750/BO. R Streicher, 818-359-8012.

AIWA Excellia XD-001 RDAT rcrdr, remote cntrl, 110:100 VAC pwr adptr, Engl instruct manual, records at 44.1 kHz from digital SPDIF input, excel cond, \$935; Tascam DA-50 RDAT rcrdr, remote cntrl, +4 and -10 dBm analog I/O, coaxial and optical digital interfaces, records at 44.1 or 48 kHz from analog and digital inputs, excel cond, \$1350. R Streicher, 818-359-8012.

HEAD RECONDITIONING
Restore your worn heads to original (new) performance specifications at a fraction of the replacement cost. Our laboratory services include:

- Digital/Optical & Electrical inspection
- Precision recontouring of heads
- Complete digital/optical alignment of assembly
- Exclusive "Audio Magnetic Head Test Report™" & Data Sheets

We also carry a full line of replacement heads and parts. Our 25 years of experience and reputation are unmatched in the industry.



MAGNETIC SCIENCES
249 Kennedy Road
P.O. Box 121 • Greendell, NJ 07839
Tel (201) 579-5773
Fax (201) 579-6021

Circle 51 On Reader Service Card

CLEAN PATCH BAYS NO DOWN TIME

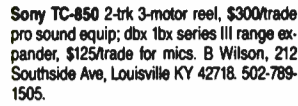

Sony TC-650 2-trk 3-motor reel, \$300/trade pro sound equip; dbx 1bx series III range expander, \$125/trade for mics. B Wilson, 212 Southside Ave, Louisville KY 42718. 502-789-1505.

Technics 1506 US 1/2-trk stereo tape machine, new heads, \$600. P Cibley, Cibley Music, 138 E 38 St, NY NY 10016. 212-986-2219

Revox A77 (3), PB only, fair cond, \$225 ea. B Spitzer, KKLK/KKMK, Box 460, Rapid City SD 57701. 605-343-6161.

Technics RS1506, 1/4", 1/2-trk, high speed, new heads, \$600. P Cibley, Cibley Music, 138 E 38th St, NY NY 10016. 212-986-2219.

Radio Syet RdDat rcrdr, used 6 mnths, \$2000. B Lord, Lord Brdcastg, 13313 SE 208th St, Kent WA 98042. 206-831-2374.

Stellavox SP-7, stereo & center rack, manual, PSU, flight case, \$1300/trade. C Collins, QI Prod, 30 W 21st St, NY NY 10010. 212-243-1186.

Ampex AG440-2, 351-2 w/Novonics 360 amps, AG 440 R/P amps, new AG 440 50 Hz motor, misc heads, parts & motors, Plus PC 2 video char gen & 16mm film editing gear. B Lindahl, 10680 SW Wedgewood, Portland OR 97225. 503-644-9643.

Magnecord 1022 stereo open reel, BO; (2) Magnecord 1021 mono open reel, BO. H Widsten, KGNB/KNBT, 1540 Loop 337 N, New Braunfels TX 78130. 512-625-7311.

Ampex 351 bridging input xfrms B-17331-1 (2), \$20 ea; (1) Ampex bridging input 4580116-10, \$20; (5) Ampex 440 bridging input 4580200-01, \$35 ea. J Newman, Box 1211, Newport RI 02840, 401-847-0455.

Revox PR-99 MKII 1/2-trk stereo reproducers (5), new in carton, \$1500 ea FOB. D Peluso, KJUL-FM, 2880 E Flamingo Rd #E, Las Vegas NV 89121. 702-732-2200.

HEAD RELAPPING/REPLACEMENT
All tape and film formats
30 years experience



350 N. Eric Drive
Palatine, IL 60067
708-358-4622

ITC REPAIR — REFURBISHMENT

Direct Factory Cartidge Machine Repair Service
Upgrades or Refurbishment
All Work Warranted

Call The ITC Technical Service Department
Toll-Free at
(800) 447-0414
(309) 828-1381

International Tapetronics Corporation
2425 South Main Street
Bloomington, IL 61704



Ampex AG-600 stereo, rack mount, \$250. B Kuchar, 1543 Eaton Ave, Bethlehem PA 18018. 717-645-8814.

Ampex 96440-01 plug-in Nuovistor mic preamps for 602 rcrdrs, \$35 ea; Ampex 351 full-trk head stack, complete, excel cond, \$75. J Newman, Box 1211, Newport RI 02840. 401-847-0455.

Scully 225 reproducer 1/2-trk stereo, BO. NW Ariz Brdcast Eng, 602-753-1995.

Sony DTC-1000 DAT R/P (4), excel cond, BO. B Evans, KBAC-FM, 740A St Michaela, Santa Fe NM. 505/471-7110.

Technics SLP-550 CD player, pro quality, auto rcrd level, edits cassette rcrdings, \$325; combo Teac AD-5 CD & auto-reverse cassette deck, auto dub from CD to cassette, \$325. Jeff, 15106-A Frederick Rd Box 309, Rockville MD 20850. 301-340-0466.

Ampex ATR 700, 7.5/15, in case, \$800/BO; (6) Revox A77 w/rack mounts, \$300/ea/BO; (2) Metrotech 1050 stereo PB, BO; (6) Scully 270 stereo PB, take 14" reels, BO; Schaller/Teac rack mount stereo R/P, BO. M McDaniel, WBTO, Linton IN 47441. 812-847-9830.

Ampex 350 1/2-trk mono, 14" reel transport and Lang SS R/P elec, \$450+freight. N Mishaan, POB 335, Lynbrook NY 11563. 516-582-1338.

Scully 225 reproducer 1/2-trk stereo, BO. NW Ariz Brdcast Eng, 602-753-1995.

Sony DTC-1000 DAT R/P (4), excel cond, BO. B Evans, KBAC-FM, 740A St Michaela, Santa Fe NM. 505/471-7110.

Technics SLP-550 CD player, pro quality, auto rcrd level, edits cassette rcrdings, \$325; combo Teac AD-5 CD & auto-reverse cassette deck, auto dub from CD to cassette, \$325. Jeff, 15106-A Frederick Rd Box 309, Rockville MD 20850. 301-340-0466.

Ampex AG-350 mono, \$500; AG440 mono, \$500; 3M M-56 8-chnl 1" full remote w/tape stock, \$2900; Sony TC854-4S w/dbx 154, \$900; Crown SX-701, \$250; Crown 800TX 4-chnl, \$300; Telex series 235 R-R stereo tape dup syst, (1) master w/spare, (4) slaves, new cond, \$600/BO. J Krepot, 7 Dustin Dr, Wilmington DE 19703. 302-798-4076.

Ampex 351 FT mono head-stack, housing, gate, cables, excel cond, \$70. J Newman, Box 1211, Newport RI 02840, 401-847-0455.

ITC 99B stereo w/ELSA, 2 yrs old, all tones, \$2800. B Downs, KTSR, Box 3248, Bryan TX 77805. 409-846-1150

VERTIGO BURNISHERS AND INJECTORS RESTORE ORIGINAL PERFORMANCE TO YOUR PATCH BAYS \$34.95 Ea.
Please write for additional information and order form today
VERTIGO RECORDING SERVICES
12115 Magnolia Blvd. #116 818-907-5161
North Hollywood, CA 91607 FAX: 818-784-3763

Ampex 351, (2), 30667-01-C, Simpson VU meters, excel cond, \$40 ea. J Newman, Box 1211, Newport RI 02840, 401-847-0455.

Tascam 34, like new, \$800; Teac A7300 mastering, 2-trk, gd cond, \$450; Teac A7030S 2-trk, gd cond, \$350; Teac A15004, mint cond, \$300; Tapesonic TR70 2-trk, gd cond, \$390. J Parsons, 10375 Cannas St, N Huntingdon PA 15642. 412-863-9590.

Ampex AG 440-2, 351-2 w/Novonics 360 amps, AG 440 R/P amps, new AG 440 50 Hz molder, misc heads, parts & motors. Plus PC 2 video character generator & 16mm film editing gear. Bob Lindahl, 10680 S.W. Wedgewood, Portland OR 97225. 503-644-9643.

Otari MX 5050 8 trk in excel cond, low hrs, w/remote controller; Otari MX 5050 2 trk in excel cond, low hrs. Bradford Technologies, 813-434-0800.

Want to Buy
Classic open reel recorders, pro-portable rcrdrs, logging machines, all models; also need open reel rcrdr accessories. J Morinelli, J Morinelli Entertain, 901 Fairfax Rd, Drexel Hill PA 19026, 215-789-2742.

Teac A7030SL, GSL; A7300; 3340SX, 3300SX; wrkg or not. J Parsons, 10375 Cannas St, N Huntingdon PA 15642. 412-863-9590.

Uher, all models and conds considered, also accessories, manuals, new parts stock, promo items, displays, ads. J Morinelli, J Morinelli Entertain, 901 Fairfax Rd, Drexel Hill PA 19026, 215-789-2742.

Ampex MR-70 in gd cond. D deForrest, 7441 Wayne Ave 10-D, Miami Beach FL 33141. 305-866-5401.

Magnecord PT6 reel hold down clamps (2), orig supplied w/rcrdr, silver w/springs, also need (4) reel hold down clamps for Revox A77. B Berry, Karavan Brdcast, 13 Montgomery Pl, Conroe TX 77384. 409-273-2801.

Ampex 440C, w/servo, gd op cond, w/out console. B Cummins, 212-219-3670.

Telex RP85 rcrding electronics. J Parsons, 10375 Cannas St, N Huntingdon PA 15642. 412-863-9590.

Uher taperecorders, all conditions considered, also accessories, manuals, new parts stock, promotional items & advertisements. J Morinelli Entertainments, 901 Fairfax Rd, Drexel Hill PA 19026. 1-800-666-2641.

Ampex MR-70, gd cond. D deForrest, 7441 Wayne Ave #10-D, Miami Beach FL 33141. 305-866-5401.

Ampex ATR100 taperecorders for parts. Circuit cards, heads, motors, machine parts, or electronic parts. Call 818-907-5161.

MCI/Sony capstan & reel motors, any cond., recdg heads, most mtgs, machines, new, used. Relapped then sold. Amp Services, 224 Datura St No 614, W Palm Beach FL 33401. 800-826-0601, in FL 305-659-4805.

CD's

Want to Sell
Adult contemporary library w/220 songs on CD & cart, incl 93 Golddiscs & 230 CDs, add'l 170 songs dubbed on Scotchcart IIs, \$13,000; country library w/1500 songs on 66 CD Golddiscs & 500 add'l Scotchcart IIs, \$8000; both used 6 months. B Lord, Lord Bdcg, 13313 SE 208th St, Kent WA 98402. 206-631-2374.

Want to Buy
Sound Ideas Series 1000 compact disc SFX library. D Miller, Airborne Audio, 11047 W 83 Ter, Lenexa KS 66214. 913-494-8992.

COMPUTERS

Want to Sell
IBM PCjr (2), BASIC, Lotus 1-2-3, keyboards, cables, software, uses CGA monitor, BO. B Harris, KXLT, 5350 S Roslyn St #210, Englewood CO 80111. 303-741-5654.

Tandy 6000HD II (2), w/printers, software, lots of disk space, excel cond, BO; Apple Macintosh Hypercard software pckge, new in box, BO. R Fess, WLRB/WKAS, 119 W Carroll St, Macomb IL 61455. 309-833-5561.

DISTRIBUTOR DIRECTORY

The following distributors serving the broadcast industry would be glad to help you with any of your requirements

SPENCER
Broadcast & Communications

AUDIO—THRU—RF
Where Service is #1
Radio Specialists
Now in our 12th year

CALL 602-242-2211
FAX 843-2860

... country, top 40, news, urban, talk, jazz, the classics, mixed bag ...

RADIO! The beat goes on!

CROUSE-KIMZEY OF ANNAPOLIS
tops in broadcast equipment

1-800-955-6800
ask for Kathleen

CORNELL-DUBILIER MICA CAPACITORS

FROM STOCK
JENNINGS VACUUM CAPACITORS

FROM STOCK
JENNINGS VACUUM RELAYS

SURBOM ASSOCIATES, INC.
2215 Faraday Ave., Suite A
Carlsbad, California 92008
(619) 438-4420

Use The Action-Gram For Immediate Action

THE SOURCE

CALL US FOR ALL YOUR NEW EQUIPMENT NEEDS
Toll free: 800-HOT-AMFM (800-468-2636)
305-651-5752
FAX: 305-654-1386
18620 N.E. 2nd Ave.
Miami FL 33179

ELECTREX COMPANY

Advertise Your Services Here for only \$40

Call
1-800-336-3045

CONSULTANTS

EVANS ASSOCIATES
Consulting Communications Engineers

FCC Applications, Design & Field Engineering
Broadcast Engineering Software

216 N. Green Bay Rd.
Thiensville, WI 53092

(414) 242-6000
Member AFCCE

W. LEE SIMMONS & ASSOC., INC.

BROADCAST TELECOMMUNICATIONS CONSULTANTS

1036 William Hilton Pkwy
Ste 200F
Hilton Head Is., SC 29928

(803) 785-4445

MAGRILL ENGINEERING
Radio Engineering Consultants

FCC Applications - Upgrades
Pre-purchase evaluations
Station planning & Design
Turnkey systems - Field service

Experienced, Economical & Fast

(904) 591-3005

Barry Magrill P.O. Box 1010
President Fairfield, FL 32634
Member IEEE

SOFTWARE
FM CHANNEL SEARCH

FM Database pool
MSDOS
EGA Graphics-Color
Broadcast Technical Consulting

Doug Vernier
Broadcast Consultant
1600 Picturesque Drive
Cedar Falls, IA 50613
319-266-8402

Consulting Communications Engineers

- FCC Data Bases
- FCC Applications and Field Engineering
- Frequency Searches and Coordination
- AM-FM-CATV-ITFS-LPTV

OWL ENGINEERING, INC.

1306 W. County Road. F,
St. Paul, MN 55112
(612)631-1338 "Member AFCCE"

Moffet, Larson & Johnson, Inc.
Consulting Telecommunications Engineers

Two Skyline Place
5203 Leesburg Pike # 800
Falls Church VA 22041
703-824-5660
800-523-3117
Member AFCCE

Huntsville Antenna Engineering

There is hope for AM radio!
AM station unipole antennas with circular polarization & beam tilt.
Broadband your present AM tower Series R shunt fed.

205-353-6747

Kenneth Casey
Consulting Radio Engineer

We Now Accept

Visa & MasterCard



MULLANEY ENGINEERING, INC.
Consulting Communications Engineers

- Design & Optimization of AM Directional Arrays
- Analysis for New Allocation, Site Relocation, And Upgrades
- AM FM TV LPTV Wireless Cable (MDS/MMDS/ITFS/OFS)
- Environmental Radiation Analysis
- Field Work *Expert Testimony

9049 Shady Grove Court
Gaithersburg, MD 20877
(301) 921-0115 Fax:(301) 590-9757
Member AFCCE

T.Z. Sawyer
Technical Consultants
1-800-255-AMDA

AM Directional Antenna Proofs
AM-FM-TV-LPTV
FCC Applications & Exhibits
Station Inspections

6204 Highland Drive
Chevy Chase, MD 20815-6610
Telefax 301-913-5799

RP Communications
Telecommunications

FCC Application Preparation
Custom Audio Console Design & Modification
Digital & Analog Recording & Broadcast Facilities Design
High Quality Field Recording

1/2 Intervale Ave
Burlington, VT 05401

802-862-7447

Don't gamble with your advertising dollars.

Advertise in Radio World and reach 18,000+ subscribers. Call 1-800-336-3045 today!

SERVICES

Steven L. Delay
AM/FM Broadcast Field Service

International & Domestic

Ground Systems	Field Intensity Measure
Broadcast Studios	Transmitting Facilities
Turnkey Construction	Purchase Evaluations
AM Directionals	
Microwave	

RR1-236 Pawnee, IL 62558
24 HR. 217-498-7339
FAX 217-498-8197

RF Components

Field phasing modifications and installation

Call Dave Gorman
215-249-9662

POB 401
Dublin PA 18917

new station construction field service AM directionals

RON KROB
broadcast technical consultant

4910 Four Star Court
Fort Collins, CO 80524 303 484 2704

TENCO TOWER

Lic. No. 357096

Installation & Maintenance of Broadcast & Communications Towers & Antennas

Donald J. Tenna

(916) 362-6846
(916) 638-8893
FAX: (916) 638-8858

9723 Folsom Blvd, Suite A
Sacramento, CA, U.S.A. 95827

SPECIALIZING IN ERECTION, REPAIRING, PAINTING AND MAINTENANCE RADIO, TWO-WAY, T.V. TOWERS AND FLAG POLES

A STEEPLEJACK CO.
PAINTING AND STEEPLEJACK CONTRACTORS

FULLY INSURED FOR YOUR PROTECTION

DON HIGLEY 3722 ROMA
713-462-6105 HOUSTON, TEXAS 77080

Communications Data Services, Inc.

- Real World Propagation™ Studies
- On-Line Services
- 3 Second Terrain Data on CD-ROM
- FCC and FAA Data Files for PC
- FCC's AM, FM & TV Data Files for PC
- PC Programs

Richard L. & Richard P. Biby, Principals

Communications Data Services, Inc.
6105-E Arlington Blvd • Falls Church, VA 22044
(703) 534-0034 • (800) 441-0034

MIRKWOOD ENGINEERING

Rural & Remote Site Field Engineering

50 Park Ave.
Claremont, NH 03743

603/542-6784

PARAMOUNT
COMMUNICATION SYSTEMS

INSTALLATION AND SERVICE OF BROADCAST ANTENNA SYSTEMS/TOWER MAINTENANCE & ERECTION

WESTMONT, NJ (609) 869-0222

THIS SPACE AVAILABLE

CALL
1-703-998-7600

Contact Radio World Newspaper for availabilities.
P.O. Box 1214 • Falls Church VA • 22041

1-800-336-3045



COMPUTERS . . . WTS

Okidata 82A printers, (1) good, (1) for parts, \$100/both. E Moody, KESE/KJEM, 216 N Main, Bentonville AR 72712. 501-273-9039.

Laser Compact XT, 640K RAM, 10 MHz, 5 1/4" & 3 1/2" drives, clock/calendar, CGA color mon, MD-DOS 3.3, BASIC, all manuals, like new, \$650; Panasonic KXP-1180 printer, \$140. M Martin, KWNO, POB 466, Winona MN 55967. 507-454-2918.

Want to Buy

Apple IIE WP software; Radio Shack TRS-80 WP software. E Stanley, KBTO, Box 12, Bottineau ND 58318. 701-228-2483.

CONSOLES**Want to Sell**

Audix 12 chnl stereo console, fair cond, w/IB, \$1500+shipping. J Sellmeyer, Rt 1 Box 270, McKinney TX 75069. 214-542-2056.

Cetec Centurion I, 18 chnl input, 3 outputs, fair cond, just removed from service, \$1150. R Beierle, KFYR-TV, 200 N 4th St, Bismarck ND 58501. 701-255-5757.

Rockwell Mark 8 stereo 8 chnl, slightly modified, gd cond, in service, avail late summer, sell/trade. B Harris, KXLT, 5350 S Roslyn St #210, Engelwood CO 80111. 303-741-5654.

Cetec 12-chnl mixing board, (2) phono cap & echo/effect sends, great for road/multi-trk use, \$400/BO. Lynn, World Class, POB 7055, Redlands CA 92375. 714-798-6483.

TAC Matchless studio console, 26 inputs, 24 buss, 8 aux sends, great EQ, 2 mute groups, full TT patch bay, 5 yrs old, \$14,000. J Block, Production Block, 906 E 5th St, Austin TX 78702. 512-472-8975.

Tascam 3 recording mixer, 8 mic or line ins, 4 outs w/4 VU, sep 8x2 mixer, like new, \$500; Ramko DAG R/E mono dist amp, line in, 6 line outs, \$100; Magnecorder PT6-1M4 mixer, 4 Dawn 30/60 ohm pots, XLR conn rack panel, \$25. E Davison, 135 N IL, Springfield IL 62702. 217-787-0800.

Tascam M-520, 20x8x2 multi-trk console, mint cond, BO. R Kaufman, Pams Prod, POB 462247, Garland TX 75046. 214-271-7625 (after 3PM).

Sony MX-16 8x4 mixer, mic/line inputs, input pad, headphone mon, slider pots, excel cond, you ship, \$150. G Hutchins, WZAP, POB 369, Bristol VA 24203. 703-669-6950.

Ramco SC-5M w/manual, \$550. R Chambers, KSUE AM/FM, 3-15 Johnstonville Rd, Susanville CA 96130. 916-257-2121.

Soundcraft 400B, 24-chnl, manual, flight case, small lights, great board, \$4500. P Thompson, Moonlight Sound, 4763 WCR 32, Longmont CO 80504. 303-535-4748.

Teac 144 Portastudio, 4 chnl stereo board w/high speed cassette, excel cond, w/manual, \$200/BO. R Fess, WLRB/WKAS, 119 W Carroll St, Macomb IL 61455. 309-833-5561.

Ramsa T820B, 1.5 yrs old, 20x16x8x2, perfect production board w/8 trk, all manuals, \$4000. K Thomas, Rebel Recording, 5555 Radio Ln, Jacksonville FL 32205. 904-388-7711.

Collins vintage remote mixer, used for Boston Red Sox broadcasts, BO. T Heathwood, Heritage Radio, POB 16, Boston MA 02167. 617-969-9966.

Trident VFM 24x8 mixing console w/road case, \$2500. D Furhey, Audio Center, 1812 Brim, Toledo OH 43613. 419-474-4301.

Quantum QM-8 8 inputs, 4 busses, quad & stereo mon, +4 dBm nom, +18 dBm max, Irg Triad input xfrms, Duncan linear faders, audiophile qual, excel cond, \$475/BO/trade. R Katz, Allegro Sound, 15015 Ventura Blvd, Sherman Oaks CA 91403. 213-859-5543.

Sphere 32x24 console w/Ampex MM1000 24-trk rcrdr, \$27,000/both. Tiki Recording Studios, 195 S 26th St, San Jose CA 95116. 408-286-4091.

Altec-Lansing 12-pot 3-chnl board, can run FM stereo and AM mono at same time, BO. J Randolph, WHIR/WMGCE, Box 1230, Danville KY 40422. 606-236-2711.

Cetec Centurion I audio console, 18 input modules, 3 outputs, \$1100. R Beierle, KFYR-TV, 200 N 4th St, Bismarck ND 58501. 701-255-5757.

Quantum 12A cust mixing console, 12 inputs w/indepen pan and assign to 4 output busses, stereo mon section for 4 busses or 8-chnl tape returns, full stereo 2-chnl effects/echo-sends and returns, sep 2-chnl headphone monitoring, indepen headphone cue buss, lots more features, excel cond, \$2800. R Streicher, 818-359-8012.

Ramko DC-8M touch control w/books; Gates Yard transistor; BO ea. M McDaniel, WBTO, Linton IN 47441. 812-847-9830.

RCA BC-50, stereo/mono operation, 120 inputs, pwr and backup supply, spare parts and components, excel cond, \$400+shipping. W Tinsley, Public TV, 1123 Holcomb St, Watertown NY 13601. 315-788-3549.

Sparta AS30B, fair cond w/efw mod; Ramko DC5MS, fair cond; CCA Ultimate III 10-chnl stereo/mono, fair cond w/efw mod; all BO by 6/91. B Spitzer, KKLS/KKMK, Box 460, Rapid City SD 57701. 605-343-6161.

Allen and Heath CMC-24 24-chnl studio board w/built-in computer patching, excel cond, \$2500. D Hunt, Finestkind Stereo, 284 Maine St, Brunswick ME 04011. 207-729-8815.

Shure M67 mixer & RCA version of same, both in excel cond, \$125 ea. H Biller, 108 Hamilton Ave, Silver Spring MD 20901. 301-565-2798.

McCurdy SS8500 series console, (11) stereo faders and machine controls, (4) prog busses and meters, digital clock and up/down counter, (4) EQ chnl, intercom talkback and select, numerous features, clean, \$2950/firm. W Clark, Clark and Assoc, 318 E Calhoun, Macomb IL 61455. 309-837-2244.

Sony MX-16 8x4 mixer, slider pots, mic/line select switch, headphone output, input pad, grt cond, \$150. G Hutchins, WZAP, POB 369, Bristol VA 24203. 703-669-6950.

Radio Systems ESA 10 stereo, excel cond w/manuals, \$5000/BO; Gates Stereo Statesman, gd cond, \$400; both \$5000. B Shannon, WKZA, 5158 Countryside Dr, McKean PA 16426. 814-476-7426.

Autogram IC-10, well-maintained stereo, 10-chnl, gd cond, \$3250. T McGinley, Cook Inlet, 630 Ivy Ln, Greenbelt MD 20778. 301-441-3332.

Gates Executive stereo 10-chnl console, \$500. G Kneisley, WEOL-WNWX, POB 4006, Elyria OH 44036. 216-322-3761.

Audix MXT1000 8-chnl master mix down, English quality, \$1500; Yamaha PM700 12x2x2 PA mixer, \$400; Shure 8x1 rack mount audio console, \$180; UREI Cooper time cube & MXR flanger-doubler, \$450. J Krepl, 7 Dustin Dr, Wilmington DE 19703. 302-798-4076.

Gately, 18 chnl, 2 out, Irg 5" meters, oak frame, \$1000; Pyramid PR8800 echo mixer, 8 chnl, 2 out, new in box, \$400. J Parsons, 10375 Cannas St, N Huntingdon PA 15842. 412-863-9590.

BE 250 series 8M mixing board, gd cond, \$1000/BO. Charlie, WRGW, Marvin Cir Rm 428, Washington DC 20052. 202-994-7314.

Sparta AC-155 studio ctrl & remote w/(2) TT, BO. A Terry, WODY, Box 545, Bassett VA 24055. 703-629-5900.

Tascam M-520 20-chnl prod board, 8 subs, perfect 8 or 16 lk console, excel cond, used 6 months, \$3500. D Miller, Airborne Audio, 11047 W 83 Ter, Lenexa KS 66214. 913-494-8992.

Henry Dub Center mixer-fastrac, dubs music library to carts w/out tying up board, \$400. B Lord, Lord Bdrctg, 13313 SE 208th St, Kent WA 98042. 206-631-2374.

Want to Buy

Wheatstone 12 chnl console or equivalent; also, Otari MX50 rcrdr & Yamaha SPX 900 effects processor. R Chambers, KSUE AM/FM, 3-15 Johnstonville Rd, Susanville CA 96130. 916-257-2121.

Gates Ambassador or President cards & spare parts incl preamps, TT amps & misc parts. J Mitchell, KSTL, 814 N 3rd St, St Louis MO 63102. 314-645-4649.

WE, RCA tube mixers and consoles, stock or custom, related brdctst and rcrding equip and literature. R Van Dyke, Caffrey House, 2 Squires Ave, E Quogue NY 11942. 516-728-9835.

Sony MX-16, MX20, wrkg or not. J Parsons, 10375 Cannas St, N Huntingdon PA 15842. 412-863-9590.

API or Neve, esp API 550A and 550B; also, same mfrs EQ and other modules, anything considered. J Kreines, DeMott/Kreines Films, 5330 Kennedy Ave, Millbrook AL 36054. 205-285-6179.

Collins 212B or Altec 230B, wrkg. R Osborne, WMVO, Box 667, Ravenswood WV 26164. 304-273-2544.

Sony MX16 or MX20. J Parsons, 10375 Cannas St, N Huntingdon PA 15842. 412-863-9590.

LPB Signature Series S-21, 10 chnl dual mono, 3 inputs/chnl, gd cond. B Pitts, 205-487-6400.

Tangent 3216, I/O, echo, master modules, wrkg cond. B Cummins, 212-219-3670.

Gates 10 chnl stereo executive, gd cond. J Gunton, WECM, 703 Berryhill Rd, Milton FL 32570. 904-623-1490.

8 to 10 chnl stereo console. D Van Zandt, WJLU, 2596 State Rd 44, New Smyrna FL 32168. 904-427-9000.

DISCO & SOUND EQUIPMENT**Want to Sell**

Technics 1200 Numark JBL disco sound system, (2) speakers, Biamp 250 amp, (2) TTs, excel cond, \$2500. H Bous, Amer Comm Sound, 1204 Axtell Dr, Cayce SC 29033. 803-791-3804.

Yamaha SPX-90 II, effect box, like new, \$400. K Thomas, Rebel Recording, 5555 Radio Ln, Jacksonville FL 32205. 904-388-7711.

Soundolier 510-5 aluminum can baffles for 5" spkr (6), new in cartons, \$25/lot; Soundolier flush ceiling baffles for 8" spkr, (7) 67-8 louvared & (10) 68-8 low ceiling diffuser, all new, \$3/ea, min \$15; intercom sub stations, new, (4) Rauland 45 ohm & (3) Bogen 16 ohm, \$5/ea, min \$15. E Davison, 135 N Illinois, Springfield IL 62702. 217-787-0800.

Publison Internal Machine 90, digital reverb, pitch shifting, delay, sampling memory, MIDI interface, independent stereo in/stereo out, BO. R Kaufman, Pams Prod, POB 462247, Garland TX 75046. 214-271-7625 (after 3PM).

Snake cable, 12 shielded pairs, XLR male/female each end, 100'; \$75. E Davison, 135 N Illinois, Springfield IL 62702. 217-787-0800.

JBL/Crown PA w/PM 700 Yamaha 1176 comp limiter, PS 400, Biamp 250, 8 mics, snake, JBL speakers, (2) monitors, vgc, \$3500. H Bous, Amer Comm Sound, 1204 Axtell Dr, Cayce SC 29033. 803-791-3804.

Snake 16 phantom-pwr inputs w/eq ps, 250' Belden 19-pair cable w/mil connectors & stnlss-steel strain reliefs, 10' Neumann XLR snake mates w/box or Belden snake, excel cond, \$575/BO/trade. R Katz, Allegro Sound, 15015 Ventura Blvd, Sherman Oaks CA 91403. 213-859-5543.

Studio Sound S-305 passive filter sets (2), matched pair, rack mount, very rare, \$175 ea. R Katz, Allegro Sound, 15015 Ventura Blvd, Sherman Oaks CA 91403. 213-859-5543.

Carvin 973 carpet-covered 3-way PA loudspkr w/metal comers, steel grill and handles, 15" woofer, 6 1/2" mid, tweeter, 400 W, bi-amp jacks, like new, \$400/pair. B Fisher, KPOK, 122 S Main St, Bowman ND 58623. 701-523-3883.

University spkr, N-3 crossovers, C63W woofers, HF206 tweeters, T30/H600 midranges, \$30 ea; (2) Ampex/JBL unmounted 12-ohm 7" spkr for 600 series portable spkr-amps, excel cond, \$50 ea. J Newman, Box 1211, Newport RI 02840. 401-847-0455.

Rane MA6, (6) 100 W chnl, like new, \$575; Rane SM6 splitter/mixer, \$225. M Norman, KCCU-FM, 2800 W Gore, Lawton OK 73505. 405-581-2425.

24TK recording studio, fully equip, call for details, \$55,000; fully equip cassette dupl plant, Ampex BLM 200A w/(5) 3400 slaves like new, 32-1 and 64-1, mastering, loading, wrapping, \$55,000. Lundy Tape Duplicators, POB 408, Heidrick KY 40949. 606-546-6650.

Yamaha REV-7 digital signal processor, 90 pre-set and user definable programs for reverb, echo, time-delay, w/remote, like new, \$685/BO. R Streicher, 818-359-8012.

JVC SEA-10 (2), 5-band EQ, unbalanced I/O; Bose 802E active EQ for (2) Bose spkr; all BO by 6/91. B Spitzer, KKLS/KKMK, Box 460, Rapid City SD 57701. 605-343-6161.

Technics 2 TT disco biamped, \$2500; JBL/Crown sound system, Yamaha PM700, (10) mics, snake, 1500 W at 8 ohms, biamped, \$3000. H Bous, WJUSC, 1204 Axtell Dr, Cayce SC 29033. 803-791-3804.

JBL/Century 4312/L-100, orig & studio cons, all US made, (4) avail, new, \$550 pair. C Keith, 9 Roxbury, Keene NH 03431. 603-352-8460.

Peavey 19-10D Anvil-type ampeffects flight case (2), 6-space case w/16 1/2" depth, heavy duty w/recessed latches, black formica-type shell w/metal comers, \$300 pair/\$175 ea. B Fisher, KPOK, POB 477, Bowman ND 58623. 701-523-3883.

Ampex/JBL unmounted 12-ohm 7" speakers (2) for 600-series portable speaker-amps, excel cond, \$50 ea. J Newman, Box 1211, Newport RI 02840. 401-847-0455.

University speaker components: (2) N-3 adjustable L/C networks, \$20 ea; (2) C-63-W adjustable-response 15" woofers, \$20 ea; (2) HF-206 hypersonic tweeters (drvs & horns), \$40 ea; (2) T-30 mid-range drvs & H-600 horns assemblies, \$30 ea. J Newman, Box 1211, Newport RI 02840. 401-847-0455.

Lexicon PCM-60 digital reverb, gd cond, \$500+shipping. D Glasser, Airshow, 7021 Woodland Dr, Springfield VA 22151. 703-642-9035.

dbx RM155 8-chnl NR unit, like new, \$750/BO. D Huettner, Dynamic Sound, 358 Bell St, Neenah WI 54956. 414-722-7228.

Russco Disco 421 compact prod mixer, brdct quality, (2) phono, line & mic inputs, 3-band tone controls, headphone cue & metering functions, excel cond, \$250; pair Altec 617-8A 12" co-axial mns, spkr only, new, still in boxes, \$350/pair. Jeff, 15106-A Frederick Rd Box 309, Rockville MD 20850. 301-340-0466.

FINANCIAL SERVICES**EQUIPMENT FINANCING "LOANS BY PHONE"**

- NO FINANCIALS REQUIRED FOR TRANSACTIONS UNDER \$35,000
- NEW OR USED EQUIPMENT
- \$2,000 TO \$200,000
- NO DOWN PAYMENT
- SALE-LEASEBACK EQUIPMENT FOR WORKING CAPITAL

TO APPLY OR REQUEST ADDITIONAL INFORMATION CONTACT MARK WILSON

ENF EXCHANGE NATIONAL FUNDING (800) 275-0185 FAX: (214) 235-5452

LIMITERS**Want to Sell**

Orban Optimod 8000, clean unit, \$575/BO. B Gray, Gray Audio, 223 W Mountain Rd, W Simsbury CT 06092. 203-658-7786.

CBS 411 & 410, stereo 411 Volumax converted to flat response, mono 410 FM Volumax. H Kneller, WKIL, 3151 Cooper St, Punta Gorda FL 33950. 813-639-1112.

Kahn Symmetra-Peak SP58-1A (2), \$250 ea. L Bruce, WROR, 3 Fenway Plaza, Boston MA 02215. 617-236-6841.

Harris Solid Statesman FM (2), BO; Spot-master FM sound briener, 2-chnl AGC/peak limiter, BO. K Stokes, WKJN, 3029 Sherwood Forest #200, Baton Rouge LA 70816. 504-292-9556.

Optimod 8000A \$1495 & UP 414-482-2638

Dorrugh 310 processor, AM/FM, gd cond, \$900+shipping. J Sellmeyer, Rt 1 Box 270, McKinney TX 75069. 214-542-2056.

Modulation Assoc CP 803, gd cond. C Edwards, WWJM, 210 S Jackson St, New Lex OH 43764. 614-342-1988.

Harris MSP-90 dual AM peak limiter, \$500. H Kneller, WKIL, 3151 Cooper St, Punta Gorda FL 33950. 813-639-1112.

Dorrugh DAP-310, tri-band audio processors w/AM limiter cards, FM limiter cards & alignment system card, vgc, recently removed from service, \$700+shipping. Bill, DeFelicce Prod, 93-2R Fowler St, New Haven CT 06515. 203-397-2595.

CRL complete 3-piece AM processor, w/preparation processor, spectral energy processor & NRSC clipper matrix unit, like new, \$2000. R Wright, 1208 N Locust Ave, Lawrenceburg TN 38464. 615-762-6200.

UREI LA-4 (2), trade for MAP II AM processor. J Randolph, WHIR/WMGCE, Box 1230, Danville KY 40422. 606-236-2711.

Mod Sciences Stereomaxx, excel cond, \$1800; Optimod XT2 accessory chassis, \$1300/swap for gd 8000A; Howe 2300 Phase Chaser (2), as-is cond, late models, \$800 ea. M Sadacca, KCKC-KBON, 740 W 4th St, San Bernardino CA 92410. 714-882-2575.

Texar Prizm, stereo, digital controlled processor and Texar Card 5 for Orban Optimod, \$2000; Vigilanti Audio Processor, \$1500. G Kneisley, WEOL-WNWX, POB 4006, Elyria OH 44036. 216-322-3761.

Aphex Compellor, 2-chnl, mint cond in box, w/manuals, \$975/BO. B Mitchell, KMXX-FM, 4745 N 7th St, Phoenix AZ 85014. 602-545-8181.

Audimax 4450A, gd cond w/manual; Volu-max 4110, gd cond w/manual; both BO by 6/91. B Spitzer, KKLS/KKMK, Box 460, Rapid City SD 57701. 605-343-6161.

Cutting Edge Tech Dividend composite filter processor, new w/manuals, \$1500/BO. D Mettler, WFBQ/WNDE, 6161 Fall Creek Rd, Indianapolis IN 46220. 317-257-7565.

CBS Audimax 4450; CRL APP 300; CBS Volumax 411; all BO. NW Ariz Brdct Eng, 602-753-1995.

Optimod 8000A, gd cond, used for back up, \$1700. B Watson, KSAC, 1551 E Amhr, W Covina CA 91792. 714-946-6249.

CRL SEP-400A, mono, \$100; CRL SEP-400B, mono, \$100; (2) Valley Ppl Dynamite, 2-chnl, \$175 ea/\$300 pair; CBS Labs Volumax 4000, mono, \$75. P Walkowiak, WWWWM, POB 167581, Oregon OH 43616. 419-255-1470.

CRL FM stereo units: SPP800 preparation processor, SMP800 mod processor, (2) SEP400B spectral energy processors, right/left chnl, \$G800 gen, \$1900/all. M Golub, WMJS, POB 547, Prince Frederick MD 20678. 301-535-2201.

Valley Ppl V/P-440 limiter/comp/DSP, used 6 months, \$300. B Lord, Lord Bdrctg, 13313 SE 208th St, Kent WA 98042. 206-631-2374.

Gates Solid Statesman AGC (2), \$250/pair. H Widsten, KGNB/KNBT, 1540 Loop 337 N, New Braunfels TX 76130. 512-625-7311.

Optimod 8000, recently factory rebuilt, \$1600. E Moody, KESE/KJEM, 216 N Main, Bentonville AR 72712. 501-273-9039.

Want to Buy

Dorrugh DAP or similar multi-band AM processor, under \$200. Tim, WOVW/WLFH, 341 S Second St, Little Falls NY 13365. 315-866-1230.

Orban Optimod 8100A. D Brooks, WCIC-FM, 3263 Court St, Pekin IL 61554. 309-353-9191.

Fairchild 660/670, Teletronix LA2A and LA3A, other tube compressors and limiters, other tube signal processing equip. J Kreines, DeMott/Kreines Films, 5330 Kennedy Ave, Millbrook AL 36054. 205-285-6179.

Optimod AM 9000 audio limiter/compressor, prefer converted w/NRSC. A Crain, WAVN, Rt 6 Box 25, Bayahia MS 38611. 801-895-6483.

Symetrix CL150B basic compressor. M Smith, WNYR, POB 98, Waterloo NY 13165. 315-539-5671.

Optimod 8000A, will pay cash, leave message at 703-276-0125.

MICROPHONES

MICROPHONES . . . WTS

Sennheiser MD 421 in new cond w/case, \$300. E Welch, 182 Monitor Cir, Moncks Corner SC 29461. 803-761-7583.

MISCELLANEOUS

Want to Sell

Altec line xfrmer plug-ins, (7), red, 15095, \$20 ea; (2) black Altec line xfrmers, 15356A, \$20 ea; (2) green Altec mic xfrmr, 4722, \$20 ea. J Newman, Box 1211, Newport RI 02840, 401-647-0455.

Racks, 19", 72" & 60", you ship, \$100; BNC patch bay 19" rack panel, BO, C Porter, WEAZ, POB 498, Carthage IL 62739. 217-357-3128.

CS Inc 302 music on hold, interface 5 lines on 6-button Bell phones, most working, \$25/ea or \$100/lot; Bogen SAM phone/page interface, new, \$50/BO. E Davison, 135 N Illinois, Springfield IL 62702. 217-787-0800.

Transformers for tube equip, new & like new: Thordarson T1SS93, T17R31, T75C61; Stan-cor A4701; UTC LS31 (2), LS30, LS32, LS34, LS141 (2), LS151, S31, S33, S34, S40, HA100, HA100X, HA101, HA101X, HA130X, HA133 (2); very low prices, call w/BO. E Davison, 135 N Illinois, Springfield IL 62702. 217-787-0800.

Rotron Blowers for Ecom, CCA, CSI, McMartin, Harris, rebuilt & new. Goodrich Enterprises Inc. 11435 Manderson St., Omaha, NE 68164 402 493 1886 FAX 402 331 0638

Various WE phones, key & 1 line, wall & desk, also key relay, sep lamps, pwr plants w/irrigating current, call for details; Raymer TPA-1 telephone interface to page amp (2), w/talk battery, relay closure, \$35 ea. E Davison, 135 N Illinois, Springfield IL 62702. 217-787-0800.

TIE E300C telephone, new, TT dial, 10 buttons, \$50; conf call switch, bridges up to 5 lines together on Bell-style 6 button key phones, new, \$25; WE Magneto phones, modern w/handset, like new, \$100/PR; wall phone, single numb auto dialer, red, new, \$35. E Davison, 135 N Illinois, Springfield IL 62702. 217-787-0800.

Toshiba Strata telephone systems (3); #1 has 10 lines, 10 phones; #2 has 20 lines, 20 phones; #3 has 8 lines, 20 phones; \$1000 to \$2500. Roman, World Video, 10625 Scripps, San Diego CA 92131. 619-695-1045.

Blonder Tongue AMT audio modulator for TV chnl 10, puts a radio on MATV systems, \$75. E Davison, 135 N IL, Springfield IL 62702. 217-787-0800.

Catel FMS 2000 FM stereo modulator, used 3 months, \$560. D Dennon, TPMD, 448 La Paloma, El Sobrante CA 94803. 415-222-5078.

KOSS ESP-10 electrostatic headphones, compl syst w/pwring module and (2) headphones, \$100; AKG K-240 headphones, passive radiator design, dynamic, circumaural phones, cable repaired, gd cond, \$40. R Streicher, 818-359-8012.

Patch bays, many audio and video avail, \$20 ea. W Tinsley, Public TV, 1123 Holcomb St, Watertown NY 13601. 315-788-3549.

USED EQUIPMENT

Water & Air Cooled Loads Hand-held Wattmeters Directional Couplers Rigid Line Components 40 kW FM Combiner AM Sampling Loops GE & Sola Voltage Regulators ROSCOM GENERAL Bob Stewart (404) 992-2230

Stancil-Hoffman mag film/video degausser; music library of (95) 15 ips tapes, (48) 12" dbl-side records; (2) lg matching audio spkrs; aluminum pole-cat set; much more, send for list. B Howard, Academy Film Prod, 3918 W Estes, Lincolnwood IL 60645. 708-674-2122.

NBC NM-50 passive telephone (nemo) EQ, \$50 vintage, \$75. B Kuhar, 1543 Eaton Ave, Bethlehem PA 18018. 717-645-8814.

Audio xfrms, Peerless, Ampex, Triad, VTC, input, matching, isolation, \$15 ea. S Lawson, KAK Prod, 928 Hyland Dr, Santa Rosa CA 95404. 707-528-4055.

ADC PJ341 snl and dbl jack strips w/rack mount mats and 10' numbered pigtails; (5) Xmas tree terminals; (12) Switchcraft 17QF17 3" patch cords, some new; (2) Weatherbark 20-key keyboards, terminated in 5 pin 180° DIN plug; all BO by 6/91. B Spitzer, KKL/S/KMKM, Box 460, Rapid City SD 57701. 605-343-6161.

Peerless xformer line, Altec octal plug-in, red #15095, green #4722, black #15356A, \$20 ea. J Newman, Box 1211, Newport RI 02840. 401-647-0455.

M-Print Central, manual pad printer, used to print directly onto audio cassettes or other items, w/instruct video, \$900. F Scheidt, Scheidt Audio, 15 Charlotte St, Rochester NY 14607. 716-232-5210.

DIGITAL AUDIO The best prices on RDAT digital audio tape decks and CD players. ROSCOM GENERAL Bob Stewart 404-992-2230

Music on hold interface to 1A2 phone systs, up to 5 lines, \$25 ea; 10 for \$100; Bogen Sam phone page interface, new, \$50/BO; Plantronics miniature operators headsets (2), w/289B DBL plug, new, \$25; WE 52 headsets w/289B plugs, jacks, gd cond, \$25; (2) Magneto field phones in Stell case, w/handsets, \$75/BO; snl numb dealer red wall phone, new, \$35/BO. E Davison, 135 N Illinois, Springfield IL 62702. 217-787-0800.

Gentner FBTRB prewire bay (10), \$225 ea; Gentner GEC-10A stereo prog switcher, \$400; Gentner GEC-FB-100 Headblock, SIE-MF2250, \$24 ea; Jim Long digital Dyaxis 320 MEG, w/Apple ICX, for digital editing, used 6 mths, \$8000. B Lord, Lord Brcdstg, 13313 SE 208th St, Kent WA 98042. 206-631-2374.

Reach Elec VIP II pagers (25); Liaison Reach dial access paging terminal; Texas Instrument data terminal; BTC SCA gen; Belar SCM SCA mac, manuals & cables; \$7995/BO. B McMa-kus, KZJH-FM, Box 2620, Jackson WY 83001. 307-733-1770.

Power Phase monitor relay, 3PH, 190-270 V, adjust trip protects xmtrs, new cond, \$25; Tone Commander RT-1900 touch-tone 19 station intercom, decodes 19 TT combinations to a relay output, new cond, \$75; telephone syst 400 line cards for 1A2 key systs, misc: relays, dials, bulls eye lights & bulbs, bells & pwr supplies, call for details. E Davison, 135 N Illinois, Springfield IL 62702. 217-787-0800.

FREE 56-PG CATALOG Complete line of audio modules and accessories for all engineered sound & broadcast applications MODULAR AUDIO PRODUCTS 1-800-333-7697 1-516-345-3100 FAX 516-345-3166 DIV OF MODULAR DEVICES INC 1 RONED RD • SHIRLEY NY 11467

Circle 27 On Reader Service Card

Data Signal MTI-700 modular telephone; (3) RCA Tactec programmable trunking mobile; 3M FAX machine; all BO. NW Ariz Brcdst Eng, 602-753-1995.

Wilkinson mod xfrmer & high voltage xfrmer for 2.5 kW AM Wilkenson xmtr, BO; Collins xfrmers, (4) 115 V primary & (2) 900V CT secondaries, BO. A Terry, WODY, Box 545, Bassett VA 24055. 703-629-5900.

RCA AVQ-21 WX radar system, \$400. D Fant, OK Two-Way, 413 NE 38 Ter, Oklahoma City OK 73105. 405-528-6467.

Sparta Elec misc audio & RF tech manuals, request list. D Peluso, KJUL-FM, 2880 E Flamingo Rd #E, Las Vegas NV 89121. 702-732-2200.

Sony RMM501 type-5 rack mount kits (6), never used, \$800. D Jordan, WDTM Inc, POB 3417, Jackson TN 38503. 901-668-1153.

FM Broadcasters: Are you interested in a listener owned Real-Time Clock Radio-system that would increase ratings? Contact Bob Lloyd, 400 N Acacia Ave, Apt C-32, Fullerton CA 92831.

Gramplan cutter head, 1D feedback (tand-berg); patch bays (4) 24 inputs single, also patch cords; Edital block for recorders 1". Mr. Oliver, 212-874-7660 in afternoons.

Lead screw for Presto 6N cutter, 120 lines; Edital 1" block for splicing tape; Audiohead alignment tape 7.5-15 ips 1/4" tape; Dynakit PAS II pre-amp. Mr. Oliver, 212-874-7660 in afternoons.

Cannon plugs, 3 prong, male & female, new tubes & resistors cheap; Lafayette TE22 audio gen; Sencore transistor & diode tester; manuals for Ampex, Pultec, others. Mr. Oliver, 212-874-7660 in afternoons.

Naval observatory clock, brown case, cream face, used by ABC radio & affiliates in the '40s/'50s, REA light flashes with reset. T Heathwood, Heritage Radio, POB 16, Boston MA 02167. 617-969-9966.

Want to Buy

Naval observatory clock, brown case, cream face, used by ABC radio & affiliates in the '40s/'50s, REA light flashes with reset. T Heathwood, Heritage Radio, POB 16, Boston MA 02167. 617-969-9966.

Military J-38 hand key and/or Vibroplex bug key, HS-30 head set. N Allebaugh, WICE, 100 John St, Cumberland RI 02864. 401-725-9000.

Leitch CLK analog impulse clocks; McCurdy SA137 timer displays; McCurdy SA138 clock displays; RCA Broadcast News. B Kuhar, 1543 Eaton Ave, Bethlehem PA 18018. 717-645-8814.

Heathkit weather station and accessories, latest model, computer interfactable, other models considered. Mike, MRG Assoc, 95 Colony Dr, Holbrook NY 11741. 516-447-1041.

Harrison Labs 8140A schematic/manual. O Diaz, KRON-TV, 1001 Van Ness Ave, San Francisco CA 94109. 415-661-8617.

Jazz record collections, 10" LP/12" LP bebop, swing, dixie, highest prices paid. B Rose, Program Recdgs, 228 East 10th, NNY 10003. 212-674-3060.

MONITORS

Want to Sell

Belar AMM-1 AM mod mon, \$500. R Wright, 1208 N Locust Ave, Lawrenceburg TN 38464. 615-762-6200.

McMartin TBM-1500 AM mod mon, excel cond, \$500+shipping; Belar RFA-2 AM RF amp, excel cond, \$450+shipping, J Sellmeyer, Rt 1 Box 270, McKinney TX 75069. 214-542-2056.

TFT 760 EBS AM rcvr/gen/decoder, needs work, fair cond, BO. B Harris, KXLT, 5350 S Roslyn St #210, Englewood CO 80111. 303-741-5654.

Harris FT80/FS80/FC80, working when removed, no crystal, \$750/set of 3. D Bryan, WCZA, POB 498, Carthage IL 62321. 217-357-3128.

TFT 724 AM mod mon w/preselector, \$750. S King, KATP, 7701 I-40 W Ste 660, Amarillo TX 79160. 806-359-5999.

TFT 760 EBS system w/one gen and decoder cards, no rcvr, \$250/BO. L Fuss, WDTL, POB 159, Fayetteville GA 30214. 404-460-6159.

General Radio 1931-B AM mod mon, gd cond when removed, BO. A Terry, WODY, Box 545, Bassett VA 24055. 703-629-5900.

RCA-75A FM mod monitor; RCA-85A FM stereo mod monitor, new caps, calibrated at Belar, 1/22/91. Excellent condition, freq 102.7 w/McMartin RF amp, \$1200. 614-655-2057.

Want to Buy

FM mon in gd cond. D Van Zandt, WJLU, 2596 State Rd 44, New Smyrna FL 32168. 904-427-9000.

Felar FMM-1 & FMS or comparable. L Maierhofer, WTGC/WUNS, 101 Armory Blvd, Lewisburg PA 17837. 717-523-3271.

Any older McMartin mod monitors. C Goodrich, 11435 Manderson, Omaha NE 68164. 402-493-1886.

MOVIE PROD EQUIP

Want to Sell

Stancil-Hoffman portable 16mm magnetic sound rcdr, 220V, gd cond, \$200; Moviola 16mm 4-gang sync, gd cond, \$100; (2) Hilux 152 variable anamorphic lenses, excel cond, \$150 ea; Spectra Professional light meter in case w/all slides & diffuser, excel cond, \$100. R Barwig, Barwig Recording, 5254 W Agate Ave, Chicago IL 60630. 312-283-2820.

Bell & Howell 566 high-intensity Marc-300 16mm sound movie projectors (2), w/pwr supplies, change over cables & more, excel cond, \$1095 pair or \$625 ea. G Ormrod, GFO Prod, 432 E X St, Tumwater WA 98501. 206-352-8028.

B & H 16mm 202 opt/mag proj, w/sync motor for interlock, M-H 816 hot splicer, Beaulieu R16E camera w/Ang 12-120 zoom lens, Hollywood rewinds, sound readers, split and solid reels, send for more info. B Howard, Academy Film Prod, 3918 W Estes, Lincolnwood IL 60645. 708-674-2122.

Magnasync Moviola Sx8, 2-gang super 8 sync w/footage counter, like new, \$50. C Easlick, 2233 Cumberland Rd, Lansing MI 48906. 517-321-1900.

Want to Buy

Reasonably priced movie equip, cameras, lenses, Nagra & Stielavox tape rcdr, other film related items. H Bluer, 108 Hamilton Ave, Silver Spring MD 20901. 301-365-2798.

Javelin small night vision device, or equiv, prefer 2nd generation C-mount, anything considered. J Kreines, DeMott/Kreines Films, 5330 Kennedy Ave, Millbrook AL 36054. 205-285-6179.

Mitchell 16/35mm, other pro 16/35mm incl Arri, Aaton, CP; optical prints esp Research Products 1000, 1001, Acme, Oxberry; cine lab equip incl sensilometer; sm/med 16 or 16/35mm processing machine; optical rcdr; Steenbecks; gd cine optics, Zeiss, Ultra-T, Angenieux, Cooke; Zeiss 9.5mm Distagon, reasonable, fair cond; will consider any film equip. J Kreines, DeMott/Kreines Films, 5330 Kennedy Ave, Millbrook AL 36054. 205-285-6179.

RECEIVERS & TRANSCEIVERS

Want to Sell

Precision 111 FM tuner SS, \$25; Precision 112A AM/FM tuner, rack mount, \$50. E Davison, 135 N Illinois, Springfield IL 62702. 217-787-0800.

Gorman Redlich CEB EBS encoder/decoder, \$200. K Stokes, WKJN, 3029 Sherwood Forest #200, Baton Rouge LA 70816. 504-292-9556.

Panasonic RF-4800 shortwave rcvr, like new. P Bailion, Miles City Bldg, 1218 Pioneer Bldg, St Paul MN 55101. 612-222-5555.

Atwater Kent TA rcvr, breadboard construction w/whorn spkr, complete, \$800. D Jack, Mountain Media, POB 1826, Boise ID 83701. 208-286-7676.

Panasonic RF-4800 shortwave rcvr. P Bailion, 612-222-5555.

Bogen TP200 digital AM/FM stereo tuner, new, shielded, \$150; Bogen TP50 mono AM/FM tuner, new, \$75. E Davison, 135 N Illinois, Springfield IL 62702. 217-787-0800.

AM STEREO RECEIVERS Portable, Home/Studio, Auto RADCO GROUP 708-513-1386

Kenwood R300, impressive SW rcvr, \$150/BO. D Gold, Gold Star Rec, 11434 Ventura Blvd, 102, Studio City CA 91604. 818-986-2911.

Johnson ST-4A SCA rcvr, (18) at 67 and (20) at 92, all new and near-new, \$40 ea. R Evans, Cable Music Network, 156 Prospect St, Wilkes-Barre PA 18702. 800-743-1221.

High quality micro-miniature 67 kHz SCA decoder, about 1" square, prewired and ready to install, \$15. D Jackway, Background Music Eng, 5742 Fairoak, Springfield MO 65810. 417-881-1846.

Motorola Mocom 35, (1) on 2 meters, (1) 160-174 MHz, (1) Mory VHG w/PL, \$100/all. P Russell, Bowdoin College, Sills Hall, Brunswick ME 04011. 207-725-3066.

Magnum/Dynalab FT-101 pro FM tuner for rack mounting, excel cond, modified w/Murata 150 kHz selectivity filters, FM/SCA circuit w/67 & 92 kHz outputs, \$461, incl shipping, B Elving, 241 Anderson Rd, Esko MN 55722. 218-879-7676.

Panasonic RF-4800 digital shortwave rcvr, \$195. D Fant, OK Two-Way, 413 NE 38 Ter, Oklahoma City OK 73105. 405-528-6467.

Want to Buy

Hammarlund HQ Series general coverage rcvrs, HQ-100, -145, -180, etc, or equivalent, need not be working. M Zuccaro, Voice & Video, 5038 Ruffner St, San Diego CA 92111. 619-271-8294.

McMartin TMB-1005 5-chnl rack mounted FM & SCA rcvr. R Bersani, Talk Info Ctr, 130 Enterprise Dr, Marshfield MA. 617-834-4400.

Fisher 90-T, 100-R or 202-R tube FM/AM tuners, gd cond, reasonable \$ J Douglas, Original Oldies Show, 402 Shirley Rd, Seaford VA 23896.

REMOTE & MICROWAVE EQUIP

Want to Sell

Macom MA23CC xmtr, rcvr & antennas, gd cond, 23 GHz, will trade for Moseley PCL 606C or 7500. C Haynes, WJMI/WORD, 1850 Lynch St, Jackson MS 39203.

Moseley SCG-8 & SCD-8 FM subcarrier gen & FM subcarrier demodulator, 110 kHz. P Bailion, Miles City Bldg, 1218 Pioneer Bldg, St Paul MN 55101. 612-222-5555.

FOR YOUR NEXT REMOTE EVENT RENT THE GENTNER EFT-3000 3-line frequency extender package with Shure SM-7 studio mics. For more info call: Dwight Weller WELER AUDIO-VISUAL ENGINEERING P.O. Box 4040, Baltimore, MD 21093 (301)252-8351

Gentner SPH3 telephone hybrid, gd cond, removed from service 12/89, sell/trade. B Harris, KXLT, 5350 S Roslyn St #210, Englewood CO 80111. 303-741-5654.

Moseley SCG-8 FM subcarrier gen & Moseley SCD-8 FM subcarrier demodulator 110 kHz. P Bailion, Miles City Bldg, 1218 Pioneer Bldg, St Paul MN 55101. 612-222-5555.

Gentner EFT-900A digital freq extender w/rack mount, \$600/BO. N Scott, KPLA, POB 77, Oakdale CA 95361. 209-847-7700.

Hnat-Hindes telephone interfaces (2), vgc, \$150 ea. G Arroyo, WONQ, 2483 John Young Pkwy, Orlando FL 32804. 407-687-9345.

Rust RC-1000 wire line remote, working when removed, new studio unit selector switch, \$300. H Kneller, WKII, 3151 Cooper St, Punta Gorda FL 33950. 813-639-1112.

Moseley MRC-1600 w/92 kHz card, excel cond, \$2100; Moseley SCG-8 185 kHz sub-carrier gen & rcvr system, \$800. T Ringer, WICO, POB 909, Salisbury MD 21801. 301-742-3212.

COMREX RENTALS 2 and 3-Line Systems Call Steve for details Silver Lake Audio (516) 623-6114

TFT 770 non-type-accepted composite dual xmtr/rcvr STL system, 1 xmtr mt wrkg, '79 vintage, BO. J Shadle, KRBE-FM/AM, 9801 Westheimer #700, Houston TX 77042. 713-266-1000.

Moseley PBR-15 remote control, studio and xmtr units, BO. L Fuss, WDTL, POB 159, Fayetteville GA 30214. 404-460-6159.

HME, prof brdcast quality VHF wireless mic system, System 85 mic, RX-722 rcvr, Excalibur aluminum case, \$395. W Clark, Clark & Assoc, 318 E Calhoun, Macomb IL 61455. 309-837-2244.

TFT 7601-C remote cntrl syst w/xmtr and (2) studio units, configured for 2 wire telco use, all manuals, spare parts, \$2000/BO. L Lindstrom, WCCO, 1520 N Rock Run Dr, Joliet IL 60435. 815-729-4400.

Trillium Panter II telephone key system, (20) 10-button phones, 2 speakers, KSU, KSS, 1 yr old, \$3500/BO. B Downs, KTSR, Box 3248, Bryan TX 77805. 409-846-1150.

Moseley MRC 1600, Applied Digital Data R/C terminal w/mono video mon, (2) Volksmodem 12 modems, \$2950/all; will consider selling separately. D McIver, KBHL-FM, Box 247, Osakis MN 56360. 612-859-3000.

Harris 6550 rcvr terminal, w/PS, down conv and baseband demod, \$750/BO; Control Resource 1055-B digital multiplexer, w/digital demod, clock recovery and Demux, \$700/BO. L Ayer, KRPL/KZFN-FM, POB 8849, Moscow ID 83843. 208-882-2551.

TFT 7900/7901 remote cntrl syst, chnl interface, direct cntrl unit, (2) model 43 loggers, CRT option w/Beehive, xmtr mt wrkg, \$3000. L Mueller, WSTF, 2500 Maitland Cir Pkwy, Maitland FL 32701. 407-660-1011.

Harris 6100/6550 satellite receive station & rcvr, foreclosure sale, \$1500. G Milstean, WTYN-AM, 1241 E Lakeshore Dr, Landrum SC 29356. 803-457-3568.

Moseley STL-606/C composite xmtr updated by Moseley 1089, \$4800. J Mauk, KJMJ Radio, POB 70002, Fresno CA 93744. 209-266-5800.

Moseley PCL303 STL on 950.00, w/kg when removed, as is, \$500; TIE 6-station phone syst & RPU, w/kg when removed, as is, \$125. E Stanley, KBTO, Box 12, Bottineau ND 58318. 701-228-2483.

Moseley SCG-4T subcarrier gen, BO. NW Ariz Brcdst Eng, 602-753-1995.

Telos 10 10-line phone syst, used 6 mths, \$1300. B Lord, Lord Brcdstg, 13313 SE 208th St, Kent WA 98042. 206-631-2374.

Want to Buy

Satellite rcvr to pick up Unistar Country. B Hearst, WWCH, 725 Wood St, Clarion PA 16214. 814-226-8600.

Gates/Harris RCG-10AC equip to operate xmtr from remote/studio location via phone lines, older equip OK; Gates RDC-10AC or similar xmtr control and metering unit, both ends or parts, buy/trade. Chip, KPCS-AM, 408 N Main, Burlington IA 52601. 319-754-6698.

Wegner satellite rcvr for SMN or Drake Chenault satellite services. G Kneisley, WCOL-WNWW, POB 4006, Elyria OH 44038. 216-322-3761.

Moseley PCL 606/C rcvr in gd cond, any chnl. T McGinley, Cook Inlet, 630 Ivy Ln, Greenbelt MD 20778. 301-441-3332.

Scala 8000/450 RF preamp. J Steele, WKVX-FM, Box 2525, Kingsland GA 31548. 912-729-6106.

Wegener Panda II SPSC rcvr for Transtar format, main frame and card #s 1689, 2046, 1610 (2), 1644 and 1630. R Paskwan, WBJJ, 3516 Mill St, Bemidji MN 56601. 218-751-3077.

Composite STL syst, xmtr and rcvr, must be in gd wrkg order and meet FCC bandwidth requirements. B Harris, KXLT FM, 5350 S Roslyn St, Englewood CO 80111. 303-741-5654.

SATELLITE EQUIPMENT

STEREO GENERATORS

Want to Sell

Moseley SCA SCD-8 & SCG-8, on 185 kHz, like new, \$750/both; Marti SC-910 SCA gen on 67 kHz, \$225. D Jack, Mountain Media, POB 1826, Boise ID 83701. 208-286-7676.

Motorola stereo exciter and mon w/manuals, sounds grt, \$7800. B Shannon, WKZA, 5158 Countryside Dr, McKean PA 16426. 814-476-7426.

Want to Buy

Optimod 8000A, will pay cash, leave message at 703-276-0125.

TAPES, CARTRIDGES & REELS

Want to Sell

FM station surplus audio tapes, 10" and 14" reel music tapes, big band variety, \$20/\$30. F Anderson, 3801 5th Ave S, Great Falls MT 59405.

The Producer, new 40-record set, never used, commercial beds and used Technic TT, \$400. M Silver, KERW/KRVL, 301 Junction Hwy, Kerrville TX 78028. 512-896-1230.

Adult contemporary library w/2200 songs on CD & cart, incl 93 Golddiscs & 230 misc CDs, add'l 170 songs dubbed on Scotchcart IIs, \$13,000; country library w/1500 songs on 66 CD Golddiscs & 500 add'l Scotchcart IIs, \$8000; both used 6 mnths. B Lord, Lord Brcdstg, 13313 SE 208th St, Kent WA 98042. 206-631-2374.

A&D

Cartridge Rebuilding Service

We clean, load & pack. Serviced within 10 work days! Work guaranteed!

3706 Vold Ct., Eau Claire, WI 54701
(715) 835-7347

Fidelipac FID-MR200 200-slot mobile cart racks (8), \$150; (70) Fidelipac FID-WR25 25-slot wall cart racks, \$15 ea; (8) Abco Wire ABO-LS50 wire CD wall racks, \$17 ea; (3) Brcdst Supply RAX100 cradle mounts for MK5050II, \$40 ea; all used 6 mnths. B Lord, Lord Brcdstg, 13313 SE 208th St, Kent WA 98042. 206-631-2374.

Fidelipac 300 Gray carts (250), most in gd cond, \$200/all or \$1 ea. E Welch, 182 Monitor Cir, Moncks Corner SC 29461. 803-761-7583.

TAX DEDUCT EQUIP

Educ FM station wants IBM or compatible computer w/MS-DOS, 20MB hard drive, floppy drive, monitor, printer; will accept parts to assemble such system; will pay shipping. R Starliner, WMSS, 214 N Race St, Middletown PA 17057. 717-948-9136.

Bdct training school for underprivileged needs any AM bdct equip for training students unable to attend regular bdct schools, able to pay shipping on small items. F Smith, The Bdct Training School For The Underprivileged, 2408 Chamberlain, Chattanooga TN 37404. 615-6247126.

Chicago-area HS needs donated radio station equip for training in brcdst prod. R McBride, St Charles HS, 1020 Dunham Rd, St Charles IL 60174. 708-377-4753.

440 and 50 MHz TX/RX gear needed for amateur repeater, also need controller and wrkg IBM 640K RAM/compat computer w/any accessories. J Bondon, KYUU-FM, 10318 Missouri Ave, Los Angeles CA 90025. 213-338-7356.

5 kW FM xmr, 2 element antenna, RF wattmeter, 200' coax, satellite receive equip. T Hunt, Faith Comm Corp, 2201 S 6th St, Las Vegas NV 89104. 702-731-5422.

Emanuel Methodist Church needs donations of any audio & video equip, will pay shipping. M Williams, Emanuel Church, POB 163, Baraboo WI 53913. 608-356-8518.

Handicap radio station needs donations of all brcdstg equip. G Pinckard, 4930 Franklin Ave, Los Angeles CA 90027. 213-661-6528.

FM radios, boom boxes, table models, lrg portables, wrkg order, for modification for blind ppl to get subchnl radio reading service, donate/sell low price. B Elving, 241 Anderson Rd, Esko MN 55722. 218-879-7676.

Educ FM station for Port-au-Prince, Haiti, needs easy listening tapes for auto syst, tax receipts avail. R Weir, Radio Lumiere, POB 15665, W Palm Beach FL 33416.

Religious group needs board & TTs, tax deductible. G Pettjohn, Hour of Truth Ministries, POB 12379, Knoxville TN 37912. 615-688-7044.

World for Christ Radio needs 50 kW xmr, non-profit foundation. C Riddle, WFCR, 6046 Greenway Ct, Manassas VA 22111. 708-878-4441.

Monte Vista Christian School, would appreciate any donations of used TV broadcast equipment. T Quinn, 408-475-0423.

Eng student desiring donation of old bdct equip (anything in repairable cond, will pay all shipping charges. EE student at Purdue. C Gill, POB 371, Indianapolis IN 46206. 317-923-2800.

TEST EQUIPMENT

Want to Sell

HP 651B test oscillator, gd cond, \$500+shipping. J Sellmeyer, Rt 1 Box 270, McKinney TX 75069. 214-542-2056.

Potomac Instruments AG-51 & AA-51, vgc, \$3000/BO. B Gray, Gray Audio, 223 W Mountaint Rd, W Simsbury CT 06092. 203-658-7786.

Bird 8745-677, 20 kW, water-cooled dummy load, \$750; Dielectric/Sola 1301 wattmeter w/calibrated 50 kW element & 3-1/8" line section, \$250. G Liebis, WPTF/WQDR, Box 29521, Raleigh NC 27626. 919-790-6315.

Leeds & Northrup precision resistance decade box, 0.01-20K ohm, 12 decades, \$100/BO; Hickok 292X RF signal gen, AM mod, tunes 125 kHz-220 MHz, 1950 design, \$50. E Davison, 135 N Illinois, Springfield IL 62702. 217-787-0800.

HP 400D VTVM, perfect cond, \$150/BO; Simpson 458 oscilloscope, old but excel cond, \$100. R Fess, WLRB/WKAS, 119 W Carroll St, Macomb IL 61455. 309-833-5561.

HP 334 distortion analyzer & audio gen, both \$550. C Porter, WEAZ, POB 498, Carthage IL 62379. 217-357-3128.

Philips PM3226 15 MHz dual trace oscilloscope, excel cond, \$825/BO; Fluke 8050A digital multimeter, \$200/BO. D Gold, Gold Star Rec, 11434 Ventura Blvd, 102, Studio City CA 91604. 818-986-2911.

Ferroglyph RTS-2 rcrdr test set, compact for analog tape rcrdr calibration and alignment, measures freq response, SNR, distortion, wow and flutter, \$750. R Streicher, 818-359-8012.

AVCOM PSA-65A, 1-1000 MHz spectrum analyzer, w/10 kHz res BW option, \$2650/BO. C Springer, KLMR, POB 890, Lamar CO 81052. 719-336-2206.

Fluke 8060A RMS multimeter, soft case, excel cond, \$150. P Russell, Bowdoin College, Sills Hall, Brunswick ME 04011. 207-725-3066.

HP/Harrison 6200B, DC pwr supply, like new, \$150. M Norman, KCCU-FM, 2800 W Gore, Lawton OK 73505. 405-581-2425.

B&K E-200D RF signal generator, like new, \$195; B&K 520B transistor tester, \$149. A Bernard, WA2JTN, POB 690098, Orlando FL 32819.

Score DVM32 multimeter, like new, \$50. E Davison, 125 N Illinois, Springfield IL 62702. 217-787-0800.

B&B AM2B phascope, used 6 mnths, \$1000. B Lord, Lord Brcdstg, 13313 SE 208th St, Kent WA 98042. 206-631-2374.

Want to Buy

Delta operating impedance bridge, field strength meters, both AM & FM. A Hoover, Professional Audio, 7906 Wrenwood Blvd Ste C, Baton Rouge LA 70809. 504-928-4757.

FM deviation meter, prefer tunable 50-950 MHz. D Dunsmoor, KRRZ/KZPR, 216 S Bdwy, Minot ND 58702. 701-852-4646.

RCA/Nems-Clarke field intensity meter. A Crain, WAVN, Rt 6 Box 250, Byahalia MS 38611. 601-895-6483.

Wattmeter, 50 ohms, 1 5/8" line up to 6 kW. B Carr, WRED, Box 6, Perrysburg OH 43552. 419-837-9696

TRANSMITTERS

Want to Sell

RCA BTF-1E 1 kW FM w/spare parts, spare exciter tuned to 102.3 MHz, BO. T Edmisson, WDKN, 106 E College, Dickson TN 37055. 615-446-0752.

Exciters: McMartin B-910 tuned and calibrated to your frequency, guaranteed: Mono, stereo, SCA. Goodrich Ent. Inc. 11435 Manderson St., Omaha NE 68164. 402-493-1886 FAX: 402-331-0638

Harris/Gates FM 1G, 1000 W FM xmr, gd cond, w/Collins A830 exciter, \$5000; Harris/Gates BC5P2 5000 W AM xmr, low hrs, \$7500; late model Marti RPT 25 2-chnl RPU xmr & matching RR50/450 rcvr, like new, \$2000/both; late model Marti RPT 40 2-chnl RPU xmr & matching RR 30/150 rcvr, on 161.70 & 161.76 MHz, like new, \$2000/both. R Wright, 1208 N Locust Ave, Lawrenceburg TN 38464. 615-762-6200.

Off Air? FM EMERGENCY TRANSMITTER SERVICE Same-Day • Major Cities Next Day by 10 am Everywhere 414-482-2638

Sparta 701 1 kW AM xmr, tuned to 1190 kHz, vgc, \$6000, you ship; RCA BTA-10U2 10 kW AM xmr, tuned to 1220 kHz, vgc, \$15,000, you ship or trade for console & STL equip. G Arroyo, WONQ, 2483 John Young Pkwy, Orlando FL 32804. 407-687-9345.

CSI 25,000 25 kW AM xmr, tuned to 1200 kHz, like new, \$30,000, you ship; CSI T-1000A 1 kW AM xmr, tuned to 1480 kHz, vgc, \$7000, you ship. G Arroyo, WONQ, 2483 John Young Pkwy, Orlando FL 32804. 407-687-9345.

Goodrich Enterprises Inc. 11435 Manderson Street Omaha, NE 68164 402-493-1886 FAX: 402-331-0638

Goodrich Enterprises Inc. 11435 Manderson Street Omaha, NE 68164 402-493-1886 FAX: 402-331-0638

Goodrich Enterprises Inc. 11435 Manderson Street Omaha, NE 68164 402-493-1886 FAX: 402-331-0638

Goodrich Enterprises Inc. 11435 Manderson Street Omaha, NE 68164 402-493-1886 FAX: 402-331-0638

Goodrich Enterprises Inc. 11435 Manderson Street Omaha, NE 68164 402-493-1886 FAX: 402-331-0638

Goodrich Enterprises Inc. 11435 Manderson Street Omaha, NE 68164 402-493-1886 FAX: 402-331-0638

Goodrich Enterprises Inc. 11435 Manderson Street Omaha, NE 68164 402-493-1886 FAX: 402-331-0638

Goodrich Enterprises Inc. 11435 Manderson Street Omaha, NE 68164 402-493-1886 FAX: 402-331-0638

Goodrich Enterprises Inc. 11435 Manderson Street Omaha, NE 68164 402-493-1886 FAX: 402-331-0638

Goodrich Enterprises Inc. 11435 Manderson Street Omaha, NE 68164 402-493-1886 FAX: 402-331-0638

MARATHON PRODUCTS COMPANY

Audio Cartridge Rebuilding Division

Rebuilding/reloading, like new, all brands, any length up to & including 3.5 minutes, \$1.75 ea. FOB our plant, 48 hrs delivery.

New NAB Marathon cartridges prices on request.

35 Years professional experience!

Lifetime member AES R.D.MYERS Sr.

Manufacturers of Audio Devices, Continuous Tape Mag.

69 Sandersdale Rd.,

Charlton, MA 01507

1-508-248-3157 or 1-508-853-0988

Circle 105 On Reader Service Card

Complete nostalgia/big band format w/2780 stereo cuts on 129 metal reels of Ampex 406, w/10 reels of big band Christmas music, excel cond, \$20/reel or trade for equip. S Callahan, WFTI-FM, 1120 Pinellas Bayway, St Pete FL. 813-866-3544.

Wooden cart rack, rotatable, 1200 cart capacity, well built, \$100+shipping. B Gagne, KTCZ-FM, 100 N 6th, Minneapolis MN 55110. 612-339-0000.

Radio programming service w/2 complete music format libraries on 456 Ampex tape and all recording equip. J Gelo, J & H Music, POB 1697, Marco Island FL 33937. 813-642-6899.

Fidelipac 300 gray carts, several hundred, \$.75 ea+ shipping. E Moody, KESE/KJEM, 216 N Main, Bentonville AR 72712. 501-273-9039.

Analog tapes, gd music, 10" & 14", 2T stereo, BO. F Anderson, 3801 5th Ave S, Great Falls MT 59405.

Fidelipac Master Cart II carts w/Dynamic 400 standard tape: (150) 40 secs, \$2.50 ea; (150) 70 secs, \$2.50 ea; (150) 100 secs, \$2.50 ea; (50) 2.5 mins, \$3 ea; (20) 3.5 mins, \$3 ea; (20) 5.5 mins, \$3.50 ea; all FOB. D Peluso, KJUL-FM, 2680 E Flamingo Rd #E, Las Vegas NV 89121. 702-732-2200.

Want to Buy

45 and 33 1/3 RPM records from 50s and 60s, great cond, we pay 50¢-\$100/record, 5% finders fee available for leads, ref furnished. B Berry, Karavan Brcdst, 13 Montgomery Pl, Conroe TX 77384. 409-273-2801.

Spot prod music libraries recorded prior to '63 on disc/tape such as Mark Century, CBS, Capitol, NY ad agencies or similar. J Douglas, Original Oldies Show, 402 Shirley Rd, Seaford VA 23696.

TRANSCOM CORP.

Fine Used AM & FM Transmitters and Also New Equipment

For the best deals on Celwave products, Andrew cable, Shively & Comark antennas.

1 kW FM	1976 Harris FM1H3	1 kW AM	1978 Harris MW1A
2.5 kW FM	1983 Continental 814R1	1 kW AM	1988 Harris SX1A
2.5 kW FM	1978 CCA 2500R	1 kW AM	1986 Continental 314R1
10 kW FM	1990 BE FM10B w/FX-50	1 kW AM	1974 Harris BC1H1
10 kW FM	1980 Harris FM10K	1 kW AM	1976 RCA BTA 1S
10 kW FM	1975 RCA BTF 10ES1	5 kW AM	1980 McMartin BA5K
20 kW FM	1979 CCA FM20,000E	5 kW AM	1972 CCA AM5000D
20 kW FM	1973 RCA BTF 20E1	5 kW AM	1977 RCA BTA 5L
20 kW FM	1975 Collins 831G2	10 kW AM	1972 Harris BC10H
30 kW FM	1983 BE FM30	10 kW AM	1972 RCA BTA 10U
		10 kW AM	1974 Collins 820E/F

201 Old York Rd. • York Plaza Ste 207

Jenkintown PA 19046

800-441-8454 • 215-884-0888 • FAX No. 215-884-0738

Circle 20 on Reader Service Card

ARMSTRONG TRANSMITTER

FINEST REBUILT TRANSMITTERS

We're the leading re-manufacturer of transmitters worldwide.

Transmitters are available:

- Tuned & Tested on YOUR Frequency
- Guaranteed and Installed
- Completely Re-manufactured
- Expedited Service Available

Trade-Ins gladly accepted - **WE DELIVER!**
See your choice in transmitters *WORKING* in our huge new showroom *BEFORE* you take it home!



NO ONE ELSE OFFERS YOU THIS!
SEE & TEST IT ALL YOU WANT!

ARMSTRONG TRANSMITTER CORP.

5046 Smoral Road Syracuse NY 13031
Phone 315-488-1269 FAX 315-488-1365

Circle 148 on Reader Service Card

TRANSMITTERS ... WTS



High performance at affordable prices.

- New front panel programmable composite STL's.
- New directly programmable FM composite receivers
- New options for synchronous boosters and translators
- New FM exciters, transmitters, amplifiers: 2W to 30kW
- Same old price, quality service and reliability

Bext, Inc.
739 Fifth Avenue.
San Diego, CA 92101
619-239-8462

Fax 619-239-8474

Gates FM5C 5 kW FM xmt, \$3000/BO. T Tucker, Desert West, POB 36717, Tucson AZ 85740. 602-797-1008.

LPB AM-30 w/TCU-30 coupler, complete carrier station, or low pwr standby xmt w/4 xtals, mint cond, will only sell together, \$850. Steve, POB 4926, Woodland Park CO 80866. 719-687-8873.

TTC XL10 10 W FM translator, like new, w/manual, \$1850. G Jones, SW Mediacast, 110 Sierra Rd, Kerrville TX 78028. 512-367-4587.

Thompson CSF 334583 chnl 2 TV xmt w/synthesized offset, 10 W, excel wrkg cond. R Paskvan, 3516 Mill St, Bemidji MN 56601. 218-751-3077.

Harris FM-3.5K, like new with 3.2 years of operation, many spares. 816-635-5959.

Transmission line, many sizes and lengths, many like new. 816-635-5959.

Harris FM 35-K, 3 years old, excellent condition, must sell. 816-636-5959.

Harris TE3 exciter, \$600/BO. E Moody, KESE/KJEM, 216 N Main, Bentonville AR 72712. 501-273-9039.

TTC/Wilkinson 2500J FM xmt w/TTC X exciter, 6 yrs old, on 100.9 MHz, excel cond, avail 7/1, also have antenna and transmission line. Dan, KDEC/KRDI, Highland Dr, Decomb IA 52101. 319-362-4251.

Harris FM-1H w/exciter and harmonic filter; 6-bay antenna tuned to 93.5 and 220' 1 5/8 feed line, wrkg when removed; BO ea. M McDaniel, WBTO, Linton IN 47441. 812-847-9830.

RCA BTF 3A 3 kW FM xmt, wrkg when removed, \$500. K Guenther, KYKA-FM, 1214 W Lincoln Ave, Yakima WA 98902. 509-453-6296.

RCA BTA10 10 kW xmt, \$8000; RCA-50H 50 kW xmt, \$12,000. V Stone, WWMQ, POB 81, Cascade VA 24069. 804-685-3128.

QEI 675T20 meter panel for low pwr FM xmts, reads RF output, SWR and voltages, \$100. S Lawson, KAK Prod, 928 Hyland Dr, Santa Rosa CA 95404. 707-528-4055.

LPB AM-30 xmts w/TCU-30 coupler, complete carrier station or low pwr standby xmt, w/4 xtals, mint cond, \$850/all. Steve, POB 4926, Woodland Park CO 80866. 719-687-8873.

CAPACITORS OVERNIGHT

- Power Supply computer grade: up to 450 VDC
- Transmitting-MICA Sangamo, Comelt-Dubiler
- Oil Filled Non-PCB Oval, Rectangular

1-800-323-0460
FAX 1-802-425-3664
Kellner Electronics, Inc.
Charlotte, VT 05445

Circle 57 On Reader Service Card

Collins 21 E/M AM xmt, most tubes replaced w/SS, may operate at 1-5 kW and/or adapt to 10 kW, \$4500. K Crosthwait, WTNN, 13206 Buttermilk Rd, Knoxville TN 37932. 615-531-2297.

1982 Harris 20 K with MS-15 exciter. Good condition. Recently taken off the air. Contact Mr. David Dovich, Celebrities Productions, POB 11543, St Louis MO 63105. 314-721-1247.

Collins 21-E 5 kW AM xmt tuned to 1380 kHz, Haye spare crystals for 1260 kHz, needs finals, 1 kW cut back on skids, gd cond, \$4500. T Edmison, WDKN-FM, 106 E College St, Dickson TN 37055. 615-446-0752.

RCA 10 kW FM, recently removed, \$5000. C Strozler, 205-928-9406.

Harris BC1H AM MW xmt, 250/500/1000 W, in use, cin, gd cond, well maint, BO; Collins 550A-1 AM xmt, 500 W, gd cond, \$2500/BO. A Terry, WODY, Box 545, Bassett VA 24055. 703-629-5900.

We Buy STL's & Exciters
414-482-2638

Elcom-Bauer 60SC, FM xmt w/exciter, 5 kW, sgl phase, SS IPA, like new, less than 1 yr old, will deliver & set up w/in 300 miles of central PA, \$25,000/BO. V Michael, WHTO-FM, RDGB 462, Muncy PA 17756. 717-323-8200.

US Navy TDD-5 50 W AM, set to your freq, rack mount, \$350; home-made carrier current, 50 W AM, set your freq, \$500. J Cunningham, KEOR/KHKC, Rt 2 Box 113B, Stonewall OK 74871. 405-265-4496.

McMartin B-910 FM exciter's. C Goodrich, 11435 Manderson, Omaha NE 68164. 402-493-1886.

McMartin BF-25K, 27.5 kW FM tuned & tested to your frequency by the original designer. Guaranteed; Also have Bauer 707. Goodrich Ent, 11435 Manderson St, Omaha NE 68164. 402-493-1886 or FAX: 402-331-0638.

Elcom Bauer 707 in gd cond. Goodrich Ent, 11435 Manderson St, Omaha NE 68164. 402-493-1886 or FAX: 402-331-0638.

McMartin BF-25K FM 25 kW, tuned & tested in excel cond, new tubes, completely reconditioned. Goodrich Ent, 11435 Manderson St, Omaha NE 68164. 402-493-1886 or FAX: 402-331-0638.

FM TRANSMITTERS

300 W QEI 675T300
1 kW Collins 830D-1A
2.5 kW Continental 816R-1
5 kW RCA BTF-5E
10 kW RCA BTF-10E
10 kW Collins 830F
20 kW RCA BTF-20E
25 kW AEL 25 KD

PMA MARKETING, INC
"Transmitting Savings To You"
414-482-2638

FINEST REBUILT TRANSMITTERS

FM TRANSMITTERS		AM TRANSMITTERS	
1 kW Gates FM1B	1 kW ITA 1000B	250W RCA 250GL	1 kW Gates BC1F
1 kW RCA BTF1D	1 kW Collins 830D1	1 kW Gates BC1T	1 kW Gates BC1J
1 kW RCA BTF1E	1 kW Harris FM 1H	1 kW CCA 1000D	1 kW Collins 20V2
1 kW Harris FM 1H	2.5kW Collins 831D1	1 kW Collins 820D1	1 kW Collins BF-1K
2.5kW Continental 814R2	3 kW RCA BTF 3E	1 kW Harris MW-1A	1 kW Bauer 707
3 kW G.E. 3KW	3.5kW B.E. 3.5A	1 kW Gates BC-1G	5 kW Gates BC5E
3.5kW McMartin BF 3.5K	5 kW RCA BTF-5D	5 kW RCA BTA5T	5 kW Collins 21E
5 kW RCA BTF-5E	5 kW AEL 5KD	5 kW RCA BTA-5L	5 kW Harris BC-5H
5 kW RCA BTF10D	10 kW Gates FM10B	5 kW Wilkinson 5000E	5 kW Collins 820E/F
10 kW Harris FM 10H	20 kW CCA 20,000E	5 kW Gates BC-5P2	10 kW RCA BTA10H
20 kW Collins 831G1	20 kW RCA BTF-20E1	10 kW Harris 8C-10H	50 kW RCA 50G
25 kW Wilkinson 25000	25 kW McMartin BF25K	50 kW GE/Canada 50KW	50 kW Continental 317B
25 kW Harris FM-25K	30 kW McMartin BF30K	50 kW Harris MW	

ARMSTRONG TRANSMITTERS
5046 Smoral Road
Syracuse, NY
(315) 488-1269
FAX (315) 488-1365

Bext has some show units at sale price. Full 2 yr warranty, like new. Exciters, amplifiers, STL's. First come first served only. Call for details. Bext, 619-239-8462.

RCA BTA-50H 50 kW & RCA BTA-5H 5 kW xmts tuned to 680 kHz. Removed from service & stored indoors, in gd cond w/many spare parts except that all PCB capacitors have been removed. Available now, as is. \$15,000 negotiable. D.E. Anderson, 415-986-8000.

Want to Buy
Dry xmt, 480V to 12,000V, 3-phase, 120 KVA. N Scott, KPLA, POB 77, Oakdale CA 95361. 209-847-7700.

USED TV TRANSMITTERS, antennas, cable, rigid line, etc. one watt to 110 kW. Fair market price paid. BUY — SELL

BROADCASTING SYSTEMS
602-582-6550
FAX: 602-582-8229
Kenneth Casey

RCA BTA 250K xmt manual/schematic. S Thompson, 1031 San Antonio, Alameda CA 94501. 415-521-1429.

10 kW FM, 10 yrs old or less, prefer single phase pwr. P Salois, KPCR, Box 1, Bowling Green MO 63334. 314-324-2283.

CCA 20 kW xmt equip, studio equip, translator and related equip. M Ebron, WOTJ-FM, Rt 2 Box 391, Morehead NC 28557. 919-240-1600.

Two 25 kW FM's, (1) 5 kW FM, (2) 10 bay FM antennas, (2) 500' lengths 3" air coax w/connectors & hardware, (1) 500' length 1-5/8" air coax w/connectors & hardware. P Titchenal, KDHL/KOCL, 507-334-0061 or Fax 507-334-7057.

WANTED

AM and FM Transmitters, all powers. Finders fee for locators. DON'T take the chance of not being paid, sell to the oldest broadcast supply house in Latin America.

GUARANTEE RADIO SUPPLY CO.
1314 Iturbide
LAREDO, TX 78040
(512) 722-3233
(512) 727-8458 (fax)

Low pwr FM xmt, 250-500 W for booster, must be FCC approved and in gd wrkg order. B Harris, KXLT FM, 5350 S Roslyn St, Englewood CO 80111. 303-741-5654.

McMartin AM/FM xmt, any model, exciter or stereo modules. Goodrich Ent., 11435 Manderson, Omaha NE 68164. 402-493-1886.

TOP DOLLAR
For Your Old Transmitter, STL or Exciter!
Call for a quote
We arrange quick dismantling & removal PCB's? No Problem Call Us.

ARMSTRONG TRANSMITTER CORP.
5046 Smoral Rd
Syracuse, NY
(315) 488-1269
FAX (315) 488-1365

Collins KW1 AM ham xmt. O Diaz, KRON-TV, 1001 Van Ness Ave, San Francisco CA 94109. 415-661-8617.

TUBES

Want to Sell
Western Electric 417A & 412A 9 pin triodes, \$12 ea. J McLane, ODD-E-O, 115 W Gutierrez, Santa Barbara CA 93101. 805-963-3941.

ECONCO
Quality Rebuilt Tubes
Approximately 1/2 the Cost of New

Call for Our Price List
800-532-6626
916-662-7553
FAX 916-666-7760

Circle 98 On Reader Service Card

Penta Labs premium output tubes, new w/warranty, KT88/HG w/TOP getter, \$18; EL34/HD w/increased plate-dissipation, \$9; custom matching & quan pricing avail; also fabled 12AX7Bs. R Katz, Allegro Sound, 15015 Ventura Blvd, Sherman Oaks CA 91403. 213-859-5543.

For the Best Prices
& 24 Hr service on transmitting tubes call 402 493 1886 day or night. FAX 402 331 0638. TELEX 940103 WU PUB TLX BSN

RCA 8134 Vidicon tubes, (3) used, \$150 ea. R Barwig, Barwig Recording, 5254 W Agatite Ave, Chicago IL 60630. 312-283-2820.

FACTORY NEW TUBES

3CX10000A3, 3CX1500A7, 3-500Z, 4CV100000C, 4CX1000A, 4CX1500B, 4CX10000D, 4CX250B, 4CX300A, 4CX35000C, 4CX350A, 4CX5000A, 4-400A, 4-400C, 572B, 6146B, PL328/TH328, PL347/TH347, 807, 813, 833A, 833C, and more...

CALL
1-800-783-2555
JOLIDA INC.
Annapolis Junction, MD

RCA 6181, 1 kW UHF for RCA TTU-1B xmt, excel cond, lw hrs, \$1000. C Fox, WOLF, Box 1490, Syracuse NY 13201. 315-468-0908.

REBUILT ELECTRON TUBES

Partial List: 6623, 23791, TH150, 6425F, 5604, 6696, 6697, 5681, 5682, 5671, 7804, 3CX10, 000H3, 3CX20, 000H3, 4CX5000A, 4CX35, 000C

Vacuum Tube Industries, Inc.
1-800-528-5014

3CX1500A7, 4CX5000A, 6146B, 4CX250B, 4CX3000A & more. We carry large inventory all major brands, Eimac, Amperex, RCA, etc. Call Stew 1-800-842-1489.

Want to Buy

TUBE REBUILDING

FREELAND PRODUCTS

Since 1940
SAVE ABOUT 50%
—We buy dud tubes—

800-624-7626
504-893-1243
FAX 504-892-7323

Amperex 40125 driver tubes, used or new. R Colaner, WRCW, 4601 Hills & Dales NW, Canton OH 44708. 216-477-8585.

We buy electron tubes.
Contact us if you have any for sale.

PATH ENTERPRISE
507 Superior Ave.
Newport Beach CA 92663
714-722-6733 FAX: 714-722-6508

ELECTRON TUBES

Partial List: 6623, 23791, TH150, 6425F, 5604, 6696, 6697, 5681, 5682, 5671, 7804, 3CX10, 000H3, 3CX20, 000H3, 4CX5000A, 4CX35, 000C

Vacuum Tube Industries, Inc.
1-800-528-5014

Visit Our New 13,000 Sq. Ft. Used Transmitter Supermarket World's Largest



Our Centrally located Low-Overhead showroom location means BIG SAVINGS to you!

Available:

- ALL TRANSMITTERS Tuned & Installed ONLY by FCC Licensed Licensed Technicians, each with 15 years MINIMUM experience in RF.
- INSTALLATION & FIELD SERVICE by Former FCC Bureau Chief & Field Inspector.
- Expedited Service
- TRADE-INS ACCEPTED
 - We tune & test units purchased from others—including units they say they've tuned.
- 3 OFFICES TO BETTER SERVE YOU: McCook, NE • Dallas, TX • Miami, FL

Phone: 308-345-7633 FAX: 308-345-7650
Hablamos Español Phone: 305-448-5066 FAX: 305-448-5127

Imperial Transmitter Worldwide

TURNTABLES

Want to Sell

Technics SP-10 MKII w/Micro-Trak arm, no base, gd cond. \$300/BO. B Gray, Gray Audio, 223 W Mountain Rd, W Simsbury CT 06092. 203-658-7786.

Stanton 310B prof stereo phone preamp, brand new, balanced output, HF adjustable; Technics SP-15 (2), brand new in box; SP-15 on black base w/one arm, gd cond; sell/trade. B Harris, KXLT, 5350 S Roslyn St #210, Englewood CO 80111. 303-741-5654.

QRK 12C, w/S-20 Rek-O-Kut tone arm, vgc, BO by 6/91. B Spitzer, KKLS/KKMK, Box 460, Rapid City SD 57701. 605-343-6161.

Gates CB77, vgc, Shure and MT 303 arms, \$95; no arms, \$75. B Kuhar, 1543 Eaton Ave, Bethlehem PA 18018. 717-645-8814.

Technics SLP-1200 & SLP-1300 CD players, in use, no remotes, \$800 ea/\$1500 pair; Technics SP-10 TT w/SME 3009-R tonearm, Ortofon MC-10 Super, Allied shock-absorber pedestal, spare pedestal insert, \$1350 pkg; (3) Urei 1122 transcription preamps, \$45 ea. P Walkowiak, WWWW, POB 167581, Oregon OH 43616. 419-255-1470.

Sony CDK007 (2), 60-disc CD playing juke boxes, like new, \$3000 ea. B Evans, KBAC-FM, 740A St Michael, Santa Fe NM. 505/471-7110.

Want to Buy

Need motor mounts for (2) Gates CB11 16" TTs. L Townsend, Imaginary Entertainment, 332 N Dean Rd, Auburn AL 30830. 205-821-7156.

Rek-O-Kut TT & Fairchild 16" arm which play old 78 rpm AFSS records. R Lamb, POB 8159, Portland OR 97207.

Disc recording equip accessories, heads, amps, limiters, needles, blanks, manuals, literature, etc. K Gutzke, Custom Recording, 7134 15th Ave S, Minneapolis MN 55423. 612-866-6183.

Gates CB500 or others, prefer wrkg w/arms. R Osborne, WMOV, Box 667, Ravenswood WV 26164. 304-273-2544.

Rek-O-Kut M125 lathe lead screw parts. J Parsons, 10375 Cannas St, N Huntingdon PA 15642. 412-863-9590.

Rek-O-Kut M512S lathe screws or compl machine. J Parsons, 10375 Cannas St, N Huntingdon PA 15642. 412-863-9590.

Fairchild 750, any cond. R Howell, Boogie Man Studio, HCIB 1203, Cabazon CA 92230. 714-849-4030.

Fairchild disc rcrding equip, #740 & similar, Presto, Rek-O-Kut, RCA, etc; also, accessories incl amps, limiters, heads, manuals, needles. K Gutzke, 7134 15th Ave S, Minneapolis MN 55423. 612-866-6183.

RCA Presto disc rcrdrs, blanks, needles; also, prerecorded discs & pressings. B Davies, Virgo Prods, 5548 Elmer Ave, N Hollywood CA 91601. 818-761-9831.

TV FILM EQUIP

Want to Sell

RCA film island, TK29B camera, (2) TP66 16mm proj, TP7 35mm slide proj, lw hrs, new tubes, like new, \$12,500; Panasonic/JVC AG1950 edit syst, (2) VCRs, A-95 controller, excel cond, \$1450; JVC KA-3U Betacam back for KY series cameras, \$395. D Brennan, Brennan Entrprs, 3596 Lorna Ridge Dr, Birmingham AL 35216. 205-623-0088.

VIDEO PROD EQUIP

Want to Sell

Echolab SE2 6-input 2-buss special effects gen w/Sony CG101 color sync gen; TEK RM529 waveform mon; (2) Hitachi 14" color video mon, excel cond, \$2000/BO. J Krepol, RNDL, 6147 Walker St, Philadelphia PA 19135. 215-624-1050.

JVC RM82V video editing controller for JVC 3/4" editors, excel cond, \$225. G Ormrod, GFO Prod, 432 X St E, Tumwater WA 98501. 206-352-8028.

Bosch Compositor dual-chnl character gen, (2) keyboards, graphics compose console election pkg, working cond, \$1800; Chyron RGU-1 dual-chnl character gen, (3) keyboards, 2-me-colorizers, remote panel, manuals, disks, in use now, \$8500. Roman, World Video, 10625 Scripps, San Diego CA 92131. 619-695-1045.

Sony LDP-1000 industrial laser video disk player, plays CAV & CLV disks, w/external sync & subcarrier inputs for use on line, RS232C serial port for computer interface, RM1002 remote, flight case, \$500. J Krepol, RNDL, 6147 Walker St, Philadelphia PA 19135. 215-624-1050.

JVC RM820 video editing controller for JVC 3/4" editors, excel cond, \$175. G Ormrod, GFO Prod, 432 X St E, Tumwater WA 98501. 206-352-8028.

Sony LDP-1000A industrial laser video disk player for CAV & CLV disks, external sync, subcarrier inputs for use on line, RS232C serial port for computer interface, remote, case, \$500. J Krepol, 7 Dustin Dr, Wilmington DE 19703. 302-798-4076.

Want to Buy

Edutron CCD 2H-2 tech manual, will pay for Xerox and related costs. R Carlsen, Univ of Wash, M/S SB 54, Seattle WA 98195. 206-543-8455.

VIDEO TAPE RECORDERS

Want to Sell

Ampex ACR25 (2), just removed from operation, \$4500. R Beierle, KFVR-TV, 200 N 4th St, Bismarck ND 58501. 701-255-5757.

Ampex VR1200B parts, lrg inventory of new video head panels, capstan & blower motors, filters, vacuum pumps, audio/ctl/erase stacks, complete set of manuals & more, \$500+shipping. J Krepol, RNDL, 6147 Walker St, Philadelphia PA 19135. 215-624-1050.

Ampex AVR-2 (2), vgc, w/Elektronik monitor bridge, (2) spare video heads, (4) stereo stacks, (3) mono, BO. B Winans, WMHT-TV, 17 Fern Ave, Schenectady NY 12306. 518-356-1700.

Panasonic NV-9400 portable 3/4" w/AC adaptor, excel cond, \$425. G Ormrod, GFO Prod, 432 X St E, Tumwater WA 98501. 206-352-8028.

Ampex VPR-2B w/TBC-2B, AST slow-mo, \$11,500; same w/stereo audio kit, \$12,500; Ampex ACR-25 (2), spare parts, carts, air compressor, \$3,500. R Beierle, KFVR-TV, 200 N 4th St, Bismarck ND 58501. 701-255-5757.

Sony VO2600 U-matic VCR (2), \$425 ea+shipping; Panasonic NV9100A U-matic player, \$350+shipping. N Mishaan, POB 335, Lynbrook NY 11563. 516-582-1338.

JVC CP5000U 3/4" U-matic player w/wired remote, grt cond, w/20 KCS20 U-matic tapes, \$550. B Hines, IPS Inc, RD 1 Box 413A, Export PA 15632. 412-468-4115.

IR/Magnavox IT4 VHS VCR will convert PAL tapes for PB on any NTSC TV w/a vertical hold control, \$400. D Rappoport, Tape Conversion, POB 650185, Miami FL 33265. 305-387-3330.

Sony BVU-100 VTR, rebuilt by Sony, PortaBrace case, excel cond, all manuals, \$2000. MRG Prod Assoc, 516-447-1041.

Sony VO2610 3/4" U-matic stereo, \$390; Sony VP2011 3/4" U-matic stereo, \$290. G Chapekis, Digital Prod, POB 22122, Denver CO 80222. 303-689-9114.

Zenith/Sony VR9800 w/VR9850 tuner/timer, Beta, matches Sony F-1 PCM, vgc, \$200/BO. J Martin, WHIL, POB 160326, Mobile AL 36606. 205-460-2395.

Sony 2600 3/4" R/P, excel cond, \$400. R Jensen, Telecab Prod, 5812 21st St, Radue WI 53406. 414-632-3131.

Sony BVU-50, 3/4", w/time gen, Kangaroo case, \$750. K Schmidt, Bristol Prod, 2401 Bristol Ct SW, Olympia WA 98502. 206-754-4260.

Sony VP-1000, \$100; VP-1200, \$120; VP-2000, \$200; VO-2630, \$300; VO-2650, \$200; VO-3800, \$250; BVE-500, \$300; BVE-500A, \$400; AV3600, \$150; AV3650, \$200; (6) Panasonic NV-9100, \$200 ea; Ampex VR1200B parts & heads, \$500. J Krepol, 7 Dustin Dr, Wilmington DE 19703. 302-798-4076.

Want to Buy

IVC 200 VCR, 1", need parts plus repair manual. J Baltar, Maine Reel, 67 Green St, Augusta ME 04330. 207-623-1941.

ACTION-GRAM

Equipment Listings

Radio World's Broadcast Equipment Exchange provides a FREE listing service for all broadcast and pro-sound end users. Simply send your listings to us, following the example below. Please indicate in which category you would like your listing to appear. Mail your listings to the address below. Thank you.

Please print and include all information:

Contact Name: _____

Title _____

Company/Station _____

Address: _____

City _____ State _____ Zip _____

Phone Number: _____

I would like to receive or continue receiving Radio World FREE each month. YES NO

Signature _____ Date _____

Please circle only one entry for each category:

I. Type of Firm

D. Combination AM/FM station F. Recording studio

A. Commercial AM station G. TV station/teleprod facility

B. Commercial FM station H. Consultant/ind engineer

C. Educational FM station I. Mfg, distributor or dealer

E. Network/group owner J. Other _____

II. Job Function

A. Ownership D. Programming/production

B. General management E. News operations

C. Engineering F. Other _____

Brokers, dealers, manufacturers and other organizations who are not legitimate end users can participate in the Broadcast Equipment Exchange on a paid basis. Listings are available on a \$25/25 word basis. Call 1-800-336-3045 for details and complete display rates.

WTS: WTB: Category: _____

Make: _____ Model #: _____

Brief Description: _____

Price: _____

WTS: WTB: Category: _____

Make: _____ Model #: _____

Brief Description: _____

Price: _____

WTS: WTB: Category: _____

Make: _____ Model #: _____

Brief Description: _____

Price: _____

WTS: WTB: Category: _____

Make: _____ Model #: _____

Brief Description: _____

Price: _____

*Closing for listings is the first Friday of the previous month. All listings are run for 3 months unless otherwise notified.

Broadcast Equipment Exchange

703-998-7600 PO Box 1214 • Falls Church VA • 22041 FAX: 703-998-2966

ADVERTISER INDEX

This listing is provided solely for the convenience of our readers. Radio World assumes no liability for inaccuracy.

Page No.	Advertiser	Reader Service No.	Page No.	Advertiser	Reader Service No.	Page No.	Advertiser	Reader Service No.
37	AEQ	92	9	Ellason Weather Radar	114	17	ITC	63
24,25	Arrakis Systems	15	21	ESE	125	7	Jampro	46
7	ATI	82	1	Fidelipac	-	34	NAB	-
8	Audio Precision	65	11	Fidelipac/Bdct Audio Division	124	28	Omega Studios	62
9	Audiopak	28	19	Frankford Wayne	3	23	Orban/AKG/dbx	30
19	Broadcast Services	122	22	Hall Electronics	68	35	Otari Corp	36
15	BSW	25	10	Harris Radio RF Equipment	101	29	Pacific Recorders	50
31	BSW	48	6	Harris-Allied Bdct Equipment	21,145	14	Prophet Systems	95
4	Burk Technology	126	22	Harris-Allied Bdct Equipment	-	32	QEI	18
36	CCA Electronics	42	27	Harris-Allied Bdct Equipment	53,75	26	Radio Systems	113
21	Communications Data Service	17	34	Harris-Allied Bdct Equipment	39,61	20	RF Specialties Group	71
27	Computer Concepts Corporation	9	28	Russco Electronics	10	28	Shure Brothers	58
3	Comrex	109	12,13	Shure Brothers	58	29	Studer Revox	77
30	Continental Electronics	89	29	Tascam	120	33	Tascam	120
33	Cortana	56	3	Tekos Systems	33	2	Wheatstone	60
32	Dataworld	32	47	Wheatstone	116	47	Wheatstone	116
			48	Wheatstone	74			

Advertising Sales Representatives:

Eastern U.S., Art Constantine: 800-336-3045 Fax: 703-998-2966
 West & Midwest U.S., Jack Ducart: 916-962-2240 Fax: 916-962-2194

Wheatstone's Bright Idea!

Just When You Thought All Furniture Was Alike

We've wedded the latest precision NC metal components to high grade solid wood trimmed laminated panels and counter surfaces. Added to this design breakthrough is the implementation of true 1-1/2" thick counters and vertical structural panels that put an end to warping, racking and delaminating problems. What's more, our wood trim comes flush to the counter surfaces to eliminate exposed laminate edges (so tempting to idle hands). In fact, the counters are separately trimmed to eliminate unsightly and short-lived formica seams.

Naturally, with all of our experience at building and interfacing consoles, we've worked out the details: like convenient hinged down punchblock panels for easy installation and maintenance, really generous cable pathways between enclosures, and equipment turrets with both back and side door access. Our rackmount base cabinets have mount-

ing rails on both sides, so equipment can be mounted any way desired or even switched at a later date. Concealment doors can be placed on cabinets intended for future electronic installation. Continuous length floor risers assure even cabinet-to-cabinet alignment. We've even included heavy duty ground bonding terminals.

This furniture family is complete, with both stand-up and sit-down versions, angled equipment turrets in two heights (with or without risers), concealed, fully isolated turntable cabinets, auxiliary wallmount equipment cabinets, wall and cabinet mount cart and CD storage, utility and file cabinet pull-out drawers, reel-to-reel tape deck mounts, interview counters—practically anything you can imagine. With this much variety, Wheatstone's rock solid construction and major market look, there really is no comparison.

So contact Wheatstone, the people with the reputation and expertise you can count on.



 Wheatstone[®] Corporation

Furniture

6720 V.I.P. Parkway, Syracuse, NY. 13211 (tel 315-455-7740 / fax 315-454-8104)

Circle 116 On Reader Service Card

World Radio History

The Closer You Get...

WE MEAN IT—we really DO provide the quality, performance, technical support, and innovation we promise!

Our model A-500 is a thoroughly engineered on-air console: it delivers the level of performance your clients now expect, and DAB demands. All components are selected for long life—gold bus connectors, gold I/O connectors, all gold contact switches, gas-filled relays, triple burned-in integrated circuits, solid state ON/OFF lamps, and precision laminated Lexan control surfaces for a lasting, wearproof finish. And we back that up with a 3-year parts and labor warranty, complete with

factory support from a technically competent and responsive staff.

We've also handled your special requirements as well with a super family of accessories, including a choice of three different telephone modules, an intercom module, an off-line mixer module for your remote feeds, talent control stations, accessory panels, failsafe power supplies, and auto cart and CD sequencing options.

So take a close look: we've got the quality, we've got the innovations, and you've got our commitment to top-notch support.



The Better We Look!

A-500