

# Radio Guide

www.radio-guide.com

Digital Issue Now On-Line

January-February 2022 – Vol. 30, No. 1

## Audio Loudness Demystified

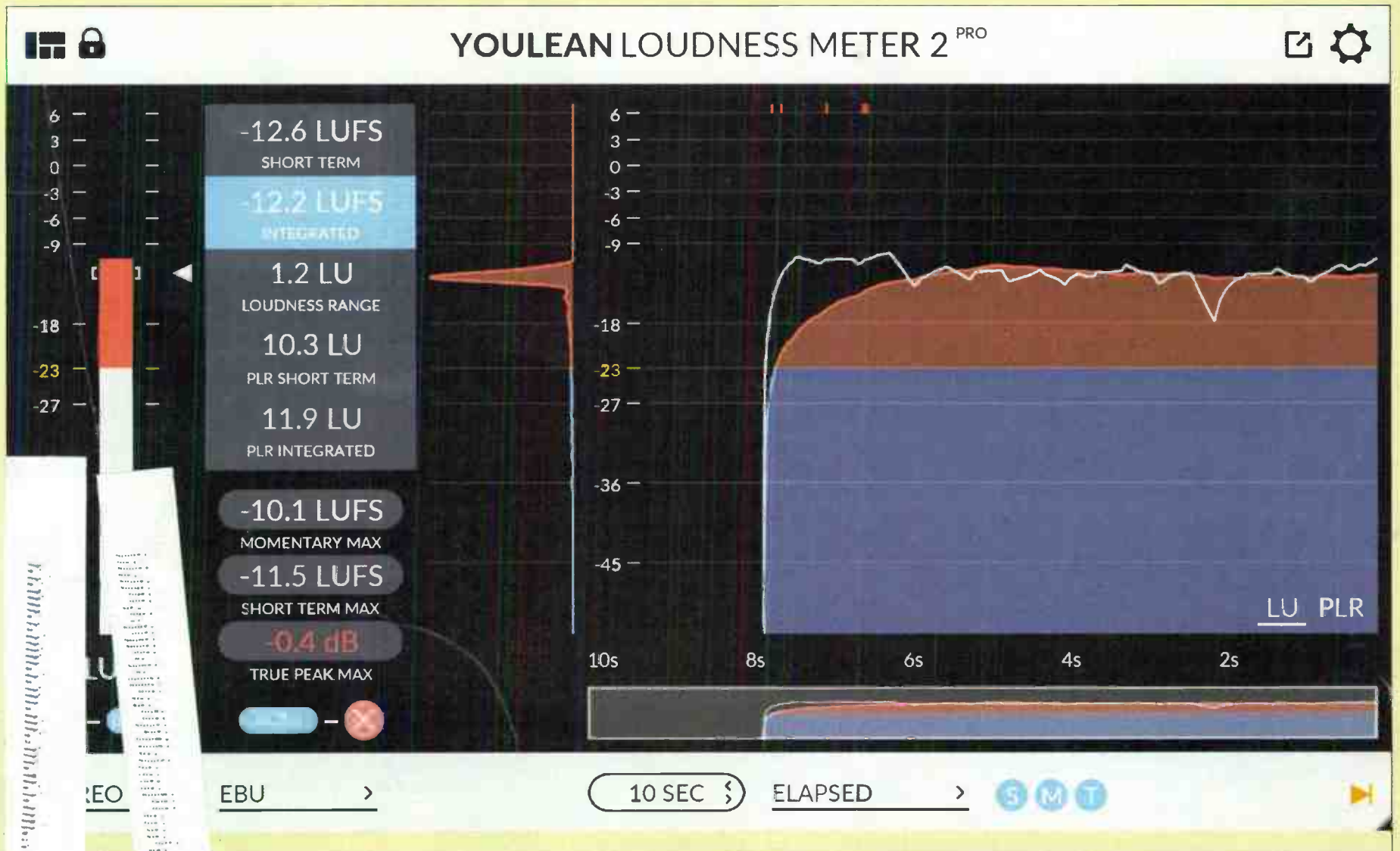

K.M. RICHARDS  
 867 P3  
 AUTO-ALL FOR ADC  
 K.M. RICHARDS PROGRAMMING SVC.  
 PO BOX 7427  
 VAN NUYS CA 91409-7427

\*\*\*\*\*AUTO-ALL FOR ADC  
 867 P3  
 K.M. RICHARDS  
 K.M. RICHARDS PROGRAMMING SVC.  
 PO BOX 7427  
 VAN NUYS CA 91409-7427

PRSRT STD  
 U.S. POSTAGE  
 PAID  
 PERMIT NO. 410  
 BEAVER DAM WI

**AARON 650**  
FM REBROADCAST RECEIVER

**For Challenging Reception Scenarios.**

# NEW! SportsCaster Simplifies Remotes!

For Radio or Video...it's the "missing link" that ties everything together.

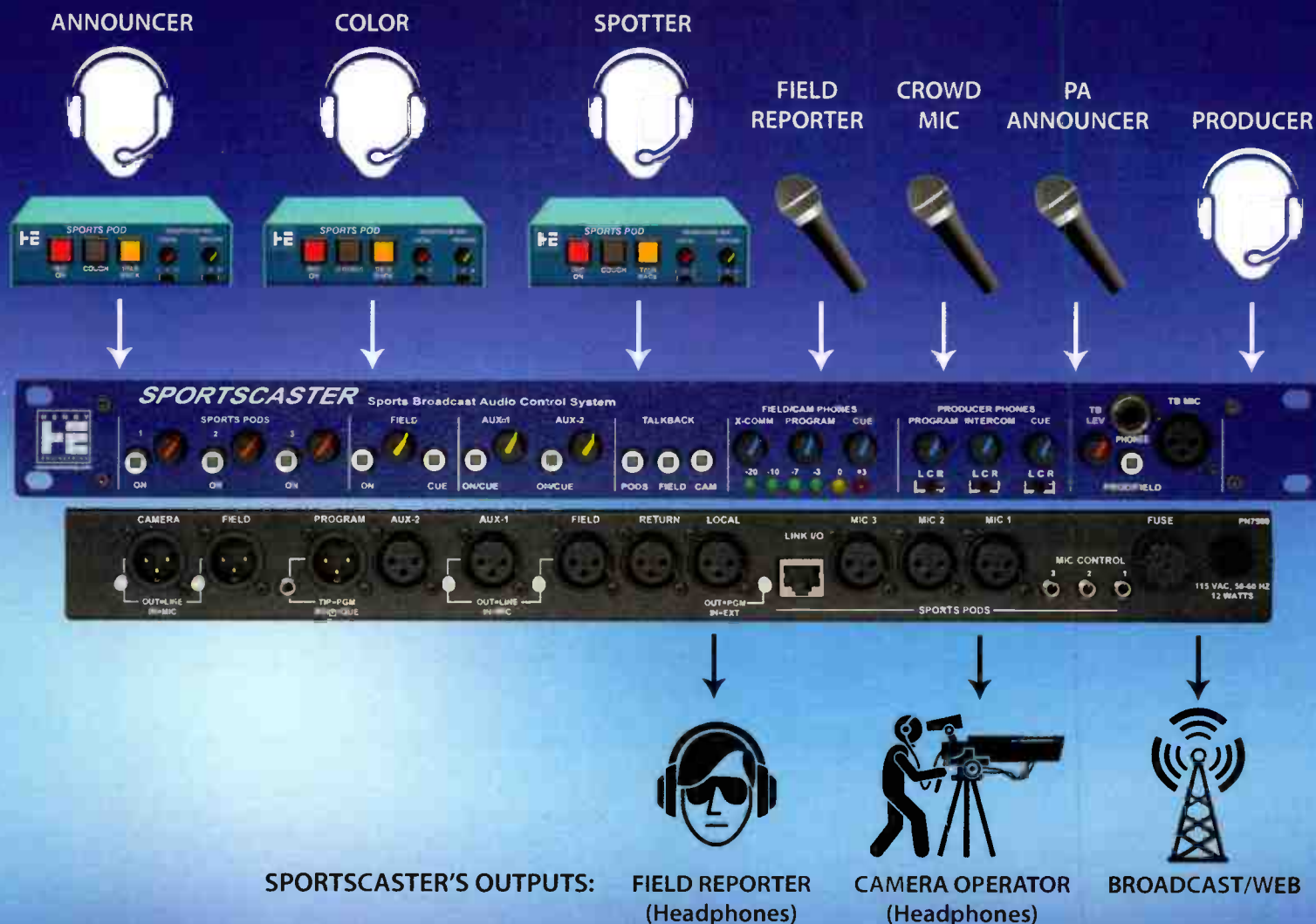

**SPORTSCASTER** is an integrated system with everything in one place!  
Used with Henry's Sports Pods, SportsCaster provides these functions...

- Talent mic audio mixing
- Talent headphone audio distribution
- Intercom between all announcers
- Talkback/Intercom facility for Producer
- Intercom between Producer and Talent
- Producer headphone audio mixing
- Field Reporter & Camera Ops headphone mixing
- Field Reporter Headphone output
- Intercom between Producer and Field reporter
- Party-line Intercom between Producer/Talent/Field reporter
- Camera Operators Headphones Output
- Talkback from Producer to Camera Operators
- Inputs for crowd mic, PA announcer, etc.
- Cue bus to audition auxiliary sources
- Main Program output to air or streaming

SportsCaster is the "missing link" that integrates all your audio and eliminates a carload of extra gear!

Call any Henry Engineering dealer, or visit [www.henryeng.com](http://www.henryeng.com). Tel: 562-493-3589



# ***SNMP Control of Audio For All Applications***

***BDI's Audio Toolbox Series Offers Synchronous AES Switching, Silence Sensor Switching, and Most Importantly the ease of SNMP Interface ...***



***Choose from 3 Model Classes:***

***ATB-300 Series for One of 8 input to all output switching***

***GPM-300 Series for True 8 X 8 Cross Point Switching***

***DAB-300 Series for Dual Path Switching for Digital Radio Applications***



***XLR, 75 and 50 Ohm BNC adapter panels for all configurations available Combined with SNMP Control Provides Total Plug and Play Installation***

***The Audio Toolbox Family of digital and analog audio switchers from BDI offer unparalleled flexibility of switching, routing and distribution. Whether you need AES, balanced analog or composite FM stereo switching and distribution choose from over 32 different models across three switching platforms. The ATB-300 for switching/DA functions, the GPM-300 series for 8 X 8 Cross Point switching or the DAB-300 for dual path IBOC switching applications. All models feature SNMP remote control and status making your remote control interface take only minutes.***

***bdi ... Serving the Broadcast Industry for over 35 years***

***Tel. (914) 737-5032 [www.broadcast-devices.com](http://www.broadcast-devices.com)***

***bdi***

# Radio Guide

## Contents

January-February 2022

<b>Cover Story</b> .....	6
<i>Audio Loudness Demystified</i>	
<b>Studio Site</b> .....	8
<i>Your Main Squeeze</i>	
<b>Chief Engineer</b> .....	10
<i>How Could I Miss That?</i>	
<b>FCC Focus</b> .....	12
<i>Sexual Harassment?</i>	
<b>Maintenance Guide</b> .....	14
<i>The Never Ending Fight With Corrosion</i>	
<b>Facility Focus</b> .....	16
<i>Equipping Your Radio Station With Today's IT Infrastructure</i>	
<b>Transmitter Site</b> .....	18
<i>Transmitter Plant Planning – Part 1</i>	
<b>Tower Topics</b> .....	20
<i>Troubleshooting AM Dplexed Systems</i>	
<b>Practical Engineering</b> .....	22
<i>A Tale of Two Blowers</i>	
<b>IT Guide</b> .....	26
<i>The Linux Connection – “I Am Your Friend ... Mr. Terminal”</i>	
<b>Practical Solutions</b> .....	30
<i>Keepin' On Keepin' On</i>	

<b>Shop Talk</b> .....	34
<i>Misc. Tech-Tips and Thoughts</i>	
<b>Small Market Guide</b> .....	38
<i>Omicron: Coming to a Small Market Near You</i>	
<b>Power Principles</b> .....	40
<i>The Mystery of the Ground Current - Part 2</i>	
<b>Service Guide</b> .....	44 & 45
<i>Radio Equipment, Products, and Services</i>	
<b>Gear Guide – New Products &amp; Updates</b> .....	46
<i>Angry Audio – Headphone Disconnect</i>	
<i>Bext Corporation – FM Antenna Improved Response</i>	
<i>Inovonics – New Model 551 and 552 HD Radio Monitors</i>	
<b>Final Stage</b> .....	47
<i>Convention, and Event Register and Advertiser Information</i>	

## Radio Guide

Volume 30 – Issue 1

Radio Guide Website: [www.radio-guide.com](http://www.radio-guide.com)

Classified Ads: [www.radio-classifieds.com](http://www.radio-classifieds.com)

PO Box 20975, Sedona, AZ 86341

Phone: 928-284-3700 • Fax: 866-728-5764

Ray Topp (publisher & editor) – [radio@rconnect.com](mailto:radio@rconnect.com)

Radio Guide, ISSN 1061-7027, is published bi-monthly, six times a year, by Media Magazines Inc., PO Box 20975, Sedona, AZ 86341. Radio Guide is copyright 2022, Media Magazines Inc., and may not be copied, reproduced, or stored in any format, without the written permission of the publisher.

## In This Issue

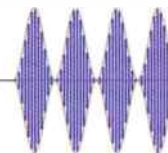

### Critical Content for Radio

#### Cover Story – by Cornelius Gould (page 6)

**Audio Loudness Demystified:** “All the audio sources are fed into the processor in real time, creating consistent loudness even with dissimilar content. Each channel more-or-less normalizes its overall level to be similar to other competitive channels. These competitive channels may be within a particular city (for over the air delivery), or on a closed delivery system (such as cable or streaming services).”

#### Chief Engineer – by Scott Schmeling (page 10)

**How Could I Miss That?:** “At this point we were ready to try just about anything. We even went to a near-by site to “borrow” a Nautel VS1. The thought was – we knew the Nautel was completely functional, and we could plug its 50 Ohm output directly into the PA input. If nothing else, we could eliminate the original exciter, preamp, and IPA as the source of the problem.”

#### TowerTopics – by Paul Thurst (page 20)

**Troubleshooting AM Dplexed Systems:** “Dplexed AM stations are becoming more common for a variety of reasons. Using a single tower or array for multiple AM stations can free up land for sale to developers and possibly cut down on operating expenses. These combined antenna systems are somewhat more complicated than single station systems – some might even call them daunting. There is no need to use words like that. The beauty of AM antenna systems is that they are simply a sum of their parts. Those parts are fairly large, easy to examine, test and measure with the right test equipment. Breaking things down into sections can help greatly in understanding them and thus finding problems and fixing them.”

# Simplified Audio Switching



## ACS 4.4 G2 Stereo Matrix Switcher

The ACS 4.4 G2 provides matrix audio switching of four stereo inputs to four stereo outputs. Matrix switching allows any/or all inputs to be assigned to any/or all outputs. The ACS 4.4 G2 may be controlled via the front panel rotary encoder and TAKE switch, contact closures, open collectors, logic and/or the multi-drop

RS-232 serial port (USB or Ethernet optional). Installation is simplified with RJ45 connectors, while GPIO connections are via plug-in euro-block screw terminals. A universal power supply is included and the ACS 4.4 G2 may be rack mounted with the optional RA-1 rack-adaptor.



Broadcast Tools is a Veteran Owned Business  
Designed, Assembled and Supported  
in WA State, USA.  
[www.broadcasttools.com](http://www.broadcasttools.com)



**BROADCAST**  
*t o o l s*  
PROBLEM SOLVED

# 200+

## FREE Technical Tools

### to have in your toolbox

Online resources to help you operate worry-free in these challenging times



### Transmission Talk Tuesdays

Learn from your peers in these popular round-table discussions.

Register for upcoming sessions at: [nautel.com/webinars](http://nautel.com/webinars)



### How to Videos

Over 25 videos that answer your most common technical questions.

[nautel.com/resources/videos/how-to](http://nautel.com/resources/videos/how-to)



Jeff Welton



### Tips 'n' Tricks

From security to critters! Technical tips from our award-winning educator, Jeff Welton.

[support.nautel.com/tips-n-tricks](http://support.nautel.com/tips-n-tricks)



### eBooks

Over 30 comprehensive eBooks covering a wide range of radio broadcasting topics.

[nautel.com/resources/ebooks](http://nautel.com/resources/ebooks)



### Webinars

40+ in-depth webinars covering a wide range of topics that qualify for SBE Recertification Credits.

[nautel.com/webinars](http://nautel.com/webinars)



### White Papers

In-depth technical papers from Nautel engineers.

[nautel.com/resources/white-papers](http://nautel.com/resources/white-papers)



### Radio Coverage Tool

Got station coverage questions? Create maps using different test scenarios.

[support.nautel.com/rf-toolkit/](http://support.nautel.com/rf-toolkit/)

Worry-Free  
Transmission

Because  
Radio  
Matters



## Audio Loudness Demystified

Cornelius Gould – Audio Processing Architect, Angry Audio

### Background

Broadcasters are quite familiar with the “normalization” of loudness levels. The broadcasting model distributes curated programming that is all under control of the broadcaster. This makes it quite simple to control levels by simply routing all content through an automatic level control device, aka, the audio processor.

All the audio sources are fed into the processor in real time, creating consistent loudness even with dissimilar content. Each channel more-or-less normalizes its overall level to be similar to other competitive channels. These competitive channels may be within a particular city (for over the air delivery), or on a closed delivery system (such as cable or streaming services).

In the digital media era of today, the task of audio level normalization is quite a different challenge. Every video program and every song delivered on most of these services originate from an audio or video file delivered directly to the audience to consume.

This means that each file delivered may have completely different audio levels. This becomes an irritation for the consumer by having to constantly reach for the volume control as the content changes. Inconsistent audio levels became such a problem in television broadcasting that congress passed the CALM act, essentially creating a loudness standard.

Though television broadcasters were compelled to comply, this idea was voluntarily adopted by online delivery sources such as YouTube, Apple Music, Amazon and others. Many audio-only content creators, such as Podcasters, jumped onto this standard as well. It has become the #1 rule for best audio production practices for podcasters.

All of the solutions in place revolve around a standard system of measuring the subjective or perceived loudness of audio content, and then convincing content creators to voluntarily adhere to a unified loudness level standard for the sake of a better experience for listeners.

### Loudness Units

The standard method of measuring sensational loudness is the ITU BS.1770 loudness meter, which is designed around the BS.1770-3 loudness standard. Each entertainment delivery service today typically has a “target” BS.1770 loudness level to which all content must adhere.

The loudness level is referred to as LUFS, or Loudness Units relative to Full Scale. Each “loudness unit” is a number that corresponds to a perceived loudness level. Similar in concept to the “Volume Unit” of level as expressed on standard VU style meters.

Keep this in mind: LUFS is *not* equivalent to “dB.” LUFS and dB are *entirely* different units of measure. Another thing to keep in mind is that the term “LUFS” is sometimes referred to as “LKFS”, or “Loudness units, K-weighted, relative to Full Scale.” Both acronyms mean the same thing. Just a slight difference in naming convention.

Some have the misconception that loudness normalization can be determined using the standard VU (dB) meter. It cannot. Don’t try to determine LUFS from a regular VU (dB) meter. Loudness measurements can only properly be determined using a LUFS meter!

What makes a LUFS meter so special? I will explain the general concept here. This is not intended as a “lab coat” description, but more of a pragmatic overview. The LUFS meter tracks two variables to provide accurate representation of perceived loudness: filtered level and time.

Humans do not experience loudness the same across the audio spectrum. We can tolerate loud bass far easier than high frequencies, such as cymbals, electric guitars, etc. The meter uses a K-Weighted filter to shape the signal according to perceived loudness sensitivity. The filter is also “somewhat deaf” to bass energy. The lower the bass frequency, the less it matters for measurements.

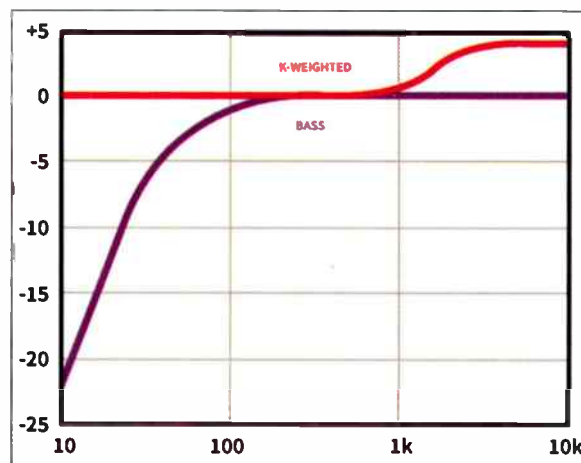

Weighted Filter Curves

The second variable is time. The longer the duration of loud audio, the more we notice it. A single drum hit, for example, might be many times louder than a shrieking heavy metal guitar, but its extremely short duration means we don’t perceive it as very loud. With this in mind, the loudness meter features several methods for measuring the temporal effect of audio content levels.

The LUFS meter averages filtered audio levels in 400ms blocks. Each block is then applied to two additional averaging systems. The first one averages the blocks over a three-second period, and then uses the resulting data to display “short term” loudness. The second is a “long term” measurement which can be a fixed time window or will run until reset, depending on the meter and application.

For file-based loudness measurements, the entire file is read at faster than real time, and the long term value is the loudness average across the entire audio file. For real-time, or “Live” measurements, some meters feature a “rolling” long term average, where the end user can define a window from a few seconds to many minutes. The rolling average is very useful when used in “live streaming” applications.

The closer the meter gets to “0 LUFS”, the higher the sensational loudness. To achieve levels above -13 LUFS typically involves the heavy use of compression and limiting, and is generally frowned upon by those concerned with audio quality. You will rarely see any recommendations above -14 LUFS.

For audio services that feature music, or stereo production, the LUFS levels mentioned in the above paragraph would represent maximum LUFS. When speech (or mono content) is present, the reference level is

typically dropped by roughly 3 LUFS to compensate for the measuring differences between mono and stereo audio content.

Many loudness meters, such as the “YouLean” (see cover photo) loudness meter can accept pre-produced files and give you the data you need. Other meters such as the “Orban loudness Meter” and the “TC Electronic Loudness Radar” can be used for audio files too but are very useful for real time monitoring applications as they both feature a user-defined real time rolling average.

### True Peak

Loudness measurements are a bit worthless without defining an actual audio level. This is where the standard (dB) level measurement comes into the scene in the form of the “True Peak” meter.

“True peak” meters are specialized level meters that show the actual peak level at the consumer’s end of the chain. This might differ from what the producer’s peak level meter shows because of certain errors that may occur with the reproduction of peak levels at the receive end. These errors can happen typically due to inter-sample peaks.

Many peak limiter designs can miss peaks that occur between audio samples. These inter-sample peaks are not “seen” at the producer’s side (because they happened between samples, and are not captured on the workstation’s peak meters). On the consumer side, the reconstruction of digital audio data to analog can recreate those missing peaks due to the filtering processes used during conversion.

True peak meters are designed to show the effect of waveform reconstruction at the consumer end. This gives the content producer the ability to provide enough “headroom” in audio levels to prevent possible distortion on consumer devices.

With the above in mind, you will see that all loudness standards will also define a true peak specification in “dBFS”, which defines the audio decibel level relative to full scale on the familiar dB peak-reading style VU meter.

### Examples

How LUFS is used depends on your intended target. Amazon, for example, defines a -14 LUFS loudness target, with a -2dB dBFS peak value for music and podcasts sent to its smart speakers and devices.

As of the writing of this article, some services are using this -14 LUFS loudness standard as well, while others are using a -16 LUFS. Other applications, such as inter-studio content delivery are using lower loudness levels entirely.

More examples:

- Broadcast TV: -23 LUFS
- Podcasts: about -16 LUFS
- Apple Music: -14 LUFS
- Amazon Music - 14 LUFS
- YouTube: -14 LUFS
- Streaming Audio services (AES proposal): -16 LUFS

For the distribution of content between studios, a different scale is used, which ranges from -23 to -18 LUFS, depending on the service used. File distribution for content consumers (the listening or viewing public) generally falls between -16 to -14 LUFS, depending on the content distribution service.

I hope this basic overview on loudness has been helpful. Loudness management is a vital step for content creators. Maintaining consistent loudness across all of the programs and services that are becoming available is a vital step for a better experience for our content consumers.

Cornelius Gould is Audio Processing Architect with Angry Audio. He can be reached at [corny@angryaudio.com](mailto:corny@angryaudio.com)

\* The Gateway-4 codec supports 4 channels only and is not upgradeable to support more channels.

Americas: +1-317-845-8000 | sales@tieline.com | tieline.com

**Tieline**   
The Codec Company

# Meet our latest audio codec...

**Gateway 4**



The Gateway-4 provides two stereo connections, or one stereo and two mono connections, or up to four mono connections.

The Gateway-4 is designed for solutions requiring up to 4 audio streaming channels\* with traditional broadcast connectors, or AoIP standards AES67 and ST 2110-30 straight out of the box.

It supports 4 full-duplex codecs with unrivaled redundancy in 1ru and is backwards compatible with all Tieline IP codecs.

## Get your Gateway-4 at SCMS

SCMS sells the full list of Tieline products.

Ask us about all of their codec lines.

Broadcast solutions from over 500 manufacturers  
scmsinc.com | 1-800-438-6040 | sales@scmsinc.com



## Your Main “Squeeze”

*How much EQ is too much?*

by George Zahn

As our station was upgrading our transmitter processing gear, it got me to thinking that we haven't addressed in-studio or DAW compression in quite a while. It's amazing that you can ask ten different radio professionals about compression and get about twenty different opinions. In this article, we'll cover some basics of compression and remind us each to think about how our “pre-broadcast” compression might interact with our broadcast processing.

If you've ever mixed live music or sound for an event, you know that processors can be of great value, especially a compressor when used correctly. Many voice processors and mic pre-amps may also have compressor settings. Just as having audio sources go through multiple digital conversions that can create unacceptable artifacts (more possible points of failure), some compression in the studio can be adversely affected by your station's on-air compression processing. Especially if changing processors in either studio or the transmitter plant, it's vital to monitor for any unwanted “squishiness” or distortion from over-compressing audio.

### Speaking Volumes

The whole game with compression is to limit the dynamic range of your audio. Dynamic range, simply put, is the range of volume between the loudest and softest sound or audio. In studio, we may use compression to “level” out overall volume in an interview or live performance. Often, for recorded segments to be aired, the compression might be added as an afterthought through a setting within a digital audio workstation. For stations with live performance studio space, that compression might have to be done in real time during the broadcast.

Our studio compression is very much for aesthetics, but your on-air processing not only affects the relative volume of elements in the broadcast, but also keeps stations legal. Classical format stations may have minimum compression to allow for the softest possible low volume passages, while Pop and Rock stations may have the compression set fairly high at the transmitter. Basically in all cases, broadcast compression will eventually limit a station from bleeding over into adjacent frequencies.

Explaining broadcast compression to students during my long collegiate teaching time, I used the pragmatic argument. If we can keep a listener's fingers away from their radio's volume control, we also theoretically keep those fingers away from the tuner or favorite station buttons – perhaps keeping a listener a bit longer!

Another major note to remember: commercially recorded and distributed music, in almost all cases, has had its own compression applied by the artist/producer team, which means you likely don't need anything other than broadcast compression on this material. Even most independent and local start up bands likely have access to basic compression.

### So Many Compressors!

Back to the studio, and without getting too deep into the weeds, there are different styles of audio compressors

we might encounter. Many have strengths and weaknesses. Here is a thumbnail of the compressors most likely found in studios:

**The Variable Mu Compressor** is the granddaddy of the pack. Many of these units use definitely older (and some would say warmer and better) vacuum tube technology to level out audio. If you're tackling a lot of sudden loud bursts, you'll likely want one of the newer technologies. It's not recommended for knocking down sudden bursts. The variable Mu, or variable gain, compressors can be very expensive, but many studios and stations use them for the rich sound from the tube apparatus. Often these compressors are used as a smoothing device after using other compressors on individual recording tracks.

**The FET, or Field Effect Transistor, Compressor** became a successor to the vacuum tube based Mu models. The transistor allows the FET compressor to react and pivot quickly – more so than the Vari-Mu models. Many pop and rock style vocals will benefit from this mode of compression.

**The Optical Compressor** is considered a good middle of the road processor. Its name gives away the fact that it uses a light source, such as an LED, and light sensing resistors. Those sensors read audio levels. The reaction time of an optical compressor tends to be a bit slower than the FET, but many prefer the slightly slower response for a smoother compression. Optical still tend to react a bit more quickly than the vari-Mu. They tend to be a bit slower on the Release, a term we'll discuss shortly.

**The VCA, or Voltage Controlled Amplifier** is akin to the FET, but the VCA sensor is in an IC, or Integrated Circuit. These compressors are fairly common and also strong for controlling sudden or loud audio transients. They tend to be precise and transparent.

If you have a choice of hardware compressors, the choice can be very subjective, based on the content and speed that you need for that content. You can also purchase software “plug ins” that can be added to digital workstations that can emulate many of the listed compressors.

### So Many Dials!

There are basic setting for compressors and, to the novice, it may seem like a lot to absorb, but the principals are pretty basic. Remember, we want to control the dynamic range, especially the louder transients or spikes. Standard audio gear without compression is ruled by unity gain, that is 1 dB of input produces 1 dB of output. If you imagine an x-y grid where input is on the horizontal line and output is vertical of a 90 degree angle, unity gain would be a 45 degree angle.

Let's discuss **Threshold**. This first setting, expressed in decibels, allows us to select a point in unity gain at which we want to wake up the compressor and put it to work. Once we hit the threshold, the compressor will begin to control unity gain based on our second setting which is **Ratio**.

**Ratio** is a relatively simple concept. We choose a ratio anywhere from 2:1 to Infinity:1. This is important,

but not too tricky. The ratio, let's say, 2:1 is fairly mild compression, meaning that once we cross the threshold, the compressor will generate 1 dB of output for every 2 dB of input. A “soft knee” compression is very mild, usually no more than 3:1 – the name comes from the unity gain line that bends slightly like a knee after the threshold.

We generally say that a ratio of 9:1, or greater, is more of a limiter than a compressor setting. It takes a major amount of level to get just 1 more decibel of audio past that threshold point, hence limiting the dynamic range. Keep in mind that once audio levels drop below the threshold, you remain at unity gain. It's easy to see how smart use of the ratio helps to even out vocals in songs or prevent feedback in live sound settings.

The third setting is **Attack**. Really, what this setting allows you to do is adjust the “reflexes” of the compressor. Fast attack times are going to react more quickly, kicking the compressor into using the ratio setting to start affecting dynamic range. If you have a talent with short sudden outbursts, a fast attack might be warranted. The attack is the beginning of action for the compressor, followed by the fourth control:

**Release**. Release determines how quickly the compressor returns to unity gain once the audio has dropped below the threshold you've selected. Very long release times, might create slight “dips” in volume when compressing. You may have heard this on some cheaper recorders with Automatic Gain Control. For many using compressors for the first time, experimenting with attack and release settings can be very educational in developing your sound.

The other two settings are **Make Up (Gain)** and **Overall Output**. These may be the same on some models. Basically what you're doing with compression is limiting the loudness of the audio passing through. These controls allow you to bring some of the “leveled out” compressed audio back up, but now under control.

### Listen to the Mix!

When producing content, I usually use minor compression, only if needed, perhaps to level out voice volumes on an interview and occasionally to level out some music in a recorded show. As stated earlier, on air compressors can alter audio in a number of different ways. Ideally the limiter is there to keep station legal and from straying into adjacent frequencies, but the on-air settings can also affect various frequency band widths. The goal is to help control the dynamic range for the radio broadcast and reach the desired presence within broadcast parameters.

Keep in mind that your on-air processing is already doing compression of its own. Listen closely to what effects your on air processing has on the material coming from your studio. Your on-air compression may already be tweaked to accentuate music content or create vocal emphasis, so over-compressing before air can really create some muffled results. It's noted by some experts that compressing heavily, anything before the actual on-air compression, can actually make the audio source sound softer than you might wish, rather than taking it to the best and loudest level as most stations want. Let me know some of your favorite compression stories!

*George Zahn is a Peabody Award winning radio producer and Station Manager for WMKV-FM at Maple Knoll Communities in Springdale, Ohio. He is a regular contributor to Radio Guide and welcomes your feedback. Share your stories with others by sending ideas and comments to: gzahn@mkcommunities.org*



# Open the door to *your* possibilities!



**ON THE AIR**

Powerful, state-of-the-art automation with the flexibility to grow with you...

- The power of OPX in one stand-alone computer
- Easy to learn
- The power to handle the largest audio libraries
- Satellite and live programming
- Additional stations
- Remote voicetracking
- Remote control

## OPXONE



**Call (888) 274-8721**  
(888) BSI-USA-1  
or email us at [sales@bsiusa.com](mailto:sales@bsiusa.com)

# Chief Engineer

## How Could I Miss That?

by Scott Schmeling

Sometimes we just seem to overlook what should be obvious. We had just such a “situation” in December of last year.

When I got up that morning there was a text, time stamped at 3:57 a.m., that one of our transmitters had dropped off overnight and would not come back on by remote control. This happened during a Minnesota snow storm – complete with high winds and dangerous driving conditions.

The transmitter is a 1988 vintage Harris HT-20. Unlike current models, this one has nothing, that in any way resembles a web interface. If it doesn't come back up by remote control, the only option is to drive out to the site and try to find out why. Keith Petermeier would make that trip since he is over an hour closer than I am – but not until the storm had passed and there was daylight. Safety first!

When he did arrive, in addition to seeing a small herd of deer on the way, he observed the red External Overload and Fault LED's lit up on the transmitter's indicator panel. What's puzzling here is that we have *nothing* connected to the External Overload input – so why the indicator?



I remembered this happening a many years ago at a different site, when some melting snow had leaked through the exhaust duct and dripped onto the upper portion of the two control circuit boards, the DIGITAL card, of a Harris FM25K (this model's predecessor).

Keith saw nothing foreign, but he swapped DIGITAL cards anyway ... with no luck. We had the same Overload and the same Fault – and the same “dead” transmitter! We had also discovered (or read in the manual) a long time ago, that pressing Filaments OFF, then starting the turn on procedure would reset a fault. But it did not.

I was on my way to the site ...

When I got to the site, Keith and I retraced everything he had done. Of course, all had the same result. We even checked the schematic and found the External Overload input and applied a ground – which cleared the overload until we tried to run the transmitter up again!

The RF path for the Harris HT-20 is: Exciter to 150 Watt Preamp, to a 700 Watt IPA, and into the PA tube. Since these are all 50 Ohm devices, this transmitter also has a very nice Flex-Patch system that allows for bypassing a preamp or IPA if one should go bad. So we tried it. We bypassed the preamp and we bypassed the IPA – *nothing* would bring this transmitter back to life!

At this point we were ready to try just about anything. We even went to a near-by site to “borrow” a Nautel VS1. The thought was – we *knew* the Nautel was completely functional, and we could plug its 50 Ohm output directly into the PA input. If nothing else, we could eliminate the original exciter, preamp, and IPA as the source of the problem.

And, yes, we *had* placed a call to GatesAir Customer Support.

We arrived back at the site with the VS1 in hand and went to work configuring it for this transmitter. All we needed to change was frequency and TPO. We had a long-enough piece of “super-flex” coax with N-type connectors on each end and power on the ceiling so we connected them. And just as we were ready to fire it up, we got a return call from Walter Freeman at GatesAir Customer Service.

I told him what was happening with the transmitter, and what we had done so far, and that we were ready to apply RF from the Nautel to the Harris. He gave us his blessing and stayed on the phone.

I mentioned earlier that the HT-20 has a 700 Watt IPA. Our normal IPA forward power is 425 Watts. Our plan was to start with only 50 Watts from the VS1 and work our way up (Walter agreed). So we started up the VS1 and the HT-20 then slowly ramped up output power from the VS1. We were probably up to a couple hundred Watts and still nothing from the Harris. Walter suggested we adjust tuning and loading for the input and output – thinking that the characteristics of the VS1 might be just enough different. So Keith cranked on the knobs and I watched the Nautel AUI for changes, hoping to find “that spot” where everything would be happy ... no such luck!

I started going through readings with Walter. Up to this point I have kept one little detail out because I didn't want you jumping ahead and figuring out what our problem was.

When I mentioned to Walter that our filament voltage meter reading was going *negative* he paused for a second, then said, “Wiggle the breaker a little bit.” (I wish I could pause for a few seconds here, because I'm pretty sure I can guess your reactions.)



Filament Circuit Breaker

I don't remember which one of us gave the filament breaker a little nudge – but, all of a sudden ... Voila! Our filament voltage reading was *back!* And the transmitter was trying to give us some output!

We had found our original problem, and all we would have had to have done was wiggle or turn the breaker off then on! In fact, if we *had* done that, we most likely would have been back on at full power. As it was, TPO was low and reflected on the VS1 was high. We were not able to find that sweet spot for the VS1, so we put the preamp and IPA back in place. We were still not able to get the good match we were looking for. It is possible either the preamp or the IPA may have been damaged. I didn't have a dummy load or in-line Watt meter with me, so we couldn't check either one into a good load. But we were able to get just over 90% of full power by making careful adjustments. That would do for now.

We had removed both the preamp and the IPA, in case we needed to send one or both in for repair. These units are cooled by the PA blower. They are mounted with their heatsinks in the air duct that goes to the PA. With the two units removed, there would not have been adequate air pressure in the cavity to satisfy the air interlock switch – so we (Keith) had covered the opening with a piece of custom-sized cardboard – you can see it in the photo below.



Covering the hole in the duct.

We got a few more e-mails from Walter. One thing he mentioned was that, considering the age of the transmitter (33 years), they have noticed a failure of some of the cabling in the Flex-patch area. GatesAir has a complete package of cables, or you can order them individually. We are also replacing that Filament Circuit Breaker!

Walter also mentioned there is a fault indicator terminal on the IPA. It's not wired to anything, but there's a terminal you can measure resistance to determine if a fault has occurred. If the IPA experiences over VOLTAGE, over TEMP, over DRIVE, or VSWR, the supply voltage is removed and the IPA stops working.

As of this writing, we still have to go back. We need to determine how well the preamp and IPA are working. We have some circuit breakers and cables to replace. And we have an intermittent “chatter” in the high voltage vault to track down.

In the world of should-a, could-a, would-a, we should-a exercised that breaker. If we had, we probably could-a gotten the transmitter back on right away and we probably would-a been at full power! But, of course, hindsight is always 20/20!

That's going to do it for now. I hope that, if or *when* you encounter a problem like this one, that you first, don't overlook the obvious! And don't be afraid to call tech support – that's what they're there for.

Happy New Year everybody!! And until next time ... Stay positive – *Test Negative* – and Keep it between 90 and 105!

*Scott Schmeling is the Chief Engineer for Minnesota Valley Broadcasting He can be reached via email at scottschmeling@radiomankato.com*

# One Receiver to Tune Them All

**Powerful, Versatile,  
Rock Solid  
Dependability!**

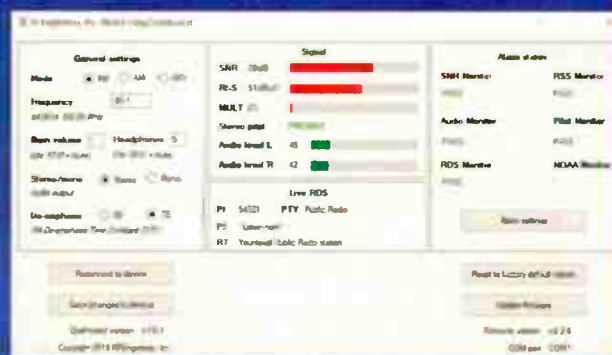

- AM / FM / NOAA Weather Receiver & Real-Time RDS Decoder
- Industrial Grade: Built to be used 24/7/365
- Unbalanced Headphone Output
- Balanced Speaker Output
  - Analog Standard, AES3 Optional
- Extensive Monitoring & Alarm System
- User API Makes Automation Easy
- Modular Design for easy reconfiguration
- Tamper Resistant Settings

For Full Information Visit

[www.rfengineers.com](http://www.rfengineers.com)



**Contact your favorite  
dealer to order today!**



# FCC Focus

## Sexual Harassment?

### #MeToo Broadcasting Industry – Your #Time's Up

by Gregg P. Skall, Member – Telecommunications Law Professionals PLLC

Workplace sexual harassment has catapulted into our collective consciousness in so many instances it's hard to count them all. Just last December, sexual harassment in broadcasting was again front and center when news broke in multiple radio journals that a former assistant producer had filed a lawsuit against Chicago radio personality Eric Ferguson, alleging an unwelcome sexual relationship during their employment at Chicago's hot AC WTMX and the refusal of a Cook County Circuit judge to dismiss the lawsuit against him.

Unfortunately, this is not new to broadcasting. We have seen allegations of sexual misconduct against some of the most respected entertainment and media personalities, including television and radio veterans such as journalist Charlie Rose, "Today Show" co-host Matt Lauer, and radio personality Garrison Keillor.

It permeates management too. A decade ago, the *New York Times* (<https://tinyurl.com/Jacor>) reported shocking harassment behavior in their coverage of the Tribute Broadcasting takeover. The Times reported that "Mr. Michaels and his executives' use of sexual innuendo, poisonous workplace banter, and profane invective shocked and offended people throughout the company."

An earlier Jacor case revolved around sexually explicit talk on radio. A female personality discussed a variety of "sexual or adult nature" topics. Despite her own participation in these routines she filed a lawsuit claiming that her cohost referred to her appearance in a demeaning and sexually degrading manner.

While not new, the #MeToo movement and the cultural response we are experiencing today is ample evidence that such behavior cannot be tolerated. Allowing it in the workplace can subject broadcasters to serious legal action as well as bad publicity. But avoiding it is easier said than done, as employers face the challenges of consensual office romances that go sour and differing perceptions as to what is acceptable behavior in the workplace.

**Office Romance** – Office romance is inevitable. Long ago a *Wall Street Journal* article, "*Is Romance Still Allowed?*" (<https://tinyurl.com/OfficeRom>) concluded, "[a]ny notion of simply banishing romantic or sexual interactions at work will fail." Studies show that even in the age of on-line dating, Americans continue to find love and sex at work. There even is a high-profile example. Former New York City mayor Bill de Blasio, met his wife while working at city hall. Reportedly, she "had zero interest." Undaunted, he flirted mercilessly, calling nonstop and trying to steal an unwelcome kiss. *Slate* questioned whether this sounded too much like sexual harassment, however, Ms. McCray was quoted saying he was "sweetly persistent, but . . . always respectful."

The de Blasio story points out how much the distinction between romance and harassment lies in the eye of the beholder. Indeed, federal courts have ruled a woman who willingly participates in and even initiates raunchy behavior at work can still successfully sue for sexual harassment once similar conduct becomes unwelcome.

**Outsiders' Conduct** – Harassment can come from any place, including non-employees. Harassment incidents have been reported coming from time buyers and advertisers toward sales people. Employees who work outside the workplace should be made aware that outside harassment will not be tolerated and must be promptly reported.

**Judgement & Balance** – This all takes a fair amount of discretion on behalf of the employer. Making the workplace too uptight will backfire. Some have found that workplace stress can lead to inappropriate humor as a coping mecha-

nism. People need to be able to joke around at work and have the trust necessary to give the company their best but also must know the limits. Having strong workplace communication and responsive management so that employees can complain without fearing retaliation or overreaction is critical in managing harassment and perceived harassing situations in the workplace.

That is difficult to achieve when workplace policies encourage rigid and punitive approaches, removing supervisor discretion. This is particularly difficult for broadcasters who must report such instances on their license renewal form. An FCC agreement with the Equal Employment Opportunity Commission requires that, harassment complaints are managed by the EEO Commission but are reported back to the FCC, and the licensee must report any such adjudication in its renewal application.

**Policies & Training** – Broadcasters should establish strong policies against harassment of any type whether it be based on sex, race, religion, national origin, disability or any other protected category. The policy should include a statement that unwelcome and personally offensive verbal or physical sexual behavior is injurious to morale, interferes with work performance and creates a hostile or intimidating work environment – and strongly state that such conduct will not be tolerated. Provide a reporting mechanism, a pledge to investigate, take appropriate corrective action and refrain from retaliation. Designate an EEO officer for this process and let employees know that if he/she believes has been the subject of sexual harassment, he/she should bring it to the attention of the designated EEO officer. Make clear that all complaints will be treated with confidentiality. The goal is to make the workplace harassment free; make the message clear that unwelcome advances, requests for sexual acts or favors or other related verbal or physical contact is not appropriate for the workplace.

Harassment training is also important. Plan periodic sensitivity training – educational sessions explaining what constitutes harassment in the workplace and that it is not tolerated. Training can also be done through a variety of videotape or on-line training sessions. Look to your state broadcaster association for good references.

In "*Harassment Training Gets a Revamp*" (<https://tinyurl.com/sex-train>), *Wall Street Journal* columnist Sue Shellenberger reports that sexual misconduct is often an open secret among co-workers. Her lesson is that, if you know that a co-worker is guilty of sexual harassment, you need to speak up, no matter how powerful the perpetrator. Emphasis must be on fostering a respectful workplace.

#### Where Do We Go From Here?

A good discussion of the #MeToo / TimesUp movement and the quandary of how to deal with harassment and punishment occurred in a 2018 edition of *CBS Sunday Morning*. Oprah Winfrey conducted a discussion with major Hollywood figures. (<https://tinyurl.com/CBSOprah>) The overwhelming consensus was that the time is up for silence and deference to power in the workplace. But, there was also a discussion of at what point an apology should be accepted. Judgment and punishment should be appropriate and sometimes it is okay to say I accept your apology and move on. The important point is to have a well thought out policy and implement it consistently.

#### Reporting Harassment

Here's what your training program should say to all employees, and all officers for that matter:

If you believe you have been subjected to harassment of a sexual nature, report it when it happens. Don't wait until it's stale news. If you witnessed harassment, you should report that as well to appropriate senior officials. "*If you see something, say something.*"

#### Investigation

As management, when a complaint is lodged, give a prompt and thorough investigation – that is documented! The investigation must be treated as confidential except to the extent necessary to investigate and resolve the issue. If corrective action is necessary, be sure to follow through, take the corrective action and document the corrective action adopted. A report should be made to the complaining party regarding the investigation and what action was taken by the employer.

#### No Retaliation

Be certain to adopt and implement a strict no retaliation policy for employees reporting violations of the anti-harassment policy or information for the investigation. A claim of retaliation can be as damaging as the claim of harassment itself.

#### Corrective Action

It is also important to emphasize that a corrective action policy does not necessarily mean automatic termination of employment. Depending upon the severity of the confirmed offense, alternatives could include coaching and counseling, documented verbal or written warning, mandatory supervised training, temporary suspension or other penalties short of termination. Finally, of course, termination should remain an option for the severe case.

#### The Bottom Line

All employers must take sexual harassment in the workplace very seriously. Encourage everyone in the workplace to report even the smallest incident. All employees should understand there are multiple avenues in the organization by which to lodge a complaint and that a prompt, thorough and fair investigation will follow together with appropriate corrective action. Underscore that retaliation is never an option.

Despite all of the attention being paid to sexual harassment in the workplace, the law has not changed much in this area. What has changed is that both traditional and social media have shone a spotlight on the issue as never before. Victims are more empowered to come forward with their complaints and recent events show that even decades old conduct is coming to light. It may not involve legal liability due to statutes of limitations or fading memories of potential corroborating witnesses, but the media attention can have severe consequences for the station's reputation, viewer or listener reaction and the ability to attract quality employees. Surveys of various industries disclose that a high percentage of women report receiving or seeing unwelcome email, text or other communications of a personal or sexual nature at work and that they have been present when comments or jokes of the sexual nature were made. Many also report bullying behavior.

Employers can no longer tolerate, condone or ignore behavior that violates company anti-harassment policies. Be certain all station personnel understand that if they are aware of any behavior that violates company policy against sexual harassment they are encouraged, and even have a duty, to report it to management. And make certain there is a safe and secure avenue for that report!

*Acknowledgment: This column was prepared with help from Richard Rainey of Womble Bond Dickinson.*

*This column is provided for general information purposes only and should not be relied upon as legal advice pertaining to any specific factual situation. Legal decisions should be made only after proper consultation with a legal professional of your choosing.*

*Gregg Skall is a member of the law firm of Telecommunications Law Professionals PLLC. He frequently lectures on FCC rules and regulations, represents several state broadcaster associations and individual broadcasters and other parties before the FCC.*

# mixIT

The industry's most affordable and versatile touchscreen console is now available in three sizes

**mixIT-6**



**6 Faders**

**\$4,950**

**mixIT-12**



**12 Faders**

**\$5,800**

**mixIT-18**



**18 Faders**

**\$7,100**

- AES67, Ravenna, Livewire™ AoIP built in
- Optional Dante® AoIP now available
- Mic In, Analog & Digital I/O
- EQ, Dynamics and Mix-Minus



**Logitek**

Networked Audio Consoles

Learn more at [logitekaudio.com](http://logitekaudio.com) or call 800.231.5870

# Maintenance Guide

## The Never Ending Fight With Corrosion

by Wiely Boswell

Things are going to rust is a fact of life. The term applies to steel but when you look at the big subject, it's all some type of corrosion. The fight goes on nonstop to control it. It can be dangerous when it comes to towers. Rod and other types of guy anchors are of big concern with "necking," – the rusting out of the rod just below ground, to the point of failure. A tower inspection includes digging around anchors to look for the condition of the rods under ground. The newer rod types have room at the end of the rod for mounting a "ping" transducer, and from reflections can tell if necking is occurring underground. Things get active starting at ground level and into the soil – the soil type is a large factor in this corrosion. An experienced soil tester can just tell by driving near the site and looking at banks along the road. Smaller 25G, or any type section of tower buried into the ground, can have serious problems right at ground level. Things get bad quickly by chemicals such as salt-laden weed killers or fertilizers. Bolts in tower construction can also become degraded. So this is a challenge that never goes away.

There is also the inadvertent encouragement of corrosion by the junction of dissimilar metals. Aluminum does not meet well with copper at all. It got my attention when an aluminum box containing a surge suppressor for a phone line came with a stainless steel plate that fit between the box and a copper ground strap. If the box was bolted down directly on the copper strap, corrosion would begin in the contact area. It is still some what of a compromise. Electrical connections rated for aluminum and copper (Al/Cu) are made from special alloys.

Oxidation is the main driver in the deterioration of metals. No-Ox-Id compound is an essential tool in fighting corrosion and it really helps in the breaker box where the breaker hits the buss. Grease is the next best way to keep oxygen out of a connection. I remember seeing grease for the first time in a Ford tail light socket years ago. Some new bulbs even come with a small packet of grease and feedline ground kits come with No-Ox-Id. A connection filled with No-Ox-Id takes up the space where water could get in the connection. You need to take boat trailer lights and grease the bulbs and sockets while shiny new, before they go under water. The same goes for a breaker box. Likewise if you use clamps on #6 Cu to a ground rod, generously apply No-Ox-Id to all surfaces before and after assembly leaving no voids. It's messy but worth it! Cadwelding is of course is the preferred method.

Dissimilar metals can be an issue, but think of the thermocouple, made of dissimilar metal electrical conductors twisted together that generate a small voltage proportional to the temperature. The conductors are made out of various metals depending on the application. The point here is, now we are talking about an electrical circuit with small currents. If two pieces of dissimilar metal are connected, the one that corrodes the fastest will prevent or reduce the other piece, the electronegative metal, from corroding. It will be the anode that corrodes. Telephone lines were specifically -48 VDC to prevent disastrous corrosion when water would enter a damaged above or underground cable. The conductors were, in the early days, simply insulated by paper wrap and was all encased by a lead shield. Water in a cable caused crosstalk between

pairs. So big cables ended up being pressurized from the Central Office and then further down the line by nitrogen tanks (sound familiar? ).

An oxidation reaction occurs on the anode and a reduction reaction occurs on the cathode. Magnesium, Zinc, and Aluminum are common metals used for the purpose of being a sacrificial anode in the "circuit." The term cathodic protection is used to describe the protection of a steel pipe line, a water heater, a water tower, a boat hull, or even a boat motor. A galvanized pipe, bolt, or cable for example, is zinc coated over steel. The coating is saving the steel as long as it is there. It will eventually oxidize away so thickness matters. If a pipe wrench scars the galvanized zinc coating the steel will begin to rust. Zinc spray paint is the answer. For large applications it is available by the gallon. It is useful in electrical work. Electrical breaker boxes outside seem to rust quickly – I don't know why they are not well painted.

Periodically along the route, a pipe line has a small negative current applied to it by a small pole mounted box with a rectifier and a variable resistance to control the DC voltage, to obtain a certain current as specified by the system. (Figure 1)

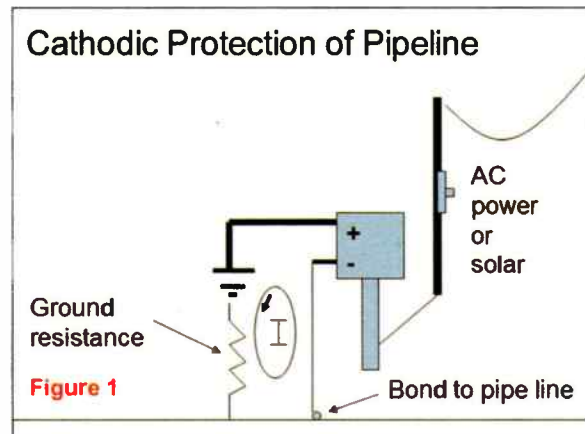

The goal is to make the pipeline electronegative. So it's a circuit completed by the ground resistance. This is considered active protection. If a pipe line were to be in close proximity to a tower it can actually negatively effect the corrosion rate of guy points. This would be a possible case of stray current corrosion.

Figure 2	Aluminum	Lead	Copper	Zinc	Stainless Steel	Galvanized Steel
Aluminum	✓	✓	✗	✓	✓	✓
Lead	✓	✓	✓	✓	✓	✓
Copper	✗	✓	✓	✗	✓	✗
Zinc	✓	✓	✗	✓	✓	✓
Stainless Steel	✓	✓	✓	✓	✓	✓
Galvanized Steel	✓	✓	✗	✓	✓	✓

The case of dissimilar metals in contact results in galvanic corrosion. It encounters an electrolyte such as salt or water and the process begins.

Figure 2 shows a simple chart of metals and their characteristics. It is like building a battery and the reaction

can be quick to damage the metals with repeated exposure to the electrolyte such as salt breeze and condensation, for example. No-Ox-Id or grease can attempt to minimize the entrance of an electrolyte like water into the connection. It is the degree of difference of electrode potential of the metals whether the connection of the two will behave badly. Some metal junctions may be permitted in a dry environment but not in a wet location.

A direct attack to a metal, such as guy wires, involves pollution and rain which starts to attack galvanized hot dip coating. Double dip coating is a good way to extend the life of the coating. The rust starts to appear as the coating oxidizes and is quicker with thin coats. Zinc gray spray paint is cold galvanizing. It may have to be reapplied later to areas starting to show rust.

Stainless steel can rust if it is in a harsh environment that can damage its thin protective coating. If a situation such as fiber type gaskets or plastic washers result in water, or especially salt water, to be trapped, it is called crevice corrosion.

One other way to stop oxidation of steel is to let it just rust until the iron oxide (rust) becomes so thick the oxygen cannot get to the surface anymore. If you see a rusty bridge framework with lots of rust staining on the concrete that is what is happening. The steel is designed with extra thickness to overcome the loss. Large power poles using this idea can run into trouble if rust drips on insulators. They have to be taken off-line to be cleaned. As a side note, salt spray breaks down the insulation also.

A new annoyance that must come up to a lot of people besides me is the garden hose connector made of aluminum. The parts you buy at a large mart look brass beautiful and are cheap. Of course they are imports. First thing you notice is they are light weight.

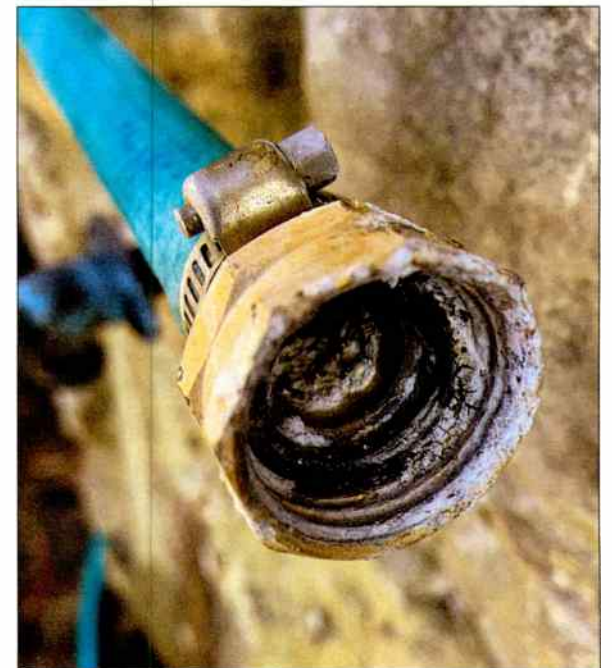

A "Simulated Brass" Connector

The figure above shows how bad it corrodes when left screwed on an actual brass spigot. It takes locking pliers to get it unscrewed. It appears to be aluminum and was taking issue with a brass spigot. You will also find many other supposedly "brass" connectors and fittings being sold – but are really aluminum with a very thin colored coating.

Wiely Boswell is Chief Engineer of Faith Broadcasting, located in Montgomery, Alabama; CBRE, CBNE, and SBE 118 Chairman. He may be contacted at: [Wiely@faithradio.org](mailto:Wiely@faithradio.org)

# Social Distancing

SINCE 2015

## PROFESSIONAL REMOTE MONITORING

FROM ANY LOCATION.  
ON ANY DEVICE.

AM | FM | HD | DAB | DAB+



TAP INTO YOUR BROADCASTS THROUGH AN EASY TO USE REMOTE WEB INTERFACE WITH INOVONICS' EXPANSIVE OFFERING OF REMOTE MONITORING EQUIPMENT.



### 531N FM Modulation Analyzer

Direct and off-air reception. Keep a sharp eye on total RF signal performance.



### 525N AM Modulation Analyzer

Third generation AM Modulation Monitor designed for accurate AM readings even in the presence of Hybrid Digital (IBOC) transmissions.



INOMINI 635 FM/RDS SiteStreamer™



SOFIA 568 HD Radio SiteStreamer+™

### SiteStreamers

Compact Size with huge features. Powerful web graphics & Internet streaming. Dante AoIP available on all SOFIAS.

www.inovonicsbroadcast.com | sales@inovonicsbroadcast.com | 831-458-0522

#### WHY INOVONICS?

- Quality Solutions. Competitive Prices.
- Three-year Factory Warranty.
- Quick to install. Easy to Program.
- Quality after sales service.



TRY OUR LIVE  
PRODUCT DEMOS!



## Why Equipping Your Radio Station With Today's IT Infrastructure Makes Sense

by Marty Sacks, Executive Vice President of Sales, Support & Marketing, Telos Alliance

Broadcasters are quick to adopt new technologies when they show clear advantages. You, our valued colleagues, have supported our forays into the future for nearly forty years since Steve Church's first product, the Telos 10. Continuing with the ground-breaking Telos Zephyr, the original Omnia processor, and our first AoIP products including the Axia Element console, broadcast engineers have joined us in pioneering new tech for the broadcast industry. We're grateful for the trust that many of you have placed in us over many years!

Today, we are on the cusp of another major innovation in broadcasting technology: Virtualized computer environments running broadcast-specific applications. Still in its infancy, virtualization, or the dematerialization of hardware, appears to be positioned to offer real benefits to broadcasters. Obvious advantages include reduced hardware costs, space savings, improved efficiency, easier updates, and scalable architecture.

One early experimenter – and then early adopter – has been BBC Local Radio. The BBC operated “local” radio stations in about 40 cities across England. In 2014, the BBC began reducing the difficulties and expenses associated with local equipment capital and maintenance costs, as well as a shortage of engineers to refit 80 complex studios. The result was “Virtual Local Radio” or VLOR. Local BBC studios operate about the same as with the old legacy equipment, but the underlying broadcast infrastructure lives within two data centers in London and Birmingham. Automation playout, talk-show systems, audio codecs, and even live on-air mixing is handled at the data centers by high-reliability servers. Redundant data connections and dual studios/data centers assure six 9's of uptime.

Recent developments are bringing broadcast infrastructure virtualization to more broadcasters – even those without large budgets. Since “virtualization” embodies several definitions, broadcasters can virtualize a few things now, then move toward radical virtualization of their infrastructure when the time is right.

A contemporary example of virtualization is moving the audio console surface, plus phone interaction and other studio controls to a touchscreen.

Another form of virtualization is to move automation playout systems onto Virtual Machines (VMs) running on powerful, server-grade platforms. Some automation manufacturers are supporting this scenario already, and most are planning on it. At Delta Radio in Mississippi, hardened servers are running five instances of the Rivendell automation system. Audio and GPIO signaling is done entirely in Livewire Audio over IP, so no sound cards or GPIO cards are needed at the server. Once set up and tested, these automation systems have worked flawlessly.

Telos Alliance is one of the very first companies to be making this technology available to broadcasters. Moreover, we take seriously our job of helping to give some perspective on this new tech – and why it matters. Engineers are noticing a growing number of well-known broadcast products such as the iQx console, the VX talk-show phone system, and our Pathfinder Core PRO facility controller, each running in a purely software environ-

ment. These virtualized broadcast products are adding to the growing cadre of hardware equipment, allowing you, the broadcast technology professional, the power to make choices.



**Axia iQs is the first soft console controlled by a full HTML-5 interface, allowing you to not only control a mix from anywhere, but on any device – Mac, Windows, tablet, laptop, even your phone!**

Let me clearly and emphatically state that Telos Alliance is not getting out of the hardware business. While we know many engineers want our broadcast hardware, and will for some time to come, technology is changing the industry landscape. Moving toward a standardized IT infrastructure lets broadcasters leverage advantages today and into the future. Server-grade computers, virtual machines, and software containerization are enabling both live and automated broadcasting with greater efficiency and reliability than ever before.

Some of us have already heard about this software technology, but for those that haven't, this is a recent move by the IT industry to take advantage of a few trends:

1) Large and small businesses – inside and outside our industry – desire the price competitiveness and flexibility brought about by more IT infrastructure in place of purpose-built systems. Companies like Dell and Cisco have very reliable building blocks that are very cost efficient. For broadcasters, this is not eliminating purpose-built hardware but using it only where it is needed. Using IT infrastructure has the benefit of reducing real estate, HVAC and conditioned powered needs because computer servers are very powerful and can replace multiple pieces of gear that used to be mounted in racks. Of course, the exact amount of these savings is dependent on specific choices and sizes of implementation.

2) System redundancy is practically built-in to today's IT infrastructure planning. The ability to have a hardened broadcast infrastructure using IT standards is mature, well tested, and relies on IT industry standards that are widely supported. These new topologies, with their ability to “spin up and down” resources as needed, remove the traditional stand-alone computer redundancies that have been the Achilles heel in the past.

3) Using IT standards lets us use our IT colleagues' skills to a higher level in our facilities while enabling remote configurations and work-flows. Much of what we used to need to go into the facility to do (production as well as maintenance) can be done remotely, anywhere there is an Internet connection.

4) More and more companies – such as broadcasters – are interested in flexibility to produce shows where and

when they want without being tied to a studio or building. We certainly saw this with Covid and the increased interest in disaster recovery planning.

The newest trend in virtualized environments – known as containers – are Linux-based systems that share a common operating system layer.

The crucial word here is agility. When we say “agility” it basically refers to getting features and updates to customers or clients faster. Containers are an important tool when you're creating the groundwork for any modern application. Primarily, it enables easy deployment to the cloud. Beyond that, container technology is also more controllable, more granular and is a microservices-based method focused on efficiency.

Broadcasters can use software containers to build, share, and run applications quickly and reliably, even shifting them from one computing environment to another. The applications are implemented in hypervisors or containers (like Docker). They allow silos (containers) of individual software to run as separate instances. They can be stopped, started, or even reconfigured. The ultimate in flexibility! It's very efficient, as you only run what you need – and only when you need it. It can all be automatically maintained by an orchestration layer that will automatically spin up instances for higher workloads or for redundancy purposes. Use of Linux gets around the well-known limitations (and cost) of using the Windows operating system in the broadcast environment. Because our software is architected using industry standards like HTML5, any of these software instances can be controlled by a web browser on your choice of platforms ranging from a phone to tablet to computer.

Regarding containers, the software is obtained through on-line repositories – as new versions of your software become available you can get those very easily when you want them and do your updates as you wish. The chaos of computer updates occurring automatically in the middle of afternoon drive is a thing of the past.

What's even more interesting? The amount of broadcast infrastructure that can be created in these containers. It's not just mixing or just phones. Today we can create a fully capable radio facility totally in software this way, all while taking advantage of our Pathfinder facility controller to customize audio workflows, just like our clients are used to today with hardware. Another way to think of this: Look at the gear in your rack today and understand much of it can now be instantiated in software. And as time goes on the choices and options will grow.

For those who wonder, “How can we create software products so quickly?” It's because for the last 20 years we've created our hardware products based on x86 platforms so moving to containerized implementations that run on others' x86 platforms are nowhere near as time consuming as creating products from scratch like many suppliers in our industry will have to do.

Just like the folks who joined early in our pioneering of AoIP for broadcast in the early 2000s, the adoption of containerized software will look quite a bit different depending on the facility. Some people might create an entirely new facility with this capability, while others will focus on disaster recovery. And there will be some broadcasters who will equip one talent or one show, to try it in one or two applications, before making a facility-wide commitment.

At Telos Alliance we're here to educate and help broadcasters and engineers get comfortable with this technology. As our customers have discovered, this water's pretty amazing – jump on in! – Radio Guide



Software-based

# visualization & talkshow

solutions that anyone can use and everyone can afford

From **\$995**  
buy-out  
Annual subscription  
pricing available.  
Price per product.



**Camera One**  
Effortless Studio Visualisation

- Intelligent camera switching
- Automated graphics
- Social media streaming & sharing

Works with Blackmagic ATEM Mini series (required)

**Caller One**  
Effortless Talkshow Software

- High quality VoIP / SIP lines
- Answer, screen and control calls from any browser
- No expensive hardware required



Find the **smartest** broadcast studio technology at [bionic.radio](http://bionic.radio)

World Radio History

Distributed in the US by   
Broadcasters General Store  
352-622-7700 [www.BGS.cc](http://www.BGS.cc)

# Transmitter Site

## Transmitter Plant Planning – Part 1

By Mike Callaghan

Transmitter plants outlast studios typically three to one, yet we spend a lot more time planning the studios for convenience and comfort. But, a broken transmitter plant can hold us captive just as long as a studio can – often with substantially more stress.

It's a rare luxury to have lots of space when you build a transmitter plant, but making everything fit properly and easy to work on is a major challenge. Every moment you spend in careful planning will come back to reward you many times over.

### Plan Everything

Draw everything and CAD everything. Get a good CAD program and learn how to use it. While all CAD programs have a learning curve, if you find one that's easy to use, you'll spend more time designing and less time straining to make the program work.

List everything and review everything – and save everything. You need numbers, distances, quantities, voltages, amperage, heights, widths, and general costs before you order anything. Try “what-if's” for everything.

Fit things in different ways. Allow plenty of work space around every item that you can't move. Plan what goes on the walls, on the floor, and on the ceiling. Envision what door your gear enters through, and don't put anything in front of a door.

Plan the transmission line routing from the beginning. Remember to route a line to the dummy load. Double-check distances by measuring to both walls from a point, adding the measurements together, and checking the sum to make sure the room hasn't “grown!”

Look at the drawings to see what it will take to move anything out and something else in. What will you do if you need to change to a larger transmitter, add equipment leasing space, or add more racks?

### Create a Good Working Environment

Install plenty of light fixtures. You cannot have too much light in a transmitter plant. Now's the time to make sure you'll be able to tell a tan wire from a grey one, when working deep inside an equipment rack.

Put in some sort of workbench with plenty of AC receptacles. Use a master switch to turn them all off at once so you don't forget to turn off that soldering iron.

You'll need to hear the station from inside a rack so use speakers and an amplifier loud enough to hear, even above the fan noise – you need to know if you cut off the station when you cut off a piece of wire.

Put the AC disconnects near the back of the transmitters – then you won't be tempted to skip using them.

### No Need for Walls

Don't spend the time and expense to build walls around the transmitters. New transmitters are a lot quieter than they used to be, and walling them in means going through a door to get from the front to the back. It slows you down, and it keeps you from being able to see the entire transmitter at once. This also means you can keep the transmission lines from going through walls. It's nice to be able to see a whole length of line at once.

In the layout, position the control rack so you can see the meters on the transmitters from the front of the control rack. It's important to know what a transmitter is doing while switching patterns or antennas.

### Coax Runs

Avoid any solid coax lines longer than 20 feet. This is the length they come in, and if the runs are shorter than this, you won't need splices. No splices means the lines can support themselves using just the ends, and this avoids hanging them from the ceiling. It's neater, cleaner, and much easier to work with in a hurry.

When hanging the lines, a laser level is imperative. Install the end fitting on one end of the line, and place the level on top of it facing the destination. Use the level to get the line level, and then take the destination fitting and hold it above the destination port so the laser beam just touches it. Then measure the space between the fitting and the equipment – that is the length you'll want for the vertical line section.

### Labels and Photos

Throughout the build, and long thereafter, a good label maker will be your best friend. Label everything. Label the license number and frequency on any STL gear – and also all AC breaker and disconnect boxes.



Label the circuit number on any telco equipment. Label power outlets with the breaker number that feeds them. Label the Main and Aux processors. Use the flexible labels and Brother P-Touch software that prints cable labels to mark the cables. The labels on both ends of a cable should be the same, showing the signal it carries and the cable number if there is one.

If you get one of the label makers that connects to a computer, you can make the labels any size you want. This helps when you label the buttons on a switcher, inputs on a panel, or anything that may have an odd length.

Get a good digital camera, and document where all the cables go on the rear of the equipment.

A picture really is worth a thousand words when you have to return equipment to a rack with a huge number of connections.

### Light Locations

Don't mount lights directly above equipment. They should go behind or in front instead.

If the backs of the transmitters or racks will face a wall, surface-mount fluorescent fixtures against the wall,

about 7 feet up, with the long edge parallel to the floor. These give an incredible amount of work light, and are well worth the effort. Also, the high mounting angle will avoid shadows in the work area.



The better you can see, the safer you are.

Never mount equipment up against a wall, even if the manufacturer says you can. The manufacturer won't be there on a stormy night, when you need to get to a part you've blocked off.

Leave room to haul anything in and out of the door. Avoid putting heavy equipment where it blocks the doorway to other equipment. Determine the size of, and allow access to, heavy metal components.

### Develop a Grounding Plan

Plan the grounds just as carefully as you plan the AC wiring. These days, all transmitters need absolute grounds, and the grounds must have integrity.

The three foot copper ground rod from the hardware store just won't make it. For stand-alone FM's on mountain tops, budget a chemical ground. The AM noise figure and rock-solid remote control make one worth it. Ground everything with copper straps.

The racks, the dummy load, and especially the transmitters and their power supplies. Many modern transmitters need a good ground reference for the control circuitry to work right. It looks neater to lay the ground straps under carpet or tile than on top of it.

### Rack Layout Planning

When you lay out the racks, leave at least one rack space between equipment placements for ventilation. Allow extra space for future additions. You'll probably add twice as much new equipment as you'll ever take out.

Leave room for Rack Mounted UPS's. Any computers need a boot time, just as surely as old equipment needed time for the tubes to warm up. A UPS keeps a 2 second power dip from becoming a 45 second re-boot outage

If you have a computerized control system, plan on installing interlock bypass switches on the rack face. When these systems re-boot, they usually open the interlock relays, and that shuts the transmitters off until the computer is back up. The bypass switch keeps you on the air if you need a restart.

*In Part 2 of “Transmitter Plant Planning” Mike will look at audio layout, RF Planning, Air Conditioning, electrical layout and more.*

*If you have comments, or if there is an area of transmitter plant planning that you want Radio Guide to discuss in more depth, let us know. Email us at: [editorial@radio-guide.com](mailto:editorial@radio-guide.com)*

*Steve Callahan, CBRE, AMD, is a member of the engineering staff at Entercom Boston. Email at: [wvbf1530@yahoo.com](mailto:wvbf1530@yahoo.com)*



## The Reporter.

Remotes are hard. After hauling out the kit, connecting everything, searching for power, finding working Internet, double-checking the algorithms and bit rate, you call the studio and wonder if it'll work.

Meet CallMe. No kits to carry, cables to pull, or apps to install; it runs in the browser on any smartphone, tablet or computer. Ah — we hear your gears turning. That's right: everyone has a broadcast codec in their pocket, on their desk, or in their bag. And they already know how to use it!

Imagine texting or emailing anyone on the planet a link. They click it, and they're instantly in your studio. Use it for breaking news, artist interviews, VIP guests, sporting events, sponsored promotions. Use your imagination. You even get your own custom-branded Web portal for listeners.



## The Anchor.

The studio side of CallMe is this brilliant little box. Notice the lack of buttons and screens? There's nothing to adjust, no menu trees to climb, no parameters to twiddle. That's because it's designed to do exactly one thing: make fast, flawless IP audio connections. And the sound quality is amazing, thanks to the OPUS algorithm. Rock-solid, reliable, and ready for air.

And since you're wondering, yes, CallMe is compatible with pretty much all of the other codecs out there — even those needlessly complex and expensive ones.

Visit [AngryAudio.com/callme](http://AngryAudio.com/callme) to learn more.



© 2021 Angry Audio LLC  
[www.angryaudio.com](http://www.angryaudio.com)

World Radio History

# Tower Topics

## Troubleshooting AM Diplexed Systems

by Paul Thurst, CPBE

Diplexed AM stations are becoming more common for a variety of reasons. Using a single tower or array for multiple AM stations can free up land for sale to developers and possibly cut down on operating expenses. These combined antenna systems – some might even call them daunting. There is no need to use words like that. The beauty of AM antenna systems is that they are simply a sum of their parts. Those parts are fairly large, easy to examine, test and measure with the right test equipment. Breaking things down into sections can help greatly in understanding them and thus finding problems and fixing them.

AM Antenna Tuning Units (ATUs) are simple L or T network impedance matching devices designed to couple the 50 Ohm transmitter/transmission line output to the characteristic impedance of the tower. AM Diplexers used to combine stations have additional components to create filters to keep each station's signal from getting into the other station's transmitter which would create problems with intermodulation, spurious emissions, VSWR and so on.

In the diagram (Figure 1), one can see the three separate sections for each station. From left to right, they are:

A. Antenna tuning network. This is the same for any Medium Wave station consisting of a T or L network.

B. Band pass filter. A 25-35 kHz wide series resonant band pass designed to pass that station's RF on to the tower and reject all other frequencies.

C. Band stop or reject filter. A parallel resonant reject filter designed to remove the other station's RF as much as possible.

Sometimes things can go wrong. Often in AM systems, antenna problems are indicated by high reflected power or

For something like this, I find a flow chart (Figure 2) to be helpful:

Next, if there are two patterns (Day/Night), see if the problem is in both patterns. If the station runs normally in one pattern but not the other, you have narrowed the problem down significantly.

Next, is the problem noted on both stations or just one? If both stations are affected, look for things that are common to both; the static drain choke, tower lighting choke, the tower or skirt RF feed conductor, damage to the skirt, etc. In some installations, particularly those with skirted towers, I have noted an inductance swamping capacitor installed past the base current meter. On a diplexed station, that capacitor could be common to both stations.

over static drain chokes, bad tower light chokes, disconnected or corroded ground straps, etc. These are obvious signs of trouble. Keep in mind that the defective component you see might be a symptom and not the actual cause. Always investigate further than the detected problem to make sure that something else isn't waiting to damage the part that was just replaced.

Individual components can be tested by various means to see if they are within specification. Many DVMs have a capacitance meter, which can be used to verify if the sus-

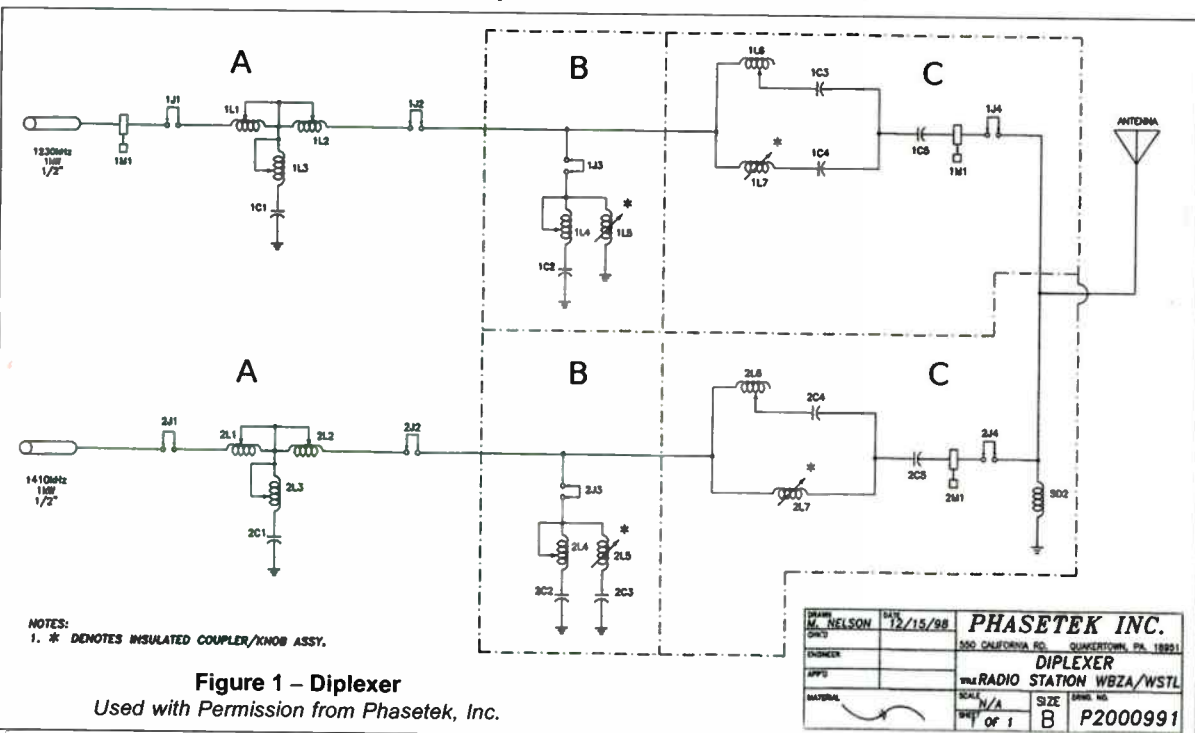
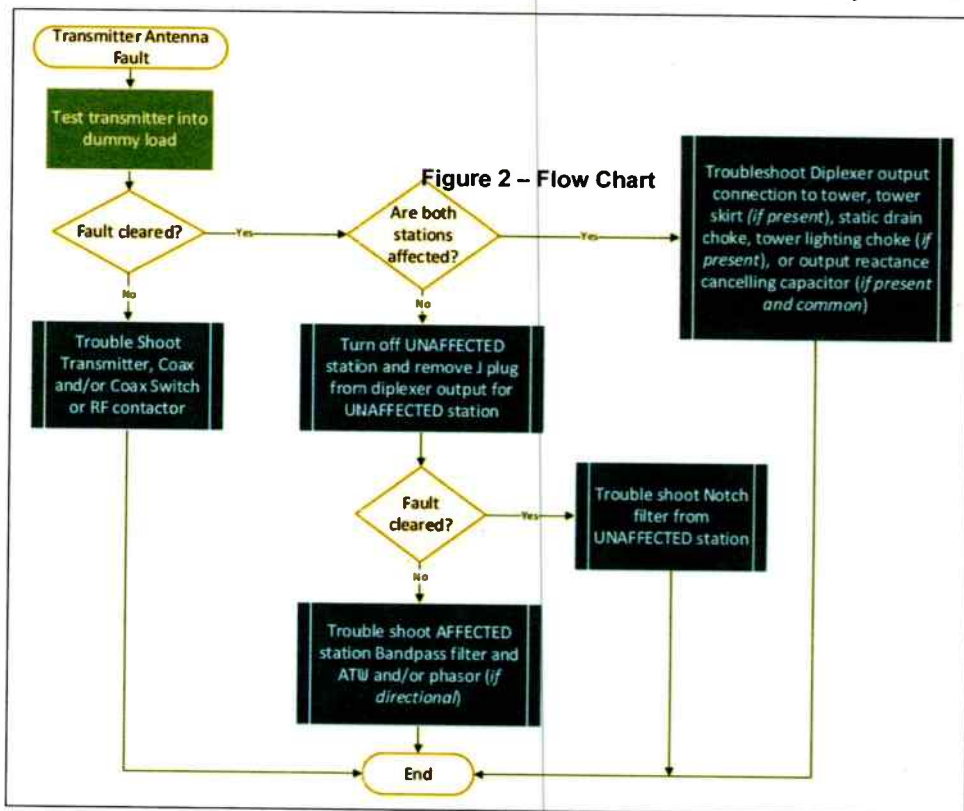

Figure 1 - Diplexer

Used with Permission from Phasetek, Inc.

other antenna faults. Another possible fault on a diplexed AM system would be spurious emissions. Unexpectedly finding your AM station's signal on several new frequencies across the AM dial (and beyond) is problematic.

The first step in any troubleshooting situation is to narrow the problem down by process of elimination. Thus, testing the affected transmitter into a dummy load, to make sure the issue is with the antenna and not the transmitter, should always be step one. If the transmitter runs normally into a test load, then continue on to the next step.

One feature of diplexed antenna systems: if only one station is showing problem, the failed component or issue might actually be with the other station's filter network. If the notch or reject filter is not showing high impedance towards the rejected station, it will shift the impedance of the reject station which the transmitter will see as high VSWR.

A complete physical inspection should be completed. Look for burned out capacitors (cracked, leaking), disconnected straps, warped inductors, corroded or burned contacts on variable inductors, bad J plugs, arced RF contactor fingers, arced

pected capacitor is open, shorted and/or will give a value that is somewhat close to the nominal value stamped on the side of the unit. In other cases, component values can sometimes drift with age, which can cause the band reject or band pass filters to go out of tune. The reject filters are closest to the tower. Therefore, the components in those filters are subjected to the highest impulse energy from lightning strikes and are most likely to be damaged.

Next, look for documentation. Phasors and ATU's should have some schematics or prints around. Sometimes, if the manufacturer is known, they may have a copy if you cannot find it locally. A schematic should show the individual parts of a diplexed system. This information will be useful when ordering replacement parts. Another very important bit of information would be the operating base impedance for both stations. If nothing else seems amiss, check the base impedance of the tower. Unless something has changed (antennas added to the tower for example), the base impedance should be stable. However, things can happen. An OIB (Operating Impedance Bridge) or network analyzer can be used to measure the base impedance.

Replacing parts in the ATU sections of a diplexer should be fairly straight forward. When components are replaced, the ATU input (transmission line/transmitter side) impedance should be checked with an OIB or Network analyzer. Normally, the ATU input impedance should match the transmission line (50 Ohms j0) or as close as possible. There may still be some installations with open wire transmission line, in which case, those values will be different depending on the impedance of the open wire line.

If components are replaced or retuned in either of the filter sections, a type of network analyzer will be needed to accurately tune up the band pass/band reject frequencies. If there are no other high powered medium wave stations transmitting nearby, this could be something that a NanoVNA could do.

Paul Thurst, CPBE, is co-owner of Data Wave, LLC. He can be reached at paul.thurst@datawave.us

“When your competitors ask what you put on the air, you can chuckle knowingly.”

“marvelous”

“VOLT wins, period!”

“...very good right out of the box”

“obvious choice”

# Best-Seller.

“perfect”



“immediately impressed with VOLT’s presets...”

“impressed with the amount of power... right out of the box”

“power beyond its entry-level price”

“loud, clear on-air sound”

“You must hear this processor to believe it”

“That’s a powerful clipper!”

“loud, clear on-air sound”



## A Tale of Two Blowers

by Scott Schmeling

I love a good mystery. One where you get information, you analyze it, and you solve it. Transmitter troubleshooting is usually like that. But once in a while you're thrown a curve ball – the most logical solution is not correct. I ran into a couple situations like that.

### Mystery #1

One of our stations is running a Harris FM 20K transmitter. This site has no 3-phase service so there's also a PhaseMaster phase converter installed. We had experienced occasional transmitter outages, and we would sometimes find the PhaseMaster breaker tripped. Sometimes all it took was pressing the Plate button, even though it hadn't come on by remote control. When the transmitter did come up, all readings were normal, and there was no indication of the possible cause.

The last time it happened, I was in the middle of a mock FCC inspection at another site a couple hours away. The station's Operations Manager could not get the FM 20K to come back on, so he switched to the backup. In the meantime, we finished the "mock" and I packed up for a drive.

### The Clues

When I arrived, I found all breakers up, but the transmitter would not fire up. When I pressed the Filaments button, I could hear a contactor energize, but nothing else was happening. This transmitter has three cartridge fuses on the blower. I checked the fuses and found one blown. I replaced it and hit the switch. Same thing: I could hear the contactor but nothing else was happening.

I checked the fuses and, again, found one blown. I could spin the blower easily by hand. I felt the case and found it warm but not excessively hot. Of course, the transmitter had been off for a few hours so I figured the motor may have cooled down. The motor appeared to be bad.

By then it was early evening, and my regular motor shop was closed for the day. I pulled the blower out and headed for home. I would take it to the shop in the morning and have it repaired.

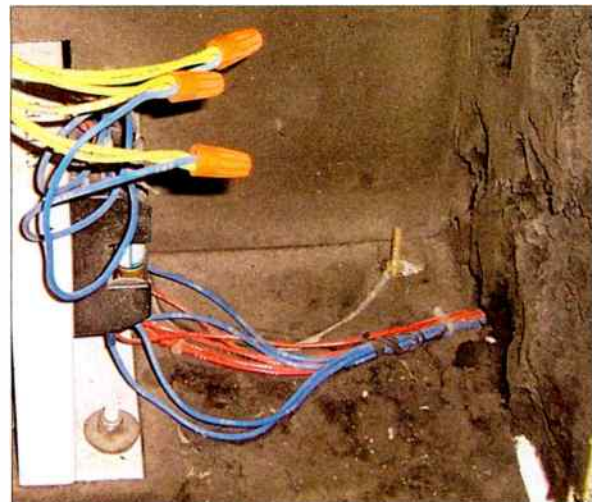

Transmitter with Foam Sound Deadener

### A Nice Twist in the Plot – But No Solution

Let me pause this thought for a minute to mention something else. In this transmitter, the area around the blower is lined with an adhesive-backed foam for sound damping. Over time the foam has dried out and some of the adhesive has started to break down.

In fact, the transmitter was down a number of years before because a chunk of the foam had broken free and blocked the airflow!

With this in mind, and since the station was on the backup anyway, I decided to remove the foam. For that, I picked up a gallon of mineral spirits, a wide-blade putty knife-type scraper, and a couple rolls of shop towels.

### Motor Check – It Works

The next morning I was waiting at the door when the electric motor shop opened – the shop I have always used. When I explained that our transmitter was off, they checked the motor right away.

It spun-up just fine and current draw on each winding was normal. The only issue they could detect was a little noise in the bearings. Considering the motor spins continuously, I wasn't surprised. They replaced the bearings while I cleaned the blower blades. Then I hit the road for the transmitter site.

### Need More Clues?

During my hour-and-a-half drive back to the site, I was re-analyzing my "mystery." When the blower fuses open, the logical assumption is excessive current draw by the blower motor. This theory had just been disproven.

Back at the site I started removing that sound-damping foam. It was a messy job but someone had to do it! In some areas it had already let loose. In other spots it took some mineral spirits and scraping.

I was able to remove all the foam; then I wiped the area down with rubbing alcohol to remove any residual mineral spirits.

### Mr. Chafe in the Hole With the Wires

After the foam was gone I discovered that "curve ball." The AC wiring to the motor enters the area through a hole in the wall of the blower compartment. What I couldn't see, because of the foam, was that there was no grommet around the hole.

After years of rubbing and vibration, the wiring insulation had worn down. There was a direct intermittent short to the cabinet!

### The Fix Was Easy

I was able to butt-splice the worn wires with crimp connectors and put a grommet around the hole. I looked at another FM 20K and found no grommet on that one either. Is it possible that over time they age and disintegrate?

A word to the wise: If you have a Harris FM 20K transmitter in use, you might want to check this and fix it before your transmitter shuts down.

### Mystery #2

The other blower was in a Collins 831 G1 FM transmitter. When I arrived on site and opened the door, I was met with "that smell!" You know, the one indicating something had gotten very hot. In this case, the blower breaker had tripped. Before resetting it, I checked the blower and could tell by the odor at the motor that I didn't want to even try it. This was Sunday night, so I pulled the blower assembly and headed for home.

### Back to the Motor Shop

In the morning I again went to my favorite motor repair shop. It was obvious the windings had burned up, so there was no fix for this one. They did not have a comparable motor in

stock, but their supplier in Minneapolis (an hour and a half away) did, so I headed up the highway – again. While I was driving, Dave, at the motor shop, was disassembling the blower and cleaning the blades. When I returned with the shiny new motor we re-assembled the blower, checked everything out, and I headed back to the site.

The blower assembly went in as easily as expected. I turned the breaker back on, pressed the Filament On button and everything was good. The transmitter was on and we were back in business.

### The Mystery Returns

Six months later the transmitter dropped off again. When Keith Wright, the Operations Manager, got to the site he found the blower breaker tripped. This was a large Heinemann breaker that looked like an oversized, old-fashioned brown light switch. The paddle was down. When he moved it back to the up position, rather than snap into place it *flopped* back down. He tried a couple more times with the same result. It was obvious the breaker was bad. (I like stating the obvious.)

### Replacement Time

I gathered some things and got ready for a two-hour drive to the site. Knowing the breaker was bad, I stopped at the electric supply house for a triple fuse block and some 10 Amp fuses. I figured it was better to have some protection than none at all.

When I arrived, we installed the fuse block in place of the breaker, hit the Filaments, and nothing! One of the new fuses had blown. We took a closer look at the motor and found it had burned up – again!

### MS Breaker Drops a Leg

The next morning I headed back up to Minneapolis for another motor. In talking with the guys at the motor shop I asked if the thermal protection should have saved it. They told me if a 3-phase motor is powered and spinning, and one of the legs drops, the motor will continue to spin, overheat, and burn itself up. Which is exactly what happened – twice!

This transmitter design does have a loss-of-phase protection circuit, but it's on the input to the transmitter. We didn't lose a leg to the whole transmitter, just to the blower because of the bad breaker.

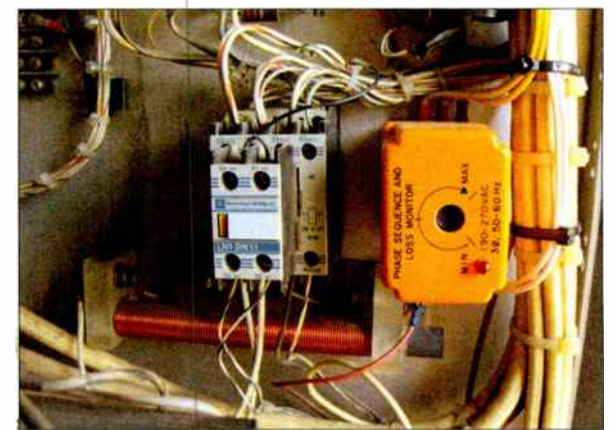

The SLA-230-ASA Three-Phase Monitor

### The Fix

To prevent this from happening again, I installed an additional phase loss monitor (Diversified Electronics SLA-230-ASA). This one monitors the 3-phase going to the blower. If we lose a leg to the blower, the monitor contact opens, causing the control relay to de-energize, releasing the blower contactor and removing power to the blower. Considering the time and expense – times two – to replace the motor, this was money well spent.

Two mysteries, each with an unexpected curve ball, both solved. Have a great 2022!

*Scott Schmeling is the Chief Engineer for Minnesota Valley Broadcasting. He can be reached via email at scottschmeling@radlomankato.com*



# Broadcasters General Store

Family Owned & Operated Since 1979

352-622-7700

www.BGS.cc



### Brand Your Station



## RDS MESSAGING

RDS ENCODING, DECODING, RECEIVERS, & SIGN DRIVERS

- Advanced Dynamic RDS Encoding
- Supports automated playout systems
- Monitor & log your FM/RDS broadcast
- Decode & display RDS data
- RDS Receiver & Sign Driver
- Remote scheduler

## EASY as SNMP!



Interface to SNMP Remote Controls with a Single CAT 5 Connection

SWP-200 Series RF Switch Controllers and SWP-300 Site Controllers with Direct Interface to all RF Switches on the Market and BDI's DPS-100D Series RF Power Meters

**ALL NOW WITH SNMP CAPABILITY!**



The DPS-100D Series RF Power Meters and Companion RMD-100

Rack Mount Remote Meter Display

Tel. (914) 737-5032

sales@broadcast-devices.com

www.broadcast-devices.com

# bdi

## Guest Interviews Don't have to be Complicated.

Quality Interviews, Simple Setup.



# COMREX

## PODCAST PRO<sup>™</sup> BY ACCU-LITE<sup>®</sup>



### Broadcast quality for a podcaster's budget!

\*Includes: mic boom, c-clamp, cable with male & female XLR connectors. Microphone not included.

PN: AL-MBP1

www.accu-lite.com  
www.ocwhite.com

Telos

Omnia  
A Telos Company

25  
seven

AXIA

L LINEAR ACOUSTIC

# PTEK FM Transmitters

- **Designed in the USA**
- **Made in the USA**
- **Serviced in the USA**



**Power Levels from 150W to 5kW \* VERY Affordable to Buy  
Designed with the Latest Rugged & Efficient LDMOS Amps**

## **PTEK Transmitters feature:**

- **Direct Digital Synthesis Exciter for extraordinary sonic performance**
- **True Proportional VSWR foldback**
- **Frequency Agile from 87.7 to 108MHz**
- **Low pass filtering for exciter or transmitter use**
- **Wide Range Input from 85 to 264VAC**
- **The FM300ES transmitter is FCC type certified for LPFM use**
- **Built in, programmable, FSK encoder**
- **Optional Webserver available for all models**
- **Built In Stereo Generator with Composite and SCA inputs**
- **Digital Front Panel metering and controls**
- **Full Back Panel Analog Metering & Control w/Serial I/O**
- **Well Cooled & Spacious Chassis with Major Parts Easily Accessible from the Top Cover**
- **Power Levels Over 1kW Feature Hot-Swappable Power Supplies**



**PTEK**

FM BROADCAST TRANSMITTERS

# [www.ptekpower.com](http://www.ptekpower.com)



# Sicon-8 Internet & Voice Remote Control



## The CircuitWerkes Sicon-8 Remote Monitor & Control

- Uses Dial-up, Internet Web server or free Sicontroller Software!
- 8 channels of metering, status and control (expandable to 32) and up to 5 alarms per channel.
- No accessories necessary to control your site right out of the box.
- Auto-ranging, auto-calibrating meters make setup a snap.
- Includes Function scheduler, auto-logging & alarm reporting.



Internal Web Server



Free Sicontroller Software

The Sicon-8 lets you control your site via Internet with its internal Web server, via telephone, auto-answering cell phone or with our free software. Setup is a breeze using the Sicontroller software that also includes scripting, e-mail alerts, multi-site management, virtual metering & much more!

# Web-Based Remote Controls w/Streaming Audio Option

Introducing the SiteSentry4 (4 channel remote control), SiteSentry2 (2 channel remote control) & WAM-2 audio monitor

- Web enabled remote controls with 6 relay outputs & 2 status inputs on all units.
- All units detect Stereo or Dual Mono Silence (independantly adjustable channels).
- User-programmed relays (DPDT) close automatically or via Web control
- All products include onboard temperature sensor
- Internal logging with onboard e-mailing.
- Supports DDNS services and Netbios names
- Upgradable firmware. Keep your product current with downloadable updates!
- Streaming audio option encodes Ogg-Vorbis & decodes mp3 or Ogg-Vorbis.



# Remote Broadcasting Solutions

Discover more online at [www.circuitwerkes.com](http://www.circuitwerkes.com)



## MicTel Mic/Line to Telephone Interface

- Outputs & Inputs for telephone handset, cellular phone or balanced line level at up to +10dBm.
- Operates up to 36+ hours on two 9V alkaline batteries.
- High quality, user-switchable, internal limiter prevents clipping.
- External power input with silent, auto-switching battery backup.
- Individual gain controls for send, receive & headphones levels.



## Unattended Dial-Up Broadcasts with the DR-10

- The DR-10 is a Dial-Up remote control with balanced, telephone audio input & output that can control many automation systems or your audio console for unattended remote broadcasts.
- Our Silencer™ option removes control tones from the audio path.
- Use the DPDT relays to insert the phone audio directly into the program path when necessary, especially for emergencies.



## TelTap Pocket-Sized Manual Telephone Coupler

- Can be used as a phone tap or a passive manual telephone coupler.
- Send or receive telephone audio.
- Compact size & low cost makes the TelTap a great addition to your remote kit for main or backup capabilities.

# Lots More CircuitWerkes Problem Solvers

- Transcon-16 - Move up to 16 contact closures from room to room over a 1 audio cable
- DT-232 - Turns DTMF sequences into user-programmed serial outputs & action steps.
- FSK Encoders, decoders, transceivers and contact-to-FSK encoders/decoders.
- SUB-03 Subaudible tone decoder and SEN-6 Subaudible encoder.
- HC-3 telephone autcoupler and AC-12 rack of autcouplers
- DTMF-16 and DS-8 DTMF tone decoders.

Find Full product info & downloadable manuals online at [www.circuitwerkes.com](http://www.circuitwerkes.com). 352-335-6555

## The Linux Connection, Etc!

*"I Am Your Friend ... Mr. Terminal"*

by Tommy Gray CPBE CBNE

### Digging Deeper

No doubt if you have used a Linux computer for a while you have run into this thing called the "Terminal." At first glance it might seem a little scary to the uninitiated. It is however, a very powerful tool that can either fix things you cannot do in other ways – or it can *totally break* your computer and cause you to have to start from scratch. Before I get into this very much, I want to touch on the most important thing in your Linux Mint Cinnamon computer (or any other for that matter) and that is your password.

### The Mighty Password

We all know the importance of strong passwords to keep our information and data secure and safe. I am sure that you have heard of silly, and I might add really stupid, passwords some folks use – for example a password of the word "password." Or another one that you might have heard of is using your birthday, or your pet's name, or your kid's name. These are all things you should avoid at all costs. Another thing to avoid it to never use the same password for everything you have a login for. If someone managed to hack your password, then they have access to everything you have accounts with. If you do a little research you will see that creating strong passwords is very important. You can find good examples of ways to make your password more secure.

### The Un-Hackable Password

Now that I have your attention, I hate to be the one that bursts your bubble, but there is no such thing as an "unbreakable" or "unhackable" password." There is always someone out there who can break it regardless of what it is. However, take heart. You can use passwords that will protect you from everything and everyone but true "Black Hat" hackers in most cases. In case you are not aware, there are robots out there that are constantly trying to hack your logins. Maybe they got your email address or personal information somehow (it is not that hard by the way). In case you are not aware, there are major companies that millions of folks use that get hacked every year and any data such as your user information and personal information have already been exposed, stolen, and probably sold on the black market.

One site that will help you to determine if your information is on the dark web is <https://haveibeenpwned.com>. When you go there and enter your email address, they will tell you if the information has been compromised. You will probably be surprised as to how many address have been compromised. I tried an old email address I haven't used in years, but I keep the password changed on regularly, and it showed up in 10 places!

This brings up a very important issue – change your passwords regularly! This will prevent a robot that has been targeting your accounts from being able to get in easily.

If they manage to get a password, chances are that you will have already changed it and you are still good. I am going to give you a little information on passwords to help you keep your Linux Mint Cinnamon computer secure and also your on-line accounts. When I took an SBE course on networking years back (I think that was the one), it had a section on secure passwords.

First, an absolute minimum of 9 characters should be used on any good password – preferably more. Passwords should contain a mix of upper and lowercase characters as most on-line passwords are case-sensitive and this help your security. Next, they should include a mix of letters and numbers. Finally they should include special characters such as \$, &, #, !, etc. Now some sites restrict certain characters, but they will tell you if one will not be acceptable. Also the on-line generators that are available on some accounts usually generate a very secure password. For example, Wordpress has a password generator for each user that will give you a good password. Here is an example of an old one I generated on Wordpress: (now it is a hum dinger!) "U5BzLxhbtoH(\*Yw4H%EGW23%" You will obviously say, "I would never remember that. I would have to write it down." Remember this ... never put your passwords in a file on your computer, because if the computer gets hacked, they have your passwords too!

Don't worry though, you can come up with a good password that is memorable. Here is one method I got off a course one time, and I use this structure to help me remember. This one has words that you can remember but are used in combinations that do not make sense. Say for instance, you have a dog you paid \$100 for whose name is Sam. A good password you could remember that also does not make sense would be, "\$amIsMy\$1000Dog\$!" Can you see for instance, I substituted a dollar sign for the "S" in the name.

(Continued on Page 28)

## DIGITAL AUDIO SWITCHING

TITUS TECHNOLOGICAL LABORATORIES  
**3-DRX**  
AUTOMATIC  
THREE CHANNEL DIGITAL REPEATER / ADC SWITCHER



## THE LOGICAL WAY **3-DRX**

Automatically switches between two AES digital audio signals or a stereo analog signal.  
Analyzes digital signal errors (CRC, bit, framing, etc.) and checks for loss of audio on the digital signal. User programmable.

**TITUS**  
TECHNOLOGICAL  
LABORATORIES

860-633-5472

**WWW.TITUSLABS.COM**

# SR

## THE POWER OF SIMPLICITY.



 **QUASAR**

When power and control collide, content creation elevates.  
Mix in simplicity, and you've got intuitive, revolutionized workflows.  
Introducing Axia® Quasar™ SR AoIP console. Advanced utility and beauty  
with a streamlined surface design allow any user from a seasoned pro  
to a guest operator to create with ease.

[TelosAlliance.com/QuasarSR](http://TelosAlliance.com/QuasarSR)

 **Telos  
Alliance**

[TelosAlliance.com](http://TelosAlliance.com) | [inquiry@telosalliance.com](mailto:inquiry@telosalliance.com) | +1.216.241.7225

World Radio History

– Continued from Page 26 –

I also used a ridiculous amount for the price of the dog. I also tacked on another dollar sign and an exclamation point at the end for good measure. This would be classified as a good password that is secure but one you could remember. It has all the points of a good password. It has a mix of upper and lower case, special characters, and numbers.

**Back on Track!**

OK, lets get back to Linux. First you definitely should have a good and secure password for your user on your Linux Mint Computer. The first rule in my book of security is: "Never use a blank password." I cringe when I go into a station to work on a system, as I did recently. I was about to work on an on-air computer's server, and when I asked for the password to get into their server, they just said, "It is blank and the user name is admin." What! You have to be kidding me. How long do you think it would take to get into that server? With Linux you may remember that I have told you that an antivirus program is not necessary. It still requires doing a few things right to keep it secure though.

The main thing is a good password. You *will* be using that password a lot in Linux, but you will probably never have to worry about security, unless you do something really dumb like clicking on a link in an email for instance! If it says "Click Here" just say, "Not on your life!" When you get emails or texts, and in the message it says it is from one of your vendors or accounts, etc., and it asks you to click on a link to check something, *Don't Do It!* Remember that they can easily use logos and other things to make their communication seem legitimate, and they do it all the time. Look at the email address and you

will find that even though the visible name is OK, the email it actually came from is usually from some bogus gmail account or something. Just go to the real account's website and use your login to get in and never use a link. The same information should be there and at least you know that you are not going to be paying for a vacation for some Chinese or Russian hacker!

**Moving On To The Terminal**

Having said all that, and now that you have put a good password in your computer, I want to talk about a very useful tool you can use in Linux Mint Cinnamon and any other version of Linux, and that is the "Terminal."

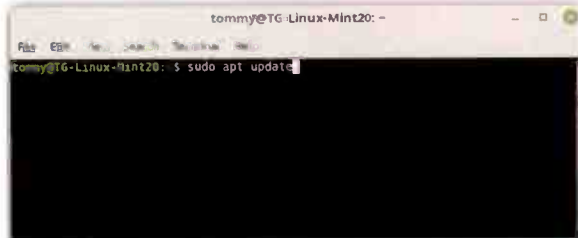

**The Linux Mint Cinnamon Terminal**

The terminal is actually not "terminal" at all. It is really the doorway to good things. Anything you can do in the GUI, from an icon or menu in Linux Mint Cinnamon, can actually be done from a command line in a terminal. It can be done many times faster as well. For instance, when you see the icon on the panel (Windows calls it the taskbar) lit up, indicating you have things that need updating or upgrading, you can click on it and the Linux Mint "Update Manager" will open up and tell you that you need to upgrade, etc. Many of these upgrades and updates are security updates with Linux Mint, and should not be ignored. When you tell it to install the updates, it is going

to ask you for a password. You will need to use your super user password or root password (administrator in windows) to perform the update. Remember that nothing can be installed on your Linux Mint computer without the password. This keeps malware from being installed on your computer.

The Super User (administrator, etc.) is called "sudo" in Linux Mint. One way to remember it is to think of it as "SuperUserDO." You are telling the computer to "DO" something that only an administrator or super user is authorized to do. For instance, if you are using the update manager to update your computer you can also do the same thing from the terminal with a simple command. One thing I like about the terminal is that if, for some reason, you were to happen to mess something up somehow, and the update manager couldn't update, usually the terminal can do it. There is a command called "apt" (formerly apt-get) that can do a lot. You can install software, do updates, and a lot of things with the terminal and apt. We will discuss apt another time. For instance, to see if you have updates or upgrades, simply open a terminal and type:

**"sudo apt update"** (without the quotes)

It will ask for your password, then it will check for upgrades, and if it finds them you can install them by entering: **"sudo apt upgrade"** (no quotes again)

This basically does the exact same thing as the update manager GUI does but can recover from some problems that the Update Manager cannot. Well we are out of space. I will pickup here and continue with our Arduino project next time.

Until Next Time!

*Tommy Gray is a veteran broadcast engineer currently staying busy doing Engineering and IT across the Continental US, through "Broadcast Engineering & Technology LLC", a Louisiana based Consulting and Contract Engineering Firm. www.BEandT.com*



**Antenna Sizes Available  
.6m to 5.0m**

**DH Sectional C/Ku Band Antennas Available:**  
1.8m ~ 2.4m ~ 2.7m ~ 3.0m  
3.7m ~ 4.2m ~ 4.5m ~ 5.0m

**Mount Options:**  
Fixed Az-EI, Polar Tracking, Horizon to Horizon,  
Fixed & Dual-Powered Gibraltar Az-EI  
Dual-Powered Gemini Az-EI

**Options:**  
Hot Dip Galvanizing, Electronics, Cabling, Filters, De-icing,  
Non-Penetrating Roof Mounts & Concrete Template Kits

**For More Information: [dhsat@mhtc.net](mailto:dhsat@mhtc.net)**

**DH Satellite  
Leading the Industry**

*Outperforming the rest for over 35 years!  
Our 3.7m 4-piece sectional antenna with computer  
generated ribs has been the industry standard  
FOR DECADES!*

*Superior Quality    Quick Delivery  
Inexpensive Shipping & Simple Installation  
Low Maintenance    10,000's Installed Globally*





**Prepare for the  
Upcoming  
5G Transition**

**[DHSatellite.com](http://DHSatellite.com) ~ 800-627-9443**



# SERIES CORTEX

Trade-in your DV-200 Units  
and **Save up to \$1200\***



## Take Your Remote Site Intelligence to the Next Level

**Trade-in / Swap out your old DV-Micro, DV-Mini, DV-208 and DV-216 units, and save up to \$1200 on the purchase of brand new Cortex 320 or 360 units, between January 1<sup>st</sup> and June 30<sup>th</sup>, 2022!**

*\*Conditions: Trade-in rebates are available for operational DV-200 units having manufacturing dates after January 1<sup>st</sup> 2011, which must be returned to the factory once the new Cortex unit is received. A rebate check will be issued to the client thereafter. For more details call or contact us at [www.davicom.com/contact](http://www.davicom.com/contact).*

[www.davicom.com](http://www.davicom.com) | T. 1 877 282-3380 | [dvsales@davicom.com](mailto:dvsales@davicom.com)

# Practical Solutions

## Keepin' On Keepin' On

*When the Giddy Up and Go Has Got Up and Went*

by Jim Turvaville

Your publisher of this fine collection of reading material is always on his toes, and is always spot-on timely in getting us contributors lined up for each upcoming issue. Or, at least he always makes us think that he is, and that's probably all that really matters. He always asks us to write from our own experiences and share something that can be of benefit to the reader in their day-to-day work lives. This time, the subject material was not a difficult choice but getting it done had its challenges.

I initially wanted to title this "Getting Sick Really Sucks" but that would not look so professional in the Table of Contents, no matter how true it might have been; the reality is that everyone gets knocked down at some point, and life has to keep going just the same. It's the nature of our broadcasting business, as we've all been told about our work: "We may doze but we never close." That means, for the tech guys and gals behind the scenes that make the magic happen, being sick is not generally accepted as an excuse, by the pencil pushers on top, for not keeping on working.

For the second time in the past 2 years, I've contracted "The Bug" and have been down for a few weeks each time; most recently in the 2021 Holiday Season. While basking in the pleasure of Quarantine, you get a

chance to reflect on how to keep things moving along at a semi-normal pace while physically restricted from certain activities. In both of my past seasons, I was *really* sick for a few days – typically 3-4 – but the recovery process took much longer, and as my body chronometer continues to advance, that recovery is not as easy as it used to be. I've collected some thoughts on that situation and share them for your amusement and enlightenment.

### Remote Connection

I've mentioned in past writings about needing to be able to connect remotely to sites and computers for efficient workflow on a routine basis. In a quarantine situation, this becomes more of a necessity than a convenience. I have a remote screen-share software which I use on all my own and my client's computers that allows me the functionality needed to effectively work on that computer as though I were physically present in their location. There are a myriad of options out there – *Splashtop, Team Viewer, AnyDesk, Bomgar*, and the list goes on – and the one I use, *DW Service*, has been chosen for my needs. All of them offer similar functionality and you should find one that does what you want to do at a price you want to pay. And yes, when you use someone's

free service, you always get what you pay for in the end. If you really want to do remote management right, you are going to have to be willing to pay for it. DW offered me the features that I need, for the functionality that I need, at a comfortable price. In their case, the cost is on the honor system, but it's comforting to know that I am contributing to their efforts to provide a really handy product and they are continually making noticeable improvements to their software.

In the past year, they have added the ability to hear the audio from the other end, about the only thing that I felt was missing when I started using their service a couple years ago. The flexibility to access my Agents from any web browser, on any device, is of importance to me as I do not spend all of my time behind a desktop PC or with a laptop – my smartphone or a tablet may be what I have handy when a need arises. As a bonus, it also works fine on a couple of Windows XP PC's at tower sites. So find a remote access software package that meets your specific needs and get it deployed where you need connection in order to continue to be functional and effective when situations arise that keep you from traveling as normal.

### Two Levels Deep

In some of the locations for my clients, as well as for my own stations, there is no direct connection to a site except from inside their LAN. I have more than one tower location that is on an IP STL that has the IP subnet separated from that in the studios, to keep internal office traffic from potentially bogging down the primary source of data for the transmitter sites. There are a few key computers in the office and studio which are programmed

(Continued on Page 32)

# WebDAD

## Mobile Radio Automation

- ✓ Award-winning, proven solution
- ✓ Powerful remote access
- ✓ Familiar user interface



[ENCO.com/VirtualDemo](http://ENCO.com/VirtualDemo)

800-ENCO-SYS

[sales@enco.com](mailto:sales@enco.com)

50<sup>years</sup> ENGINEERING  
THE FUTURE.



Shine on.  
The all-new diamond.



lawo.online/RG  
diamond Video



www.lawo.com

www.lawo.com  
World Radio History

## Practical Solutions

– Continued from Page 30 –

to reach both the Office/Studio LAN as well as the Tower Sites LAN, by programming the network adapters in the machines to see both sides. Because of that configuration, it was not possible to have those tower locations directly accessible from the outside world using remote access software.

But using a Port-80 based remote access allows you to connect to one of those dual-LAN enabled computers in the studio, and then open the usual remote connection already set up for the tower site. This is a situation where the security and encryption used on the remote access software becomes a valuable consideration, so this should be carefully thought out when picking remote software for your specific needs. If the connection involves someone besides your own employ, then consulting with the client's IT staff is also critical so they understand what you can access, and the risk they may have in doing so. The remote access that I use has a simple Tray Icon, that one can click, that can disable and enable at will, so many of my clients have my access turned off until they need my assistance. I'm fine with that, since they are comfortable that there is zero risk of any hack happening since the service is not running on the computer until they activate it, and I'm just a click away from being able to assist them remotely.

### Cows Don't Care

Of course, once I was past the *really* bad part of being sick, that quarantine and recover time made me

start to feel pretty useless. Then I realized that I could handle those emergency visits to towers with little fear of actually seeing another human, and any germ that may have gotten left behind out there would pretty much be dead by the time me or another person was present 2 weeks later.

I did make several visits to several towers in those time periods, actually making a mental challenge of how many places I could go and avoid contact with not one single person. After all, most drive-thru food places have gone "contact free" and one can find a non-busy gas station to fill up and go down the road. I even packed a lunch a time or two, in the days that I was on the road while still trying to be courteous to my fellow man and not spread any remnant of the latest bug around.

### Spring Cleaning

On those days when I felt up to it, I took the quarantine time to be productive in ways that work often gets in the way of – cleanup and organization. I have an office at home as well as at my radio stations, and those are a mess all of the time because I'm never in either one long enough to get them organized. While I couldn't clean up my desk at the station by remote (I tried, could not find that feature!) I did take the opportunity to get the home desk back in order. I even found dead wiring <Gasp!> in the jumble of 2 computers, 3 monitors and a printer.

If you do much contract work, you probably "live" out of your work vehicle. My Trailblazer is *always* full, because "things always multiply to equal or exceed space available" and after most field projects everything just gets tossed in to be sorted out "later" (which never comes, it seems). The quarantine gave

me a couple of afternoons to get excess parts cleaned out and sorted, tool box reorganized, broken things trashed and supplies restocked.

### Reality Check

Just so you don't think I just jumped up and got busy, the reality is that these bugs can make you feel absolutely horrible. When you want to sleep for 3 hours every 4 hours, then you should do what your body wants – God gave our body the ability heal, if we pay attention to it. So do what your doctor says, take your prescribed medication, eat right and when you feel the need to rest, then get some rest. But in this recuperation process, when you feel good then you want to do *something* to make you feel like you're "normal" again. Those are the times that I got out and went to a tower site, or sat at my desk at home and logged into my stations' and my clients' remote computers to get work done or help them with a problem.

That entire process was typically three weeks both times around; some are slower, some are faster at that recovery. If you've been there too, then we're all in this together now – and if you have not had any of these bugs going around, then be thankful – very, very thankful. Everyone should take a moment and consider how you can remain productive in a travel limited situation; no one knows when it will happen to them.

*Jim "Turbo" Turvaville is semi-retired from 43 years in full-time Radio Engineering and lives in Rural Wheeler County Texas in a "tiny house" where he maintains a small clientele of stations under his Turbo Technical Services ([www.t-t-s.us](http://www.t-t-s.us)) operation providing FCC application preparation and field work.*

From low power translators to high power multi station system,  
we have products for all your FM needs.

## Antennas, Filters, Combiners and Coax

Side-mount antennas  
Re-tunable antennas  
Broadband antennas  
Panel antennas  
Filters and Combiner systems  
Coax products  
Low, medium and high power



**Shively Labs**<sup>®</sup>  
a division of Howell Laboratories, Inc.

100% employee owned company

[www.shively.com](http://www.shively.com)

888-744-8359



# Break Out



New from StudioHub! Meet the XLR Breakout Panel. Sixteen XLR connectors up front and a combination of RJ45 and DB-25 connectors around back. Use for microphones, mono or stereo analog lines, or AES/EBU. Featuring premium components and a compact 1RU powder-coated steel chassis that fully encloses the circuitry. No exposed circuit boards. Four different combinations of male/female connectors are available. Only \$295 (MSRP).



## Adapters

Audio over CAT-5. StudioHub is the original broadcast adapter.



## Cables

Premium shielded CAT-5 patch cables.



## Dongles, Splitters, & Couplers

DSUB to RJ45 converters, level pads, splitters and more.



## Hubs & Patch Panels

Breakout boxes, patch panels and punch blocks.



## MatchJacks

Audio balancers, converters and accessories.



## Distribution Amps

Analog and digital distribution amplifiers.



## Power over CAT-5

Exclusive power injection system enables CAT-5 cables to deliver audio plus power.



## Panels

Headphone amps, mic preamps, buttons and jacks. There's a panel for everything.



## Mounts

Put your panels in their place with our bezels and mounting systems.



© 2021 Angry Audio LLC  
www.studiohub.com





## Misc. Tech-Tips and Thoughts

Happy New Year! Here we are in a new year. I hope for you it brings challenges and rewards that you will enjoy. If there is something new that you have learned, or a piece of news you want to pass along, please be in touch.

### AM Radio

It seems like there is some hope for AM radio stations in America. You would think that, with the addition of FM translators married to AM signals, things would be better. In my opinion, things have not improved much for AM stations. While it's nice that many AM owners now have translators, many people in our country don't bother listening to the legacy band. At least there are the translators that AM stations can use to have some kind of audience.

In my opinion, the trouble started when our government did nothing about appliances and electrical devices that cause all kinds of electrical noise and make AM radio listening impossible. Have you ever turned on your computer near an AM radio? If you have, you know what I mean. When I was a teenager, I remember listening at night to AM stations hundreds of miles away. That's almost impossible now with all of the electrical noise you can pick up on an AM radio.

In addition to the electrical noise, the bandwidth is terrible. Yes, I know why the NRSC and the FCC cut back on the bandwidth, but I think it did more harm than good. Back in the 1970s, AM radio sounded nearly as good as FM. I have had the opportunity to listen to AM stations all over the country, and most of them sound no better than the old

fashioned POTS phone line. Some of the stations, especially the ethnic variety, sound distorted. So why would people who are used to approximately 20 kHz of audio bandwidth want to tune in to an AM station with 5 kHz or less of audio bandwidth and all sorts of electrical noise? I managed a powerful AM station back in the 1990s, and when there was a thunderstorm nearby, it was painful to listen to the signal.

And to add to the problem, many car manufacturers do not include radios capable of receiving AM.

### MA3

Roughly 20 years ago, we had IBOC, which stood for In Band On Channel. I have an engineer friend who used to call it "I Buz." If you owned an AM station that was on a nearby frequency of a station that was using it, IBOC wiped you out.

Now we have MA3, and from what I have been reading about it, it seems very promising. WWFD uses it, and their chief engineer says it sounds as good as FM and delivers audio in stereo. I have also read where RDS can be transmitted using that standard, and possibly album art as well.

Other stations across the country are also lighting up the AM dial with MA3, including WSRO in Massachusetts and WFAS in New York. The key to bringing back an audience is audio quality, which MA3 seems to have. But equally important is whether or not car manufacturers install radios capable of receiving digital AM signals. I have read that some radios that can receive FM HD are also capable of receiving AM digital signals.

If car manufacturers install radios that are HD capable, and there is some promotion of the AM stations, there could be renewed interest in the legacy band. I do think, however, that it is going to take a lot of effort to save AM radio. MA3 could be the tool that brings AM back to life.

### Audio Playback Software

Late last year, we upgraded our audio playback system at the radio station where I am the general manager and chief engineer. There were a lot of directions I could have gone. There is everything from free software to very expensive software and hardware. I decided to keep the same brand of audio software we were using before, only updated. My staff is mostly middle-aged people. Their comfort with new things varies, so I decided to upgrade our system with their old friend, making the learning curve shorter and giving them as much comfort as possible as we upgraded to the latest software.

For stations with low or no budgets, I found out there are inexpensive, and even free, software.

If your station has someone on staff who is comfortable with the Linux operating system and installing software onto computers, you may wish to consider *Rivendell*. It's a free software package that can work well on most computers.

When I worked as an engineer for a group of stations in the DC market, we used *Rivendell*. It seemed to be a stable system that was capable of doing a lot. I also worked as an engineer for a radio network down south that used *Rivendell* to insert IDs at each of its owned stations across the US.

*Rivendell* works best with Audio Science brand sound cards. These are about the best, and the most expensive, sound cards you can buy. The software also works with less expensive sound cards, and even with Sound Blaster, although not quite as well, and you can't utilize all of the features of *Rivendell*, like real-time audio stretching or expansion. You can find the software here: <http://www.rivendellaudio.org/>

(Continued on Page 36)

## Why Not Switch to



## Complete FM / TV Product Line



Coax switches available in  
Type-N and 7/16 DIN and  
7/8" through 6-1/8"

- Antennas
- Splitters
- Notch Filters
- Harmonic Filters
- Power combiners
- Channel combiners
- N +1 Switching Matrix

Control panels available.

A subsidiary of **MEGA** RF Solutions

[www.megaind.com](http://www.megaind.com)

Toll Free: 800-545-0608 | [www.mcibroadcast.com](http://www.mcibroadcast.com)



- Feature-rich
- Full integration with Internet program providers such as LRN and BOB-FM
- Ballgame/special event automation
- Easy to use
- Designed by radio people who listen to what you want
- Experienced support people who get to know you by name

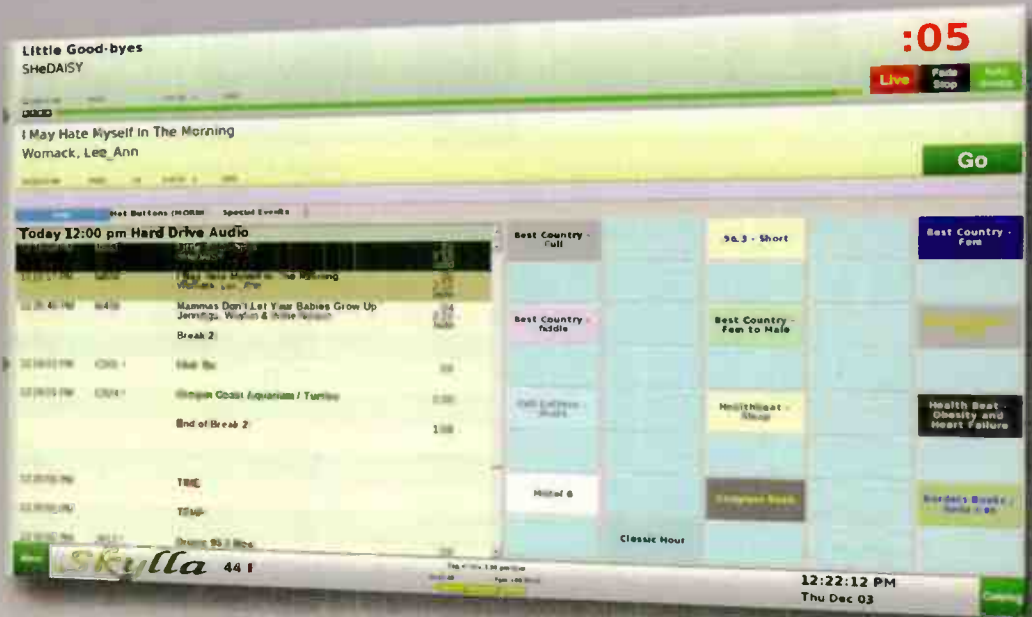

Skylia's Special Event interface, designed with the input of professional sports organizations, makes it easy to air sporting events and remotes, from youth league baseball to the World Series. Because sporting events are scheduled separately from regular programming, rainouts and cancellations require little handling returning to "your regularly scheduled programming" is a snap.

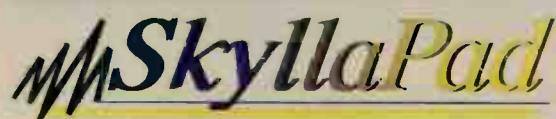

SkyliaPad allows you to use a web browser to securely log in to your station and control Skylia from your smartphone, tablet, or laptop.

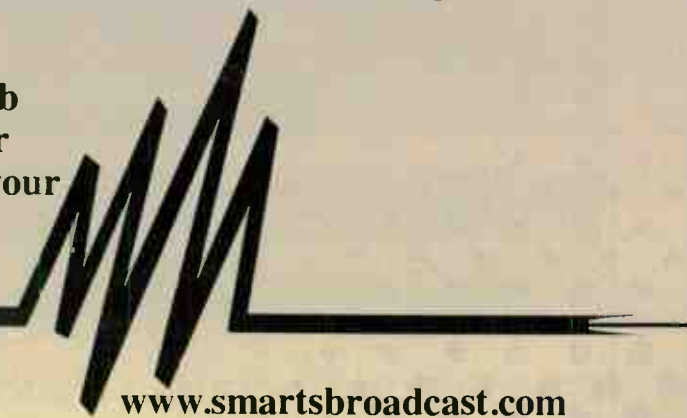



– Continued from Page 34 –



Rivendell Screenshot

Another free software playout system for Windows is a package called *Zara*. I've had some experience with this system as well. There is a free package and a paid package.

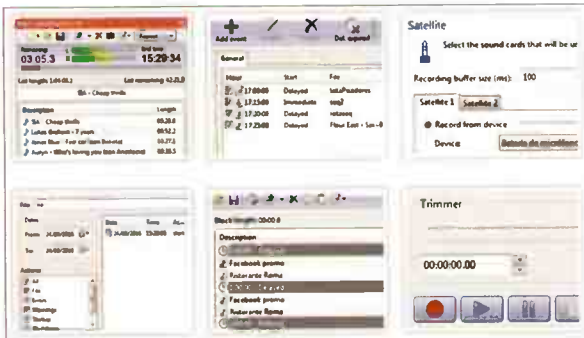

Zara Screenshot

The free package does a lot, but comes with no support. There is a Facebook group where you can learn a lot if you need to. Some people love this software, others don't care for it. You will have to decide for yourself. It is available as a free download here: <https://www.zarastudio.io/>

Here's another free playout software package called *Play It Live*. I have no experience with this software, but I have seen a good number of comments about it on a radio automation Facebook page. Most of the users have great things to say about it. Download it here: <https://www.playitsoftware.com/>



Play It Live Screenshot

You can probably find many more choices by using your favorite search engine and typing in Free Radio Automation, or words to that effect.

In my next column I plan to write about other apps and software that you may find interesting. If you know of something that may be of interest to other engineers, please let me know about it. My email address is near the end of this article.

### Useful Tips

There is nothing special about the tips I am going to mention here. They are normal things we need to check on. I just think it's good to remind you of the things we need to stay on top of.

Plan your trips to the transmitter. What do you want to accomplish, outside of an emergency trip, that needs to get done? Have you had your central air conditioning unit at the transmitter cleaned and checked this year? Having it cleaned and checked over by your AC service company could save your transmitter from shutting down due to overheating.

Have you replaced the memory battery in your transmitter lately? What about the battery on the UPS that keeps your transmitter's controller operational? I'm told a controller can take about 30 minutes to boot up after a brief power failure, but only a couple of minutes once power is restored to the building, if it is connected to a UPS.

What do your building air filters look like? Have you replaced them lately? What about the filters on your transmitter? As you know, heat and dirt are your equipment's enemy. Keep your building cool and very clean year round.

Do you document your repairs or maintenance? With a black marker, you can write the date you installed a new filter on its frame. It's good to know how long it has been between filter changes.

### Looking for Input

Are you an engineer who has learned something new? Maybe you discovered a cool app that you love having on your smartphone. Or perhaps you found some software that is very helpful. Whatever gem you may have discovered, I would love hearing from you. Feel free to contact me at [stuzeneu@sbe.org](mailto:stuzeneu@sbe.org); your useful information will be appreciated by my readers and me.

Thanks for reading my column. I hope you found something interesting or useful. The thoughts, ideas, and opinions in this column are my own, and do not necessarily reflect the views of *Radio Guide* or its publisher.

*Steve Tuzeneu, CBT, is the general manager and chief engineer for WJIS 104.9 FM in Middletown, Connecticut. He is licensed by the FCC as an engineer and is a Certified Broadcast Technologist with and member of the SBE, and an extra class radio amateur.*

# DEVA<sup>®</sup> BROADCAST

Available in stock from  
Broadcast Depot, Call: 800-313-7592  
[www.devabroadcast.com](http://www.devabroadcast.com)



Price: \$3200

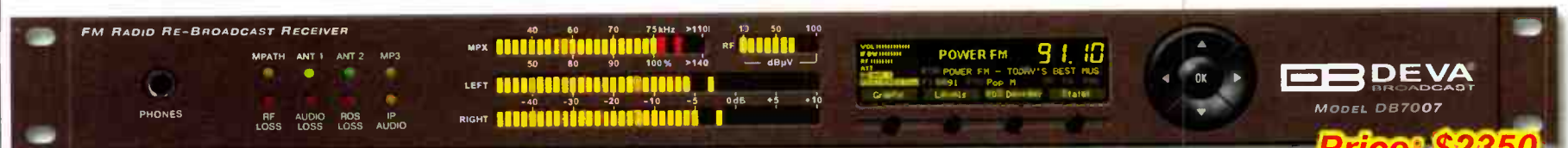

Price: \$2350



Price: \$1950



Price: \$2100

Modulation Monitors • Rebroadcast Receivers • RBDS Encoders • Broadcast Tools

If you thought that you couldn't afford new Automation,  
then think APEX !



- Triple Play with Dual Record
- Sound card hardware included
- 16 input switcher included
- Hard disk & Satellite automation
- Voice tracking
- Ball games mode
- Music scheduler
- User configurable

**only \$125/month**

APEX is ideal for Live On Air, Hard disk automation, Satellite automation, Internet Radio, and so much more. For a single low monthly cost, you get software, switcher, & sound cards ... including support and updates (just add a PC) !!!

advanced radio consoles for ALL jobs,  
the ARC-10 and ARC-15



ARC-15  
\$3,999



ARC-10  
starts at \$1,799

The ARC-10 and ARC-15 are ideal for On Air, Production, and News studios. Available in either balanced or unbalanced models they fit every application.

- 10-15 channels, Pgm & Aud outputs
- Built in telephone channel for Call in shows
- 2-5 mics. (depending on model)
- PC sound card built in. Bluetooth optional

for over 40 years ... **Arrakis Systems** ... made in America

the **MARC-15**  
modular, analog console

starts at only  
**\$5,775**



PC interface  
module for digital  
playback and record

- modular
- 3 mixing buses
- 2 inputs per channel
- control room and studio
- supports 2 phone channels
- electronic switching w LED lamps

[www.arrakis-systems.com](http://www.arrakis-systems.com)

970-461-0730

## Omicron: Coming to a Small Market Near You

by Roger Paskvan

If you own or operate a radio station in a small market town you are a prime target for the next wave of the Covid virus, now called Omicron. As I write this article, rumors are going around about another round of political orders, mask mandates and mandated vaccinations. When does this end?

Yes, we have a new variant that has mutated from the parent virus, just like all other viruses do. Cases are showing up in some areas but the average person is hardly sick. Some complain of a headache and cold-like symptoms but for the most part you get over it in a week. If you have had Covid already, you're probably not going to get this Omicron variant – maybe a slight case, if any. If you had the vaccine, you may have little to worry about. To date, only one Omicron death has been reported in the USA, but that may have been due to other pre-existing conditions.

Well, the political machine is gearing up to take drastic measures again. Some governors are recommending mandated closures and many businesses will be forced to close their doors, *again*. Our small town will *again*, turn into a ghost town – no one on the streets, no one shopping, no restaurants open, a town in suspended animation. Those that dare to venture outside are masked and in hiding.

Next comes the cancellations from all the faithful advertisers that have been keeping your radio station

going. Well, if they are going to be closed or reduced in hours, why advertise? Like all text books say, the first item in budget cuts is advertising. Now your sales income drops by more than half and that's not good for any business, especially radio.

The broadcast radio business is suffering but our bills stay the same. ASCAP, BMI and SESAC still want their monthly cut. The electric company supplying you with all that energy to keep your transmitter on the air needs to be paid. Payroll needs to be met and the list continues but your income is way down.

So where does this insanity stop? We can't keep shutting down the country every time a new virus shows up. This new Omicron strain has milder symptoms. Businesses are tired of closing their doors. This hurts our radio station

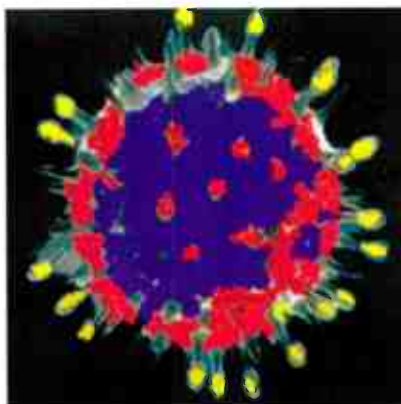

small market bottom line too, which in the end hurts all of us.

These businesses are especially hard hit in small market towns since the work pool and number of customers is limited. In small market, radio stations have to make it on a very tight budget and that margin is getting thinner all the time. Last week, I talked to a restaurant owner/client about their limited hours. Can you imagine, McDonalds closing in the middle of the day due to no help. Yes, we are on Covid year number two and these concepts are still hurting businesses everywhere.





Wouldn't it be nice if radio stations could just shut down like other businesses? We could stay on the air during the day and go off when there is no ad income periods. Well, we all know the Federal Candy Company takes a dim view of that concept. Radio is an essential service to the community.

It is this writer's opinion that a second wave of government mandated shut downs will do the economy in and the bottom will fall out. I know from talking to a lot of businesses, that most of them are hanging on by a thread. Another round of shut downs will be the end, especially for the mom and pop shops. Yes, the big box stores can weather the storm but that will still have its limitations.

The insanity needs to stop. The politicians need to quit manipulating this virus for political purposes. Who can you believe on TV anymore? The mainstream media is corrupt. People want honest answers. We need the real medical community, following the real science, to take control in order to bring us out of this pandemic. Time will tell ... but time is running out.

*Roger Paskvan is a Professor of Mass Communications at Bemidji State University, Bemidji, MN. You may contact him at: [rpaskvan@bemidjistate.edu](mailto:rpaskvan@bemidjistate.edu)*

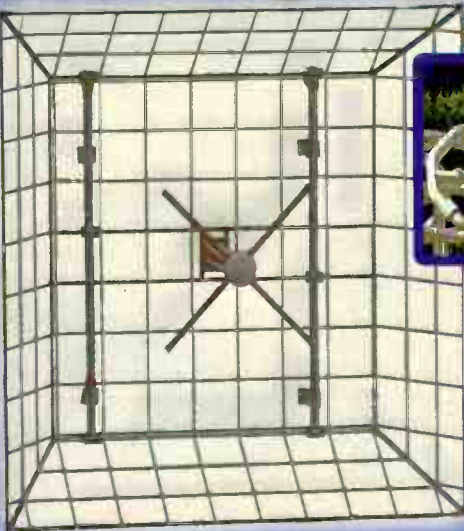
# Quality FM & TV Antenna Systems



SLANT-V DIRECTIONAL

FM PANEL

POWER-TILLER

POWER-TILLER WITH RADOME

PSI is dedicated to designing and manufacturing the highest quality product. Working diligently with station engineers, consultants and outside vendors ensures that each project is completed to the customer's satisfaction.

Wide range of antenna models are available at all power levels, directional and non-directional, multi-station and more.

Additional products include..

- Transmission Line
- Combiners
- Filters
- Turnkey Systems

## Propagation Systems, Inc.

Phone: (814) 472 - 5540 Fax: (814) 472 - 5676  
Email: [sales@psibroadcast.com](mailto:sales@psibroadcast.com) [www.psibroadcast.com](http://www.psibroadcast.com)





# Coaxial Dynamics

A CDI INDUSTRIES, INC. COMPANY  
SPECIALISTS IN RF TEST EQUIPMENT & COMPONENTS

COAXIAL DYNAMICS has been a leading manufacturer of precision equipment for the measurement and termination of RF Power since 1969. Our equipment is used by engineers in a wide variety of applications throughout the world.

Our products include:

- Directional Wattmeters for both Analog & Digital applications from 1 W to 100 kW and from 2 MHz to 2.3 GHz.
- Watchman RF Monitor/Alarm Systems.
- Line Sections & Plug-In Elements.
- RF Loads - Dry, Oil, Water, and Air designs up to 200 kW.
- Low Pass Filters & Power Sensors.

6800 Lake Abram Drive, Middleburg Hts., Ohio 44130, USA  
440-243-1100 • Toll Free: 1-800-COAXIAL • Fax: 440-243-1101  
E-Mail: [sales@coaxial.com](mailto:sales@coaxial.com) • Web Site: [www.coaxial.com](http://www.coaxial.com)

- **Broadcast Equipment** •  
Watchman - High Power Wattmeters - Elements
- **Line Sections & Meters** •
- **Termination Loads** •  
Dry - Oil - Water - Air



# ALTRONIC RESEARCH INC.

Performance By Design

## RF DUMMY LOADS for ALL YOUR APPLICATIONS

- AIR-COOLED • HDTV
- HD • WATER-COOLED



## ALTRONIC RESEARCH INC.

P.O. Box 249 Yellville, Arkansas 72687 870-449-4093 Fax: 870-449-6000  
E-mail: [info@altronic.com](mailto:info@altronic.com) Web Site: <http://www.altronic.com>



# Power Principles

## The Mystery of the Ground Current

### Part 2

by John L. Marcon, CBRE CBTE 8VSB Specialist

From our first installment (Nov/Dec-21), we discovered that not all the return current was on the neutral wire. The clamp meter I used was a new Fluke 323 true RMS clamp meter, to ensure the current readings would be reliable. Around 40% of the return current was through the ground wire. In the process of troubleshooting, we asked the electric utility company to check their transformer secondary wirings, especially the return side. They found out that some connections in the distribution box were loose, yet after tightening the screws, there still was no change in the ground current. I decided to investigate further the true nature of this ground current, using other instruments. The set-up of the electric supply is shown in **Figure 1**. Notice that the two Electric supply, Entergy Electric A & B, are from the same company but from different transformers.

doubt on the result. The second clamp meter I used was an old Radio Shack 22-602 analog clamp meter and the result from this one was similar to the Fluke – it was a bit off but the reading was close enough. The third one was a TENMA 72-10415 Digital Multimeter with a 10A AC current meter. The result with the TENMA added another mystery in to the scene. It was no way near the readings of the other meters.

When the TENMA meter was in series, the current was tenfold less than the reading with the clamp meter. For example, if it read 1.0 Amp on the Fluke clamp meter, it read 0.1 Amps on the series-connected ammeter. I hooked up the meter on another section of the ground line and I still got the same result. How did that happen? This seemed not to follow the laws of Physics. When measuring current, we often use alligator clips on

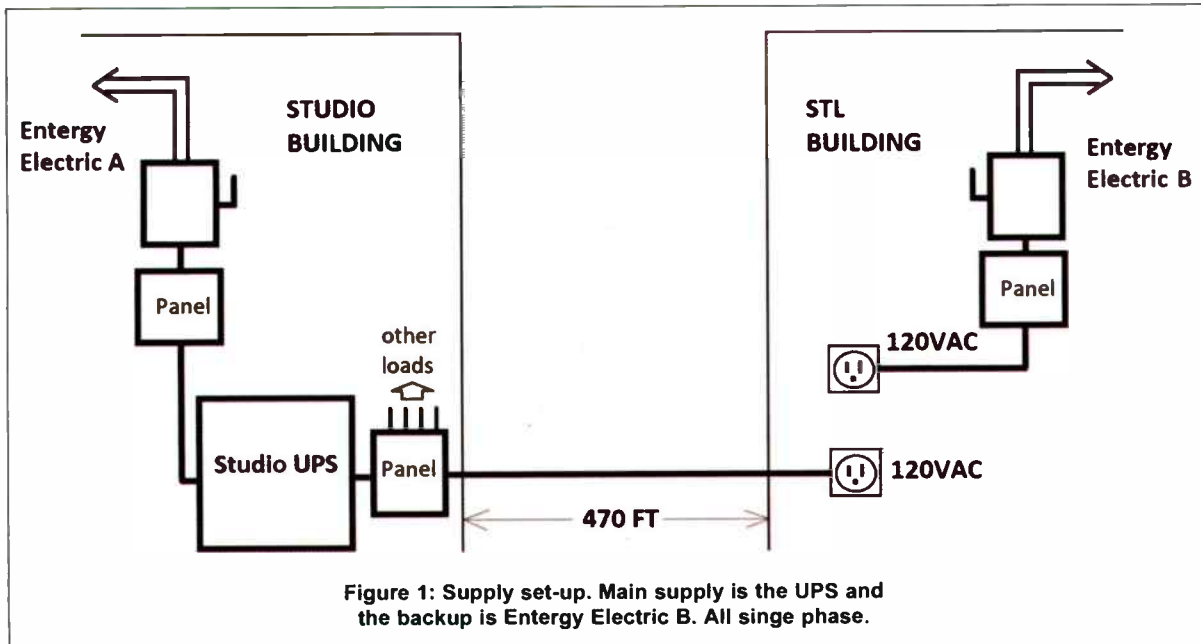

Figure 1: Supply set-up. Main supply is the UPS and the backup is Entergy Electric B. All single phase.

The ground current problem was happening on the Entergy Electric B supply. It was also happening on the power outlet from the UPS but I think this was because the neutrals and grounds of both supplies were connected.

both the positive and negative test leads and clip it to the wires where we are measuring the current. I thought that the clip was not making a good connection so I added one more, making two parallel alligator clips from the test lead to the ground wire. This made the ground current reading increase a bit. As I added more alligator clips from the lead to the wire, the ground current increased even more. In other words, the more conductors I connected to the wire, the more the current increases. This is not how it should work. What should happen per Ohm's law: no matter the size of the conductor, the voltage will push all the current in the conductor. The wire will either survive or burn up depending on the amount of current.

The next thing I did was to determine if this ground current was just a ground leak coming from one of the equipment in the rack. 4 Amps of ground leakage current was large and some component should have blown at 4 Amps. A ground leak current is usually in the milliamp range only. To prove that this was not coming from the rack equipment, or from any other device from inside the

STL room, I needed to use a separate ground connection, one that was not using the ground line from inside the room. I also needed to plug the whole rack to an independent power source, not coming from either the studio UPS or the utility. This allowed me to isolate the circuit of Entergy B from the shack. The microwave shack had a 1200W UPS but the batteries were dead for a long time. Thankfully, after replacing the batteries, the UPS was still OK. I used this UPS as the rack power supply for a few minutes while I was setting up the measurement of the ground current using an external ground wire. I then disconnected the neutral and ground of Entergy B from the microwave building and connected it to a separate ground wire which I set-up earlier. The load is a single heater. Sure enough, there was ground current of 7 Amps. I now verified that the equipment from inside was not causing the ground leakage current and that it was a real AC current.

When I used the clamp meter, it was clamping around a #8 wire bolted to the ground block with a 1/4-inch screw. With this wire, there was a larger surface area in contact with the other conductor, compared to the area in contact when using the alligator clips (with the series ammeter). Only the teeth of the clips were in contact with the ground block in the latter case. There must be some explanation on the current readings from these two types of connectors but I think the current in the ground wire was caused by a capacitive interaction between the ground circuit and the hot wire.

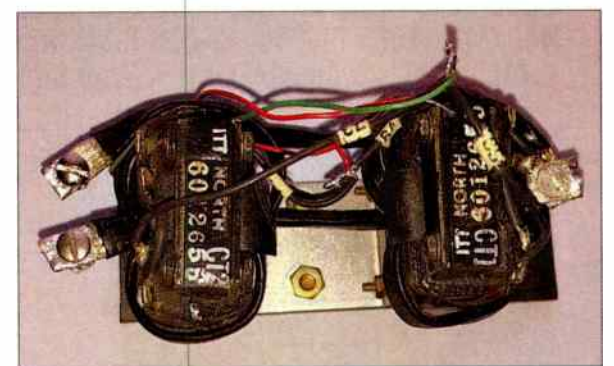

Figure 2: 500:1 60Hz AC current transformer.

The impedance (or capacitance) of this interaction changed, once a thinner wire was used, hence the change in current. If it was capacitive, it must have some value but there was no proper way to measure the ground capacitance. To have some estimated value on this capacitance, I used an electronic simulation program. The circuit in the simulation was an inductor parallel to a capacitor (much like a tuned RF tank circuit). The value of the inductor was equal to the inductance of the neutral wire. A 100 foot #8 wire would have an inductance of around 54 uH. I used different sizes of capacitor to see 40% of the current flow through the capacitor instead of all going to the inductor. The capacitance value came out to be 100mF. Only 60% went through the wire.

If this was, indeed, a capacitive interaction, it can be eliminated inside the shack by using an isolation transformer. We do have an isolation transformer but the secondary is only 75 VAC, not enough to power any 120V equipment in the rack. At any rate, I still tried this experiment by connecting a heater to the 75V secondary and grounding one side of the secondary. It produced some amount of heat even at this voltage, thereby producing current in the wire. Lo and behold, there was no ground current measured.

(Continued on Page 42)



Ammeters used in measuring the ground current.

Not that I do not trust the first readings with the Fluke, but using other instruments should bring zero



**AM Diplexers & Triplexers**

**Analog or HD**

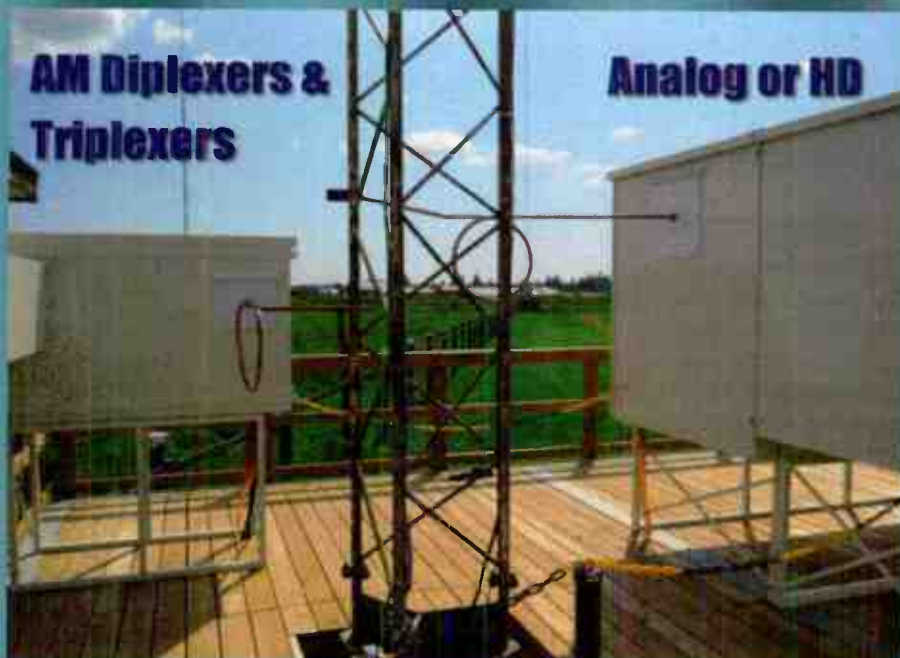

**Kintronic Labs™**

An ISO 9001 registered company  
Kintronic is a trademark of Kintronic Labs, Inc.

**NEW Kintronic Online Store Going LIVE in February 2022**



**Dummy Loads, DC – 110 MHz 5 – 75 kW**



**LAB4.50 Dehydrator**

- 6 Air Outlets
- 300 l/hour flow rate
- MTBF: 165,000 Hours
- Dual compressors & drying chambers

**Email:** [ktl@kintronic.com](mailto:ktl@kintronic.com)

**Tel:** 1-423-878-3141

**Web:** [www.kintronic.com](http://www.kintronic.com)



**Studio Items Inc**



**Mic Booms  
On-Air Lights  
Speaker Mounts  
[www.studioitems.com](http://www.studioitems.com)**

**TORPEY TIME**

*(The Good Time People)*



**Clocks  
Up/Down Timers  
[www.ram68.com](http://www.ram68.com)**

**Dixon  
Systems**



**News Mixers  
Line Matchers  
[www.ram68.com](http://www.ram68.com)**



**RAM Systems**

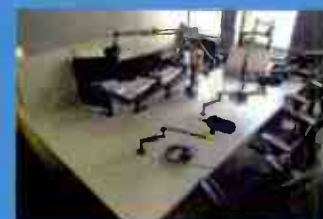

**Broadcast Furniture  
Sound Absorption Panels  
[www.ram68.com](http://www.ram68.com)**

### Mystery of the Ground Current

Part 2

— Continued from Page 40 —

Measuring and “seeing” the current are two different things and I decided to actually look at the waveform of this current. The voltage induced on a small segment of wire was too small for a regular scope. I could use a resistor in series and hook up the scope probe on it but as we saw earlier, this affected the current. Instead, I used a current transformer for this task. Fortunately, we had an old high current battery charging equipment with a 500:1, 60Hz current transformer (Figure 2 - page 40). This turns ratio was suitable for the oscilloscope. A waveform appeared on the Tektronix 2445A scope from the current transformer. The ground current went down a bit but it was still a good enough level.

Figure 4 is the waveform that showed up. The left side was a zoom-in view of some kind of switching noise. This can be from the T-Mobile and AT&T base station switching power supplies. The right side was the actual AC ground current waveform. As you can see, it was not a perfect sine wave. You can also see the noise signal riding the AC current waveform. The clamp meter is catching this current because it was a 60Hz varying signal, albeit not a sine wave. The remarkable thing on this waveform was that, on the positive going side, it was a steep rise (fast charging). This was not purely capacitive but likely some combination of RLC. Remember that this was coming from the ground. However, on the



Figure 4. Ground Current Waveform

downward side of the curve (yellow circle), it clearly showed a capacitive-discharge like curve.

Just out of curiosity, I asked the AT&T tech if they also experience noise in the power supply and he said that they also were having noise issue on their power lines. I tried to filter out the noise using powdered iron cores (for low frequencies) and even ferrite cores (for high frequencies) but there was minimal reduction with the noise.

It seemed that the only way to reduce this ground current was to use a thin wire, just as I described in previous paragraphs. However, because this was the ground wire, a thin wire is not an option. When I used a low value resistor, it resulted in a low ground current also, although not eliminated. I think this can be a solution.

However, to make the 1 Ohm more robust, I used 10 pieces of 10 Ohm resistors in parallel resulting into 1 Ohm in series with the ground. This combination

also reduced the ground current. These parallel resistors also had enough power handling to withstand surge current and still would not affect the ground impedance because of its low value. Unless there is a way to get the hot wires off the ground, this was my solution for the moment.

One other observation worth considering is that, in that small fenced area, there are two monopole towers and a number of outside metal wire trays supported by two-inch metal poles. Note that the two grounds (from the two monopoles) are tied together and the big towers surely have a big rebar cage as foundations. As such, all these metals, tied together, became large enough to create the capacitive interaction.

*John L. Marcon, CBTE CBRE 8VSB Specialist, is the Chief Engineer for Victory Television Network (VTN) in Arkansas, with international experience in both Radio and Television Broadcast, and has an Electronics Teaching background.*



The most trusted Nautel  
dealer for 35 years

Contact your local RF Specialties office  
for more information

[rfspecialties.com](http://rfspecialties.com)



  
nautel

## Why do broadcasters love Bext antennas?

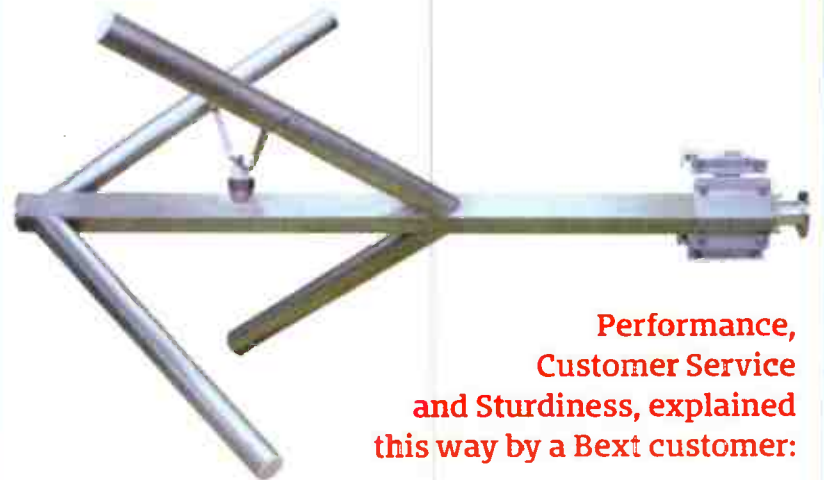

**Performance,  
Customer Service  
and Sturdiness, explained  
this way by a Bext customer:**

*“I love Bext Antennas. Its high-power TFC2K\* model is built so sturdy and seems virtually unbreakable. We trust those for our stations located in hurricane-prone areas.”*

— DAVID HOXENG, ADX Communications, Pensacola, Florida

\* TFC2K arrays can be rated up to 75 kW power handling.

[bext.com](http://bext.com)

888 239 8462

**BEXT**

# ECONCO

## Rebuilt Power Tubes



*Approximately One Half the Cost of New*  
**3,000 Hour Unconditional Guarantee**  
*Call for Your Quotation*



Phone: 530-662-7553 • Fax: 530-666-7760  
 Toll Free: 800-532-6626

[www.econco.com](http://www.econco.com)

1318 Commerce Ave, Woodland, CA 95776

# NiCOM

HELPING YOU SEND CLEAR SIGNALS SINCE 1997

AMERICAN



MADE



FM & TV TRANSMITTERS



STL SYSTEMS

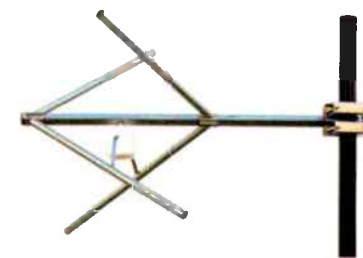
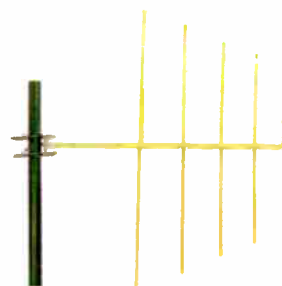

FM & TV ANTENNAS

619.671.9500

[NICOMUSA.COM](http://NICOMUSA.COM)



## The HIGH EFFICIENCY BROADBAND ANTENNA

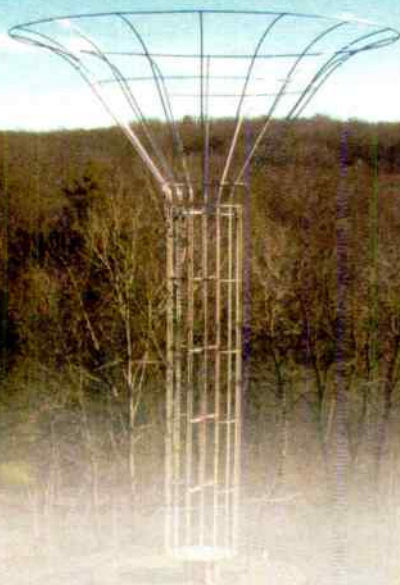

(877) HEBA-4-US (781) 275-1147  
[www.worldwideantennasystems.com](http://www.worldwideantennasystems.com)



**WORLD WIDE**  
 ANTENNA SYSTEMS

## TRANSCOM CORPORATION

Serving the Broadcast Industry Since 1978

Visit Our Website – [www.fmamtv.com](http://www.fmamtv.com)

Send your e-mail requests to: [transcom@fmamtv.com](mailto:transcom@fmamtv.com)

### Fine Used AM & FM Transmitters & New Equipment

	1 kW	2005	Nautel J1000
	1 kW	2016	BE 1A
	5 kW	2015	GateAir DAX5
	5 kW	2004	GateAir DAX5
<b>AM</b>	10 kW	1997	Nautel ND10
	10 kW	2006	Harris DX10
	12 kW	2001	Nautel XL12
	50 kW	1994	Harris DX50
	50 kW	2006	Nautel XR50

*Please see our current listings on our website.*

	50 W	2016	Technalogix (transmitters/translators)
	55 W	2000	Harris DIGIT™ CD
	150 W	2016	Crown (transmitters/translators)
<b>FM</b>	150W	2016	Technalogix (transmitters/translators)
	2.5 kW	2018	GatesAir Flexiva
	10.0 kW	1998	Nautel FM10
	25.0 kW	2000	Harris HT 25CD

*Please see our current listings on our website.*

**Special** — 1 kW 2018 Radio Partes 1000

#### Used Misc. Equipment:

Burk ARC PLUS • Burk Technology Plus-X ICRU  
 Burk Technology ARC Plus Touch • Burk Technology Plus-X IIU



*Please go to our website for updated listings. Retuning and testing available – call for quote!*

**OMB STL systems for radio, complete with antenna and cable for under \$5,000!**

PO Box 26744, Elkins Park, PA 19027  
 800-441-8454 • 215-938-7304 • Fax: 215-938-7361

## Bay Country Broadcast Equipment

Buy • Sell • Trade

Your #1 Source for Quality Used Radio Broadcast Equipment

View our latest list of equipment on-line at:

[www.baycountry.com](http://www.baycountry.com)

(Website Updated Daily)

All equipment sold with a 15 day return guarantee.

**Turn Your Excess Gear Into Cash**

Send your list to us and we will respond with our offer promptly.

We only buy good working equipment with traceable serial numbers.

Send Your List Today – [sales@baycountry.com](mailto:sales@baycountry.com) -or- Fax 443-596-0212



E-mail: [sales@baycountry.com](mailto:sales@baycountry.com)  
 877-722-1031 (Toll Free) 443-596-0212 (Fax)  
 7117 Olivia Rd, Baltimore, MD 21220

## TRANSMITTING CAPACITORS

MICA-VACUUM-CERAMIC

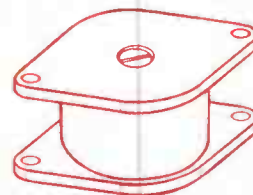

SURCOM ASSOCIATES, INC.  
 (760) 438-4420  
[LINK@SURCOM.COM](mailto:LINK@SURCOM.COM)



## AM-FM Transmitters

Pre-Owned Units  
 40 Years of Service

[www.Besco-Int.com](http://www.Besco-Int.com)

Rob Malany – Owner

321-960-4001 • [sales@Besco-Int.com](mailto:sales@Besco-Int.com)

## Professional Broadcast Engineering Software

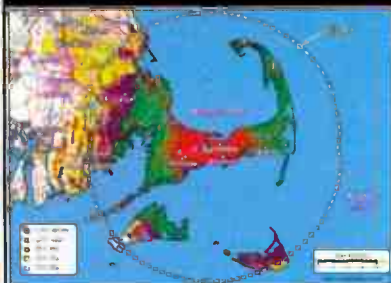

Probe 5™ Longley-Rice coverage map with FCC contour.

[www.V-Soft.com](http://www.V-Soft.com)

- Create stunning 'real-world' coverage maps, interference studies, and population reports with Probe 5™
- Find STL broadcast auxiliary and Part 101 microwave frequencies and generate PCN letters with Microwave Pro™
- AM Pro 2™, used daily by FCC engineers, performs skywave and groundwave allocation studies and AM coverage mapping
- Map FM stations and discover upgrade possibilities using FCC minimum separations and contour-to-contour methods with FMCommander™



V-Soft Communications®

(800) 743-3684

## Broadcast Signal Lab

With humble origins as Cambridge Crystals and Cambridge Thermionic in the 1940's, Rick Levy purchased and expanded the enterprise in 1982. As Broadcast Signal Lab, BSL came to include onsite transmitter measurements and calibrations, coverage maps and surveys, annual and periodically required measurements, RF safety surveys and compliance assistance, reports for inclusion with FCC filings, and off-air frequency measurement done from a NIST compliant laboratory.



Calibrated test  
 Equipment  
 Rapid  
 Response  
 Insured  
 45 Years  
 Industry  
 Experience



BSL, LLC Broadcast Signal Lab, LLC  
 P.O.Box 827 3 Jackson Park  
 Gardner, MA 01440  
 508-479-5278 cell 617-864-4298 office  
[dpeabody@broadcastsignalab.com](mailto:dpeabody@broadcastsignalab.com)

## RFENGINEERS, INC.

- Tower Grounding & Lightning Protection
- Coverage Modeling & Maps
- RF Exposure Studies
- FCC Applications

Call us to discuss your project needs.

352-367-1725

[rfengineers.com/services](http://rfengineers.com/services)



A  
 Professional  
 Engineering  
 Company

## TLM-2 TOWER LIGHT MONITOR

Total Monitoring for Older Lighting Systems



A microprocessor based system designed to monitor the status of FAA type A incandescent tower lights.

- Individual alarms for photocell, flasher, beacon & marker.
- Status outputs for lights on/off and beacon on/off.
- LED indicators for each alarm and status output.
- Opto-isolated fail-safe outputs for each alarm.
- Easy setup – one button calibration.
- Installs at the circuit breaker panel.
- Available through broadcast distributors.

FM Services

[www.towermonitor.com](http://www.towermonitor.com) • 336-667-7091

## Orban legacy Parts & Service

BY Circuit Research Lab, Inc.  
 920 Edison Ave. Benton, AR 72015  
 (501)794-6994

New Product Dealer Sales: **Jay Brentlinger**  
 5500i / 5700i / 8600SI / 8700iLT / 9300  
 (480)747-5330  
[Sales@Orbanlegacy.com](mailto:Sales@Orbanlegacy.com)

Service for All Older Models: **Robert Leembruggen**  
 8100 / 8200 / 8300 / 8400 / 8500  
 9100 / 9200 / 9200 / 9300  
 (501)650-8453  
[Robert@Orbanlegacy.com](mailto:Robert@Orbanlegacy.com)

# YOUR ULTIMATE SUPPLY & SERVICE SOLUTION



From our Facility to yours



Design & Integration

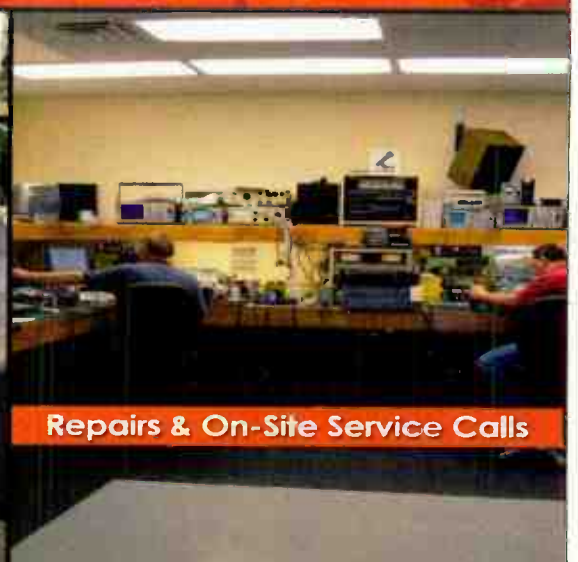

Repairs & On-Site Service Calls



**LIGHTNER ELECTRONICS** [www.lightnerelectronics.com](http://www.lightnerelectronics.com)

Toll Free 1-866-239-3888

Shop online [www.broadcastavsales.com](http://www.broadcastavsales.com)

## Radio-Classifieds.com

- Buy or Sell Your Used Equipment
- Place as Many Ads as You Like
- **FREE!** – There's Never Any Charge



**Radio-Classifieds.com** Latest 20 ads

Antennas [0]	Codecs & AvTP [0]	Internet & Stream [0]	STL, RPU, TSL [0]
Audio Amplifiers [0]	Computers & IT [0]	Microphones [0]	Satellite Gear [0]
Audio Delay [0]	Converters & Mixers [0]	Monitors & Racks [0]	Speakers & Phones [0]
Audio Editing [0]	Directional Gear [0]	Phone & Hybrids [0]	Timers & Clocks [0]
Audio Processing [0]	EAS Gear [0]	RDS, RBDS, SCA [0]	Tools & Test Gear [0]
Audio Routing [0]	Exciters & Gen's [0]	Recorder & Player [0]	Towers & Cbax [0]
Audio Storage [0]	Furniture & Racks [0]	Remote Control [0]	Transmitters [0]
Automation [0]	Grounding & Surge [0]	RF & IFV Equip. [0]	MISC OTHER [0]

Powered by Media Magazines Inc. - Publisher of *Radio-Club Magazine* | *Radio-World*

- **End Users** – Buy or Sell Used Equipment – No Limit!
- **Manufacturers** – Sell Your Demos and Overstock
- **Enter and Edit Your Own Ads** – Include Your Photos
- **Thousands of Users** – Sell Your Gear Right Away
- **Always Free** – Never a Charge – Buying or Selling

## Angry Audio

### New Headphone Disconnecter Ends Headphone Abuse

Radio jocks are hard on headphones. It seems every engineer keeps a box of ruined cans, cables and connectors for repair. Angry Audio has introduced a simple solution to this pervasive problem.

Meet the new Headphone Disconnecter. This short adapter is inserted between the headphone jack and cable. Yank it and the in-line magnetic quick-release connector separates before anything gets damaged. Reconnecting is just as fast and easy. Just get the two connector poles near each other and they snap together again.

The strength of the magnets has been carefully engineered so the connector stays together during normal use but separates when needed. The Headphone Disconnecter is the solution for forgetful “walkaways,” chair rollovers, cable stomps, and dancing DJ’s getting a little too jiggy in the studio.

Four versions are available, covering all types of plugs and jacks. You can even use the Headphone Disconnecter as a plug adapter. Perhaps your equipment has the large 6.3 mm but your headphones use the small 3.5 mm plug. Just order the Headphone Disconnecter with the ends you need – and end the need for those adapter things.

Angry Audio products are available from the world’s finest broadcast equipment dealers. Check out the complete line of Angry Audio problem-solvers at [AngryAudio.com](http://AngryAudio.com)

Angry Audio makes the gadgets and gizmos that solve difficult studio problems for broadcasters and content creators.



**Angry Audio LLC**  
[www.angryaudio.com](http://www.angryaudio.com)  
[answers@angryaudio.com](mailto:answers@angryaudio.com)

## Bext Coporation

### BEXT Continues to Improve Its Product Lines

Bext Corporation, a well known supplier of Broadcast Antennas, RF Combiners, RF Filters and Transmitters, continues to improve its products. The company’s stainless steel antennas are known for rugged durability and good performance, but Bext never stops refining them. One of the recent achievements has been to improve the flatness response of the broadband models.

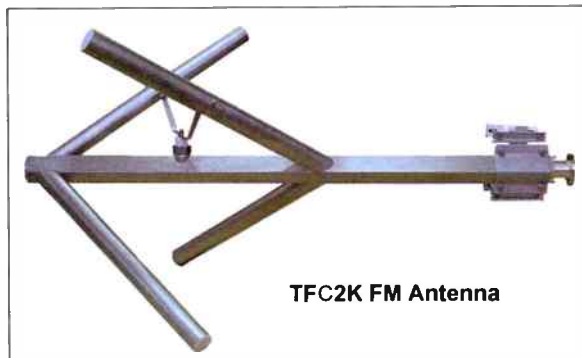

TFC2K FM Antenna

Achieving a near perfect broadband response everywhere on the entire 88 to 108 MHz FM band is not easy, and the company says it has worked relentlessly to refine every detail for the purpose of making sure that FM stations on any channel, with any number of bays, could rely on a very good return loss and a very low VSWR – with no tweaking required no matter what frequency the stations operate on. That achievement is appreciated under all circumstances, but it is particularly useful in cases where two or more stations operating on vastly different frequencies are combined into the same antenna system (Bext of course also offers a vast line of RF combiners exactly for those kinds of projects). Some of the company’s best seller antennas are the TFC2K, the TFC2K-D and the TFLBDI, all of which have benefited from the continuous refinements. Power ratings are up to 7 kW per bay and up to 75 kW on multi-bay systems. Radomes are available. And Bext offers phone tech support with live persons to help anyone who has questions during or after installation of any Bext product.

**BEXT Coporation**  
[www.bext.com](http://www.bext.com)  
 888-239-8462

## Inovonics

### Inovonics Introduces Two New Products for Monitoring HD Radio Broadcasts

Inovonics, Inc is pleased to introduce the new 551 and 552 HD Radio Modulation Monitors, providing the ultimate choice for advanced FM and HD Radio signal monitoring. Incorporating all the necessary features for station setup, regulatory compliance and remote monitoring, both models are on schedule to begin shipping mid-February.



The Model 551, with its 7-inch TFT Touch Screen, displays all the essential modulation data in a graphic format on the front panel, as well as the remote Web interface. In addition, full-time audio outputs are available for FM and digital channels HD1-HD4.



The Model 552 is designed for remote installations where information is accessible via the graphic Web interface and is available at a more modest price point.

Ben Barber, President & CEO of Inovonics says, “When we look back over the past two years of development, we have made great strides in designing a complete and comprehensive FM/HD Radio Mod Monitor. With the dynamic web interface that can be remotely accessed from any smart phone, tablet, or PC, and its SNMP capabilities, these two products take innovation to a new level.”

Currently, several Beta units have been placed with trusted radio engineers for testing to provide Inovonics with valuable feedback which will be used to make some final tweaks to the firmware before shipping.

Inovonics is already accepting purchase orders for both models, and orders will be processed on a first come, first served basis. For more information about price and availability, please contact Inovonics Sales Department.

**Inovonics**  
[www.inovonicsbroadcast.com](http://www.inovonicsbroadcast.com)  
[sales@inovonicsbroadcast.com](mailto:sales@inovonicsbroadcast.com)

## PHASETEK INC.

### Custom Phasing Systems

Phasetek, Inc. is dedicated to provide the broadcast industry high quality AM Phasing and Branching systems, Antenna Tuning units, Multiplexers, and RF components.

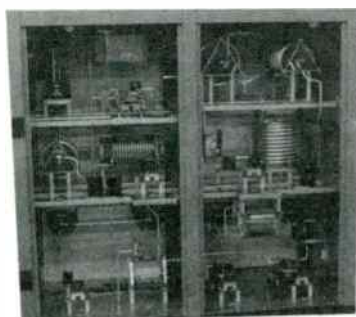

**Phone: 215-536-6648**  
[sales@phasetekinc.com](mailto:sales@phasetekinc.com)  
[www.phasetekinc.com](http://www.phasetekinc.com)

## Distribution Made Easy



### 2x6 DA Plus/RJ 2x3 or 1x6 Distribution Amplifier

The 2x6 DA Plus/RJ provides 3 channels of stereo or 6 channels of mono audio distribution in a compact, easy to use form factor. It accepts professional balanced +4 dBu analog audio input (RJ45) or consumer unbalanced -10 dBV (RCA) inputs eliminating the need for an additional unbalanced to balanced level converter.



Broadcast Tools is a Veteran Owned Business  
 Designed, Assembled and Supported  
 in WA State, USA.  
[www.broadcasttools.com](http://www.broadcasttools.com)

**BROADCAST**  
**tools**  
 PROBLEM SOLVED

# FINAL STAGE



## RADIO ROUNDUP

The Radio Guide Event Register

Email your dates and info to: [radio@rconnect.com](mailto:radio@rconnect.com)

### NATE Unite 22

February 21-24, 2022  
Las Vegas, Nevada  
<https://natehome.com>

### Great Lakes Media Show

March 2-3, 2022  
Lansing Center, Lansing, Michigan  
[michmab.com/programs-events/great-lakes-media-show/](http://michmab.com/programs-events/great-lakes-media-show/)

### 2022 NRB Convention

March 8-11, 2022  
Gaylord Opryland, Nashville Tennessee  
[www.nrbconvention.org](http://www.nrbconvention.org)

### 2022 NAB Show

April 23-27, 2022  
Las Vegas, Nevada  
[www.nabshow.com/2022/](http://www.nabshow.com/2022/)

### Dayton Hamvention

May 20-22, 2022  
Greene County Fairgrounds, Dayton, Ohio  
<https://hamvention.org>

### Texas Association of Broadcasters (TAB 2022)

August 3-4, 2022  
JW Marriot Downtown – Austin, Texas  
[www.tab.org/convention-and-trade-show](http://www.tab.org/convention-and-trade-show)

## Radio Guide Advertiser Info – January-February 2022

### Advertiser - Page

Altronic - 39  
Angry Audio - 19  
Angry Audio - 33  
Arrakis - 37  
Bay Country - 44  
Besco - 44  
BEXT - 42  
Broadcast Bionics - 17  
Broadcast Devices - 3  
Broadcast Devices - 48  
Broadcasters General Store - 23  
Broadcast Signal Lab - 44  
Broadcast Software Intl. - 9  
Broadcast Tools - 4, 46  
CircuitWerkes - 25  
Coaxial Dynamics - 39  
Deva - 36  
Davicom - 29  
D&H Satellite - 28  
Econco Tubes - 43  
Enco - 30  
ESE - 47  
FM Services - 44  
Graham Studios - 47  
Henry Engineering - 2  
Inovonics - 1, 15

### Website

[www.altronic.com](http://www.altronic.com)  
[www.angryaudio.com](http://www.angryaudio.com)  
[www.angryaudio.com](http://www.angryaudio.com)  
[www.arrakis-systems.com](http://www.arrakis-systems.com)  
[www.baycountry.com](http://www.baycountry.com)  
[www.besco-int.com](http://www.besco-int.com)  
[www.bext.com](http://www.bext.com)  
[www.bionics.co.uk](http://www.bionics.co.uk)  
[www.broadcast-devices.com](http://www.broadcast-devices.com)  
[www.broadcast-devices.com](http://www.broadcast-devices.com)  
[www.bgs.cc](http://www.bgs.cc)  
[www.broadcastsignallab.com](http://www.broadcastsignallab.com)  
[www.bsiusa.com](http://www.bsiusa.com)  
[www.broadcasttools.com](http://www.broadcasttools.com)  
[www.circuitwerkes.com](http://www.circuitwerkes.com)  
[www.coaxial.com](http://www.coaxial.com)  
[www.devabroadcast.com](http://www.devabroadcast.com)  
[www.comlab.com](http://www.comlab.com)  
[www.dhsatellite.com](http://www.dhsatellite.com)  
[www.enco.com](http://www.enco.com)  
[www.enco.com](http://www.enco.com)  
[www.esa-web.com](http://www.esa-web.com)  
[www.towermonitor.com](http://www.towermonitor.com)  
[www.graham-studios.com](http://www.graham-studios.com)  
[www.henryeng.com](http://www.henryeng.com)  
[www.inovon.com](http://www.inovon.com)

### Advertiser - Page

Kintronic Labs - 41  
Lawo - 31  
Lightner Electronics - 45  
Logitek - 13  
Mega Industries / MCI - 34  
Nautel - 5  
Nicom - 43  
Owl Engineering - 47  
Phasetek - 46  
PTEK - 24  
Propagation Systems (PSI) - 38  
Radio-Classifieds.com - 45  
RF Engineers - 11  
RF Specialties / Nautel - 42  
Shively - 32  
Smarts Broadcast Systems - 35  
Stackley Devices - 47  
Studio Items - 41  
Surcom - 44  
Telos Axia - 27  
Telos Omnia - 21  
Tieline - 7  
Titus Labs - 26  
Transcom - 43  
V-Soft Communications - 44  
Worldwide Antenna Systems - 43

### Website

[www.kintronic.com](http://www.kintronic.com)  
[www.lawo.com](http://www.lawo.com)  
[www.lightnerelectronics.com](http://www.lightnerelectronics.com)  
[www.logitekaudio.com](http://www.logitekaudio.com)  
[www.mcibroadcast.com](http://www.mcibroadcast.com)  
[www.nautel.com](http://www.nautel.com)  
[www.nicomusa.com](http://www.nicomusa.com)  
[www.owleng.com](http://www.owleng.com)  
[www.phasetekinc.com](http://www.phasetekinc.com)  
[www.ptekpower.com](http://www.ptekpower.com)  
[www.psbroadcast.com](http://www.psbroadcast.com)  
[www.radio-classifieds.com](http://www.radio-classifieds.com)  
[www.rfengineers.com](http://www.rfengineers.com)  
[www.rfspecialties.com](http://www.rfspecialties.com)  
[www.shively.com](http://www.shively.com)  
[www.smartsbroadcast.com](http://www.smartsbroadcast.com)  
[www.stackleydevices.com](http://www.stackleydevices.com)  
[www.studioitems.com](http://www.studioitems.com)  
[www.surcom.com](http://www.surcom.com)  
[www.telosalliance.com](http://www.telosalliance.com)  
[www.telosalliance.com](http://www.telosalliance.com)  
[www.tieline.com](http://www.tieline.com)  
[www.tituslabs.com](http://www.tituslabs.com)  
[www.fmamtv.com](http://www.fmamtv.com)  
[www.v-soft.com](http://www.v-soft.com)  
[worldwideantennasystems.com](http://worldwideantennasystems.com)

## OWL ENGINEERING, INC.

Consulting Communications Engineers  
5844 Hamline Ave. N., Shoreview, MN 55126  
**651-784-7445**

- AM/FM/NCE Applications
- Allocation and Upgrade Studies
- Pre-Purchase Inspections
- ANSI and NRSC Measurements
- AM Directional Array, Design, Tuning and Proof using Method of Moments
- Tower Detuning
- Intermodulation Studies
- Radiation Hazard Evaluation and Measurements

Fax (651) 784-7541    E-mail: [info@owleng.com](mailto:info@owleng.com)    "Member AFCCE"

### TIME TO SYNCHRONIZE

## ES-185E/NTP6 GPS Master Clock

Accurately generate time code with ESE's Master Clock via the 12-channel GPS receiver and output multiple types of Time Code, SMPTE-LTC/EBU, ESE, IRIG-B, ASCII (RS-232 & USB), and an extremely accurate 1PPS signal. Further reliability with dual battery back-up, and new control panel software. ESE's NTP6 feature provides an NTP server compatible with the latest version of Internet Protocol, IPv6. You can also easily interface with new or existing computers, automation and clock systems. Visit [www.esa-web.com](http://www.esa-web.com) for all your time synchronization needs.

**www.esa-web.com**  
**+1-310-322-2136**

Precision | Innovation | Proven

## GRAHAM STUDIOS

Broadcast Furniture

815-222-3556    866-481-8696 | [www.graham-studios.com](http://www.graham-studios.com)

## Remote Reboot of AC Powered Devices

**Stackley Devices LLC**  
**(609) 647 9677**

**RemOutlet Reboot Mini \$179**  
Adjustable Power OFF Time

**www.RemOutlet®.com**

# Accuracy, Peace of Mind and Reliability

*These are at Least Three Reasons Why the DPS-100D Series Power Meter has Become the Choice of Broadcasters Worldwide*

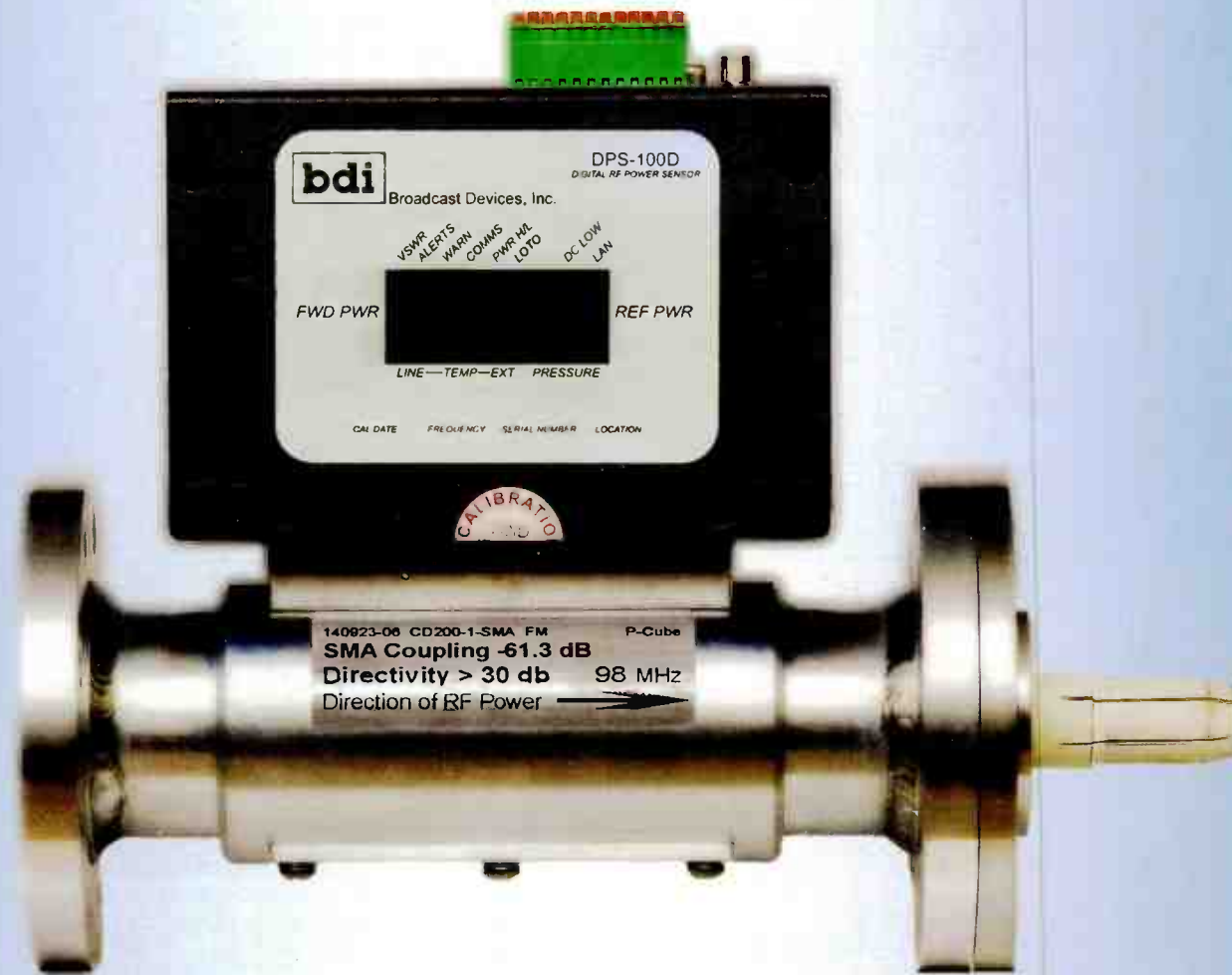

*No other power meter on the market meets the stringent and changing requirements like BDI's DPS-100D Series True RMS Power Meters. FM broadcasters, television broadcasters and now AM all digital broadcasters can take advantage of the DPS-100D Series feature set including 40 dB dynamic range, measurement of analog FM and IBOC simultaneously, measurement of multiple carriers simultaneously for master antenna applications and much more. With BDI's exclusive 3-Strike™ VSWR protection algorithm your system is protected from damage. The DPS-100D interfaces directly to our SWP-200 series motorized switch controllers, SWP-300 remote controls and our SWP-206 master antenna monitor system. Email alerts, SNMP IP interface and a host of other features make the DPS-100D series unmatched in flexibility and ease of use.*

**bdi ... Serving the Broadcast Industry for 35 years**

**Tel. (914) 737-5032 [www.broadcast-devices.com](http://www.broadcast-devices.com)**

