

# Radio Guide

Radio Technology for Engineers and Managers

July 2006

## The Father of Radio – Tesla at 150



### Inside Radio Guide

Nikola Tesla  
Father of Radio  
Page 4

It is amazing how few in broadcasting know of one of mankind's greatest geniuses and accomplished inventors. Not only did he lay out the basics of radio transmission and reception, Tesla foresaw shortwave broadcasting, standing wave ratios, multicasting(!) from a single antenna, the microwave waveguide, today's computer logic gate, radar, and more.

A strong case can be made to say that Tesla in fact is one of the greatest inventors of all time, even eclipsing Thomas Edison. Although this is nearly forgotten, Tesla held over 700 patents. And those were the ones he remembered to patent.

### FM Rebroadcast Receiver



A professional second-generation translator receiver with selectable IF bandwidth, overmod protection, full signal metering and alarm tallies.



**Inovonics**  
1305 Fair Ave. • Santa Cruz, CA 95060  
TEL: (831) 458-0552 • FAX: (831) 458-0554  
www.inovon.com • e-mail: info@inovon.com

**Model 631 - \$1390**

Visit [www.inovon.com](http://www.inovon.com)  
for full technical details



# Don't Get Zapped!



**PowerClamp** surge suppressors clamp lightning-induced powerline transients to within a few volts of normal AC voltage!

**PowerClamp** will pay for itself by reducing expensive damage to transmitter site equipment caused by powerline spikes and surges.

Protect your transmitter and **Stay On The Air with PowerClamp!**



DISTRIBUTED BY  
**Broadcasters  
General Store**

[www.bgs.cc](http://www.bgs.cc)

**1-352-622-7700**

## ENERGY-ONIX CONTINUES TO SELL AT LEAST ONE AM AND ONE FM TRANSMITTER EVERY DAY!

### DRE

You can generate multiple digital stereo on your Existing FM Transmitter

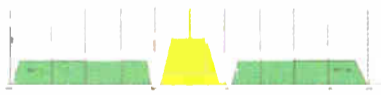

#### System consists of:

- (1) Encoder @ \$9,000.
  - Receiver @ \$150. ea.
- No changes required in your present analog transmitter.

#### Sample Applications:

- Stereo Digital Channel For 2nd language
- Digital Channel for Books for the Blind
- Dedicated Channel for Supermarkets
- STL for multiple station owners
- Normal Radio programs within the 1 mv contour for both analog and digital

### Roadcaster

*Remote Pick up*



- Portable Solid State 40 watt VHF/UHF Transmitter and receiver
- 16 RF Channels Selectable
- 4 Channel Audio Mixer
- Can work from 115v/220v AC and 12 volts DC

#### Selling Prices:

Transmitter - \$ 1,995  
Receiver - \$ 1,495

### Internet STL

#### *Tele-Link -2*



Stereo Quality STL Link permits duplex operation on the Internet or any other Ethernet connection.

Can be expanded to encode (3) stereo programs. Each terminal contains a LINUX based encoder and decoder with automatic adjustment to match useable bandwidth.

Cost per Stereo terminal including hardware and software **\$3,000.**

### Documentor 2

*(Audio Logger)*



**365 day Audio Logger** capable of driving 10 monitor terminals and selecting pre-recorded programs by minute, hour, day and month.

Can be configured with many Documentors to record and monitor multiple programs.

**\$1,295.**



**ENERGY-ONIX**  
*The Transmitter People*

**Your Source for AM & FM Transmitters**

**Phone: 888.324.6649 / 518.758.1690 Fax: 518-758-1476**

**E-Mail: [info@energy-onix.com](mailto:info@energy-onix.com) [www.energy-onix.com](http://www.energy-onix.com)**

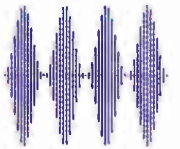

**Nikola Tesla  
Father of Radio** ..... 4  
*Nautel's V10: A versatile performer.*

**Field Guide** ..... 8  
*A brief look at top-loaded antennas.*

**RF Guide** ..... 10  
*A brief look at top-loaded antennas.*

**Tech Tip** ..... 12  
*Sharing the common status.*

**The Worst I've Ever Seen** ..... 12  
*The trailer park tower.*

**Studio Guide** ..... 14  
*Creating the ideal (budget conscious) PC audio workstation.*

**Maintenance Guide** ..... 18  
*Finding monitor and radial points after a disaster.*

**FCC Focus** ..... 20  
*Benefiting from the ABIP.*

**The New Radio Pipeline Magazine** ..... 24  
*Radio Guide introduces a new publication in August.*

**A Radio War Story** ..... 26  
*Explaining multipath to a GM.*

**First Person** ..... 28  
*Engineering interns make your job easier as you train them.*

**Transmitter Shack** ..... 34  
*Understanding lightning helps to protect stations.*

**IT Guide** ..... 40  
*Expanded uses for VoIP.*

**Consultant Guide** ..... 42  
*Radio Consulting Engineers*

**Service Guide** ..... 44  
*Radio Equipment Products and Services*

**Final Stage** ..... 46  
*Radio Roundup Date Book and Advertiser Information*

**Cover Photo:** Courtesy of the Tesla Society – Switzerland  
[www.teslasociety.ch](http://www.teslasociety.ch)

## Radio Guide

Volume 14 – Issue 7

PO Box 20975, Sedona, AZ 86341  
Phone: 928-284-3700 Fax: 866-728-5764  
[www.radio-guide.com](http://www.radio-guide.com)

**Ray Topp** (Publisher)

Email: [radio@rconnect.com](mailto:radio@rconnect.com)

**Barry Mishkind** (Editor)

Email: [editor@radio-guide.com](mailto:editor@radio-guide.com)

Radio Guide, ISSN 1061-7027, is published monthly, 12 times a year, by Media Magazines Inc., PO Box 20975, Sedona, AZ 86341. Radio Guide is copyright 2006, Media Magazines Inc., and may not be copied, reproduced, or stored in any format, without the written permission of the publisher.

### “INFORMATION! WE WANT INFORMATION!”

Before you accuse me of sounding more than a bit like “the new #2,” let me frame that statement in the correct direction, I know *you* want information. And, given your busy schedule, you want that information to be easily accessible.

Of course, that is the goal for *Radio Guide* – to provide the information you need to get your job done. And we are always seeking better and easier ways to help get that information to you.

For example, every issue of *Radio Guide* is available on CD ([www.olderadio.com/bdr.htm](http://www.olderadio.com/bdr.htm)). Requests for help in locating many of the “White Papers” delivered at NAB and other venues led to building the on-line resource at [www.radiopapers.net](http://www.radiopapers.net)

Several of you have commented on the difficulty in typing in the long, involved URLs listed in some articles. So starting with this issue, you will find a list of the URLs in each issue of *Radio Guide* at [www.radio-guide.com/URL.html](http://www.radio-guide.com/URL.html)

### MORE INFORMATION IS COMING

About two weeks from now, you will see another request being fulfilled. Folks have asked for more information on the latest products. Our response: *Radio Pipeline*.

*Radio Pipeline* is a completely new publication, designed to bring you the latest information on new equipment that is ready to be released, previews of what is coming, as well as a handy place to learn about new factory upgrades and service bulletins. More information is on Page 24.

As we prepare this new offering for you, we have been excited by *Radio Pipeline*'s content. We hope you will like it, too. As always, we invite your comments on how to improve either (or both) publications.

We know you want information. We plan to bring it to your mailbox. And you do not have to ask the new #2 to get it for you. Be seeing you! – *Radio Guide* –

# When You Want More Than Just An Antenna



**Full line of  
HD Radio Accessories:  
Circulators, Mask Filters,  
Reject Tuners, and  
Rigid Components.**



Made in USA since 1954



**MASTER FM  
DUAL INPUT  
HD ANTENNA**



**JSHD DUAL INPUT  
HD SIDEMOUNT  
ANTENNA**



**RCHA 10dB  
HIGH LEVEL  
HD INJECTOR**





# Nikola Tesla Father of Radio

By Kevin Webb

July 2006 marks the 150th anniversary of Nikola Tesla's birth. It is likely you know the name. But what do you know about the man? Kevin Webb fills us in.

If you are in broadcasting, you must remember these four words: Nikola. Tesla. Invented. Radio.

Even if you stopped reading at this point you would be richer in having that knowledge and at least know whom to thank for laying the first foundations of broadcasting back in the 1800s. Yes, the 1800s!

## MORE THAN A COIL

By now, you may be thinking "Hmm, Tesla. Yes I believe I have heard the name. There's the Tesla Coil and, um something else." Yes, something else indeed!

It is amazing how few in broadcasting know of one of mankind's greatest geniuses and accomplished inventors. Not only did he lay out the basics of radio transmission and reception, Tesla foresaw shortwave broadcasting, standing wave ratios, multicasting(!) from a single antenna, the microwave waveguide, today's computer logic gate, radar, and more.

A strong case can be made to say that Tesla is, in fact, is one of the greatest inventors of all time, eclipsing even Thomas Edison. Although he is often nearly forgotten, Tesla held over 700 patents – and those were the ones he remembered to patent.

## AMAZING STUFF

Imagine being at Madison Square Garden and witnessing a radio remote-controlled submarine that could execute complex macro commands using the precursor to your modern-day computer's logic gate over three separate radio frequencies – in 1898!

The sheer brilliance of this and similar inventions inspires the great passion many engineers need to share with fellow broadcasters about Tesla.

To touch just the surface of what Tesla has accomplished – some feats still amaze scientists to this day, while some feats are still unexplained – would take hundreds of hours of video. Tesla's inventions changed the world and were precursors to much of today's technology.

## BACK AT THE START

When did radio start? 1920 at KDKA? 1909 at WHA or at Herrold's station? Try 1893, when Tesla appears to have invented his radio, although he did not apply for a patent until four years later. (He was still over three years ahead of Marconi.) It took until 1943, shortly after Tesla's death for him to be vindicated – by no less than the US Supreme Court – as being the true inventor of radio.

Speaking of Marconi: he was the one who claimed to have received one single letter – which could easily have been mistaken for static – not to mention there is the pesky fact that Marconi could not reproduce that same feat for several more years.

So many others have either borrowed or outright taken from Tesla what was rightfully his or have smeared his name (including Thomas Edison) that very few really are aware of the true extent of Tesla's immense contributions to technology.

But I digress. The best way to introduce you to Nikola Tesla is to focus on just who he was and what Tesla contributed to radio. Heck, Tesla is the True Father of Radio.

## VITAL STATS

Precisely at midnight between July 9 and 10, 1856, Nikola Tesla became the fourth child born to The Reverend Milutin Tesla and his wife Duka Mandić Tesla in the village of Smiljan, Croatia.

Nikola's home life seemed an ideal incubator for a fertile mind and prolific inventor-to-be. His father was a Serbian Orthodox priest, a gifted writer and poet. His mother was able to recite entire volumes of native and classic European poetry and was, in his own words, a great inventor in her own right.

Tesla inherited a mix of his parent's characteristics. He was a poetic dreamer, highly intelligent and altruistic. Tesla believed his inventive genius and photographic mind came from his mother. As a youth Tesla spent countless hours in his library reading and absorbing as much as possible.

Most importantly, it is Tesla's exceptionally steely self-discipline which he developed as a teen along with a desire for invention that drove him every day of his life as an adult.

## A YOUNG PRODIGY

At age five Tesla built a small waterwheel unlike anything found anywhere in his countryside. Even though it was smooth and had no paddles, it spun quite effectively in the water's current. This was to be the basis for a unique bladeless turbine which he perfected years later.

Tesla later put it this way: "Before I put a sketch on paper, the whole idea is worked out mentally. In my mind I change the construction, make improvements, and even operate the device. Without ever having drawn a sketch I can give the measurements of all parts to workmen and, when completed, all these parts will fit just as certainly as though I had made the actual drawings.

"It is immaterial to me whether I run my machine in my mind or test it in my shop. The inventions I have conceived in this way have always worked. In thirty years there has not been a single exception. My first electric motor, the vacuum wireless light, my turbine engine and many other devices have all been developed in exactly this way."

During his childhood, Tesla continued to invent. As befit a young man, not everything was genius. One whimsical invention consisted of a motor powered by sixteen live June bugs! When the glued insects beat their wings the bug-powered engine appeared ready to take off. However we will never know if this engine was meant to be or not. A young friend of Tesla's stopped by, noticed the jar of June bugs, and proceeded to cram a mouthful of the live "engine fuel" into his mouth. Young Tesla promptly threw up and abandoned his project.

## ILLNESS ... OR INSPIRATION?

Beginning in childhood, Nikola was plagued throughout his life from time to time by a unique

"ailment:" strong flashes of light that interfered with his normal vision during moments of excitement, something that his brilliant older brother Daniel suffered from as well before his untimely death at a young age.

In later years, Tesla would describe it as "a peculiar affliction due to the appearance of images, often accompanied by strong flashes of light, which marred my sight of real objects and interfered with my thought and action. They were pictures of things and scenes which I had really seen, never of those I imagined.

"When a word was spoken to me the image of the object it designated would present itself vividly to my vision and sometimes I was quite unable to distinguish whether what I saw was tangible or not. This caused me great discomfort and anxiety. None of the students of psychology or physiology whom I have consulted could ever explain satisfactorily these phenomena."

He believed that these hyper-real images were caused by a reflex action of the brain upon the retina while under great excitation and were not hallucinations. At night when a scene would appear before his eyes, Tesla described how the vivid scene would thrust itself before his eyes. The scene would be so realistic that even if he jabbed his hand through it, it would remain fixed in space.

## SEEING HIS INVENTIONS

Tesla was unique in that he could visualize an invention before even creating it in physical form, a feat many of his employees and associates would verify years later.

In his mind Tesla was able to picture the object of his impending invention and measure its dimensions within fractions of an inch. He said his mental projections were "absolutely real and tangible in every detail, even to the minutest marks and signs of wear."

Tesla's disdain for anything drawn out on paper caused consternation with Tesla's employees, assistants and engineers with whom Tesla worked as he never required a blueprint or drawing to commence with

construction while those around him did. Perhaps the very ailment that drove Tesla to a physical wreck at times was also his greatest strength since he could so vividly visualize his ideas in his mind in three-dimensional form, complete with motion and exploded views.

## COLLEGE DAYS

Tesla completed his elementary and "high school" education in Cartstatt, Croatia, where he distinguished himself by compressing the four years' course into three and graduated in 1873. Returning home during a cholera epidemic, he was stricken by the disease so seriously that his formal studies were interrupted for fully two years.

However, Tesla did not waste the time for he had become passionately fond of experimenting, devoting his energies to electrical study and investigation. Resuming his studies at the Polytechnic School in Gratz, he finished at the University of Prague where he was to prepare for work as professor of mathematics and physics.

Fortunately for mankind, while at Gratz, Tesla first saw and operated a Gramme machine, which inspired him to improve on the motor's necessity to use commutators and brushes. Rather than become a professor as his parents had hoped, he would go on to create a stunningly-simple, yet effective, AC motor from this point of inspiration. (At that time DC power ruled the world but it was extremely inefficient and dangerous to transfer.)

(Continued on Page 6)



Nikola Tesla (1856-1943), at age 37.



Tesla often was lost in study and thought.



# Indecency Processor



No, this product doesn't remove naughty words, but if you do run a profanity delay or simply have a buildup of digital latency, talent can't listen to the processed air signal. Instead, their feed is probably direct from the console. Compared to the air sound, this can seem weak, dull and lifeless.

Our Model 255 Triband Spectral Loading™ processor has zero delay and can deliver a dense, tight, and punchy 'broadcast' sound to headphones and control room speakers... a sound you can't achieve with a general-purpose "utility compressor." Other 255 applications include the program feed to telephone hybrids and IFB processing.

*Give talent and other house feeds a sound that's closer to your air sound. See your preferred equipment supplier for a demo of the 255 in your monitor channel.*

**Inovonics**  
 1305 Fair Ave. • Santa Cruz, CA 95060  
 TEL: (831) 458-0552 • FAX: (831) 458-0554  
 www.inovon.com • e-mail: info@inovon.com

**Model 255 - \$2100**

Visit [www.inovon.com](http://www.inovon.com)  
 for full technical details

## FM Broadcasters' First Choice

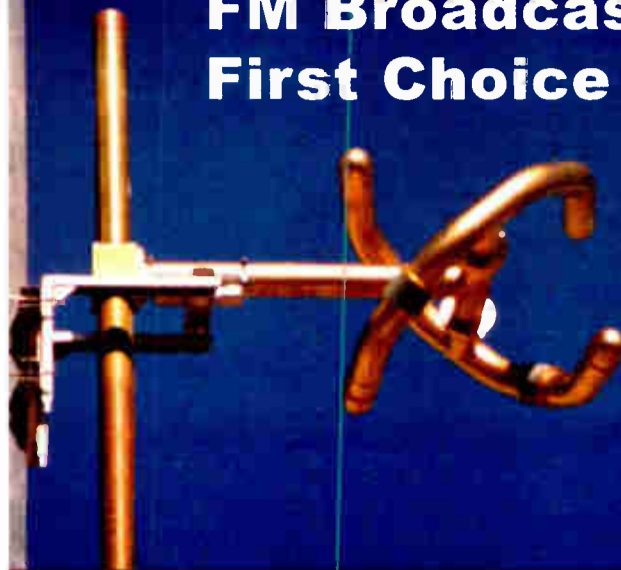

### SHPX ROTOTILLER® FM Antenna HD Radio Ready™

- Rugged brass construction
- Stainless steel brackets
- Reliable series fed elements
- Welded internally pressurized feed connection
- Multiplexed versions available

"HD Radio" is a trademark of iBiquity Digital Corporation

**ERI®** ELECTRONICS RESEARCH, INC.  
 (812) 925-6000 | [www.eriinc.com](http://www.eriinc.com)



## Wireless Broadband Internet Remotes

Now Shipping



*The first time out with the Tieline was a brilliantly simple experience for everyone involved. For lack of a better phrase, the codec just worked.*

-Christian Vang Chief Engineer  
 Clear Channel St. Louis



\*Verizon, Cingular and Sprint now offer broadband IP cell phones you can plug into a Tieline codec and deliver reliable, broadcast quality remotes from wherever you're standing

800-780-4750

Read the full story and get a **FREE** IP demo  
[www.tieline.com/ip](http://www.tieline.com/ip)

\*Verizon, Cingular and Sprint are trademarks of their respective corporations

**Tieline®**  
[www.tieline.com](http://www.tieline.com)



# Nikola Tesla Father of Radio

Continued From Page 4

As was typical for Tesla, he was reciting a favorite passage of poetry when he was inspired by a sunset. Suddenly he stopped, waving his arms – frozen in midair as if he was having a seizure. Tesla had another major epiphany: “*The idea came like a flash of lightning, and in an instant the truth was revealed.*” he said. It was at that precise moment in time that Tesla revolutionized the world with Alternating Current.

This was an entirely new system of delivering polyphase AC power, of the AC induction motor, and of the dynamos that would generate the AC electricity. This was a significant moment in technical history for all mankind. Tesla changed everything.

## INTO THE COMMERCIAL WORLD

Tesla soon gave up his intention of becoming a professor once and for all and decided to embrace a steely resolve and discipline that would forever steer his life. His level of high discipline would enable him to work for days on end with very little or no sleep, while creating some of his most magnificent inventions.

Leaving school, Tesla began working for the Central Telegraph Office in Budapest, improving the voice amplifiers used in telephones. After working for the Edison company in Paris, Tesla left to work for Edison himself, emigrating to the United States in 1884 – where he landed with four cents in his pocket.

Edison was struck by Tesla’s single-handed ability to complete complex projects where other engineers had given up. But the relationship did not last very long.

When Tesla offered to improve Edison’s primitive DC dynamos, Edison accepted the challenge promising him “there’s \$50,000 in it for you if you can accomplish it.” Tesla promptly set upon his task working almost non-stop, through days and nights with very little sleep, for a year – but he completed the task. When Tesla asked Edison for his \$50,000, Edison simply exclaimed “Tesla, you simply do not understand our American humor.”

It would not be the first time that Tesla would be swindled out of what was due to him. Some accounts say Tesla resigned instantly, walking away without a word. He then founded his own “Tesla Arc & Light Co.,” and started producing motors and generators for polyphase alternate currents. Soon, George Westinghouse bought the patent rights to Tesla’s system of dynamos, transformers and motors. eventually using Tesla’s alternating current system to light the World’s Fair Exposition of 1892 in Chicago.

In time, Tesla himself held some forty patents basic to AC power generation and transmission. Although he did employ assistants, Tesla did the majority of his own work.

## THE COIL ... THE COIL!

The product that carries his name most prominently today, the Tesla Coil – a high-voltage coreless transformer – was invented in 1891, as Tesla sought to solve the problem of transmitting power through the air without wires. His vision was a Utopian world where all people would have free and unlimited power.

It is ironic then that Tesla’s original application for radio transmission came from wanting to send raw power through the air. Nevertheless, Tesla was the first to postulate in US Patent No. 725,605 that for a radio communication system to work it must have “two tuned circuits each at the transmitter and receiver, all four tuned to the same frequency,” by which he meant tuned antenna (output/input) and oscillator (signal/detector) circuits coupled by transformers in each piece of equipment.

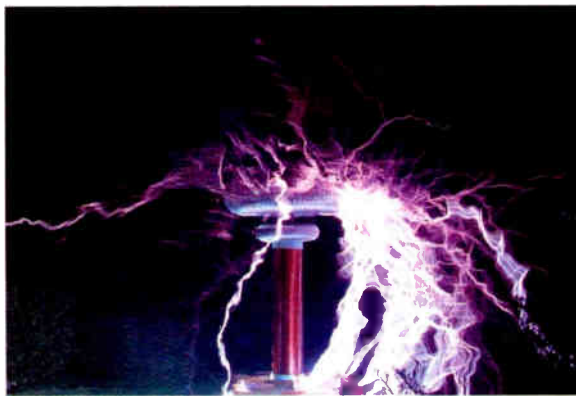

Tesla Coil

Later, from 1901 to 1905, Tesla built what was known as the Wardencllyffe Tower near New York, NY. It was an ill-fated endeavor.

Tesla intended the tower for radio broadcasting and the wireless transmission of electrical power across the Atlantic. A multi-purpose platform, it would also provide a defensive “shield” against incoming missiles or attacking airplanes.

This was such a grand undertaking that it would require an entire article devoted to explain this mysterious tower project that was never able to take shape due to a lack of funding and, some say, vision on the part of the investors.



The Wardencllyffe tower.



Artists drawing of Tesla's Power Transmission station.

In the meantime, Tesla accepted a commission from Lord Kelvin in 1893 to harness the power of Niagara Falls, culminating in 1896 with ten generators successfully providing 15,000 horsepower of AC electricity – a stunning amount for the era, and bringing many honors to Tesla.

## LATER YEARS

Though he should have been one of the richest men of his time, Tesla was cheated time after time by investors, circumstances, and, to a great measure, his

own lack of business acumen – he really was more interested in his work than marketing it. If only he had been as good an entrepreneur as he was an inventor, he would have been as rich and as famous as Bill Gates is today.

Finally, the world began to recognize him as a true genius. More awards came his way but despite the honoraries Tesla received later in life, he never did get the same level of recognition as many other great inventors. He performed fewer lectures and had less funds, becoming dependent on the grace of good friends and the occasional stipend from (guilty?) past investors.

As Tesla aged, his eccentricities and quirks increased as well. He believed that pigeons could talk to him and he attributed these “talks” as inspiration for some of his wilder ideas in his twilight years.

It is sad to note that such a great inventor died a tragic, lonely death at the age of 86. A maid found his lifeless body in his hotel room where he had been living by himself for many years. The medical examiner later placed the time of death at 10:30 PM on January 7, 1943, with the cause of death being coronary thrombosis. Tesla had apparently died in his sleep.



Tesla's death mask.

## A REAL VISIONARY

As to how relevant Tesla is to today’s technology, you may not have thought about this, but right now you use at least several of his inventions most every day: AC power, fluorescent lights, radio transmission and reception, etc. among them.

Also consider this proposal Tesla had for the application of radio: “A ‘world system’ of wireless communications to relay telephone messages across the ocean; to broadcast news, music, stock market reports, private messages, secure military communications, and even pictures to any part of the world.”

“When wireless is fully applied the earth will be converted into a huge brain, capable of response in every one of its parts,” Tesla told financier J. P. Morgan. That last sentence could well have been predicting today’s Internet.

Computer scientists with Bell Labs, M.I.T. and many other think tanks were very surprised to learn when they tried to patent new computer-related technology such as robotics or logic gates that they had already been beaten to the finish line by no less than Tesla, many decades previously.

## A TRUE GENIUS

To this day, no one can explain many of Tesla’s feats – things he demonstrated to many witnesses such as Mark Twain or even to World’s fair audiences and fellow scientists. Even now scientists are discovering new truths that Tesla espoused back in the late 1800s!

During this month marking 150 years since Tesla’s birth, let us remember the man that had such a major effect and impact on today’s electronics and broadcasting industry. Pop “Tesla” into a search engine and you will find there is a lot more to learn about this fascinating individual.

We also hope you will pass some of this knowledge on to others. We all will be richer for the experience.

Our thanks to the Tesla Society – Switzerland ([www.teslasociety.ch](http://www.teslasociety.ch)) for the pictures used in this article.

A longtime broadcaster, Kevin Webb is now serving as the GM for Tieline Technology in Indianapolis, IN. Contact him at [kevin@tieline.com](mailto:kevin@tieline.com)

[www.radiopapers.net](http://www.radiopapers.net)

White papers and technical information from the entire radio broadcast industry.

Get them on-line – right now.



Internet remotes...  
there's been talk.



➔ **Live from 37,000 Feet—No kidding—Live Broadcast from a Lufthansa flight!**



... successfully aired his three hour talk show from a commercial airplane [using ACCESS] at 37,000 feet on a regularly scheduled flight between Frankfurt, Germany and New York, US.

*Peter Greenberg—Host of the syndicated radio program Travel Today*

*For the complete story visit  
<http://remotebroadcasts.blogspot.com>*

➔ **Radio Free Asia—Live from the Himalayas**



"The results [with ACCESS] were especially reliable considering that Dharamsala has one of most "problematic" Internet infrastructures that we have come across." — David Baden, Chief Technology Officer Radio Free Asia

*For the complete story visit  
<http://remotebroadcasts.blogspot.com>*

➔ **Ski Mountain Remote**



This picture, really demonstrates what ACCESS is about. This product truly has the ability to cut the wires.

*For the complete story visit  
<http://remotebroadcasts.blogspot.com>*

➔ **JAMN 94.5—Walk for Hunger**



"ACCESS was used on the air exclusively for JAMN945 at this one. It was all over EVDO with a tremendous amount of active cell phones in the area. The ACCESS was connected to the Verizon wireless Broadband..."

*For the complete story visit  
<http://remotebroadcasts.blogspot.com>*

**Put Comrex On The Line.**

Toll Free: 800-237-1776 • [www.comrex.com](http://www.comrex.com) • e-mail: [info@comrex.com](mailto:info@comrex.com)  
19 Pine Road, Devens, MA 01434 USA • Tel: (978) 784-1776 • Fax: (978) 784-1717

**COMREX**



by Chris Tarr, CBRE, CBNT

## Nautel's V10 A Versatile Performer

I remember the email from our Corporate Engineer like it was yesterday: "Hang on – Here we go!"

### A TALE OF TWO SITES

This was a bit over two years ago, and Clay Freinwald was writing me about the launch of HD transmissions at our Milwaukee stations. I started working on becoming an "expert" on HD immediately.

I looked at the layout of my plants. WMYX was going to be easy – there was plenty of room in the transmitter building. High-level combining would be a no-brainer there.

WXSS was an entirely different matter, however.

### THE "FUN" SITE

WXSS is located at a shared antenna site. At the time we were running a BE FM 30T as the main transmitter and a Harris FM20H3 as a backup. Those two monsters took up pretty much all of our available space. So Clay and I started our planning sessions.



A tightly packed transmitter room.

We had a few options. For instance, the dual-input antenna had just been released. We could put one of those up and hang a transmitter from the ceiling. That posed some challenges, mainly the cost involved with a structural analysis, an increase in lease fees, an additional run of coax, and then, of course, a transmitter hanging from the ceiling!

The second option was split-level combing. That would require replacing the relatively new BE transmitter, plus since split-level was in its infancy at the time there were a lot more questions than answers.

In the end, we opted to go with a high-level combining system – with a slight twist.

### COVERING TWO NEEDS

Initially, I was concerned that to make room for a transmitter capable of producing the 2.1 kW of pre-injector RF we needed, we would have to take out the Harris rig.

Sure, most people would be happy about losing a transmitter of that vintage. But I had just gone through it and it was an excellent backup rig. While we do have an auxiliary transmitter at a separate location, I still was not excited about the prospect of losing a good, full-power backup transmitter.

Our solution was to try and find a transmitter that would serve as both an HD transmitter and an emergency analog backup. When Clay and I drew up the specifics for this install, one important piece of the puzzle was a transmitter that could effortlessly change modes, preferably by just a remote control closure.

### A SOLUTION APPEARS

Clay's mission at NAB that year was to find a transmitter that met our requirements. Right after the convention, I got a call from an excited Clay.

"I was talking to Gary Manteuffel at Nautel about their new V10," Clay said. "I told him what we wanted, and he said the V10 can deliver. I asked him to show me and sure enough it worked!"

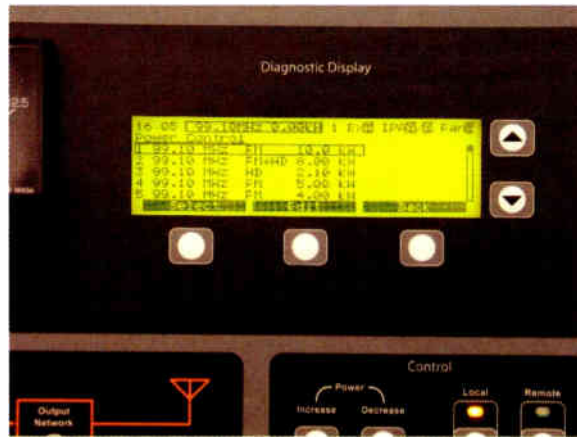

The V10 can be programmed to switch instantly to Analog, HD, or both.

I did some further investigating and Clay and I teamed up against The Powers That Be – we wanted the V10! It was a happy day when I signed the purchase order for two V10s.

### DOUBLE DUTY

One of the greatest (and most underrated) features of the V10 is the ability to change mode, power, or even frequency on the fly. You simply set the parameters in the exciter and transmitter as presets.

These presets also can be called by remote control, so I can have one preset for 2,100 watts of HD and another preset for 10,000 watts of analog FM – or a combination of both. All the biasing and drive settings are computed on the fly, so there is no user intervention involved.



A custom controller provides flexible switching.

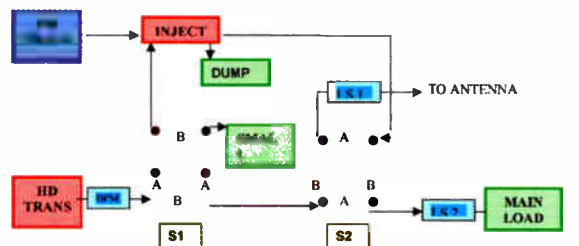

SWITCH MODE	CONNECTIONS	NOTES
S1-A & S2-A	FM TO ANTENNA VIA INJECTOR HD TO ANTENNA VIA INJECTOR	NORMAL MODE
S1-B & S2-A	FM TO ANTENNA VIA INJECTOR HD TO MAIN LOAD	HD TX TEST MODE
S1-A & S2-B	FM TO LOAD VIA INJECTOR HD TO LOAD VIA INJECTOR	OVERALL SYSTEM TEST
S1-B & S2-B	FM TO LOAD VIA INJECTOR HD TO ANTENNA	FM TX TEST MODE HD HYBRID MODE ON AIR

The only other thing we needed was a way to have the V10 bypass the injector while in "FM Backup" mode. We used two coax switches and a custom designed switch control built by Steve Tunwall at Tunwall Radio.

There are four buttons, which select the modes. The "Normal" mode routes the FM 30T and V10 into the injector and on to the antenna. The "Hybrid" mode routes the V10 around the injector and into the antenna. Two additional test modes place either transmitter into a dummy load.

With the help of Mike McCarthy from MRE, we built a frame out of strut that allowed us to hang the two switches and the injector from the ceiling, saving us precious real estate. Mike and I pre-built the frame at my shop at the studio site (where we had plenty of room) plumbed it and then took it up to the site where it was hung.

It was a whole lot easier setting it up on the ground than trying to assemble it while it was hanging from the ceiling.

### HOW DO I LOVE "V"? LET ME COUNT THE WAYS

Using the remote control, I can shut down all the transmitters, switch the V10 into the antenna, change its mode and power from 2,100 watts HD to 10 kilowatts analog, and turn it back on.

Even better, using the Burk Auto-Pilot scripting, I can run the entire process with one click of the mouse. It takes a little hack, but it works well: I have an empty channel on the Burk wired to trigger a latching relay connected to that channel's status light.

Clicking "lower" on that channel, which is labeled "Backup" (or pressing lower on the Burk R/C) turns on the status light, which triggers the script. The script is essentially a few raise and lower commands, along with a few status checks as a fail-safe.

Raising the channel, which is labeled "Normal" turns off the status light and runs the script that reverses the process. There may be a more elegant way to accomplish this – be sure to let me know if you have found one.

### GETTING THE JOB DONE

Using the same footprint that I started with, I now have not only HD, but quite a bit of redundancy as well, built into a very nice solid-state analog backup rig. I simply love my V10.



Nautel V10

The transmitter is built like a tank. The M50 exciter sounds great – in my opinion the V10 would also be a very capable FM-only or FM+HD transmitter. And, of course, Nautel's customer support is second to none. We had a few minor issues during the setup, but all of our questions and concerns were handled quickly.

Looking back, I think the only thing I would change in the design of the transmitter is the wiring for the mode switching. Since the mode of both the exciter and the transmitter need to change together to switch modes, we ended up tying the contacts for the two together to accomplish the "one closure" criteria.

It would be nice to have the option of linking the two preset lists together, though I can see the benefit of having them separated for flexibility.

One of the good things about the rise in HD rollouts is that it puts us all in a position to think outside of the box and come up with new and creative ways to solve the challenges that invariably crop up. I now look forward to each HD project that comes my way – it really keeps my creative juices flowing.

Chris Tarr, CBRE, CBNT, is Entercom's the Director of Engineering in Milwaukee and Madison, WI. He can be contacted at ctarr@entercom.com



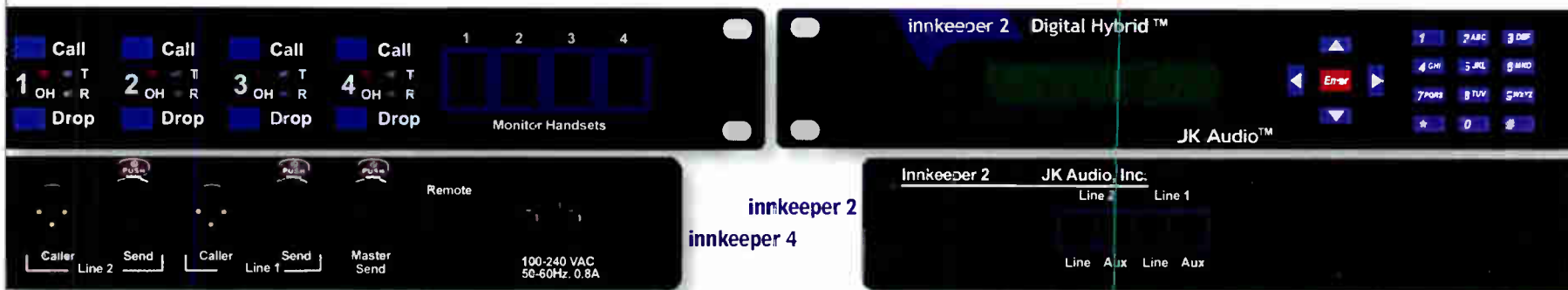

# REMOTE CONTROL. PHONE BOOK. FLASH MEMORY. AUTO-ANSWER.

innkeeper 2 & 4 multiple digital hybrids kinda redefine the entire concept of "work..."

The remote interface provides remote control of the Call and Drop buttons as well as providing LED confirmation of the keypad.



There are times when a single digital hybrid just isn't enough, but rack space is at a premium. No sweat. Innkeeper 2 and innkeeper 4 squeeze two or four independent digital hybrids (respectively) into a 1U rack space.

The front panel keypad, display, and handset jacks provide easy speed dialing and call setup. Digital hybrids allow you to send signals into the phone line while maintaining excellent separation between your voice and the caller. The balanced XLR output jacks contain only the

caller's voice. The Digital Signal Processor (DSP) continuously monitors both the phone line and audio signals to deliver excellent separation. This proprietary dual-convergence echo canceller algorithm can achieve excellent separation without any setup and without sending a noise burst down the line.

Innkeeper 2 and 4 feature Auto-Answer, Auto Disconnect for use in on-air applications such as telephone interviews and talk shows as well as behind the scenes applications

like intercom, monitoring and conference room full duplex applications.

When your application calls for multiple digital hybrids that are smart enough to know how to handle the workload, innkeeper 2 or innkeeper 4 are your best choice - by a long shot.

## JK Audio

TOOLS FOR SUCCESSFUL RADIO

JK Audio, Inc. Sandwich, IL 60548 USA • Toll Free: 800-552-8346 • Tel: 815-786-2929 • Fax: 815-786-8502 • www.jkaudio.com • info@jkaudio.com



# FCC APPROVED

# KinStar

**The first electrically short AM antenna with FCC pre-approved efficiency and radiation characteristics for full time use in the U.S. market.**

## KinStar Features:

- Direct replacement for a quarter wave tower with 67% reduction in height.
- Approved for non-directional Class B, C or D full-time operations.
- Land requirement: Must accommodate 120-radial quarter wave ground system.
- Requires no lights or paint.
- Input bandwidth compatible with IBOC HD Radio.
- Enhanced survivability in hurricane zone due to short height.
- Excellent, low cost auxiliary antenna.
- Suitable for installation near airports.



423.878.3141 fax 423.878.4224 Email: [ktl@kintronic.com](mailto:ktl@kintronic.com) [www.kintronic.com](http://www.kintronic.com)



by Curt "Cowboy" Flick

## A Brief Look at Top-Loaded Antennas

Sometimes there are height limitations to an antenna installation, due to proximity to an airport, zoning, or other reasons. Top loading may be a way to solve these issues. Curt Flick offers some basic information that might help you determine if top loading will help your facility.

For those of you trying to improve your AM signals, enhancing radiation efficiency is the goal. There are a number of approaches to take, top loading being attractive, as it allows shorter towers to act as if they were taller.

### RF RADIATION

The electro-magnetic radiation of a radio station comes primarily from the *current* in the antenna.

Such current pretty much follows a sine wave from the maximum current at the bottom of a quarter-wave stick to nearly nothing at the very top – or “open” end of the radiator. As such, the top few feet contribute virtually nothing on any stick (in the medium wave bands), but must be electrically present so that the feed point impedance (*Z*) is manageable.

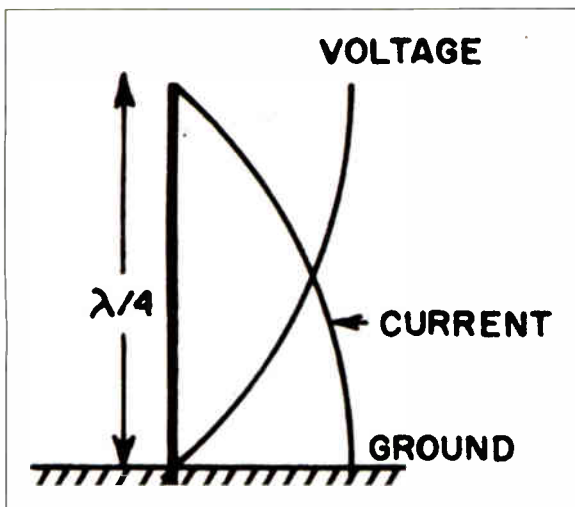

Relative Current and Voltage levels in a quarter-wave antenna.

It is important to note that the *radiation resistance* of a shortened radiator is lower regardless of the means used, whether by loading coil, capacitance hat, or simply a short radiator that is “force-fed.”

Since the current at the open end of the radiator is always near zero, near zero signal is radiated from the open end, even though dangerous voltages do exist there.

If the radiator is more than 90 degrees in electrical length the current will hit its maximum 90 degrees from the top, and then decrease further down the tower (with the subsequent rise in voltage) until you reach the feed point. (The voltages above and below the 90-degree point are out of phase, but the current is in phase, so radiation is not cancelled, but the reactance as seen at the feed point is now inductive, rather than capacitive as it is in a short stick.)

### SHORT ANTENNAS

In general, putting up a shorter antenna is like whacking off a portion from the *bottom* of the stick. One way to look at it is to start at the top (where the signal current is at its minimum) and follow the sine wave downward

Since we have cut off the bottom of the antenna where the high current point is located, the “efficiency” of the radiation is reduced by approximately the percentage area encompassed by that sine wave you just eliminated.

Additionally, as the radiation resistance drops with decreased length and becomes a smaller portion of the total feed point resistance (because the loss resistance has not changed), less power is dissipated in the radiation and more in the losses.

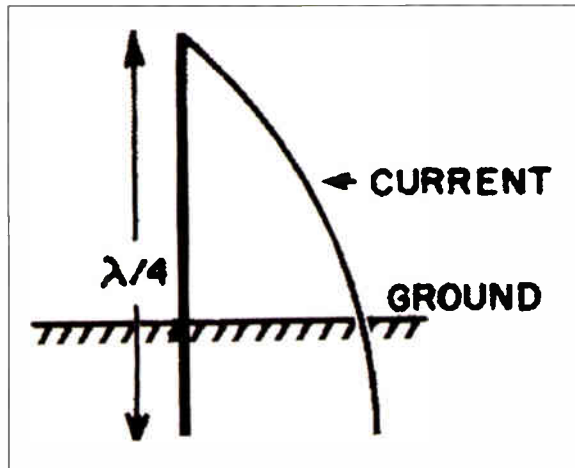

Towers under a quarter-wave are less efficient radiators.

It gets easy to see that shortening a radiator loses radiation “efficiency” rather quickly as the total area in our diagram is decreased. For example, just going from 90 degrees to 70 degrees can cut the radiation resistance by more than one-half, while the system loss resistance stays the same.

### SHORTER ... BUT NOT SHORTER

What if there was an effective way to shorten the radiating element from the top rather than from the bottom?

Clearly, the area encompassed by that upper portion of the sine wave (at the top of the tower) contributes little to the radiated signal as compared to that at the bottom – which we want to leave intact.

This is exactly what top loading does!

It really matters little whether the loading is the form of a disk, some other structure resembling a disk, or simply a top set of special “guy” wires erected for the purpose. While the physical structure is shorter, the electrical “length” presented to the transmission source appears “normal.”

### TOP LOADING

When an antenna is top-loaded, the current from the bottom decreases from maximum, following the sine wave, just as it does with the quarter-wave stick, to the point where it abruptly goes to zero at the hat. (Actually it continues to flow out into the coil or capacitance loading toward the edges where it goes to zero at the very edge, usually horizontally, and usually equally in opposite directions away from our radiator. Thus whatever radiation might occur is of opposite polarity, and cancels itself in space.)

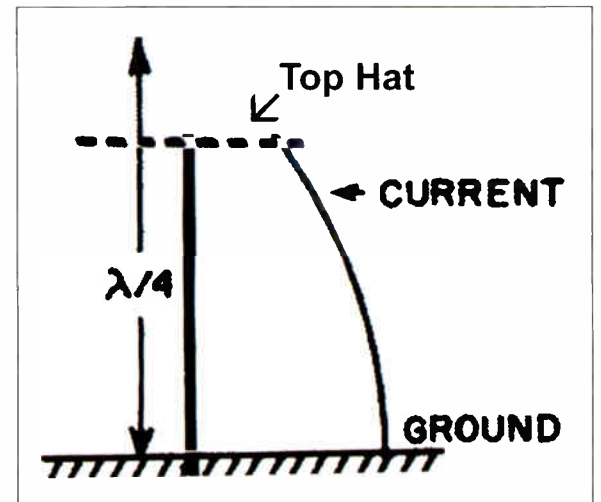

The electrical effect of top loading.

Overall, it can be considered that the current decreases from whatever it is at the bottom of the hat connection point to near zero at the top of the hat unless one is in very close proximity – less than the width of the loading structure – to the loading structure itself.

### MIDDLE LOADING

It is also interesting to consider what happens when the loading hat or coil is placed in the “middle” of a radiator. For example, take our 90-degree radiator and remove 45 degrees from the middle by putting loading equivalent to 45 degrees at the mid-point.

The result is a radiator with total length of 45 degrees. But the current distribution in this model is very interesting.

Looking from the bottom of the radiator, the current starts at the same value it would have on a 90-degree stick and decreases following the sine wave up to the hat or coil. From this section is where the bulk of the radiation occurs. As you look down from the top, the current starts at zero and increases down to the hat (or coil) following the sine wave.

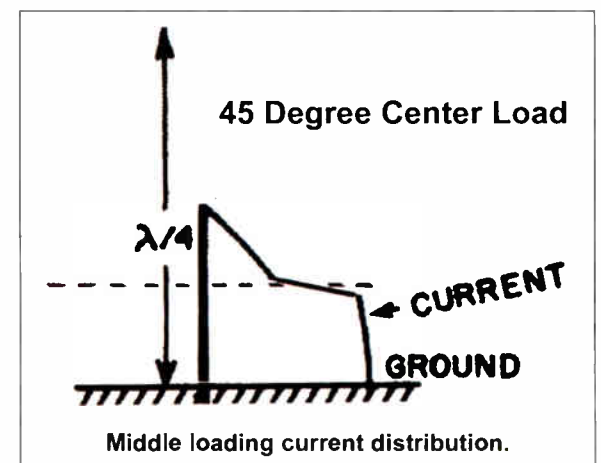

Middle loading current distribution.

(Continued on Page 12)

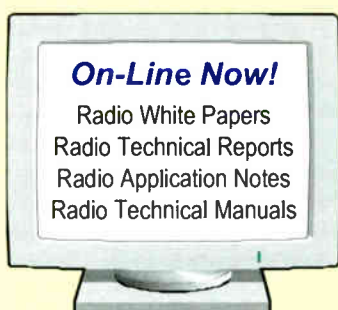

**On-Line Now!**

Radio White Papers  
Radio Technical Reports  
Radio Application Notes  
Radio Technical Manuals

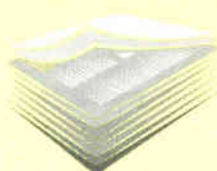

– [www.radiopapers.net](http://www.radiopapers.net) –

White papers and technical information from the entire radio broadcast industry.

**Get them on-line – right now.**

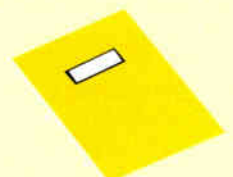

Then sign up for personal email notification, as new radio white papers are released.



# End-to-End Solutions From SCMS AudioArts Engineering D-75 Digital Live Radio Console



Get Your **Studio** Solution  
from the Dealer That Knows Radio.



Install an AudioArts Engineering D-75 in your studio and you'll know you've made the right choice as soon as you power it up. You get the benefits of its predecessor, the D-70 plus more functionality.

The modular plug-in design is key for installation and service—making it easy and FAST for you to change configurations.

Even better is the fact that you can get it from the most reputable supplier in radio broadcast—SCMS.



Contact SCMS at any of its offices  
to discuss your needs.

**HQ in Pineville, NC: 1-800-438-6040**

**Bob, Ernie, Matt Mike**

Mid-South: 1-877-391-2650 Bob Mayben

Central: 1-731-695-1717 Bernie O'Brien

West Coast: 1-866-673-9267 Doug Tharp

Mid-West: 1-513-899-3036 Mary Schnelle

South-Atlantic: 1-770-632-1295 Art White

North-East: 1-315-623-7655 Jim Peck

South-West: 1-877-699-9151 Tyler Callis

Pro Audio 1-877-640-8205 Ric Goldstein



**www.SCMSinc.com**



## Continued from Page 10

At the loading point, the current goes from whatever it is at the bottom of the loading, to whatever it is at the top of the loading rather abruptly.

Since a capacitance hat has the opposite polarity from the radiator, it can be considered "missing" – although it really is not – and contributes nothing to the radiation. (There is some radiation from a loading coil, however, by that portion of the current not consumed by coil losses.)

Compare the areas under the curve, bottom to top, and it is easy to see that minimal – but not "none" – radiation is contributed by that portion above the loading.

### LOADING COILS

Using loading coils presents some very similar solutions and issues as a capacitance hat.

The change in voltage and current is still across the loading, whether inductive loading with a coil or capacitive loading with a hat. Rather than reduce the feed-point capacitive reactance by providing more capacitance – therefore less capacitive reactance – we are cancelling it by introducing the opposite inductive reactance.

Because the voltage at the open end of the radiator is still at maximum, we do not want our coil at the top for that reason. With a coil placed at the top, the voltage at the top turn of the coil can be greatly different from the adjacent turn and can arc at almost any "reasonable" power – even with virtually zero

current. Normally, the voltage at the top inch of the radiator is virtually the same as the voltage in the next inch. With a loading coil at the top, it is easy to see that this is not necessarily true.

### PLACEMENT AN ISSUE

Nor do we really want to put coils at the bottom, because that is where the most current is flowing – more current to be dissipated in fixed coil resistance rather than radiated.

High current coils mid-way in towers are generally less cost effective than simple capacitive loading, so is not seen in AM broadcast towers, though fairly common in mobile two-way applications as a best compromise. (Not at the top, so they do not arc and burn up, yet are still are not placed at the bottom. They are moved up where current is lower, so resistive loss will be less, yet low enough to be still mechanically stable.)

The basic problem is that the entire voltage change that would be present across however much of the radiator is replaced by the coil is compressed such that that entire voltage change appears across the short distance of the coil alone. And the voltage in the top inch of the coil can be greatly different than in the next inch.

### CORONA AND PROXIMITY ISSUES

Because corona can be a big problem, there is almost always a "stinger" at the top, above a coil, to reduce this voltage and move any corona away from the windings of the coil. This is true even if the antenna is a full-length coil (a helical antenna).

Carried to its extreme, I once built a 28 MHz "vertical" antenna five inches tall using a loading coil with a hat.

It worked. Mostly.

One other issue we need to touch upon with loaded towers is: the "pattern" from such a short radiator creates some problems because the radiation from the top and the bottom combine in space differently than

a quarter-wave radiator when the normal 90-degree spacing between top and bottom is absent.

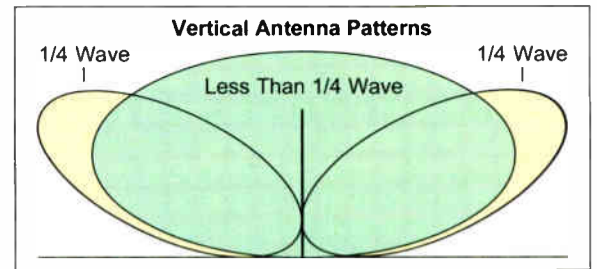

Shortened towers can exhibit skywave and proximity issues.

This occurs mostly at elevation angles other than zero, as the time difference for the approaching wave radiated from the top versus the bottom approaches zero, while it normally differs. At great distance (more than about 10 wavelengths) broadside to the antenna, this difference is negligible, but close in is easily seen.

Because the distance from the radiator approaches the same at all points from a shortened radiator, loaded by any means, the radiation at angles above and below zero approach the same radiation as at zero elevation. The classic donut pattern radiated by a quarter-wave vertical more closely resembles a squashed sphere, resulting in greater energy sent skyward.

Since the portions of a vertical radiator above the loading – whether coil or capacitance hat – contribute little to the radiation, comparatively, loading may be an attractive way to accomplish several goals.

As we have seen, it is possible to use loading to maximize radiation from less than optimal antennas. Another use that comes to mind is when diplexing (or triplexing, etc.) stations into one tower. Carefully designed loading can overcome some of the "odd" tower sizes that develop.

*Curt Flick is a contract engineer based on various airlines, with a mailing address in Akron, OH. Known as "Cowboy," he can be seen almost anywhere in the country as he works on a variety of broadcast and IT projects. Contact him at curt@spam-o-matic*

# Tech Tip

by Mike Callaghan

## Sharing the Common Status

Very often we find there are multiple tenants at transmitter sites and they all want to know when the generator is running, the fire detector has tripped, or the entry alarm has gone off.

Of course, each station would like to have its own set of isolated contacts. After all, who knows what kind of remote control system these contacts will be feeding? Or what interaction that could result if they "saw" each other?

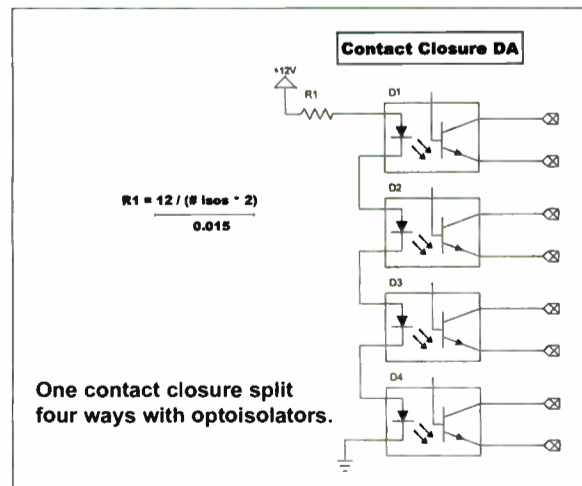

### OPTOISOLATORS

After a futile search for a relay with enough contacts to make everyone happy, I thought about this solution – a sort of distribution amp, where there is no practical limit to how many closures you can provide.

Need more contacts for a new tenant? Each additional output adds something like 25 cents to the project cost. And the contacts will never get dirty, either!

### CALCULATING THE LOAD

The resistor value (R1) depends on the number of optoisolators used. You can figure on a drop of a couple of volts for each one and a current draw of about 15 milliamps. That should be enough to turn on the transistors and close the outputs.

If, for some unfathomable reason, you need to turn AC on and off, just hook a small bridge rectifier between the transistor and your switched device.

Remember the optoisolators will not do very well above 70 milliamps or so at the output, so do not try anything too extreme. The principal idea for this particular project was to fire a status alarm, which uses a very small amount of current.

*Mike Callaghan is Chief Engineer for Clear Channel's KHIS-FM in Los Angeles. He can be reached at mikecallaghan@clearchannel.com*

# The Worst I've Ever Seen

A Visual Display of the Good, the Bad, and the Plain Hard-to-Believe

## The Trailer Park Tower

by Richard Rudman

You may have seen transmitter sites built near trailer parks, but how many have you seen sites that used trailer parts for their towers?

### INTERESTING SUBSTITUTION

Case in point: A two-tower DA in a [location withheld to protect the guilty]. This site was rebuilt but, for some reason, using trailer-hitch balls in place of real iron balls for the ball gaps. Before you ask, no, we do not think it was a way

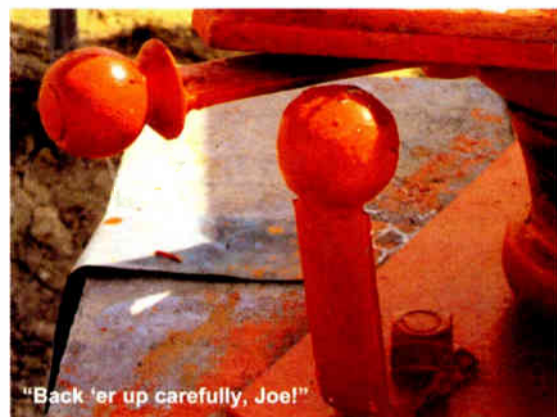

to move the towers more easily to some new site.

We would have to give the person who came up with this solution ten points for creativity – but imme-

diately subtract fifteen points for a lack of understanding about how ball gaps should be installed to actually protect a tower.

By the way, the aviation orange tower paint adds a certain amount of art to the effort, but that will have to go, too.

Right after we install the correct balls and fix this gap, we may need to send up a tower climber to find out if the obstruction lamps and beacons are FAA-approved – or maybe are really 12-volt trailer stop lights!

*After four decades, Richard Rudman still has not seen it all, and he continues to enjoy the challenges of radio engineering. Contact Richard at rar01@earthlink.net*



# We're all talk.

## And all action, too.

All talk and no action? That certainly doesn't describe any radio station we've ever seen. With guest interviews, news and traffic feeds, live reports and listener calls to juggle, a talk studio is one of the most active places on the planet. Seconds count, and there's no room for mistakes.

That's why we created Status Symbols® for the Telos TWOx12 Talkshow System. Instead of flashing lights to decipher, there's easy-to-understand picture icons that give talk pros the information they need with just a glance. What caller's next? Who's screened, and who's just holding? With Status Symbols, you'll know instantly. And only Telos has them.

TWOx12 has lots more benefits. Like Digital Dynamic EQ, for uniform caller audio despite less-than-perfect lines. Twin DSP-powered hybrids for quick, no-hassle conferencing. A unique Dual Studio Mode that lets you use your 12-line phone system like dual six-line systems for extra flexibility. And TWOx12 is the world's only talk show system that can work with either POTS or ISDN lines to deliver exceptional caller clarity. Impressive? You'd expect no less from the company that *invented* the digital broadcast hybrid.

Is TWOx12 the perfect union of word and deed? Thousands of broadcasters worldwide think so. Why not see for yourself?

*Telos*  
AUDIO | NETWORKS



12 lines, two digital hybrids, and superior audio performance. Desktop Director controller features handset, speakerphone and headset jack. Drop-in controls available for popular consoles.



New Call Controller has Status Symbols, DTMF pad and recorder controls (like Desktop Director), but lets talent use their favorite wireless phone or any standard handset for call screening.



Status Symbols show exactly what's what. Intuitive icons show calls locked on-the-air, which hybrid they're on, who's next in queue and more. So much better than a panel of blinking LEDs.



Assistant Producer enables talk show production via LAN or WAN. Status Symbols, Caller ID support, instant messaging and caller database are just a few benefits. Supports touchscreens, too.



# Studio Guide

by Eric Caver

Continued from Page 14

Digidesign, with its recent acquisition of M-Audio has recently released a moderately-priced line of soundcards that work with a special version of Pro Tools (called M-Powered). I will say that M-Audio makes some of the best soundcards available for both towers and laptops, and the prices are just right! They are solidly built, the quality is outstanding, and their support is decent. Other popular brands include RME, Echo, and Edirol.

## INTEGRATED SYSTEMS

Another option that has recently become economical is to purchase a mixer that does triple duty as a soundcard, mixer and midi-controller. These are usually connected via Firewire, USB or MIDI and are becoming quite popular very quickly.

Mackie, Alesis and Tascam all make excellent options in this category. These are for the "Old Schoolers" like myself who like to have fader control at their fingertips as opposed to "mouse mixing." I have a Yamaha 02r96 mixer that controls my DAW software. It has templates for Cubase SX3 and Pro Tools, allowing you to control everything from faders to plug in/EQ parameters to transport controls without having to use your mouse.

Many of you remember MIDI (Musical Instrument Digital Interface). Back in the day, it was only used to sync keyboards or tape transports to a computer, whereas now MIDI is capable of so much more in your production.

In addition to being used to control fader boxes and mixers, MIDI now can control Virtual Instruments (VSTi's).

VSTi's are software that emulate classic keyboards, samplers and drum machines – all controlled from within your chosen host software (Cubase, Pro Tools, Adobe Audition etc) and accessed via a MIDI controller keyboard. You can use these VSTi's to compose music, trigger sfx, create interesting and bizarre sound design elements and more.

VSTi's are less expensive than buying a standalone keyboard or rack-mounted sampler and usually contain thousands of sounds that you load onto your hard drive (another reason to have lots of storage on hand). Spectrasonic's Stylus RMX, Native Instruments' Komplete and Tascam's GigaStudio are three very popular virtual instrument packages. These packages come with huge libraries of sounds and loops on DVD and are being expanded as we speak.

## SOFTWARE CHOICES

Finally, what software should you use for production? There are a ton of options for the PC user. Many programs offer free demos that you can download and experiment with before you buy. (Check out the FAQ's and forums for each product to see what people are complaining about the most, and feel free to ask questions.)

Things to consider when you are shopping for production software – are you a traditional style recording/production person or are you more open to newer interfaces and design? How much money are you willing to throw into the system? What features will you use most often? Will you be using virtual instruments?

Popular traditional multitrack software includes Digidesign's Pro Tools, Yamaha/Steinberg's Cubase/Nuendo, and Adobe Audition 2. These all have the familiar multitrack interface with the familiar mixer page and are capable of utilizing virtual instruments. They come in a variety of flavors that fit almost any budget.

Other software choices such as Yamaha/Steinberg's Wavelab and Sony's ACID 6 have variations on the traditional multitrack interface. ACID 6 is a loop-based music production tool, utilizing pre-produced music loops to create music and sound design.

Wavelab's version of multitrack is called the Audio Montage – a workspace where you combine your audio clips and process them in a multitrack-like fashion. You can assign multiple effects to individual audio clips as well as tracks – great for sound design.

Wavelab is by far the fastest and most stable software that I have encountered and although different by design, nearly 80% of my production can be done easily using only Wavelab. Adobe Audition 2, ACID 6 and Wavelab also include features for creating your final master – text encoding, CD burning and DVD authoring.

There also are several shareware/freeware products that can handle simple editing tasks. Do a search on "Goldwave" or "Audacity" for more info on these types of software. I have used these in limited capacity and they do work, but you do not get nearly as many features as you would with the products mentioned throughout this article plus there is no tech support to help you when you are in a bind – so be cautious.

## LAUNCHING PAD

I have only scratched the surface of the possibilities with computer DAWs, but this should get you started in the right direction.

Certainly, there will always be issues with hardware and software compatibility – some video card is conflicting with a sound card etc. The main thing to remember is to always – ALWAYS – check for driver updates for your hardware and download revisions for your software as they become available. This tends to solve most problems right away, since many products do not ship with the latest drivers available.

Now that technology lies in the hands of the common man, anyone with a modest budget can afford to assemble a quality workstation to handle all of their production needs.

*Eric Caver is the Senior Director for Programming Operations at Premiere Radio Networks in Los Angeles. He can be contacted at [ecaver@premiereradio.com](mailto:ecaver@premiereradio.com)*

# RADIO SYSTEMS' CONSOLES DAS HYBRIDS CLOCKS



Year after year, broadcasters depend on Radio Systems' studio products. For performance, price and dependability **THERE IS NO BETTER VALUE.**

Millenium 6, 12, 18 & 24 Channel Analog and Digital Consoles • 4x4a & DA-16 Distribution Amplifiers DI-2000 & TI-101 Telephone Hybrids • CT-2002 Clock and Timing Systems w/GPS and Infrared Remote



Radio Systems, Inc.  
601 Heron Drive, Logan Township, NJ 08085  
phone: 856 467-8000 Fax: 856 467-3044 [www.radiosystems.com](http://www.radiosystems.com)



# Independent Talkback

*A Headphone System with Selectable Talkback for Each User*



## FlexPhones Master

The FlexPhones Master is a professional Broadcast/Studio six channel distributed headphone system with independent talkback capabilities. Each of the six channels provides stereo program monitoring and selective talkback with interconnection via CAT5 cable to multiple Active Headphone Remotes (AHR-1) and/or Monitor Selector Interface (MSI). Multiple masters may be cascaded to form larger systems.

The FlexPhones Master is equipped with inputs for stereo program and talkback audio. Rear panel program and talkback trimmers are provided to pre-set maximum input levels. The microphone/line level talkback input is available via a rear panel plug-in euroblock connector, while the front panel XLR connector facilitates the use of a user-provided gooseneck microphone or headset. The front panel is equipped with a level control for local headphones with both 1/4" and 1/8" stereo headphone jacks. The six front panel talkback switches allow the user to independently communicate with each AHR-1 listener and can be configured to insert talkback audio into only the left or both ears and dim either or both program channels. Any combination of switches may be pressed, while the "All-Call" interrupts all listeners. The Talkback function can be remotely controlled. Six RJ45 jacks are provided to distribute audio and power via CAT5 cable to the AHR-1's, which conform to the Studio Hub format. Low-Z balanced audio distribution is used to preclude audio degradation with long cable runs.

## AHR-1 Active Headphone Remote

The Active Headphone Remote (AHR-1) contains a stereo amplifier designed to work with any combination of high-efficiency headphones with impedances between 24 and 600 ohms. The AHR-1 is equipped with 1/8" and 1/4" headphone jacks, level control, user-configured utility momentary pushbutton and LED indicator. Two rear panel RJ45 jacks are provided for connection via CAT5 cable to the FlexPhones Master. The AHR-1 may be desktop mounted, under counter or with the optional HR-1/MP or HR-1/MP-XLR mounting plates, which may be turret or counter-top mounted.



Manufactured with  
Pride in the USA

**BROADCAST**  
*t o o l s*

support@broadcasttools.com  
www.broadcasttools.com

**INNOVATIVE PROBLEM SOLVING TOOLS FOR BROADCAST**



## Benefiting from the ABIP

What if I told you there was a magic program that could help you find and eliminate most of the violations at your radio and/or television station – issues that would normally draw a fine? Would you be interested?

And if I told you that to get into the program, all you need to do is make a telephone call? Are you still interested? Finally, what if I said the program would insulate you from random and surprise inspections from the FCC for three years? Have I got your full attention now?

### YES, YOU CAN

Today is your lucky day because there is such a program. Magic is not involved, nor are you required to donate money to any Senator's re-election campaign. It is called the Alternative Broadcast Inspection Program (ABIP) and it is offered by most, if not all, of the state broadcaster associations.



The ABIP program has helped many stations stay in compliance and avoid costly fines.

The ABIP was started in 1994 for several reasons. The primary reason for the program was to help stations stay in compliance with FCC Rules without the threat of a surprise inspection and/or heavy fine.

Jim Wychor, the Executive Director of the Minnesota Broadcasters' Association, realized the rapidly changing FCC Rules, along with varying interpretations around the country, were creating problems for stations trying to stay in compliance. Meanwhile, the FCC realized that state broadcasters' association inspections could help broadcasters find out if they have overlooked any FCC Rules, and then, once in compliance, avoid most FCC inspections.

### BUILDING A PROGRAM

Seeking advice from other state executive directors and some of the FCC's top staffers, Wychor sought to foster a standardized interpretation of the Rules. By 1995, a program was developed giving stations a non-threatening way to have an inspection, correct any deficiencies, and be "certified in good faith as basically compliant."

To make the program more appealing, the FCC has stipulated that once they are notified of a satisfactory inspection the subject station will be precluded from surprise, random inspections for three years.

However, there are a couple of "exclusions" to the inspection-free period. Even if your station has gone through and passed an ABIP inspection, the FCC always reserves the right to inspect stations should they receive serious complaints. Also, certain EEO, political file matters, and safety issues with towers are not included in the exclusion

### ABIP

The Alternative Broadcast Inspection Program is conducted similar to – and uses the same protocol as – a standard FCC inspection. To fully qualify, the inspectors must have demonstrated their knowledge of the Rules and Regulations and most have spent time in the field with a real FCC inspector.

The ABIP inspection examines:

- The public information files.
- Station licenses (main and any auxiliaries).
- EAS system compliance.

- Daily and monthly logs.
- Additionally, the verification of proper station operations in accordance of the license includes:
  - Transmitter power (and efficiency).
  - Frequency
  - Modulation
  - Tower lighting and marking.

### GETTING INTO THE PROGRAM

Participation in the program is very easy. First, you need to contact the state association of broadcasters where you are located.

In most instances, you are not required to be a member of your state broadcasters' association. But since the associations defray some of the costs for members, you should be prepared to pay more if you are a non-member. (Most associations charge up to twice the costs to non-members, compared to the fees members pay.)

(Continued on Page 22)

## 40 Years as the World Leaders for Vacuum Capacitors

Since 1965, COMET has been manufacturing high quality fixed and variable vacuum capacitors for broadcast applications.

Our commitment to superior product quality and customer service has enabled close cooperation with leading international companies in the RF industry.

COMET vacuum capacitors are utilized in various applications in broadcasting, from medium- and short-wave broadcast and communications transmitters to antenna tuning units or couplers in avionics and mobile equipment. Our fixed and variable capacitors are proven the world over...

Contact us for information on the broadest product portfolio in the industry!

COMET North America  
76 Progress Drive  
Stamford, Connecticut 06902  
USA  
T +1 203 969 2161  
F +1 203 969 2162  
usa@comet.ch

[www.comet.ch](http://www.comet.ch)





# Bay Country Broadcast Equipment

Buy • Sell • Trade

Your #1 Source for Quality  
Used Radio Broadcast Equipment

View our latest list of equipment on-line at:

[www.baycountry.com](http://www.baycountry.com)

Or call and we will fax it to you.

All equipment sold with a 15 day return guarantee.

### Turn Your Excess Gear Into Cash

Fax or email your list to us and we will respond with our offer promptly. We only buy good working equipment with traceable serial numbers.

Fax Your List Today – 443-596-0212



<http://www.baycountry.com>

(Website Updated Daily)

E-mail: [sales@baycountry.com](mailto:sales@baycountry.com)

877-722-1031 (Toll Free) 443-596-0212 (Fax)

7117 Olivia Rd, Baltimore, MD 21220

**BEXT**

## FROM THE TALL TO THE SMALL

**FM & TV  
Transmitters**  
Solid State or Tube  
Antennas & Combiners

20 Years of Service  
Asistencia en Español  
24 Hour Support  
2 Years Warranty

[www.bext.com](http://www.bext.com)  
Tel 619 239 8462  
Fax 619 239 8474  
[bext@bext.com](mailto:bext@bext.com)

**NEW  
EXCITERS/TRANSMITTERS**  
w/stereo generator & audio limiter,  
field programmable FSK ID keyer, all built-in!



25 kW



50 kW

AM transmission just right for YOUR station.



15" XGA Graphical User Interface

The new 25 kW 4MX 25, like the award winning 4MX 50, is designed to meet the demands of both analog and digital transmission. Based on BE's patent pending 4M Modulation — they both boast unparalleled 88% typical efficiency into a small footprint with a price to match. Power amplifiers, each with their own power supply, can be removed and replaced while the transmitter remains on the air. Dual, low voltage power supplies allow full operation with no loss of power or service even if one goes off line. Power levels down to 250 W meet all your power level needs, day and night.



Broadcast Electronics, Inc. • 4100 North 24th Street, Quincy, Illinois 62305-3606  
Telephone: (217) 224-9600 • Fax: (217) 224-9607 • E-Mail: [bdcast@bdcast.com](mailto:bdcast@bdcast.com)

Broadcast Electronics and the BE logo are registered trademarks and 4MX and 4M Modulation are trademarks of Broadcast Electronics Inc

# FlipJack FJ-500

**NEW!**

In Use  
Around The  
World



## CELL PHONE INTERFACE MIXER

The FlipJack is the latest addition to the Conex line of cell phone interface products. The FlipJack is designed to interface most hand held phones that have a 2.5 mm hands-free adapter jack.

FOR MORE INFORMATION

1-800-645-1061

[www.conex-electrc.com](http://www.conex-electrc.com)

### FEATURES:

- Two headphone jacks ... each with it's own volume control.
- Two Mic inputs and a seperate Line Input
- Connection To A Standard Telephone Line.
- Separate headphone cue switch for more flexibility
- Operates on "AA" batteries (Included) or external power (Optional)
- Balanced Line Level Output
- Slots for shoulder straps.
- All IC's socketed for easy maintenance
- Tuner input for off-air monitoring
- LED level indicator

**CONEX ELECTRO SYSTEMS**

1602 Carolina St PO Box 1342 Bellingham WA 98227  
phone: 360.734.4323 fax: 360.676.4822



by Scott Cason

### Continued from Page 20

Costs vary between associations and also will depend on your facilities – a stand-alone, non-directional AM, directional AM, FM, and/or TV or a cluster of different stations. AM costs will vary the most, depending on how many monitor points you have in your pattern and how many patterns you have.

Comparing some prices acquired from several state broadcasters' associations in the Southeast, I learned that the South Carolina Broadcasters' Association charges \$225 for a non-directional AM/FM combo, while the Georgia Association of Broadcasters charges \$250 for a non-directional AM/FM combo, and the Texas Association of Broadcasters charges \$350 for a single FM or a non-directional AM.

Check with your state broadcasters' association for their current prices. But, as you can easily see, \$350 is a bargain compared to what some fines can cost you.

#### THE INSPECTION

Once you have signed the agreement with the broadcasting association and paid the monies due, the agency will then notify the FCC of a pending inspection. For 150 days after the notification, the FCC will not conduct an inspection on the subject station.

You also may have a choice how you want the inspection done. In most states, you can set a specific day and time for the state agency inspector to visit your stations.

In some states, the stations can opt to allow a "surprise" visit from their inspector. This is the truest form of an FCC inspection and will allow you to see how well your employees would handle the situation should an Enforcement Bureau inspector show up at your door.

In all cases, the inspection will use the broadcast self-inspection checklists that are found on the FCC's website: <http://www.fcc.gov/eb/bc-chklsts>

As a rule of thumb, once the inspection begins you should allow four to six hours for the inspector to finish. Of course, complex operations with multiple sites will take more time than a co-located studio and transmitter.

For example, a six-station cluster with a couple of directional AM's that have separate day and night patterns with many monitoring points definitely will take longer than a couple of FM's, unless the transmitters are located on a mountaintop several hours away.

#### BENEFITTING FROM THE ABIP

As the inspection progresses, the inspector will make notes and discuss any issues of non-compliance as they come up. After the inspection is over, the inspector will sit down with you, your management, and Chief Operator. Together you can discuss the non-compliance areas, as well as the necessary remediation.

Several days after the inspection, you should receive a more detailed (and confidential) report on violations and deficiencies found – and the possible forfeitures that would have been realized if the FCC

had found them. You now have a list of what needs to be fixed and corrected.

However, do not let time get away from you! You will only be given a short amount of time to get the deficiencies corrected.

In some cases, you will need to provide the inspector with proof of compliance – for example, a signed contract for tower painting. In other cases, a re-inspection may be in order.

#### SAVED BY THE CERTIFICATE

Once your inspection is complete and you get a clean bill of health, you will receive a Certificate of Compliance from the inspection agency.

I would recommend posting this Certificate in a very prominent place in the station's main lobby. For one thing, it is something of which to be justifiably proud. And secondly, sometimes the FCC does make mistakes and stations will get left off the "Do Not Inspect" list.

A chief engineer in Augusta, Georgia told me not too long ago about his experience when an FCC inspector showed up at his stations and went to work. It took a very worried manager about fifteen minutes of digging about in the filing cabinets to locate the Certificates of Compliance for the stations.

However, as soon as the Certificate was shown, the FCC inspector simply said, "Well, why didn't you show me those to begin with?" The inspector then closed his notebook, bid the station employees adieu, and left.

That was easy, right?

It does not take a brain surgeon to understand the mathematics. You can spend approximately \$300 for an inspection from a friendly agency or risk tens of thousands of dollars in fines from the long arm of the FCC's Enforcement Bureau.

Which way would you rather go?

*Scott Cason is a contract engineer based in Louisville, KY. He can be contacted at [scott@lagrange-com.com](mailto:scott@lagrange-com.com)*



## HD RADIO?™ I'M GOING WITH MOSELEY.

My challenge is to make the right STL choice for today, as well as for tomorrow.

With Moseley, it's no problem.

Check out their **Starlink SL9003Q-2SLAN**, the first STL to provide AES digital audio and Ethernet data over the traditional 950 MHz band.

Or add a bi-directional Ethernet LAN extension and serial data link to a new or existing STL with the license-free 900 MHz **Lanlink 900D**.

For T1 lines or license-free 5.8 GHz links, the **Starlink SL9003T1** STL/TSL transports bi-directional AES digital audio, Ethernet LAN extension, remote control, and telephones.

Your best connection to the future is a smart STL choice today. Take it from me, Moseley will insure that your station is ready for HD Radio and the new services of tomorrow.

Give the digital experts at Moseley a call for more details.



# Moseley

Dave Chancey .... 805 968 9621  
Bill Gould ..... 978 373 6303  
[www.moseleysb.com](http://www.moseleysb.com)



AM RF Systems...



without the surprises.



LBA Technology is a proven, worldwide supplier of HD radio ready AM antenna systems. Our array of RF products includes directional antenna systems, diplexers and triplexers, ATU's, and components for every power level. LBA systems are designed and custom fabricated to your distinct requirements.

We put our 40 years of AM RF experience into helping you reach farther and sound better! See what we can do for you at [www.LBAgroup.com](http://www.LBAgroup.com) or call us at 252-757-0279



**LBA Technology, Inc.**

Reach Farther, Sound Better.<sup>SM</sup>

252.757.0279 • [www.LBAgroup.com](http://www.LBAgroup.com) • 3400 Tupper Drive • Greenville, NC 27835

## INTRODUCING the FIRST Analog & HD Digital FM Translators



### The TRX-HD Series

from



All of your listeners can now hear your analog and HD Radio<sup>®</sup> Programming!

*Shipping beginning in late June.*

HD Radio<sup>®</sup> is a registered trademark of iBiquity Corporation

## Remotes *fast & easy* from *anywhere* in the USA!

CD quality digital stereo  
**audio to GO!**

- ▲ Mounts on most vehicles or trailers, folds flat
- ▲ Great for news, special events, and remotes
- ▲ Finds satellite in minutes with no engineer
- ▲ Use it as a backup STL when not out making money
- ▲ Go where your station has never gone before and give YOUR station a competitive edge!

Satellite **Lynx**

**888-SAT-LYNX**  
728-5969

[sales@satellitelynx.com](mailto:sales@satellitelynx.com)  
Satellite Lynx, LLC  
205 River Road  
Walden NY 12586





# Coming August 1st

# Radio Pipeline Magazine

Now you have two radio publications,  
for total radio technology coverage.

## Radio Pipeline

August 2006

from *Radio Guide*

– New Technology for New Solutions –

### Processing and Monitoring Critical Components of HD Radio™



Omnia One Audio Processor



Inovonics 532 HD Mod Monitor

#### Inside the Pipeline

The **Omnia One** is designed around a new audio processing firmware platform that offers the tools to finally bring forth a concept that Frank Foti has dreamed of since the initial inception of his DSP audio processing lineup. (Page 5)

The **Inovonics 532** comes with a wide selection of tools, all selectable via a menu driven system. A handy LCD screen shows you where you are, as well as providing a basic visual diagnostic on several key parameters – most interesting, the same display can also be used to show real time RF spectrum analysis. (Page 7)

#### In the Field



Tietline iMix G3 Codec

The new i-Mix G3 combines six essential live remote broadcast products into one 16" x 9" box weighing just four pounds.

## Radio Guide

Radio Technology for Engineers and Managers

April 2006

### Digital Radio – Evaluating the Coverage

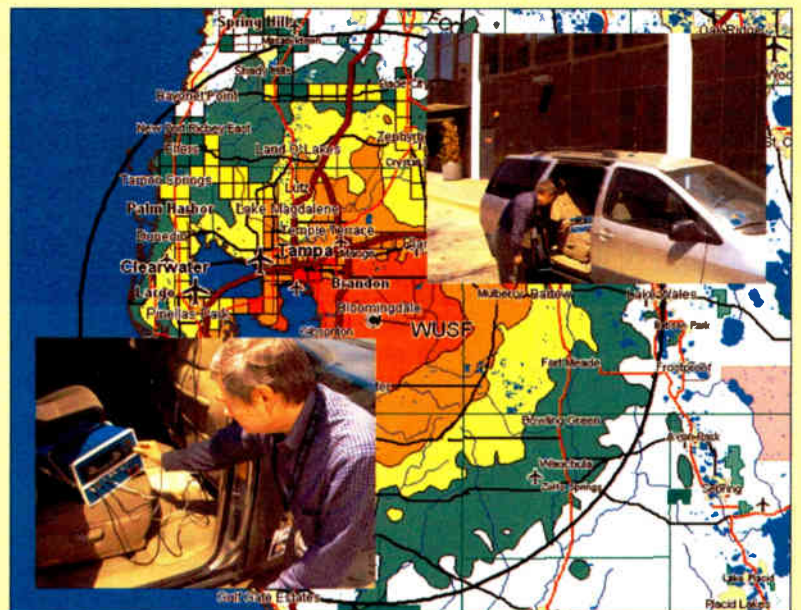

#### Inside Radio Guide

Comparing Digital to  
Analog Coverage  
Page 4

As we continue our discussion of NPR Labs' HD Radio Coverage Measurement Initiative, we are going to take a sample station and walk through the analysis process. Then we will be looking at the resulting drive-test maps and an HD prediction map NPR Labs is developing.  
WUSF, a C1 in Tampa, Florida, will be our test case in this exercise. WUSF was the first public radio station to light up their primary HD channel in early 2003 – they began broadcasting in October of 2005. As a leader in HD Radio implementation, WUSF seemed a logical choice to be test case for this article; their long history, combined with straightforward results, makes it a great example.

#### FM & HD-Radio MOD MONITOR

**NEW!**  
Model 532



Visit us at NAB Booth N3206  
Inovonics Also see our full range of HD/HDOS solutions  
Look for the **GIANT RADIO!**

### Find the New Gear You Need

#### A Message from the Publisher:

For many years the **Radio Guide** has delivered consistently useful technical information that can help you more effectively use and maintain the gear you already have installed at your broadcast facility.

**Radio Guide** has also delivered “station stories,” from which you can discover what your peers have accomplished and how they have solved many of the same problems that you could face down the road.

**Radio Guide** is all about choosing the right gear and working with the equipment you currently have in place.

But what about the new gear that is planned or has just been released by the manufacturers? In other words, what is in the radio equipment pipeline?

### Work With What You Have

Since you have asked, we have created a companion to the **Radio Guide** – we call it the **Radio Pipeline**.

In **Radio Pipeline** we will show you *what* is new, *why* it was developed, and *how* you can use it to solve existing problems or implement new solutions at your station.

We will ask the right questions of the manufacturers and give you their answers – as well as the inside stories that you will not find in any other radio publication.

If you currently receive **Radio Guide** you will also receive **Radio Pipeline** about two weeks later. If you are not a current **Radio Guide** subscriber then please email your postal address to me at [radio@broadcast.net](mailto:radio@broadcast.net), and I will place you on the mailing list for both publications.

Ray Topp – Publisher



# Shively Labs®

FM Antennas and Components

From Multistation to Multicasting  
Quality signals require quality components.

Model 2600  
Bandpass  
Filter



318F-9C  
Field Flange

Model 9413  
Power  
Splitter



318F-62  
Adapter



Model 6813  
FM Antenna



A Division of Howell Laboratories, Inc.  
Bridgton, ME 04009 USA  
(207) 647-3327 (888) SHIVELY  
sales@shively.com

- An Employee-Owned Company -

www.shively.com

# Pristine Systems

## CDS<sup>32</sup>

### Radio Automation

- Music on Hard Drive
- Satellite Operations
- AutoPromo Builder
- "Wet" Voice-Tracking
- WEB/RDS Radio Text
- HD Radio Ready
- CobraNet & LiveWire
- LAN/WAN Operations
- Content Depot Ready
- Easy to Use!

Pristine Systems

www.pristinesys.com

www.summittraffic.com

1•800•795•7234

## BLACKBOX Audio Logger

- Record up to 16 Channels
- Off Air & Dead Air Alerts
- Compliance & Verification
- Web Browser Access
- Talent & Market Monitor
- PodCast Recorder
- Available in Spanish
- Extended Support for
- AM/FM/TV Tuner Boards
- Mic & Timed Skimming



SUMMIT  
TRAFFIC & BILLING



# A Radio War Story

by Mike Gorniak

## Explaining Multipath to a GM

The story you are about to read is true. Only the names have been changed to protect the innocent. My name is Mike, I'm a radio engineer. I work the day shift.

### MONDAY, MONDAY

It was an April Monday morning in Minneapolis, one of those rainy, gray, soggy days that make you forget when it was that you last saw the sun. The time was 8:05 AM.

I walked through the front door of the radio station and before I could say "Good Morning" the receptionist said: "The Manager wants to see you as soon as you get here." "Good," I replied, "Maybe he wants to give me a raise!" The receptionist smiled, ever so slightly; at least it looked like a smile.

"Happy Monday!" I said silently as I trudged over to the Big Office. [SFX: knocking on door.] The GM looked up at me and said, "What the &#@! is wrong with our signal?"

### THE SKY IS FALLING

My mind's inner-ear soundtrack exploded with some cheesy TV Game Show audio: "OK, the category is 'Signals' for \$25. Go!"

"Ummm, do you mean AM or FM?"

"FM. And it's horrible! I hear static and noises *everywhere*. And I don't hear it on the competition's signal at all." He was glaring at me. He had this thing about playing the "stare down" game.

"Hmmm, that's odd," I replied. "Both stations are running the same power from the same antenna."

"I know that. Go find out what's causing the problem and fix it *now*!" He pointed at the door. My day was already wet in more ways than one.

### MAKING THE MEASUREMENTS

A few silently deployed "expletives" later, I was back in my car with an umbrella and an FIM 71. I had checked the transmitter and everything was absolutely normal as far as I could tell.

The FIM 71 is an excellent instrument when used in some specific ways, although most broadcast engineers know that taking "spot" field strength measurements with an FIM 71 often can be a frustrating exercise of dubious value.

Essentially, measuring FM signal strengths at specific places on this Earth is rather difficult with an instrument that uses a portable, adjustable dipole antenna. Nevertheless, I did my best and wrote down the results.

My cursory investigation turned up nothing out of the ordinary. There had to be something.

### IS IT FIXED YET?

Going over the information so far, the amazing thing for me was how free these stations actually were from multipath distortion. The transmitting antenna was located on Minneapolis' tallest building at 822 feet and it covered the market excellently.

I was contemplating what the next step should be when my pager went off. It was 11:25 AM. I did not have to guess who was calling.

"Have you fixed it yet?" the telephone barked.

"Ummm, no. I'm still trying to identify the problem." Unfortunately, this response fell into the GM's category of "Wrong Answer."

### A DISTRESSING SITUATION

"I've already identified the problem for you! The signal is horrible. Something is broken and I am holding you responsible to fix it."

"OK, but I'm not observing the problem that you describe. *All* stations have *some* multipath distortion in various places. It's considered normal."

"I know all about that. I'm telling you that I hear it *only* on *our* station, not the competition's. I heard it driving in this morning. What part of this don't you understand?"

Silently my answer was "All of it." However, to the GM, I replied "Let me make some more measurements."

Before the phone went "click," I heard him say, "Stop measuring and get this fixed!"

Well, that was fine with me. It was still raining and I was getting tired of juggling an umbrella and the FIM 71. Looking at my checkbook ledger, I debated a career change. "Let's see: I've got enough for two more house payments and 64 boxes of Kraft Macaroni and Cheese. Cool! I'm covered for 60 days!"

### A GLIMMER OF A SOLUTION

I decided to take a ride. I drove over to the GM's house, admired the expensive estate from the public road, and then drove back to the station. I listened to the radio the whole time, punching back and forth, trying to wear out the tuning preset buttons.



One thing was clear: there was multipath distortion on this route. However, it certainly was not excessive, especially considering that the road was right next to the Mississippi River. Bluffs blocked the path to the transmitter site. This is about as bad as it gets for FM reception in the Twin Cities. Both stations seemed equally affected by multipath distortion in the same places.

*Of course* the GM would travel *this* particular road between home and work!

I arrived back at the studio at 2:15 PM to face the GM. He was unhappy and I was struggling for a way to explain to him what I had finally figured out.

"Did you fix the problem?" he demanded.

### GETTING SOME HELP

Taking a big chance, I told him: "I've got a few ideas, but I need your help in sorting them out."

"I'm very busy. I just need you to fix the problem. Have you fixed it yet?"

"I'm working on it"

"Fine. What do you need?"

"Let's hop in your car. You drive home while I listen to your radio. I'll take notes."

"Just fix it and tell me when you're finished. I can listen on the way home."

"I honestly need your help. Only *you* can help me fix this."

Somehow, that "Only you can help" line must have gotten to him. He grunted. "OK."

### IN SEARCH OF THE ANSWER

So, we got into his car, flipped the radio on to our station, and the GM began driving to his house.

3:05 PM: We heard the familiar sounds of multipath. "There it is! Do you hear that?" the GM barked, as he reached for the radio.

"*Don't touch the radio!*" I barked back. "Yes, I heard that. Please, you drive - I'll take care of the radio." Meanwhile, I put a little mark on a map of the area that I had brought along.

### HOLDING BACK IMPATIENCE

The GM vented: "You're *not* listening to me. When I switch stations that noise won't be there. This is what I am trying to tell you."

"*I am* listening to what you are saying. But I want us to listen to our station on the way to your house and to the competition on the way back. If we can't do that, there is no point in continuing this exercise. I am trying to show you the solution to the problem."

He finally relented. Grudgingly. We eventually started to hear and acknowledge the multipath distortions mutually and each time I would put another "hash mark" on the map.

When we arrived at his house, we admired his expensive estate. He pulled into his driveway, turned his car around, and we flipped the radio to our competitor's station. Back to the office we went, again listening for multipath. I drew new hash marks on my map with a different color of ink.

4:10 PM: Not surprisingly, both stations wound up with the same number of hash marks on that map, *in the same places*. Both stations experienced multipath distortions that were, as far as "real world" perceptions could reveal, equivalent and interchangeable.

"I believe I know what is happening," I offered.

"What?" The GM gruffly (but very slightly insecurely) intoned.

### THE EXPLANATION

"I believe you are primarily listening to our station as you drive to work. When you hear multipath distortion, it annoys you. It makes you feel like there is something wrong with our station's signal."

"Reflexively, you tune to our competitor to see if they are experiencing something similar. After all, we share the same antenna. When your radio locks in, you do not hear any multipath on their signal. Your suspicions are confirmed. You think 'There is something wrong with our signal.'"

"There is something wrong with our signal!" the GM affirmed.

"*No, there is not*," I replied strongly. "The distortions you hear are not only fairly infrequent, but absolutely normal and statistically equivalent to those of your competition. Your car is moving at 50 miles per hour. By the time you hear the distortion and tune to the competition, you have traveled out of the multipath zone for both stations."

"*You're wrong!*" he shouted. "I was on that button instantly and I know what I heard!"

"*You're wrong!*" he shouted. "I was on that button instantly and I know what I heard!"

### THE BREAKTHROUGH

I took a deep breath and put the issue in his lap: "OK. Well, this is the best I can do for you at this moment. I'll tell you what. Here's the map I just marked as you drove to your house and back again. It's got different colored pen marks that indicate multipath zones for each station."

"As you go home, check it out. If you find any inconsistencies anywhere, park your car as close as possible to the problem area and call. I will get there as fast as I possibly can to investigate."

It was clear by his reaction that I finally managed to vocalize what it was that the GM really needed: a way out.

He said, "OK. I will." And then he actually squeaked out, "Thanks."

The time was now 4:30 PM. The rain had finally stopped. And we never discussed multipath again.

*After a 35 year career in broadcasting, Mike Gorniak is now semi-retired and living on a farm in East-Central Minnesota, from where his wife occasionally allows him to dabble in radio projects. Contact Mike at [mgorniak@genesiswireless.us](mailto:mgorniak@genesiswireless.us)*



# Multicasting.

It's like trying to fit —  
well, you know.



Management has decided to multicast. Which seems like a terrific idea — until you consider just how little bandwidth each channel will get. How will the sound of your station(s) survive these shrinking bitrates? Omnia can help.

New Omnia Multicast with SENSUS™ restores the fullness and depth that bit-reduction steals. Our DSP gurus teamed up with the codec experts at Telos (the folks who introduced broadcasters to MP3 and MPEG AAC). Together, they developed a unique suite of tools to pre-condition audio for HD Radio™ multicasting.

SENSUS technology enhances punch, preserves presence, and reduces artifacts. Even heavily bit-reduced channels (like multicast) can be significantly improved by Omnia running SENSUS. And like all Omnia processors, Omnia Multicast delivers the smooth, clean, pure signature sound that grabs your listeners and holds them hour after hour. No wonder the top stations around the world choose Omnia over all other processor brands.

Multicast like you mean it... with Omnia Multicast.



*Omnia Multicast with SENSUS codec conditioning, Omnia Bass Management system and distributed look-ahead limiter significantly improves the sound of HD multicast and other bit-reduced streams.*



[OmniaAudio.com](http://OmniaAudio.com)



by Bob Burnham

## Engineering Interns Make Your Job Easier as You Help Them

*Sometimes looking to the future means looking to the past. As we seek new "blood" in our industry, it may help to stop and consider how we got here. Bob Burnham, Chief Engineer at the Specs Howard School of Broadcast Arts in Southfield (Detroit), MI, considers how his start in the industry helps him as he comes in contact with the "new recruits."*

My career in broadcasting started at a time when there were lots of small to medium-sized AM stations that originated their own programming. Ownership and staff often worked together in a closely knit way – almost as a family.

Most of the staff handled more than one function. I was on the air fulltime, but I often found myself in the engineering workshop helping the Chief Engineer repair cart machines and other equipment.

### LEARNING THE TRADE

In the late 1970s, I found myself at WAAM in Ann Arbor, Michigan, helping Chief Engineer, Randy Custer testing and eventually installing brand new Pacific Recorders audio consoles and setting up RPU equipment at remote broadcasts on a weekly basis. Even that was not enough for me. I wanted to know how the station's sound was created from the microphone input on the console to the ATU input at the tower.

Randy taught me a lot of what he knew, but he was also was a cool guy. With his Dallas accent, he soon also played a vital role in the comedy skits I wrote and aired on my show every night. Amazingly, we actually got paid to be there, but mostly it was just a fun job. (By the way, I understand the consoles are still in service to this day.)

I had an FCC "Third Phone Endorsed" license. However, by the time I was ready to take the FCC's General Class license test, it was already obsolete. Nevertheless, I had already accumulated years of hands-on experience thanks to people like Randy Custer.

### ON THE JOB TRAINING

Over the years, I would put that knowledge to practical use at several other stations, constantly building upon what Randy had taught me by just "doing it." There was a lot of manual and schematic reading in those days, and the occasional minor "oops!" along the way. But I learned a lot.

I have no prestigious University degrees, yet I have been able to design and build radio studios – and entire stations from the ground up – because of the knowledge and experience I have gained. Basically, this ability has come from acting as an information "sponge" among others who know more than me – a process that actually lasts a lifetime.

Sometimes, I am asked where and how I learned all that I know. I usually will admit to taking a brief correspondence course in Basic Electronics, but most of the knowledge I use on a daily basis comes from that hands-on experience. The fact that I have always had a natural curiosity about how things work is an attribute of most broadcast engineers today.

Sadly, radio stations like those where I "cut my teeth" in the business – where hands-on, day-to-day activities *and* a family atmosphere exist – are not as common today. This is why a school like ours is so important – because our goal is to help our students learn by doing.

### FEEDING THE YOUNG

One of the interesting aspects of my job as one of the main tech guys at the Specs Howard School of Broadcast Arts is noticing how students and staff now play the role of sponge around me.

I do not teach in a formal capacity, but rather am a resource to the students and the school in general. I try to be more than just a "tech dude" who sits hidden from sight in a back room that nobody ever sees. Instead, I encourage dialog with the students, happily answering their questions.

A broadcast engineer is not an easy role to fill nor is it easy to find people with interest in that sort of thing ("Where did you learn all that stuff?"). At one time, Specs Howard offered a Broadcast Engineering course, but it was phased out due to declining interest – most students were focused on becoming "talent."

On the other hand, occasionally a student will go out of their way to pick my brain about studio operations, editing tricks, or some other advice I can offer. That very nature is one of the attributes of some of our most successful graduates.

### AN UNUSUAL REQUEST

It is routine for our instructors in both Video and Audio departments to make use of student interns to assist with the many tasks necessary for the work we do. This year, however, one student specifically requested an internship with the Operations Department, of which I am a part.

The student who approached us explained that he did not want to know merely how to use our digital consoles – he wanted to know how they work.

He seemed to have that natural curiosity and appetite for information that would make a good prospect. He was instantly put to work completing our equipment inventory. He later was sent on various studio inspection missions and we spent some time showing him some studio "tricks."



The author and intern, Matt Inskeep (l) in the rack room.

Before he left the school, we had given him the basic training he would need to wire a digital studio and understand what he was doing. Will he stay in the industry? That is hard to say, because even as the equipment has changed, so has the job.

### OVERCOMING THE ROADBLOCK

For technically inclined people, the disappointment is that broadcast engineering is not one of the better paying technical fields. More money is available in many places, from IT to research and development companies.

In contrast, the Chief Engineer's role often is one that, over time, can lead to "burn out" for some of us. This often happens when we are charged with the responsibility of four or six or more stations and get little real support from management and staff to effectively execute our job. Being a "miracle worker," keeping a station (or several) together with little more than bubble gum and a few rubber bands, does get pretty old after a while.

So why should anyone in their right mind ever want to become a broadcast engineer? For many, it is because radio simply gets in your blood – a passion as important to your bodily chemistry as water.

Those that stay in the business find the daily trials and tribulations of the job are unimportant compared to the joy of accomplishment – epitomized by the physical act of punching up that station on the dial and knowing it would not sound the way it sounds and have the coverage it has without your tender, loving care. That is what makes it all worthwhile.

### HELPING THOSE WHO FOLLOW

Sharing our love for radio can have a positive effect upon others, even those that are not innately technically inclined. It does, however, take a measure of patience.

In a different environment, a couple years ago, I was the Contract Engineer and the designated Chief Operator at Detroit Public Schools' public radio station WDTR, a full-powered FM in the Detroit area. The station was staffed by "technicians" who were basically glorified board operators. Sadly, most of them did not have technical experience and the air sound was horrible when I first arrived.

However, despite a shoestring budget, by working with management I gradually was able to completely re-build their air chain. I also spent time to help the "technicians" better understand what they were doing and how to communicate with the engineer. Communication skills are so incredibly important. How can we fix something if we do not know it is broken?

The staff responded with a new enthusiasm for their job and we ended up with an air sound that rivaled the commercial stations in Detroit

### INTERNS WHO DO MORE THAN LEARN

One particular staff member evolved into a role as my assistant and a paid engineering "intern." In a sense, she essentially played a very major role in my success.

This particular "technician" was introduced to me as a "fast learner." As I quickly discovered, she was much more than that. Her prior experience as an electronic panel builder, as well as her former role in charge of Detroit Public Schools' Computer Lab, became a major asset to me.

Her most useful attribute, however, was her "no nonsense" work ethic – a dedication to her job and learning only the *right way* of doing each and every task. Over time, she built a strong alliance with both management and myself. When I asked her to perform a small task in addition to her other station duties – pull some wires, implement a logging system, etc. – she was not only eager to do it but would complete my assignments and ask for more to do.

She was a detail oriented type of person; if someone messed something up technically or otherwise, she made sure the appropriate person was immediately aware of the matter and that I knew about it, too. As one might expect, this way of handling things alienated some of her co-workers from time to time.

### RECOGNIZING TALENT

As she grew in experience, management gave her duties that amounted to the position of Traffic Manager.

Still, as soon as she caught up with these responsibilities, she reverted to the tech side – *always* busy cleaning equipment, working on logs and picking my brain!

(Continued on Page 30)





# nott ltd

3801/4001 La Plata Hwy  
Farmington, NM 87401

Manufacturers  
of the  
**Gila-Stat**  
Lightning  
Prevention  
System

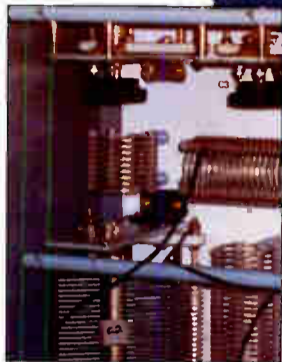

Design and Manufacture of  
**Folded Unipole Antennas**  
Structure Detuning Systems



**N E L L O**  
CORPORATION

Distributors of  
**Nello Towers**  
and Accessories

Phone: **505-327-5646**  
Fax: **505-325-1142**  
Website: [www.nottltd.com](http://www.nottltd.com)  
Email: [info@nottltd.com](mailto:info@nottltd.com)

Over 40 Years  
Broadcasting  
Experience



- Model MBC-1 Message Board Controller**
- converts status inputs to LED display data
  - 15 prioritized logic-level signaling inputs
  - momentary or maintained signal inputs
  - fully programmable color display with graphics
  - pre-programmed "starter" messages
  - multiple displays from one controller



- Model ACU-1 Audio Control Unit**
- 8 input by 1 output stereo audio switcher
  - 8 momentary or maintained output relays
  - 16 logic-level status inputs
  - silence sensing with adjustable sensitivity
  - optional temperature sensing capability
  - computer controlled via "multidrop" RS-232

## Innovative solutions

**Model CAS-1 Con/Air Switcher**

- eliminates delay from studio headphone monitor
- immediate warning on air signal failure
- adjustable EQ and compression of monitor audio
- air signal is not altered in any way
- balanced audio input and output
- optional rack mount available



**Model TAS-1 Telephone Announcement System**

- digital message storage--no moving parts
- variable outgoing message format
- inactive or defective telephone line indicator
- resettable incoming call counter
- temperature delivery in Fahrenheit or Celsius
- battery backed AC synchronized clock



 **Sine Systems**, Inc.

615.228.3500  
[www.sinesystems.com](http://www.sinesystems.com)



# RF Specialties® Group

**Hi, thanks for reading our ad.**  
Most sporting events are off and running.  
**The RF Specialties Group** has the remote  
equipment you'll need to do a  
bang up job covering the games.  
Microphones, Sports-Headsets, Mixers,  
POTS, ISDN, Marti RPU equipment  
and the list goes on.

**Give us a call!**

The call is free and you'll discover,  
**RF Specialties** is your ticket  
to a perfect Sports Season.

**WELCOME! RF Specialties of Georgia with offices  
in Thomasville, GA and Crestview, FL**

## RF is Good for You!

Visa and Mastercard are welcome.  
Offices Independently Owned and Operated.

[www.rfspec.com](http://www.rfspec.com)

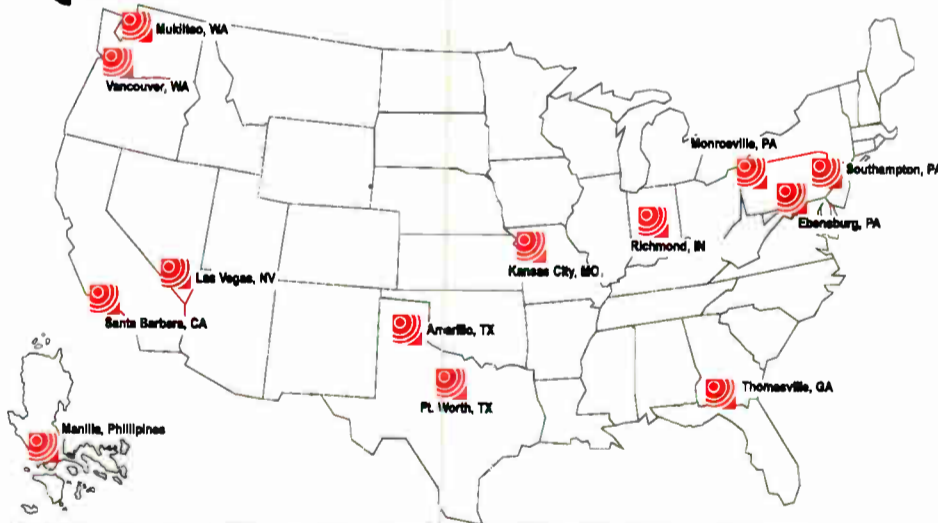

- |                             |   |                |
|-----------------------------|---|----------------|
| Sam Lane                    | Santa Barbara, CA                               | 1-800-346-6434 |
| Bill Newbrough              | Las Vegas, NV                                   | 1-888-737-7321 |
| Bob Trimble                 | Vancouver, WA                                   | 1-800-735-7051 |
| Walt Lowery                 | Mukilteo, WA                                    | 1-425-210-9196 |
| Don Jones                   | Amarillo, TX                                    | 1-800-537-1801 |
| Wray Reed                   | Ft. Worth, TX                                   | 1-888-839-7373 |
| Chris Kreger & John Sims    | Kansas City, MO                                 | 1-800-467-7373 |
| Rick Funk                   | Richmond, IN                                    | 1-888-966-1990 |
| Ed Young                    | Monroeville, PA                                 | 1-866-412-7373 |
| Dave Edmiston               | Ebsensburg, PA                                  | 1-866-736-3736 |
| Harry Larkin                | Southampton, PA                                 | 1-888-260-9298 |
| Alan Slaughter & Chris Hall | Thomasville, GA                                 | 1-800-476-8943 |
| Ed Edmiston                 | RF Specialties of Asia<br>(Manila, Philippines) | +63-2-412-4327 |



# First Person

Continued From Page 28

A future broadcast engineer needs to possess these characteristics, but they also need to have initiative and dedication. These people are tough to find, but when you do, try not to lose track of them! Broadcast engineering needs a lot more people like these.

Unfortunately, not every individual is going to have the initiative combined with the ability to absorb knowledge that will develop the necessary level of skill an engineer will need to function effectively over a period of decades.

## BACK TO THE ROOTS

Regular meetings with interns constantly reminds me of images of my past when the roles were reversed.

Turning the time machine on again – taking me back over thirty years – there I was, sitting as usual in that Ann Arbor studio with Chief Engineer, Randy Custer. He taught me a lot, in many areas.



The picture may be old, but the heart still beats “young.”

One moment, Randy would have me literally rolling on the floor with laughter, using his dry sense of humor to deliver the lines I had written for his character on my comedy skit. The next, he would assign me to measure the percentage of distortion from every input of every console before we installed it, making sure it exceeded factory specifications.

It was an education in itself working in that environment and it lit the fire that still burns in me today.

## SHARING THE FIRE

When a dedicated student comes along, there is no guarantee he or she will be successful in whatever field they choose without the right attitude and fire.

Indeed, whether they end up in broadcast engineering or not probably will be affected by what I and others at the school – as well those encountered during their future career – can convey in terms of our attitude and the “Passing on of the Passion.”

It does take a certain breed of individual to make a career of Broadcast Engineering – and no two of us are alike, either. Today, our school has students from all walks of in top jobs in broadcasting (including at least one fellow *Radio Guide* writer!). We need to cultivate more of these types.

## FINDING SOMEONE WITH WHOM TO SHARE

I certainly feel that I was fortunate to have been at the right place at the right time when I came into the industry. I

could not have asked for a better mentor than Randy Custer. And I hope to be as helpful to others – it is one way to “put something back.”

The process of finding good interns also may be no more than being at the right place at the right time. The process certainly is unique to the facility and region. In an educational environment you would think there would be a built-in supply. But that may not be the case for this kind of work.

Having an assistant around of any type is rare. But remember, while existing technical skills are handy,

they are not the absolute most important attributes. An intern who is eager to learn is often worth his weight in gold, if you have the time and sometimes patience to get him acclimated to the way we do things.

In my opinion, the ideal intern has to be someone as close to what I was like as is possible: In short, completely fascinated by radio. Someone you would love to have as a paid assistant, if such a budget existed.

## TREAT THEM CAREFULLY

Of course, you cannot expect a newcomer to automatically have the skills and/or knowledge you may have accumulated over a long period. Despite their background, do not assume they even know how to wire an XLR and do it the way you would do it if you do not personally show them and give them some “practice” time.

(Continued on Page 32)

## Prophet Systems Your Technology Resource.



Now released, **NexGen 2006** was designed with enhancements in mind to make station management easier. With input direct from our customers, we've added several enhancements that are sure to keep NexGen Digital as the premier option for digital automation. Included are new Ordered Rotations, improvements to Streaming and VoiceTRACs, and the ability to create and use Log Backups just to name a few.

We are committed to constant research and innovation in all areas of audio and content management. Deliver your content with ease, enjoy constant reliability, quick deployment and the lowest possible cost for the technology.

**HD Radio**

**Content Management**

**Music Scheduling**

**Podcasting**

**Newsroom Software**

**Streaming Software**

**Logging**

**WANcasting**

**The list goes on.....**

**1-877-774-1010**

Sales@prophetsys.com ■ www.prophetsys.com







## HD Radio the way it should be done

HD Radio and Analog FM in a single box. Continental Electronics stands alone with the proven and most efficient HD solution. Upgrade your existing Continental Electronics 816R-C FM transmitter now or buy a new Analog FM Transmitter upgradeable when you need HD.

And, don't forget its "Built Continental Tough".



Licensed Manufacturer

800.733.5011 • www.contelec.com

### Digital and Analog Transmitter Audio Switching Solutions, Analog to IBOC!



The AES-302 Digital Audio Switcher/DA/D to A Converter



The CDS-300 Composite Audio Switcher/DA



The CDS-302 Automatic Composite Audio Switcher/DA

Introducing the next generation transmitter audio switchers from BDI. Now you can have complete confidence in your signal path with this series of switcher/DA systems. We have **composite** and **digital** solutions for your routing and distribution requirements. If your system is all digital, choose the AES-302 to automatically switch, distribute and monitor your transmitter audio feeds. Still running an analog STL or stereo generator? Use either the CDS-300 or 302 to switch and distribute your baseband audio signals. Select one of the optional modules for the CDS series and convert your analog signal path into an AES digital output suitable for digital excitors and IBOC implementations. Visit our web site and download complete information about these problem solver products.

**Broadcast Devices, Inc.**  
Tel. (914) 737-5032 Fax. (914) 736-6916  
Website: [www.Broadcast-Devices.com](http://www.Broadcast-Devices.com)



75412 Highway 25 • Covington, LA 70435 - U.S.A.

800-624-7626 • 985-893-1243

Fax: 985-892-7323 • [www.freeland-inc.com](http://www.freeland-inc.com)

Email: [freeland-inc.com@freeland-inc.com](mailto:freeland-inc.com@freeland-inc.com)

**LOOKING TO CUT YOUR BUDGET?  
LET US HELP REDUCE YOUR  
ENGINEERING COSTS WITH REBUILT TUBES.  
WE OFFER A GREAT WARRANTY, QUICK  
SERVICE, AND A MONEY SAVING PRICE!**

**We also buy used tubes.**

**Recycle those unwanted duds for \$\$\$ CASH \$\$\$**



We are a third generation,  
American owned and operated company,  
rebuilding quality tubes since 1940.

### Freeland Products, Inc.

75412 Highway 25 • Covington, LA 70435  
1-800-624-7626 • 985-893-1243 • [freeland-inc.com@freeland-inc.com](mailto:freeland-inc.com@freeland-inc.com)

**Take  
10% OFF**

**— THE COST OF YOUR NEXT  
REBUILT TRANSMITTER TUBE.**



This original *Radio Guide* coupon must accompany the used tube when sending it in for rebuilding, for discount to apply.

This coupon is only valid for one rebuilt tube.  
COUPON COPIES ARE NOT VALID



# First Person

Continued From Page 30

Similarly, make careful decisions as to which Mission Critical tasks that you should handle yourself. For example, if you are changing a PA tube – or, for that matter, almost any internal transmitter work – let them bring you tools and be your assistant (as in an Operating Room). Let them be your “lifeguard” when you have to pull an “overnighter” – your person to dial 911 should you make a dangerous mistake.

High voltages are just one area where, without thinking, it could be easy to send someone off on a mission which they are ill-equipped to handle due to a lack of experience. While you are busy with four other things at the same time, their inexperience could lead to expensive or catastrophic damage, injury or even death.

## PROTECT THEM, BUT TEACH THEM

That is not to say they should never get the chance to make a tube swap themselves. You need to show more respect and challenge than merely sending them on errands to McDonalds – even if you buy.

The point is that you are the “doctor” – the one with experience that your client or employer has entrusted with their gear. You bear the responsibility to know when they are qualified and at what tasks. After all, you do not get to say “It was Tommy that bent the tube socket.”

Again, try not to let them get too discouraged and feel like they are little more than slaves. Treat them as you would like to be treated. In the process, there will be something to be learned by all concerned.



The author in 1980, already on the road to being a broadcast engineer.

I feel very fortunate to have worked among some of the best in the business – folks who let me do more than just “honking and jiving” behind the microphone.

## ONTO A LIFETIME CAREER

In the end, if they are of the “right stuff,” they might join the select breed of engineer which never leaves the business. We thrive on the challenges and whether we stay at one station or move on (and upward) to other markets, anytime we get “down” we just sort of hang a bag of serum labeled R.A.D.I.O. and let it empty into a major artery.

Sure, we are called upon to “jump” an employee’s dead car battery, be the chauffeur to a station remote, be awakened at any hour because the station is off the air (or a

tower has come down!), personally weed-whack all the tower bases, or install new CD players all in one day.

We also find ourselves having to be a psychiatrist, a voice of reason, and a teacher and friend to the employees while doing budgetary battle with that mean-ogre general manager who promptly forgets how you keep the station on the air for so little money.

I certainly hope we can keep helping our Specs Howard interns into the business, just as the people I worked with over the years did for me. At least my recent intern is now “out in the world,” seeking additional experience and advice from other Detroit area broadcasters.

## CHALLENGE FOR ALL

The word “mentoring” comes to mind, but to me, it seems much too stuffy and formal. Crank up the jams in the workshop.

There are a lot of young folks out there that need training. True, everyone is busy; there is a ton of work

to be done every day. But the “party atmosphere” is still very much alive among many of us Getting-to-Be-Old-Timers!

Thanks Randy Custer – and many others from that era and later – for inviting me to the “party!”

*Bob Burnham has spent his lifetime in broadcasting, usually somewhere deep in the trenches. He does not feel nearly as intelligent as most of the people responsible for his being in the business today. He has, however, learned a thing or three in the process and tries to pass on that knowledge onward. Contact Bob at: [bburnham@specshoward.edu](mailto:bburnham@specshoward.edu).*

[www.radiopapers.net](http://www.radiopapers.net)

– On-Line Now! –

- Radio White Papers
- Radio Technical Reports
- Radio Application Notes
- Radio Technical Manuals



## Ready for Digital. Ready for Anything.



### Virtuoso V5

1.5 kW Digital, 4 kW Hybrid, 5.5 kW Analog Transmitter

#### More Versatility

- Digital adaptive pre-correction
- Integrated Engine
- Programmable pre-selections for frequency, power and audio source
- Frequency agile: N+1
- Better than 62% overall efficiency
- AC Voltage: 185-250VAC, Single and Three Phase

#### More Robust

- Redundant ventilation fans
- Dual IPA power supply
- Dual low voltage power supply
- Dual IPA

#### More Service-Friendly

- Hot-pluggable RF modules
- Hot-pluggable PS modules
- Dual digital exciters
- Compact, light weight rack (23"W x 72.5"H x 34.5"D) is ideal for tight spaces



Phone: (207) 947.8200 Fax: (207) 947.3693 info@nautel.com www.nautel.com

HD Radio is a trademark of iBiquity Digital Corp. All rights reserved.

## Making Digital Radio Work.



Take the Day Off! Generation IV is in Control!

## The BTSG "AutoMax Generation IV"

Newest in a Long Line of Great Automation Products.  
Still going since 1994 \* Priced Starting @ \$1200



Total Walkaway Automation for your station.  
No more missed Holidays, or Sleepless Nights!  
The BTSG Generation IV can do everything from  
Running your On-Air Format, to turning on  
the Coffee Pot for you in the Morning!

BTSG Software \* 1802 Abrams Pkwy # 80 \*  
Dallas, Texas 75214-6218  
Ph. 318-395-8410  
[www.btsg.com](http://www.btsg.com)



**GORMAN-REDLICH**

257 W. Union Street, Athens, OH 45701  
Phone: 740-593-3150 – Fax: 740-592-3898

30 Years Experience with  
Alerting Equipment



Model CRW-S Weather Receiver

**Model CRW-S Weather Receiver**

For receiving alerts from the  
National Weather Service (NWS).  
Redesign of our Model CRW now  
with the "SAME" decoder feature.

**Easy to Use and Reliable EAS Equipment\***

- Pre-programmed for your location.
- Program interrupt relays built in.
- Six audio inputs.
- 2 minutes stored audio.
- All operations via keypad.

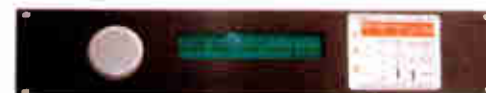

EAS1 Encoder-Decoder

**EAS1** Encoder-Decoder

**EAS1** Decoder

**EAS1-CG** Encoder Decoder with built-in character generator.

\*Optional DTMF interface available.



Model CMR Digital Antenna Monitor

**Model CMR Digital Antenna Monitor**

- Remote Controllable
- True ratio readings.
- Phase sign automatic, no extra operation.

Contact Jim Gorman at: 740-593-3150  
[jimg@gorman-redlich.com](mailto:jimg@gorman-redlich.com) – [www.gorman-redlich.com](http://www.gorman-redlich.com)

## Design » Build » Installation

## Radio and Television Studios

Ram Broadcast Systems builds studios for most of North America's major networks, group stations, and news organizations.

Ram offers comprehensive studio design, fabrication, systems integration, and components. Put Ram's 35 years of experience to work for you:

- Studio Design & Fabrication
- Pre-Wired Systems
- Broadcast Furniture
- Switchers
- Metering
- Amplifiers
- Wire & Cable
- Racks
- Accessories
- Used Equipment
- And More!



RAM Broadcast Systems  
[www.ramsyscom.com](http://www.ramsyscom.com)  
**800.779.7575**



# Transmitter Shack

by John Stortz

## Understanding Lightning Helps to Protect Stations

*Lightning storms happen all year long. But summer is the time when we see some of the most dangerous electricity flashing around. Is there any way to really protect your facility? John Stortz shares his experience.*

In recent years, Moody Broadcasting acquired three less-than-perfect FM stations in central Florida, the "Lightning Capital" of the Western Hemisphere. Since then we have struggled to "lightning-proof" these stations.

### KNOCKING ON THE DOOR

In summer, we frequently have two thunderstorms each day. One engineer friend regularly stands in the doorway of his AM transmitter room, watching the thunderstorms roll in.

When lightning strikes a tower, his 50 kW, solid-state Nautel transmitter trips off, momentarily, then turns back on – no damage, no problems. It can be done.

Our stations were sustaining lightning damage but the solution for each required somewhat different approaches. Fortunately, we only had to deal with one station at a time. From these experiences, we have developed what I call the "Jacob's Ladder Principle" to understand and protect equipment from lightning.

### JACOB'S LADDER

The two electrodes in a Jacob's Ladder are arranged somewhat like the letter "V." Both sides are isolated from each other by an air gap. When high voltage is applied, a spark jumps the air gap between electrodes – always beginning at the narrowest part of the gap near the bottom.



A Jacob's Ladder demonstrates lightning behavior.

Current heats the air within the arc, causing the air (and arc) to rise. As the arc rises, the distance between the two electrodes becomes greater so the arc becomes longer and longer. As the arc lengthens, its resistance increases.

Eventually the arc breaks when the heated air path develops more resistance [voltage drop] than needed to create an arc in the air gap at the bottom. Then a new arc is formed at the bottom and the process repeats.

This is essentially what happens during a lightning strike, only a lot faster. The lightning will take the path of lowest resistance and arc over it until the current is interrupted – or the pathway itself (including equipment) burns up!

### ALTERNATE PATHS

Consider what would happen if there were two Jacob's Ladders connected in parallel to a common high voltage source. As with a conventional parallel circuit, current will divide in proportion to the resistance of each branch.

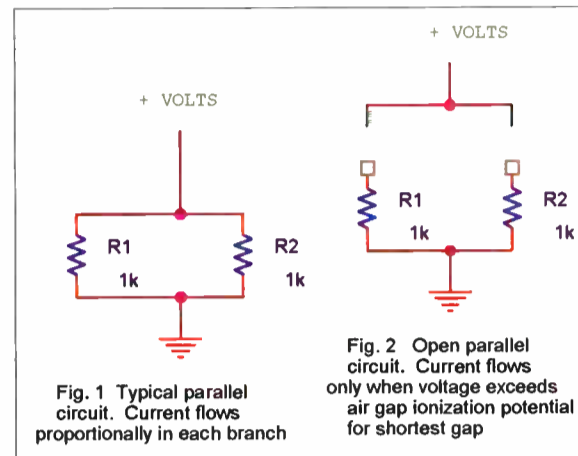

However, if each parallel "branch" includes an air gap or other insulator, current will only flow in a branch where the ionization voltage has been exceeded. Once current begins flowing in one path, it will tend to keep the potential voltage from rising high enough to jump across another path in parallel.

Now, let us apply this to lightning protection in a broadcast facility.

### MINIMUM CODE

After purchasing WKES, the station was completely rebuilt. We installed a new tower, antennas, building, standby generator and transmitter.

*(Continued on Page 36)*

**LARCAN**  
We hear you. Loud and clear.

## LOOK TO LARCAN FOR TRULY MADE TO MEASURE FM SOLUTIONS

Designed with a difference to ensure the highest quality audio performance - LARCAN offers a superior range of solid-state FM solutions from 25w to 5kW. Customer driven and purpose designed for optimum performance - we bring you the ultimate in FM broadcast technology from 'start to service'.

We hear you. Loud and clear.



25w FM Translator  
FMT-25

U.S. Tel: 1-303-665-8000 • Fax: 1-303-673-9900 Canada Tel: 1-905-564-9222 • Fax: 1-905-564-9244

[www.larcan.com](http://www.larcan.com)

Email: [sales@larcan.com](mailto:sales@larcan.com)

### Custom Fit Features:

- Superior Audio Performance
- Modular Design
- Wideband Operation
- Automatic Tuning (front-end)
- High Selectivity
- Fully Synthesized (Tx and Rx)
- Internal FCC Code Key Module
- Compact 1RU Design



"At KPWR (Los Angeles), our CCA transmitter would occasionally trip breakers and go off the air without any obvious cause.

**PowerClamp solved our problem immediately."**

Tom Koza, Chief Engineer

"At KBIG (Los Angeles) we had continuing problems of our transmitters throwing breakers, unexplainable input power glitches, and a host of other power line-related problems.

**Ever since we installed PowerClamp our problems just went away."**

Terry Greiger, Chief Engineer

"KYSR (Los Angeles) uses a pair of Continental 816 transmitters, which use internal SCR regulators to control the screen and plate voltages. When the voltage of one AC phase was high, the SCR regulators would kick in, generate harmonics on the AC power line, and knock the other transmitter off the air.

**We installed a PowerClamp and it totally solved the problem."**

Chuck Ide, Chief Engineer

KYSR KBIG KPWR

**Off the air?  
Transmitter damage?  
Transmitter circuit  
breaker trips for  
no reason?**

**A 2-hour drive to  
reset it?**

**Lost ad revenue?**

**Stay On The Air with  
POWERCLAMP!**



PowerClamp TVSS eliminates the spikes, surges, and AC powerline transients that trip circuit breakers, cause unreliable operation, and damage your equipment.

PowerClamp TVSS is the "ounce of prevention" that will pay for itself in only a few months!

See for yourself: More testimonials and full info at [www.henryeng.com](http://www.henryeng.com).

PowerClamp is available from all Henry Engineering dealers.

**626.355.3656**

[www.henryeng.com](http://www.henryeng.com)

**We Build Solutions!**

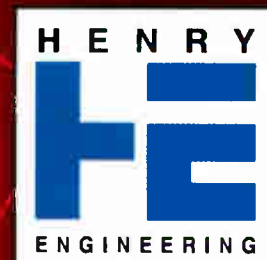



# Transmitter Shack

by John Stortz

Continued from Page 34

The manufacturer (now under a new owner) installed the new 489-foot guyed tower and used two, solid #6 ground wires connected to two eight-foot ground rods at the tower base. Each guy anchor also had a #6 stranded ground wire connected to an eight-foot ground rod.

This met minimum code, but was not sufficient to protect modern electronic equipment. Additionally, no one thought to connect the tower to the building ground. During a lightning strike, large voltages would appear between the different "grounds."

## NEVER A DULL MOMENT

Early in our first lightning season, our new strobe light controller was destroyed several times and could have set the entire building on fire.

The controller had a motherboard containing about 20 octal sockets for plug-in relays. The center of each octal socket allowed a screw to support the motherboard to a grounded back plane using steel standoff spacers. Lightning seemed to travel down the wiring and jump across the steel standoffs, destroying the printed circuit on the motherboard.

When the manufacturer seemed to have no solution, we replaced the controller's one-inch steel standoffs with nylon standoffs. Our intent was to protect the motherboard by increasing the flashover gap and it worked.

We have never lost another motherboard. But we failed to consider what other miseries this change would cause. The lightning problem moved to a differ-

ent location, as the "Jacob's Ladder Principle" predicts: the arc will always occur where ionization resistance is lowest.

## WHAT NOT TO DO

Our attempt to protect the strobe controller worked. Increasing the spark gap within the strobe controller led to a point where the lightning energy found an easier path. However, by increasing the discharge gap, the modification also allowed the energy to build to a higher voltage.

That, unfortunately, made the next lightning hit even more damaging. The higher voltage discharged at a different place and caused greater damage. It destroyed the relays and wiring harness in a coaxial antenna relay, as well as some external interlock circuitry, knocking the station off the air for a couple of hours until someone could arrive and make temporary repairs.

That first attempt was intended to raise the ionization point and it worked. However, we failed to consider how much potential voltage could be produced by a lightning stroke. We learned we needed to consider the site as a unit, rather than as many individual pieces of equipment.

## A BETTER WAY

From then on, effort focused on *lowering* the voltage by creating low resistance paths around sensitive points, rather than increasing insulation at flashover points.

We replaced the original #6 ground wires with three-inch copper ground strap at the tower base, connected the three-inch copper ground strap to the coax where the coax entered the building, and also tied the building ground to the tower ground with still more three-inch copper strap.

This is like reducing the gap at the bottom of the Jacob's Ladder, rather than increasing the gap. It did not prevent lightning, but channeled the energy harmlessly *around* our equipment. Thankfully, there has been no additional damage at that site for six years.

## SECOND STATION – EVEN MORE OF THE SAME

WKZM was formerly a simple one-site operation. We purchased WKZM in December 1999 and immediately added dialup remote control and program delivery by a dedicated T-1 line.

By early spring, "lightning season" had begun causing problems. Previous seasons brought so much damage to adjacent businesses that one had already relocated. The auto repair shop (in the building just beyond the large tree) had seen lightning balls floating around their service bay.



WKZM tower and transmitter building.

One witness described seeing lightning hit the tower, jump to the poorly-grounded fence adjacent to the tower, then travel along the top of the fence to a point where a water pipe came up, and then into the earth.

We learned the station's former owner had also sustained damage to the strobe light, transmitter, and STL receiver – in other words, everything he had in the building. The 280-foot self-standing tower legs are 63 feet apart at the base. The transmitter building is within six feet of one leg. And one additional concern: the large tank at the left contains 38,000 gallons of liquid propane for a gas company.

(Continued on Page 38)

## AM Ground Systems Co.

Ground System Construction,  
Evaluation & Repair

1-877-766-2999

[www.amgroundsystems.com](http://www.amgroundsystems.com)

- ◆ Has your station lost coverage over time?
- ◆ Is your AM ground system over 30 years old?
- ◆ Do you have a new CP or are moving transmitter sites?
- ◆ Has your ground system been damaged or vandalized?
- ◆ Is your base impedance or directional pattern unstable?
- ◆ Just wondering if you are getting all of the range your station is capable of?

If the answer to any of these questions is YES  
Call today for a free construction, repair or evaluation quote.

Reliable On-time Installation

Quality Workmanship

Tower Tune-up

Free Budgetary Estimates &  
Quotes

## PTEK

FM Broadcast  
Solid State  
Power  
Amplifiers  
& Transmitters

New 550W \$2,950  
June 2006 ONLY reg \$3,800

Use as:

- IPA Replacement
- Back up
- Stand Alone

Call us today 408-448-3342

[www.ptekpower.com](http://www.ptekpower.com)



# The New Sicon-8 Voice Remote Control



## The CircuitWerkes Sicon-8 Voice Remote Control

- ▶ Use our pre-recorded voice responses or record your own!
- ▶ 8 channels of metering, status and control (expandable to 16) and up to 5 alarms per channel.
- ▶ No accessories necessary to control your site right out of the box.
- ▶ Auto-ranging, auto-calibrating meters make setup a snap.
- ▶ Function scheduler, auto-logging & alarm reporting included.

Introducing the Sicon-8, a revolutionary transmitter site controller with custom voice recording technology for perfectly natural sounding dial-up or radio link control. All of the I/O, including 8 channels of relays, are included on the main board so there is no need to buy anything else. All metering, status and control connections are on depluggable screw terminals. An expander chassis, the SX-8, adds eight channels of metering, status & control to an existing Sicon-8 for a maximum of 16 channels. Designed to be controlled from any dial-up telephone, an auto-answer cell phone or from its serial port, the Sicon-8 gives you the control options that you need. A free, Windows program, the Siconcontroller, gives you full access to all of the Sicon-8's programming and control functions. Basic logging functions are included. Live Internet interfacing is accomplished with an inexpensive accessory. Visit us online at [www.circuitwerkes.com](http://www.circuitwerkes.com) for complete info on the Sicon-8.

# Remote Broadcast Solutions



## MicTel Mic/Line to Telephone Interface

- ▶ Outputs & Inputs for telephone handset, cellular phone or balanced line level at up to +10dBm.
- ▶ Operates up to 36+ hours on two 9V alkaline batteries.
- ▶ High quality, user-switchable, internal limiter prevents clipping.
- ▶ External power input with silent, auto-switching battery backup.
- ▶ Individual gain controls for send, receive and headphones levels.



## Unattended Dial-Up Broadcasts with the DR-10

- ▶ The DR-10 is a Dial-Up remote control with balanced, telephone audio input & output that can control many automation systems or your audio console for unattended remote broadcasts.
- ▶ Our Silencer™ option removes control tones from the audio path.
- ▶ Use the DPDT relays to insert the phone audio directly into the program path when necessary, especially for emergencies.



## TelTap Pocket-Sized Manual Telephone Coupler

- ▶ Can be used as a phone tap or a passive manual telephone coupler.
- ▶ Send or receive telephone audio.
- ▶ Compact size & low cost makes the TelTap a great addition to your remote kit for main or backup capabilities.

Discover more online at [www.circuitwerkes.com](http://www.circuitwerkes.com)



CircuitWerkes, Inc. - 2805 NW 6th Street, Gainesville, Florida 32609, USA. 352-335-6555

**rfSoftware** has the engineering tools you want and money saving features that you'll love!

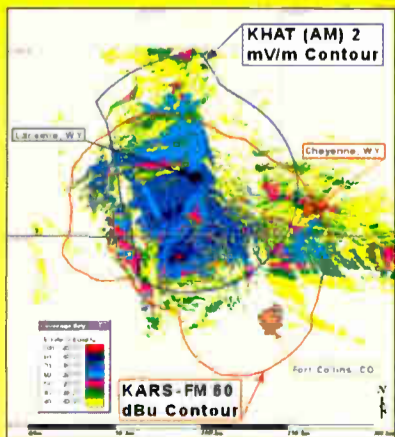

**rfInvestigator** is a tool for analyzing FCC spacing, FCC contours & much more! Population data, LULC data, terrain data, Longley-Rice models, Topo! maps & drive test data can all be displayed in **rfInvestigator**. It offers a host of advanced features, many of which are not found in similar programs or are offered as expensive additions, like a terrain profile tool and our antenna design tool that can automatically calculate your antenna pattern for you. Add our **DB-Builder** program and **never buy another FCC database!** Ever!

Although **rfInvestigator** offers sophisticated features, the user interface is intuitive & simple to use. **rfInvestigator's** power makes it useful to the experienced engineer while its easy-to-use menus make it friendly for station and group owners.

## Need AM Tools? Call Us!

**rfSoftware, Inc.**

innovative engineering tools

Visit us at [www.rfsoftware.com](http://www.rfsoftware.com) or call us at 352-367-1700 for info on our AM & FM tools!

World Radio History



# Transmitter Shack

by John Stortz

Continued from Page 36

## VISIBLE LIGHTNING EFFECTS

As we inspected the site more closely, we noted where lightning had discharged out from each of the three concrete tower foundations, causing the concrete to shatter, just below surface level. Such damage exposes the foundation rebar to air & water, accelerates rusting, and may cause early foundation failure.



Lightning flashed out through the concrete to reach the ground rod, vaporizing some concrete and blowing away the outer layer.

Each tower leg was originally grounded with only a #6 solid wire connected to an eight-foot ground rod. The owner had seen a need to improve the grounding and added the #2 wire seen in the next photo. This was still not adequate.

## REMEDIATION

In applying the Jacob's Ladder principle, we attempted to keep the tower voltage as low as possible and equally distributed on all three tower legs. To do this, we installed three-inch copper strap, leaving the previous cables intact.

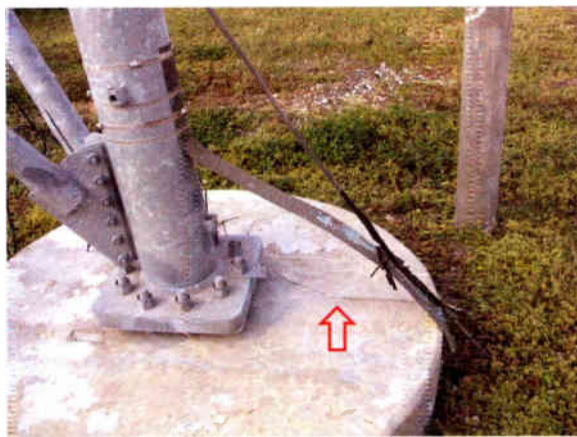

Original #6 ground wire is barely seen above concrete (arrow). The former owner added #2 wire, we added the strap.

Because this is an unpainted tower, copper should not be bonded directly to the galvanized tower or chemical action will destroy the coating. While grounding the WKES tower, we were unable to find a reasonably priced mold for Cadweld, so we coated the one side of the copper strap with lead solder, then fastened the copper to the tower with stainless steel straps. A contact area of more than ten square inches helped insure a good connection.

Lead solder normally prevents the copper from reacting with the zinc galvanize. Unfortunately, we used up our supply of lead solder at WKES and were unable to locate more for WKZM. But we found a better solution.

Our home improvement store had just what I needed: a piece of shiny brass plate, about 4" x 12" long. They

sell them as push-plates for doors. Approximately nine square inches of the copper strap was silver-soldered to the brass, then the brass was strapped to the tower leg with stainless steel hose clamps (or Wrap-Lock).

## ENSURING THE GROUND IS GROUND

We also discovered WKZM had been using separate ground rods for each tower leg, the transmitter, electrical panel and strobe light. The means each piece of equipment could be at dangerously different ground potentials during a lightning strike.

The solution was to tie all of these grounds together with copper strap, plus grounding the transmission line where it entered the building. All of the existing eight-foot ground rods were replaced with larger, 3/4" [copper-clad over steel] ground rods driven to a depth of about 25 feet and attached to the tower legs with three-inch copper/brass strap.

Lastly, still more 25-foot ground rods were driven approximately 50 feet away from each tower leg. All points were tied together with the same copper strap. The goal was to keep the entire area around the tower and transmitter at the same ground potential, while dissipating the energy over a larger area of earth. When adding this additional grounding, we also grounded the fence posts near the tower.

Since completion of these ground additions, there has been no lightning damage during the past four years for the station nor any of the surrounding businesses.

Considering all the problems we had with lightning at these two stations, what would be the situation at our third station? We will take a look at how things shook down at WHGN next time.

*John Stortz is Chief Engineer for the Moody stations, based at Clearwater, FL. When not dodging lightning strikes, John can be contacted at KA4FLX@aol.com*

New Broadcast equipment at exceptional prices.

Quality pre-owned equipment.

Customized automation systems.

Complete turnkey installation

Console pre-wiring packages.

Broadcast equipment repair.

Complete engineering services.

Studio design and project management.

Lightner Electronics Inc.  
Your Ultimate Solution.

Toll Free: 866-239-3888  
Fax: 814-239-8402  
www.LightnerElectronics.com



## BROADBAND FM RF AMPLIFIERS

Three power levels to meet your needs  
300 Watts • 600 Watts • 1.2 Kilo-watts

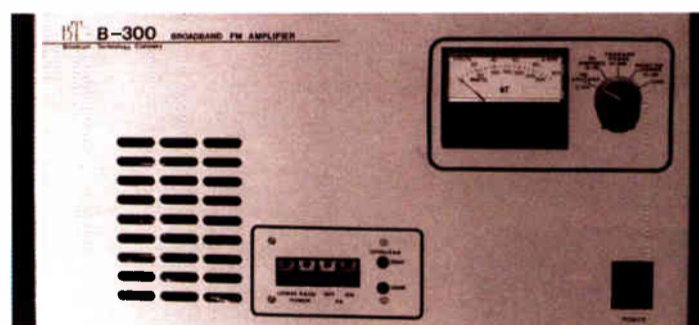

### Features:

- 100% solid state
- No tuning required
- Rugged power supply
- VSWR, current & temperature overloads
- Power trim standard
- Full remote control capability, with outputs for all main parameters
- Compact 19" rack mount design.

**Broadcast Technology Company**

PO Box 2581, Garden City, KS 67846

620-640-3562 – www.broadcasttech.com



# PHASETEK INC.

## Quality

PHASETEK'S manufacturing facility and components expertise are available to design and fabricate any type of inductor or special RF component.

Our engineering and production staff's years of experience and commitment to quality are available to fill any special requirements.

## Dependable

### RELIABLE & DEPENDABLE RF COMPONENTS & PARTS

- Variable & Fixed Inductors
- Variable & Fixed Vacuum Capacitors
- Fixed Mica Capacitors
- RF Contactors
- Vacuum RF Contactors
- Test Jacks and Accessories
- Static Drain and Lighting Chokes
- Isolation Inductors
- Sampling Loops
- Dial Counters and Couplers
- Transmission Line Terminations
- Ribbon Clips and Tubing Clamps
- Horn Gaps
- Toroidal Current Transformers
- And More!

550 California Road, Unit 11  
Quakertown, PA 18951

Phone: 800-742-7383 215-536-6648  
Fax: 215-536-7180 Email: kgpti@epix.net  
Website: www.phasetekinc.com

## Custom Manufactured

- Antenna Phasing Systems
- Control Systems
- AM/MF Antenna Tuning Units
- Diplexers (NDA/DA and expanded band)
- Triplexers
- Transmitter Combiners
- Dummy Loads (with matching networks)
- Tower Detuning Units/Skirts
- Broadband Matching Networks
- Tunable Skirt Assemblies (TSA's)
- Isolation Transformers

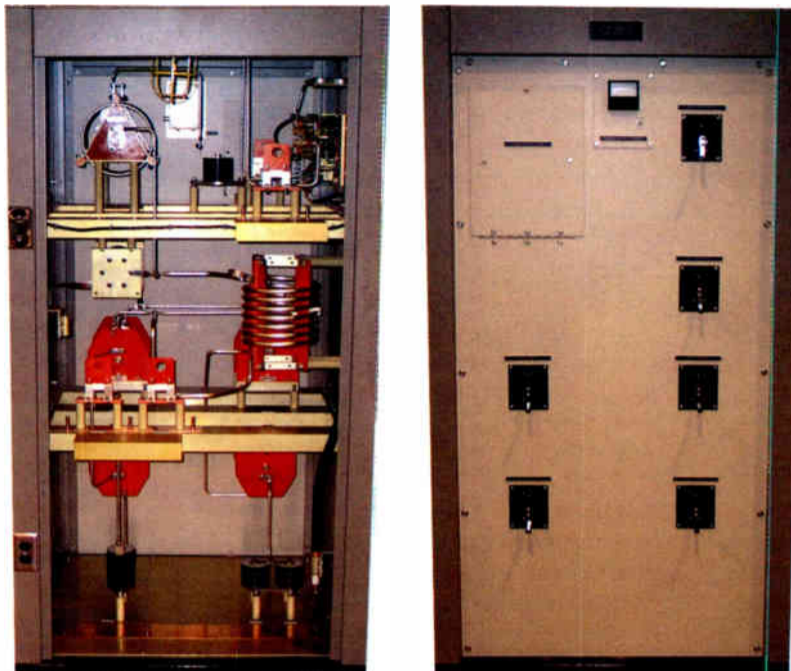

Custom Phasing Systems

## Experience

Phasetek's experienced staff of engineers and production personnel are dedicated to provide the broadcast industry the highest quality, custom designed phasing equipment.

## Value

### OTHER SERVICES AVAILABLE:

- Phasing System Design
- Engineering & Technical Field Support
- AM & FM Installations.

## Missing Some of Your Radio Guides? Get Them All on the BDR

Sometimes that magazine you lent out does not come back. Or, you left it at the studio, and need it at the transmitter. Version 2.7 of the Broadcaster's Desktop Reference (BDR) now includes every issue of **Radio Guide** from January 2003 to the present. Plus, there is an index for the PDFs, for easier location of older articles.

The BDR is an ongoing effort to provide useful tools, information, and history of interest to broadcasters.

The CD includes several sets of **Radio Utilities**, an AM and FM/TV database viewer (including DA patterns), as well as EAS printer paper sources, project schematics, historical data and pictures – even some humorous **Top Ten** lists.

Recent additions include the archives of the **BROADCAST** mailing list from www.radiolists.net, going back over seven years. Using your reader, lots of tech tips from the field and other helpful info are quickly searchable.

A Table of Contents for the BDR can be found at: [www.olderadio.com/bdr.htm](http://www.olderadio.com/bdr.htm)

The proceeds from this CD fund both future improvements of the BDR as well as helping the efforts of olderadio.com to document the industry's history.

There is no set price for the BDR. Many find \$15-\$20 appropriate to cover the costs of materials and shipping, plus a little extra for funding the improvements. If you pay more, it will be put to good use.

If you have wideband Internet, we can now make arrangements for you to get the BDR quicker, via the Internet.

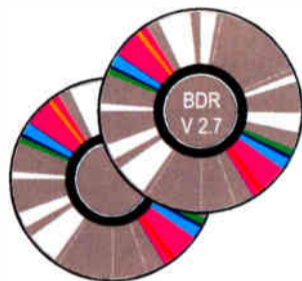

Credit Card Payments Accepted at:  
[www.radio-guide.com/products.html](http://www.radio-guide.com/products.html)

Or send your check or money order to:

**Barry Mishkind, 2033 S. Augusta Place, Tucson, Arizona 85710**  
Please include your snailmail and email addresses.

## the PETER DAHL CO. for custom transformers



DC filter capacitors • variable capacitors  
custom rectifier assemblies • transient suppressors  
and then some...

### Peter Dahl Co.

write or fax for an extensive catalog

915 751-2300 • fax: 915 751-0768 • 5869 Waycross • El Paso, TX 79924  
[www.pwdahl.com](http://www.pwdahl.com) • [pwdco@pwdahl.com](mailto:pwdco@pwdahl.com)



## Expanded Uses for VoIP

We hope our series has given you a good idea of what VoIP is all about and enough information so you can make the decision whether it is for you and your facility. Perhaps you still worry about the cost. Some recent events may help make your decision easier

### CHEAP ENTRY POINT

Over the past couple of months, we have seen a bit of a price war between two major VoIP providers, as they both fight for market share.

ViaTalk and SunRocket both have been occasionally offering USA/Canada unlimited service as inexpensively as \$99 per year—about eight dollars a month. On Memorial Day I grabbed the special deal and signed up with SunRocket for the \$99 dollar price.

Thus far, service has been flawless and has a very high WAF (wife acceptance factor, one of the most important VoIP “features”). ViaTalk is also a good provider, well worth your business.

### MODEMS AND FAXES

In the past, neither modems nor faxes worked very well with VoIP, because of the perceptual coding (bit-rate reduction) taking place in the codecs.

Recently this has changed for the better due to near universal adoption of the T38 protocol, a protocol designed specifically for data (fax and modem) usage. T38 automatically comes on when fax or modem tones are sensed and works well with both.

It is also possible now even to use WiFi with your ATA (Analog Telephone Adaptor).

### WIFI TO PHONE

There are two ways to do this. The first way is to use Internet Connection Sharing with your laptop. This works very well.

Simply use your wireless connection to hook to the Internet and then connect your ATA up to your laptop’s wired Internet connection with a crossover cable (a special cable which “flips” some of the wires).

The second way is to use either a dedicated Internet Wireless Bridge or a router or access point that can be configured as a bridge. Once again, you will need a crossover cable if you plan to connect the bridge directly to the ATA.

I have used both of these methods before and found they both work very well.

### VOIP THE PBX

Although various commercial applications are starting to appear, you can cook up a VoIP PBX system using open source software.

This open source project is called Asterisk, and was developed by Digium.com. They decided to release it to the Linux open source community, where it really took off. If purchased, this full-featured PBX would cost many thousands of dollars. Yet, by doing some of the work yourself, it can cost you practically nothing.

Asterisk offers everything that pricey business PBXs offer – and a few things they do not. To implement Asterisk (or its simpler sibling, trixbox), you will need an old computer running a Linux OS. Since this PBX is open sourced, there are many people and companies involved with making and improving the PBX.

Setup is not difficult, but a full step-by-step description is beyond the scope of this article. Here are some links that will get you started:

• [http://www.tomsnetworking.com/2005/08/26/review\\_aah/](http://www.tomsnetworking.com/2005/08/26/review_aah/) This is a good review of trixbox (formerly known as Asterisk@home). It shows how to set up and configure the PBX system.

• <http://www.trixbox.org>. This is a “dumb” guide for trixbox. If you follow this guide, you will be able to set up and run your PBX.

• [http://voipspeak.net/index.php?option=com\\_content&task=view&id=45&Itemid=28](http://voipspeak.net/index.php?option=com_content&task=view&id=45&Itemid=28) Here is a way to run the PBX under Windows with an emulator. However, this one is complicated stuff, not for the faint of heart!

• [www.digium.com](http://www.digium.com) The Digium web site, where information about Asterisk is available.

### OPTIONS 'O PLENTY

If you would prefer to have someone else build your PBX, there are many companies offering pre-configured Asterisk PBX systems – Google “asterisk” for more information.

Other companies will sell you a fully set up and operating PBX for pennies on the dollar of the cost of a commercial one (not to mention that the phone service will also be much cheaper than POTS). Again, Googling asterisk will literally give you hundreds of web sites.

All the above said, I do realize that Linux and Asterisk can be a bit overwhelming, but if you still want a PBX at a bargain price, Linksys can help you.

(Continued on Page 42)

## MS2721A Spectrum Master™ Handheld Spectrum Analyzer

100 kHz to 7.1 GHz Frequency Range

Anritsu's Spectrum Master is a fully-functional handheld spectrum analyzer designed to conduct highly accurate analysis on the new wave of wireless signals, including 802.11a, 3G, ultra-wideband, and WiMAX. Providing continuous frequency coverage from 100 kHz to 7.1 GHz (tunable to 9 kHz), the MS2721A has the performance necessary for the most demanding measurements. It has the highest input power capability of +43 dBm and much more:

- Dynamic range >80 dB
- Capable of making AM and FM NRSC measurements
- Makes Field Strength Measurements
- Demodulates AM and FM signals

Learn more about the Spectrum Master at [www.us.anritsu.com/spectrum-master](http://www.us.anritsu.com/spectrum-master)  
To order or schedule a demo, call 1-800-ANRITSU.



A Family of Measuring Tools

Sales Offices: USA and Canada 1-800-ANRITSU, Europe 44 (0) 1582-433433, Japan 81 (46) 223-1111, Asia-Pacific (852) 2301-4980, South America 55 (21) 2547-6922, [www.us.anritsu.com](http://www.us.anritsu.com) ©2006 Anritsu Company



**Anritsu**  
Discover What's Possible®



Wizard 4 Windows  
now brings  
Multi Station  
Monitoring  
to your desktop  
with true multitasking

www.belar.com 610-687-5550  
Email sales@belar.com

See our interactive demo  
at www.belar.com

**BELAR**  
"When accuracy counts, count on Belar."

The screenshot displays a Windows desktop environment with several open windows. On the left, there are three station monitoring windows showing frequencies like 98.9 WJYY, 63.9 MODULATION, and 102.7 MODULATION. On the right, there are three FMMA-1 TOTAL Bar Graph windows for Rack1, Rack2, and Rack3, each showing a percentage bar chart with a legend for PEAK (107.4%), AVE (94.2%), and MIN (51.0%). At the bottom, there is a detailed control panel for RFA-4, FMMA-1, FMSA-1, and RDS-1, along with a graph titled 'FMMA-1 TOTAL vs Time' showing a signal waveform over 700 seconds. The taskbar at the bottom shows 'wizwin' and other applications like 'Adobe Photoshop Elements' and 'Inbox - Outlook Express'.

**NEW**

**ECONCO**

**ECONCO**  
New Power Tubes

*Newly manufactured tubes  
are now produced by Econco  
in Woodland California*

**ECONCO** 1318 Commerce Ave., Woodland, CA 95776  
Phone: 530-662-7553 Fax: 530-666-7760  
Toll Free: 800-532-6626 Website: www.econco.com

\* Gibraltar IV Series  
\* Horizon to Horizon  
\* Standard AZ-EL  
\* Heavy Duty Polar

**ANTENNAS**  
ANTENNAS  
ANTENNAS  
ANTENNAS  
ANTENNAS  
ANTENNAS

**COMMERCIAL QUALITY**  
(6m, 9m, 10m, 12m, 15m, 17m, 24m, 27m, 30m, 33m, 37m, 39m, 42m, 45m, 50m)

Call For Info  
**800-627-9443 608-326-8406**

[www.dhsatellite.com](http://www.dhsatellite.com)

Offering:  
\* Feed Horns  
\* LNB's  
\* Multi-Cable  
\* Receivers  
\* Controllers  
\* Antenna Covers  
\* Custom Fabrications

OVER 600,000 Manufactured  
\* High Efficiency \* Custom Fabrications  
\* Fast Direct Delivery \* 5 Year Warranty

Fax: 608-326-4233  
Email: dhsat@mhtc.net

Buy Factory Direct &  
Save!



Continued From Page 40

## A REAL "FIND"

A while back, Linksys came out with a network accessory that allowed you to add storage to your computer network painlessly. This unit was known as a network attached storage unit (NAS) and its installation was easy. All you did was buy one of these (for well under a hundred dollars), plug a USB drive into it, and plug it into your network. Presto – instant additional hard drive space.

One particular, well-known brand of these is Snap Server. It turned out that Linksys' unit ran on Linux, and before long it had been hacked to do all kinds of things never envisioned by Linksys. One particularly interesting thing that someone did was turn the unit into an Asterisk PBX, by putting all the software on a 1-Gigabyte USB "stick drive." He even had half the drive left over for storage of voice mail messages!

Linksys saw this and decided that it would be a great addition to their VoIP product line, so they now manufacture it as the SPA 900, with a list price of \$350.00. The basic unit handles up to four phones, but can be unlocked to handle up to 16. It is a painless way to get a full featured VoIP PBX for a low price. They also offer a wide range of ATA units, VoIP stand-alone telephones, routers, switches etc.

## STL OVER IP

Though not specifically VoIP per se, there is another use of the technology that I believe will interest you. This is STL over IP (SoIP).

I recently was given an interesting project. A client of mine is signing on a new AM station in a top 10 market. The tower is in the middle of a golf course with no way to get

audio or telephone lines to the transmitter location (AC is already there). They will be using a Sine Systems remote control, so I needed a way to bring both audio and telephone to the site. The nearest available building is about 600 feet away.

After research, I found an inexpensive Wireless Ethernet Bridge System – the Connex Wireless Q Bridge ([www.connexwireless.com](http://www.connexwireless.com)). This turnkey wireless ethernet bridge comes with two weatherproof bridge units with internal 15-inch flat-plate antennas, two 75-foot shielded outdoor ethernet cables, and two injector power supplies. Operational range is up to four miles line-of-sight.

## STL, PHONE, AND MORE

Installation is a breeze – all you do is mount the bridges using the supplied brackets (they mount to either poles or walls), plug in and run the cables to the bridges and power supplies, power the system up, align the system, and plug your network into the RJ-45 plugs on the power supplies. 128 bit WEP encryption is enabled by default, and they provide 4.5 Mb/sec real world throughput.

Your network will see a (band-limited) piece of wire connecting the two ends of the bridge. The best news is the price: \$450.00 shipped.

We plan to install one of these inside the transmitter building (Why inside? To protect the antenna from little white missiles otherwise known as golf balls!) and the other on the back of the Pro Shop building. We will have DSL at the Pro Shop and use the bridge to extend the Internet to the transmitter, where a VoIP phone will connect to the Sine remote control.

Sending the audio presented another challenge, but fortunately one we already have dealt with previously. My client's Pittsburgh station has been sending audio to its transmitter via a fractional T-1 line using devices manufactured by Barix ([www.barix.com](http://www.barix.com)) for several years.

## SIMPLE BUT POWERFUL

These stereo/dual mono units are known as Exstreamer and Instreamer. They are small units that have RCA audio inputs or outputs (depending on the unit) and an RJ-45 jack.

Configured by a web browser, they encode and decode audio (in either MP3 or WM player formats, up to 380 kbps) to a network. A big advantage is that they run an imbedded operating system on flash memory so there is no hard drive to crash or computer to lock up. These units are literally "set and forget" devices – I like set and forget, don't you?

They also can be set up to stream via either the HTTP (compatible with web browsers) or the RTP protocol (very low latency). New Exstreamer firmware allows for IP fallback in that you can put two IP addresses into the unit and if the primary one stops, it will automatically connect to the backup IP address.

Both are reasonably priced: the Exstreamer is about \$200, the Instreamer about \$380. One each of these units, combined with the wireless bridge makes for a CD-quality short-haul STL system for a bit over a thousand bucks. No FCC license is needed. In fact, if you have Internet at both locations already, you do not even need the wireless bridge.

## BUILDING IT OUT

My client's studio is about a mile from the golf course and we plan to install static IP business DSL there as well. Verizon has assured us they can give us DSL service for both locations from the same DSLAM, which means both circuits will be on the same subnet. This assures low latency and minimal packet loss.

Of course, UPS units with surge suppressors will also be used on both sides of the link. And for the remote control, the plan is to use Free World Dialup with IpKall for the Sine Systems incoming number – which will not cost anything!

Although this system is not yet installed in its final location, field tests using similar circumstances confirm robust operation and CD quality audio. I will try to provide pictures of the final installation in a future article.

*Dana Puopolo is a contract engineer equally at home with transmitters and computers. He is more than happy to answer your questions at [dpuopolo@usa.net](mailto:dpuopolo@usa.net)*

# Consultant Guide

# Radio Consulting Engineers

**Consulting Communications Engineers  
EMC Test Lab**

- FCC Applications
- Frequency Searches and Coordination
- AM-FM-CATV-ITFS-LPTV
- EMC Test Lab - FCC and European (IEC)

**OWL ENGINEERING, INC.**  
651-784-7445 Fax: 651-784-7541  
Email: [info@owleng.com](mailto:info@owleng.com)  
5844 Hamline Ave. N., Shoreview, MN 55126 Member AFCCE

**RF Engineers, Inc. 352-367-1725**

**Professional Engineering Services**

- ★ FCC Applications
- ★ Coverage modeling
- ★ RF exposure limit reports
- ★ STL & microwave path analysis
- ★ Co-location and interference studies
- ★ Expert witness testimony by P.E.s

**Doug Vernier  
Telecommunications Consultants**  
Broadcast Engineering Consulting

- AM/FM/TV/DTV
- Custom Mapping Service
- Frequency Searches
- Propagation Prediction
- FCC Application Preparation
- Directional Antenna Design

**VSoft COMMUNICATIONS** [www.v-soft.com](http://www.v-soft.com)  
consulting@v-soft.com  
(800) 743-3684

**The Coverage Map Store**  
**REALcoverage.com**  
High Performance Engineering  
for Maximum Coverage

**EVANS ASSOCIATES**  
Consulting Communications Engineers

FCC Applications • Design • Field Engineering • Tower Detuning Upgrade & Relocation Studies • AM Directional Array Tuning & Proof

**EXPERTS IN:**  
FM • Directional Antennas • RF Exposure • TV • DTV Transition

210 S. Main St, Theinsville, WI 53092 • 262-242-6000 • Fax: 262-242-6045  
[www.evansassoc.com](http://www.evansassoc.com) Member AFCCE

**MBC Consulting  
FM Broadcast  
Engineering Specialists**

- Applications & Upgrades
- Frequency Search \$199
- Custom Mapping

**800-219-7461**  
[www.MBCRadio.org](http://www.MBCRadio.org)

**ERI Structural Analysis**

**Electronics Research, Inc.**  
812.925.6000 [www.ERInc.com](http://www.ERInc.com)

REGISTERED PROFESSIONAL ENGINEERS  
STRUCTURAL ANALYSIS  
ERI Incorporated 1943  
TOWER REINFORCING

**Herb Kravitz  
Broadcast Engineering  
Consultant**

AM-FM  
Professional Technical Support  
Comprehensive Field Service

Phone: 609-347-4821  
Fax: 609-347-6397  
[hkradio@att.net](mailto:hkradio@att.net)  
18 N. Montgomery Ave, Atlantic City, NJ 08401

**Communications Technologies Inc.**  
Radio Frequency/Broadcast  
Engineering Consultants

AM • FM • TV • LPTV  
**Cellular/PCS Site Analysis**

P.O. Box 1130, Marlton NJ 08053  
Phone: 856-985-0077  
Fax: 856-985-8124  
[web:www.comtechrf.com](http://web:www.comtechrf.com)  
**Clarence M. Beverage  
Laura M. Mizrahi**



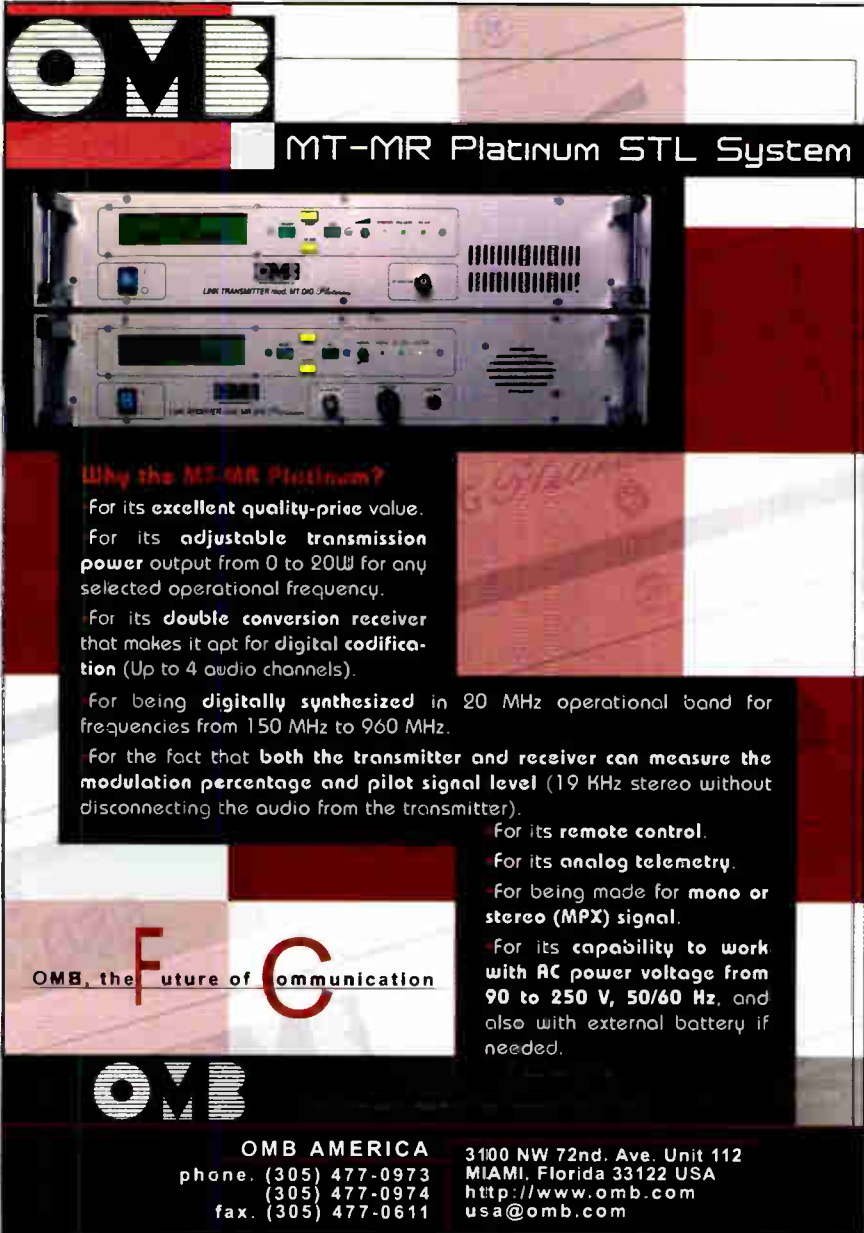

**OMB**  
MT-MR Platinum STL System

**Why the MT-MR Platinum?**

- For its **excellent quality-price value**.
- For its **adjustable transmission power** output from 0 to 20W for any selected operational frequency.
- For its **double conversion receiver** that makes it apt for digital codification (Up to 4 audio channels).
- For being **digitally synthesized** in 20 MHz operational band for frequencies from 150 MHz to 960 MHz.
- For the fact that **both the transmitter and receiver can measure the modulation percentage and pilot signal level** (19 KHz stereo without disconnecting the audio from the transmitter).
- For its **remote control**.
- For its **analog telemetry**.
- For being made for **mono or stereo (MPX) signal**.
- For its **capability to work with AC power voltage from 90 to 250 V, 50/60 Hz**, and also with external battery if needed.

OMB, the **F**uture of **C**ommunication

**OMB**

OMB AMERICA  
phone. (305) 477-0973  
(305) 477-0974  
fax. (305) 477-0611

3100 NW 72nd. Ave. Unit 112  
MIAMI, Florida 33122 USA  
http://www.omb.com  
usa@omb.com



**Micro Communications, Inc.**  
Full Line of FM Products

**FM Antennas**  
Horizontal Polarization  
Vertical Polarization  
Circular Polarization  
Top Mount  
Side Mount  
Leg Mount  
Custom Patterns

**Coaxial Components**  
Coax Switches  
Filters  
Power Combiners  
Channel Combiners  
Transmission Line Components

**Micro Communications, Inc.**  
PO Box 4365, Manchester, NH 03108  
Phone: 366-329-3394 Toll Free  
Fax: 603-624-4822  
E-Mail: jim.destefano@mcibroadcast.com  
www.mcibroadcast.com



**TITUS TECHNOLOGICAL LABORATORIES**  
**3-DRX**  
DIGITAL AUDIO SWITCHING  
THE LOGICAL WAY

Automatically switches between two AES digital audio signals or a stereo analog signal. Analyzes digital signal errors (CRC, bit framing, etc.) and checks for loss of audio on the digital signal. User programmable.

**800.806.8851 WWW.TITUSLABS.COM**



**A Rectifier To Fit Your Transmitter**

HVCA  
HVCA 872B

No matter what transmitter you own, we can provide quality rectifiers from stock. We have a reliable, cost-effective solution to meet the requirements of most AM and FM transmitters built since the 1950s at prices better than the manufacturers'.

**We Have CCA Rectifiers**

- Rectifier Upgrades Available
- Same Day Shipments

**CKE** 

**www.rectifiers.com** ■ **800-649-6370**



# Service Guide Radio Equipment Products and Services



**Rebuilt Power Tubes 1/2 the Cost of New!**

Se Habla Español

# ECONCO

Se Habla Español

Tel: 800-532-6626 Web: [www.econco.com](http://www.econco.com)  
 Intl: +1-530-662-7553 Fax: +1-530-666-7760



TRANSMITTING  
**CAPACITORS**  
 MICA-VACUUM-CERAMIC

**SURCOM ASSOCIATES, INC.**  
 (760) 438-4420  
[LINK@SURCOM.COM](mailto:LINK@SURCOM.COM)

**Silver Plating Powder**  
 Silver Plate On-The-Job with Cool-Amp!!

<p><b>Cool-Amp</b>  <i>Silver plating powder</i></p> <ul style="list-style-type: none"> <li>*Maintain your RF frequency</li> <li>*Keep your PCBs cool</li> <li>*Increase conductivity</li> <li>*Minimize power loss from corrosion &amp; oxidation</li> </ul>	<p><b>Conducto-Lube</b>  <i>Silver based lubricant</i></p> <ul style="list-style-type: none"> <li>*Reduce resistance</li> <li>*Prevent power interruptions</li> <li>*Prevent data errors</li> <li>*Prevent power failure</li> </ul>
---	---

**EEEL-AMP COMPANY** *Conducto-Lube*  
 Ph: 503-624-6426 Fax: 503-624-6436  
[www.cool-amp.com](http://www.cool-amp.com) 60 years customer satisfaction! email: [sales@cool-amp.com](mailto:sales@cool-amp.com)

**RF PARTS COMPANY**  
 From Milliwatts to Kilowatts™

Eimac • Amperex • Svetlana • M/A-Com  
 Motorola • Toshiba • Philips • Mitsubishi

Se Habla Español • We Export  
**800-737-2787**  
 760-744-0700 Email: [rpf@rfparts.com](mailto:rpf@rfparts.com)  
[www.rfparts.com](http://www.rfparts.com)

**AM Ground Systems Co.**

Ground System Construction,  
 Evaluation & Repair

**1-877-766-2999**  
[www.amgroundsystems.com](http://www.amgroundsystems.com)

**BAUER TRANSMITTERS, INC.**  
[www.bauertx.com](http://www.bauertx.com)

**BAUER - ELCOM BAUER - SPARTA - CETEC**  
 Re-Manufactured  
 Bauer Transmitters Available

AM/FM – 2.5 kW to 25 kW  
[www.bauertx.com](http://www.bauertx.com) [paul@bauertx.com](mailto:paul@bauertx.com)  
 915-595-1048 Fax: 915-595-1840

**Now Available! New Sections!**

The updated 2004 version of Eimac's *Care & Feeding of Power Grid Tubes* Handbook is now available.

Contact Richardson Electronics today for your **FREE** copy.

**Richardson Electronics**  
 Engineered Solutions

Toll Free: 800-882-3872  
 630-208-2200  
 Internet: [broadcast.rell.com](mailto:broadcast.rell.com)  
 E-mail: [broadcast@rell.com](mailto:broadcast@rell.com)

**DA HOOK DA GAP**  
 Safety Grounding Hook Lightning Dissipation Gap

Solid Brass Hook & Hardware  
 Fiberglass Rod Handle  
 #10 Copper Cable & Alligator Clip

Available with Horn or Ball Gaps  
 Patented (#5,661,262)  
 Hot Adjust Mechanism

**Wilk Science and Technology Inc.**  
 1112 North Grove Avenue, Oak Park, Illinois 60302  
 Telephone & Fax: (708) 524-8588

**D&C Electronics Co.**  
 - New Tubes -

*We have the alternatives for all your needs, at the lowest prices, direct from our stock!*

EIMAC, SVETLANA, PRO-TEK®, EEV, and many others.

**352-688-2374 or 800-881-2374**

VISA & MASTERCARD Accepted

**Chris Scott & Associates**  
 Visit our website  
[www.scott-inc.com](http://www.scott-inc.com)

Ph: (270)781-5301  
 Fax: (270)781-1232  
 Bowling Green, Kentucky

**NRSC Loop Antenna**

**AM-FM Notch Filters**

**CCA PARTS & SERVICE**  
**V&J Electronics**

Can supply all parts, schematics, and manuals for CCA, CSI, Sintronic, and Visual transmitters. Field service and complete rebuild transmitters available.

Call Van or Jerry Meier: 770-907-2694  
 Fax: 770-907-2694 – 24/7 Service  
 COD, Visa, Master, Discover, NET-15/30  
[www.ccaelectronics.net](http://www.ccaelectronics.net)

Board Traces for Attenuators  
 Bal to UnBal  
 UnBal to Bal  
 Bal to Bal

**1500 V.D.C. Pri - Sec Isolation**

Quality Transformers

1/8" Mounting Holes

Industrial Glass Epoxy Board (2"x2.3")  
 Plated thru Holes

Response 40 - 20 K

**Audio Lightning Isolator (& Hum ISO)**

Hertel Engineering & Newman Kees Measurements  
 8611 Slate Rd  
 Evansville, IN 47720  
 812-963-3294  
[nkeey@insightbb.com](mailto:nkeey@insightbb.com)

**\$27.50 ea.**  
 Free Shipping w/ an Order of 4 or more

**DCS** DIVERSIFIED COMMUNICATIONS SYSTEMS

*"SERVING BROADCASTERS SINCE 1981"*

BROADCAST EQUIPMENT REPAIR  
 Audio/RF Equipment - AM/FM Transmitters  
 Free Consultation/Loaners Available

[www.divcomm.biz](http://www.divcomm.biz)  
 814-756-3053 • [rpogson@aol.com](mailto:rpogson@aol.com)

Around the County      Around the Country      Around the World

George Whitaker Owner

[www.mikeflags.com](http://www.mikeflags.com)      Practical Radio Communications  
 Arlington, TX

**OWN A LPAM STATION!**  
**LICENSE FREE!**

- 1-2 Miles Range Possible
- FCC Part 15 Type Accepted
- Best sound in the business!

Tel 919-362-9393 Fax 919-367-0607 Visa/M/C  
<http://www.am1000RANGEMASTER.com>  
[sales@am1000RANGEMASTER.com](mailto:sales@am1000RANGEMASTER.com)





**ST Connectors for 66 Blocks...**  
 Bag of 10: \$ 6.95  
 Bag of 100: \$65.00  
*(Ridiculously Expensive!)*

Squeeze them on Jumper Wire. Great for temporary or permanent jumpers. You need 2 per pair!

We also have Punching Doublers, 66 Blocks, Single Pair Jumper Wire in Assorted Colors, 66 Block & Modular Attenuators, and many other Unique, Problem Solving Telecom Products.

**Fix RF Problems!**  
 Handset Modular: \$18.95  
 1 Pair Modular: \$14.95  
 2 Pair Modular: \$18.95  
 1 Pair Hard Wire: \$ 8.95

**99% Success Rate!**  
  
**RF Filter**

Choose the frequency range for maximum rejection:  
 • 5 to 3m hz (AM) • 3 to 30m hz • 26 to 60m hz • 60 to 150m hz (FM)

Now Available... Combination AM & FM Filters!  
 See the RF Troubleshooting Flow Chart and four page RF Tech Bulletin at:  
[www.sandman.com](http://www.sandman.com)

Mike Sandman... Chicago's Telecom Expert  
 Call for FREE Catalog: 630-980-7710



**rf Investigator V 3.0**  
**FM...AM...or Both**  
**You choose!**  
 rfSoftware, Inc.  
 innovative engineering tools

Are you tired of switching from program to program to complete a project?  
 How about displaying your drive test output on top of your Longley-Rice prediction to SEE how your station is operating.

Save time, money, and hard drive space, with software that gives you all the tools in one program to work *smarter not harder*.

Call 352-367-1700 for Details!  
 Visit [www.rfsoftware.com](http://www.rfsoftware.com) Today



**MOORETRONIX**  
 BROADCAST & INDUSTRIAL ELECTRONICS

**Our 5<sup>th</sup> Year**

Our client list continues to grow. Thank you for your confidence and equipment purchases.

**We Re-Condition**  
 Pacific Recorders BMX I-II-III, AMX, ABX and RMX, Stereo-Mixer and Mixer News-Mixer products.

Solve Your System Wiring Problems Fast!



With **STEREOTRACER**  
 See our Web News-Update page, for details.

Tel: 800-300-0733 Fax: 231-924-7812  
[WWW.MOORETRONIX.COM](http://WWW.MOORETRONIX.COM)

**RFE Professional Engineering Services**

- ★ FCC Applications
- ★ Coverage modeling
- ★ RF exposure limit reports
- ★ STL & microwave path analysis
- ★ Co-location and interference studies
- ★ Expert witness testimony by P.E.s

[www.rfengineers.com](http://www.rfengineers.com)  
**RFEngineers, Inc. 352-367-1725**

**DANGER**  
 NO ENTRY FOR ANY PURPOSE  
 RF TRAINED PERSONNEL ONLY  
 DO NOT TOUCH TOWER  
 HIGH RF VOLTAGES  
 OPTIONAL- PHONE OR ASR HERE

**ANTENNA ID PRODUCTS 610-458-8418**  
 FCC compliance signs for AM & FM tower sites  
 ASR signs - Guy wire protectors - Antenna tags  
[www.antennaID.com](http://www.antennaID.com) [antennaID@msn.com](mailto:antennaID@msn.com)

**BESCO INTERNACIONAL**  
 "Now in Our 34th Year"

**World Leader in AM-FM Transmitters**

**AM & FM Pre-Owned Units in Stock**  
 All Powers and Manufacturers  
 Instruction Books - Spares - Complete

Visit our Website: [www.besco-int.com](http://www.besco-int.com)  
 Or Call Rob Malany at: 321-960-4001



**Let IBS plan your new Studio Build or Site Renovation**

Contact:  
**Olen Booth or Houston McDavitt**  
 24 Years in Business  
 with over 300 build outs.  
 662-324-6934 • [www.fixmystation.com](http://www.fixmystation.com)



**Global RF Solutions<sup>SM</sup>**  
 RF Engineering Consultants  
 "We've Rewritten The Book on RF Safety"  
[www.grfs.net](http://www.grfs.net)  
 (480) 814-1393  
[rfolutions@cox.net](mailto:rfolutions@cox.net)

- FCC Compliance Specialists
- RF Safety Training
- Site Surveys, Narrowband & Broadband
- MPE Software Analysis, Sales, Training
- Safety Programs

**Professional Equipment Repair**  
 at Lightner Electronics, Inc.

- ▶ Consoles
- ▶ Exciters
- ▶ STLS
- ▶ Automation Systems
- ▶ Audio Processors
- ▶ Transmitters
- ▶ Remote Equipment



Toll Free: 866-239-3888  
[www.LightnerElectronics.com](http://www.LightnerElectronics.com)

**McPherson Radio**  
 Specializing in pre-owned QEI transmitter products.

**QEI – 6 Month Warranty – QEI**

All equipment tuned and tested on your frequency. MRC has a repair facility to meet your broadcast needs, for repair of QEI exciters and low power transmitters. Other broadcast manufacturer products are welcomed too.

Bob Brown at 856-232-1625 Fax: 856-232-2075  
 Email: [mcpersonradio@comcast.net](mailto:mcpersonradio@comcast.net)



**Innovative and Reliable R.F. Engineering Software**

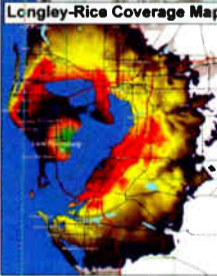

- Create stunning "real-world" coverage maps and interference studies using Longley-Rice, PTP, Okamura/Hata and FCC with Probe 3™
- Search FM channels under spacings and contour protection using FMCommander™
- Prepare AM skywave and groundwave allocations studies and map AM FCC contour coverage with AM-Pro™

The Leader in Broadcast Engineering Software  
[www.v-soft.com](http://www.v-soft.com) [info@v-soft.com](mailto:info@v-soft.com) (800)743-3684

[www.digitalradioengineering.com](http://www.digitalradioengineering.com)  
 Phone: 845-355-4001

**digitalradio engineering**

**Professional Broadcast Engineering Services**  
 Consulting • Project Management • Contract Engineering  
 FCC Alternative Inspections • Due Diligence Inspections  
 Engineering Staff Oversight • Engineering Staff Assistance  
 Facility Inventory • Broadcast Equipment Acquisition  
 New & Pre-owned Broadcast Equipment Sales

**Zonum Industries**  
**Quality Rebuilt Tubes**  
 4,000 Hour Guarantee

- Se Habla Español -

Phone: 530-476-2400 Fax: 530-476-3210  
[zonumindustries@yahoo.com](mailto:zonumindustries@yahoo.com)  
[www.zonumindustries.com](http://www.zonumindustries.com)

**Who you know can make all the difference...**

**SBE**

- 100+ Local SBE Chapters
- 5,400+ Members
- Nationally-Recognized Certification Program
- JobsOnline & ResumeBank

[www.sbe.org](http://www.sbe.org) • (317) 846-9000





## Radio Guide Ads: July 2006

Advertiser - Page	Website
AM Ground Systems - 36	www.amgroundsystems.com
Anritsu - 40	www.anritsu.com
Armstrong Transmitters - 23	www.armstrongtx.com
Audion - 19	www.audionlabs.com
Axia - 15	www.axiaaudio.com
Bay Country - 21	www.baycountry.com
Belar - 41	www.belar.com
BEXT - 21	www.bext.com
Broadcast Devices - 31	www.broadcast-devices.com
Broadcast Electronics - 21	www.bdcast.com
Broadcast Software Intl. - 47	www.bsiusa.com
Broadcast Technology - 38	www.broadcasttech.com
Broadcast Tools - 17	www.broadcasttools.com
BTSG - 33	www.btsg.com
CircuitWerkes - 37	www.circuitwerkes.com
CKE - 43	www.rectifiers.com
Comrex - 7	www.comrex.com
Comet - 20	www.comet.ch
Conex Electro Systems - 21	www.conex-electro.com
Continental - 31	www.contelec.com
D&H Antennas - 41	www.dhsatellite.com
Econco Tubes - 41, 44	www.econco.com
Energy Onix - 2	www.energy-onix.com
ERI - 5	www.eriinc.com
Fanfare - 19	www.fanfare.com
Freeland Products - 131	www.freeland-inc.com
Gorman Redlich - 33	www.gorman-redlich.com
Harris - 48	www.broadcast.harris.com
Henry Engineering - 2, 35	www.henryeng.com
Inovonics - 1, 5	www.inovon.com
Jampro - 3	www.jampro.com
JK Audio - 9	www.jkaudio.com
Kintronic Labs - 9	www.kintronic.com
Larcan - 34	www.larcan.com
LBA Technology - 23	www.lbagroup.com
Lightner Electronics - 38	www.lightnerelectronics.com
Micro Communications - 43	www.mcibroadcast.com
Moseley - 22	www.moseleysb.com
Nautel - 32	www.nautel.com
Nott Ltd. - 29	www.nottltd.com
OMB America - 43	www.omb.com
Omnia - 27	www.omniaaudio.com
Orban - 48	www.orban.com
Peter Dahl - 39	www.pwdahl.com
Phasetek - 39	www.phasetekinc.com
Pristine - 25	www.pristinesys.com
Prophet Systems - 30	www.prophetsys.com
PTEK - 36	www.ptekpower.com
RAM Broadcast Sys. - 33	www.ramsys.com
Radio Systems - 16	www.radiosystems.com
RF Specialties - 29	www.rfspec.com
Satellite Lynx - 23	www.satellitelynx.com
SCMS Inc. - 11	www.scmsinc.com
Shively Labs - 25	www.shively.com
Sine Systems - 19	www.sinesystems.com
Telos - 13	www.telos-systems.com
TFT - 19	www.tftinc.com
Tieline - 5	www.tieline.com
Titus Technology - 43	www.tituslabs.com
Transcom - 19	www.fmamtv.com

2006

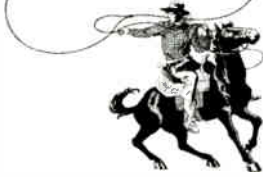

# RADIO ROUNDUP

The Radio Guide Industry Date and Event Register

Email your dates and information to: [radio@rconnect.com](mailto:radio@rconnect.com)

National & SBE • Regional & State • FCC Applications & Deadlines

### 31st Annual Conclave

July 13-16, 2006  
Minneapolis, Minnesota  
[www.theconclave.com](http://www.theconclave.com)

### SBE Leader-Skills Course II

August 8-10, 2006  
Radisson Holte Airport, Indianapolis, Indiana  
[www.sbe.org/cal\\_index.php](http://www.sbe.org/cal_index.php)

### AM/FM License Expiration Dates

August 1, 2006  
Delaware & Pennsylvania  
[/www.fcc.gov/mb/audio/renewal/index.html](http://www.fcc.gov/mb/audio/renewal/index.html)

### PAB Engineering Conference

September 7, 2006  
Hershey Lodge, Hershey, Pennsylvania  
[/www.pab.org](http://www.pab.org)

### BOS-CON 2006 Boston SBE Regional Convention

September 13, 2006  
Marlborough, MA  
[www.bos-con.com](http://www.bos-con.com)

### BOS-CON 2006 Ennes Workshop

September 12, 2006  
Marlborough, MA  
[www.bos-con.com](http://www.bos-con.com) – [www.sbe.org](http://www.sbe.org)

### NAB 2006 Radio Show

September 20-22, 2006  
Dallas, Texas  
[www.nab.org/conventions/radioshow/2006/](http://www.nab.org/conventions/radioshow/2006/)

### 34th Annual SBE22 Broadcast & Technology Expo

**SBE 2006 National Meeting**  
September 26-27, 2006  
Verona, New York • [www.sbe22.org](http://www.sbe22.org)

### 121st AES Convention

October 6-8, 2006  
Moscone Convention Center, San Francisco, CA  
[/www.aes.org/events/121/](http://www.aes.org/events/121/)

### SBE Chapter 20 – Pittsburgh Regional Expo

October 12, 2006  
Monroeville, Pennsylvania  
[www.broadcast.net/~sbe20](http://www.broadcast.net/~sbe20)

### 2006 Broadcasters Clinic

October 24-26, 2006  
Madison, Wisconsin  
[www.wi-broadcasters.org](http://www.wi-broadcasters.org)

### CBI Conference

October 24-30, 2006  
Adam's Mark Hotel, St. Louis, Missouri  
[/www.askcbi.org](http://www.askcbi.org)

### SEA-CON 2006

Fall 2006  
Seattle, Washington  
[www.broadcast.net/~sbe16](http://www.broadcast.net/~sbe16)

### Texas Association of Broadcasters (TAB)

**53rd Annual Convention and Trade Show**  
August 9-11, 2006  
Austin, Texas  
[www.tab.org/convention.php](http://www.tab.org/convention.php)

– 2007 –

### Great Lakes Broadcasting Conference & Expo

March 2007  
Lansing, Michigan  
[www.michab.com](http://www.michab.com)

### OAB Annual Convention and Engineering Conf.

Spring 2007  
To be announced.  
[www.oabok.org](http://www.oabok.org)

### SBE Certification Exam Dates

Exam Dates	Location	App. Deadline
November 10-20	Local Chapters	Sep. 22, 2006

Send your event info to: [radio@rconnect.com](mailto:radio@rconnect.com)

## NEW Alert Monitors



# BIONDO

COMMUNICATIONS

### Internet Solutions for Broadcasters

- Live Streaming Media
- On Demand Streaming
- Podcasting
- AV Encoding
- Web Design / Web Hosting
- Search Engine Marketing

Call Us: 215-778-8530

Email Us: [sales@biondocomm.com](mailto:sales@biondocomm.com)

Visit Us: [www.biondocomm.com](http://www.biondocomm.com)

[www.radiopapers.net](http://www.radiopapers.net)

On-Line Now!

Radio White Papers  
Radio Technical Reports  
Radio Application Notes  
Radio Technical Manuals

# Microphone Flags



800.450.6275  
[micflags.com](http://micflags.com)

All our Mic Flags feature our PRO-TECH paint (non-chip). All shapes and sizes, CUSTOM and BLANK mic flags.  
camera stickers-promotional products-lapel pins your first choice for quality and service



# Broadcast Software

1-888-274-8721  
www.bsiusa.com

## Radio Automation

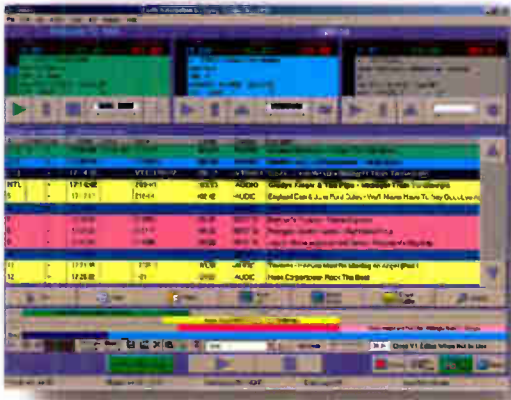

**Simian** - radio automation and digital playout system.

## Instant Audio



**Stinger** - Instant Access to 288 'rapid-fire' audio files.

## Digital Cart Player



**WaveCart** - the original on-screen cart machine replacement.

## Audio Logging



**SkimmerPlus** - skimming and audio logging with web playback.

## Complete Systems



**Systems** - fully configured with hardware, software and music.

## Music Library

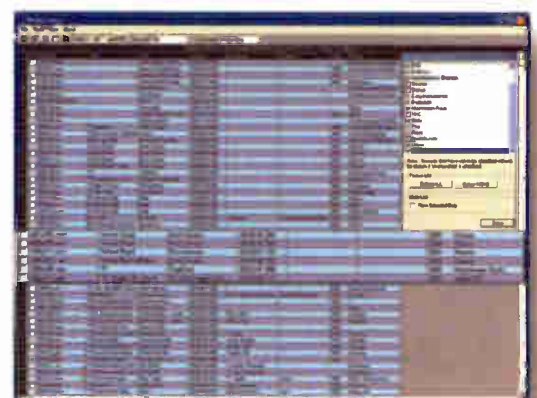

**MusicStore** - select from over 48,000 ready-to-play songs.

## CD Ripping

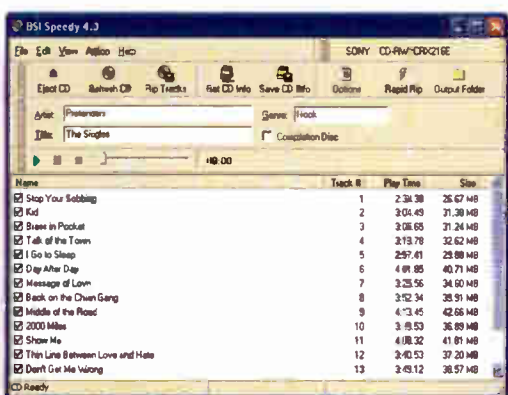

**Speedy** - fast CD ripping with automatic file tagging.

## Sound Cards



**AudioScience** - professional sound cards built for broadcast.

## Remote Control



**Trigger & Relay Kits** - for GPI/O and satellite operation.

**Broadcast Software International**  
503 E. 11th Avenue  
Eugene, Oregon 97401 USA  
Direct: 541-338-8588  
Fax: 541-338-8656  
www.bsiusa.com sales@bsiusa.com





# SOMETIMES...

the price of progress is lower than you think.

## Five-Band Optimod-FM 5300



Optimod-FM 5300 puts coveted five-band and two-band Optimod processing into a *single rack unit* package and brings it to you at the *most affordable price ever*. The 5300's five-band processing is ideal for any pop music format (even the most competitive and aggressive CHR), while phase-linear two-band processing yields ultra-transparent sound for classical, classic jazz, and fine arts formats. Regardless of your choice, 5300's optimized technology ensures unusually high average modulation and coverage for a given level of subjective quality. Unlike many lesser processors, the 5300 handles speech particularly well — it's always clean, even when you process for loudness.

## Big Optimod Sound. Affordable Price.

- Automated dayparting
- Ultra-low delay five-band processing
- GPI, Ethernet, RS-232 serial remote control
- ...and, most importantly, the five-band Optimod-FM 5300 offers that inimitable, consistent Optimod sound.
- Advanced PC software
- Dual composite outputs with independent level controls
- Orban's patented "Half-Cosine Interpolation" composite limiter

# HARRIS

For more information on complete end-to-end digital radio solutions including the Orban Optimod-FM 5300 call us today at 1-800-622-0022

[www.Broadcast.Harris.com](http://www.Broadcast.Harris.com)



[www.orban.com](http://www.orban.com)

Right on the money

Not long ago, stepping up to the 5300's level cost thousands more. Now it's a feasible option for many non-commercial and small/medium market broadcasters. So before you buy a processor, you owe it to yourself to check out the new price of progress. We think you'll find that the Optimod-FM 5300 is right on the money.

PRSR STD  
U.S. POSTAGE  
PAID  
PERMIT NO. 410  
BEAVER DAM WI

### – Radio Guide Websites –

Radio Guide: [www.radio-guide.com](http://www.radio-guide.com)  
White Papers: [www.radiopapers.net](http://www.radiopapers.net)  
Used Gear: [www.radio-classifieds.com](http://www.radio-classifieds.com)  
Radio History: [www.olderadio.com](http://www.olderadio.com)  
Radio Web Links: [www.radiolinks.net](http://www.radiolinks.net)