

CHIEF ENGINEER
KBNA AM/FM
5710 TROWBRIDGE DR
EL PASO TX 79925-3341



RADIO GUIDE

A Forum for Radio Engineers

BULK RATE
U.S. POSTAGE
PAID
ROCHESTER, MN
PERMIT 445

October 1988 Volume 1 - Issue 2 Copyright 1988 Rochester Radio 511 18th Street SE Rochester, MN 55904

ROCHESTER RADIO GUIDE THANKS YOU

I'm impressed! You've done a terrific job. The number of phone calls and letters exceeded even my best expectations. This is what I was waiting to hear. It lets me know that the Radio Guide is a publication that apparently has been needed.

When I began this venture, I really didn't know whether or not I would receive support from radio engineers. I had no doubts that you would enjoy reading about technical topics - but contribute articles? That's something else. Well, if the first few weeks are any indication, the Radio Guide should have more than enough technical information to publish.

The Radio Guide will operate in a very open-forum fashion. Literally everything that is sent to me will be printed. I am not going to serve as some sort of editorial traffic cop. I don't see it as my function to determine what is correct or fit to publish. It doesn't matter whether you are an experienced writer or just have have a simple schematic to share, everyone is welcome. Remember, to get it published, all you have to do is send it in. Just keep it nuts & bolts.

A Fact of Life

There's always a basic decision that every publisher has to make. Can the publication afford to make it without advertising? I've done a lot of soul-searching, and the only other way is to charge a subscription fee of some sort.

Some of you have expressed disappointment at the fact we must have advertisers. There is no way that Radio Guide can achieve the widest possible distribution without advertising dollars - it's a fact of life. I know a lot of engineers are afraid that if the Radio Guide accepts advertising then it can't provide straight-forward editorial copy.

If a piece of equipment has a problem, it doesn't mean that the company that produced the gear is in shambles. It simply means that one piece of gear has a problem! Not one company on earth makes gear that doesn't fail. What we will do here is find ways to correct those failures. Better still, we may even find ways to prevent them from happening at all, through preventative maintenance. Manufacturers will be asked for their input too - after all, they designed and built the stuff and are usually aware of their equipment's problems long before most station engineers. Radio Guide will welcome manufacturers equipment modifications and updates for publication.

Technical Truth

Most manufacturers I know will work with us in an open forum such as this. Why not? It will help them to design a better product and help to squash rumors before they get a foot hold. This way, Radio Guide serves its primary purpose of providing technical information and at the same time, serves it advertisers as well. You will always find the truth here, because both sides will always have their say. Fair enough?

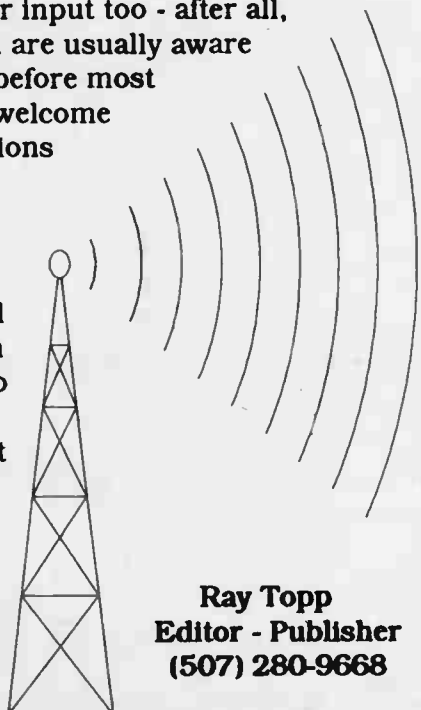

Ray Topp
Editor - Publisher
(507) 280-9668

The Radio Guide is sent out each month via bulk mail, with a very generic "chief engineer" on the label. I know there are a lot of you out there who work as contract or field service engineers. There are probably many more who work in various allied job categories, who would like to get on the mailing list.

If you wish to be included in the monthly mailing, just send me the proper information for insertion into our mailing list. As the Radio Guide grows, we will be constantly updating our mailing list to change to a more personalized first and second name basis.

Many of you work as contract engineers, serving more than one (sometimes many more) station. Radio Guide is compiling a nationwide listing of contract engineers. If you have your own contract or field service business, even if it's only part-time, call or write to me and we'll place your name and business on our list. Contract service is a large part of radio engineering. This list will be published every month for the benefit of our readers. Now, who said there's no such thing as a free lunch?

Keep It Coming

I have received enough articles and technical tidbits for this issue. Now, what about next issue? The longer you receive the Radio Guide, the longer you will see my perpetual pitch for articles. The Radio Guide gets mailed out to around ten thousand radio stations each month, but I honestly don't know how many articles to expect from you.

It's not what I expect that counts, but what I receive. So, dip into your files and send a technical article, hint or kink, special test procedure, or schematic to Radio Guide. Remember, this really is your forum. It's been set up that way. The only danger is, if I don't bug you, and you don't send stuff in, Radio Guide dies - - 'nuff said!

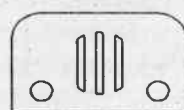

Contents

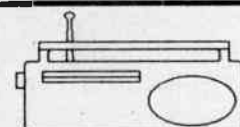

- Page 2** Noise Free Radio
- Page 3** MCI Recorder Gremlins
- Page 4** Harris FM 2.5K Transmitter Problem
Tech Tips & Tid - Bits
- Page 5** FM Transmitter - AM Noise
Ole Mom Nature Trick
- Page 6** True VSWR Measurements
- Page 7** Tips From the Field
Contract Engineers
- Page 8** Short Cut for Shorts

Noise Free Radio

One Step Closer

George Yazell, PE (Retired), Lakeland FL

Last month we introduced NFR, a proposed new transmission system for the Medium Wave Band, commonly referred to as "Broadcast Band" or "AM Band". To review briefly, AM stations are declining in stature, audience, and revenue. The primary reasons for the decline are limited audio frequency range, distortion, noise from natural and man-made sources, and interference from radio stations on the same or adjacent channels.

Since the many "improvements" introduced in the past twenty years have not solved the problem, let's take a giant step and convert the AM band to NFR modulation. The change-over can be simple, inexpensive and fast, and we don't have to wait for FCC approval!

NFR is simply Narrow Band FM (peak deviation 3 kHz) applied to the carrier of a Medium Wave Broadcast Transmitter and converted to Wide Band FM (peak deviation 75 kHz) in an NFR receiver.

Everything we have to do to create NFR has been done or is being done now. It will require a simple modification to the present AM transmitters and another simple modification to receivers. During the transition period - business as usual! An AM transmitter can carry AM and NFR simultaneously. Any AM receiver can still pick up the AM modulation with all its noise, distortion and interference. But, when an NFR receiver picks up the signal from an NFR transmitter, reception will be exactly the same as heard on the FM band! Crystal clear audio, no noise and no interference.

Think of the other advantages. When NFR wipes out co-channel and adjacent channel interference, we can eliminate the need for most of the directional antenna farms, most day-timers can operate full time and night-time coverage will be tremendously improved.

I concluded, in last month's article, with a request for letters and phone calls to get reaction from a broad segment of broadcasters. I did not expect too many letters, but was shocked to get none! Phone calls were many and interesting. As I expected, about half were from enthusiastic supporters, who didn't really believe I had my head on straight, but encouraged me because they need a miracle. The other half were knowledgeable engineers who were evenly divided between pro and con. Quite a few of the pros are now spending time trying out NFR. Some of the cons have been converted and have phoned a second time for more details.

We know the transmitter plan for NFR is workable since Motorola C-Quam stereo utilizes AM for the L+R signal and narrow band PM (phase modulation) for the L-R signal. If you have a station in your area transmitting AM stereo using the C-Quam system, all you have to do is listen to the L-R signal to determine that it is clear and noise free, with the monkey chatter and static wiped off! But that is not as easy as it sounds since stereo demodulation in most AM stereo radios is done in an IC chip. You just can't listen to L-R.

And even if you could listen to the L-R signal, you would still not be too impressed. If the station transmits a mono spot announcement or newscast, there will be no modulation on the L-R channel. And, even if you hear the music, there will be only a moderate improvement over AM because this is Narrow Band phase modulation, and Wide Band FM is required for the FM demodulator to do its thing.

In a standard FM receiver, the IF is 10.75 MHz, peak deviation is 75 kHz and channel separation is 200 kHz. Remember those parameters!

If you'd like to build a workable NFR receiver, find an old AM/FM radio you can modify. Look for one with tunable IF transformers and separate AM and FM IF strips. First, re-tune the AM IF transformers from 455 kHz to 430 kHz, and re-align the RF and mixer stages for proper tracking across the AM band. Then tap off the IF signal after the first AM IF transformer and run the signal through a series of frequency multipliers, multiplying the 430 kHz

signal 25 times. We now have an IF of 10.75 kHz with a peak deviation of 75 kHz. Please notice that the 10 kHz channel separation on the AM band has now become 250 kHz - - that's better than the FM band.

Inject this signal into the first or second FM IF transformer and switch the output of the FM demodulator into the audio amplifier. You now have a workable NFR (noise free radio).

Next month we'll cover methods of converting AM transmitters to NFR. Meantime, keep those cards and letters coming and phone me if you like. If you attend the SBE convention in Denver, Sept 22-25, look me up.

George W. Yazell, P.E. (retired)

Box 8086, Lakeland, FL 33802

(813) 682-2270

The more I hear about NFR, the more I come to believe that it is a realistic alternative for AM broadcasting. I know a lot of you probably don't feel we need any more "AM improvements", this late in the game.

I don't care if we have twenty AM stereo systems or NRSC style modifications; we are dealing with an inherently noisy medium - - AM. Using narrow-band FM modulation on the standard broadcast band should be given a chance. We're not dealing with new technology here, just a new application.

The bottom line is, it will either work or it won't! If it can be shown to work, then there really is no point in putting any more time, money or effort into systems that limit themselves to "improvement" of the present AM system.

Everyone involved must learn to put their egos in their back pocket and do what is best for AM radio. If you have the facilities to experiment with this NFR method, please do it. If you have suggestions, comments, or wish to get involved with NFR, give Mr. Yazell a call.

Radio Guide will keep you informed of the progress of NFR. Forget about what's been done. It hasn't worked! Let's use our technical talents to develop a system that will be able to compete head-to-head with FM. We've wasted years on the other systems.

If any existing "improvement" system had the potential of producing sound that could compete with existing FM stations, do you really think that AM stations would still be waiting? - - editor

MAIL LABELS

AM, FM & TV BROADCAST STATIONS

FAST SERVICE

100% ACCURACY GUARANTEED

SELECT BY TYPE OF STATION, TRANSMITTER
POWER, GEOGRAPHICAL AREA, MARKET SIZE,
COMMERCIAL/EDUCATIONAL, ETC.

CHESHIRE OR PRESSURE SENSITIVE LABELS.

TOTAL COST: \$55.00 PER THOUSAND LABELS.

PHONE (800) 338-3264

BROADCAST MAILING SERVICE

Two Cures for MCI Recorder Gremlins

By Hank Landsberg, Henry Engineering

While I had the opportunity of maintaining 27 MCI model JH-110A and B recorders, there were two problems that would occur on almost every machine, with some regularity. (1) The low-frequency response of the reproduce electronics would disappear and, (2) the tape lifters would have difficulty lifting the tape during rewind or fast-forward. Here are the causes and cures for the two MCI gremlins...!

The LF reproduce difficulty was traced to a dirty CUE RELAY in the reproduce circuit. This is the relay at the rear of the audio electronics drawer that activates when the front panel CUE button is engaged. The relay is wired directly to the reproduce and record tape heads, and is therefore operating with extremely low levels of audio on its contacts. A very slight amount of contamination on either the relay contacts or the relay socket will cause a "dirt capacitor" to form in series with the reproduce head, which will cause a pronounced loss of low frequency response. Cure: clean or replace the relay. If the socket is dirty, clean it also with Cramolin or a similar cleaning substance. BE CAREFUL when removing or inserting the Cue relay from its socket! The socket is soldered to the bottom of the circuit-board; its contact pins are very small and can be easily broken. Many times I have had to remove the motherboard to re-solder a broken socket solder joint. If this happens, it's a good idea to re-solder ALL of those Molex connectors to the bottom side of the PCB. They'll break loose eventually.

The weak tape lifter problem seemed to happen to almost every machine about once every year, more often if the machine was used heavily. The lifters just seem to lose their ability to hold the tape away from the heads under the tension of rewind or fast forward. Problem: a magnetized lifter solenoid plunger. After several months of use, the plunger in the lifter solenoid becomes magnetized with the same polarity as the coil windings. This results in lower "pulling ability" when the solenoid is energized. There's no need to replace the solenoid; just demagnetize the plunger. Remove any PC boards that block access to the solenoid. Remove the plunger after removing the pin that connects the plunger to the lifter linkage. Now find the strongest tape demagnetizer at the station (a tape-head demagnetizer won't work). Turn on the demag, and "erase" the plunger just as though it was a reel of tape. Withdraw it very slowly from the magnetic field before turning off the demagnetizer. Re-install the plunger into the solenoid and put the machine back together. Give the lifters a try - - they should have plenty of pull after this de-mag procedure.

Madison Broadcast Engineering Conference

October 18-20 1988

Don Borchert and the University of Wisconsin, once again, present the 34th annual Broadcast Engineering and Telecommunications Seminar. Conference dates are: October 18, 19, and 20th. It will take place at the Holiday Inn Southeast located at highways 12 & 18 at I-90, in Madison, Wisconsin. Phone number for the Holiday Inn is 608-222-9121. Don Borchert may be reached at 608-263-2157 (WHA).

This will be the 34th annual technical conference. The name has been changed from "FM Clinic" to its current title, but only to reflect a changing communications industry and the converging technologies. There will be more equipment exhibits and more exhibit hours this year. Don't judge this conference by it's size. It's one of the best.

The Complete RF Exposure Measurement System from Holaday Industries

Measure Both E and H Fields

ANSI RF exposure standard requires measurement of both the electric and magnetic field.

Automatic Self-zero

Completely automatic self-zeroing eliminates drift, improves accuracy of readings.

Recognized by Federal Agencies

Evaluated and used by NIOSH, OSHA, EPA and CDRH, as well as state, local health departments and consulting engineers.

NBS Probe Design

Isotropic probe design originated by National Bureau of Standards.

Displays Time Average Reading

Real-Time display of the current six minute average relates directly to the ANSI RF exposure standard. Also calculates average of user-selected test intervals. This feature is also useful for doing spatial averaging by programming appropriately timed test intervals and using constant probe velocity over a prescribed area.

Exclusive from Holaday Industries, Inc.



Model HI 5000SX



For more information, please call or write:

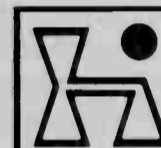

HOLADAY INDUSTRIES, INC.

14825 Martin Drive
Eden Prairie, MN 55344
Telephone: (612) 934-4920
Telex: 29-0922 FAX: (612) 934-3604

Introducing The most innovative STLs on the market.



PCL 6000 Series STLs

- Frequency agility
- Switchable monaural or composite operation
- 100 to 500 kHz channel spacing for receiver IF bandwidth
- Built-in receiver transfer circuitry
- Comprehensive front-panel metering
- Dual conversion 6020 Receiver
- Triple conversion 6030 Receiver

Moseley

111 Castilian Drive
Santa Barbara, CA 93117
(805) 968-9621 FAX: (805) 685-9638

Harris 2.5K TX Problem

Dan Greer, WDZZ-FM, (313) 767-0130

Sometimes I'm amazed at how the station can practically run itself for two, three, or more months. Then, everything breaks at once! But through patience and perseverance, I always seem to get the problem solved. Of course it helps to have tech service from manufacturers and answered prayer from the lord.

Anyway, I have a big question that maybe your readers can help me with. First, we're a class A FM station at 92.7. I have a Harris 2.5K transmitter and it seems to want to burn up its loading cap from time to time. With our antenna gain, we only put out 2100 watts from the transmitter and to attain that, plate current is rated at 0.77 amps and plate voltage at 3750 Volts.

The capacitor is an air-variable 6-12pF with 3 rotor fins and 3 stator fins. When it gets burned, both rotor and stator get damaged. We've had 3 field techs from Harris plus an outside consultant look at this problem and all seem to be stumped. I've been able to get around the problem by keeping the plate current around 0.74 Amps. This still allows me to keep output power around 93-95% which really doesn't cut down our coverage area. Still, its not 100%.

Keeping the plate current at 0.74 Amps seems to do minimal damage to the loading cap. It's badly scorched, but not melted or perforated like before. We are in a high-rise building with our transmitter and antenna on the roof. There are about eight other various transmitters up there as well, and it has been proposed that some strange RF products are being made as a result of the all the RF being emitted. But again, a spectrum analyzer doesn't reveal anything strange.

I'm sure more info is needed to come up with some possible ideas. If anyone has any ideas to solve this problem, please feel free to contact me or Walt Harris at Harris Broadcast or write to Ray and have him put it in the next Radio Guide.

Tech Tips and Tid-bits

Five Tech Tips to Make Life Easier

By Stu Engelke, WWDJ, Hackensak NJ

1. To protect 3-phase blowers and power supplies, install a 3-phase power monitor. What you do is connect the three incoming AC phases to the monitor and the monitor gives a contact closure if all three phases are there, with correct voltage and phase rotation. Put the contact closure in series with the interlocks or other control to shut things down. This has saved the blower and high voltage rectifiers on an MW-50, since installed.

2. To keep air-conditioner circuit breakers from opening, due to compressor lockup after short power failures (or people constantly changing thermostat settings), install a five minute time-delay gadget in the thermostat circuit. These are available from most HVAC dealers.

3. AT&T Spirit telephone systems work well in high AM RF environments, if you get their "RF" phones. The speaker-phone portion also works well for simple on air talk shows.

4. If you have interlock defeat switches on transmitters or phasors or whatever, use a 60-minute mechanical timer switch. This way you won't forget to "un-defeat" interlocks

5. If you have a 7 second delay unit for talk shows, that's of the solid state variety, hook its bridging input to the program line all the time and switch its output between the transmitter feed when in use, and the input to a cassette deck the rest of the time. Have the cassette start recording when the announcers mike is turned on, and stop 14 seconds after he or she turns it off. You'll get a skimmer that records 7 seconds of program before and after the mike goes on and off. Great for air-checks. Use a capacitor across a sensitive coil to get the delay.

ACCURATE SOUND CORP

Studio Condenser Microphone Model CR-3A

*For today's demanding digital recording needs:
studio quality at a reasonable price...
only \$795.00 plus \$5.00 shipping and handling.*

Try it for 10 days, you'll like it! If not, just return it.

Features Include:

- -10 dB pad switch
- Cardioid polar pattern
- High pass filter switch
- Classic European styling
- 3-pin "Cannon" type connector
- Gold coated polyester membrane

All accessories Included:

Fixed mount Operator manuals
Suspension mount Calibration tape
Foam windscreen Carrying case

Optional: @ \$179.00

DJ-601 Power Supply (good for two microphones)
Microphone Cables (5m, 10m, 20m)



1/2 Actual Size



Accurate Sound Corporation
3515-A Edison Way
Menlo Park, CA 94025
(415) 365-2843 Telex: 34 8327

POWER-side™

The solution to many of AM radio's
most serious technical problems

From the developers of the
AM STEREO system
"that isn't afraid of the dark"



425 Merrick Avenue
Westbury, N.Y. 11590
(516) 222-2221

FM Transmitter - AM Noise

David W. Ludwig, KIWR-FM, Council Bluffs, Iowa

Our station operates at a full 100 kW and like all other stations we have our share of problems that seem to happen to us that no one else could possibly have. Take, for example, the following problem that caused me a bit of hair pulling that I could ill afford (I have so few left now days).

For a couple of days the announcers began to notice a strange noise during quiet passages of music that could be heard on the "off-air" monitor, but not in the board output monitor. Of course every time I tried to hear the "strange sound" it was not there.

One evening the announcer called me at home and said the noise was back. He left a few seconds of "dead air" during selections so I could hear it at home. The best way I could describe the noise is to say that it sounded like one side of the telephone line had lost connection on a program line and the result was a loud line hum. The noise was at least 30 dB down so it was not so noticeable during normal programming. We normally sign off at midnight, so that night I began to isolate the noise by starting at the output of the audio board, through the processing equipment and stereo generator, to the input of the STL transmitters. The noise was still there. By now I had conjured up all the hours that could be spent checking all the power supplies and solid-state components that would have to be checked out with scope and meters. I would have to come back later.

On the night scheduled for the testing, I sat down and began to look for the location of all the power supplies that I would have to check, when I began to get a nagging notion that I was in the wrong ball park. I began to realize that the noise was more like a ground hum than a 60 cycle hum. I decided to give this new approach only one hour to prove out, then I would have to go the power supply line of thinking. I fired up the transmitter and found that the AM noise was only about 30 dB down; one more indication that it might be a power supply problem. I put the output of the exciter into a dummy load and with a broadband scope, looked at the RF. It seemed to be clean. I disconnected the IPA and fed it into a dummy load and found it to be clean and free of noise, so I figured that I better get back to the power supplies before the night got away from me.

I restored everything to normal and once again fired up the transmitter, only to see that the AM noise had dropped to a -40 dB. Operating on a hunch, I replaced the right-angle "N" adaptor and the "N" to "BNC" adaptor on the coax and also cleaned the connectors in the transmitter. When I fired up the transmitter again, the AM noise was now better than -55 dB.

About twice a year now, I have to go over to the transmitter site and repeat the replacement of the adapters and cleaning of the connectors in the transmitter because of the returning hum noise.

Next time, the story about how the STL decided to turn the transmitter on and off with no instructions to do so.

Ole "Mom" Nature Trick

By Ray Miller, Technical Director, KGWA, Enid OK

The chief engineer of one of the stations in Oklahoma contacted me to resolve a radiated pattern variation. He had checked all the capacitors, inductors, and lines in the phasing cabinet and line terminating units. He had found no fault and wanted help. I jumped in the car and two hours later arrived on site.

Upon inspection, the common point and line currents were correct at the phasor and LTUs. No sign of heating or loose connections. No insulators cracked or broken. No indication of faulty lighting system. No fault in static discharge RF chokes. Ball gap on antenna #1 OK - - but, ball gap on antenna #2 was welded shut!

Ole Mom Nature had formed a pearlite weld that was exactly the same resistance as the base driving resistance of that antenna! I told him to whip out his hacksaw and file. Problem solved!

Blank Audio Cassettes

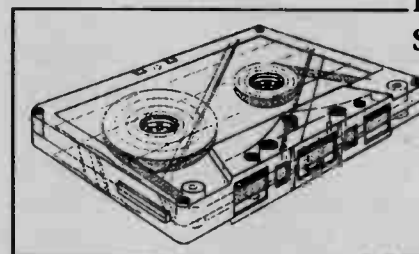

BASF Pure Chrome
Shape Precision see-thru shell

as low as

C-90	\$1.06 ea.
C-60	\$.75 ea.
C-30	\$.55 ea.

Custom Lengths available to fit your needs!

AGFA PE649/949 Normal Bias
Michelex German made shells

as low as:

C-90	\$.99 ea.
C-60	\$.71 ea.
C-30	\$.51 ea.



PHONE: (507) 288-7711

FAX: (507) 288-4531

Tom Jones Recording Studios

220 South Broadway

Rochester, Minnesota 55904

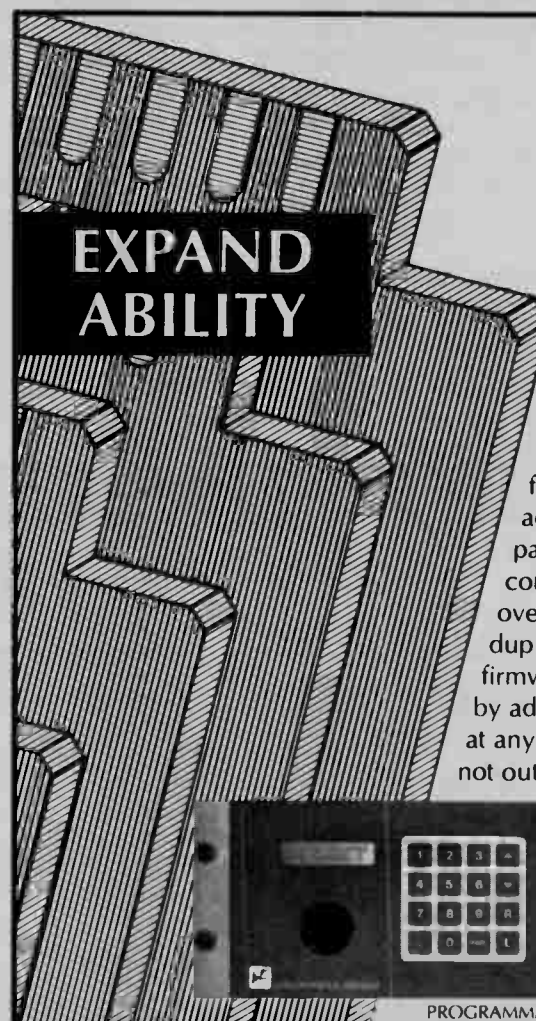

EXPAND
ABILITY

Expandable
Digital Remote Control.

As your station metering requirements grow to additional sites and channels, the DRC190 from Hallikainen & Friends grows with you. By its inherent, modular-expansion design, the DRC190 can accommodate a single transmitter or grow to manage up to 100. Reliable firmware includes a multiple access, anti-contention data packet system, allowing any site to communicate with any other site over wire-line, subcarrier or half-duplex UHF radio. The same firmware allows expanding the system by adding additional sites or channels at any time. For a system to grow with, not out of, expand with the DRC190.

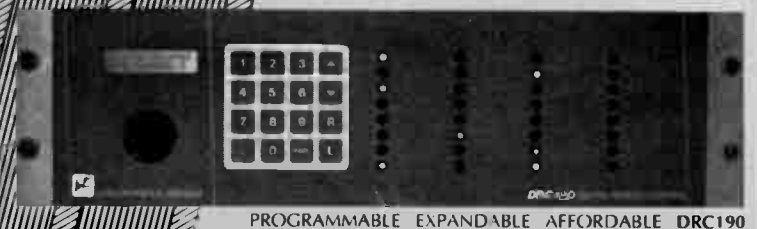

PROGRAMMABLE EXPANDABLE AFFORDABLE DRC190

HALLIKAINEN & FRIENDS

141 SUBURBAN E4 805 / 541-0200
SAN LUIS OBISPO, CALIFORNIA 93401-7590 USA

True VSWR Measurements

By Doc Daugherty

Harris Broadcast Corporation - Senior Field Service Engineer

How accurate are the VSWR measurement taken for a typical FM transmission system? It is often assumed that the VSWR measurement available on the front panel of a typical FM transmitter is absolutely accurate for all readings, but this is not the case.

For VSWR readings above 1.2 to 1, the transmitter indicators are fairly accurate and can be used to protect the transmitter from excessive reflected power. But readings for VSWR of less than 1.2 to 1 can have large errors and should not be relied upon as being true enough to make important value judgements such as fine tuning the transmission line and antenna system.

The reason for the errors in VSWR reading, is the directional coupler used to make the measurements. A directional coupler provides isolated samples of forward and reflected power from the same transmission line, and has two properties that are of concern here: the isolation and the directivity.

Isolation is a statement of how small the forward or reflected sample is, compared to the actual value of forward or reflected power. Isolation is the lesser known of the two parameters, it tells the amount of forward signal that leaks into the reflected port. If no reflected power is present, the reflected port of the directional coupler will still have a signal sample present. This is the leakage of forward power into the reflected port of the directional coupler.

In the actual system, two voltages present in the reflected port of the directional coupler make up the total signal by which the VSWR is measured. They are the:

1. Actual voltage sample proportional to the reflected power.
2. Leakage voltage sample from the forward power.

If the forward and reflected voltage samples in the reflected port are in phase, the reflected port voltage sample will increase and the VSWR will appear worse than it actually is. If the forward and reflected voltage samples are out of phase, the reflected port voltage will decrease and the VSWR will appear smaller than it actually is.

It is difficult to determine if the forward and reflected voltage samples mentioned above will add or cancel, as that is controlled by the:

1. Length of line between the transmitter and the antenna.
2. The operating frequency (which depends in part upon the modulation level).
3. The temperature (which will change the phase angle between the two voltages because of line length changes due to expansion or contraction).

Example:

$$P(\text{transmitter}) = P(\text{forward}) = 25 \text{ kW} = 44 \text{ dBW}$$

$$\text{System VSWR} = 1.0 \text{ to } 1$$

$$P(\text{reflected}) = 0 \text{ W}$$

Directional coupler with...

$$\text{Isolation} = 40 \text{ dB}$$

$$\text{Directivity} = 30 \text{ dB}$$

The forward port signal is...

$$4 \text{ dBW or } 2.51 \text{ Watts, or } 11.2 \text{ Volts}$$

The reflected port signal is...

$$-26 \text{ dBW, or } 2.51 \text{ Watts, or } 0.354 \text{ Volts}$$

Table 2

VSWR	Return Loss
0.0	0 dB
1.925	10 dB
1.22	20 dB
1.065	30 dB
1.02	40 dB

Table 1 shows the results of various actual VSWRs in combination with a directional coupler with a directivity of 30 dB. This is typical of directional couplers used in FM transmitters.

To understand the rational behind the relationship to directivity of a coupler, to the accuracy of VSWR measurements, two facts are important:

1. VSWR and return loss are mathematically related.
2. The couplers directivity must be at least 10 dB greater than the return loss that must be accurately measured. (see table 2)

If a VSWR of 1.02 is to be accurately measured, the coupler's directivity must be at least 50 dB.

Table 1

Actual VSWR	Reflected Voltage Sample	Forward Leakage Voltage Sample	Total Reflected Port Voltage		Indicated VSWR	
			Maximum	Minimum	Maximum	Minimum
1.4	1.86V	0.354V	2.21V	1.51V	1.49	1.31
1.2	1.016V	0.354V	1.37V	0.662V	1.28	1.13
1.1	0.532V	0.354V	0.886V	0.178V	1.17	1.03
1.065	0.354V	0.354V	0.708V	0.000V	1.14	1.00
1.02	0.111V	0.354V	0.465V	0.243V	1.09	1.04
1.002	0.0112V	0.354V	0.365V	0.343V	1.07	1.06

Tips From The Field

Misc. Technical Tips From Around the Country

A "Cool" Dummy Load

Jack Collinworth of WFXE in Columbus, GA, called to tell me that a couple of times he had a need for a dummy load for a 1 kW AM transmitter. At the time, he could only come up with a 50 Ohm, 50 watt resistor. Jack reasoned that if he could find a way to keep the 50 Watt resistor cool enough, it could handle more than 50 watts of power.

His solution? Immerse the resistor in a gallon or two of ice-cold distilled water in a plastic jug. He said he really expected the resistor to give up in a short time, but with very cold water, he actually fed a 1 kW transmitter into it for two hours! The jug did get slightly warm, but the resistor did not burn out.

Wireless is Wonderful

How many times have you brought your Marti to a shopping center only to find out (usually too late) that it just won't get through the concrete and steel? Jack came up with an alternative that is quick and easy - - cheap too.

Pick up a wireless intercom set. Feed the output of a mixer into the intercom transmitter unit and take the intercom receiver unit to a suitable location, closer to the outside of the shopping center. Feed the output of the intercom receiver into the Marti audio input and you're on your way. Audio quality may not be perfect, but it's better than nothing.

Otari Reel Holder Saver

Morgan "Skip" Reynolds II, CE, WFFX-FM, Tuscaloosa AL

I am the engineer of an AM/FM combo with an automation on the AM. The two stations have owned Otari MX-5050 series and ARS-1000 series machines since 1979. Over the years, we have had to replace several of the reel retainers because they lose gripping power.

When ordering the retainers, no one thought to ask if there was a way to fix the old ones, neither did we receive a product bulletin from Otari.

However, I discovered that by putting a drop of oil between two brass pieces located just under the top knurled knob, the retainers once again will grip well. Apparently the brass dries out, or something (don't laugh), and needs just the small amount of lubrication to free these pieces.

Now the station owns five spare reel retainers, and hasn't lost or broken any!

A Use For Tubes

Frederick E. Fess II, WLRB Radio, Macomb, IL

If you use an Electro-Voice 313A shock mount clamp, the bands that hold the mike away from the support probably have broken, or worn out, many times.

My solution is this: get an old 1 3/4 inch bike inner-tube and cut it into small bands. The inner-tube is very strong and will stretch enough to make the shock mount work correctly. I've been using inner-tubes on all of our mikes and haven't had any problems yet.

Please-We Need Your Help!

If you have any short tech-tips, send them in or better still, call me at (507) 280-9668 and we'll talk about them. Remember, it doesn't do anyone any good if you keep that information to yourself. Don't assume that everyone knows about your special technical tip. Send them in - - they'll be printed in the next issue ... editor

Contract Engineers

Marti Electronics has provided us a list of contract engineers. Radio Guide will provide space here for this list, as well as the names of any other contracting or consulting engineers who wish to become rich and famous.

This list is not a recommendation of any particular engineer. You will have to determine for yourself the qualifications of a particular person for the job.

Norac Broadcast Systems
8215 North Oracle Road #250
Tucson, AZ 85704
602-575-0975

Jim Stanford
2755 South 4th Ave., Suite 852
Yuma, AZ 85634
602-782-9108

Wind River Broadcast Services
Box 481
Broomfield, CO 80020
303-532-4311

John Morton
2263 County Road 220
Durango, CO 81301
303-247-8734

Phil Baker
#7 McCoy Drive
Rome, GA 30161
404-232-4698

Kirk Wallace
113 Dorris Drive
Fiarfield, IL 62837
618-842-7785

Gary Wilson
504 A Ave. East
Oskaloosa, IA 52577
515-673-5204

Dick Hyatt
Main Engineering Association
Route 1, Box 178 A-12
Gardiner, ME 04345
207-582-4192

David Gardiner
84 Pleasant Street
Fairhaven, MA 02719
401-434-2400

Phil Woods
27045 Belmont
Southfield, MI 48076
313-569-8000

Segue Services
Broadcast Engineering
HCR #1, Box 266-D
Merrifield, MN 56465
218-765-3333

Denny Ozbirn
Route 2, Box 341
Rienzi, MS 38865
601-728-5301

Montanavision Inc.
502 South 12th Ave.
Bozeman, MT 59715
406-586-4106

Larry L. Beavers
126 Warren Street
Concord, NH 03301
603-228-8910

Gerhard Straub
7128 Tesque Dr. NW
Albuquerque, NM 87120
503-389-7885

Gary Frierson Haertig
17714 A SE Addie
Milwaukee, OR 97267

Charles Ray
190 Alleghany Ave.
Pittsburgh, PA 15202
412-734-2823

Kirk Harnak
88 Union Ave., Suite 309
Memphis, TN 38103
901-529-0098

Tom Green
5724 Sagebrush Trail
Arlington, TX 76107
817-572-4926

Joe Potet
Box 648
Palestine, Tx 75801
214-723-0877

Dave Hebert
Box 2442
Pasco, WA 99302
509-545-9672

Chuck Gennaro
240 Lyons Street
Wisconsin Rapids, WI
54494
715-423-6763

Robert L. Miers
499 East Valley Street
Grand Junction, CO 81504
303-434-3435

Short Cut for Shorts

By **Steve Sandlin, Senior Broadcast Engineer**

It's three AM and you've just gotten a call that your main transmitter just went off the air. Sleepily, you tell the announcer how to re-set the overloads, and the transmitter comes back up, with all readings normal. This is the third high-voltage overload you've gotten in the last couple of weeks, but you can't seem to induce a failure when you're looking for it.

Bright and early next morning, you're at the site with the auxiliary transmitter on the air, so you can do some more troubleshooting on the main. All the capacitors in the circuit check good, the diode stack checks out, and out of other ideas, the spare final is installed. Still with no firm diagnosis, the transmitter is operated into the dummy load with everything operating as it should. After a few minutes, the transmitter goes down with overloads indicated in the high-voltage supply.

About the only thing left to check is the power transformer. It checks OK with your VOM, but signs are really pointing to it shorting. There's no spare to substitute, and it's too expensive to replace just on a hunch. You get a great idea that might work.

With power off, and everything discharged, the transformer is unbolted from the chassis of the transmitter. A piece of plywood is put under the transformer, insulating it from the rest of the transmitter. Finally, you locate an in-line fuse-holder and connect it from the chassis of the transmitter to the frame of the transformer. You then install a 1 amp fuse in the holder and button everything back up.

The transmitter ran fine for the next week. During your weekly maintenance, with the standby transmitter on the air, you discover the fuse blown in your temporary fuse holder. That proves it - - the transformer is shorting to ground intermittently. Until you get a new transformer, you leave the plywood in place, and label the transformer as being "hot".

A few weeks later, the new transformer is installed. Finally, no three AM calls.

NORTHERN
MAGNETICS

CERTIFIED TAPE HEAD SERVICES

Northern Magnetics is an industry leader in the supply and service of tape heads and tape head products.

P.O. Box 16409
Minneapolis, MN 55416

Phone: (612) 333-3071
Telex: 1561238 MPS UT
FAA Repair Station # C14-57

ADVANCED BROADCAST CONSULTANTS

JOSEPH S. SHERMAN

IHOR "SLIM" SULYMA

APPLICATIONS & FIELD SERVICES

204-B CROSS KEYS RD. ■ BERLIN, NEW JERSEY
(609) 767-7070 08009

The Dorrrough Console Model 700

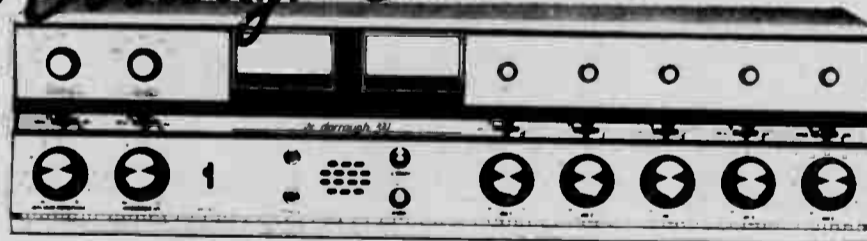

Dual Channel Mono Console

Features

- Seven mixing positions
 - Two microphone positions with switchable third
 - Five line level positions with three inputs each
 - Two balanced program busses
 - Three external monitor inputs
 - Fifteen watt monitor amplifier
 - Shallco stepped attenuators
 - Telephone type key switches
 - Plug-in IC circuits
 - Metal cabinet construction
- Trimpots on all line inputs allow professional and consumer products to be preset to a desirable point of mixer rotation. Easy installation, as microphones are on XLR connectors, line inputs and outputs are barrier strip type, and located on a recessed rear panel.

A HIGH QUALITY CONSOLE AT A REASONABLE PRICE—\$2825.00

Block Diagram

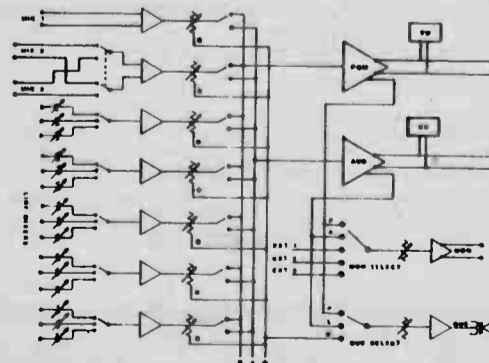

the dorrrough 700

Dorrrough Electronics • 5221 Collier Place • Woodland Hills, CA 91364 • (818) 999-1132