

Speaker Builder

THE LOUDSPEAKER JOURNAL

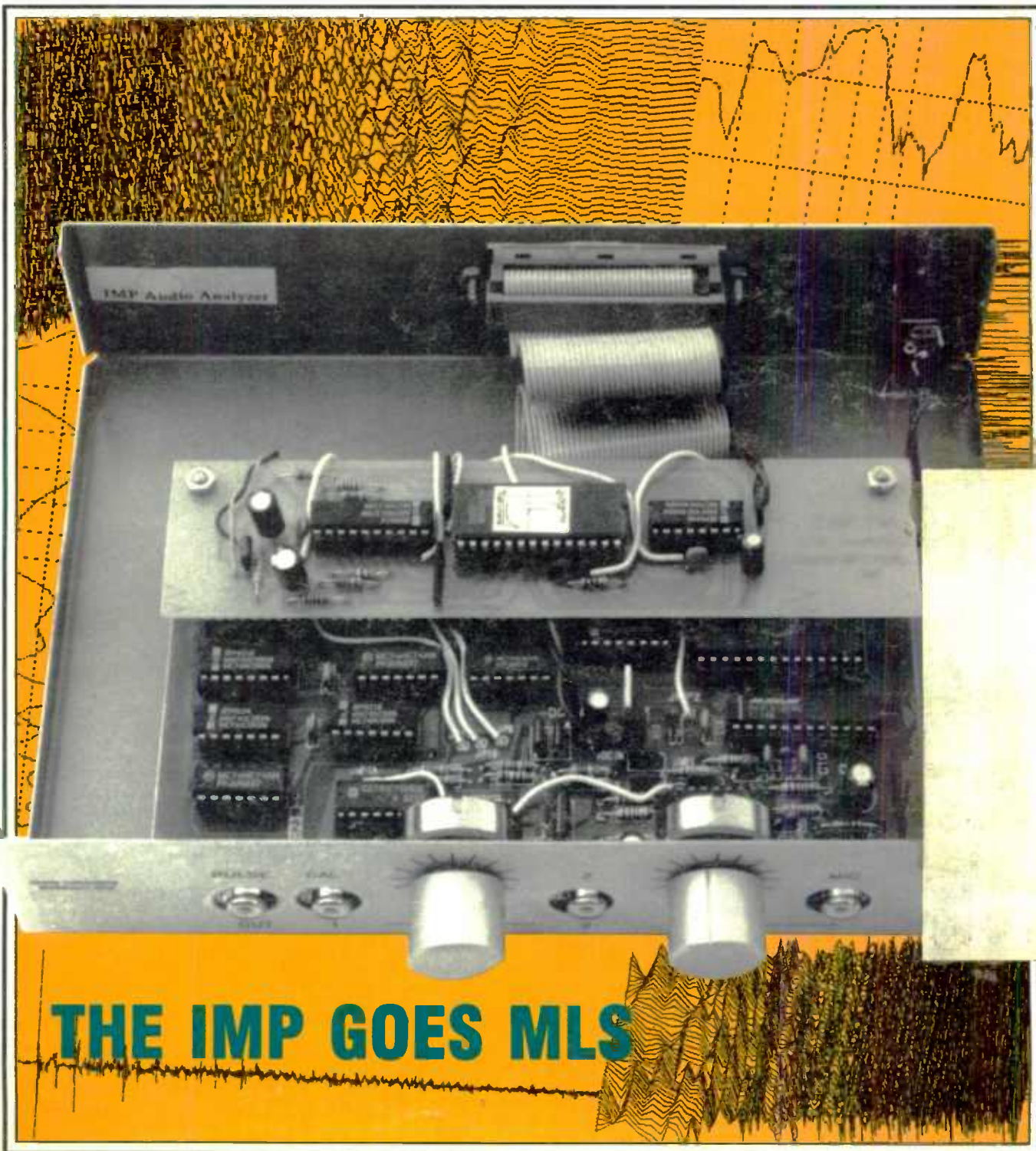

THE IMP GOES MLS

What do ...WILSON AUDIO, VTL, AUDIO RESEARCH, HALES, SONIC FRONTIERS, CARY, ARTEMIS, NESTOROVIC, PARADOX, MAS, WHATMOUGH, JACKSON BROWNE STUDIOS, ATHENA PRODUCTIONS, WATER LILY ACOUSTICS... **have in common?**

The MultiCap

Why? FIRST – because it improves the sonic performance of their products. Audio manufacturers around the world are increasingly aware that when they need the best performance, MIT's unique, patented self-bypassed MultiCap delivers what other capacitor manufacturers claim but cannot offer: the highest level of *sonic* performance.

SECOND – MIT offers more: We can help you get the best results from our capacitors in your designs. MIT has over a half-million dollars in advanced test equipment. We know what it means when a capacitor

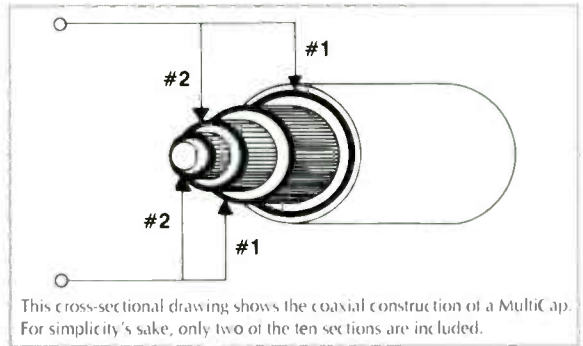

has "phase deviations," "high ESR," and "high series inductance." We know how important it is – to the final sound of your products – to reduce these and other parasitics.

Whether you use all MultiCaps in your all-out efforts or a few in only the most critical places for cost-effective products, you will find the MultiCap advances performance.

So get the real story: We don't want you to invest thousands of dollars in the best drivers and equipment only to have your sonics bottle-neck through a \$2 capacitor. MIT's conservative designs are trusted throughout the industry – our 200 volt dielectric is equivalent to another "audiophile-grade" capacitor's 600 volt rating!

Call us for our literature – which major capacitor companies outside of audio have used in in-house training for its informative and accurate presentations. And don't hesitate to call us for application advice.

MIT MultiCap

"The most advanced capacitor design in the world."

For U.S. Inquiries: CVTL Inc.,
Component Division of Music Interface Technologies
3037 Grass Valley Hwy.
Auburn, CA 95603
(916) 823-1186 FAX (916) 823-0810

Papers Available

Considerations for a High Performance Capacitor
The MIT MultiCap: Phase Response vs. ESR
MIT Introduces the New Metallized MultiCap
The MIT MultiCap in Power Supplies & Filter Circuits
The MIT Film & Foil MultiCap: Installation & Applications
Questions & Answers About Capacitors

For International Inquiries:
MIT Components
760 Pacific Road, Unit 19
Oakville, ONT Canada L6L 6M5
(416) 847-3277 FAX (416) 847-5471

Good News

■ SNELL

The Type D three-way loudspeaker has flat response to within $\pm 1.75\text{dB}$ from 36–20kHz (half-space anechoic), both on- and as much as 25° off-axis. The design supports use with amplifiers rated from 20–200W/channel. Driver configuration includes a 1" titanium dome tweeter with a pleated titanium surround, a rear-firing supertweeter, a 5" midrange driver, and an 8" woofer. Snell Acoustics, 143 Essex St., Haverhill, MA 01832, (508) 373-6114, FAX (508) 373-6172.

Reader Service #70



⌚ POLYDAX

The AW025S1 tweeter combines a pure titanium diaphragm with a soft polymer suspension. Its moving assembly integrates a high-energy acoustic lens with an adjusted suspension. The motor structure is magnetically shielded for audio/video applications. Frequency range is 3–20kHz, with a free-air resonance of 1.5kHz, power handling of 80W RMS, and a sensitivity rating of 92dB 1W/1M. Polydax Speaker Corp., 10 Upton Dr., Wilmington, MA 01887, (508) 658-0700, FAX (508) 658-0703.

Reader Service #52

■ WILMSLOW AUDIO

The ATCK50 and ATCK100 kits offer highly damped hi-fi/studio drive units, soft-diaphragm midrange units, high-frequency units (damped fabric diaphragm), and edge-wound ribbon voice coils. Optimized suspension systems allow maximum cone extension. The kits represent a collaboration between Wilmslow Audio and ATC Loudspeaker Technology. Wilmslow Audio Ltd., Wellington Close, Parkgate Trading Estate, Knutsford, Cheshire WA16 8DX, England, (0565) 650605, FAX (0565) 650080.

Reader Service #59



■ C&S AUDIO

The Woofer Tester is a combination hardware and software system that runs on any IBM-compatible PC with EGA or better graphics capability and at least one RS-232 serial port. The software (one 3.5" diskette) will give all measurements needed to characterize a raw driver and design and build closed- or vented-box woofer systems, including woofer and system resonant frequencies, Q, and system tuning ratio. Test results are available both onscreen and written to the PC disk drive. C&S Audio Labs, Floyd, VA, (301) 498-8737.

Reader Service #53



⌚ LIBERTY

The IMP Audio Analyzer is a Fast Fourier Transform spectrum, impedance, and network analyzer for use with IBM-compatible computers. The device, which makes frequency response and phase measurements, connects externally to the computer via the standard printer port. The IMP's graphically based software enables extraction of quasi-anechoic

acoustic measurements, transient response analysis in 3-D "waterfall" format, and correction for microphone response, among other features. Liberty Instruments, Inc., PO Box 1454, West Chester, OH 45071. Also available from Old Colony Sound Lab, PO Box 243, Peterborough, NH 03458-0243, (603) 924-6371, FAX (603) 924-9467.

Reader Service #54

⌚ AUDIOCONTROL

The new C-101 Series III octave equalizer has a built-in digital pink-noise test generator and a real-time audio spectrum analyzer. Octave-spaced sound controls allow for adjustment while pairing left and right sliders. The Series III can be connected to any home stereo, comes with a calibrated microphone, and features an 18dB/octave Chebychev alignment subsonic filter. AudioControl, 22313 70th Ave. West, Mountlake Terrace, WA 98043, (206) 775-8461, FAX (206) 778-3166.

Reader Service #57

Good News

■ POLYDAX

The latest line of woven Kevlar® cone mid-bass speakers includes the HT100K0 (4"), HT130K0 (5¼"), HT170K0 (6½"), and HT210K0 (8"). Design features include high-loss rubber surrounds, large (20 oz.) magnet structures, and high-temperature voice coils wound on aluminum voice coils. Polydax Speaker Corp., 10 Upton Dr., Wilmington, MA 01887, (508) 658-0700, FAX (508) 658-0703.

Reader Service #51

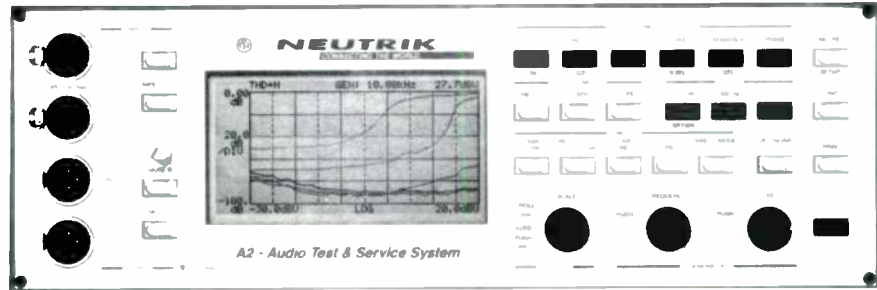

Ⓞ NEUTRIK

The A2 Audio Measurement System controls and maintains transmission and reproduction sound quality. The stand-alone unit can be used with or without computer interface to proof and service broadcasting and recording equipment. Measurement functions include harmonic and intermodu-

lation distortion, noise, phase shift, and crosstalk. The device has a built-in digital storage audio oscilloscope and spectral analyzer. For more information contact Vincent DeSouza, Neutrik Instruments, Inc., (514) 344-5220.

Reader Service #55

■ WORLD COLLEGE

The Cleveland Institute of Electronics has announced the organization of its affiliate college, offering bachelor's degrees in electronics engineering technology (pending approval from the Virginia Council of Higher Education). The college

offers extensive electronics and related courses, and is accredited for home study. World College, 1776 E. 17th St., Cleveland, OH 44114, (800) 243-6446.

Reader Service #75

■ NORTH CREEK

Three new Unlimited Series kits from North Creek (for crossover, cabinet, and Okara loudspeakers) all feature the Scan-Speak D2905 fabric dome tweeter, Vifa and Scan-Speak woofers. Unlimited Crossovers are housed in their own dedicated enclosure, and feature 10 AWG inductors, polypropylene caps, and Ohmite

1% precision power resistors. All components are matched to ±1%. Also new is the complete passive crossover replacement for the B&W 802 Series II and III loudspeaker systems. North Creek Music Systems, Route 8, PO Box 500, Speculator, NY 12164, (518) 548-3623.

Reader Service #58



Ⓞ PARASOUND

The second generation of the HCA-1200 power amp has been certified by Lucasfilm THX™ Home Cinema. It incorporates new John Curl circuitry and 5-mm-thick, 19" rack-mount panel. The HCA-1200II has output of 205W/channel into 8Ω, 2 × 315W into 4Ω, and >630W bridged into 8Ω. A 1kVA toroid transformer with 60,000µF power supply sustains continuous 40A and peak 57A current with 2dB headroom. Curl's design includes ten pairs of 60MHz, 15A bipolar output transistors. Parasound Products, 950 Battery St., San Francisco, CA 94111, (800) 822-8802.

Reader Service #65

Ⓞ PYLE INDUSTRIES

Pyle NeoDome™ tweeters utilize focused field neodymium magnet structures and chemically laminated titanium domes. Other features include ferrofluid-cooled motors and computer-designed housings. Three models are available with surface, flush or pivot-mount housings. Pyle Industries, Inc., 501 Center St., PO Box 620, Huntington, IN 46750, (219) 356-1200, FAX (219) 356-2830.

Reader Service #62



Speaker Builder (US ISSN 0199-7920) is published bi-monthly, at \$25 per year, \$45 for two years, Canada add \$6 per year; overseas rates \$40 one year, \$70 two years; by Edward T. Dell, Jr., President at 305 Union Street, PO Box 494, Peterborough, NH 03458-0494. Second class postage paid at Peterborough, NH and an additional mailing office.

POSTMASTER: Send address change to:

Speaker Builder, PO Box 494
Peterborough, NH 03458-0494

Continued on page 6



HEAR, HERE!



Our 1993 product line just arrived and there's lots to celebrate. A comprehensive array of nearly 100 drivers. Innovative technologies. Leading edge materials. Engineered to provide flexibility in your design process and clear cut sonic quality advantages at every level of performance.

*You've heard about our quality for years.
Now's the time to hear it for yourself.*

polydax
SPEAKER CORPORATION

Subsidiary of Audax Industries, France.
For your nearest authorized distributor
please call 508.658.0700

Good News

■ IMPULSE

The H6 horn loudspeaker incorporates the same high-frequency unit used in the H1 and H2 models with compact design. Cabinet dimensions are 36" x 7.5" x 14". Nominal impedance is 8Ω with sensitivity of 89dB (2.83V at 1M). Low and midfrequencies are produced by a doped paper coned drive unit which is backloaded by a horn. Impulse Loudspeakers, 5 High Parade, Streatham High Road, London SW16 1EX, (081) 769-5726, FAX (081) 769-0353.

Reader Service #64

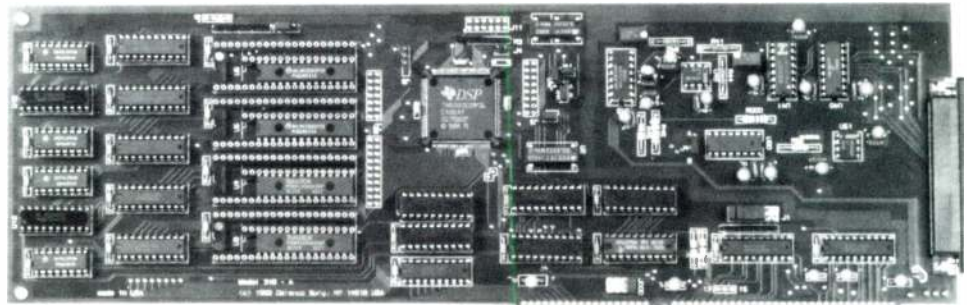

Ⓞ DALANCO SPRY

The Model 310A DSP and Data Acquisition Board was designed for the IBM PC/AT and bus-compatible microcomputers. Based upon the Texas Instruments TMS320C31, the floating-point DSP operates at 33MHz for up to 33 MFLOP performance. The Model 310A provides data acquisition for four differential channels at 14-bit resolution, with programmable gain and a maximum sampling rate of 150kHz. Dalanco Spry, 89 Westland Ave., Rochester, NY 14618, (716) 473-3610, FAX (716) 271-8380.

Reader Service #63

■ M&P TECHNOLOGIES

All Selenium products (woofers, horn drivers, horns and tweeters) are now available from M&P. The Pro Unit Woofers (12", 15", 18") feature 1kW continuous power handling with up to 100dB SPL (1W/1M). Factory computer-aligned set screws allow for replacement of cone, spider, former and voice coil. Selenium also manufactures customized speakers. M&P Technologies, Inc., 75 E. Uwchlan Ave. #128, Exton, PA 19341, (800) 355-0500, FAX (215) 524-5531.

Reader Service #67

■ M&K

The S-90 speaker system was designed to achieve a timbre-match with other front-channel speakers to avoid the sonic discontinuity which occurs when sound pans across the left, center, and right

channels of unmatched speakers. Miller & Kreisel Sound Corp., 10391 Jefferson Blvd., Culver City, CA 90232, (310) 204-2854, FAX (310) 202-8782.

Reader Service #74



Ⓞ SYON

TRU-BOND® premixed, two-part frozen epoxy compounds are available in a variety of standard and custom formulations, including electrically and thermally conductive, and copper- and silver-filled. Packaged in 2-60 cc syringe kits, the compounds cure to a 85 Shore D hardness, with flexural strength of 6,000 psi. They are resistant to moisture, acids, and alkalis. Syon Corp., 280 Eliot St., Ashland, MA 01721, (508) 881-8852, FAX (508) 881-4703.

Reader Service #66

Ⓞ DECADE ENGINEERING

LoudMan™ is a 30W/channel stereo power amplifier kit designed for direct connection to the ear-phone jack of a Walkman™ or other low-power stereo product. It can also drive high-performance 8Ω speakers from portable stereos. Kit includes glass-epoxy PC board, heatsink, all electronic com-

ponents, assembly instructions, and Theory of Operation document. Total power is 60W and load impedance ≥8Ω, with typical mid-band distortion below 0.05%. Decade Engineering, 2302 5th St. NE, Salem, OR 97303, (503) 363-5143, FAX (503) 399-9747.

Reader Service #61

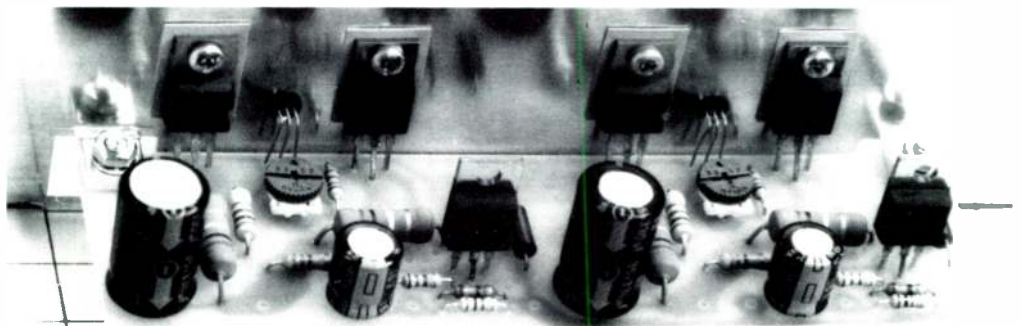

Good News

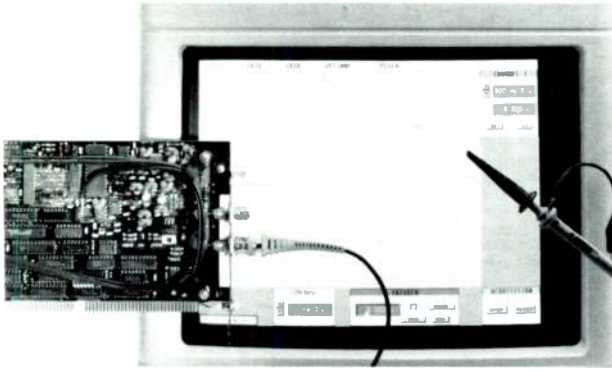

PC INSTRUMENTS

The 420 and 430 Series oscilloscope boards for PCs provide two independent channels in one expansion slot. The single-channel scopes can be upgraded to dual channel. Both are available with two different attenuators, and provide 200MHz bandwidth, 500 ps/div minimum timebase setting, and 200 gigasample/sec. equivalent sampling rate. Optional BenchCom™ software handles scope controls and waveform display, and allows communication with existing software. PC Instruments, Inc., 9261 Ravenna Rd., Bldg. B11, Twinsburg, OH 44087, (216) 487-0220, FAX (216) 425-1590.

Reader Service #71

SCANTEK

The new brochure on the precision Type 116 Sound Level Meter from Norsonic describes features and specifications. With an 80dB dynamic range, the meter simultaneously measures peak and RMS values of A- and C-weighted noise levels. Data is presented both numerically and graphically, and the unit is PC compatible. Scantek, Inc., 916 Gist Ave., Silver Spring, MD 20910, (301) 495-7738, FAX (301) 495-7739.

Reader Service #68

POLYDAX

AUDIO TALK, Polydax's new quarterly newsletter, informs speaker enthusiasts of new developments, products, and ideas within the industry. Articles are written by professionals both inside and outside the company. Topics covered in the first edition include break-

throughs in loudspeaker technology and new products entering the market. Polydax Speaker Corp., 10 Upton Dr., Wilmington, MA 01887, (508) 658-0700, FAX (508) 658-0703.

Reader Service #73

MEADOWLARK

Keldamp is an adhesive-backed gasket material made from a high-density compound with damping characteristics which control the transfer of energy between driver and enclosure. The material does not flatten out, but retains its resili-

ency to ensure an air-tight seal. Keldamp is available in 1/16" x 1/2" x 108' rolls, and in other thicknesses and widths. Meadowlark Audio, 1648 Marbella Dr., Vista, CA 92083, (619) 598-3763.

Reader Service #60

DESIGN ACOUSTICS

Features of the 15-inch-high DA800 bookshelf model speaker include broad bandwidth (150Hz-4kHz), 8" downward-firing woofer, and small front baffle. Diffraction effects are further reduced with Sonofoam acoustic foam. Design Acoustics Division, A.T.U.S., Inc., 1225 Commerce Dr., Stow, OH 44224, (216) 686-2600.

Reader Service #56

TRI-STATE

The new catalog of home stereo, automotive, and professional speakers, parts and accessories, refoaming and reconing services is now available. Normally a \$1 value, the catalog is currently being offered free to any speaker builder who calls. Tri-State Loudspeaker, 650 Franklin Ave., Aliquippa, PA 15001, (412) 375-9203.

Reader Service #69



B&W

The Matrix 803 Series 2 loudspeaker features three 6" drivers, and a sloping shelf; cabinet dimensions have also been reduced. Frequency range is 20Hz-22kHz; sensitivity is 90dB SPL (2.83V/1M); nominal impedance is 8Ω. B&W Loudspeakers of America, PO Box 653, Buffalo, NY 14240, (800) 387-5127.

Reader Service #72

New!
LEAP

Version 4.5

LEAP

Precision Development Tools for Precision Loudspeaker Designs

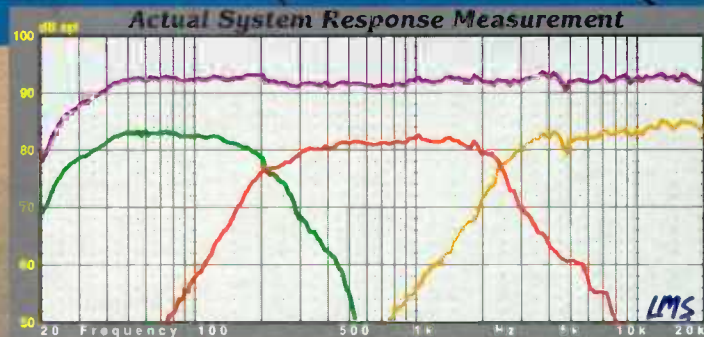
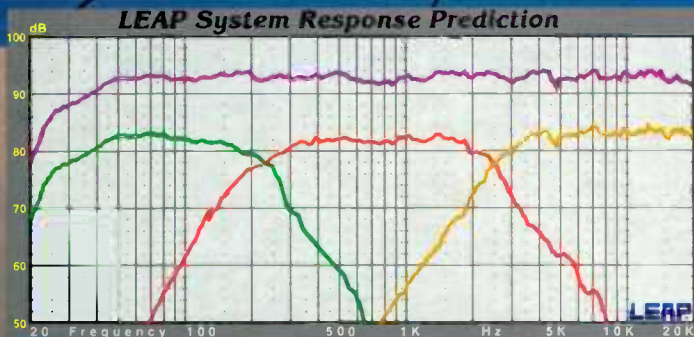

The Art and Science... of loudspeaker system development today has become more complex than ever before. Competition is tough, and to compete each design must perform to the best of its ability, and make the most out of every dollar's worth of transducer cost. The simple approach of choosing a combination of seemingly appropriate transducers coupled with ordinary networks and filters, has given way to a painstaking process of meticulously blending selected transducers in combination with carefully devised and matched crossover designs.



LEAP (Loudspeaker Enclosure Analysis Program) is a complete full range analysis package which provides virtually all of the tools necessary to develop precision loudspeaker systems, for today's demanding audio markets. Whether your applications are consumer audio, car stereo, professional audio, or custom esoteric marvels, LEAP provides the power, flexibility, and accuracy to investigate every possible design permutation. The open architecture and broad spectrum of features provided will dramatically reduce your development time, while improving the quality of the final result... and demonstrates why LEAP has become the #1 choice of professional loudspeaker designers world-wide!

Advanced System Analysis Features

- ✓ Use simulation or imported actual measured SPL/Z data.
- ✓ 5-Way crossover system modeling, and more.
- ✓ Time offset between transducers.
- ✓ Active or Passive based crossovers.
- ✓ Hilbert-Bode transform for deriving phase.
- ✓ 22 Passive components per xover section.
- ✓ 16 Active filter blocks per xover section.
- ✓ Passive Network Optimizer for single/system response.
- ✓ Active Filter Optimizer for single/system response.
- ✓ Frequency ranges from 1Hz to 100kHz.

Printer/Output Formats

- When you wish to produce a hardcopy output of your finished designs and graphical data, LEAP supports a large number of printer standards, and even supports numerous desktop publishing graphic formats in both black & white and color! Portrait/Landscape orientations in any custom size and aspect ratio are user controllable.
- ✓ IBM/Epson 8 Pin Dot Matrix
 - ✓ Epson 24 Pin Dot Matrix
 - ✓ HP LaserJet Series Printers
 - ✓ HPGL Compatible Plotters
 - ✓ PostScript EPS/TIF, B&W, Color
 - ✓ AI-Adobe Illustrator, B&W, Color
 - ✓ NEC 24 Dot Matrix
 - ✓ TOSHIBA 24 Dot Mat
 - ✓ HP DeskJet 500C
 - ✓ PostScript Printers
 - ✓ DXF AutoCAD
 - ✓ TIFF, BMP, PCX Plots

Extensive Documentation

The two volume manual set comprises almost 1,000 pages of documentation which thoroughly covers the operation of the program and provides numerous examples of how to maximize your use and understanding of the program's many features. The Reference Manual describes all graphs, menus, commands, and their operation. This manual explains the unique and special non-linear speaker and port models, as well as proper use of the optimizers, importing data, and the many other utilities. The Application Manual provides many exciting examples showing how to use the powerful features of the system in a combined manner to perform both simple and complex design tasks. Both novice and experienced users alike will find this information invaluable for exploiting the full power of the system. Additional information is also provided on loudspeaker measurements, design tips, filter calculations, and complete crossover system development for both passive and active based systems.

- ✓ 502 Page Reference Manual
- ✓ 436 Page Application Manual

Advanced Transducer/Enclosure Simulations

- ✓ Sealed, Vented, Bandpass, PR Simulations with multiple speaker/ port capability.
- ✓ Large signal analysis of TempVC, and Non-Linear BL/ Ports/ Compliance.
- ✓ Acoustic Parallel or Acoustic Series (Isobaric) Driver Mounting.
- ✓ Port Standing Wave resonance modeling.
- ✓ Frequency Dependent Revc and Levvc modeling.
- ✓ Library storage of 36 transducer parameters, and over 24 enclosure parameters.
- ✓ Generic transducer modeling of electro-dynamic, ribbon, and piezo devices.

LinearX Systems Inc
7556 SW Bridgeport Rd
Portland, OR 97224 USA
Tel: (503) 620-3044 Fax: (503) 598-9258

Call for a free
Demo Disk!
TEL: (503) 620-3044



■ Seminars/Workshops available, call for details.

International Dealers: Argentina: Interface SRL (54-1)778-2713/Australia: ME Technologies 61(0)65-50-2200/Austria: Audiomax 49(0)71 31-162225/Belgium: Belram 32(0)2-736-50-00/Brazil: SDS Equipamentos 55(0)11-887-7597/Canada: Gerraudio 416-696-2779/China: Rhyming Industrial 86(7620)562-011/Denmark: A&T Ljudproduktion 46(0)8-623-08-70/France: Belram 32(0)2-736-50-00/Germany: Audiomax 49-71-31-162225/Indonesia: Ken's Audio 62(0)21-380-2118/Italy: Outline snc 39-30-3581341/Korea: Sammi Sound: 82(02)463-0394/Luxembourg: Belram 32(0)2-736-50-00/Malaysia: AUVI 65-283-2544/New Zealand: ME Technologies 61-65-50-2254/Norway: A&T Ljudproduktion 46(0)8-623-08-70/Poland: Inter-Americom 48(22)43-23-34/Singapore: AUVI 65-283-2544/Spain: Audio Equipment Services 34(94)681-81-20/Sweden: A&T Ljudproduktion 46(0)8-623-08-70/Switzerland: Audiomax 49-71-31-162225/Taiwan: Gestion Taycan Intl 886-2-562-3883/Thailand: AUVI 65-283-2544/The Netherlands: Duran Audio 31-41-80-15583/Turkey: Silver Productions 44(0)722-336221/UK(England): Munro Assoc 44(0)71-379-7600.

Editorial

TIMELY NEWS

The upcoming 1994 year marks two anniversaries: This magazine turns 15, and *Audio Amateur* will celebrate a quarter-century of publication. I confess to being somewhat surprised by this turn of events, but, on the whole, rather pleased to have seen a pair of brainchildren survive for this time span.

Much is new with your publishing company. We are now a corporation for any number of reasons—which mostly escape me most of the time. The folks we pay to advise us about such things all seem to think it is a good idea. So we are. For legal reasons I sign things these days with a pretentious pair of titles, but my favorite appellation still continues to be: Editor/Publisher.

A number of new people have joined our ranks recently. Although Laurel Humphrey is not new to the company, having served as a circulation clerk for a year previously, she returned to us as Circulation and Promotion manager last June. Already activities in her important department have become greener since a national brokerage now handles our mailing lists and we have added several new, large newsstand outlets, one of them being Tower Magazines, a division of Tower Records. She also manages circulation promotion and a pesky computer network we are trying to subdue to our will.

Martha Povey has joined us as National Advertising Director, coming to us from stints at the WGE and IDG organizations here in Peterborough. Her work is being aided considerably by those we recently asked to help us by responding to a survey form about who you are, what you do, how you use this magazine and just how you practice your hobby of speaker building. We'll have a full report in the magazine early next year. Meanwhile Martha is getting to know our advertisers and working

with them to bring you details about their offerings of wares and services.

And speaking of news, we are exceptionally pleased to announce an additional two issues of *Speaker Builder* beginning in 1994. This brings the total to eight per year, giving us room for more articles, pictures, reports and reviews. That means a price increase also, unfortunately, but we still welcome your renewal at the 1993 rate for six issues if you act before December 31 of this year. The new rate of \$32 per year (U.S. only) becomes effective as of January 1, 1994.

You may have noticed a new look in our other periodicals having to do with typefaces and page design. The "look" now comes to *Speaker Builder* as well. By now everyone has heard of desktop publishing. While we are not, as yet, fully "desktop" we are moving closer by the week. In time, our pages will go to our printer on a removable data storage disk or on a high speed modem, rather than a large package of film negatives from which printing plates are made.

Text has, for many years, been computer generated and fed to a digital typesetting machine. But the latter used photosensitive paper which required development in a large machine full of water and chemicals. As this issue goes to press, the "old" typesetter leaves the building bound for a nearby printing establishment to upgrade a system even further behind technologically than ours. You will see further changes in the look of our pages as the months pass. We welcome your comments, as always.

You might be interested to know that our overseas subscriber lists are growing faster, in some cases, than those within the U.S. Almost one out of four of *Glass Audio's* subscribers lives outside the United States. This reach to the other countries of the world includes the books this

company publishes through its Old Colony division. Vance Dickason's bestselling *Loudspeaker Design Cookbook* is now also available in German and Portuguese translations. We hope to announce other versions soon.

Speaking of new books, we are offering a couple of new ones full of old ideas. *Audio Anthology* No. 5 is now off the press. This popular series is a resurrection of one published by the precursor of *Audio* magazine in the early sixties. The other oldie resurrects a selection of editorials from *Audio Amateur* over its first fifteen years and puts them between hard covers. It offers a few predictions, meditations on music and other matters under the title *Of Mockingbirds and Other Irrelevancies*. Pick up a copy at your local 7-11 or wherever popular titles are sold.

I find it interesting to note how far we have moved in this quarter century span. Life for these periodicals began in 1969 in the attic room of 307 Dickinson Avenue, Swarthmore, Pennsylvania. We did our work on blue gridded sheets of legal size paper, typing on a used IBM Selectric typewriter. For headlines we reached for presstype, and changed the Selectric's golfballs to do italic or boldface.

As I sit in our building in Peterborough twenty-four years later, I am capturing this text in Times New Roman, 12 point (and two keystrokes enables italic) under the guidance of Microsoft Word for Windows on a 486/50MHz IBM clone, with Vaughan Williams' Symphony No. 4, conducted by Sir Adrian Boult, coming to my ears through headphones being fed by a CD ROM player in the top slot of the computer. The distance somehow seems a whole lot more than 24 years. But *what* a journey. I would not have missed it for anything.—E.T.D.

PC AudioLab

...Finally, a complete low cost PC based solution for all of your loudspeaker and audio measurements. Use your home computer and the CD quality 16 bit sound card from Media Vision to actually measure the performance of your loudspeakers, electronics and crossover filters. PC AudioLab does it all!

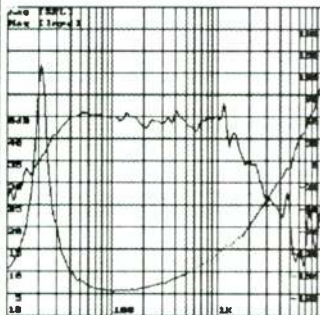

System Requirements:

- IBM 386/486 AT / coprocessor
- 4 Mb RAM memory
- VGA Graphics Display
- Media Vision Pro 16 Sound Card



MICROACOUSTICS
AUDIO SOFTWARE PRODUCTS



MEDIA VISION

2553 CARPENTER ST., THOUSAND OAKS, CA 91362 (818) 719-2566 PHONE/FAX

Reader Service #20

PRODUCT HIGHLIGHTS:

- OSCILLOSCOPE
- SPECTRUM ANALYZER
- NETWORK ANALYZER
- DISTORTION ANALYZER
- LOUDSPEAKER ANALYZER
- IMPULSE ANALYZER
- ROOM ACOUSTICS ANALYZER

- TEST CABLES
- DETAILED MANUAL
- GRAPHICAL USER INTERFACE
- PRINTER OUTPUT SUPPORT
- MOUSE SUPPORT

About This Issue

The articles appearing in this, the final issue of 1993, are testimony to the ingenuity of speaker builders. Each design bears the indelible stamp of its creator, as evident in our lead article. Already well-known for his show horns, Contributing Editor **Bruce Edgar** describes the process of designing, constructing, and testing "The Monolith" (p. 12). We think you'll be impressed by this massive undertaking.

Do your speakers take up too much space? As a solution, **Bill Fitzmaurice** proposes "Orbiting Satellites," beginning on page 26. It just goes to show what a little furniture remodeling can do for your creativity. In this case, it transformed Bill's beloved Klipsch clones into something out of this world.

Ralph Gonzalez brings us back to terra firma with variable-Q formulas in "Real-World Three-Way Crossovers" (p. 30). Whether your crossovers are ideal or the nonideal variety, the computer program Ralph describes will enable you to choose exactly the right Q for your system.

Riddle: How is a loudspeaker like a string instrument? As **Ernie Pfannenschmidt** explains, it's all in the enclosure. His design begins with a simple analogy—in fact, he calls it "The Simplex"—and, for ease of construction, it lives up to its name. Simple is definitely better, as you'll learn beginning on page 32.

Faithful *SB* readers are familiar by now with **Bill Waslo's IMP**: it was born in our pages almost one year ago. This chapter in the IMP saga describes noise stimulus, maximum length sequence test signal, and the new version M software with all its bells and whistles, as "The IMP Goes MLS" (p. 40).

For an idea of how an "average" speaker builder appears to the uninitiated, turn to page 38, where **Nancy MacArthur** describes "Living With a Speaker Builder." Obviously, she's totally objective and unbiased! The tables have turned with this gritty exposé of the "other side."

Rounding out this issue, **Bob Wayland** sets the record straight in "Wayland's Wood World" (p. 50); the resources of several *SB* readers have been pooled in "Tools, Tips & Techniques" (p. 56); and **Stephen Katz** describes his gym horn in "Craftsman's Corner" (p. 60).

See you next year!

Speaker Builder

The Staff

- Edward T. Dell, Jr.** Editor and Publisher
Contributing Editors
Joseph D'Appolito **Robert Bullock**
John Cockroft **David Davenport**
Vance Dickason **Bruce C. Edgar**
Gary Galo **G.R. Koonce**
Mary Wagner Managing Editor
Brenda Baugh Assistant Editor

Christine Orellana Graphics Director
Glenn Galloway Production Assistant

Laurel Humphrey Circulation Director
Circulation Assistants
Doris Hamberg **Pat Kavenagh**
Robyn Lasanen

Advertising

- Martha L. Povey**
National Advertising Director
Diane J. Smith
Advertising Coordinator
(603) 924-9464 FAX (603) 924-9467

The peculiar evil of silencing the expression of an opinion is, that it is robbing the human race; posterity as well as the existing generation; those who dissent from the opinion, still more than those who hold it."

--JOHN STUART MILL

Speaker Builder is published bi-monthly in the interest of the art and craft of speaker building.

Subscription Inquiries

To subscribe, renew or change address write to Circulation Department. Call (603) 924-9464 or FAX (603) 924-9467 for MC/VISA charge card orders. For gift subscriptions please include gift recipient's name and your own, with remittance. A gift card will be sent.

Send circulation and editorial correspondence to PO Box 494, Peterborough, NH 03458-0494. No responsibility is assumed for unsolicited manuscripts. All MSs must include a self-addressed envelope with return postage. The staff *will not* answer technical queries by telephone.

Printed in the USA. No part of this publication may be reprinted or otherwise reproduced without the written permission of the publisher. Copyright ©1993 by Audio Amateur Publications, Inc. All rights reserved.

Speaker Builder

THE LOUDSPEAKER JOURNAL

VOLUME 15 NUMBER 6

DECEMBER 1993

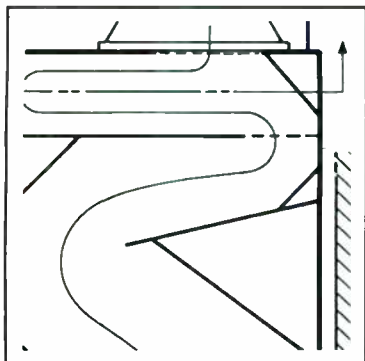

12

12 The Monolith Horn

BY BRUCE C. EDGAR

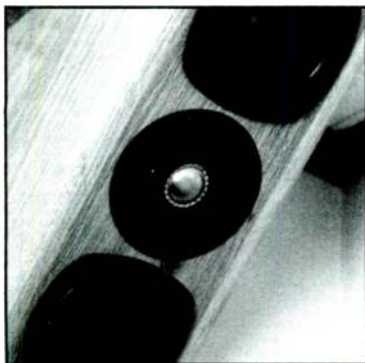

26

26 Orbiting Satellites

BY BILL FITZMAURICE

30 Real-World Three-Way Crossovers

BY RALPH GONZALEZ

32 The Simplex

BY ERNIE PFANNENSCHMIDT

38 Living With a Speaker Builder: A View From the Other Side

BY NANCY MACARTHUR

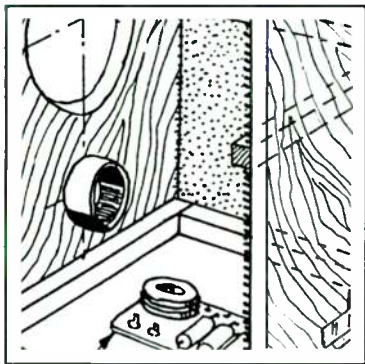

32

40 The IMP Goes MLS

BY BILL WASLO

DEPARTMENTS

3 GOOD NEWS

9 EDITORIAL *Timely News*

50 WAYLAND'S WOOD WORLD

BY BOB WAYLAND

56 TOOLS, TIPS & TECHNIQUES

BY JAMES T. FRANE, MATTHEW
HONNERT, GARY RIOLO, AND
DON STAUFFER

60 CRAFTSMAN'S CORNER

BY STEPHEN KATZ

62 VINTAGE DESIGNS

63 BOOK REPORT

BY FRED GLOECKLER

65 SB MAILBOX

72 CLASSIFIED

THE MONOLITH HORN

By Bruce C. Edgar
Contributing Editor

After my "Show Horn" article appeared (*SB* 2/90, p. 10), I received a number of inquiries about designing a bass horn that would go down to 30–40Hz. One *SB* reader, Fred Ireson, requested a 40Hz horn for a 15" driver, and I have been refining the design and construction details ever since.

The 40Hz horn is shown in *Photo 1*. Since the structure is rather imposing, I have nicknamed it the "Monolith." Despite some unusual features, such as a mouth that exhausts out of the bottom and a top-mounting driver compartment, the modular construction is well within the capabilities of a skilled home craftsman with a table saw.

EXPERIMENTAL STAGE

Experimentation helped me avoid potential problems. Since bass horns can be huge, designers try tricks such as 180° folds, reducing the mouth size, and shortening the length in an effort to keep the overall volume to reasonable proportions. Unfortunately, if they are not applied intelligently, these techniques can lead to numerous response anomalies.



PHOTO 1: The Monolith Horn.

One of the classic horn-folding designs utilized a series of 180° folds that approximated an exponential flare in steps.¹ The overall response of the rear-loaded bass horn (*Fig. 1*) rolls off above 200Hz, and it is unclear whether this is due to the cone mass or the

folds. If we move the rolloff up to 400Hz, however, we can achieve good wide-band performance with a reduction in volume.

Before conceiving the "Show Horn," I was asked by a reader to design a 50Hz corner horn with the smallest volume (for shipping overseas) plus a wide bandwidth to mate with a 500Hz midrange horn. In my naïveté, I set off on my mission not realizing the potential conflicts in the design requirements. To attain the 500Hz bandwidth, I chose to use the EVM 12L driver, which has a mass rolloff over 500Hz. *Figure 2* is a design sketch featuring several 180° folds with a top-mounted driver and a bottom exhaust mouth—precursor to the Monolith.

I proceeded to build the bass horn and measure its response (*Fig. 3*). You can see the big 20dB "hole" between 300 and 400Hz, which is clearly unacceptable. At first, I didn't have a clue as to the root cause, but after some discussion with Dave Rowe and other colleagues, we arrived at the concept of placing the corner reflectors along the diagonal. When I replaced the existing corner reflectors with larger ones, the response hole partially filled up (*Fig. 4*), indicating that this approach was leading in the right direction.

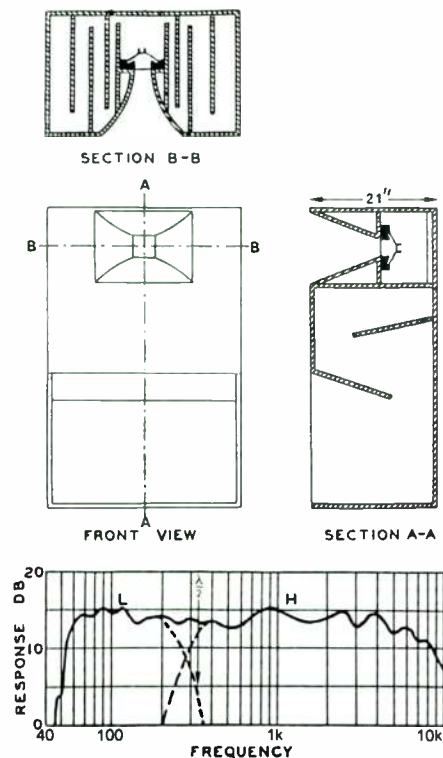

FIGURE 1: Olson and Massa's 1936 horn.

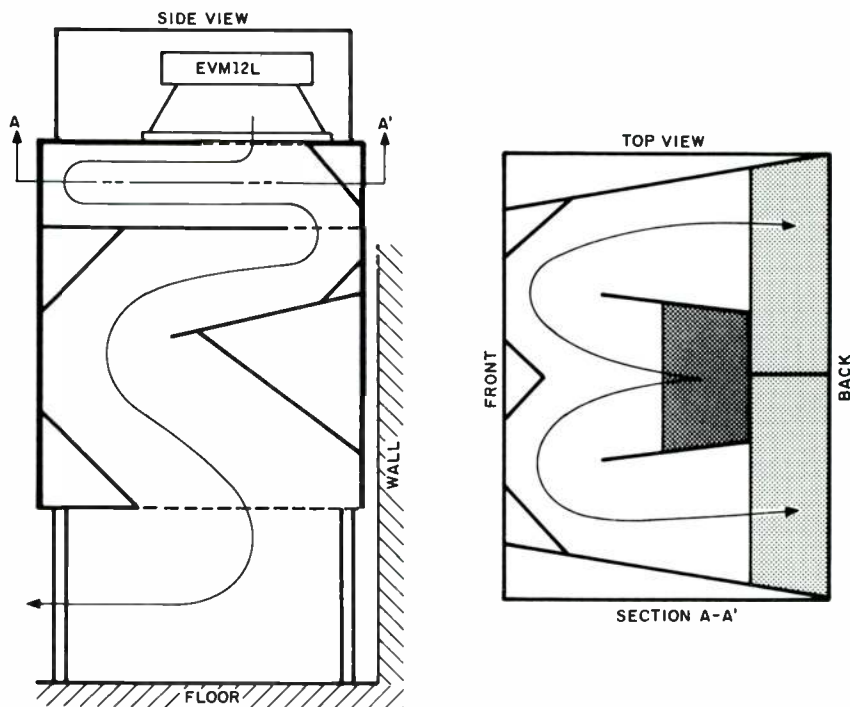

FIGURE 2: An Edgar experimental 50Hz horn design circa 1984.

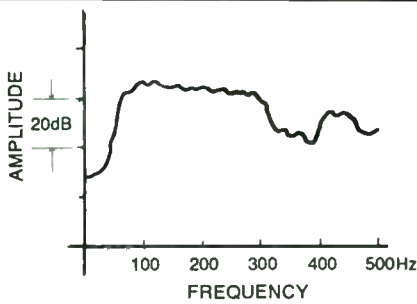

FIGURE 3: Response of the 1984 design with dropout between 300-400Hz.

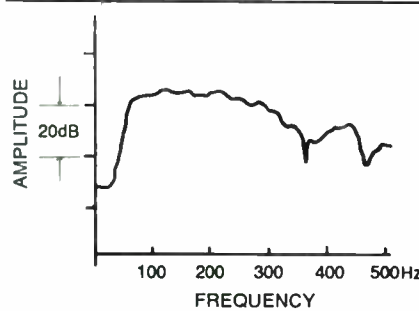

FIGURE 4: Response of 1984 design with diagonal reflectors.

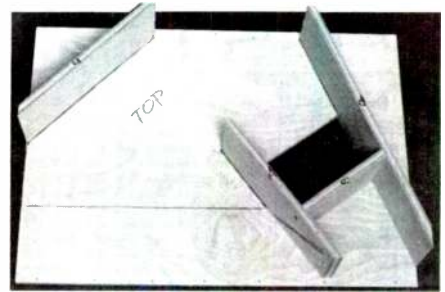

PHOTO 2: Throat partitions mounted to the top.

After the Show Horn article appeared, several people questioned why a diagonal reflector would make such a difference over a radius bend (*SB 2/90, Figs. 4 and 5, p. 14*). The radius bend dimensions are still a fraction of a wavelength (45" at 300Hz), which satisfies Olson's conditions for proper horn folds.²

If you look at a 90° bend from a short-wavelength perspective, a reflector along the diagonal makes more sense. *Figures 5 and 6* graphically show Huygen's construction principle of wave fronts traversing a 90° bend using both types of reflectors. As you can see from *Fig. 5*, a radius-bend reflector gives both backward- and forward-traveling waves in response to the initial wave fronts, and those coming out of the bend are incomplete. Com-

pare that with *Fig. 6*, where no backward-traveling wave exists, and the forward-traveling wave fronts coming out of the bend are completely reconstructed.

A 180° bend can be modeled as an acoustical inductance, and a horn with many folds can be modeled as a series of acoustical transmission-line strips separated by inductances (*Fig. 7*).³ At the frequency where the length of the transmission-line strip is half a wavelength (at 300Hz, 22.5"), any transmission line will transfer to the input the impedance seen at the load end.

If a series of transmission-line strips of equal length are separated by inductances, the input impedance at the half-wavelength condition becomes a bunch of inductances in series. In the case of a multifolded horn where the bends are separated by equal lengths, the inductance load condition at the half-wavelength will swamp the mouth impedance and the response is choked off at that frequency.

In mathematical terms, the frequency for the half-wavelength condition is:

$$f = \frac{c}{2 \times l}$$

where:

c = the speed of sound

l = the length of the horn section between bends

In the case of *Fig. 2*, the length between folds

was 19½", which corresponds to a half-wavelength frequency of 345Hz—right in the response hole of *Fig. 3*. In the case of Olson's horn example, $l = 21"$, for a null frequency of 321Hz. The bass-horn response has a very sharp rolloff at 300Hz, which leads me to speculate that his horn was indeed affected by the null caused by reflections at the bends and the equidistant spacing between bends.

I discovered during my investigation of horn bends that the same principle is used to design mufflers. A muffler is a series of pipe lengths separated by small volumes which are acoustic capacitances. By adjusting the pipe lengths and volumes, you can design a very effective acoustical stop-band filter. So between 300 and 400Hz, my original horn design was behaving like a muffler!

A diagonal reflector will help, but not completely cure, the response ills occurring with 180° bends. You should first try to reduce their number or make them less severe. You can also use the nulling phenomenon from the bends to shape the horn's upper-frequency cutoff to your advantage, such as in a subwoofer horn.

DESIGN STAGE

After some discussion with Fred Ireson, we settled on the JBL 2220H 15" pro driver. Using formulas from the Show Horn article, its T/S parameters ($f_s = 37\text{Hz}$, $Q_{MS} = 0.18$, and $V_{AS} = 10.5 \text{ ft.}^3$) give an optimum throat size of 56 in.² and a mass rolloff of 411Hz. Even though a

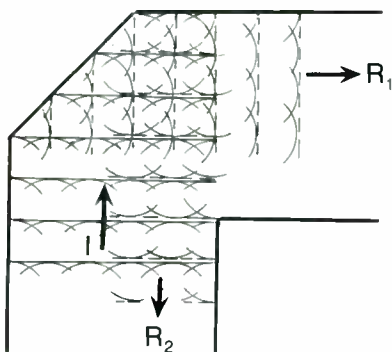

FIGURE 5: Huygen's wavefront construction for a 90° duct bend with a radius reflector. "I" is the incident wave; "R1" and "R2" are the reflected waves.

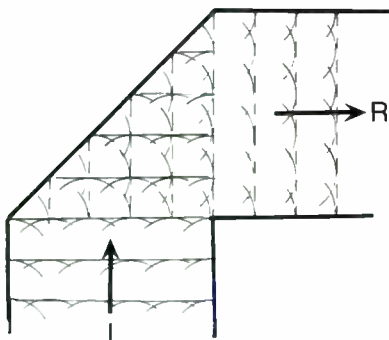

FIGURE 6: Huygen's wavefront construction for a 90° duct bend with a diagonal reflector. "I" is the incident wave; "R" is the reflected wave.

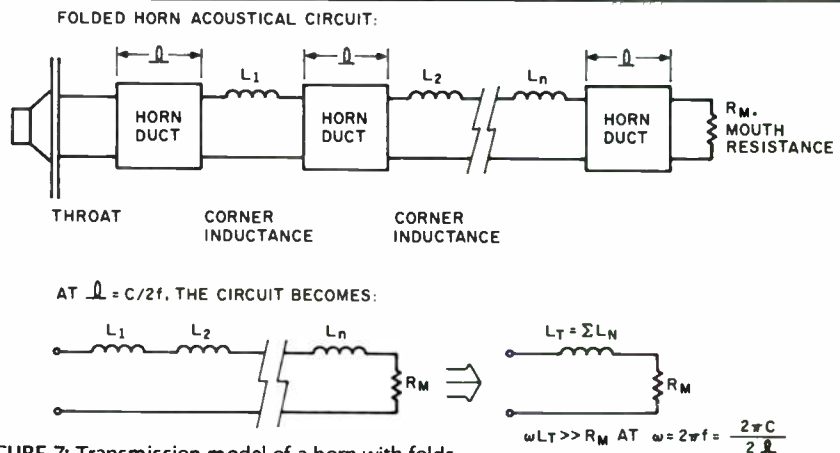

FIGURE 7: Transmission model of a horn with folds.

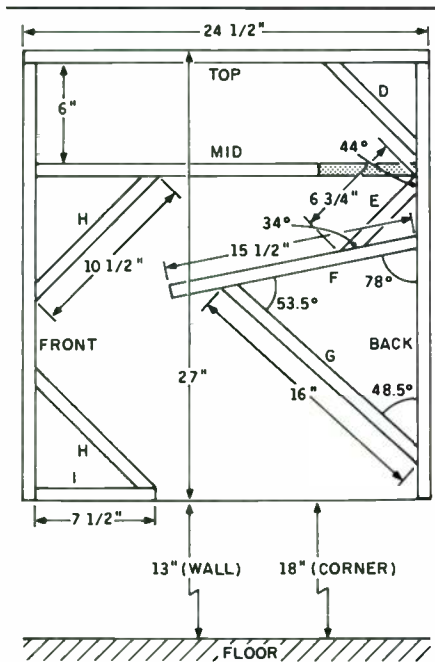

FIGURE 8: Top view of the horn throat manifold.

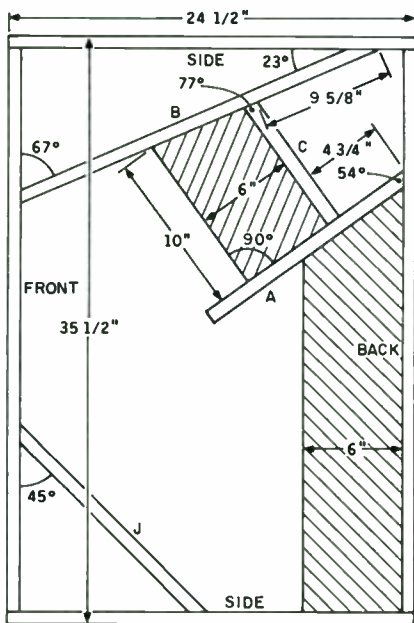

FIGURE 9: Side view of the Monolith bass horn.

resonance frequency of 37Hz would allow a lower flare frequency, I chose 40Hz to keep the size to manageable proportions. For the best response down to the flare cutoff frequency, I selected a hyperbolic exponential expansion of $M = 0.6$. Even with a one-eighth-sized horn, the path length is over 7' and the mouth size is nearly 8 ft.² (1,133 in.²), which gives you an idea of its imposing size.

The concept of a bottom exhaust for the mouth is not new: both the Lowther TP-1 and the Gately Super Horn used it.^{4,5} With a bottom exhaust, the mouth can be wrapped around the horn base perimeter. If the two side and front widths add up to a length L_m , then

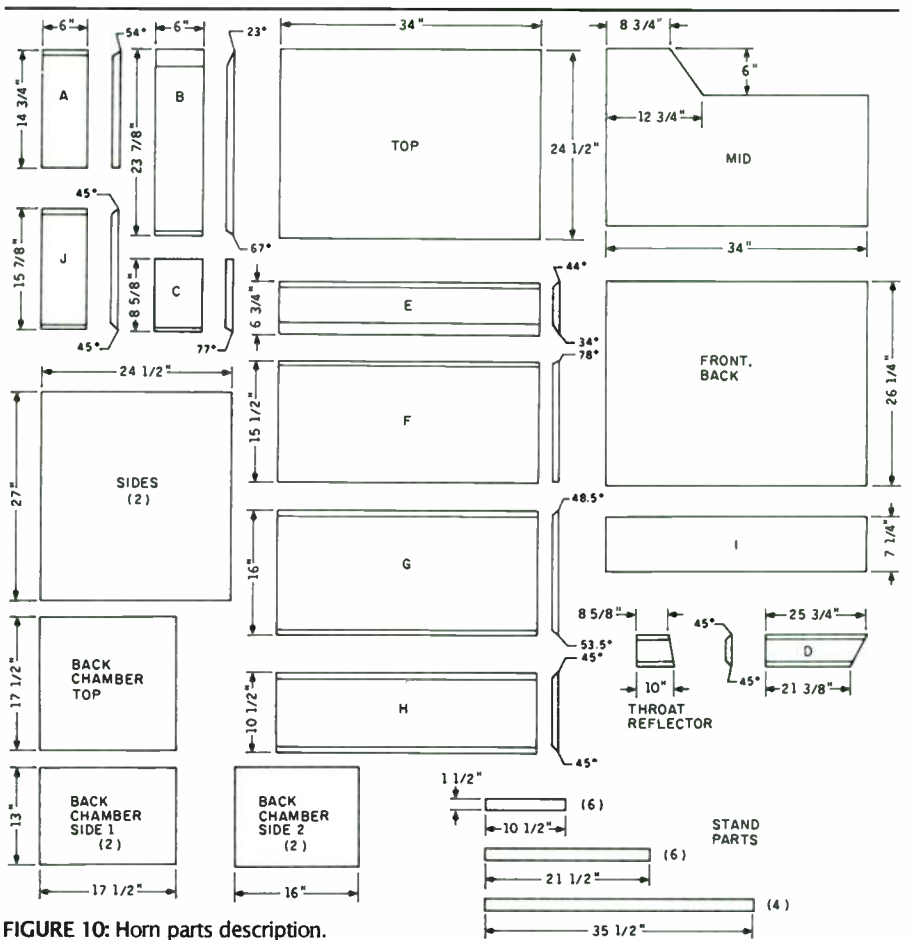

FIGURE 10: Horn parts description.

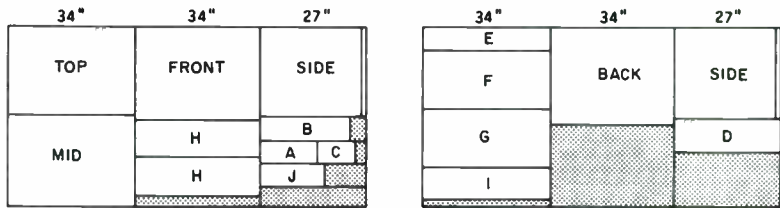

FIGURE 11: Sawing guide for 3/4" plywood.

the height (h) of the exhaust opening above the floor is h (in.) = 1,133/Lm.

In the Monolith's case, this distance from the floor turned out to be 13" for a wall position (two

side areas and a front area forming a mouth) and about 18" for a corner position (one side area and a front area); however, this separation distance can be adjusted for the smoothest response, as we will examine later. The mouth's close proximity to the floor allows for good coupling to the acoustical images below the floor and behind the wall. The formation of these images multiplies the effective mouth area to provide good bass.

TABLE 1

MONOLITH HORN PARTS LIST	
PART	DIMENSIONS
A	6" × 14 3/4"
B	6" × 23 7/8"
C	6" × 8 5/8"
D	8 1/2" × 27"
E	6 3/4" × 34"
F	15 1/2" × 34"
G	16" × 34"
H (2)	10 1/2" × 34"
I	7 1/4" × 34"
J	6" × 15 7/8"
Sides (2)	24 1/2" × 27"
Top	24 1/2" × 34"
Front, back (2)	34" × 26 1/4"
Back chamber side 1 (2)	12 3/4" × 17 1/2"
Back chamber side 2 (2)	12 3/4" × 16"
Back chamber top	17 1/2" × 17 1/2"

MONOLITH CONSTRUCTION
 The Monolith's throat manifold layout and side view are shown in Figs. 8 and 9, respectively. The former is similar to the Show Horn; however, with the back chamber on top, you can locate the throat and driver in an optimum position and not have to leave room for the back side duct. With a 15" driver, a top mounting is a decided advantage in reducing the horn's depth. The internal depth

Continued on page 16

MADISOUND'S

SHOWER OF SAVINGS



Sale Expires
March 1, 1994

QTY	DESCRIPTION		PRICE	
5,000	10ohm 5 watt 5%	Wire wound Resistor, Sand cast	3/8" Sq x 7/8" long, 1-1/2" leads, axial	10 for \$1.50
21,000	4.7mfd Mylar HitachiCap.	100V, 1/4" x 1/2" oval by 1-3/16" long	1/2" long solid leads, axial	10 for \$4.00
34,000	2.2mfd Mylar Capacitor	100V, 10%, 3/8" D x 1" long	Yellow, 1 -5/8" long solid leads, axial	10 for \$2.00
41,000	5mfd Mylar Elpac Capacitor	50V, 10%, 1/4" x 3/8" oval by 1-1/4" long	2-1/8" long solid leads, axial	10 for \$4.00
1,430	4.6mfd Mylar West-Cap Capacitor; 450V, 10%, 3/4" D x 1-3/4" long;		2-1/4" long solid leads, axial	10 for \$9.00
399	60mfd Solen Polypropylene Capacitor; 250V, 5%, 1-3/4" D x 2-3/4" long		2" long solid leads, axial	\$10.00 each
41	47mfd Solen Polypropylene Capacitor; 250V, 5%, 1-5/8" D x 2-1/2" long		2" long solid leads, axial	\$8.00 each
150	45mfd Solen Polypropylene Capacitor; 250V, 5%, 1-1/5" D x 2-1/5" long		1-3/4" long solid leads, axial	\$8.00 each
Take a 25% discount on all Carll Mylar Capacitors: 1, 2.7, 3.3, 3.9, 4.7, 6, 6.8, 8, 10, 12, 15, 20 mfd. (Cannot be used with other discounts; does not apply to dealer and OEM sales.)				
400	.15mH Iron core Inductor; 24awg wire on an iron bar		1/2" D x 2" long	10 for \$5.00
2950	.2mH Air core Inductor; 19awg wire on a plastic bobbin		1-1/2" D x 1-1/8" tall	10 for \$7.50
1,400	2.0mH Air core Inductor; 19awg wire, bobbinless		2" D x 1" tall	\$1.75 each
Take a 25% discount on 5-1/4", 6-1/2", 8" and 10" Autosound Steel Grills; Black perforated metal grill with mounting ring. (Same restrictions as above for dealers and OEM.)				
650	Audax DW6x11M 8ohm 6cm x 11cm 3/4" dome tweeter; Fs 2050Hz, DCR 6.5ohms, 14mm VC, 96.5dB, 70W. Perfect as super tweeter or for autosound use.			\$6.00 each
100	LPG 25NP Neodymium magnet 1" Polyamide dome tweeter, 48mm D, Fs 1800, 8ohm, 90dB, 80W; Wedge & Hinged Wedge Available; Introductory Special			\$22.00 each
100	LPG 26NA Neodymium magnet 1" Aluminum dome tweeter, 48mm D, Fs 1850, 8ohm, 92dB, 80W; Wedge & Hinged Wedge Available; Introductory Special			\$26.00 each
22	Eton 25DTF250C 1" Aluminum alloy dome tweeter; 110mm metal flange, 72mm cut out, Fs 1000Hz, 8ohm, 92dB, 130W, metal grill, double magnet			\$48.00 each
192	Seas 25TF H456 1" Damped Textile dome tweeter; 104mm glassfibre/plastic flange, 72mm cut out, Fs 1000Hz, 6ohm, 91.5dB, 50W, 26mm VC			\$12.00 each
5	Eton 50DMF100C 2" Aluminum alloy dome midrange; 140mm metal flange, 102mm cut out, Fs 490Hz, 8ohm, 93dB, 100W, metal grill,, fabric surround			\$75.00 each
65	Audax MH10P25FSM 4ohm, 4" square, paper cone foam surround mid, Magnesium cast frame, Fs 61Hz, Qts .4, Vas 5.8ltrs, 90dB, 30W, 92mm cut out			\$19.00 each
118	Madisound 5102-8 4-1/2" midrange, black polypropylene cone, foam surround; 8ohm, Fs 71Hz, Qts .37, Vas 6ltrs, 89dB, 50W; 4-1/4" cut out, 2" depth			\$14.00 each
144	Peerless 1882 6-1/2" double magnet woofer, poly cone rubber surround, 8ohm, Fs 35, Qts .28, Vas 37ltrs, 100W, 89dB, Very flat response to 4.5K, Good Buy!			\$28.00 each
156	Famous maker ... rhymes with NOSE... 6.5" paper cone cloth surround woofer, 8 ohm Fs 69Hz, Qts .55, Vas 10ltrs, for small sealed enclosure			\$7.50 each
36	Peerless 1732 CC line 6-1/2" poly cone rubber surround woofer; 8ohm, Fs 35, Qts .35, Vas 33ltrs, 150W, some drivers have foam tape gasketing			\$25.00 each
160	Vifa M22WR-45 Cast frame 8" woofer; damped paper cone with rubber surround, 2" VC, 8ohm, 6.5mm X-max peak, Fs 27, Qts .3, Vas 75ltrs, 89dB, 150W			\$44.00 each
50	Focal 8K415S 8" Kevlar cone woofer with rubber surround, Fs 21.6Hz, Qts .245, Vas 168ltrs, 90.5dB, 150W, 40mm Kapton VC, Used in Aria 3 design.			\$85.00 each
232	Peerless 1721 8" woofer, Poly cone rubber surround, 8ohm, Fs 32.4, Qts .3, Vas 62.4ltrs, 39mm VC, 6.5mm X-max peak, 180W, F3 of 45Hz in 1cf vented box			\$35.00 each
140	Eminence T1040 10" Woofer, paper cone , accordion surround; 8ohm, Fs24, Vas 270ltrs, Qns 7.74, Qes .34 Qts .33, 92dB, 40oz magnet, 2" VC, 150W			\$25.00 each
33	Dynaudio 24W 75XL 4ohm woofer, Poly cone foam surround, 3" voice coil, Fs 32, Qts .46, Vas 92.4ltrs, 130W, 89dB, Fast and accurate bass response.			\$80.00 each
5	Audax PR24LXT100 Professional 10" woofer, Paper cone, foam surround, Fs 63Hz, Qts .47, Vas 46ltrs, 98dB, 100W, 8 ohm, high quality bass-midrange.			\$70.00 each
233	Danmar 12" woofer, 8ohm, paper cone foam surround; suitable for sealed enclosures, 25W; perfect as a low power replacement driver.			2 for \$15.00
420	Klipsch K5K 8" woofer, Paper cone cloth surround; Fs 40; Vas 46 ltrs; Qts .33; 91dB; 12Ω; 75Watts; Excellent High Output D'Appolito woofer.			\$20.00 each
160	Klipsch K6K 8" Woofer; Paper cone cloth surround; Fs 41; Vas 42 ltrs; Qts .325; 92dB; 6Ω; 75Watts; High efficiency, for 2-Way Hi Fi or stage monitors.			\$20.00 each
575	Klipsch K82K Horn Tweeters; 4" x 10" Exponential; Fs 1500; 100dB; 16Ω; use a 12dB x-over at 3K; 3 to 17.5K; Exceptional value.			\$20.00 each

Madisound has some designs using the Klipsch products, if you are looking for high efficiency, high output systems at reasonable prices, give us a call. This is a rare opportunity.



Madisound Speaker Components; P.O. Box 44283, Madison WI 53744 Tel:608-831-3433, Fax:608-831-3771

Reader Service #1



PHOTO 3: Positioning the top piece on the front and back panels.

Continued from page 14

of 23" results in a null frequency of almost 300Hz due to the series of 180° bends. A horn with more depth would push the null frequency below 300Hz, which I wanted to avoid. I thought that with the corners properly mitered, the null effects for the configuration could be minimized. The mass rolloff at 411Hz would provide both a graceful attenuation of the response above 400Hz and good mating with a midrange horn above 500Hz.

The Monolith can be assembled from two sheets of 3/4" plywood, MDF, or particle-board. I used birch veneer plywood to reduce the weight for shipping. Figure 10 shows the part shapes, with a plywood cutting guide in Fig. 11. The constant-width box design allows for a certain amount of cutting efficiency. If your lumberyard has a good table or plywood saw, have them make the 34" and 27" cuts for easier transportation back to your shop. You can then make the smaller cuts on your table saw. I also recommend redrawing to full scale the plans in Figs. 8 and 9 as a check on sizes and angles. You can also trace templates for the angles from these drawings.

I first built the horn using only screws, but reassembling it with screws and glue seemed to provide better damping. When I say "attach

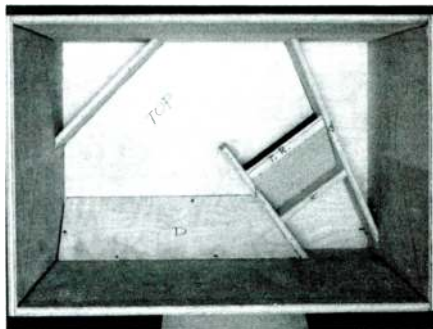

PHOTO 7: Duct reflector "D" installed.

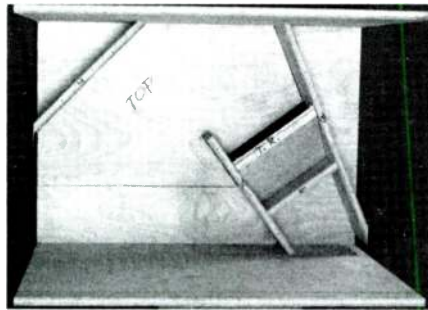

PHOTO 4: Inside view of the throat manifold with attached front and back panels.

piece A to B," therefore, you have the option of either using screws and glue or screws only. Begin by cutting the partition pieces (A, B, C, and J) and assembling them to the top piece, as shown in Fig. 8 and Photo 2. Draw out to full scale the throat manifold on the top piece to ensure your angles are cut correctly. Once the throat partition pieces are attached, you can cut the throat opening with a sabre saw. A router with a long, flush cutting head will do a nice job of trimming the throat port flush to the edges of A, B, and C.

Stand the top piece with the throat partitions on the edges of the front and back pieces (Photo 3), using corner clamps to hold them together while you attach the top to the front and back. Then add the two side panels, as shown in Photos 4-6. Once you have finished assembling the box, finish joining the throat partitions to the back, front, and side panels. Fill any gaps between the throat partitions and sides with a caulking material such as mortite or silicone rubber.

The duct reflector (D) must be fitted next. This procedure is outlined in the Show Horn article. You first determine the compound angle by cutting and fitting scrap pieces which have the same widths and 45° angles as piece D. Once you have determined the proper saw blade and miter gauge angles, make the same cut on D longer than that specified in Fig. 10. Keep trimming D until it just fits. Attach the duct reflector to the back, top, and side. To further aid construction, you can fit little 45° triangular pieces under D for alignment and attachment points. Next, redraw the locations of the throat partition pieces on the midpiece. Slide the midpiece into the box and blind screw it to the throat partitions, then fasten the sides, back, and front to it from the outside.

Make some triangular alignment pieces from scrap stock (Photo 9). Attach piece I to one of the H reflectors and set it aside (Fig. 9). Slide the other H reflector down into the box and attach it with screws to the midpiece, sides, and front.

With more scrap material, cut the triangular pieces that align panels F and G to the correct angles, then attach them on a flat

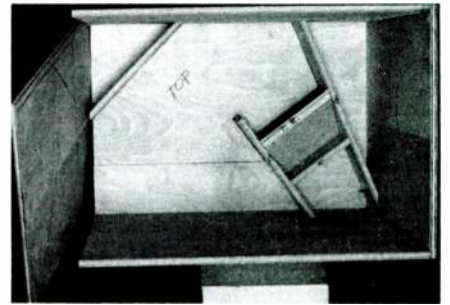

PHOTO 5: Attachment of the side panels.

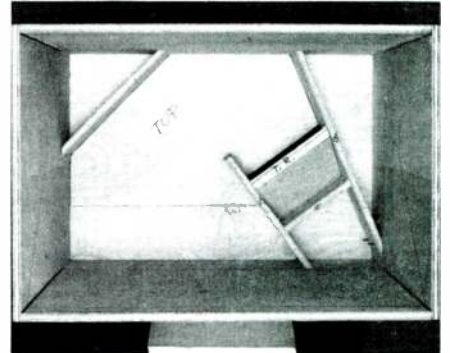

PHOTO 6: Completed horn box.

surface. While the structure is still flat, mount the E reflector to panel F, as shown in Fig. 10. Using alignment blocks for E is optional. Place the box on its back and slide the divider structure (F, G, and E) into it. Be certain reflector E is touching the midpiece. Attach the divider structure with screws from the sides, then turn the box over and attach it with screws to the back (Photo 11). Attach the H-I reflector to the bottom (Photo 12). Finally, install the throat reflector.

MAKE A STAND

I constructed the stand from square 1 1/2" stock, which I cut by ripping up scrap 2 x 4s. Begin the assembly by clamping the top frame on a flat surface, then screw it together with 3 1/2" wallboard screws. Repeat the procedure for the bottom frame, and join the frames with the leg pieces. I also added corner braces to correct warping (Photo 13). The parts are shown in Fig. 11.

Continued on page 18

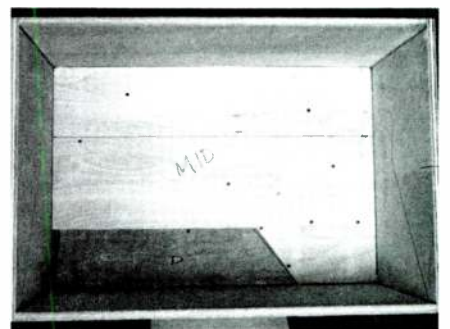

PHOTO 8: Midpiece installed.

ZALYTRON

YOUR ONE STOP SHOPPING CENTER

FOCAL

VIETA

Cabasse
LA REFERENCE EN HAUTE FIDELITE



seas



ZALYTRON
CUSTOM WOOFERS



PHILIPS



Polydax
speaker corporation

l'atelier audio
F A N A S I C

ACCUTON

WHAT YOU'LL BE SEEING IN COMMERCIAL SPEAKERS IN THE FUTURE IS AT ZALYTRON TODAY!

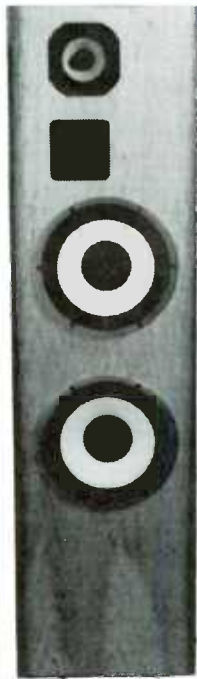

Zalytron is the leading distributor of high quality
raw speakers in North America

We specialize in the high quality
loudspeakers and accessories imported
by Kimon Bellas of Orca Design. These
items include FOCAL, CABASSE,
VIETA, ACCUTON, SCR, AXON WIRE,
TOP BOX SOFTWARE, BLACK HOLE
DAMPING MATERIAL and more.



We also handle Morel,
Polydax Seas and our
own line of ZALYTRON
CUSTOM WOOFERS.

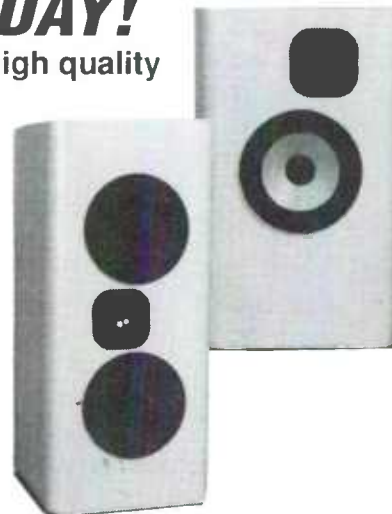

If you want to buy speakers and design your own
system or use our already established systems call
for our catalogues. More than 200 pages of
information in three booklets. Plus new mailings twice
yearly. The pictures in this ad are just a small sample
of what we build when you see all the systems we
offer you will be shocked.

ZALYTRON INDUSTRIES CORP.

469 JERICHO TURNPIKE, MINEOLA, N.Y. 11501

TEL. (516) 747-3515

FAX (516) 294-1943

Our warehouse is open for pick-up 10AM to 6 PM daily, Monday thru Saturday
UPS orders shipped same day • Minimum order \$50.00

WRITE OR CALL FOR ALL YOUR SPEAKER NEEDS OR INQUIRIES

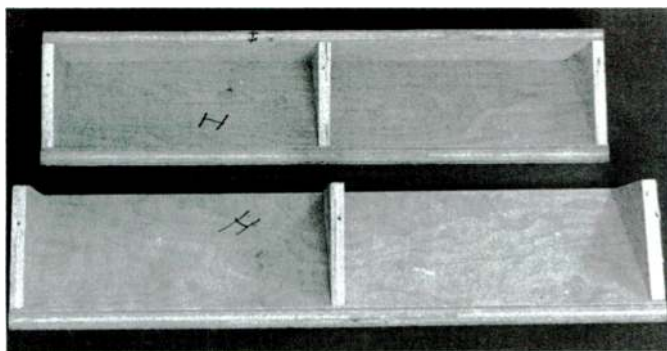

PHOTO 9: Reflectors (H) with triangular alignment pieces.

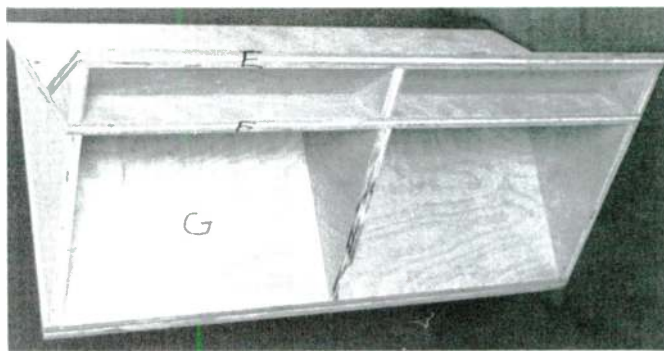

PHOTO 10: Internal divider structure.

Continued from page 16

I determined the stand's height with the best response from a near-field response test, using a Sennheiser MD-421 microphone laid on the floor in front of the horn mouth and a Spectrum Dynamics FFT analyzer operating in an averaging mode with a white-noise input to the speaker. A 10½" stand from a previous project gave me a first trial response. I then shimmed up the horn with a series of scrap ¾" planks and 2 × 4s and measured the response at each height. The most balanced response occurred with 3" spacing on the stand, for a total height of 13½".

Figure 12 shows the response with the horn on a 13½" stand in a wall position. This "warts and all" response shows much structure in the expanded plot, which is within the ±3dB standard. Above 300Hz, the 3dB drop is probably due to the effects of the 180° bends and the 23" internal depth, as discussed earlier. The 3dB drop is minor, however, compared to the 20dB hole I experienced in the earlier design.

A one-eighth-sized horn is really intended for corner placement. Figure 13 shows the white-noise response for a corner height of 21". Below 200Hz, there is an increase of approximately 3dB above the wall position

response of Fig. 12. Above 200Hz, the response is quite ragged compared to the wall position response. The horn apparently needs a mouth reflector to smooth out the reflections. Figure 13 includes the response as measured by an AudioSource octave-band-pink-noise analyzer to demonstrate how deceptive such a coarse resolution measurement can be.

While the white-noise/FFT-averaged response technique works quite well in the mid-band, it loses resolution at the low end. For example, Fig. 12 shows that the response at the flare frequency is down some 10dB from the midband bass. Since listening tests did not indicate any serious bass deficiencies, I doubted the validity of the white-noise test at the low end. The Spectrum Dynamics FFT has a transient capture mode, so I decided to use it with a bass pulse. I didn't have a suitable pulse generator, but I found an isolated bass drum pulse on a Telarc CD (#80038, track 3) that made a nice alternative signal. As Figure 14 shows, the bass drum pulse excites the horn's response down to and just below the 40Hz flare frequency. The response's coarse structure is probably caused by comb filtering in the FFT.

As I looked at the Monolith stored on its

side in the corner, I realized that this was the same configuration used by the "Fold and Staple Bass Horn" project, where the mouth exhausts onto the wall.⁶ I decided to try it, and Fig. 15 shows the response plots for several separation distances from the corner. As you would expect, a 5" separation reduces the output significantly, but the spectrum is markedly more balanced compared to the corner response of Fig. 13. Used in the British "Impulse Horn" design, this narrow mouth loading appears to work from a measurement standpoint ("A New Hope," SB 4/89, p. 65). A quick listening check tended to favor the larger mouth sizes, although more careful evaluations need to be done. For larger separation distances, the primary differences are in the ripple or standing-wave patterns.

BACK CHAMBER

One of this design's nicest features is the easy-to-access back chamber. I tried a number of test boxes to find two test volumes that would resonate at frequencies below and above the 40Hz flare frequency. To determine the resonant frequencies, I used a signal generator driving the speaker with a 1kΩ resistor

Continued on page 24

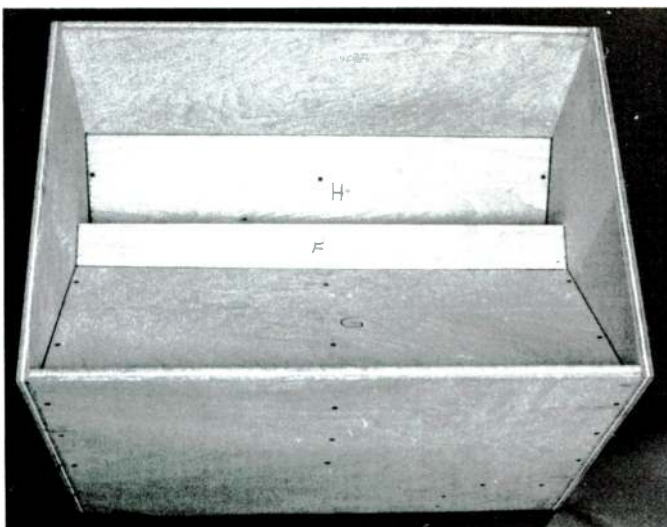

PHOTO 11: Divider structure in place.

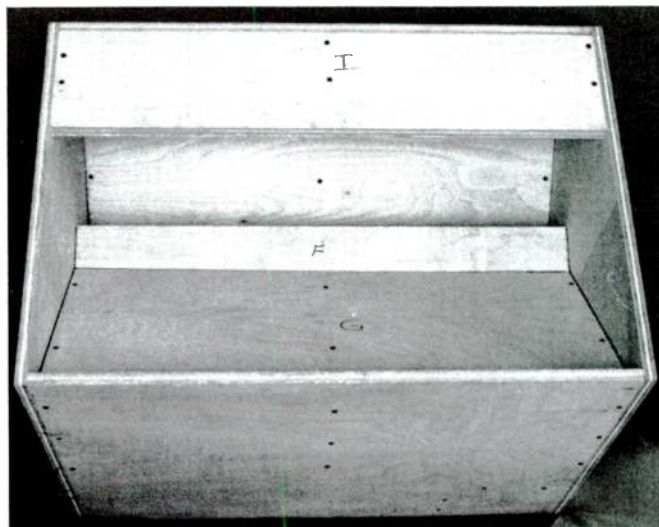

PHOTO 12: Final reflector installed.

MLSSA Maximum-Length Sequence System Analyzer

- Industry Standard
- Fast Measurements
- High Noise Immunity
- Measurement Bandwidth to 40 kHz
- Time-Bandwidth Product to 20,000
- Loudspeaker Measurements
- Room Acoustics Measurements
- Room Equalization Adjustments
- Speech Intelligibility

Industry Standard

Since its introduction in 1987, *MLSSA* (pronounced "Melissa") has become the loudspeaker industry's standard measuring tool as recognized by the world's leading loudspeaker designers and manufacturers. *MLSSA* is also the system chosen by auto makers, academicians, recording studios and government agencies for many other applications including room acoustics and speech intelligibility measurements.

MLSSA pioneered the maximum-length sequence (MLS) method of system analysis which offers an unsurpassed combination of speed and noise immunity with an enormous time-bandwidth product. Nonetheless, without the powerful and comprehensive post-processing functions offered by the *MLSSA* software, the full potential of MLS techniques cannot be realized. The easy-to-use *MLSSA* software undergoes constant improvement with at least one new software upgrade released each year.

Noise Immunity

Most acoustical measurements are made in environments subject to significant levels of interfering background noise. Nonstationary noise, such as impulse noise due to doors closing or, sporadic noise due to local traffic can result in severe errors with some other measuring systems. A significant advantage of *MLSSA* is that all nonstationary interfering noise, whatever its source, is automatically converted to stationary noise during the measurement process. Stationary noise is much more benign than nonstationary noise because it is spread out evenly over time and is largely windowed away in loudspeaker frequency response measurements. In some room acoustics measurements, *MLSSA* provides post-processing algorithms capable of removing even the residual stationary noise.

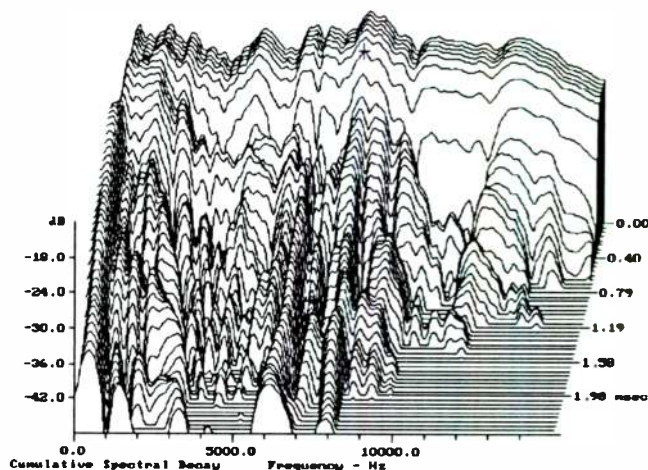

-14.75 dB, 7635 Hz (129), 0.297 msec (6)

ESC to exit, F1 to print, F2 and cursor keys move cursor

MLSSA: Waterfall

Fast Measurements

Although *MLSSA* contains no DSP chip, it is actually faster than some more costly DSP-based systems when running on the faster personal computers. Eschewing an integrated DSP chip not only lowers hardware costs but also forestalls obsolescence by allowing *MLSSA*'s performance to improve in step with improvements in PCs. Running on a 33 MHz 486, for example, anechoic loudspeaker frequency response measurements including acquisition, computation and display require only 3.1 seconds using a full-length 64K-point MLS stimulus or, just 1.6 seconds using a shorter 32K-point sequence. Altogether, four distinct sequence lengths of 4K, 16K, 32K and 64K-points are provided in hardware for high precision, low jitter MLS generation.

Enormous Time-Bandwidth Product

A third fundamental advantage of *MLSSA* is its enormous time-bandwidth product. This feature is especially useful in room acoustics and speech intelligibility applications because it allows you to measure a long impulse response over a wide bandwidth quickly and store the results to disk. Then, through its powerful post-processing functions, software can perform detailed narrowband analysis later from stored time-domain measurements. But this feature is equally useful in impedance measurements of drivers or loudspeaker systems. A time-bandwidth product of 20,000 allows you, for example, to measure impedance over a 1 kHz bandwidth with 0.06 Hz resolution or, over a 20 kHz bandwidth with 1 Hz resolution.

Room Acoustics

Room Response

MLSSA measures and displays room impulse response curves up to 65535 points in length with a maximum time-bandwidth product of 20,000. This allows a 4 second impulse response over a 5 kHz bandwidth or, a 2 second response over a 10 kHz bandwidth. Room impulse response measurements can be stored on disk and later retrieved for further octave-band or other analysis. Room impulse response measurements can also be exported.

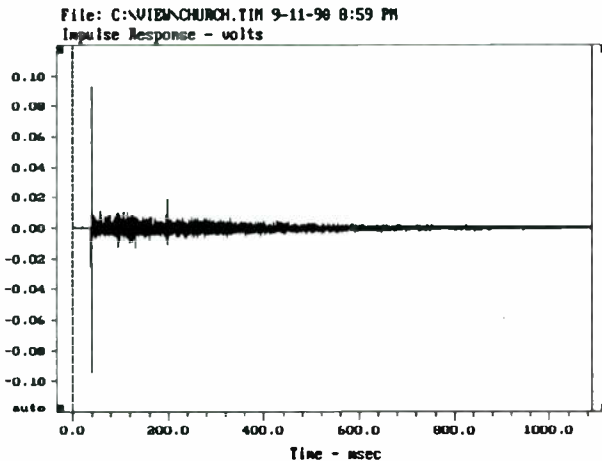

TIME DOMAIN MENU: Go View FFT Waterfall Acquisition Setup Transfer Macro
Overlay Calculate Printer DOS Units Library Info Quit
F1 for Help MLSSA: Time Domain

By applying a large FFT to the room impulse response, *MLSSA* determines the room frequency response which can then be smoothed to 1/1 or 1/3 octave (see figure opposite). FFT sizes ranging from 32 to 65536 points are supported.

Math Operations and Spatial Averaging

MLSSA can perform many mathematical operations on both time and frequency data files including average, add, subtract, multiply, divide, smoothing, convolution, correlation and the inverse FFT. Many mathematical operations also accept both real and complex constants for scaling operations or other purposes.

Both complex and power averaging are provided for frequency data files. Power averaging is required for correct spatial averaging of room frequency response data. Room impulse response measurements can also be averaged to determine spatially-averaged acoustical parameters such as reverberation time.

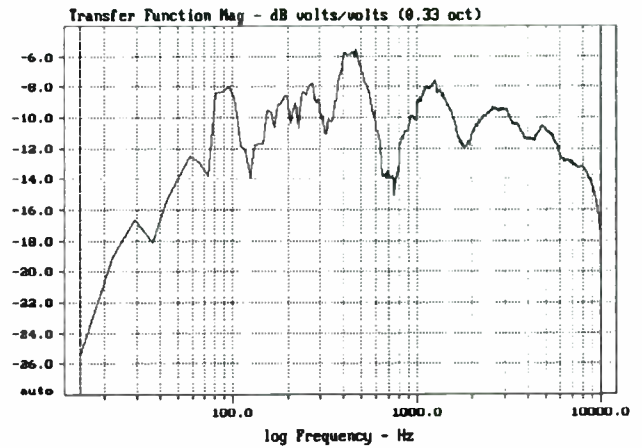

FREQUENCY DOMAIN MENU: Go View Reference Acquisition Setup Transfer Macro
Overlay Calculate Printer DOS Units Library Info Exit
F1 for Help MLSSA: Frequency Domain

Fast Equalizer Adjustments

Currently used for final test and equalization of high-end home theater installations, *MLSSA* simplifies and speeds equalizer adjustments in equalization applications. After measuring the smoothed and spatially-averaged room response, simply connect *MLSSA* to measure your graphic or parametric equalizer in nearly real time. Then you merely adjust the equalizer for the desired target frequency response. Adjust equalizers quickly, as a simple post-processing operation which is much faster than trying to repeatedly remeasure the average room response.

Schroeder Plots and Reverberation Time

A Schroeder plot is the reverse integral of the squared room impulse response and reveals reverberant decay of the sound field. When graphed on a logarithmic scale, its slope is a measure of reverberation time. As a post-processing operation, *MLSSA* can usually remove the influence of both stationary and nonstationary background noise from Schroeder plots for improved accuracy. *MLSSA* not only calculates wideband Schroeder plots and reverberation times but can derive them for any desired frequency band through its built-in programmable digital bandpass filter. This bandpass filter permits reverberation measurements to be made over any octave or fractional octave band simply by post-processing the measured wideband impulse response. Reverberation time is determined from Schroeder plots using linear regression over selected decay ranges.

Room Acoustics

Energy-Time Curves

MLSSA computes both wideband and narrowband (filtered) ETCs as the envelope of the measured impulse response with a choice of frequency domain window functions. Computes unwindowed and half-Hann ETCs as recommended by John Vanderkooy and Stanley Lipshitz of the Audio Research Group. ETCs can locate room reflections or, assist in time delay adjustments of loudspeaker clusters. The figure below shows a wideband noise-corrected Schroeder plot (dotted curve) displayed simultaneously with the wideband energy-time-curve (solid curve).

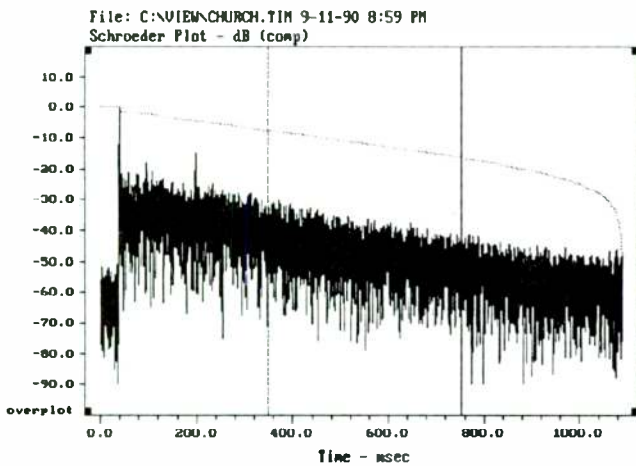

T60 reverberation time = 2.713 seconds

TIME DOMAIN MENU: Go View FFT Waterfall Acquisition Setup Transfer Macro
Overlay Calculate Printer DOS Units Library Info Quit
F1 for Help MLSSA: Time Domain

Tabular Acoustical Parameters

MLSSA computes reverberation time (RT) as well as other important acoustical parameters automatically in IEC-standard octave bands (see figure opposite). Computes C50, C80, EDT and Ts as well as RT for four selectable decay ranges and displays the results in tabular form for easy interpretation and documentation. Room noise correction is automatically applied to EDT and RT measurements for high accuracy.

DAT Machine Support

A special Asynchronous Cross-correlation acquisition mode makes possible remote room measurements using any DAT machine. DAT machines can be used to pre-record the MLS stimulus or, to record the raw room response data for later analysis by MLSSA. This eliminates the need for long cables when making measurements in large spaces.

Absolute SPL and NC Ratings

MLSSA measures sound or noise levels in dB-SPL in IEC-standard 1/1, 1/2, 1/3, 1/6 octave bands. Determines the NC (noise criteria) rating of noise sources and calculates A, B, and C weighted dB-SPL.

IEC Octave Band Acoustical Parameters

Band Parameter	3 125	4 250	5 500	6 1000	7 2000	8 4000	9 8000
S [dB-SPL]	71.7	75.6	78.6	81.0	82.6	84.3	83.1
M [dB-SPL]	54.5	56.0	55.8	59.2	60.1	61.0	58.4
S/M [dB]	17.2	19.6	22.8	21.9	22.6	23.3	24.7
C50 [dB]	-8.48	-5.57	-5.87	-5.88	-3.32	-1.33	1.35
C80 [dB]	-7.17	-4.43	-3.32	-3.52	-1.52	0.30	2.96
Ts [ms]	237.8	232.4	215.2	219.1	194.5	139.8	88.7
EDT [s]	2.952	3.420	3.270	3.185	3.169	2.647	1.916
RT-1 [s]	2.489	2.602	2.889	2.659	2.653	2.477	1.826
(-5,-20) r	-0.989	-0.997	-0.991	-0.997	-0.998	-1.000	-0.999
RT-2 [s]	2.300	2.426	2.620	2.411	2.451	2.369	1.855
(-5,-25) r	-0.990	-0.992	-0.983	-0.989	-0.993	-0.998	-0.999
RT-3 [s]	1.728	1.985	1.967	1.909	1.939	2.067	1.869
(-10,-30) r	-0.980	-0.961	-0.971	-0.976	-0.976	-0.989	-1.000
RT-4 [s]	1.234	1.150	1.245	1.321	1.326	1.616	1.770
(-15,-35) r	-0.937	-0.933	-0.941	-0.959	-0.955	-0.972	-0.999

ESC to exit or F1 to print.

MLSSA: Acoustics

Energy-Time-Frequency Plots

Reverberant decay can also be visualized through the 3D energy-time-frequency plot (see figure below). MLSSA also provides this function complete with 3D cursor readout.

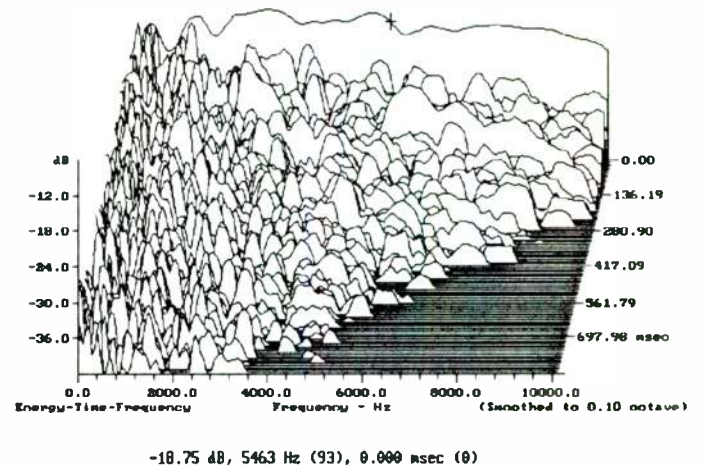

ESC to exit, F1 to print, F2 and cursor keys move cursor

MLSSA: Waterfall

Speech Intelligibility

Speech Transmission Index

Based on the modulation transfer function (MTF), the speech transmission index (STI) is an objective measure of speech intelligibility, widely recognized as being highly accurate in predicting subjective speech intelligibility. *MLSSA* computes full STI from the measured impulse response and, properly accounts for all contemporaneous interfering background noise whether stationary or nonstationary noise. *MLSSA* has recently been approved for use by aircraft companies to measure the STI of cockpit voice flight recorders.

MTF Matrix (Calibrated)

Frequency-Hz	125	250	500	1000	2000	4000	8000
level dB	-24.5	-22.9	-23.2	-24.8	-26.4	-32.2	-65.5
m-correction	1.000	1.000	1.000	1.000	1.000	0.999	0.685
0.63	0.988	0.987	0.977	0.936	0.791	0.552	0.071
0.80	0.982	0.984	0.975	0.933	0.794	0.542	0.067
1.00	0.982	0.984	0.975	0.933	0.794	0.542	0.067
1.25	0.978	0.982	0.974	0.935	0.793	0.553	0.068
1.60	0.978	0.982	0.974	0.935	0.793	0.553	0.068
2.00	0.973	0.979	0.973	0.936	0.798	0.548	0.068
2.50	0.967	0.976	0.972	0.933	0.793	0.545	0.052
3.15	0.958	0.971	0.968	0.938	0.791	0.558	0.058
4.00	0.946	0.967	0.966	0.929	0.787	0.535	0.047
5.00	0.935	0.961	0.962	0.929	0.793	0.536	0.068
6.30	0.928	0.952	0.958	0.925	0.787	0.544	0.072
8.00	0.905	0.946	0.953	0.923	0.786	0.555	0.074
10.00	0.888	0.933	0.947	0.928	0.786	0.549	0.059
12.50	0.854	0.928	0.948	0.918	0.786	0.551	0.057
octave TI	0.926	0.967	0.975	0.874	0.693	0.528	0.189

STI value= 0.704 (0.751 modified) ALcons= 3.8% Rating= GOOD

ESC to exit or F1 to print.

MLSSA: STI

MLSSA's STI function properly accounts for both interfering background noise and nonlinear distortion based on a single measurement, provided only that the MLS stimulus is first passed through a simple speech-weighting filter prior to applying it to the system to be analyzed. This important feature was previously available only on costly dedicated RASTI instruments.

In addition to rooms, *MLSSA* also correctly measures the STI of digital devices, such as Codecs, as well as analog tape recorders which include a tape monitor function.

For STI measurements performed with a human mouth simulator, software correction of errors in the simulator's frequency response is also supported. *MLSSA* also estimates the percentage articulation loss of consonants or %ALcons from the measured STI value. Running on a 33MHz 486 computer, a full STI analysis is completed in a mere 4 seconds.

Rapid Speech Transmission Index

MLSSA can also measure the less accurate but internationally standardized rapid speech transmission index (RASTI) according to IEC 268-16. Like STI, the RASTI function also properly accounts for interfering background noise provided a speech-weighting filter is present.

MTF Matrix (Calibrated)

Frequency-Hz	125	250	500	1000	2000	4000	8000
level dB			-23.1		-26.2		
0.71					0.786		
1.00			0.979				
1.41					0.797		
2.00			0.988			0.888	
2.80							
4.00			0.978				
5.60						0.797	
8.00			0.976				
11.20						0.797	

RASTI value= 0.831 ALcons= 1.9% Rating= EXCELLENT

ESC to exit or F1 to print.

MLSSA: RASTI

Modulation Transfer Functions

MLSSA's also makes wideband or fractional octave MTF measurements for more detailed analysis than is possible with STI alone.

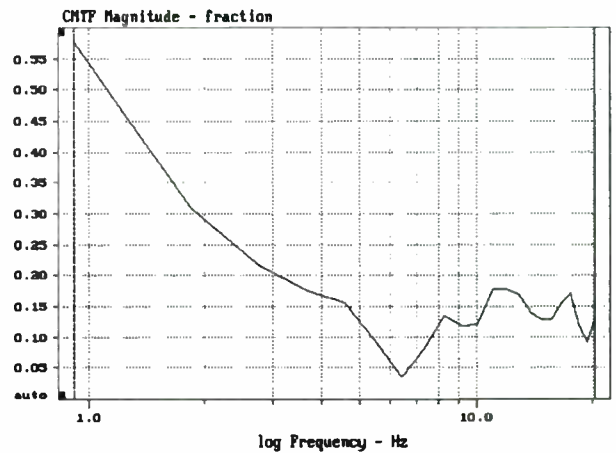

CURSOR: y = 0.128575 x = 20.1921 (22)

FREQUENCY DOMAIN MENU: Go View Reference Acquisition Setup Transfer Macro
 Overlay Calculate Printer DOS Units Library Info Exit
 F1 for Help MLSSA: Frequency Domain

General Information

Microphone Calibration and Correction

You can enter and store microphone sensitivity data on up to 10 microphone/preamp combinations. For higher accuracy, *MLSSA* will optionally calibrate your microphones using an external microphone calibrator. *MLSSA* will also correct out minor deviations from flat response by importing microphone frequency response data taken from its calibration curve.

Autorange and Programmable Bandwidth

MLSSA automatically adjusts its input gain on each measurement for maximum dynamic range. Input levels from 10 millivolts to 20 volts RMS are easily accommodated. Autorange can also be disabled and the input gain set manually if desired. Measurement bandwidth can also be programmed anywhere from 1 kHz to 40 kHz through *MLSSA*'s high-quality 8th-order on-board antialiasing filter.

Logarithmic or Linear Data Export and Import

MLSSA will export data in a standard text file format for use by loudspeaker CAD packages such as *CALSOD*, *LEAP* or *XOPT*. Exports frequency domain data in either linear format or, in logarithmic format for reduced file size. In the frequency domain, you can import both text and binary data files. The imported data is automatically interpolated by cubic splines to match the frequency spacing of the currently displayed curve allowing you to overlay curves having different frequency spacings.

Integrated Macro Processor

MLSSA contains an integrated macro processor. A complex series of *MLSSA* commands can be recorded as a macro and then played back later through the action of one or two keystrokes. No programming skills are required to create macros. Special macro commands permit remote initiation of measurement cycles or, they can be used to synchronize *MLSSA* with a motorized turntable for automated polar response measurements.

Autonamed Filenames

MLSSA provides a automatic filename system to keep your measurement data organized. Whenever you save data to a file, *MLSSA* will optionally create a new numbered filename and save that file to any preselected drive and directory. *MLSSA* also maintains an audit trail for all measurements saved to disk files because all measurement setup parameters are automatically stored along with the measurement data.

Built-in Screen Capture

A integrated utility captures any graphics screen in full color to a PCX file. Used for importing graphics into desk-top publishing (DTP) packages or for future re-display by *MLSSA*. Text screens are captured to plain text files for exporting STI, RASTI or the tabular acoustics screen.

Printer Support

MLSSA offers direct support for HP LaserJet, IBM Graphics, Epson and Okidata printers. You can also redirect printer output to a file when a printer is not available. Later, *MLSSA* can print the contents of the file. An optional header or footer file can also be attached to all graphics printouts, including waterfall plots. These files can contain anything including company logos or product information.

Computer Requirements

MLSSA consists of a full-length card and software designed to run on standard personal computers running the MS-DOS operating system versions 2.1 and above. The card is compatible with all XT (8-bit), AT (16-bit) and EISA (32-bit) full-length expansion slots.

Your computer must contain a math coprocessor chip except on 486DX machines which already include the math coprocessor on the main CPU chip. Your computer must also include CGA, EGA or VGA graphics, a hard disk and, at least 640 kilobytes of memory. For optimum performance a 386SX computer or better is recommended having at least 2 megabytes of memory, VGA color graphics, MS-DOS version 5.0 or better and, an HP LaserJet series III, 4 or compatible printer.

Ordering Information

A complete *MLSSA* system includes a 1 year hardware warranty and free software updates for the first year after purchase. For a demo disk, current prices or, a list of authorized overseas distributors contact:

DRA Laboratories
24 Halifax CT
Sterling, VA 20165
USA
Tel (703) 430-2761
Fax (703) 430-0765

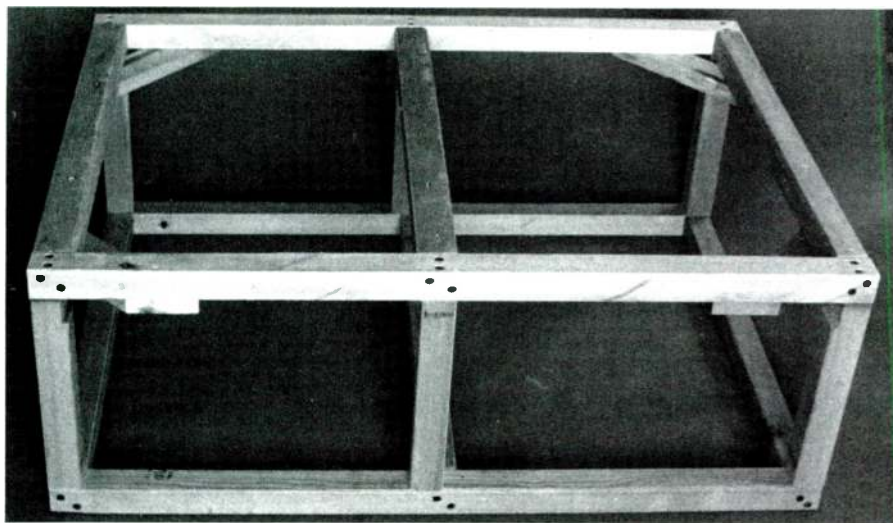

PHOTO 13: Finished 13½" stand.

Continued from page 18

in series and an AC voltmeter across the speaker input. I then plotted the resonant frequencies (Y axis) and their corresponding volumes (X axis) on linear graph paper and drew a straight line between the two points. At the point where the line crossed the 40Hz frequency, I read the required volume off the X axis. With a table saw, I trimmed down the larger of the two test volumes to the required volume. Rechecking the horn/back volume system's resonant frequency showed it very close to 40Hz.

I found the resultant back chamber volume to be 1.81 ft.³, corresponding to an enclosure with external dimensions of 17½" × 17½" × 13". If I had it to do over, I would make the square dimensions slightly rectangular. Feel free to experiment. I calculated the theoretical back volume to be 1.17 ft.³ (based on annulling the throat reactance of an infinite horn by a back volume). Assuming a driver volume of 0.2 ft.³, the experimentally determined back volume is 38% larger.

In my experience, the experimental back

volumes for one-eighth-sized horns are always larger than the theoretical ones, sometimes by as much as a factor of two. The fact that the Monolith's back chamber is off by only 38% indicates that it is close to the ideal infinite horn. For one-quarter-sized bass horns, the back chamber is usually much closer to the ideal limit—but at the expense of a much larger horn enclosure.

I used ½-inch-wide foam rubber weather stripping to seal the edge of the back chamber where it mates to the top of the horn. To confirm that reactance annulling actually works, connect a signal generator set at 40Hz directly to the speaker input with the back chamber in place. Adjust the generator output until you can hear the 40Hz signal. Since the horn is very efficient, you don't need an amp for this experiment. Pop the back chamber seal by slightly prying up one side of the box with a screwdriver. As soon as the air seal is popped, the 40Hz signal cannot be heard; restore the air seal and the signal returns.

The back chamber can be firmly attached to the top of the Monolith with L-brackets, or

with the more decorative copper-colored chair brackets. I also attached a speaker mounting plate to the top for added mass and strength. You can compensate for the decrease in volume with acoustical stuffing in the back volume.

INTEGRATION AND PERFORMANCE

When I started this project in 1988, the 2220 was a staple of JBL's pro line, but they discontinued the model in late 1992. Some surplus units may be found on the used market, but other models will also work. The EVM15L is the closest to the 2220 with a mass rolloff above 400Hz; the "B" version will have a lower mass rolloff near 300Hz. Drag out any of your old 15" drivers and try them on the Monolith horn as an interesting experiment. Those designed for direct radiator applications will sometimes work well, but experiments show that a horn needs a driver with a big magnet and light cone. In addition, many different drivers will resonate near 40Hz with the same back chamber.

I compared the relative pink-noise responses between a well-calibrated midrange horn and the Monolith with the 2220 driver. The Monolith in a wall position appears to have a sensitivity of about 105dB, measured with the horn positioned against a wall but close to a corner (4'). Against a long wall, the apparent sensitivity can be lower.

The Monolith appears to be less directional than the Show Horn, because the mouth exhausts onto the floor. This broad radiation pattern can impact the Monolith's integration with a midrange horn. After some experimen-

SOURCE

Bright Star Audio
2363 Teller Rd. #115
Newbury Park, CA 91320
(805) 375-2629
FAX (805) 375-2630

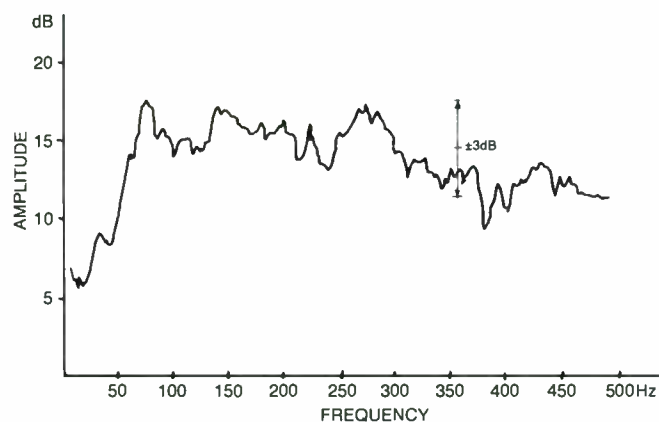

FIGURE 12: Monolith 40Hz horn response with a 13½" stand, wall position.

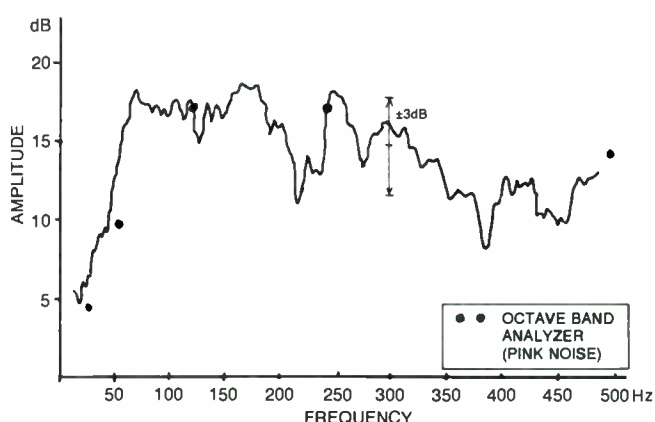

FIGURE 13: Monolith 40Hz horn response with a 21" stand, corner position.

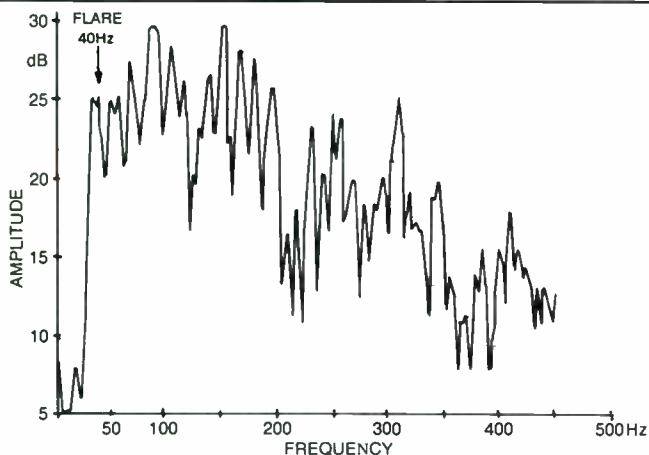

FIGURE 14: Response of the Monolith horn to a Telarc bass drum pulse.

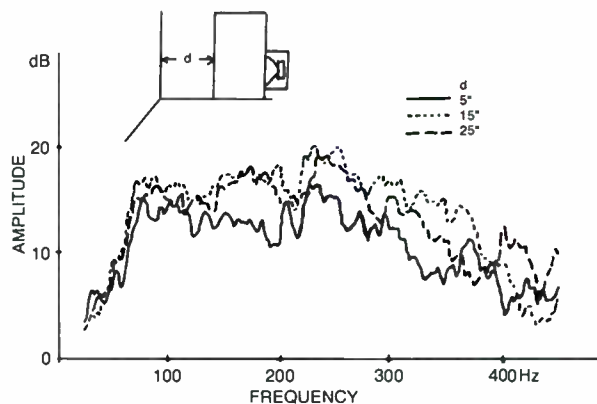

FIGURE 15: Response of the Monolith horn in an upright position for several separation distances from the corner.

tation, I found that the Monolith bass and midrange horns integrated best when the latter's radiation pattern is the broadest in the horizontal plane. For most rectangular-mouth midrange horns, this occurs when the horn's longest axis is horizontal. For the Show Horn, which has a narrower radiation pattern in the horizontal plane, the midrange horn's long axis must be arrayed vertically so the radiation patterns match.

The Monolith stands high, so I do not recommend mounting the midrange horn atop the bass horn—it needs to be at ear level. I usually mount the midrange horn in a separate box and place both it and the tweeter on a 2' spiked stand in front of the bass horn, as shown in Fig. 16.

Finally, you must tune the Monolith. This may be the first time you have heard anyone refer to "tuning a horn" other than adjusting the back chamber system resonance. My friend Barry Kohan of Bright Star Audio has taught me about damping speaker systems with sand loading. The improvements can be dramatic, especially in the bass.

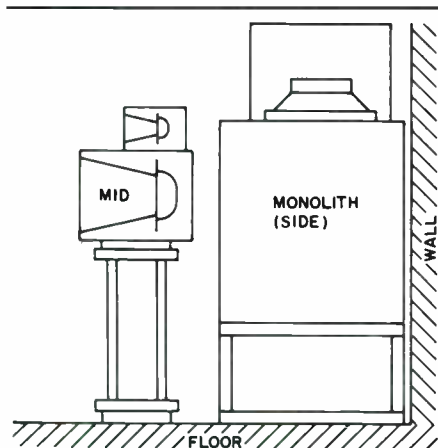

FIGURE 16: Monolith horn with midrange horn configuration.

One of the problems with the throat manifold design is an apparent multiple backwave reflection region around the back duct opening (Fig. 8). Play any CD with a tremendous bass pulse and place your hand on the top of the Monolith over the back duct. You will definitely feel the wood give and rise up in response to the pulse.

You can damp out this enclosure flexing with mass damping, using a Bright Star "Little Rock" isolation pod on top of the Monolith next to the back chamber (Fig. 17). An alternative is to buy several sacks of lead shot and place them on top of the throat manifold. The effect can be dramatic. You can also buy a Bright Star "Big Foot II" sand-filled isolation base and cover the rest of the top plate. A second improvement can be made by loading the top of the back chamber with sand or lead. A "Little Rock" pod or a single bag of sand or lead shot will work.

ACKNOWLEDGEMENTS

I thank Fred Ireson for suggesting the project. His enthusiasm for horn loudspeakers kept me on track. I also thank Manfred Buechler for his excellent photos.

REFERENCES

1. Olson, H.F., and F. Massa, "A Compound Horn Loudspeaker," *Journal of the Acoustical Society of America* (Vol. 8, 1936): 48.
2. Olson, H.F., *Acoustical Engineering*, D. Van Nostrand, 1957, p. 241. [Available from Old Colony Sound Lab as #BKPA1.—Ed.]
3. Cummings, A., "Sound Transmission in 180-Degree Duct Bends of Rectangular Section," *Journal of Sound and Vibration* (Vol. 41, 1975): 321-334.
4. Gately, E.J., and T.A. Benham, "The Super Horn," *Radio and TV News* (Vol. 50, September 1953): 38.
5. D.M. Chave, US patent #2,975,852.
6. Davis, N., "Fold and Staple Bass Horn," *Audio Amateur Loudspeaker Projects*, Marshall-Jones, 1985, p. 103; *The Audio Amateur* (Issue 1, 1977): 10-13, 20.

People have asked me about the advantages of a horn design going down to 40Hz. For many types of music, it doesn't make much difference, but the 40Hz horn does resolve the low end better than a 50Hz horn.

The Monolith horn was a learning project with two main lessons: understanding horn folding problems and sand loading. The effects of 180° bends can be neutralized somewhat by intelligent placement of diagonal reflectors. Sand loading can damp out multiple reflection problems and improve the bass quality. The 40Hz Monolith horn project is complicated, but any good wood craftsman should find it well within his means. Its modular design and construction should lend itself to much experimentation. ▶

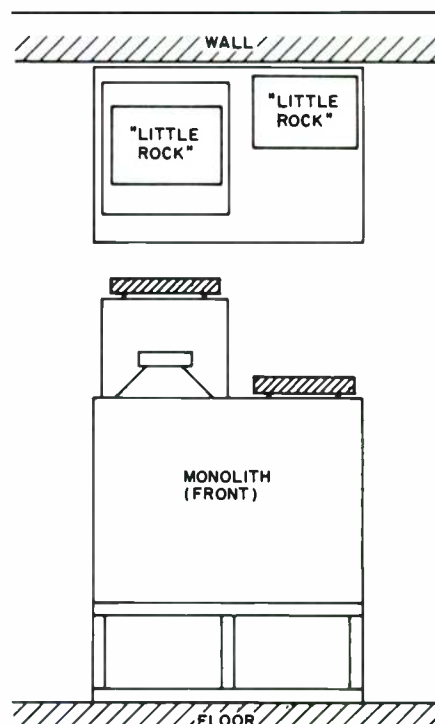

FIGURE 17: Sand loading of the Monolith horn.

ORBITING SATELLITES

By Bill Fitzmaurice

Changes in living space forced me to change my speaker setup. Specifically, the acquisition of a large entertainment center left me with no home for my 15-year-old corner horns. Between new furniture and some other remodeling, I just had no place for my faithful Klipsch clones.

A subwoofer-satellite setup I had used some 25 years ago seemed the reasonable way to go again, but even conventional satellites mounted on the wall at listening level wouldn't fit my available space. I finally decided on a mounting scheme that would virtually allow me to launch my satellites into orbit: at the junction of the wall and ceiling, as high as possible without blasting through the roof (Photo 1).

This design offers a few advantages over standard practice. The satellites are removed from kids and pets, so protective grilles are unnecessary. The downward-firing angle ex-

pands the depth of the listening area, and the triangular shape eliminates standing waves and conserves on expensive materials. As a bonus, the cones don't even collect dust.

I resisted the temptation to spend more money than I had to achieve the desired result. For drivers, I chose Pioneer 4 1/2" woofers and a generic titanium-dome tweeter.

The small amount of wood required made solid wood economically feasible and vastly simpler than veneer. I used solid oak for the exposed surfaces and 1/2" baltic birch plywood for the remainder. The unexposed pieces can be plywood, MDF, or whatever you have on hand.

ASSEMBLY LINE

Simultaneously cut the top, top liner, back, and baffle to width on a table saw, so the rip fence setting will remain unchanged and all the parts will be identical. When cutting the top to length, using anything other than 1/2" plywood will cause an alteration in the part's length. For instance, 3/4" material will result in an overall top length of 11 1/4".

Cut the top for the crossover mounting (Fig. 1). Glue and screw the liner to the inside of the top, then attach the top/liner assembly to the back.

Cut the driver holes in the baffle and drill it for the driver mounting T-nuts. Prefit the

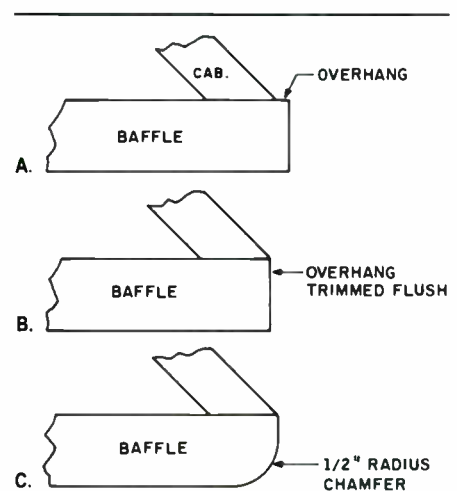

FIGURE 2: Baffle joint detail: a. with overhang; b. overhang trimmed flush; c. with chamfer.

baffle in place, checking that the woofer magnets don't hit the top or back. If they do, rout out sufficient clearance as necessary. Now you can glue and screw the baffle to the cabinet. You'll have a slight overhang at each end which is trimmed flush, as in Fig. 2.

Using the top/back/baffle assembly as a template, trace out the sides on the 1 x 10s, leaving at least 1/8" of selvage all around.

Continued on page 28

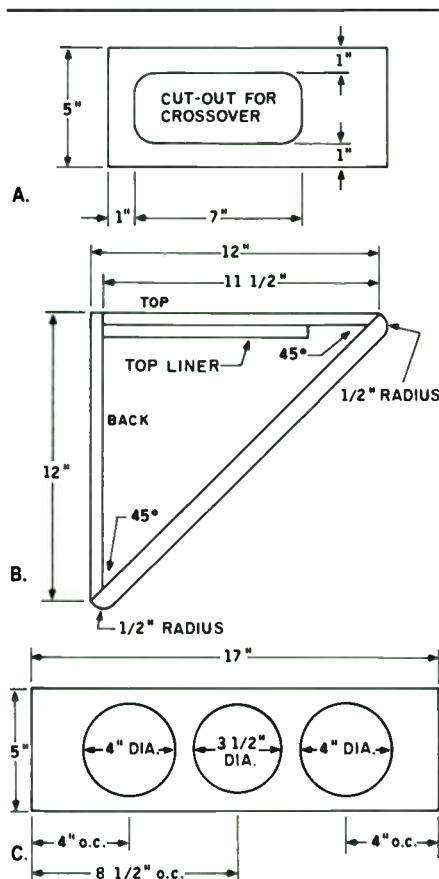

FIGURE 1: Parts layout: a. top view; b. side view; c. baffle front view.



PHOTO 1: Completed cabinet, front view.

TABLE 1

SATELLITE PARTS LIST	
Qty.	Description
Crossover	
2	0.9mH coils
1	0.3mH coil
1	0.2mH coil
1	10Ω 10W resistor
1	47mF capacitor
1	22mF capacitor
3	4.7mF capacitor
Lumber	
17"	1 x 6
5'	1 x 10
1/2"	Plywood or other material as desired (for top, top liner, back) 5" x 32"
Tweeter	
1	Titanium Dome (MCM #53-325)
Woofers	
2	Pioneer 4 1/2" (MCM #51-075)

Miscellaneous

Glue, wood screws, T-nuts and bolts for driver mounting, silicone sealant, speaker wire, binding posts or jacks, water-based urethane.

Note

All materials are per cabinet. Two cabinets will require doubling materials count.

flatline cable™

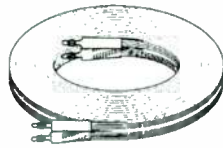

Flatline Cables with Gold Plated Banana Plugs

Unit Length Price. \ pair
 FL12G10BP10ft.\$73.00
 FL12G15BP15ft.\$96.00
 FL12G20BP20ft.\$119.00
 FL12G25BP25ft.\$143.00
 FL12G30BP30ft.\$166.00

Bi-amp Cables with Gold Plated Banana Plugs

FL12G15BA15ft.\$183.00
 FL12G25BA25ft.\$276.00

Cable by the Foot Price. \ foot

FL12GF1 to 20ft.\$3.00
 21 to 50ft.-10%
 51 + ft.-20%



Flatline Cable - "Simply the Best"

- » Extruded Teflon® insulation - the best insulation available.
- » Oxygen-free copper wire - delivers purer sound, 300Volt.
- » Solid rectangular wire - runs cooler and has less skin effect, (0.254mm x 1.27mm) x 4 strands \cong 16awg x 2.
- » Capacitance 3 times less than high-end PVC cables, results in sparkling sound - 6 pF / ft.
- » Very low inductance - keeps signals apart, 0.00009mH / ft.
- » DC resistance = 0.0042 Ω / ft or 238 ft = 1 Ω resistance.
- » Very fast rise time - reacts very quickly to signal changes for superb detail.
- » Thinner than a dime - install anywhere, especially under carpet
- » Will not burn.
- » Not affected by sunlight (ultraviolet light) - can be run outdoors.
- » Can be buried without conduit.
- » Virtually no signal loss over long runs.
- » Made in the U.S.A.
- » Technology used by NASA in the space program.
- » Totally non-hygroscopic - not affected by oil, gasoline or seawater.
- » Will never crack or split apart.
- » Very tough insulation, will not tear

In-Wall Speakers

We are proud to introduce the **WS006** speaker system for in wall mounting. The **WS006** is a complete system consisting of a Polypropylene 17 cm (6.5") woofer, a poly dome 25mm tweeter, a 12db crossover filter, housed in a sturdy baffle with an attractive metal mesh grid and beveled frame.

Outside measurement is 8 5/8" x 12 1/16" with a depth of 3" and is designed for easy installation in between 16" O. C. 2x4 stud walls. Cut out size is 7 3/8" by 10 3/4", a template and thorough instructions are supplied.

Whether you are an experienced installer who is trying to find a way to give your clients a better system and still have some margin left for you, or you are a hobbyist who is building or remodeling and wants access to quality audio installation products, the **WS006** is what you are looking for.

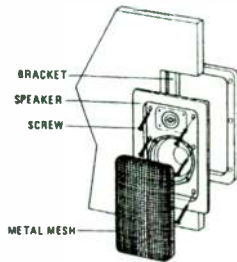

Specifications:

Impedance	8 ohms
Frequency Response	45 to 20K Hz
Power Handling	40 Watts Nom.
Sound Pressure Level	90db
Resonant Frequency	50Hz
Woofer	6.5" Polyprop., 1" VC 10oz magnet
Tweeter	1" soft dome, 6oz magnet
Crossover Frequency	3000Hz @12db
Speaker Weight	69.68oz

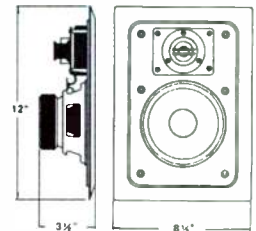

Introductory Price \$140 / pair, New construction kit \$15 / pair

Elka Gold Series Dual Banana Plug

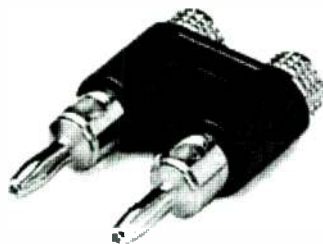

EG-PLUG

- All brass, gold plated.
- Accepts wire diameter up to 5.5mm (4awg)
- Pins are spaced at 3/4" and will accept another banana plug inserted in the back.
- Banana plugs come in Red and Black and each pin is designated red or black with a colored band. The ground pin is also designated by a black ridge on the plastic housing.
- Overall dimensions are 55mm long by 32.5mm wide and 13mm thick.
- Improved slipped locking springs for better contact between banana plug and binding post.
- Price \$6.00 each

Madisound Speaker Components; P.O. Box 44283, Madison WI 53744 Tel:608-831-3433 Fax:608-831-3771

Reader Service #8

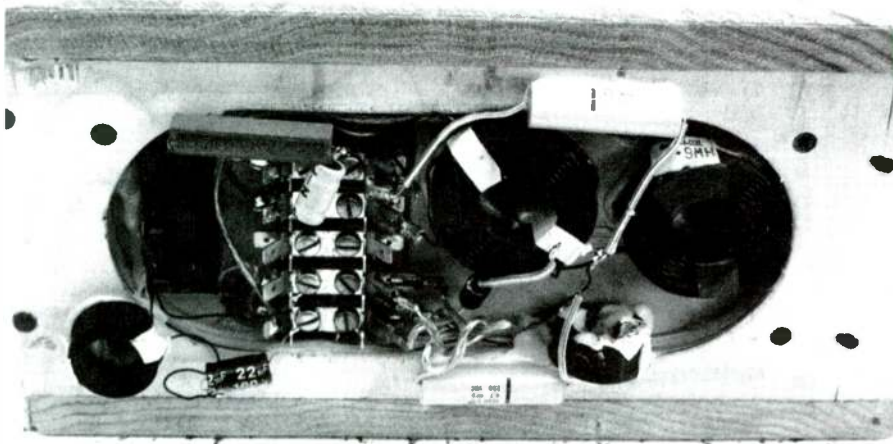

PHOTO 2: The crossover mounted in its recess on the cabinet top.

Continued from page 26

Simultaneously glue both sides to the assembly. While the glue sets, you'll need three clamps with a minimum of 7" capacity to hold the assembly together: one at each corner. Use a flush-trimming router bit to trim the sides with the top/back/baffle, then chamfer all the edges using a 1/2" radius on the baffle face and a 1/4" radius on the remaining edges.

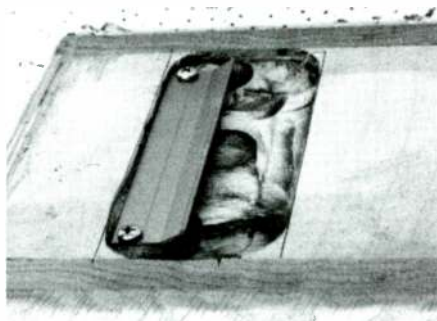

PHOTO 3: Hanger bracket detail, showing recessed bracket mounting.

Drill three 1/4" holes in the top liner for driver wiring, and whatever holes are required by your choice of binding post/jack. If you plan to inlay your wall hanger on the back, rout it out as well.

To finish the cabinets, I used a water-based urethane. After first sanding them smooth with 100- and 220-grit papers, apply one coat. Within two hours, sand again with 220-grit paper and apply the finish coat. Water-based urethanes do not impart any color to the wood, so you must stain to match your furniture.

Wire up your drivers and mount them to the baffle. Run separate wires from the woofers and the tweeter through the top liner. Be certain to label them and note their polarities. Seal the drivers to the baffle with silicone sealant; seal the wiring holes, as well. Depending upon your jack/binding post arrangement, you may also need to run wires from the posts to the inside of the cabinet and then back out again through another hole. Do this

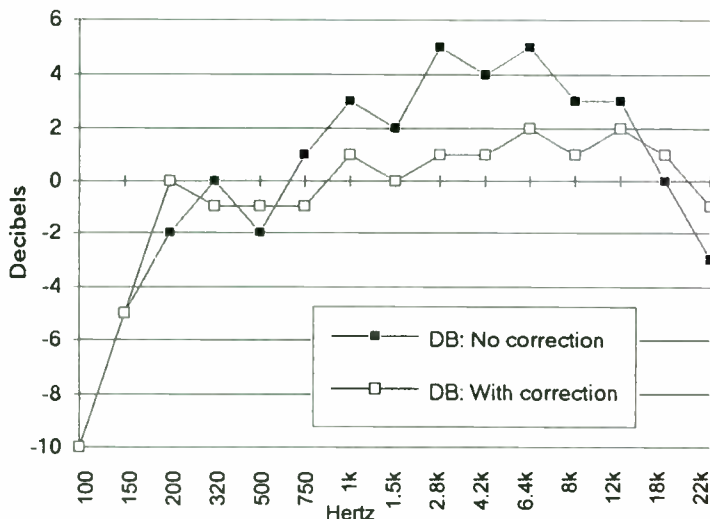

FIGURE 4: Frequency response, measured with Radio Shack sound-level meter at 1/2 m, on tweeter axis. Plot corrected for meter high-frequency rolloff.

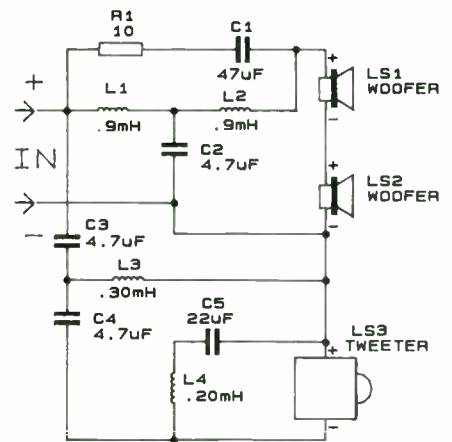

FIGURE 3: Crossover schematic/wiring diagram.

before sealing the drivers in place. With all the wiring on the exterior, you can wire up your crossover and test or modify it without reopening the cabinet.

BOTTOM LINE

I began my design with a simple 18dB crossover at 3.2kHz, and wired my woofers in series rather than parallel (Fig. 3, Photo 2). The resulting 16Ω impedance lowers woofer response relative to the tweeter, which compensates for the woofers' corner loading.

As you might expect, the original response curve is fairly ragged with a peak in the crossover area. To smooth it, I added a band-pass rolloff filter to the tweeter. This cut the undesirable peak from 2.4–6.4kHz without

Continued on page 71

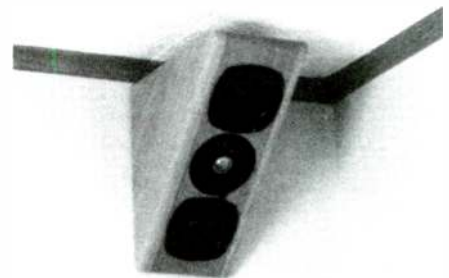
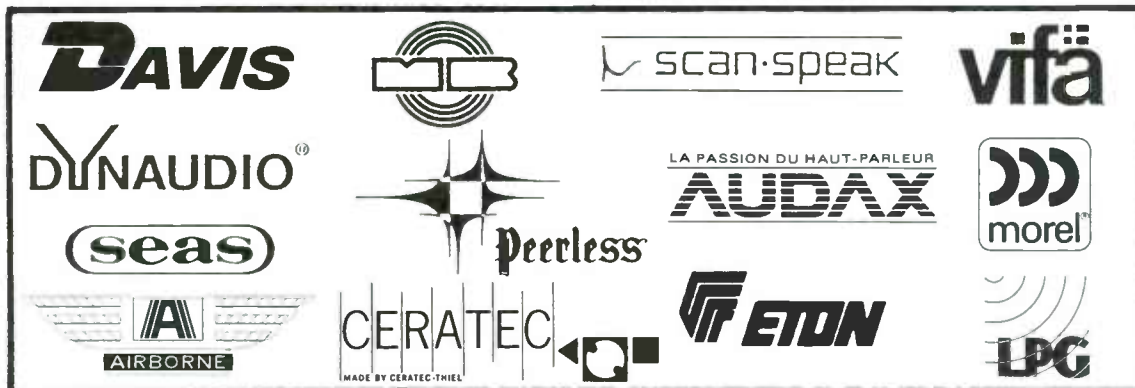
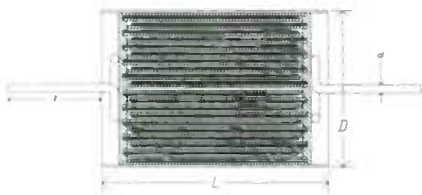

PHOTO 4: A satellite "in orbit" above the entertainment center.

SOLEN SPEAKER COMPONENTS



CROSSOVER, SPEAKER COMPONENTS



FAST CAPACITORS

Metallized Polypropylene (Non-Polarized)
 Values from 1.0 mfd to 200 mfd.
 Voltage Rating: 250 VDC / 150 VAC

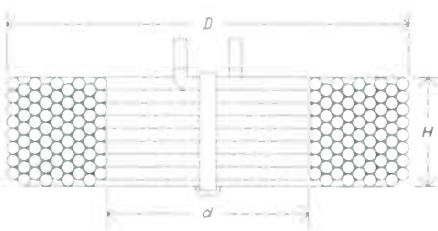

SOLEN INDUCTORS

Perfect Lay Hexagonal Winding Air Cored
 Values from .10 mH to 30 mH
 Wire sizes from #20 AWG to #10 AWG



HEPTA-LITZ INDUCTORS

Seven Strands Litz-Wire Constructions
 Values from .10 mH to 30 mH
 Wire sizes from #16 AWG to #12 AWG

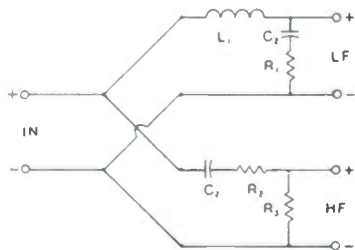

SOLEN CROSSOVERS

Custom Computer Design
 Passive Crossover for Professional, Hi-Fi and
 Car Hi-Fi, Power up to 1000 Watt

CROSSOVER, SPEAKER PARTS

Gold Speaker Terminals, Gold Banana Plugs
 Gold Binding Posts, Crossover Terminals
 Power Resistors, Mylar Capacitors,
 Bi-Polar Capacitors, Plastic Grille Fasteners,
 Nylon Ties, Car Speaker Grilles, Speaker Books,
 Speaker Kit Brochure, Miscellaneous Parts



SOLEN INC.
 4470 Thibault Ave.
 St-Hubert, QC J3Y 7T9
 Canada
 Tel.: (514) 656-2759
 Fax: (514) 443-4949

**COMPUTER AIDED DESIGN FOR
 ENCLOSURE AND CROSSOVER
 AVAILABLE TO CUSTOMER**

Product specifications and prices
 available upon request.

REAL-WORLD THREE-WAY CROSSOVERS

By Ralph Gonzalez

In my article "Real-World Two-Way Crossovers: A Design Method," (SB2/92 p. 18) I described "variable-Q" formulas for varying the amplitude at the corner frequency of second-order high- and low-pass crossovers. Varying this parameter helps account for the bandwidth limitations and phase shifts present in real-world drivers. I mentioned in the article that more complicated formulas exist for second-order bandpass (midrange)

crossovers. Figure 1 is a BASIC computer program which uses these formulas.

You enter the low and high crossover frequencies and their respective Q values, as well as the load resistance (including the effects of attenuating resistors). The program then prints the capacitor and inductor values for a second-order bandpass crossover (Fig. 2) with the desired characteristics. An example of the filter response with $f_L = 500$, $f_H =$

4,000, $Q_L = 1$, $Q_H = 0.350$ is shown in Fig. 3. This sort of response may be useful to equalize a midrange driver which has an overdamped low end and a peaky high end.

Recall from my previous article that an ideal two-way Linkwitz-Riley second-order crossover has $Q = 0.5$ for both the high- and low-pass sections. (This means that the woofer and tweeter amplitude is -6dB at the crossover frequency, producing a flat overall

```
PI = 3.1415926
```

```
INPUT "Enter LF and HF corners (Hz)";fL,fH
S = fH/fL
IF S <= 2. THEN
  PRINT "Too narrow spread"
  STOP
END IF
a = 2.*(S-1.)/SQR(S^2-2.*S)
PRINT "(Q for ideal APC crossover: ";1./a;)"
INPUT "LF and HF Q";QL,QH
H = S+a^2-4.+3./S
B = S+a^2+1./S
K = B-1.
EG = 20.*LOG(K/H)/LOG(10.)
PRINT "(Excess gain of ideal APC crossover: ";EG;)"
INPUT "Enter total load resistance (Ohm)";k0

wL = 2.*PI*fL
wH = 2.*PI*fH
xL = 1./2./QL
xH = 1./2./QH
```

```
b4 = 1./wL^2/wH^2
b3 = (2.*xL*wL + 2.*xH*wH)/wL^2/wH^2
b2 = (wL^2+wH^2+4.*xL*xH*wL*wH)/wL^2/wH^2
b1 = (2.*xL*wL*wH^2 + 2.*xH*wH*wL^2)/wL^2/wH^2
b0 = 1. 'assume b0=1 in transfer function

k1 = b4/b3/k0
k3 = b1*k0 - (b3^2*k0/(b2*b3 - b4*b1))
k4 = b3*k0/k3/(b1*k0-k3)
k2 = b1*k0 - k3

PRINT
PRINT "C1 =" ;k1*1e6;"uF"
PRINT "L1 =" ;k2*1e3;"mH"
PRINT "L2 =" ;k3*1e3;"mH"
PRINT "C2 =" ;k4*1e6;"uF"
```

END

FIGURE 1: Program listing. Finds components for second-order bandpass crossover, given the user's choice of corner frequencies and their

respective Q values. Suggests values for ideal second-order APC as a starting point, based on Robert Bullock's SB 2/85 article.

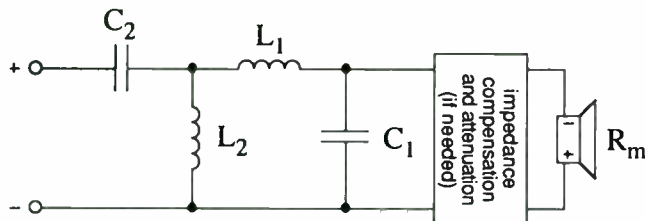

FIGURE 2: Second-order bandpass crossover.

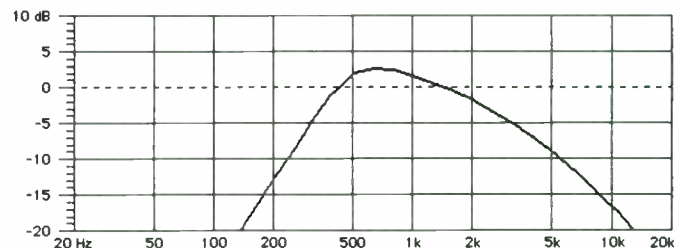

FIGURE 3: Sample custom filter response.

frequency response.) I recommended this value as a starting point for attempting to develop a crossover using real-world (non-ideal) drivers. However, the choice of Q is not so simple in the case of an ideal three-way crossover: it varies according to the spread of the crossover frequencies.

Part II of Robert Bullock's "Passive Crossover Networks" (SB 2/85, p. 26) presents formulas for computing, among others, ideal second-order three-way networks. Bullock's "a" parameter is equal to 1/Q in the second-order case. My bandpass program computes this parameter using Bullock's formula, and suggests the corresponding Q as a possible starting point for both Q_L and Q_H .

It also shows the excess gain of Bullock's ideal bandpass crossover, the starting point for calculating the values of attenuating resistors (Bullock's RA). If you use the same "ideal" Q in my original formulas for the woofer and tweeter crossovers, and if you reverse the midrange polarity, you will obtain Bullock's three-way all-pass crossover (APC). This crossover will have a flat frequency response—until you use it with real-world drivers.

If measurements or computer modeling indicate that a peak or valley occurs at one or both crossover frequencies in the real-world system, you can use the same approaches I previously suggested to customize the crossover: reverse one driver's polarity, vary the Q of the respective crossovers, or use noncoincident crossover frequencies (such as a 400Hz low-pass filter on the woofer and a 600Hz LF corner on the bandpass filter).

In the case of the bandpass crossover, you may vary Q_L and Q_H independently. You may also find it necessary to use a different gain value from that in the "ideal" crossover, by changing the series resistor value. This necessitates recomputing the network values with the new load resistance, unless you use a series-parallel combination to maintain the same overall resistance.

SOURCE CODE INFO

Copies of this BASIC IBM program are available on 3 1/2" 720K DS/DD disk (specify SOF-GON1B3) or 5 1/4" 360K DS/DD disk (specify SOF-GON1B5) for \$6.95 plus \$3 s/h from Old Colony Sound Lab, PO Box 243, Peterborough, NH 03458-0243; (603) 924-6371, FAX (603) 924-9467.

ARE YOU MOVING?

Please send us your *new* address 4 weeks in advance. Thank you.

CFAC INDUCTOR™

Copper-Foil Air-Core Inductor™

Extremely Designed For Precision Audio Transducer Speaker Driver Crossover Network.



Recommended By The Major Hi-End Speaker Manufacturers

PRODUCT HIGHLIGHT

FEATURE

- Very low power loss (15-50% less)
- Very low DC resistance
- Very low AC resistance
- Improved Q factor
- Higher precision coil reactance
- Uniform current density
- Minimized Skin Effect resistance up to 100kHz
- Very high winding density
- Computer optimized coil size
- No saturation distortion
- No hysteresis distortion
- Made in USA

CFAC INDUCTOR™ - LOWEST R_{dc}

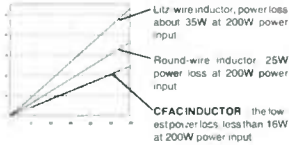

CFAC INDUCTOR™ - CLOSE TO THE IDEAL INDUCTOR

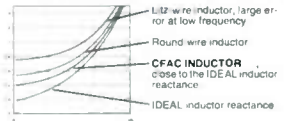

CFAC INDUCTOR™ - ELIMINATE SKIN EFFECT

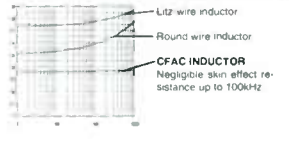

PRICE EXAMPLE:

14awg 0.47mH \$ 9.31
12awg 0.47mH \$ 12.69
14awg 1.80mH \$ 18.89
12awg 1.80mH \$ 26.55

PLEASE CALL FOR A FREE CATALOG
TEL: (510)887-8016 FAX: (510)887-1657

Solo Electronics, 2462 Triguiloli Way, Hayward, CA 94545, USA.

Reader Service #40

SPEAKER CITY, U.S.A.

PROUD TO DISTRIBUTE

EXCLUSIVELY

in Southern California

☆ **HELLA-BEAT WOOFERS** ~ made in U.S.A.

☆ **Vifa** excellence from Denmark

OTHER HIGH END LINES INCLUDE:

scan-speak

FOTAL
technologie d'avant-garde



DYNAUDIO

polydax
SPEAKER CORPORATION

Introducing the Versa-Tronics 8" woofer
model FQB210R PP 8Ω



f_s - 30Hz
 Q_{TS} - .42
 V_{AS} - 81.72 L³
86 dB -1W/1m



115 S. Victory Blvd., Burbank CA 91502
(818) 846-9921 FAX (818) 846-1009

Please call for pricing and catalog

Reader Service #32

Speaker Builder / 6/93 31

THE SIMPLEX

By Ernie Pfannenschmidt

Bowed stringed instruments produce some of the most pleasing musical sounds imaginable, yet they are just simple wooden boxes brought to resonance by catgut stroked with strands of horsehair—not exactly high technology by anyone's standards.

Since no one has so far come up with a perfect transducer, our loudspeakers may also be considered musical instruments. We can build them, like fine violins, without recourse to technological wizardry. The Simplex (Photo 1) is an example of what you can do with inexpensive components in an ordinary enclosure. Coupled with a suitable subwoofer, it rivals systems in the four-figure price bracket but costs under \$200 to build.

The only tools required are common household woodworking tools and a soldering iron. The definitive testing instruments are your own ears and sound perception. You alone must be happy with them; test lab results, favorable or otherwise, are irrelevant.

THE DRIVERS

The drivers in this vented, two-way speaker are fed by a biwired passive first-order Butterworth crossover. The woofer is zobelized. I started the project by purchasing two Radio Shack model 40-1296 crossovers that offer a choice of crossover frequency at 2, 2.4, or 4kHz.

I then looked for inexpensive drivers to match the 6dB slope of these crossovers and chose the Radio Shack model 40-1011-A 6½" polypropylene woofer. This woofer is well made and moderately priced. Its parameters are: $Q_{TS} = 0.4-0.46$, $f_s = 38-50\text{Hz}$. The frequency response extends to 5-6kHz and then drops off at a suitable slope. The exact values are not terribly important for this project. Good stereo reproduction does not necessarily require precisely matched pairs of drivers in the right and left enclosures. A change in the Radio Shack catalog number suffixes after I bought my woofers indicates a switch in manufacturers and some deviation



PHOTO 1: The Simplex speaker.

in specifications. The quoted spread is typical and quite acceptable.

Figure 1 shows a typical impedance sweep of a 40-1011 woofer. I ran some tests to decide what I should do about the zobel. I soldered

the components in series (Fig. 2) directly across the driver tabs. If you like to experiment, retain the resistor and try different capacitors to suit your ears.

The 100 DT 26/72 Peerless tweeters are a bargain. They offer sufficient overlap for a possible low crossover point of 2kHz, and their efficiency level matches the woofers'. Most important for a two-way system with a 6dB crossover is that the tweeters have an excellent high-power-handling capacity.

THE ENCLOSURE

Few speaker builders will dispute the importance of volume in designing enclosures for the lower-octave regions, yet relatively few seem to give it much thought when addressing the mid-range. Miniaturization seems to be in vogue. I prefer a healthy ratio between the driver cone area and the box volume for the midrange as well. The Simplex enclosure (Figs. 3 and 4) has an internal net space of 0.82 ft.² and a box resonance of about 62Hz. Without consulting Thiele/Small, I guessed at a 1½-inch-diameter vent duct that was 1-1½" long, which worked out just right in the end.

When it comes to soundstage imagery, there is little to fault in vertically and symmetrically aligned driver arrangements. The speaker's front baffle is as narrow as convenient and both beveled and round-edged to

Continued on page 34

ABOUT THE AUTHOR

Ernie Pfannenschmidt is a retired engineer who spent much of his career designing scientific instruments with the National Research Council of Canada. He has been an audio enthusiast since the 1950s and enjoys sailing among the islands and along the fjords of British Columbia.

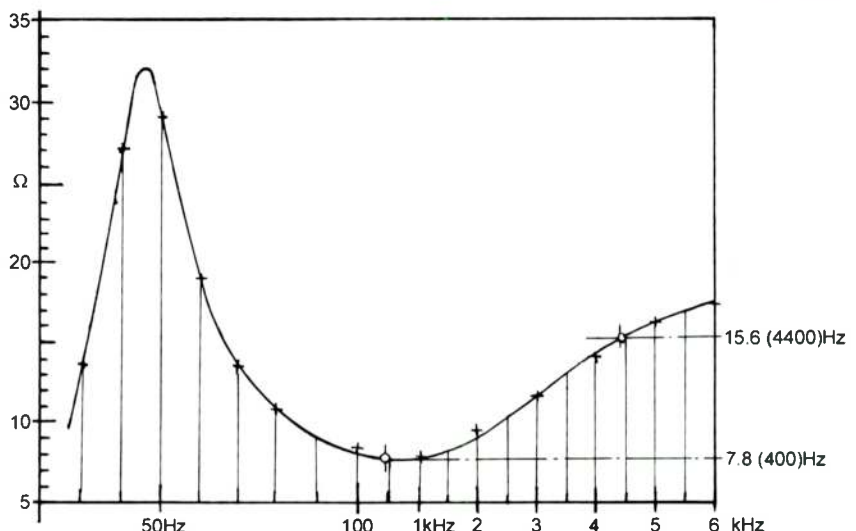

FIGURE 1: Impedance curve for the Radio Shack model 40-1011-A 6½" woofer.

World Famous
PYLE DRIVER® SPEAKERS...

**Your Source for
Quality Woofers, Midrange,
Tweeters and Crossovers**



- Over 200 speaker models and sizes available
- Parameters available for every loudspeaker
- Recommended cabinet sizes available for all woofers

Pyle is the source for all your loudspeaker needs!

PYLE

Pyle Industries, Inc. • 501 Center St. • Huntington, IN 46750 • (219) 356-1200

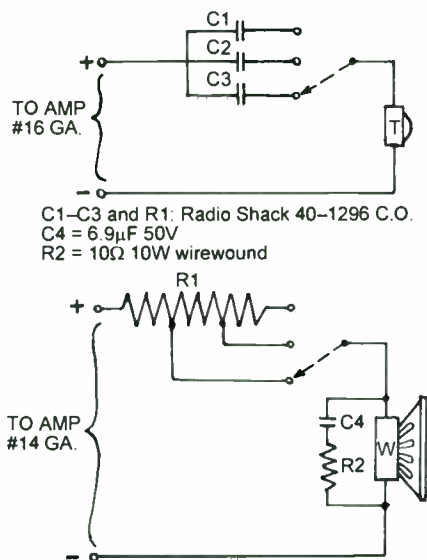

FIGURE 2: Biwired crossover for the Simplex speaker.

Continued from page 32

reduce diffraction effects and enhance dispersion. The proportions of the box sides relative to one another are based on averages derived from an analysis of especially good sounding vented speakers of similar volume.

Over the years, I have built speaker enclosures of various materials, but I still prefer high-grade plywood, in this case 3/4" 6- or 7-ply birch. It seems to give a natural and less synthesized timbre to the music, particularly when playing some of the "harsher" compact discs. The front baffle is a laminate made of a 3/4-inch-thick air- or kiln-dried spruce board and a 3/8" fir plywood backing. The enclosure is important to the success of this project, so follow the drawings carefully.

To decouple the woofers, rest them on a silicone seal or a custom-cut soft gasket underlay. They should be flush with the baffle face. You can screw the tweeters directly onto the baffle without recessing or decoupling.

LETTER WRITERS AHOY . . .

We need your cooperation in the matter of your welcome letters to authors and other readers. Please enclose a stamped and addressed envelope if you expect a reply. If the author/reader lives outside the USA, please include two International Postal Reply coupons (available at your post office) instead of stamps on your envelope.

In questioning authors, please leave room in your letter for replies which should relate to the article, be framed clearly, and written legibly. Please do not ask for design advice or for equipment evaluations.

Use Elmer's white glue and finishing nails to assemble the enclosure. Pipe clamps hold things plumb and square until the glue cures. The side and back panels have internal braces at different heights. Glue rubber-backed nylon carpeting to the side and rear panels only (Fig. 3). The bottom panel is held in place by countersunk flat-head wood screws and is removable, providing access to the inside. Work carefully here and at the vent hole so you get a snug fit. Fill each cabinet evenly and loosely with 5 1/2 oz. of polyester Fiberfil.[®]

Modify the crossover as in Fig. 4. On final assembly, place neoprene washers under the crossover board and fasten it to the enclosure bottom with round-head brass wood screws.

TUNING YOUR SPEAKERS

When you're finished building the enclosures, install the drivers, to which long heads have been soldered. Do not install the crossover yet. Have some cardboard vent tubes 1-3" long at hand. Insert either the shortest or the longest of these tubes and feed the speaker wires through to the outside, where you can clip them to the crossover. Also feed the crossover the signal from the amplifier's outputs. Then proceed to "tune" your creations: this is the fun part and will keep you busy many an evening.

Use your own amplifier/receiver. Play only discs with which you are familiar, over and over again. They must span the musical spectrum, but remember that these speakers will produce only an acceptable upper bass and no lower bass.

First decide which crossover frequency sounds best under all circumstances. It should be the 4kHz crossover, which lets the woofer supply the necessary power and impact. Placing the crossover dip there moderates tape hiss because this is where it peaks.

Now determine which vent length provides the cleanest bass (not necessarily the lowest). I settled for 1 1/2" vents, but you must make your own decision based on what sounds best to you. Line the inside of your vent with Neotex, an open-mesh, nonskid, neoprene-coated matting sold by yacht chandlers or at outlets catering to people with physical handicaps. Provided you don't start manufacturing such a vent, you won't violate the Russian patents addressing this way of modifying the backwave. The material also works well as a mat atop speaker stands.

Finally, you may try changing the amount of Fiberfil stuffing in your speakers. Like a luthier tuning a fine violin, you can get it just right with patience.

Continued on page 36

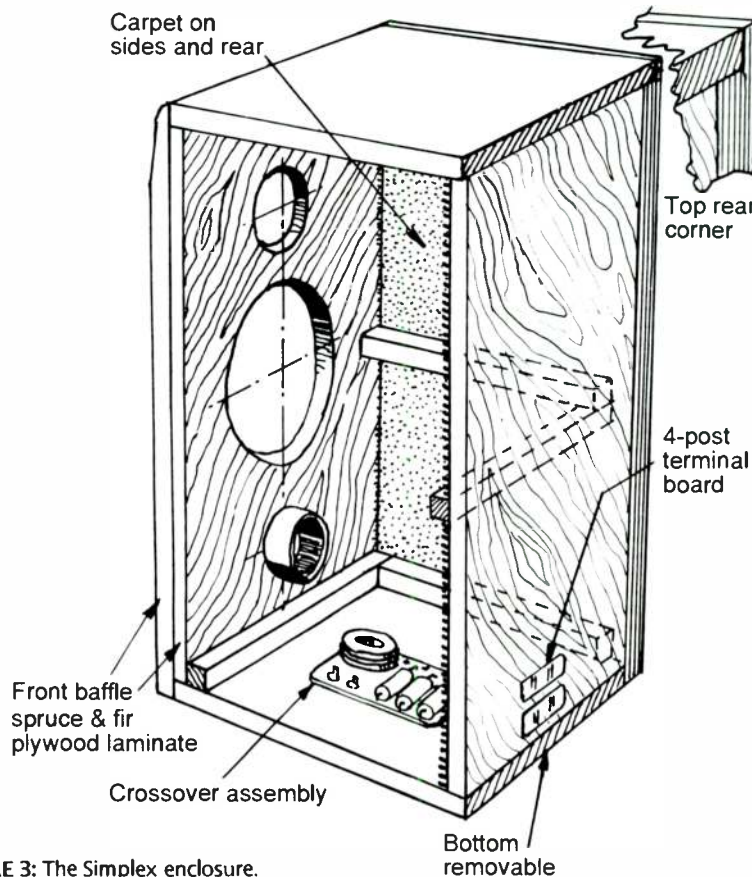
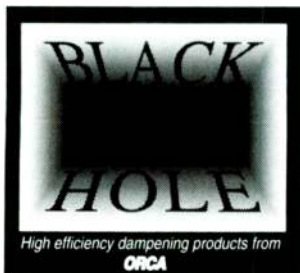

FIGURE 3: The Simplex enclosure.



A better speaker damping material...

If you've been building speakers for some time, you know how much guesswork goes with speaker damping and stuffing. The choices seem endless: fiberglass, wool, Dacron, flat foam, convoluted foam, felt, tar, plus various "magic" compounds that you're invited to brush or pour into your new cabinets. Everyone has their own recipe, and who knows if it's a recipe for disaster? Or what effects the vapors emitted by these chemicals might have on the glues that bond your woofer surround to its cone and chassis? In this era of costly, space-age drivers and computer-assisted design, we think such risks are totally unacceptable. So we went to work to find the ideal solution.

The problems are fairly well-known: a driver transforms electrical energy into mechanical energy. This mechanical energy is transformed into acoustical energy which is radiated to the outside of the cabinet - the useful front wave - and to the inside - the sometimes-useful back wave. Unfortunately, it is also transmitted through the frame of the driver to the cabinet itself, which acts as a very large "cone" of very small excursion. This means that the spurious resonances and vibrations of the cabinet have to be controlled in a predictable and reproducible way. That's how we came to BLACK HOLE 5 and the BLACK HOLE PAD.

First, THE PAD. It's a thin (1/16 inch) black flexible viscoelastic damping material (filled vinyl copolymer) with maximum performance between 50 and 100 degrees F (we hope that that covers the temperature range of your listening room) and excellent flame resistance - it meets UL94 V-O. Thanks to its outstanding damping characteristics, THE PAD will dramatically reduce the vibration energy stored in the walls to which it is applied.

Easy to cut and apply. THE PAD has a pressure-sensitive adhesive back: simply peel off the release paper and press hard onto a clean surface. You can use THE PAD on just about anything you suspect of vibrating: driver frames, thin panels like car doors, and, of course, the walls of your speaker cabinets. And it can be used to recess a driver without using a router: just laminate enough layers to match the thickness of the driver frame and apply to the front baffle. Finally, it is the ideal material for "constrained layer" wall construction, where two panels are laminated on each side of a damping material for optimum transmission loss. Because THE PAD has a fine grain leather finish, you can wrap an entire cabinet exterior and give it an attractive appearance at the same time!

For applications which require **maximum damping, isolation and absorption**, we've developed BLACK HOLE 5. One and 3/8" thick, BLACK HOLE 5 is a high-loss laminate that provides optimum acoustical damping performance. It consists of five layers:

Thin diamond-pattern embossing, densified with a polyurethane film surface. This unique surface layer dramatically improves the performance of the whole acoustical system, especially the lower mid-range and mid-bass frequencies where simple acoustical foam loses its effectiveness.

One-inch deep polyester urethane foam, structurally optimized for acoustical damping. Highly effective at "soaking" maximum sound energy with minimum thickness.

Barrier septum, 1/8 inch thick. Made of limp flexible vinyl copolymer loaded with non-lead inorganic fillers, it is a "dead wall" that isolates the vibrations in the walls of your cabinet from the vibrations created inside the enclosure.

Polyester urethane flexible open-cell foam, 1/4 inch thick. Thanks to special vibration-isolation characteristics, it decouples the vibrating structure (the wall) from the rest of the damping system, thus optimizing performance.

High-loss vibration damping material, same as The Pad. It is strongly bonded to the cabinet wall with pressure sensitive adhesive.

These layers are laminated using an adhesive-free mechanical and thermal process, thus optimizing performance and eliminating the risk of solvent fume damage. BLACK HOLE 5 can be used in any enclosure, as well as for acoustical panels to improve the characteristics of your listening room. **YOU PROVIDE THE MUSIC; BLACK HOLE FIVE WILL TAKE CARE OF THE NOISE!**

orca	1531 Lookout Drive Agoura, CA 91301 U.S.A	818-707-1629 FAX 818-991-3072
-------------	--	----------------------------------

AEON_{Cables}

New from ORCA!

AX-ON (Greek axon, axis): that part of a nerve cell through which impulses travel away from the cell body. AXON 8 speaker cable combines outstanding design features with component quality usually associated with the most expensive cable. With eight AXON 1 solid-core conductors and utilizing mylar/ polypropylene construction, AXON 8 offers outstanding performance for amp-speaker connections and perfectionist internal speaker wiring. Our superb AXON 1 AWG 20 solid core conductor is also available separately. Oxygen-free and 99.99% pure, it is ideal for most internal wiring applications.



- Outer insulation: UL approved TPE
- Cable geometry: non interleaved spiral
- Individual conductor insulation: 105 degree Celsius. UL approved PVC
- Cable equivalent gauge: total - AWG 11, 2 conductors - AWG 17, 4 conductors - AWG 14
- Individual conductors: solid core AWG 20 copper, long-grain and ultra-soft, free of all contaminants and oxygen.
- Cable core: crushed polypropylene
- Inner envelope: mylar film

THE SUBWOOFER

I solved the problem of the missing lower bass with a subwoofer consisting of a strong, well-braced wooden box of 3 ft.² capacity and a 1950s 12" Wolverine driver that I purchased for \$8 at a church thrift shop. It's one of those die-cast monsters with a stiff paper cone and a large, porous dust cap. I modified it in much the same way as advocated by Brian Smith ("Adjusting Woofers For High Performance," *SB* 6/89, p. 22), coating the cone with polyurethane and applying felt to the rear of the driver basket. The subwoofer is fed through a hand-wound coil of wire salvaged from a discarded washing machine motor and produces sound below approximately 240Hz. Friend and foe alike are amazed that the Simplexes seem to put out clean bass down to 30Hz.

My second set of Simplexes, which I built for one of our married children, is supplemented by a subwoofer based upon Eldon Sutphin's findings ("Measuring Drivers With Radar," *SB* 3/91, p. 10). It uses a 10" Radio Shack model 40-8053 driver ($F_s = 27$, $Q_{TS} = 0.41$, $V_{AS} = 4.8$) installed in a 2.8 ft.² vented box. The 2½-inch-long duct has a 2" diameter.

Quite a number of interesting designs are offered in back issues of *SB*, so take your pick. Powering the subwoofer with a separate am-

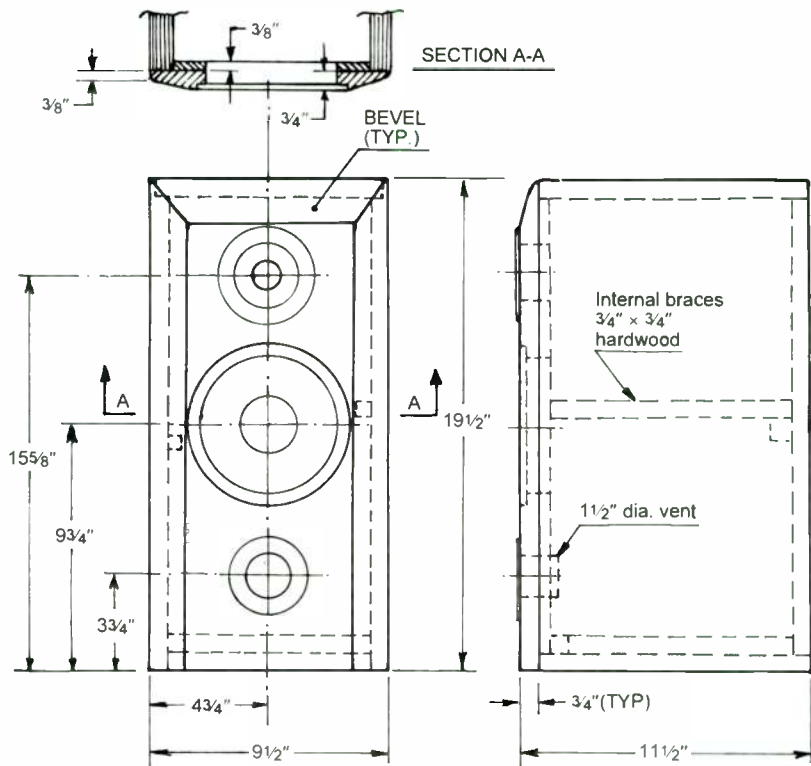

FIGURE 4: Plan and dimensions for the Simplex enclosure.

plifier is another way to improve your sound system. Purchase a secondhand unit and feed its auxiliary input with the stereo signal taken from the headphone jack on your integrated amplifier or receiver.

PLACEMENT

These speakers are tolerant with regard to room volume. Our children's living room has a sloped ceiling that is 18' high at one end, and the Simplexes work well there, as well as in small- or medium- sized rooms. The reason for this tolerance is the speaker efficiency: I drive them with a 35W/channel Yamaha amplifier, and they have power to spare.

Locate the speakers at approximately equal distances from the listening position and separate them by 7-8'. Place the tweeters at or slightly below ear level for a seated person and at least 3-4' from the room's side walls. Experiment with their distance from the back wall; a distance of 1½-2¼' usually provides good results. In most cases, people will be seated close to or against the opposite wall, so give the speakers a slight toe-in that best suits your needs.

The smoothest response and best coupling to the Simplexes is often obtained by locating the subwoofers at substantially unequal distances from the nearest three room surfaces. Mine are offset from center stage in one case and firing into a corner in the other. It pays to experiment with subwoofer placement to

avoid cancellation or enhancement of the deep bass.

I also installed a broadband absorption medium behind the speakers. It consists of a ½-inch-thick fiber mat behind heavy woolen drapes and extends across the entire width of my basement listening room. By absorbing 50-75% of all sounds above 500Hz, it effectively improves both stereo imagery and ambience.

PERFORMANCE

The Simplexes are clean and airy, and you can listen to them for hours without fatigue. They evoke an intimate presence, and the imaging is precise. As for timbre, string ensembles sound natural—the cellos full and firm, the violins resinous yet silky smooth. The inner voicing evident in combos makes it seem as though they are right in the room. Woodwinds are delightful, and brass are bright and sharp but not shrill. Symphonic music is spacious, with no loss of clarity or detail in the crescendos. Triangles shimmer and bells twinkle naturally. The piano comes across convincingly, provided you have the subwoofer tuned right to handle the bottom end. Voices, male or female, are pleasurable, whether solo or choir.

Like any good speaker, the Simplex is merciless with regard to turntable rumble, surface noise, mistracking, distortion, and tape or FM hiss. It also will expose goofs. This may spoil listening to some of your favorites, but it will make you nearly ecstatic when auditioning the high-quality recordings you own.

THE WOOFER TESTER

The *Woofers Tester* is a combination Hardware and Software system that runs on any IBM compatible personal computer with EGA or better graphics capability and at least one RS232 serial port. The *Woofers Tester* takes the following measurements:

• Raw Driver or Sealed Box:

- f_s - resonant frequency
- Q_{TS} - woofer Q
- V_{AS} - equivalent volume of air of driver compliance

• Vented Box:

- f_{SB} - resonant frequency of box
- h_a - f_{SB} / driver f_s
- alpha - V_{AS} / Box volume

The power of measurement systems costing thousands of dollars is now available to you at an unbelievably low price.

PRICE: Introductory price is \$399.00.

Includes everything you need.

Ask your wife to buy you one for Christmas, or buy it yourself for Christmas! Start the new year building perfect woofer systems.

Call Brian 301-498-8737
C&S Audio Labs, Floyd VA

Reader Service #7

Constructive Gift Ideas That Can Spread Holiday Cheer All Year

AND SAVE UP TO 25% ON GIFT GIVING

Now is the perfect time to give your technically sharp friends a gift that gives all year long. Choose from our three high-tech handcraft journals which can bring your friends the kind of challenge and delight that only high-quality technical publishing can provide.

Order one subscription at full price and the subsequent ones are up to 25% off on all three of our information-packed magazines. To order, just fill in the names below and we'll do the rest. We'll even send a personalized card to each one acknowledging your gift.

Offer ends December 31, 1993

Gift Subscription Order Form

AUDIO AMATEUR

For twenty-four years the world's only quarterly for audiophile crafts. Features new construction and customizing classics. All types of construction from simple buffers to power amps to mixers. Quarterly only \$20/year in US.

Canada add \$4 per year postage. Foreign rates: 1 year \$35 for first order; \$30 for additional orders.

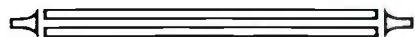

SPEAKER BUILDER

The world's only magazine devoted entirely to loudspeaker construction and design. Features hands-on projects of all speaker formats, customizing older designs and computer implemented enclosure and crossover design. Bi-monthly only \$25/year in US.

Canada add \$6 per year postage. Foreign rates: 1 year \$40 for first order; \$34 for additional orders.



GLASS AUDIO

The world's only all-tube audio construction and upgrade magazine. Tubes are back and never sounded so good. Quarterly only \$20/year in US.

Canada add \$4 per year postage. Foreign rates: 1 year \$30 for first order; \$25 for additional orders.

Send TAA SB GA to:

NAME _____

STREET & NO _____

CITY _____ STATE _____ ZIP _____

Sign Gift Card From _____

Send TAA SB GA to:

NAME _____

STREET & NO _____

CITY _____ STATE _____ ZIP _____

Sign Gift Card From _____

Send TAA SB GA to:

NAME _____

STREET & NO _____

CITY _____ STATE _____ ZIP _____

Sign Gift Card From _____

Send TAA SB GA to:

NAME _____

STREET & NO _____

CITY _____ STATE _____ ZIP _____

Sign Gift Card From _____

Please list additional names on a separate sheet.

MY NAME _____

STREET & NO _____

CITY STATE ZIP _____

Please enter/extend my own subscription to:

TAA SB GA at these special rates

I am ordering a total of _____ 1 year subscriptions as follows:

First TAA at \$20 _____

_____ TAA's at \$15 each _____

First SB at \$25 _____

_____ SB's at \$19 each _____

First GA at \$20 _____

_____ GA's at \$15 each _____

Total enclosed _____

All remittances must be in US \$ drawn on a US bank

Check

Money Order

Mastercard

VISA

Card Number _____ Exp Date _____

Audio Amateur Publications, Inc. P.O. Box 576, 305 Union Street, Peterborough, NH 03458-0576 (603) 924-9464 FAX (603) 924-9467

LIVING WITH A SPEAKER BUILDER: A VIEW FROM THE OTHER SIDE

By Nancy MacArthur

Living with a speaker builder is not always easy. I don't worry about the noise, the mess, or the smell of drying glue. What bothers me is the complete change of personality—a Dr. Jekyll/Mr. Speaker Builder transformation—that my husband Duncan undergoes whenever he starts designing a new set of speakers.

Under normal circumstances I like living with Duncan. His face lights up when he sees his family at the end of the day, and he's handy to have around the house: he can fix anything and does more than his share of housework. But "normal" is not a word I would apply to anyone in the throes of a Speaker Building Fit.

COMMUNICATION BREAKDOWN

Some stages of the Fit are relatively easy to cope with. The only inconvenience resulting from the construction of speaker boxes, for example, is an occasional unspeakable buzzing sound emanating from the garage. During this stage, I can still communicate with Duncan if only via hand signals. He can't hear me, because he's wearing earplugs and goggles as he hunches over a roaring table saw. On the other hand, if he sees me waving at him frantically from the door, he's willing to take a break to find out what's going on.

Communication is infinitely more difficult during the earlier stages of the Fit, when Duncan starts to design a new speaker. He secludes himself in an out-of-the-way corner of the house, surrounded by piles of circuit

diagrams and old issues of *SB*. Staring off into space, he murmurs such cryptic comments as: "A five ohm resistor and a forty microfarad capacitor will equalize the woofer's impedance," or "Low WAF on this one."

He won't tell me what "WAF" means, but it must be something truly dreadful. Once the Fit has passed, he's usually only too happy to explain to me, in detail and at great length, why a resistor is different from a capacitor, and why he can't live without the new ones advertised in the latest catalog instead of using up the mounds of tiny parts he has piled on his desk.

I've thought about taking a *laissez-faire* approach to Duncan whenever he starts designing a new set of speakers. He could stay hunkered down in his corner, muttering into his catalogs and parts lists. I could go on with my regular activities, pausing only to toss an occasional haunch of meat his way. He would avoid starvation, and I would avoid getting irritated with him. The trouble with this approach is that sooner or later a problem will arise which I can't solve without his input.

The usual methods of gaining his attention don't work when he's in the design stage of a Speaker Building Fit. For example, under normal circumstances, I can count on an enthralled response whenever I mention the word "food." But during the extreme throes of the Fit, food is of much less interest to him than the visions of new speakers floating over his desk.

Getting through to Duncan during this phase requires combining the persistence of a New York street vendor with a creative disregard for the truth. I start with a straightforward approach:

"Duncan, I need to talk to you."

"Mmph."

"Supper's ready," I add craftily.

"Jussec." He burrows deeper into his piles of circuit diagrams.

"Nuclear war was just declared."

"Arglemph."

"Duncan, the baby just set fire to your power amp."

"Mmmm...*What did you say?*"

It's simply a matter of understanding his priorities.

FIT OF PASSION

If I'd had the sense God gave a bunny rabbit, I would have seen what was in store for me years ago on our first date, when he spent two hours lecturing me on why I should build a transmission line as opposed to a bass reflex speaker. Luckily for Duncan, I already had a crush on him or sixteen years of happy marriage might never have come to pass.

I even get into trouble when I try to help him. One holiday season a few years ago, Duncan decided that the only present he would consider was—you guessed it—raw drivers for building new speakers. I called a well-known speaker company, ordered the drivers, and asked if they would arrive in time for my husband to open at Christmas. At first, all I heard on the other end of the line was stunned silence.

"Hello? Hello?"

"What do you mean, you want to give your husband speakers for Christmas?" a deep voice bellowed back at me.

I was bewildered. "Well, you do sell them, don't you?"

A weary sigh came over the line. "Look, lady, whenever someone's wife calls me, it's because her husband is spending all his time in the garage building speakers and she wants to yell at me for selling him the drivers. What are you, some kind of nut?"

I guess so, Mr. Speaker Man. I guess so. ▶

ABOUT THE AUTHOR

Nancy MacArthur is a freelance writer who lives in northern New Mexico with her husband Duncan, a seasoned audio fanatic, and their small son Colin.

We are pleased to announce
that the 1994

A&S speakers

Audiophile Sound-off
will be held on or about
July 16, 1994

... I guess they can't revoke
your soul for trying.

Call or write for rules and entry forms.

Good Luck!

**A&S
speakers**

3170 23rd St. San Francisco, CA 94110

(415) 641-4573 Fax (415) 648-5306

Reader Service #31

THE IMP GOES MLS

By Bill Waslo

IMP is an inexpensive circuit board and software complement which makes a PC into a sophisticated FFT analyzer for loudspeaker and audio equipment evaluation and development. I introduced it to the world in *SB 1/93* (p. 10). When used for measuring transfer functions or impedances, IMP operation is based on the fact that frequency response is the Fourier Transform of a time impulse response. This mathematically sound concept yields very accurate results and close agreement with measurements obtained by other means.¹

A narrow pulse is attractive as a measurement stimulus for several reasons. It is easy to generate using inexpensive circuitry. It contains a wide frequency spectrum allowing simultaneous measurement of most or all of a speaker's range. Both the phase and magnitude of its spectrum are essentially uniform over a wide range of frequencies. In the time domain, echoes in a device's pulse response are easily identified and removed.

NOISE INTRUSION

Pulse testing's weakness, however, is the test signal's rather low energy content.² The pulse stimulus is very brief, while the response data collection time must be many times longer in order to provide low-frequency information.

This affords an opportunity for noise to intrude into the measurement.

The test signal energy cannot be arbitrarily increased by "turning up the volume" into the unit under test. The crest factor (defined as the ratio of the signal's peak power to its average power) is very high for a pulse stimulus. You may clip your amplifier or drive your speaker into nonlinear operation with many watts of peak power, while only applying microwatts of average power to do battle with the noise. Due to the nature of most environmental noise and the need for long response collection times, the problem is most severe at lower frequencies.

In the original IMP, noise is dealt with by employing repetitive pulse stimuli and averaging. The stimuli must be spaced enough in time to permit obtaining low-frequency information and allow device pulse responses to decay sufficiently. For every doubling of the number of time responses averaged, the signal-to-noise ratio, neglecting quantization and coherent noise, theoretically should increase by 3dB.³ The trade-off is measurement time versus increased noise immunity. Averaging two responses yields 3dB improvement, 6dB with four responses, and 9dB with eight.

The simple averaging scheme works quite well for most speaker measurement purposes,

TABLE 1

IMP/MLS SATELLITE BOARD PARTS LIST

Ref. Description

Capacitors

- C1 22 μ F, 10V aluminum electrolytic
- C2, 5 0.1 μ F ceramic
- C3 0.001 μ F (1,000pF) ceramic
- C4 (Not used)
- C6, 7 330 μ F, 6.3V aluminum electrolytic
- C8 3,900pF film

Resistors

- R0 422k 1% 1/4W metal film resistor
- R1 210k 1% 1/4W metal film resistor
- R2 105k 1% 1/4W metal film resistor
- R3 52.3k 1% 1/4W metal film resistor
- R4 26.1k 1% 1/4W metal film resistor
- R5 13.0k 1% 1/4W metal film resistor
- R6 6.49k 1% 1/4W metal film resistor

Ref. Description

- R7 1k 5% carbon film
- R8 (Not used)
- R9 100 Ω , 5% carbon film
- R10 2.21k 1% 1/4W metal film resistor
- RN1, 2 5 \times 220k SIP resistor network, one pin common
- U1 74HC4040 CMOS divider
- U2 IMP/MLS programmed 28-pin PROM
- U3 74HC374 CMOS octal latch

Miscellaneous

- Printed circuit board
- Sockets for ICs
- Mounting hardware
- Approximately 30" hookup wire, 26 gauge
- Approximately 12" color-coded twisted-pair hookup wire, 26 gauge

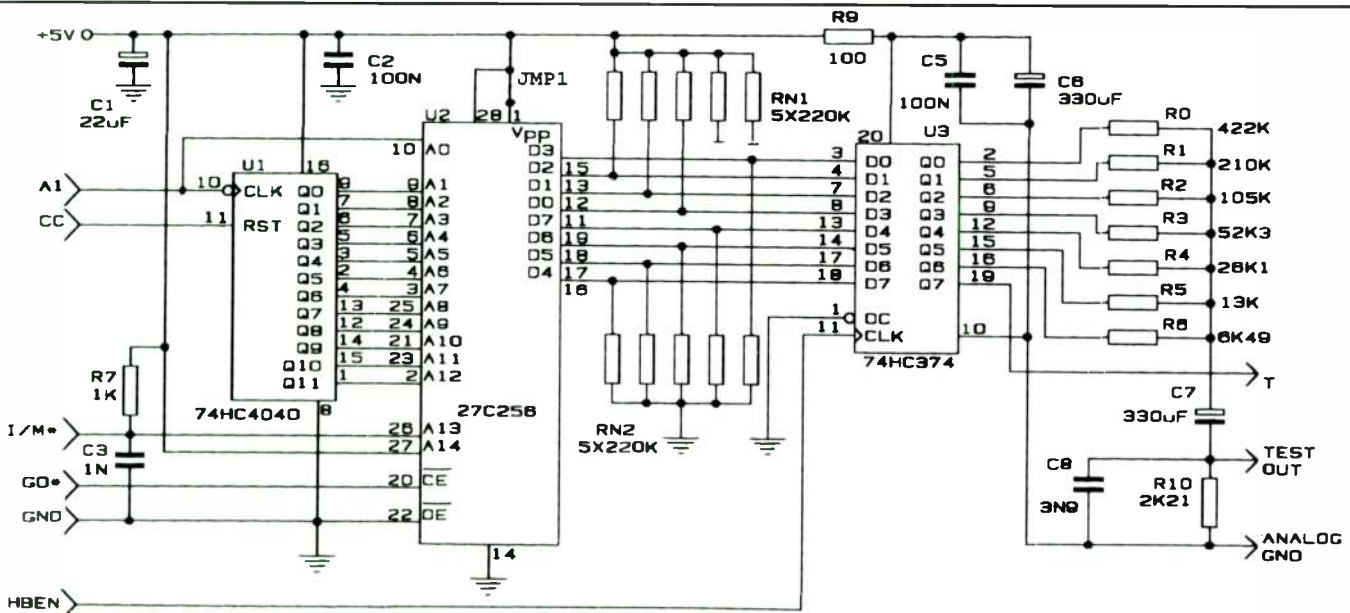

FIGURE 1: IMP/MLS satellite board.

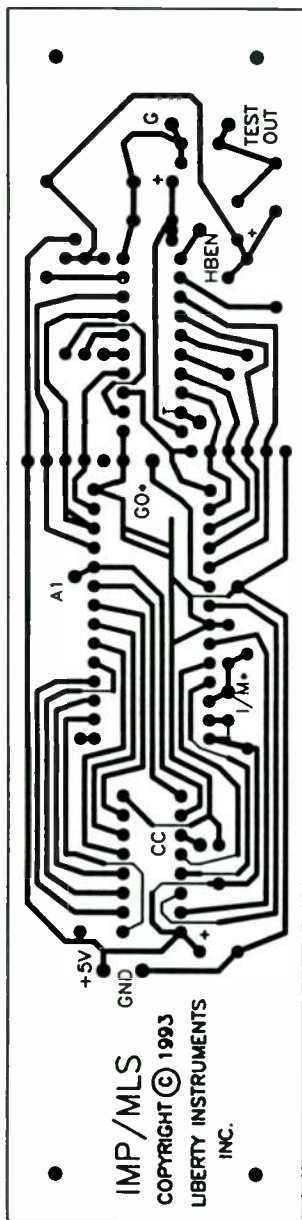

FIGURE 2: IMP/MLS satellite single-sided PC board pattern.

and for home builders who can afford the extra time and have reasonably quiet surroundings. If you wish to increase the noise rejection by 30dB, however, you'll need to average over one thousand responses. That might take longer than you care to wait.

Other broadband stimuli are also characterized by flat spectra magnitudes, but possess friendlier crest factors than the pulse. One is the frequency sweep or its optimized version, the chirp. This stimulus is not as simply generated, and phase information can be difficult to obtain unless the system being measured is already definitely known to be minimum phase. Random white or pink noise is another broadband test signal in which the magnitude spectrum is generally flat or gradually sloped but the phase is random. Due to this random factor, two channels (input and output) must

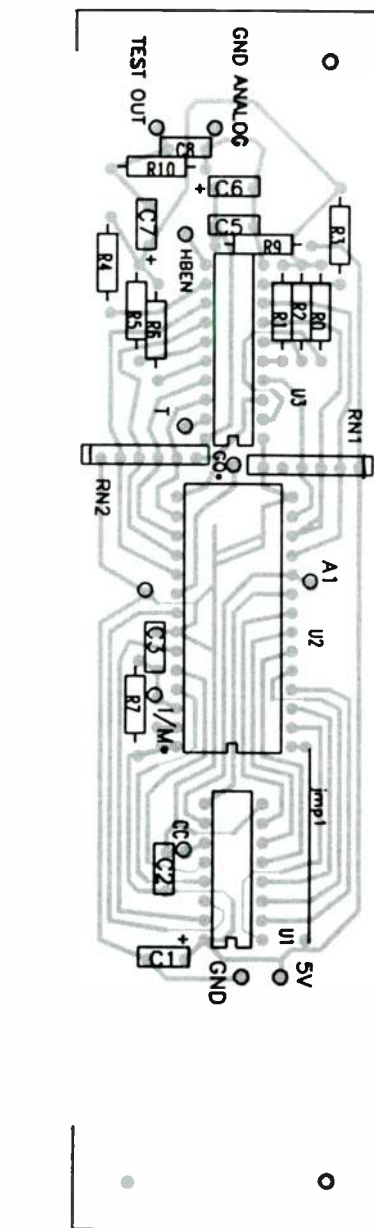

FIGURE 3: Component placement guide.

be measured simultaneously for accurate determination of a system response.

PRECISION NOISE

A very convenient stimulus is pseudorandom noise, which is an analog version of a digital signal known as a Pseudorandom Number (PN) pattern or Maximum Length Sequence (MLS). PN sequences are used extensively in spread-spectrum radio communications, data encryption, music synthesizers, and even computer games. In pseudorandom noise, the magnitude of the spectrum is basically flat, while the phase is scrambled—but not really random. The spectrum is absolutely deterministic and repeatable, like that of the pulse, so only a single measurement channel is required.

The MLS has the additional property that its autocorrelation function yields an impulse

signal, and the cross-correlation function of a system's response to an MLS with the MLS itself is that system's impulse response. An example might help clarify the meaning of this intimidating-sounding statement.

A maximum sequence length of seven, modified so that digital zeroes are represented as negative ones, is the series:



After the last value, the sequence returns to the beginning and repeats. If one copy of this sequence is lined up beneath another, and the corresponding values are multiplied and their products summed, the resulting value is seven:

shift=0:

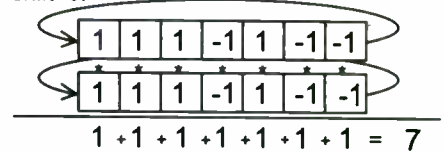

Due to the MLS's periodic nature, a circular shift of digits to the left corresponds to a time delay (any digits that run off the left can be pasted back onto the right). If the same multiply-and-sum operation—a form of correlation—is performed instead with a time-shifted MLS as the lower sequence, the result will be the value minus one. For example, here's a shift to the left of five places:

shift=5:

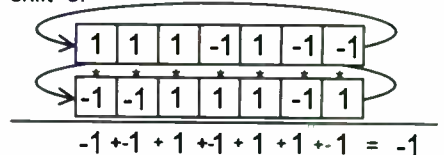

A plot of the autocorrelation result versus the time shift shows a large peak at zero shift, and at multiples of seven, and a small negative value elsewhere:

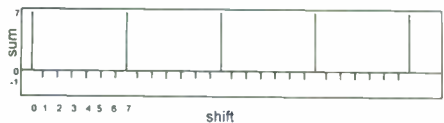

This plot is quite similar to a periodic impulse signal. If we used an MLS with a length of 4,095, the peak value would be 4,095; it would repeat every 4,095 points, and the "baseline" value would still be only -1.

CROSS-CORRELATION

Suppose that an N-point MLS were converted into an analog signal by making each value a sample into a digital-to-analog (D/A) converter, and then fed repeatedly through a sys-

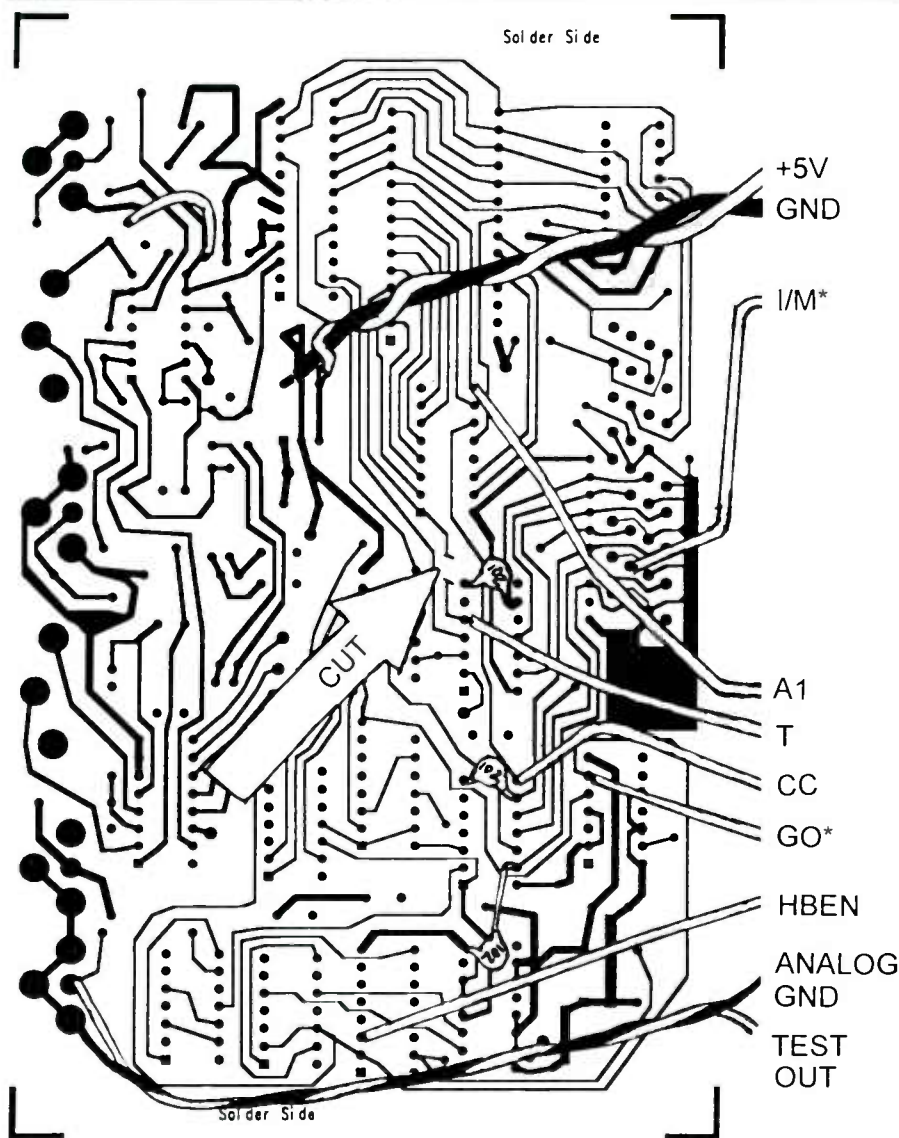

FIGURE 4: Solder side of the IMP board.

tem to be tested. Suppose you then digitize N points of the resulting response from the system, and perform the multiply-and-sum operation of this data stream versus that of the original MLS stream for every circular shift (called a cross-correlation operation). The result versus time shift plot would be the same as the system's time impulse response—or very nearly so, assuming that the impulse response decayed sufficiently within the time period of the N samples.

Such is the idea behind MLS testing. Several cycles of the N -length sequence are fed into the unit being tested, and its response is subjected to some intensive number crunching. The resulting impulse response is the same as you would get from an IMP-type stimulus, but with an important difference. The benefit of adding this more complex stimulus and all of the computational overhead is that the resulting impulse response has the noise immunity of averaging the re-

sponses to N -actual pulses. In addition, any unintentional transient noise picked up during the measurement is spread evenly across the time interval by the cross-correlation operation and appears as more benign low-background noise.

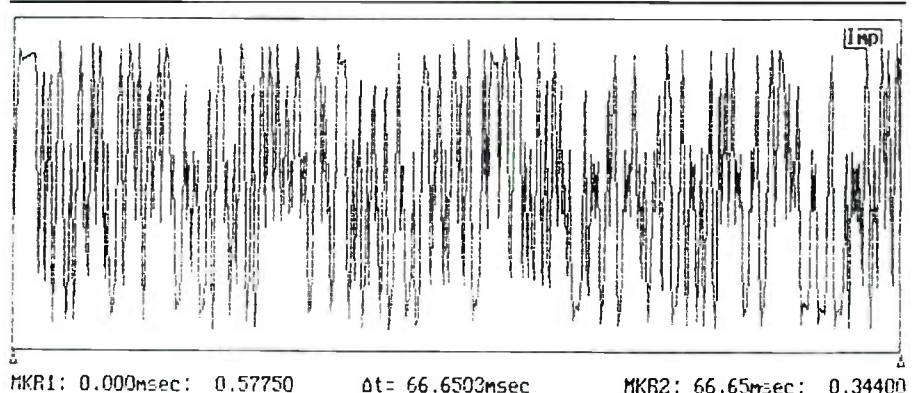

FIGURE 5: The MLS pseudo noise in the time domain.

All of this is achieved within the time period of a single data collection and two N -length sequences, allowing for one "warm-up" run. When N is equal to 4,095 or more, the improvement in noise immunity and reduction in measurement time are considerable.

The technique dates back to 1979: Around 1982, the Fast Hadamard Transform was applied to greatly speed up the correlation arithmetic.⁴ Commercially, MLS stimulus testing has been made available in the DRA Laboratories' MLSSA system, which allows use of sequence lengths from 4,095 to 65,535 points.

IMP SATELLITE

I have designed an add-on board to the IMP main board. When operated from the IMP software version 2.0, it will allow 4,095-point, MLS-based measurements to be performed. The software utilizes an integer-based version of the Fast Hadamard Transform, which makes clean, quiet impulse response acquisitions extremely quickly—typically, before you are ready for your next step.

The IMP/MLS satellite board schematic is shown in *Fig. 1*, with the parts list in *Table 1*. The MLS sequence and control signal are stored on CMOS programmable read-only memory (PROM) to minimize required hardware. The original IMP pulse stimulus is also coded onto the PROM to allow you to choose either stimulus via software control.

Two other ICs address the PROM and latch the data and control signal. The output latch is configured with weighted summing resistors for use as a seven-bit D/A converter to provide inexpensively for possible future enhancements. The latch IC supply lines are filtered to prevent digital noise feedthrough. Note that with this arrangement the latch IC gets its power supply ground from analog ground—be sure this ground is connected. *Figures 2 and 3* show the satellite's single-sided PC board pattern and component placement guide, respectively.

Continued on page 44



"... they form a highly refined full-ranged loud-speaker system rivaling the best dynamic systems.

In fact, the Audio Concepts system has a transparency and effortlessness that will compete favorably with many dipole systems.

*At the price Audio Concepts is asking, these loud-speakers are a steal."**

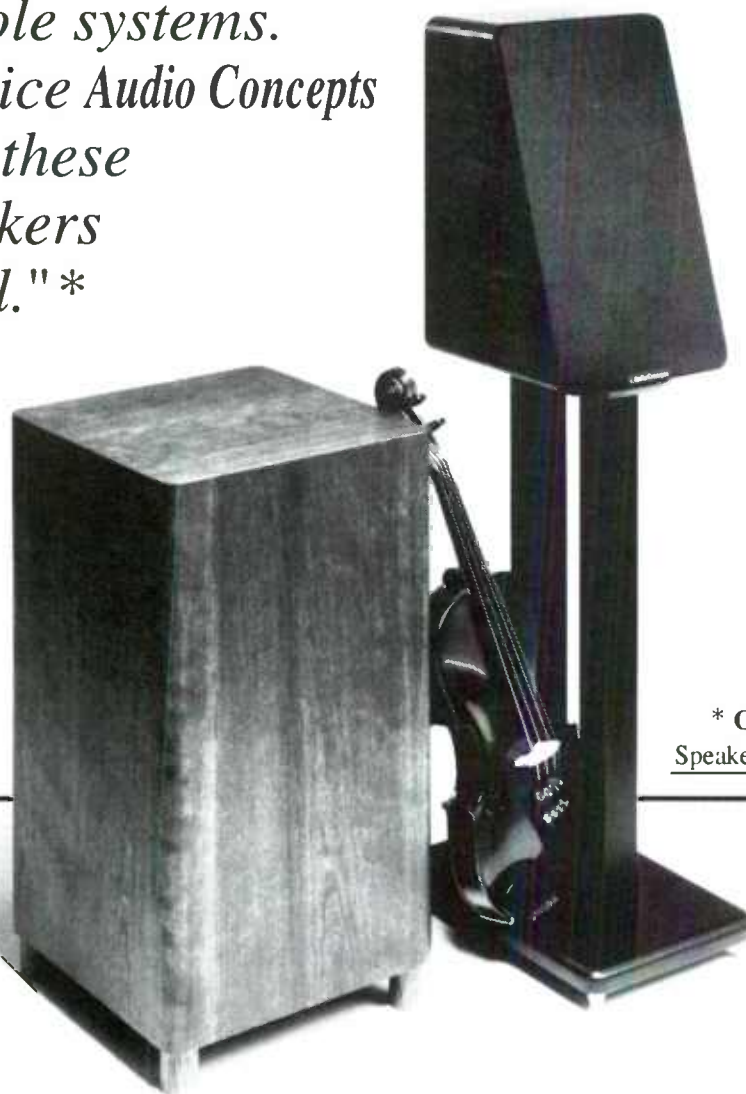

** Gary Galo
Speakerbuilder 3/91*

Audio Concepts, Inc.

901 South 4th St.
La Crosse WI 54601

Since 1977

Phone (608) 784-4570

Fax: (608) 784-6367

** Call or write for free catalog **

Reader Service #6

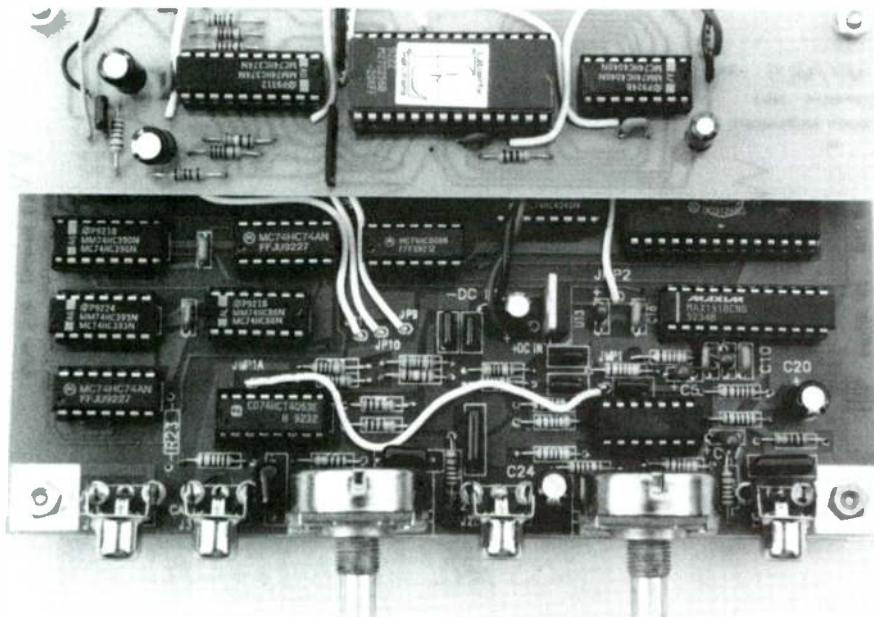

PHOTO 1: Recommended mounting arrangement for MLS board.

Continued from page 42

Six single wires and two twisted pairs are run between the IMP/MLS and IMP boards for signal and power exchange. In addition to connecting wires from the satellite board to

pads on the IMP board, you must remove resistor R23 from the main board and cut one trace on the IMP board's solder side (Fig. 4). Use a sharp razor knife to cut and remove a small section of the indicated trace.

To build the satellite board, first solder the IC sockets and all passive components (don't forget jumper JMP1), then decide where the board will be mounted. Avoid placing it too close to the analog circuitry near the front of the IMP board, or you may end up generating rather than suppressing noise problems. The satellite board is designed to mount piggyback style over the back of the IMP board via two mounting holes and standoffs (Photo 1).

After you have determined the mounting location, cut the trace as shown in Fig. 4 and the solder wires as follows—no lengthier than necessary—from the IMP/MLS board to locations on the solder side of the IMP board. Connections to the main board must be surface-soldered on existing pads. The lengths in parentheses are appropriate for piggyback mounting.

- +5V and GND (color-coded twisted pair) of the MLS board to the positive and negative pads, respectively, of C4 on the main IMP board (4.75")
- Test Out and AGND (another color-coded twisted pair) from the satellite to the center conductor and shield of connector J4 (6.25")
- Point CC of the MLS board to U11 Pin 8 on the main board (4.75")

Continued on page 46

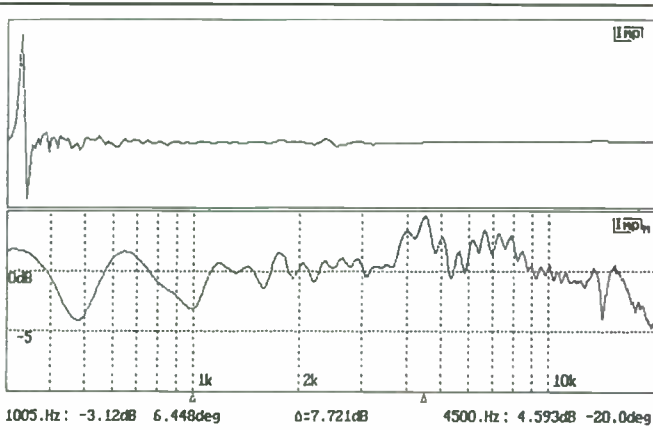

FIGURE 6: Pulse-derived loudspeaker response.

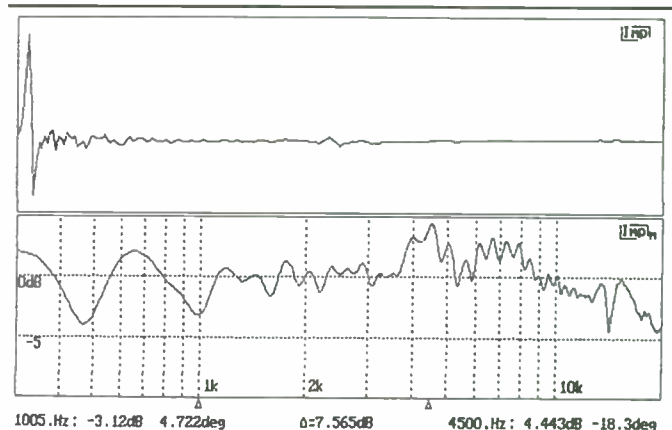

FIGURE 7: MLS-derived loudspeaker response.

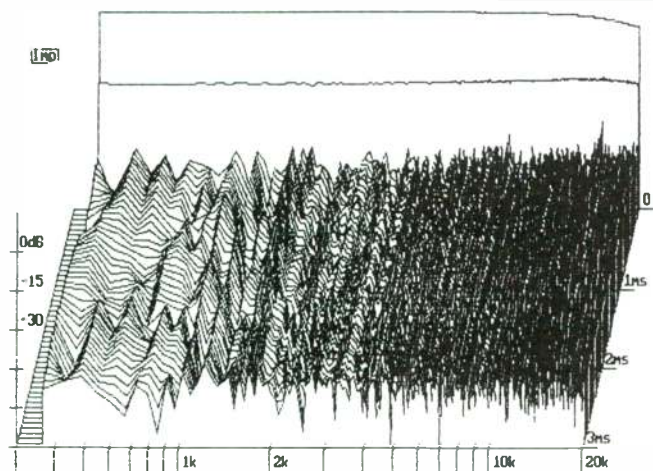

FIGURE 8: Waterfall plot of Cal signal, five averaged pulses.

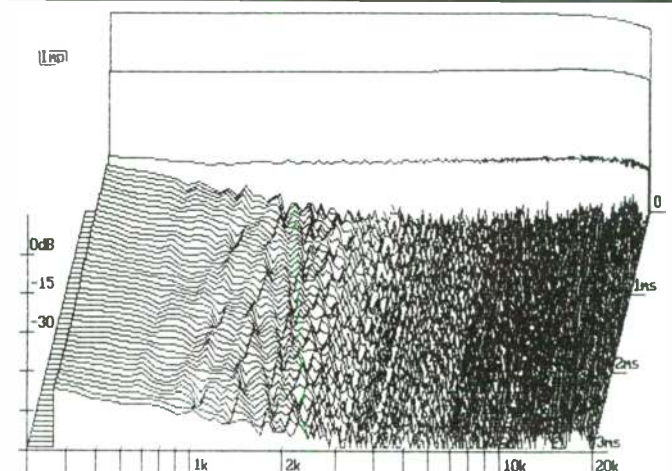

FIGURE 9: Waterfall plot of Cal signal, single MLS stimulus.

DAVIS



DAVIS

THE SPEAKER WORKS, INC.

1021 E. Camelback Road
Phoenix, Arizona 85014
Phone (602) 230-0344

WE MADE A SPECIAL BUY ON A QUANTITY OF DAVIS ACOUSTICS MOST POPULAR WOOFERS AND WE ARE PASSING THE SAVINGS ON TO YOU. THESE WOVEN KEVLAR AND WOVEN CARBON GRAPHITE DRIVERS ARE AMONG THE FINEST THAT FRENCH TECHNOLOGY HAS TO OFFER. OUR PRICING IS FAR AND AWAY THE BEST YOU WILL FIND ANYWHERE SO PLACE YOUR ORDERS NOW! INVENTORIES OF SOME MODELS LIMITED.



25GCA10W
10 in. woven carbon fiber
Cast Frame
1.5 in. VC
Foam Anulus
100 Watts
91.4 db 1W/1M
Vas 237.7 L.
Fs 24.6 Hz.
Qts. .33
X max 10 mm.
COST \$89.00



20MC8A
8 in. woven carbon fiber
Cast Frame
1.0 in. VC
Welbex Anulus
60 Watts
91.5 db 1W/1M
Vas 77.7 L
Fs 39.8
Qts. .46
X max 8 mm.
COST \$67.50

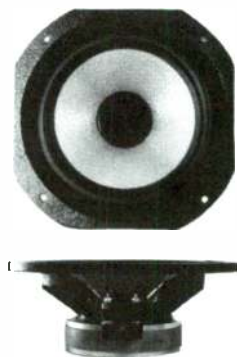

20KLV8A
8 in. woven kevlar
Cast Frame
1.5 in. VC
Welbex Anulus
80 Watts
92.1 db 1W/1M
Vas 81.7 L.
Fs 38.5 Hz.
Qts. .38
X max 6 mm.
COST \$79.50



17RCG-DB
6.5 in. woven carbon fiber
Stamped Frame
DUAL 1 in. VC
Welbex Anulus
60 watts
89 db 1W/1M
Fs 50 Hz.
Qts. .627
Vas 20.57 L
Cost \$69.00

ALL VOICE COILS 8 OHM

WE HAVE SUGGESTED ENCLOSURE PLANS FOR ALL MODELS. THE 17RCG-DB ALONG WITH THE PEERLESS CC-1 DOME TWEETER MAKES UP INTO A WONDERFUL CLASSICAL AND JAZZ LOUDSPEAKER. WE'LL BE HAPPY TO SUPPLY PLANS.

ANY QUESTIONS - CALL US
F.O.B. PHOENIX VIA UPS
We Accept VISA - MasterCard - Check - No C.O.D.

Continued from page 44

- Point I/M* of the MLS satellite to the main board pad corresponding to J5 Pin 4 in Fig. 4 (4.75")
- The pad marked A1 on the MLS board to U15 Pin 9 on the main board (4")
- Point GO* on the MLS board to U14 Pin 6 on the main board (3")
- Point T of the MLS board to U12 Pin 5 on the main board (4.25")
- The pad marked HBEN on the satellite to U3 Pin 3 of IMP board (4.75")

Install ICs U1, U2, and U3 into their sockets. Notice that when the satellite is to be mounted as shown in *Photo 1*, the satellite board ICs mount in the opposite orientation to that of the main board ICs. Remount the IMP board, and then mount the satellite board. You should now be ready to go.

OPERATION

In order to access the modified IMP's MLS capabilities, you must use the new Version "M" IMP software. Under the [Acquire]

menu, an option called "MLS" now toggles between off and on when selected.

You can see what the MLS signal looks like in the time domain by arranging a typical IMP measurement, setting MLS on, and selecting [Acquire Repeat]. As with the pulse stimulus, set the appropriate input gain control so the trace peaks are within the IMP input's linear range (i.e., within the display window). You will now have a continuous stream of what looks like noise rather than a single peak (*Fig. 5*). If you use [Esc] to stop the stimulus and vary SIZE—using F1 after each change to redraw—you can observe the MLS signal on various scales.

Selecting [Acquire Collect] will result in a different picture. The Fast Hadamard Transform will now be applied between the data acquisition and the display. The resulting trace will resemble the old familiar IMP signal, and, from this point on, can be processed in the same ways but will yield greatly improved noise rejection.

An important point: the input gain adjust-

ments must be made for the MLS signal peaks only as you see them when using [Acquire Repeat]. The size of the pulse peak after using [Acquire Collect] is not directly related to the IMP input dynamic range when in MLS mode. Typically, MLS-derived pulses will be much lower in amplitude than the normal time impulse responses, due to noise peaking when the MLS is passed through a speaker.

If you wish, you may still average responses when using MLS stimulus by using new selections under the [Setup Average_num] menu. You can also configure the program to start up in MLS mode (as well as at your selection of most other program settings, such as frequency range, screen colors, or response smoothing) each time you use it. This new Version "M" software also features mouse support, user macros, on-screen titles, and overlaid plots. Additional information on using MLS and other software features can be obtained with the new position-sensitive on-line Help facility, reached via Shift-F1.

COMPARISONS

The equivalence of pulse-derived and MLS data is illustrated in *Figs. 6 and 7*. *Figure 6* is a loudspeaker time and frequency response measured using 15 averaged pulse stimuli and removal of the more prominent echoes. The "m" near the IMP logo in the lower plot indicates that Cal has been used to correct for pulse shape and filter characteristics, and that a microphone calibration file also has been factored into the plot to correct for the microphone's response. Microphone calibration data can be provided with the Old Colony Mitey Mike and with test microphones from Josephson Engineering.

Figure 7 shows equivalent data taken using the MLS stimulus in a single acquisition. I adjusted the GAIN parameter so the 1,005Hz measurement agrees with that of *Fig. 6*. The two plots are virtually identical.

Figures 8 and 9 are waterfall plots of the Cal signal taken with pulse (five averages) and MLS stimulus (one), respectively. The MLS-derived plot shows a marked advantage in these figures (the scale is 15dB/division).

One situation in which IMP may work

IMP and IMP-RELATED PRODUCTS NOW AVAILABLE

The following products for the IMP are now available from Old Colony Sound Lab, PO Box 243, Dept. SB3, Peterborough, NH 03458; (603) 924-6371; FAX (603) 924-9467. MC/Visa accepted. PLEASE ALLOW 4-6 WEEKS FOR DELIVERY OF ASSEMBLED ITEMS.

SOF-IMP1B5GD	IMP Software Demo 1 x 5 1/4" DS/DD	\$ 5.00
SOF-IMP1B3GD	IMP Software Demo 1 x 3 1/2" DS/DD	5.00
NOTE: Software demo cost is deductible from later purchase of full package.		
SOF-IMP1B5G	IMP Software 1 x 5 1/4" DS/DD	49.95
SOF-IMP1B3G	IMP Software 1 x 3 1/2" DS/DD	49.95
SOF-IMP2B3G	New IMP Software Version, including MLS, 3 1/2" IBM DS/DD	89.95
SOF-IMP2B5G	New IMP Software Version, including MLS, 5 1/4" IBM DS/DD	89.95
SOF-IMPUP	Upgrade from IMP 1.22+ or earlier software to new MLS Version. Please provide previous IMP registration or invoice number and new disk size desired.	40.00
PCBW-4	IMP Double-sided PC board, without parts	39.95
PCBW-4MLS	IMP MLS PC Board, without parts	13.95
STMLS	IMP MLS PROM	24.95
HDCSW-4	IMP enclosure, including mounting hardware and knobs	24.95
KW-4	Unassembled Basic IMP Kit, including software (please specify disk size), PC board, ICs, passive components, connectors, power supply, controls, microphone capsule; excluding enclosure (see above)	275.00
KW-4A	Assembled Basic IMP Kit, including software, enclosure, and assembled (but uncalibrated) microphone wand and probes, excluding cables external to IMP enclosure	440.00
KW-4MLS	Unassembled IMP MLS Add-On Kit, including PC board, parts, and PROM (less software and hookup wire)	54.95
KW-4AMLS	Assembled Basic IMP with MLS Add-On Feature, including software, enclosure, and assembled (but uncalibrated) microphone wand and probes, excluding cables external to IMP enclosure	599.00
KMW-4	Unassembled KW-4 Basic IMP Kit (as above) plus Unassembled KD-2 Mitey Mike Test Microphone	425.00
KD-2AMI	Assembled Old Colony Mitey Mike Test Microphone, with IMP calibration files on disk (please specify size)	219.00
KD-2AMMI	Assembled Old Colony Mitey Mike Test Microphone, with both MLSSA and IMP calibration files on disk (please specify size)	229.00

SHIPPING (US):

For orders of less than \$50, please add \$3 for shipping/handling. \$50-99.99: \$4. \$100-199.99: \$5. Greater than \$200: \$6. Outside the US, please inquire.

REFERENCES

1. Berman, J. M. and L. R. Fincham, "The Application of Digital Techniques to the Measurement of Loudspeakers," *JAES* (Vol. 25, 6/77): 370.
2. Rife, Douglas D. and John Vanderkooy, "Transfer-Function Measurement with Maximum-Length Sequences," *JAES* (Vol. 37, 6/89): 419.
3. Fincham, L. R., "Refinements in the Impulse Testing of Loudspeakers," *JAES* (Vol. 33, 3/85): 133.
4. Borish, Jeffrey and James B. Angell, "An Efficient Algorithm for Measuring the Impulse Response Using Pseudorandom Noise," *JAES* (Vol. 31, 7/83): 478.

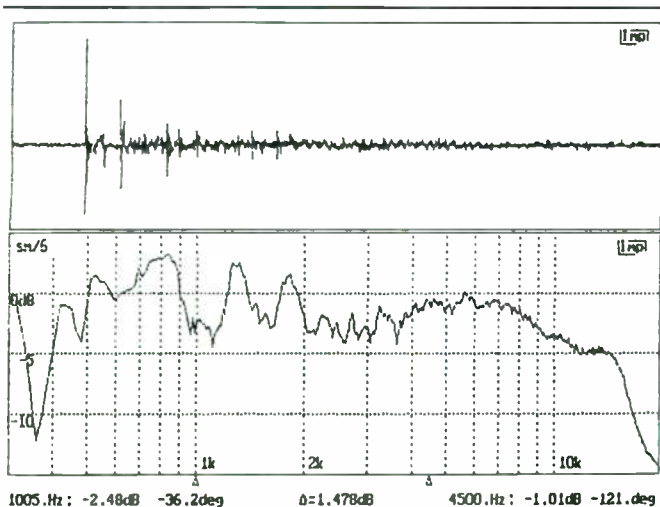

FIGURE 10: MLS far-field microphone measurement in moderately live room.

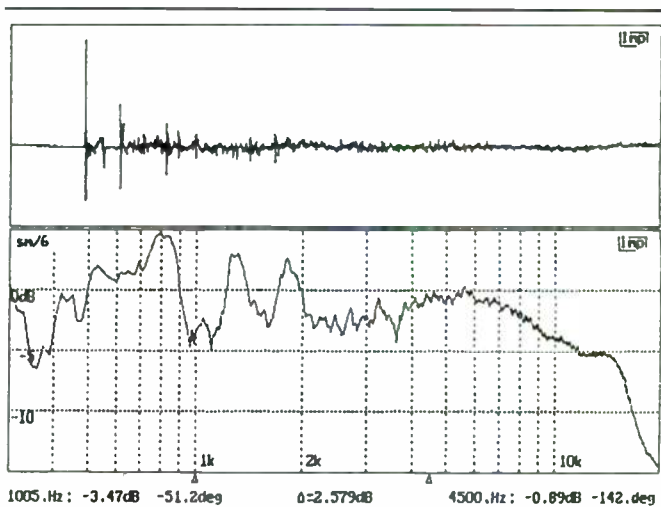

FIGURE 11: Pulse equivalent of Fig. 10. Note the quieter period just before the impulse.

better with the pulse rather than the MLS stimulus is when far-field measurements are made in highly reverberant rooms. The pulses can be spaced apart in time intervals of arbitrary length, but the IMP MLS is mathematically constrained to repeat every 4,095 samples. If the time response hasn't sufficiently died out within such a period, the response tail will reappear both before and during the beginning of the recovered pulse response. This is shown in the top plot of Fig. 10, and can be compared with the pulse-derived equivalent in Fig. 11. The sixth-octave smoothed frequency response plots of the two measurements (lower plot in each figure) nonetheless do not seem to differ greatly.

The MLSSA system allows for use of considerably longer MLSs to avoid such potential problems in slow-decay-rate environments. With IMP, you could still use the pulse stimu-

lus in such reverberant rooms, but a few dollars spent on throw rugs or wall treatment would be more to the point and would improve the sound as well. Using the lower sample rate for bass measurements will also stretch out the MLS time period thirty-two fold, usually out of danger's way.

DRIVER PARAMETERS

The MLS stimulus greatly improves the repeatability of T/S measurements using IMP. In addition, measurements are made much more quickly, room noise is hardly a concern, and added-mass launching is much less likely using the MLS.

Very-low-frequency impedance measurements are more reliable, and even IMP's estimation of the voice coil DC resistance is more trustworthy, reducing the need for an accurate ohmmeter. Best of all, those annoy-

ing 60 and 120Hz bumps often caused by line pickup in the cables—50 and 100Hz for some of our overseas IMP users—no longer appear in the impedance plots.

If you find you don't have time for all the IMP measurements you'd like to make, if you don't like asking others to be "quiet for just a minute" while you average another bunch of responses, or if you'd just like to increase the performance of your IMP analyzer system, MLS capability is well worth including. I don't think we'll be hearing much longer about how amateurs are building speakers almost as good as the commercial units. Now that we can provide intensive individual care and also have access to inexpensive measurement gear and design software, I think the speaker manufacturers will soon be comparing their products to those of the amateurs.

BassBox™ 5.0

for Microsoft®
WINDOWS™

Design loudspeaker boxes fast and accurately with BassBox software. Accepts both Thiele-Small (Fs, Qts, Vas, η) and Electro-Mechanical (Qes, Qms, Mms, Bl) parameters with equal ease.

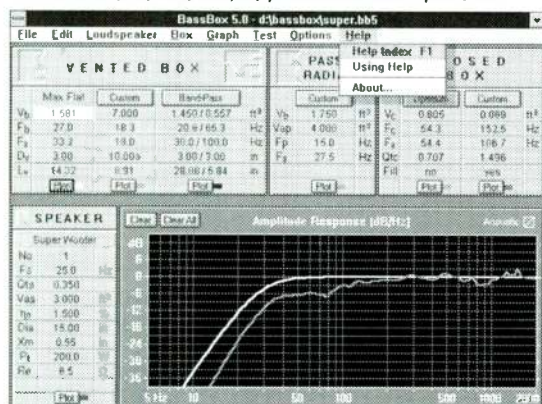

- ◆ Easy to use
- ◆ On-line help
- ◆ Improved graphs
- ◆ More options
- ◆ Low price

Design Types:

- Maximally Flat Vented
- Extended Bass Vented
- Custom Vented
- 4th & 6th-order Band-Pass
- Passive Radiator
- Optimum Closed
- Custom Closed
- Multiple Woofer designs (including isobaric)

Built-In Test Procedures:

- Test and calculate loudspeaker parameters*
- Test and calculate passive radiator parameters*

*Requires basic test equipment: sine wave generator, frequency counter, power amplifier, 1 kohm resistor, voltmeter, ohmmeter, test box.

NEW!
Driver Database
with hundreds of drivers.

Design Options:

- Small and large-signal analysis
- Examine one loudspeaker in several different boxes or...
- Examine several different loudspeakers in the same box
- New max acoustic power graph
- New voice coil impedance graph
- Multiple ports
- Box dimension calculator with 18 different volume shapes
- Enter loudspeaker amplitude (acoustic) response
- Custom graph controls
- Use English or metric units
- Read BassBox 4.0 & 3.0 files
- Save and recall designs



\$99.00

plus \$4.00 S&H
(Canada: +\$6.00)
(Overseas: +\$12.00)

Tel: 616-641-5924
Fax: 616-641-5738

Harris Technologies
P.O. Box 622
Edwardsburg, MI
49112-0622 U.S.A.

Also available

X-over 2.0 passive cross-over program for Windows.
X-over calculates the component values for 1st, 2nd, 3rd and 4th order 2 way and 3 way networks, load compensating networks and L pads. **Regular price: \$29** (\$19 if purchased with BassBox.)

System Requirements:

MS-DOS 5.0, Microsoft Windows 3.1 & compatible computer (IBM® PC w/ 386SX or better), 1.44 MByte 3.5" disk drive and mouse. 4 MBytes RAM recommended.

Harris Technologies reserves the right to make changes without prior notice.

Copyright © 1993 by Harris Technologies. All rights reserved worldwide. BassBox is a trademark of Harris Technologies. Other trademarks are the property of their respective companies.

Always-Enjoyed Old Colony Gift Certificates **GCOC**

Available for any amount, Old Colony Gift Certificates have no expiration date and are usable for any of our products. They are a great solution to audio gift-giving dilemmas and offer great flexibility to the giver as well as the recipient. And by the way, there's no better means to provide a hint than to circle this item and leave this page open in a place where your favorite giver will see it! These great gifts are usually sent by mail, but at no extra charge you can also arrange to have one sent by fax! Please be sure to provide full name and address of recipient.

Manual Resist Etched Circuit Board Kit **KS-101A**
\$17.95

Produce basic PC boards by applying etch resists directly on surfaces of unsensitized boards and then etching. Kit contains three 3" x 6" blanks clad on one side with 1-ounce copper, resist ink pen, assorted pressure-sensitive terminal circles and conductor strips, graph layout paper, ferric chloride etching solution with tray, and cleaning pad to prepare board for soldering. By Kepro.

Photoresist Etched Circuit Board Kit **KP-101A**
\$23.95

This kit provides three 3" x 6" phenolic boards for etching by the photo-etch method used by professionals. The boards are presensitized, require only sunlight or a #2 photo floodlamp to expose, and can be handled in subdued incandescent light. The kit includes PC blanks, cut-and-peel mechanical negatives, exposure frame glass, clips, glass developer tray, ferric chloride etching solution with tray, and cleaning pad for removing resist after etching. By Kepro.

Woodworking for Automotive Enclosures Video **VDWWG**
\$49.95

An innovative look at all aspects of the field, this video introduces you to putting wood to its best use in your auto sound enclosures. Topics include bending and contouring wood into custom shapes, as well as using jigs, routers, and specialty tools. Five-sided boxes included. By the National Academy of Mobile Electronics. VHS, 1:00.

Automotive Enclosure Design Video **VDDES**
\$49.95

This videocassette is the best we've found on the subject, covering geometry, acoustic theory, loudspeaker construction, measuring Thiele-Small parameters, and much more. Examples include closed box, ported box, isobaric, and bandpass enclosures. Includes printed reference guide with important formulas. By the National Academy of Mobile Electronics. VHS, 1:00.

The Musician's Guide to Multimedia **BKMP1**
\$19.95

The computer industry is seeing unrivaled growth in the multimedia sector, and the integration of MIDI, computers, and other tools has produced avenues of creativity unknown by composers before today. For musicians, this offers opportunities to expand and move into new and exciting areas of sound design. This book by veteran sound and music designer Rick McDonald is a rich compilation of tips, methods, standards, formats, companies, terminology, hardware and software info, and much more, guaranteed to serve as a valuable road map for this largely uncharted territory. From Multimedia Productions.

Silver Sonic T-14 Speaker Cable **MWRSS14**
\$2.99/ft.

This high performance speaker cable was designed to provide optimum sound from today's improved audio equipment and digital recordings. In this new design, a synergistic combination of silver, Teflon, and copper delivers musical signal to your speakers with maximum accuracy. Features include silver-plated, high-purity copper conductors; pure, highest grade TFE Teflon dielectric; low-inductance geometry excellent for long runs; compact size (5/16" o.d.); and compatibility with all amplifiers and speakers. From D.H. Labs. Black only.

ELECTRONICS WORKBENCH Software

EWB bills itself as "The Electronics Lab in a Computer," and that is exactly what it is. Used in scores of schools, universities, and other settings throughout the world, it is a powerful tool which simulates and teaches the behavior of circuits and test equipment. Both the analog and digital modules are simple and intuitive, using a click-and-drag interface with your mouse. If your circuit gets too big, simply scroll and keep building. Because wires are routed automatically and a grid is available, even complex circuits are readable. All commands can be issued from menus with a mouse, and common operations also have keyboard shortcuts. Groups of parts can be cut, copied, and moved, or put into a macro "black box." Macros can be used simultaneously in more than one place, and even put inside one another. Analog features include function generator, oscilloscope, bode (frequency response) plotter, SPICE simulation, and transient and steady-state analysis. The digital module includes fast simulation, word generator, logic analyzer, and logic converter. Also available in French and Spanish—please specify. By Interactive Image Technologies, Ltd. Purchasing options shown below. FOR ORDERS OUTSIDE THE USA AND CANADA, PLEASE INCLUDE US\$40 IN ADDITION TO NORMAL SHIPPING CHARGE.

- SOF-EWB1B5GD** ELECTRONICS WORKBENCH Demo Disk, 5 1/4" DS/HD IBM; requires MS-DOS 2.0+, mouse, 1.2Mb, 520K free RAM; shows analog portion of program for purpose of introduction and demonstration of ease of use (usable as \$5 credit toward later purchase of full package). **\$ 5.00**
- SOF-EWB2B5G** IBM Personal Plus Version, with number of circuits limited only by memory capacity. 5 1/4" DS/HD IBM; monochrome; requires MS-DOS 3.0+; PC/XT/AT, PS/2, or true compatible; 512K RAM; two floppy drives or one hard disk; Microsoft-compatible mouse; CGA/EGA/VGA or Hercules graphics display; does not support math coprocessor. **199.00**
- SOF-EWB2M3G** Macintosh Personal Plus Version, with same capability as IBM Personal Plus. Monochrome only; requires Macintosh Plus or greater; supports Imagewriter or Laserwriter if available. **199.00**
- SOF-EWB3B3G** IBM Professional Version, color feature with enhanced interface. 5 1/4" DS/HD; supports math coprocessor if available; requires IBM AT, PS/2, or true compatible with 286 or greater; 640K RAM; Microsoft-compatible mouse; EGA/VGA graphics; hard disk; MS-DOS 3.0+. **299.00**

QUICK & EASY TRANSMISSION LINE SPEAKER DESIGN Booklet and Software **SOF-QET1B5**
\$8.95

This unique new booklet starts with the basics: what a TL is, where it came from, and how it evolved over the years. Then it lays out a step by step process for designing a TL system that will sound good every time. Some math equations are involved, but not to worry: all you need is a desire for knowledge, some imagination, and a calculator with a square root key. And for those of you who own a personal computer with Lotus 123 or equivalent on it, there's also a computer worksheet diskette included that does the math for you and prints out your system design information. Imagine being able to know what density of stuffing material is needed for a particular woofer, in a line of a certain cross-sectional area, and what length of line constitutes a quarter-wavelength TL—this booklet tells you how to do all of that and more! By Larry D. Sharp. 1993, 22pp., 8 1/2 x 11, spiralbound; 5 1/4" DS/HD. Booklet is easily usable without software, but PLEASE NOTE: LOTUS 123 OR EQUIVALENT SPREADSHEET SOFTWARE IS REQUIRED TO RUN WORKSHEET DISK AND IS NOT SUPPLIED WITH THIS PACKAGE.



OLD COLONY SOUND LAB
PO Box 243, Department B93
Peterborough, NH 03458-0243 USA
24-Hour Lines:
Telephone: (603) 924-6371 or
(603) 924-6526 FAX: (603) 924-9467

OUR DISCOUNT POLICY

Order Value	Discount
<\$50.00	0%
\$50.00-\$99.99	5%
\$100.00-\$199.99	10%
>\$200.00	15%

Mastercard, VISA, check or money order in US funds drawn on US bank.

PLEASE BE SURE TO ADD SHIPPING CHARGES

Shipping Charge According to Destination and Method Desired (\$)

Order Value	United States		Canada		Other	
	Surface	Air	Surface	Air	Surface	Air
< \$50.00	3.00	7.50	5.00	7.50	10.00	20.00
\$50.00-99.99	4.00	15.00	7.50	15.00	20.00	30.00
\$100.00-199.99	5.00	20.00	15.00	20.00	30.00	40.00
> \$200.00	6.00	30.00	25.00	30.00	40.00	50.00

NEW THIS ISSUE



Point of Reference Test CD: CDPOR The Digital-Analog Audio Handbook \$79.95

This powerhouse is a digitally generated and recorded master reference disc for use in the motion picture, television, broadcast, and record industries and all other applications where faithful and exact audio measurements and transfers are needed. It meets or exceeds all international standards—and creates some of its own. You may notice that all of the continuous tone sweeps are in phase at all transition points and that there is no variation in level at any frequency. This CD is made for testing digital equipment—such as the Sony PCM 1610/1630, R-DAT, and DASH machines; F-1, 701, 601, 501, and other EIAJ processes;

and CD players—as well as analog systems such as tape decks, amplifiers, equalizers, crossovers, outboard gear, monitors, and rooms. Test equipment useful with this disc includes an AC VTVM voltmeter; oscilloscope; IM 60Hz/7kHz tone distortion analyzer; harmonic distortion analyzer; spectrum analyzer; and frequency counter. Engineered and compiled by Hank Waring. Produced by FDS Labs, Inc. Detailed instruction booklet included.

Contents: [1] 1kHz, 0 reference level, 2:00. [2] 1kHz, L only, 2:00. [3] 1kHz, R only, 2:00. [4] 300Hz in phase, :30. [5] 300Hz out of phase, :30. [6] Digital black (all zeros), 1:00. [7] 1kHz, 10kHz, 100Hz at reference level, :45 each. [8]-[10] Spot frequency checks. [11] IM distortion, 2:00. [12] 3kHz wow and flutter test, 3:00. [13] 500Hz square wave, 2:00. [14] Pink noise octave bandwidths from 20Hz-20kHz, 2:00. [15] White noise, 20Hz-20kHz, 2:00. [16] Weighted noise signal A weighted, 2:00. [17] Transient response test 1kHz sine wave, 1kHz tone bursts, 2:00. [18] Digital level check, -60dB, :20. [19]-[22] Digital level checks, -48dB, -32dB, -20dB, -10dB, :12 each. [23] Zero maximum digital recording level, :12. [24] Digital overload test, +22dB, :12. [25] Spot frequency test, 1/3 octave, 24 between 20Hz-20kHz, 5:00. [26]-[28] Frequency sweeps, both channels, L only, R only, 20Hz-20kHz, 1:00 each. [29]-[65] 37 full frequency runs, 20Hz-20kHz, :35 each. [66]-[67] Digital pre-emphasis tests, :20 on, :15 off. [68] A 440 reference tuning note, 1:00. [69]-[71] Enhanced music for system testing.

New IMP MLS Add-On Kit

This great new upgrade adds Maximum Length Sequence to IMP's already-imposing list of features. Modification includes addition of new MLS piggyback PC board to existing IMP unit. By Bill Waslo. Purchasing options available:

KW-4MLS	Complete Unassembled IMP MLS Add-On Kit, including PCB, parts, and PROM (less software and hookup wire)	\$54.95
PCBW-4MLS	IMP MLS PC Board, without parts	13.95
STMLS	IMP MLS PROM	24.95
SOF-IMP2B3G	New IMP Software, including MLS, 3 1/2" IBM DS/DD	89.95
SOF-IMP2B5G	New IMP Software, including MLS, 5 1/4" IBM DS/DD	89.95
SOF-IMPUP	Upgrade from IMP 1.22+ or earlier software to new MLS Version. Please provide previous IMP registration or invoice number and new disk size desired.	40.00

Other New IMP Products

PLEASE ALLOW 4-6 WEEKS FOR DELIVERY OF ASSEMBLED ITEMS.

HDCSW-4	IMP enclosure, including mounting hardware and knobs	\$ 24.95
KW-4A	Complete assembled Basic IMP Kit, including software, enclosure, and assembled (but uncalibrated) mic wand and probes, excluding cables external to IMP enclosure	440.00
KW-4AMLS	Complete Assembled Basic IMP with MLS Add-On Feature, including software, enclosure, and assembled (but uncalibrated) microphone wand and probes, excluding cables external to IMP enclosure	599.00

Test Disc III Hi-Fi News & Record Review

**CDIII
\$30.00**

This newest addition to HFNR's world-renowned test library was produced by Trevor Butler and executive produced by Steve Harris. Includes description/instruction booklet. 1993; from the United Kingdom; one disc; 72:36. HFN #020.

Contents: [1] La Rejouissance/Handel's Royal Fireworks Music, 4:36. [2] Jerusalem/Parry, 2:46. [3] Henry V extract/Doyle, 4:43. [4] Trumpet Concerto in C/Vivaldi, 2:57. [5] Peter & the Wolf Introduction/Prokofiev, 1:58. [6] Peter & the Wolf, The Triumphant Procession/Prokofiev, 4:26. [7] Welcome, Welcome Glorious Morn/Purcell, 4:02. [8] Mahler 8, 1st Movt., Gloria Patri Domino/Philharmonia, 2:31. [9]-[13] Corkhill, Five Short Pieces, percussion sonata, 7:26. [14] Rio Napo RSS demo, 3:14. [15] XYLO: People Who Hit Things, "The Whistler," 2:25. [16] Nimbus' Dawn Chorus, 1:44. [17] Return of the Garage Door, 0:38. [18] At the dentist, 1:30. [19] Harrier jet vertical take-off, 0:40. [20] Gongs, 2:48. [21] Ratchets, 0:17. [22] Flexatone, 0:07. [23] Stereo walkaround (Wiltshire), 0:29. [24] LEDR tests, 2:26. [25] 1kHz L,R, -15dB, 0:30. [26] 1kHz L,R, -15dB, 0:11. [27] 1kHz L,R, -15dB, 0:12. [28]-[37] 1kHz L,R, 0dB -90dB, 10dB steps, 0:16/0:17. [38] 10Hz L,R, 0dB, 0:16. [39] 40Hz L,R, 0dB, 0:15. [40] 100kHz L,R, 0dB, 0:17. [41] 400Hz L,R, 0dB, 0:17. [42] 1kHz L,R, 0:16. [43] 4kHz L,R, 0dB, 0:17. [44] 8kHz L,R, 0dB, 0:17. [45] 10kHz L,R, 0dB, 0:17. [46] 12kHz L,R, 0dB, 0:17. [47] 14kHz L,R, 0dB, 0:16. [48] 16kHz L,R, 0dB, 0:17. [49] 18kHz L,R, 0dB, 0:17. [50] 20kHz L,R, 0dB, 0:17. [51]-[52] 20Hz-20kHz sweep L and sweep R, 0dB (0:10 kHz sync), 1:01 each. [53] 5kHz-22kHz sweep L&R, 0dB (0:05 1kHz sync), 1:07. [54] S/N ratio, zero mod, emphasis on, L&R, 0:21. [55] S/N ratio, zero mod, emphasis off, L&R, 0:27. [56] Impulse test, pulse L&R, 0:28. [57]-[58] Impulse tests, L and R, 0dB, 0:21 each. [59]-[60] Impulse tests, L and R, -70dB, 0:17/0:16. [61]-[62] Intermod tests, 19/20kHz, L&R 0dB and -10dB, 0:17/0:16. [63] Fade-to-noise, low-level dither, 0:31. [64] Pink noise, L&R, -20dB average rms, 0:26. [65] White noise, L&R, -20dB peak value, 0:31. [66]-[68] Tape recorder tests, L&R 0dB, 315Hz, 10kHz, 3150Hz, 0:16/0:17. [69] Monotonicity, 10 levels, 0:18. [70] 1kHz tone burst, L&R, 0dB, 0:17. [71] 100Hz squarewave, L&R, -15dB, 0:18. [72] 1kHz squarewave, L&R, -15dB, 0:16. [73] 5kHz squarewave, L&R, -30dB, 0:17. [74] Digital silence, 1:39.

Speaker System Designer 4.0 Software for Windows

SSD4.0 is an extension of the previous SSD3.0 DOS package. It requires Windows 3.1 and enables the designer to create, evaluate, and then optimize 2-, 3-, 4-, or 5-way loudspeaker systems prior to starting enclosure assembly. The designer is also able to model the behavior of the crossover when loaded by the driver in an enclosure and observe the dramatic effect on the frequency response curve of the crossover which the driver may have. A suitable design compensation network can then be created by another SSD4.0 tool and the effect on the crossover re-examined. The program allows the designer to pinpoint problems and test possible solutions so that the frequency response of the crossover is as close to the "ideal" as possible.

Functions available in this package include driver reference library creation; loudspeaker enclosure design and optimization; compensation of the driver impedance or amplitude; crossover filter design and optimization; system frequency response evaluation and optimization; frequency response of the system "in room"; L-pad, series LRC, and zobel network calculators; impedance peak suppressor; and thermal analysis, which enables the user to examine the frequency response and structure temperatures at all input power levels.

Environment: Windows 3.1. User interface: mouse, keyboard, Windows. Program control: mouse, menus, TAB key for data entry in dialog boxes, cursor keys for data entry in display windows. Mass storage: SAVE and LOAD menu options. Hard copy: graphics printer, preferably with banding capabilities. Screen output: VGA, 640 x 480 pixels, 16 colors, or SVGA, 800 x 600 pixels, 16 colors. Processor: 286 minimum. RAM: 2Mb minimum. Hard disk required: 2.5Mb minimum plus 1Mb to install. By Bodzio. Detailed instruction manual included. Purchasing options available:

SOF-SSD2B3GD	Speaker System Designer 4.0 Demo 1 x 3 1/2" DS/DD	\$ 5.00
Note: Software demo cost is deductible from later purchase of full package.		
SOF-SSD2B3G	Speaker System Designer 4.0 3 1/2" DS/specify DD or HD	199.00
SOF-SSDUP	Speaker System Designer 4.0 Upgrade from SSD3.0, 3 1/2" DS/specify DD or HD; please provide invoice or registration number from SSD3.0	99.00

OLD COLONY SOUND LAB

PO Box 243, Department B93
Peterborough, NH 03458-0243 USA
24-Hour Lines:
Telephone: (603) 924-6371 or
(603) 924-6526 FAX: (603) 924-9467

OUR DISCOUNT POLICY

Order Value	Discount
<\$50.00	0%
\$50.00-\$99.99	5%
\$100.00-\$199.99	10%
>\$200.00	15%

Mastercard, VISA, check or money order in US funds drawn on US bank.

PLEASE BE SURE TO ADD SHIPPING CHARGES

Shipping Charge According to Destination and Method Desired (\$)

Order Value	United States		Canada		Other	
	Surface	Air	Surface	Air	Surface	Air
< \$50.00	3.00	7.50	5.00	7.50	10.00	20.00
\$50.00-99.99	4.00	15.00	7.50	15.00	20.00	30.00
\$100.00-199.99	5.00	20.00	15.00	20.00	30.00	40.00
> \$200.00	6.00	30.00	25.00	30.00	40.00	50.00

Wayland's Wood World

LET'S GET THIS STRAIGHT

By Bob Wayland



PHOTO 1: Making a test line with a marking knife.

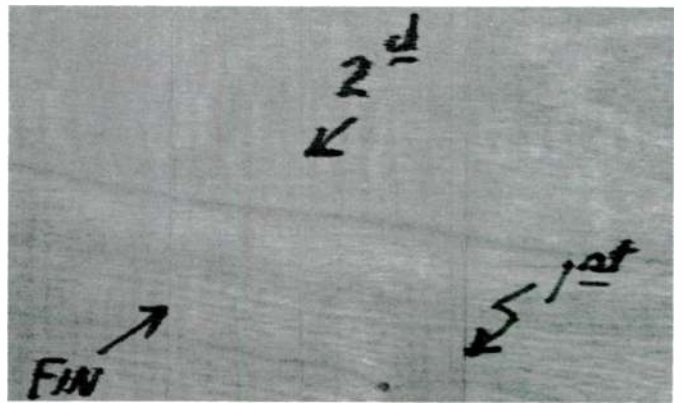

PHOTO 2: Results of the flopping interface for a try square. Chalk is used to make the scribes visible.

Perhaps one of the most frustrating aspects of building speaker enclosures is ensuring they are square. After carefully cutting out each piece and preparing the joints, we all too often become careless in gluing up the carcass. The resulting slightly off-square box makes fitting the back, front grille, and stand difficult. The greatest discomfort is seeing the Leaning

Tower of Pisa every time you look at your speaker. You can purchase very expensive, highly accurate squares which are a minimal help, but then you must be very careful never to drop or in any way abuse the delicate tool. All of this is inhibiting, but, thankfully, there is a simple way around the complications.

Woodworking, like all activities, has its

share of tricks that extend throughout the trade. When checking whether something is square (a cut, a try square, or what have you), the trick is the *flopped interface*. If a right angle is slightly off, and you separate along the "perpendicular" line, turn one part over by 180°, then replace it next to the other part with the bases remaining on a straight line, any

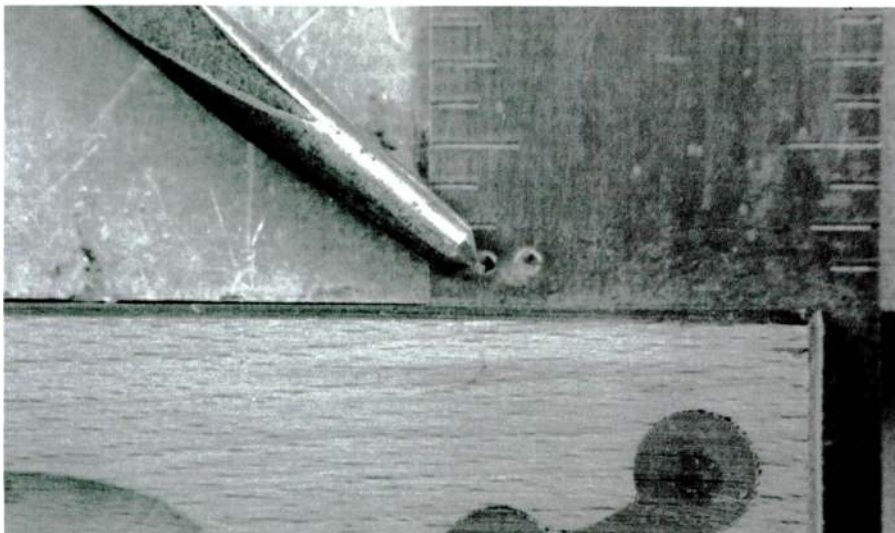

PHOTO 3: Peening the blade of the try square to obtain alignment.

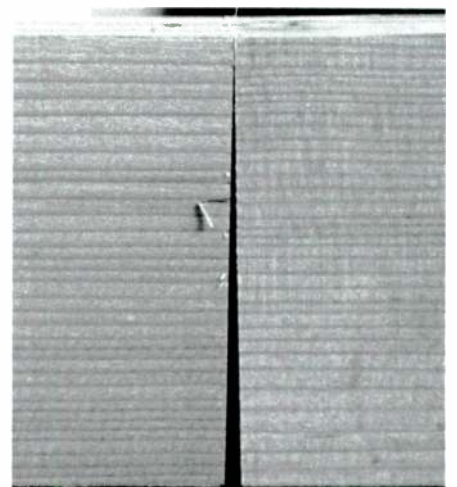

PHOTO 4: A 2 x 4 crosscut with a 1° error. The saw table is used as the reference flat surface.

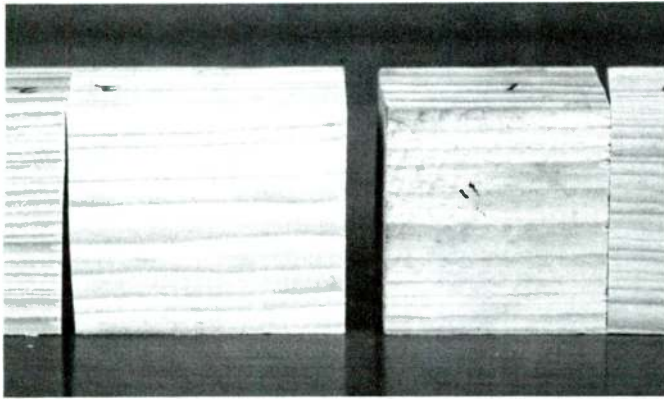

PHOTO 5: A 2 x 4 crosscut with only a 0.1° error.



PHOTO 6: Saw blade check on a piece of 2 x 2 stock.

variance from perpendicular will be amplified by two. With care, you should be able to detect an error on the order of $1/20$ of a degree.

SQUARE OFF?

The first step is to be certain that your tools—hand and power—are set up square. One of the handiest testing tools you can own is the try square, although those you buy at the corner hardware store tend not to be true. To determine whether it is, find a piece of scrap wood with a straight edge. Be certain to test the straightness against a good metal

straightedge or flat surface, such as your saw's tabletop. Place the square on the straight edge and mark a line on the wood along the perpendicular blade. We are concerned with accuracy, so use a marking knife (*Photo 1*). This provides a narrower line and will also be much closer to the blade.

Flop the square to see if the blade aligns with the line. When I tried this with an old, cheap try square, the result was the first set of lines in *Photo 2*. To avoid replacing the try square, I decided to straighten it by peening the metal blade at the corner with a sharp pointed punch. Do this either at the top or

bottom of the blade, depending upon which way you want it to go (*Photo 3*). As you can see, this is usually a two-step process. You could have filed the blade to obtain alignment, but you would have only one side perpendicular unless you filed both edges. Besides, that is a lot of unnecessary work.

Before worrying about the squareness of your enclosure, you must start with square pieces. Once again, the accuracy of your saw's miter gauge and the perpendicularity of the saw blade are in question. We can use the same technique as described above to ensure an accurately aligned table saw. A 1° error in

Roy Allison's Famed Tweeter Now Available

Pre-Christmas Prices now in Effect -- Save Big \$\$ on every purchase

RDL drive units are made by hand in our Massachusetts factory which overlooks the headwaters of the Charles River. We don't claim that the location gives them any special virtue; *that* comes from decades of experience in design and manufacture of what many consider to be among the finest systems available. Our pulsating-dome tweeter, for example, has wider and more uniform dispersion than any other.

**For Specifications and Ordering Information:
Call 1 800 227 0390**

RDL ACOUSTICS

26 Pearl Street, #15
Bellingham, MA 02019

Reader Service #39

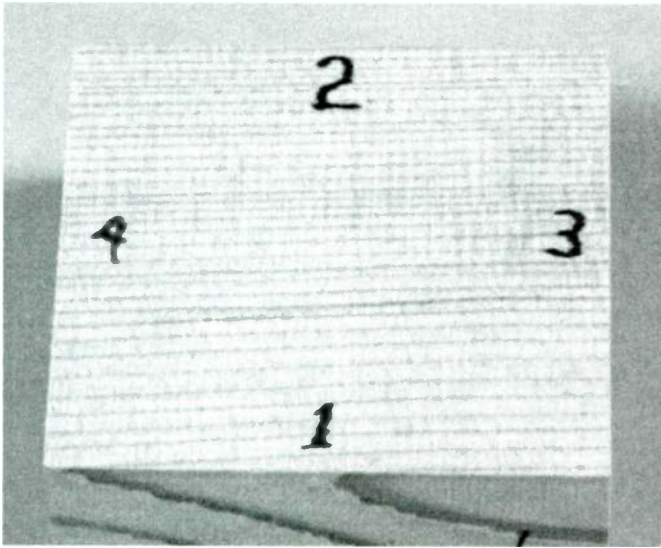

PHOTO 7: A suggested order for squaring up stock.

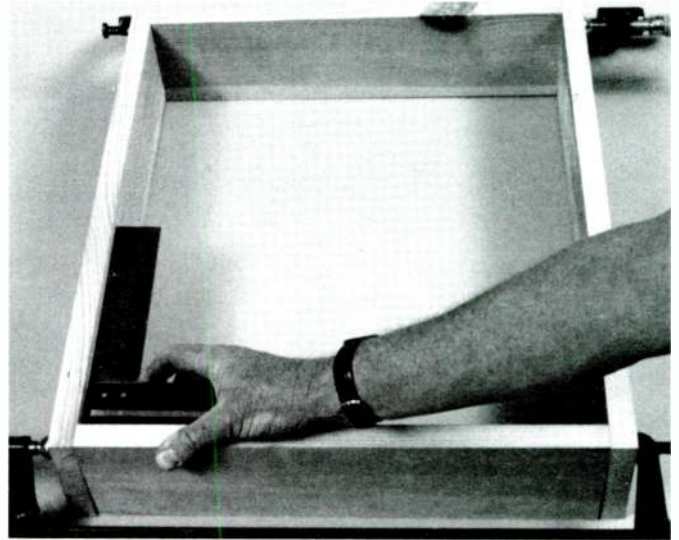

PHOTO 8: Checking for squareness with a try square.

the miter gauge will produce unacceptable results in even a common 2 x 4 (Photo 4).

For this technique to work, the top and bottom faces must be exactly parallel and the comparison made on a flat reference surface. The same applies for an error as small as 0.1°, as seen in Photo 5. While this is over a short distance of 3.5", you normally will be working with widths of ten or more inches—so

watch out. The owner's manual for your saw should provide detailed instructions on how to align it.

The check for the saw blade relative to the saw table (Photo 6) was made with a 2" x 2" board. The blade in the left-hand cut was 1/6° off perpendicular and dead on for the right-hand cut. The two pieces on the right have been set with a small angle between them so

you can spot any deviation more easily. For an idea of this adjustment's importance, think about a 1/6° error in a butt joint at the end of a 20" board.

Let's consider for a moment the best way to square up a side (or, for that matter, the top/bottom or front/back) of your enclosure. Begin by creating a straight edge that is perpendicular to the face of the board, preferably

1994=8 ISSUES!

Yes, the good news is true! Beginning with the first issue of 1994, *Speaker Builder* will be published **eight times a year**. That's two more project-packed issues, filled with the latest information on all facets of loudspeaker technology.

But wait, there's still more good news! In anticipation of the increase to 8 issues, the publishers of *Speaker Builder* are happy to offer you a one-year renewal at the present **1993 rate**. But please hurry, this offer is only good through the end of 1993. As of January 1, 1994, the price for a one-year subscription to *Speaker Builder* will increase to \$32 per year or \$58 for two years (Canada please add \$8 per year for postage.) Overseas subscriptions, 1 year \$50 or 2 years \$90.

To take advantage of this special offer, send in the order form below. Just be sure to have your order postmarked by December 31, 1993. Absolutely no orders will be accepted after that date. Simply send the form with your check or money order or your MC/VISA number (including exp. date). You may also FAX your MC/VISA orders to (603) 924-9467. All remittances must be in US dollars drawn on a US bank.

Yes, please renew my subscription for one year at \$25. (Canada add \$8 for postage). Overseas rate: \$40 for one year.

MC/VISA NO	EXP DATE
NAME	ACCOUNT NO
STREET	
CITY	ST ZIP

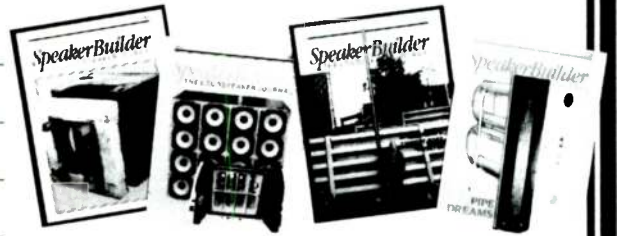

Speaker Builder, PO Box 494, Peterborough, NH 03458-0494 Phone (603) 924-9464 FAX 924-9467



PHOTO 9: Pointed edge of the squaring rod.

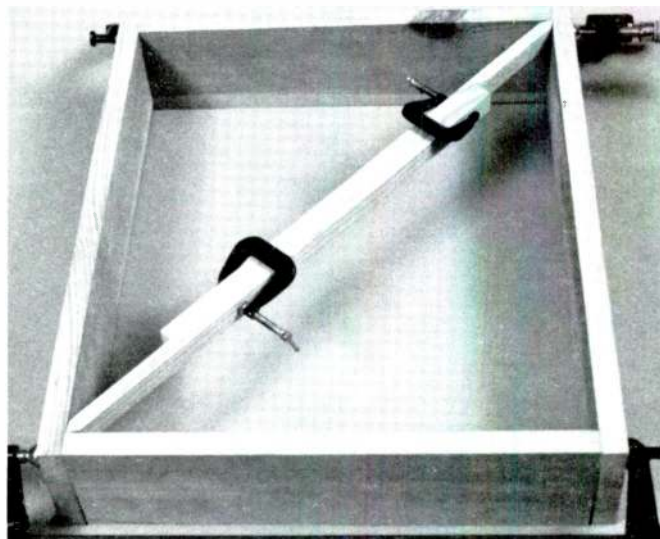

PHOTO 10: Using squaring rods to measure a diagonal.

in the direction of the grain if you are working with solid wood (*Photo 7*). This task can most easily be done on a joiner, but you can also use a table saw followed by a careful pass of a joining plane.

With this reference edge, use your table saw to cut a parallel edge at the desired width. Then make the cross cuts to cut the side to length. Each step is very dependent upon your

saw's accurate alignment. You can make the same cuts with a hand or circular saw, but this requires your undivided attention.

DIAGONAL DIAGNOSIS

Once all the pieces are true and square, you are ready to glue up your enclosure. Perhaps the most common mistake is to use a try square to check for the alignment (*Photo 8*).

While this provides a useful first approximation, it is unsatisfactory if you check only one corner. On assemblies with long sides, it can gauge only a fraction of the lengths involved. If the slightest curve or taper exists, or if the sides aren't straight across their bottom edges, a try square won't work at all.

A more accurate (and easier) technique is to ensure that the diagonals of the enclosure

MCM DELIVERS PYLE

For The Serious Audiophile

For years Pyle speakers have been known by audiophiles as a cornerstone of the audio industry. Years of research and development have made Pyle Industries one of the leaders in high-fidelity sound reproduction. You will find a wide variety of sizes and options, from woofers to tweeters, 4 and 8ohm, single or dual voice coils, and power handling in excess of 200 watts. You will always find the speaker to fit your needs at MCM Electronics. Call today and MCM Electronics will ship your order within 24 hours.

**WE'RE PROUD TO ANNOUNCE THE OPENING OF OUR NEW
DISTRIBUTION FACILITY IN RENO, NV!**



MCM ELECTRONICS
650 CONGRESS PARK DR.
CENTERVILLE, OH 45459-4072
A PREMIER Company



To request a free catalog...
1-800-543-4330
To order by FAX...
1-513-434-6959
Product Questions...
1-800-824-TECH(8324)

S8-12

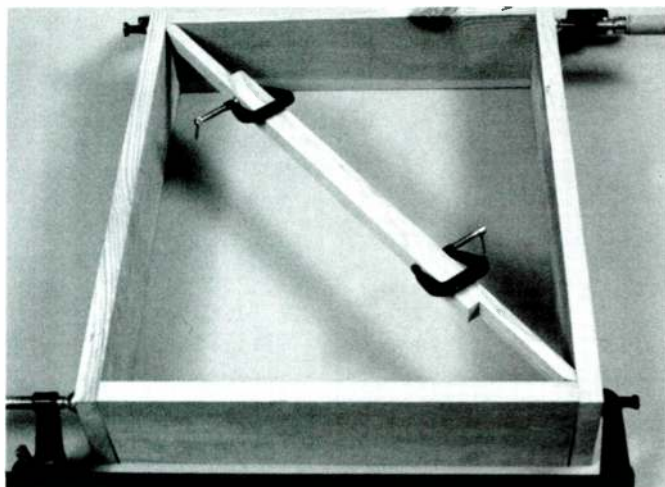

PHOTO 11: Checking the opposite diagonal.

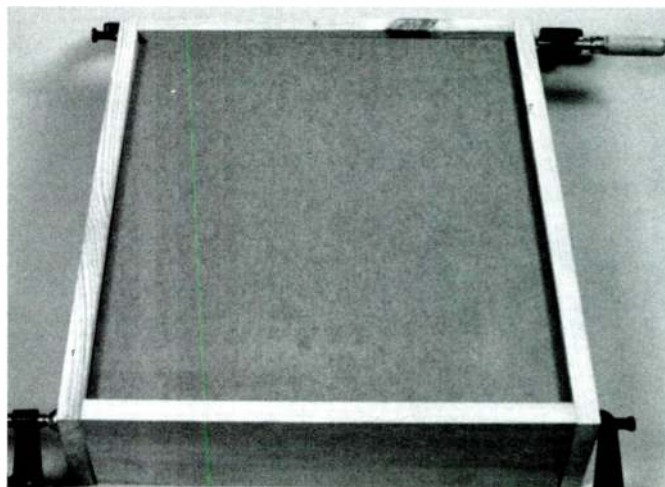

PHOTO 12: Using the enclosure back to square up.

THE PERFECT PITCH

A ONE YEAR SUBSCRIPTION TO

**HI-FI
NEWS
&
RECORD REVIEW**

COSTS £39.40 for SURFACE MAIL,
£57.40 for AIR MAIL.

...SUBSCRIBE TODAY

Please send me 12 monthly issues of *Hi-Fi News & Record Review* commencing with the next available issue

Surface Mail £39.40 (US\$62) Airmail £57.40 (US\$92)

I enclose a cheque/international money order payable to Link House Magazines Ltd.
or debit my credit card VISA ACCESS/MASTERCARD DINERS AMEX

Credit card no. Expiry date _____

Signature _____ Name _____

Address _____

_____ Zip _____

To: **Hi-Fi News & Record Review**
Subscription Department, 1st Floor, Stephenson House, Brunel Centre, Bletchley, Milton Keynes, MK2 2EW,
ENGLAND. Tel: 011 44 908 371981. Fax: 011 44 908 642889.

I understand that I am committed to one year's subscription and should I wish to cancel no refund will be made.

Data Protection: Occasionally we may make names and addresses available to carefully vetted companies who sell goods and services by mail that we believe may be of interest to our readers. If you would prefer not to receive such mailings please tick this box Registered in England and Wales No. 1311940

AA93

are the same. You will first need to make a pair of squaring rods, sometimes called pinch rods. Choose a stable, straight-grained wood for a pair of rods about $\frac{3}{4}$ " \times $\frac{1}{2}$ ", say three-quarters the length of the diagonal. After you have built a few enclosures, you will have your own collection of various lengths. Put a tapered edge along the wide dimension at one end of the rod, somewhat less than 90° (Photo 9), to allow the edge to easily fit in the corner of your enclosure.

Place the rods across a diagonal as shown in Photo 10, and clamp them together with two small C-clamps; then test the opposite diagonal (Photo 11). If they are the same, your enclosure is square; you can make corrections by tilting the clamps. With a difference of, $\frac{1}{8}$ ", for example, the carcass will be $\frac{1}{16}$ " out of square. The size of your enclosure will determine whether you are willing to live with this: the larger the enclosure, the more tolerable the slope.

I often use another simpler method. Carefully cut the back for your enclosure, being absolutely certain that it is square. Loosely clamp up the enclosure and place the back into its opening (Photo 12). Choose one corner and screw it into the backing brace. When you tighten the clamps, the enclosure will automatically be square. Take care that you don't glue the back to your enclosure.

If you have questions, please send them to me via SB and I will try to answer them in future columns.

PREVIEW Glass Audio

Issue 4, 1993

- Nuvector Preamp
- Balanced Tube Alternatives
- PSPICE Simulations
- World Directory

Speaker Builder

BACK ISSUES

1980 OUT OF PRINT.

1981 A Testing Unit for Speaker Parameters • Variable-Volume Enclosure • Thiele/Small Theory, Pt 1-3 • Easy to Make Enclosure Using Concrete Blocks • The Tractrix Horn: Good Dispersion Bass From an Old Design • Diffuser Port for Small Boxes • Mini-Speaker Made From PVC Tubes • Closed vs. Vented Box Efficiency • Interview with P.G.A.H. Voigt • Dual 8" Symmetrical Air Friction Enclosure • Thiele/Small Calculator Computation • Thiele/Small Parameters for Passive Radiators •

1982 Transmission Line Theory • Thiele/Small Sixth-Order Alignments • The Quad 63 • Table Saw Basics • AR-1 Mods • Active Crossovers and Phase • Three Transmission Line Speakers • A Beginner's First Speaker • How Passive Networks Interact with Drivers • Horn Loaded Heil • Phase Correcting Active Crossover • Wind Your Own Inductors • Series and Parallel Networks • High Performance Corner Speaker • Using Zobel's to Compensate for Driver Characteristics •

1983 Building the Two-Way Dynaudio • A Crossover That Offsets Speaker Impedance • Using a Calculator for Box Design • Choosing a Calculator • A Simple Peak Power Indicator • A Small Horn Speaker • Audio Pulse Generator • How to Use Speaker Pads and Level Controls • An Easy-to-Build Voltmeter for Speaker Measuring • Nomograms for Easy Design Calculations • Interview with KEF's Raymond Cooke • Build a Simple Wattmeter • A New Type of Speaker Driver •

1984 Build an Aligned Satellite/Woofer System • BOXRESPONSE: A Program to Calculate Thiele/Small Parameters • Casting with Resins • A Phase Meter • An Interview with Ted Jordan • Building the Jordan-5 System • Self-Powered Peak Power Indicator • Closed Box Design Trade-offs • How to Build Ribbon Tweeters • Build a Dual Measurement Impedance Meter • A High-Power Satellite Speaker System • Build and Use a White/Pink Generator • Sound Pressure Level Nomographs •

1985 OUT OF PRINT, some single issues still available.

1986 The Edgar Midrange Horn • Sand-Filled Stands • Crossover Networks: Passive and Active • 5-Sided Boxes • A 2 x 4 Transmission Line • The Free-Volume Subwoofer • Notch Filters • By-Wiring the LS3/5A • A Push/Pull Constant Pressure System • Current and Power in Crossover Components • The Unbox (Egg) • Upgrade Speakerlab's S-6 Crossover • Measure Speakers with Step Response • A Gold Ribbon System • A Visit with Ken Kantor • A Tractrix Horn Design Program • Reviews: Audio Concepts "G"; Seven TL Midranges; Focal's Model 280; the Audio Source RTA-ONE •

1987 A Compact TL Woofer • Frequency Response and Loudspeaker Modeling, Pt 1-3 • A Manual Coil Winder • The Model-One Speaker • Designing a Listening Room • A Sixth-Order Vented Woofer • Tapered Pipe Experiments • Visiting Boston Acoustics • A Vented Compound System • The Octaline • Spreadsheets for Speaker Design • In Memoriam: Richard Heyser, Pt 1-2 • Using Non-Optimum Vented Boxes • Building Speaker Stands • Evaluating Driver Impedance Compensation • Tuning Bass Reflex • Six Woofers Compared • Bullock on Passive Crossovers: Alternate Bandpass Types • Fast, Easy Filter Calculations • A Mobile Speaker • Polk 10 Mod •

1988 Electronic Turns Counter • Two-Way Design • Minimus-7 Mod • Dome/Midrange/Tweeter Array • Plotting Complex Impedances • A Driver Design Primer • A Cabinet Primer • Tuning Up Old Systems • Low-Cost AR-3 Upgrade • Electronic Time Delay • Enclosure Shapes and Volumes • Minimum-Phase Crossovers • Spot Sound Absorbers • How to Add a Subwoofer • The Swan IV System • Sub-Bass Power Boosting • The Online: A Short TL • Active Filter Computer Design Program • Low-Cost Two-Way Ribbon • Amp-Speaker Interface Tester and Construction Plans • The QB₃ Vented Box is Best • A Pentagonal Box System • Keith Johnson Profile • Sheathed Conductor ESL • A Symmetrically Loaded System, Pt 1 • Ceramic Enclosure • Inductance Measuring Technique • Polk 10 Mods •

1989 (5 Issue Set: VERY LOW STOCK) The Audio Laboratory Speaker System • A Passively Assisted Woofer • Digital Filter Tutorial • The Listening Arc Alignment • Small IC Power Amp & Crossover • Easy Surround Sound • Building Speaker Spikes • An Isobarik in a Thunderbird • Sheetrock Cabinetry • A Picket Speaker • Servo-Controlling AR-1 • Silent, Safe Muting System • Equalizing the Klipsch Cornwall • A Test Switcher • Visiting the Klipsch Kingdom • Rehab for Kitchen Music • Spreadsheet Design • A Subwoofer/Satellite System • Impedance Measurement as a Tool • Practical Passive Radiators • A Symmetrical Dual Transmission Line, Pt 1-2 • The Microline • A Voice Coil Wheatstone Bridge • Tweeter Q Problems • A Dipole Subwoofer for the Quad • Adjusting Woofer Properties • Modifying Paradigm's 7se •

1990 Acceleration Feedback System • Cylindrical Symmetric Guitar TLs • Compact Integrated Electrostatic TL, Pt 1-3 • Minimus-7 Super Mod • The Show (Bass Horn) • A Small Two-Way System • Helmholtz Spreadsheet • Heresy Upon a (Klipsch) Heresy • Beer Budget Window Rattler • Contact Basics • MDT Mini-Monitor Speaker System • Titanium + TPX + Polypropylene = Fidelity • Tom Holman, Skywalker, and THX, Pt 1-2 • Bud Box Enclosure • Klipschom Throat Riddle • Modular Three-Way Active Speaker • CD Speaker System • SPEAKER DESIGNER Software • Symmetrical Isobarik • Novice Crossovers • Triamplified Modular System • Magnetic Crosstalk in Passive Crossovers • Mitey Mike Loudspeaker Tester • Symmetrical Loading for Auto Subwoofers • Improved Vented Box with Low Q_{TS} Drivers • BOXMODEL Woofer System Design Software • Four Eight By Twos • Dynaco A-25 Mod • Klipschom Throat Revisited •

1991 Students Building Systems • Servo Subwoofers • An Apartment TL • L-R Crossover for the Swan IV • More or Less Power • New Guidelines for Vented Boxes • The Pipes • Macintosh's Wave and Sound Programs • Creating Professional Looking Grilles • Octaline Meets D'Appolito • Using Radar to Measure Drivers • Deep Bass for GMC • PSpice LF Response Calculating • Pipe and Ribbon Odyssey • The Delac S-10 • Infrared Remote Volume Control • Backloaded Wall Horn Speaker • Mod for the Minimus 7 • Simplifying Cabinet Assembly • Fibrous Effects on TLs • The DOALs • Loudspeaker Cable • Speaker to Ear Interface • Speaker Sensitivity to Errors in T/S Parameters • TL Speaker Evaluation • Cable and Sound • Kit Reports: Little V; Audio Concepts' Sub-1 •

1992 Rumreich on Box Design & Woofer Selection • MLSSA • Double-Chambered Reflex by Weems • Active Crossover and Delay • Electrical Circuit Bandpass Enclosure • A Dreadnaught System (satellite swivels) • Designing Real-World Two-Way Crossovers • 20-foot Ribbon Dipole Speaker • Biamping the Sapphire II • Capping Passive Crossovers • A High Quality Speaker Cabinet • 1/3-Octave Noise Source • Disappearing Loudspeaker • The A&S Soundoff Winner, Pt 1-2 • Alignment Jamming • Marc Bacon's "Danielle," Pt 1-2 • Double-Chambered Isobarik Bass • Ferguson's Pickup Installation • Electronic Counter for Coil Winding • Oakley on Speaker Placement • Making Your Room Hi-Fi, Pt 1 • More on Dust Caps • Spreadsheet for Nonoptimum Vented Box Design • Acoustic Resistance Tuned Enclosure •

Please send me the following back issues of Speaker Builder

- | | | |
|------------------------------------|------------------------------------|------------------------------------|
| <input type="checkbox"/> 1992 \$25 | <input type="checkbox"/> 1988 \$23 | <input type="checkbox"/> 1984 \$18 |
| <input type="checkbox"/> 1991 \$25 | <input type="checkbox"/> 1987 \$20 | <input type="checkbox"/> 1983 \$18 |
| <input type="checkbox"/> 1990 \$25 | <input type="checkbox"/> 1986 \$20 | <input type="checkbox"/> 1982 \$18 |
| <input type="checkbox"/> 1989 \$21 | <input type="checkbox"/> 1981 \$18 | |

Speaker Builder Magazine

Post Office Box 494, Dept. B93
Peterborough NH 03458-0494
(603) 924-9464 FAX (603) 924-9467

Answering machine for credit card orders only—before 9:00 a.m., after 4:00 p.m. and weekends
Please have all information plus MC/VISA available.

SHIPPING BACK ISSUES

UPS: Domestic ground service by value of order: **Total Magazines** _____
 Less than \$60.00-\$4.50 \$131.00-220.00-\$ 8.50
 \$61-\$130.00-\$6.50 \$221.00+-\$10.50

Canada: Add \$6.00 per year. **Postage** _____

Foreign Air: Europe: add additional 40% of total order
 Other destinations: 50% of total order. **TOTAL ENCLOSED** _____

Foreign Surface: add additional 20% of total order.
 Rates subject to change without notice. **All remittance in US \$ only drawn on US bank.**
 Check or Money Order VISA MC

NAME _____ ACCOUNT NO. _____

STREET & NO. _____

CITY _____ ST _____ ZIP _____

MC/VISA NO. _____ EXP. DATE _____

Tools, Tips & Techniques

FINDING RESONANT FREQUENCY

Finding the point of zero phase shift is the best way to determine resonant frequency. My second-hand scope doesn't do Lissajous traces; however, it has two inputs with inversion switches and a "chop" switch which causes the superimposed display of both channels.

I measure impedance using the constant-current method, which puts about a 700Ω resistor in series between the signal and the driver, by attaching one set of input leads (with the invert switch for that channel off) to the signal generator, and the other channel (with the invert switch on) to the load (driver). If both channels are carefully zeroed, the resonance is the frequency at which the two traces cross each other and the zero line at the same point.

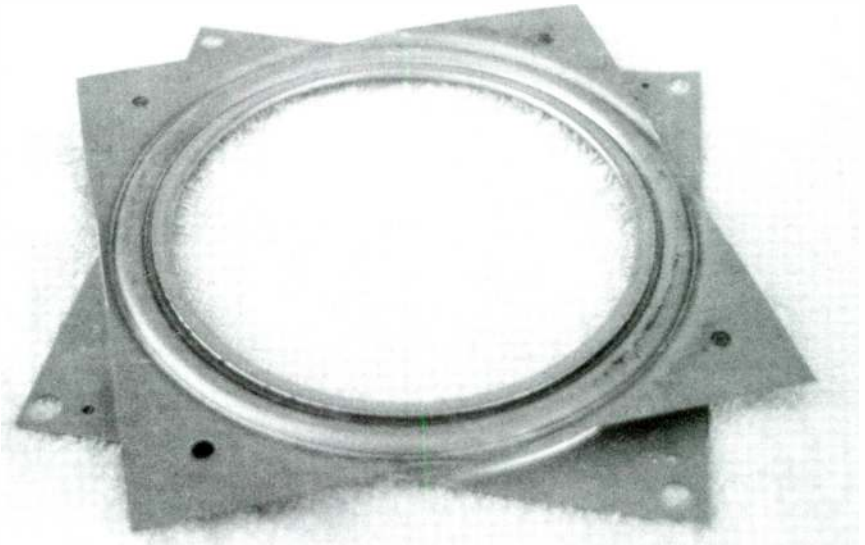

PHOTO 1: "Lazy Susan" bearing.

Don Stauffer
Dallas, TX 75211

LAZY BEARINGS

If you have large, heavy speakers, and have them placed on flooring other than carpeting, experimenting with toe-in can be a difficult proposition. Rotating the speakers can cause damage to both cabinets and floors, while lifting them can be a job for two or more

people. One workable solution is to mount them on "lazy Susan" bearings (Photo 1), several ball bearings in a raceway between two pieces of stamped sheet metal, which permit the metal pieces to turn easily with respect to one another even with a heavy load imposed on them.

The bearings can be fastened to the bottom of the speaker cabinets with double-sided adhesive tape. Unwind a short length of tape from the spool and peel off the backing to expose both

adhesive-coated sides, then simply apply light pressure to stick the tape to the surface.

Placing the bearings between the cabinets and the floor allows you to turn the speakers easily. Several drawbacks do exist: the speakers may turn too easily, making it difficult to maintain the desired toe-in, and the bearings may have too much play and wobble. Both problems are solved by adding a small wedge, marble, cone, or large machine nut between

Put *SpeakEasy* Designers to Work for You.
creative audio software tools

For the IBM PC

LOW FREQUENCY DESIGNER 3.0
State of the art loudspeaker modeling.

Still only \$195 each.

FILTER DESIGNER 1.5
Flexible passive and active filter design.

**Powerful
Friendly
Efficient
Versatile**

CALL TODAY FOR A FREE DEMO DISK TEL: 617-969-1460 FAX: 617-969-5833
SpeakEasy 46 Cook St., Newton MA 01258 USA

the cabinet bottoms and the floor to lock the speakers in place and add stability.

These bearings can be a big help when setting up speakers and later removed, if you desire, when you have determined the ideal toe-in.

James T. Frane
Orinda, CA 94563

ACCURATE MEASUREMENTS

I have always had trouble taking the accurate measurements necessary for vented-box design, especially at frequencies below my DVM's rating. Readings were tedious, inaccurate and inconsistent from one sitting to the next.

I discussed this problem with my friend, John Levreault, who came up with an oscilloscope method which not only solved the problem of accurate impedance measurement, but also protected readings from dial inaccuracies on my audio signal generator. I can't believe how much this has helped. It was also less tedious.

Instead of reading frequency in hertz (and impedance in ohms) as absolute numbers, read them as *relative* oscilloscope scale readings wherever possible (when the equations in which the values are used are proportions in which the units cancel). For example, to find the Q_{MS} , Q_{ES} and Q_{TS} of a woofer find the resonant frequency and set your scope time base so a complete half-cycle will show at the F1 frequency (which must be found using the DVM). This will take some experimentation; usually two or three half-cycles will show at the resonant frequency.

Now count the number of time units for all the complete half-cycles showing on the scope at the resonant frequency, and write down the proportion of half-cycles to time units. Don't touch the time base knob again after this.

Read F1 and F2 the same way as F_S and use the value of proportions in the formulas for Q_{MS} and Q_{ES} , as well as the double check value, $\sqrt{F1 \times F2}$ (which should be near F_S if your measurements are accurate). The results will be mathematically the same as if you had used the absolute frequencies.

John sets his signal generator extremely low to measure R_E , allowing him to even measure R_{MAX} (or R_M) and R_E as relative values to calculate R_O . My generator doesn't go that low, so for me R_{MAX} will have to be an absolute measurement, as will R_E . I highly recommend the Wheatstone Bridge ("A Wheatstone Bridge for Your Voice Coil," *SB* 5/89, p. 36) to measure voice coil resistance;

this is perhaps the most mathematically sensitive value of the whole process, and should be as precise as possible (0.05Ω accuracy is not unreasonable). I use the constant-current method and a good DVM for R_{MAX} , which is OK because usually F_S isn't too low for my DVM to be stable.

What you are really doing is reading absolute frequency (or impedance), but not in hertz or ohms. As long as you keep the time base (or, if you're measuring impedance using the constant-current method, the voltage scale) constant, the results will be correct in any formula where the units cancel.

This also works well when measuring

woofer compliance, or analyzing whether a box is on target (refer to Bullock's "Five Points of Vented Speaker Design," *SB* 2/81, p. 18). I have used this technique with the following formulas:

For driver parameters:

$$Q_{MS} = F_S \times \frac{R_O}{(F_2 - F_1)}$$

$$V_{AS} = V_{BT} \times \frac{(F_H^2 - F_M^2) \times (F_M^2 - F_1^2)}{(F_H^2 \times F_1^2)}$$

For Q adjustment (*SB* 2/81, p. 22), F_{SB}

Do a Little Something for Your Music's Image



Model R8-2
\$2495 per pair.
Dual 8" woofers
crossed over to
dual 15" Ribbons
at 900hz. Systems
start at \$1095/pair.

High Resolution Ribbon Loudspeakers from Newform Research.

Our new Ribbon technology produces smooth, extended response, excellent dispersion, good efficiency and high purely resistive loads. The result is superb speed and soundstaging at mid-fi pricing.

Ribbon drivers (8", 15" and 30") are available in pairs for the custom installer and hobbyist.

Newform Ribbons require no transformer. They are a pure resistive load, mono-polar and have low external magnetic fields. They are ideal for home theatre. Call or write for reviews, full information, prices and the name of the authorized audio specialist nearest you.

In U.S.A.	In Canada:	In Germany:	In Italy:
Newform Research Inc.		Zoller Hi-Fi GmbH	ATD
203 Eggert Rd.	P.O. Box 475	Feldheider Str. 42	via Plinio 43
Buffalo, NY	Midland, Ont.	40699 Erkrath	20129 Milano
14215	L4R 4L3	Germany	Italy
1-716-871-1110	1-705-835-9000	02104-39123	02 29404487

Reader Service #19

International distributor and dealer inquiries welcome.

Affordable, 1/3 Octave, Real Time Analyzer With Memories & SPL Display Under \$1000

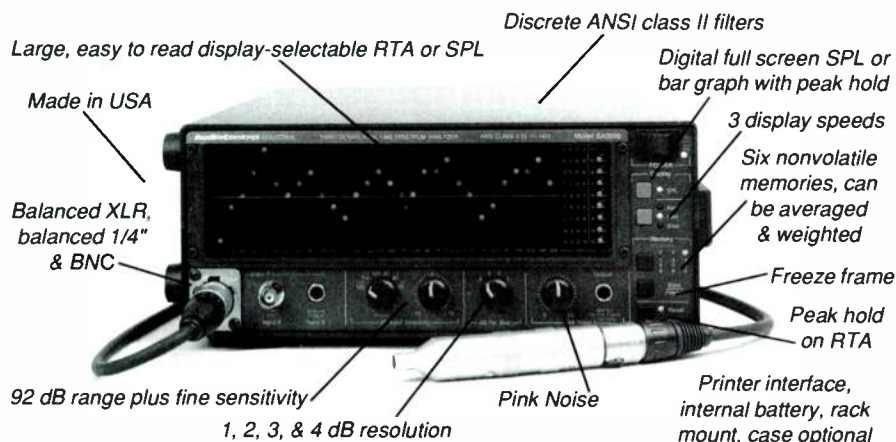

- SA3050A with Mic \$ 995
- With Battery & Printer Interface \$1300
- Rack Mount \$ 55
- Soft Case \$ 59
- A/C Weighted Filter \$ 44



Call TOLL FREE: 1-800-732-7665

Reader Service #4

itself can't be found using this method, since its formula has two frequencies in the numerator but only one in the denominator:

$$F_{SB} = \frac{(F_1 \times F_H)}{F_M}$$

However, F_{SB} is used in the following formulas for modified Q values:

$$Q_{TB} = \frac{F_S}{F_{SB}} \times Q_T$$

$$Q_{MSB} = \frac{F_S}{F_{SB}} \times Q_{MS}$$

$$Q_{ESB} = \frac{F_S}{F_{SB}} \times Q_{ES}$$

Since F_S/F_{SB} is always used as an adjustment factor to the Q values, we can find:

$$\text{Adjustment Factor} = \frac{(F_S \times F_M)}{(F_H \times F_1)}$$

using this method instead of F_S/F_{SB} to adjust the Q_T , Q_{MS} and Q_{ES} .

For target analysis:

$$H_A = \frac{F_M^2}{(F_1 \times F_H)}$$

$$\alpha_A = \frac{(F_H^2 - F_M^2) \times (F_M^2 - F_1^2)}{(F_H^2 \times F_1^2)}$$

Don Stauffer
Dallas, TX 75211

NEEDLING CONES

For anyone whose speaker surround is peeling off a plastic cone, I have a solution. Several years ago I bought a case of Seymour Sound woofers which employed a plastic surround and slippery plastic cone. Over time they had delaminated, and were repaired with rubber cement. Recently, when trying to use my last driver in a dual-vented bandpass system, the cone repeatedly fell apart. The pressures were too much for the fragile bond.

Finally, I glued and sewed the cone to the surround. I drilled a series of holes about 1/4" apart along the circumference through both the cone and the surround, using a Dremel tool with a PC-board bit. I then stitched the cone to the surround with light fishing line.

For best results, use two needles and stitch from both sides as you would in leather crafts.

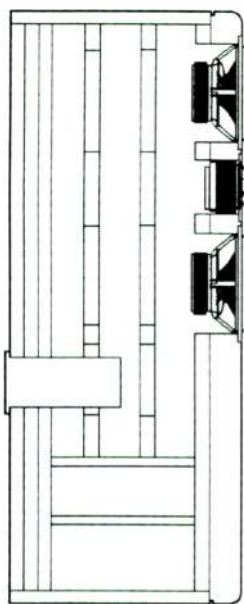

RHYTHM

High performance two way, three driver floor standing loudspeaker system featuring:

- **SCAN-SPEAK** D2905 1" Fabric Dome Tweeter.
- Dual **SCAN-SPEAK** 18W/8544 7" Kevlar® Woofers.
- 10 AWG **Music Coil** Hex-Laid Inductors.
- **SPRAGUE** High Frequency Metallized Polypropylene Film Capacitors bypassed with 1 μF **Ultra-CAP** Capacitors.
- **OHMITE** Precision Power Resistors
- All crossover components **hand matched to 1%**.
- QB3 Partition Vented, Aperiodically Braced Cabinet with 2 1/4" Composite Front and Rear.
- Sand-Filled lower chamber.
- Crossover is externally housed in its own cabinet and connected via a dedicated cable.
- Available as a Woodworker's Kit, with pre-veneered cabinet flats, or as a Complete Kit.

For a complementary copy of our complete catalog, including drivers, crossover components, accessories, and *all 10* of our High Performance Loudspeaker Kits, please give us a call or drop us a line.

North Creek Music Systems

Route 8, PO Box 500, Speculator, NY 12164
Voice/Fax (518) 548-3623.

Reader Service #17

Seal the stitches and any air leaks with a good cement, like Pliobond or RTV silicone. Your system will withstand the pressures of time.

Matthew Honnert
Carol Stream, IL 60188

FINISHING TOUCH

Since I started reading *SB* three years ago, I've noticed a lot of attention is paid to cabinet construction, and almost none to different types of finishes. Let's face it: the speaker may sound wonderful, but if the finish isn't high-caliber, you'll be reluctant to put it into your living room. I have tried various methods of finishing speakers, such as staining, lacquering, and so on.

On my last project, Ralph Gonzalez's excellent Delac-10s, I used Multispec Fine Speck™ paint. A gallon will generally be enough to cover two to three pairs of small-to-medium-size cabinets. Fleckstone™ should yield similar results. Both of these paints produce a granite-type finish which requires little preparation, and are available in a variety of colors.

You will need an airless spray gun to apply the Multispec (you can probably use a compressor-type sprayer, as well). Considering what we spend in the pursuit of better sound, the price of the sprayer is not too much, besides having other uses around the home.

Before applying the paint, fill in any gaps, screw holes or large gouges with wood filler. The cabinets then just need a rough sanding with 100–120 grit paper. No need for a mirror-smooth surface with this stuff, as it covers just about anything.

The rate at which you apply the paint and the diameter of your spray tip will determine how the paint grain will look. Most spray guns have a flow regulator you can adjust for applying different types. Experiment to find the setting that gives you the best look. I applied my paint with a Krebs model 40T, which tends to make the grain look less pronounced, while the Graco produces thicker, more marbled grain lines.

Avoid working too close, because the paint will run; however, standing too far away will yield a poor grain pattern. As with most types of spray painting, you should remain 10–12" from your project, use nice smooth strokes, and avoid overspraying. The paint usually dries in one to two hours, but I leave mine overnight before doing any touch-up. I like this paint for its ability to cover most jobs in one coat.

Read all the directions *before* you begin painting (which most of us, myself included, never

do). Do not mix the paint too vigorously: you are just stirring up the heavier particles from the bottom. Overstirring will mix the different colors instead of leaving them suspended in the paint, thereby killing your granite look. This paint does not like cool temperatures, so stay within the manufacturer's guidelines. Once the paint is dry, you can obtain a polished look by spraying or brushing on a few coats of water-based high-gloss polyurethane, and then sand lightly with fine-to-ultra-fine sandpaper between coats. This also produces a harder, more durable finish.

My work with Multispec has always been on MDF, although I did spray a test sample of some pine and it had much the same appearance. So your results shouldn't vary much from one type of wood to another. This look may not be for everyone, but it *is* different, aesthetically pleasing, and fairly easy to use. In my opinion, this adds up to more time spent listening to my latest project instead of sanding smooth that 18th coat of lacquer.

Gary Riolo
The Woodlands, TX 77381

TopBox for the Macintosh

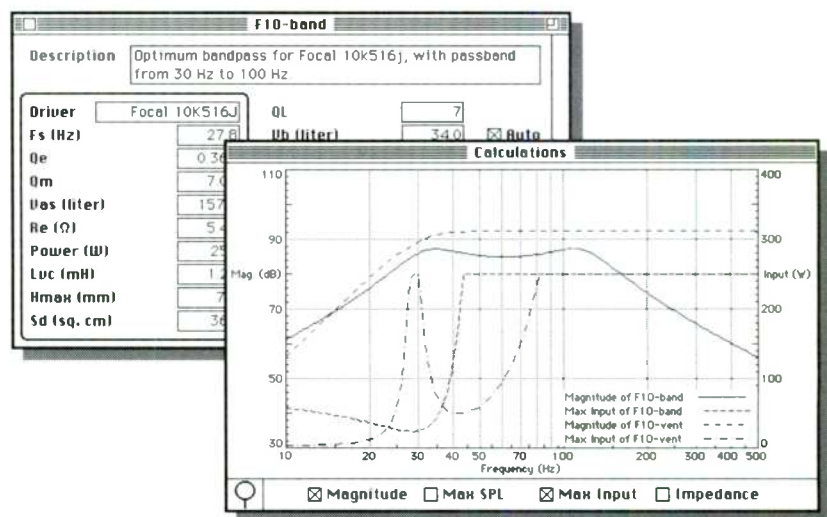

Introducing TopBox software for Macintosh computers

by Joe D'Appolito, Ron Warren, and Ralph Gonzalez. **TopBox** accurately predicts the response of sealed, vented, and bandpass loudspeaker configurations, allowing the user to compare their impact on frequency response, maximum output SPL, power handling, and impedance. Its intuitive interface provides unsurpassed power, speed, and flexibility.

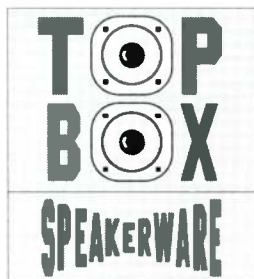

Design Types

- 2nd, 3rd, and 4th-order Closed Box
- 4th, 5th, and 6th-order Vented
- 4th and 6th-order Bandpass
- Round and rectangular vents, metric or English units

Output Features

- High-resolution black & white or color graphs, with up to six overlay curves
- Graphs and tables can be imported directly by word-processing or page-layout applications
- Tables can be imported by spreadsheet applications

TopBox is distributed with an extensible library of popular drivers and several sample designs. Data can be shared with the PC version. **TopBox** is compatible with all Macintosh computers with at least 512k RAM.

Price: \$99.95. Dealer inquiries invited. Also available: **TopBox** for PC-compatibles.

ORCA

1531 Lookout Drive • Agoura, CA 91301 • USA
Tel: (818) 707-1629 • Fax: (818) 991-3072

Reader Service #3

Craftsman's Corner

A HORN FOR THE GYM

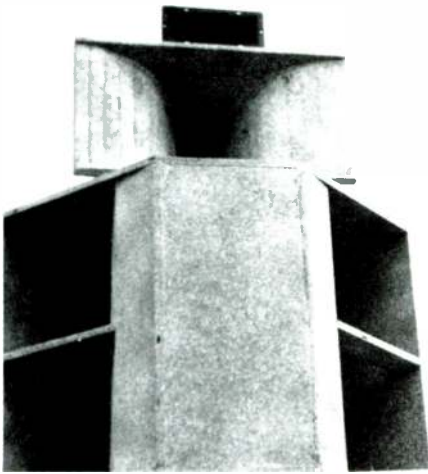

PHOTO 1: Three-way horn for gymnasium PA system.

I wrote to Bruce Edgar to ask his advice on the suitability of his 70Hz corner horn design for use in a gymnasium PA system, and his reply was most helpful ("Horns Aplenty," *SB* 4/93, p. 76). I subsequently built two systems (*Photo 1*).

In my original letter, I underestimated the size of the gym, which is actually 100' x 50' x 24'. I built the 70Hz horn, Bruce's midrange horn, and bought the Pyle H2610 horn for the tweeter. The bass driver is the Pyle 6520, and the midrange is the Pyle MH516 stage monitor. I built a 6dB crossover at 500 and 5,000, treating the 4Ω woofer as an 8Ω due to the horn loading.

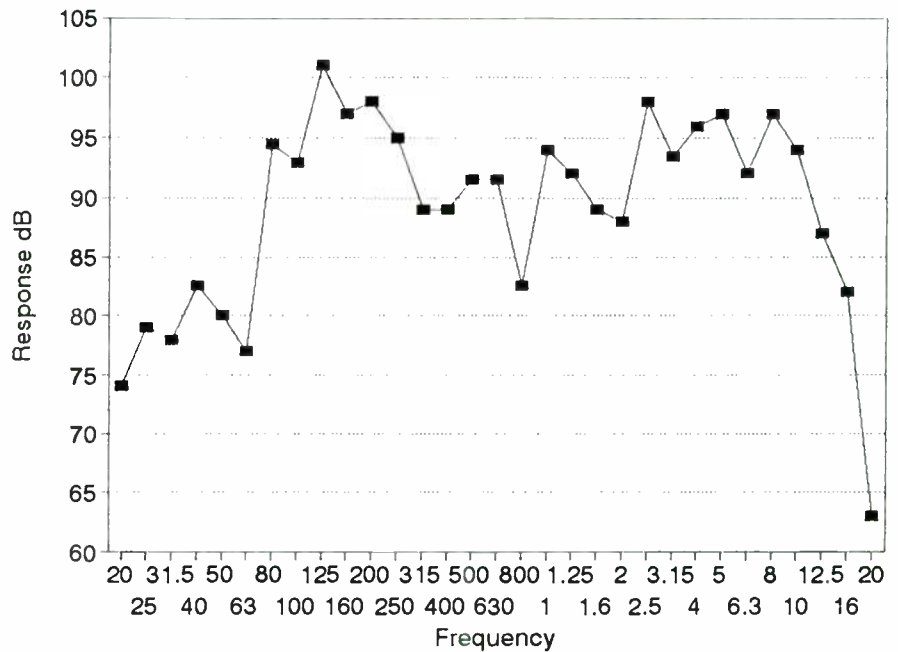

FIGURE 1: Three-way horn system frequency response.

The three-way system easily and cleanly fills the entire room to uncomfortably high levels at very low inputs. Typical input levels (according to the meters on the inexpensive receiver the gym uses) are less than a full watt. In the 25W range, kick drums are readily palpable at 30' from the system. The sound is

quite clean with no audible distortion at any level, although you quite clearly hear any inadequacies in the input. The sound is also uncolored: on PA, people actually sound like themselves. Further, with only one system operational, a trip around the gym floor disclosed no changes in frequency balance or

FOTAL

ACCUTON

ORCA CONNECTORS



SPEAKERS

QUALITY DRIVERS & MORE

etc.



polyda

SPEAKER CORPORATION

Custom made Litz Speaker Cables & Interconnects

**We Offer State Of The Art Speaker Components and Kits
(Specializing in Speaker & Crossover Design)**

1828 W. Peoria
Phoenix, AZ 85029
Phone (602) 944-1878
FAX (602) 371-0605

Call, write or fax for a free catalog

(Mntn Std Time)
10:00 AM - 7:00 PM Weekdays
10:00 AM - 5:00 PM Saturdays

Reader Service #38

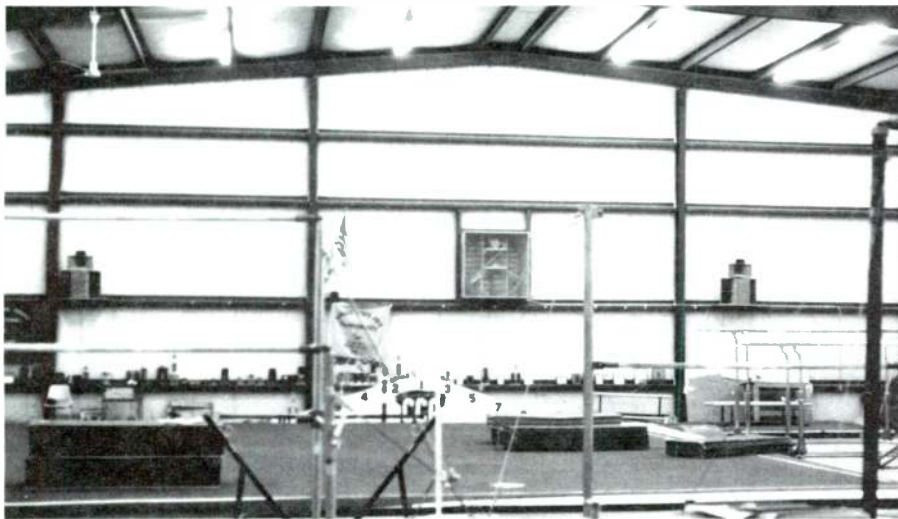

PHOTO 2: Horns wall-mounted on shelves.

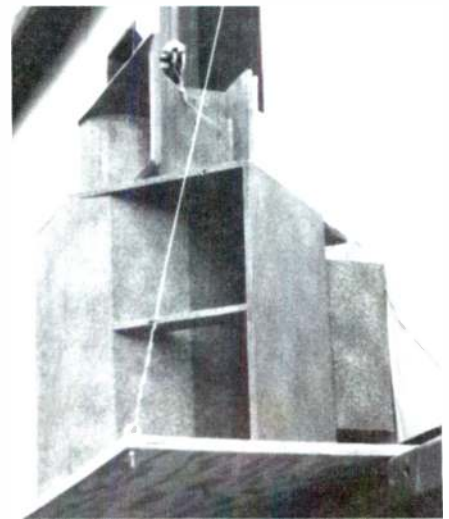

PHOTO 3: Detail of horn mounting.

timbre; the systems seem uniformly cylindrical in their radiation pattern.

The frequency response graph (*Fig. 1*), as measured with a Radio Shack SPL meter in my garage (on a 30" stand in the corner, both doors open) from a Japan Audio Society test CD, was within ± 5 dB from 70–12,500, with a dip at 800 that may have been a test artifact. (I couldn't hear it except with test sweep tones.)

To date, we have burned out one tweeter coil, which was easily replaced. Since about 100 children a day have access to the system, it was likely abused, but it may be that a steeper-slope crossover should have been employed.

The chalk dust which coats everything in the gym may also have been a reason for the failure, as the systems lived on the floor next to the exercise springboard for many months. They are now mounted on shelves on the wall

(*Photo 2*). Since they are not in corners, and were only designed to reach down to 70Hz, deep bass is lacking but adequate for the intended purpose.

*Stephen Katz
Topeka, KS 66601*

HIGH PERFORMANCE ELECTRONIC CROSSOVER NETWORKS THESE COMPONENTS AVAILABLE FULLY ASSEMBLED OR AS KITS



XM9 Automotive System



XM9 Home System

XM9-CA2 and XM9-CA3 Custom Cabinet (for automotive use) Accommodates 2 or 4 XM9 or XM16 Crossovers and PS15 (or PS10) power supply to make either 2-way or 3-way system. • Buy cabinet only, kit, or fully assembled with circuit boards.

PS10 Power Supply (for home use) converts 120 VAC to dual 15 VDC supply • Regulated • Can support 8 crossover networks.

PS15 Power Supply (for automotive use) converts 12 VDC to dual 15 VDC supply • Can support 4 crossover networks.

XM9 Crossover Network • 24 dB/octave slope • fourth-order constant-voltage design • Outputs in phase • Low noise • Controls on circuit board or panel • Settable crossover frequency from 20–5,000 Hz.

XM16 Crossover Network • 48 dB/octave slope • Eighth-order constant-voltage design • Outputs in phase • Low noise • Controls on circuit board or panel • Settable crossover frequency from 20–5,000 Hz.

XM9-C and XM16-C Custom Cabinets (for home use) Accommodates 2 or 4 XM9 or XM16 Crossovers and PS10 (or PS15) power supply to make either 2-way or 3-way system. • Buy cabinet only, kit, or fully assembled with circuit boards.

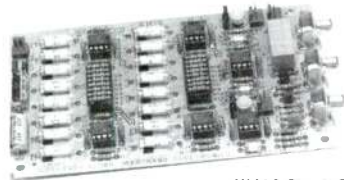

XM16 Circuit Board



WM8 "BASSIS"
Bass Correction Equalizer

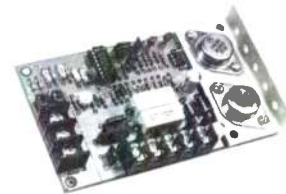

PM22 Power Amplifier

WM8 "BASSIS" Bass Correction Equalizer extends bass response by 1 to 2 octaves • Adjustable bass boost and damping • Rumble filter • 20 Hz subsonic filter.

PM2 and PM22 Power Amplifier Modules provide 75 watts RMS into 8 ohms • Complementary Darlington output stage • Integrated-circuit driver circuit • Over-current and over-temperature protection • Class A or Class AB operation.

WRITE NOW FOR FREE LITERATURE ABOUT THESE AND OTHER MARCHAND PRODUCTS

SEND YOUR NAME AND ADDRESS TO: MARCHAND ELECTRONICS, INC.

P.O. Box 473 • WEBSTER, NY 14580 • PHONE (716) 265-4930 • FAX (716) 265-1614

Reader Service #29

Vintage Designs

Jensen Treasure Chest Duette

Courtesy of Charles Hickey, Charlotte, NC 28203

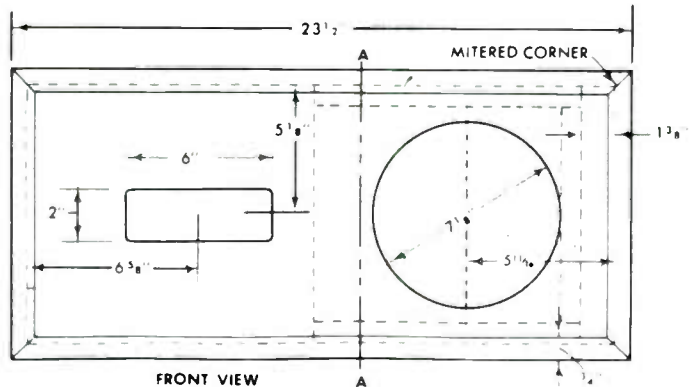
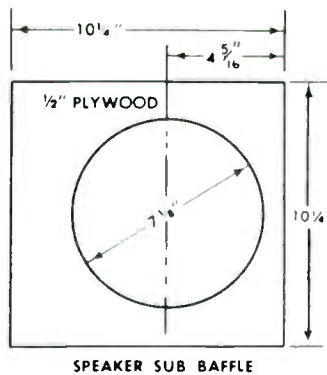
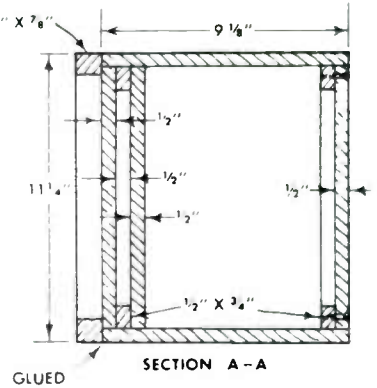
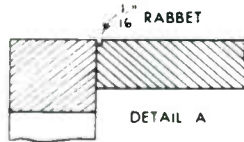
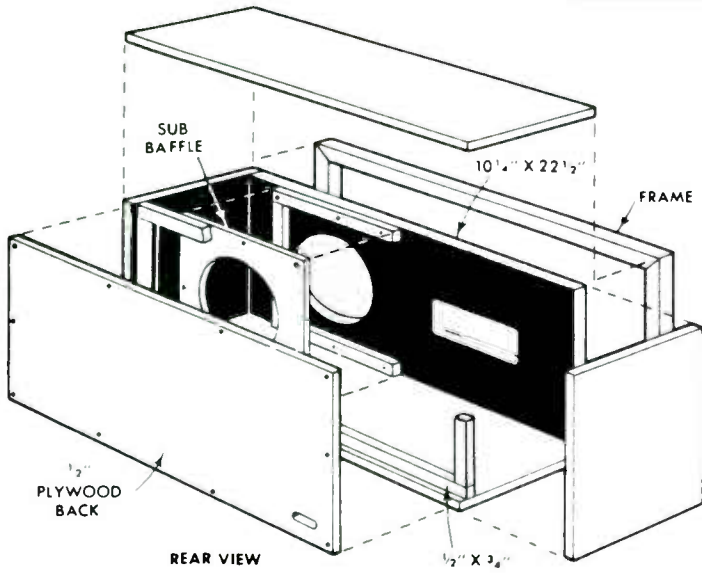
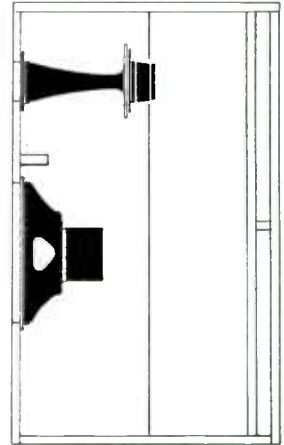
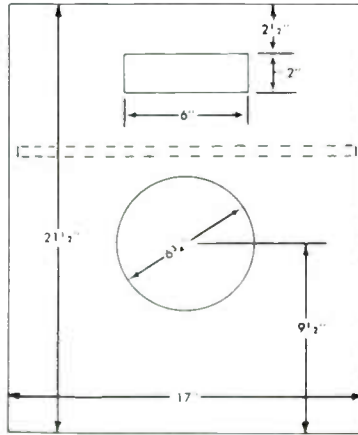
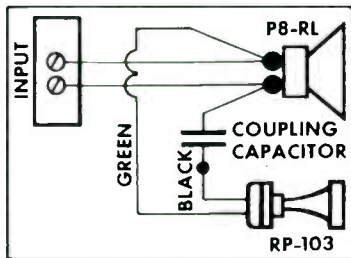
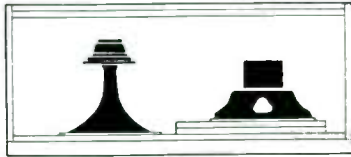
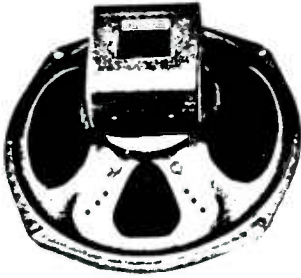

Book Report

HEATH NOSTALGIA

Reviewed by Fred Gloeckler

Heath Nostalgia, by Terry Perdue. Available from Old Colony Sound Lab, PO Box 243, Peterborough, NH 03458-0243 for \$9.95 plus \$3 shipping (USA).

Heathkits stimulated my early interest in electronics. I assembled my first Heathkit, a small power amplifier, around 1960. Most of my test equipment started out as Heathkits, with modifications along the way. Most likely many have grown up with Heathkits and share similar experiences.

In the early days, we assembled electronic gear from kits for a number of reasons. First, providing your own assembly labor was a major economic benefit, with the personal satisfaction derived from building your own equipment equally important. In addition, Heath's designs, detailed instructions, trouble-shooting procedures, and customer support ensured success, as well as an education. Since professional test equipment often was very expensive, kits were an affordable alternative for individuals and small service shops.

Since then, the world has changed. Kits are only of minor interest in the electronics industry. Though there are a few education-oriented kits in the latest catalog, Heath no longer produces mainstream kits.

Heath Nostalgia chronicles Heath's growth and decline as the major force in the electronic kit industry. After a brief history of the company (followed by 24 pages of pictures), the author delves into the recollections of several people associated with Heath.

Heath Airplane Company was established by Edward Heath in the early 20th century. Among the wares sold by the company were parts kits for various aircraft assemblies, from which one could assemble an entire light plane. Heath's first mail order catalog was published in 1925. After Heath was killed in a plane crash in 1931, the company was sold and renamed the International Aircraft Corporation: it closed in 1934 due to business difficulties.

Howard Anthony purchased the company's name and remaining assets from the IRS in 1935, and moved the business to Benton Harbor, MI to sell aircraft and accessories. Anthony resurrected Heath's training program to build and fly planes, and added aircraft radio receivers and transmitters to the

catalog. Heath's staff grew to 80 employees during World War II.

After the war, business shrank drastically and the company started dealing in war surplus. Electronic parts and assemblies were

advertised in a monthly flier which described the items and proposed applications. The first electronic kit was the 0-1 oscilloscope, which was developed to use surplus CRTs. After additional test equipment kits, audio gear was

Finally - Value Redefined

Introducing...

N.E.W.

Setting The New Class A Value Standard

You finally have your new speakers!

How can I get the most sonic performance at a price I can afford?

The benefits of High-Bias, Class A operation are well known. Now hear all the detail, definition, ambiance, and realism you've been missing.

The Evolution of a Legend

In 1978, *Audio Amateur* Contributing Editor, Nelson Pass, created the legendary A-40 amplifier, which to this day is still a classic in terms of musicality and popularity. Finally, the long awaited advanced and updated version is now available!

The Amazing New A-20

Experience the wonders of REAL Class A operation assembled by name worthy American perfectionists for only \$598.00, *that's right, only \$598.00*

We Make It Easy

We're so sure you will love N.E.W. that we offer 30 days to get to know us. Demo the amazing A-20 stereo amplifier in the comfort of your own home through your preferred system and speakers. Of course...without that high pressure salesman looking over your shoulder.

California residents please add 7¼% sales tax.

The Legend Continues...Call Today

N.E.W.

P.O. Box 1148, Rancho Santa Fe, CA 92067 • (619) 756-9561

Reader Service #41

Speaker Builder / 6/93 63

A Quality Texture Look

Without Laminating Costs and Labor!

Designed For Use On Speaker Cabinets

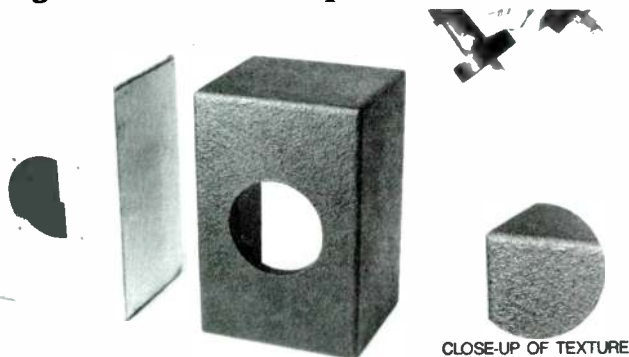

CLOSE-UP OF TEXTURE

RESTORES OLD WORN OUT SURFACES

TEXTURELAC Spray finish produces a three-dimensional look that resembles a pebble, stucco or leather texture. It can be handled within 15 minutes of spraying and eliminates most sanding, spackling or extra paint operations. Dries to a hard mar-resistant and washable finish.

—Can reduce production spray room material and labor costs by 70 percent or more—

TEXTURELAC Is formulated for use on all wood, and composition woods, plastics and metal castings. It is available in most colors.

For a trial order or swatch panel of TEXTURELAC with descriptive literature call or write:



Abilene Research and Development Corp.

PO Box 294, Hewlett, NY 11557 • (516) 791-6943 • FAX (516) 791-6948

Reader Service #33



The brief history, while far from complete, provides an overview of key Heath people, facilities and corporate relationships. One of the things that struck me was that, even though kit builders were involved with Heath products at the personal level, Heath grew to be a very large business. Once it attained reasonable size, the company had to operate under the same constraints as any other large organization. That Heath's personal involvement with customers could be sustained for so many years is a tribute to the many people involved in designing, developing, marketing and supporting Heath products. Terry Perdue doesn't chronicle all of the kits and products offered by Heath throughout its history; perhaps someone else will provide a detailed history of Heath's wares.

Most of the pictures in *Heath Nostalgia* are of people or Heath facilities, and a few early advertisements are included. The graphics are reproduced with a large grain, which, while not too obtrusive in the photographs, renders the smaller print in the advertisements illegible. If poster-size reproductions of some of the early literature were made available, they would make interesting collectibles.

Continued on page 71

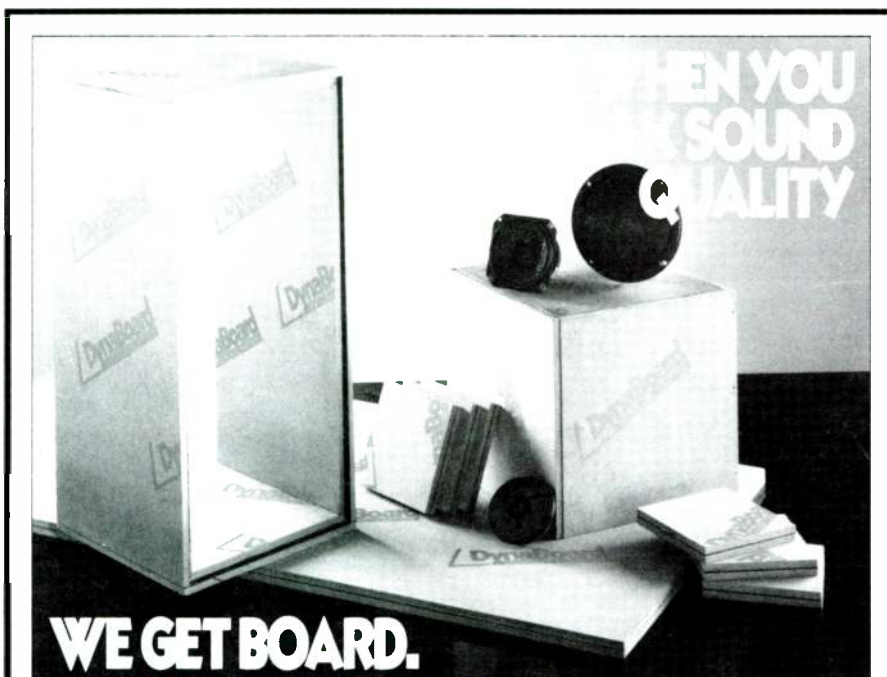

WE GET BOARD.

DynaBoard is the new enclosure material from Dynamic Control. We take a sheet of Dynamat® damping material and with high pressure, sandwich it between two sheets of 3/8" MDF. The resulting

composite panel has excellent acoustical properties. This self-damped enclosure material offers a **breakthrough in speaker performance technology.**

Dynamic Control
125-B Constitution Drive
Fairfield, Ohio 45014.
1-800-225-8133



Reader Service #5

SB Mailbox

SOUNDS FISHY

My home system consists of a pair of Aria 5s and an Eminence 15" dual-voice-coil subwoofer in a sealed box. I use separate amplifiers and a 24dB/octave electronic crossover set to 100Hz. Each low-frequency channel powers its own voice coil in the subwoofer.

Originally, I used the subwoofer in the front-firing position, but found the subjective room response lacking in the low bass and excessive in the midbass. As I thought about possible remedies, I recalled that the close-miked frequency response of the Audio Concepts Sub 1 was essentially a fairly narrow hump centered on 50Hz, but the room response was extremely flat when the unit was

used as designed with the driver very close to the floor.

I positioned my subwoofer, driver-down, in exactly the same place as before. I propped it up on three tuna fish cans to give the driver frame about 2" of clearance from the wood floor. The subjective room response improved phenomenally. I was able to turn down the gain of the subwoofer's amplifier and enjoy smooth, extended response without the 80Hz hump that had resulted previously from the subwoofer's rising room response.

What is this effect whereby the low bass of a subwoofer is boosted by very close placement to the floor?

Kurt Rosenfeld
New York, NY 10003

SMOKING BAN

Randy Parker's article in *SB* 4/93 on "The Prism V Satellite/JBL Subwoofer" (Part 1, p. 16) was excellent. Technically, it has something for everyone and covers a wide range of skills. The author, with the tech support of David Clark, has done a great job with the passive and active crossover designs for this loudspeaker system.

The passive crossover design uses a 30 μ F capacitor in the parallel resonant circuit L4-R2-C5, providing a notch filter. These circuits are widely used to make small corrections due to undesirable acoustic responses.

Above this notch filter's resonance frequency, the capacitor carries all of the load current (i.e., the audio frequency current into

MENISCUS

Proudly supplies:

CAPACITORS -

- Polypropylene
- Mylar
- NP Elec.

INDUCTORS -

- Air Core
- Ferrite Bobbin
- 20 - 14ga. OFC

RESISTORS -

- Wire wound
- Non - Inductive
5 W - 25 W

ACCESSORIES -

- Terminal cups
- Gold posts
- Speaker cabinets
- Wire & connectors
- Grille cloth & fasteners
- Black screws
- Port tubes & trim
- Spikes & cones
- Damping materials
- Design books
- Custom foam grilles

SPEAKERS -

AUDIO CONCEPTS

CERATEC

DYNAUDIO

ECLIPSE

ENTRÉE

ETON

EMINENCE

FOCAL

MB

MADISOUND

MAGNAT

MOREL

POLYDAX

PEERLESS

SCAN SPEAK

SWAN

VERSA/TRONICS

VIFA

MENISCUS - 2575 28th St. SW #2 - Wyoming, MI 49509
(616) 534-9121 FAX (616) 534-7676

Reader Service #12

42,738

ELECTRONIC COMPONENTS

Whether you order 1 part or all 42,738...MOUSER stocks and...ships same day!!



CALL...
(800) 992-9943
for your
FREE
CATALOG

2401 Hwy. 287 N.
Mansfield, TX 76063

MOUSER® ELECTRONICS

Sales & Stocking Locations Nationwide

Reader Service #30

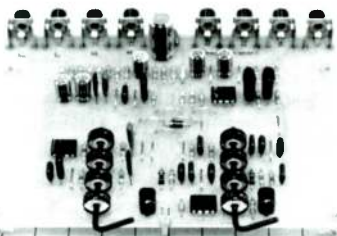

VERSATILE Electronic Crossover Kit

The Decade 1000 offers independently variable low-pass and high-pass frequencies. Separate inputs allow cascading, so the basic 12dB per octave 2-way kits may be used in multiples to create 24dB per octave and 3-way or 4-way systems. Simple mods convert the 1000 into a powerful Bass Equalizer and/or Subwoofer Crossover. 12VDC operation, low current. Gold I/O connectors. Price: \$39.95.

Decade also offers a 2-Digit Voltmeter, Speech Scrambler, Oil Tester, and a 30Wx2 Power Amplifier Kit that connects to the earphone jack on your portable stereo!

MC/VISA accepted. We ship from stock.

Decade Engineering

2302 5th St. NE, Salem, OR 97303-6832
(503) 363-5143 FAX (503) 399-9747

Reader Service #22

the driver). This current can be quite substantial at high power levels: in the order of 1-3A for a loudly played brass choir passage into a 4Ω midrange driver (not necessarily the case in this article).

Capacitors used in impedance-correcting networks for woofers and midrange drivers may also be subject to high audio currents. Those used for tweeter crossover sections have dramatically less current flowing through them, because the energy in that portion of the speech and music spectrum is quite small, and their generally lower capacitance values open up a wider selection of device types.

The big caps, such as the 30μF device used in the article's passive notch filter, are nearly always nonpolarized electrolytics. Audio current of 1-3A through one of these demands selection of a low-ESR (equivalent series resistance) type. Audio frequency current is called "ripple current," and each capacitor design—the manufacturer's part-number series—nearly always has a maximum continuous amount specified in the data sheet. Exceeding the manufacturer's limit repeatedly for long periods will severely damage or destroy the capacitor. Some readers will remember the bad press the early switch-mode power supplies received 20 years ago due to excessive ripple current failures.

Many *SB* readers buy components from Digi-Key in Minneapolis. Glancing at the capacitor section in their catalog is revealing.

A LETTER

Asking

For
Help

Without

A

Self
Addressed
Stamped
Envelope

Goes

HERE!!



Audio Amateur

THE JOURNAL FOR AUDIOPHILE CRAFTS

The innovative, independent
audiophile journal for the thoughtful
and capable music lover

Audio Amateur's articles deal with how audio equipment works, as well as how to build or modify it. Construction and modification articles are plentiful, supplying all needed parts, performance and assembly details. Exceptionally high quality designs.

Audio Amateur offers a number of features in each issue that abound with useful ideas. The *Letters* column is an open forum for problem solving and information interchange; *Classic Circuitry* reprints schematics of state-of-the-art gear—old and new; *Audio Aids* relates readers' experience with simple modifications to equipment and construction techniques. We also feature many useful and practical hi-fi accessories you can build to further your audio enjoyment.

For a small investment you can make your music system sound better—very probably a lot better.

AUDIO AMATEUR

- Two years (8 issues) \$35
 One year (4 issues) \$20

Canada add \$4 per year postage.
Remit in US \$ drawn on a US bank.

NAME _____
STREET & NO _____
CITY _____
STATE _____ ZIP _____
MC OR VISA _____ EXP _____

AUDIO AMATEUR PUBLICATIONS, INC.

PO Box 576, Dept. B93
Peterborough, NH 03458-0576
(603) 924-9464 FAX: (603) 924-9467

Answering machine for credit card orders only:
before 9:00 a.m., after 4:00 p.m. and weekends.
Have all information plus MC/VISA available.

From their Catalog #935, I found that the Panasonic NHE (an axial-lead aluminum electrolytic) is listed as value/volts = 33/25, with maximum ripple current of 1.3A. Although the spec is included for the guidance of switch-mode power supply designers at 100kHz, the 1kHz value is nearly the same.

In a recent loudspeaker design, I needed to use two paralleled sets of back-to-back Panasonic NHEs to provide for the correcting network's longevity with a clear conscience. This speaker system is for high-powered speech reinforcement and will be in a very difficult location to maintain. I don't want to smoke a cap in that application, and I imagine you don't want to smoke one at home, either!

Dick Campbell
WPI/ECE Acoustics Lab
Worcester, MA 01609

DIRECTION FINDER?

I have been looking in past and present issues of *SB* for information dealing with the construction of in-wall speakers. I know this is a less than ideal situation, but since I am doing new construction I thought I might have more control. In any event, could you point me in the right direction with articles or sources for plans? I have heard of using "Great Stuff" foam to create sealed volume between studs/joints, although controlling the exact internal volume must be difficult. Thank you for any assistance you can provide.

Steve Treat
Yarmouth, ME 04096

FOR GOOD MEASURE

When describing the RATE function in Part II of his IMP series (*SB* 2/93, p. 30), Bill Waslo states that the higher sampling rate of 61.44kHz can be used for measuring frequencies above 650Hz. Is this low-frequency limit due to generalized room boundary conditions, or is it a function of the acquisition/FFT routines?

PREVIEW *Audio Amateur*

Issue 3, 1993

- Borbely Power Amp Modules
- High-Quality Headphone Amp
- The Heat's Off
- RIAA Network Limitations

First,
let's talk sound
design



USAP utilizes and distributes



Term™ sound design software.

then let's talk about
our sound line.



USAP features over 25 models of horns, tweeters and woofers.

Call USAP today:
(713) 894-2227

USA Products, Inc., 11802 Cassia Cr.,
Houston, TX 77065 FAX: 713-894-2119

SPEAKERWORKS

YOUR CURE FOR SPEAKER HEADACHES!

- **FACTORY AUTHORIZED SERVICE:** Advent, B•I•C, Cerwin Vega, EPI, Genesis, JBL, & RTR
- **WE RECONE, RESURROUND AND MANUFACTURE**
- **Polypropolene Cones For Reconers** 8", 10", 12" & 15"
- **WE BUY, SELL AND TRADE** MARANTZ, McINTOSH, Tube Equipment
- **Parts & Adhesives**
- **25 Years Audio Experience**
- **We Buy Blown Speakers**
- **Custom Grilles for B•I•C, JBL, Marantz, Altec, & Cerwin Vega** From \$29.95 Each
- **Call Us For Hard To Find Parts**



1-800-526-8879



4931 A-1 South Mingo • Tulsa, Oklahoma • 74146

Crossover Capacitor Bonanza

Madisound has purchased a large surplus lot of non-polar electrolytic capacitors that are perfect for subwoofers and autosound.

- * All units 100 WV, 10% tolerance.
- * Axial with 1.5" leads; radial leads designated by "R".
- * Manufactured by "T" Tecate or "K" KSC.

QTY	MFD	Type	Price
400	1.5	K	10 @ \$1.50
3600	4	K	10 @ \$1.50
370	5.8	TR	10 @ \$2.00
530	25	T	50¢
165	29	TR	50¢
2400	40	K	75¢
1150	75	K	\$1.25
600	100	T	\$1.50
90	110	T	\$1.50
840	125	T	\$1.60
540	225	T	\$2.00
1050	240	T	\$2.25
530	250	T	\$2.25
130	400	T	\$3.00
100	450	T	\$3.00
1050	500	T	\$3.50
3200	600	TR	\$3.50
460	1300	T	\$5.00

All orders shipped by UPS and you are billed the exact UPS charge. We accept Visa, Mastercard and COD cash. Shipped promptly.



Madisound Speaker Components
(8608 University Green)
P.O. Box 44283
Madison, WI 53744-4283 U.S.A.
Voice: 608-831-3433
Fax: 608-831-3771

Reader Service #26

Mahogany Sound

2610 Schillingers Rd. #488
Mobile, AL 36695
(205) 633-2054

TRANSMISSION LINE SPECIALISTS

Q&ETLD

QUICK & EASY TRANSMISSION LINE SPEAKER DESIGN is a new booklet that is a must for TL fans. It offers a step-by-step design procedure that really works. All you need is a calculator with a square root key, and imagination. There is also a computer diskette for use with Lotus 123, and a 6 1/2" 2-way TL project called *The Mini Monolith TL*.

Q&ETLD is \$8.95 postage paid.

ACOUSTA-STUF

ACOUSTA-STUF is absolutely the best sound absorption fiber for transmission lines. You should order one pound per cubic foot of enclosure.

ACOUSTA-STUF costs \$8.95 per pound, UPS paid.

WRITE OR CALL
FOR A FREE CATALOG

Reader Service #9

I'm interested in making off-axis measurements. Intuitively, this does not seem possible using near-field techniques. Of course, I'll have to go outdoors, but this eliminates room-boundary conditions. So it would be nice to make full-range measurements at a single sampling rate.

In addition, I would like to make full-range impedance measurements so I can import the impedance/phase curves into LEAP, which also has a T/S parameter calculation routine. (LEAP uses a frequency dependent motor model to describe a driver's high-frequency impedance rise.) If I can indeed make full-range acoustic measurements with the IMP set to the higher sampling rate, can I also make full-range electrical/impedance measurements?

Bill Waslo deserves a lot of praise for introducing an affordable measurement device, as well as his series of articles, to amateur speaker builders! Many thanks.

Don Vogel
APO AE 09180

Bill Waslo responds:

Actually, the implied low-frequency limit is due to imprecise writing on my part. What I meant to get across was that the lower sample rate of 1.92kHz could not be used for measuring frequencies above 650Hz. Above that, the higher sample rate must be used; however, this rate can be used to measure down to 30Hz or so, provided the largest sample SIZE is used and the data is not truncated to remove echoes.

The upper and lower limits of the frequency range over which measurements can be made are determined by the sample rate and the sampling duration, respectively. One-half of the sample rate, known as the Nyquist frequency, represents an absolute limit to the highest measurable baseband frequency. Assuming a perfect brick-wall antialiasing filter was wired ahead of an analog-to-digital (A/D) sampling at 61.4kHz, the highest frequency you would have any chance of measuring would be 30.7kHz. Less than ideal real-world filters reduce this upper limit to something less than half the sampling frequency. IMP reports results only up to approximately one-third the sample rate, or about 21kHz for the higher sample rate.

IMP can collect up to 4,095 samples. At the upper sample rate of 61.4kHz, each sample represents 1/61,400 seconds; 4,095 of them amounts to a duration of 4,095/61,400 = 0.0667 seconds. The lowest frequency about which any data could possibly be valid will then be 1/0.0667 = 15Hz (one cycle of 15Hz energy is 66.7ms long). The measurement resolution will

SALE! PLUS FREE ADHESIVE!

MARKERFOAM™ ACOUSTIC FOAM GIANT 54" x 54"
Immediate Shipping

2" Reg. \$29.95 Now \$19.99 • 3" Reg. \$39.95 Now \$29.99! KILL NOISE QUICK!
High performance, full-size sheets of super high density Markerfoam. EZ mount. Blue or gray. Super-effective sound absorption for studios. Markerfoam offers best value, looks professional & is proven in studios worldwide. Request Foam-Buyers Guide/Catalog, specs & free samples today. VISA, MC, AMEX, COD, PO's, QUANTITY DISCOUNTS.

MARKERTEK JUMBO SOUND ABSORB BLANKETS
Heavy-duty 72" x 80" padded blankets absorb sound wherever they're hung or draped. Fabulous for stage, studio & field use. Top professional quality at a super saver price! Weight: 6 lbs. Black, \$19.99.

MARKERTEK BLADE TILES™

HIGH PERFORMANCE
LOW, LOW COST!
\$3.49 per tile, 16x16x2". America's best acoustic tile value, only from Markertek! Charcoal. Also available 16x16x3" as shown, \$4.49 each.
MARKERSTIK™ foam adhesive. FREE with any Foam purchase in this ad! Limited offer. A \$5.95 per tube value.

SONEX
All the colors and sizes plus great prices!

Get our FREE 149-page catalog of over 6,000 exclusive and hard-to-find supplies for audio & video.

800-522-2025 America's most unique
FAX: 914-246-1757 catalog for audio & video!

MARKERTEK™
4 High St., Saugerties
New York 12477 U.S.A. VIDEO SUPPLY

Reader Service #10

FOR THE CONSTRUCTOR

Ideal for desktop devices that require easily accessible controls, meters, switches, etc.

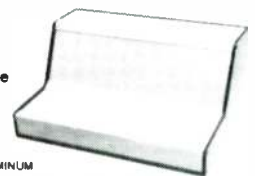

PANELS ARE .063" ALUMINUM

MODEL	DESCRIPTION	PRICE \$
DS-1	4 x 6 x 4 x 1.2 x 1.9 x 2.4 x 1.6	59.00
DS-2	6 x 6 x 4 x 1.2 x 1.9 x 2.4 x 1.6	65.25
DS-3	8 x 6 x 4 x 1.2 x 1.9 x 2.4 x 1.6	67.50
DS-4	10 x 6 x 4 x 1.2 x 1.9 x 2.4 x 1.6	71.50
DS-5	12 x 6 x 4 x 1.2 x 1.9 x 2.4 x 1.6	76.00
DS-6	18 x 6 x 4 x 1.2 x 1.9 x 2.4 x 1.6	81.00
DS-7	4 x 8 x 6 x 2 x 3.1 x 3.5 x 1.9	69.00
DS-8	6 x 8 x 6 x 2 x 3.1 x 3.5 x 1.9	73.00
DS-9	8 x 8 x 6 x 2 x 3.1 x 3.5 x 1.9	78.00
DS-10	10 x 8 x 6 x 2 x 3.1 x 3.5 x 1.9	82.75
DS-11	12 x 8 x 6 x 2 x 3.1 x 3.5 x 1.9	87.75
DS-12	18 x 8 x 6 x 2 x 3.1 x 3.5 x 1.9	100.75

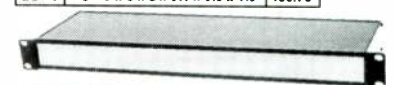

PANELS ARE .063" ALUMINUM

MODEL	DESCRIPTION	PRICE \$
1RU5	19 x 5 x 1.75	30.85
1RU7	19 x 7 x 1.75	33.10
1RU10	19 x 10 x 1.75	35.25
2RU5	19 x 5 x 3.5	33.10
2RU7	19 x 7 x 3.5	35.25
2RU10	19 x 10 x 3.5	37.50
3RU5	19 x 5 x 5.25	41.90
3RU7	19 x 7 x 5.25	44.10
3RU10	19 x 10 x 5.25	46.30

SEBCOM ALSO STOCKS HEAVY DUTY RACK CHASSIS, METAL CABINETS, EXTRUDED BOXES AND MORE! CALL OR WRITE FOR YOUR FREE 24 PAGE CATALOG



USA AND CANADA ORDERS (800) 834-3457
SEBCOM, INC., 2100 WARD DRIVE
HENDERSON, NEVADA 89015 USA
TECHNICAL HELP (702) 565-3400
FAX (702) 565-4828
VISA AND MC ORDERS SHIPPED GROUND AT NO CHARGE. (48 STATES)

Reader Service #23

also be 15Hz (i.e., you will get data output at frequency points spaced 15Hz apart).

It would be best not to trust the first point; after all, IMP only got to look at a single cycle of it. So the lower frequency limit for the higher rate is 30Hz. Similar calculations can be performed using the lower sample rate of 1.92kHz, yielding data results below 1Hz and resolution below 1/2Hz. Due to capacitive coupling in the IMP analog sections, the lowest frequency reported is 2Hz. These results hold for acoustic, electrical, or impedance measurements.

In most cases, IMP will attempt to suppress plotting data about which it can have no knowledge. You may have noticed that frequency response and waterfall plots generally have no data plotted below certain frequencies. IMP performs the FFT only on real data between the time markers, so the time duration between those markers represents a hard limit on the lower frequency about which the derived frequency response can have any meaning. IMP reports no data below this frequency. On the waterfall plots, the time span which is transformed is shortened on each successive trace; hence the left edge of the trace will often advance forward as the waterfall plot progresses.

Concerning the making of off-axis measurements, I agree that near-field techniques do not seem appropriate, but you shouldn't have to go outdoors. You can make the off-axis measurements just like the on-axis ones, removing the echoes digitally. I do this by simply rotating the speaker and keeping the microphone fixed. Off-axis measurements at low frequencies will not likely yield much in the way of results. The bass is pretty much

If you should have a **TECHNICAL QUERY...**

about an article appearing in this magazine, write it clearly, leaving space for a reply and referencing the magazine, the article and the page about which you are inquiring. Enclose a self-addressed stamped envelope and send these to **Speaker Builder, PO Box 494, Peterborough, NH 03458.**

If it's warranted, we will forward your query to the author or a Contributing Editor for a prompt reply.

Help us by not calling in your question. We have neither the staff nor the time to respond to technical questions by phone.

WE HAVE GONE FAR TO HAVE them HERE...

90 of EUROPE'S FINEST KITS



The most ingenious designs from European speaker kit builders, now available here. Order our special **EUROPEAN KIT BROCHURE**, featuring **90** fully detailed drawings and specifications for only **\$6!** Exclusively available from:

SOLEN Électronique Inc.
phone (514) 656 - 2759
fax (514) 443 - 4949

4470 Thibault Ave.
St. Hubert, QC J3Y 7T9
Canada

Reader Service #25



Your Vital Statistics Are Special to Us!

While changing our subscription management software, we changed from **MAGIC** numbers to the present **ACCOUNT** numbers.

This number applies to all of your subscriptions and any back issue orders you may place. Your number looks like this:

A0123450

This **ACCOUNT** number will always have an **A** at the beginning and a **0** at the end. The six digits in between tell us just who you are.

In speaking with our customer service staff, your **ACCOUNT** number can give them quick access to your computer file. Including it with a back issue order will speed the processing of your order to the shipping department.

You'll find your **ACCOUNT** number located on the upper left-hand corner of your mailing label on your magazine. It will also appear in the upper right-hand corner of any bills or renewal notices we send to you.



MOTOROLA Ceramic Products



Have you ever wondered how so many companies successfully use Motorola piezo speakers?

Call TODAY for your **FREE** engineering book on "How To Use A Piezo." Ask for Melisa on (505) 822-8801, ext. 213.

Reader Service #37

VALVES/TUBES FROM WEST EUROPE

Please note supplies to dealers, manufactures and distributors only—minimum export order £200GBP/\$350 USD. Minimum UK order £50 plus VAT.

- LIMITED STOCKS OF WEST EUROPEAN MADE 6L6GC, 12AT7, 12AU7, 12AX7, 211 GE, ECC81, ECC82, ECC83, EL34, EL84, KT66, KT88, VT4C by GEC, Mullard, Brimar, Tungstam etc. We probably have the largest stocks of West European manufactured valves in the world.
- Low cost, large volumes available from Russia/East European factories.
- One million valves/tubes in stock including cathode ray tubes, tube sockets etc.
- 3AMP1A C.R.T. (for Marantz tuner) \$36 USD each. 200 in stock. Discount for quantity.

Send today for our updated audio valve catalogue.

Billington Export Ltd.

1E Gilmans Industrial Estate, Billingshurst, Sussex RH14 9EZ, U.K.

**CALLERS STRICTLY BY
APPOINTMENT ONLY.**
FAX: 0403 783519,
Telex 923492—TRAG
TEL 0403 784961

Reader Service #35

omnidirectional; it's difficult for a speaker with a maximum dimension of about 4' to have significant directional affect on a 100Hz wave which is 11' long.

Regarding full-range impedance measurements: you can make them, but the 15Hz resolution obtainable with the higher sample rate won't give LEAP's routines much to work with. A better solution might be to combine data from two impedance measurements of the same device, one run at a low sample rate (for resolution at the low end) and one at the higher rate. This could be done via a spreadsheet program, or perhaps a simple utility could be written in Basic to perform the function. I'm not familiar with the format LEAP requires, so you will have to check your documentation to see whether or not this is practical.

Thanks for your kind words regarding my IMP project. I'm glad you find it useful, and I hope it leads to some novel designs.

INCONTESTABLE FACTOR

I have some comments to offer on the Galo/Crawford exchange concerning damping factor, as it appeared in SB 6/92 ("Damping Factor Dialog," p. 46). I believe that speculations on the affect of damping factor on driver behavior are a holdover from vacuum tube days, before Thiele/Small developed a rational approach to the design of loudspeaker systems' bass performance. For example, if a woofer system is designed following T/S procedures, the effects of various resistances (amplifier source, interconnection cable, and passive crossover components) will all have been recognized in the calculation of the electrical Q.

In "Thiele, Small, and Vented Loudspeaker Design" (SB 4/80, p. 7), Robert Bullock describes exactly how to arrive at an effective electrical Q. He also quotes Thiele as stating that response variations will not exceed 0.4dB if the driver electrical Q is used without correction, provided the sum of the amplifier source resistance and other series resistive elements are less than 5% of the nominal driver impedance.

In Mr. Galo's example, he used 16 AWG wire to connect the speaker to the amplifier and was shocked to note that the effective damping factor dropped from 400 to 56. Thiele's rule, however, would permit the sum of the amplifier source and interconnection resistances to be 0.4Ω, which would result in an effective damping factor as low as 20!

Do not interpret from the above discussion that I think amplifiers with low damping factors are OK. On the contrary, it is obvious they should be high, in order that the effective

CANADIAN SPEAKER BUILDERS

Free Speaker and Accessories Catalog. Call or Write Today.

polydax EMINENCE

FOTAL MOTOROLA

PHILIPS PIONEER

... PLUS MANY OTHERS

Q COMPONENTS
DIRECT MAIL ORDER

638 COLBY DR., WATERLOO,
ONT. N2V 1A2

PHONE: (519) 884 - 1140

CANADA ONLY PLEASE.

Reader Service #2

A WORD TO THE WISE .



Your input is important to us!

Here are some tips to ensure you get the attention you deserve:

- Include a self-addressed envelope with a loose stamp (or postal coupons if you live overseas) whenever you have a question you would like answered.
- If you would like us to forward a letter to an author, an envelope with a stamp clipped to it will help it reach its destination.
- Don't be misunderstood--a type-written letter helps cut down on errors.
- Identify yourself! Always provide us with your full name and address.
- Give us the goods on that author. We want to know who wrote the article you have so many questions/comments about. (In fact, the more information you can give us about the article, the more it helps us.)

Don't forget to write!

damping remains high even after all of the intervening resistances have been added.

An amplifier should have a high damping factor (i.e., low internal resistance) for yet another reason: it must drive speaker systems whose impedance varies widely as a function of frequency—often over a five-to-one range. While doing so, it must maintain a flat frequency response. To do this, it must have a constant voltage source, which implies that its internal resistance is very low. For the unfortunate affect on frequency response of a low-damping-factor amplifier driving a speaker, see the January 1991 issue of *Stereophile* (p. 231).

David J. Meraner
Scotia, NY 12302

on the cabinet and one on the wall, it is very secure. By also routing a recess in the back of the cabinet, you can achieve a very tight fit to the wall (*Photo 3*).

These units sound great. I mated them with two 2 ft.³, 12" subwoofers, crossed over at 180Hz. As I had hoped, the tweeter's heightened response overcomes the added midbass caused by the corner placement. Even at low-level listening, the treble is crisp and clear. With the system hooked up to the TV, voice reproduction is very natural (*Photo 4*). In fact, it sounds so good that I never watch TV without running it through the stereo. MTS stereo and Dolby surround have turned me into a video freak—but that's the subject of another article.

other experiences of the 1980s. The early aircraft business is examined along with the electronic kits which built Heath's reputation among my generation. "Miscellany" covers a wide territory, including product development, business practices, fabrication, marketing and speculation on Heath's future. Some contributions are serious, others humorous. Heath seems to have had more than its share of characters and practical jokers.

While touching on most of Heath's product lines, the recollections seem to emphasize test equipment and radio amateur gear. Perhaps this reflects the author's amateur radio background. I'd have liked greater coverage of audio equipment.

Before receiving the review copy, I expected a history book. After realizing that reality didn't match expectations, I sat back and enjoyed *Heath Nostalgia* for what it is. The title was aptly chosen.

The golden age of electronic kit building is gone. In the past, Heath shifted its product emphasis to meet the challenge of change. Let's hope present management has the wisdom to provide and support useful products desired by customers. In the meantime, we'll have our memories and a collection of still-functioning gear we assembled ourselves.

Satellites

continued from page 28

hurting the high end (*Fig. 4*). I also tried a zobel to flatten the woofers' response. The schematic does not contain a misprint—I accidentally wired up the zobel incorrectly and found that it improved the response. Don't ask me why, but it works.

A simple and cheap way to hang the units is with angled carpet edging. With one piece

Book Report

continued from page 64

The largest section of the book, "Memory Miscellany," is a collection of remembrances from over a dozen contributors spanning the period from Howard Anthony's teenage foray into the radio business to the HERO 1 robot's exploits passing through airport security and

IT'S A CLEARANCE SALE!

Although we stopped publishing Elektor Electronics USA in November 1992, we still have a limited number of back issues available. We're happy to offer those issues to you at a reduced price to move them out of storage and into the hands of electronics projects lovers like yourself!

We're so sure you'll want to take advantage of this special offer that we've sweetened the deal.

Buy any 11 issues of *Elektor Electronics, USA* (that's the equivalent of a year's worth of issues) AND

YOU'LL RECEIVE AN ATTRACTIVE VINYL BINDER ABSOLUTELY FREE!

That's right, your issues will come to you bound in an emerald green leather-look binder (a \$9.95 value!)

Here are some of the projects contained in these issues:

- "AM/FM Tuner", April 1992
- "A Mini Subwoofer", November/December 1990
- "A Class A Power Amplifier", November/December 1991
- "Digital Phase Meter", June 1991
- "Audio Video Processor", May/June/July, 1992

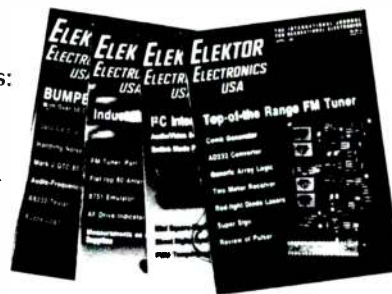

All the issues from October 1990 through November 1992 are still available with the exception of the February 1991 issue which is already sold out. Act today so you won't miss a single project! *These issues are priced to sell and with the free binder offer, the whole deal is just too good to miss!*

- Elektor Electronics USA Single issues \$3.00
- Elektor Electronics USA Double issues July/August or December \$5.00

These prices include postage to US addresses. Canada please add \$1.00 per issue. Overseas add \$2.00 per issue.

Audio Amateur Publications, Inc. P.O. Box 576, 305 Union Street, Peterborough, NH 03458-0576

Classified

TRADE

ACT AUDIO GIVES GOOD SOUND! Computer analysis of your listening room. Send SASE for details. **ACT AUDIO**, 619 Moon Clinton Rd., Coraopolis, PA 15108. T4/94

PYLE DRIVERS! We are your prime source for the over a hundred current models of PYLE woofers, tweeters, midranges, and musical instrument speakers. Price list on request. VISA/MC accepted. Dealer inquiries? **SPEAKER SHOP**, 318 South Wahsatch, Colorado Springs, CO 80903, (719) 475-2545. T6/93

HAFLEER HEADQUARTERS IN PENNSYLVANIA! Featuring the highly-rated TransNova Power Amplifiers (*Stereophile* Class B), new FET preamplifiers; professional power amps with balanced inputs. Free shipping. Call or write. **AUDIO ARTS**, RD 2, Wernersville, PA 19565, (215) 693-6740. T3/94

ELECTROSTATIC parts, supplies, exotic circuits. Free catalog. **DAVID LUCAS, INC.**, 924 Hulton Rd., Oakmont, PA 15139, (412) 828-1967, FAX (412) 828-0422. T6/93

JBL: 2405 tweeters & 3106 8kHz crossover pair, \$450; 2311 2" horn, \$40/pr.; 2404 H 1" driver, \$299/pr. **RICK**, (503) 228-2222. T6/93

Premium Parts & Accessories

The largest selection of audiophile capacitors, resistors, connectors, chassis wires in North America. MIT MultiCaps, Wonder Caps-solder-wire, SCR, Solen cap, Rel-Cap: Vishay, Holco, Caddock, Mills, Resista resistors: MIT, CARDAS, KIMBER, & silver chassis wires, custom cables & terminations: all types of audio connectors and adaptors: silver contact toggle, rotary switches & stepped attenuator kits. PMI BUF-03's (kit too!). Hubbell hospital grade plugs & outlets. Tubes, feet, damping sheets & compounds, tools and many accessories. Extensive inventory - no delays, good prices and good service! Phone (415) 669-7181 or fax 669-7558 for a catalog. **Michael Percy, Box 526, Inverness, CA 94937**

CONTROL CABINET VIBRATIONS AT THE SOURCE: specially designed high-density speaker gasket material that is D-E-A-D. Stays resilient, adhesive backed. One roll 1 1/16" x 1 1/2" x 100', \$48.00 **MEADOWLARK AUDIO**, (619) 598-3763. T6/93

MONARCHY DAC, \$695 w/bal out, level 1 MOD, \$259 (\$159 kit); Digital cable, \$75; 2-way monitor w/accuton tweeter, \$1,795 (\$1,195 kit); **Room Acoustics Handbook**, \$14.95, **MACH 1 ACOUSTICS**, RR2 Box 334A, Wilton, NH 03086, (603) 654-9826. T1/94

ACT AUDIO COMPUTER SYSTEMS. Custom configurations for your design needs. Lowest Prices. Ship anywhere in USA. Send your wish list, we send quote. **ACT AUDIO COMPUTER SYSTEMS**, 619 Moon Clinton Rd., Coraopolis, PA 15108, FAX (412) 264-0677. T4/94

AUDIO CABLES & MORE! Don't pay exorbitant prices for top quality. We have years of experience in wire manufacturing & have equalled the high-priced brands. High-priced equivalents as low as .74/ft. We demystify wire technology. Send for explanation literature which also includes all our Audio Products price list or call our Literature Request # (800) 321-2108, 24 hours/day. FAX (609) 428-1832. **L A T INTERNATIONAL**, Dept. B, 317 Provincetown Rd., Cherry Hill, NJ 08034. Dealer inquiries invited. T6/93

MYLAR FILM 1/2 mil, genuine DuPont, 48" wide, \$1 per running foot; also ESL transformers. **ROGER SANDERS**, R1, Box 125, Halfway, OR 97834, (503) 742-7640. T1/94

SPEAKER BUILDER CLASSIFIED ORDER FORM

PLEASE PRINT IN CLEAR BLOCK LETTERS OR TYPE. SPELL OUT EACH WORD. NO ABBREVIATIONS.

1	2	3	4	5	6	7	8	9	10
11	12	13	14	15	16	17	18	19	20
21	22	23	24	25	26	27	28	29	30
31	32	33	34	35	36	37	38	39	40
41	42	42	44	45	46	47	48	49	50

For Sale

Wanted

Trade, indicate number of insertions _____

For Sale ads are to sell personal equipment or supplies. **Wanted** ads are to find supplies, equipment or services. Both are "not for profit" ads and will only run once unless they are resubmitted. **Trade** ads are for any business or private party selling something for a profit.

Ad copy: A word is any collection of letters or numbers with a space on either side. **Illegible ads will be discarded.**

Price: All ads are \$1.00 per word. Deduct 5% on a 6X contract for **Trade** ads. Ten dollar minimum per insertion. **Payment must accompany ad. No billing.**

Subscribers receive **free For sale and Wanted** ads up to 50 words; .20 each additional word. Only one ad per category, per issue.

Please include your name, address and telephone number.

Please charge to my MasterCard/Visa:

CARD NUMBER _____ EXP. DATE _____

Check/Money Order Enclosed

Subscription Account Number: A

NAME _____

COMPANY _____

STREET & NO _____

CITY _____ ST _____ ZIP _____

PHONE _____

FOR SALE

Polypropylene caps, 4MFD 200V Rel-Cap, \$7/10; 6MFD 200V Rel-Cap, \$12.50/10; 8MFD 200V Ultra-Cap, \$15/10. Choke, 4.75mH, \$1.50/ea. Resistors, 15Ω, 225W dummy load, \$3.95/ea., plus shipping. SASE for list of other items. Steve Slater, 3045 Orange Ave., LaCrescenta, CA 91214, (818) 248-0416. T1/94

Dahlquist DQ-10i's, \$1,000/pr. or best offer. Pick up in Savannah. Polk 5jr+, \$175/pr. or best offer. JBL SE 460 power amp, \$75. Ron Meyer, 1508 Cedar Grove Plantation Dr., Savannah, GA 31419, (912) 925-2311.

7N-313 Mids, \$75/pr.; 5N313 Mids, \$60/pr.; Powerar 3-stage toroidal power conditioner common mode pi-filter, 120V AC, 13A, 5³/₄ × 9⁵/₈ × 13¹/₂, 39# \$125. Jim, (708) 425-6719.



The exciting, illustrated review magazine of classical music recordings and high-fi gear.

Guaranteed you're gonna like it!

2nd Anniversary Special:
Six issues \$15 Remit CD Digest.
Box 192, Ringwood, NJ 07456

Sorry, no credit cards this offer.

Magnaplanar Tympani 1-D \$699/pr.; Sony HFP-200 Beta Hi-Fi Processor (MTS), \$125; Sony MDP-200 (as is, plays intermittently, with remote), \$199; Audio Concepts Cadwell oak Strathearn speakers, \$999/pr. I rebuild Strathearns \$100/ea. Michael Marks, 2334 Morgan Lane, Dunn Loring, VA 22027, (703) 641-5824.

TAD 1601, \$300/pr.; very fine ARC LS-1, \$875 & CLASSIC 30, \$1,400; original Fisher 400-T receiver, superb FM & audio, recent service, \$200; Goldline 1/3 Octave RTA & calibrated microphone, \$950; NAK BX-300, \$400; Sony D-3, \$75. Steve, (203) 397-3888.

ULTIMATE STEREO MICROPHONES

Micro-sized head-worn DSM stereo microphones are perfect for 3-dimensional live sound recording!

DAT POCKET BATTERY™!

Sealed Lead-Acid design. Dependable! Compact! Reg. #229.

NOW ONLY \$199.!

Sonic Studios
138 Soup Creek, Reedsport, OR 97467
CALL: 503-599-2217



Car stereo components: HiFonics Vulcan 100 WRMS Power Amplifier (audiophile specs), like new, half price \$135; Boston Acoustics 797 6x9 3-way speakers, new in box with grilles and hardware, \$135/pr., (\$220 cost). Fred, (215) 693-6167.

Acoustat Spectra 2200, 3300, excellent condition, \$1,200, \$1,500, shipping not included. Two Dynaudio 30W100 frames (need reconing), \$75. Steve Burgess, 755 University Village, Salt Lake City, UT 84108, (801) 581-9414.

OVERSEAS FRIENDS

Due to the limitations of our Reader Service program, we are unable to process requests for information from our overseas subscribers.

HOWEVER, our advertisers would certainly like to hear from you directly via mail, phone, or FAX. Please don't hesitate to contact them for the products/information you are interested in.

Morel PP-8 dual woofer, \$100; Sequerra HF-1 with extra ribbons, \$375; Gold Ribbon Concepts 3.1, \$400; EPI LS-841 car system, \$125; Electro-Voice CP-X 2-way crossover, \$175, D28AF 2/\$75; Swan/ARIA5 with C2-11, \$450. Ron, (201) 543-2971.

Drivers: two Accuton C211, \$275/pr.; six Audax TX2025RSN, \$70/pr.; six SEAS CB17RCY, \$60/pr.; three SEAS CA 21REX, \$70/pr.; four Dynaudio 15W75, \$170/pr.; assorted Focal tweeters and more! All parts mint. Pyramid speaker cabinets for 5" & 7" Dynaudio woofers, \$75/ea. Call (415) 665-0899 before 10 p.m. PST.

Pair Accuton C222, \$190; B&K EX-442 amplifier, latest model, \$690; Rane ME60 1/3 octave stereo equalizer, \$450; two Marchand XM-9 crossovers with power supply, \$130; two JBL 2235H, \$325/pr. All equipment is "as new" and I will pay shipping. Jerry, (601) 264-6971.

Highly modified Audio Concepts speakers, all Dynaudio, 21W54MRS, D52, D28, Multi-enclosure, minimum baffle enclosure cabinets, poly crossover, Audioquest wire. Must pick-up Western Mass., Northern Conn. area. Sacrifice \$350/pr. Call Jack, (413) 525-1678.

STATEMENT OF OWNERSHIP, MANAGEMENT AND CIRCULATION.

(Required by U.S.C. 3685.) Date of Filing, Sept. 30, 1993. Title of Publication: SPEAKER BUILDER. Frequency of issue: Bi-monthly.

Annual subscription price \$25. Location of the headquarters or general business offices of the publishers: 305 Union St., Peterborough, NH 03458-0576. President/Publisher: Edward T. Dell, Jr., PO Box 494, Peterborough, NH 03458-0494; Managing Editor: Mary Wagner. Owner: Audio Amateur Publications, Inc., PO Box 494, Peterborough, NH 03458-0494. Known bondholders, mortgagees, and other security holders owning 1 percent or more of total amount of bonds, mortgages or other securities: None.

	Average # copies each issue during preceding 12 months	Single issue nearest to filing date
Total # copies printed	14,333	14,000
Newsdealer sales	271	437
Mail subscriptions	10,605	10,665
Total paid circulation	10,876	11,102
Free distribution complimentary	167	162
Total distribution	11,043	11,264
Office use, leftover	3,290	2,736
Return from news agents	0	0
Total	14,333	14,000

I certify that the statements made by me above are correct and complete.

Publication No. 01997920

Edward T. Dell, Jr.,
President/Publisher

"IF YOU'RE NOT USING
TERM-PRO™
...GET SERIOUS!"



TERM-1: \$199
TERM-PRO: \$399

Shipping \$3 USA, \$5 other surface, \$10 other air

ENCLOSURE DESIGN

Enables you to design 20 different types of enclosures including: Sealed, Ported, Isobarik, Single Reflex Bandpass, Dual Reflex Bandpass and many more!

PASSIVE CROSSOVER DESIGN

Design Highpass, Bandpass, Lowpass, and Notch networks with just a few simple keystrokes!

PORT DESIGN

Design ports with a user-specified Diameter, Length, or Area. Our unique Port Velocity Bargraph will alert you to potentially noisy ports at a glance!

ENCLOSURE LAYOUT

Enclosure Layout for Rectangular, Wedge, and Bandpass enclosures—including dimensions and an animated 3-D scale representation of the design.

POWERFUL DATABASE FEATURES

The included driver library contains more than 600 of the most popular drivers available. You may add, edit and delete drivers at any time!

FURTHER INFORMATION AVAILABLE
ON REQUEST!

AVAILABLE FROM

Old Colony Sound Lab

PO Box 243, Dept. B93
Peterborough, NH 03458-0243 USA
Tel. (603) 924-6371, (603) 924-6526
FAX (603) 924-9467

BOXES & BINDERS

FOR YOUR TECHNICAL LIBRARY

THE BINDER

A "loose wire," heavy book binder cloth construction case holds twelve issues of your magazines in a readily accessible format. The metallic logo is hot stamped on the cover and spine.



\$9.95
EACH

THE BOX

Library quality boxes. 4 1/4 x 9 1/4 x 12" high, brown woodgrain, folding corrugated boxes with label to identify contents. Holds 12 issues of *Audio Amateur*, *Speaker Builder*, *Elektor Electronics USA*, *Glass Audio*, or other valuable magazines in your technical library. Each order supplied with pre-printed labels for each magazine.



\$3.95
EACH

QTY. _____

PRICE _____

Binders @ \$9.95 for _____

TAA SB GA EEUSA

Boxes @ \$3.95 _____

SHIPPING _____

TOTAL _____

SHIPPING INFORMATION

Order Value	UNITED STATES		CANADA		OTHER	
	Surface	Air	Surface	Air	Surface	Air
<\$50.00	3.00	7.50	5.00	7.50	10.00	20.00
\$50.00-99.99	4.00	15.00	7.50	15.00	20.00	30.00
\$100.00-199.99	5.00	20.00	15.00	20.00	30.00	40.00
>\$200.00	6.00	30.00	25.00	30.00	40.00	50.00

MC

VISA

CK/MO

NAME _____

STREET _____

CITY _____

ST _____

ZIP _____

MC/VISA

EXP _____

Old Colony Sound Lab

PO Box 243, Dept. B93

Peterborough, NH 03458-0243

Phone (603) 924-6371 FAX (603) 924-9467

Audio Teknology LMS (Loudspeaker Measurement System) \$750. Manny (415) 332-4861.

Acoustic Research - three enclosures, two woofers OK, Mids blown, 1 tweeter blown, 1 grille missing; two Wharfedale 12 speakers - two Audio Dynamics 450A speakers, BO or trades. John (410) 636-1951.

Matching pair of vintage KEF speakers Model K-2 Celeste MK II's, made in England, sold by Radio People Ltd., Kowloon Hong Kong with serial numbers, size: 6 1/2 x 18 x 11. These are rare collector units in excellent condition. They sound fine, they are clean and in good shape. \$225, (305) 931-7131.

SpeakerLab K-Horn bass section with Marchand Electronic crossover, \$550/pr. (San Francisco Bay area only) Eminence 15" woofer aluminum die cast frame, \$100/pr. All in excellent like new condition. You pay shipping. Jim Pann, 3245 South Ridge Dr., Richmond, CA 94806, (510) 223-6986. Leave message.

WANTED

Bogen M-100A; Eico HF-22; Fisher 70A; Fisher 70AZ; Eico HF-20; Fisher 90C; Ampec 350 tape preamp; McIntosh C-104; Lafayette LA-70. Old theatre amps, equipment, output transformers. Dennis Boyle, (214) 428-3901.

One each: Jensen P15LL for reconing, University C15W, H-600 with T-30 driver and 4401 with mid-T driver. Dave Faulds, 1136 Kirkwall Dr., Akron, OH 44321, (216) 666-6805.

Any information for 10" Becker poly drivers, 910A208, 2481440. Don Wallace, 1904 Papeete Dr., Plano, TX 75075, (214) 812-2804.

STATE OF THE ART CROSSOVER NETWORKS 100% PASSIVE DESIGNS

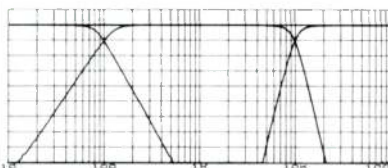

AUDIOPHILE QUALITY CROSSOVER COMPONENTS
* CALL OR WRITE FOR FREE DESIGN GUIDE *
ALL-PASS TECHNOLOGIES Inc.
P.O. BOX 453 AMITYVILLE, N.Y. 11701
PHONE : (516) 598-1320

CLUBS

PRO-SOUND HOBBYISTS, or current employees in sound reinforcement field to correspond with USAF serviceman in England. Looking for equipment sources and contact with anyone who has a passion for quality reproduction of live music. Rick Diaz, PSC 41, Box 6912, APO AE, 09464.

MEMPHIS AREA AUDIO SOCIETY being formed. Serious audiophiles contact J.J. McBride, 8182 Wind Valley Cove, Memphis, TN 38125, (901) 756-6831.

CLASSIFIED



INFORMATION

Four types of Classified Advertising are available in *Speaker Builder*:

FOR SALE: For readers to sell personal equipment or supplies.

WANTED: Help readers find equipment or services.

TRADE: For any business or private party selling equipment, supplies or services for profit.

CLUBS: Aid readers in starting a club or finding new members. Specific guidelines apply to *Club* advertising. Please write to the Ad Department for terms. Don't forget, include a #10 self-addressed stamped envelope.

PRICING

All advertising is \$1.00 per word, \$10 minimum per insertion. Deduct 5% for a 4x contract. Please indicate number of insertions. Payment **MUST** accompany ad. *No billing for word classified advertising.*

AD COPY

A word is any collection of letters or numbers with a space on either side. *No abbreviations*; please spell out all words. Count words, not letters. Ad copy should be clearly typed or printed. Illegible ads will be discarded.

SUBSCRIBERS

Receive *free For Sale, Wanted, and Club* advertising; 50 words maximum; each additional word just \$.20. Please only one ad per category, per issue.

Please include your name, address, and telephone number. If **TRADE** please indicate number of insertions on the ad. All free ads are run only once, then discarded. Ad questions, copy and copy changes cannot and will not be answered on the phone. All correspondence must be in writing addressed to:

Speaker Builder

Classified Department

PO Box 494

Peterborough, NH 03458-0494

THOSE INTERESTED IN AUDIO and speaker building in the Knoxville-East Tennessee area please contact Bob Wright, 7344 Toxaway Dr., Knoxville, TN 37909-2452, (615) 691-1668 after 6 p.m.

AUDIOPHILES IN THE DAYTON/SPRINGFIELD, OHIO AREA: We are forming an audio club. Please contact me if you're interested in construction, modifications, testing, recording or just plain listening to music. Ken Beers, 1756 Hilt Rd., Yellow Springs, OH 45387, (513) 767-1457.

ARIZONA AUDIOPHILE SOCIETY Located in Metropolitan Phoenix is a growing and active club in the pursuit and reproduction of recorded music. New members are welcome. Meetings are last Tuesday of each month. Receive monthly newsletter and bi-annual journal. Club discounts with local high-end audio dealers. Send inquiry to Arizona Audiophile Society, PO Box 13058, Scottsdale, AZ 85267, or call Bob Williams, (602) 944-5929.

AUDIO SOCIETY OF MINNESOTA Now in its 15th consecutive year! Serving the many and varied interests of audiophiles in the upper mid-west. Monthly meetings, tours, audiophile concerts, special guests. For information and a sample of our latest newsletter, write ASM, PO Box 32293, Fridley, MN 55432 or call our 24 hour "Audio Hotline," (612) 825-6806.

WASHINGTON AREA AUDIO SOCIETY Meetings are held every two weeks, on Fridays from 19:00 hours to 21:30 hours at the Charles Barrett Elementary School in the city of Alexandria, Va. Prospective members are welcome but must register in advance in order to be admitted to the meetings. No exceptions please. If interested please call Horace Vignale, (703) 578-4929.

THE CATSKILL AND ADIRONDACK AUDIO SOCIETY invites you to our informal meeting. Join our friendly group of audio enthusiasts as we discuss life, the universe and everything! Tubers, Transistors, vinyl canyons or digital dots. No matter what your level of interest, experience, or preferences, you are welcome. Contact CAAS at (518) 756-9894 (leave message), or write CAAS, PO Box 144, Hannacroix, NY 12087. See you soon!

(616) 534-9121

MENISCUS

HIGH FIDELITY SPEAKER COMPONENTS

DYNAUDIO MOREL FOCAL ECLIPSE
2575 28th St., S.W., Unit 2, Wyoming, MI 49509

CONNECTICUT AUDIO SOCIETY is an active and growing club with activities covering many facets of audio—including construction, subjective testing, and tours of local manufacturers. New members are always welcome. For a copy of our current newsletter and an invitation to our next meeting, write to: Richard Thompson, 129 Newgate Rd., E. Granby, CT 06026, (203) 653-7873.

PACIFICNORTHWEST AUDIO SOCIETY (PAS) consists of 60 audio enthusiasts meeting monthly, second Wednesdays, 7:30 - 9:30 p.m. at 4545 Island Crest Way, Mercer Island, WA. Be our guest, write Box 435, Mercer Island, WA 98040 or call Bob McDonald, (206) 232-8130 or Nick Daniggelis, (206) 323-6196.

ELECTROSTATIC LOUDSPEAKER USERS GROUP is now a world-wide network for those interested in sharing valuable theory, design, construction, and parts source information. If you are interested in building, or have built, your own SOTA ESL we invite you to join our loose-knit organization. For information, send a SASE to: Barry Waldron, 1847 Country Club Dr., Placerville, CA 95667.

LONDON LIVE D.I.Y. HI-FI CIRCLE meets quarterly in London, England. Our overall agenda is a broad one, having anything to do with any aspect of audio design and construction. We welcome everyone, from novice to expert. For information contact Brian Stenning, 081-748-7489.



COMING SOON!

TC SOUNDS makes no-compromise drivers with linear motor-structures (underhung), high-compliance linear mechanical systems, and stiff lightweight composite polymer solid diaphragms. Individual T/S-parameters, 5.5", 8", 10", 12", 15", 18" call (619) 622-1212

NEW JERSEY AUDIO SOCIETY meets monthly. Emphasis is on construction and modification of electronics and speakers. Dues includes monthly newsletter with high-end news, construction articles, analysis of commercial circuits, etc. Meetings are devoted to listening to records and CDs, comparing and A-Bing equipment. New members welcome. Contact Frank J. Alles, (908) 424-0463, 209 Second St., Middlesex, NJ 08846; or contact Bob Young, (908) 381-6269, or Bob Clark, (908) 647-0194.

You Don't Need A BOUNTY HUNTER

*to track down
the latest
Speaker Builder*

They can be found at:

Audio Lab
5269-2 Buford Hwy.
Doraville, GA

Zalytron Industries
469 Jericho Turnpike
Mineola, NY

Sound Designs
1242 Fascination Circle
El Sobrante, CA

Cody Books, Ltd.
Blaine, WA

Parts Express
340 E. 1st St.
Dayton, OH

Egyetti Ltd.
1st Fl, Chung Shan Bld. 13
Chung Shan North Rd.
Taipei
TAIWAN

Also available at selected
Tower Record stores.

*If you prefer home delivery, use
the handy subscription form en-
closed.*

**This publication
is available
in microform
from University
Microfilms
International.**

Call toll-free 800-521-3044. In Michigan, Alaska and Hawaii call collect 313-761-4700. Or mail inquiry to: University Microfilms International, 300 North Zeeb Road, Ann Arbor, MI 48106.

PIEDMONT AUDIO SOCIETY Audio club in the Raleigh, Durham, and Chapel Hill area is meeting monthly to listen to music, demonstrate owner-built and modified equipment, and exchange views and ideas on electronics and speaker construction. Tube and solid state electronics are of interest and all levels of experience are welcome. Kevin Carter, 1004 Olive Chapel Rd., Apex, NC 27502, (919) 387-0911.

THE LOS ANGELES AREA LOUDSPEAKERS DESIGNERS GROUP If you're just starting out or an experienced builder and would like to share ideas on speaker design and listen to each others latest creations, give us a call. Geoffrey (213) 965-0449, Edward (310) 395-5196.

OF Mockingbirds

And Other Irrelevancies

by Edward T. Dell, Jr.

20 Years of Editorials from
the pages of *The Audio Amateur*

"Music's claim on our mind, its primal
appeal, is nearly universal."

Music is the intersection of Science and Art. In this fascinating collection of essays, Ed Dell offers far more than thoughts for the audio amateur. He explores this intersection where sound becomes life, offering perspective for a confused age. While Dell's essays are framed as journal editorials, they explore far-reaching themes such as the place of art in technology and poetry in science, the individual inventor, technological fright, a creative relationship with machines, and the human appetite for and quest after music.

♦ ♦ ♦

These essays reflect on the nature of man in the world. Intriguing titles—"Cash vs. Consciousness," "Beer and Bach," "Of Mockingbirds," "Ears and Science," "Myths Warfare" and "Tracking Truth"—are followed by equally intriguing prose. The realm of sound becomes the lens through which Dell's readers see the world. Says the author, "This entrancing hobby of ours is a satisfying end in itself as a craft. But it is, as well, a means to unlock one of the great, mysterious catalysts of our humanness."

♦ ♦ ♦

Woven through the essays, many written in the 1970s, are a number of uncanny prophecies about both audio technology and society in general. Dell is a philosopher and a writer who clearly delights in both. This collection is rich, musical and full of wisdom for our time.—*From the dustjacket.*

1993, hardbound, 96pp.,
Marshall Jones Co., \$9.95

MAKES A GREAT GIFT!

- Yes, please send me ___ cop(ies) of
Mockingbirds (BKAA9)
@ \$9.95 each \$ _____
Plus shipping (\$3 USA; \$5 other
surface; \$10 other air) _____
- Check/MO MC Visa Total \$ _____

MC/Visa No _____ Exp. Date _____

Name _____ Today's Date _____

Street _____

City _____ St _____ Zip _____

OLD COLONY SOUND LAB
PO Box 243 Dept. B93
Peterborough, NH 03458 USA



Tel. (603) 924-6371
(603) 924-6526
FAX (603) 924-9467

THE INLAND EMPIRE AUDIO SOCIETY (soon to become) THE SOUTHERN CALIFORNIA AUDIO SOCIETY—SCAS is now inviting audiophiles from all areas of Southern California and abroad to join our serious pursuit for that elusive sonic truth through our meetings and the IEAS' official speaker, *The Reference Newsletter*. For information write or call, Frank Manrique, President, 1219 Fulbright Ave., Redlands, CA 92373. (714) 793-9209.

MONTREAL AREA SPEAKER BUILDER looking for others interested in speaker design and construction from small to large systems. Feeling like I'm the only one. Prove me wrong! Andrew McCree, 4701 Jeanne Mance, Montreal, PQ H3V 4J5, Canada, (514) 281-7954.

DO YOU LIVE NEAR LAWRENCE KANSAS? I am a student at the University of Kansas looking for other speaker builders within driving distance. I would like to exchange ideas and listen to other homebrew systems. Michael Marmor, 1520 Lynch Court #2, Lawrence, KS 66044, (913) 843-8993.

T-SHIRT CLEARANCE

TELEPHONE ORDERS
ONLY!

Reg. NOW \$6.95 EA.
\$13.

AVAILABLE SIZES:

- Green "Old Colony Sound Lab":
S, M, L, XL
- Black "Speaker Builders Do It
With Raw Drivers": S, M
- Red "Audio Amateur": S, L, XL
- Blue "Speaker Builder": S

- ALL SALES FINAL
- MC/VISA WELCOME
- SUPPLIES LIMITED

OLD COLONY SOUND LAB



(603) 924-6371
(603) 924-6526

HI-FI COLLECTOR/HOBBYIST seeks "living letters" audio pen pals from other states to correspond via reel-to-reel tape. Non-commercial strictly; make up short monologues on subjects from vintage technology, with regional FM excerpts for background or equipment samples, from personal tales of yard sales scavaging success, repair/restoration tactics and strategies, favorite service centers, general ways to handle the burgeoning obsession with arcane hi-fi gear. All correspondence on 3", 5", 7" reels (1/4" tape) will be cheerfully answered and tapes returned via parcel post. James Addison, 171 Hartford Rd., Apt. #7, New Britain, CT 06053.

ESL BUILDERS GROUP is a new address for people who have built or want to build ELECTROSTATIC LOUDSPEAKERS and ASSOCIATED (TUBE) DRIVERS, or are just interested. We will concentrate on ESL-related building projects but also look at the theoretical aspects of acoustics and electronics. Interested? An answer is ensured, if you include some kind of compensation for postage and handling. Write to: Gunter Roesch, Buhler STR.21, 7030 Boblingen, Germany.

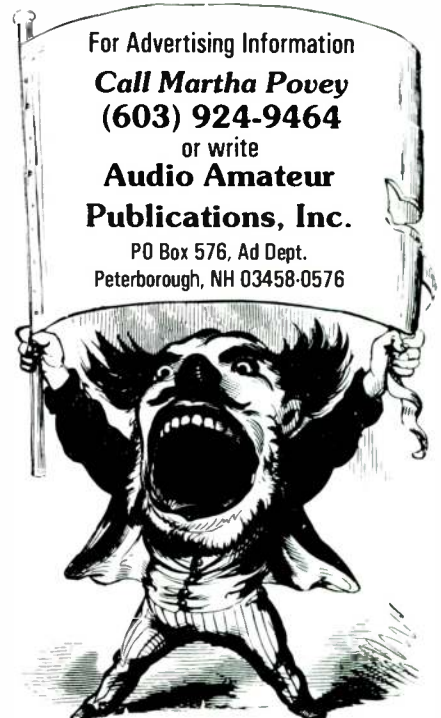

THE WESTERN NEW YORK Audio Society is an active, long established club located in the Buffalo area. We issue a newsletter and hold meetings the first Tuesday of every month. Our meetings attract many prominent manufacturers of audio related equipment. We are involved in all facets of audio—from building/modifying to exposure to the newest high-end gear, and the chance to hear more types of music. For information regarding our society, please write to WNY Audio Society, PO Box 312, N. Tonawanda, NY 14120.

SOUTHEASTERN MICHIGAN WOOFER AND TWEETER MARCHING SOCIETY (SMWTMS). Detroit area audio construction club. Meetings every two months featuring serious lectures, design analyses, digital audio, A-B listening tests, equipment clinics, recording studio visits, and audio fun. The club journal is *LC, The SMWTMS Network*. Corresponding member's subscription available. Call (313) 544-8453 or write David Carlstrom, SMWTMS, PO Box 721464, Berkley, MI 48072-0464.

THE ATLANTA AUDIO SOCIETY is dedicated to furnishing pleasure and education for people with a common interest in fine music and audio equipment. Monthly meetings often feature guest speakers from the audio manufacturing and recording industry. Members receive a monthly newsletter. Call: Chuck Bruce, (404) 876-5659, or Eddie Carter, (404) 847-9296, or write: A.A.S., 4266 Roswell Rd. N.E., K-4, Atlanta, GA 30342-3738.

MW114-S

Neodymium Magnet DPC Cone 4" Woofer

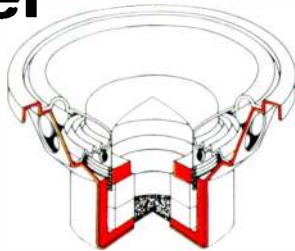

Specification

Overall Dimensions	Ø118mm (4.64") x 58mm (2.29")
Mounting Baffle Hole Diameter	Ø95mm (3.75")
Magnet System	Pot Type, Vented, Neodymium Magnet
Nominal Power Handling (Din)	150W
Transient Power - 10ms	800W
Voice Coil Diameter	54mm (2.125")
Voice Coil Type/Former	Hexatech Aluminium
Frequency Response	55-7000 Hz
FS - Resonant Frequency	65 Hz
Sensitivity 1W/1m	87 dB
Z - Nominal Impedance	8 ohms
RE - DC Resistance	5.6 ohms
LBM - Voice Coil Inductance @ 1kHz	0.47 mH
Magnetic Gap Width	1.25mm (0.050")
HE - Magnetic Gap Height	6mm (0.236")
Voice Coil Height	12mm (0.472")
X - Max. Linear Excursion	3mm
B - Flux Density	0.88T
BL Product (BXL)	6.75
Qms - Mechanical Q Factor	2.32
Qes - Electrical Q Factor	0.36
Q/T - Total Q Factor	0.31
Vas - Equivalent Cas Air Load	3.18 litres (0.113 cu. ft.)
MMS - Moving Mass	7.00gm
CMS	807µm/n
SD - Effective Cone/Dome Area	53cm ² (20.86 sq. in.)
Cone/Dome Material	DPC (Damped Polymer Composite)
Nett Weight	0.500 kg

Specifications given are as after at least 45 minutes of high power, low frequency running, or 24 hours normal power operation.

The 114-S is the first of Morel's new generation of woofers, featuring a powerful Neodymium magnet system which provides increased sensitivity, lower Q_t and reduced distortion. For a 4" driver it is unique in having a large 54mm (2.125") diameter Hexatech aluminium voice coil.

Benefits of this large voice coil diameter include a very high power handling capacity and lack of sound level compression. In addition, it allows the use of a very shallow cone profile. Coupled with the use of Damped Polymer Composite cone material and a rubber surround, this provides excellent dispersion (off-axis response), resistance to cone break-up (even at high sound pressure levels) and lack of colouration.

Frequency and phase response are very flat, while the roll-off is very smooth. The MW 114-S may be used either as a bass-mid range in 2-way systems, or as a mid-range in multi-way systems.

The vented magnet system is encased within a steel chassis, which improves efficiency and shields the magnet, virtually eliminating stray magnetic fields. The MW 114-S is ideal not only for high quality hi-fi, but also TV, video and surround-sound applications.

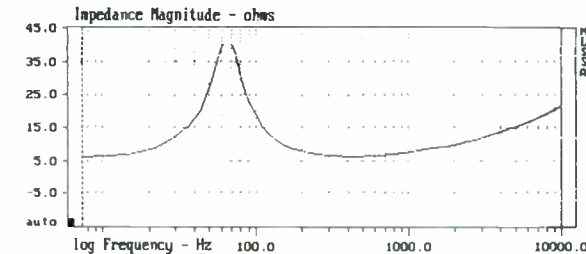
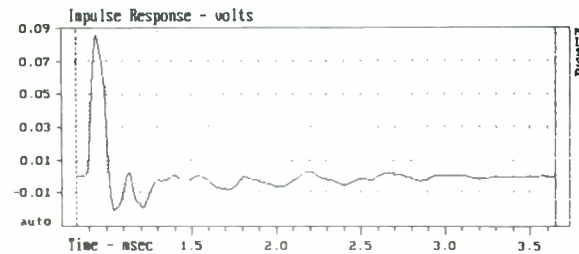
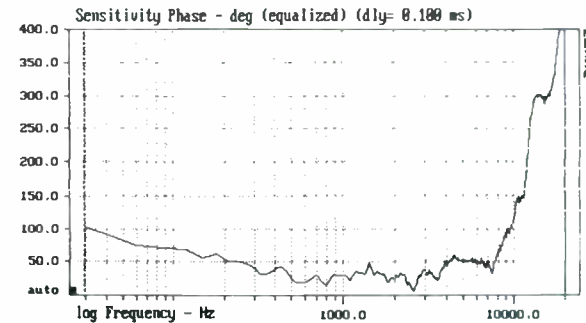
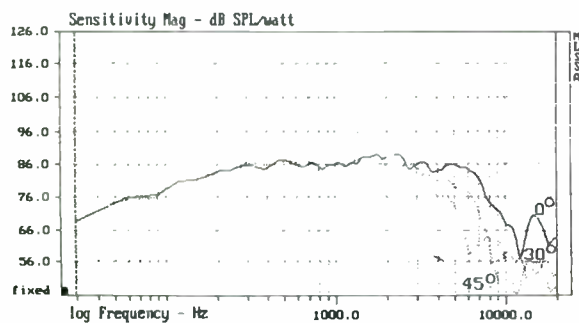

Morel operate a policy of continuous product design improvement, consequently specifications are subject to alteration without prior notice.

World Radio History

morel

high fidelity
range

morel (U.K.) Ltd.
11 Foxtail Road,
Nacton Rd. (Ransomes)
Industrial Estate,
Ipswich, IP3 9RT
England
Tel: (0473) 719212
FAX: (0473) 716208

morel acoustics USA
414 Harvard Street
Brookline, MA 02146
Tel: (617) 277-6663
FAX: (617) 277-2415





In any language, when the world cries "Help!" CARE is there. Please. Be there for CARE.

1-800-242-GIVE

THE COLORADO AUDIO SOCIETY is a group of audio enthusiasts dedicated to the pursuit of music and audiophile arts in the Rocky Mountain region. We offer a comprehensive annual journal, five bi-monthly newsletters, plus participation in meetings and lectures. For more information, send SASE to: CAS, 11685 W 22nd St., Lakewood, CO 80215, (303) 231-9978.

TUBE AUDIO ENTHUSIASTS. Northern California club meets every other month. For next meeting announcement send a self-addressed, stamped #10 envelope to Tim Eding, PO Box 611662, San Jose, CA 95161.



WANTED

AUDIO CLUB MEMBERS

(Good singing voice not required)

Learn about the latest equipment, techniques and recordings through group meetings, tours and newsletters. Ask questions. Share viewpoints and experiences. *Have fun!*

If there's no club in your area, why not start one? Our club ads are free up to 75 words (\$.20 per word thereafter). Copy must be provided by a designated officer of the club or society who will keep it current.

IF YOU ARE an "Organ Music Lover" and like to test your audio system, SFORZANDO has room for a few more members. We have about three thousand "Live," on-the-spot, cassette tapes that are not available in the stores. We are happy to lend them to you via the mail. Just ask EA Rawlings, 5411 Boccage St., Montreal, Canada, H4J 1A2.

THE HI-FI CLUB of Cape Town in South Africa sends a monthly-newsletter to its members and world-wide subscribers. To receive an evaluation copy of our current newsletter, write to: PO Box 18262, Wynberg 7824, South Africa. We'll be very pleased to hear from you.

THE BOSTON AUDIO SOCIETY the nation's oldest (founded 1972), seeks new members. Dues includes the monthly meeting notice and our newsletter, the *BAS Speaker* (6 times/year). Recent issues cover Carver, a/d/s; the founder of Tech Hi-Fi; Photo CD; plus visits from famous speaker designers; listening tests; measurement clinics; research investigations; and more. Back volumes available. Membership includes engineers, journalists, consultants, and music-loving audiophiles like yourself. For information write to PO Box 211, Boston, MA 02126-0002, USA.

Electronic

by
ACE AUDIO CO.

• est. 1973 •

RD3 Box 351

Homer City, PA 15748

write for free flyer

Crossovers

THE PRAIRIE STATE AUDIO CONSTRUCTION SOCIETY. (PSACS) meets every other month. Meetings feature audio construction, design, and analyses, blind listening tests, equipment clinics, autoseound, lectures from manufacturers and reviewers. PSACS, PO Box 482, Cary, IL 60013, call Tom, (708) 248-3377 days, (708) 516-0170 eves.

Ad Index

Advertiser	Page	Advertiser	Page
A & S Speakers	39	SOLEN	
Abilene Research and Development	64	1993 Catalog	29
Audio Concepts	43	Europe's Finest Kits	69
AudioControl	58	Solo Electronics	31
Billington Export Ltd.	70	SpeakEasy	56
C&S Audio Labs	36	Speaker City, U.S.A.	31
Decade Engineering	66	Speaker Works	67
DRA Laboratories	19-23	Speakers Etc.	60
Dynamic Control	64	The Speaker Works, Inc.	45
Harris Technologies	47	USA Products, Inc.	67
Hi-Fi News & Record Review	54	Zalytron Industries Corp.	17
LinearX Systems, Inc.	8		
MADISOUND		CLASSIFIED SECTION	
Capacitor Bonanza	68	Ace Audio Co.	78
Flatline Cables	27	All Pass Technologies	74
Shower of Savings	15	Classical disCDigest	73
Mahogany Sound	68	Meniscus	75
Marchand Electronics, Inc.	61	Michael Percy	72
Markertek Video Supply	68	Sonic Studios	73
MCM Electronics	53	TC Sounds	75
Meniscus	65		
MicroAcoustics	10	GOOD NEWS/NEW PRODUCTS	
MIT Components	CV II	A.T.U.S., Design Acoustics Division	7
MOREL ACOUSTICS		AudioControl	3
MW 114S	77	B&W Loudspeakers of America	7
High Tech	CV IV	C&S Audio Labs	3
Motorola Ceramic Products	70	Dalanco Spry	6
Mouser Electronics	66	Decade Engineering	6
N.E.W.	63	Impulse Loudspeakers	6
Newform Research, Inc.	57	Liberty Instruments, Inc.	3
North Creek Music Systems	58	M&P Technologies, Inc.	6
		Meadowlark Audio	7
OLD COLONY SOUND LAB		Miller & Kreisel Sound Corp.	6
Boxes and Binders	74	Neutrik Instruments, Inc.	4
New Products	48-49	North Creek Music Systems	4
Of Mockingbirds and Other Irrelevancies	76	PC Instruments, Inc.	7
T-Shirts	76	Parasound Products	4
Software	73	POLYDAX SPEAKER CORP.	
ORCA		Audio Talk	7
Black Hole/Aeon Cables	35	AW025S1	3
TopBox	59	Kevlar Speakers	4
Parts Express	CV III	Pyle Industries, Inc.	4
Polydax Speaker Corp.	5	Scantek, Inc.	7
Pyle Industries	33	Snell Acoustics	3
Q Components	70	Syon Corp.	6
RDL Acoustics	51	Tri-State Loudspeaker	7
Sescom, Inc.	68	Wilmslow Audio Ltd.	3
		World College	4

Parts Express

International Inc.

Look no further than Parts Express for your speaker building needs. We offer some of the finest accessories available at very reasonable prices. We stock every item we advertise and most orders are shipped within 24 hours of order placement. Our technical support staff can help you select the best drivers for your particular application, choose suitable enclosure volumes and even calculate crossover values. The best part is that this advice is free. So call now for your copy of our free 172 page catalog and see what you've been missing. We'll even pay for the call!



Crossover Components ▲▲▲▲▲



Gold Plated Connectors ▲▲▲▲▲



Audax Loudspeakers ▲▲▲▲▲



Cabinet Accessories ▲▲▲▲▲

For more information on these and all of the other fine products at Parts Express, call Toll Free 1-800-338-0531, and don't forget to ask for your free catalog.

Parts Express Int'l. Inc. ♦ 340 E. First St., Dayton, OH 45402-1257
 Local: (513) 222-0173 ♦ Fax: (513) 222-4644



High-Tech Audiophile Loudspeakers

For Further Information Please Contact: **morel acoustics USA**

414 Harvard Street
Brookline, MA 02146
Tel: (617) 277-6663
FAX: (617) 277-2415
World Radio History



Typical Double Magnet Woofer Cross Section.