

# SOUND & COMMUNICATIONS

Volume 39 Number 2

February 25, 1993



## CHURCH OF THE FUTURE

Sunshine Ministries has been instrumental in bringing Christian music to Western Michigan since the church opened five years ago. Initially, however, the sound system was less than optimum for musical reproduction. In came Ascom, who has been able to take the church to new heights in sound, affordably. **38**

### IN THIS ISSUE

#### • Sound on Ice

Hockey arena needed flexibility, ease of use, and clear sound. Mavri, Inc. designed and installed a completely new system for the Student Development Complex of Michigan Technological University. **44**

#### • The 124th ASA Meeting

New Orleans hosted this fall's gathering of the Acoustical Society of America. Myriad technical specialties were covered from acoustical oceanography to musical acoustics, by diverse sources such as MIT and NASA. **16**

#### • This is a Test

The automated remote testing of teleconferencing facilities is an important recent development caused by the increased employing of facilities and the resulting failure of certain components. **54**

## AUDIO IN ASIA, PART 2

We continue the audio tour of Asia with our t t s a Mike Klasco. This month Mike Seoul and offers personal ob on the city, the country, and the SS. **28**

## POST-TECHNOLOGY ER

ch audio business frequently operates h technology" business. Some suggestions ion on bringing about business tech- new era. **18**





# PERFORMANCE

## THE PEAVEY PERFORMANCE SERIES™



**T**he Performance Series™ 3680 Sound Reinforcement Console is the result of ongoing research by Peavey to meet the rigid requirements of today's sound engineers. Many technological advancements have been included with this new console, but we have also kept in mind the most needed and most often used features that are common to virtually every sound reinforcement application.

The totally modular concept, coupled with performance, function, features, and exceptional specifications, has offered to the sound engineer a console that is "tailor made"... and affordable!

### ULTRA LOW-NOISE DESIGN

The input stage is discrete and contains the lowest noise transistors that are currently available. The signal-to-noise spec of the Performance Series 3680 input stage has approached the theoretical limit at -133 dB while maintaining 60 dB of gain.

### DIFFERENTIAL SIGNAL ROUTING

All bus signals are differential to eliminate crosstalk and annoying ground conduction.

### GOLD PLATED INTERCONNECTS

Gold plated connection contacts are used throughout for lowest noise and maximum reliability. The highest degree of signal integrity is maintained with all signal interconnects to provide "low-noise" operation.

### K SOCKETS

All ICs are individually socketed for ease of service as opposed to ICs that are soldered directly to the circuit board.

### INPUT CHANNEL FLEXIBILITY

Now available in 24 and 36 channel versions, channel options are unlimited for the future and for special applications requiring more than 36 channels.

### ELECTRONICALLY BALANCED INPUTS

New electronically balanced input circuit offers 100 dB of common mode rejection, allowing the console to operate in most any environment without interference.

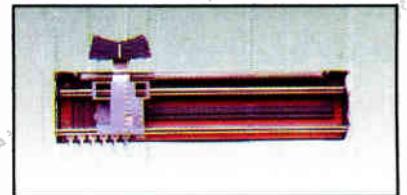

### PREMIUM FADERS

Rails are center ground and highly polished to match perfectly with nylon bushings for a silky smooth feel. The shaft is offset to prevent dust and debris from entering the fader mechanism.



# ENGINEERED... SOUND REINFORCEMENT CONSOLES

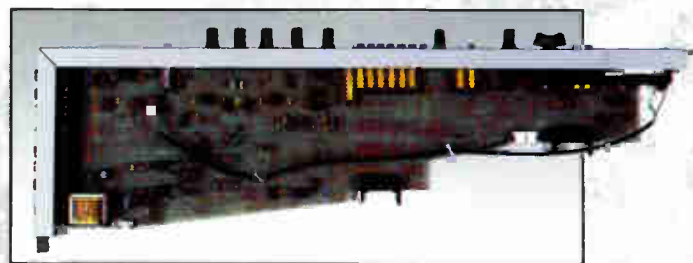
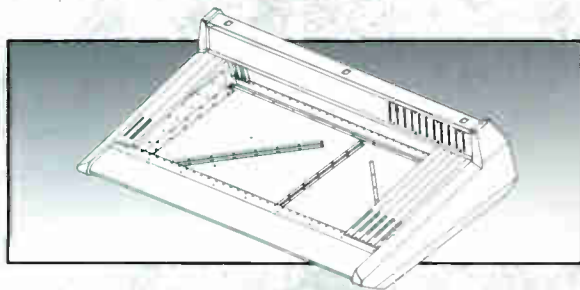
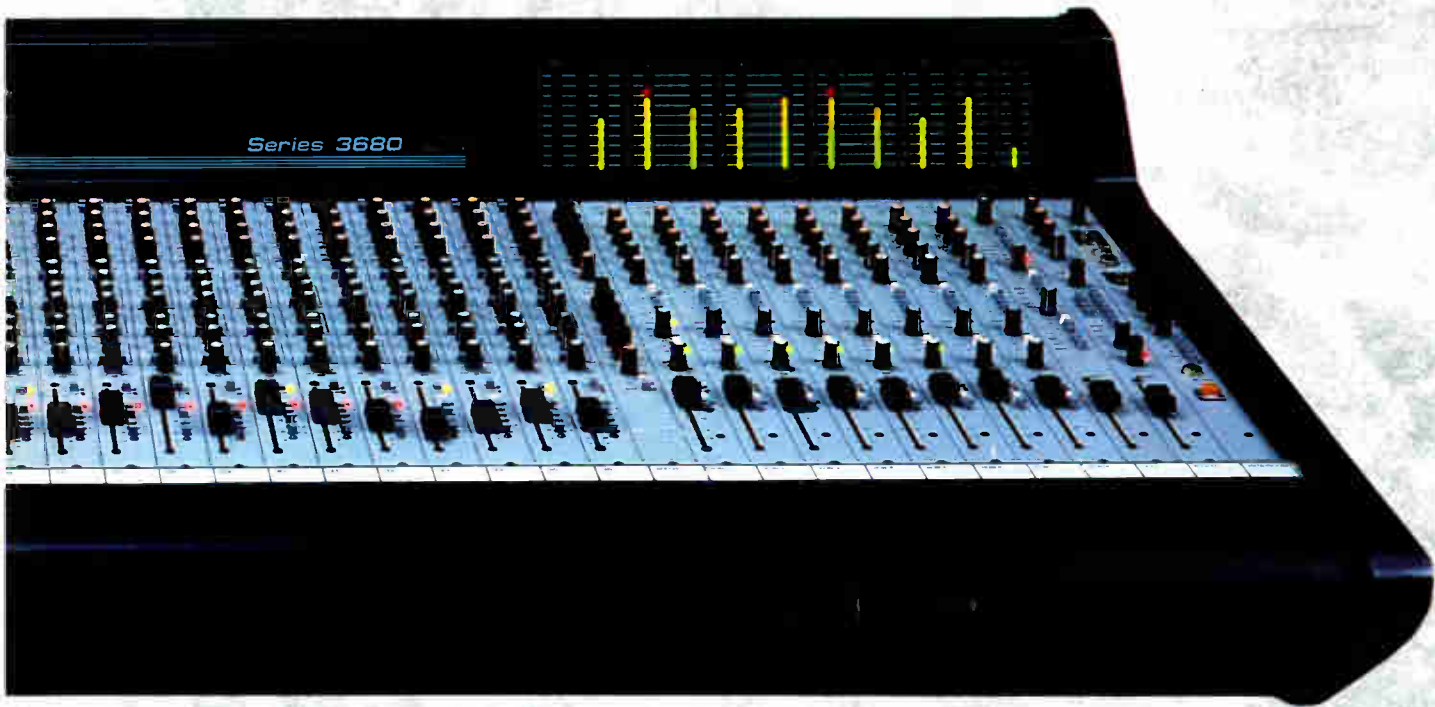

## MONOCOQUE CHASSIS CONSTRUCTION

A unique monocoque chassis construction has been selected for maximum rigidity and resistance to "flexing" of the chassis mainframe. This super-strong chassis design minimizes electronic problems due to the mechanical "bending" of the console chassis during transportation, set-up, and tear-down.

## TOTALLY MODULAR CONCEPT

The Performance Series 3680 is a totally modular mixer from the standpoint of numbers of channels, and because channels may be removed separately. Each channel stands alone from the input to the 100mm fader. Removing the channel module also removes the entire array of input jacks and all patch points for that particular channel. From a service standpoint, the channel may be easily checked out on the bench or outboard from the main mixer housing since the input patch panel is part of the channel module.



## EXTERNAL POWER SUPPLY

Rugged external power supply mounts in standard 19" rack and occupies only two vertical rack spaces.

# PEAVEY®

ARCHITECTURAL ACOUSTICS®

A Division of Peavey Electronics Corporation  
711 A Street, Meridian MS 39302-2898 (601) 483-5376 Fax: (601) 484-4278  
Circle 201 on Reader Response Card



**THERE'S MORE TO  
AIPHONE THAN MEETS  
THE EYE.**

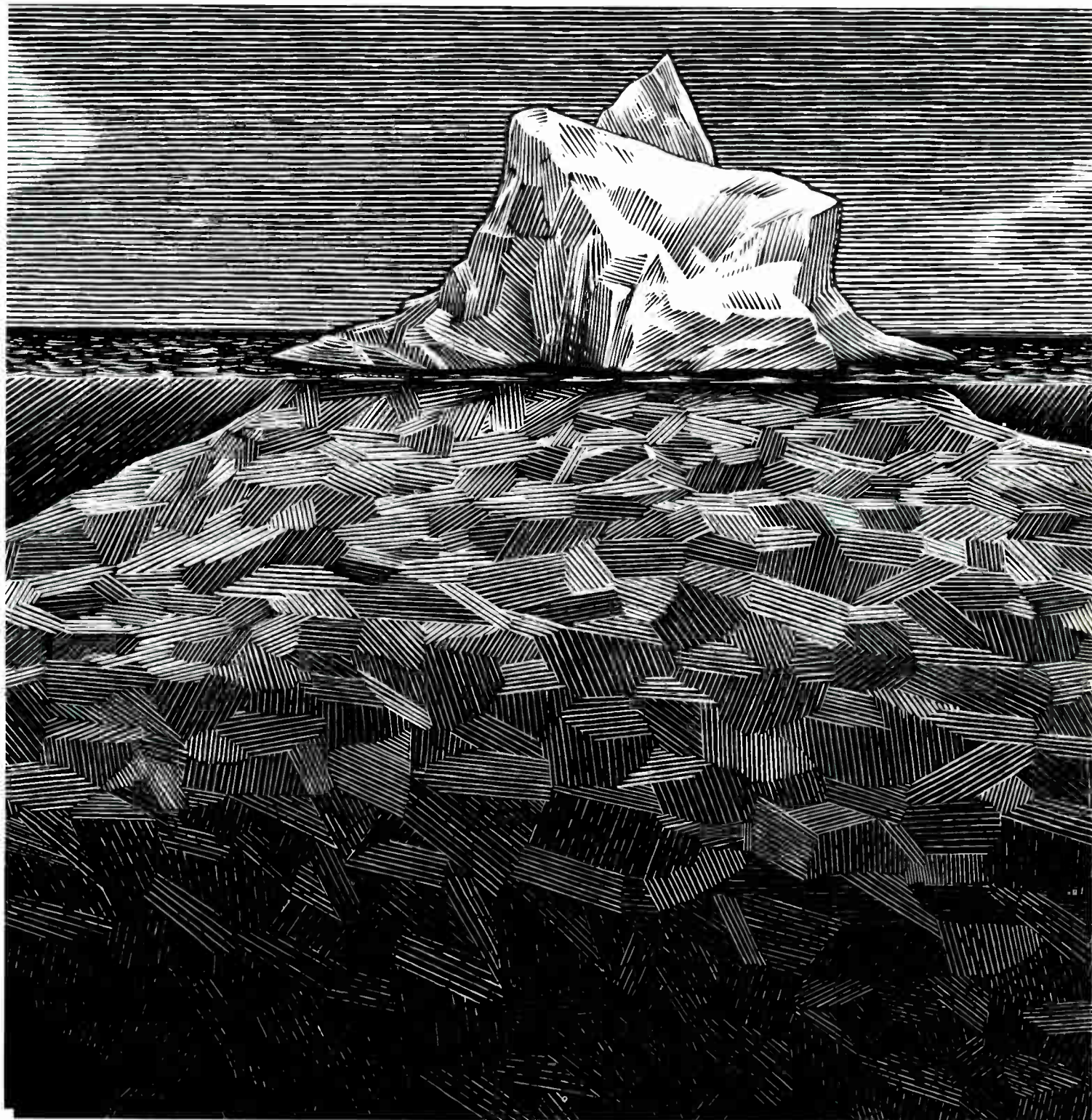



While it's true that video entry security systems play an important role, they represent just a small part of our total business.

For instance, our commercial and residential intercoms vary from simple 2-line telephone types to sophisticated microprocessor systems accommodating hundreds of stations. Combine intercoms with entry security and you'll approach 35 differ-

ent systems. Add our Special Order Products, and the combinations are somewhere in the thousands.

So rather than deal with a sea of different suppliers, call us at 206-455-0510 for our free full-line catalog.

Because when it comes to creating the most diverse line in the business, we've got the market down cold. **AIPHONE®**

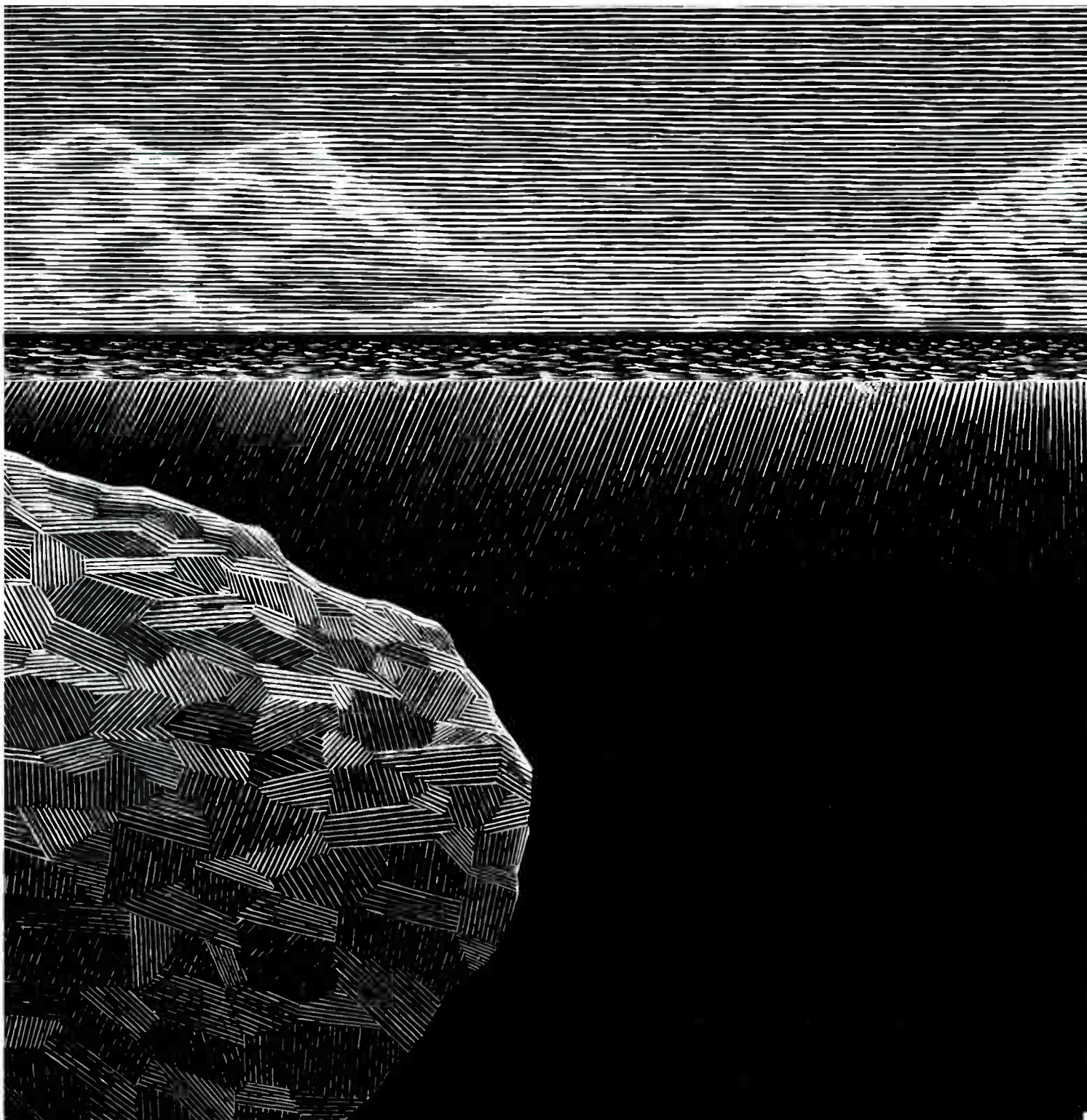

*Aiphone products are ADA compliant and GSA approved.*

Circle 202 on Reader Response Card

# CONTENTS

Volume 39 Number 2

February 25, 1993



18



28

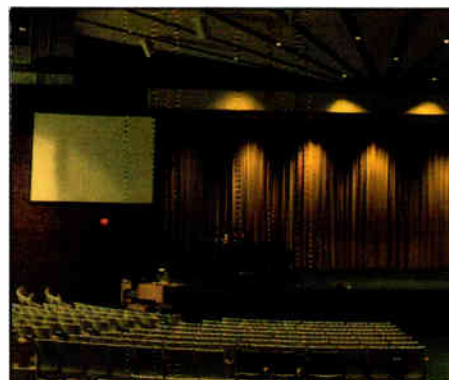

38

## FEATURES

### 38 SUNSHINE MINISTRIES

*By Wendy J. Duch*

This Grand Rapids church has been in the forefront of Christian music and has gone through a major redo to provide quality on a budget. The piecemeal installation process has taken time, but has been well worth it for church and contractor alike.

### 44 THE MICHIGAN TECH ICE ARENA

*By Keith Clark*

The ice arena at Michigan Tech's sound system had to overcome trouble spots, peculiarities and even hockey pucks in the bass bins. Many "quick fix" solutions were tried but it new an overhaul to fix this troublesome room.

### 54 TELECONFERENCE TESTING

*By Bradley Basnett*

A method to check on the "health" of corporate audio teleconferencing systems was devised in order to avoid potential failure through constant use. For ease of use, an automated remote system was created at a centralized location.

### 16 TRADE SHOWS: THE ACOUSTICAL SOCIETY OF AMERICA'S 124TH MEETING

*By Neil Shaw*

### 18 THEORY AND APPLICATION: THE POST-TECHNOLOGY AUDIO DEALER

*By Steven J. Orfield*

### 28 FIRST PERSON: AUDIO IN ASIA, PART 2 — KOREA

*By Mike Klasco*

### 65 NEWS FROM AROUND THE INDUSTRY

### 69 PRODUCTS

### 73 LITERATURE

### 74 PEOPLE

### 74 CALENDAR

### 76 AD INDEX

### 76 MARKETPLACE

### 78 PRODUCT CHECK: RESIDENTIAL SYSTEMS

## DEPARTMENTS

### 9 NEWSLETTER

### 12 LETTER FROM THE EDITOR

# SOUND COMMUNICATIONS

# Eclipse.



... The total or partial obscuring of one celestial body by another. It's a rare and significant event that happens when the planets are aligned in such a manner that one casts a shadow over another.

In April, at NSCA in Orlando, come to the Bose® booth to participate in an event of audio significance... and learn how to eclipse *your* competition.

***BOSE***<sup>®</sup>  
Better sound through research.



**BACKBOX:**

Choice of seven.

**SPEAKER:**

Choice of eleven.

**BAFFLE:**

Choice of nine.

**TRANSFORMER:**

Choice of five.



## With 3450 standard assemblies, Quam gives you custom-designed flexibility with off-the-shelf delivery.

When we say Quam offers a broad line of 8" assemblies, we don't mean a few speakers with a lot of baffles. We mean 11 different speakers, with nine baffles, to suit virtually any application. Add any of seven backboxes and five transformers (and more of each coming), and you have more than 3450 combinations to choose from.

You specify it the way you want, and you receive it when you

want. All the components are in inventory... 70,000 pieces! You order and we assemble and ship within 24 hours. No waiting.

Our broad commercial sound accessories line is a change from the days when Quam concentrated exclusively on speakers. And we'll continue to change, adding innovative, high-quality products that help make you more profitable.

What will never change is our tradition of quality and service.

Make Quam your Sound Decision. Call or write now for your free Commercial Sound Products catalog, and we'll add you to our mailing list for catalog updates and product announcements as they occur.

**Quam:** The Sound Decision



QUAM-NICHOLS COMPANY • 234 E. Marquette Road • Chicago, Illinois 60637 • (312) 488-5800

Circle 204 on Reader Response Card

World Radio History



# NEWSLETTER

## **MUSIC & SOUND AWARDS PRESENTED**

The Seventh Annual Music & Sound Awards, sponsored by Testa Communications and The Music & Sound Retailer magazines, was held during the NAMM show in January at the Pacific Ballroom of the Anaheim Hilton. Among the winners, chosen by the readers of The Music & Sound Retailer, are (for innovative product): QSC MXa Series amp; Peavey Mini Monitor II system; Mackie CR-1602 automation board; Alesis ADAT; Samson UR-5; DigiTech RP-1, Peavey Lighting Solutions Rhythmlite. Charlie Eaton was chosen rep of the year. Most Effective Dealers included Manny's/Audio Techniques and Hermes Music (sound reinforcement), Gand Music & Sound and Daddy's Junky Music (recording related products), and Washington Music Center and Hermes Music for lighting equipment. Skip's Music and House of Guitars both won for Promotion of the Year and for Music Education Program of the Year.

The Music and Sound Awards are presented each year during the Winter NAMM show.

## **RIGGING SEMINARS PLANNED**

Two three-day rigging seminars have been announced by Dr. Randy Davidson and Harry Donovan. The first will be held at the Ramada Inn-Dunwoody in Atlanta, March 23 through 25. The second will be March 30 through April 1 at the Holiday Inn-Harbor Blvd. in Anaheim, California. The Rigging seminars will include safety issues, factors and methods: liability, risk, and limitation of liability; OSHA regulations; strength and inspection of rigging equipment; theory and practice; engineering principles; vectors; and arena and auditorium rigging equipment. For information, contact Rigging Seminars, 12370 W. Co. Rd., 100 N., Norman, IN 47264. Phone 812-995-8212.

## **CES "OPTIMISTIC" ABOUT 1993 SALES**

The 1993 International Winter Consumer Electronics Show was held in January in Las Vegas and totaled an attendance of 78,503 and 1,630 exhibitors over 912,906 net square feet. The Home Theater/Custom Installation areas showed a growth in exhibitors of 33 percent. The high end audio product area grew four percent. During the show Las Vegas became the first city with 10 radio stations permanently broadcasting with the RBDS signal. RBDS (Radio Broadcast Data System) was standardized shortly before the show and RBDS products were shown by Denon among others.

## **NAB DISTINGUISHED SERVICE AWARD**

The National Association of Broadcasters has announced that Dick Clark will receive the 1993 Distinguished Service Award on April 19 during the opening ceremony of NAB's annual convention in Las Vegas. Other DSA winners include former President Ronald Reagan.

## **SPARS CONFERENCE PLANNED**

The Society of Professional Audio Recording Services (SPARS) will host a weekend technical conference and interface with leading manufacturers of digital audio workstations on May 15 and 16 at the Hudson Theatre in New York City. Manufacturers initially slated to give presentations and offer hands-on demonstrations are: Akai, ARAS-Sadie, Avid, Digidesign, Digital FX-Waveframe, Fairlight ESP, Otari, Roland Pro Audio/Video, Siemens AMS, Solid State Logic, Sonic Solutions, Studer/Dyaxis II, and Spectral Systems.

## **HDTV AT INAUGURATION**

The Advanced Television Research Consortium and the International Brotherhood of Electrical Workers jointly presented a demonstration of Advanced Digital HDTV during the "Salute to Children" presidential inaugural event at Kennedy Center in Washington, D.C. The demonstration featured an original video production, "Child's Play," produced in Advanced Digital HDTV and narrated by Ahmad Rashad. Members of the ATRC include NBC, North American Philips, the David Sarnoff Research Center, Thomson Consumer Electronics, and Compression Labs.

# NEWSLETTER

## **SANDERS TO SHARP**

W. Paul Sanders has joined the LCD Products Group at Sharp Electronics Corporation as national sales manager for industrial products. He manages sales of LCD video and data projection systems, as well as direct view monitor products. He was previously executive vice president at Photo and Sound Company.

## **HARRIS AWARDED CONTRACT**

Harris Corporation has been awarded a \$3.5 million contract to modernize the Federal Emergency Management Agency's existing Private Automatic Branch Exchange system. Under the terms of the contract, Harris Electronic Systems Division in Palm Bay, Florida will design, develop and integrate the agency's telecommunications equipment. The new switch will add voice conferencing capabilities. Lewis Kling, vice president/general manager of HESD, said, "The telecommunications system will provide FEMA with significantly improved DCWS user services to include voice, data and compressed video."

## **COMPACT POWER LISTING**

Compact Power Company has announced that it has received both UL and CSA listings for its DS-300 Series Commercial Sound Power Amplifiers. Units are available from stock.

## **CCTMA PROGRAM DEEMED SUCCESSFUL**

The Closed Circuit Television Manufacturers Association, a division of the Electronic Industries Association, sponsored its First Annual CCTV Technical Seminars in November in New Orleans. The educational program with concurrent sessions oriented toward end-users and dealer/designers attracted over 100 industry professionals. Sixteen speakers from CCTMA member companies addressed the attendees on topics such as video theory, lighting, coaxial cable, wireless video transmission, fiber optics, switching, multiplexing, time laps recorders, and system integration.

Based on participants' reactions, the CCTV Technical Seminars will be held again in the fall of 1993 and every fall thereafter in different host cities.

## **OTARI AND FMT AUDIO OPEN DEMO FACILITY**

Otari Corporation in conjunction with FMT Audio has announced the opening of a demonstration facility to provide a hands-on environment of Otari Audio Post-Production Systems. Clients will be able to operate Otari's new DE-24 editing system, which was developed with Todd-AO/Glen Glenn Sound. The demo facility also provides prospective buyers with access to Otari's ProDisk-464 digital audio workstation, the Series 54 mixing console, and selected Otari machines. The facility is in Los Angeles.

## **JOINT DEVELOPMENT AGREEMENT**

IBM and Laser-Pacific Media Corporation have announced an agreement for the joint development of an MPEG digital compression application using IBM's Power Visualization System. In announcing the relationship, Armando Garcia, IBM's Director of Visualization Systems, stressed that "this will combine IBM Research's leading role in compression technology and its numerous contributions to the MPEG standards with Laser-Pacific's expertise in creating innovative facilities for high-quality, large-volume electronic image and sound processing. Targeted to be fully operational in mid-1993, the compression operation will be based at a new facility near Laser-Pacific's Hollywood headquarters. In the joint development effort, IBM and Laser-Pacific seek to solve the technical and operational challenges of creating an efficient, high quality approach that will facilitate the emerging technologies of video on demand, CD-based full motion video, and other digitally



Being born into a famous family is no free ride.

Standards are high.

Expectations are great.

So when Shure unveiled its L Series Wireless Microphones a few years ago, we knew they had to be better than good.

They were. In fact, the L Series has emerged as one of the most affordable, trouble-free lines in the business. One that includes nearly every kind of wireless – from hand-held to lavalier to instrument systems – with both diversity and non-diversity receivers.

The all-new, L11 body-pack transmitter is a prime example. With its compact surface mount construction, the L11 is the smallest unit in its class. Battery life is 40 to 50% greater. And its crystal clear output signal lets you operate more systems simultaneously than ever before.

Of course, the L11's reliability is a given. After all, we have a family reputation to uphold.

For information on the L Series of wireless microphones and accessories, call 1-800-25-SHURE. The Sound of the Professionals®... Worldwide.

# SHURE

## The Only Wireless That Lives Up To Its Name.



**THE SHURE WIRELESS  
L SERIES**

Circle 205 on Reader Response Card



L4 DIVERSITY WIRELESS REC

POWER

## LETTER FROM THE EDITOR

# NSCA Expo Coming Up

A press release issued by the National Sound and Communications Association hit our desk today offering preliminary information on the NSCA Expo coming up. The relevant dates are April second through fourth. The place is Orlando. The venue is the Orange County Convention Center.

The press release states the objective of Expo as "Greater Contractor Profitability," an objective we can all support. Per Haugen, the Expo Chairman, says, "Everything at the Expo and Conference is aimed at that one goal." Haugen goes on to say that although the economic situation seems to be getting a little better, "we're still not out of the major slump. The surviving contractors will be those who are best prepared for lean times and slow growth. The survivors will be managed by skillful leaders committed to keeping up with new technologies."

Any comments out there?

Approximately 400 exhibitors are expected at this year's Expo. Social events will include the Contractor's Caper sponsored by independent rep companies, and the West Penn Wire party on Saturday evening. Discount tickets to Disney World are being offered through NSCA.

The Clarion and Peabody hotels are "co-headquarter" hotels and are next to and across the street respectively from the Convention Center. Free shuttle buses will run from the Orlando Marriott and Quality Inn Plaza to the Convention Center.

Educational seminars and courses will again be offered. Basic and Advanced Sales and Estimating courses are being offered two days before the Expo floor opens as are MATV and CCTV courses. Certificates of completion are issued to those attending. In addition, more than 100 hours of seminars will be conducted during the NSCA Expo, including four tracks — sales, management, audio and specialty.



The annual NSCA meeting will take place at 8 am on April 2nd. The keynote address will be delivered by Colonel Charles W. Scott, the former Iranian hostage. The title of his speech is "Responding to Adversity," which seems like a gross understatement considering his experience of 444 days as a hostage in Iran. NSCA says, "The techniques that Colonel Scott mastered in an Iranian prison can help us manage our stress — whether we're raising a family or trying to succeed as a contractor."

During the Expo you can again learn via television. Testa Communications will be producing NSCA-TV news, the daily news program at NSCA. The program is transmitted to convention hotel rooms and to monitors on the exhibit floor. We're beginning to collect information now on what will be hot and new at NSCA, and we'll impart that information to you via television and in our post-show issues of Sound & Communications. Our reporters will be in and around the show, and we'll be informing you as things happen.

We'll see you at NSCA.

Best regards,

Judith Morrison  
Editor in Chief

## SOUND & COMMUNICATIONS

Publisher/Editorial Director  
Vincent P. Testa

Editor-in-Chief  
Judith Morrison

Technical Editor  
Mike Klasco

Associate Editor  
Steve Jacobs

Research Assistant  
William F. Cordo

Contributors  
Bradley Bassett, Keith Clark,  
Steven J. Orfield, Neil Shaw

Technical Council  
Dr. Mort Altshuler  
Professor Audiology, Hahnemann  
University, Chief of Audiology, V.A. Hospital,  
Phila, PA

C. Leroy James  
Rees Associates, Inc.  
Richard N. Jamieson  
Jamieson and Associates, Inc.

Russell Johnson  
Artec Consultants, Inc.

Joel Lewitz  
Lewitz and Associates

Daniel Queen  
Daniel Queen Associates

Jon Sank  
Cross Country Consultants

Neil A. Shaw  
Menlo Scientific Acoustics, Inc.  
William R. Thornton  
Phd, PE

Art Manager  
Alicia Celli

Artists  
Janice Kallberg, Janice Pupells,  
Kerri Reilly, Wendy Ser, Lori Vilardi,  
Colleen Warenik

Production Manager  
Michelle Montoya

Electronic Composition  
Diane Catanzaro  
Kim Marchica

Circulation Director  
Debbie Vandenberg

Advertising Manager  
John Carr

Classified Ad Manager  
Patricia Torrisi

Traffic Manager  
Ron Perone

Director of Sales and Marketing  
Nancy Davis

Editorial and Sales Office  
Sound & Communications  
25 Willowdale Avenue  
Port Washington, New York 11050  
(516) 767-2500  
FAX: (516) 767-9335



Sound & Communications • DJ Times  
Post • Producer  
Sound & Communications Blue Book  
The Music & Sound Retailer • The Retailer Red Book  
The Music & Sound Buyer's Guide  
CES-TV News • NAB-TV News • NAMM-TV News  
NSCA-TV News • AES-TV News



# Small Wonder

ASHLY was founded in 1972 with the stated goal of producing professional audio equipment that would set new standards for sonic excellence and reliability. The Company originally manufactured large mixing consoles with on-board signal processing for touring sound systems. Later, the consoles' built-in processing components were offered as separate rack-mounted units. The initial product line consisted of limiter/compressors, parametric equalizers, and a full selection of electronic crossovers. ASHLY added power amplifiers to its product offerings during the late '70's, and soon gained a solid reputation for the amps'

outstanding sonic performance and incredible reliability.

Building on this background of success and technological innovation, ASHLY has set out to expand its amplifier product line to encompass new markets. The new model SRA-120 professional stereo amplifier has been developed toward this goal, and offers superior sonic quality, rugged construction, and many useful features in a single rack space chassis. The compact SRA-120

is suitable for full-range applications, such as small control room monitor systems or as an ideal headphone distribution amp. With its excellent signal bandwidth, the SRA-120 is also well-suited for driving the high-end of a bi-amplification sound system setup.

The amplifier will deliver 60 watts per channel into 4 ohms stereo, 45 watts per channel into 8 ohms stereo, or 120 watts total into 8 ohms mono-bridged. Its design is based on "Class A" voltage amplifier stages with a complementary bipolar output section for low distortion and excellent overload behavior. Features include turn-on delay circuitry and instantaneous turn-off to eliminate any transients to the speaker. Each channel will also independently turn off its output if an overheated condition occurs.

This model also features rear panel switches to select between two choices of input sensitivity, stereo or mono operation, or normal or bridged mode. Rear panel input connections may be made via 1/4" balanced phone jacks or barrier strips with ground lift provision. Level attenuators for each channel are provided on the front panel, along with a stereo headphone jack. Status L.E.D.'s on each channel include signal present, clip alert, and "protect-mode" indication.

The SRA-120 is approximately 10" deep and weighs in at under 20 pounds, yet has performance characteristics and features typically found only in larger, more costly competitors. All Ashly amplifiers are covered under the company's exclusive Five Year Worry-Free Warranty program, offered at no extra cost to the user.

- 60 WATTS PER CHANNEL INTO 4 OHMS
- 45 WATTS PER CHANNEL INTO 8 OHMS
- 120 WATTS BRIDGED-MONO INTO 8 OHMS
- SWITCHABLE STEREO, MONO, BRIDGING MODES
- INPUT SENSITIVITY SELECT SWITCH
- 1/4" PHONE JACKS AND BARRIER STRIP INPUTS
- CLASS A FRONT END
- TOROIDAL TRANSFORMER
- TURN ON DELAY
- INSTANTANEOUS TURN-OFF
- INDEPENDENT THERMAL PROTECTION
- STEREO HEADPHONE JACK
- CONVECTION COOLED

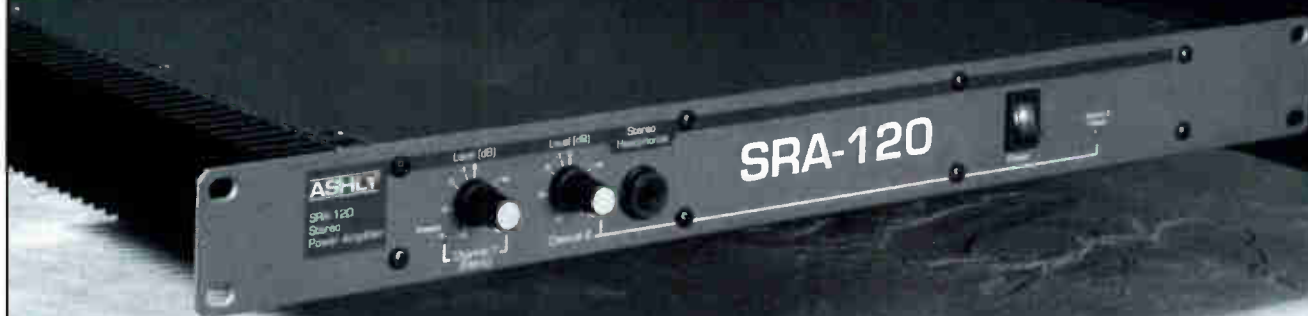

Ashly Audio Inc., 100 Fernwood Avenue, Rochester, NY 14621 • Toll Free: 800-828-6308 • 716-544-5191 • FAX: 716-266-4589  
In Canada: Gerraudio Dist Inc., 2 Thorncliffe Park Dr - Unit 22, Toronto, Ontario M4H 1H2 • 416-696-2779 • FAX: 416-467-5819

**ASHLY**

Circle 206 on Reader Response Card



# NEW! 8-BUS CONSOLES

**IF WE  
MACKIE  
HE'D  
OUR NEW**

Built-in, test-instrument-grade, ultra-low radiation **POWER SUPPLY** with toroidal transformer and external heatsink.  
Two **TAPE OUTPUT SUBMASTER** jacks per bus (total of 16). Balanced or unbalanced.

+4dBu balanced **TAPE RETURNS**, switchable to -10dBV unbalanced.  
Balanced **MIC**, balanced **LINE IN**, **PHASE invert**, **DIRECT OUT** & **CH. INSERT** on every channel.

All channels have Mackie's renowned discrete, wide-bandwidth **MIC PREAMP** circuit for ultra-high headroom & low noise. All mic inputs have +48V phantom power with switches in groups of eight channels.

Optional **METER BRIDGE**.

**6 AUX SENDS** with Solo and Solo LED.

**MIX B/MONITOR** section can be assigned to L/R Mix or used as direct out.

**6 STEREO AUX RETURNS** with 20dB gain. 1 & 2 are pannable; all have Solo and can be used in stereo or mono.

**4-BAND EQ** with "Expensive British Console Sound." Includes **TRUE PARAMETRIC HI-MID**, swept LO MID, shelving HI & LO plus 18dB/oct hi pass (lo cut) filter at 75Hz.

**TWO SEPARATE HEADPHONE SECTIONS** can be used totally independently of each other with source selection between Control Room & any combination of Aux 1, Aux 2, Mix-B or External source. Solo allows control room to hear what musicians are hearing in their headphones.

**SPEAKER** section with separate Control Room & Studio levels. Source selection between L/R mix, Mix-B, Tape & External. Can be switched to Mono.

**TALKBACK** with assign to all Tape outs, Aux 1, Aux 2 or Phones.

-40 to +10 bar graph **LED DISPLAYS** for each submix channel & Solo/Main (with +28dB CLIP LEDs).

**ALTHOUGH** there are 8 buses, 16 tape outs are created by a second set of output jacks.

Built-in talkback MIC.

Conventional faders are overscreened with a second layer of resistive material in an attempt to create a logarithmic taper. Our **PRECISION NETWORK FADERS** are single-layer screened with both the primary linear resistive elements and also a complex extra element to create a true logarithmic curve as found in ultra-expensive console faders (blue graph line).

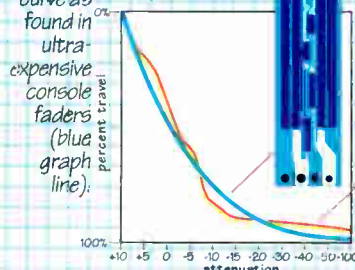

**MIX-B/MONITOR** section on each channel effectively doubles number of inputs during mixdown.

**T**HANKS TO ADVANCES in component technology and quality, our ability to buy parts in large quantities — and a lot of fanatical Mackie engineering — you can "have it all" without hocking the proverbial farm.

**BECAUSE WE SPECIALIZE IN MIXERS** (and because we're probably a little crazy), we began the design of these consoles by first asking ourselves, "What is it that makes the finest British consoles perform the way they do? — And how much of that can we duplicate (using modern materials and methods) on far less expensive boards?"

**YE OLDE ENGLISH SOUNDE.** For example, older Neve consoles have much wider-band mid EQ than lower priced consoles — it really has an effect on overall sound quality. So we incorporated the same capabilities on our new 8•Bus Series (along with our trademark low noise and high headroom). This also enabled us to add the flexibility of a variable "Q" control for true parametric Hi Mid EQ. It was an expensive proposition, but well worth it in terms of sound quality. We also wanted the same kind of true logarithmic



# HADN'T THREATENED TO HIT GREG UPSIDE THE HEAD WITH A RANCID SALMON, PROBABLY STILL BE ADDING FEATURES TO 32, 24 & 16-CHANNEL 8-BUS CONSOLES.

24 channels just \$3995! Finally, the "quality gulf" between \$20,000+ imported consoles and more affordable boards has been eliminated. No longer must budget considerations force you into compromise over questionable sound quality, poor EQ, hard-to-use layouts or unreliable mechanical designs. Only Mackie Designs could spawn values like these!

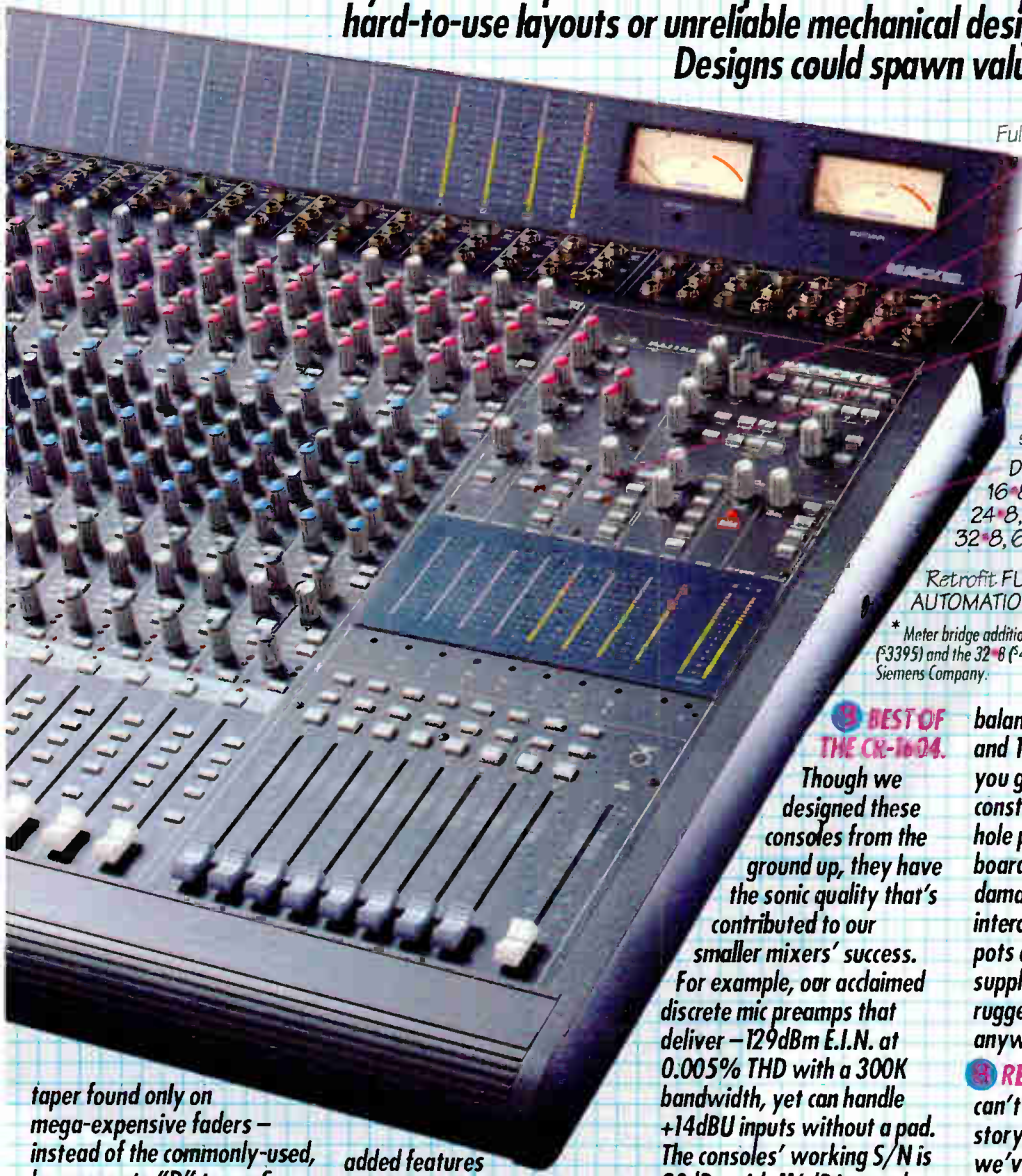

Full SUB-MASTER and MASTER inserts.  
Rugged STEEL CHASSIS.  
SEALED rotary potentiometers resist dust and liquids.  
Two independently assignable HEADPHONE monitoring sections plus separate TALKBACK and SPEAKER sections.  
DIMENSIONS (H x W x D):  
16" 8, 6" x 26.7" x 28"  
24" 8, 6" x 35.5" x 28"  
32" 8, 6" x 44.3" x 28"

Retrofit FULL-FADER/MUTING AUTOMATION available in the future.

\* Meter bridge additional. Equally low prices for the 16" 8 (\$3395) and the 32" 8 (\$4795). Neve is a trademark of Neve, a Siemens Company.

## BEST OF THE CR-1604.

Though we designed these consoles from the ground up, they have the sonic quality that's contributed to our smaller mixers' success. For example, our acclaimed discrete mic preamps that deliver -129dBm E.I.N. at 0.005% THD with a 300K bandwidth, yet can handle +14dBu inputs without a pad. The consoles' working S/N is 90dBu with 116dB internal headroom. Bottom line: For hard disk recording, ADAT or DAT, you've found your board.

**OPTIMIZED FOR PA AND RECORDING.** Along with elaborate monitor capabilities,

balanced XLR main outputs and 18dB/oct. hi pass filters, you get non-flexing steel construction, fiberglass thru-hole plated, horizontal circuit boards that minimize impact damage, gold-plated interconnects, sealed rotary pots and a built-in power supply. You won't find more rugged, compact PA boards anywhere.

**READ ALL ABOUT IT.** This ad can't possibly tell the whole story of the design innovations we've packed into these consoles. Call us right now toll-free for a comprehensive 8-page brochure, the name of your nearest Mackie 8-Bus Dealer... maybe even info on the type of salmon that we threatened Greg with.

In-line FLIP reverses tape and mic/line inputs. Incredibly nifty feature but hard to explain in an ad, so read our brochure to appreciate it.

AUX SENDS 1-2. PRE button selects pre-fader/post EQ or post-fader/post EQ.

AUX 3-4 / 5-6. SHIFT changes 3-4 to 5-6.

SOURCE selects signal source of

AUX 3-4/5-6 from ch. strip to ch. Mix B/Monitor send so you can build an effects mix to assign to phones during tracking.

True 3-control parametric HI MID EQ with ultra-wide 500-18k frequency sweep range. Bandwidth can be adjusted from a very wide 3-octave width to a very narrow 1/2-octave width. 15dB boost/cut.

LO MIDEQ with ultra-wide 45Hz-3K sweep, 15dB boost/cut.

±15dB shelving HI (12kHz) & LO (80Hz) EQ.

Multi-purpose 18dB/oct. LO CUT filter @75Hz. Cleans up "mix mud," creates a "neo-peaking" bass control, cuts PA rumble, etc.

MIX-B (Monitor) section with pan, level & source. Functions as independent monitor section, extra stereo Aux send during mixdown or doubles number of inputs during mixdown.

Mix-B SPLIT EQ assigns HI & LO EQ to Mix-B.

Constant power, buffered PAN pot for rock-solid panning.

Selectable SOLO with CHANNEL METERING not only allows soloing in full stereo perspective but also displays soloed channel operating level on master L/R meters so input trims can be adjusted for optimum levels.

At last! HIGHLY ACCURATE 100mm FADERS on an affordable console! (See explanation at left).

taper found only on mega-expensive faders - instead of the commonly-used, less accurate "D" taper. So we commissioned a totally new custom 100-mm fader with the same taper as the most expensive British faders, yet at a fraction of the cost.

**DOUBLE THE INPUTS & MORE.** Each channel has in-line monitoring that effectively doubles the number of inputs (48 on our 24" 8, for example). We also

added features we personally find useful such as dual independent head-phone systems and separate MIX-B monitor section with Split EQ. The consoles' internal -10dBV to +4dBu level conversion allows use with semi-pro tape decks without the inherent noise penalty found in semi-pro mixers that operate at 10dBV internal levels.

12230 WOODINVILLE DR. • WOODINVILLE • WA • 98072 • USA

# MACKIE.

PHONE TOLL-FREE 800/258-6883 • FAX 206/487-4337

Circle 207 on Reader Response Card





# THE SESSIONS OF THE 124TH ACOUSTICAL SOCIETY OF AMERICA MEETING

By Neil Shaw

**The 124th Meeting of the Acoustical Society of America was held in New Orleans at the Fairmont Hotel from 31 October to 4 November 1992.**

Over 79 technical sessions, with 770 papers, in 14 different technical specialties, were given. There were also 13 technical committee and standards committee meetings. The diverse technical specialties covered acoustical oceanography, animal bioacoustics, architectural acoustics, bioresponse to vibration, engineering acoustics, musical acoustics, noise, physical acoustics, psychological acoustics, physiological acoustics, speech communication, structural acoustics and vibration, underwater acoustics and education in acoustics. Papers at these sessions provided participants with information regarding "leading edge" advances in techniques, understanding and processes in the field of acoustics. Many of these will soon be affecting the sound and communications industry in the form of new products, better products and more effective products.

The sessions on virtual environment were sponsored by various technical committees. This joint sponsorship allowed the interdisciplinary quality of this subject to be explored. There

were four sessions jointly sponsored by the technical committees on architectural acoustics, psychological acoustics and physiological acoustics, one session sponsored by architectural acoustics and psychological acoustics, and one session sponsored by architectural acoustics and musical acoustics. These sessions included papers that discussed the design of sound systems for the technology and development of devices that also simulate the touch and feel (haptic sense) of an object. Papers also discussed simulators of room acoustics and the simulation, or "auralization," of rooms, as well as techniques for simulation of the motion of sounds using the laws of mechanics.

**AN EXAMPLE OF  
A VIRTUAL  
ENVIRONMENT IS A  
FLIGHT SIMULATOR.**

**AN EXAMPLE OF  
A TELEOPERATOR  
ENVIRONMENT IS  
ARTHROSCOPIC  
SURGERY.**

The session on The Auditory Channel — Synthesizing Acoustic Objects included a paper from the MIT Virtual Environment and Teleoperator Research Consortium. This paper provided an overview of the field and what the important research problems and application areas associated with virtual environments are. Note that a vir-

tual environment is when you are experiencing and are proactive/reactive to computer controlled stimuli; a teleoperator environment is when you are experiencing and are proactive/reactive to real stimuli. An example of a virtual environment is a flight simulator. An example of a teleoperator environment is arthroscopic surgery.

There were also papers from the NASA/Ames Research Center that discussed integration of virtual acoustic systems, and the spatial information they provide, into an integrated information system with visual displays. One feature would be the offloading of information from the visual channel to the auditory channel, for example, in a spacecraft. This would enable the visual channel to carry less information and unclutter the visual display.

The session on Computer Modelling in Room Acoustics presented papers from Menlo Scientific, The Technical University of Denmark, Altec Lansing Corp., Chalmers University of Technology, The Telaske Group and RPG Diffusor Systems. These papers described the current efforts in modeling acoustic spaces using personal computers and the problems that still exist. One of these is how to handle the reflection of a sound wave from a surface; How much is specular? How much is diffraction? How much is diffused?

There was a demonstration session — Computer Modelling and Virtual Environments — which included equipment and system demonstrations and poster presentations. This session

---

*Neil Shaw is a partner at Menlo Scientific Acoustics.*



included demonstrations by The Acoustics Laboratory from the Technical University, the Room Acoustics Group of the Chalmers University of Technology, Altec Lansing, Bose Corporation, the Music and Cognition Group of the MIT Media Lab, the Biomedical Department of Boston University and Crystal River Engineering. This was a well attended and appreciated session, and there were long lines to try the simulations. The Crystal River demonstration, which seemed especially popular, consisted of a hood with stereo visual display and binaural headphones. The visual and audio displays moved as you did since you also wore a transducer that measured if you turned.

The session on Auralization and Architectural considerations was concerned with the computational aspects for and the verification of accuracy of audible simulation — auralization — systems, as well as computational models, wave-front synthesis, early reflection perception and localization problems and solutions.

A session titled The Haptic Channel discussed the problems, and progress made, in dealing with the sense of touch in a virtual environment. An example is how you provide feedback to a haptic glove so that you know how strong you are grasping a virtual guitar? Neural mechanisms and their impact on implementation, kinesthetic acuity in humans (especially fingers), design of haptic interfaces and haptic illusions in human perception of “virtual items” were presented.

The final session dealing with virtual environments concerned itself with multichannel considerations. One paper in this session, from the Adaptive Systems Branch of the Naval Research and Development Laboratory in San Diego, discussed the experiences gained in multichannel telerobotic systems and use of these experiences as background in the design of virtual environments. The Naval Postgraduate

*(continued on page 64)*

# It's Small... It's Quiet... And It'll Never “Turn” On You.



## Why waste great performance?

**Directional microphones are of little use if they point backwards, sideways, or in any direction but at the source.**

The new CH230 miniature back-electret condenser microphone from Electro-Voice is suspended from a cable with a braided shield (instead of spiral). The result: the mic stays where it's supposed to be instead of spinning out of control with changes in temperature and humidity.

Did we mention great performance? The CH230's dynamic range of 105 dB is almost 14 dB higher than most competitive models, and a humbucking transformer reduces hum pickup by more than 20 dB. A steel shield over the preamp eliminates electronic and radio-frequency interference, while screw terminals on the output provide greater long-term reliability than typical three-pin connectors.

Ideal for miking choirs, orchestras and live theatre, the new CH230 from Electro-Voice puts a new “spin” on great performance.



Also available in white (CH230W)



# THE POST-TECHNOLOGY AUDIO DEALER

By Steven J. Orfield

**The consumer and professional audio fields have always been entangled in an interesting contradiction. While the products of the field are often “high tech” in their design (and/or in their marketing), there has been little predictable about technology in the business of the field itself.**

Much like the retail grocery environment before the entry of the big chains, the audio dealer business is, on the whole, a ma and pa business in a number of ways.

Three issues in particular suggest that audio dealerships are generally “pre-technology” companies:

- There are no major groups of audio dealers operating under similar business practices in the United States (marketing and engineering).
- Dealers have no high-level, preformulated engineering practice.
- Dealers do not sell a “product,” but rather sell a custom process of design and products.
- Dealers have no consistent, high quality marketing support; the quality

*Steven J. Orfield is the President of Orfield Associates Inc. in Minneapolis, Minnesota.*

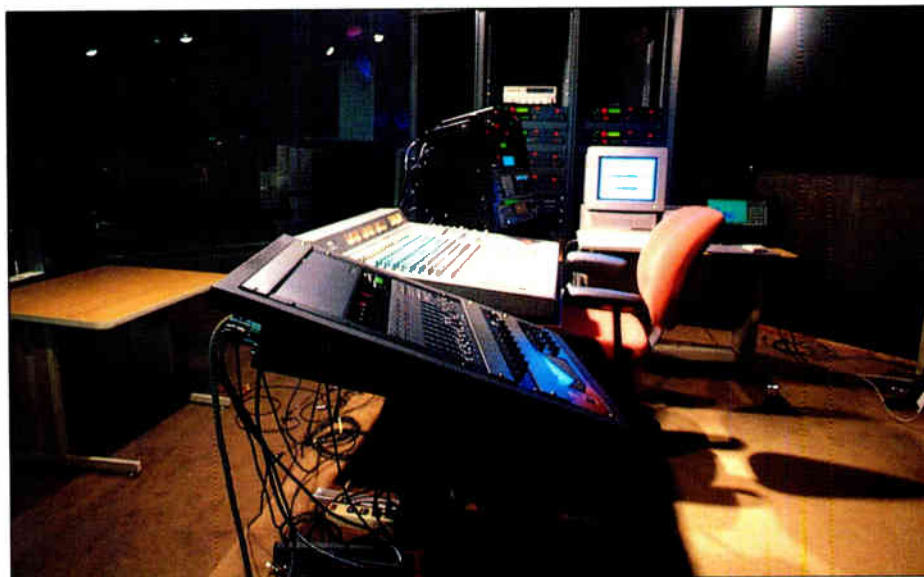

*Control Room Demo Set-Up.*

of the effort is determined by the individual salesman.

As a result of this lack of formal structure and practice in the audio field, the audio salesman has burdens much greater than a salesman in a post-technology industry (computers, office machines, copiers, etc.). While these higher-tech companies place the burden of sales on the sales staff with great expectations of success, the audio dealer typically places a specific and greater set of burdens on its sales staff:

1. Perform the marketing task.
2. Perform the programming task (determine what is needed).
3. Perform the pre-engineering (and possibly engineering) task.
4. Perform the budgeting task (what is to be spent).
5. Prepare a quotation and develop a presentation to “sell” the project.

6. Supervise or inspect the installation and interface with the client after the sale.

Of these tasks, only three are generally associated with high-technology sales, and these are pro-gramming (number 2), budgeting (number 4) and sales (number 5).

Thus, in the audio-dealer field, the success of the organization is to a large degree dependent upon assuming that each of the salesmen are, in and of themselves, profit centers which will succeed or fail by their own devices (independent of the organization and training of the firm).

With this dealer industry background in mind, there has long been a need for formalization and organization of the audio dealer field into a “post-technology business,” and this article describes our efforts to standardize dealer design and



# "It's no longer necessary to sacrifice musical fidelity for vocal intelligibility."

Kenton Forsythe, Vice President of Engineering, EAW

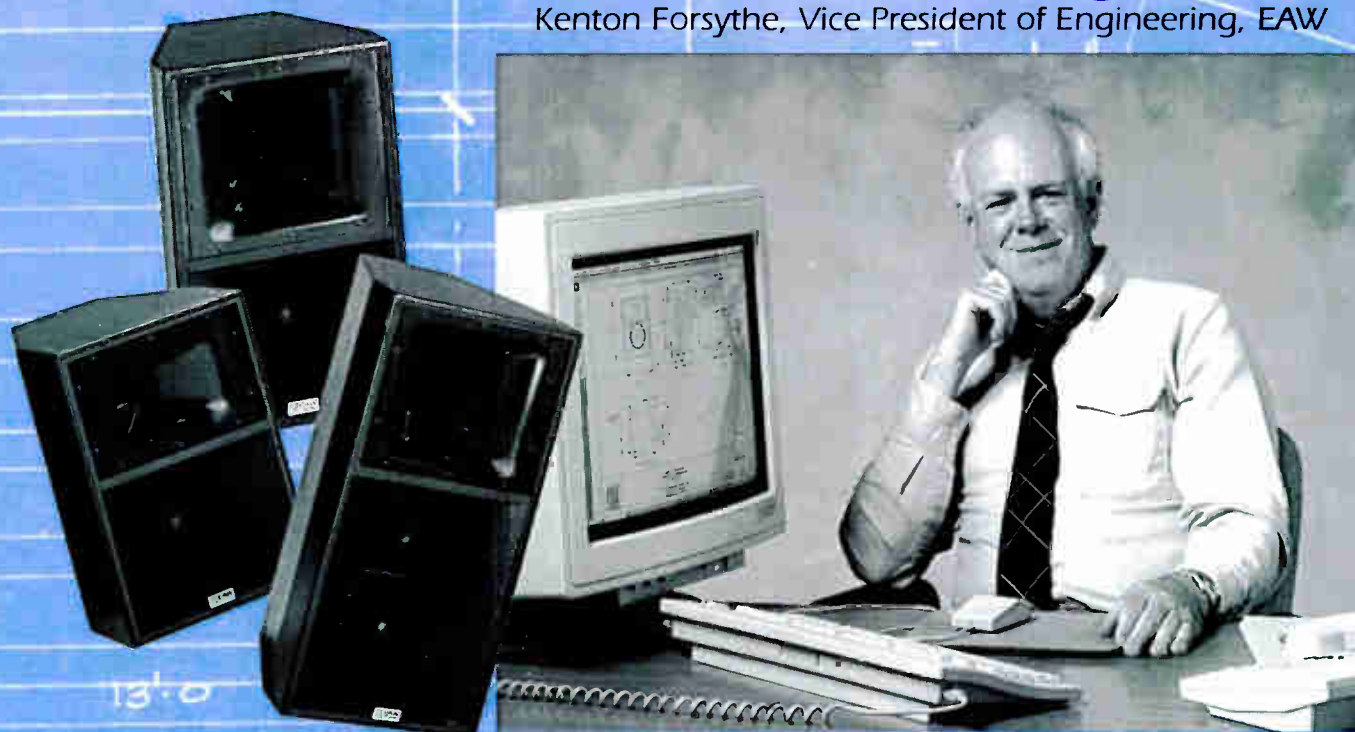

## MH Series Engineered Sound Systems—part of a new series of tools for acoustical designers from the engineers of Eastern Acoustic Works.

- Effective pattern control:** .....60° or 90° horizontal by 40° vertical.
- Consistent power response:** .....±3 dB from 160 Hz to 19 kHz.
- High peak output:**.....140 dB peak SPL—extremely low distortion.
- Predictable arrayability:**.....Trapezoidal cabinets match horn coverage angles.

**O**n world tours and in permanent installations, for chart-topping rock bands and renowned symphonies, Virtual Array™ Technology has set new standards of musical fidelity from New York to Tokyo. Now Kenton Forsythe has used VA™ design principles to develop a new set of high-performance tools for engineered sound systems. This new approach merges the predictability and intelligibility of constant directivity horns with the superior definition and output of VA™ touring systems. It's a combination that has already turned several acoustical nightmares into dream projects.

Consistent pattern control is central to VA™ design. The horn-loaded MH Series controls dispersion precisely in both horizontal and vertical dimensions, over a much wider frequency range than previous devices. Acoustic energy goes where you aim it, not onto reflective surfaces. Minimal cabinet interaction allows accurate, predictable arrayability.

MH Series horn-loaded midbass cone drivers are the centerpiece of a true three-way design. Add EAW low-frequency systems to build a high out-

put, low distortion system that handles everything from lectures to a full spectrum of music.

Standard MH Series configurations solve the problems of typical engineered sound systems. For unusual applications, you can call on EAW's advanced engineering and manufacturing capabilities to ensure success.

If you're always looking for better ways to solve difficult sound engineering problems, we invite you to apply for membership in the EAW Acoustical Performance Partnership program. Or contact us for full information and specifications on the new MH Series. Either way, you sacrifice nothing—except, perhaps, a few preconceptions.

**EAW**  
EASTERN ACOUSTIC WORKS

Eastern Acoustic Works, Inc.  
One Main Street, Whitinsville, MA 01588  
(800) 992-5013 • (508) 234-6158 • Fax (508) 234-8251  
Circle 212 on Reader Response Card



marketing practice to achieve this goal.

### BACKGROUND

In 1984, Orfield Associates, as an acoustical, A-V and lighting consulting firm, began providing audio (and later video) dealer support services, and these services covered a broad variety of activities:

- Sound system design.
- Dealer technical training.
- Product selection assistance.
- Preliminary site testing on projects.
- Standardized preformatted designs and budgeting procedures for sound systems design.

This initial work was solicited by audio dealers based on the view that they needed either assistance with sound system design and room acoustics or alternately, they needed a con-

sultant to "protect" them from other consultants' specifications and attendant risks of bidding on and taking responsibility for work which they had not originated.

Elemental in this dealer interest was the fact that the dealer was a partial

### IF THE PROJECT DID NOT WORK OUT, THE DEALER COULD BE BLAMED FOR SYSTEM DESIGN (EVEN IF HE WAS ONLY A BIDDER).

player in the typical project and yet his risk was not limited; if the project did not work out, the dealer could be blamed for system design (even if he was only a bidder) and could also be blamed for degradation in system per-

formance due to the problems of complex or inadequate room acoustical performance. Also involved in the dealers' interest was the idea of using outside resources for design and testing, and thereby limited equipment investment, technical training needs and salesmen's "engineering" time.

In our early work with audio dealers, there was a clear distinction between the quality of system installation and the quality of system performance. Even if the dealer was only responsible for the installation, he was often blamed for the lack of system performance. Thus, our early response to this dilemma was on two fronts. On one hand, we provided the dealer with assistance in developing disclaimers for responsibility when he had not, in fact, executed the design. On the other hand, we assisted the dealer in deter-

## INTRODUCING THE GALAXY AUDIO HOT SPOT PM

**N**ew from Galaxy Audio, the Hot Spot PM is destined to become the loudspeaker of choice for installations requiring a small high performance voice and music system. Featuring two five-inch drivers, the Hot Spot PM series approaches the efficiency of a horn while delivering superb intelligibility over a frequency range from 150Hz to 15kHz. The PM's wide range of versatile options make it an appropriate choice for virtually every compact speaker installation.

- Model PM: 120 watts power handling capacity with nominal impedance of 16 ohms.
- Model PM-B: includes swivel wall/ceiling bracket.
- Model PM-70/100: 70 or 100-volt versions with selectable taps from 3.5-50 watts for use in distributed systems.
- Model PM-F: available in black, white, or paintable primer gray.
- Model PM-W: includes weather resistant cone treatment.
- All models feature rugged ABS enclosures with metal grille.
- 3-year warranty.

For additional information and literature about the Hot Spot PM series or the entire line of Galaxy products, contact your local representative or Galaxy Audio directly at (800) 369-7768.



**GALAXY  
AUDIO**

625 East Pawnee Avenue  
Wichita, Kansas 67211  
316/263-2852  
800/369-7768 ■ Fax 316/263-0642

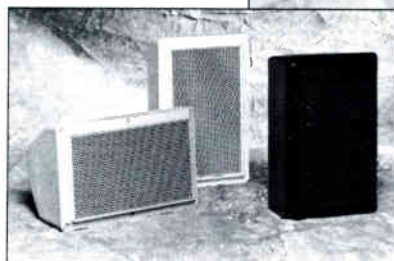

Made in U.S.A.

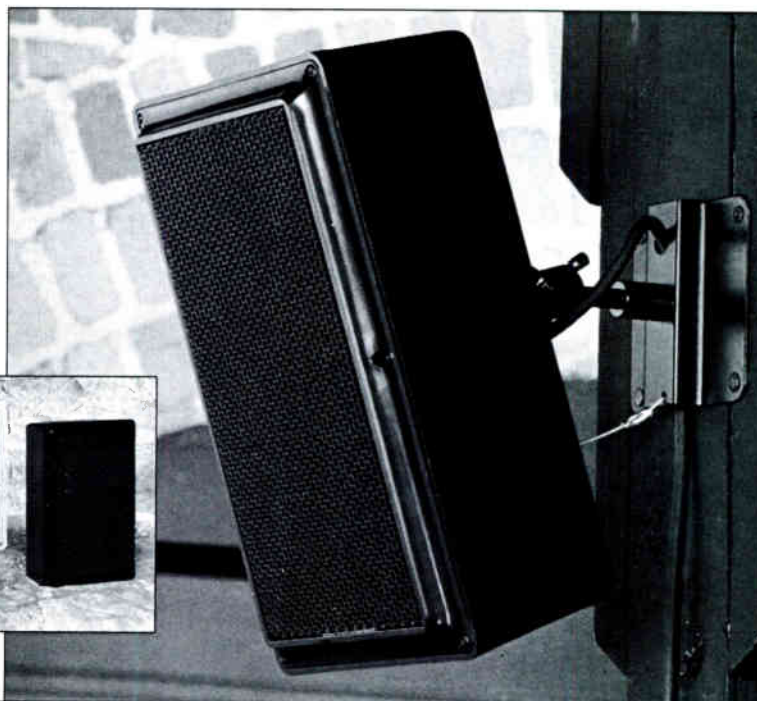



mining the appropriate room acoustics and audio design solutions to insure success on projects which were undertaken and designed by the dealer himself.

Although these services were often helpful, the problem of the audio dealership underlying these issues quickly became apparent, and this related to the cost of doing business. In order to compete on a project successfully, the dealer had to perform a "preliminary design," had to assemble a quotation and had to promote that solution to the client. If the project in question was a \$10,000 project, the dealer might spend \$1,000 — \$2,000 in time and effort (in speculative services) in chasing the project. If the dealer was 50-percent successful in receiving contracts based on his proposals, his net cost of marketing might range from 20-30 percent of total sales. If his success was less, there was increasing reason to believe that the risk (speculation versus results) was too great.

**IN ORDER TO  
COMPETE ON  
A PROJECT  
SUCCESSFULLY,  
THE DEALER HAD TO  
PERFORM A  
"PRELIMINARY DESIGN,"  
HAD TO ASSEMBLE A  
QUOTATION AND  
HAD TO PROMOTE  
THAT SOLUTION  
TO THE CLIENT.**

Unlike the salesman in a "post-technology" product field, the salesman in the pro-audio field was faced with operating a multifaceted business on his own to achieve success, and the effort on the average project was often a high cost risk with no assurance of success. As a corollary, when a dealership lost a good salesman, there

was no continuation in the methods and skills of his replacement. The new man would hopefully be as good or better, but he would always be different in his knowledge base, his product interests and in his methods. This lack of continuity provided the interesting result that when personnel moved from one firm to another, the customer base would often move with the em-

ployee, as that was where he would find predictability and continuity.

Additionally, the new dealer hiring the salesman from the old firm would often attempt to gain access to the lines of the old dealer, as this was the knowledge and specification base of his new employee. As this typical new employee event played out, often the person in the poorest position of con-

## **DATABEAT LETS YOU... PLAY IT YOUR WAY!**

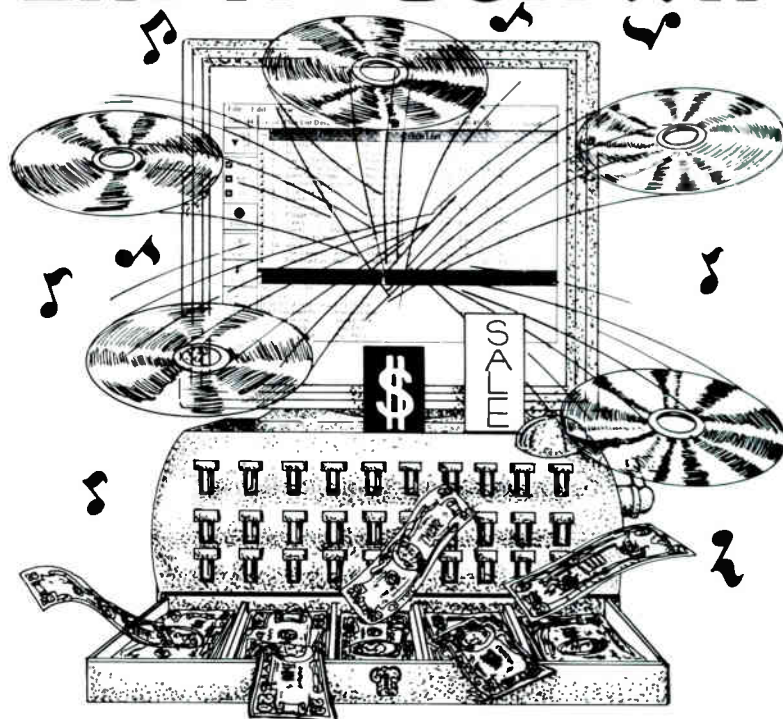

Finally, a solution to your music programming headaches! **DATABEAT** software combined with the latest in laser disc technology allows your music program to be as unique as your business. **IDEAL FOR** Pubs, Military Clubs, Night Clubs, Hotels, Retail and Recreational Centers of all types

### **DATABEAT FEATURES:**

- Control of unlimited number of CDs
- Completely automated or instantly DJ interactive
- Security for your investment
- Over 500 international users including Hard Rock Cafe, Virgin Mega Stores, Hilton Hotels, Cruise Lines, etc.

### **YOU WILL BENEFIT FROM DATABEAT WITH:**

- Hundreds of hours of professionally cued and mixed music
- Reducing DJ time and expense
- Increased sales and expanded repeat customer base
- Making money while saving money

*DEALER INQUIRIES WELCOME*

**For additional information, pricing and demo, call us today!**

**WUSA**  
WALPORT USA

840 Bond Street • Elizabeth, NJ 07201

1-908-527-1223 • FAX: 908-527-8772 • TELEX: 139381 WALPORT USA

The racks  
you've been  
waiting for

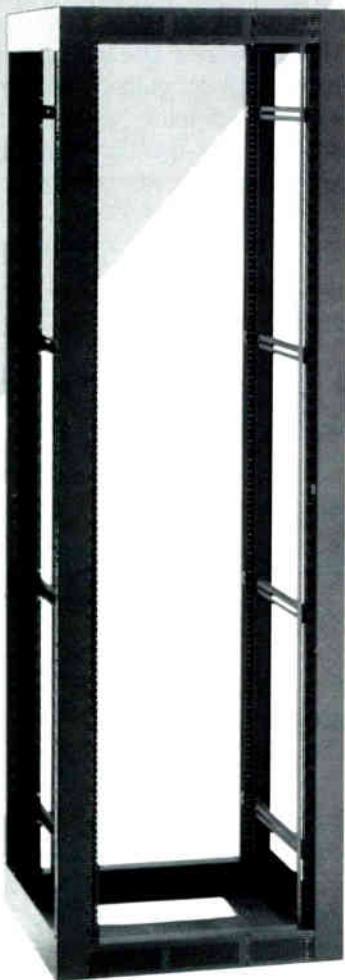

- Quick Delivery
- Time Saving Features
- Modern Looks



Middle Atlantic Products

P.O. Box 29 5142 Commerce Ave., Unit C  
Riverdale, NJ 07457 Moorpark, CA 93021  
201-839-1011 805-529-6104  
FAX 800-392-3955 FAX 800-645-7509

Circle 268 Reader Response Card

Testing  
Instrumentation.

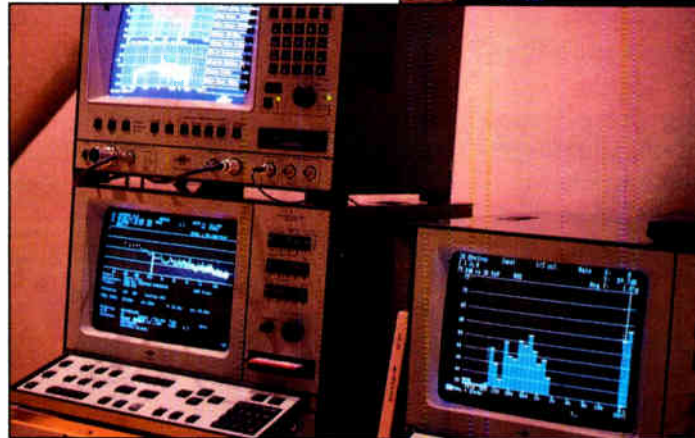

Equalization  
on large  
screen.

trol was the previous dealer, as there was little he could do to easily resolve this crisis. His dealership was not more than an assemblage of his personnel, and its stability was based on the stability of his employee base.

In summary, the very issues which made the dealer business costly and difficult to operate made it hard to retain stability within the dealer business; thus, there was clear need for a new paradigm, what we refer to as the "post-technology" dealer.

#### THE NEW DEALERSHIP CONCEPT

Orfield Associates worked on the concept of this new dealer type for over a year, discussing it with a number of dealer organizations across the country who were already clients. This included the old Audio Group Franchise, Muzak and a number of nationally established multi-dealer networks. This was due to our preliminary belief that this type of structure could best be established under the umbrella of a large dealer distribution network. What we failed to find, partially due to the recession, was an aggressiveness on the part of dealer organizations to undertake a change in the industry without a very large base of dealers receiving those benefits.

On a second look, an alternative became apparent in considering the large non-exclusive dealer base of many large audio manufacturers. Many manufacturers in the past developed some type of dealer support network, based on engineering software and training, and the advantage of this approach was the large number of

**MANUFACTURERS  
WHO PROVIDE  
SIGNIFICANT  
SUPPORT SERVICES  
HAVE SEEN  
CLEAR EXPANSION  
OF THEIR  
MARKETS BASED ON  
THE CONCEPT OF  
EASING THE AUDIO  
DEALER'S BURDEN  
OF DESIGN.**

dealers who could be quickly incorporated. Additionally, manufacturers who provide significant support services have seen clear expansion of their markets based on the concept of easing the audio dealer's burden of design. If these past efforts have had any clear limitation, it has been that the



dealer still had a complex set of tools and software.

Even with better tools, the sales process was still essentially a custom process, and substantial time and effort was required by the dealer before a project could be quoted. Also, there has been an unwelcome effort on the part of many of these supporting

**THE BEST OF THE EFFORTS OF MANUFACTURERS TO ASSIST PRO-AUDIO DEALERS HAS BEEN QUITE LIMITED.**

manufacturers to force the dealer to use their products. (Over the past five years, my own firm has been told by two of these manufacturers that we would not be allowed to purchase their design software unless we could insure reasonable quantities of specification of their product.) As a result, the best of the efforts of manufacturers to assist pro-audio dealers has been quite limited.

In contrast to these past efforts, our concept was intended to provide the dealership with a set of choices to become increasingly independent of the current limits on the audio dealer.

Specifically, these objectives were outlined:

- Dramatically reduce the need for engineering support prior to the quotation of an A-V system.
- Standardize engineering practice via the use of specific training, manuals and cookbooks of solutions.
- Standardize software in use by all dealers, including engineering and marketing software.
- Standardize the sales and marketing training process via the use of specific training, manuals and sales aids.
- Provide off-site assistance to those dealers who desire it, via an engineering support staff, newsletters for dealer distribution to their clients, and other technical and market assistance.

**PORTABLE DSP RTA**

Lab • Studio • Live Sound  
Optional Printer & RS232 Ports



**STUDIO Test and Alignment:**

- 1/4 dB accuracy
- Fast machine alignment using standard test tapes
- Selectable filter slopes

**LIVE Equalization:**

- Voice rooms
- Eliminate feedback
- Large 85 dB window
- Scroll display

**Retail \$1500**

Contractor Prices Available



Box 500 • West Redding, CT 06986 • Ph (203) 938-2588 • Fax (203) 938-8740

Circle 269 Reader Response Card

**6" Ceiling Loudspeakers**

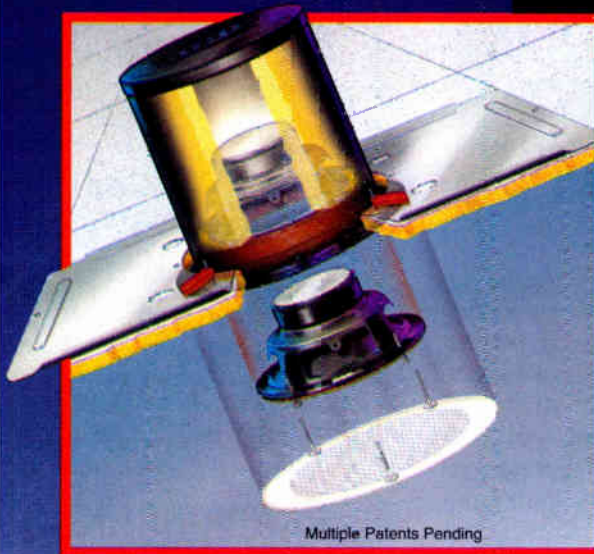

- Fidelity of an 8" System with Better Sound Coverage
- Coaxial and Full-Range Models
- Acoustic Enclosures
- Fast and Easy Installation
- Small Attractive Grilles
- No Exposed Hardware



**ATLAS/SOUNDOLIER**

ATAPCO SECURITY & COMMUNICATIONS GROUP  
3859 INTERTECH DRIVE / FENTON, MO. 63026  
TEL: (314) 349-3110 / FAX: (314) 349-1251

*Strategy Series*

6" CEILING LOUDSPEAKERS

*"an engineered plan for superior installation, performance & aesthetics"*

Circle 270 Reader Response Card



*Seminar Instruction.*

- Certify dealers who participate in training and who work with the support staff.

### **A POST-TECHNOLOGY DEALER SYSTEM**

Having worked through these issues over a number of years with a large number of dealers, I began to open a discussion of this new paradigm with a client of mine from previous efforts, Gerry Tschetter of Yamaha Professional Audio. Our initial views on this new dealer type were quickly quite parallel, and after a number of months of discussion, a project to develop this dealer process was defined and underway. The project outlined a joint development process, with Orfield Associates defining the overall program and developing the engineering tools and manuals, and Yamaha (with the assistance of Ken Barasch) developing the specific market support process and marketing manuals.

This dealer development program is being initially aimed at dealers selling projects in the \$5,000-\$20,000 range, and our first national ADD (Audio Dealer Design) seminar was held at Orfield Associates labs from Novem-

ber 16th to 18th and was instructed by Gerry Tschetter and Rick Pierson. The first day was an introductory "Audio Basics" course for newer initiates to the field, the second day was spent on audio engineering and acoustics in

**ALL OF THE PRESENTATION MATERIAL WAS PREPARED IN AN ALDUS PERSUASION FORMAT AND PRESENTED, ALONG WITH LIVE ANALYZER MEASUREMENTS, LIVE ON A REAR-SCREEN-VIDEO COMPUTER INTERFACE.**

audio, and the third day was entirely dedicated to issues of marketing audio services. All of the presentation material was prepared in an Aldus Persua-



*First ADD Graduating Class.*

sion format and presented, along with live analyzer measurements, live on a rear-screen-video computer interface; a notebook was developed for hand-out, and notes from this Persuasion presentation were provided supporting the video images. Finally, a full notebook of completed typical designs (a design "cookbook") was handed out.

To avoid the usual technical training process, the Orfield lab was prepared with a full stereo and mono Yamaha sound system installation, as well as mixing and simulation systems. Thus, the seminar shifted between technical discussion and perceptual demonstrations of the same issues either live or simulated via Yamaha processing systems.

The intent of this program over the next year is to train and certify dealers who will then be capable of selling and installing predesigned "System Products" or who can depend upon consulting support for any other type of audio or A-V system design, based on 800-number support lines, training and design software support, computerized AutoCAD translation and support, and consulting assistance related to audio and acoustics.

We expect that this program will be a model for the industry and the first of a new generation of programs to support the audio dealer who is committed to becoming a post-technology dealer in a pretechnology industry. This program has just been formally introduced at the NAMM show in January with Gerry Tschetter of Yamaha Pro Audio and myself in attendance. ■



## UHF's time has come.

With the introduction of the Samson UHF\* Series, we thought it might be helpful to provide you with new information about this technology.

### 1. UHF gets better reception.

Yes it does, in the sense that UHF operates at the higher frequency range of 902-952 MHz. There is a lot less *traffic* up in that bandwidth. And, more importantly, less RF interference and noise.

### 2. New UHF technology has recently been made available.

For the UHF Series, Samson put four of our finest wireless engineers on the case. Using up-to-date developments like Di-Electric filters, Gas-Fet and new cellular technologies, they were able to bring UHF up to a higher level of performance.

### 3. UHF sounds better.

A dangerous generalization perhaps, but it *does* have wider RF dynamic range. And because we're the first to use dbx† Noise Reduction in UHF, the resulting audio quality is even more impressive.

### 4. More frequencies are available.

Samson offers seven UHF frequencies that can be used simultaneously. If you're already running a lot of VHF on stage, you can place our UHF frequencies on top of these without any interference.

# EIGHT THINGS YOU SHOULD KNOW ABOUT UHF

### 5. Samson UHF offers more microphone options.

The all brass UH-4 hand-held transmitter is available with an incredibly wide variety of the industry's most popular mic elements. The streamlined UT-4 belt pack transmitter comes equipped with a broad range of high quality lavalier microphone capsules.

### 6. Samson UHF antennas set new standards.

Custom made so they are acutely sensitive to our bandwidth, Samson's high efficiency cellular antennas can be either front or rear-mounted. Because they are positioned at a 45° angle to the front panel, several UHF systems can be cascade-mounted in a single rack with all antennas in the clear.

### 7. UHF is more expensive.

**Until now.** Because of robotics assembly techniques and surface-mount technology, Samson was able to make UHF a realistically priced option for a whole new class of users.

### 8. Write for a free Samson UHF White Paper.

Find out more about UHF and one company's approach to this exciting technology. A higher method that promises clearer reception for everyone in the wireless future.

## **SAMSON®**

**WE ARE THE WIRELESS FUTURE®**

Samson Technologies Corp. P.O. Box 9068, Hicksville, NY 11802-9068 (516) 932-3810 FAX (516) 932-3815  
© 1990 SAMSON TECHNOLOGIES CORP.



\*In case you were reading too fast, we wanted to remind you that this ad is about UHF, not VHF wireless. †As long as you are reading our ad this closely, we thought we'd tell you who they are: Yukinaga Koike, Doug Bryant, Takao Horiuchi, Susumu Tamura. †dbx is a registered trademark of Carillon Industries.

Circle 209 on Reader Response Card

World Radio History

# AUDIO IN ASIA, PART TWO — A LOOK AT KOREA

By Mike Klasco

**A topic I have found to be popular at dinner parties is the insider's view of audio in Asia, and in these pages I have told of my experiences in Japan: Who builds what for whom and so on.**

Well, I am not going to give away too many big secrets, but over the years many readers have asked me about Menlo Scientific, my consulting company. What do I do for a living, what is my connection with Asia, what products did I design, and so on? I will try to answer a few of these questions while telling some stories about my experiences and personal observations while working in Asia.

I first started working with Japanese audio companies when I owned GLI, a disco equipment manufacturer in New York, my home town. In the late 1970s, GLI's less expensive mixers were produced in Japan. Later GLI was acquired by Variable Speech Control (VSC), a technology licensing concern with a working relationship with many of the large Japanese companies. After I moved to the West Coast I occasionally consulted for VSC and had the opportunity to pick up a number of international clients from these contacts.

But my first connection with Korea was pure chance. I was at the NSCA



*Main Olympic Stadium: large enough for a baseball and football game to be held at the same time.*

convention at Las Vegas in 1983. Back then, the NSCA was only a side show to the EIA Distributors show, although both shows were held together. Through the Korean affiliate of the EIA, the Korean government subsidized a small group of booths at the show. I wandered into this area and saw a compression driver ring radiator ("bullet") tweeter my company had been buying from England. The tweeter had given us lots of trouble. I asked the person at the booth (who turned out to be the company president) how much the tweeter cost and was told \$10. I examined it closely and it appeared to be identical to what I was buying for \$40. I mentioned that the tweeter had five serious problems. After some discussion the fellow conceded that it had three problems. I reviewed what I understood to be the

problems and the solutions I would like to try. The response was to invite me to Korea to resolve the problems.

### SOUND CONTRACTING IN KOREA

Church sound systems are a major business in Korea. The population is about 40,000,000 with half the people located in Seoul, the capital. About 15 percent of the population is Christian and there are over 25,000 churches. A few small companies manufacture product lines specifically for church sound systems. Although not casually apparent, shamanism (a general belief in the spirit world) is very strong here.

Korea is a big supplier to many countries with whom the U.S. does very little trade, such as Turkey, India, Libya and others. During one my first visits to Korea I was helping upgrade

---

*Mike Klasco is the Technical Editor of Sound & Communications magazine.*



the performance of an inexpensive compression driver. By coincidence, a major customer for the part, from Istanbul, was visiting the factory. He proudly stated that his firm bought 20,000 of these devices per year. I was surprised and commented that there must be many clubs and discos in Turkey. His shock and dismay that he was dealing with a heathen were instantaneous — as he replied that the compression drivers were used for Islamic prayer call!

Small and medium-sized meeting and convention centers are another big chunk of commercial sound, with multi-language translation systems (usually Philips) being an integral part of these designs.

Clubs and discos are everywhere in the big cities of Korea. A hotel cannot be rated Four-Star without a club! Most clubs are located in the basement. The “regulation” Korean style club has a dance floor and lots of seating. The fanciest clubs also have live entertainment, including bands and dancers. Design of the sound systems in Korea, like anywhere else, varies greatly. Sometimes the equipment is piled high on the dance floor, while

## IN KOREA THE DOMESTIC INSTALLERS JUST DO NOT WANT TO GET INVOLVED IN ACOUSTICS.

other installations are elegant without any visible loudspeakers.

Koreans are really into Karaoke. You can find many bars with laser-karaoke systems (laserdisc plus projection TV), which have been mostly Pioneer and Nikkodo products from Japan, but more recently Samsung, the large Korean firm, has introduced laserdisc models. Karaoke sound systems are as common in Korea as jukeboxes used to be in the U.S.



*The Han river cuts through Seoul. In 1985, the entire length of the riverside was developed into recreation areas. Sightseeing boats cruise the river.*

In Korea the domestic installers just do not want to get involved in acoustics. Architects feel they have more important priorities than to pander to my “theoretical” objections. In the end, the sound contractor gets into trouble, as the facility managers consistently blame the sound system rather than the intrinsic acoustical problems of the space. All of this makes me feel just like I was at home!

Many large jobs are awarded to U.S. contracting companies, which then use a local contractor as a partner. Lottie World is an example of this approach. Lottie is a very large corporation that owns department stores, hotels, food brands, and is a major audio manufacturer. A little bit of history is that they started out as a chewing gum manufacturer (and that is still a major part of their business). Lottie builds hi-fi equipment for a number of Japanese audio companies on an OEM basis and until recently was the Pioneer licensee (“Lottie — Pioneer”) for the Korean domestic market. Lottie also has a complete line of commercial sound equipment. Lottie also has built an enormous theme park right next to its flagship hotel and department

store/shopping mall. For a closer look at what is inside the theme park (from a sound contractor’s perspective), Sound & Communications has an installation article in the works from one of my associates who recently found himself working on the Korean equivalent of Disney’s Pirates of Penzance ride at Lottie World.

My own experiences have been mostly with projects entirely designed and installed in Korea. For years I consulted with Je-il Electronics, which had been one of Korea’s largest sound contractors. Korea was occupied by Japan for many decades and it is easy to see many elements of Japan in Korea. Je-il patterned itself after the large Japanese contractors and built its own amplifiers, limiters, mixing boards and speaker systems. The amplifiers were clones of BGWs, the mixing boards were based on the British Studiocrافت, and the speakers were JBL-ish. The drivers themselves were from Sammi, a large Korean company I also worked with.

Je-il was located on the outskirts of Seoul. According to the post office, they were in Buchan, a city near Seoul, but the capital of Seoul had expanded

so as to make the beginning and end of each municipality indistinguishable. I found that the only way to tell was by phone — the phone system in Buchan was terrible, along with the

## THE OFFICIAL STORY IS THAT THIS WAS JUST TOO EARLY TO ATTEMPT TO PRODUCE WORLD CLASS CONSUMER ELECTRONICS IN KOREA.

water supply. The water was pure enough (the water for Seoul comes from the snow caps from the surround-

ing mountains — sort of Evian-on-tap), but supply was erratic.

Inkel is another big manufacturer/installer. Mostly, I have come across their installations in hotels. Inkel has an interesting heritage, the factory having started out as Electro-Voice Korea in the 1960s. The official story is that this was just too early to attempt to produce world class consumer electronics in Korea and E-V eventually pulled out. The infrastructure was not developed enough — the capacitors, semiconductors, even the circuit boards at the time were below grade. International Korea Electronics (“Inkel”) was formed to take over the factory and later produced hi-fi receivers for Sherwood, eventually taking over the U.S. company. Inkel still has a good relationship with E-V and is their distributor in Korea.

Another version of this story is that E-V had the factory built without properly treating for spirits, and the factory became haunted. Workers kept seeing spirits and did not want to work there.

## THE MANUFACTURING SOPHISTICATION HAD FINALLY REACHED THE THRESHOLD OF WORLD-CLASS QUALITY, YET COSTS WERE LOW.

When Inkel took over they brought in an expert Shaman to have the problem spooks removed. Before you laugh at

# SOUNDSPHERE SPEAKERS KEEP NEWSDAY PRESSES ROLLING...

The Newsday corporate offices and printing plant are in a large building in Melville, N.Y. It contains the largest color offset operation in the country with ten printing presses. While they operate at the highest efficiency, the collation and inserting operations could not be stopped quickly when problems were encountered. The insert machines could not be turned off resulting in improperly collated newspapers.

After trying flashing lights, buzzers and various horn speakers, a Soundsphere #2212-1 model was tested and five more were installed in the extremely noisy inserting operations room.

Patrick O'Hanlon, Production Maintenance Electrical General Foreman at the site states, "The area in question is a high density noise area and communication is difficult. When Bernie Lory of Craftsman Sound talked about Soundsphere speakers in airport terminals, I knew it was the system for us. The even distribution allowed us to maintain a volume level that would not be overbearing, to permit quick quality control adjustments in the insert area and to still be heard in remote corners of the room."

The installer, Bernie Lory has also put two Soundsphere #2212-2 speakers in the stacker area to improve the efficiency of that portion of the operation. He is planning to use more Soundsphere loudspeakers at this site to solve other operational problems.

Write or call direct for further information.

**SOUNDSPHERE** A PRODUCT OF  
**SONIC SYSTEMS, INC.**

737 Canal Street • Bldg 23B • Stamford, CT 06902 • USA • Tel (203) 356-1136

Circle 252 Reader Response Card

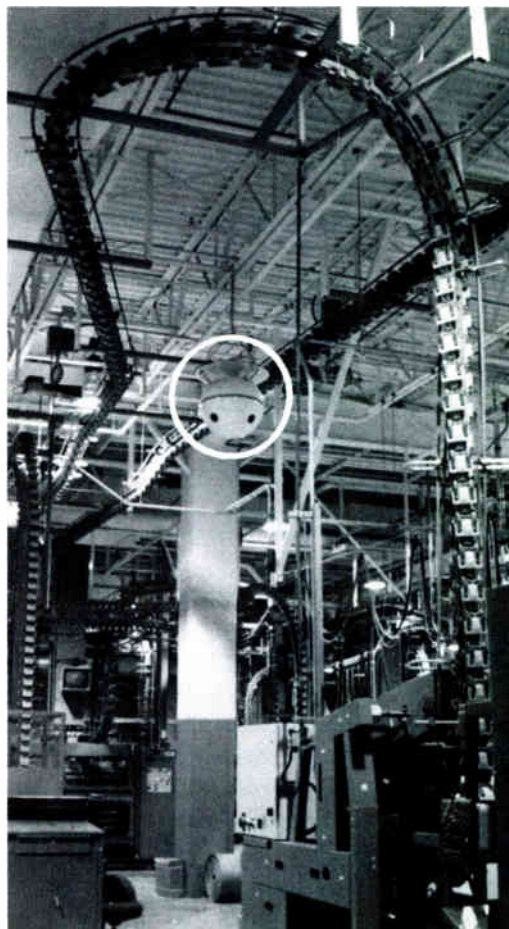



the Koreans' superstitions, try to remember the last time you saw a 13th floor in a building, walked under a ladder, or petted a black cat.

For a brief period in the late 1980s Inkel became an important OEM supplier of mixers and amplifiers for a half dozen U.S. hi-fi and commercial sound companies (AB Systems, SAE, Adcom, to mention a few). Inkel was not exactly subtle in their OEM business, with the SAE brand being sold in Korea as SAE/Inkel. One of their export managers left the company and set up the brand "Senior" in the U.S. which was a popular paging amplifier company. This period, just before the 1988 Olympic Games, was Korea's brief moment in the sun. The manufacturing sophistication had finally reached the threshold of world-class quality, yet costs were low.

Inkel was not the only guy making

money... so was I. Sammi, the Korean speaker factory that I represented in the U.S., was producing reasonable quality products at terrific prices. Just as the business started to

**OF COURSE MANY  
COMMERCIAL SOUND  
EQUIPMENT  
MANUFACTURERS IN  
KOREA DO NOT DO  
INSTALLATIONS, AND  
MANY SOUND  
INSTALLERS DO NOT  
BUILD ELECTRONICS.**

take off, the combination of unions, politics, the Olympic Games, spiraling inflation, along with rapidly climbing

salaries and prices put an end to much of Korea's export business.

Today many Korean brand products that are sold internationally are no longer built in Korea, but rather in less developed areas: the Hyundai Elantra is built in Canada, even many of Sammi's speakers (Korea's largest speaker company) are assembled at Stanford Acoustics, their Danville, Kentucky operation. Sammi has also just taken over Allison Acoustics, a popular U.S. hi-fi speaker company. The Korean engineers working there marvel at the low pricing of homes and the friendly natives. Sadly, I am only half kidding. My firm helps source and qualify vendors for a number of U.S. companies, and there are still quite a few viable suppliers with good pricing and performance in Korea.

# "AND THE WORD WAS SPOKEN"

But can you afford to make it heard? Now you can, with the new Flex Series modular sound system approach.

Flex modules now make possible a top quality, custom design that can suit your particular needs AND budget, without sacrificing big-system features. The seemingly modest system shown here actually provides more sophisticated functions than large systems costing several times as much. Like built-in paging over-ride, multiple outputs and separate equalization to reduce feedback.

Ask your local sound contractor to explain the powerful capabilities of the Flex Series, the affordable answer to superlative church sound.

RANE CORPORATION 10802-47th Ave. W., Mukilteo, WA 98275. (206) 355-6000

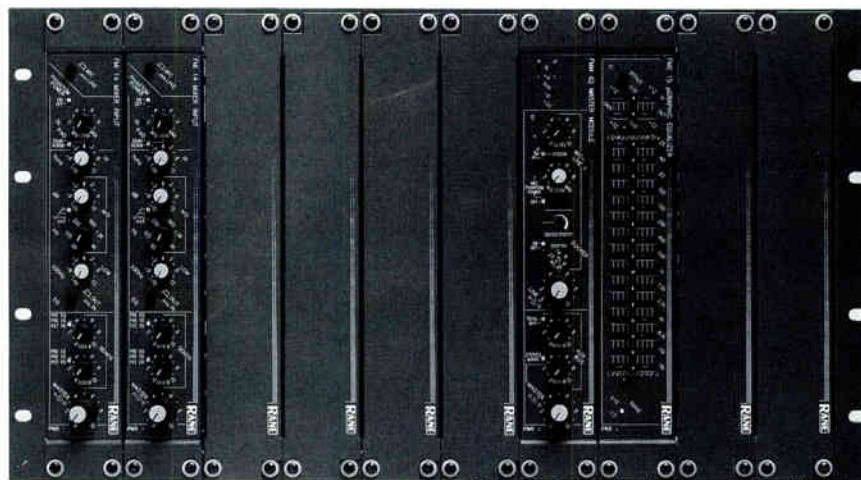

Circle 253 Reader Response Card



*There was a period of time when I practically lived at the Olympic Park area where the sports arenas were located. Today it is a large recreation area surrounded by high-rise apartments. During its construction it was swarming with anti-terrorist troops.*

Of course many commercial sound equipment manufacturers in Korea do not do installations, and many sound installers do not build electronics. Most of the firms that build commercial

sound equipment do not even market these products in Korea. For example, Dae Sung builds mic mixers for Radio Shack and cheap disco mixers for three of the lower end disco

mixer companies in the U.S. While the Radio Shack unit is clean and simple, the disco mixers are designed as "knobs per dollar" products and are rat's nests of wiring inside. The digital sampler is really a solid state TAD (Telephone Answering Device) chip with about 40 dB S/N ratio. I can not really blame these products on Dae Sung, as they also build a top class

# TRUST WORTHY.

Want great sound you can depend on? Target's T1200I and T1500I two-way fixed systems are an installer's and system designer's dream.

Featuring the balanced, full-range sound PAS is famous for, this passive two-way system features a sanded, ready-to-finish Baltic Birch plywood enclosure and ring-type flying points for easy, more secure mounting. The finest American craftsmanship is backed by our limited five year warranty.

Target T1200I and T1500I. The mark of excellence in fixed installations.

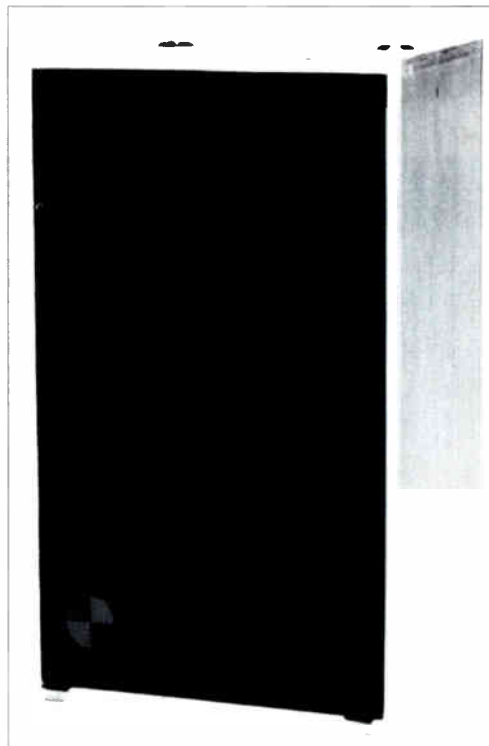

Professional Audio Systems 660 N. Twin Oaks Valley Rd., Suite #101, San Marcos, CA 92069  
TEL: 619-591-0360 FAX: 619-591-3602

## WORKING IN KOREA PROVIDED ME WITH A FEW FANTASTIC ENGINEERING EXPERIENCES.

mixer for a Belgian firm (that is labeled "Made in Belgium"! ). Although the fellows who build Bogen's mixers do so on an exclusive basis, they are not quiet about it and display these products at Korean trade shows.

Speaking of trade shows, KES (Korean Electronic Show) is the big exposition for consumer electronics in Korea and takes place in October. I was quite impressed with this year's show, with high definition television, TVs with built-in satellite receivers, prototype Mini-Disc and DCC machines, and tons of karaoke systems on display. The International Broadcast & Audio Equipment show is toward the end of June. The Monthly Journal of Audio is the one Korean magazine that covers high end audio and pro sound. Each issue is about 225 pages and has articles about design technique, influential audio designs from the past, interviews with engineers, and many ads.

### MIKE'S BIG AUDIO ADVENTURES IN KOREA

Aside from the usual sound system consulting jobs, working in Korea provided me with a few fantastic engineering experiences. One of these projects was a feasibility study for the high-intensity sound system at the DMZ (de-militarized zone) between



North and South Korea. About five miles of rocky terrain separate the two adversaries. Unlike the Czechs and Slovaks or the Serbs and Croatians, the northern and southern Korean groups are culturally the same, except for the political realities. They have found a very civilized way to express the differences in their positions — they yell at each other through high output sound systems. It is my hope that Korea will someday be able to export this concept to Ireland, Lebanon and Yugoslavia.

Usually during the night, one of the many semi-portable high-intensity sound systems sitting on flat-bed trucks will be transported into the DMZ “no-man’s-land” area so as to get it closer to the North Korean bunkers. Offers of higher pay in the South

*The author at the Korean Electronics Show shortly after the 1988 Seoul Olympic Games.*



Korean army, a bonus for showing up with a tank or two, and other banter is the usual fare. The logistics of projecting intelligible speech five miles are formidable. Air absorption of the

top-end response, temperature gradients, and the inverse square law conspires to confound effective communications. For example, during the day the ground absorbs heat so at night

# “MORE HAVE COME TO HEAR”

Flex Series means effortless system expansion, without the high cost of replacing obsolete equipment. By simply adding more modules, the system shown on the previous page can now handle two more sanctuary mics (wireless, for example), four choir mics with equalization, and a powerful zone controlling system to send program/paging to eight different additional locations throughout the church.

As your needs grow, your Flex System grows with you, always providing cost-effective, superlative quality and powerful system capability. No system is too small or too large to enjoy the advantages of Flex.

RANE CORPORATION 10802-47th Ave. W., Mukilteo, WA 98275. (206) 355-6000

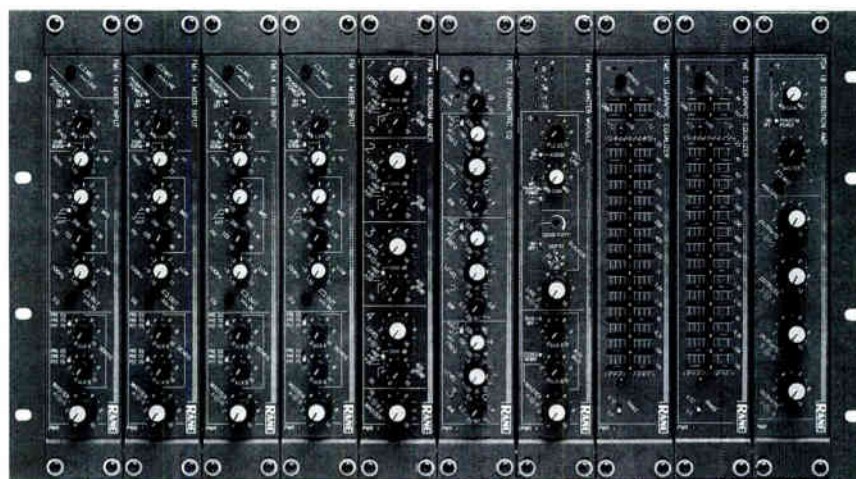

Circle 255 on Reader Response Card

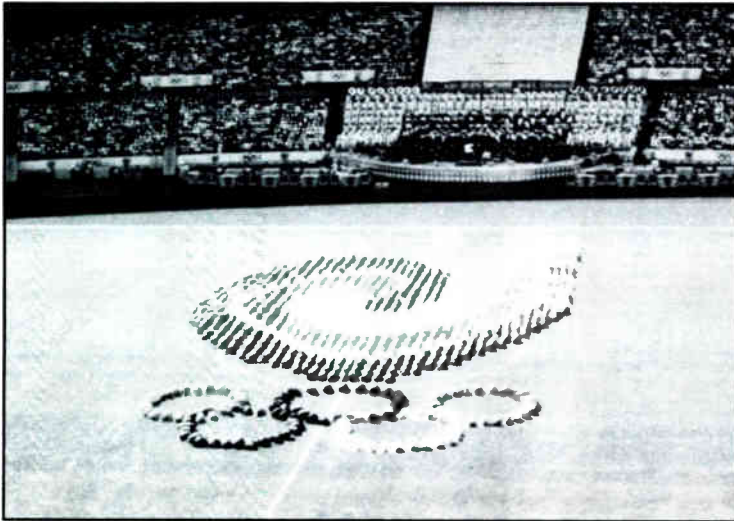

*The Main Olympic Stadium during the Opening Ceremonies in 1988.*

when the air is cold, the ground is radiating heat energy that must be accounted for when the speakers are aimed. This error can be significant.

Of course, just the opposite occurs in the morning when the South Koreans provide their wake-up call for the North.

I found a lot of useful info on long distance sound projection from studies by LTV Altec (now Ling) on air modulation speakers that were (and are still) used for foghorn voice warning by the U.S. Coast Guard. Projecting sound five miles is a "breeze" for these monster transducers! One of these installations, at Pt. Reyes, is an afternoon's drive from my house in Northern California. Still another one of these air modulation speaker systems is used just south of my house by Lockheed for destructive noise testing of aerospace applications. If Lockheed and the U.S. Coast Guard ever coordinate their activities, all of North California can have stereo background music!

Aside from air modulation speakers, we evaluated the various very large

## SHOP & COMPARE



**300 WATTS**

**\$399.00**

(Unit qty., dealer/contractor)

### **TRUE COMMERCIAL SOUND DIGITAL AMPLIFIER MORE STANDARD FEATURES — NO EXTRA COST**

- Transformer isolated input & output
- 25V, 70V, 100V, 2Ω, 8Ω, 16Ω, outputs
- Subsonic & ultrasonic filters
- Exclusive SAT-SENSE™ limiter is field set to prevent distribution transformer saturation or speaker over-excursion
- Adjustable maximum output power 75-300 WATTS
- Fully adverse load & short circuit protected
- Soft start, regulated D.C. power supply
- Patented, 85% efficient PWM-MOSFET Digital Power Amplifier
- Convection cooled, no noisy fans, small size, light weight
- Circuit breaker & varistor protection
- LED status indicators
- 2-year warranty, stock delivery, foreign power units available



**COMPACT POWER CO.**  
17282 ORANGE DRIVE  
YORBA LINDA, CA 92686, U.S.A.  
TEL 714-996-5826 FAX 714-996-5826



VISIT US  
AT NSCA





format compression drivers and even prototyped a few ourselves. All this development has not gone to waste as these same compression drivers are now made in Kentucky by Stanford Acoustics, the U.S. affiliate of the Korean speaker company that originally made the drivers and are marketed by Federal Signal, the world's largest siren/voice warning company. The large format compression driver research ended up helping win another OEM parts supply contract from the manufacturer of the highest output (4-inch horn exit) driver.

My other Korean audio adventure was working on the sound systems for the 1988 Seoul Olympic games. This project started with the building of half-a-dozen sports areas for the 1986 Asian Games. After computer simulations and construction and installation, testing of these sound systems was very exciting. During these years the South Koreans were more than concerned that the North Koreans would attempt to disrupt the Games, perhaps blowing up the facilities that I was working on. What worried me more was all the very young anti-terrorist troops with machine guns who were all over the place. Each morning I would practice looking not-North Korean (this was not so tough as my grandparents were run out of Romania). Happily, all the events came off without a hitch.

Unfortunately, the sound installer for the games, Je-il Electronics has not fared so well over the years. When I first came to Korea in the early 1980s it cost about \$3 for an upscale cab ride from the airport to the opposite end of the city. Keep in mind that Seoul has a population about the combined size of New York and Chicago put together. A stay at a "domestic" hotel, which would be an immaculate small room with rug, comfortable bed, color TV, U.S. style bathroom, air conditioning, would cost about \$12 per night. By the way, most hotels would also offer the traditional Korean style room

with a large pillow-bed on a heated floor.

You could take a friend out to dinner with style with a total tab of \$4. A young worker on the production line made about 30 cents per hour. All workers could read and write Korean. School in Korea is six days a week (actually a half day on Saturday). English is taught every day from the

earliest grade on up. I guess many Koreans have been told that their "English is very good" to the point of this remark being a joke. During a large and rather serious meeting in Korea, an old Korean gentleman turned to me and commented "I have been listening to you talk, and I must say that your English is very good." Of course everybody broke up over this

I asked our dealer  
**"How do we  
 install a 209 lb. monitor?"**



**"Your best bet is the Jumbo Mount from Peerless," he told me.**

Now that we've got it installed, I see what he meant. We really like the Jumbo's innovative features. Its unique "arm in arm" design gives it plenty of strength, even for our 35" monitor. This also provides extra rigidity and prevents excessive tilt.

Special adjustment slots help the installer find the set's balance point, so it's the most stable mount we've ever put up. It's even UL listed, and I like knowing that.

The optional patented security package is also important to us. It makes our installation theft-resistant.

But the biggest challenge we threw at our dealer was getting the job completed in one week. He said he could do it. "The Jumbo® Mount is American made and Peerless will ship within 48 hours," he told us.

Quality engineered, UL Listed, American made, and promptly shipped. Now that's the way I like to do business!

**SOLID SUPPORT**

**peerless**

Call today for our free Product Guide

**1-800-729-0307**

In Illinois 708-865-8870

and the mood of the discussions was lightened.

Especially during the late 1980s the standard of living and inflation climbed rapidly. The same taxi ride now takes the equivalent of a \$10 bill just to get the cab to stop. As cabs ride by, candidate riders yell "double!" (I will pay you double the meter) in order to entice the cab driver to stop and let them in. I think this must be due to a mistake by the Korean government in bringing New York cab drivers to train Korean cab drivers (this is only my theory)! In any case, the same trip from the airport is now going to cost you closer to \$20, your hotel bill in Seoul will be from \$70 to \$140 a night (even more downtown), and dinner for two will be at least \$20 and more likely double. Seoul, Korea is pretty much as



*Mike Klasco at a speaker basket factory in 1985.*

expensive as New York or any other big U.S. city. Workers on the production line make a few bucks an hour, the same as workers in most industrial

cities in the U.S. Unions are now big in Korea.

To avoid the expenses of the capital many companies have set up affiliates

# MIXa Amps. Pure QSC.





and subsidiaries in the countryside. Inland, many farmers work part-time in factories when not planting and harvesting their crops. If this seems foreign to you, you will be surprised that this is exactly how one of the biggest U.S. speaker companies, Eminence (located in Kentucky), operates.

I think the most appealing locations for a company in Korea are in Pusan. This is the big port city on the Southern tip of the country. The weather is the best here — it never snows, while Seoul's weather is reminiscent of Chicago's most of the year. The entire city is spread out near Paradise Beach, a large resort area on the ocean. The backdrop for the city is a ridge of snowcapped mountains. On a clear day you can see a few islands off the coast

of Japan. An express train runs from Seoul, which is at the northern end of the country, directly to Pusan. The cost is about \$20, about one tenth of a similar trip in Japan. You can also fly, flight time being about 40 minutes and cost about \$35. Whether you fly or take the train, almost all seats are taken on weekends.

Driving is impossible now that everyone has a car and nobody has learned to drive yet! The ride takes about five hours and is a great way to get a cross-sectional view of the country. It seems that every inch of the country is a factory, home, or under cultivation.

So I started to tell you about Je-il Electronics, the sound contractor that did not survive Korea's lightning transition from being a third world

country. As you know, in sound contracting you often bid jobs for installations that will not be completed for years. With salaries doubling and tripling in Korea, it was impossible to conservatively predict costs yet bid competitively. Especially at the onset of Korea's intense growth, the spiraling increases in salaries and materials were unforeseeable. Je-il bid and won too many long term jobs and simply could not survive. Sadly, Korea does not have the same type of bankruptcy laws as the U.S. and when you go under, you are charged with fraud. Inevitably, the president or owner goes to jail as punishment. Ouch!

Next month I will take you to Taiwan, the land of a million people, five million lead-breathing motor scooters and 200 speaker factories. ■

Take a world class industry standard. Add power. Add new features\* and a higher level of technical sophistication. Add a new model. Make them all lighter. All at no additional cost to you. That's Pure QSC.



**\*MXa Professional Amplifier Series Features**

- ▶ High Output Efficiency in a Low Profile
- ▶ LED Indicators Monitor Performance
- ▶ All Protection Systems Independent on Each Channel
- ▶ Level 1 Open Input Architecture™
- ▶ 3 Year Warranty

AMPLIFIER MODEL	8 OHM*	4 OHM*
MX 1000a	250 Watts	350 Watts
MX 1500a	350 Watts	500 Watts
MX 2000a	450 Watts	650 Watts

\*20 Hz to 20 kHz, 0.1% THD

QSC is a registered trademark of QSC Audio Products, Inc. 1675 MacArthur Blvd. Costa Mesa, CA 92626-1468 Telephone (714)754-6175 Facsimile (714)754-6174

Circle 258 Reader Response Card

# Sunshine Ministries

## *A Vision of Future Sound in Western Michigan*

BY WENDY J. DUCH

**T**here is a rapidly expanding market for all genres of Christian music in Western Michigan. In former President Ford's hometown of Grand Rapids, Sunshine Ministries has become instrumental in bringing major Christian musical groups to the area. Located on East Beltline Drive, the church first opened its doors for public worship about five years ago. When starting out, the church followed a primarily voice-oriented worship format. They had no way of knowing that within a few short years, theirs would become an extremely musical church.

A voice-quality horn and bass bin multiple cluster system had originally been installed in the church's 2,300-seat sanctuary by Ascom, Inc. of Grand Rapids. The contract had originally been given to another, lower-bid installer, but Ascom was brought in by the customer who reported dissatisfaction with the first contractor. The fan-shaped, single floor sanctuary requires wide dispersion angles for uniform room coverage. The multiple cluster system worked well for this purpose. Powered by seven Altec Lansing 9444-A amplifiers, it employed 14 small-format HP-series Electro-Voice horns and three Altec low-end bins with 515 drivers. When installed, the system was well suited for its intended use. The church was a satisfied customer. And that might have been the end of it.

---

*Wendy J. Duch is a freelance audio writer who currently resides in East Lansing, Michigan.*

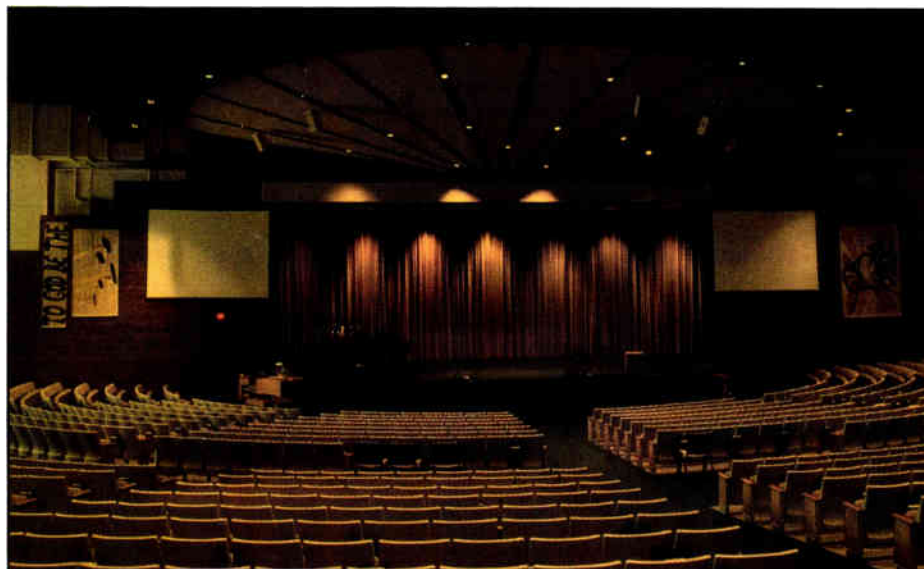

*Sunshine Ministries' 2,300-seat sanctuary.*

Then Sunshine hired Randy Umfleet as Director of Fine Arts, and everything changed.

Suddenly, there was an abundance of song in Sunshine's sanctuary. Although the church owned a very nice electronic organ, they wanted additional options. They wanted to be able to run instruments through the house PA, along with prerecorded instrumental tracks and amplified vocals. Most importantly, they wanted to bring major Christian recording artists into the church for special concerts. First, they tried modifying the existing system to fit their expanded needs.

What Sunshine needed, however, was a vision — a plan for the future. In quest of the realization of this vision, they brought in Texas-based acoustical design consultant Bob

Adams, formerly of the Joiner-Rose Group. Together, the church and designer inked out a clear vision that reflected future, as well as present, needs.

This sound system renovation project was then bid on by a number of installers, including Ascom. For what the church proposed to do, bids came in at a scope of \$218,000. This was unfortunately too great a financial burden for the church to handle all at once. However, Ascom had developed a healthy working relationship with the client in years past, and it was only natural for them to meet with church administrators in an effort to work out a solution to Sunshine's dilemma.

In the meantime, the church had stopped using the multiple cluster system. Instead, they were renting a



# THESE CONSOLES SO MANY FEATURES COULDN'T FIT THEM ALL ON THIS PAGE



**SOLO.** A new breed of console packed with more features per square inch than anything in its class. And the pure, transparent sound that has made Soundtracs so popular in studios and on stages around the world. At prices that make sense for today's cost-conscious professionals.

**SOLO LIVE.** Available in 16, 24 and 32 input frame sizes. Four independent sub-groups, right/left master and mono sum output. Four band EQ with two swept mids. Six auxiliary sends. Balanced inputs and outputs. Four stereo effect returns. 48V phantom powering for all mic inputs. Raised meter bridge.

**SOLO MIDI RECORDING.** Available in 16, 24 and 32 input frame sizes. Automated MIDI Muting on all channel inputs, monitor inputs, group outputs, stereo effect returns and auxiliary masters. Four band EQ with two swept Mids, assignable to monitor inputs. Six auxiliary sends—four assignable to monitor inputs. Four stereo effect returns with two band EQ, balance and level controls. Raised meter bridge.

**We wanted to list *all* of the features on SOLO consoles but we ran out of space. If you want to find out more about even**



## SOUNDTRACS

Exclusively distributed in the U.S. by Samson Technologies Corp.  
P.O. Box 9068, Hicksville, NY 11802-9068 Tel (516) 932-3810 Fax (516) 932-3815  
© 1992 Samson

World Radio History

Circle 210 on Reader Response Card

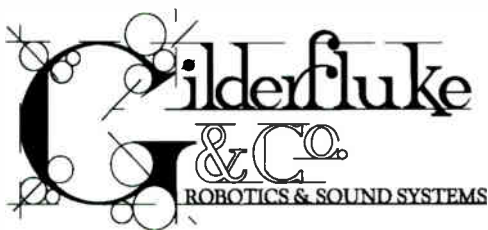

**We are pleased to announce our new  
AB-CLOCK CARILLON AND CLOCK CHIME SYSTEM**

In response to your enquiries regarding our Digital Audio Repeaters' use in carillon and clock chime systems, we have taken our largest selling repeater, the AB-100 AudioBrick, added a clock, a lot more memory, and some special firmware to create our newest product, the **AB-Clock**. It's features include:

- Each AB-Clock is a complete audio playback system (except for amplifier and speakers).
- Any sound that can be recorded (voices, music, sound effects, etc.) can be digitized and put into an AB-Clock.
- The length of sounds is virtually unlimited.
- Up to 255 different sounds can be stored.
- Bandwidths to 15 KHz, dynamic range 72 dB.
- Clock can chime on each quarter, half and full hour, and toll on full hours.
- Up to 60 special shows and times each day.
- External inputs can select and play a sound for alarms or to start unscheduled shows.
- All configuration is done through easy menus using virtually any computer or terminal.
- Schedules can be set for 8 days a week.
- Lithium battery to protect from power failures.
- Automatically adjusts for clock drift.
- Easy to adjust clock for daylight savings time
- Status output can give remote 'running' indication or pulse once each minute to run 'regulator' style remote clock faces.
- Volume, bass and treble controls.
- Balanced and single ended line level outputs.
- 5" wide x 12" long x 2-1/2" tall case.
- Includes UL listed wallmount power supply.

**GILDERFLUKE & COMPANY • 820 THOMPSON AVENUE #35 • GLENDALE, CALIFORNIA 91201  
800/776-5972 • 818/546-1618 • FAX 818/546-1619**

Circle 271 Reader Response Card

**Hearing Assistance + Worship Space =**



No sound system for worship is complete without a Williams hearing assistance system. Only Williams offers high quality [FM and Infrared](#) systems to suit any worship space. Our systems also meet ADA requirements for theaters, cinemas, conference rooms, auditoriums, and arenas. For complete specifications, call today.

- 3 Year Warranty
- Over 15 years experience
- Full Product Line
- Made in USA

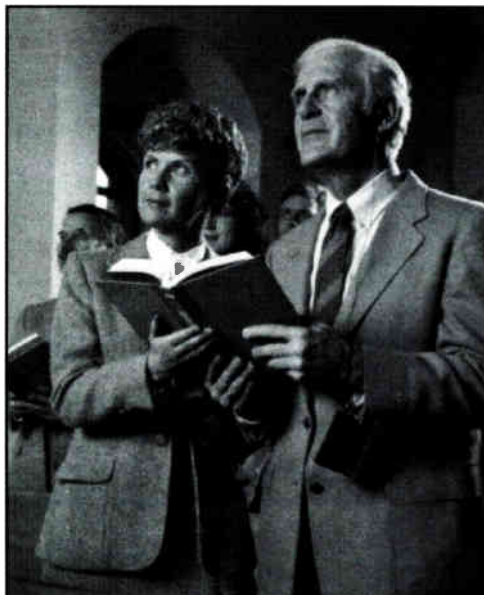

A hearing assistance system makes a wonderful memorial gift or youth project!

**Call Toll-Free: 1-800-328-6190**

Circle 272 Reader Response Card

triamplified system that gave them the fidelity they were looking for. But the speaker stacks, set to either side of the stage, lacked the widespread dispersion characteristics needed for uniform room coverage. With this in mind, Ascom took the initiative to break Adams' design down into affordable phases of installation. Although this approach considerably slows down project completion, in the end Sunshine will own the system they wanted to begin with at a cost relative to what they were already paying out in monthly rental fees. Needless to say, church administrators really liked this idea.

The initial installation was completed a year ago. This was the most critical phase of installation, from a performance standpoint. The original cluster system was removed, so that two concentric rings of Electro-Voice DeltaMax loudspeakers could be flown over the sanctuary in their place. The DeltaMax speakers are supplemented on the extreme low end by a pair of E-V MTL-4 manifold subwoofers placed in the front of the sanctuary.

The inner ring of loudspeakers consists of seven DeltaMax DML 1122APFs, powered on the low end by the original Altec 9444 A amplifiers, and on the high end by new Altec 9442-A amplifiers. The outer ring is designed to fly eight E-V FR 200s, powered by additional 9442-As, but the church found that it could not afford the additional cost at that time. Instead of compromising on a cheaper and less efficient alternative, they decided to hold off on purchasing enough speakers to fill out the outer ring, and to fly two FR 200s over the mix position on the outer ring to give the console operator a better idea of the overall SPL in the sanctuary.

If the full outer ring were in place, all loudspeakers would be flown at an angle of 45 degrees. Since this is not the case, existing speakers have been tilted at a more gradual angle of 25



## World-Class Duplicating. World-Class Performance.

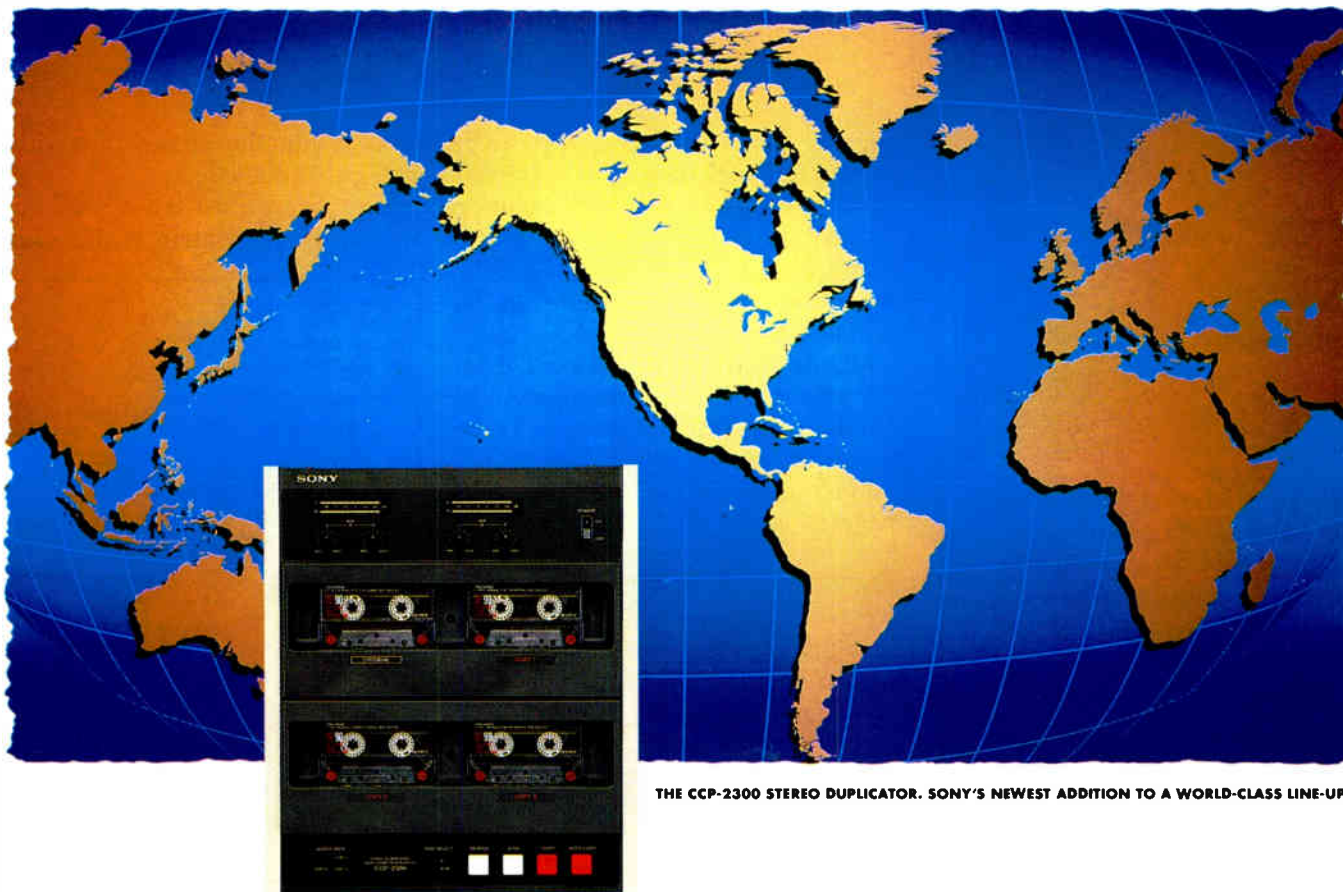

THE CCP-2300 STEREO DUPLICATOR. SONY'S NEWEST ADDITION TO A WORLD-CLASS LINE-UP.

For over 15 years, Sony has been the leader in high speed audio cassette duplicator technology. Setting the standard by providing superior sound quality with equipment that is easy-to-use and reliable.

Whether you need copies of teaching or training material, a sermon or special speaker, or a music performance, you can trust Sony quality. Sony has a full line of professional/industrial audio duplicators which can meet your needs. Advanced features of newly designed systems, mono or stereo, include microprocessor controlled operation, precision tape guiding systems and extended wear heads for trouble-free operation and consistently superior sound reproduction. By connecting expansion copy units to the master control unit, you can easily increase your duplicating capacity as your needs expand.

Call today for the Sony Authorized Duplicator Dealer nearest you. These professionals can provide information on Sony's line of audio cassette duplicators and bring you into the realm of world-class duplication technology.

# SONY

### EDUCATION SYSTEMS DIVISION

Business and Professional Group  
A Division of Sony Corporation of America  
10833 Valley View Street  
Cypress, California 90630

## 1-800-326-SONY

## STAGE POCKETS

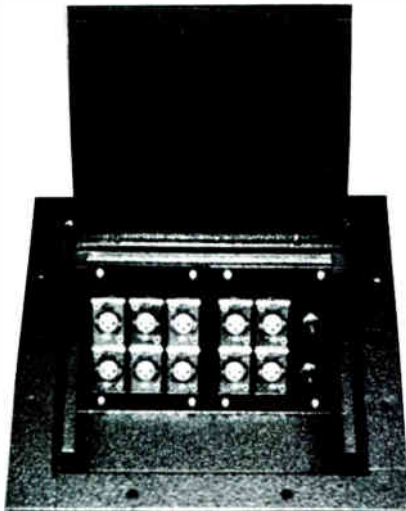

- Up to 12 audio connectors
- Welded steel construction
- Decorator poly-coat finish
- Brass & stainless trims
- Also MINI & HALF pockets

for PRICES & AVAILABILITY contact:

**ACE BACKSTAGE CO.**

P.O. Box 417, Castaic, CA 91310  
(805) 295-5760 • Fax (805) 295-1122

Circle 284 Reader Response Card

## How To Mic Your Piano!

**C-DUCER**

C-P SERIES

Preferred By More Professionals

Models also available for:  
Guitar, Harp, Bass, Violin,  
Mandolin and Dulcimer.



Contact Your Dealer or  
Call 800 C-T AUDIO

Circle 285 Reader Response Card

degrees. This shallow angle helps cover the back rows of sanctuary seating, but is a temporary solution at best. In order to achieve a uniform room coverage of  $\pm 3\text{dB SPL}$ , the outer ring would have to be completed.

Adams' design called for a pair of E-V MTL-4 manifold subwoofers to be fitted underneath the stage. These subs contain four 18-inch drivers per cabinet. Each cabinet is driven separately by an E-V AP 2300 power amplifier. An APX-2 electronic crossover unit is used to drive the subs at a crossover frequency of 90 Hz. Ascom systems engineers were a bit concerned about putting something that powerful underneath the stage. So they placed the subs in front of where they were to be installed, and ran some tests. According to Ascom's Senior Systems Engineer Dave Spoelhof, the results were fairly obnoxious. As an alternative, they decided to fly the subs in the same coves where the organ subwoofers were located, to either side of the stage. Here, they are out of sight, yet do the job of filling out the extreme low end of the house system. Spoelhof jokes that "... when we start to rattle the HVAC duct work, we know we're getting a pretty good SPL level!" and laughs.

While working out the details for Sunshine's initial phase of installation, Ascom arranged for several of its clients — including representatives from Sunshine Ministries — to visit Willow Creek, a 4-5,000-seat church in Illinois where an L-R L-R stereo cabinet system had recently been installed. Until then, Sunshine had not even considered stereo to be an option. Once they had experienced the difference, however, they decided to have Ascom design essentially the same type of L-R L-R stereo response into their new DeltaMax system. Spoelhof has found that when setting this array up for an odd number of loudspeakers flown in a concentric ring, that the odd speaker

blends into the stereo mix without noticeable detection.

Sunshine Ministries is well on its way to the realization of their sound

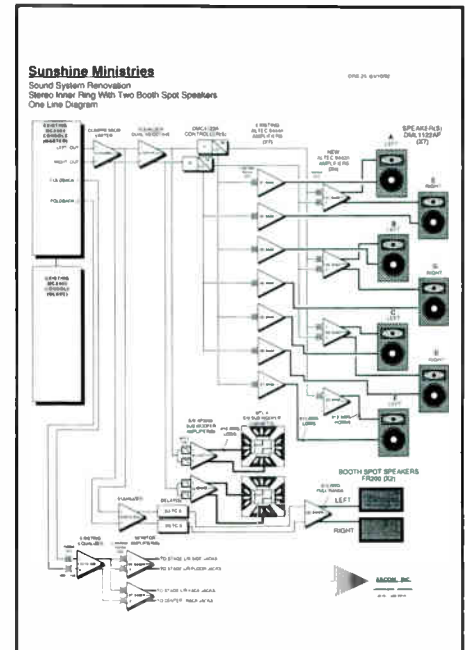

The Sunshine Ministries renovation included a stereo inner ring with two booth spot speakers.

vision, thanks to the willingness of Ascom representatives to work out an affordable solution with them. Future installation phases will include completing the outer ring of loudspeakers. There is some debate at this point whether it is better to drive this outer ring using E-V DML 1122APFs with a passive crossover in place of the FR200s, or to go with some other type of cabinet altogether. Eventually, the church will purchase a Yamaha PM 3000 or PM 4000 40-channel mixing console to replace the two 24-channel boards that are still in current use. New patch bays will be installed in the control booth and an array of new signal processing components will be added to the system. Although it will still be some time before this project reaches actual completion, Sunshine Ministries continues to be a satisfied customer. ■



# SIMPLE GENIUS



The SPM412 Stereo Preamp/Mixer for

Bars . . .

Restaurants . . .

Board Rooms . . .

Aerobic Studios . . .

School Gymnasiums . . .

Church Meeting Rooms . . .

Come see it in action  
**NSCA booth #205**  
or call for a free brochure  
**1-800-826-1457**

**advantage** 

Biamp Systems, 14270 N.W. Science Park Drive,  
Portland, OR 97229 (503) 641-7287



# Michigan Tech Ice Arena

*A New System for Diverse Needs is Established  
on the Michigan Campus*

BY KEITH CLARK

**T**he Student Development Complex (SDC) Ice Arena, located on the campus of Michigan Technological University (MTU) in Houghton, Michigan, serves a wide variety of needs.

Home to the MTU Huskies of the Western Collegiate Hockey Association, the 4,200-seat facility is also the site of many local, regional and state high school hockey games. In addition, it's used for physical education classes, intramural ice hockey, figure skating, recreational skating as well as the renowned MTU Summer Hockey Development Center. It's also host to commencement exercises and large-scale speeches and presentations.

MTU, one of the foremost technical schools in the United States, commissioned construction of the building in the early 1970s. Almost from the beginning, there had been dissatisfaction with the facility's audio system, although it was not fully replaced until this year. Some attempts were made over the years by students and faculty to rectify the audio/acoustic problems, but no long-term solutions were effected.



*The 34 clusters surrounding the seating areas are each made up of two Community RS-220 speakers. The clusters are spread 25½ feet apart and suspended from a steel grid along the ceiling that runs around the entire room.*

In Spring 1991, however, the university contracted Mavri, Inc. of Jenison, Michigan to design and install a completely new system. Mavri subsequently retained Media Design Consultants of Byron Center, Michigan to provide independent mapping and proving of the new system. Relying upon thorough research and their extensive experience with installations of

this type, Mavri installed a system that has received rave reviews from both the university and attendees of various events.

## **HOCKEY PUCKS IN THE BASS BINS?**

The former system had featured a two-cluster design. One cluster was suspended above the main scoreboard

*Keith Clark is the President of Priority Communications of South Bend, Indiana.*





*LaserKaraoke*



*Laserdisc Movies*



*LaserHits™ and CDs*

# OFFER YOUR CLIENTS THOUSANDS OF SINGERS, ACTORS AND MUSICIANS IN ONE CONVENIENT PACKAGE.

With the new Pioneer LC-V200 50-Disc Auto-changer System, your clients can have the hottest entertainers on the planet at their beck and call. And you can earn big margins on one of the hottest products on the market.

It stores and plays up to 50 LaserKaraoke discs, laserdisc movies, LaserHits videos, and CDs. And changes them instantly, with no down-time, because it has two built-in



laserdisc/CD players. Connect four autochangers together and control up to 200 discs.

It even has an RS-232 computer interface for custom installations. Making it the most complete and convenient professional entertainment system on the market. Yet still fitting everything in a small footprint.

For a demonstration of the new LC-V200, the starting point for the ultimate entertainment system, call (800) 421-1624 and ask for LaserKaraoke.

**LaserKaraoke®**  
**PIONEER®**  
The Art of Entertainment

at "center ice," and was used primarily for sound reinforcement at hockey games. A secondary cluster, suspended near one end of the rectangular arena, was used for applications such as commencement.

In-depth TEF analysis of the entire arena was performed while the old system was still in use. Using this initial data, the installation team was able to map out trouble spots and other peculiarities of the room, which measures about 250 feet long by 150 feet wide. Main seating runs along each long side of the rectangle, while temporary bleachers can be erected at one end. The other end does not have provisions for seating. The flat ceiling, supported by a network of steel girders, reaches about 60 feet above the main floor.

The concept of the original system was to employ a central cluster that took advantage of the room's natural reverberance in order to produce a good level of sound. While this principle has worked effectively at other venues, it just wasn't performing at an acceptable level.

**"From what we can surmise, it became a contest among the hockey players to try and shoot pucks into the cabinets."**

One interesting development as the old system was coming down: several

hockey pucks were discovered in the bass bins! "From what we can surmise, it became a contest among the hockey players to try and shoot pucks into the cabinets," says Mavri project engineer Max Krueger. "Judging from the number of pucks that came out of those bins, the players evidently became pretty good at hitting their target. This also might have been a contributing factor to the system's poor performance."

With the new system, Mavri determined that instead of a central cluster system, they would utilize a two-pronged attack. The ice/main floor would receive primary sound reinforcement from two Soundsphere 2212-2 speaker systems that each would cover one-half of the surface. Seating areas would be covered by a total of 34 two-speaker clusters.

# CONQUEST U.S.A.



**NOBODY SELLS**

Switchcraft®

**FOR LESS!!!**

*PLUGS - CONNECTORS - JACKS - ADAPTERS*

**- PLUS -**

*WE MANUFACTURE OVER 20,000 AUDIO WIRING PRODUCTS FROM CABLES TO SNAKES TO PANELS AND CUSTOM DESIGNS.*

- FAST DELIVERY
- CUSTOM DESIGN SERVICES
- LIFETIME WARRANTY
- SERVING THE AUDIO INDUSTRY SINCE 1975
- CALL FOR A FREE CATALOG

26113 S. RIDGELAND MONEE, IL USA 60449

- 800-323-7671 -

Circle 259 Reader Response Card



With their two 12-inch speakers pushing into baffles, the SoundSphere speakers effectively eliminate all direct sound, cancelling early reflections.

This principle comes in very handy where reverberation is a major threat, providing a smooth pattern that is especially ideal on a flat surface like the ice.

The 34 clusters surrounding the seating areas are each made up of two Community RS-220 speakers. The clusters, spread 25 ½ feet apart, are suspended from a steel grid along the ceiling that runs around the entire room directly above the edge of the ice where the seating sections start.

The EASE dispersion program was employed to map out the location of the clusters. The program is highly accurate in mapping out dispersion angles, and it helps in correlating the 'hot spots' of a venue. A little luck was also involved in the determination of cluster hanging points.

Mavri wanted the clusters to have the most support possible, and it happened that the steel grid is reinforced every 25 ½ feet. According to their research, these supported areas turned out to be the optimum places for hanging the clusters. Therefore, they were able to place the clusters exactly where they needed to go without extra reinforcement of the grid.

**Mavri wanted the clusters to have the most support possible, and it happened that the steel grid is reinforced every 25½ feet.**

In the clusters, one of the speakers is aimed at a downward angle to cover the lower seating levels, while the other speaker is aimed at a more out-

ward angle toward the back wall about 60 feet away, providing coverage to the upper seating levels. The clusters provide such good coverage that support speakers aren't required.

Extensive TEF analysis was again applied during aiming and final system testing. Measurements were taken from more than 150 spots throughout the arena. Using pink noise and other

source material, SPL levels were taken at a relative center of 75 dB. How well does it work?

The installation team had desired to create a "wall of sound," which has definitely been accomplished. There are variances of no more than ± 3 dB at any given spot, with the variance in the majority of the arena significantly less than that.

# microphones



**WE DO MICROPHONES! . . . WE DO THEM ALL!! AND WE DO THEM AT THE RIGHT PRICE!**



**ELECTRO-VOICE** For years you bought microphones from factory reps, ordering 6 or 12 pieces of one brand and getting end column pricing. You got the best price so you could be competitive, but it cost you something . . . poor cash flow and being over-inventoried on many items.



If you don't believe me, check your inventory! If any of those microphones are paid for, you've got a negative cash flow.



**TODAY . . . DO IT THE SMART WAY!**

Buy in smaller quantity, *mix and matching* any of the mentioned eight **BRAND NAMES**. Yes . . . you will end up with fewer microphones in inventory and a positive cash flow. Let **THE MUSIC PEOPLE** carry the inventory for you! Our salespeople are musicians—they know microphone applications and specifications and can direct you to the "movers" in each line.



For fast delivery, call 1-800-289-8889 and order by 3:00 P.M. Eastern Standard Time. Your order leaves our warehouse by 5:00 P.M. the same day!

*Do your mics with us—we're the largest microphone distributor in the U.S. and can save you time and money!*

**TELEX.**

**The Music People, Inc.** P.O. Box 648 West Hartford, CT 06107

DISTRIBUTORS

**1-800-289-8889 Ask For Mike!**

Walkways, locker rooms and other areas outside the main arena are covered by a 70-volt distributed system. No matter where someone might be within the arena, he is able to hear what is going on very clearly.

### COMPUTER CONTROL

Because Michigan Tech is an advanced technological university, students and faculty are highly computer literate. They fully realize the advantages and benefits of using computers.

This philosophy makes the use of Crown's computer-controlled IQ System a natural.

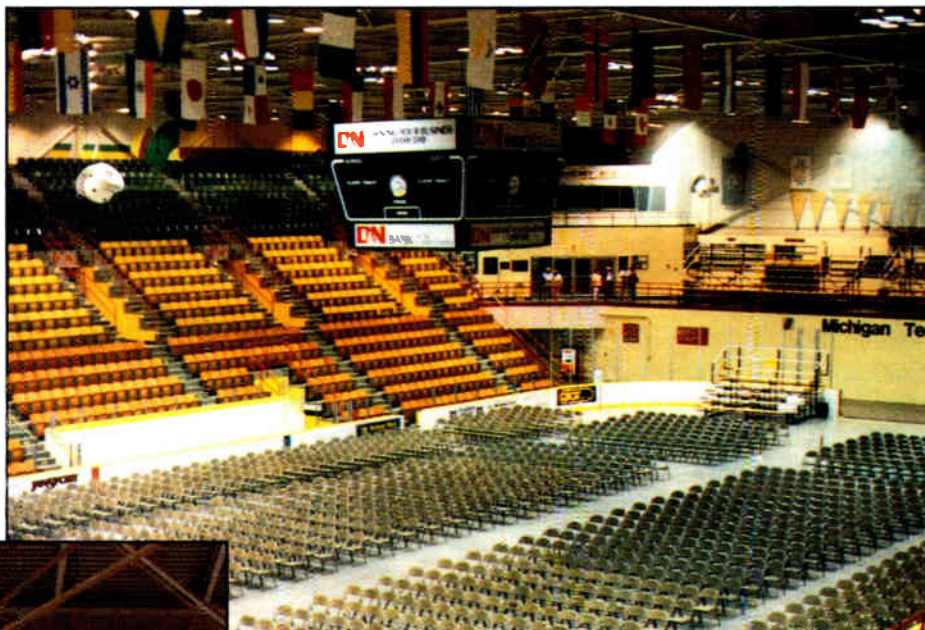

*The ice/main floor receives primary sound reinforcement from two Soundsphere 2212-2 speaker systems (above) that each cover one-half of the surface.*

*The Soundsphere systems hung on each side of the scoreboard.*

for this is its graphic orientation. You can actually build a graphic representation of the entire system on a single screen."

The IQ System allows for control of a variety of functions, including user-access and power levels, as well as on/off and level control of specific components and clusters.

### Walkways, locker rooms and other areas outside the main arena are covered by a 70-volt distributed system.

One of the most valuable functions, however, is the IQ System's ability to store up to eight system presets, allowing the system to be programmed to meet the specialized needs of an event. When the operator specifies a preset, the entire audio system is automatically configured with the most effective levels and combination of components. Mavri programmed a variety of presets, including those for hockey games, hockey pre-game shows and

IQ Macintosh version 1.4 software controls the arena's 20 Crown Com-Tech 400 (CT-400) amplifiers via IQ-P.I.P. modules from a single computer screen located in the audio control booth. IQ PC software is also installed,

although not currently in use. It may, however, be used for future expansion of the IQ System.

"The Macintosh system is easier for most people to use, operate and understand," Krueger says. "The reason



# DN800

CONFIGURABLE  
ACTIVE CROSSOVER

## The reputation that won't crack on the rack.

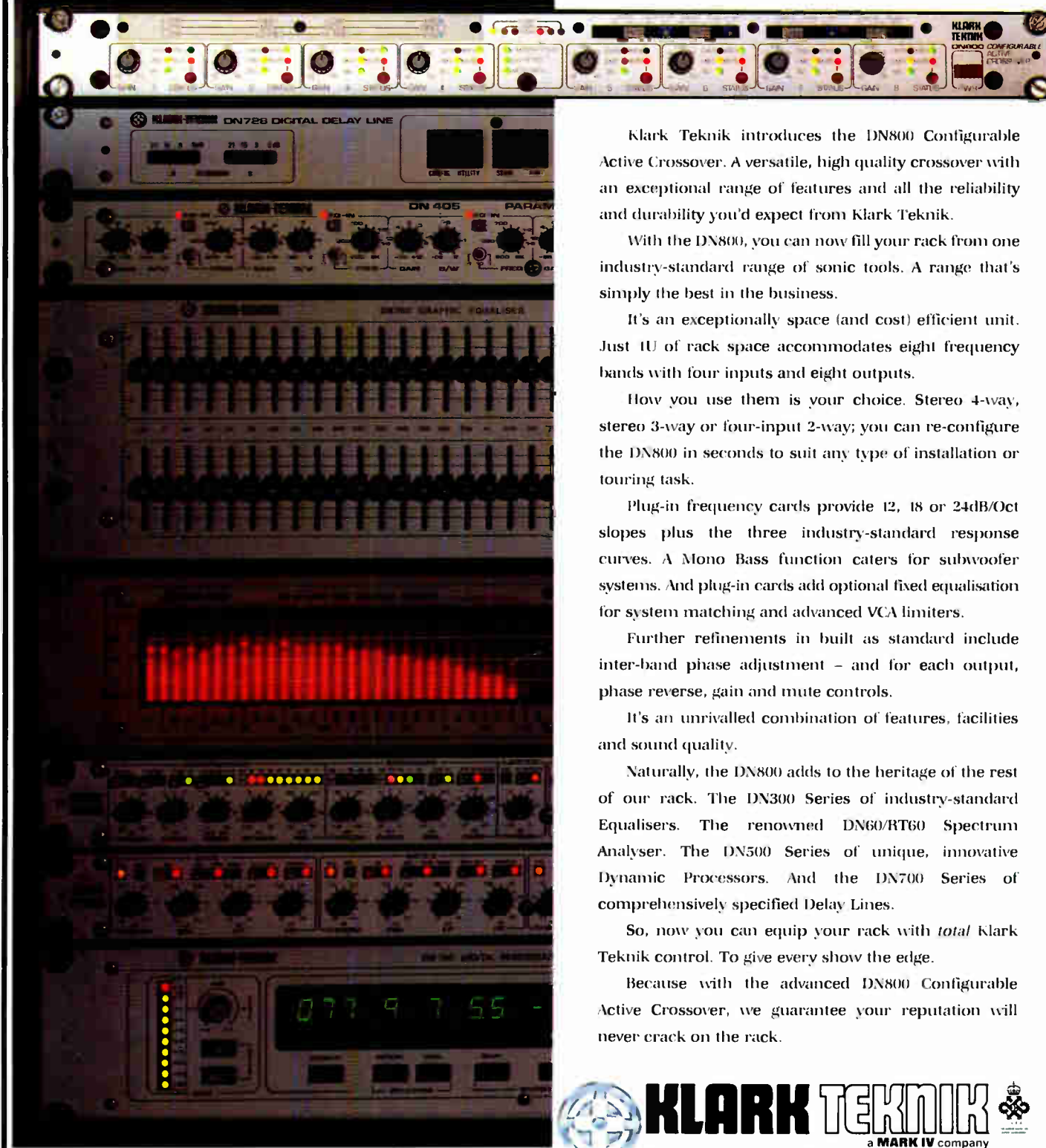

Klark Teknik introduces the DN800 Configurable Active Crossover. A versatile, high quality crossover with an exceptional range of features and all the reliability and durability you'd expect from Klark Teknik.

With the DN800, you can now fill your rack from one industry-standard range of sonic tools. A range that's simply the best in the business.

It's an exceptionally space (and cost) efficient unit. Just 1U of rack space accommodates eight frequency bands with four inputs and eight outputs.

How you use them is your choice. Stereo 4-way, stereo 3-way or four-input 2-way; you can re-configure the DN800 in seconds to suit any type of installation or touring task.

Plug-in frequency cards provide 12, 18 or 24dB/Oct slopes plus the three industry-standard response curves. A Mono Bass function caters for subwoofer systems. And plug-in cards add optional fixed equalisation for system matching and advanced VCA limiters.

Further refinements in built as standard include inter-band phase adjustment – and for each output, phase reverse, gain and mute controls.

It's an unrivalled combination of features, facilities and sound quality.

Naturally, the DN800 adds to the heritage of the rest of our rack. The DN300 Series of industry-standard Equalisers. The renowned DN60/RT60 Spectrum Analyser. The DN500 Series of unique, innovative Dynamic Processors. And the DN700 Series of comprehensively specified Delay Lines.

So, now you can equip your rack with *total* Klark Teknik control. To give every show the edge.

Because with the advanced DN800 Configurable Active Crossover, we guarantee your reputation will never crack on the rack.



**KLARK TEKNIK**  
a MARK IV company  
The first name with sound system designers

Klark Teknik PLC, Klark Industrial Park, Walter Nash Road, Kidderminster, Worcestershire DY11 7JL, England. Tel: 0562 741515 Fax No: 0562 745371.

Triangle Audio 200 Sea Lane, Farmingdale, N.Y. 11735, USA. Tel: (516) 249-3680 Fax No: (516) 420-1863.

Circle 214 on Reader Response Card

## Visual-Pager for Churches, Auditoriums and Restaurants

The **VISUAL-PAGER** system quickly pages an individual from a waiting room, restaurant or a large audience without disturbance. **VISUAL-PAGER** by Microframe Corp. is used in hundreds of churches all over America for quietly paging mothers to the nursery when needed. Send for a free brochure today describing easy installation. Discount to qualified system installers.



Visual-Pager Systems from \$398  
2, 3, and 4 Digit versions available

**FREE Brochure "B4" - CALL TOLL FREE 1-800-635-3811**

Microframe Corp., P.O. Box 1700, Broken Arrow, OK 74013

**B6**

Circle 286 Reader Response Card

## If Speaker Design Is Physics,



## Shouldn't Physicists Design Speakers?

The design and development of professional speaker systems are not activities to be practiced by the novice. True sound design is a craft of science, not simply carpentry.

That's why OAP Audio asked Dr. Eugene Patronis, eminent professor of physics at Georgia Tech, to guide the development of their newest speaker design.

His response? The new Pro-Ax 1090!

You'll want to hear the Pro-Ax for yourself - the speaker that's got everyone talking. And listening!

Call OAP today at (404) 945-1028. OAP Audio: Together with Dr. Patronis, putting the "physics" back in speaker design.



310 Peachtree Industrial Boulevard • Buford, Georgia 30518 • (404) 945-1028

Circle 261 Reader Response Card

announcements, general skating, commencement and speaking events, and several others.

The IQ System is also used for system diagnostics. When there is a problem, such as an area not receiving coverage, the configuration is called up on the computer screen, allowing the operator to immediately determine the extent of the problem and its source. Most of the time, it can be fixed with a couple of computer commands.

To help arena officials operate the system correctly and efficiently, Mavri supplied a concise manual that provides clear, easy-to-follow instructions. The manual covers everything from general operating procedures to selecting a specific preset to shutting off the entire system after an event. The bottom line: The Zamboni driver maintaining the ice can handle complete system on/off capability without assistance.

A TOA SAORI System is employed in conjunction with IQ. Using the AUX port of the IQ-P.I.P.'s, the IQ System software controls equalizer, delay and notch filter presets. To avoid potential groundloops, Mavri chose to opto-isolate the IQ and SAORI Systems, with

**The bottom line:  
The Zamboni  
driver maintaining  
the ice can  
handle complete  
system on/off  
capability without  
assistance.**

the SAORI allowing the match of equalization to any IQ System presets.

The SAORI mainframe includes a liquid crystal display for monitoring EQ settings. Another IQ feature provides the ability to lock the SAORI settings — they can't be changed unless the IQ System is unlocked via a special access code.



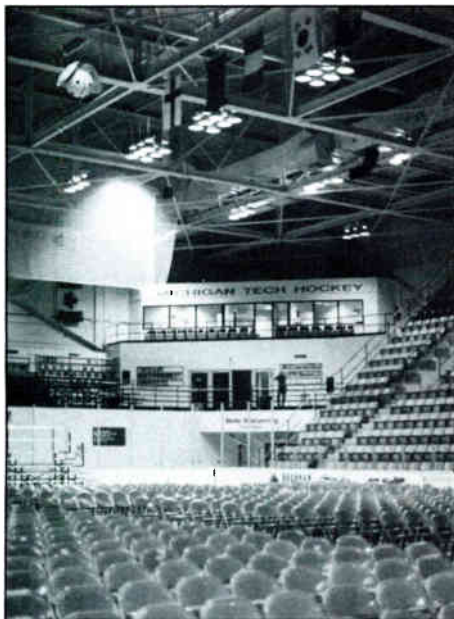

The ice arena as set up for commencement exercises.

Mavri had previously employed the IQ System/TOA SAORI combination with great success at the Kellogg Arena, a large, multipurpose arena in Kalamazoo, Michigan. This combination has also been employed in other notable venues like the Seattle Kingdome, where it was installed by Proshow USA of Redmond, Washington.

#### CUSTOMIZED RACKS

Amplifiers and most electronic components are rack-mounted and kept in a small room on the main level of the arena. Because the room interior can be viewed by the public, custom racks were designed and assembled to present a clean, "high-tech" look.

The room has white walls and gray floor tiles, so Mavri constructed the

racks from wood and then covered them with medium gray Formica. The Com-Tech amps and other components largely have black face plates

**The racks were pre-loaded and then rolled into the room where they were placed on blocks that provide added stability.**

that blend in nicely with the color scheme of the room and racks. When they were complete, the racks were pre-loaded and then rolled into the



# CAL SWITCH

CALIFORNIA SWITCH AND SIGNAL, INC.

**YOUR #1 SOURCE FOR:**

# Switchcraft®

Audio Connectors, Adapters, Jack Panels, Patch Cords, Plugs, Switches

**Off the Shelf Delivery**  
**Competitive Pricing**  
**Just in Time Delivery**  
**Value Added Services**  
Assembly, Engraving, Modification

[800] CAL-SWCH

Circle 262 Reader Response Card

room where they were placed on blocks that provide added stability. The racks also include jumpers that run to a common ground source.

This room also features four plugs that tie into the building's Emergency Paging System (EPS). The main mixing, a RackMax II 16 channel model, some signal processing gear and two Crown CT-400 amplifiers provide

sound to the two Soundsphere speakers upon activation of the EPS. It was a university requirement to make sure that sound is provided to the building, no matter the situation.

The mixing console, along with a Carver CD player and cassette deck, are housed in the main audio booth, while a variety of microphones, both wired and wireless, are available for use.



The electronic components are housed in custom racks.

# Another Great Sound from the **FRAZIER**

122 dB SPL 1M, FULL POWER

WIDELY ACCLAIMED CAT™  
COAXIAL DESIGN

INTEGRATED FLYING  
HARDWARE AVAILABLE

CAAD DATA ON BOTH 60° AND  
90° MODELS

Represented by a limited network of factory authorized contractors who would rather design systems than assemble loudspeakers from parts.

Recognized worldwide by leading consultants and specifying engineers for extended bandwidth pattern control and reliable specifications.

Model F1620, 60°x 40°  
Model F1630, 90°x 40°

Compact upper unit 25" x 25" x 17"  
18" Subwoofer 42" x 25" x 17"



# FRAZIER

Route 3, Box 319 • Morrilton, Arkansas USA 72110-9532  
(501)727-5543 • Toll Free 1-800-422-7757 • FAX (501)727-5402

Marketed in the US, Canada, Mexico, Scandanavia, Germany, Austria and Switzerland. Importing opportunities elsewhere.

Circle 263 Reader Response Card



**Because the room interior can be viewed by the public, custom racks were designed and assembled to present a clean, "high-tech" look.**

## CONCLUSIONS

"One thing that might be of some surprise is the fact that this new system, even with its state-of-the-art computer control devices, cost less than just the clusters for the old system," Krueger says.

Comments about the system have been highly complimentary. The university has expressed its complete satisfaction with all facets of the system. And in fact, Mavri received a letter from a grateful season-ticket holder, stating that for the first time, he can actually hear everything clearly. ■





THIS CONSOLE EXPECTS THE UNEXPECTED.  
BUT YOU EXPECTED THAT FROM US, DIDN'T YOU.

Be prepared. That's something most of us learned when we were kids wearing uniforms. Using the MC04II mixing console is a sure way to earn a lot more than a merit badge. Because it's been designed to handle just about anything that comes its way (was that a sigh of relief we heard?).

With two mix matrices for output routing flexibility, four-band EQ with two variable frequency mids, assign capabilities and an 80 Hz high pass filter, this mixing console will give an engineer more confidence than a professor teaching kindergarten.

Available in 12-, 16-, 24-, and 32-channel models, the MC04II gives you everything you want from a mixer: Flexibility. Sonic purity. Clear logical layout. Reliability.

And many happy listeners.

About those mix matrices—basically, they let you create two independent mixes from the group and stereo buses. Ready for some examples? Good. "I need a feed for broadcast and the show starts in 10 minutes!!!" "We can't hear the instrumentals in the foyer."

No matter what, the MC04II lets you handle all those day-to-day challenges without extra gear, excuses or sweat.

For more information, call 1-800-937-7171 ext. 30C.

Oh, the price. Let's just say this: To get a mixing console with everything the MC04II has to offer, you'd expect to pay a great deal more. But you expected that from us, didn't you.

**YAMAHA**®

# Testing Teleconferencing

## *A Method for the Automated Remote Testing of Facilities*

BY BRADLEY BASNETT

**E**xpectations for performance of teleconference facilities have grown in tandem with recent usage increases. By acquiring quality devices and deploying them in conducive acoustic environments, a network of effective meeting tools is created. However, various components of the teleconference system are subject to potential failure through heavy daily use and unforeseen operational faults.

To prevent customers from encountering failed or problematic devices, a method to check on the "health" of corporate audio teleconference systems was devised. The method involves a daily comprehensive electroacoustic test from a centralized location.

The implementation of the method incorporates available audio test tools, PC software, and advanced telephony devices. The method and test station are described fully below.

### TEST METHODOLOGY

A teleconference system is a specialized audio device. There are several components not normally found in the traditional audio path.

The components of a typical teleconference system are as follows:

- Transmit path. Microphone(s), preamp, mixer (if more than one mi-

crophone), acoustic processor (echo canceller and/or echo suppressor or voice switch), further signal processing (EQ, AGC circuitry), and telephone network interface.

- Receive path. Telephone network interface, AGC circuit, taps for the acoustic processor, amplifier and loudspeaker(s).

A simple way of determining the operational "health" of any audio system is to perform a frequency response measurement from system in-

### **The acoustic processing circuitry, essential for stable system operation, is a problem for a test system.**

put to output. Driving the teleconference system input (receive) with a test signal, and measuring the amplitude of the output (transmit) frequency response provides a status of the system.

The acoustic processing circuitry, essential for stable system operation, is a problem for a test system. The main function of the acoustic processor is to prevent signals arriving at the receive port from reaching the transmit port. To overcome this roadblock, some control device is required. The acoustic processor of the system under test must be momentarily disabled

by the control device. Once this roadblock is removed, a traditional audio test (*i.e.*, frequency response) may be applied with some confidence.

A comparison of the system's current measured frequency response with a reference response would point to any performance flaws or system failure. A failure would typically appear as a dramatic level drop or a radically different frequency response when compared to the reference.

For the test system to be cost effective, it should be connected to the telephone network and therefore be capable of testing many teleconference systems. The test apparatus must be capable of running in an automated fashion before working hours.

Based on the requirements above, a test system was defined as follows:

*Requirements for a remote audio teleconference test system.*

- The audio link between the test station and the teleconference system under test should be via a switched eight wire circuit (*i.e.*, E&M, Type II, with two pair for audio and two pair for signalling). This is one type used in dedicated circuits for audio conferencing and telephone company trunking. For test purposes, it basically provides a separate transmit and receive path to and from the test station. For conference calls, these types of circuits ensure high echo return loss, allow signalling, and eliminate the degradation of telephone hybrids. Normal analog voice lines may also be used but would

---

*Bradley Basnett is a specialist in the Teleconferencing Department of Bell-Northern Research in Ottawa, Ontario.*



# Reach The Entire Audience

Your sound system may not be addressing the 10% of Americans who are hearing impaired. Sennheiser infrared systems solve this problem by providing interference-free coverage in any venue. And have you comply with the ADA as well.

Sennheiser offers the widest range of infrared equipment and accessories, including unique multi-channel systems for dual-language and simultaneous translation applications.

Comfortable, lightweight receivers with the most intelligible sonic quality combined with reliable and powerful transmission equipment provide cost effective solutions and years of trouble-free operation.

And Sennheiser manufactures the Audiolink™ Personal Listening Systems for the National Captioning Institute, universal standard in infrared compatibility for both public facilities and home users.

Reach your audience...with Sennheiser infrared.

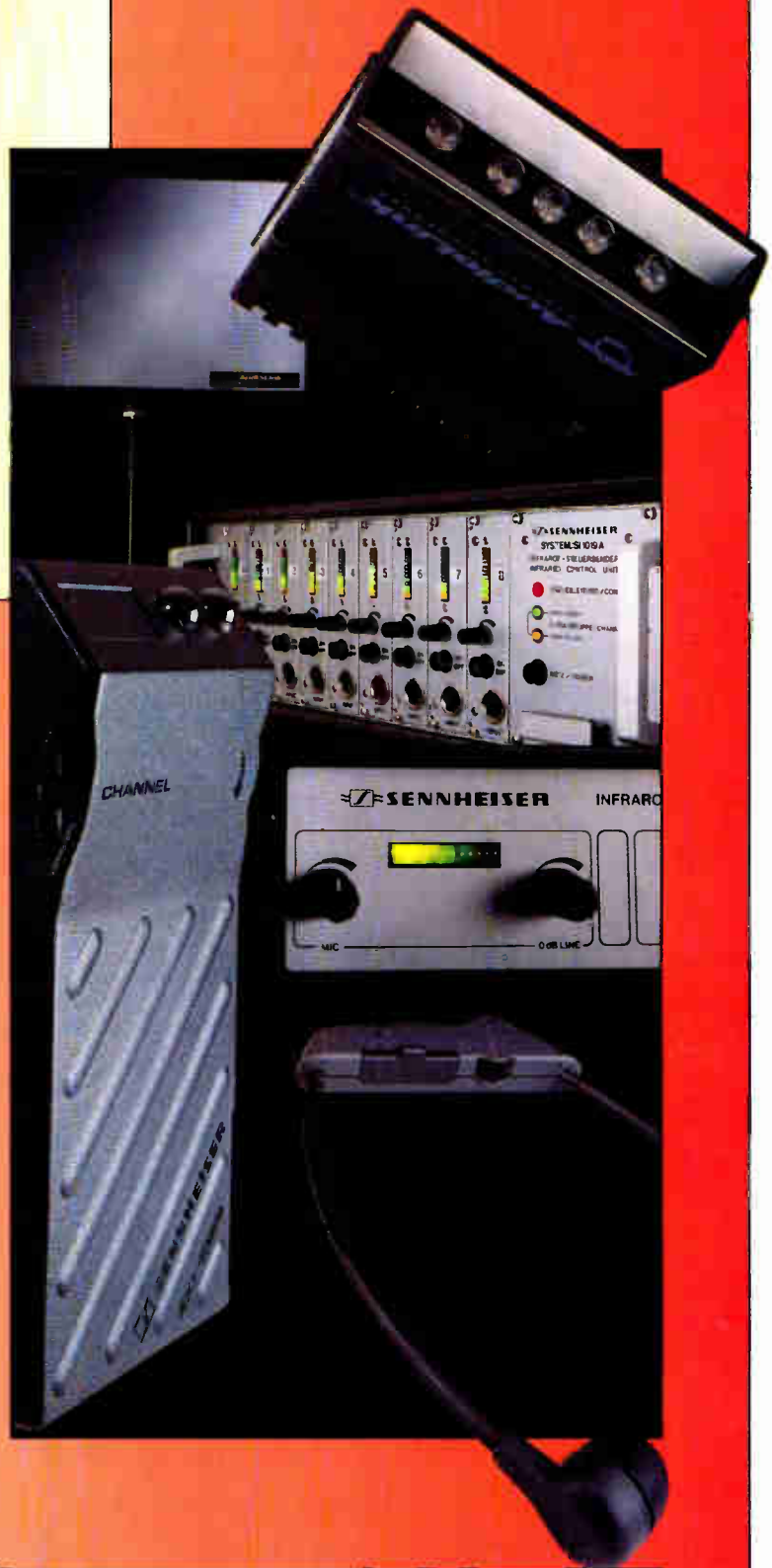

6 VISTA DRIVE, P.O. BOX 987, OLD LYME, CT 06371 · TEL 203.434.9190 FAX: 203.434.1759  
IN CANADA: 221 LABROSSE AVE., PTE-CLAIRE, PQ H9R 1A3 · TEL 514.426.3013 FAX: 514.426.2979

Circle 216 on Reader Response Card

World Radio History

# WHICH SPOOL WOULD YOU BUY?



When it comes to buying and installing low-voltage electronic cable, don't trust an unknown. Rely on West Penn Wire for the quality your installation deserves.

For over 20 years, we have risen above the fray of generic producers by manufacturing only the finest in cable products. Products like CL2, FPL, CM, plenum and non-plenum cables that meet and exceed the new NEC Codes. Products you can rely on for years.

And there's no mystery about our customer service. We like to feel it's the best in the industry. We're proud of our record for prompt, efficient, personal handling of all your needs...from order entry to delivery. Our reputation is built on

**WAW**  
**WEST PENN WIRE**  
*NOT EQUAL...BUT BETTER.*

our ability to help customers meet individual product requirements.

**West Penn offers a complete selection of low voltage electronic cable. All backed by the dependable quality, service, competitive pricing and engineering assistance you've come to expect from West Penn Wire.**

Don't take a chance on an unknown. It could leave you shorted in the long run. To place your order, call your local West Penn Wire distributor. For a catalog or more information, call us on **800-245-4964** (in PA, 800-222-8883). Or write P.O. Box 762, 2833 West Chestnut St., Washington, PA 15301.

In the UK

Shuttlesound

Tel: 081-640-9600  
FAX: 081-640-0106



On the Continent  
Leeds UK  
Tel: 44-532-509659  
FAX: 44-532-509307

**THE WIRE**  
**GROUP**  
INTERNATIONAL

Circle 217 on Reader Response Card

World Radio History



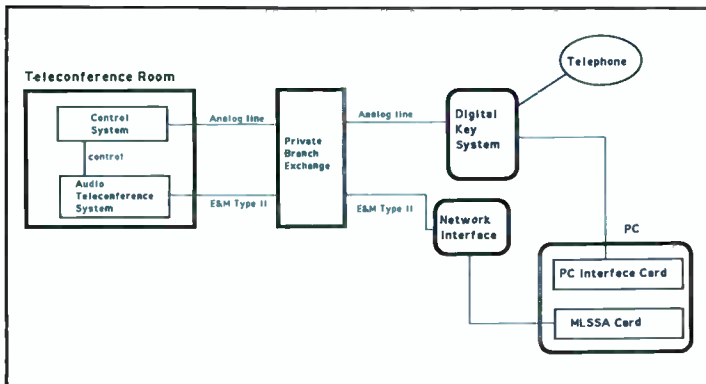

Figure 1. Audio Teleconference Test System Hardware.

require additional circuitry to separate the transmit and receive paths, and introduce the effects of multiple telephone hybrids.

- The teleconference system should be outfitted with some simple control device capable of preparing the teleconference system for the test. The operating mode of the teleconference system shall be switched from normal to test and back. This control device must be capable of receiving action commands via the switched telephone network.

- A sophisticated telephone controller is required at the test station to establish and supervise the telephone

connections for the control and the audio test portions.

- The electroacoustic measurement device must be capable of generating and analyzing a test signal. It should also be relatively immune to potential noise interference and have post processing capabilities.

### TEST STATION IMPLEMENTATION

From the requirements, a test system was constructed using commercially available hardware and software. Some customized software was also required to control the telephone system. Notably, very little programming was involved due to the sophistication of the "bought" packages. (A block diagram of the test system hardware is shown in Figure 1. A flow chart showing the actions of the implemented test system is shown in Figure 2.)

A personal computer is the core of the test system. To automate the setup and test tasking, a software package replaces an operator typing keystrokes at specific times and in particular order. The keystrokes call batch files that launch other commercial software packages (acoustic test, telephony control) that in turn control hardware devices (PC cards, telephones). Macros within these programs are also launched by the keystroke processor.

The batch files and macros are inde-

**A test system was constructed using commercially available hardware and software.**

pendent entities and can therefore be easily updated and reused as new systems and situations arise.

I have divided the test system into subsystems and describe each of them

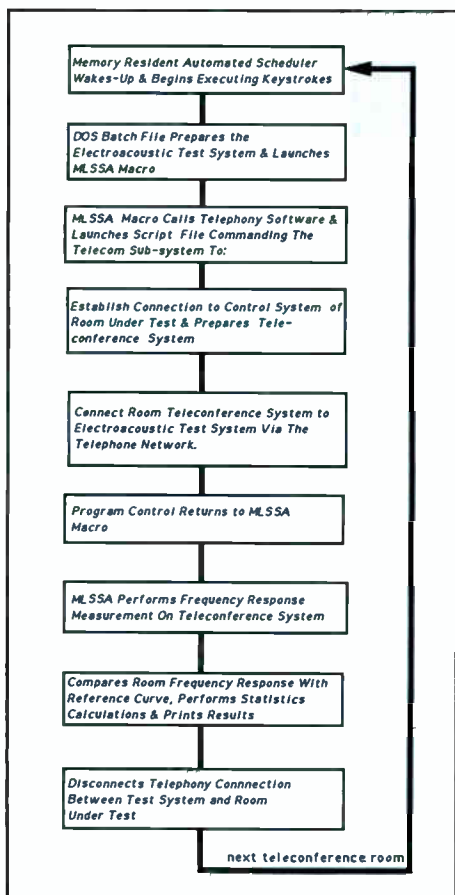

Figure 2. Flow Chart Describing Teleconference Test System Operation.

The best way to make your message clear...

CM-30  
Choir Mic

from above or below.

LM-300  
Lectern Mic

Here's just two of a complete line of high-performance choir, lectern and alter microphones designed to meet every unique miking problem you face. Including tight budgets.

Call us toll-free for more information or a free copy of the Crown Microphone Application Guide for Houses of Worship.  
1-800-535-6289

**CROWN**  
Guaranteed Excellence

Circle 273 Reader Response Card

**Tek-VIEW  
VM-Series Video Intercom**

TekTones® answer to affordable video-intercom systems.

VM104

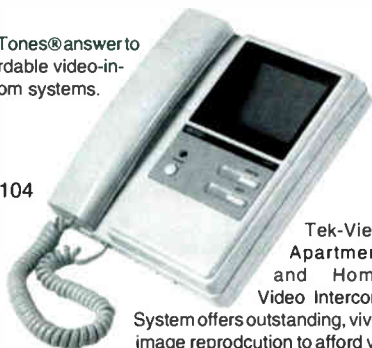

Tek-View Apartment and Home Video Intercom System offers outstanding, vivid image reproduction to afford visual identification of visitors.

**Call or Write To:  
TekTone Sound & Signal Mfg.**

1331 S. Killian Drive  
Lake Park, Florida 33403 \*  
Phone (407) 844-2383 FAX (407)845-1587  
Order Toll Free: (800) 327-8466

\* TekTone © North Carolina  
27 Industrial Park Drive  
Franklin, N.C. 28734  
Phone: (704)524-9967 Fax: (704) 524-9968  
Order toll free: (800) 448-1811

\* TekTone © Canada  
4190 Fairview St., Unit B-8  
Burlington, Ontario, Canada L7L-4Y8 \*  
Phone: (416) 333-0051 Fax: (416) 333-0599

Circle 287 Reader Response Card

**"With the BBE® system, it sounded cleaner, crisper, brighter, & simply put... BETTER!"**

DJ Times Magazine



*"BBE is the most inexpensive way to stand out from the competition. BBE is easy to use and will make your music so exciting, you'll be booked solid!"*

DJ Times Magazine

**BBE** Sound Inc. Huntington Beach, CA (714) 897-6766

ASK YOUR DEALER FOR A DEMO TODAY

Circle 288 Reader Response Card

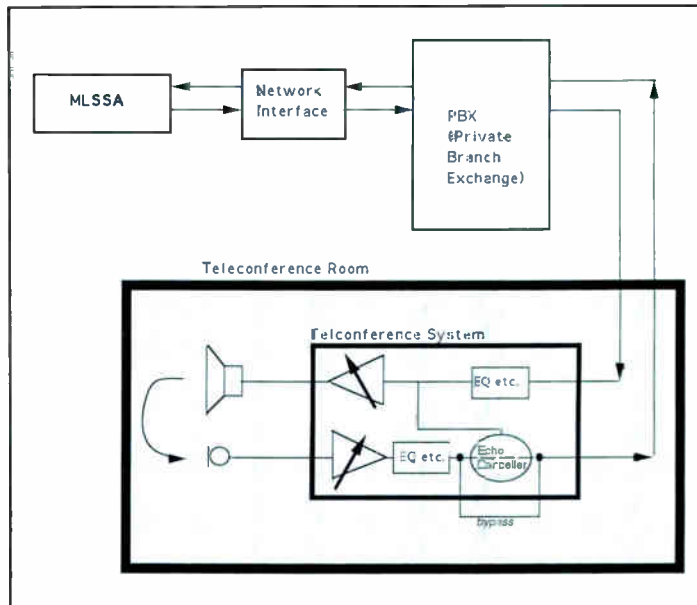

**Figure 3.  
Measurement Path for Audio Teleconference Test.**

below. Most components, except the telephone subsystem, would likely be in the arsenal of most audio companies.

**Scheduler.** Capable of issuing keystrokes at specific times in a certain order. Commercially available memory resident software for the PC (*i.e.* AutoMite).

**Electroacoustic Test Subsystem.** This subsystem generates a test signal, measures the impulse response of the teleconference system and calculates the frequency response. It compares the current result with a reference and prints the results of the comparison. DRA's MLSSA system is used. (Details of the electroacoustic test are presented later in this article.)

**Teleconference Unit Control Subsystem.** Commands are generated by the telephone subsystem, and routed via the telephone network to a DTMF (dual tone multi-frequency) decoding device. This control device operates relays that prepare the teleconference system for testing.

Essentially the echo cancelling circuitry is disabled with a dry contact closure so that the test signal may pass through the teleconference system and re-appear at the transmit output.

**Telephony Control Subsystem.** This controls all telephony functions of the test station. The hardware is comprised of a Digital Key System Unit (popular with small businesses), associated telephone set, and a PC interface card to enable custom PC software to control and monitor most of the functions of the telephone. This

subsystem handles the initiation and supervision of calls that:

- connect the teleconference system under test to the Electroacoustic Test Subsystem via the telephony network.
- connect with and issue commands to the Teleconference Unit Control

**The echo cancelling circuitry is disabled with a dry contact closure.**

Subsystem.

- disconnect all of the above telephone connections at the appropriate times.

**MEASUREMENTS**

This method uses the measurement of frequency response to determine the operational "health" of a teleconference system. The measurement path is shown in Figure 3.

The implemented measurement procedure is listed below:

- A 16383-point maximum-length sequence (MLS) with a bandwidth of 5 kHz is fed from the MLSSA card to the "receive" port of the teleconference system under test via the switched telephone network.
- The test signal passes through the audio teleconference system, and re-appears at the transmit output. The signal returns to the test station on the other pair of the audio circuit via the telephone network.
- The loudspeaker/room impulse response, encompassing the whole



teleconference system, is then measured. In this instance, the teleconference microphone serves as the measurement microphone.

(The measurement path also includes the telephone network. Therefore, the effects of the network will appear in the results. However, the effect on the measurement is usually only one of band limiting.)

- A 2048 point FFT (Fast Fourier Transform) is then performed on the impulse response. The result of the FFT is the amplitude of the frequency response. It is then compared with the reference frequency response. Statistics provide information on the similarity of the two curves (*i.e.* relative level shift). The results are then printed. Obviously, a well matching curve proves that the path through the system under test is operating as de-

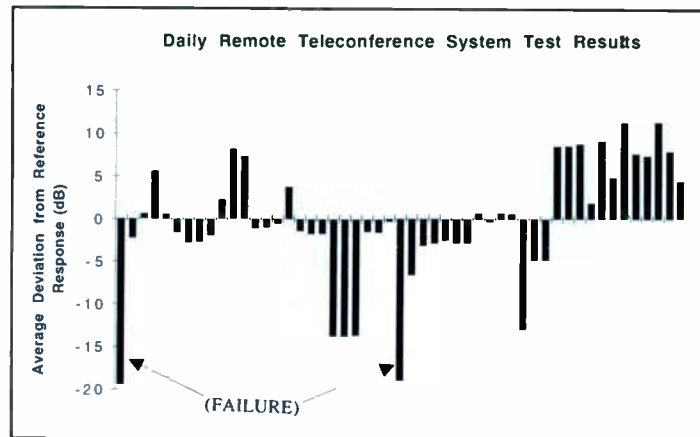

Figure 4. Teleconference System Remote Testing Results.

signed. A poor match indicates trouble and must be investigated.

### TEST RESULTS

Figure 4 shows the results of two months of testing on one room equipped with a testable teleconference system. The results show two failures. The failures were minor; both were caused by brief power interruptions and only required that the teleconference system be reset.

The average difference in level, shown in Figure 4, is only one of the

statistics available. However, it is a good indicator of system status. The shape of the curve, as compared to the reference, is also scrutinized for potential problems.

Figure 5 shows the results of a comparison of a measurement with a reference curve having close agreement (pass). The irregularity of the current measured frequency response is caused by the interference effects of room boundaries. Figure 6 shows one in poor agreement with the reference (failure).

© 1992, FerroSound is a trademark of Ferrofluidics Corporation

**THE RESPONSE TO OUR LATEST FERROFLUID IS OUTSTANDING.**

WOOFER; BLACK - NO FLUID, BLUE - FERROFLUID

FREQUENCY (kHz)

### Increased power handling and lower distortion from new woofer-compatible ferrofluids.

Created to handle increased peak power demands even in woofers, this new generation of ferrofluids represents a dramatic new low in speaker design. Tailored to meet the performance requirements of your specific design, today's ferrofluids demonstrate both low viscosity and high saturation magnetization while maintaining ultra-high thermal stability. Qualities that ensure stable sound quality, smooth frequency response, more efficient heat transfer and reduced distortion even at large voice coil excursions.

These benefits can be flexibly achieved without the need for extensive engineering changes to existing woofer designs. Once in the field, you and your customers will also discover another tremendous advantage to these ferrofluids — longer speaker life and fewer returns.

For more information, call 603-883-9800 or fax 603-883-2308.

**FerroSound**  
The Solution Is Loud And Clear™

Ferrofluidics Corporation, 40 Simon Street,  
Nashua, NH 03061

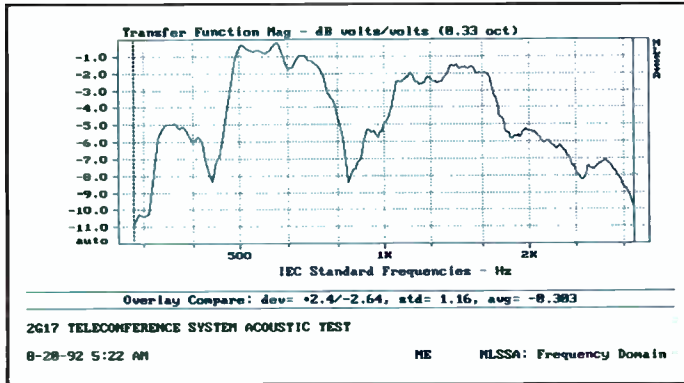

Figure 5. Results of Comparison of Measured Frequency Response with Reference (PASS).

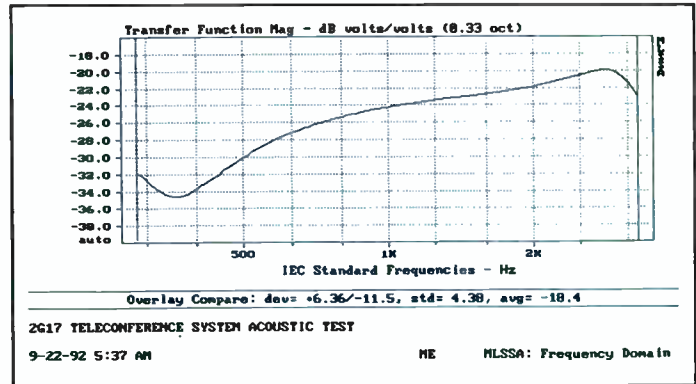

Figure 6. Results of Comparison of Measured Frequency Response with Reference (FAILURE).

### EXPECTATIONS FOR AGREEMENT BETWEEN REFERENCE AND MEASURED VALUES

In this particular case, the loudspeaker volume control of the teleconference system may be adjusted by the user. Therefore some variability in the measured level is expected.

The curve is examined to see that it

has a proper profile and a level that is within the predefined range. Currently, this portion is done by visual inspection of the frequency response curve, but may soon be automated.

### SPIN OFF FROM TEST ROUTINE: FAX TESTER

During the test station project, another application was developed. This one uses the same test station, but in

a slightly different way. It checks FAX machines. It checks their "health" by calling them up and "listening" to the handshake tones that they generate. Essentially, the electroacoustic test subsystem acts as a digital storage scope. Next, it calculates the frequency response and then compares the current measurement to a reference curve. Again, the result is printed and reviewed to find errors (machine unplugged, phone line unplugged, FAX machine defective). The test algorithm is shown in Figure 7.

### FUTURE

As videoconference systems become more ubiquitous and relied upon for important business communications, some form of remote testing will be required. The method described here may provide the basis for the audio portion of remote videoconference system testing.

### SUMMARY

This article has reviewed the development of an automated test station that measures the frequency response of teleconference systems remotely for quality assurance purposes. The test station has proved useful during field trial and with further refinement will be expanded to provide more comprehensive testing of current and future teleconference facilities. ■

[Acknowledgment: The author would like to thank the Information Technology Division, Bell-Northern Research for support of this work. He would also like to thank John Lighthall for encouraging and actively supporting this project.]

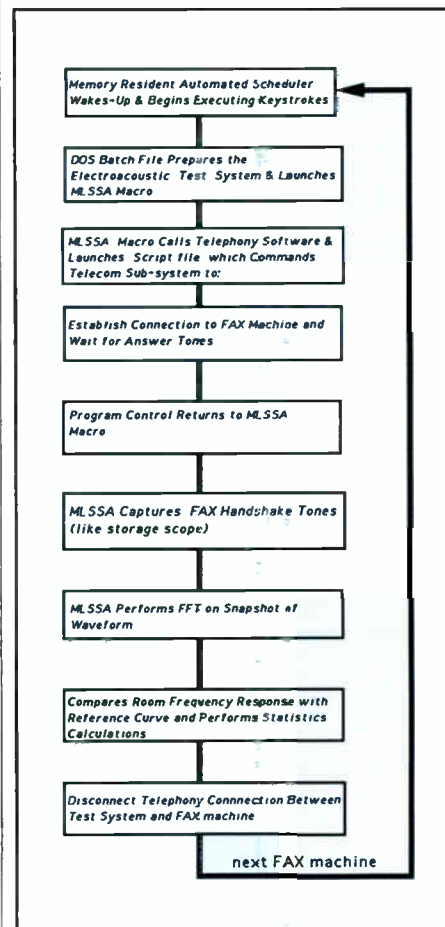

Figure 7. Flow Chart Describing FAX Test.

**Affordable Solutions to Hearing Accessibility**

Choose the Easy Listener FM or StarSound Infrared System to meet ADA requirements easily and inexpensively.

Call for free catalog  
 800/227-0735 U.S.  
 800/387-3158 Canada

**Phonic Ear**

Circle 289 Reader Response Card



# Now! Extended reach that leaves the competition out of touch!

## Engineered Sound™

It's hard to believe how well these miniature microphones reduce off-axis ambient noise pickup. Despite their tiny size, their significantly narrower acceptance angle solves your most difficult sound pickup problems. The unique line + gradient design is precisely scaled to provide a polar pattern that until now was available only in much larger microphones.

Because they don't compromise sound quality for either size or concentrated coverage, the AT933 MicroLine condensers are unusually effective for both vocal and instrumental music sound reinforcement. Or use them to provide almost invisible theater stage coverage.



So light they can be hung by their own cable, the AT933 models are available in black or white with either a ceiling-plate or an in-line power module for

utmost versatility. Plus, we now offer several desk-mounted MicroLine models for use on lecterns, tables, and in other fixed locations.

Don't just bemoan bad acoustics. Solve the tough problems with the new MicroLine models from Audio-Technica. They are part of our exciting new line of Engineered Sound™ products developed exclusively for the sound contractor. From the creators of UniPoint® and the leader in miniature microphone design. Call or write today for details.

**New AT933PM/ML and AT933R/ML  
MicroLine™ condenser microphones.**

Shown actual size.  
Also available in  
white matte finish.



**audio-technica.**

INNOVATION □ PRECISION □ INTEGRITY

Available in the U.S. and Canada from Audio-Technica U.S., Inc.  
1221 Commerce Drive, Stow, OH 44224  
(716) 686-2600 • Fax (716) 686-0719  
In Canada call: (800) 258-8552

Circle 218 on Reader Response Card

## TRADE SHOWS

(Continued from page 17)

School in Monterey presented a paper regarding the software required for the computer generation of virtual environments. Other papers discussed the dimensions of synthetic experience, telepresence, and simulator sickness.

The session on Chaos in Music featured a paper by Dr. Manfred Schroeder of Bell Labs that discussed chaos in musical instruments, and showed how it can cause turbulence in woodwinds and malfunctions of the vocal cords. Chaos here means that these systems have fundamentally unpredictable properties even though the mathematical equations describing them have no random or

unpredictable elements. Another paper, presented by a mathematician from Rice University, entitled "Fractal Waveforms and Cellular Dynamics," was basically a performance art piece, in which the equations describing

### THE EQUATIONS DESCRIBING FRUIT FLY POPULATIONS WERE USED TO CONTROL A YAMAHA SYNTHESIZER THAT PROVIDED MUSIC.

fruit fly populations were used to generate a visual display that showed

the growth and propagation of fly populations, and to control a Yamaha synthesizer that provided music. This performance was better than described.

Twenty-five years ago there was more commonality of acoustical developments between the Audio Engineering Society and the Acoustical Society of America. The new technologies of virtual environments, especially auralization, provides a great potential for commonality between the AES and the ASA, with the audio industry the beneficiary.

(There will be a special workshop dealing with Auralization at the 1993 AES convention.)

For more information of the Acoustical Society of America, contact Ms. Elaine Moran at 516-576-2360. ■

# MENLO SCIENTIFIC ACOUSTICS, INC.

## ACOUSTICAL CONSULTING & DESIGN SERVICES FOR SOUND CONTRACTORS

### SPECIALIZING IN:

**SOUND SYSTEM DESIGN  
AUDIO/VISUAL SYSTEM DESIGN  
ELECTRO ACOUSTICS  
ARCHITECTURAL ACOUSTICS  
NOISE & VIBRATION CONTROL  
PRODUCT DEVELOPMENT & TESTING  
PRODUCTION FACILITY DESIGN**

### CONTACT:

**MICHAEL A. KLASCO  
NEIL A. SHAW**

**531 MAIN STREET SUITE 428  
EL SEGUNDO, CALIFORNIA 90245-3060  
TEL.: (310) 322-3086 FAX: (310) 322-3016**

Circle 265 Reader Response Card



# NEWS FROM AROUND THE INDUSTRY

## U.S. Sound Acquired; Tannoy in Calgary

### Carver Acquires U.S. Sound

Carver Corporation has announced that it has acquired the assets of U.S. Sound, Inc. U.S. Sound designs and manufactures speaker components and markets and installs high-intelligibility sound systems.

"The acquisition of U.S. Sound technologies combined with our leading edge professional amplifier expertise should give Carver Corporation a strong presence in the professional sound reinforcement system market," stated Tom Graham, Carver's president and CEO. "Our early focus will be directed toward marketing sound reinforcement systems for use in major arenas and stadiums, both in the U.S. and Europe," added Mr. Graham.

The purchase price included \$1 million in cash, 20 percent of the outstanding shares of USS Corporation, the new subsidiary company, and earn-out payments over several years of up to 10 percent of the net revenue on sales of systems using U.S. Sound technology.

### Tannoy Has Culture

Tannoy Contractor Series components were used at the Calgary Chinese Cultural Center.

The physical space that the Cultural Center occupies has dimensions similar to a basketball arena.

The sound problems that accompany a large, open space were dealt with by the Tannoy Contractor Series components, explains Mike MacLeod, a designer with the Calgary Sales Division of William F. White, Ltd., the theatrical design group that designed and supervised the renovation.

"We mounted three Tannoy CPA-15's arrayed in a central cluster, and two more CPA-15's in a left-right proscenium pair," MacLeod says of the \$100,000 sound installation.

### Miller and Meder Sign Agreement

Gary E. Miller announced the formation of GEM Electronics, Inc. to exclusively import products manufactured by Meder Electronic GmbH of Singen, Germany and service the North American market. The product line includes reed relays and sensors for applications in the telecommunications, test and measurement and security alarm industries.

Formerly the director of product and market development for Coto Wabash, Miller says that he selected Meder to represent because of their ability to respond to customer needs worldwide, in terms of research and development, production, distribution and quality assurance.



Gary E. Miller

### RCI and the Pageant of Peace

RCI Sound Systems was contracted for the 3rd consecutive year to provide full audio reinforcement and holiday music for the annual Pageant of Peace. The event, held on the grounds of the Ellipse directly across from the White House in Washington D.C., marked the start of the Christmas Season and ran from December 10 through January 3rd. Special



(L to R) William M. Pagett, director marketing & sales, Switchcraft, Inc., David Simmonds, president, A.C. Simmonds & Sons, Ltd., Keith A. Bandolik, president, Switchcraft, Inc.

holiday music provided by the AEI Music Network was played throughout the Ellipse area each day from 10:00 am until midnight, with a variety of live entertainment by performers from across the country. RCI Sound Systems was entirely responsible for all audio reproduction for the month long event, including all stage audio, the perimeter systems covering the grounds, and all holiday music reproduction.

### Shen Milsom & Wilke In Hong Kong

Shen Milsom & Wilke Inc. has opened a branch office in Hong Kong. Ward Sellars, an audio/video engineer with over 12 years experience in Hong Kong, will run the office. Sellars was previously involved in television studio design, three large sound systems for horse racing track, and an audio/video system for the Hong Kong Government's Executive Council Chambers.

Sellars is assisted by an acoustician, two electrical engineers with backgrounds in video systems and computer-controlled audio systems, and office support staff. There is also a full-time telecommunications engineer/manager. The office is equipped with a Novell Network running AutoCAD V.12, an E size (AO) H-P DesignJet Plotter, high speed modem's for Wide Area Networking through to the head office in New York, and Bruel & Kjaer

Acoustical measuring instruments.

### REP NEWS

#### Switchcraft Appoints Canadian Rep

Switchcraft, Inc., has announced the appointment of A.C. Simmonds & Sons, Ltd., as its Canadian stocking distributor. A.C. Simmonds & Sons represents many North American and European passive component manufacturers offering complete services, as well as packaging and value added facilities where needed.

#### World Arts Reps Bag End

World Arts of North Hollywood, CA, has signed an agreement with Bag End Loudspeaker Systems to represent the loudspeaker systems manufacturer for international markets. The announcement was made jointly by John Vitale, sales manager for Bag End, and Martin Miranda, president of World Arts. "Interest in Bag End has been growing in international markets, especially in England, Western Europe, and the Orient," says Vitale. "We felt the time had come to put a formal marketing structure in place for those markets. Martin has an outstanding reputation in the music industry worldwide, so he and World Arts fit our needs perfectly," he continued.



Billboard Music Awards show

### Xenotech Lights Awards

Xenotech, Inc., provided 11 automated lighting devices for last year's Billboard Music Awards, held in December. The annual event, honoring the music industry's best selling recording artists, was televised live on the Fox Network.

Bob Dickinson, lighting director for the Third Annual Billboard Music Awards, chose Xenotech to provide six automated 7,000-watt Britelight lighting devices, and five automated 2,000-watt Britelights. These were used dur-

ing most of the evening's musical performances, including songs by Genesis, Guns and Roses, Travis Tritt, Richard Marx and Boyz II Men

### SMT Name Change

Syncopated Marketing Technologies, who represents Bag End in the Mid-Atlantic region, has changed its name to Mid-Atlantic Marketing, according to a recent announcement by Lenny Robinson, president of the firm. "Our new name, Mid-Atlantic Marketing, describes more accu-

rately who we are and what we do," Robinson says.

### Accupoint 1000

Laser Arts has announced the Accupoint 1000, a remote-controlled graphics laser pointer for use in auditoriums, classrooms, and learning centers.

Instead of either front or rear projection applications, the system consists of a stationary laser projection unit operated from a joystick remote control mounted at the speaker's podium. The joystick allows the user to move the pointer image to any location on the screen. In addition, several different graphic pointer images can be selected for different types of emphasis.

The Accupoint provides its graphics capability. The Laser Arts product allows the presenter to select four different orientations of arrows, plus a circle, a square, horizontal and vertical lines, a star, and cross hairs. In addition, the size of the circle and square and length of the lines can be adjusted by the user.

Accupoint is priced at \$6,875.00 retail. This price includes the projector unit, helium-neon laser, joystick remote control unit, and

cables. Each system is covered by full one year parts and labor warranty.

### Peavey Receives National Literacy Award

Peavey Electronics Corporation was recognized as a recipient of the National Literacy Honors Award. Hartley and Melia Peavey accepted the award from President and Mrs. Bush recently, in the East Room at the White House. Peavey was recognized for its involvement with the Job Skills Education Program that provides basic skills training for Peavey Employees.

### Intelligent Automation

CM AUTOMATION started delivering the MX-816 and FX-100 Automation Control Console, a turn-key interactive intelligent automation system. The FX-100 in conjunction with the MX-816 creates a control system for automated mixing. The eight channel FX-100 has built-in expandability and 100 millimeter linear faders to send audio volume messages and a mute/solo switch for track muting. The FX-100 can be phantom powered from the MIDI input or output jacks, simplifying cabling.

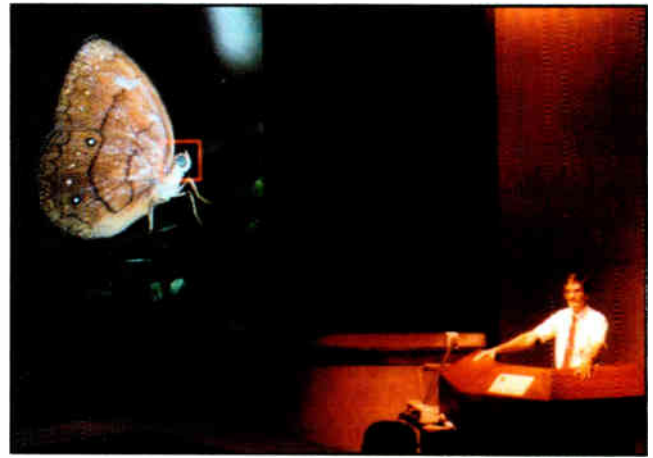

The Accupoint 1000 Laser Pointer

## Eastman Presents The "Able" Cable

Eastman's New RISER Cable should have been called the "Able" Cable because. . .

- RISER is *able* to achieve greater fire resistance than CL2, FPL, or CM rated cables.
- RISER is *able* to fulfill your requirements for security, fire, sound and intercom cable.
- RISER is *able* to give your customer higher rated NEC/UL listed cables at no greater cost than general purpose cables.



Specialist in UL Listed Riser Wire & Cable for the security, fire, electronics, and sound industries. All products meet the 1993 National Electric Code Specifications. If you would like a new catalog, please call or write:

1085 Busch Highway  
Pennsauken, NJ 08110  
609-488-8800  
609-488-8899 (fax)  
1-800-257-7940

20952 Currier Road  
Walnut, CA 91789  
714-594-5886  
714-598-0549 (fax)

Circle 276 on Reader Response Card



The FX-100 and MX-816 Automated Control Console



# THE SPEAKER FOR PEOPLE WHO ALREADY HAVE THE PERFECT CABINET.



We see your home as more than just a good place to raise a family or build equity. We see it as the perfect speaker cabinet. And while some people may view this as extreme, those of us who are passionate about music and aesthetics have a slightly different way of looking at things.

And that's precisely why we've developed the Parasound Custom Series/Titanium line of in-wall speakers. Four remarkable two-way models and a thundering subwoofer. Each is built to rigorous high-end audio standards. And each is loaded with impressive features you'd expect to find on speakers costing much more.



And like our critically acclaimed electronic components, we concentrate on the performance rather than the superfluous.

This hallmark approach not only gives you better sound quality, it also leaves some extra money in your pocket.



For more information contact your authorized Parasound Dealer or Custom Installer. And hear the perfect speaker for people who just happen to live in the perfect speaker cabinet.



PARASOUND  
*affordable audio for the critical listener.*

Parasound Products, Inc. 950 Battery Street, San Francisco, CA 94111 • 1-800-822-8802; 415-397-7100; Fax: 415-397-0144  
In Canada, distributed by: Absolute Sound Imports, 7651 Granville Street, Vancouver, BC; 604-264-0414

Circle 219 on Reader Response Card

World Radio History

*else*  
**LOOK WHAT QUAM  
 HAS FOR YOU!**



**ROUND BACKBOX ENCLOSURES**  
 ERD-8 Series

- Seam and leak free
- Radius corners to provide improved audio response
- Fire retardant materials eliminate mechanical and acoustical resonances
- Shape of units permits nesting

Ask for FREE Tech Spec TS-37

**Quam-Nichols Company**

234 East Marquette Road, Chicago, Illinois 60637  
 Phone: 1 312 488-5800 • FAX: 312 488-6944

Circle 277 on Reader Response Card



(L to R) Alan White, Yes, Jim Keltner, West L.A. Music salesperson Cathy Curtiss and Reek Havok, president of Drastik Plastik at West L.A. Music's Music Expo

**West LA Music Expo**

West L.A. Music recently presented its sixth annual Music Expo. Thousands of musicians, producers, composers and educators attended the two day event at the L.A. Airport Hilton.

The Music Expo featured a variety of items from the latest computer products to major brand guitars, amps, drums, keyboards, recording equipment, sound systems and accessories. Professional product demonstrations and seminars took place throughout the Expo, and guests were encouraged to try out the equipment on display.

Celebrities and musicians added excitement at Music Expo '92. Among the guests who attended were Tommy Lee of Motley Crue, Alan White and Trevor Rabin of Yes, Mark Schulman of Foreigner, Nick Menza from MegaDeath, Bruce Kulik and Eric Singer of Kiss, Rudy Sarzo of Whitesnake, Neil Peart from Rush, Steve Stevens and California Angels' pitcher Mark Langston.

Highlights of the show included rock and roll demonstrations by Marshall clinician Nick Bowcott, and Bruce Kulik from Kiss. Nick presented several 15 minute medleys demonstrating the sound and versatility of Marshall's new rack mount JMP-1 MIDI preamp. Kiss drummer, Eric Singer, was on hand in the Pearl exhibit for the unveiling of Pearl's drum kit, the Export Pro.

In an impromptu question and answer session, Eric discussed Pearl gear and his personal touring kit. Guitar superstars Steve Stevens, Tracii Guns and Darren Householder helped introduce Washburn's new MG 104 and MG 94 guitars. Trevor Rabin of Yes presented a seminar on Digidesign's ProTools, multi-track recording and editing system for Macintosh. The presentation included a step-by-step demonstration on how he uses ProTools for recording and editing in his personal project studio.

Other features of the Expo include the introduction of: Korg's new Wavestation SR; Roland's JV-880 sound module, GR-1 guitar synthesizer, AX-1 remote midi keyboard controller, TDE-7 percussion system, the BOSS DS-D30 Dr. Synth, and the DJ-70 sampling workstation; Yamaha's SY 85 synthesizer, the PSR-SQ 16 advanced portable keyboard, and the TG 500 rack mount tone generator. Ibanez premiered the JS6 Joe Satriani 3-D body guitar with a new non-locking tremolo design and DOD/Digitech demonstrated the new RP-1 and PCM-10 effects gear.

**Jeron Appoints New Rep**

Jeron Electronic Systems, Inc. has appointed Jeff Kingston and Kingston Sales Corporation of Indianapolis, Indiana as the sales representative for the Indiana and Western Kentucky territories.

**Winsted®**

**SECTIONAL  
 WALL  
 CABINET  
 for  
 Sound and  
 Security  
 Systems**



**3 sizes...  
 immediate shipping!**

Cabinets offer secure rack space for rack mount electronics, PA systems, amplifiers, alarms. Cabinets back mount on 16" centers, door mounts either left or right side.

- Heavy duty 16 gauge steel • Louvered sides with 1/2", 3/4" electrical knockouts • Built to strict EIA standards • Black baked enamel finish • Sizes: 17 1/2", 26 1/4", 45 1/2"

For more information write or call **TOLL-FREE**

**1-800-447-2257**

**THE WINSTED CORPORATION**

10901 Hampshire Ave. So. • Minneapolis, MN 55438 • (612) 944-8556  
 FAX: 612-944-1546

*Preferred by Professionals Worldwide*  
 Circle 278 on Reader Response Card



## PRODUCTS

# Sound Lab Software From Techron; TOA's F-505 Loudspeaker



### Techron Releases New Software

Techron's Sound Lab-PC version 1.3 has been released for shipment. Using 3-D waterfall displays and a Noise Level Analysis (NLA) module, Sound Lab-PC provides TEF 20 users with displays ranging from 2 to 36 curves which can be viewed from left, right, front or back perspectives.

The software provides continuous Leq information during a measurement and displays Leq, Ln, and Lmean values, even if a measurement is interrupted before completion. Fractional percentile values are also available, along with the ability to calculate the Ln that corresponds to a given dB level. Other new features include NLA cursors, AutoRepeat mode, Combine Files feature, and muting. Data values are displayed at the NLA cursors while the Leq value is shown between the cursors.

Circle 1 on Reader Response Card



### TOA's F-505

The F-505 loudspeaker from TOA Electronics has a frequency response of 70 Hz to 20 kHz, can handle figures of 80 watts RMS and 240 watts continuous pro-

gram, with a sensitivity at 93 dB.

Drivers in the F-505 start with a single 8-inch woofer. At 3 kHz, frequencies are directed to a constant directivity horn coupled to a compression driver for smooth coverage in a 60 degree by 40 degree nominal pattern.

Measuring 11 inches wide by 18 inches high and 9 inches deep, the F-505 weighs 16.5 lbs. The input panel is equipped with two ¼-inch phone jacks and a pair of push-in terminals. A built in protective circuit is provided to safeguard from excessive input levels. With a suggested retail price of \$558, the F-505 is available either in ivory or gray.

Optional accessories include mounting racks. For applications requiring additional low frequency response, the F-605 loudspeaker is also available. Outfitted with a larger 12-inch woofer, it has a retail price of \$958.

Circle 2 on Reader Response Card

### B&K Precision DC Power

A 3 to 14 volt, high current DC bench power supply with regulation and low ripple is now available from B&K Precision. Model 1686 is designed to output 12A maximum at 13.8V DC. The 1686 provides simultaneous monitoring of voltage and current output. Voltage is continuously adjustable over the 3 to 14 volt output range.

The 1686 has reverse polarity protection from an external DC source, overload protection, short circuit protection and current limiting.

Plus and minus outputs are isolated, so either polarity may be floated or grounded. Two Model 1686 supplies can be connected in parallel to double the current output, or in a series to double voltage output.

Circle 3 on Reader Response Card

### ½-inch CCD Video Camera

Elmo Mfg. Corp. has introduced an "economy priced" ver-

sion of its SE360 high resolution, low light ½-inch CCD monochrome video camera. The new SE360S features the performance of 500 TV (H) and low light sensitivity of 0.15 lux at f-1.4. It is available in 24VAC, CS mount and incorporates line lock with a S/N ratio greater than 46 dB.

Circle 4 on Reader Response Card

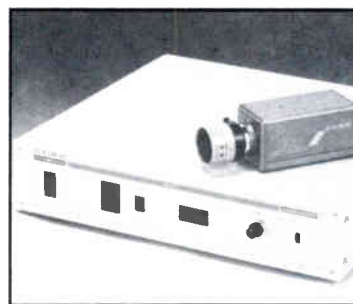

### Philips Enhanced Telephone

Philips Home Services International has announced the introduction of the Philips Enhanced Telephone. The Philips ET is a screen-enhanced phone that offers visual features and Text Telephone capabilities.

Philips has integrated a five-inch, tilt-up LCD screen, a slide out keyboard, and an auto-answer modem. The phone also has an auxiliary port for connecting standard printers and other peripheral devices. It comes with a built-in standard memory card, making it possible for users to add new software applications as they become available.

Circle 5 on Reader Response Card

**NEW!**

*From the Leaders of  
Ballroom Combining...*

**\*\* THE ML-104 SYSTEM \*\***

The perfect system for up to four rooms of control  
with a price tag to fit any budget.



The ML-104 comes complete with the main rack unit, four locking control panels, and power supply. Any manufacturers mixer or amplifier can be used with the ML-104.

Call today for the NEW ML-104 color data sheet!

**FSR, Inc.**

244 Bergen Blvd., West Paterson, NJ 07424  
201-785-4347

Circle 279 on Reader Response Card



### Marquee 8000 and Marquee 9000 Projectors

Electrohome Ltd. has introduced the Marquee 8000 and Marquee 9000 projectors. The Marquee 8000 has three 8-inch electromagnetic focus CRT's and has a horizontal scanning capability of up to 130 kHz. The Marquee 9000 features three 9-inch electromagnetic focus CRT's and also has a horizontal scanning

capability of up to 130 kHz. These new projectors generate images directly from a user's computer or video equipment. Each projector has a capacity of 54 sources, with the use of optional decoders and interfaces. Users can control projector software functions through a variety of devices: a built in keypad; an optional remote wired keypad; a high-frequency infrared remote that comes standard with

each unit; an external PC that can drive standalone or networked projectors through RS-232; or a reduced-function presenter's remote. The Marquee projection systems accommodate a variety of screen sizes. The 8000 produces images with a diagonal range of 6-25 feet; the 9000 images range from 8-25 feet.

The Marquee 8000 offers 1,350 x 1,100 ANSI pixels and the Marquee 9000, 1,500 x 1,200 ANSI pixels, with accessibility of 2,500 x 2,000 pixels. Their brightness measures are 900 lumens peak, or 175 ANSI lumens for the Marquee 8000, and 1,200 lumens peak, or 250 ANSI lumens for the Marquee 9000. The Marquee 8000 has a bandwidth of 100 MHz; bandwidth of the Marquee 9000 is 120 MHz.

Both projectors can be ceiling- or table-mounted for front or rear-screen projection. They measure 17 x 28 x 32 inches.

Circle 6 on Reader Response Card

dolly is American made using heavy duty steel and comes with ball bearing wheels. The unit weighs approximately 10 pounds.

Circle 7 on Reader Response Card

### Quality Technologies Optical Switches

Quality Technologies has introduced a new series of optical switches, the QVA Series, the QVB Series, the QVB Series with Wire Termination, the QRB1113/1114 Reflective Optical Switch, the QRB113/1134 Reflective Optical Switch with Wire Transmission.

These switches consist of an infrared LED and an NPN phototransistor. The phototransistor

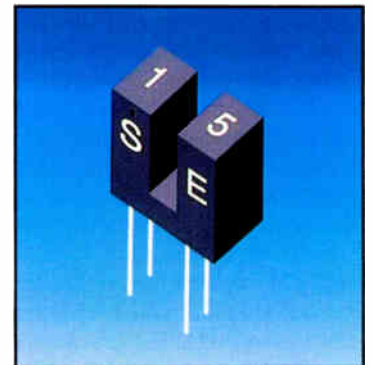

detects the presence of light from the LED until the light is blocked by a mechanical object. These switches use a design to prevent dust accumulation in the optical path. The design also allows easy cleaning should particles become attached to the surface.

The QRB113/114 Reflective Optical Switch uses infrared light in a reflective mode to detect objects in close proximity. Optically reflective switches are useful for sensing paper or other non-contact applications. Both the QRB1113 and the QRB1114 offer output currents with min/max limits.

Quality Technologies has also introduced the QED522 and QED523. The QED522 offers output power minimum of 0.15 mW/10 while the QED523 offers output power minimum of 0.20mW/10.

Circle 8 on Reader Response Card

**FEEDBACK ELIMINATORS**

For P. A. SYSTEMS

---

**MESSAGE REPEATERS**

MULTI-LINE / RANDOM ACCESS



- Complete record/playback systems with high quality audio, digitally recorded in semiconductor memory (no tape).
- TELEPHONE ANNOUNCING UNITS** with up to 6 lines and 48 minutes of audio messages. Lines may have common or separate messages.
- SECURITY and ALARM ANNOUNCING UNITS** with up to 36 random access messages.
- FEEDBACK ELIMINATORS** that can simultaneously answer and record pages from 1 to 5 phone lines (or other paging source) then sequentially feed them into selected P. A. system zones.



800-722-6664 / 216-351-1755  
5504 State Road  
Cleveland, OH 44134-7330

ATTENTION CONTRACTORS:  
WE WILL CUSTOMIZE FOR YOU!

Circle 280 on Reader Response Card



### Hello Dolly

AAMP of America has introduced a portable cable dolly. The dolly is designed for transporting and dispensing 500-foot or 1,000-foot rolls of wire. A spring-loaded brake system prevents back-lashing of cable and release of unwanted amounts of wire. The



**THE  
FUTURE  
IS WITHIN  
YOUR  
GRASP**



**APRIL 2-4, ORLANDO, FLORIDA**

**Low Voltage  
Electronic Systems  
Contractors**  
meet at the National Sound  
& Communications Association Conference & Expo  
April 2-4 in Orlando, FL.

**100+ Hours of Quality  
Education**  
in electronic systems inte-  
gration, system design &  
estimating, testing, and  
other topics for technicians,  
salespeople, managers, and  
owners

**400+ Exhibitors**  
eager to bring you the latest  
in low voltage systems tech-  
nology in a professional  
atmosphere

**EXPLORE TOMORROW'S OPPORTUNITIES TODAY**

For Registration Packet, call 800-446-NSCA or 708-598-7070 - FAX 708-598-4888  
National Sound & Communications Association, 10400 Roberts Road, Palos Hills, IL 60465

# LOOK WHAT <sup>else</sup> QUAM HAS FOR YOU!

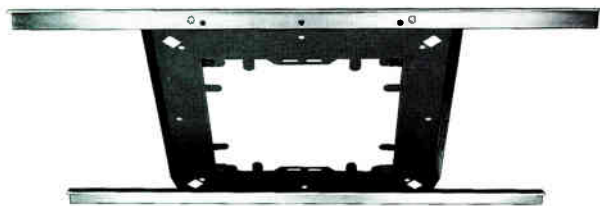

## UNIVERSAL SPEAKER MOUNTING SUPPORT BRIDGES

Part No. SSB-2

- For mounting 4" and 8" loudspeakers and baffles
- Eliminate tile sag
- Reduce required installation time
- Mount square or round baffles; eliminate need for stocking different mounting devices
- Speaker Support Channel permits installations in spaces too small to accommodate bridges

Ask for FREE Tech Spec TS-25

## Quam-Nichols Company

234 East Marquette Road, Chicago, Illinois 60637  
Phone: 1 312 488-5800 • FAX: 312 488-6944

Circle 281 on Reader Response Card

# COMING IN APRIL

## • CORPORATE FACILITIES AND BOARDROOMS

Today's technologies and how they are being applied.

- **PLUS**, the latest in technology, trends, multimedia, and news.

Advertising Closes: **March 15**  
Materials Due By: **March 22**

Contact: John Carr at (516) 767-2500  
or FAX (516) 767-9335

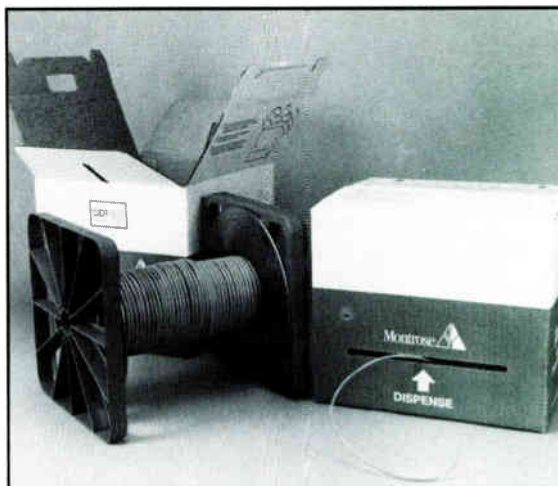

## Cable Dereeling Box

A new dereeling box has been introduced by Montrose Products Company. It accommodates a wide range of cables. Constructed with plastic hubs inside the box to accommodate standard spools, this box eliminates the twisting and kinking of plenum cable associated with reel-less boxes. Allowing installers to pull cable from one or several boxes simultaneously, the Montrose Dereeling box is stackable and can be filled with a full range of cable including Thin-New Coax, Type 3 and Type 9 plenum, Type 9 PVCX, UTP single cable in category 4 and 5 shielded and unshielded, and UTP Siamese cable. The Montrose Dereeling Box is a packaging benefit offered with their line of installing cabling.

Circle 9 on Reader Response Card

## Tannoy Adds To DMT Series

Tannoy has enhanced its line of Monitor Series DMT studio reference loudspeakers, from System 8 NFM through System 215 DMT. Tannoy has also added the new System 6 NFM DMT Dual Concentric loudspeaker to the Monitor Series, replacing the discrete component System 2 DMT. Also of significance is the addition of a DMT crossover to the entire series.

The System 8 NFM, System 10 DMT and the new System 6 NFM use a new HF tulip waveguide for improved definition. The waveguide's 4:1 compression ratio provides lower second harmonic distortion and improved symmetrical dispersion across the horizontal and vertical axis. The System 8 NFM and System 10

DMT are also equipped with a new high-power copper-clad aluminum voice coil.

The System 6 NFM through System 12 DMT loudspeakers use newly developed cones, thicker at the apex and thinner at the edge. The cones are terminated with a nitrile rubber surround attached in a two part molding process.

Circle 10 on Reader Response Card



## DM-7100 Digital Multimeter

A.W. Sperry Instruments, Inc. has announced the introduction of its new, 3 ¾ digit, Dual Display Digital Multimeter, the DM-7100.

The DM-7100 features 19 functions on 29 ranges including capacitance, frequency, continuity, analog bar graph display, min/max function, timer, auto-hold, diode test, transistor HFE, simultaneous display of volts and frequency, and auto off. It comes complete with test leads, batteries, fuses and operating instructions for \$149.95.

Circle 11 on Reader Response Card



## LITERATURE

### Self Help; Accessories Catalog

#### Prompt Publications Self Help Manuals

Prompt Publications recently released four self-help reference books and a radio nostalgia series. Semiconductor Cross Reference Data Book is four cross references in one, showing replacement from NTE, ECG, TCE, and Radio Shack. The volume contains over 475,000 part numbers, type numbers, and other identifying numbers, from the U.S., Europe, and the Far East. The Phone Book: Money Saving Guide to Installing or Replacing Telephone Equipment in Your Home or Business provides instructions explaining how to install phone systems. Prompt Publications introduced two volumes, written by Mark Waller, dealing with the relationship between

electricity and computers. Surges, Sags and Spikes is written for personal computer users concerned about protecting their computer equipment from the electronic environment. Managing the Computer Power Environment: A Guide to Clean Power for Electronic Systems provides background in electrical technology and computers to data processing specialists, field engineers, technicians, and computer network professionals. Radios of the Baby Boom Era is a reference to classic radios of the post-World War II years with nearly 35000 photographs. The six volume set includes photos of popular radio models from 1946 to 1960, indexes containing information about models, vacuum tubes, and tube substitutions, and trouble-

shooting aids to help restore old radios to operating condition.

Circle 12 on Reader Response Card

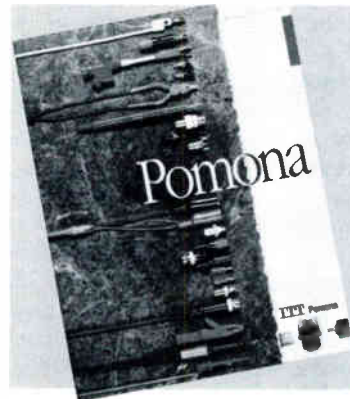

#### Pomona's New Test Accessories Catalog

Pomona Electronics new, 142-page 1993/1994 Catalog of Electronic Test Accessories intro-

duces several new DMM test accessory products and an expanded line of oscilloscope probe kits. Twelve categories are presented with an index that includes the company's selection of jumpers and cables, boxes, plugs, and jacks, connectors, adapters, single-point test clips and static control devices.

Circle 13 on Reader Response Card

#### LEAP Version 4.5 with New Manuals

Included with the new LEAP manuals is the release of Version 4.5, with features requested by LEAP users added. The reference manual contains 19 chapters of 502 pages written by the creator of the program describing graphs, menus, commands, and their operation.

Circle 14 on Reader Response Card

## SOUNDSPHERE SPEAKERS LOOK & SOUND CHOSEN BY CUB FOODS STORE CHAIN

While Soundsphere Loudspeakers have been utilized in Cub Foods stores in Eden Prairie, Cottage Grove, Bloomington and Plymouth, Minnesota, the most recent installation has been at the newest 120,000 sq. ft. store in Apple Valley. Twenty-five Soundsphere #110A speakers with transformers tapped at 75 watts were installed to gain quality music and voice page.

Craig Streich, the Store Manager, takes advantage of the music quality and added efficiency of clear voice page when reassigning workers to various tasks in the expansive store.

Scott Miller, Manager of Pro Sound at Muzak of Minneapolis, notes that the Cub Foods executives selected parchment-colored #110 Soundspheres to meld with the ceiling color and felt that the shape and color were highly compatible with the contemporary interior design esthetic.

Write or call direct for further information.

**SOUNDSPHERE** A PRODUCT OF  
**SONIC SYSTEMS, INC.**

737 Canal Street • Bldg 23B • Stamford, CT 06902 • USA • Tel (203) 356-1136

Circle 266 on Reader Response Card

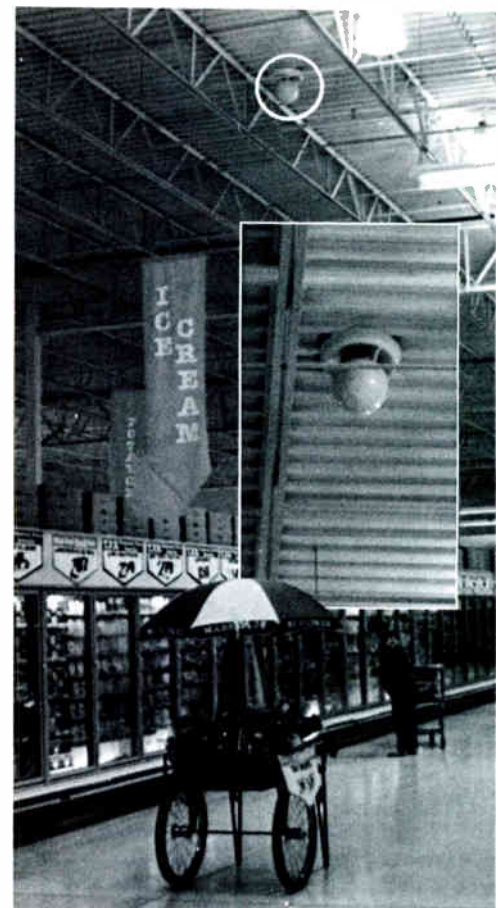

## PEOPLE

### Blumberg at Nakamichi

**Blumberg at Nakamichi**  
Robert S. Blumberg has been appointed to the position of senior vice president, sales and marketing of Nakamichi America Corporation. Blumberg has over 15 years experience in the field, and for the past twelve he has served as the Nakamichi New England area representative.



Blumberg

### Phi Technologies Adds Product Manager

Phi Technologies has recently placed Danny Grimes in the position of product manager for the Nagra Film, Video and Professional Audio Products.

Grimes has been an employee of Nagra USA for years, most recently as the independent sales representative on the West Coast.

His responsibilities will include expanding the market for the Nagra IV-S TC and T-Audio product lines, and the introduction of the Nagra-D digital audio field recorder.

### Burke Named Senior VP

Dennis Burke has been named senior vice president of Team Concepts Holdings, Ltd., Hong Kong.

He will coordinate the activities of Team Concepts three U.S. subsidiaries: Fox Electronics and Technology, Inc.; Integ, Inc.; and Rave Engineering Corp. Burke was formerly president of the Cobra Electronics Group of Chicago-based Dynascan Corporation.

### McLagan Joins QSC

Greg McLagan has joined QSC Audio Products, Inc. as the western regional sales manager. McLagan will be responsible for sales of the company's full line of professional power amplifiers and computer control systems for the professional audio, music, motion picture, contractor and affiliated markets, in the western U.S.

Prior to joining QSC McLagan was national sales manager at University Sound, Sylmar, CA.

### Digital F/X Expands Sales Organization

Digital F/X announced an expansion of its sales and service force by more than 200 percent.

Appointed to key positions were Sheila Ross, director of video products, West; and Marty Frange, director of video products, East.

Ross joined Digital F/X in 1987 and now has sales responsibility for the Composium and IMPACT lines in the western United States, British Columbia and Mexico.

Frange started with Microtime in 1989 and joined Digital F/X when the companies merged in 1992. He will be responsible for the same lines as Ross, but on the eastern United States, Toronto and the Caribbean.

### Wissmann Joins Lowell

Tim Wissman has joined Lowell

Manufacturing Company, as design engineer.

The St. Louis, Missouri company manufactures commercial sound products.

### Promotions at Ferrofluidics

Ferrofluidics Corp. has appointed Jan R. Kirk as president of the Systems Group and Alvan F. Chorney as president of the Components Group. Kirk, previously the company's CFO and COO of International Operations, will focus on expanding the company's domestic and European markets, coordinating the company's alliance with Fuji Seiki, Inc., and managing the relationships with Israeli and Japanese licensees.

Chorney will be responsible for expanding the market for Ferrofluidics sealing systems technology, developing new applications and markets for the company's fluid bearing technologies, and expanding the U.S. sales group.

### Jeron Electronics Appoints Sales Manager

Jeron Electronics Systems, Inc. has announced the appointment of Roger M. Carroll to the position of national sales manager, Communications Division.

Carroll has 21 years of experience in the industry and is the former marketing manager of IRP, Professional Sound Products. He will be responsible for the marketing and sales of Jeron's communications systems nationwide.

### Feldman's Territory Increased

Symco Inc. is increasing Burt Feldman's territory to include Pennsylvania, Delaware, and New Jersey.

Tom O'Hanlon will cover New York City, Long Island and the 914 area code of New York State.

## CALENDAR

### Upcoming Events

#### FEBRUARY

**ComNet:** Washington, D.C. Contact: (508) 879-6700. February 1-4.

**Image World:** San Jose, California. Contact: (800) 800-5474. February 1-5.

**Association for Research in Otolaryngology:** St. Petersburg Beach, Florida. Contact: (515) 243-1558. February 7-11.

**ISCWest:** Anaheim, California. Contact (708) 390-2462. February 16-18.

**National Hearing Conservation Association (NHCA):** Albuquerque, New Mexico. Contact: (515) 243-1558. February 18-20.

#### MARCH

**National Association of Music Merchants (NAMM):** Frankfurt, Germany. Contact: (619) 438-8001. March 3-7.

**Audio Engineering Society (AES):** Berlin, Germany. Contact: (212) 661-8528. March 16-19.

**Image World — The Government Show:** Washington, D.C. Contact: (914) 328-9157. March 17-19.

**United States Institute for Theatre Technology (USITT):** Wichita, Kansas. Contact: (203) 325-5020. March 17-20.

**Fiberoptic Splicing and Termination Workshop:** Washington, D.C. Contact: (508) 347-8192. March 22-26.

**Rigging Seminar (Syn-Aud-Con):** Atlanta, Georgia. Contact: (812) 995-8212. March 23-25.

**Fiberoptic Splicing and Termination Workshop:** Dallas, Texas. Contact: (508) 347-8192. March 29-April 2.

**InterMedia:** San Jose, California. Contact: (203) 352-8243. March 30-April 1.

**Rigging Seminar (Syn-Aud-Con):** Anaheim, California. Contact: (812) 995-8212. March 30-April 1.

#### APRIL

**National Sound and Communications Association (NSCA):** Orlando, Florida. Contact: (800) 446-NSCA. April 2-4.

**National Association of Broadcasters (NAB):** Las Vegas, Nevada. Contact: (202) 429-5300. April 18-22.

#### MAY

**Fiberoptic Splicing and Termination Workshop:** Washington, D.C. Contact: (508) 347-8192. May 10-14.



# AT THE NSCA SHOW WATCH . . .

The logo for NSCA-TV NEWS features the letters 'NSCA' in a stylized, bold font where the letters are interconnected. Below this, the words 'TV NEWS' are written in a clean, sans-serif font.

**NSCA**  
**TV NEWS**

## EXHIBITORS!

Your entire staff can travel to this year's NSCA exhibition on your VCR. All the news and happenings at your convenience.

**ALL 3 SHOWS ARE JUST \$59.95**  
**To order, phone [516] 767-2500**

*Visa, Mastercard, Amex and Checks accepted*

### DON'T MISS IT!

IT'S YOUR:

- DAILY PLANNER
- NEW PRODUCT INFORMATION SOURCE
- SEMINAR DIRECTORY
- GUIDE TO TODAY'S LATEST TRENDS & TECHNOLOGIES

**Get the most out of  
your NSCA show.**

Get full, daily television coverage of the people and products important to your business.

The logo for Testa Video Communications features the word 'TESTA' in a large, bold, sans-serif font above the word 'VIDEO' in a smaller font, with 'COMMUNICATIONS' in an even smaller font below it. The entire logo is enclosed in a rectangular border.

**TESTA**  
**VIDEO**  
COMMUNICATIONS

**SEE IT ON THE AIR, EVERY HOUR, IN YOUR HOTEL ROOM.**

ALSO ON LARGE-SCREEN TELEVISIONS ON THE EXHIBIT FLOOR

NSCA-TV is written and edited by *Sound & Communications*. It is produced by Testa Communications and is no way associated directly with the National Sound & Communications Association.

## AD INDEX

Company	Page	RS #
Ace Backstage Company	42	284
Advantage/Biamp	43	223
Aiphone Communication Systems	4/5	202
Ashly Audio	13	206
Atlas/Soundolier	25	270
ATS-Applied Technical Systems	77	232
Audio Logic	CIII	221
Audio Technica	63	218
BBE Sound	60	288
Bose	7	203
C-T Audio	42	285
Cal Switch	51	262
Compact Powder Co.	34	256
Conquest Sound	46	259
Crown International	59	273
Eastern Acoustical Works	19	212
Eastman Wire and Cable	66	276
Electro-Voice	17	246
Exchange National Funding	77	230
Ferrofluidics	61	264
Frazier	52	263
FSR	69	279
Galaxy Audio	20	250
Gilderfluke & Co.	40	271
Gold Line	25	269
Heliotrope General	77	233
JBL Professional	CIV	—
Klark Teknik/Pinnacle Audio	49	214
Mackie Designs	14/15	207
Menlo Scientific	64	265
Meridian Communications	77	231
MicroFrame	50	286
Middle Atlantic Products	22	268
Music People, The	47	260
Music Supply Corp.	77	235
O.A.P. Audio	50	261
Opamp Labs	77	234
Parasound	67	219
PAS-Professional Audio Systems	32	254
Peavey Architectural Acoustics	CII/3	201
Peerless Sales Co.	35	257
Phonic Ear	62	289
Pioneer Laser Entertainment	45	213
QSC Audio	36/37	258
Quam-Nichols	8	204
Quam-Nichols	68	277
Quam-Nichols	72	281
Racom	70	280
Rane	31	253
Rane	33	255
Samson Technologies	27	209
Sennheiser Electronics	55	216
Sescom	77	236
Shure Brothers	11	205
Sonic Systems/Soundsphere	30	252
Sonic Systems/Soundsphere	73	266
Sony Educational Systems	41	211
Soundtech	19	208
Soundtracs	39	210
t.c. electronics	77	237
Tektone Sound & Signal	60	287
Walport U.S.A.	21	251
West Penn Wire	56	217
Williams Sound	40	272
Winsted	68	278
Yamaha Pro Audio	53	215

**FREE INFORMATION**  
Use the Reader Service Card  
opposite page 22. Just circle the RS#  
of products that interest you.  
Detach, and Mail!

*"While every care is taken to ensure that these listings are accurate and complete, Sound & Communications does not accept responsibility for omissions or errors."*

# MARKETPLACE

## HELP WANTED

### REGIONAL SALES MANAGER

**BOGEN COMMUNICATIONS, INC.** Bogen Communications, Inc. a 60 year old leader in institutional and commercial sound, telephone paging, and now business communications is currently seeking an aggressive individual to be our eastern regional engineered sound systems sales manager.

Responsibilities include: account training and motivation, working closely with architects and engineers, tracking account activities, input to product development, and continual competitive analysis.

Qualifications for this position are: commercial and institutional sound industry sales experience, an electronics background, low voltage contractor level sales experience, capable of extensive territory travel.

In addition to working with an aggressive company and product line, Bogen provides a competitive compensation and benefits package.

If you're willing to work hard, meet the above description, and thrive on winning, send or fax your resume and salary history in confidence to:

Thomas G. Parker  
National Sales Manager  
Engineered Systems  
Bogen Communications, Inc.  
50 Spring Street  
Ramsey, NJ 07446  
FAX: 1-800-999-9016

### SENIOR DESIGN ENGINEER

with strong technical background wanted to handle international projects from estimating, design and specification, to quotation and proposal. 5-7 years in audio and video contract design, sales support and project management, system design and engineering required. B.S. Engineering or equivalent work experience. 3 years experience with AutoCAD or equivalent CAD system.

To apply for positions: Send current resume with references to  
P.O. Box 20469, Seattle, WA 98102

### PRODUCTION SYSTEMS ENGINEER

for international A/V company. Minimum 3 years design experience in RF, audio, video, and A/V control design plus experience with AMX programming, CAD, video design and computer display. Position requires estimating, design, and project management.

To apply for position: Send current resume with references to  
P.O. Box 20469, Seattle, WA 98102

### A-V/Sound Systems Engineer/Installer

Well established South Florida sound, video & A-V systems contractors and pro-audio dealers looking for top notch individual to lead installations and field engineer high caliber projects such as convention centers; meeting facilities; hotel & boardroom systems; churches; schools; airport projects; hospitals and government facilities. Individual to be able to read plans, manage installation personnel team(s), and solve technical problems. Salary and benefits commensurate with abilities.

Contact: Rod Sintow at  
PROFESSIONAL SOUND SERVICES, INC.  
Tel: 305-891-2206

## LEASING/FINANCING

### FINANCING ON ALL

#### AUDIO EQUIPMENT

- Easy to qualify
- Fixed-rate, long-term leases
- Any new or used equipment & computers
- 100% financing, no down payment
- No financials required under \$50,000
- Refinancing existing equipment

**EXCHANGE NATIONAL FUNDING** Call Mark Wilson (800) 275-0185

Use Our Experience For Your Business

Circle 230 Reader Response Card

### SALES ENGINEER

Established, Professional Sound, Video & Communications Company Seeks Individual with 3 Years Experience In Nurse Call, School Intercom, MATV, CATV, Sound Systems, Design and Application. Excellent Benefits, Salary and Bonus Package. If you have the Self-Motivation and Ambition, submit your resume and salary history to:

General Manager Sound Engineering  
12933 Farmington Road  
Livonia, MI 48150  
or Fax to: 313-522-1222

### GET RESULTS

Put a Market Place ad  
to work for you.

For rates and information —

Call:  
(516) 767-2500



# MARKETPLACE

## 8x8 MIXING MATRIX

**DISTRAMIX**

- Room combining, monitor mixing, teleconference mix-minus, console combining, and creative audio distribution
- Linking capability for input and/or output expansion

### MERIDIAN COMMUNICATIONS

PO Box 97, Alameda, CA 94501 USA  
Ph: 510.769.1515 Fax: 510.523.6296

Circle 231 Reader Response Card

**THINK**

DIGITAL MESSAGE REPEATER?

THINK TAPELESS™ RECORDER

1-800-552-8838  
Heliotrope General, Spring Valley, CA

Circle 233 Reader Response Card

**WANTED**  
1940 — 1965

Hi-Fi and Theatre equipment  
Amplifiers, Speakers, Horns, Microphones, Tube Collections, etc. Especially Western Electric

Please Call Collect — (908) 249-3738

Free Catalog & Audio/Video Applications

Routing Switchers (S/A/V) (24, 16, 12, 8, 4, 2 stations)

Press Boxes 1-in/16-out Video/Audio 2-in/24-out Audio

Video & Audio Dist. Amps. RGB-Sync Dist. Amps.

OPAMP LABS INC (213) 934-3566  
1033 N Sycamore Av LOS ANGELES CA, 90038

Circle 234 Reader Response Card

### MUSIC SUPPLY CO., INC.

PUSH-PULL RODS • Push cable in impossible places  
EASY-KARY® Wire Reel Holders • 5 sizes  
HANDY-MAN Cable Guide • Makes pulling cable easier.  
SPEAKER SUPPORTS • Trusses and Enclosures  
TESTSET • For the Audio Serviceman

FREE 16 PAGE CATALOG OF "STUFF"

ALL 50 STATES & CANADA 1-800-527-1522  
FAX 50 STATES & CANADA 1-800-345-5657

Circle 235 Reader Response Card

## STOP THEFT!

order a **BLUE BOOK**  
for everyone who borrows yours!

Send \$12.00 per copy  
(Postage & Handling Included)

CIRCULATION DIRECTOR  
The BLUE BOOK  
25 Willowdale Avenue  
Port Washington, NY 11050

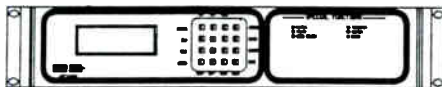

## TIME SWITCHES AND MASTER CLOCKS

1, 2, and 8 OUTPUT TIME SWITCHES, CYCLE TIMERS, MASTER CLOCKS, SEQUENCERS AND BELL RINGERS. FEATURES INCLUDE ALPHANUMERIC DISPLAYS, 48 HOUR CAPACITIVE BACKUP SYSTEMS, DAYLIGHT SAVINGS AND LEAP YEAR CORRECTION, RACK MOUNT UNITS AVAILABLE.

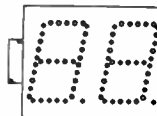
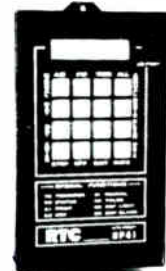

## CLOCKS AND LARGE DISPLAY SYSTEMS

1", 4" OR 12" SUPER BRIGHT LED DISPLAYS. AVAILABLE AS CLOCKS ELAPSED TIME INDICATORS, COUNTERS, AND TOTE BOARDS, OR AS BOARD LEVEL DEVICES FOR OEM

## CUSTOM ELECTRONIC DEVELOPMENT

PCB ARTWORK, MICROPROCESSOR SOFTWARE AND CIRCUIT DESIGN. CIRCUIT BOARD ASSEMBLIES AND MODULES FOR OBSOLETE EQUIPMENT AND SYSTEMS. PRODUCTION LINE TEST EQUIPMENT.



FAX: (318) 631-7813 SHREVEPORT, LA. 71148

CALL (800) 444-7161

Circle 232 Reader Response Card

## CABLE TESTER

AVOID PROBLEMS; TEST YOUR CABLES BEFORE USE

TESTS MAJOR AUDIO AND VIDEO CABLES HAND HELD AND BATTERY OPERATED



\$79.00 USA - SHIPPED PRIORITY  
\$89.00 OUTSIDE USA - SHIPPED AIRMAIL  
PREPAID ORDERS ONLY

OFFER GOOD THROUGH 4-30-88  
USA AND CANADA ORDERS (800) 634-3457  
(702) 565-3400  
SEBCOM, INC./SEBCOM DIRECT  
2100 WARD DRIVE, HENDERSON, NV 89015 USA  
FAX (702) 565-4828

Circle 236 Reader Response Card

OF DENMARK

## t.c. electronic

### INTEGRATED SYSTEMS (WEST)

The award winning TC6032 Moving Fader Eq Remote System available directly from the source  
(805) 373-1828

Circle 237 Reader Response Card

OF DENMARK

## t.c. electronic

### INTEGRATED SYSTEMS (EAST)

The award winning TC6032 Moving Fader Eq Remote System available directly from the source  
(800) 451-6032

Circle 237 Reader Response Card

## How To Place a Sound & Communications Ad

Print or type copy indicating capital letters and bold type. All rates are based on column inch. 1X rate for a classified ad \$63. (Includes borders, typesetting and company logo if desired.) 1X rate for a marketplace ad (product) is \$96. Frequency discount available. Call for information.

### CLASSIFIEDS

- Business Opportunities
- Employment Wanted
- Equipment for Sale
- Facility for Sale
- Help Wanted
- Miscellaneous

### MARKETPLACE

All product and services  
**Sound & Communications Ads  
Get Results!**

Company Name \_\_\_\_\_ Name \_\_\_\_\_

Address \_\_\_\_\_ Phone \_\_\_\_\_

Method of Payment  Check Enclosed  Visa  American Express  MC

Card # \_\_\_\_\_ Exp. Date \_\_\_\_\_ Signature \_\_\_\_\_

Mail or Fax Copy to:

Sound & Communications Marketplace  
25 Willowdale Avenue, Port Washington, NY 110050  
Phone: 516-767-2500 FAX: 516-767-9335

# PRODUCT CHECK: RESIDENTIAL

Products used most frequently in residential installations . . .

## ... NOW IN PROGRESS

**P  
R  
O  
D  
U  
C  
T  
S**

	FIRST PLACE	SECOND PLACE	THIRD PLACE
A/V Control Systems	NILES	YAMAHA	CARVER
Signal Processors	SONY	RANE	DENON
In-Wall & Ceiling Speakers	NILES	JBL	KEF
Speakers	BOSE	JBL	BOSTON
Audio Tape Players	YAMAHA	KENWOOD	ACOUSTICS
CD Players	SONY	YAMAHA	DENON
Amps/Tuners	ONKYO	DENON	DENON
VCRs	SONY	MITSUBISHI	SONY
Video Monitors (for A/V)	SONY	MITSUBISHI	HITACHI
Projectors	SHARP	RCA	PHILIPS
Laser Disc Players	PIONEER	SONY	ZENITH
Screens	STEWART	VIDIKRON	RCA
Security Cameras	PANASONIC	CREST ELECTRONICS	ZENITH
Video Monitors (for CCTV)	PANASONIC	AIPHONE	JAVELIN
Intercoms	PANASONIC	AIPHONE	MITSUBISHI
			NUTONE

\* Indicates tie

## ... IN LAST SIX MONTHS

**P  
R  
O  
D  
U  
C  
T  
S**

	FIRST PLACE	SECOND PLACE	THIRD PLACE
A/V Control Systems	NILES	YAMAHA	VIDEOLINK
Signal Processors	SONY	DENON	RANE
In-Wall & Ceiling Speakers	NILES	JBL	SONANCE
Speakers	BOSE	JBL	BOSTON
Audio Tape Players	YAMAHA	DENON	ACOUSTICS
CD Players	SONY	YAMAHA	ONKYO
Amps/Tuners	DENON	ONKYO	DENON
VCRs	SONY	MITSUBISHI	SONY
Video Monitors (for A/V)	SONY	MITSUBISHI	TOSHIBA
Projectors	SHARP	RCA	PHILIPS
Laser Disc Players	PIONEER	SONY	ZENITH
Screens	STEWART	ZENITH	RCA
Security Cameras	PANASONIC	CREST ELECTRONICS	VIDIKRON
Video Monitors (for CCTV)	PANASONIC	AIPHONE	JAVELIN
Intercoms	PANASONIC	AIPHONE	MITSUBISHI
			NUTONE

\* Indicates tie

## SURVEY METHODOLOGY

1. The sampling pool for the survey consists of sound and communications contractors from Sound & Communications' subscription list. Only contractors within the United States and Canada are called.
2. In a telephone survey, contractors/installers selected at random are asked to identify what brand they used for various products in installations completed in the past six months and those in progress. A different type of installation is highlighted each month.
3. On completion of the survey, results are tabulated and the product brands are ranked on a scale from one to three, with number one having the most votes. Separate rankings are made for installations occurring in the past six months and for those in progress.
4. An asterisk (\*) denotes a tie for that ranking.

Copyright © 1993 SOUND & COMMUNICATIONS PUBLISHING, INC. Reprint of any part of contents without permission forbidden. Titles Registered in the U.S. Patent Office. Sound & Communications (U.S. P.S. 943-140) (ISSN #0038-1845) is published monthly plus a special thirteenth issue in the fall by Sound & Communications Publications, Inc., 25 Willowdale Avenue, Port Washington, N.Y. 11050. 516-767-2500. President, Vincent P. Testa. Subscription rates: U.S. — 1 year \$15.00, 3 years \$37.50. All other countries — 1 year \$25.00, 3 years \$67.50. Subscriptions outside of U.S. must be paid in American currency. Second-class postage paid at Port Washington, NY and at additional mailing office. POSTMASTER: Send address changes to Sound & Communications, 25 Willowdale Avenue, Port Washington, NY 11050.



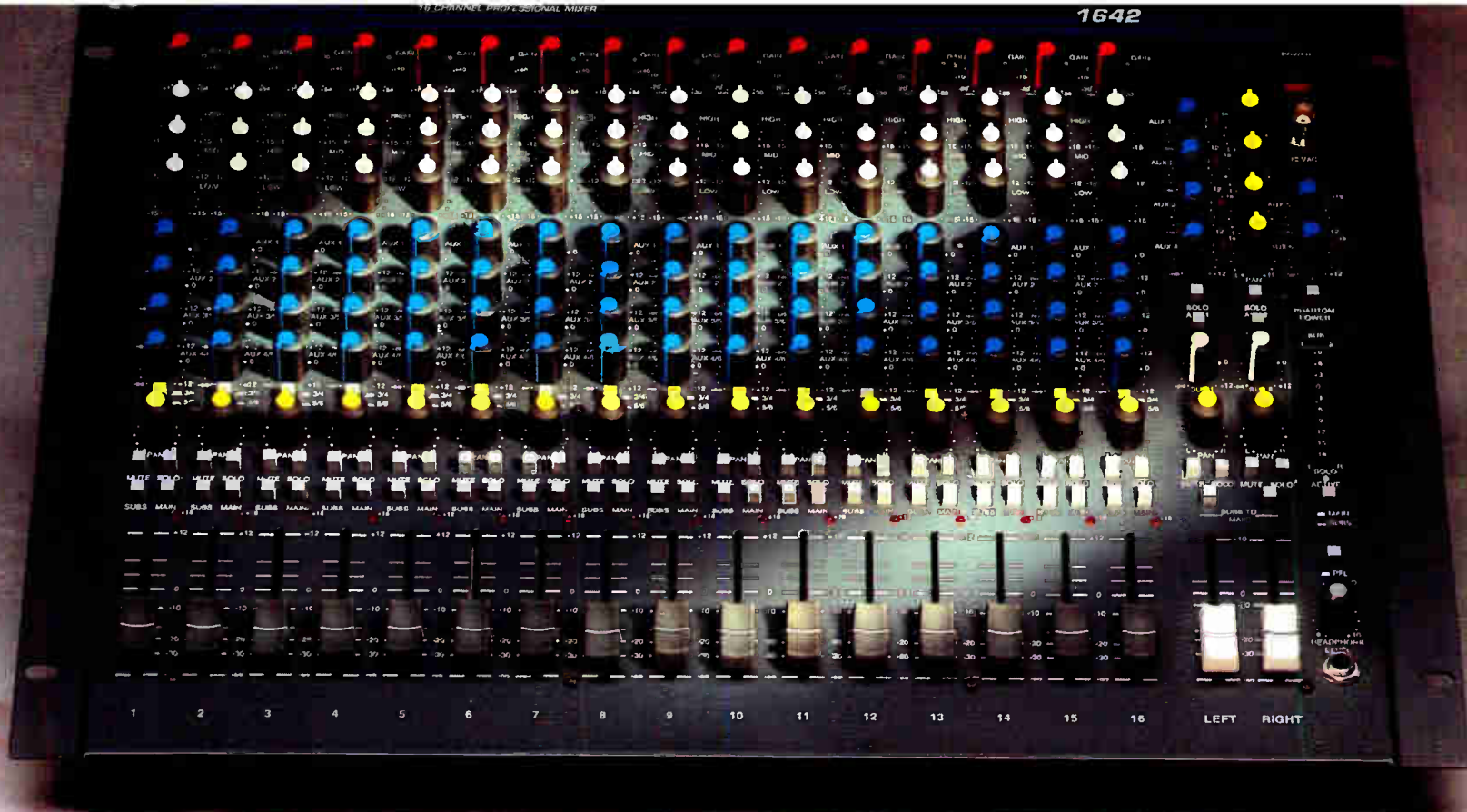

# The other guys missed the bus. Actually, 2 of them.

Why settle for a simple 16 channel stereo mixer, when you can have the 1642 4 bus mixer for \$1099.

Or if 8 or 12 channels are enough, you'll find most of the same features on the 822 and 1222 stereo mixers, starting as low as \$429.

With four similar discrete outputs (Sub1, Sub 2, Left and Right), the 1642 may be used as a 16x4 for recording, or, by assigning the subs to the L/R outputs, as a 16x2x2 for sound reinforcement. Each channel of the 1642 has a 3-band EQ

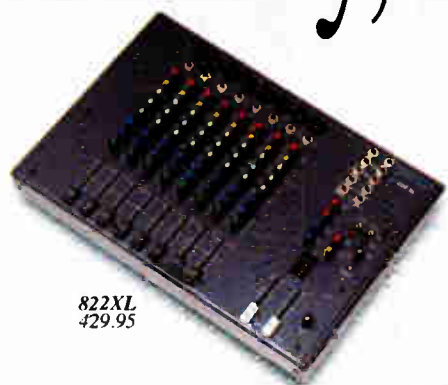

822XL  
429.95



1222XL  
599.95

*"Also available as 822RM and 1222RM rack mount versions at the same prices."*

with Adaptive-Q circuits for a contoured response that adds clarity to the highs and warmth without "boomy-ness" to the lows.

The 822 and 1222 models are offered in two versions, designated XL (table top) or RM (for rack mounting). Each comes with phantom power, 3 bands of EQ, 1 monitor and 2 effects sends,

and monitor & headphone outputs. We're so confident that you'll love our new mixers that we'll back them with a two year warranty. So if you want some great mixers with low

fares, don't miss the bus. Check out the 1642 and the rest of the DOD lineup at your favorite Dealer now.

# DOD

**H** A Harman International Company

©1992 DOD Electronics Corp.  
5639 South Riley Lane, Salt Lake City, Utah 84107  
(801) 268-8400.

Circle 221 on Reader Response Card

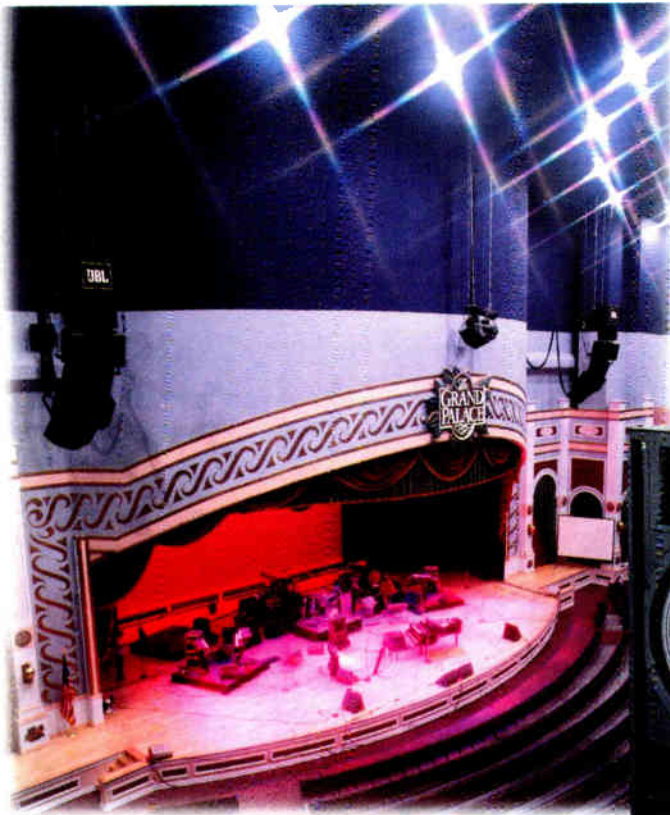

# Array Series. Designed To Impress Everyone Who Has Heard It All Before.



The competition to produce the "ultimate" sound reinforcement system is fierce. Each new system design brings claims of having *achieved perfection* or touts *this is the one*. Yet, in time, you can expect the very same manufacturers to introduce new models claiming to have further *perfected perfection* or that their *unorthodox* technology has rewritten the laws of physics. Sound familiar? So how do you impress everyone who has heard it all before? Simple.

JBL engineers have drawn upon proven advancements in loudspeaker design and state-of-the-art digital electronics to create Array Series: a comprehensive sound reinforcement system concept with performance second to none. Developed as dedicated array elements, Array Series systems can be easily configured to fill any venue with seamless coverage from a deceptively small package.

Such performance could only be achieved by designing the exact transducers required for the job. The Array Series is the first professional loudspeaker system to use neodymium magnets. The LF transducer's unique motor structure topology also includes proven Vented Gap Cooling (VGC™) and a deep copper-sleeved gap to significantly reduce distortion and power compression.

The 38 mm (1 1/2 in) exit HF compression driver also uses a neodymium magnet structure, a Coherent Wave™ phasing plug and damped titanium diaphragm. The result is effortless and reliable high frequency output with outstanding accuracy. A 45° Optimized Aperture Flat-Front Bi-Radial® horn assures proper matching and summing of multiple Array Series systems.

The 13 ply hardwood enclosure has 45° sidewalls to match the horn coverage in arrays, and is reinforced with integral steel attachment hardware, designed to interface with S.A.F.E.™ flying hardware for quick and secure cluster assembly.

System functions, such as crossover filter points, transducer acoustic center alignment, system equalization and protective limiting are achieved totally in the digital domain by the ES52000 Digital Controller. The ES52000 employs Finite Impulse Response (FIR) filters for zero phase shift and requires no amplifier output sensing cables, so you can expand your system by adding Array Series loudspeakers without having to add additional controllers.

The sum of these parts is Array Series: a complete system providing extremely high power handling, very high sound pressure levels with full dynamic range, low distortion and unmatched fidelity. Truly a system capable of impressing *anyone who has heard it all before*.

Call or write for detailed specifications. Or, for more *immediate* response, you can get current product information on Array Series, the ES52000 Digital Controller and all JBL Professional products, *VIA FAX* by calling (818) 895-8190.

*Pictured above, Array Series installation at the Grand Palace, Branson, Missouri.*



JBL Professional  
8500 Balboa Boulevard, Northridge, CA 91329  
(818) 893-8411  
FAX Information: (818) 895-8190

■ A Harman International Company