

SOUND & COMMUNICATIONS

Volume 36 Number 12

December 21, 1990



The 1990 Suppliers' Survey and Economic Report

Our fifth annual survey of manufacturers — their businesses, their perceptions, their predictions, and their spending.

37



HOSPITAL COMMUNICATIONS

What are the hospitals thinking of? Our interviews the purchasers themselves on communications systems, their wants and needs.

46

INSTALLATION PROFILE

The Margo Jones Auditorium is a 1,117 seat room originally constructed in 1922 on the campus of Texas Women's University. The assembly hall was turned into a multipurpose performance facility via a host of talent, good equipment and three-and-a-half million dollars.

63

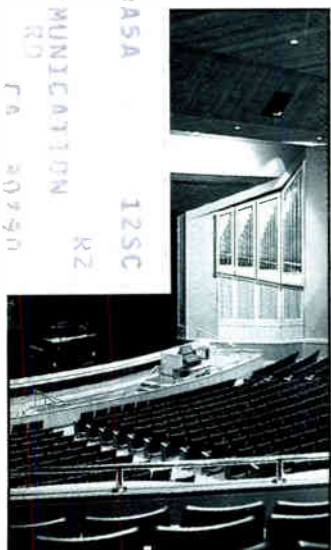

IN THIS ISSUE

• Sales and Marketing

Leave the hard parts to last. That's one of the hints for getting what you want in a successful negotiation. **52**

• The Digital Plan Measure

There's a neat, compact and relatively cheap tool that simplifies and speeds take offs from drawings. **69**

• Theory and Applications

Acoustical room simulation has a potential for multifaceted design, but even in a hypothetical model, budget has to be considered. **32**

Wireless Technology

The perils and triumphs of wireless technology. It's here to stay, but as one source says, contractors would be just as happy if it all went away. Nothing is as reliable as a hardwired microphone. Nevertheless, technology moves on with ease for the end user, and some surprising comments from manufacturers. **21**

Controlled, not processed

Spectral balance and controlled protection — a performance combination exclusive to DeltaMax™ electronically controlled speaker systems

Prior to the introduction of the Electro-Voice DeltaMax speaker line, dedicated processor-based systems have all exhibited a common problem — audible changes in sound quality when protection circuitry is activated.

With the development of DeltaMax, this compromise is a thing of the past. The heart of the DeltaMax speaker system is the dedicated DMC controller. The DMC features a dual-time-constant compression circuit with a variable compression ratio which provides protection from amplifier clipping and excessive temperature, while a soft-clip limiting circuit protects against over excursion. All of this is accomplished by broadband VCA compression/limiting without affecting the system's spectral balance or subjective dynamic range. Additionally, the DMC controller also offers crossover, equalization and signal-delay functions.



The DeltaMax line consists of two full-range compact trapezoidal systems, the DML-1122A and DML-1152A, a Manifold Technology® subwoofer, the DML-2181A, the DML-1152MC slant monitor and three dedicated DMC electronic controllers.

All DeltaMax speaker systems employ dual Neutrik (NL AMP-R) Speakon™ connectors and are available in three-point flying versions utilizing Aeroquip hardware. No other competitive system can deliver the accuracy, reliability or output-per-pound performance of DeltaMax electronically controlled speaker systems.

With DeltaMax, having the best of both worlds is simply a matter of control.



Electro-Voice®
a MARK IV company

WITH GENERIC CABLE, YOU DON'T HAVE A CLUE ABOUT QUALITY.

Choosing generic low-voltage electronic cable can be a puzzling experience. While generics may look like other electronic cables, you never really know for sure where they came from, what they're made of or how they're going to work once they're installed.

Thankfully, West Penn Wire has taken the mystery out of low-voltage cable. For over 18 years, West Penn Wire, a leading name-brand producer of quality electronic cable, has manufactured products you can count on for the long haul. Products like CL2, FPL, CM, plenum and non-plenum cables that meet and exceed the new NEC Codes. Products backed up with service that the generics just can't match.

So don't take a chance on an unknown cable in your low-voltage installations. It might leave you baffled when you really need a connection.

West Penn offers a complete selection of low voltage electronic cable. All backed by the dependable quality, service, competitive pricing and engineering assistance you've come to expect from West Penn Wire.

Contact the cable experts at West Penn Wire today. Call us on **800-245-4964** (in PA 800-222-8883) or write P.O. Box 762, 2833 West Chestnut Street, Washington, PA 15031. Fax 412-222-6420.

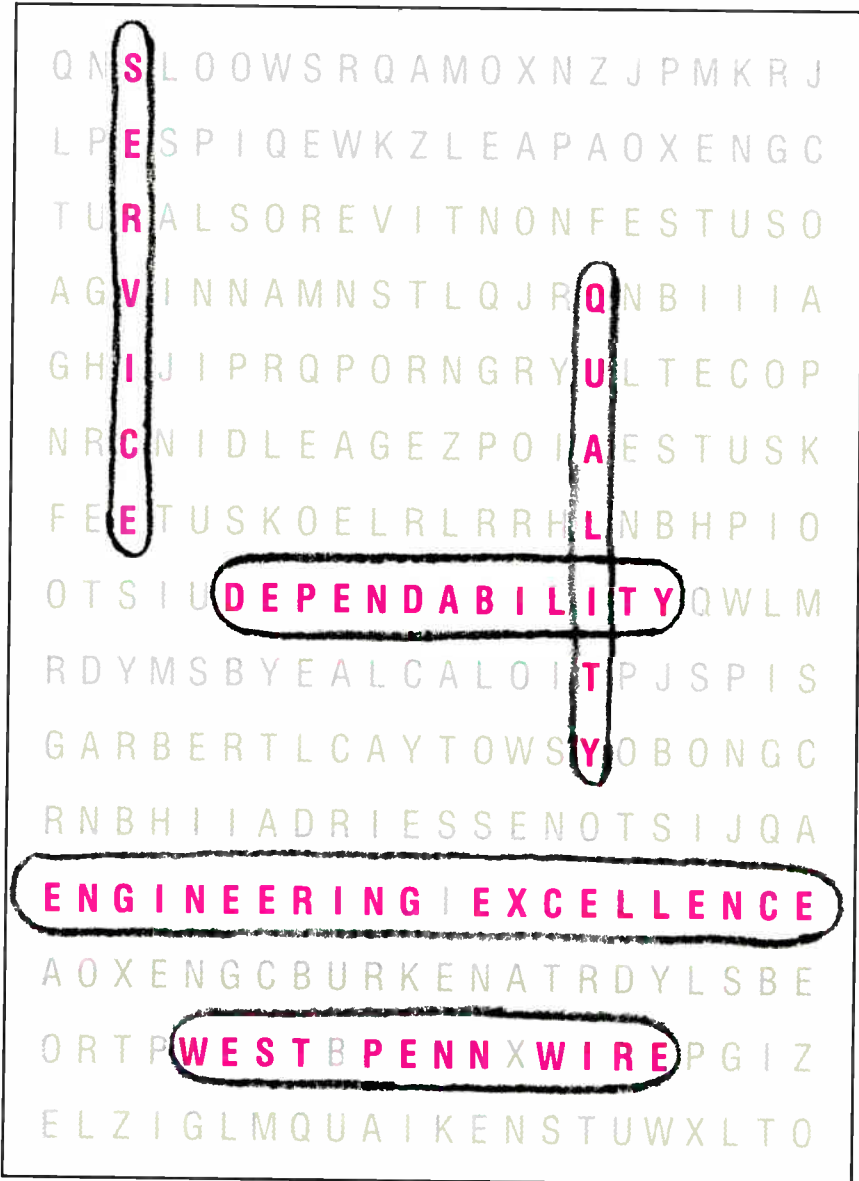

Circle 211 on Reader Response Card



CONTENTS

Volume 36 Number 12

December 21, 1990

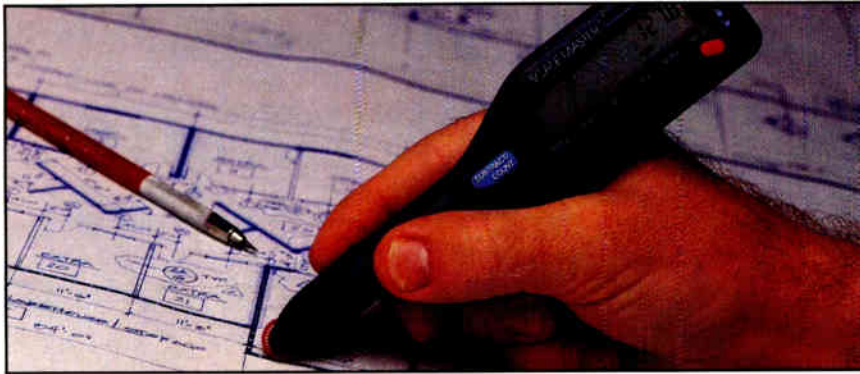

69

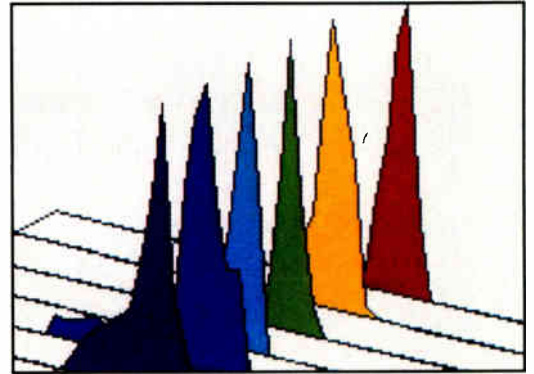

54

FEATURES

21 THE PERILS AND TRIUMPHS OF WIRELESS TECHNOLOGY

By Allan Varela

An overview of the freedom involved and limitations of wireless.

27 WIRELESS APPLICATIONS

By Gary Stanfill

In this excerpted piece, the installation of wireless equipment is discussed.

30 WIRELESS INTERFERENCE

By Bill Mayhew

If you've taken the usual precautions in selecting your frequencies and you still have unusual problems, read this article.

37 SUPPLIERS' SURVEY AND ECONOMIC REPORT

By Judy Morrison

Our annual survey of manufacturers says that you can look for less technical innovation and more emphasis on the low end in 1991. But that's not all!

46 HOSPITAL COMMUNICATIONS

By Richard J. Grula

With the increase of life expectancy due to medical advances, one sure growth market for contractors will be in health care installations.

54 BOSE MODELER REVISITED, PART 2

By Mike Klasco

This month we get to the nitty-gritty aspects including creating the room model, testing and refining the design, and the performance simulations of the finished specifications.

63 INSTALLATION PROFILE

By Charles Hulme

Texas' Margo Jones Auditorium was constructed in 1922 and has recently undergone a renovation three years and three and a half million dollars in the making.

69 THE DIGITAL PLAN MEASURE

By Mike Klasco

We look at this compact and relatively cheap tool that simplifies and speeds take-offs from architectural and engineering drawings.

DEPARTMENTS

6 LETTER FROM THE EDITOR

7 LETTERS

13 TESTING AND MEASUREMENT: MEASUREMENTS THAT I HAVE ENJOYED

By Carolyn Davis

16 THE REP COLUMN

By Wes Alderson

32 THEORY AND APPLICATIONS: ACOUSTICAL ROOM SIMULATION PART 1

By Steven J. Orfield

52 SALES AND MARKETING: TECHNIQUES FOR SUCCESSFUL NEGOTIATIONS

By David Lander

66 NEWS FROM AROUND THE INDUSTRY

72 PRODUCTS

75 LITERATURE

76 MARKETPLACE

76 AD INDEX

78 PEOPLE

78 CALENDAR

SPLIT PERSONALITY.

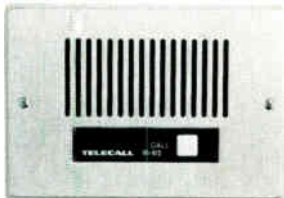
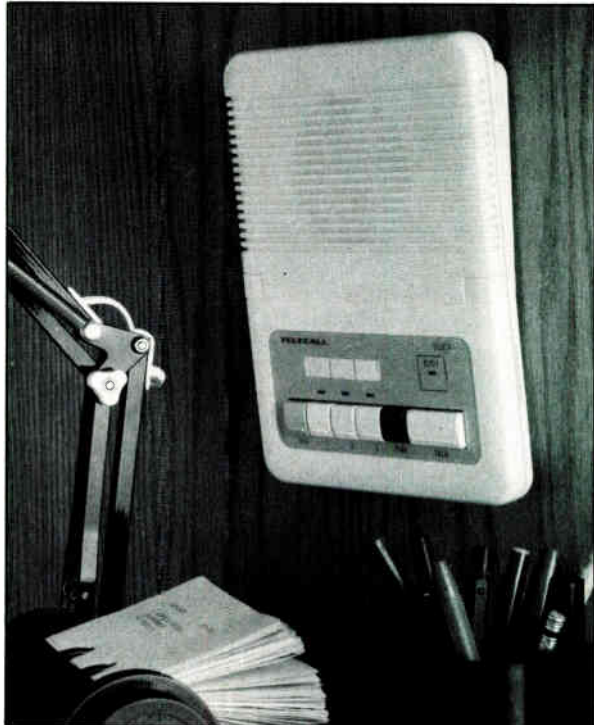
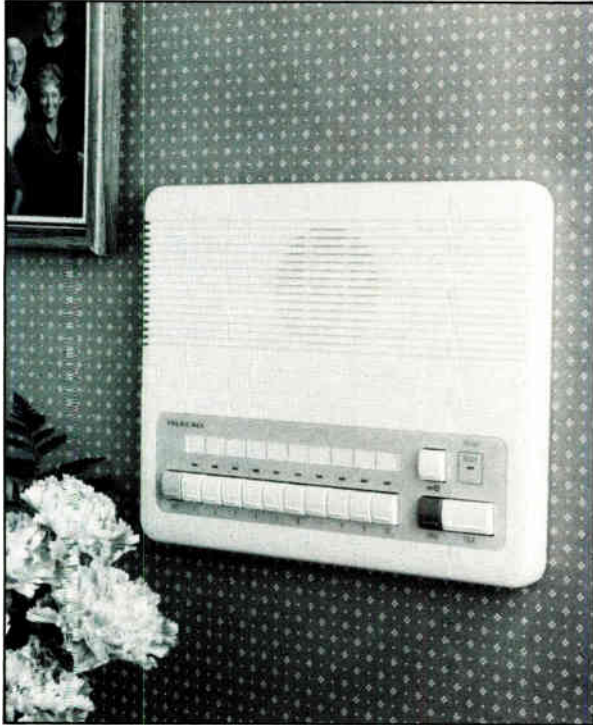

Whether your customers' intercom needs are commercial or residential, the 95 Series intercom from Telecall is one flexible system.

Available in 3, 6 and 10-call masters, communication is possible between master to master and master to sub station. With 3 weather resistant outdoor and 4 different indoor subs,

we've got your customers covered. When flush mounted, all indoor stations are very unobstrusive—only $\frac{3}{4}$ " deep.

To save both time and money, you can tie the master stations directly to an existing PA system without an adaptor.

For more information on the 95 Series, including many optional features, please call us toll-free at 1-800-752-2860.



Circle 209 on Reader Response Card

Communicating — and Reporting

This month we talk to everyone — contractors, manufacturers, and even the client. What's on the client's mind? Ease of use and good service. Period. Or mostly. That's what hospital administrators told our reporter regarding their new hospital communications systems. They talk candidly in this issue about why they purchased what they purchased, and what they look for in a vendor.

And what's on the manufacturers' minds? This month marks the fifth annual Supplier's Survey and Economic Report sponsored by SOUND & COMMUNICATIONS. And there are some surprises therein. This year manufacturers show a decidedly friendlier view toward contractors, and are relatively optimistic about their businesses. Particular segments of the business fare differently, and we may predict fewer technical innovations this coming year based on our survey. This Economic Report is done each year via questionnaires to manufacturers in the sound and communications business. The results are tabulated by an independent market research firm; the questionnaires are anonymous. And our analysis of the results are in these pages, along with some comparison to the figures we've culled in past years.

This month you'll also read more about the Bose Modeler program, as Mike Klasco continues his hands-on review of available software. Mike likes the Bose Modeler, and we think you'll like his review. Mike has also written for this issue on some digital tools of use to the sound contractor. Mike also, like our hospital administrators, appreciates ease of use; and he's on a search for tools to make his life as a consultant easier. Fortunately, he's generous with his information.

This issue of SOUND & COMMUNICATIONS is chock full of information — of news, views, product and procedures. Wes Alderson talks from the rep's perspective in a particularly astute piece on education in the field. Steven Orfield writes of his investigations in processed sound. And Allan Varela surveys contractors for the best and the worst in their experiences with wireless.

What did the priest do to the wireless mic? That's not a shaggy dog joke. That's a serious consideration in some quarters. Read Mr. Varela's article and you'll get the answer.

Answers are looked for in all places — often enough at conventions. This company — Testa Communications, parent company of SOUND & COMMUNICATIONS — held a convention sponsored by our sister publication DJ Times. DJ Expo was held in October in Atlantic City, and brought forth over 1,400 attendees made up of DJs, club designers, and others with a vital interest in the club scene. The show was deemed successful by all, and the company is planning a west coast version this spring. We'll keep you informed of the plans. Meanwhile, we'll have a rundown of what you may have missed at the fall DJ Expo in our next issue of SOUND & COMMUNICATIONS.

For this, our end of the year issue, we wish you a happy end of the year with much prosperity and good business in the coming year. Happy holidays.

Judith Morrison
Editor in Chief

SOUND COMMUNICATIONS

Publisher/Editorial Director
Vincent P. Testa

Editor-in-Chief
Judith Morrison

Technical Editor
Mike Klasco

Assistant Editor
Steve Jacobs

Contributors

**Wes Alderson, Carolyn Davis, Richard J. Grula,
Charles Hulme, David Lander, Bill Mayhew,
Steven J. Orfield, Gary Stanfill, Allan Varela**

Technical Council

Dr. Mort Altshuler

*Professor Audiology, Hahneman University, Chief of
Audiology, V.A. Hospital, Phila, PA*

C. Leroy James

Rees Associates, Inc.

Richard N. Jamieson

Jamieson and Associates, Inc.

Russell Johnson

Artec Consultants, Inc.

William Parry

Maryland Sound Industries, Inc.

Daniel Queen

Daniel Queen Associates

Jon Sank

Cross Country Consultants

William R. Thornton

Phd, PE

Art Director

Germaine Egan Cassidy

Assistant Art Director

Joyce Dolce

Artist

Janice Pupelis, Alicia Celli

Production Manager

Joanne Commisso

Typography

Christina Buckley

Diane Catanzaro

Circulation Director

Robert Evans

Classified Ad Manager

David Saraf

Traffic Coordinator

Ron Perone

Advertising Director

Nancy Davis

Editorial and Sales Office
Sound & Communications
25 Willowdale Avenue
Port Washington, New York 11050
(516) 767-2500
FAX: (516) 767-9335



Sound & Communications • DJ Times • Post
Sound & Communications Blue Book
The Music & Sound Retailer • The Retailer Red Book
The Music & Sound Buyer's Guide
CES-TV News • NAB-TV News • NAMM-TV News
NSCA-TV News • CROSSTALK / AES-TV News

LETTERS

Address Request: Rap for Reps

This month's mailbag was a mixed bag of complaints, kudos and clarifications. The articles in our October issue that elicited the most interest were on racks and Multi-room residential systems.

— Editor

READER SERVICE

I thoroughly enjoy reading Sound & Communications. In general, with a few minor exceptions, I find it to be an excellent publication.

One of those exceptions is the reason for this letter. Case in point: the article on racks in the October 17 issue.

In nearly all such technical articles, various manufacturers products are mentioned, but rarely (if ever) are we told how to obtain them. With only a manufacturer's name, it is often very difficult, if not impossible, to locate them.

You should take a lesson from Car Craft Magazine. They provide a full list of sources of all items mentioned in a sidebar at the end of such articles.

Inclusion of such a list would change such articles from an interesting curiosity to a valuable source of information.

It would also be nice if this policy extended into the New Products section. Often only a reader service number is offered as a contact. If the item is required at a time after the card has expired, or if the card has been used already, there is usually no way to contact the manufacturer.

Dave James
Gencom Canada Ltd.
Vancouver B.C.

A PICTURE IS WORTH...

I was pleased to see the item about the Sonance rep meeting in the October issue of Sound & Communications. However, we feel that simply noting the event does not convey the full impact of Dave Donald's inspirational presentation.

To do that completely would require a full-bore audio/video demonstration with high volume, balloons, and lights. However, I enclose the next best thing — a photo of Dave presenting "The Most Inspirational Rep" award to Greg Grasso. Yes, that is a Sonance M30 baffle and grille hanging from the chain around Dave's neck.

Creativity in sales is not a lost art form, and we, at Sonance, are very proud to have Dave Donald on our team.

Mitch Simon
Public Relations Director
Sonance
San Clemente CA

WRONG REVERB

The article concerning the Jack Breslin Coliseum was very informative but a few items must be clarified. The reverberation time (mid-frequencies, unoccupied) was 2.5 seconds, not 1.5 seconds as noted. Also, the acoustic pads for the ceiling were 1-inch thick cloth faced glass fiber lay-in ceiling tiles, and for the walls, 1-1/2-inch Tectum furred out with unfaced glass fiber in the cavity.

We always enjoy hearing favorable comments concerning one of the projects that

*Sonance
rapmaster
Dave Donald
congratulates
Greg Grasso
at the
conclusion
of Sonance
rep meeting.*



our firm has designed. All individuals involved in this project must be commended on their excellent efforts in constructing one of the most flexible and state-of-the-art facilities around.

Thank you for your prompt clarification of these items in your magazine.

Bradley A. Gordon
Coffeen Fricke & Associates
Lenexa KS

SURPRISE READ

A couple of weeks ago I was opening up my mail and came across my copy of "Sound & Communications." As I was browsing through, not really expecting to see an article on SAVT, a picture caught my eye. What a surprise and joy it was to read about our company as well as SPAC and Hunter Mountain. I have sent copies to my clients at these venues. I'm sure they will appreciate them as much as I did.

Thanks to Keith Bose for writing an accurate and interesting view of our work. I look forward to future articles by him.

Michael J. Cusick
President
SAVI
Clifton Park NY

PICTURED BELOW IS OUR IDEA OF THE APPROPRIATE SPEAKER INVENTORY FOR A COMMERCIAL SOUND CONTRACTOR

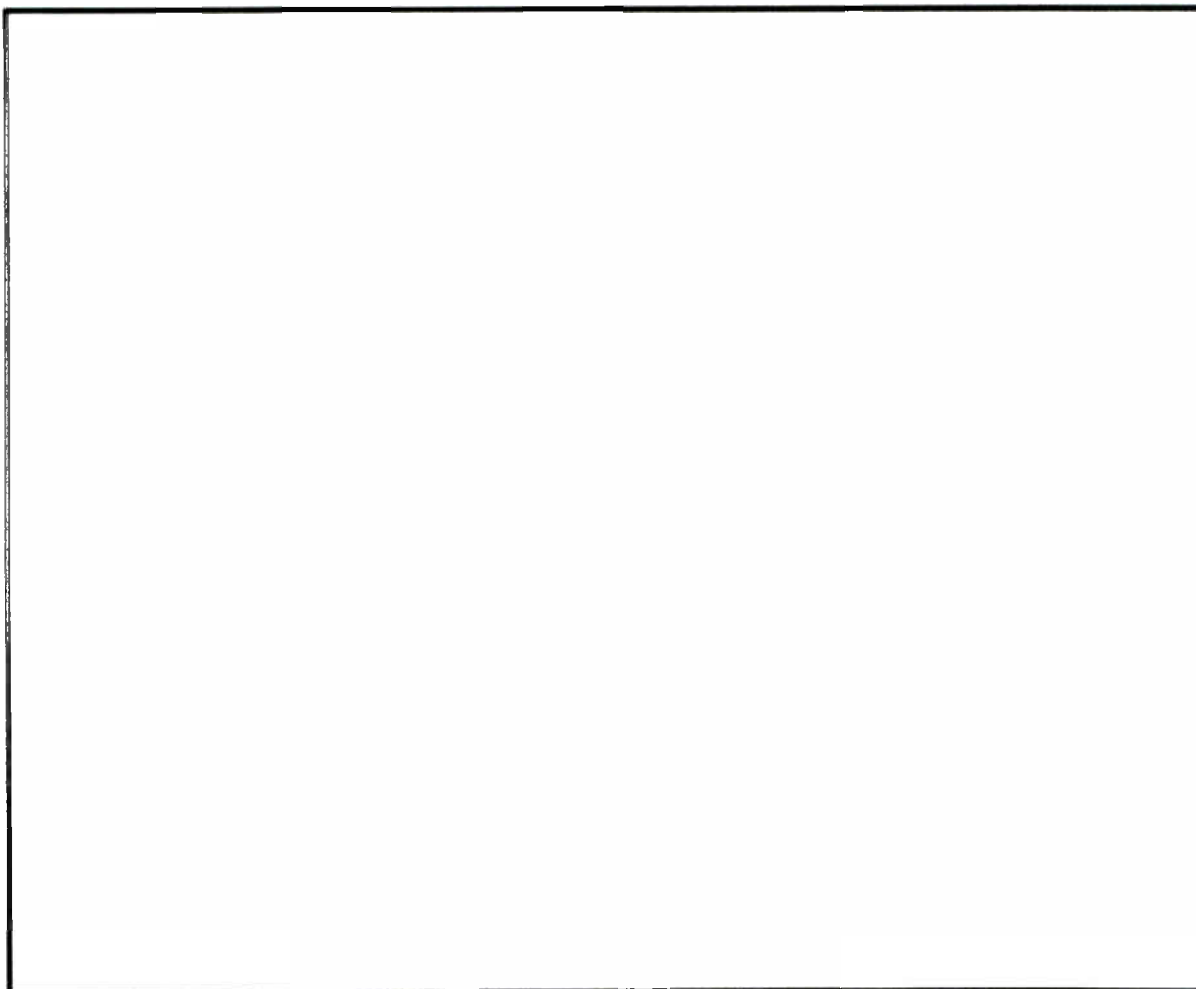

At Quam, we believe you should sell and install sound products, not inventory them. So Quam saves you the high cost of owning inventory by stocking 70,000 units in our factory warehouse. It's meant to be *your* stockroom, and we'll ship from this stock on a moment's notice.

We manufacture the broadest line of commercial sound speakers available, everything from intercom to background music speakers.

We stock transformers and baffles, too. So you can even have complete baffle assemblies shipped immediately from stock.

Remember, too, that Quam is a manufacturer with 60 years' experience in sound. That means we'll respond to your special needs as quickly as we respond to your stock needs.

Save your money and let Quam hold your inventory. To find exactly what's in it, write for our Commercial Sound Products Catalog.

Quam • The Sound Decision



Quam-Nichols Company

234 E. MARQUETTE ROAD • CHICAGO, ILLINOIS 60637
PHONE: 1 312 488-5800 FAX: 1 312 488-6944

SPONSOR



National
Sound and Communications
Association
for sound and electronics system contractors

Circle 201 on Reader Response Card

World Radio History

NEWSLETTER

ART FASTEST GROWING

Applied Research and Technology (ART) has been cited as the fourth fastest growing privately owned business in Rochester, New York, according to a study done by KMPG Peat Marwick and published in the Rochester newspaper, Democrat and Chronicle. ART was also the fastest growing privately owned manufacturer in the city. ART has reportedly increased its sales 50 percent or more each year for the past three years, and has grown from six employees in 1984 to more than 70 now. ART president Phil Betette said, "Our success has been recognized within our industry. It's nice to be likewise recognized as a hot company within our own community."

JBL RIGGING DISTRIBUTED

JBL Professional is allowing the general distribution of its Concert Series rigging hardware, which was designed in conjunction with Sound Manufacturing Inc. and was previously available only with JBL's Concert Series systems. Mark Gander, vice president of marketing for JBL Professional, commented, "In the interest of rigging safety throughout the industry, JBL and Stan Miller of Sound Manufacturing, Inc. have come to a mutual agreement that Concert Series rigging hardware should be available to anyone who is qualified and wants to use it." Miller is reportedly working with other manufacturers to include this hardware in their enclosure designs.

APPLICATION NOTES SERIES

TOA Electronics has begun a new series of Engineered Sound Application Notes covering the company's new products. The first Application Note, by Chuck McGregor, covers "Saori Applications: Multi-Way Sound Speaker Systems." The Saori, of course, is the company's new digital sound reinforcement processor.

SYN-AUD-CON SCHEDULES

Synergetic Audio Concepts (Syn-Aud-Con) has announced its 1991 schedule for seminars and workshops. Two-day seminars will be held in Orlando January 31 through February 1; in Anaheim March 12 through 13; and in Seattle March 20 and 21. Three day seminars will be held in Indiana in May, July, September and October. In addition a Loudspeaker Designer's Workshop will be held in Atlanta February 7 through 9, conducted by Eugene Patronis, Don Keele and Jay Mitchell. Syn-Aud-Con can be reached at 812-995-8212.

HANDBELLS USE BOSE

Bose 802 Series II speakers have been used in live outdoor performances during the Christmas season by the "Bells of Boston" handbell ensemble. Mark Mayfield of Bose designed the speaker system using 10 of the Bose 802s in a distributed sound system spanning Faneuil Hall Marketplace. The speakers will also be used for the 1992 Olympics in France and were the official sound source of the 1988 winter Olympics in Calgary. The Bells of New England Festival at Faneuil Hall in Boston draws 55 groups (600 handbell players) and is the largest gathering of bell ringers in the world.

ELEVATOR INTERCOM PROJECTS

Ring Communications has been awarded contracts to provide supervised communications systems for the elevator networks of the Rockefeller Center buildings and the Empire State building in New York. A modernization and upgrading of the elevator systems is currently underway at these two Manhattan landmarks. Ring is working with Millar Elevator, Otis Elevator and Schindler Elevator, and anticipates that the projects will provide for communications between all elevator cabs and several central locations, in addition to a variety of communications paths between service, security and maintenance personnel. The project is expected to be completed by late summer of 1991.

DESIGN SEMINARS

Bose Professional Products Design Seminars are planned for 1991, with the next one scheduled for January 8 and 9 in Philadelphia. The one-and-a-half-day seminar uses The Bose Professional Products Design Guide as the accompanying text.

Why you should make **SYSTEM** your next sound

WE MAKE SIGNAL PROCESSING COST EFFECTIVE.

IRP believes you shouldn't have to sacrifice sound quality to save a few dollars. So we've spent years rethinking installed sound. The result is our completely modular System 41 - easier and less expensive to spec, install and service than traditional signal processing systems.

WE MAKE FABRICATION MORE FUNCTIONAL.

Whether your application is simple or complex, System 41's modular construction eliminates the tedious spec writing necessary for stand-alone configurations as well as excessive inventory. With System 41, you get only the signal processing functions you need, tailored to meet the application. Set-up controls behind a locking front panel keep operations hands-free and minimizes

callbacks. Troubleshooting is simplified, thanks to concise documentation, easy access rear panel connections and individual status LED's for each module. System 41's modularity gives you flexibility to meet your needs now, and our commitment to further module development ensures variety and versatility into the future.

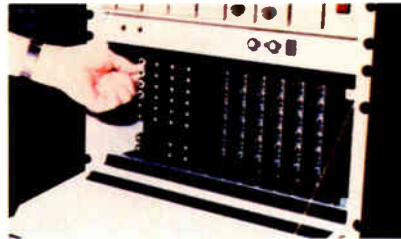

The System 41 mainframe contains 10 modules. There is room here for three more modules.



WE MAKE END-USER OPERATION SIMPLE.

While System 41 improves sound quality, it reduces operation to its simplest terms. Many modules include remote switching and level control. All inputs and outputs are balanced and rear panel connections make interfacing with additional equipment effortless. Just select the proper modules for your needs and you're on your way.

WE MAKE INSTALLATION COMPACT AND EASY.

System 41 features a compact mainframe designed specifically to reduce rack and floor space. All processing functions are contained in the single mainframe to simplify bench set-up and testing, and minimize on-site installation time.



The model DJ-4101 mainframe holds 13 modules in 10-1/2" of rack space, while the compact model DJ-4150 holds 4 modules.

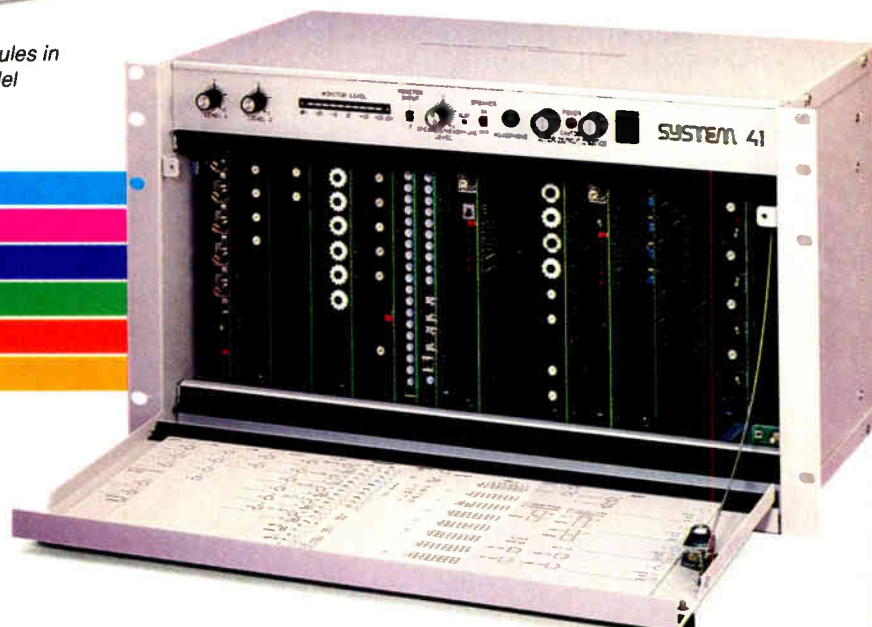
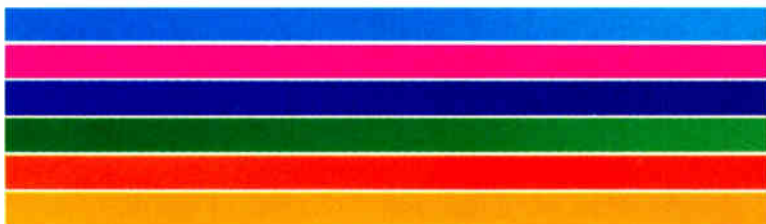

41[®] decision.

WE MAKE STATE-OF-THE-ART STANDARD.

Our patented technology for System 41 has become industry standards. We're well-known for field-proven products like the Voice-Matic[®] Automatic Microphone Mixer, Level-Matic[®] Automatic Level Controller, TEQ[®] Transversal Equalizer and Audio Signal Delay.

WE MAKE PRODUCTS WE CAN STAND BEHIND.

When we sound good, you look good. We believe in System 41. And because we want you to share our confidence, we back it with a three year warranty to be free from defect in material and workmanship.



Cibola Systems (Orange, CA) project engineer, Jim Fletcher, installed System 41 at the Los Angeles World Trade Center.

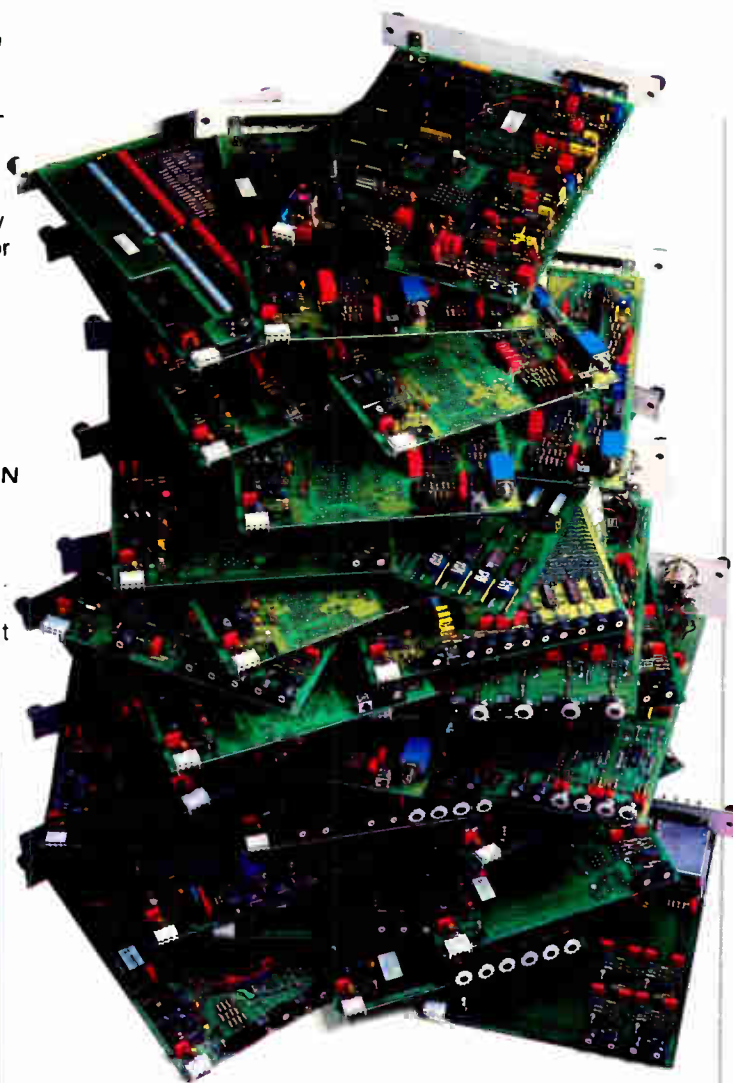

With over thirty modules to choose from, System 41 provides superior signal processing for almost any installation. The modular system lets you easily expand functionality as your needs grow!

WE MAKE THIS COMMITMENT TO OUR CUSTOMERS.

To fully understand the value of our products and the extent of their usefulness, call our Applications Engineers TOLL FREE at 1-800-255-6993 or FAX us at 708-640-9607. Specific technical solutions will be applied to your project to ensure your success from design through installation.



It's this commitment to service which has made IRP the choice of acoustical consultants and leading sound contractors. Make a sound decision with IRP and let us show you how to make great sound easy.

We make great sound easy.

IRP[®] professional
sound
products
A Knowles[®] DIVISION

321 Bond Street, Elk Grove Village, IL 60007
Phone: 708-640-9553 or 1-800-255-6993
FAX: 708-640-9607

Circle 203 on Reader Response Card

Ingenious.

You've waited 20 years for a paging projector with all these benefits.

The innovative PA430, a 30-watt paging projector, gives you easier, more economical installation than any other paging speaker...*plus* better sound and more controlled area coverage. And it fits a wider variety of applications.

The versatile PA430 mounts directly to all common electrical backboxes and is quickly clamped to posts or beams. An exclusive University-developed swivel assembly permits pinpoint orientation in any direction, at any angle.

You won't find a paging projector with better speech intelligibility. As the first paging projector ever to feature our constant-directivity principle, it provides accurate 60° x 40° pattern control over the important 2 kHz to 10 kHz range. And its double-slit phasing plug—another "first" in paging projectors—boosts high frequencies for improved off-axis performance. Its durable, high-impact horn eliminates the hollow ringing common in metal horns.

Designing the PA430 for improved speech intelligibility was a major advance. Designing it to reduce total installed costs...*now, that was ingenious.* The PA430—pro quality in commercial sound—available only from:

 **University Sound**TM
a MARK IV company
13278 RALSTON STREET
SYLMAR, CA 91342-7607
(818) 362-9516 FAX (818) 367-5292
Circle 210 on Reader Response Card

Mark IV Audio Canada
345 Herbert Street
Gananoque, Ontario K7G 2V1
Phone (613) 382-2141
FAX (613) 382-7466

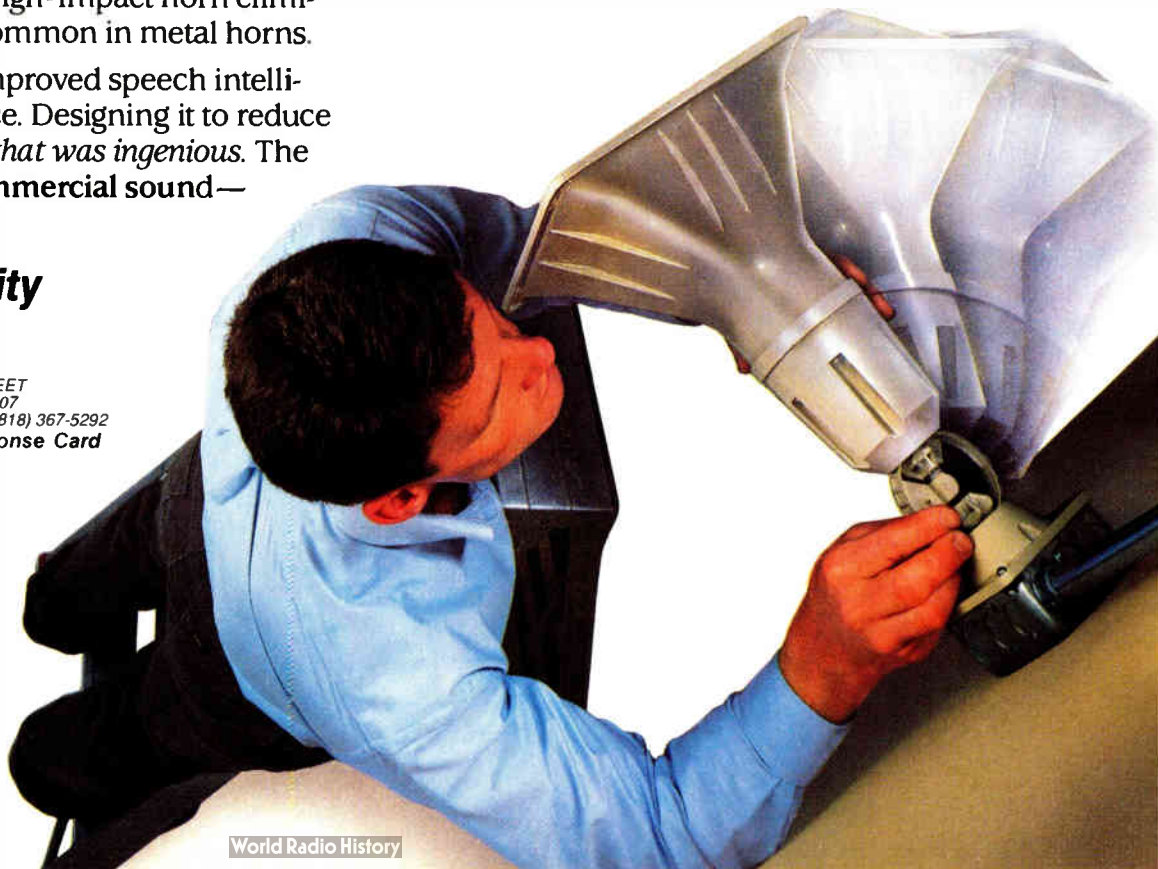

MEASUREMENTS THAT I HAVE ENJOYED

By Carolyn Davis

We have made many fascinating measurements with the TEF analyzer and we have had many measurements shared with us by others — measurements which increase our learning at a tremendous rate. Once the problem is identified and defined, the solution is at hand.

We have received permission from MorningStar Productions, Rolly Brook, and Dr. Eugene Patronis to share the following measurements.

“WE HAVE MET THE ENEMY AND THEY IS US!”

We had an exceptionally pleasant experience thanks to a group called MorningStar Productions. They, working with producer Kyle Lehning, have provided audio support and management for Dan Seals. They have produced many successful recordings for Dan Seals (also Randy Travis) in their studio. Not satisfied with the status quo, they contracted with us to do a class just for them at their recording studio headquarters in Hendersonville just north of Nashville, Tennessee.

Dan Seals is a truly first class country-western musician with a genuine drive to make the best better. He attended a majority of the sessions along with his sound men and proved to be not only a great artist but remarkably alert to sound system details.

Seals is a left-handed guitar player and



Dr. Eugene Patronis

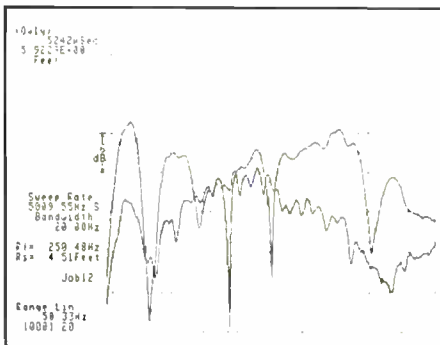

Figure 1: Upper trace is Dan Seals with cowboy hat and guitar.

was having trouble with acoustic feedback whenever he turned to his left at the microphone. His two monitors were on the floor — one to his left and one to his right just forward of his microphone position. It's not every day that we get a chance to hook an artist up to a TEF analyzer, so we quickly did so. The curves tell the story of how the monitors look at the microphone; how they are affected by the artist's body; and, finally, how the combined guitar reflection and the hat brim reflection combine acoustically at the microphone to cause a genuine excess gain problem. (See Figure 1.)

When he turned to the left, the body of his guitar reflected the left monitor towards the microphone and his hat brim reflected the right monitor to the same place. The system operated with enough feedback stability margin to cope with either one or the other of these reflections but not both at once. When Seals saw these curves, he turned around with a wide-eyed exclamation and said, “We has found the enemy and they is us.” This is just a small sample of the fun all of us had exploring the problems they wanted answers to, but it also demonstrated clearly why Dan Seals recordings and performances are so well received. He cares about audio quality and has assembled a team with real talent and the hardworking drive to solve them.

MorningStar is no “laid back” group but rather a team of young men with “the bit in their teeth” determined to exploit every problem they encounter to the benefit of their total experience in the business. MorningStar personnel literally hummed with energy and receptivity. We came away with the feeling that what we had to share was usefully absorbed. We felt privileged to have worked with such a dynamic team.

COAXIAL LOUDSPEAKER DEVELOPED

Dr. Eugene Patronis is always full of surprises when it comes to product design. When we get data from Dr. Patronis, we know we are seeing the no-cosmetics, warts-and-all view of whatever it is he is examining.

Jim Young from American Audio in Ruston, LA wanted to have a high Q, full range system for a super large church but lacked space to put it in. Dr. Patronis' solution used the Community M4PC1564 combination and then mounted an E-V HP 640

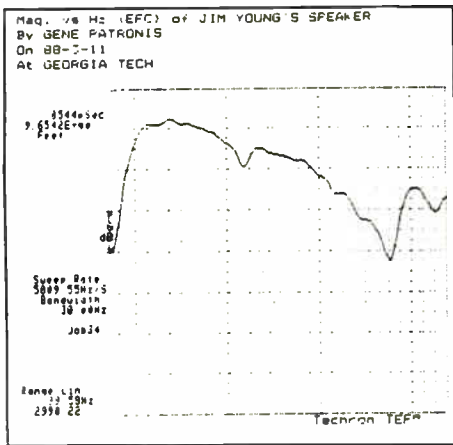

Community M4PC1564 without coaxial.

or HP 940 horn with an E-V DH1A driver inside the Community horn to convert it into a coaxial unit.

Dr. Patronis gave us a copy of the TEF measurements made during the development of this system.

Note how Dr. Patronis determines how the Community system measures by itself, not only on-axis but at multiple points off-axis as well. Then he inserts the second

unit down into the throat of the first unit and once again measures the effect on the Community system with the E-V system in its throat. (E-V system not connected at this point.)

Finally we have measurements of the two systems operating at the same time and using the delay line and crossover net-

WHY, OH WHY, DO FOLKS PAY US SO MUCH MONEY FOR ADVICE AND THEN IGNORE IT?

work as designed and adjusted by Dr. Patronis. The measurements speak eloquently for themselves. Elegant measure-

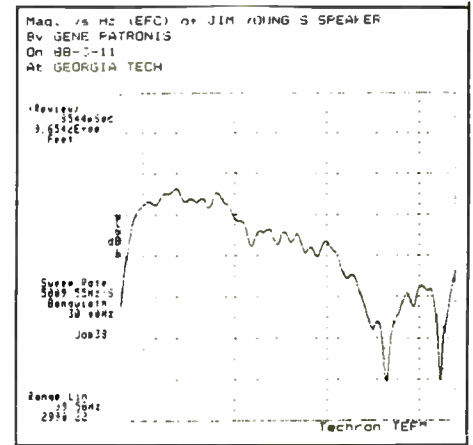

40 degrees off axis.

ments, elegant performance, elegant solution to Jim Young's problem.

ROLLY BROOK ON LOUDSPEAKER ALIGNMENT

The First Baptist Church of Pomona, CA is a 2500 seat room with main floor and balcony. It has a mid-band RT of about 1.5s with no acoustical problems for the sound system. The room is fully carpeted with

SYN-AUD-CON

SYNERGETIC AUDIO CONCEPTS
Consulting ♦ Seminars
R. R. 1, Box 267, Norman, IN 47264

Loudspeaker Designer's Workshop—Atlanta, GA

♦ Dr. Eugene Patronis ♦ Jay Mitchell ♦ Don Keele ♦

February 7-9, 1991—\$600

Sound System Engineering Seminars

♦ 2-Day Seminars—\$500

Orlando, FL—Jan. 31 - Feb. 1, 1991
Anaheim, CA—March 12-13, 1991
Seattle, WA—March 20-21, 1991

♦ 3-Day Seminars—\$525
Farm—Norman, IN

May 16-18 — July 25-27
Sept. 19-21 — Oct. 17-19

For More Information
Call—812-995-8212
or
Fax—812-995-2110

Circle 256 on Reader Response Card

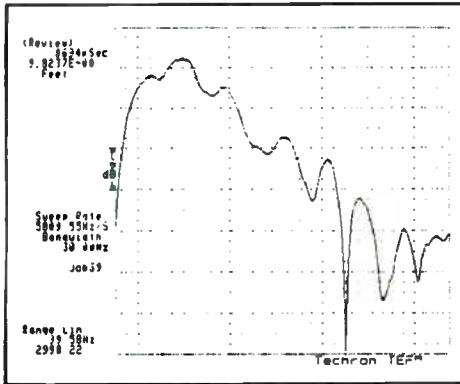

On axis with coax.

heavily upholstered benchseating. Ron McKay lost the battle with the church committee to hold down the fuzz in order to get a higher RT and better support for the choir. Now, of course, the music people are less than thrilled with the choir sound. Why, oh why, do folks pay us so much money for advice and then ignore it?

The cluster is made up of three little mini-clusters, each consisting of a JBL 4648 dual 15-inch LF and a JBL 2360/2445 90x40 HF. The cluster is located directly above the pulpit. It is not boxed in, therefore it is directly open to the pulpit and stage area below. This is not my favorite way to do it, but far too often one does what will fit the space and/or the budget.

The building was completed just before the long-scheduled grand opening and before we had time to align the cluster (isn't it always the way!). The contractor (Continental Sound — one of the best) balanced the system and did an EQ for the opening. The alignment would follow the next week. The opening went well and there were no real problems with the system. The gain-before-feedback at the pulpit was adequate, but certainly not generous. My estimate was that when the pulpit was removed and the area used as a stage, multiple miking would likely be a problem.

Before doing the alignment, I walked the room with pink noise on the system. No doubt about it, the area under the pulpit was hot. The phasing hash in the two overlap zones was obvious on the main floor but much less so in the balcony (a curiosity I'll have to look into someday). The overlap zones are centered in two aisles; more good luck than clever design. The phasing hash was not limited to the aisles, it overlapped about four seats on each side.

I aligned the cluster in two steps: first aligning the crossover of each section; then bringing the side sections into alignment with the center section in the overlap areas. Following the procedure I had worked at Orange County PAC, I located the test mic at the center of the worst of the phasing hash in the overlap zone. ETC was used to get the delay times close; then the final delay setting was determined by looking for the best amplitude and phase response. The correct setting was clear and unambiguous. After alignment I found the following four items of interest:

- Not surprisingly, the system sounds better. Much better definition in the midrange.

HE INSERTS THE SECOND UNIT DOWN INTO THE THROAT OF THE FIRST UNIT AND ONCE AGAIN MEASURES THE EFFECT.

- The overlap zone hash, while not completely gone, is greatly reduced in area in harshness. In fact, I can not hear it at all in program material. Even with pink noise, there is no hash in the seating, what remains is entirely in the aisles.

- The high-frequency band level went up so much that it was necessary to reduce the gain of the HF amplifiers by 6 dB.

HE WAS HAVING TROUBLE WITH ACOUSTIC FEEDBACK WHENEVER HE TURNED TO HIS LEFT AT THE MICROPHONE.

Wow, 6 dB of "free" headroom just from aligning! When we did the new EQ, we pulled the mid-highs (2—3K) down a little more.

- The stage area under the cluster is now almost a sonic hole. Upon walking on to the stage area from the congregation, the falloff is very noticeable. The minister

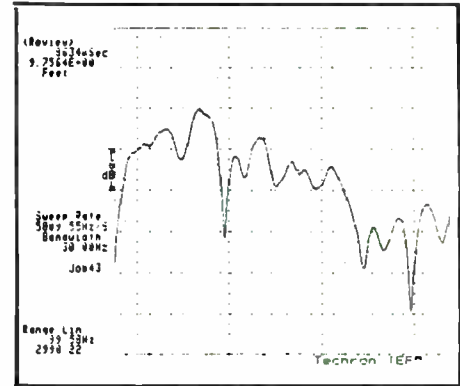

40 degrees off axis with coax.

even complained that he could not hear himself coming back from the system. The under-cluster area has benefited not only from the 6 dB HF drive reduction, but also a lobe has been removed. The increase in gain-before-feedback at the pulpit is in the order of 9 dB.

There is no doubt in my mind about the cost/benefit ratio of an alignment system. Crossover alignment is worthwhile, overlap alignment is damn near mandatory. ■

"BBE® is the most hearable advance in audio technology since high fidelity itself!"

Music Connection Magazine



With today's exacting requirements for accuracy, detail, texture, and most important, voice intelligibility, BBE is an essential element in state-of-the-art systems.

BBE Sound Inc. Huntington Beach, CA (714) 897-6766

ASK YOUR DEALER FOR A DEMO TODAY

Circle 289 on Reader Response Card

THE BETTER MOUSE TRAP: THE NEED FOR EDUCATION

By Wes Alderson

During the United States Industrial Revolution, when new ideas were becoming new inventions and these were resulting in new products, a clever slogan became popular: “If a man invents a better mouse trap, the world will beat a path to his door.”

In those days, new developments frequently took the form of wonderful things such as staplers, coat hangers, or paper clips. People could understand them. When they saw or heard about these “nifty devices,” they did indeed seek out the source and clamor to buy them.

As time went on, the ideas, inventions, and new products became more sophisticated and technologically advanced. Automobiles and telephones and finally radios were invented. Although these were harder for the average man to understand, enough people understood how to use them at least, so that these devices still created a need in the population and in commerce.

But as the twentieth century unwound into the '70s and '80s and now the '90s, what had been the industrial revolution passed through the technological revolution and became a simultaneous theoretical and applications revolution. New developments are no longer understood by the average man on the street. Statistics indicate that not one person in 20 understands how a simple wall switch interrupts the flow of electric current to turn a light on and off. What percentage of the people

on the street know how their automobile works, understand how the CRT in their TVs function, know what a gravity well is, or what critical mass is?

What has happened is that the sophistication of the general technology required in the conception, production, and application of items commonly used in our culture has elevated itself to the point where people can no longer understand it. Technology has outrun application understanding. It is the “applications gap.” This is no secret.

It is also no secret that our sound and audio visual industry is one of the market niches where this applications gap is impacting us severely. Why? Very sophisticated theory underlies the products that

MANUFACTURING A SUPERIOR PRODUCT DOES NOT AUTOMATICALLY CREATE A DEMAND FOR THE PRODUCT.

we now use prolifically — microprocessor theory, psychoacoustics, for example.

We are fortunate that the contractors and consultants in our industry are far more knowledgeable than the “person on the street.” But what about new personnel hired by a contractor? What about unprecedented developments? The point remains that the scientists and engineers who develop new ideas, and therefore create new products, can no longer count on users of these products to automatically understand how they should be used simply by opening the box and reading the spec sheet.

Those who attempt to do so, — i.e.,

those manufacturers who expect the world to beat a path to their door to buy the better mouse traps, are sadly disappointed. In other words, simply manufacturing a superior product does not automatically create a demand for that product.

A vehicle must be created by which the manufacturers can pipe the applications knowledge possessed by the designers of new, sophisticated products to the consultants and contractors who are designing the systems which use (or should be using) these new products. During the past 10 years it has become more fashionable for the manufacturers to use representatives to carry applications information to the users. This has created a need for representatives who are more than just “peddlers” and who must be able to grasp some science and technology in order to function as an information pipeline. Sometimes such representatives can be located.

During the same ten-year period of time, manufacturers have also seen the need to develop applications seminars to pipe the knowledge to contractors. Extremely good work has been done by objective, independent audio seminars. Examples are Syn-Aud-Con by Don and Carolyn Davis, and the basic, intermediate, and advanced classes included in our NSCA Show each year.

Seminars of various sorts have become increasingly popular during the last three years simply due to the needs outlined above. That is, you can't expect your product to be used in installations unless you train the contractors in how to use it! The contractors and consultants also recognize the need for these seminars and are generally quite willing to create the time needed to attend them.

Recently an interesting refinement of

this seminar process has developed. Individual manufacturers of sophisticated equipment such as IED, AMX, Crown, and Bose have created their own seminar series. These seminars are not "sales-oriented" in that they do not simply hype the manufacturer's product. In each case they attempt to help the contractors and new employees of the contractors to better understand the product and how it is intended to fit into applications. In each

"FREE" CLASSES ARE SOMETIMES PERCEIVED AS VALUELESS CLASSES.

case the classes also impart better overall understanding of the general technology, entirely apart from the manufacturer's products.

The sum result of all of the seminars, classes, etc. which are developing will certainly have a positive effect on the flow of information to the designers, sellers, and installers of sound and audiovisual systems. I strongly recommend that every person involved in our industry take the time to participate in such events. A contractor should remember that if he decides he is too busy to attend a class, some of his competitors can get a leg up on him in terms of today's technology.

We must now return to an earlier point — The Role of the Representatives in this education process. The sales representatives must be involved if these seminars are to be effective! Representatives function as a servo mechanism which enables the intended targets and the providers of the education to best interact with each other.

The AMX Corporation of Dallas, Texas serves as an ideal example of how a "roving seminar" should work. Here are the steps which AMX has employed in order to produce a very successful series of seminars in various cities throughout the nation.

1. AMX tries to conduct a seminar in conjunction with each major trade show in
2. AMX also enables its representatives to select key cities in which a seminar takes place.

QUALITY ISN'T EXPENSIVE



It's Priceless!

At BIAMP Systems, the **QUALITY** of the **sound** is always our continuing design criteria. BIAMP's new CASCADE stereo mixers use discrete transistor preamps and low noise, high slew-rate electronics for clean, transparent, no-compromise sound.

CASCADE mixers also give you four aux sends, three returns, balanced outputs, phantom power and much, much more.

In 12 or 16 input portable consoles or an 8-channel rack mount model, CASCADE mixers represent an **ideal balance** of price, performance, reliability and the features you need.

Call us toll-free at 800-826-1457 for free descriptive literature and the name of a BIAMP dealer near you.

biamp  **AMERICAN
SOUND
CRAFTSMANSHIP**

14270 N.W. Science Park, Portland, OR 97229 (503) 641-7287

Circle 240 on Reader Response Card

3. The representatives are responsible for targeting the contractors and consultants who are to be invited.

4. The representatives are responsible for date and site selection, hotel and

meeting room, and coordination.

5. AMX provides the demo equipment, the factory engineers, and pays for the event.

When planning these events, here are

some tips that usually help:

- Check your industry calendar for potential conflicts.

- Make a definite assessment of what your fundamental goal is.

- Do not try to "educate" too wide a variance of students, — i.e., both basic and extremely advanced.

Make certain the person conducting the class is a good teacher, a good presenter.

Charge a deposit or a fee of some sort, payable with the application, even if you refund it later. Reason: Attendees are much more likely to show up if they have paid something... and "free" classes are sometimes perceived as valueless classes.

Make certain well in advance that you have all of the aids required in order to make a proper presentation: e.g., overhead projectors, blackboards, product demo gear, etc.

Have a well-planned agenda — a lesson plan; but provide frequent question and answer periods.

Better to be over-organized than under-organized.

If the class is longer than one day, and there is an evening to use wisely, a social event is nice...but it is a mistake to make the social event the most important aspect of the event. Those attending should be present to learn!

Wherever possible hold your class in conjunction with a major event in our industry such as our NSCA Show. This assures better attendance and reduces travel cost.

We are urging all manufacturers to conduct classes, seminars, and workshops. We also urge contractors and consultants to attend these events whenever practical. By doing this we will narrow the applications gap. The old adage must be reworded: *If a manufacturer invents a better mouse trap, he will have to beat a path to the world's door. And the best way to do so is with seminars.* ■

Wes Alderson is President of WesTech Marketing, the manufacturers representative organization based in Culver City, California.

DREAM MACHINE

Imagine. A professional DJ mixer with features and sonic performance that can rival broadcast and recording studio boards. A dream? No, it's the DM1912 preamp mixer from Numark's Professional Products Division.

For mixing live track acts, CD and DAT sources, the DM1912 features inputs for four mics, six stereo line sources and three turntables. A source assignable six-band graphic equalizer lets you fine-tune only those input sources you select.

With the DM1912's input assignable monitor bus, you can listen to one source in your left earphone and another in your right earphone for more precise cueing. A special voice-activated talkover feature automatically lowers the program volume when you speak.

In addition to a source assignable crossfader, there's also a special Beat-Blend™ feature that enhances the sound quality of two program sources during beat mixes.

Check out Numark's DM1912 mixer at your local professional audio retailer and see the mixer of your dreams come to life.

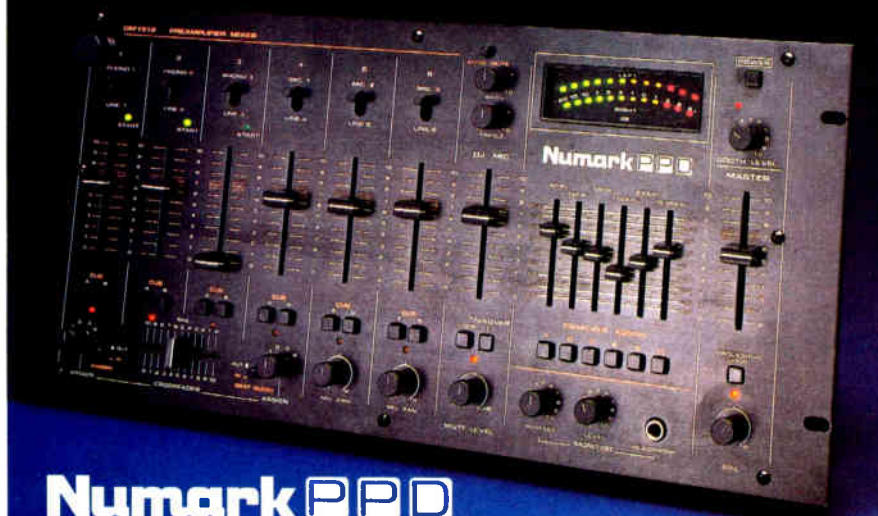

Numark PPD

A world leader in interactive audio mixing products

DM1912

Numark Electronics General Offices
503 Newfield Ave., Raritan Ctr., Edison, NJ 08837
(201) 225-3222 Telex: 287-249 Edin
Fax: (201) 287-2155

West Coast Branch:
4486 Runway Street, Simi Valley, CA 93063
(805) 522-3550 Fax: (805) 584-8416

Circle 257 on Reader Response Card

The Perils and Triumphs of Wireless Technology

An Overview

By ALLAN VARELA

The stage is set; the show must go on. The performer, a tinge of self-consciousness etched on his face, walks out in front of the crowd. His hand reaches down under his jacket, and fumbles around for the tiny mute switch on his transmitter. Click! The switch is pushed, and with a shrug of his shoulders, he puts a smile on his face to engage the audience. He takes a deep breath; everyone waits with anticipation. Then... nothing. No sound happens. The hall is filled with tension, and not the booming voice of the performer.

He rushes his hand to the transmitter and clicks the on/off switch, and tries again with the same lack of results. At this point the engineer runs up to the stage to examine what is wrong. The transmitter is removed, and it is quickly determined that a bad battery is at fault. The battery is replaced, and the performer begins anew — with a little egg on his face.

Wireless microphones always create a love/hate relationship with users: people love the freedom, but hate and seldom understand the limitations. Yet, wireless is here to stay. Many of the early problems, for the most part, have been solved, but nothing will ever be as reliable as a mic hardwired into a system. Problems of interference continue. Placement of wireless requires special attention, choices have to be made between VHF and UHF. Budget constraints and usage need to be meshed

with the demands of wireless technology.

Last, but not least, the client has to be dealt with. There may in fact be unreasonable demands made by the client on wireless technology. Handling is a problem, as some users treat the equipment with box-

ing. Lectrosonics, Telex, Williams, TOA, and Nady are several of the products that Power Sound uses. For Jennings, the actual design of the mute switches can become problematical.

“The biggest drawback that we have



Williams Sound's Liberator One wireless microphone system.

ing, as opposed to kid, gloves. Wireless also requires much more user cognizance. Mute and on/off switches must be remembered. Batteries must be checked and replacements kept on hand. If an engineer is being used to mute the wireless channels at a control board, the engineer must know when to mute them, and, therefore, must stay awake — a problem for some nonprofessional engineers.

Peter Jennings from Power Sound of New England, a New Hampshire based sound company, uses wireless systems for his clients. Power Sound's business centers around the Catholic Church, schools, industry, background music and



The Comtek RPT 182 repeater and accessories.

found, especially for priests, is that a good many of the wireless systems that we use have a small, flush slide mute switch," says Jennings. "For a priest or other clergy who wear robes, to try and reach through the robe to find a slide switch is almost im-

possible. A new Lectrosonics and a Telex model have a toggle switch on the top of the transmitter." Not muting can be very embarrassing as off stage remarks or not for public activities will transmit through the system with revealing results!

Wireless systems find their limitations from the political world more than from the technical world. It is certainly technically possible to build powerful, almost foolproof systems. However, the FCC rules regarding wireless systems hinder this from happening. In effect, a wireless user can be thought of as a mini-broadcaster. It would be impossible and impractical for the FCC to license everyone with a wireless mic, so restrictions as to transmitting frequencies and transmitting power are in force for all wireless systems from the mic systems found in churches to the intercom systems found in playhouses. The game for the manufacturers is to get the best possible results from within set rules both political and physical.

Whereas a high power radio or television station may transmit within their respective frequencies at say 50,000 watts, a wireless system is restricted to 50 milliwatts. If your particular system doesn't offer good signal capture ratio, any transmission from a frequency along side of your frequency can leak into your receiver. The stronger that side frequency transmission, the greater the chance that interference will occur. The geographical location of the wireless system, therefore, becomes very important. If you are in a remote area of the country where little else is happening in the local broadcast world, less concern about your transmitting frequency is in order than if you are in New York City where the air is full of everything, everywhere. Also, if you are using multiple systems with frequencies next to each other, good capture ratio is imperative.

Even when all these considerations are dealt with, a more direct interference problem can happen simply because of the immense popularity of wireless systems. Tom Smith, owner of Shade Tree Productions in Longwood, Florida explains:

"There are so many people out there



Sony's WRT-28 UHF wireless transmitter.

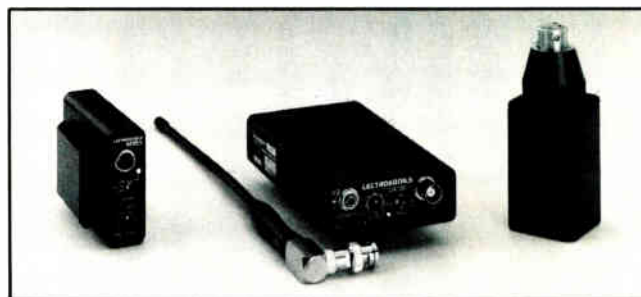

Lectrosonics' CR185 receiver, M185 transmitter and H185 plug-on transmitter.

that use wireless. I did a job at a hotel in Orlando using wireless. Everything was fine until the rock band in the next room started playing. They were using the same frequencies that I was using." Smith is in favor of setting up a local wireless network to reserve, as much as possible, brand use and frequency allocation within a particular venue. "This is a problem for me because I have to bring several systems to each job."

A person with a talkback mic in the audience may be sitting, and probably will be sitting, in a null spot.

The frequency location of a particular unit is important as well. In the VHF band between 130 MHz and 230 MHz, a wireless system may have plenty of room to breathe depending upon where you are using it. If, however, your system falls within the VHF low band (25 MHz to around 80 MHz), you may find a local CB user issuing his handle during your performance even though you are in a remote area.

Antenna length is a factor as well; the lower the transmitting frequency, the longer the radio wave. An antenna of possibly 5 feet is needed for a lower frequency, while an antenna of around 15 inches fits the bill in the VHF high band. UHF units can live with an antenna of five inches. Each frequency band has its own limitations as to range, ability to penetrate walls, reaction to metal beams, and drop-

out areas. The UHF band limits range, but penetrates walls better. There are fewer other broadcasting activities in UHF, so outside interference may be slight, but the incidence of null zones or signal dropouts around a given room can increase.

Wireless systems range in price from 50 dollars for low band systems to several thousand for the top of the line. Oddly, the price of a system doesn't guarantee the best of all specs. The two hundred dollar range Samson and Nady systems offer some of the best signal-to-noise ratios on the market. Signal-to-noise ratio problems were solved by a technique called companding. Companding is much the same as noise reduction for a tape machine. The signal is first compressed, transmitted, and then expanded again.

John Nady was one of the first to use this technology, and holds a patent on it. Early UHF systems were designed with signal-to-noise in mind, yet it still wasn't the answer.

"The first UHF unit that came out in the 900 MHz area was from Sony," says Nady. "They came out with it because up at that frequency you can modulate plus or minus 300 kHz. That allows you to get 90 dB signal-to-noise ratio. However, today almost everyone uses companding."

Systems are now available from a multitude of manufacturers from Comtek and HM Electronics to Sony and Vega; from Peavey to Beyer. One thing that is a problem is lack of interchangeability between systems. Frank Coates from Ace Music in Maitland, Florida does a lot of wireless work including the new Dick Tracy exhibit for Disney.

"I have more trouble with just the lavalier cables on the belt pack systems as they are always pulling out, or pulling from

the head piece.” says Coates. “Basically, I wish everyone could come to some kind of standard on the LEMO connectors. The LEMOs are a real problem with dealing with this particular unit or that particular unit. When you do a rental stock situation for a convention service company, it would be nice if we could give them a choice of mics to interchange with all their systems.” This would allow tailoring the sound of the microphone with the job,

The game for the manufacturers is to get the best possible results from within set rules.

rather than having to settle because the particular mic is the only one available.

The durability of these systems is still in the hands of the end user. Once again, Peter Jennings relates his experience:

“Another problem with some of these wireless systems, and it is a problem that somebody should watch out for, is whether or not the microphone is hardwired into the transmitter or if it goes into a connector,” explains Jennings. “The most chronic problem with every wireless is the fact that the wires are often pulled. When the user gets through using it at the end of a session, they grab the wireless microphone wire and wrap it tight around the case because it is convenient to put it away that way. The wires are forever breaking. If the thing is wired in, it is very difficult to repair. If it goes to a connector it is very easy to repair. A connector oriented microphone on a wireless is important.”

Even with proper training and best intentions, abuse can happen. “Trying to make them [the customer] handle wireless gently is important,” says Jennings. “But the situation of a priest after a mass talking to everyone who wants to talk is a reality. While he is talking, he is removing his wireless, and he might wrap the wire tight around it. A good strain relief, if anyone could come up with such a thing, would be important.”



Vega's R-42A pro plus diversity receiver.

Channel Plus®

MULTIROOM VIDEO

Push buttons to select channels

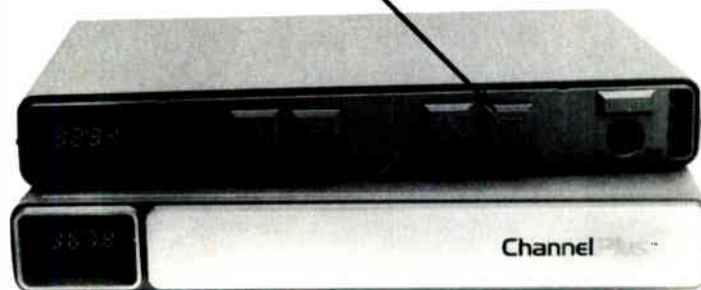

Model D2V—modulates 2 video sources

PICTURE PERFECT CUSTOM VIDEO SYSTEMS

ChannelPlus modulators put each video source on a different UHF or cable channel so that your customers can watch VCRs, satellite receivers, CCTV cameras, cable boxes, etc. on every TV. Create private cable head-ends quickly and economically. For each video source select the desired output channel number by front panel controls. From 1 to 24 channels can be combined with antenna or cable service.

Write, Call, or FAX for free brochures and application notes.



multiplex®
technology, inc.

3200 East Birch Street, Brea, CA 92621-6258, U.S.A.
714-996-4100 • 800-423-0584 • FAX 714-996-4900



© 1990 Multiplex Technology, Inc., Brea, CA 92621

Circle 254 on Reader Response Card

EIGHT THINGS YOU SHOULD KNOW ABOUT UHF WIRELESS.

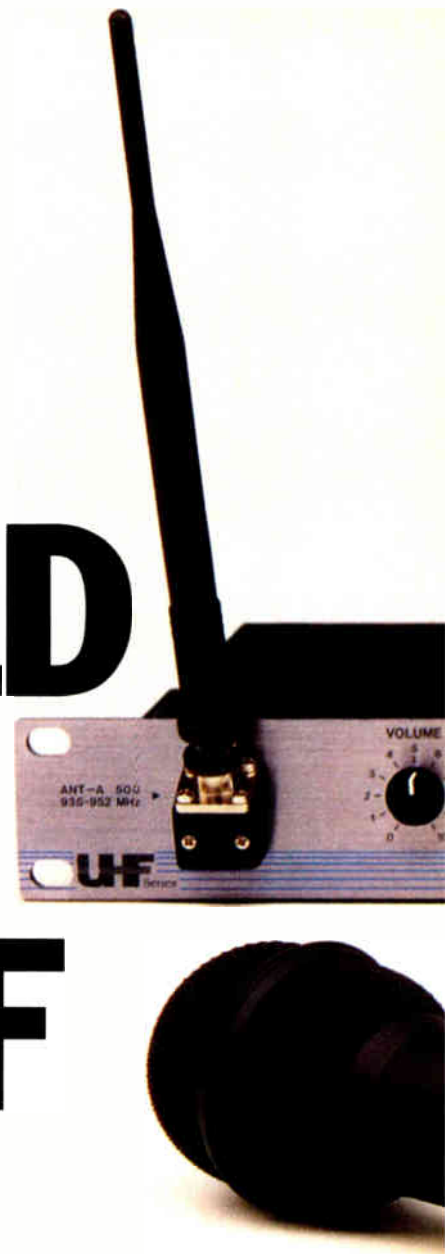

UHF's time has come.

With the introduction of the Samson UHF* Series, we thought it might be helpful to provide you with new information about this technology.

1. UHF gets better reception. Yes it does, in the sense that UHF operates at the higher frequency range of

902-952 MHz. There is a lot less *traffic* up in that bandwidth. And, more importantly, less RF interference and noise.

2. New UHF technology has recently been made available. For the UHF Series, Samson put four of our finest wireless engineers on the case. Using up-to-date developments like Di-Electric filters, Gas-Fet and new cellular technologies, they were able to bring UHF up to a higher level of performance.

3. UHF sounds better. A dangerous generalization perhaps, but it *does* have wider RF dynamic range. And because we're the first to use dbx† Noise Reduction in UHF, the resulting audio quality is even more impressive.

4. More frequencies are available. Samson offers seven UHF frequencies that can be used simultaneously. If you're already running a lot of VHF on stage, you can place our UHF frequencies on top of these without any interference.

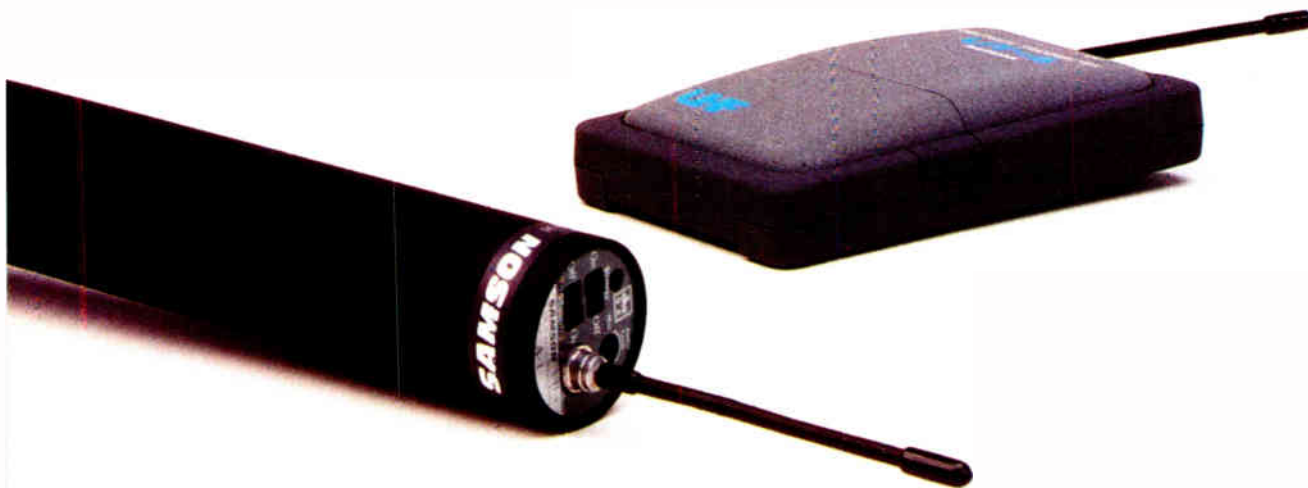
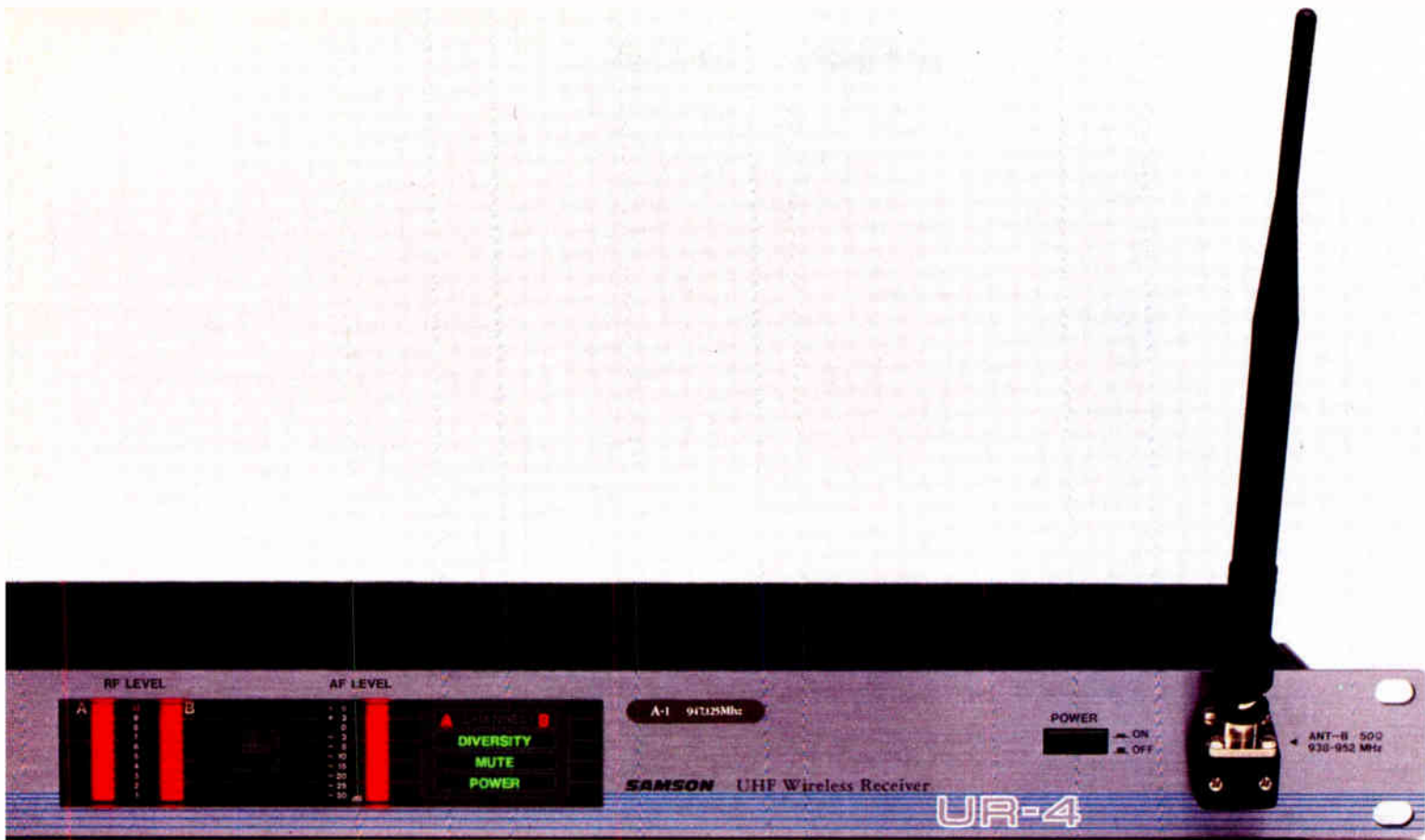

5. Samson UHF offers more microphone options.

The all-brass UH-4 hand-held transmitter is available with an incredibly wide variety of the industry's most popular mic elements. The streamlined UT-4 belt pack transmitter comes equipped with a broad range of high quality lavalier microphone capsules.

6. Samson UHF antennas set new standards. Custom made so they are acutely sensitive to our bandwidth, Samson's high

efficiency cellular antennas can be either front or rear-mounted. Because they are positioned at a 45° angle to the front panel, several UHF systems can be cascade-mounted in a single rack with all antennas in the clear.

7. UHF is more expensive.

Until now. Because of robotics assembly techniques and the very latest in surface-mount technology, Samson was able to make UHF a realistically priced option for a whole new class of users.

8. Write for a free Samson UHF White Paper. Find out more about UHF and one company's approach to this exciting technology. A higher method that promises clearer reception for everyone in the wireless future.

In case you were reading too fast, we wanted to remind you that this ad is about UHF, not VHF wireless.

◊ As long as you are reading our ad this closely, we thought we'd tell you who they are: Yukinaga Koike, Doug Bryant, Takao Horiuchi and Susumu Tamura.

†dtx is a registered trademark of Carillon Industries.

SAMSON®
WE ARE THE WIRELESS FUTURE®

Samson Technologies Corp. P.O. Box 9068, Hicksville, NY 11802-9068
(516) 932-3810 FAX (516) 932-3815

Circle 206 on Reader Response Card

World Radio History

Wireless Solutions

Need hearing assistance?

The T72 Auditory Assistance system by Lectrosonics offers more features than any other wireless hearing assistance system, at a lower cost. This noise free system includes advanced signal processing with selectable HF boost, LF roll-off and a unique dynamic processor to improve intelligibility dramatically. The receivers are tunable and the transmitter includes a test tone generator to simplify re-tuning in the field. This is the best system you can install at any price.



Wireless mics...from A to Z



Whether you need a low-cost system, or an advanced multi-channel system, there is a model or system available to meet your needs. These are high performance, highly reliable wireless systems made in the USA by an experienced staff of the finest engineers in this country. High sensitivity, high selectivity receivers are matched with a broad assortment of transmitters to offer a wireless system for any microphone requirement. Call us. We understand RF and your needs.

Automatic mixing...with wireless?

The Modular Audio Processor combines advanced signal processing functions with an optional dual-channel wireless microphone receiver and hearing assistance transmitter. The applications range from churches to courtrooms and large scale legislative council chambers. A single control center can be configured for fully automatic operation in any application. For simultaneous recording, tele-conferencing and sound reinforcement, this is the system to use.

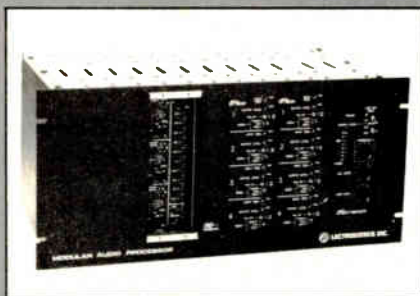

Call us toll free: (800) 821-1121



LECTROSONICS, INC.

P.O. Box 15900 • Rio Rancho, NM • 87174
581 Laser Rd. NE • Rio Rancho, NM • 87124
(505) 892-4501 • (800) 821-1121 • FAX (505) 892-6243

A diversity system also may be in order for some locations. Essentially, a dropout can occur because of 180 degree reflections arriving at the receiver antenna with the direct signal. The phase cancellation nulls the signal. Also, a person with a talk-back mic in the audience may be sitting, and probably will be sitting, in a null spot as regards his distance from the receiver and a quarter wavelength of the transmitting frequency. Many times the engineer must physically move a receiver to gain the signal back.

Enter the diversity system. This system uses two antennas to pick up the signal. There are three approaches to these systems. The most expensive is the post detection combining system. This system uses two separate receivers, one for each

One thing that is a problem is lack of interchangeability between systems.

antenna. The signal output signal from the receivers is compared and the stronger is chosen. Awareness of the system "breathing" as it switches between the two receivers can be a drawback. A switching diversity system compares the signals from the two antennas and feeds the strongest signal to the receiver. If, however, the stronger signal is interference, the interference will be chosen. A third type, and perhaps the best system, is the antenna combination system. The receiver antennas' (two or more) signals are amplified, and then they are combined to yield one stronger signal.

With all of this said, yes, wireless mics are used very successfully every day in every way. Awareness of the limitations of wireless, and awareness of why things may go wrong, can make the contractor's job easier when installing systems, and when training the end user. Education is the key. Although a hardwired mic requires less attention, many wireless users prefer the freedom that wireless offers, and must learn how to use and care for their wireless system. ■

Wireless Applications

Installation and Antenna Systems

BY GARY J. STANFILL

This article is excerpted by permission, from "Wireless Microphone Application Techniques," written by Gary J. Stanfill, President of Vega, and published by Vega, a Mark IV company.

Aside from remote antennas and RF distribution systems, installation of wireless equipment does not differ greatly from the installation of other types of audio equipment. For example, provisions should be made for adequate cooling of the receiving equipment, especially when it will be rack mounted. Although wireless equipment is no more sensitive to heat than other types of audio equipment, wireless systems usually have more alignment and adjustment points. For this reason, aging due to excessive heat may have more pronounced effects than for some other types of equipment.

Mounting of wireless receivers next to digital devices such as effects generators, digital delays and microprocessor-controlled instruments should be avoided. Even when the digital equipment meets current government regulations for interference (and a great many older units do not), there may be problems. The government limits are designed to protect other equipment in the immediate area, not equipment stacked on top of the digital equipment. In many cases, mounting a wireless receiver in a rack just above or just below the digital device will cause problems. Often, the wireless system will work more or less normally, but squelch operation with the transmitter "off" may be erratic, or the squelch may not function at all. In rare instances, the wireless audio may be affected in some manner.

Whatever the nature of the problem, it can generally be fixed by simply moving the wireless receiver further away from the digital device. Quite often, a move of only 5 or 10 inches (12 to 25cm) will completely solve the problem.

Particular care should be taken to keep the wireless receiver away from high power audio amplifiers. Not only do power amplifiers produce considerable amounts of heat, they may contain high power digital switching circuitry. A growing number of

Mounting of wireless receivers next to digital devices should be avoided.

modern designs employ high frequency switching power supplies or switching power amplifier sections. Because of the high power involved, the potential exists for wireless interference. Other types of digital equipment such as personal computers and digital remote control equipment (zone control systems, for example) can also be troublesome. Although no actual problems will be encountered in a majority of installations, it is important to keep the possibility in mind in the event of difficulties with the wireless equipment.

If the wireless system is being permanently installed, especially in an equipment rack, care must be exercised to avoid shielding or blocking of the antenna. It is almost necessary to use remote antennas when wireless receivers are mounted in equipment cabinets. Even if the back of

the cabinet or rack is open, the antennas will be in close proximity to the metal in the enclosure, as well as other equipment which may be installed. Sometimes overlooked is the fact that cabling can also effectively shield an antenna, even its own cable in the case of an external antenna. Metal window frames are also often overlooked as a source of shielding, especially since it may not be apparent that they are metallic. It is always advisable to spend a few minutes examining the installation area for potential problems of this type. This simple precaution can often save substantial headaches later.

In spite of the recent trend towards heavier use of diversity systems, non-diversity systems can perform effectively in most installations. This is especially true of fixed installations, where conditions do not often change and there is adequate time for checkout and setup. When non-diversity systems are used, it is almost always necessary to check the installation to make sure that there are no dropouts in the areas where the transmitter will be used. This can be accomplished by 'walking' the coverage area while listening to the sound system. If any dropout problems are encountered, it does not necessarily mean that adversity system will be needed. Unless there are a number of dropouts or they are unusually severe, it probably will be possible to quickly correct the problem without an equipment change.

If a dropout or two are experienced, the receiving antenna installation should be reexamined. Particular attention should be paid to possible blocking and pattern distortion problems caused by metallic ob-

jects. If blocking doesn't seem to be a problem, it may well be that a slight relocation of the antenna will solve the problem. Quite often, a shift of only a few inches will cure a stubborn dropout zone while not introducing any new problems. Raising the antenna is very often helpful, especially if it is not well above the level of the transmitter. If a problem persists, perhaps a better antenna such as a dipole, or moving the antenna slight closer to the transmitter will help. With a little experi-

Nondiversity systems can perform effectively in most installations.

mentation (and a little experience), it should almost always be possible to quickly arrive at a fully satisfactory configuration.

Because of potential overload problems, it is necessary to ensure that the wireless transmitters cannot get too close to the receiving antenna in the amplified systems. Normally, it is desirable to place the receiving antenna relatively close to the location where the transmitter will be used. However, operating a transmitter closer than about 20 feet (6m) to an antenna with an attached amplifier invites problems. This is a particularly important consideration in installations where multiple transmitters will be used. In spite of the potential overload and intermodulation problems, the RF line amplifier must always be located at the antenna, not the receiver. This is because once the signal has been attenuated by the cable, amplification is more or less useless. In fact, adding an amplifier at the wrong end of the cable can often actually decrease range, especially when a high quality receiver is being used.

Because of the necessity of remotely locating the line amplifiers, supplying the necessary operating power and protecting them from the environment, system reliability may suffer. For example, it is not all that unusual for power to accidentally become disconnected from an amplifier,

resulting in performance far poorer than would be the case without the amplifier. However, since there is often no recognizable major failure, the problem may go unnoticed for some time while other equipment is blamed for any difficulties. For all the reasons, it is virtually always better to install a lower loss cable, move the receiver closer to the antenna or select a higher performance antenna if the use of the line amplifier can be avoided.

Oftentimes, it is desirable to have one antenna feed two or more receivers. In this case, a multicoupler (amplified signal splitter) may be used. These devices typically have four outputs, allowing one

Oftentimes, it is desirable to have one antenna feed two or more receivers.

antenna to drive up to four receivers. However, multicouplers are wideband active devices much like line amplifiers and have most of the same limitations in respect to overload, intermodulation and interference rejection. Splitters are RF signal dividers with no amplification. These devices provide a good RF impedance match to minimize signal loss, unlike simple "tee" connectors, which are often extremely lossy. Splitters can be used to divide the signal from one antenna to drive two receivers. However, it is important to realize that each two-way split will reduce the range of the wireless by about 32%. This may be acceptable in situations where the antenna is short and the operating range is not too long. Splitting more than two ways will reduce the operating range to less than 50% of normal and should never be attempted.

When both a line amplifier and a multicoupler are needed, it is possible to use both at the same time. It is also possible to use more than one coupler in series to drive from 5 to 16 receivers. The practical

limit is 16 receivers; multicoupler driving four other multicouplers, each of which in turn drives four receivers. Using either a line amplifier and multicoupler combination or one multicoupler driving a second multicoupler will, unfortunately, further increase the possibility of encountering interference or overload. However, satisfactory operation will be obtained in most instances. Use of more than two active devices (two multicouplers or one line amplifier and one multicoupler) in series is strongly discouraged. It is sometimes possible to configure combinations of line amplifiers, splitters and multicouplers in such a way as to avoid some of the inherent limitations. Because these solutions depend upon the characteristics of specific items of equipment, it is highly advisable to contact the manufacturer for technical assistance before proceeding.

A common question is whether or not it is necessary to terminate unused multi-

A shift of only a few inches will cure a stubborn dropout zone.

coupler outputs in 50 ohms. While it is always good practice to do this, whether or not it is actually necessary depends upon the characteristics of the particular piece of equipment. Leaving unused outputs unterminated may reduce the isolation of the multicoupler (the attenuation from one output to another output). Poor isolation can sometimes cause one receiver connected to the multicoupler to interfere with another connected receiver. For some units, this may be a problem even with all outputs terminated. This problem may appear when using multicouplers with inherently poor isolation or receivers with high leakage out of the antenna connector. In the event of problems with systems using either line amplifiers or multicouplers, it is a good idea to try connecting whip antennas directly to the receiver input to see if this corrects

the difficulty. In troubleshooting this type of system, the obvious shouldn't be overlooked. Line amplifiers and multi-couplers are usually separately powered and it is often easy for the power to be turned off and become disconnected.

It is worthwhile to confirm that it is not being caused by noisy ac power.

Sometimes it is desirable to cover an unusually large area, to extend coverage to an isolated secondary area or to satisfy some other special or unusual requirement. In a majority of cases, it will be possible to provide the capabilities desired and to achieve good results. However, a significant amount of hardware may be necessary to properly implement the antenna and RF distribution systems. Purchase and installation of this equipment is likely to be expensive and mistakes may be costly. Because of this and the specialized nature of such systems, it is usually best to obtain expert assistance. Often, the wireless manufacturer can provide valuable assistance. However, because it is frequently necessary to make an on-site survey prior to preparing a design or making recommendations, it may be necessary for the manufacturer to make a referral to a qualified consultant.

In a surprising number of instances, interference problems in wireless systems are caused by noisy ac power. That is, the interference enters the receiver through the ac power line, rather than thru the antenna connector. Aside from noise injected on the power lines by digital devices and equipment with switching power circuits, site electrical machinery and lighting equipment can be significant noise sources. Arcing contacts, poor electrical connections, defective fluorescent ballasts and tubes, lamp dimmers, defective motors, and many other electrical devices not only radiate noise, but also can inject

noise onto the ac power lines. Both continuous noise, such as that caused by motors and rotating contracts, and random noise bursts are commonly encountered. Wireless equipment can also be affected by high energy transients appearing on the power lines. Because these transients are often very high in amplitude, they can couple through the power supply in the wireless receiver and affect the circuitry.

When interference is experienced in a wireless system, it is worthwhile to confirm that it is not being caused by noisy ac power. If noise is present on the audio output when the receiver is squelched, it is virtually certain to be power line noise. Burst or impulse type noise also often enters the wireless system via the ac source. One quick way to check for the

noise source is to use a battery operated FM radio tuned to a weak station. If the FM radio does not receive the same noise as the wireless, it is highly likely that the ac line is at fault. In order to correct this type of problem, the best choice is changing the ac power source to one free of interference. If this isn't feasible, a combination power line filter and surge suppressor, such as sold for use with personal computers, will often help. However, the less expensive versions of these devices have only minimal filtering and may not work very well. Better quality filters are sold by both electrical and electronics distributors. Keeping a quality power line filter on hand for troubleshooting purposes can be a wise investment. ■

EVERY MAJOR TRADE SHOW ON VIDEO

Television news programs covering the conventions that are of import.

**ORDER THEM
NOW!**

NSCA-TV NEWS
AES-TV/Crosstalk
CES-TV NEWS
NAMM-TV NEWS
NAB-TV NEWS

CES-TV NEWS

NAB

TV NEWS

Crosstalk

AES

TV NEWS

NAMM TV NEWS

TESTA COMMUNICATIONS
25 Willowdale Avenue
Port Washington, NY 11050

CALL FOR INFORMATION: 516-767-2500

Wireless Interference

Everything You Ever Wanted to Know!

BY BILL MAYHEW

Wireless interference is a subject that really cannot be covered in just a few paragraphs, so let's dig in. To start, let's talk about interference that is not caused by other wireless microphones being used at the same time and at the same location. For lack of a better term, let's call it outside interference.

If you have taken the usual precautions in selecting the frequencies of the wireless mics you are going to use in a given area, most people would say that you should experience no trouble. The real trouble may be in the use of the word usual. Most manufacturers design their wireless mics to operate in a frequency group between 154 MHz and 216 MHz. Within this group of frequencies is the VHF TV channels. The unused TV channels within a given area are a good start in selecting a workable frequency. I have found that if you are further than 75 air miles from a TV channel's transmitter you, from a practical stand point, should be able to use wireless within that TV channel's bandwidth. For instance, in the Los Angeles area the unused channels are 8, 10, and 12. The problem is that if you were to take a wireless to the San Diego area that was on channels 8, 10 or 12 it would not work because the San Diego area has TV stations working on channels 8, 10 and 12.

Happily, the FCC has opened up a group of frequencies that allow for clear channel operation within the USA. At least I think that was the intent of the group that was able to convince the FCC that clear channel wireless mic frequencies are really needed. The truth is that the FCC took the list of frequencies submitted and changed it a bit. Here is the list of the fre-

quencies in Megahertz:

- 169.445
- 169.505
- 170.245
- 170.305
- 171.045
- 171.105
- 171.845
- 171.905

At first glance we all yelled 'Eureka!,' but at second glance we realized that the spacing was far too close. In fact, you can get only three of the above frequencies to work together at the same time. The rest of the bad news is that there are some

If the squelch is too loose when you turn off the transmitter, the receiver could allow the spectrum noise into your system.

areas in the country that wireless mic users have experienced interference on these frequencies. So far in the Los Angeles area I have found the following frequencies to be interference free:

- 169.445
- 171.105
- 171.845

WHAT IT SOUNDS LIKE

If you are "lucky," the interference will be understandable in your wireless receiver. By this I mean that you will be able to get the call letters of the station that is interfering with your wireless. With this information, it can be found if you had a fault with your wireless or if you are in fact on the wrong frequency for a given area of usage.

I have found that most of the outside interference in wireless microphone receivers comes blasting thru. It usually causes the receiver's VU meter to peg. The reason for this is that usually it's a commercial TV broadcast station that is causing the interference. Since they use FM modulation with one deviation of 25kHz, you can see why the wireless mic receiver (12 to 15kc of deviation) really hears the outside signal.

A good on-site test, to see if you are going to be interfered with, is to turn on the receivers and open the squelch. Now, listen to the spectrum noise. It should be just noise. If you hear a carrier you might want to drag out that old mic cable. But if you enjoy playing Russian Roulette with a shotgun there are a couple of things you can do. First, look at the receiver's meter. In the RF position, if the meter reads higher than 2 microvolts with the interfering carrier present, you will most likely have trouble. Even though FM wireless mics work on the capture principle (the strongest signal is captured by the receiver), this is not much of a help when you consider that your transmitter is moving about the acting area. With this movement, the signal is being received at varying strengths by the receiver. During a period of weak reception from the wireless transmitter the interfering signal could be received by the wireless receiver. If the interference is 2 microvolts or less on the RF meter of the receiver, try moving the receiver a few feet. This could make all the difference in the world. The idea is to find a location that causes the receiver not to receive the interference. You might also

(continued on page 60)

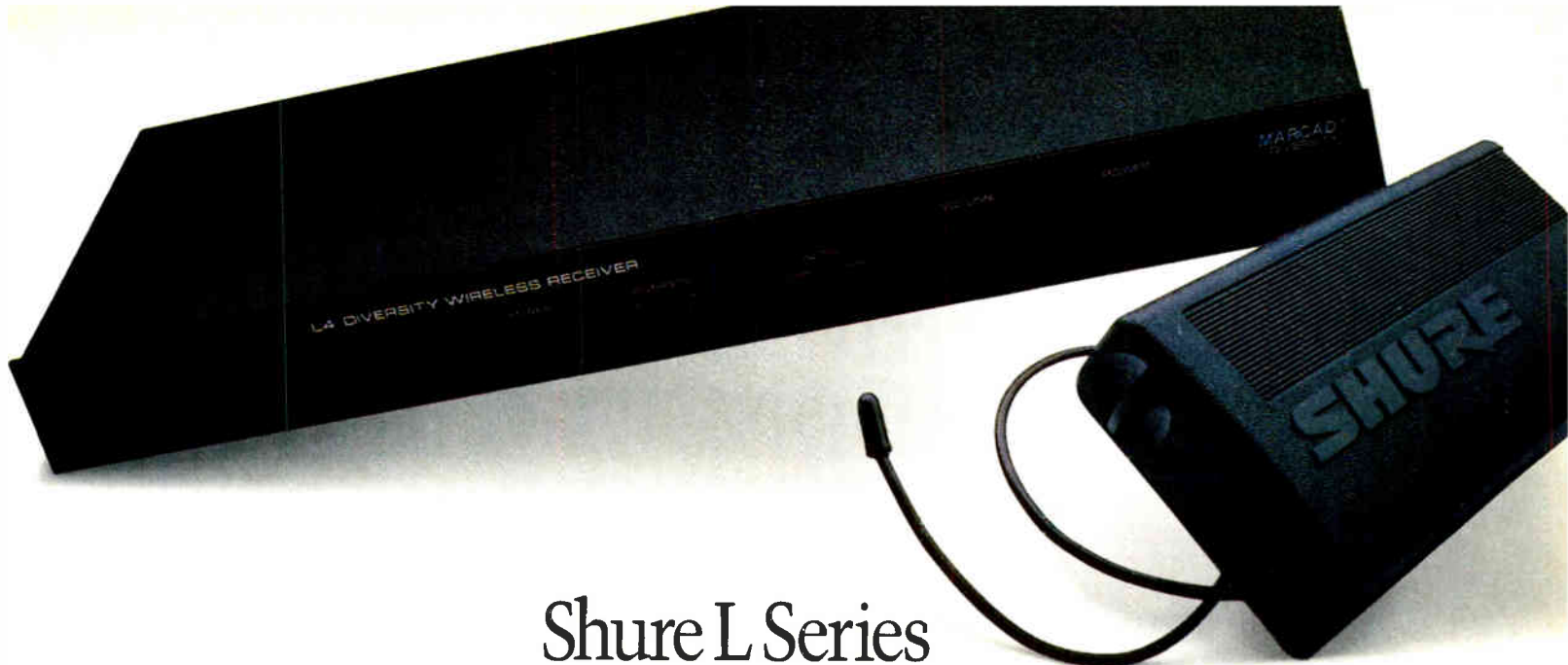

Shure L Series brings reliability to affordable wireless.

Why take chances with anything else?

If you're providing wireless microphone systems to churches, schools, or other value-conscious users, you need reliable equipment you can sell at an affordable price—and make a profit doing it.

That's what the L Series from Shure is all about. The L Series sets a new standard of value in its price range, offering features, performance and reliability other "economy" systems can't match.

We didn't forget the details.

Designed and built by Shure in the U.S.A., L Series systems include many of the features that set professional-quality wireless systems apart from the "toys." L Series receivers are sturdy, metal-cased, and rack-mountable. Antennas are detachable and may be placed in remote locations, providing excellent performance in situations where many other wireless systems have trouble.

Our L1 Body-Pack Transmitter has features like a separate audio mute switch and a universal 4-pin "Tiny QG" connector that accepts a variety of microphone and other inputs. And L Series lavalier systems come with the 839W, a reliable Shure condenser lavalier microphone designed for clear, natural vocal pickup. The L2 Handheld Transmitters, available with interchangeable

SM58, SM96, and Beta 58 capsules, offer durability, compact size, light weight, and provide the same distinctive sound as their wired counterparts.

Performance meets economy.

Even though L Series components are economically priced, they incorporate sophisticated RF technology. The L4 Diversity Receiver utilizes "intelligent" MARCAD™ circuitry to monitor signals from its two independent RF sections, blending them in the optimum proportion—not merely switching them. The result is reliable, uninterrupted audio with no clicks, no pops. And all L Series systems feature Shure "Mirror Image" companding, plus high-gain, low-noise MOSFETs, a high-fidelity quadrature detector, and a 3-pole Chebyshev audio low-pass filter. It all adds up to outstanding audio quality with exceptional freedom from noise and distortion.

Why risk callbacks with anything else?

Other systems may not meet expectations. But you can recommend a Shure L Series system with confidence. So why risk callbacks—and your reputation—with anything else?

For more information about the Shure L Series, call Shure Customer Services at 1-708-866-2553. The Sound of the Professionals®...Worldwide.

THE SHURE™ WIRELESS
L SERIES

Circle 207 on Reader Response Card

ACOUSTICAL ROOM SIMULATION, PART ONE

By Steven J. Orfield and Richard G. Pierson

There have always been two different views regarding the evaluation of “acoustic quality,” whether this evaluation refers to an electro-acoustic signal or to a room. On the one hand, the listener can evaluate “quality” subjectively but often quite accurately via simply listening. On the other hand, many more formal evaluation techniques have been attempted or employed.

Since the 1950s, interest has been growing steadily in the field of psychoacoustics, particularly as it applies to room response. This interest of the architectural acoustics community was clear and eloquent in the Beranek study, “Music, Acoustics and Architecture,” in the noted Cremer & Muller work, “Principals and Applications of Room Acoustics,” as well as in a number of other studies of approximately the same time period. While the listener’s response to a room has been an ongoing interest for a much longer period, the 1950s suggested an increased interest in experimental validation of the causes of psychoacoustic “room quality.”

While the last 30 to 40 years have shown an increasing interest in room performance among the acoustical community, the last 10 to 15 years have established a period of broader interest in both the acoustical

and audio communities. This is due in part to the clarification of basic research in the area and in part to the development of inexpensive, portable acoustical test instrumentation with which to document many performance claims. Testing metrics and data directly or indirectly convertible to psychoacoustic information has recently become more and more a part of the professional design and verification process.

While the 1980s was clearly a time to begin to quantify and test for “psychoacoustic quality,” the 1990s will certainly be the most fertile period in acoustic history for the simulation and recreation of acoustical signals and thereafter to simulation of room performance. This simulation process, here referred to as “Acoustical Room Simulation” (ARS) is of interest to the design community for a number of reasons. First, if electronics could partially or fully substitute for physical architectural

acoustics, many new facilities could be designed as “multi-purpose rooms” in the broadest sense of that descriptor. Second, if room simulation were possible, acoustical simulation rooms which allow the investigation of physical acoustics via listening experiments (programming an as yet unbuilt room into an accurate audio demonstration) could greatly influence how the “client” makes decisions regarding acoustical performance. Thus, whether one is an architectural acoustic “purist” insisting on no electronic reinforcement of spaces or one is open to electronic solutions of high quality, there are clear advantages to the concept of Acoustical Simulation Rooms (ASR).

Part I of this series of articles will provide a look at the theory and application of ASR rooms along with a look at a potential design of such a room. Future parts will describe the actual implementation and performance of a system assembled to

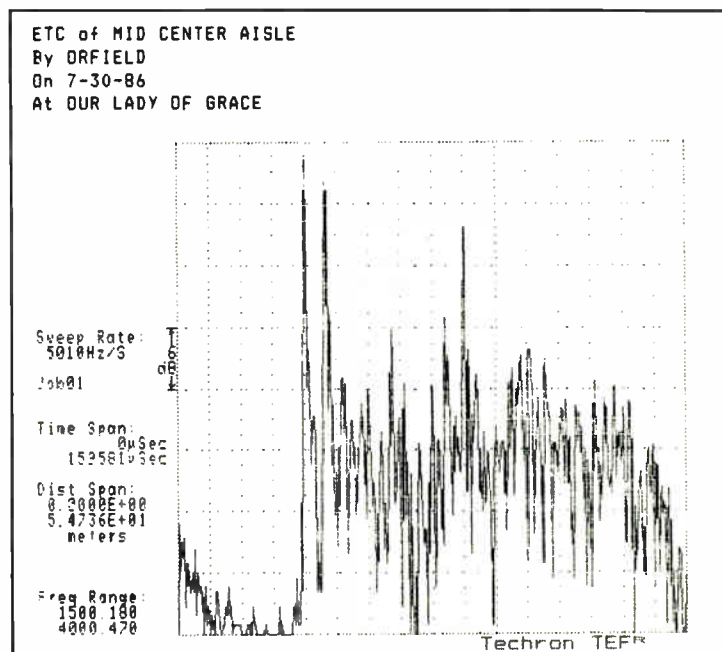
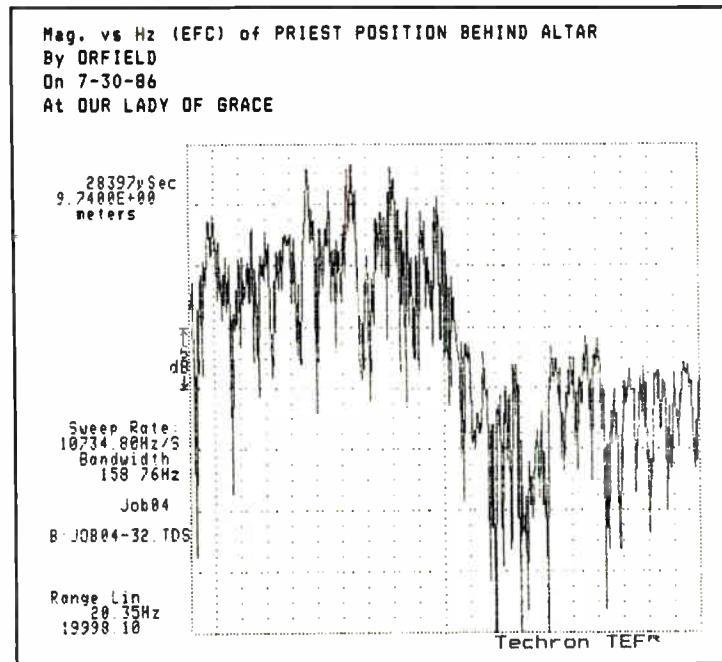

Figure one. TEF Energy Time Curve.

Figure two. TEF Energy Frequency Curve.



provide room simulation. Underlying this work is a cooperative research effort underwritten jointly by Yamaha Professional Audio and Orfield Associates for the purpose of developing a practical view and application of audio simulation.

BINAURAL LISTENING & ROOM RESPONSE

Over the past two months, Sound & Communications has published a two-part series on the theory and application of the binaural recording process. This process is of interest due to the basic fact that there are numerous cues provided to the live listener via the aural system and the physical ear structure. In addition, any room provides different cues to each ear, as the listener is generally not at a symmetrical midpoint of any axis of the listening room. As a result, binaural sound recording attempts to recreate the physical reflection pattern at each ear in order to provide natural shifts in frequency response, amplitude and time arrival. The ideal result of binaural recording will be a highly accurate reproduction of the live performance as heard at the binaural torso position (mic position).

While the binaural series of articles began to look at the characterization of the receiver of sound (the listener), the current series is more interested in the source-path-receiver description, as this entire process is what ARS must attempt to model.

ROOM ACOUSTICS

The acoustical benefits of rooms has been debated for years, and resolution to many of these questions is quite recent. From Beranek's determination of the benefit of the "Early Time Delay Gap" (the period between direct sound and the first reflections) to the work of many acousticians in the consideration of lateralization of sound (the power, time and frequency differences in sound arriving at the two ears of a listener), there has been increasing clarity in the definitions of what is a desirable set of room characteristics. (Cremer, in chapter III.1 of his "Principals and Applications of Room Acoustics,"

notes recommendations for reverberation time, a "clarity index," background noise levels, a "late to early sound arrival index," along with many other suggestions. Beranek, in "Music Acoustics and Architecture" (unfortunately out of print) includes an entire table of recommended values for room performance.

BASIS IN MEASUREMENT

In looking for a paradigm for both measurement and existing data, the Time Delay Spectrometry (TDS) measurement process has established the broadest data base so far in time-base measurements known as Energy-Time-Curves (ETC). These graphs represent a "time window" snapshot of sound. The ETC graphs can be viewed as amplitude versus time plots. They can also be viewed as frequency response information over a predefined "time window" via use of an alternative data display referred to as an Energy-Frequency-Curve (EFC).

Figure Three.

Room Simulation Variables

- Source position
- Source condition (live or reinforced)
- Source binaural time delays
- Room surface reflections
- Surface frequency response (NRC, etc.)
- Phase shift at reflections points
- Background noise level
- Reverberation time

While software has not yet been introduced which will provide lateral or vertical directional (polar) information from single position measurements, this is close on the horizon and will allow for verification of actual live-versus-ASR comparisons. An alternative program which calculates psychoacoustic metrics, has been available from Norwegian Electronics for a number of years for use on their dual channel analyzer.

PROBLEMS AND VERIFICATION OF ROOM RESPONSE SIMULATION

As one begins to consider the simulation of a particular room, many variables become quickly apparent. Some of these are noted in Figure 3.

In addition to these variables, judgments must eventually be made in order to establish what constitutes a significant difference with reference to each variable. Finally, one must establish the "resolution" of the reproduction process which attempts to provide a simulational benefit. Once this initial information (or hypothesis) is determined, verification procedures must be developed in order to establish reasonable comparative performance.

INITIAL MODEL DEVELOPMENT

For selection of a hypothetical model, Orfield Associates began by considering the limiting factors of the actual assembly of the room in question. The first clear limit, if this was to be a useful tool to the serious acoustic or audio professional, was budget. As an initial budget ceiling, it was

**Figure Four.
ASR Limiting Variables**

- Budget
- Room size
- Room treatments
- Installation difficulties
- Control and operation strategies
- Visual cue potential
- Number and location of sources

decided that an expenditure of \$25,000 for audio componentry, along with the use of only inexpensive acoustic treatments, would be the rule. These limiting variables were identified as shown in Figure 4.

Additionally, it was assumed that this system should be amenable to computer control, and MIDI interface was determined to be the most practical embodiment.

Since there was a clear geometric limit which assumed that sound "zones" must fall in both the horizontal and vertical planes (and be symmetrically placed), it was decided that our initial model would be based on the 16 zones. (See Figure 5.)

These zones were selected to allow reproduction of the horizontal and upper vertical sound planes for a moderate sized group of people arranged in a rectangular configuration. Because the normal presence of an audience typically minimizes contribution from the lower vertical sound plane, and also due to practicality considerations, no zones are included for reproducing this sound plane (in-floor speaker positions). It should also be noted that due to the proximity and relative location of the source, improper psychoacoustic cues will result at ASR room boundaries and corners (due to loudspeaker coverage patterns).

ASR OPERATION

In order to simulate the psychoacoustic behavior of a wide variety of spaces, each of the 16 zones was designed to be discrete and unique. Each zone is able to provide a distinct initial time delay gap, early reflections, equalization, reverberation and relative sound level. In order to achieve this, each of the 16 zones is comprised of a multi-effects processor, providing control over delay, early reflections and system gain (Yamaha SPX1000) and an equalizer (Yamaha DEQ7). An amplifier (Yamaha P2160) and compact full range loudspeaker (Yamaha NS10MC) are also included for each zone. Figure 6 is a concept diagram showing interconnection of the system components.

The advancements made in digitally programmable audio equipment in recent years greatly simplifies the task of pro-

gramming and operating an ARS system. The Musical Instrument Digital Interface (MIDI), provided on most recent high quality effect and equalization units, simplifies the task of programming and changing programs at the effect and equalization units for each zone. MIDI provides a readily available means of programming each component, plus it allows for storage of each zone program setting for later simultaneous recall.

In order to allow for a wide range of acoustical environment simulation, a neutral acoustical environment is essential for an acoustical simulation room. This would include a low reverberation time as well as a relatively flat frequency response with no room resonances. A very low background noise level is also a critical requirement. These are all being incorporated into the ASR project.

ASR APPLICATIONS

ASR technology can be used either in support of live or recorded performances or it can be used for acoustical demonstrations. Performance applications for ASR technology include multi-purpose auditor-

iums, concert halls, recording studios, churches, convention centers, meeting rooms, theaters, cinemas and even home entertainment systems. Acoustical room simulation has been used in cinema for a number of years in the form of Surround Sound and surround sound systems are also currently available for home entertainment systems. On a large scale, an ASR could be used for a rock concert one night, a convention the next, an opera on a following night, a large mass the next day, etc. Such capabilities could ensure a facility consistent booking by providing a wide potential client base.

Such a room would also have applications in the recording industry. This would be used both as a special effect and also for motivation of musicians by providing the psychoacoustic cues to give them "the feeling of the hall" which is normally absent in the studio. As an effect, the simulation of lateral and vertical effects provided by an ASR should provide a more three-dimensional feel than possible with the common practice of adding effects in the mixdown process of stereo recordings.

In the field of acoustics, a room which could simulate a wide variety of acoustical events and phenomena would be a great asset in the design process. Such a room would aid the design team and client by allowing demonstrations of various acoustical parameters such as background noise, reverberation and reflections to help them better understand the impact of the design and related criteria. An ASR room could also be useful in legal cases concerning aircraft noise, factory noise, highway noise by allowing simulation of the actual event to a jury under controlled conditions.

A space which can provide the ideal acoustical ambience for a wide variety of events has been sought after for some time. Early attempts to achieve this utilized schemes to physically alter the volume or amount of acoustical absorption of a room with operable partitions and variable acoustic panels. Some variable acoustic panels allow a choice of absorptive, hard reflecting and diffusive reflecting surfaces. Rooms which utilize electronic means of providing enhancement to the acoustical

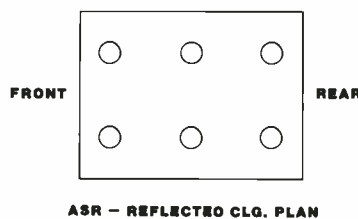
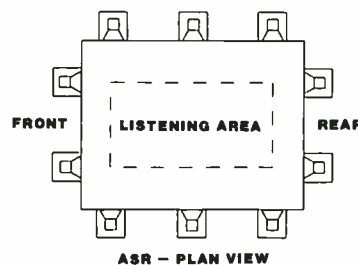

ASR - REFLECTED CLG. PLAN

Figure five. Diagram of OA Simulation Room.

environment of a room date back to the early sixties and include the 6000 seat Congress Hall of Moscow. Yamaha Corporation in Japan has developed and installed several elaborate electronic systems for sound field control called the Assisted Acoustic System. (More about this in a later article.)

ASR SIMULATOR BENEFITS

The benefits of ARS technology include increased retention of information presented within the room by providing highly intelligible sound, as required, along with the aural cues necessary to focus a listener's attention on a speaker via source localization. ARS technology also can enhance a service or presentation by providing the optimum acoustical ambience and also by providing the proper cues to give a musical performance a high degree of blend and ensemble. An ASR would also allow the sound field to be readily changeable to provide the optimum room response for various selections or sections of a musical performance.

Finally, the acoustical consulting and the audio engineering community have long

been in the position of recommending very expensive applications via extensive and complex reports; often based on theory and conjecture. An ASR would allow simulation and subjective analysis of the impact of these recommendations and could minimize costs by determination of which recommendations provide a truly significant benefit.

SUMMARY

Acoustic room simulation (ARS) will provide the acoustic and audio practitioner with a powerful new tool which will bring him far closer technically to his client. Instead of describing in technical terms what a newly designed church, concert hall or sound system should technically accomplish, the consultant will shortly be able

USEFUL READING

AES, "Time Delay Spectrometry," an anthology of the works of Richard C. Heyser on measurement, analysis and perception, 1988.

Bradely, J. S., "Auditorium Acoustic Measure from Pistol Shots," Journal of the Acoustical Society of America, July 1986.

Beranek, Leo, "Music, Acoustics and Architecture," John Wiley & Sons, Inc., 1962.

Cremer, Lotha and Muller, Helmut, "Principals and Applications of Room Acoustics," Applied Science Publishers, 1978.

Jordan, Vilhem Lassen, "Acoustical Design of Concert Halls and Theaters," Applied Sciences Publishers, 1980.

Orfield, S. J., "Psychoacoustics and Performance Sound, Part I: Theory," Sound & Communications, December 1987.

Orfield, S. J., "Psychoacoustics and Performance Sound, Part II: Measurement," Sound & Communications, January, 1988.

Orfield, S. J., "Binaural Audio, Part I: Theory, Benefits and Applications," Sound & Communications, Sept., 1990.

Orfield, S. J., "Binaural Audio, Part II: Recording System Development Applications," Sound & Communications, Oct., 1990.

The shape of pure sound...

Community's design philosophy has always been a little unconventional.

When everyone else was insisting on metal, we promoted the precise shapes achievable through fiberglass. When others built walls of direct radiators, we built efficiency. When most of professional sound was divided at 800 Hz, we concentrated on midrange.

For those prepared to listen, the rewards of good design are clear.

In the RS220 Wavefront Coherent™ Loudspeaker system we have created the true culmination of Community design—precise fiberglass curves flowing into matched components—a system designed for effortless performance with maximum efficiency, power and clarity.

Community's RS220
The shape of pure sound...

Community
PROFESSIONAL SOUND SYSTEMS

333 East Fifth Street
Chester, PA 19013
(215) 876-3400
FAX (215) 874-0190

Circle 252 on Reader Response Card

to demonstrate the intent of the design by allowing the client to listen to the result. Such questions as "Is this room shape as important as the architectural design issues?" or "Will the last \$100,000 spent provide significant benefit?" will suddenly be resolvable by a client decision based not on faith but on professional practice. Conversely, the consultant who does involve himself fully in the problem may well be embarrassed by the resulting demonstration. This simulation practice will certainly be applauded by many in the consulting community and be opposed by others; it may also draw legitimate distinctions between professionals and, in a more common parlance, "separate the men from the boys." As a result, "accuracy" may begin to enter the standard language of the acoustical professional. ■

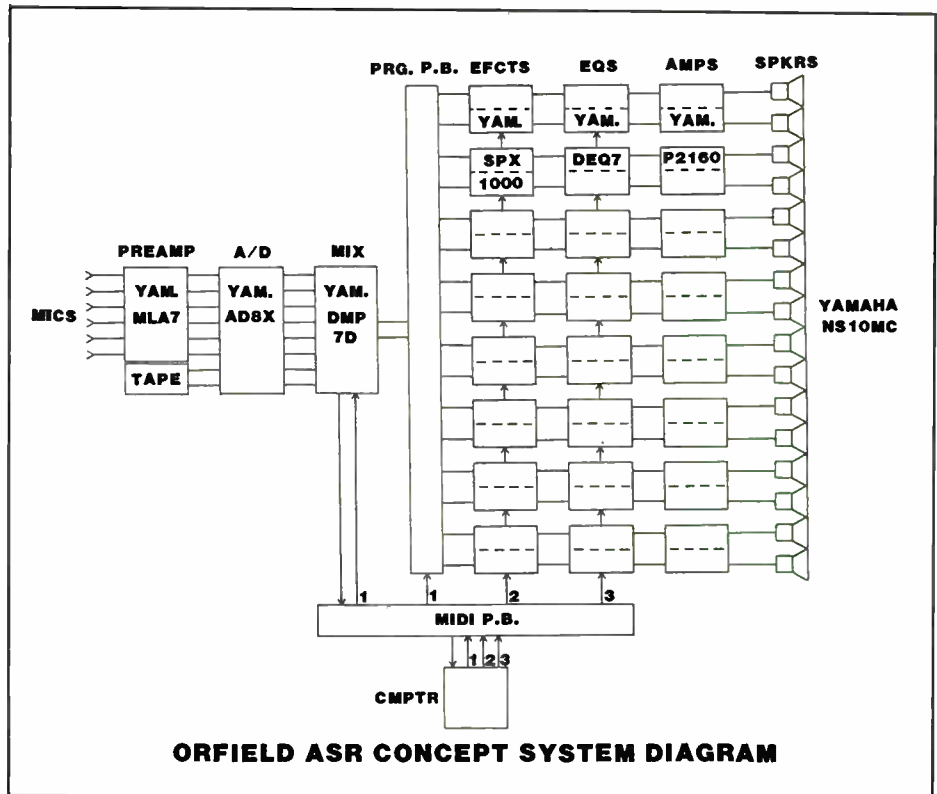

Figure six. OA ASR Concept System Diagram.

"...WITH SOUNDSPHERES... EMPLOYEES ARE PLEASED THAT THEY CAN ACTUALLY HEAR THEIR PAGES."

For a warehouse (high, open ceiling) type set-up, these speakers are ideal and with an acoustical ceiling, the sound is even better.

Michael Marusevich/Director of Field Operations. Pergament Home Centers, Inc.

Matt Maloney/Telecommunications Manager writes:

About two years ago, Pergament was seeking ways to improve the clarity and coverage of the sound systems in our stores. At that time, the Spring Valley N.Y. Pergament store was under construction. Our NY MUZAK representative, Bob Lauro, proposed using Soundspheres there, and guaranteed in writing to replace them with twice as many wall baffle speakers if we were not satisfied.

At that installation and at each new store since, Soundspheres have provided Pergament with significantly improved sound quality, improved dispersion of sound around high and heavily stocked store fixtures, and quicker system installation than with conventional speakers as less Soundspheres are needed.

We never did consider taking MUZAK up on their replacement guarantee.

Write or call direct for further information.

SOUNDSPHERE A PRODUCT OF
SONIC SYSTEMS, INC.
 737 Canal Street • Bldg 23B • Stamford, CT 06902 • USA • Tel (203) 356-1136



Circle 255 on Reader Response Card

SOUND COMMUNICATIONS

1990

SUPPLIERS' SURVEY AND ECONOMIC REPORT

- ▶ INTERCOM
- ▶ TESTING
- ▶ A-V
- ▶ WIRE
- ▶ AUDIO
- ▶ SECURITY
- ▶ MISCELLANEOUS

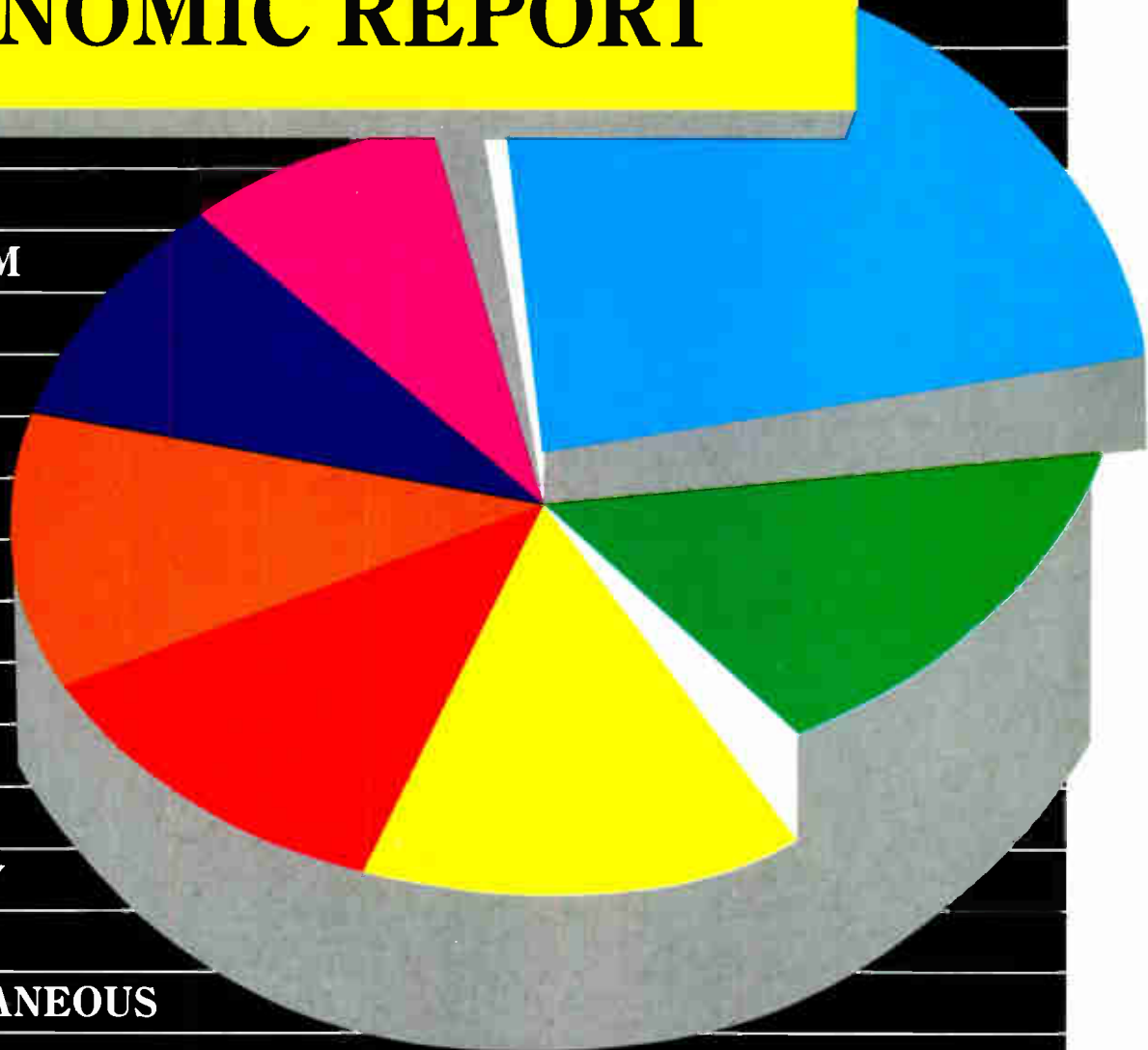

1990

SUPPLIERS' SURVEY AND ECONOMIC REPORT

BY JUDITH MORRISON

Attitude toward industry as a whole

		1990
Very Positive	▶	8.5%
Positive	▶	43.7
Neutral	▶	38.0
Negative	▶	9.9
Very Negative	▶	0

Not to be negative — but look for less technical innovation and more emphasis on the low end in 1991.

On the positive side though, your suppliers are generally optimistic about their own businesses and are feeling far more friendly toward contractors — even though they are increasingly slow payers.

What else is happening? Read on. This is the annual survey of manufacturers sponsored by SOUND & COMMUNICATIONS magazine each end-of-the-year to lend perspective to the business and to research the suppliers' attitudes, perceptions and plans.

And do they have an attitude? We'll say.

Our survey is based on a 24-part questionnaire sent to virtually all suppliers to the contracting business. Respondents anonymously returned the form to Survey Analysis of Palm Beach Gardens, Florida who tabulated and provided us with the numerical results upon which this report is based.

As for attitudes: the love affair with contractors is on again, you'll be happy to know. Between 1986 and 1989, our survey showed a consistent decrease in the percentage of sales made through dealer/contractors. This year, for the first time, there has been an *increase* — from 55 percent to 61 percent. The losses came from distributors and end-users. Of those suppliers reporting an increase in sales through contractors, and who filled out our write-in question asking why, the most common explanation was an "increase" or "restructuring" of marketing efforts. One manufacturer cited a "new representative network."

Sound & Communications

Industry Trend

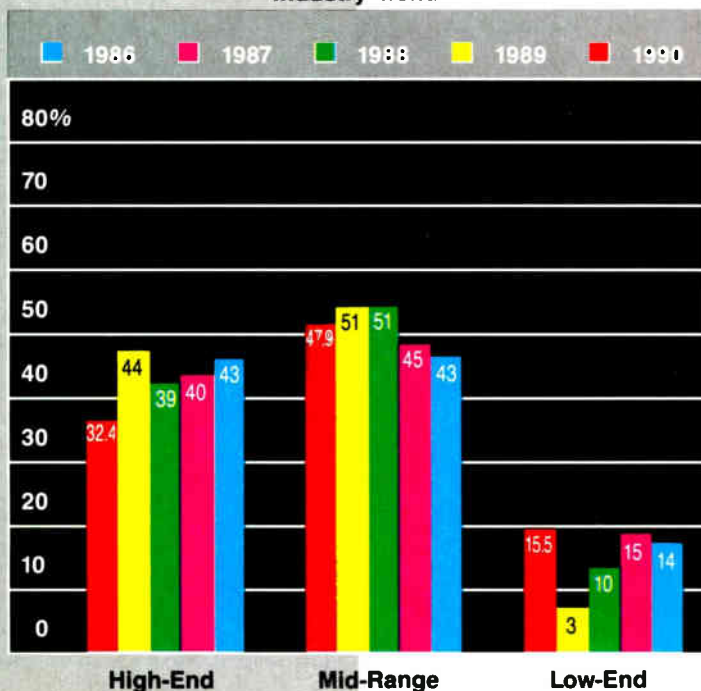

Perceived Customer Criteria (most important)

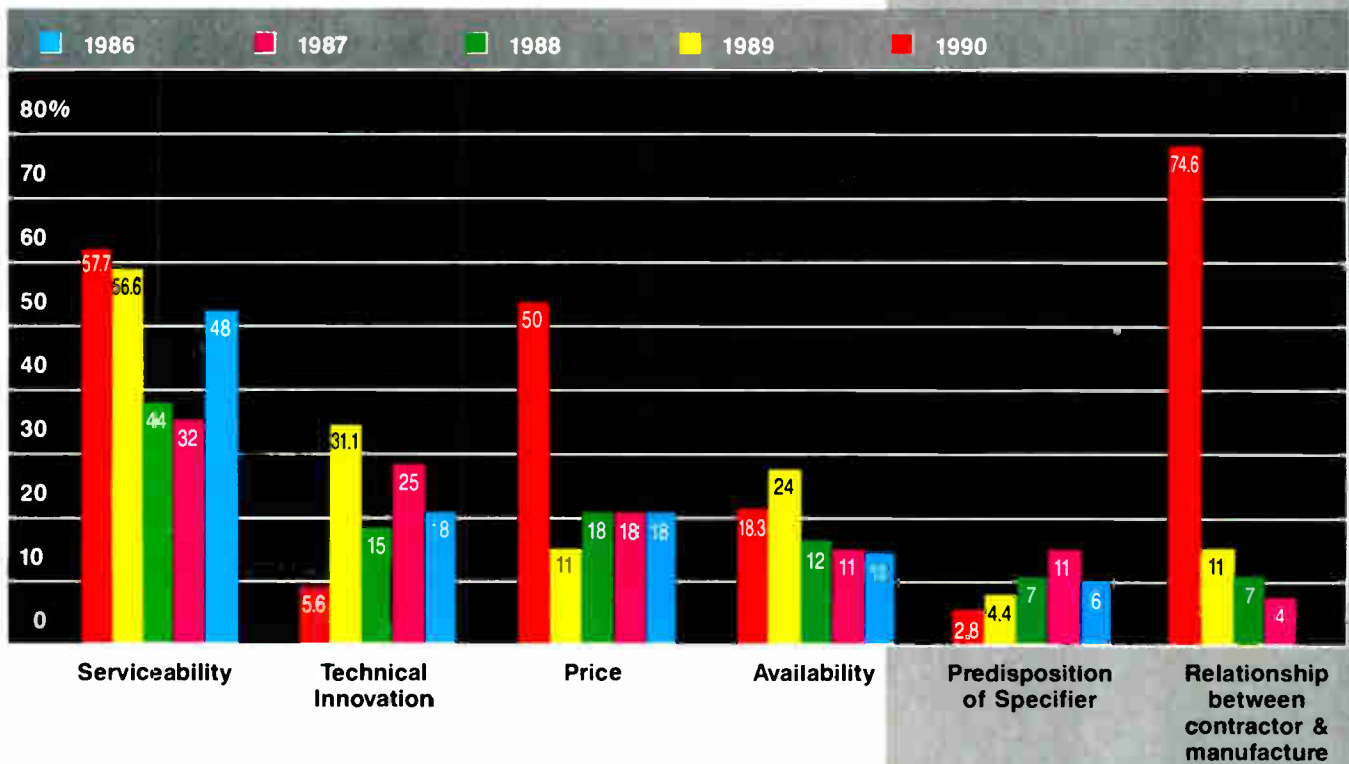

What is the proportion of companies using independent reps? 74.6 percent of our respondents have a rep network (larger companies are more likely to). And how good is that relationship? Comme-ci comme-ca. Over a third of our respondents are "not pleased" with their reps performance (a far larger proportion of smaller companies are unhappy than are larger companies). But nearly half of the companies are pleased with their reps. And 13.2 percent are "very pleased." We can surmise that larger companies doing larger volume find it easier to engage the services of the best reps. But there's grumbling down the line, folks.

We asked the industry in what direction they saw buying trends going. Almost half of the questionnaires came back with "midrange" checked off. A third saw things moving toward the high end, and over 15 percent saw the low end moving. While that's a neutral sort of spread by itself, in context with previous surveys, we see a decrease in both the high end and midrange (for 1989 those figures were 44 percent and 51 percent respectively) and a large increase in the low end (from 3 percent last year, following a three-year-old downward trend).

Whatever the product, we wanted to know what the supplier thinks is the motivating factor in a purchase. (That

Sound & Communications

Expectations Unit Sales		
	1989	1990
Increase in unit sales	93.3%	81.7%
Decrease	4.4	2.8
Same	0	14.1

Percentage of Sales Through Various Outlets

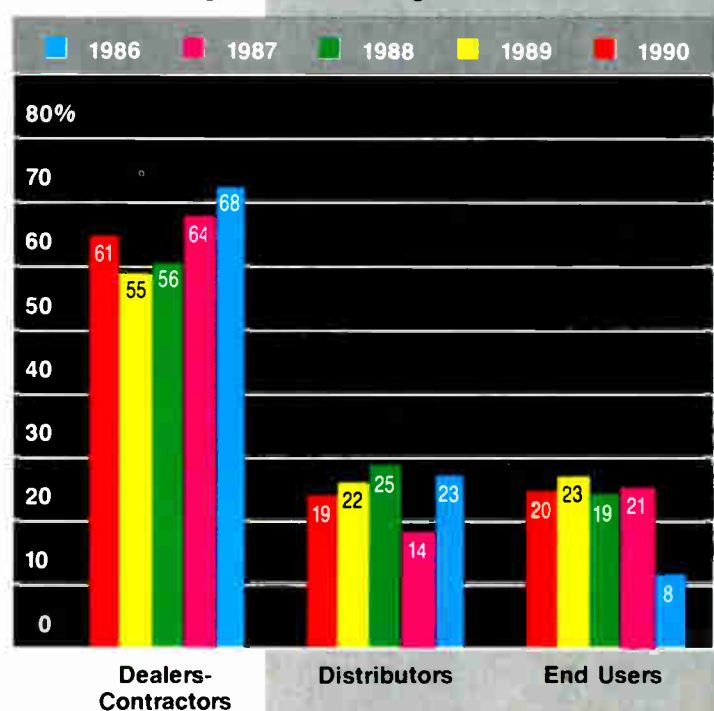

Expanding Sources for Company Business
(In descending order)

▶	Worship Houses
▶	Schools
▶	Boardrooms
▶	Concert Halls
▶	Factories and Office Building
▶	Hospitals

Look for less technical innovation and more emphasis on the low end in 1990.

doesn't necessarily mean it is, but that the manufacturer thinks it is.) Once again, we saw some changes in thinking this year. Far more suppliers thought that price and the relationship between the contractor and manufacturer were the most important criteria. Far fewer thought that technical innovation was crucial. A paltry 2.8 percent thought the predisposition of the specifier was most important.

Fewer people thought availability was crucial than thought so last year; more people thought serviceability and reliability were most important. No one at all thought this last classification was unimportant. Conversely, almost half the companies thought that technical innovation was less than important (with over a third reporting that as the "least important" criterion).

No matter what they see as criteria for purchases, most suppliers are relatively positive about their companies' health (although that doesn't necessarily agree with their predictions for the industry). Over three-quarters of the respondents were positive or very positive toward sales for their company in 1991. Another 17 percent were neutral, and only 5.6 percent were negative. This was approximately stable for both big companies and small. However, for the industry as a whole, only a little over half felt positively, with well

Priorities in the Coming Year (most important)

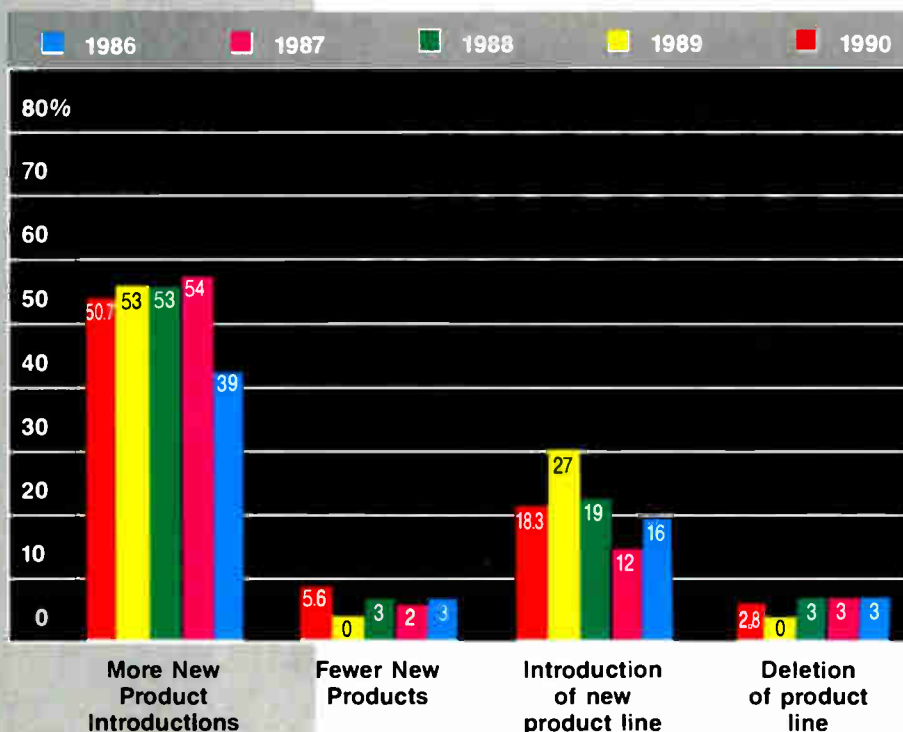

Attitude Towards Future Sales

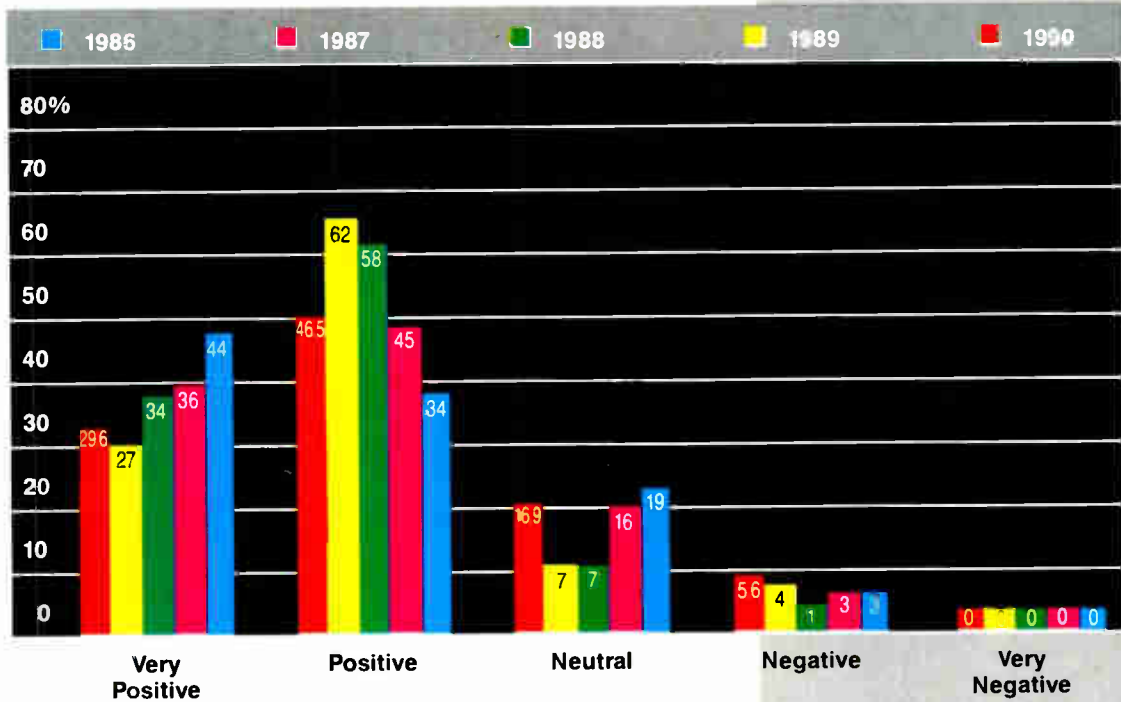

over a third feeling neutral. And 9.9 percent felt negatively. The good news is that positive aspects still ruled the results, and no one again, for the fifth year in a row felt very negative about their own sales (or about the industry). As a matter of fact, those answering "very positive" for their companies increased from last year. We suspect part of the disparity in answers has to do with the feelings one has toward one's business. We can do it, we can do it, the salesman says. Along with the optimistic predictions goes the fact that 81.7 percent of our respondents expect unit sales to increase in the next year. Only 2.8 percent expect a decrease, and 14.1 percent expect things to remain the same.

Along with this relatively positive attitude beware of some danger signals. Almost half of our respondents tell us it's getting longer for them to get paid. Forty-three percent say it's taking the same amount of time. And only 1.4 percent say it's taking less time. While one can't necessarily expect quicker payment, slower payment is a signal — along with the fact that over 90 percent report higher costs of doing business (only 8.5 percent say it's the same as last year), and nearly a third report having refused credit to more

How much money do these companies make, anyway?

Perceived Customer Criteria (Least Important)		
	1989	1990
Serviceability	0%	0%
Price	6.7	5.6
Technical Innovation	6.7	33.8
Availability	2.2	14.1
Predisposition of Specifier	15.6	32.4
Relationship between contractor & manufacturer	13.3	0

Priorities in the Coming Year (Least Important)			
		1989	1990
Fewer New Product Introductions	▶	33.3%	33.8%
Introduction of another product line	▶	15.6	14.1
Deletion of product line	▶	53.3	32.4
More new product Introductions	▶	4.4	5.6

**Your suppliers
are generally
optimistic
about
their own
businesses.**

customers this year (versus only 5.6 percent saying they've refused fewer customers). However, 62 percent say the rate of refusal remains the same.

How important are you? Pretty important. Each classification of "contractor" on our survey (contractor/management; contractor/installer; contractor/engineer) garnered over a fifth of the votes for "important in making the buying decision." The consultant and the end-user each gathered a quarter of the votes. And nearly half of those surveyed plan to spend more time with consultants.

Manufacturers either thought 1989 was an unusually aggressive year, or their energy is weakening. Fewer of them plan to be more aggressive next year than reported those plans last year (but over half of them still plan to be more aggressive, and nearly 40 percent plan to be as aggressive — up from last year.

We asked for a write-in explanation of these plans. Of those saying they planned to be more aggressive, these are some of the reasons given:

- "It's a jungle out there."
- "More aggressive — because I see other vendors pulling back."
- "With the current economic situation and people taking 60—120 days to pay bills, we are going to go aggressively after *other* markets."

Suppliers' Advice to Contractors

- ▶ "Sell! Don't wait for bids."
- ▶ "Know the product."
- ▶ "Establish a contractor certification program."
- ▶ "Watch the recession, pay your bills, don't do jobs for zero profit."
- ▶ "Avoid pricing contests. Increase contact with the end user and decision maker."
- ▶ "Watch your cash flow."
- ▶ "Pay on time."
- ▶ "Don't stick to tradition. Keep informed on new products and innovations."
- ▶ "Watch your margins."
- ▶ "Get advance deposits on jobs. Turn down low ball offers."
- ▶ "Be careful on payments, place more customers on C.O.D. or C.I.A."

- "We need to capture more share of the market."
- "It's a case of either making it this year or considering going out of business."
- "Gotta push in tougher times."
- "It's a great time to pick up market share."

New product introductions apparently play a part in this aggression, with over half those surveyed thinking new product introductions have the highest priority and another third finding product intros only slightly less important.

Almost half of our respondents tell us it's getting longer for them to get paid.

Comparing this year's survey to last year's, we find more people considering "fewer new products" as their highest priority (last year nobody considered that the highest priority). And less than a fifth (27 percent last year) consider introduction of a new line as the highest priority. The market seems to be taking a breather.

A little under a third of our respondents expect to make changes in their distribution pattern (but 70 percent plan none). What kind of changes? Of those who answered this write-in question, some of the answers included: "European"; "use more sound contractors"; and "rep changes." More of the larger companies reported no plans to change than did the smaller companies.

Selling Posture in Coming Year

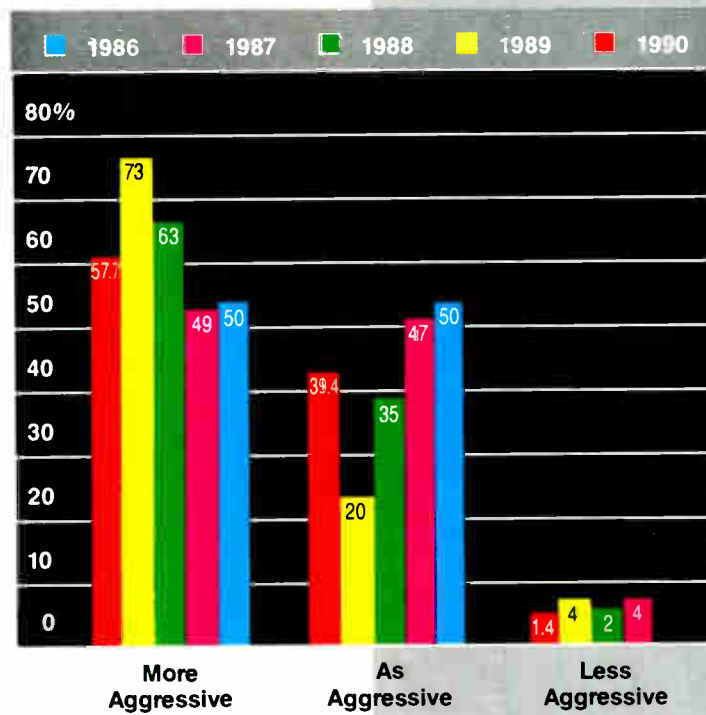

Contractors Doing an Unusually Good Job

- ▶ Long Communications
- ▶ Maryland Sound
- ▶ Peerson Audio
- ▶ Leo's Audio
- ▶ Davis Audio
- ▶ Electrical Systems
- ▶ American Sound
- ▶ Florida Sound Engineering
- ▶ Cardinal Sound and Communications
- ▶ D. Roescia Communications
- ▶ Harris/Allied
- ▶ Functional Communications
- ▶ Lifesong Audio
- ▶ Baker Audio
- ▶ Web Communications
- ▶ Roehm Radio and Sound
- ▶ Scenero Sound

New Markets and Applications

- ▶ Paging
- ▶ Audio-Video Teleconferencing
- ▶ Office Products, Consumer Electronics
- ▶ Telecommunications
- ▶ Digital Signal Processing
- ▶ Powered Mixers
- ▶ Surveillance/Security
- ▶ Control Systems
- ▶ Sound Absorption
- ▶ Fiber Optics
- ▶ Microprocessor Controlled Systems
- ▶ Wireless Systems
- ▶ Wireless Data Entry
- ▶ Miniaturization of Loudspeaker Systems
- ▶ Test Equipment
- ▶ Hearing Assistance
- ▶ Sounding Devices for Life Safety
- ▶ PC Mount Connector
- ▶ Sound Reinforcement — Residential
- ▶ Boardrooms; Video Presentations
- ▶ Architectural Acoustics
- ▶ LANs
- ▶ Foreground
- ▶ Broadcast

What segments of the market are perceived as expanding, and which ones as contracting? All the segments we asked about received both positive and negative votes. The net was that worship houses received a positive net of 39.4 percent (53.5 percent said it's expanding; 14.1 percent said it's contracting). Larger companies were far more apt to see this as an expanding market. Other segments with positive nets included schools, boardrooms, concert halls, factories and hospitals. Residential was a wash, with as many people seeing it as expanding as saw it contracting.

**Nearly half
of those
surveyed
plan to spend
more time
with
consultants.**

How much money do these companies make, anyway? Ten percent of them had gross revenues of over \$6,000,000 last year, with nearly a quarter of them reporting between \$2 million and \$4 million. The mean was \$6 million, although 8 percent grossed under a million dollars.

We asked on a write-in question for names of contractors who are doing an unusually good job. Most of our respondents chose not to answer that question. Of those who did, their list appears elsewhere in these pages. The companies racking up the most votes were Long Communications and Maryland Sound.

More respondents were prone to give advice to contractors. Among the comments was:

“Watch the recession, pay your bills, don't do a job for zero profit.”

Not bad advice for any of us.

"It's an exhibition which, if I didn't come, I would miss it. I did one year, one year out of 15 I didn't come, and I missed it terribly and I was about a year behind on the information. So we're here every year."

— Bob Jackson
Media Tech

INFOCOMM™

INTERNATIONAL

February 12-17, 1991
(Exhibit Dates: February 14-16)
Orange County Convention Center
Orlando, Florida

For more information call or write:
INFOCOMM/ICIA'91
3150 Spring Street, Fairfax, VA 22031
Phone: (703) 273-7200
Fax: (703) 278-8082

A & S Teleconferencing • Acme-Lite Mfg. Co. Inc. • Advance Products Co. • Agency for Instructional Tech. • AIMS Media • Alpha Audio • Ambrose Video Publishing • American Video Communications • **AMIGA-COMM** • **AMI Gold Tour Premiere** • AMPEX Corp. • Ampro Corp. • AMX Corp. • Anchor Audio Inc. • Anthro Co. • Anvil Cases Unit of Zero • Aphex Systems, Inc. • Apogee Sound, Inc. • Apollo Audio Visual • Arion Corp. • Atlas Specialty Lighting • **Audio Seminars** • Audio Services Corp./Topham Audio Inc. • Audiotronics Corp. • Audiscan Products Co. • Auto-Graphics, Inc. • Auton Company • Avant Inc. • AVAS Corp. • Avcom Systems Inc. • AVL • Banner American Products Inc • Barco Electronics Inc. • Bergen Expo Systems Inc. • BRAHLER • Bretford Manufacturing Inc. • Buhl Industries Inc. • Bulbman Inc. • Bullfrog Films, Inc. • Califone International Inc. • Canare Cable & Connectors, Inc. • Canopy Road Software • Carpel Video, Inc. • CBM Metal Products • CEL Electronics • Chief Manufacturing Inc. • Chip Taylor Communications • Chisholm • Christy's Editorial Film Supply • Churchill Films • **Cindy Awards Banquet** • ClearLight/Cornerstone • CNA Insurance Co. • **Communications Achievement Awards** • Communications Group, Inc. • Comprehensive Video Supply • **Computer Seminars** • Coronet/MTI Film & Video • Covid Inc. • Crestron Electronics Inc. • Crystal Video Corp. • Curriculum Product News • Da-Lite Screen Co. Inc. • Daniels Publishing Group, Inc. • Davis & Sanford Co. Inc. • Daylab-Pfaff Products • Display Products Inc. • Draper Shade & Screen Co. • Dukane Corp. • Dymaxion Research Ltd. • Eastman Kodak Company • ECHOLab Inc. • ECOVISION USA, Inc. • Egan Visual • ELKI International, Inc. • Electrohome Limited • Electrosonic Systems Inc. • Elmo Mfg. Corp. • Emerging Technologies • Encyclopaedia Britannica Educ. Corp. • Encyclopaedia Britannica USA • Extron Electronics • Fast Forward Video • Fiberbilt Cases Inc. • Films for the Humanities & Sciences • Films Inc. • Fleetwood Inc. • Folex Film Systems • Follett Software Co. • Fujinon Inc. • Galaxy Communications Inc. • Gaylord Brothers • General Audio-Visual Inc. • General Electric PDP • General Projection Systems, Inc. • GentnerElectronics Corp. • GPN (Great Plains National) • Gretag Image Systems • Guidance Associates • H. Wilson Company • Hamilton Electronics Corp. • Hardwood Visuals • Harman Electronics Video Prod. • Harnel Fibre Box Co. • Hartley Courseware, Inc. • **HDTV Theater and Seminar** • HEDCO Electronic Devices Corp. • Highsmith Co. Inc. • Hitachi Denshi America • Hudson Photographic • **ICIA Institute for Professional Development** • IDEN Videotronics Corp. • Ikegami Electronics (USA) • Imtech International Inc. • In Focus Systems Inc. • Inline Inc. • Instant Replay • International Electronic • International Simultaneous • **Interactive Video & Multimedia Conference and Showcase** • IRIS Technologies • Jack The Ripper Tableskirting • James Grunder & Associates • JAN-AL Innerprizes • KCD, Inc. • JVC Professional Products Co. • K-L Industries • KET, The Kentucky Network • Kimball Audio-Video Inc. • Kinetronics Corporation • Kirkwood Community College • Knox Video • Labelon Corp. • Laird Telemedia, Inc. • Laserex Inc. • Lawrence Productions • Lectrosonics Inc. • Lee Metal Products • Libraries Unlimited, Inc. • LINECO Inc. • Lucerne Media • Luxor Corp. • Macro Data Inc. • **Management Seminars** • **Louise Mandrell • Marketing Seminars** • Mast Development Co./Keystone View Div • MasterVision • Maxell Corp. • Media and Methods Magazine • Media Flex, Inc. • Media Guild • Meeting Services Inc. • Meetings Plus • Micro Innovations, Inc. • **MICROTRENDS** • Midwest Communications Corp. • Miralite Communications • Mitsubishi Electric Sales/ Prof. Electronics • Modern Talking Picture Service, Inc. • Montage Publishing • Multiplex Display Fixture • Multivision Systems Inc. • National AudioVisual Center • Navitar A-V Division of D.O. Industries • NEC Technologies, Inc. • Neumade Products Corp. • NewsBank, Inc. • Nova Systems Inc. • nVIEW Corp. • Open Learning Agency • Optixx Screen Systems • Oscarvision Systems Inc. • Oxberry • Pacific Innovations • Panasonic Communications & Systems • Paso Sound Products Inc. • PBS Video • Peerless Sales Co. • Perma Power Electronics Inc. • Peter Li Inc. • Phoenix/BFA Films & Video • Pioneer Communications of America • Pivotelli/USA - Giant Products Inc. • Plus Corporation of America • Portac Inc. • Power R. Inc. • Presentation Electronics Inc. • **Presentation Center of the Future** • Prime Image • Prime Technologies Inc. • Progressive Marketing Products • **Projection Shoot-Out** • Proxima Computer Accessories • PTN Publishing/AV Communications Inc. • Pyramid Film and Video • Quality Education Data, Inc. • Quartet Ovonics • Quickset International Inc. • R-Columbia Products Co. Inc. • Rainbow Educational Video, Inc. • Rampart Cases Inc. • Rangertone Research, Inc. • Reactive Systems Inc. • Recordex Corporation • **Relax and Learn Park** • **Rental Seminars** • Retroscreen Inc. • RGB Technology • RMF Products • RMI Media Productions Inc. • RTI - Research Technology Int'l. • Russ Bassett Co. • Sales and Marketing Management • Samson Technologies Corp. • Sayett Technology • Scherer Manufacturing Co. • Schneider Corp. of America • Scott Resources Inc. • Screen Works Ltd. • Seal Products Inc. • Sharp Electronics Corp. • Sierra Video Systems • SilverPlatter Information • **Simulations** • Sirtage Inc. • Smith System Mfg. Co. • Sonex Acoustical Division/Ilbruck, Inc. • Sony Corp. of America • Sound-Craft Systems Inc. • Stantron, Unit of Zero Corp. • Star Case Mfg. Co. Inc. • Stewart Filmscreen Corp. • Synsor Corp. • 360 Systems • 3M Company • T.H.E. Journal • Tamron Industries Inc. • Tandberg Educational Inc. • TEAC America Inc. • Tech Electronics Inc. • Technical Acoustics, Inc. • **Technology Seminars** • TEK Data Systems Co. • Tekskil Industries Inc. • TELAV Audio Visual Services • Telecourse People, Miami-Dade C.C. • Telepak San Diego • Telescript, Inc. • Television Laboratories Inc. • Telex Communications Inc. • Tersch Products Inc. • **Thursday Late Night Party** • Toletco Fasteners Int'l. • ToteVision • Training Magazine, Lakewood Publish. • Transilwrap Co. Inc. • Turner Educational Services • **Art Turock** • TVOntario • Unique Business Systems • University of California Extension Media • Ushio America Inc. • USI Inc. • VALIC • Van San Corp. • Video Design Pro • Video Duplications, Inc./ Global Video • Videonics • **Video Seminars** • VideoTours, Inc. • Viking Cases • Vinylweld • VIS Consultants Inc. • VPS-Visual Products & Supply • **War of the Walls** • Wheelit Inc. • Wiko Ltd. • Winnebago Software Co. • Winsted Corp. • World Book Educational Products • Yankee Photo Products • York Controls • Zenith Sales Co. • **And More!**

From the Other Side

Hospital Communications From the Client's Point of View

BY RICHARD J. GRULA

With the one-two punch of America's growing senior citizen population and the increase of life expectancy due to medical advances, one sure growth market will be health care facilities such as hospitals and nursing homes. By state and federal law, every one of these facilities require extensive communication networks ranging from public address systems to bedside nurse call systems.

But bidding for and installing a nurse call system is nothing like tossing up a P.A. in the local school auditorium. Sound & Communications decided to speak with the other side — the hospital staff responsible for selecting nurse call systems — about recent installations in their facilities. (Because these facilities were extremely wary about appearing to endorse products, we've left out references to manufacturers).

Tony Caparco was Assistant Director of Plant Engineering for the Imperial Point Medical Center in Fort Lauderdale, Florida during the start of a complete four-floor renovation:

Sound & Communications: Who in the hospital deals with choosing a nurse call system?

Caparco: If it's a renovation where we're replacing an old system, the engineering department can do it and deal directly with the vendor. If it's a brand new facility, the engineers are not involved, because there is no engineering staff. That's when the architect and consulting engineer will spec the system.

Sound & Communications: How much input will the staff have?

Caparco: Staff will say up front what kind of systems they like, the kind of features they want, how it should be programmed, and then they spec a system that meets those needs. We want it simple to repair, self-diagnostic so it'll say, "Cord in room 301 has been pulled out," multiplex — meaning it's got a minimum of wires going from point to point, expandable and — of course — with a good price.

"There are a lot of regulatory agencies which determine how a hospital is to be built."

Sound & Communications: Is price vital?

Caparco: Usually low bid that meets the spec gets the job. If you want somebody that's not low bid, you better have good reasons. Governing boards of hospitals who control the finances need to know why. You have to have justification. It could be just one reason, but you have to have it.

Sound & Communications: Do you insist on certain standards?

Caparco: All equipment has to be UL approval. That was my own standard when I ordered. It's got to have a UL label. If the power supply is an independent component, it must have its own UL label. Plus, there are a lot of regulatory agencies which determine how a hospital is to be built. In Florida you've got South Florida building codes, state codes, national fire protection association (FTA) codes. They all have something

to say about patient call systems and they all have to be met.

Sound & Communications: How much do you check out a system before its installed?

Caparco: When you're talking about four or eight systems, that's a capital investment and you want to make sure that system has been proven reliable. You're not going to spend \$200,000 on what the salesman promises you. We asked for references, we asked questions of people in other facilities about how their system is working. And the vendor was willing to fly me to another installation, which was good. They believed in their system enough to invest money to fly me somewhere without guarantees of a sale. That tells you right there they believe in the system.

Sound & Communications: Does the sale include training?

Caparco: Yes. I specify a minimum number of hours of factory training. We'd include it in the contract that they have to fly me to wherever the factory is.

Sound & Communications: What about service?

Caparco: Most hospitals require one year parts and labor. After that, we'd usually maintain it ourselves. We don't farm out stuff like that. The little bitty hospitals might have a service contract, but a large organization has their own maintenance crew.

Sound & Communications: Was there anything in a certain system that turned you off?

Caparco: I got quotes on three systems, and the other two were not user-friendly. They were extremely complex with too many buttons to push and too many directions to follow. No matter how much train-

ing is offered, we don't want to deal with that because the nurses are up there to take care of patients. They don't want to take a ten-hour course on how to operate a little computer. They want it as hands-free as possible with minimum control. They want to be able to communicate with the patient, activate the calls, identify the type of call, and if the system has a problem, they want the system to be able to tell them what's wrong. That's basically it. They don't want the complex, expensive stuff that looks fancy but is really impractical. Most of those features are not used in many hospitals.

Sound & Communications: How long do you expect the system to last?

Caparco: When I did the paper work, I gave it a ten-year life expectancy. The



Imperial Point Medical Center in Fort Lauderdale.

American Hospital Association has charts on systems and equipment for depreciation purposes on what the life expectancy is.

Sound & Communications: What tips can you offer contractors bidding in this market?

Caparco: Focus on simplicity and ease of use. Don't go in with massive doses of com-

plex system theory and operation. Not many people really care about that. And they should know the kind of staff that's going to maintain it. Sometimes they'll make a system work or fail. If they've got a guy who's just a handy-man, they should try to sell a service contract.

EMERGENCY CALL & COMMUNICATION SYSTEM

EC-103 REMOTE PULL CORD STATION

ECC ROOM STATION (Model ECC-51A Shown)

ECC MASTER STATION

EMERGENCY CALL SYSTEMS

Mircom offers reliable audio-visual and audible-visual emergency call systems.

EMERGENCY CALL SYSTEM

EC-100 PULL CORD STATION

EC-103 PULL CORD STATION WITH LED

EC-104 DOME LIGHT

EC-105DC CORRIDOR HORN

EC MASTER STATION

For use in hospitals, nursing homes, or rest or nursing homes, Mircom's EC (Emergency Call) and ECC (Emergency Call & Communication) systems provides visual and/or audio alarm signalling. Features include; annunciation of normal and emergency calls, audio communication with room stations (ECC only), easy to read visual display of calls, tone silence and handset communication for privacy (ECC system only).

MIRCOM COMMUNICATION & SECURITY INC.
 429 Alness Street
 Downsview, Ontario, Canada
 Phone: 416-885-4301
 Fax: 416-885-2825

Circle 250 on Reader Response Card

David Boyce is Director of Equipment Procurement for Humana Inc., a for-profit corporation based in Louisville, Kentucky that operates over 80 hospitals with 17,000-plus beds. He estimates Humana will spend \$500,000,000 in 1991 to build and renovate facilities. Humana's centralized, corporate structure is seen by many as the model for future health care organization.

Sound & Communications: How does Humana select a nurse call vendor?

Boyce: We deal directly with manufacturers. They complete a Request For Proposal (RFP) — a fairly lengthy document, covering technology, service locations, life-cycle cost, pricing, etc. After they submit this documentation, some are invited to a central site and presented to a committee of end-users.

When we get a committee together for the first time, we glean ten or twelve different rating items from them: — Ease of Use, Serviceability, etc. Before meeting vendors, we ask the committee to weigh those criteria. So if one of the most important things in a nurse call system is Ease Of Use, that rating might be a 20%, versus a 10% rating for something not as important.

Committee members may go in thinking some vendor is better, but as they go through the presentation, look at their sheet and consider the ranking areas, it becomes difficult to hold to any bias. By the end of the day, people are surprised. Ask them for an overall ranking from one to ten, and they might say that guy's a three. But with the rankings and weightings and the totals, they may have actually given that guy a seven.

Vendors are always concerned who's on the committee, where it's held, that kind of thing. But when you get people to focus in on the 10 or 12 of the most important features of a product and say that's where the rating comes from, you focus people's attention on the product and those issues. I believe you end up with an outcome that gets rid of the bias.

As a result of this presentation, and based on scores and ratings, we select one or two national suppliers and sign an agreement with a fairly long life, about three years. We've selected two supplies for nurse call systems.

48 *Sound & Communications*



Rochester Methodist Hospital in Rochester, Minnesota.

Sound & Communications: How much of a factor is price?

Boyce: We don't even start dealing with price until we get the committee's recommendation.

“If the committee says, ‘We want this vendor,’ and the price is out of the ballpark, we may try to negotiate.”

Sound & Communications: The committee doesn't know the price when rating the system?

Boyce: We don't want our committee talking about price as the deciding factor. Remember, we request an RFP from every vendor. Part of that form is “What is your price to Humana going to be?” If the committee says, “We want this vendor,” and their price is out of the ballpark, we may try to negotiate the price down. We may even pay a little bit more if the committee feels the vendor is much more solid. But we're not going to pay 50% more. We let our committee independently decide who has the best product and then try to reconcile between the two to get the best blend of price and non-price.

Sound & Communications: Do you use only one vendor per installation?

Boyce: The whole issue of a single nurse call system for a hospital is not necessarily that big of a deal. We have a lot of facilities with split systems, depending on who was

the contractor during renovations. I expect that will become an issue when we get into information exchange, which is where computer bedside management systems are headed. Humana is developing a bedside terminal-type system for our patient rooms and it's possible nurse call will somehow tie into the data management system. The question still out there is who's going to be the vendor for this information network.

Sound & Communications: What data would the system provide?

Boyce: The thrust is to get nurse's notes, nursing care plans and physician's orders in a data base. From a Nurse Call, I don't know that we'll need an integrated system as much as we'll need it to provide information on frequency of calls, amount of time to answer — things that would give us information for our management system. The thing we're trying to learn by capturing these data is quality measure for our patients. We want to be able to say your call will be answered, your illness will be handled with a measurable level of quality better in a Humana hospital than it will be elsewhere.

But what we're looking at in nurse call today is somewhat like the old analog switch gear. We're really not looking for a lot of new exciting things. We're not pushing the envelope as much as the nurse call vendors are because we really don't see that fitting into our overall game plan as much as we see this other data system.

You could make a very big argument in the industry right now that nurse call systems have in some ways gotten way too complex. If what I want is a tone to go off, and clear communication with the patient as to what the requirement is, we've found some

nurses and engineers frustrated with the new digital systems than they have been satisfied.

Sound & Communications: What's the life expectancy of a nurse call system for Humana?

Boyce: Our replacement rate is about 12 to 15 years.

Sound & Communications: What other features do you look for?

Boyce: One feature we haven't bought off on 100 percent is the nurse locator. We've got that in some facilities and it's met mixed success. Another that probably has more potential (but to be frank, I don't see a real need), is the paging feature — the ability to send a call directly to a nurse's pager. The advantage is it's less noisy, and since the staffing at nurse station is not always what

“Modular design of the system was rated positively from a maintenance standpoint, as was system simplicity.”

we'd like it to be, there's not always someone there to take a call. It has some real potential from a manpower standpoint, but it's got some added expense. That necessarily hasn't been a drawback. Our end-users just don't seem to get too excited one way or another about these features. The nursing personnel tend to support me on the fact that they just want a reliable call system.

Jim Colburn is Project Engineer at Rochester Methodist Hospital of Rochester Minnesota, a Mayo Foundation Hospital. The hospital is currently renovating eight floors with 800 beds and 35 nursing stations. Colburn came onboard after the system had been spec'ed but before it was purchased.

Sound & Communications: How did you select a vendor?

Colburn: There were three preselected vendors, based on their local support primarily — they had local distributors. We knew two of those three systems pretty well. A nearby hospital had one, and another vendor had a pretty comprehensive demonstration unit. With the third, we ran a trial, actually set one up in the hospital for six months.

Personnel Register Designed by People who have installed the others!!!



*“We Can Easily Customize
To Replace Your Existing Systems”*

CALL TOLL FREE

1-800-852-6522

AUDSCO

Audio Systems Co. • 1815 Michigan Ave. • Bismarck, ND 58504

Circle 283 on Reader Response Card

NO HOME RUN WIRING

Introducing the
**5000 Audio/Visual
Nurse Call System**

By **MEHLICH**
("Maylick")

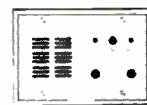

The master and all remote stations (up to 100 plus 10 door monitors) can be connected to a 16 conductor cable.

- Fewer cable requirements
- Fewer & simpler connections
- Simple system design
- Easy future expansion
- No wire labeling necessary

See the 5000 system at the NSCA convention
Booth #806 / May 25, 26, 27 - Opryland Hotel, Nashville

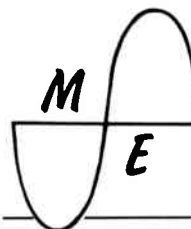

German Engineering
Made in the USA

Mehlich Electronics, Inc.

P.O. Box 33276
Raleigh, North Carolina 27636-3526
Tel (919) 832-4292

Circle 282 on Reader Response Card

All the vendors demonstrated their products and held several question and answer sessions. After each session, we requested feedback from the staff who attended the demonstrations. They rated each system as to ease of use, whether they found it intimidating. We got comments like "This takes up too much space," or "Good voice reproduction."

Sound & Communications: What did you like or dislike about certain systems?

Colburn: Modular design of the system was rated positively from a maintenance perspective, as was system simplicity. Also, how much intelligence is in the patients' rooms, vs. how much intelligence is in the nursing station. Some of the vendors had microprocessors located in the patients' room that would communicate back to a master panel. That was a negative. It affects the cabling and we wanted to minimize that. Plus, we felt it makes it harder to troubleshoot, and the more complicated it is the more that can go wrong.

Based on the feedback, we made a decision. The nursing staff had a different opinion from the engineering staff as to what system was best. The nurses preferred one that was easier to use and less intimidating. The other was really high-tech — it looked good on paper, being a nice modular system you could really expand on. But the nursing staff was reluctant to use that. The one the administration wanted was tried in the hospital and we had a lot of problems with that. So the system the nurses wanted was selected.

Sound & Communications: What were some positive features of the system you chose?

Colburn: The most important features were for the future; we're not using them yet. One is the ability to interface with our paging systems. The nurse carries a pager, and when the patient calls the nurse, the nurse would know what room it was via her pager. Since we use a primary nursing system, where a nurse is assigned to a patient, they found that to be a benefit. In addition to the paging system, there's a nurse locator. The nurse wears an ultrasonic device and another device in the rooms picks up the signal and notifies the

"We had some systems that intimidated people."

master station that the nurse is in the room. That's kind of nice, but we haven't implemented it because it's not nurse specific.

Sound & Communications: What's the expected system life?

Colburn: I believe on the cost analysis, it's 20 years.

Sound & Communications: What factors do you feel a contractor/vendor should

keep in mind when bidding this market?

Colburn: Keep it simple. We had some systems that were overly complex and intimidated people. One of the systems generated so much heat, it actually required us to cool the rooms to operate it properly. That was totally unreasonable.

Another point is flexibility — being able to expand the system where and when you need it, and flexibility from the nursing standpoint. All functions should be available from each system unit, rather than different devices for each need. And if you can tailor the system to individual nursing stations, you're able to keep costs down. Instead of buying it all, you can buy only the parts you need. ■

CONSIDERING HEALTH CARE COMMUNICATIONS

- Know the standards. In addition to UL1069 and Life Safety Code NFPA101, there are city, state and national regulations to be aware of. They are the law.
 - The large number of codes and regulations give Health Care communications the highest liability in the sound contracting market. If a system you installed fails and someone gets hurt (e.g., a patient trips while getting out of a bed to call the nurse) the installers, vendor and manufacturer may be found liable and soon involved in a lawsuit.
 - Because of the above, be sure you have sufficient liability insurance.
 - Check out humidity conditions. Many hospitals have extremely low humidity which can cause in excess of 100,000 volts of electro-static discharge. That can fry a microprocessor-based call system fairly fast. (Note: service calls for fried nurse call systems from ESD go up noticeably in the northeast during the dry winter months.)
 - Training the hospital staff (nurses and engineers) in use of the call system is vital. Most will not read manuals (though short, function-oriented manuals near nurse stations are helpful). Due to irregular staff shifts, you'll probably have to schedule several training sessions at vastly different hours. Beware — insufficient training can also be cause for liability lawsuits.
 - Proper training will minimize your service calls, which, if uncontrolled, can kill your profit.
 - This business does not run on low mark-up. Hospitals are wary of low-ball prices.
 - Find what the old system in a hospital was like. Even if it was hated, the staff is probably used to the sounds or lights used (e.g., red light for emergencies, blinking white light for bathroom call, etc.) Programming your new system to mimic those functions will make your system user-friendly to the staff.
 - Microprocessor systems for small facilities may be a matter of overkill. Consider the function, size and real needs of a care facility before reaching for high technology.
- For more in depth discussions on these and other issues regarding Health Care Communications, check out the September, 1989, *Sound & Communications* panel discussion featuring representatives of Dukane, Rauland Borg, TekTone and Fisher Berkeley, and contractor Ron Rosen.

MEET THE NEW PLAYER...

TEK-MICRO CARE SERIES NC300 NURSE CALL

A MICROPROCESSOR-BASED AUDIO-VISUAL NURSE CALL SYSTEM FOR NURSING HOME, HOSPITAL AND HEALTH CARE RELATED FACILITIES.



#1069 Listed

TekTone®

Sound & Signal Mfg., Inc.

1331 S. Killian Drive, Lake Park, FL 33403
Phone: (407)844-2383 Fax: (407)845-1587

27 Industrial Park Drive, Franklin, NC 28734
Phone: (704)524-9967 Fax: (704)524-9968

Circle 208 on Reader Response Card

World Radio History

TECHNIQUES FOR SUCCESSFUL NEGOTIATION

By David Lander

A clear understanding of negotiating techniques is something no sound and communications specialist should be without.

Negotiating is persuading people to accept a given set of terms on which agreements are based. On a day to day basis, sound contractors negotiate with suppliers, subcontractors, landlords, employees and everyone else with whom they are eager to sign contracts or come to arrangements.

Dealing with potential customers also involves negotiation. Selling, after all, is persuading people to buy the services and merchandise one has to offer. Both buyer and seller must agree on such issues as product categories, brands, models and prices before any deal is closed.

Several books are available to those interested in negotiation strategies. The basic text on the subject is based on an academic endeavor known as the Harvard Negotiation Project, a research program carried out at Harvard University. Called

THE BEST DEFENSE IS A FIRM, UNYIELDING STANCE.

“Getting to Yes: Negotiating Agreement Without Giving In,” it was co-authored by Roger Fisher and William Ury. It’s published by Houghton Mifflin and sells for \$17.95.

A number of consultants teach negotiating techniques to people in business. One such specialist, New York City-based George W. Fahlgren, points out that preparation beforehand can be essential to a successful negotiation.

Astute businessmen will begin the process well in advance by considering what negotiable issues may arise during an upcoming discussion. Fahlgren recommends that they list negotiable issues point by point on paper. The more points listed, the better, since issues are currency in the routine of give and take.

The more a sound and communications specialist knows about those he’s dealing with, the better. In many cases, he’ll be acquainted with the other party involved — and may even have engaged in previous negotiations with that individual. If not, as the negotiation progresses, it’s possible to

SOME ADVERSARIAL NEGOTIATORS IMPOSE DEADLINES IN AN ATTEMPT TO EFFECT EARLY SETTLEMENTS.

ascertain important information about the person seated across the table.

For one thing, a sound contractor can and should determine whether the other party is trying to address issues rationally or whether he is being adversarial.

An adversarial negotiator, George Fahlgren explains, might start out by presenting a totally unacceptable series of demands. This, he explains, is a ploy frequently used to lower the other party’s expectations. Some adversarial negotiators impose deadlines in an attempt to effect early settlements on their terms. Others try to force agreements by making opposing parties uncomfortable enough to give in to their requirements.

The first step in dealing with adversarial tactics, Fahlgren counsels, is to recognize that they’re being used. Once this is ac-

complished, the best defense is a firm, unyielding stance. When an adversarial negotiator sees that his stratagems aren’t provoking a reaction, he’ll probably drop them.

Power is a crucial factor in negotiations, and it’s important to understand which side holds the most trump cards. A sound contractor, for example, may know he’s bidding against one or more successful competitors. That could give the other party the upper hand and lead the contractor to outline less demanding terms than he otherwise might. Should the sound contractor in question have exclusive access to certain products or lines that the customer wants, however, circumstances might lead him to insist on a more favorable deal.

In either situation, Fahlgren advises facing up to reality, which he says makes reaching an agreement simpler.

Sound contractors should also consider — in advance — the best alternatives to a negotiated agreement. For example, someone seeking new office space in today’s soft real estate market is likely to have a number of attractive options available. This makes a successful negotiation with any particular agent or landlord less crucial than it might have been a few years ago.

NEVER MAKE A CONCESSION WITHOUT RECEIVING SOMETHING IN EXCHANGE.

Conversely, reaching an accord with an employee who would prove difficult to replace might be critical to the near-term future of a sound and communication pro’s business. If no desirable alternative to a

negotiated agreement is in sight, businessmen should be willing to give more and demand less, says Fahlgren.

Following are some other tips from consultant George Fahlgren on how to negotiate successfully:

In advance, create a sensible opening position and devise strategies. Determine precisely where you're willing to give and decide what you should demand in return for concessions.

POWER IS A CRUCIAL FACTOR IN NEGOTIATIONS.

When negotiating, never make a concession without receiving something in exchange. Getting the other party to give in on a point, even if the compromise is very small, conveys the important psychological

message that you're in control.

Never give in large increments. The technique of yielding in small steps also has psychological significance. If a negotiator has to work for it, he'll think any concession on the other party's part is a real accomplishment. If, however, someone moves from an opening position to the bottom line in a single giant step, the other party is likely to get the impression that, by pressing, he'll get even more.

Be sure all aspects of a negotiation are on the table before bargaining actually begins. An agreement is the sum total of its parts, and the party with whom you're dealing is more likely to give in on certain points when it's clear that something is being gained in return. That's more easily accomplished when all issues are in view.

During negotiation, write specific things down as they're discussed. Once some-

thing is put on paper, the other party may be inclined to perceive it as a given.

Leave the hardest-to-resolve issues for last. Address — and agree on — the simplest points first. Doing otherwise could result in discussions becoming bogged down at the outset.

ISSUES ARE CURRENCY IN THE ROUTINE OF GIVE AND TAKE.

Above all, sound and communications professionals should remember that, in a successful negotiation, everyone concerned walks away happy. There are situations where one party doesn't care about the other's feelings, of course, but dealings between people with ongoing relationships are not in that category. ■

Menlo Scientific, Ltd.

Acoustical Consulting
and design services for
sound contractors

Contact Michael Klasco

Menlo Scientific, Ltd.
39 Menlo Place
Berkeley, California 94707

(415) 528-1277

FAX (415) 526-8087

Circle 253 on Reader Response Card

Bose Modeler Revisited

Part 2: Getting to the Nitty Gritty

BY MIKE KLASCO

Last month we discussed Modeler's evolution over the last five years, licensing requirements, user interface, and documentation and support. This month we will continue to explore Modeler 3.1 and get to the nitty-gritty aspects: creating the room model, testing and refining the design, and the performance simulations of the finished specifications.

PROGRAM FLOW

The user first opens the Room Model window, enters the floor, walls and ceiling locations and surface materials. Speakers are selected and aimed. Performance simulations are run, typically starting with uniformity of coverage and speaker selection; aiming points, and locations are fine tuned. Additional simulations, such as maximum sound levels and intelligibility, are checked, and final revisions, if needed, are made.

CREATING THE ROOM MODEL

Modeler allows the rapid construction of complex room models using its Drawing Tools palette. No other CAD drawing programs are required, although the Bose SpeakerCAD program adds the capability of showing how the speakers or clusters will appear in an internal view of the room.

The user begins a new project by entering Modeler and opening the Room Model window. A blank window appears along with the Drawing Tools. When Modeler made the transition to release 3.0 last year

the Drawing Tools were revamped to better take advantage of the Mac interface and more closely resemble the drawing tools of other Mac programs. This transition was the turning point for Modeler where the program's speed and ease of creating a room model gained a clear lead over any of the sound system programs released so far. If you are already a Mac user, then learning Modeler will be faster than any of the MS-DOS programs as the

Proficient users ought to be able to knock out a rough simulation in less than a half hour.

Mac user interface is now very closely followed in Modeler 3.1. As with other Bose S3 programs, on line help is available in the form of a mini user's manual. This is accessed within Modeler at any time by choosing "About Modeler" from the pull-down menu.

Advanced drawing capabilities include instant doors and windows, planes up to 10 sides (such as playing fields in arenas), and literally every other utility that I had complained was missing from release 2.0 in my first review. Color compatibility has been added, both for color monitors and color printers.

Before creating the room model, the user opens up a materials list, sort of a "short list" of surface materials that you are considering using for the job. You browse through a master list of materials, which also displays the absorption coefficients in octave bands to aide your selection. New materials can be added to the master list.

Once you have picked out the candidate materials, you can begin to construct the room model. In constructing the room, you start with the floor, using the rectangular or polygon surface tool which you will select from your drawings tools displayed along the top of the screen. Using the mouse, and monitoring the coordinates that are displayed on the screen, you point and click off the coordinates. You then define the elevation for these coordinates. The next step is unique and is another aspect that sets Modeler apart from its competition; the program asks for the surface material for the plane you have just marked off.

By combining the generation of planes with the defining of the surface materials, the keystrokes and time to create the room model is cut at least 30 percent, maybe more, and the potential for errors is reduced. Later on, when the user determines the reverberation time, the surface materials may be revised in order to see how the room can be improved.

From the floor the user proceeds to

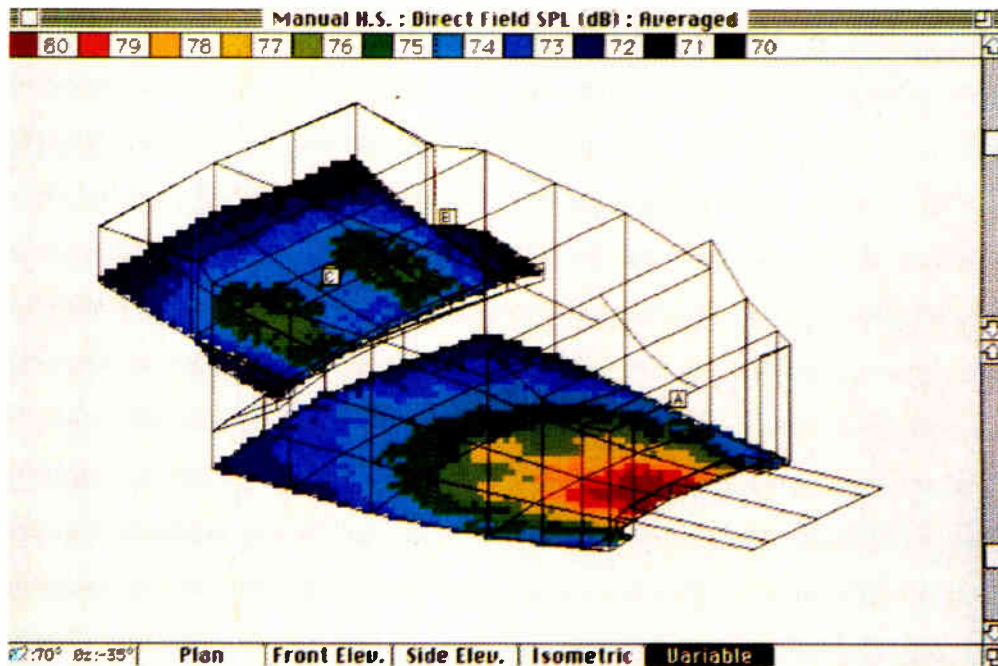

Manual H. S. auditorium.

construct the walls using the "draw wall" tool, creating walls from the endpoints of the floor.

For many jobs, and especially "freebie" estimates for design proposals, I felt that sophisticated programs such as Modeler were too time intensive. Between the new drawing tools and combining the plane construction and defining the surface materials into one stage reduces the time and effort to less than half of version 2.0, and certainly faster than any other 3D program. But I think this still is not fast enough for a real quick estimate, and the fellows at Bose have suggested that for quickie estimates the user only model the floor and leave the walls and ceiling undefined (this is similar to the room model used in the original version of JBL's CADP). By inputting the reverb time (measured or guesstimated) instead of surface materials for walls and ceiling, the program will still be able to provide useful performance estimations for most functions.

I have seen this approach in action and it works fine, and proficient users ought to be able to knock out a rough simulation in less than a half hour, start to finish. If the job comes through then the file can have the model expanded to include all the room's surfaces, enabling the intelligibility predictions to be run. While this estimating technique is not covered in the manual, it will be covered in one of Modeler's Technical Bulletins, an added support program starting in the first quarter of 1991.

Once you have completed the room model, you can admire your work and correct any errors that have shown up. By a

View	
125 Hz	
250 Hz	
500 Hz	
1 kHz	
2 kHz	
4 kHz	

<input checked="" type="checkbox"/> Superimposed	

<input checked="" type="checkbox"/> STI Graph	
Time Arrivals	

<input checked="" type="checkbox"/> STI	
%Slansi	
%ALcons	
Descriptor	

push of an on-screen button, you can quickly display any view desired such as Plan, Front, Side and Isometric (3D) views. These views and other screen displays may be printed at any time. By using the scroll bars, you can manipulate the model to virtually any perspective. Aside from changing the viewing angle, the model can also be "dragged" throughout the window and zoomed in on. Zooming is controlled by changing the Scale menu (one of the pull down menus) that reside along the very top of the screen. Architectural scales are now supported in Modeler 3.1 to major dimensions of 2000 feet. The program works in feet or meters, and the user can switch back and forth at will.

Adding of doors, windows, speaker clusters, or listeners are all accomplished by pointing and clicking the mouse. Moving any of these only requires pointing the mouse, holding the click button down, and dragging the item to where you want it. This is not as approximate as it seems, as readouts on the screen indicate the object's coordinates. A "tape measure" is always available by clicking on the tape measure icon, clicking at the start point and then on the end point, and the scale distance is indicated. If you have ever used a program that requires each individual speaker to be moved by redefining each coordinate, the elegance of moving entire clusters with the sweep of the mouse is wonderful. Getting rid of objects also is done by selecting CUT from the file menu and a touch to the mouse clicker.

The room may be resized quickly by

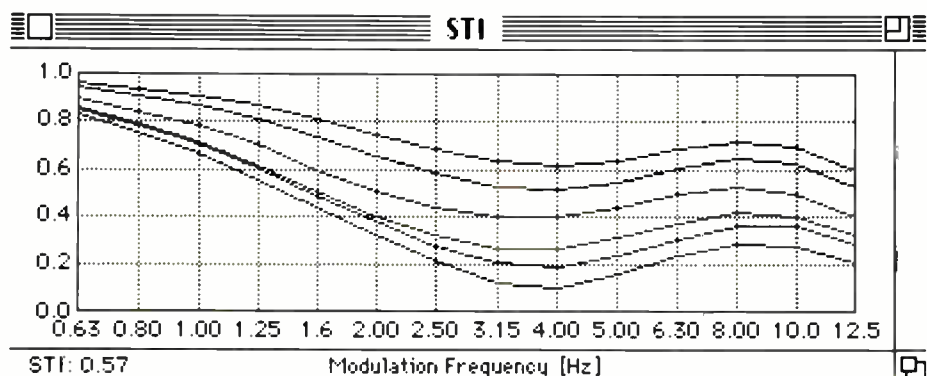

STI Window.

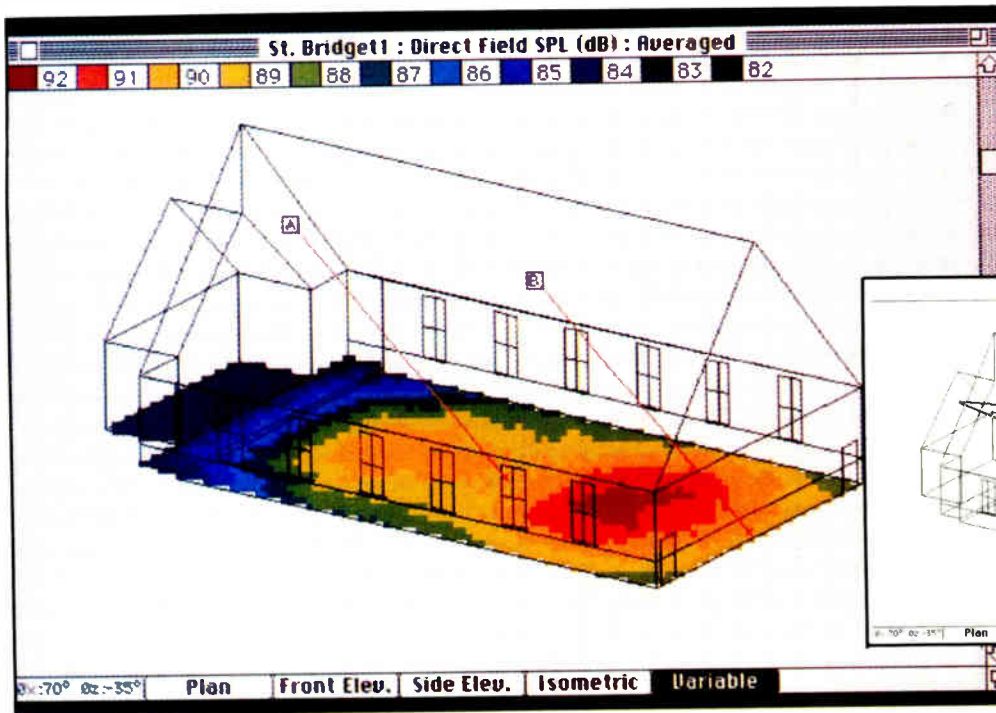

St. Bridget's Church:
coverage with hit points

Point Response Window
with one reflection.

using the mouse. You can rubber band sections, and pull out or push in corners. As the dimensions of most rooms remain stable during the job, this capability may not seem to be of use at first, but when even vaguely similar jobs come up in the future, you can avoid redrawing the room; you need only edit your previous work, poke at a few corners, drag a few speakers, windows and doors, and you have a model of your new job. This is a very attractive feature. Of course your old job is still intact.

Still another feature of Modeler is mirroring, that is, if the room is symmetrical, either one-quarter or one-half of the room, then only that section needs to be drawn. By using the mirror function the program will automatically draw the remaining sections.

Speaker selection is similar to selecting materials. You select from a master list from the Speaker Info window. Various visual tools are provided for locating and rough aiming of the speaker, including coordinates for pitch, yaw, and length of the speaker from its aiming point to the floor. As with most information in other S3 programs, this aiming info is organized into a spreadsheet format for easy editing and intuitive printouts. Modeler no longer allows the user to enter or edit speaker dispersion data but, instead, continues to allow speaker manufacturers to provide their data directly to Bose for inclusion into the program. Bose feels this data review policy helps to insure that manufacturers

have accurately used Modeler's special dispersion data entry utility (supplied free to any manufacturer who wants to participate in Modeler's speaker library). Data from a wide variety of speaker manufacturers is already available in the Modeler speaker library. This includes data for one box signal-processor speakers such as Apogee, to "omni" foreground speakers such as Soundsphere, to the major suppliers of raw speakers and horns.

While it is not easy to separate how to share the credit between Bose and the Macintosh interface, in my opinion, Modeler is unmatched by any currently available program in its capabilities in creating and manipulating the room model.

SpeakerCAD

A purpose of the room model is to aid in the creation of the cluster drawings. Modeler uses a supplementary program, SpeakerCAD for this function. Speaker-

CAD simulates the physical characteristics of speakers and arrays, as well as the interior space of the room. SpeakerCAD is able to import the coordinates from Modeler (although it cannot export back to Modeler). SpeakerCAD prepares the cluster drawings, including rigging, center of gravity, component collisions and even color renderings of how the speakers will appear in the room.

SpeakerCAD 1.0 was reviewed in the May 1989 issue of *Sound & Communications*. Revisions in 2.0 include a revised user interface that more closely conforms to Macintosh conventions, adoption of Cartesian coordinates, spreadsheet style editing of speakers and locations, improved file format saving technique, much faster hidden line removal, and color support, both for monitors and printers. SpeakerCAD can now export clusters in PICT format, which means prints can be sent to AutoCAD (on the Mac).

Calculation Parameters dialog box for point response.

Calculation Parameters

<input checked="" type="radio"/> Power Sum	Direct+Reflected	<input checked="" type="checkbox"/> Floor
<input type="radio"/> Coherent Sum		<input type="checkbox"/> Walls
<input type="checkbox"/> Obstructions	20 mS	<input type="checkbox"/> Ceiling
<input checked="" type="checkbox"/> Trace Reflect	40 mS	<input type="checkbox"/> User 1
<input type="checkbox"/> Smoothing	✓ 100 mS	<input type="checkbox"/> User 2
	200 mS	<input type="checkbox"/> User 3
	500 mS	<input type="checkbox"/> User 4
	1000 mS	<input type="checkbox"/> User 5
Reflections		
<input type="text" value="1"/>	Single Pt.	Batch
	Cancel	

THE SIMULATIONS

The basic questions of whether the sound system design will work are; is the coverage even enough, will it play loud enough, will it sound good, will it be intelligible, does it have adequate gain-before-feedback. The results of the simulations should answer as many of the above questions as possible.

UNIFORMITY OF COVERAGE

Modeler can calculate coverage in the six octave bands from 125 Hz to 4 kHz. This bandwidth is used through the program including the analysis of room acoustics, reflections and speech intelligibility. The sound level coverage is shown by the user's choice of a gray field sound intensity map or a numeric field. The gray field provides a more intuitive feel for coverage while the numeric field is more qualitative. Providing both options is a good approach to aid the fine-tuning of speaker aiming. Modeler gives the user a Mapping Parameters dialog box in which a number of options may be selected such as the bandwidth shown, power or coherent summing of the speakers in the sound field, resolution (vs. computing time), direct sound or direct/reflected, and location of sampling (floor, ear height). Aside from uniformity of coverage, maximum sound levels can be shown. The MAX SPL function brings the system up to the maximum rated sound levels and displays the results.

Modeler provides a unique secondary display that shows coverage statistics. While the gray scale and numeric field help

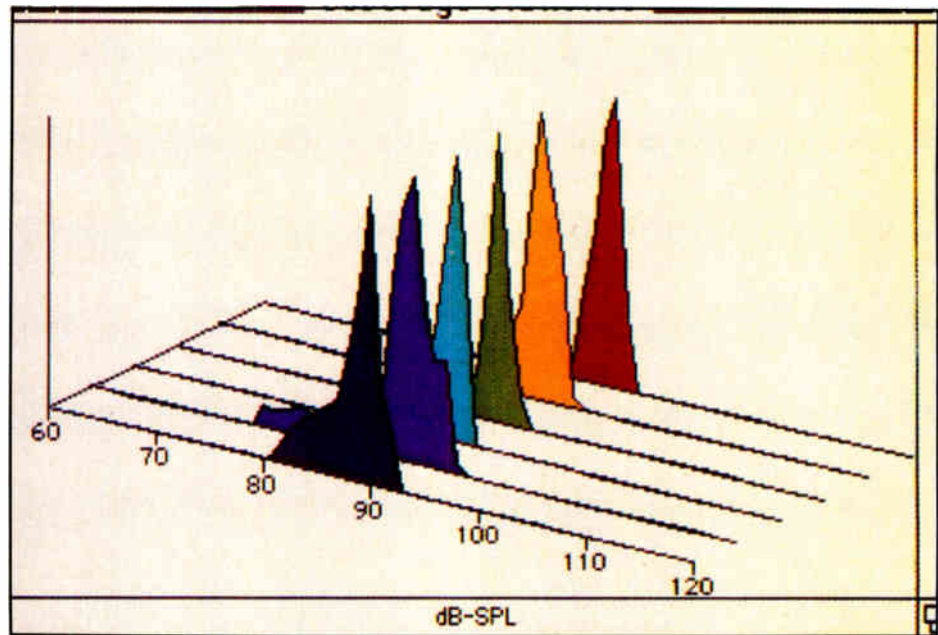

Coverage statistics: Waterfall

aim speakers, the uniformity of coverage can be directly shown statistically with a chart showing sound level versus what percent of the room falls at that level. A well designed sound system will have a sharp peak, while a room that has uneven coverage will have a broader peak. Individual octave bands or a waterfall 3D plot of multiple bands can be viewed. Refining your sound system using these design tools can be time consuming, but with the time saved in efficient room model creation, it is better you spend your time here. Beyond these capabilities, this module offers on-screen display of standard deviation, mean, and a couple of other displays that will become progressively useful to the "power users" of this program.

REVERBERATION PREDICTION

Modeler has a powerful Room Acoustics module, although only the Sabine equation is supported for reverberation time. Other

equations, such as Norris-Eyring, are not supported, as the absorption coefficient data base is not compatible. The Sabine equation is not accurate when the reverberant time is short or if the surface materials are not evenly distributed. These are not uncommon conditions, but the software developers at Bose feel that this trade-off is better than the inaccuracies that occur with the other equations.

The reverberation time module is easy to use, with a pop-up menu to plug in the effects of different size audiences on the RT60. The user can toggle between reverberation time vs. frequency and absorption coefficient vs. frequency.

If you have control over the surface materials in the room, then you can do some "what ifs" by calling up the Room Info window. Changing materials in a room model is fast and intuitive in Modeler. By changing materials you can quickly see their effect on reverberation time.

Direct Time Arrivals

The "point response" displays the time relationship of the sound at any user defined location. This is useful for setting aiming angles, power levels and determining time offsets between clusters and underbalcony speakers. Time offset between speakers can be corrected by electronic delays and this can be simulated with Modeler by calling up the Aiming Info spreadsheet and entering a new time delay for the speakers producing the earlier arriving sound.

STI Calculation Parameters

<input type="checkbox"/> Decentralized	<input checked="" type="radio"/> Power Sum	<input checked="" type="checkbox"/> Floor
<input type="checkbox"/> Indoors	<input type="radio"/> Coherent Sum	<input type="checkbox"/> Walls
<input type="checkbox"/> Floor	<input type="checkbox"/> Obstructions	<input type="checkbox"/> Ceiling
	<input type="checkbox"/> Smoothing	<input type="checkbox"/> User 1
		<input type="checkbox"/> User 2
		<input type="checkbox"/> User 3
		<input type="checkbox"/> User 4
		<input type="checkbox"/> User 5

STI Calculation Parameters dialog box.

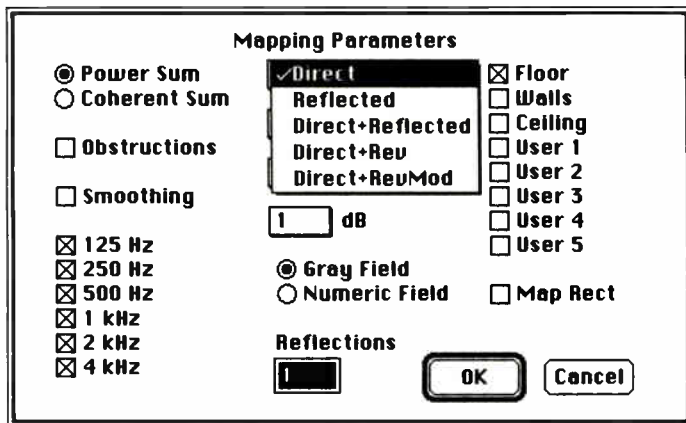

Mapping Parameters dialog box for coverage calculations.

Another Point Response display is the calculated time arrivals in six octave bands at one time and is depicted as an octave band frequency response. I am not so sure how useful this is, but it is only an option on the menu, and you are not forced to pass through it. If a function is found to be rarely used, then the software developers at Bose may remove it from later releases of the program. One example is the localization map, which, in release 2.0 depicted the spatial qualities of the sound system, but is not included in release 3.1. This might be more of a sad comment on the attention stereo imaging is paid by sound contractors than of the usefulness or quality of this module.

REFLECTED TIME ARRIVALS

Modeler provides a facility to display direct sound in conjunction with reflections as an aid to determining if there will be strong late reflections (flutter echoes). Sound paths can be visually traced in the room model as well as viewed on the time arrival graph.

INTELLIGIBILITY PREDICTIONS

Modeler 3.1 is the first commercially available software program to include the Speech Transmission Index (STI), which is a method for measuring intelligibility. STI is now an IEC standard. B&K pioneered test instrumentation using a simplified variation, RASTI, followed by Techron adding RASTI and STI utilities to their TEF analyzer. The DRA MLSSA system adopted RASTI and STI, and Ariel is working on incorporating this test in the next release of SYSid.

But these instruments are test gear, and Modeler is a software program for predicting results. As STI is a test, it requires a sophisticated enough model that a valid simulation can be carried out. While a de-

tailed discussion is beyond the scope of this review, the engineers at Bose developed a less computationally intensive approach that would be practical for personal computers. The treatment in the Modeler manual of STI is excellent, informative, and credible. I hope future releases of Modeler expand this annotative approach to other portions of the manual. The Speech Trans-

Coverage statistics: frequency response.

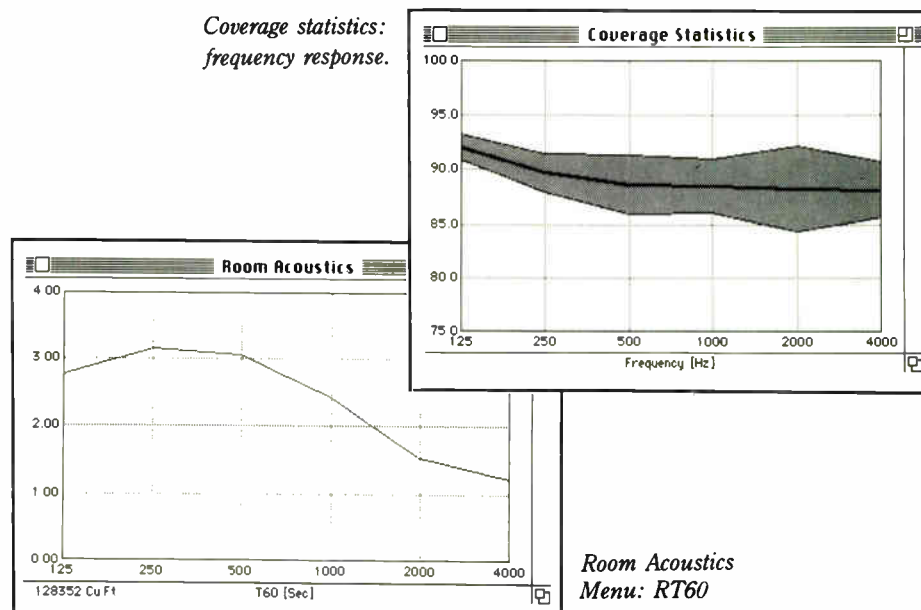

mission Index is becoming a "must-have" capability for sound system engineering programs and EASE, AcoustacADD 2.0, and CADP2 will include some sort of RASTI/STI modules.

The STI module in Modeler 3.1 asks the user to define whether the sound system is centralized (single cluster), decentralized (split or multiple clusters) or distributed (multiply single speakers). Actually, Modeler automatically recognizes what type of system is being used and sets this function automatically. The environment, that is whether the space is indoors or outdoors, is next defined. STI prediction re-

quires that the noise floor at octave bands be entered, and this requires the user to have actually measured this at the job site, or to enter valid estimates. STI information is then displayed wherever the user clicks the mouse on the room model.

Also available are other intelligibility measures; %SI ansi, which is the percent English word intelligibility. This number is derived from the STI calculation.

%Alcons, percent articulation loss of consonants, also derived from the STI calculation, but with the added benefit of the background noise factored in.

Additionally, a qualitative description "good," "fair," etc. is provided at the STI data points in the room model.

CONCLUSIONS

The Bose Modeler 3.1 is a state-of-the-art program. While Bose continues to provide a maximum of useful and well-thought-out features, it should be obvious that the accessibility of that information and the ability to communicate the results (using-prints) are all of equal importance. In this respect Bose has successfully adapted the sophisticated yet intuitive user-interface of the Macintosh to Modeler. Both Macintosh and Bose have refined their products over the years and now are delivering on what was once only promised. With the recent product intro-

Specify the Best...

ductions, Macintosh has become better, faster, and cheaper and comparable in value to MS-Dos computers.

Bose Modeler has enhanced the room modeling module where it is presently the quickest to use, yet also the most sophisticated of the programs I have reviewed. The extensive speaker library contains products from almost all manufacturers that have directional data on their products, and the surface material library is also comprehensive. The performance simulations are comprehensive and allow the user a wide range of control, both in setup parameters and graphic display. Other programs in the Bose Sound System Software series include SpeakerCAD for cluster design, and RackMaker for both rack layout and bill of material generation.

The program is excellent; there is simply very little to criticize in the current release of Modeler. The program has come a long, long way from releases 1.0 and 2.0 (the version I reviewed almost two years ago). Perhaps the one suggestion I would make would be to have the graphics enhanced in such a way to better aid the entail rough cut selection and aiming of speakers (a -3 or -6 dB contour "iso-beam" or directional balloon, maybe even tie this into the intelligibility data to determine acceptable projection limits?). Mic feedback prediction would be a powerful addition, but nobody else has included a workable solution to this problem yet either.

Other considerations in selecting Modeler are external to the program, such as do you have or want to acquire a Macintosh computer (Apple just introduced three new Macintosh computers with drastically lowered prices.) And remember this program is available only to sound contractors who are Bose dealers, although Bose does not restrict the distribution to consultants.

For the moment, Modeler is King of the Mountain (pun intended), but with the recent introduction of EASE from Renkus-Heinz, soon to be followed by JBL's CADP2 and the second major release of Mark IV's AcoustaCADD, there are formidable challengers approaching. ■

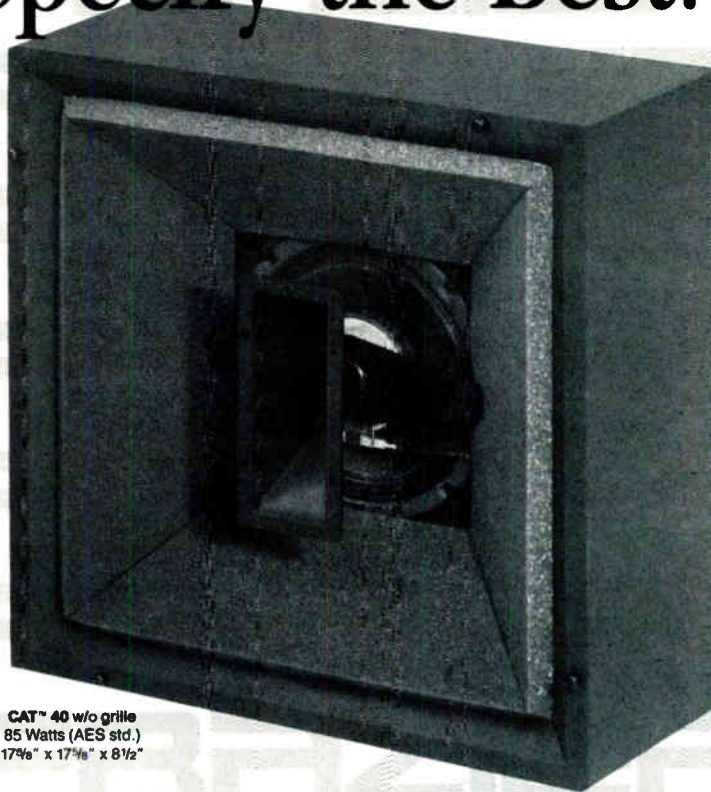

CAT™ 40 w/o grille
85 Watts (AES std.)
17⁵/₈" x 17⁵/₈" x 8¹/₂"

the CAT™ 40 family will do the rest.

- Controlled Directivity 90° x 90° Pattern
- CAT™ Design—Coincident Aligned Transducers
- Full Range Systems, 40-17 khz ± 3dB (F1450)
- Isobar tabular data available for PhD/CAD
- Optional Furniture Grade finishes in Oak & Walnut
- Compact cabinets 17⁵/₈" wide



CAT™ 46 w/o grille
250 Watts (AES)
31¹/₈" x 17⁵/₈" x 14¹/₈"

F1450
250 Watts (AES)
41⁷/₈" x 17⁵/₈" x 14"

If natural, intelligible speech reinforcement as well as full-range music reproduction is important to your church, school or auditorium customer...FAX or call TOLL-FREE **NOW** for complete data on these state-of-the-art **FRAZIER** systems.

FRAZIER

Route 3, Box 319 • Morrilton, AR 72110
(501) 727-5543
Toll Free 1-800-643-8747 • FAX (501) 727-5402



Circle 241 on Reader Response Card

MAYHEW

(continued from page 30)

try different antenna polarizations. Sometimes a 45 degree angle from the vertical works well. Remember that the wireless transmitter and receiver antenna must be polarized in the same direction. Maintain a minimum distance between the wireless transmitter and receiver. This helps insure that the receiver will only be captured by its transmitter and not the interference. One last point: make sure that the receiver is turned off when the transmitter is not in use.

How strong of a signal will interfere? I found that a signal as low as 2 microvolts (.002) can cause interference problems.

FREQUENCY SELECTION

If all you need is one or two wireless

microphones then the frequency selection process is quite simple. The problem becomes more complex when you require many more channels. The licenseable wireless channels that exist have some degree of compatibility but as I said before, the problem can get quite complex. If you take into consideration IF frequencies, bandwidth, spurious emissions and image rejection the problem becomes apparent.

MCO and HME have both come up with computer programs that will allow for upwards of 22 channels of wireless microphones to be used at the same time in the same location. To do the math long hand involves hundreds of thousands of addition, subtraction and comparison problems. Of course with the aid of the computer, the tedious task is reduced to just entering the parameters you wish to use. For the average end user the answer for frequency

selection can be found with the dealers and/or manufacturers of wireless equipment. After all, they want the wireless they make to have the best chance of working, and we all found out very early in the game that frequency selection is a very important aspect.

SQUELCH

The purpose of squelch is to mute the spectrum noise the receiver is receiving when no carrier is present. There seems to be two schools of thought when it comes to squelch controls in wireless microphones. The first school says that the end user should not have to adjust the squelch on the receiver. They put the squelch control inside their receivers away from the end user. Another thought in this school is that the end user cannot misadjust the squelch.

The second school of thought says that the preset squelch control does not allow for the most sensitive receiver. Also, it does not allow for the disabling of the squelch which would allow for the better scratch track. Lastly, with a user adjusted squelch it is possible at times to squelch out faint interference.

HME has subscribed to the second school with its professional receivers. Here is how to correctly adjust the squelch on the HME receivers:

- Make certain that the transmitter is off.
- With the receiver in place and the antenna connected, turn the receiver on.
- Adjust the squelch control counterclockwise until the receiver emits the loud rushing noise.
- Now turn the squelch control slowly clockwise until the receiver just quits.

That's it. You are done. Turn on the transmitter. To make the receiver less sensitive turn the squelch control clockwise. To loosen the squelch, turn the control counterclockwise. Caution: If the squelch is too loose when you turn off the transmitter, the receiver could allow the spectrum noise into your system. This noise has been known to blow out ear drums, high and low frequency drivers and also makes an excellent lease breaker.

One additional thought. You should readjust the squelch whenever the unit has been in for repair, when you change locations or if you have reason to believe that someone has diddled the control. ■

Bill Mayhew is the owner of Mayhew & Company.

	
Model 2901B+ TDR Cable Fault Locator \$845	Model 525 DESIGNATOR Cable I.D. System \$395
	<h2>CABLE TEST EQUIPMENT</h2> <ul style="list-style-type: none">• SIMPLE TO OPERATE• PRECISION ACCURACY• LOW PRICE
Model 1210 TDR Cable Fault Locator \$4395	
<h1>RISER-BOND INSTRUMENTS</h1> <p>505 16th STREET, P.O. BOX 188 AURORA, NEBRASKA 68818 402-694-5201 Circle 258 on Reader Response Card</p>	

Installation Profile

Margo Jones Auditorium

BY CHARLES HULME

Renovation work was recently completed at the Margo Jones Auditorium, located on the campus of Texas Women's University in Denton, Texas. The 1117-seat room was originally constructed in 1922, and has served as the main performance and assembly hall for the university. The facility, which was originally dubbed "The Main Auditorium and Music Hall," was renamed in 1982 after Margo Jones, known as the patron of regional theater. The auditorium has been used for performances by such notable artists as Robert Frost, Carl Sandberg, Vladimir Horowitz, John Phillip Sousa, and the Vienna Boys Choir. A complete interior renovation of the structure began in 1987, and was completed in early 1990, at a cost of three and a half million dollars.

The architectural firm of Kirkpatrick & Nelson was enlisted by the university to turn the aging building into a modern multi-purpose performance facility. Design and specification of the acoustics, stage lighting, rigging, and sound system was performed by The Joiner-Rose Group of New York and Dallas. Rigging systems and stage lighting were supplied by Texas Scenic of San Antonio, with rigging control, software and programming supplied by Skjonberg Controls of Ventura, California. Core Systems of Houston was responsible for installation of the sound reinforcement, intercom, and recording systems. Redman Organ of Fort Worth is currently constructing a four manual, seventy-eight rank pipe organ for the hall with a total of 4417 pipes, some of which were reused from the original organ that was installed in 1928 by the Moeller Organ Company.



The control room during construction.

THE INSTALLATION

Work on the sound began in the fall of 1988 and was completed by December of 1989. The sound reinforcement system is a biamplified central cluster system with seven satellite clusters on delay lines. Electro-Voice DH-1A compression drivers are coupled with HP-6040 and HP-640 horns. The low frequency drivers consist of nine JBL model 2225H loudspeakers individually mounted in custom enclosures. A steel mounting frame was fabricated allowing the horn and low frequency enclosure to be suspended as a single unit, simplifying installation of the clusters. A section of half-inch metallic tubing is attached along the axis of the horn throat to facilitate aiming of the device.

Positioning was accomplished by placing a marker on the floor of the building at each of the aiming points specified by the consultant. The installer was then able to use the metallic tube like a gun barrel sight and align each loudspeaker assembly.

These tubes allowed the consultant to quickly check for proper placement and aiming of the clusters, and as it turned out, no readjustment was required.

Power amplification is provided by nine QSC model 1700 amplifiers operated in bridged mono for the low frequency loudspeakers, with three QSC model 1200 units supplying the power for the compression drivers. A special switch panel allows each driver to be switched to a set of test points on the face of the amp rack without disconnecting any speaker leads.

The crossover for the system is a Rane AC 22, the outputs of which are routed to four Klark-Teknik DN 716 digital delay units, each of which has three independent delay taps. This configuration allows alignment of the low and high frequency drivers in each loudspeaker assembly, as well as providing the proper amount of room delay required for each satellite cluster.

Equalization is handled by a Klark-Teknik KN-405 notch filter used in conjunction with a White Instruments 4200 third octave equalizer. A dbx 160X compressor limiter is also incorporated into the front end.

A Williams Sound PPA-T4 transmitter and PPA-R7 receivers are provided for hearing impaired patrons of the theater. The transmitter audio feed is supplied by an ART PD-3 digital delay line to help offset the propagation delay of the sound from the main cluster. Individual earpieces are used with each battery operated receiver, and are available as an earplug or headset. A set of rechargeable ni-cad batteries helps keep down operating costs.

The system is configured with two separate mixers, with one dedicated for

PHOTOS BY CRAIG McALEXANDER

unattended use in what is termed the "assembly" mode, with the other requiring an operator. The assembly system is accessed through a control panel located to the left of the stage. From this position it is possible to turn on the sound system and control the level of three microphone inputs and one line level source. The other mixer, a Yamaha MCI604, is located in the control booth, along with the patch bay, system ac power control, the effects rack, cassette player, CD, and two-track. The console and effects units are tied in via a multipin disconnect, with an alternate mix position provided on the floor of the auditorium which utilizes an identical disconnect wired in parallel with the control booth. This arrangement allows quick set up in either location and reduces the chance of incorrect interconnection of the system.

Remote switching of the ac power is accomplished with a custom built set of sequenced relays that operate Square D type QO motor activated circuit breakers located in the technical power panel. Visual indication of power status is provided at the assembly control panel, at the equipment racks, and in the control room. Fabrication and installation of the power control and other portions of the system was handled by Dean Languell and Jack Bullis of The Waveform Group, a systems contractor and design firm located in Central Valley, New York.

STAGE MONITORS

A four mix monitor system provides foldback for performers and stage personnel. In addition, a program and talkback monitor system accessed via the stage announce function of the intercom, is supplied. Two Yamaha S-20X loudspeakers cover the backstage area, with a local volume control adjacent to the assembly control panel. The main monitor system is comprised of two JBL 4602B floor wedges, and two JBL 4698B sidefills. Two QSC 1400 power amplifiers provide amplification to locations on the apron, upstage and downstage left and right, and on both sides of the fly deck above the rigging motors. The latter is provided to allow

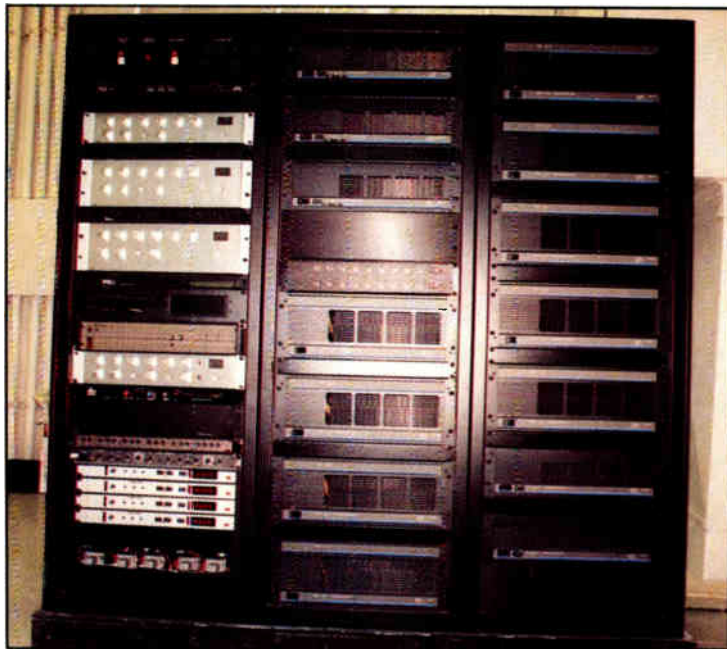

The front of the equipment rack

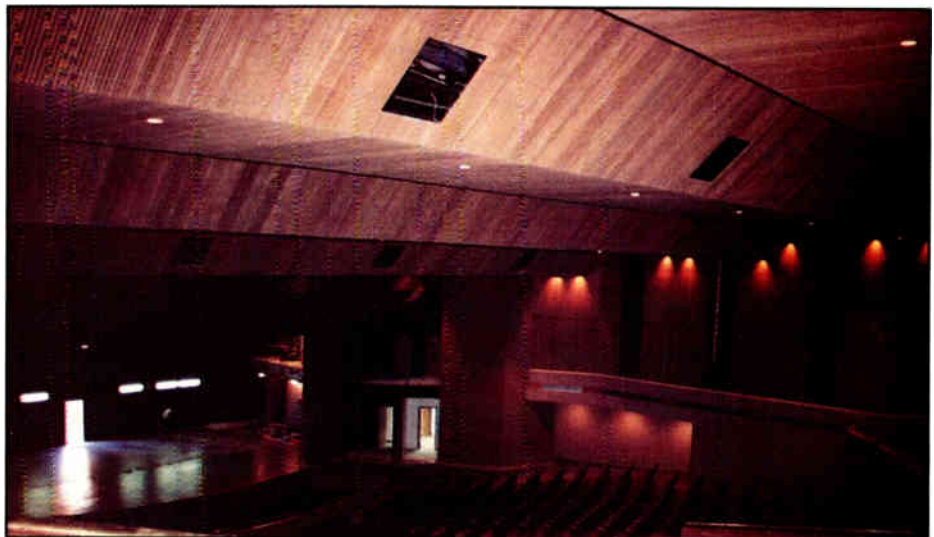

Work on the sound of the auditorium was completed by December 1989.

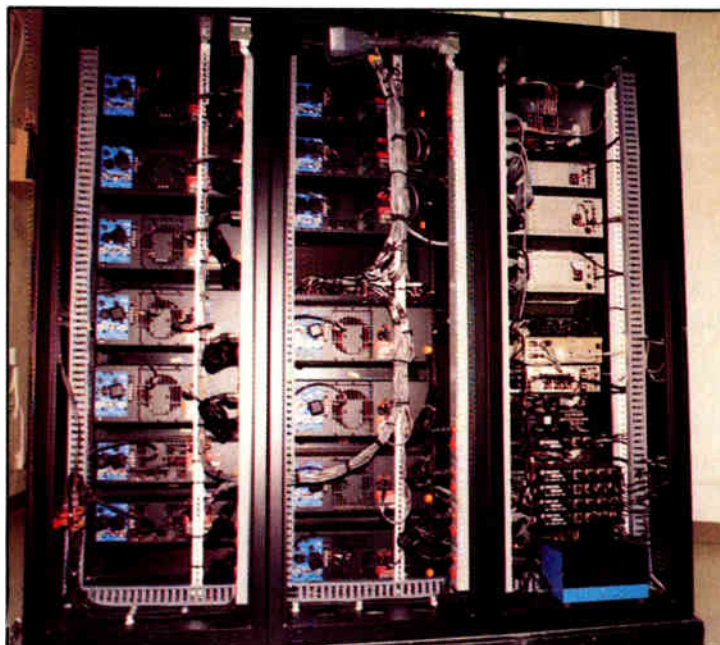

The back of the rack showing connections.



Texas Women's University's Margo Jones Auditorium.

monitors to be flown above the stage. Monitor equalizers are Yamaha model Q2031 one-third octave units, located in the portable effects rack in the control booth.

INTERCOM SYSTEMS

The stage communication and production intercom system provides three in-

dependent channels for use by technical personnel and the stage manager. The system is powered by a Clear-Com PS-20 power supply, and utilizes RS-501 and RS-502 beltpacks with Beyer DT-108 and DT-109 headsets. The control booth is outfitted with a Clear-Com RM-120A master station for use by the sound operator. Model KB-112 wall speaker stations are

mounted in the dressing rooms, stage manager's office, and the green room. These units can be called from the stage manager's beltpack, and also receive the main audio program. A patch point in the control booth also allows an alternate audio program to be delivered to the speaker stations. Jackplates for the intercom are located on stage, at the pinrail, in the staging areas, on the fly deck, on the catwalks, at the followspot positions and in the control and equipment rooms.

SYSTEM CALIBRATION AND ACCEPTANCE TESTING

Once the installation was completed and the as built documents finished, Richard Zweibel of The Joiner-Rose group arrived on site to perform the final setup and equalization of the system. Prior to his arrival, Richard had specified that certain adjustments and tests be performed and the results recorded, including measurement of speaker line impedance, overall hum and noise at the amplifier outputs, electrical frequency response, and the polarity of the loudspeaker systems. In addition, the system was checked for stray RF pickup, as well as uniform distribution of sound using a sound pressure level meter with pink noise as the test signal. The gain structure of the system was also adjusted prior to the consultant's arrival. Once the initial adjustments and tests were performed, Richard arrived to complete the setup and adjustment. Armed with an Ivie portable spectrum analyzer, Bruel & Kjaer spl meter, and Techron TEF 12 analyzer, Zweibel was able to quickly adjust the delay lines and equalize the system for optimal performance.

Once the acceptance testing was completed, training sessions were scheduled for the facility personnel. Topics covered were system setup, operation, and maintenance; microphone selection, use and technique; recording practices, patchbay operation, as well as configuring and equalizing the stage monitors. The additional time spent training and familiarizing the new owners of the system has virtually eliminated call backs, and greatly increased the level of customer satisfaction. ■

EQUIPMENT LIST

2 AKG C-460B Microphones	4 Klark-Teknik DN-716 Digital Delays
4 AKG KM-10A Mic Stands	1 Klark-Teknik KN-405 Equalizer
10 AKG KM-201A/2 Mic Stands	18 P&B CH, KHS, & KUL Series Relays
6 AKG KM-211/1 Bocms	3 QSC 1200 Power Amplifiers
1 AKG KM-211/2 Boom	2 QSC 1400 Power Amplifiers
2 AKG KM-235/1 Stereo Bars	9 QSC 1700 Power Amplifiers
2 AKG KM-238 Stand Clamps	4 QSC PL-1 Octal Socket Limiters
1 ART PD-3 Digital Delay	23 QSC T-1 Input Transformers
2 Atlas DS-7E Desk Stands	1 Rane AC-22 Crossover
2 Beyer DT-108 Headsets	1 Tascam 112 Cassette Deck
2 Beyer DT-109 Headsets	1 Tascam 42-B Reel-to-Reel
1 Beyer MCE-5 Lavalier Microphone	1 Tascam CD 501 Compact Disc
8 Clear-Com IC-25 Cables	1 Telex PH-24 Headset
2 Clear-Com IC/25-6 Cables	2 TOA A-906A Mixer/Amplifiers
4 Clear-Com KB-112 Speaker Stations	1 TOA M-900B Mixer
1 Clear-Com PS-20 Power Supply	3 TOA M-21S Input Modules
1 Clear-Com RM-120 Intercom Station	1 TOA L-01S Input Module
6 Crown PCC-160 Microphones	1 TOA T-01S Output Module
1 dbx 160X Compressor/Limiter	1 White Instruments 4200A Equalizer
9 Electro-Voice DH-1A Compression Drivers	1 White Instruments 4391 Output Transformer
5 Electro-Voice HP-6040 Horns	1 Wireworks MCM Series Custom Multipin/Fanout System
4 Electro-Voice HP-640 Horns	1 Yamaha MC-1604 Mixing Console
6 Electro-Voice N/D 308 Microphones	1 Yamaha NS-10M Loudspeaker
6 Electro-Voice N/D 757 Microphones	1 Yamaha Q2031 Equalizer
9 JBL 2225H Loudspeakers	2 Yamaha S-20X Loudspeakers
2 JBL 4602B Monitors	1 Yamaha SPX-90 Digital Effects Processor
2 JBL 4698B Loudspeakers	
11 JBL 8120H Loudspeakers	

NEWS FROM AROUND THE INDUSTRY

Air Show Sound; System Installations

Air Show Uses E-V

Electro-Voice MT-4 concert sound systems were used to provide the main PA at Airshow '90 held in Midland, Texas at the Midland International Airport. More than 10,000 spectators attended. Four EV MT-4 systems, each consisting of a high- and low-frequency cabinet, were located adjacent to the aircraft display and arranged as a cluster. The high frequency cabinets were flown, with the low frequency units placed beneath them at ground level. Fitzco Sound of Midland provided the MT systems, where were used for announcements and background music, as well as for music to accompany the demonstrations.

OAP Installations

OAP Audio Products has announced several system sales. Jim Reed of Music Biz in Illinois sold a system to the Midwest Christian Center. The Church is in the process of constructing a new 4,000 seat amphitheater. Innovative Communications of Columbus, Georgia installed OAP systems in the Columbus Civic Center. Lonnie Crenshaw was chief engineer. For nearfield seating two T-122s were suspended from four T-122s in a horn down configuration.

University Installs

University Sound has announced several new installations of its products. General Cinema Corporation has installed CS810-T ceiling loudspeakers in indoor theater lobbies and PA430T paging projectors in outdoor theater lobbies. The Orange and Rockland Utility Company's Lovett Power Generating Plant in Tompkins Cove, New York has installed 56 Cobraflex III horns and 24 PH re-entry horns. The Chateau Whistler Hotel in Vancouver is using the CS810-T distributed ceiling loudspeaker system.

Broncos Use Yorkville

Yorkville Sound has announced that the Denver Broncos is using Yorkville sound systems to amplify music performed by the Bronco Band at all home games. Jesse Gerardi of the Broncos is quoted as saying, "The Yorkville system is far superior to the \$250,000 built-in stadium." Yorkville is also being used at the annual Children's Hospital Festival of Trees in Buffalo.

Phonic Ear Award

The Alexander Graham Bell Association, a 100-year-old non-profit organization that helps people with hearing disabilities, honored several companies for their dedication. Among the honorees were Phonic Ear, Inc., Wells Fargo, Pacific Telesis, and Safeway. The award cited Phonic Ear as a leader in the development of equipment for people with speech, language, and hearing problems.



Rick Pimentel and Jim Mulford of Phonic Ear, with William Castel (center), president of the Alexander Graham Bell Association.

Electro Sound Relocates

Electro Sound is relocating its manufacturing operations to Sun Valley, California. The move allows Electro Sound, a Mark IV company, to share functions with Gauss, already operating in Sun Valley. Shared efforts will be in product technology development, administration and machine shop operations. New products in both audio and video are expected from Electro Sound.



Corning Announcements

Corning has made three product announcements: A miniature 1 x 4 planar fiberoptic coupler that is less than 1/100th the size of conventional devices; a family of directional couplers with achromatic optical performance; a single-mode optical switch that is virtually transparent to a network. Corning says all three products are suitable for a wide range of industrial and military applications.

Video Workshop To Be Built

Construction is starting on a video workshop at the U.S. headquarters of the McCann-Erickson advertising agency. The Workshop, designed and built by A.F. Associates, will be used to mock up video and print ads, make presentations, produce rough-cuts, audition talent and produce in-house communications for the 150 McCann agencies in 71 countries.

TimeLine Moves

TimeLine has moved its corporate headquarters from New York to California. Gerry Block, president of the company, said "We've built a significant international customer base, as well as a very solid domestic clientele. It was time to expand our design and manufacturing facilities." TimeLine has also announced that nine of its Lynx Time Code Modules under the control of the Boss/2 Automated Audio Editor from Alpha Audio are being used in Disney's new Circle Vision 360 films.

Bernie Gilmore (left) of Mitsui Futosan and Gerry Block, president of TimeLine in front of TimeLine's new headquarters in Vista, California.

Carver Award

Carver Corporation has received a quality award for Outstanding Achievement in the Pursuit of Quality from The Association for Quality and Participation. The Association is an organization of personnel from the manufacturing and service industries.

ITCA Awards Coherent

The International Teleconferencing Association has granted a Special Recognition Award for an Audioconferencing Product or Service to Coherent Communications Systems Corporation for the AC-1200 Echo Cancelling Audio System.

Infocomm Plans

Events expected at the Infocomm show in Orlando February 14 through 16 include a speech by Art Turock on ways to achieve a results driven business outlook. Turock's ideas have been featured in major magazines, and he has spoken to leading corporations. His talk will be called "Sustaining Exceptional Performance."

In addition, Louise Mandrell will perform at Orlando's Peabody Hotel at a banquet to honor Achievement Award winners on February 15. The Infocomm show, in Orlando, is sponsored by the International Communications Industries Association.

Cellular on Buses

Conway Bus Service of Cumberland, Rhode Island has outfitted its fleet of buses with Nynex Mobile Communications cellular telephones. The company operates tours.

Military Headset

Electro-Voice is now making available a military headset featuring "Active Noise Reduction" which, says the company, "substantially reduces high- and low-frequency ambient noise." The headset incorporates EVENR (Electro-Voice Enhanced Noise Reduction) and features the M162/AIC boom microphone that "greatly improves intelligibility" and provides total broadband noise attenuation above 40 dB. The active low-frequency attenuation can exceed 16 dB in the 5 — 700 Hz range.

WE'LL TAKE YOU THERE

VIDEO CASSETTES NOW AVAILABLE WITH FULL COVERAGE OF ALL THE INDUSTRY TRADE SHOWS IMPORTANT TO YOUR BUSINESS.

You and your key personnel can travel to the trade show on your VCR. Each video cassette contains 3 full days of on-the-spot show coverage of the people, products, and hottest news in the industry.

**DON'T MISS A THING!
ORDER YOUR TAPES TODAY.**

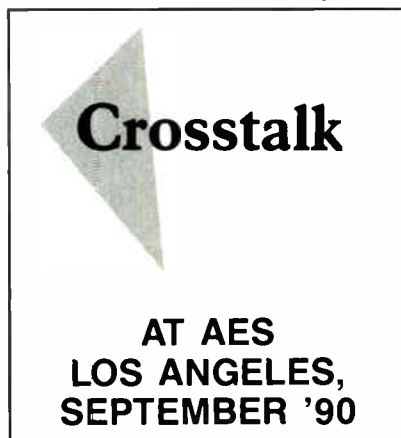

Please check the Show(s) you want.
First tape **\$49.95**; Additional tapes just **\$24.98** each

- NSCA-TV NEWS — Las Vegas**
Nat'l Sound & Communications Assn
Contractors Expo '90
- NAB-TV NEWS — Atlanta**
Nat'l Assn. of Broadcasters Show
- NAMM-TV NEWS — Chicago**
Nat'l Assn. of Music Merchants
- CROSSTALK, A Television Symposium**
Audio Engineering Society Convention, LA
- CES-TV NEWS — Chicago**
Consumer Electronics Show

All shows are independently produced by Testa Communications

Please send _____ tape(s).
1 Tape, **\$49.95**; 2 for **\$74.93**; 3 for **\$99.91**; 4 for **\$124.89**;
All Five for **\$149.87**.

Name _____
 Company _____
 Address _____
 City _____ State _____ Zip _____
 Telephone: _____
 Indicate payment method: (prepayment required)
 Credit Card # _____
 Visa MC AmEx Check Enclosed
 Expiration Date _____
 Signature _____

Mail to: **TV TAPES**, 25 Willowdale Avenue, Port Washington, N.Y. 11050

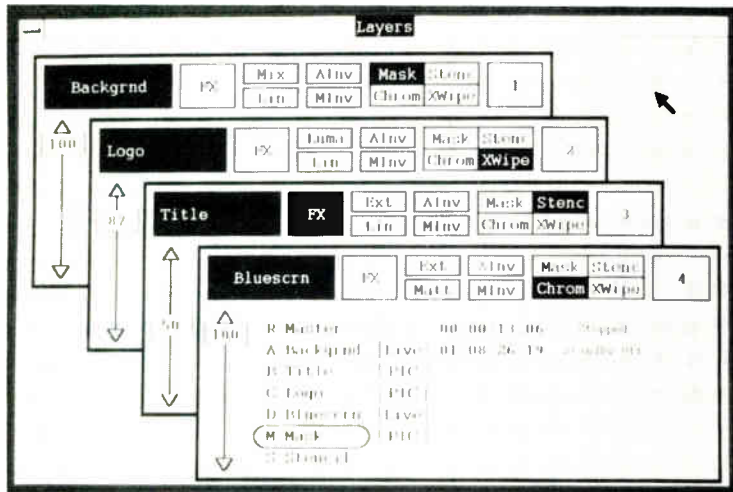

Compositum Layers Window

New Software for Compositum

Digital F/X has announced the 3.0 software release for its Compositum family of digital video post production systems. The new software adds a full-fledged four-layer digital switcher to the Compositum digital production suite. A rotoscoping menu and a curve-draw menu were also added to all members of the Compositum family of systems.

Building Addition

Winegard Company has begun construction on a building addition which will increase the company's warehousing capabilities by nearly 60 percent. According to Robert M. Fleming, vice president of marketing, "Increased product inventory will aid in leveling our production rates, which fluctuate seasonally."

Radios in the Desert

The radio industry has produced its first shipment of 2,000 radio receivers with batteries to U.S. Armed Forces in the Persian Gulf. The goal of the campaign, called "Air/Lift," is to provide 25,000 radio receivers.

Concurrently, the Electronics Industries Association, has donated 11,300 portable AM/FM radios along with 17,400 batteries to the U.S. Armed Forces serving in the Persian Gulf. The radios are being shipped to the USO for direct distribution to U.S. military personnel serving as part of Operation Desert Shield.

Sound Restoration

BMG/RCA Recording Studios is the first U.S. facility to order the CEDAR Sound Restoration System distributed in this country by Gotham Audio Corporation. CEDAR, which stands for Computer Enhanced Digital Audio Restoration, removes unwanted noise from both new or old and damaged recordings. CEDAR runs on a PC, using proprietary digital signal processors with floating point processors. End users can purchase the software processing modules — scratch removal, equalizer and noise reduction — separately.



DENTORI

T-Mark Offered

Belden Wire and Cable is offering the Japanese "T"-Mark on power supply cords for appliances and electronic equipment. Products with a T-Mark rating conform to the Dentori Law which regulates appliance and materials control in Japan. The approval is granted by Japan's Ministry of International Trade and Industry. Testing was conducted by Japanese Electrical Testing.

Interactive Voice Response

A new application integrating interactive voice response and voice messaging technology has been introduced by Missing Link Computer Technology. Developed for Eastman Kodak, the application enables callers to interact with Kodak's voice processing system. Employees considering retirement can register for benefits meetings over the phone. Employees with rotary phones are accommodated by an automatic voice message recording mode,

Toxic Torts

The "sick building syndrome" is being fought by a relatively new company, Air Quality Sciences, which, for a fee, studies a building's chemical emissions caused by the materials in it. "Toxic torts" is, according to Air Quality, viewed as one of the rapidly emerging law fields of the nineties. According to the company the telecommunications industry is at risk because indoor air quality is caused by volatile organic compounds passing through filters in networking equipment switching stations.

REP NEWS

New Office

George M. Conneen Company has opened a second office in Harrisburg, Pennsylvania, to be manned by Jack McCarthy. The Springfield, Pennsylvania company covers eastern Pennsylvania, southern New Jersey and Delaware, and has been operating for forty years.

Maddox Sales for Panduit

Panduit Corp. has appointed Maddox Sales Company as exclusive sales representative in Arizona and southern California. Maddox Sales is headquartered in Pico Rivera, California, and has a regional office in Phoenix. John Maddox is president and Jack Keefe is manager in Phoenix.

Wilson Reps Hill

Hill Audio has signed Wilson Audio Sales to represent Hill's line of mixing consoles and power amplifiers. Wally Wilson has offices in Nashville and Sevierville, Tennessee and is opening an office in Alabama. Wilson represents Hill products in Georgia, Alabama, Tennessee, Mississippi and the Carolinas.

BBE Appoints

BBE has appointed Ron Tunks Sales as BBE's representative in the southeast, including Florida, Georgia, Alabama, Mississippi, Tennessee, North Carolina and South Carolina. Ron Tunks, Joe Wilson, Jim Greenhill, and Chuck DiModica are responsible for BBE in the MI, pro audio and sound contracting fields.

Eastman Reps

Eastman Wire & Cable has appointed seven firms as manufacturers' representatives for the company. The firms include: The MacInnes Company (for New England); CSA (for Florida, Caribbean and Bahamian Islands); Termatech Electronics Marketing (for Minnesota, North Dakota, South Dakota, Wisconsin and Iowa); Cavendish and Winchester (for Georgia, Alabama, Tennessee, North Carolina and South Carolina); George Zouboulglou in Greece; Cardkey Locks in New Zealand; and Shamrad Electronics in Israel.

RPG Announces

RPG Diffusor Systems has appointed Greg Hockman of Seabridge Audio Marketing as manufacturers' representative for California, Nevada and Arizona. In announcing the appointment, Dr. Peter D'Antonio, president of RPG, said, "A dramatic increase in sales in southern California has made it necessary for us to provide a knowledgeable applications engineer in the field." Hockman also offers TEF measurement capability.

YSA Technologies Signed

Fiberoptic Communications Corporation has signed an agreement with YSA Technologies in Dallas to represent Fiberoptic Communications in the southwest as the "source for practical hands-on training in testing, splicing, installation and maintenance of fiber systems."

TMC Appointed

TMC Sales Corporation of Fort Lee, New Jersey, has been appointed factory sales representative for Bib America. The announcement was made by Ken J. Messina, president of TMC Sales. The rep company has a sales force of 10, has been in business for 27 years, and covers New York City, Long Island, lower Westchester, Rockland County and northern New Jersey.

The Digital Plan Measure

A Tool for Speeding Coordinate Take-Offs from Prints

BY MIKE KLASCO

When I receive a set of prints, I first look them over to get an idea of what I am in for. Secondly, I need to make some measurements off the drawings. If I am at my office, I could use a mechanical drafting system to determine the coordinates of interest. The data of interest would be ceiling height and other elevations, room length and width, locations of seating areas and ear heights, speaker mounting points and distances between possible speaker cluster locations and seating locations. For calculation of reverberation time, the room surface area and volume must be determined, as well as a dozen other measurement chores.

When I am working away from my office, or if the mechanical drafting system is buried under layers of debris (which happens when you have converted over to a CAD system), I can mark up the axis of the prints with a ruler or architectural scale. Of course the print already has been dimensioned by the architect, but sound contractors and acoustical consultants are interested in speaker locations, distances to ear height, wire runs, and various other coordinates that have yet to be determined (I hope!) before the drawings get to us. Where this is leading to is a neat, compact, and relatively cheap tool that simplifies and speeds take-offs from architectural and engineering drawings. Called the digital plan measure, it consists of a handheld device with a roller wheel that you glide along any line or curve, or between any points, that you want to scale. You set the

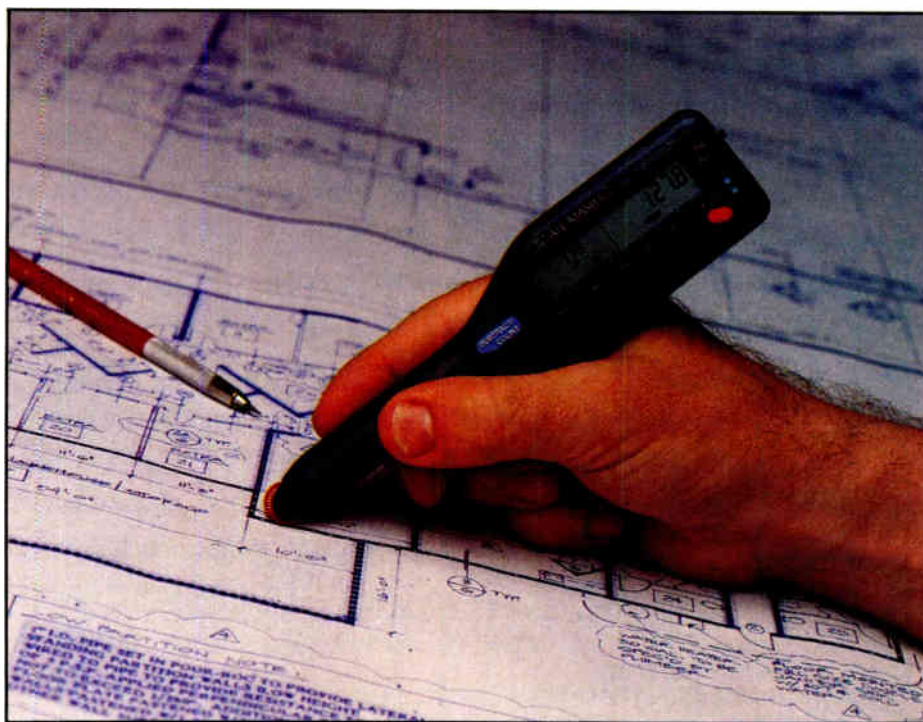

Calculated Industries' Scale Master; a digital plan measure.

scale: architectural scales, engineering scales, metric, etc., and then glide the probe's wheel along the path of interest and read the distance on the display.

Digital plan measures are new, and so far I have only seen a few products. A relatively inexpensive one is made by Calculated Industries. This firm also has developed a very good rangefinder and a unique Contractor's Calculator. Both of these were discussed in our survey of rangefinders [Sound & Communications, May 1990] and included in Tom McCar-

thy's followup field test [Sound & Communications, July 1990]. The second digital plan measure we will look at is from Trade Services Corporation. It is a more expensive device with a couple of very advanced features.

THE SCALEMASTER

The ScaleMaster is a small handheld multi-scale digital plan measure, with dimensions of $6\frac{3}{4}'' \times 1\frac{5}{8}'' \times 5.8''$ and weighting only 2.5 oz. This unit is targeted against conventional dial-faced measures.

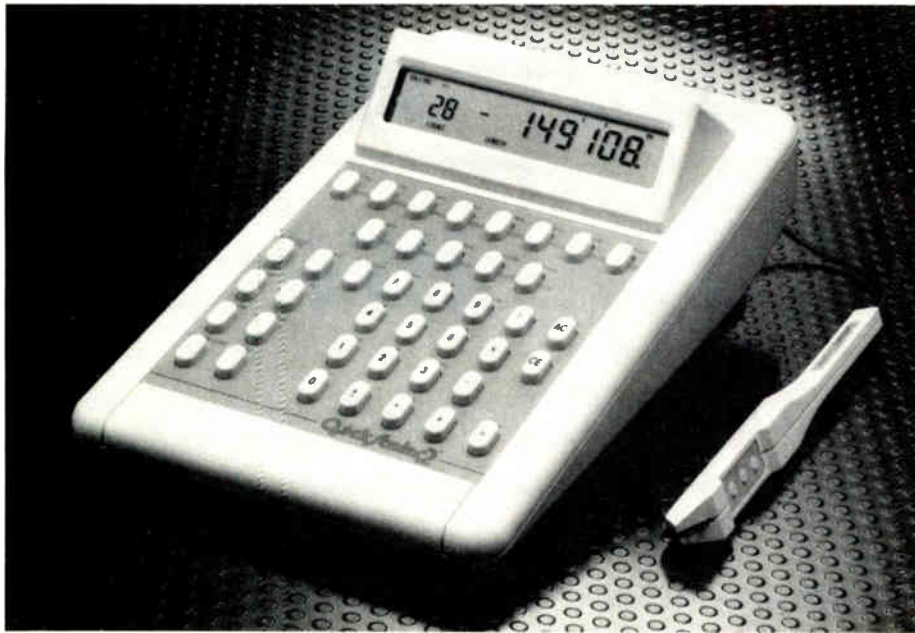

The QuickScaler2 from Trade Service Corporation.

If you are familiar with the mechanical type measures then you know that they are awkward to read and you need at least a set of them, as each only covers a couple of scales, while the ScaleMaster has 42

pre-programmed scales. Although mechanical measures are cheaper than the ScaleMaster, the combined cost of two or three conventional measures would be more than the ScaleMaster. One unique and extremely useful capability of the ScaleMaster is its custom scale feature. This allows compensation for prints that have been "shrunk." If you are like me, you get prints that are generations away from the original and often in reduced size. With the ScaleMaster, you only have to calculate the reduction factor once, enter it, and start to measure.

Description

A lock/unlock switch on the side of the device prevents the user from inadvertently toggling the scales during operation. A clicker (which you can turn off) provides an indication of accurate operation. The instrument also finds rectangular areas and volumes, converts between scales and dimensions, has a built in counter, and includes a custom scale feature that lets the user define and roll in any scale. Its memory stores linear area and volume.

The Display

The display is sectioned into two areas: the main display which shows the rolled distance, and the scale display, which shows the current mode and scale.

Next to the display is the subtract/count button which performs two functions. Pressing it while rolling subtracts the rolled distance from previously rolled distances or from zero. Secondly, in the count mode,

it is used to increase the count.

Beneath the display are six more buttons:

- Mode, which sections architectural, engineering, map (larger engineering), metric, custom and count.
- Scale, allows scrolling the scales available within the selected mode.
- M+, adds displayed value to the memory and clears display to 0.

If you are like me, you get prints that are generations away from the original and often in reduced sizes.

- M*, multiplies displayed value by the contents of the memory. This is handy to find areas and volumes.

- M-R/C, pressing once displays the contents of memory without clearing. Pressing twice clears memory.

- Reset, used to reset the display.

Other special functions can be switched by pressing the subtract/count button simultaneously with one of the five buttons, such as turning the clicker on or off, meters or feet, feet-inches and decimal-feet, etc.

The display is sectioned into two areas.

This is truly a wonderful gizmo. If you have switched over to a computer-aided drafting system, then the ScaleMaster eliminates the vestigial functions that had remained for your mechanical drafting system. A digital plan measure is the perfect adjunct to all of the sound system engineering software programs.

On a recent job, the end walls of an arena were curved off a changing radius. Normally, determining the surface area would have required a piece of string laid over the curved line and then straightened out next to a scale and then multiplied by the height. With the ScaleMaster, I quickly

When You Need It
We've Got It

Switchcraft®
A Raytheon Company

- JACK PANELS
- AUDIO CONNECTORS
- PLUGS AND PATCH CORDS
- MULTI-SWITCH® SWITCHES

WE STOCK THE COMPLETE SWITCHCRAFT LINE

**Cal Switch
(800) CAL-SWCH**

13717 S. Normandie Avenue
Gardena, California 90249

Circle 288 on Reader Response Card

rolled over the curved line and got my number. Everything works as claimed, I am delighted with the ScaleMaster, and so far, I have not been able to find anything to criticize.

(Calculated Industries, Inc. 22720 Savi Ranch Parkway, Yorba Linda, CA 92686).

I quickly rolled over the curved line and got my number.

THE QUICKSCALER2

Trade Service Corporation is better known to electrical contractors than sound contractors. In this one instance, we should not hold this against them. They have a complete line of software to aid a contractor in estimating jobs and tracking jobs; and interfacing these are related programs with accounting systems. (A case study report on the relevance of these programs for sound contractors is now being prepared.) To further speed the job estimating process, Trade Service has introduced the QuickScaler2 at \$495. The QuickScaler2 is battery operated, about the size of a small desktop calculator (2 inches x 5 inches x 8.5 inches) with a separate take-off probe. Aside from the functions of the ScaleMaster reviewed above, the QuickScaler2 can output data directly to your printer, interfaces with your computer, and has a wide range of calculator functions (and a full calculator keyboard). Additionally, the QuickScaler2 has a number of functions useful to contractors for calculating wiring installation, such as adding Drops and Risers at a press of a button.

The Scaling Probe

The QuickScaler2 probe has three buttons which allow counting, adding (predefined lengths), and clearing. The probe measuring wheel scheme is essentially the same as the ScaleMaster, although by splitting the functions between a main unit and probe, the probe becomes thinner while many more functions can be added to the main unit, as well as a much larger

data display (and a four times higher price!).

The Main Unit

Keys on the QuickScaler2 allow you to indicate the type of measurement: length, width, height, and the scale to be used. Units such as inches, feet, yards, or meters can be selected. Conversion to different units of measure is at the touch of a button. Full calculator functions are built into the main unit.

The display area indicates current count and measurement while the take-off is being performed. Take-off calculations are stored in the unit's 247 memories, which can be accessed and reviewed at any time. The QuickScaler2 is obviously a more am-

Conversion to different units of measure is at the touch of a button.

bitious device than the ScaleMaster. The QuickScaler2 is both battery operated and AC (with external power supply/recharger, included). Field measurements can be recorded in memory without requiring the operator to prepare written documentation, and then transferred into a CAD program directly at the office.

The QuickScaler2 will directly interface with any parallel printer, providing hardcopy of your data.

Computer Interface

The QuickScaler2 interfaces with a computer through a serial port. An optional 25 foot interface cable is available. Data output of the device is in ASCII format which is about as standard a data export format as you can get. Trade Services supports the QuickScaler with its ALEC Estimating Software (which will be reviewed by us in the first quarter of 1991) and already sells the QuickScaler2 to other software developers for use with their programs. One hopes a few sound system engineering software developers will get hold of this device and take advantage of it as it would greatly speed creation of the

room model.

(Trade Service Corporation, 10996 Torreyana Road, San Diego, CA 92121).

CONCLUSION

In some ways a digital plan measure is similar to a graphics tablet/stylus, but the

In this one instance, we should not hold this against them.

plan measure is not size-limited as graphic tablets. Large D or E size graphic tablets are expensive, and constantly realigning large drawings on small tablets is a pain. On the other hand, a digital plan measure can only indicate distance, not the direction of a line or point by point coordinates of an arbitrary curve. The ScaleMaster is a handheld without an umbilical cord, so it is not limited by drawing size. The QuickScaler2 has a 7.5 foot cord, which ought to be enough! Unfortunately, at times you lose the confidence factor of your readings as the display is only on the main unit and cannot always be monitored when you are at the far reaches of a large print.

Mechanical plan measures for maps have been around for a long time, but have limited scales and can be awkward to read. The Trade Service QuickScaler 2 is a very sophisticated digital plan measure, is the size of a telephone, but costs about \$500, and many of the advanced features such as computer interface are not supported by the sound system CAD programs. Alternatively, at \$125, the ScaleMaster hand-held digital plan measure is a very cost effective and convenient solution to the tedious chore of coordinate take-offs from prints, although there is no hardcopy or potential of direct data transfer to your computer. I know of no other handheld units that exist besides the ScaleMaster, and there are only a few other two-part devices that compete with the QuickScaler2. Depending on your budget, either would be a useful addition to your drafting system. ■

PRODUCTS

Yamaha and JBL Announce Amps; E-V Intros Mic Mixers

Pro Amp

The Professional Audio Division of Yamaha Corporation of America announced the PC4002M professional power amplifier. The amp is designed for sound reinforcement and studio applications.

The PC4003M delivers 700 watts per channel into 4 ohms, or 430 watts into 8 ohms stereo, and 1,400 watts in BTL — monaural configuration. It features twin power supplies and transformers and has a separate power supply for the input stage.

Circle 1 on Reader Response Card



Speakers and Amps

JBL Professional has recently introduced new lines of amps and loudspeakers. The SR4700 series loudspeakers consists of six models featuring titanium diaphragm compression drivers with surround, 'bi-radial' horns and vented gap cooling low frequency transducers.

The SR series of power amplifiers consists of three models that use Urei design philosophy as well as a cooling fan that continuously varies speed according to operating temperature.

Circle 2 on Reader Response Card

Auto Mic Mixers

Electro-Voice has introduced a series of automatic microphone mixers for use in meeting rooms, convention centers, churches and for teleconferencing. The 2500 series four-input models 2504 and 2505, and eight-input models 2508 and 2509. They provide a switch selectable "last-on" feature, in addition to two channels with individual bass and treble controls, and remote of auxiliary and master inputs.

The 2504 and 2505's seven inputs and the 2508 and 2509's 11 inputs consist of automatic gating inputs with tone controls, a non-gating unbalanced auxiliary line input, a background music input and a paging applications input.

Circle 3 on Reader Response Card

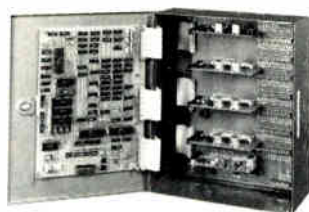

Access Control

Galaxy Control Systems has announced the model 260 Access Control unit. Each 260 controller can support up to eight access points. Multiple units can be networked together for control of up to 800 points of entry. The modularly designed unit also contains built-in surge protection. In addition to access control functions, the 260 can be used to control and monitor equipment such as HVAC, lighting, alarms and elevators.

Circle 4 on Reader Response Card



Dry Cases

Underwater Kinetics has introduced the Kinetics 822 and 827 Dry Case. The cases are constructed of injection molded, ABS/Polycarbonate, are waterproof to 30 feet and are designed to protect larger instrumentation and delicate equipment.

Circle 5 on Reader Response Card

Sweep/Function Generator

B&K Precision has introduced its Model 3040 13 MHz universal sweep/function generator with six digit 30 MHz frequency counter. It includes a second variable signal source for sweeping the main generator, generating the burst gate, modulating the generator by AM or FM or for use as a second, independent output.

Circle 6 on Reader Response Card

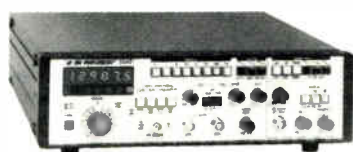

Dual-Transport CD

Numark has introduced the CD5020 dual-transport professional CD player, designed for professional CD mixing at an 'entry level' price. The CD5020 consists of a separate control unit and transport module that houses two CD player drives.

Both components are rack-mountable. The unit features duplicate function controls and display indicators for operating and monitoring each CD transport.

Circle 7 on Reader Response Card



Compact CCTV

The Javelin JE8042 Mini-Trak is a single package containing a 4-inch dome, 1/2-inch CCD camera, auto iris lens, pan/tilt and audio microphone. Intended for use with Javelin's Omni systems, the Mini-Trak is controlled by the system through a JO216DCU accessory control unit.

Circle 8 on Reader Response Card



Coax Multi-Use Loudspeakers

Atlas/Soundolier has introduced its SEQ coaxial loudspeaker series for churches, shopping malls and boutiques, school auditoriums and multi-purpose rooms, as well as custom residential audio systems.

These surface mounting loudspeaker systems are available in 25, 50 or 65 watt power options and incorporate four-, eight- or 12-inch diameters low frequency woofers plus independent high frequency drivers.

Circle 9 on Reader Response Card

Acoustical Barriers

Illbruck, Inc. of Minneapolis has introduced a line of barrier and composite materials. These materials are designed for applications where transmission loss and noise reduction are required.

ProSPEC Barrier is a loaded one pound-per-square-foot vinyl sheeting for isolating noisy equipment. ProSPEC Acoustical Foam is a one-inch polyether foam with a polyurethane film facing and a pressure-sensitive adhesive backing, designed for lining enclosures and other applications. ProSPEC Composite, which claims both transmission loss and absorption properties, is a vinyl barrier sandwiched between one inch of polyether acoustical foam with a polyurethane film facing and a 1/4-inch foam decoupler with pressure-sensitive adhesive backing.

Circle 10 on Reader Response Card

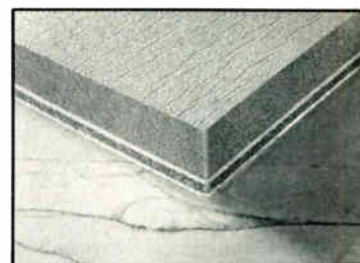

VGA Splitter

The VGA-DA has been announced by FSR, Inc. The unit splits the computer VGA output to drive an existing monitor via a 15-pin high-density connector, as well as providing five BNC connectors for a projector or switcher. The unit comes with a UL-listed power supply.

Circle 11 on Reader Response Card



Live Console

Soundcraft has added the Delta Monitor to its line of consoles. Designed for live applications, the Delta Monitor incorporates the chassis of the 200 Delta and Venue consoles with and operates as a 12-bus stage monitor mixer with up to 40 inputs.

Input features include balanced mic and line inputs. The monitor outputs each have two sweepable notch filters with separate ON switches. The master section has external communication capabilities in its talkback routing.

Circle 12 on Reader Response Card

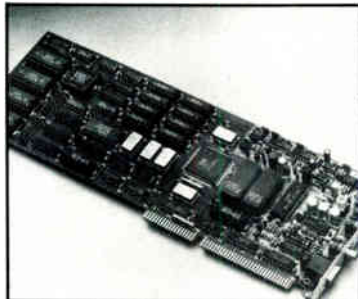

Board For Presentation

Antex Electronics Corporation has introduced the AV-16 "Audiographics" add-in board for IBM PCs and compatibles which integrates digital stereo audio output, extended VGA graphics and NTSC compatible video output on a single card.

The AV-16 card integrates an extended VGA graphics adapter, a stereo digital audio playback subsystem with 4:1 com-

pression and standard NTSC composite video output. The three functions are integrated on a single card which fits into the expansion slot of any IBM-AT, PS2 Model 30 or 286/386 compatible.

Circle 13 on Reader Response Card

Infrared Interface

Audioaccess has demonstrated a pre-production prototype of the SEI infrared interface module. The SEI will memorize the infrared command codes for any piece of source equipment and will 'play back' the infrared code streams to an infrared LED that will in turn trigger the sources. The installer will teach the SEI the correct codes by use of remotes that are provide with source equipment.

Circle 14 on Reader Response Card



Voice Announce System

Corby Industries, Inc. has announced the Programmable Voice Announcer. The PVA is an audio digital recorder with no moving parts. It contains four megabytes of memory which can store one 128-second message, two 64-second messages, four 32 second messages or eight user-created messages. The PVA is designed to enhance or replace announcement devices such as bells or buzzers used with security systems, sound and communication systems or anywhere automated voice messages are required.

Circle 15 on Reader Response Card

CLIFF ELECTRONICS... A Contact You Can Count On

There are some solid reasons to make Cliff Electronics your #1 audio contact.

Worldwide Reputation

Whether it's across the Atlantic, Pacific, or right here at home, Cliff products are designed and tested for almost any environment and application.

A Sense for Service

Satisfaction assurance—No hassles. If this is what you're looking for in a supplier make the Cliff contact today!

Quality Selection

Over 225 quality components are available, each matched to the standards of the most demanding application or budget requirement.



Speakers • Jack Sockets • Cabinet Hardware • Connectors • Test Probes • Power Inlet Sockets • Terminal Binding Posts

CLIFF Electronics

Robert Tupper
9821 Whithorn Drive
Houston, TX 77095
(713) 855-6685
(713) 855-6684 FAX

Circle 251 on Reader Response Card



Concert Sound

The TopFly loudspeaker from Outline is a controller assisted, two-unit, three-way full-range speaker system contained in medium-sized trapezoidal-shaped enclosures.

The low frequency unit is based on an 18-inch long excursion ferrofluid cooled woofer loaded by a hybrid design. The unit claims up to 800 watts of continuous power producing 132 dB of maximum spl.

The medium/high frequency unit contains two fiberglass horns of equal dimensions that are interchangeable to accommodate various factors involved in array design.

Circle 16 on Reader Response Card



CCD Cameras

Cohu, Inc., Electronics Division has announced the 8200 series color CCD cameras. Available in NTSC/Y-C and RGB models, the cameras provide resolution in excess of 460 TV lines. The cameras also provide sensitivity of 1.1 lux at 80-percent video with AGC on, an eight step electronic shutter, and side panel access to AGC, color balance and other adjustments.

Circle 17 on Reader Response Card

Full-Duplex Teleconferencing

NEC America Inc.'s Data and Video Communication Systems Division has announced VoicePoint, an audio teleconferencing unit for simultaneous multi-line communication without the need for microphones and telephone speaker phones. The system allows for simultaneous communication involving any number of people.

Circle 18 on Reader Response Card

Compact Audio

The Anchor Audio Mini-Vox is a five pound compact audio system designed for outdoor situations such as guiding tours, controlling crowds and officiating at sports events. The unit is packaged in polyethylene and can be handheld or carried over the shoulder. Features include auxiliary output and "signal alert" option to activate a siren-like sound.

Circle 19 on Reader Response Card



FCC Approves UHF

The Vega Pro Plus UHF wireless microphone system has been granted authorization by the Federal Communications Commission and is now available.

The UHF system is part of the Series 600 line and includes the R-662 receiver and T-677 transmitter. It features Dynex III audio processing and dual-receiver diversity operation. Options include a rack mount adaptor and several types of remote antennas.

Circle 20 on Reader Response Card



Digital Effects System

Lexicon has introduced the LXP-15, a multi-effects system that combines MIDI effects automation and remote control, effects and user interface. Functions are controlled from the front panel with a switch, an adjustment knob and a soft-key controlled display.

The LXP-15 incorporates Lexicon's Dynamic MIDI, which provides remote control of its 27 variable parameters. It also provides remote functions without the need for MIDI.

Circle 21 on Reader Response Card

Amplifier Module

SMC International has introduced the ML-2.5, a small 2.5 watt audio amplifier PC board that can be factory or field added to NT-1 and NT-1A SCA tuners. It can also be installed in other SCA tuners where there is a limited amount of available space.

Circle 22 on Reader Response Card

Universal Counter

Tektronix has introduced the CDC250 universal counter. The dual-channel instrument will count signal frequency of sine, square and triangle waves from 5 Hz to 175 MHz at input levels from 20mV to 24V peak. The unit also provides period measurements, frequency ratio, time interval and totalize measurement functions.

The CDC250 can function as a stand-alone calibration tool or as a "rack-and-stack" component of a complete test bench set up.

Circle 23 on Reader Response Card

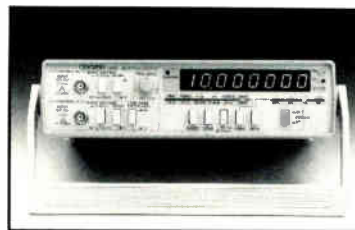

Vibration Analyzer

Computational Systems Incorporated has introduced the Model 1900 Vibration Analyzer. The 1900 is a vibration measurement and analysis tool that is meant for quick assessments of machinery conditions. Results are displayed in spectral and waveform displays.

The 1900 features built-in analog integrators to convert from acceleration to velocity, acceleration to displacement or velocity to displacement. In addition, measured data is stored in 63 kB temporary "working" memory.

Circle 24 on Reader Response Card



Teleconferencing Systems

MultiLink, Inc. has announced a series of "intelligent" audio teleconferencing systems designed for high-capacity applications. These include two high capacity bridges in the Linx product line: the ACN-96 which provides up to 96 ports per node with up to four operators handling up to 36 conferences; and the ACN-192 which provides up to 192 ports per node with up to four operations handling up to 48 conferences.

Circle 25 on Reader Response Card

Rackmount Monitor

The AMP-1A from Wohler Technologies is an upgraded version of the AMP-1 powered rackmount stereo audio monitor. The AMP-1A's design consists of three amp/driver combinations: two for mid-range and high frequency material in stereo and a third center channel for summed low frequency information. It comes in a single rack unit size and has a frequency response of 80 Hz to 15 kHz +/-7dB.

Circle 26 on Reader Response Card

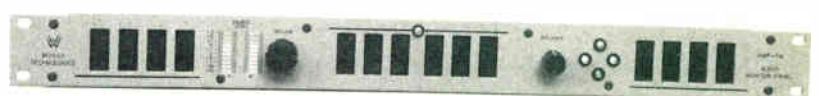

LITERATURE

Telex Headsets; Crest Healthcare

Two-Way Radio

Information about professional two-way radio communications headsets is available from Telex Communications, Inc. The brochure contains information on how to select a headset. A number of models are shown from very light weight to high-noise attenuating headsets including a model that fits under a helmet.

Circle 27 on Reader Response Card

Healthcare Maintenance

Crest Electronics has announced a catalog of replacement parts and equipment for healthcare facility maintenance. The 220-page catalog features replacement parts and components for hospitals, nursing homes and medical clinics.

The catalog illustrates products including pillow speakers, replacement cable assemblies, momentary and locking cordsets, bed controls and motors, medical items, general maintenance, fire protection and security and surveillance. In addition, an eight-page section of healthcare TV system components is included.

Circle 28 on Reader Response Card



Audio Interfacing

Marshall Electronics has introduced its 1990-91 catalog for the industry. The catalog features a variety of component parts for interfacing both professional and industrial audio and video equipment. Included in its 48 pages are connector, cable assemblies, installation accessories, panel assemblies and patch bays.

Some items include BNC panel connectors with built-in termination switches that operate automatically when inserting a mating plug, molded patch cords that can be made in any color and RCA and panel jacks that come in strips of up to eight across. The catalog also features Marshall's line of High-Definition Video coaxial cable assemblies.

Circle 29 on Reader Response Card

Tools and Testing

The 1991 Master Catalog from Jensen Tools features quality products for computer/electronic service and repair. The catalog contains 232 pages of tools, tool kits, test equipment, cases and shipping containers.

Other products include LAN equipment and diagnostics, soldering/desoldering supplies, power analyzers and regulator/adaptors, work holding devices, lighting and optical aids and ESD protection.

Circle 30 on Reader Response Card



Communications Equipment

The 1990-91 edition of "The Equipment Directory of Audio- Visual, Computer and Video Products" is now available from the International Communications Industries Association (ICIA). The directory lists over 2,500 products from more than 200 categories of audio-visual, video and computer-based equipment.

Circle 31 on Reader Response Card

Test Chart

Burle Industries, Inc. Tube Products Division has issued the P200 Test Chart for measuring camera-tube resolution. The chart is designed to provide resolution measurements and is designed to be used with a line-selector oscilloscope so that the location of the line being used can be shown on the picture monitor. It contains blocks of lines representing TV line patterns extending from 28 to 1600 TV lines per picture height.

Circle 32 on Reader Response Card

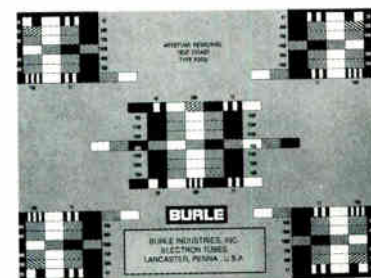

Engineering Applications

JaBro Batteries, Inc. has announced the availability of a catalog designed for use by design engineers involved in projects requiring the use of a rechargeable battery.

"O.E.M. Battery Guide Selector" lists over 150 batteries currently manufactured by JaBro, arranged in ascending order by voltage and electrical capacity.

Circle 33 on Reader Response Card

Headphone Catalog

Sennheiser has introduced its Stereo Headphones catalog subtitled "A music lover's privilege." The catalog contains descriptive and technical explanations of Sennheiser's headphone products including its wireless series.

Circle 34 on Reader Response Card

Electronics Catalog

Newark Electronics, a Premier Industrial Company, has published a 1280-page electronics catalog, Catalog 111. The catalog contains technical information and dimensions on more than 100,000 products from 250 manufacturers.

Features include expanded Surface Mount Devices section and an indexed Premises Wiring Products section.

Circle 35 on Reader Response Card

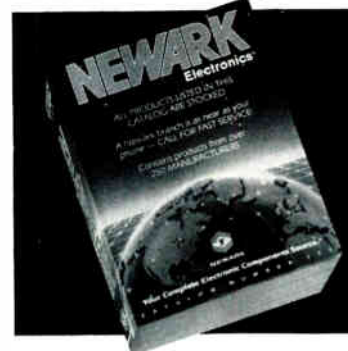

Communications Module

An eight-page, four-color brochure describing Hubbell's new multi-port Networker surface-mounted premise module with up to 30 different face plate combinations for handling a wide variety of voice, video and data communications in offices has been published by the Kellums Division.

In addition to product features and an exploded view of the Networker communications module with callouts, the brochure describes installation options, outlines order information and illustrates the various Networker faceplate configurations.

Circle 36 on Reader Response Card

Piezoelectric Alarms

Murata Erie North America is offering a 20-page catalog describing its line of Piezoelectric Audio Alarms. Performance and mechanical specifications are included as well as application information.

Circle 37 on Reader Response Card

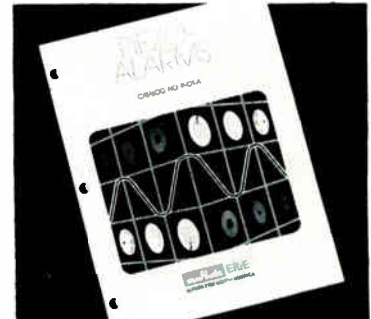

Video Furniture

The Winsted Corporation has published its 1990 catalog of video furniture. The full-color, 108-page catalog includes the company's line of video cabinets and consoles, tape and film storage systems and accessories.

Featured in the catalog is Winsted's Pro Grey System/85 line of modular furniture. Other new products include modular editing and post production consoles, custom wood consoles, tape storage systems and A/V carts. FOTO: LIT-3 (WINSTED)

Circle 38 on Reader Response Card



Satellite Interference

Electronic Specialists has announced the availability of a satellite reprint entitled "Curing Satellite System Electrical Interference & Interruptions." Sources of interference, interruptions, and possible damage are described in the article. Steps that have been successful in preventing these problems are also suggested. Both winter and summer conditions are discussed along with problem solutions.

Circle 39 on Reader Response Card

ADVERTISER INDEX

Company	Page	RS #
ART-Applied Research & Technology (716) 436-2720	CIII	204
Audio Systems — Audsco (800) 852-6522	49	283
BBE Sound (714) 897-6766	15	289
Biamp Systems (503) 641-7287	17	240
Cal-Switch (800) CAL-SWCH	70	288
Cliff Electronics (713) 855-6685	73	251
Community Light & Sound (215) 876-3400	35	252
DB Systems (603) 899-5121	77	265
Electro-Voice (616) 695-6831	CVRII	202
Frazier (501)727-5543	59	241
Infocomm International (703) 273-7200	45	212
IRP Professional Sound (708) 640-9553	10-11	203
JBL Professional (818) 893-8411	CIV	205
Lectrosonics (800) 821-1121	26	239
Mehlich Electronic's (919)832-4292	49	282
Mellotone (803) 839-6341	77	270
Menlo Scientific (415) 528-1277	53	253
Mircom Communication & Security (416) 665-4301	47	250
Modular Audio Products (800) 333-7697	77	271
Multiplex Technology (714) 996-4100	23	254
Music Supply Co. (800) 527-1522	77	267
Numark (201) 225-3222	18	257
Opamp Labs (213) 934-3566	77	268
Quam-Nichols (312) 488-5800	8	201
Riser-Bond (402) 694-5201	60	258
Samson Technologies (516) 932-3810	24-25	206
Shure Brothers (708) 866-2553	31	207
Sonic Systems/Soundsphere (203) 356-1136	36	255
Syn-Aud-Con (812) 995-8212	14	256
TekTone Sound & Signal (407) 844-2383	51	208
Telecall (800) 752-2860	5	209
True Image (619) 480-8961	77	269
TV Tapes (516) 767-2500	67	—
University Sound (818) 362-9516	12	210
West Penn Wire (800) 245-4964	3	211

FREE INFORMATION

Use the Reader Service Card opposite page 22. Just circle the RS# of products that interest you. Detach, and Mail!

HELP WANTED

NATIONAL SOUND AND MUSIC COMPANY System Sales Opportunity

National company seeks sales individuals that have a background and knowledge of sound, CCTV and video system sales. Blueprint and system design capabilities is a must. We are looking for career minded individuals in the L.A., San Francisco, Chicago and Charlotte, North Carolina markets. If you would like to explore an outstanding opportunity, please send a resume and salary history to:

Jim Sorenson,
900 E. Pine,
Seattle, Washington 98122.
All responses considered confidential.

SOUND SYSTEM DESIGN AND SALES

for expanding independent Dukane distributor for Michigan and Ohio areas. Seeking individual experienced in the design, layout and bidding of commercial sound systems and nurse call systems. Salary, commission and benefits. Reply to:

Sound & Communications Classifieds
Dept. 121
25 Willowdale Avenue
Port Washington, NY 11050

JAFFE

ACOUSTICS, INC.

a leading consultancy in the fields of acoustics, sound system and audio/visual design is seeking two experienced designers, one each in the areas of sound system design and audio/visual design. Successful candidates will have experience of 5 years or more. CAD skills and previous project management expertise will be a plus in any applicant. Salary commensurate with experience. Benefits include hospitalization/major medical plan. If interested, send resume w/ salary history and references to:

Paul Scarbrough
Jaffe Acoustics
114A Washington Street
Norwalk, Connecticut 06854
Jaffe Acoustics is an equal opportunity employer.

ACROMEDIA CORPORATION LOS ANGELES, CALIFORNIA

Established electronics contractor seeks systems engineer to work on variety of projects. Experience desired, but will also train.

Call Mr. Ferreghy at 213/410-4141.

Your Professional Connection

For Quality Response Use the

MARKETPLACE

ACOUSTICAL / SOUND AND TELEVISION SYSTEMS ENGINEERS

Major audio-visual consulting engineering firm is seeking engineer to design acoustical

EQUITY/OWNERSHIP SITUATION WANTED

Two individuals with strong technical experience in sound system design seeking equity or total ownership in a business.

SOUND SYSTEM DESIGN AND SALES

for expanding independent Dukane distributor for Michigan and Ohio areas. Seeking individual experienced in the design, layout and bidding of commercial sound systems and nurse call systems. Salary, commission and benefits. Reply to:

FOR SALE

Ref System 12 — upgraded with battery backup, extensive software including many programs Mic. stand, printer cables. Must sell. Call 416-6600

SITUATION WANTED

Experienced audio professional seeking related business opportunities in VA. Formal training in engineering and sound. pro sound h

WANTED

ELECTRONIC SERVICE TECH
Established Clientele Excellent Opportunity
Contact n

MANUFACTURER'S REPS

Leading manufacturer of Horn/Speaker Assemblies and Baffles seeks

Every Month in Sound & Communications

MARKETPLACE

Test CDs from ASA, *Audio* (Germany), CBS Labs, Chesky, Denon, EBI, HFN/RR, Japan Audio Society, Philips, Pierre Verany, Prosonus, Sony, and others available from **DB Systems**, Main Street, P.O. Box 460, Rindge Center, NH 03461-0460. Phone (603) 899-5121. fax (603) 899-6415. VISA/MC accepted.



Circle 265 on Reader Response Card

BUSINESS OPPORTUNITY

BUSINESS OPPORTUNITY

Specialized Southern California Altec Sound System Contractor wishes to sell business. Established for 35 years. Many expansion possibilities in a fast growing area. Flexible terms. Please respond to:

Sound & Communications
Dept. 91
25 Willowdale Avenue
Port Washington, NY 11050

BUY • SELL TRADE

"We pay **CASH** for **SURPLUS INVENTORIES**. Obsolete, overruns, buy-backs. Consumer items. Capital equipment and trade supplies.

J.C. VAN WACK
1733 Helsinki Way, Livermore, CA 94550
415-449-7139 Fax 415-449-3909

CLASSIFIEDS GET RESULTS

For rates and information, please call

(516) 767-2500

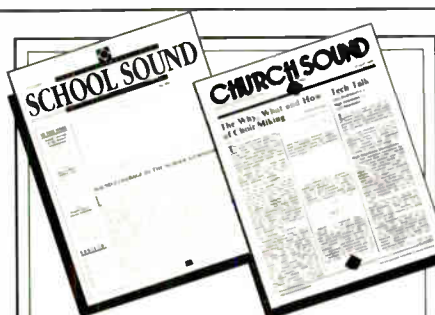

How to Publish Your Own Newsletter Without Doing Any of the Actual Work.

Newsletter Marketing for Sound Contractors. Proven and affordable. Exclusive territories are available.

For more information call
(612) 231-2122
FAX (612) 231-1147

I am interested in: Churches Schools

Name _____

Company _____

Address _____

City _____ State _____ Zip _____

Phone _____

Huisinga & Olsen Publishing, Inc.
P.O. Box 53 Willmar, MN 56201

Circle 266 on Reader Response Card

FREE 56-PG CATALOG

Complete line of audio modules and accessories for all engineered sound & broadcast applications

MODULAR AUDIO PRODUCTS
1-800-333-7697 • 516-345-3100 • FAX 516-345-3106
DIV. OF MODULAR DEVICES INC. • 1 IRONED RD. • SHIRLEY NY 11967

Circle 267 on Reader Response Card

Free Catalog & Audio/Video Applications

Routing Switchers (S1-A/V) (24, 16, 12, 8, 4, 2 stations)
Video & Audio Dist. Amps.
RGB-Sync Dist. Amps.

Mic, EQ, Line, Tape, Phono, Osc. Trans., Video, ACN, Pwr. Supp.

Press Boxes
1-in/18-out
Video/Audio
2-in/24-out Audio

OPAMP LABS INC (213) 934-3566
1033 N Sycamore Av LOS ANGELES CA, 90038

Circle 268 on Reader Response Card

INSTALLERS!



EASY-KARY®
Wire Reel Holders

● 3 SIZES
● All Steel Construction Carry like a briefcase.

PUSH-PULL RODS Get cable through impossible places. Extends 45'. Light weight. Flexible.



SPEAKER & TILE SUPPORTS

SPEAKER ENCLOSURES



ALL STEEL LIGHT WEIGHT but STRONG for all 4" and 8" SPEAKERS in ALL types of CEILINGS
U.L. LISTED FREE SAMPLES



The Audio Serviceman's Right Arm. Check the complete sound system from MIC to SPEAKER -- and much more.

30 DAY FREE TRIAL INSTANT OPEN ACCOUNT
CALL OR WRITE FOR BROCHURE

MUSIC SUPPLY CO., INC.

809 North Madison Dallas, Texas 75208
ALL 50 STATES 1-800-527-1522
FAX 214-946-9155 Local 214-946-8450

800-527-1522

Circle 269 on Reader Response Card

FLAME RESISTANT ACOUSTIC GRILLE FABRICS

Meeting Fire Code Safety Standards.

ALL FABRICS INVENTORIED AND AVAILABLE FOR IMMEDIATE SHIPMENT

CALL OR WRITE FOR YOUR FREE SAMPLE FOLDER AND PRICE SHEET

MELLOTONE®

Mills: Post Office Box 145 • 108 East Church Street
Blacksburg, SC 29702 • (803) 839 6341
Fax (803) 839 2911

Circle 270 on Reader Response Card

Speaker Design on the Mac!

- Calculates Vent and Enclosure Dimensions
- Plots the response of any Driver/Box Combination
- Large Driver Library Included (easy to expand)
- Software and Users Guide: \$145.00

MacSpeakerz 349 W. Felicita Ave., Suite 122,
Escondido, CA 92025

from True Image 619-480-8961 Visa/MC

Circle 271 on Reader Response Card

PEOPLE

Mark IV Promotes Graham; Schofield at Telex

VP for Mark IV

Ronald Graham has been named a vice president at Mark IV Audio, Inc. Graham is responsible for overseeing management of human resources for all companies in the Mark IV Audio group and is coordinating the communication activities of all Mark IV companies.

VP at Telex

John Schofield has been named senior vice president for sales and marketing of Telex Communications, Inc. He also became a corporate officer and was named to the company's executive committee.



Schofield

Schofield earned a BSEE from NSW Institute of Technology in Sydney. He also worked as an engineer for the Australian Overseas Telecommunications Commission, and has held a variety of sales, marketing and general management positions for Raytheon Data Systems and the Memorex Telex organizations.

President and CEO at Anchor

Anchor Audio, Inc. has appointed David Jacobs as President and CEO. Past President Jim Van Way will stay on as Chairman of the Board.

Prior to joining Anchor Audio, Jacobs was President of Colony Capital and co-founder of SuperShuttle International, Inc.

Fuji Promotes Perrin

Dave Perrin has been promoted to Midwest Regional Sales Manager, Professional Products. Perrin is responsible for all facets of sales of Fuji Professional Videotape in the midwest region.

Perrin has been with Fuji since 1984 as Professional Products Account Representative in Orlando, Florida and was promoted to Senior Account Representative for the southeast region in 1989.



Perrin

Sales at Burle

Raymond E. Meier has been appointed to the position of Security Products Sales Manager, Europe. As European Sales Manager, Meier is responsible for the sales of all security products offered by Burle in Europe and for the management of the European sales force.



Meier

Anixter Appoints VP

Anixter Bros, Inc. has appointed Roland Watkins to the position of executive vice president—technology and engineering. Watkins is responsible for technology, products and business opportunities.

He was most recently the senior vice president of engineering and product management and has been with Anixter for the last 18 years. He has also served as chairman of the IEEE Insulated Conductors Committee.

Valley Promotions

Valley International, Inc. has promoted Jason Dunaway, previously Director of Engineering, to Vice President of Product Development and Marketing. Jay Nelson, previously Operations Manager, has been named Vice President of Sales and Operation.

Jacoby at JBL

Tom Jacoby has been appointed to the position of President of JBL Consumer Products, Inc. In this capacity Jacoby will be responsible for all operations of JBL Consumer Products regarding the company's domestic operations, including all phases of the operation from product development to U.S. distribution. Jacoby most recently served as Executive Vice President for Harman America.



Jacoby

Mager in New Haven

The University of New Haven has appointed Guillermo E. Mager, Assistant Professor of Music and Sound Recording. Mager had been the Senior Instructor for Advanced Technologies at the Institute of Audio Research and served as the Music and Technology Program Coordinator at New York University until 1986.

The University of New Haven offers Bachelor of Science and Bachelor of Arts degrees in music and sound recording including course work in audio production and engineering and electrical engineering.

Gove at GPT

Thomas P. Gove, Jr. has been appointed general manager of United States Operations at GPT Video Systems, a manufacturer of videoconference systems and equipment. Gove is responsible for all aspects of Video Systems' U.S. operations including sales and marketing, administration and finance.

CALENDAR

Upcoming Events

JANUARY

ISC WEST: Anaheim, CA: Contact: (312) 644-6363. January 9-11.

Winter Consumer Electronics Show: Las Vegas, NV: (709) 299-9331. January 10-13

NEDA Test Measurements & Control Div. Conf.: Scottsdale, AZ: Contact: (312) 588-9114. January 12-15

ATE&I West (Auto. Test Equip. & Instr.): Anaheim, CA: Contact: (800) 223-7126. January 14-17.

NAMM (Nat'l Assoc. of Music Merchants): Anaheim, CA: Contact: (619) 438-8001. January 18-20

San Diego Electronics Show: San Diego, CA: Contact: (619) 284-9286. January 23-24.

BUSCON/West: Santa Clara, CA. (203) 852-0500. January 29-31.

FEBRUARY

RF Technology Expo: Santa Clara, CA: Contact: (303) 220-0600. February 5-7.

InfoComm International: Orlando, FL: Contact (703) 273-7200. February 14-16.

NEPCON/West '91: Anaheim, CA (708) 299-9311. February 25-28.

MARCH

NAMM (National Association of Music Merchants): Frankfurt, Germany: Contact: (619) 438-8001. March 2-6.

ENTELEC (Energy Telecommunications & Electrical Association): Houston, TX: Contact: (301) 468-3210. March 4-6.

Video Expo: San Francisco, CA: Contact: (914) 328-9157. March 4-6.

CAMMP (Computer Aided Graphics, MultiMedia and Presentations): San Francisco, CA: (914) 328-9157. March 4-6.

Interface '91 Plus: Atlanta, GA: Contact: (617) 449-6600. March 26-28.

SOUTHCON: Atlanta, GA. Contact: (213) 772-2965. March 26-28.

Int'l Mobile Communications Expo: Anaheim, CA: (303) 220-0600. March 26-28.

APRIL

Midlantic Electronics Show: King of Prussia, PA: Contact: (215) 828-2271. April 2-3.

ERA Annual Conference: Lisbon, Portugal: Contact: (312) 649-1333. April 4-11.

Facilities Security and Protection Expo and Conference: Chicago, IL: Contact: (708) 299-9311. April 9-11.

NAB (National Association of Broadcasters): Las Vegas, NV: (202) 429-5300. April 15-18.

EDS: Las Vegas, NV: Contact: (312) 648-2300. April 30-May 2.

Copyright © 1990 SOUND & COMMUNICATIONS PUBLISHING, INC. Reprint of any part of contents without permission forbidden. Titles Registered in the U.S. Patent Office. Sound & Communications (U.S. P.S. 943-140) (ISSN #0038-1845) is published monthly by Sound & Communications Publications, Inc., 25 Willowdale Avenue, Port Washington, N.Y. 11050. 516-767-2500. President, Vincent P. Testa. Subscription rates: U.S.—1 year \$15.00, 3 years \$37.50. All other countries—1 year \$25.00, 3 years \$67.50. Subscriptions outside of U.S. must be paid in American currency. Second-class postage paid at Port Washington, NY and at additional mailing office. POSTMASTER: Send address changes to Sound & Communications, 25 Willowdale Avenue, Port Washington, NY 11050.

15 YEARS OF EXCELLENCE IN PROFESSIONAL SOUND

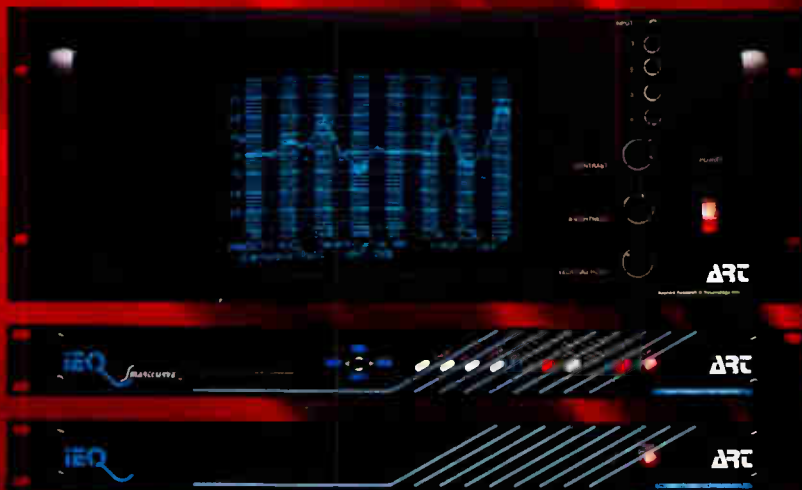

THE IEQ PROGRAMMABLE EQUALIZERS

Available in 15 and 31 band versions, the IEQs offer Smartcurve for virtual elimination of adjacent band interaction. One controller can remotely operate up to 15 satellites. .009% THD, 102 dB signal-to-noise ratio.



THE PD3 SPEAKER ALIGNMENT DELAY

A 1-in-3 out digital delay with a 64 kHz sampling rate for utterly flawless signal reproduction at a price hundreds less than comparable units - 20 Hz-20 kHz bandwidth.



THE HD SERIES EQUALIZERS

Utilizing the same revolutionary filter technology as the IEQs, the H-D EQ's offer a new standard in audio performance. Available with XLR, 1/4 inch and terminal strip connectors, they offer complete flexibility in professional applications. There is minimum phase shift and no center point drift regardless of fader settings. Automated computer manufacturing has reduced the cost to less than half of comparable units! Freq. response 2 Hz-153 kHz, signal-to-noise ratio -115 dB (R.E. +20 dBm), THD <.005%.

Circle 204 on Reader Response Card

Export Distributors:

FINLAND/MS-Audiotron/Helsinki/90-5664644/SWEDEN/Muskantor & Co./Molndal/031-878080/France/High Fidelity Services SA/Paris/(1) 42.85.00.40/CANADA/Yorkville Sound LTD./ Scarborough 416-751-8481/ITALY/Fratelli Crasno/Pavia 0385 48 029/WEST GERMANY/PME Audio/Bad Friedrichshall 071 36-6029/SWITZERLAND/Musikengros P. Gutter/Sissach 061-983757/HONG KONG/Audio Consultants LTD./Kowloon/3-35183628/JAPAN/Nihon Electro Harmonix/Tokyo (03) 232-7601/INDONESIA/PT Kirana Yudha Teknik/Jakarta 3806222/SINGAPORE/Lingtec PTE. LTD. 7471951/SPAIN/Aplicaciones Electronicas Quasar SA/Madrid 6861300/DENMARK/M.I. Musik/Kobenhavn 1-854800/U.K./Harman U.K./Slough 075376911/ISRAEL/Jazz Rock Tel Aviv 03-282022/TAIWAN/Sea Power Co./Taipei 023143113/GREECE/Zozer Piraeus/014170151/NEW ZEALAND/Arcusound Professional Pty./Auckland 09-688-759/HONG KONG (Music Prod.) Tsang Fook Piano Co./5-238146/PHILIPPINES/Audiophile Components/Manila/58-30-32/AUSTRALIA/Dynamic Music/Brookvale N.S.W./2-939-1299/BELGIUM/S.E.D. Brussels 02-522-70-64/EASTERN EUROPE/Y. Mudrav/Surrey, U.K./01-942-9689/NORWAY/Starton Musikk A.S./Lorenskog/02-70-60-30/PORTUGAL/Remedius Music/Lisbon/01-777-486/AUSTRIA/Herbert Music Import/Rankweil 05522-42124

APPLIED RESEARCH & TECHNOLOGY INC., 215 Tremont Street, Rochester, New York 14608, (716) 436-2720, TELEX: 4949793 ARTROC, FAX (716) 436-3942

World Radio History



Even Our Smaller Systems Can Fill A Big Hall.

SR4700 Series

You've seen and heard our big systems, installed in major venues around the world and on tour with some of the biggest names in the music business. The SR4700 Series Loudspeaker Systems are equally at home on the road or in the hall.

Their legacy comes from Cabaret® Series, a prime player in small to medium club sound reinforcement since the seventies. Their influence is Concert

Series™, the new standard in packaged JBL systems. With

Cabaret as the starting point and

Concert Series as our current direction, we

listened to your comments and suggestions, turning them into the sound system of the nineties and beyond.

The SR4700 Series is pure pro audio. Pure JBL components, the same caliber as those in our larger systems, including the Vented Gap Cooling™ low frequency drivers and the 2445J compression driver. Pure JBL enclosures, five times stronger than traditional designs, and protected by plastic-coated steel grills and super-durable fabric-laminated plywood cabinets. Pure JBL sensibility, interlocking enclosures with heavy-duty steel handles and recessed input connectors, so they travel tighter, set-up easier and last longer.

SR4700 Series, pure JBL. Be the first in line to hear them today at your local JBL dealer.



JBL Professional
8500 Balboa Boulevard, Northridge, CA 91329 USA
A Harman International Company

Circle 205 on Reader Response Card