

SOUND & COMMUNICATIONS

BLUE BOOK

078A HVS8F Q211UA1A URSC
00017872 STOP R2
N N GUREEN
REAR SOUND & COMMUNICATION
21000 W WINFIELD RD CA 90290
TOPANGA

TWENTY-NINTH
1989
1990
EDITION



You can't build a better mousetrap unless you know your mice.

For years, those of you who wished to enjoy the many benefits of processed speaker systems had to endure one major drawback: loss of sound quality when the system switched into the protect mode.

The new DeltaMax™ electronically controlled loudspeaker systems put an end to such frustration.

We built our knowledge of loudspeakers . . . and their destruct modes . . . into a controller which addresses overexcursion, voice-coil overheating, and amplifier clipping without altering frequency response—the system's incredible clarity remains unchanged.

In addition, front-panel LED's indicate these problems clearly and distinctly. From that point, it's your option to either make a change in the mix yourself or allow the controller to compensate automatically.

We also rigged these systems for flight—with optional three-point harnesses equipped with steel-reinforced pan-fitting hardware, perfect for safely arraying speakers in multi-cabinet clusters.

DeltaMax is brought to you by the same company that invented a variety of better mousetraps for the audio world, including constant-directivity horns and the world's first neodymium compression driver, the N/DYM® 1.

Give us a call today for more information and engineering data sheets.

Circle 202 on Reader Response Card



Electro-Voice®

a MARK IV company
600 Cecil Street
Buchanan, MI 49107
Phone: 616-695-6831

In Canada: Mark IV Audio Canada, Inc.
345 Herbert Street
Gananoque, Ontario K7G2V1

Get automatic mixing capabilities
and the best modular
signal processing.

SYSTEM 41...

with
VOICE-MATIC®
Modules

Two new Voice-Matic microphone mixer modules add automatic flexibility and operating performance to System 41 installations. The DJ-4114 Voice-Matic Microphone Mixer Module and DJ-4115 Voice-matic Master Module offer noise-free interconnection and total compatibility with all other System 41 components.

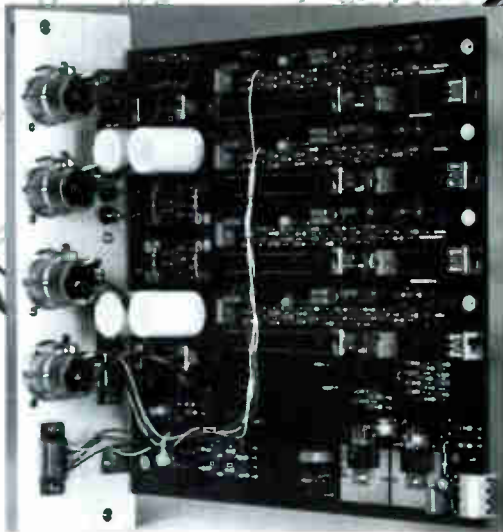

Model DJ-4114 Voice-matic Microphone Mixer Module

The DJ-4114 Input Mixing Module features buffered pre-amp outputs, pre or post gates, status LED and logic outputs and 18 volt phantom power supply. Optional features include remote level and input controls and 48 volt phantom power.

All IRP Products are made in the U. S. A.

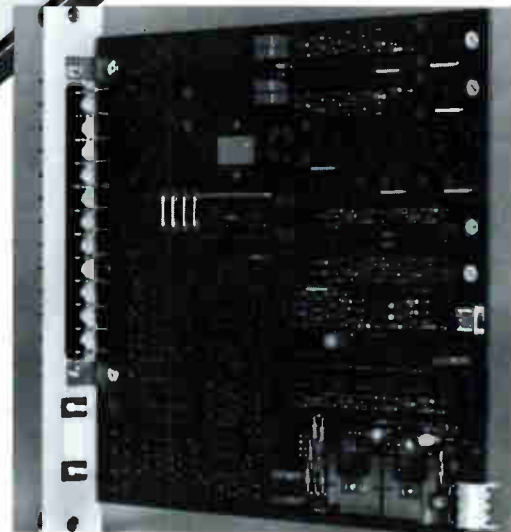

Model DJ-4115 Voice-matic Master Module

The DJ-4115 Voice-matic Master Module mixes the microphone signals from all DJ-4114 Modules in the system along with any auxiliary input signals. Various remote controls are optional.

IRP industrial
research
products, inc.
A Knowles COMPANY

321 Bond St. • Elk Grove Village, IL 60007
TOLL FREE: 1-800-255-6993 • In IL: 312-439-3600
TELEX: 701845 • FAX: 312-640-9607

This is the 29th edition of the Sound & Communications Blue Book, the only complete directory of suppliers to the sound contracting industry. You can find it all in the Blue Book, from carillons to powered mixers: Who makes them, where they are, who the personnel are. If it's not in the Blue Book, it probably doesn't exist.

The Blue Book is a mammoth undertaking which begins with The Form. The Form is sent several months prior to publication to all the manufacturers in the sound contracting industry. They fill in their information and return it to us, at which point we enter the information in the Blue Book database. It all sounds very easy; but of course there are deadlines and glitches and changes at the manufacturing level. A group of dedicated professionals at *Sound & Communications* makes it all happen.

This book is designed to be used all year as a reference work to do its job while you're doing your job. It can be used easily, and you can depend on its accuracy.

In recent years, we have added fax numbers for those of you who need information in a hurry. And we now have a listing of manufacturers representatives, so you know where to contact those people who are so vital to the industry. We've included a Brand Name Index, a Product Index, and an Index of Manufacturers.

This issue also contains a listing of that most elusive of suppliers — the software companies. It's the most complete listing we know of, in this business or any other, of those companies producing CAD software, with names, addresses, personnel and product descriptions all included.

We're proud of the Blue Book. We hope you'll use it and enjoy it. Please send your suggestions for next year, so we can continue to make it more and more useful and timely.

Welcome to the Blue Book.

SOUND & COMMUNICATIONS

Editorial Director/Publisher
Vincent P. Testa

Editorial Consultant
Jesse Klapholz

Assistant Editor
Maria Conforti

Technical Council
Dr. Mort Altshuler
*Professor Audiology, Hahneman University,
Chief of Audiology, V.A. Hospital, Phila, PA*

Mike Biegel
EPD Technology Corporation

C. Leroy James
Rees Associates, Inc.
Richard N. Jamieson
Jamieson and Associates, Inc.

Russell Johnson
Artec Consultants, Inc.
Richard Negus
Purcell Noppe Associates, Inc.

William Parry
Maryland Sound Industries, Inc.
Daniel Queen

Daniel Queen Associates
Jon Sank
Cross Country Consultants
William R. Thornton
Phd, PE

Art Director
Gerard Caramannello

Staff Artists
Steven E. Ingram
Germaine Cassidy

Typesetting
Leo Ancona

Type Consultant
Hannah Klapholz

Circulation Director
Robert Evans

Advertising Director
Nancy Davis

Vice President/Editorial
Judith Morrison

Editorial and Sales Office
Sound & Communications
25 Willowdale Avenue
Port Washington, New York 11050
(516) 767-2500



Sound & Communications • DJ Times • Post
Sound & Communications Blue Book
The Music & Sound Retailer • The Retailer Red Book
The Music & Sound Buyer's Guide
CES-TV News • NAB-TV News • NAMM-TV News
NSCA-TV News • CROSSTALK / AES-TV News



When it's all on the line.

Samson Wireless.

When every system has to perform flawlessly with superior sound and the quiet performance of dbx Noise Reduction.

When you need absolute structural integrity and longterm reliability because your professional reputation is on the line.

Samson. The only choice when nothing less than *perfect* wireless will do.

SAMSON[®]
WE ARE THE WIRELESS FUTURESM

ASSOCIATIONS

American Institute of Architects (AIA)

1735 New York Ave., NW
Washington, DC 20006
(202) 626-7300

American National Standard Institute (ANSI)

1430 Broadway
New York, NY 10018
(212) 354-3300

Audio Engineering Society (AES)

60 East 42nd St., Suite 2520
New York, NY 10165
(212) 661-8528

Electronics Distribution (EDS)

222 South Riverside Plaza
Suite 2710
Chicago, IL 60606
(312) 648-1140

Electronics Industries Association (EIA)

1722 Eye St. NW, Suite 300
Washington, DC 20006
(202) 457-4900

Electronic Technicians Associations (ETA)

Room 130, Hoover Hall
Iowa State University Station
PO Box 1258
Ames, IO 50011
(515) 294-5060

International Association of Auditorium Managers (IAAM)

325 Central Ave., Suite 225
White Plains, NY 10606
(914) 683-1000

International Business Music Association (IBMA)

280 Federal Avenue NW
Massillon, OH 44646
(216) 833-4164

International Communications Industries Association (ICIA)

3150 Spring St.
Fairfax, VA 22031
(703) 273-7200

Institute of Electrical & Electronics Engineers (IEEE)

345 East 47th St.
New York, NY 10017
(212) 705-7900

International Security Conference

1350 East Touhy Ave.
Des Plaines, IL 60018
(312) 299-9311

International Society of Certified Electronic Technicians (ISCET)

2708 West Berry St.
Fort Worth, TX 76109
(817) 921-9101

National Association of Broadcasters (NAB)

1771 N St. NW
Washington, DC 20036-2891
(202) 429-5300

SEPTEMBER						
S	M	T	W	T	F	S
					1	2
3	4	5	6	7	8	9
10	11	12	13	14	15	16
17	18	19	20	21	22	23
24	25	26	27	28	29	30

OCTOBER						
S	M	T	W	T	F	S
1	2	3	4	5	6	7
8	9	10	11	12	13	14
15	16	17	18	19	20	21
22	23	24	25	26	27	28
29	30	31				

NOVEMBER						
S	M	T	W	T	F	S
			1	2	3	4
5	6	7	8	9	10	11
12	13	14	15	16	17	18
19	20	21	22	23	24	25
26	27	28	29	30		

DECEMBER						
S	M	T	W	T	F	S
					1	2
3	4	5	6	7	8	9
10	11	12	13	14	15	16
17	18	19	20	21	22	23
24	25	26	27	28	29	30
31						

JANUARY						
S	M	T	W	T	F	S
	1	2	3	4	5	6
7	8	9	10	11	12	13
14	15	16	17	18	19	20
21	22	23	24	25	26	27
28	29	30	31			

FEBRUARY						
S	M	T	W	T	F	S
				1	2	3
4	5	6	7	8	9	10
11	12	13	14	15	16	17
18	19	20	21	22	23	24
25	26	27	28			

EVENTS

SEPTEMBER 1989

PLASA
London, UK
9/10 — 9/13

IBMA
Scottsdale, AR
9/20 — 9/23

OCTOBER 1989

NECA
Chicago, IL
10/1 — 10/3

SBE
Kansas City, MO
10/5 — 10/8

AES
New York, NY
10/18 — 10/21

NOVEMBER 1989

Lighting Dimensions
Nashville, TN
11/17 — 11/19

Acoustical Society of America
St. Louis, MO
11/27 — 12/1

DECEMBER 1989

Sound & Communications
Annual Economic Report

JANUARY 1990

NAMM
Anaheim, CA
1/19 — 1/21

EVENTS

FEBRUARY 1990

ICIA
Anaheim, CA
2/1 — 2/3

ISC South
Orlando, FL
2/15 — 2/17

MARCH 1990

AES
Montreux, Switzerland
3/13 — 3/16

APRIL 1990

NSCA
Las Vegas, NV
4/18 — 4/21

EDS
Las Vegas, NV
4/24 — 4/26

MAY 1990

Sound & Communications
Annual Contracting Report

ISC West
Anaheim, CA
5/1 — 5/3

JUNE 1990

ISC Central
Dallas, TX
6/12 — 6/14

NAMM
Chicago, IL
6/15 — 6/17

JULY 1990

Deadline for **Blue Book** forms

AUGUST 1990

Sound & Communications
Annual
Blue Book Directory

MARCH						
S	M	T	W	T	F	S
				1	2	3
4	5	6	7	8	9	10
11	12	13	14	15	16	17
18	19	20	21	22	23	24
25	26	27	28	29	30	31

APRIL						
S	M	T	W	T	F	S
1	2	3	4	5	6	7
8	9	10	11	12	13	14
15	16	17	18	19	20	21
22	23	24	25	26	27	28
29	30					

MAY						
S	M	T	W	T	F	S
		1	2	3	4	5
6	7	8	9	10	11	12
13	14	15	16	17	18	19
20	21	22	23	24	25	26
27	28	29	30	31		

JUNE						
S	M	T	W	T	F	S
					1	2
3	4	5	6	7	8	9
10	11	12	13	14	15	16
17	18	19	20	21	22	23
24	25	26	27	28	29	30

JULY						
S	M	T	W	T	F	S
1	2	3	4	5	6	7
8	9	10	11	12	13	14
15	16	17	18	19	20	21
22	23	24	25	26	27	28
29	30	31				

AUGUST						
S	M	T	W	T	F	S
			1	2	3	4
5	6	7	8	9	10	11
12	13	14	15	16	17	18
19	20	21	22	23	24	25
26	27	28	29	30	31	

ASSOCIATIONS

National Association of Business & Educational Radio (NABER)

1501 Duke St.
Alexandria, VA 22314
(703) 739-0300

National Association of Music Merchants (NAMM)

5140 Avenida Encinas
Carlsbad, CA 92008
(619) 438-8001

National Association of Radio & Telecommunications Engineers (NARTE)

PO Box 15029
Salem, OR 97309
(503) 581-3336

National Council of Acoustical Consultants (NCAC)

PO Box 359
Springfield, NJ 07081
(201) 379-1100

National Electronics Contractors Association (NECA)

7315 Wisconsin Ave.
Suite 1300W
Bethesda, MD 20814
(301) 657-3110

National Federation of Local Cable Programmers (NFLCP)

PO Box 27290
Washington, DC 20038
(202) 829-7186

National Fire Protection Association (NFPA)

Batterymarch Park
Quincy, MA 02269
(617) 770-3000

National Sound & Communications Association (NSCA)

10400 S. Roberts Rd., Suite D
Palos Hills, IL 60465
(312) 598-7070

National Society of Professional Engineers (NSPE)

1420 King St.
Alexandria, VA 22314
(703) 684-2800

Society of Broadcast Engineers (SBE)

7002 Graham Rd., Suite 216
Indianapolis, IN 46220
(317) 842-0836

Security Equipment Industry Association (SEIA)

2800 28th St., Suite 101
Santa Monica, CA 90405
(203) 450-4141

Society of Motion Picture & Television Engineers (SMPTE)

595 West Hartsdale Ave.
White Plains, NY 10607
(914) 761-1100

The 1989/1990 Blue Book

ACCESSORIES 12	CCTV/VIDEO COMPONENTS & SYSTEMS 34
direct boxes, audio interfaces, transformers, lights	accessories, cameras, channel converters, computer interfaces, connectors, dummy cameras, effects generators, enclosures, fiber optics, hardware, lenses, message generators, modulators, monitors, multiplexers, pan/tilts, remote controls, signal distribution, specialty cameras, surveillance, switchers, time-lapse recorders, transmission systems, video mixers, video projectors, VTRs
ACOUSTICAL TREATMENT 14	DISCO COMPONENTS & SYSTEMS 179
absorption, absorptive partitions, ceiling panels, dampening material, diffusion, grille cloth, noise control panels, and enclosures, spray-on absorption materials, vibration isolation material, systems, and devices, wall coverings, wall panels	DJ mixers, headphones, lighting controls & effects, processors, sub-woofers, turntable cartridges, and accessories, turntables
ALARM & SECURITY27	HARDWARE & TOOLS 22
access control, ancillary components, announcement systems, audio surveillance, burglar alarms, CCTV, door-lock systems, duress, fire alarm, intercom, intrusion detection, signalling devices, sirens, smoke detectors, strobes, vibration sensing, video motion detection, video surveillance, wireless systems	cabinet hardware, cable clamps, cleaning chemicals, connectors, fabrication supplies, hanging systems, knobs, lamps, linemen's test sets, markers, panels, raceways, stands, speaker hardware, tool kits, wire pulling devices, wire terminations
AUDIO AMPLIFIERS 41	HEADPHONES & HEADSETS 23
25/70-volt amplifiers, bi-amp systems, dual-channel, low-frequency amplifiers, mixer amplifiers, modular amplifiers, monitor amplifiers, portable, signal processing amplifiers, single-channel, telephone paging amplifiers, tri-amp systems, zone-paging amplifiers	boom-mic headsets, communications headsets, intercommunications headsets, isolation headsets, personal/stereo headphones, telecommunications headsets
AUDIO SIGNAL PROCESSORS 160	HEARING ASSISTANCE SYSTEMS 201
1/3 octave equalizers, ambient noise controlled level controllers, audio/video synchronizers, automatic equalizers, preamps, crossovers, de-essers, digital effects, digital encoding, digital reverbs, digital delays, digital signal processors, equalizers, compressors, graphic equalizers, interface units, levelers, limiters, noise gates, notch filters, parametric equalizers, octave equalizers, signal enhancers, signal metering, transcription preamps, VCAs	closed loops inductive, infrared systems, multi-channel, programmable, wireless systems AM/FM
AUDIO-VISUAL EQUIPMENT/SYSTEMS 50	IN/OUT REGISTERS 63
A/V speakers, audio for A/V, boardroom sound systems, closed-loop audio systems, computer control, electronic displays, image projectors, intercom, interface units, lectures, multi-media controls, screens, supplies, wireless control	access control, intercom, manual personnel, medical, monitor reporting, PC-based, telephone reporting, terminal reporting, visual
BACK/FOREGROUND SYSTEMS & LIBRARIES 60	INTERCOM—APARTMENT/RESIDENTIAL 64
automatic mixers, CATV, CD changers, music libraries, stock and custom, music services, SCA equipment, tape systems	access control, apartment station, custom, duplex, lobby, mailbox panels, microprocessor, music combination, panel/entrance, simplex, talk-back, telephone, video
CABINETS, FURNITURE, CASES & RACKS 17	INTERCOM—DUPLEX 71
accessories, ATA cases and racks, chassis, computer consoles, consoles, electronic racks, enclosure systems, custom cabinets & consoles, equipment cabinets & enclosures, flight cases, furniture systems, hardware, instrument cabinets, modular boxes, molded racks & cases, panels, portable tables, rack AC power, rack fans, rack hardware, shelves, rack-mounts, shock mount racks & cases, slides, soft cases & bags, specialty cases, stands, storage racks & cases, tables, technical workbenches, tool cases	closed-circuit, custom, digital, drive-thru, loudspeaking, microprocessor, multi-channel, programmable, telephone, telephone, video/audio, VOX, wireless
CARILLONS & CHIMES 71	INTERCOM—HOSPITAL HEALTH CARE 74
analog & digital tones for time and signalling, music playback-type	A/V, annunciators, direct select, emergency call, microprocessor, nurse-call, pillow speakers, visual, voice paging
	INTERCOM—INDUSTRIAL 77
	drive-thru, environmentally protected, headset/handset, loudspeaking, telephone
	INTERCOM—INSTITUTIONAL/SCHOOL 79
	clock, console, microprocessor, multi-channel, paging, talkback, telephone, video
	INTERCOM—PRODUCTION & THEATRICAL 82
	handset, headset, IFB, loudspeaker, microprocessor, multi-channel, processors, radio interface, VOX, wireless
	INTERCOM—SIMPLEX 85
	closed-circuit, custom, digital, IFB, loudspeaking, micro-

PRODUCTS DIRECTORY & INDEX

processor, multi-channel, pro-grammable, telephone, video/audio, VOX, wireless	PATCH BAYS & ROUTING SWITCHERS 177
LIFE-SAFETY & VOICE EVACUATION SYSTEMS 33	A/V, components, digital, matrix, μ processor, mic splitters, mult boxes, pre-wired, remote, telephone type
audio, DC battery supply, emergency intercom, handset, message announce, tone, visual	PORTABLE SOUND SYSTEMS 193
LOUDSPEAKER ACCESSORIES 90	amplifiers, columns, DC battery powered, lecturns, megaphones, mixer amplifiers, mixers, powered speakers, speakers, weatherproof speakers, wireless
attenuators, baffles, connectors, crossovers, enclosure hardware, enclosure, grille cloth, grilles, mounting hardware, stands, transformers	POWER PROTECTION/CONDITIONERS 26
LOUDSPEAKERS 94	inverters, line isolators, line protectors, noise suppression, outlet strips, power control, power conversion, power relays, transformers, uninterrupted power
ceiling, columns, compact, components, custom, decorative, environment protected, explosion-proof, flush-mount, foreground, full-range, high-frequency drivers, high-power, horns, low-frequency drivers, mid-bass, monitor panels, multi-way/high-powered, music system speakers, noise masking, omni-directional, outdoor, paging horns, paging, portable, powered, processor controlled, stage monitors, studio/reference monitors, sub-woofer, surface-mount, systems, talkback, tweeters, underwater, voice communications	PRO-AUDIO SOUND SYSTEMS & PRODUCTS 197
MAGNETIC TAPE SYSTEMS & SUPPLIES 186	auxiliary accessories, distribution, interface devices
cart recorders/players, carts, cassette players, cassette recorders, cassette tape, cleaners, degaussers, demagnetizers, heads, high-speed duplicators, labeling systems, multi-tracks, reel tape, reel-to-reel recorders & players, tape splicers, test tapes, transcription systems, videotape	REMOTE CONTROLS 57
MESSAGE REPEATERS & STORECASTERS 183	A/V, audio level, boardroom, custom, DTMF, EQ/remote, hardwired, μ processor, remote monitoring, video, wireless
digital systems, cart machines, message units, digital voice recording, sign systems	SIGNALING SYSTEMS 86
MICROPHONES, WIRELESS 150	alarm, annunciator, audio, bell, call-light, tone, visual
body packs, hand-held	TELECONFERENCING SYSTEMS 59
MICROPHONES 142	automixing, manual, microphone specific, microprocessor, telephone interface
boundary, carbon, communications, condenser, contact pickups, dynamic, electret condenser, goosenecks, hand-held, headset boom, implant, instrumentation, miniature, podium, push-to-talk, ribbon, shotgun, specialty, stands, stereo	TEST EQUIPMENT 202
MIDI 175	analog multimeters, audio tape diagnostics, bench-top instrumentation, cable testers, digital multimeters, digital storage oscilloscopes, distortion analyzers, DSP hardware, DSP software, dual-channel spectrum analyzers, FFT-spectrum analyzers, filter sets, FM stereo testing, function generators, logic analyzers, metering systems, MTS test equipment, noise & vibration analyzers, oscilloscopes, precision amplifiers, realtime analyzers, RF signal generators, RT60 meters, sound intensity measurement equipment & microphones, speech transmission analysis, SPL meters, transmission link testing, vector scopes, video test signal generators, waveform recorders
signal processing, system controllers, software, hardware	TUNERS & CD PLAYERS 200
MIXERS & MIXING CONSOLES 154	AM, changers, FM, tuner-amplifiers
automatic, broadcast, combo, compressor/leveler, custom, digital, disco, ENG, gated, microprocessor, MIDI, modular, monitor, paging, portable, powered, production, rack-mount, recording, theatrical, VCA	WIRE/CABLE COMPONENTS 208
PA SYSTEMS 188	accessories, adapters, alarm, audio, computer cable & peripherals, conduits, connectors, control, data, fiber optics, fuses and holders, hardware, hybrids, jacks, low-capacitance, markers, panels, plenum cable, plugs, pre-wired systems, raceways, security, shielded, sleeving, specials, switches, telecommunications, terminals, transformers, tubing, video, XLR connectors
mixer/amplifier, mixer/preamps, modular, music distribution, signalling, telephone, zoned	WIRE/CABLE SYSTEMS 212
	audio, cable reels, custom, data, fiber optics, instrument, microphone cable, snakes, MIDI, multi-pair, multi-pin disconnect, panels, speaker, splitting, stageboxes, video

1989 **BLUE** 1990 B O O K

- 6 Contractor's Notebook**
- 8 The 1990 Blue Book Products Directory & Index**
- 12 Accessory Products/Hardware/Tools**
 - 12 Accessories
 - 14 Acoustical treatment
 - 17 Cabinets, furniture, cases & racks
 - 22 Hardware, tools
 - 23 Headphones, headsets
 - 26 Power protection, conditioners
- 27 Alarm/Security Products**
 - 27 Alarm, security
 - 33 Life-safety, voice evacuation systems
 - 34 CCTV/Video components, systems
 - 63 In-out registers
- 41 Audio Amplification**
 - 41 Audio amplifiers
- 50 Audio-Visual Products/Control Systems**
 - 50 Audio-visual equipment/systems
 - 57 Remote controls
 - 59 Teleconferencing/systems
- 60 Background/Foreground Systems**
 - 60 Background/foreground systems & libraries
- 64 Intercommunications Equipment**
 - 64 Intercoms: Apt, residential
 - 71 Carillons, chimes
 - 71 Intercoms: Duplex
 - 74 Intercoms: Hospital, health care
 - 77 Intercoms: Industrial
 - 79 Intercoms: Institutional, school
 - 82 Intercoms: Production, theatrical
 - 85 Intercoms: Simplex
 - 86 Signaling systems
- 90 Loudspeaker Products**
 - 90 Loudspeaker accessories
 - 94 Loudspeakers
- 134 CAD Software**
- 142 Microphones**
 - 142 Microphones
 - 150 Microphones (wireless)
- 154 Mixers/Mixing Consoles**
- 160 Signal Processing**
 - 160 Audio signal processors
 - 175 MIDI
 - 177 Patch bays & routing switchers
- 179 Sound System Products**
 - 179 Disco components
 - 183 Message repeaters, storecasters
 - 186 Magnetic tape systems & supplies
 - 188 PA systems
 - 193 Portable sound systems
 - 197 Pro-audio sound systems
 - 200 Tuners, CD players
 - 201 Hearing assistance systems
- 202 Test Equipment**
- 208 Wire & Cable**
 - 208 Wire/cable components
 - 212 Wire/cable systems
- 215 Index of Manufacturer's Representatives**
- 221 Index of Trade Names**
- 222 Index of Advertisers**
- 223 Index of Manufacturers**

S E C O N D E D I T I O N

• New chapters on MIDI & SMPTE • New index • New diagrams



Here's the only plug you'll see on our new product.

At Yamaha, we've been putting all our sound reinforcement expertise into our equipment for years. Now we've put it all into words.

Presenting the Yamaha Sound Reinforcement Handbook. Without a doubt the only volume of its kind.

In it you'll find nearly 400 pages of explanations, definitions, diagrams and answers about sound. Covering everything from "What is a sound System?" to "Putting it all Together," plus every component and variable in between.

Which makes it perfect for the newcomer to audio. And a welcome refresher for the seasoned professional.

The Yamaha Sound Reinforcement Handbook. Available at your nearby Yamaha Professional Audio Dealer, college, university and technical bookstores. Published by Hal Leonard Publishing Corporation, P.O. Box 13819, Milwaukee, WI 53213.

Pick one up today. It just may be the best source material you ever get to work with.

Yamaha Music Corporation, Professional Audio Division, P.O. Box 6600, Buena Park, CA 90622-6600. In Canada, Yamaha Canada Music Ltd., 135 Milner Ave., Scarborough, Ontario M1S 3R1.

YAMAHA
Engineering Imagination™

Circle 227 on Reader Response Card

World Radio History

ACCESSORY PRODUCTS/HARDWARE/TOOLS

ACCESSORIES

Aris/Eta
1710 Enterprise Pkwy
Twinsburg, OH 44087
(216) 425-3388, FAX# 216-425-9700
Mkt'g: Bob Harris
Products: lights

Audisar
PO Box 1561
Bellevue, WA 98009
(206) 454-2040, 868-5217
Owner: Robert Munger
Products: audio interfaces, transformers

Black Audio Devices
PO Box 106
Ventura, CA 93002
(805) 653-5557

SECURITY COVERS

from **Hi Lo**

THE #1 CURE FOR A #1 PROBLEM!!

*Secure your equipment settings
with a tamper-proof cover.*

- Fits standard 19" rack
- 1 High and 2 High size
- Non-glare black and clear
- Tough ABS plastic
- 1" knob clearance depth
- OEMs, Distributors, Contractors business welcomed



*for information contact:

Hi Lo

FABRICATION AND
MANUFACTURING

A Division of



P.O. BOX 509 — CR 105
RIO VISTA, TEXAS 76093
(817) 373-2247 (leave message)

Circle 83 on Reader Response Card

SOUND & COMMUNICATIONS BLUE BOOK AUGUST 89/90

Bourns/Trimpot Div.
1200 Columbia Ave.
Riverside, CA 92507
(714) 781-5690, FAX# 714-781-5174

Capitol Lighting Products
159 Alexander St.
Yonkers, NY 10701
(914) 969-3400, 800-LIGHT-ON, FAX# 914-968-6567
VP Sls: Colin Gaines
Products: lights

Clarostat Mfg.
1 Washington St.
Dover, NH 03820
(603) 742-1120, FAX# 603-742-0481

Communications Co.
3490 Noell St.
San Diego, CA 92110
(619) 297-3261, FAX# 619-297-3279
Exec. VP: Michael Jordan, Eng./Mfg.: David Johnson,
Order Desk: Bobby Willis, Order Desk: Laura
McCullough, Shipping: Ritchie Willis, Pres.: Peter
Jordan
Audio Mkg Assoc., Brecksville, OH, 216-526-2426
Bencsik Assoc., Ocala, FL, 904-732-9775
Secom Systems, Dorville, GA, 800-241-9409
Brian Trankie & Assoc., Belmont, CA, 415-595-4004
Western Audio Sls, Glendale, CA, 818-246-3806
Products: audio interfaces

Conquest Sound
PO Box 268
Monee, IL 60444
(312) 534-0390, 800-323-7671,
FAX# 312-534-0398
Pres.: Robert Jares Jr., VP: Larry Spalla, Sls Mgr.: Ken
Bernad, Purch.: Sue Condon, Plant Mgr.: Debbie
Hawtrey, Office Mgr.: Janet Jares
Products: direct boxes, audio interfaces, transformers

Countryman Assoc.
417 Stanford Ave.
Redwood City, CA 94063
(415) 364-9988, 800-669-1422, FAX# 415-364-
2794
CEO: Carl Countryman, Sls Mgr.: Jay Morse, Office
Mgr.: Carolyn Countryman, Accounts Mgr.: Rosa
Pimental
Contact Distr., Ontario, Canada, 416-287-1144
Products: direct boxes

DOD Electronics
5639 South Riley Ln.
Salt Lake City, UT 84107
(801) 268-8400, 800-453-7484, FAX# 801-262-
4966
Pres.: John Johnson, Int'l Sls: Wayne Morris, W. Sls:
Scott Grow, VP Finances: Jay Fuller, Comm.: Dean
Stubbs

Products: direct boxes

J.W. DAVIS & CO.
PO Box 26177
Dallas, TX 75226
(214) 651-7341, 800-527-5705, in-state 800-in TX
800-442-1564, FAX# 214-939-0328
Pres.: Charles Griffith, VP Sls: Jack Tucker
Products: transformers

Electro-Voice
600 Cecil St.
Buchanan, MI 49107
(616) 695-6831, 800-527-6701, FAX# 616-695-
1304
Pres.: Robert Pabst, VP Sls & Mkt'g: Paul McGuire,
Dir. Mkt'g: Jim Long, Chief Eng.: Earl Harris
Products: audio interfaces, transformers

Emcor Products/Crenlo
1600 Fourth Ave. NW
Rochester, MN 55901
(507) 289-3371, FAX# 507-287-3405

FSR
220 Little Falls Rd.
Cedar Grove, NJ 07009
(201) 239-0988, 800-332-FSR-1, FAX# 201-239-
7708
Pres.: William Fitzsimmons, VP: Janice Sandri, Eng.
Mgr.: Joseph Fischer, Proj. Mgr.: John Macaluso,
Metal Shop Mgr.: Joseph Amico, Inside Sls: Marilyn
Cullen
Design Factors, Hacienda Heights, CA, 213-697-7576
Sigmet, Freehold, NJ, 201-462-1221
Richard Pass Assoc., Langhorne, PA, 215-757-6100
Peregrine SW, Houston, TX, 713-589-8481
Henry Phillips, Roswell, GA, 404-992-3070
Piper Assoc., Needham, MA, 617-449-1144
Brian Trankie & Assoc., Belmont, CA, 415-595-4004
Ziskind Assoc., Rolling Meadows, IL, 312-577-1624
Meyer Mkt'g, Deerfield Beach, FL, 305-481-9250
Avwest, Fountain Hills, AZ, 602-946-1811
Burcaw, Warren, MI, 313-573-4605
Products: audio interfaces, transformers

Heath
Hilltop Rd.
St. Joseph, MI 49085
(616) 982-3200, 800-253-0570

Henry Engineering
503 Key Vista Dr.
Sierra Madre, CA 91024
(818) 355-3656
Owner: Hank Landsberg
Products: audio interfaces

IED Innovative Electronic Designs
9701 Taylorsville Rd.
Louisville, KY 40299
(502) 267-7436, FAX# 502-267-9070

VP Mkt'g & Sls: Tom Roseberry, Mkt'g Asst.: Robin Lasley, Sls App. Eng.: Jeff White, Mkt'g Adm.: Wanda R. Martin, VP Eng.: Ed Young, Pres.: Hardy Martin Repworks, Chicopee, MA, 413-533-0845
Darmstedter Assoc., Baldwinsville, NY, 315-638-1261
John Anthony, Stamford, CT, 203-322-9202
Sigmet, Valley Forge, PA, 215-783-6666
Secom Systems, Atlanta, GA, 404-455-0672
Bencsik Assoc., Ocala, FL, 904-732-9775
C.L. Pugh, Cleveland, OH, 216-238-1777
Monford Electronics Mkt'g., Indianapolis, IN, 317-872-8877
C.M. Sls, Farmington Hills, MI, 313-553-8070
Ludwig Mkt'g., Kenosha, WI, 414-697-9355
B.C. Electronic Sls, Mission, KS, 913-262-1720
Mkt'g Concepts, Irving, TX, 214-869-0669
Yora, White Bear Lake, MN, 612-770-9760
Torbett/Keiser Group, Loveland, CO, 303-669-1008
Derek Allen Assoc., Toluca Lake, CA, 818-840-8327
Plus Four Mkt'g, Walnut Creek, CA, 415-937-0650
North Shore Mkt'g, Seattle, WA, 206-284-9699
Island Instruments, Kaneohe, HI, 808-235-7544
Products: direct boxes, audio interfaces

Impart
2225 4th Ave.
Seattle, WA 98121
(206) 728-0184, 800-544-3343, FAX# 206-441-9641
G. Mgr: Steven Corey, Nat'l Sls Mgr.: Laird Laabs, Mkt'g Dir.: Peter Sherwin

Jensen Transformers
10735 Burbank Blvd.
North Hollywood, AZ 91601
(213) 876-0059, FAX# 818-763-4574

Pres.: Deane Jensen, VP Eng.: Steve Hogan, Sls Mgr.: Dave Hill

Lightronics
789 Seahawk Circle
Virginia Beach, VA 23452
(804) 427-0852

Littlite/CAE
10087 Industrial Dr.
Hamburg, MI 48139
(313) 231-9373, FAX# 313-231-1631
Sls Mgr: Fred Mikeska, Sls: Julie Sanders
Products: lights

Lowell Mfg.
3030 Laclede Sta. Rd.
St. Louis, MO 63143
(314) 781-9058, 800-325-9660, FAX# 314-645-4852
Chairman: Ben Lowell, Pres.: Dorothy Lowell, Sls Mgr.: John Lowell, Op.: Wilhelm Lowell, Eng.: Karl Schneider, Credit Mgr.: Mary Tiepelman
Design Factors, Hacienda Heights, CA, 213-697-7576
Meyer Mkt'g, Deerfield Beach, FL, 305-481-9250
Peregine SW Reps, Houston, TX, 713-589-8481
H.W. Phillips, Roswell, GA, 404-992-3070
Pusecker Sls, Upper Montclair, NJ, 201-744-1834
Products: transformers

Peter Mangone (Tag-It Div.)
12687 W. Cedar Dr., Ste. 100
Lakewood, CO 80228
(303) 986-7700, 800-338-2448

Microtran
PO Box 236
Valley Stream, NY 11582

(516) 561-6050, FAX# 516-561-1117
Pres.: Albert Eisenberg, VP Sls: Walter Benschler, Chief Eng.: Vulf Ozechov, Purch. Agent: Belle Moskowitz, Prod. Mgr.: Charles Meyer, Adv. Mgr.: Lou Anne O'Conner
Products: transformers

Pacific Transformer
4750 E. Wesley Dr.
Anaheim, CA 92807
(714) 779-0450, 800-325-0501, FAX# 714-779-0718
Chief Eng.: Randy Neverka, VP Mkt'g: Pat Thomas, Ord. & Bill.: Jim Richardson, Sls Mgr.: Mike Dolce
Prime Technical, Houston, TX, 713-894-2400
Horne & Assoc., Stow, MA, 800-876-1742
Powersafe, Sunnyvale, CA, 408-773-1220
Products:

Peavey Electronics
711 A St.
Meridian, MS 39302
(601) 483-5365, FAX# 601-484-4278
Pres.: Hartley Peavey
Products: direct boxes, audio interfaces, transformers, lights

Why do Jensen Transformers have Clearer Midrange and Top End?

The high frequency rolloff of a *Jensen Transformer* is optimized, by computer analysis, to fit the *Bessel Low Pass Filter* response. This means *minimum overshoot and ringing* and *flat group delay* for best *time alignment* of all spectral components of the musical waveform.

In other words, the harmonics arrive at the same time as the fundamental frequency.

The result is a clear midrange and top end without the harsh, edgy sound which has been one of the most objectionable sonic complaints about transformers.

There's no "midrange smear."

Only *Jensen* has this benefit of hi-tech computer optimization.

Visitors by appointment only. Closed Fridays.
10735 BURBANK BOULEVARD • NORTH HOLLYWOOD, CA 91601
FAX (818) 763-4574 • PHONE (213) 876-0059

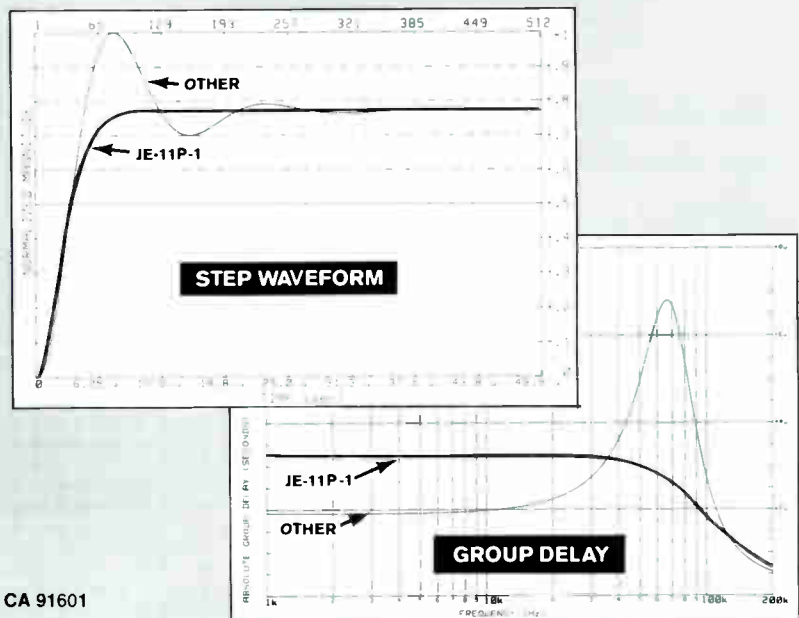

jensen transformers
INCORPORATED

Circle 282 on Reader Response Card

**TRANSFORMERS
FOR THE AUDIO INDUSTRY**

**HOW
YOU WANT THEM
WHEN
YOU WANT THEM**

- POWER
- IMPEDANCE MATCHING
- SPECIALTY

**BUILT TO YOUR
SPECIFICATIONS**

OR

**CHOOSE FROM OUR
STANDARD LINE**

**FOR FRIENDLY ASSISTANCE
OR INFORMATION**

CALL

(800) 325-0501



**PACIFIC
TRANSFORMER
CORPORATION**
4750 WESLEY DRIVE
ANAHEIM, CA 92807 • FAX (714) 779-0718

Circle 86 on Reader Response Card

Penn Fabrication (USA)

PO Box 506
Hawthorne, NJ 07506
(201) 423-4404
Sls Dir.: Mike Panasuk, G. Mgr.: Richard Stratford, G.
Mgr.: Gavin Naismith
Products: lights

Pro Co Sound

135 E. Kalamazoo Ave.
Kalamazoo, MI 49002
(616) 388-9675, 800-253-7360, FAX# 616-388-9681
Pres.: Charlie Wicks, VP Pro. Div.: Jerry Smelker, VP
Comm. Div.: Jeff Garstick, Dir. Mkt'g: Chuck Gushwa

Protech Audio

Flowerfield, Bldg. #1
St. James, NY 11780
(516) 584-5855, FAX# 516-584-5904
Sls Mgr.: Bill Murphy, VP Eng.: Joseph Giambone
Peregrine SW Repts, Houston, TX, 713-589-8481
Products: transformers

Runco Int'l

42329 Osgood Rd., Ste. E
Fremont, CA 94539
(415) 683-9360, FAX# 415-683-9363

Russco Electronics Mfg.

5690 E. Shields Ave.
Fresno, CA 93727
(209) 291-5591
Pres./G. Mgr.: Russell Friend, Sls: Vicky Jarrett,
Design Eng.: Michael Vink
Allied Broadcast Systems, Richmond, IN, 317-962-8596
Broadcast Supply W., Tacoma, WA, 206-565-2301
Professional Audio Supply, Ft. Worth, TX, 817-483-7474
Singer Products, Hialeah, FL, 305-558-3000
Electrex, FL, 305-651-5752
Products: audio interfaces

Shallico

PO Box 1089

Smithfield, NC 27577
(919) 934-3135, FAX# 919-934-3298

Stewart Electronics

11460 Sunrise Gold, Ste. B
Rancho Cordova, CA 95742
(916) 635-3011, 800-367-7945, FAX# 916-635-1787
Owner: Wade Stewart, Adm.: Michelle Horan

TEC

83 E. Central Ave.
Pearl River, NY 10965
(914) 735-7878, 800-431-1120, FAX# 914-735-1000

TOA ELECTRONICS

PO Box 2047
S. San Francisco, CA 94080
(415) 588-2538, 800-843-4750, in-state 800-in CA
800-632-2157, FAX# 415-588-3349
Pres.: Yoshiro Ishida, Nat'l Sls Mgr/Comm. Pro.:
Richard Krochmal, Nat'l Sls Mgr./Pro. Music & Ent.:
Rick Kamlet, Nat'l Sls Mgr./Intercom: Al Burns
Products: transformers

Technical Projects

PO Box 3247
Barrington, IL 60010
(312) 381-5350, 800-562-5872, FAX# 312-381-4360
Pres.: Glenn Mullis, Sec./Treas.: Sibbelina Mullis,
Tech.: Mike Barrett
Professional Audio Mkt'g, Melville, NY, 516-367-8620
Watt Mkt'g, Allentown, PA, 215-820-7586
Audio Mkt'g Assoc., Brecksville, OH, 216-526-2426
Professional Sound & Lighting, Lakewood, CO, 303-986-5999
Design Factors, Hacienda Heights, CA, 213-6917-7576
Products: direct boxes, audio interfaces

**Yamaha Music Corp. of America/Prof.
Audio Div.**

PO Box 6600
Buena Park, CA 90662
(714) 522-9011, FAX# 714-522-9312

ACOUSTICAL TREATMENT

ASC—Tube Traps

PO Box 1189
Eugene, OR 97440
(503) 343-9727, 800-ACS-TUBE, FAX# 503-343-9245
Pres.: Arthur Noxon, Sls: Doug Martin, Tech.: Michael Nemeth, Canadian Factory: Larry Moore, Italian Factory: Alfredo Gallacci, Japan: Gary Douglas
Rich Lomax, Hollywood, CA, 818-763-9587
Octavio Brito, Boston, MA, 617-924-0660
Sam Lynn, Chicago, IL, 312-657-7787
John Nolan, St. Louis, MO, 314-343-4765
Joe deBuglio, Toronto, Canada, 416-241-4240
Products: absorption, ceiling panels, diffusion

AVL Systems

5540 SW 6th Pl.
Ocala, FL 32674
(904) 854-1170, 800-228-7848, FAX# 904-854-1278
Pres.: J. Philip Hale, Sls/Mkt'g Dir.: C.W. Culbertson
Products: absorption, absorptive partitions, ceiling panels, dampening material, diffusion, grille cloth, noise control panels, and enclosures, vibration isolation material, sys-

tems, and devices, wall coverings, wall panels

Acoustiflex

1300 Division St.
Plainfield, IL 60544
(815) 436-4640, 800-421-8368, FAX# 815-436-1912

Acoustone Grille Cloth

80 Wythe Ave.
Brooklyn, NY 11211
(718) 782-5560, FAX# 718-782-7367
Pres.: George Backer, Prod. Mgr.: Larry Lubliner,
Office Mgr.: Al Allentoff, Order.: Inge, Order.: Judy

Aerocoustic

4876 Victor St.
Jacksonville, FL 32207
(904) 731-3577, FAX# 904-739-5680

Alpha Audio

2049 W. Broad St.

Richmond, VA 23220
(804) 358-3852, FAX# 804-358-9496

VP: Eric Johnson, Prod. Mgr.: Kathy Wynne, Sls: Bobbie Winn, Sls: Mike Binns
Products: absorption, absorptive partitions, ceiling panels, dampening material, noise control panels, and enclosures, wall coverings

Alpha Recording

2049 W. Broad St.
Richmond, VA 23220-2075
(804) 358-3852, FAX# 804-358-9496

American Acoustic Products

9 Cochituate St.
Natick, MA 01760
(508) 237-4223, FAX# 508-651-1306

Armstrong Cork

333 Liberty St.
Lancaster, PA 17603
(717) 397-0611, 800-233-3823

- BLI**
507 Canal St.
Stamford, CT 06902
(203) 325-3883, FAX# 203-359-8597
- Doug Biron Assoc.**
PO Box 413
Buford, GA 30518
(404) 945-2929
- Bostick**
Boston St.
Middleton, MA 01949
(617) 777-0100, 800-343-8178, FAX# 508-774-7376
- Brejtus Business Environments**
1329 E. University Dr.
Tempe, AZ 85281
(602) 968-1112, FAX# 602-968-1173
Products: wall panels
- Capaul**
1300 Division St.
Plainfield, IL 60544
(815) 436-8500, 800-421-8368
VP Sls: Craig Lindblad
Products: ceiling panels
- Celotex**
PO Box 31602
Tampa, FL 33631-3602
(813) 871-4811, FAX# 813-871-4787
- Controlled Acoustics**
12 Wilson St.
Hartsdale, NY 10530
(914) 428-7740
- Decoustics**
65 Disco Rd.
Toronto, Ontario, Canada M9W 1M2
(416) 675-3983, 800-387-3809, FAX# 416-675-5546
Pres.: Roy Hints, Nat'l Sls Mgr.: Steve Wilson, Mgr./Acoustic Control Sys.: Ed Romaniuk
Sls Reps in all principal cities in the U.S. and Canada
- Duracote**
PO Box 512
Ravenna, OH 44266
(216) 296-3486, 800-321-2252, in-state 800-in OH 800-362-0588, FAX# 216-296-5102
- Eckel Industries—Acoustic Div.**
155 Fawcett St.
Cambridge, MA 02138
(617) 491-3221, FAX# 617-547-2171
Pres.: Alan Eckel, VP: John W. Flood, Sls Coord.: Joseph McDonough
Products: absorption, ceiling panels, noise control panels, and enclosures, wall panels
- General Design Group**
3664 W. 2100 St.
Salt Lake City, UT 84120
(801) 973-6497
Pres.: Per Haugen, VP: Perry Haugen, Sec./Treas.:
- Harold Haugen, Designer: Mark Vought, Designer: Kari Nielson
- Industrial Acoustics**
1160 Commerce Ave.
Bronx, NY 10462
(212) 931-8000, FAX# 212-863-1138
Pres.: Martin Hirschorn, VP Mkt'g.: John Handley, VP Arch.: Robert Buelow, Dir. Comm.: Zachary Jaquett
Products: absorption, absorptive partitions, ceiling panels, noise control panels, and enclosures, vibration isolation material, systems, and devices, wall panels
- Interior Acoustics**
176 Rt 206 S.
Somerville, NJ 08876
(201) 874-4155, 800-221-0580, FAX# 201-874-4525
Pres.: Art Barkman, Mkt'g Mgr.: Scott Randolph
Lansky Zagoren Assoc., Boston, MA, 617-330-6999
Controlled Acoustics, Hartsdale, NY, 914-428-7740
Lizotte Assoc., Edgewater, MD, 301-261-7776
JW Fox, Grapeville, TX, 817-481-5559
Carlson/Hall Group, Cincinnati, OH, 513-598-1000
Products: absorption, dampening material, diffusion, grille cloth, noise control panels, and enclosures, wall coverings, wall panels
- Korfund Dynamics**
PO Box 235
Westbury, NY 11590
(516) 752-2453, FAX# 516-694-6558
- Mason Industries**
PO Box 410
Smithtown, NY 11787
(516) 348-0282, FAX# 516-348-0279

**What's new? Each month,
Sound & Communications Products
Department showcases many of the new
products being introduced by both large
and small manufacturers. And noted
technical writer and consultant Gary Davis
focuses on one new product each month in
his commentary, A Closer Look.
Don't be left out!
Send all your product news (with photos) to:**

Managing Editor
Sound & Communications
25 Willowdale Avenue
Port Washington, NY 11050

Notes:

Pres.: Norm Mason, VP: Patrick Lama, Treas: Anthony Slota, Controller: Mary Patterson, Purch. Agent: Arnold Stillman, Plant Mgr.: Henry Smith
Mason Industries, Anaheim, CA, 714-535-2727
Mason W., Anaheim, CA, 714-630-0701
Mason Dallas, Euless, TX, 817-267-8651
Louis Imbert, Chicago, IL, 312-777-4020
Frank Dean, Reisterstown, MD, 301-833-9191

Mellotone

PO Box 145
Blacksburg, SC 29702
(803) 839-6341, FAX# 803-839-2911
Pres.: Allan H. Silverman, VP: Alan W. Silverman,
VP/G. Mgr.: Robert Silverman, Mellotone Coord.: Sylvia Grigg
Products: grille cloth

Northern Sound

2401 Lowry Ave. NE, Ste 201
Minneapolis, MN 55418
(612) 788-9296

O'Brien Partition

5301 E. 59th St.
Kansas City, MO 64130
(816) 361-2334

Owens-Corning Fiberglas, Acoustic

Prod. Div.
Fiberglas Tower
Toledo, OH 43659
(419) 248-8000

Penn Fabrication (USA)

PO Box 506
Hawthorne, NJ 07506
(201) 423-4404
Sls Dir.: Mike Panasuk, G. Mgr.: Richard Stratford, G.
Mgr.: Gavin Naismith
Products: dampening material, grille cloth, noise control
panels, and enclosures, wall coverings, wall panels

Pittsburgh Corning

800 Presque Isle Dr.
Pittsburgh, PA 15239
(412) 327-6100, 800-245-1217, FAX# 412-733-
4815
Robert DeGusipe

Proudfoot

PO Box 338
Botsford, CT 06404
(203) 459-0031, FAX# 203-459-0033
Pres.: David Proudfoot, G. Mgr.: Michael Thompson
Products: absorption, absorptive partitions, dampening
material, noise control panels, and enclosures, wall cover-
ings, wall panels

Pyrok

8F Henshaw St.
Woburn, MA 01801
(617) 933-1622, FAX# 718-768-3980
Pres.: Phil Malarkey, Mgr.: Howard Podolsky, Plant
Mgr.: Frank Persico
Pyrok, Carrollton, TX, 214-306-0623
Pyrok, Brooklyn, NY, 718-788-1225
Controlled Acoustics, Hartsdale, NY, 914-428-7740
Winsome Ind'l, Rocky River, OH, 216-331-0136
RPM, Orangeville, CA, 916-334-0355

RPD DIFFUSOR SYSTEMS

12003 Wimbledon St.
Largo, MD 20772
(301) 249-5647, FAX# 301-249-3912

Pres./CEO: Peter D'Antonio
RPG Europe, Wembley, UK, 011-441-900-0355
Products: absorption, absorptive partitions, ceiling pan-
els, dampening material, diffusion, wall panels

Sammi Sound Technology "America"

39 Menlo Place
El Segundo, CA 94707
(415) 528-1277, FAX# 213-322-0720
Pres.: Mike Klasco

Sims Vibration Dynamics

17724 15th Ave. N.E.
Seattle, WA 98155
(206) 362-0700

Sound Absorbent Materials

PO Box 837
Westwood, NJ 07675
(201) 742-7078
Pres.: Andy Munteanu, VP Sls: John Lugano
Products: absorption, absorptive partitions, dampening
material, noise control panels, and enclosures

Soundcoat

One Burt Dr.
Deer Park, NY 11729
(516) 242-2200, FAX# 516-242-2246
CEO: Frank Kirschner, VP Mkt'g E.: Carl Wolaver, VP
Mkt'g W.: Chet Rudzinski
Blair Eng., Dallas, TX, 214-241-5655
Brandon Assoc., Norristown, PA, 609-767-2899
Erhart Eng., Stockbridge, MI, 313-229-6958
J.B. Donell, Mission Viejo, CA, 714-581-2497

Soundforms

2790 Loker Ave. W, #100
Carlsbad, CA 92008
(619) 753-4634, FAX# 619-753-4634
G. Mgr.: Lee Benelli
Products: noise control panels, and enclosures

Thermocon Products

2508 Marlin Hwy.
Waco, TX 76705
(817) 756-3713, FAX# 817-753-5622

USG Interiors

101 S. Wacker Dr.
Chicago, IL 60606
(312) 606-3865, FAX# 312-606-5864
G. Mgr.: H.A. Rowe, G. Mgr.: A. Descrescenzo, G.
Mgr.: J.H. Meister, Group VP: S.R. Sax, Prod. Mgr.:
J.H. Dobby

United States Gypsum

101 S. Walker Dr.
Chicago, IL 60606
(312) 606-3865
Mgr. Mkt'g/Prod. Dev.: D.E. Powers, Exec. VP: G.E.
Murphy, Prod. Mkt'g Mgr.: R.R. Erickson

Vibration Specialty

100 Geiger Rd.
Philadelphia, PA 19115
(215) 698-0800

Wenger

PO Box 448
Owatonna, MN 55060-0448
(507) 455-4100, 800-533-0393, FAX# 507-455-
4258

CABINETS, FURNITURE, CASES & RACKS

A & S Case
1111 N. Gordon St.
Hollywood, CA 90038
(213) 466-6181, FAX# 213-466-4068

Aarmor Case
2100 Lapo Rd.
Lake Odessa, MI 48849
(616) 374-5431, 800-722-5763
Sls/Svce: Mark Hike

Products: ATA cases & racks, electronic racks, enclosure systems, custom cabinets & consoles, flight cases, molded racks & cases, shock mount racks & cases

Alpha Omega Case
3130 Martin St., Ste 200
East Point, GA 30344
(404) 761-2900, 800-241-1129
Products: ATA cases & racks

Amco Engineering
3801 Rose St.
Schiller Park, IL 60648
(312) 671-6670, FAX# 312-671-9469
Pres.: Edwin Anderson, G. Mgr.: Thomas Anderson, Nat'l Sls Mgr.: Floyd Johnson, Mkt'g Mgr.: James Walenda, Quotations/Eng. Mgr.: James Witchea Knight, Los Angeles, CA, 213-670-2833
F + F Metro, Great Neck, NY, 516-482-4080
Kemp Instruments, Atlanta, GA, 404-452-8050
Temco Sls, Tampa, FL, 813-855-7566
Heyda Hanks Assoc., St. Paul, MN, 612-484-8531

Anvil Cases
4128 Temple City Blvd.
Rosemead, CA 91770
(818) 575-8614

Aris/Eta
1710 Enterprise Pkwy
Twinsburg, OH 44087
(216) 425-3388, FAX# 216-425-9700
Mkt'g: Bob Harris
Products: shelves, rack-mounts, stands

ATLAS/SOUNDOLIER
1859 Intertech Dr.
Fenton, MO 63026
(314) 349-3110, 800-876-7337, FAX# 314-349-1251

VP/GM: Pete Marsac, VP/Mkt'g: Herbert Jaffe, W. Reg./Sls Mgr.: Bud Waters, W. Reg./Ass. Sls Mgr.: Jim Edwards, E. Reg./Ass. Sls Mgr.: Walter Best, Order Entry Dept. Mgr.: Dale McIntyre
Atlas/Soundolier, Parsippany, NJ, 201-887-7800
Atlas Electronics, Toronto, Canada, 416-789-7761
Atlas/Ind'l, Fenton, MO, 800-362-5673
Atlas/Exp. Dept., Fenton, MO, 314-349-3110
Products: accessories, enclosure systems, custom cabinets & consoles, equipment cabinets & enclosures, rack AC power, rack fans, rack hardware, shelves, rack-mounts

BAL
PO Box 875
Elizabeth, NJ 07207
(201) 354-9625
Mgr.: Les Weinstock, Robert Schwarz

Bobadilla Cases
2302 E. 38th St.

Los Angeles, CA 90058-9990
(213) 589-5214, FAX# 213-589-5268

Bud Industries
4605 E. 355th St.
Willoughby, OH 44094
(216) 946-3200, FAX# 216-951-4015

CBM Metal Products
2016 Lebanon Rd.
W. Mifflin, PA 15122
(412) 655-2800, 800-387-4834 US, FAX# 412-655-2494

Mkt'g Mgr.: Les Houle, Sls Mgr.: Andy Finotti
CBM, Mississauga, Ontario, 416-670-7471
Products: equipment cabinets & enclosures, furniture systems, stands, storage racks & cases, tables

Cabtron Systems
200 Anets Dr.
Northbrook, IL 60062
(312) 498-6090, FAX# 312-272-1095

CAL SWITCH
13717 S. Normandie Ave.
Gardenia, CA 90249
(213) 538-9830, 800-225-7924, FAX# 213-327-2741
Products: computer consoles, equipment cabinets & enclosures, rack hardware

Calzone Case
225 Black Rock Ave.
Bridgeport, CT 06605
(203) 367-5766, 800-243-5152, FAX# 203-336-4406
Pres.: Joseph Calzone, VP Sls: Vincent Calzone, Prod. Eng.: Tom McChno, Reg. Sls Mgr.: Gary Pelfrey
Products: ATA cases & racks, equipment cabinets & enclosures, flight cases, portable tables, rack fans, rack hardware, shock mount racks & cases, tool cases

Cases
1745 W. 134th St.
Gardenia, CA 90249
(818) 575-8614

Caseworks of Chicago
3050 N. Western Ave.
Chicago, IL 60618
(312) 472-8111, 800-728-8111

J.W. DAVIS & CO
PO Box 26177
Dallas, TX 75226
(214) 651-7341, 800-527-5705, in-state 800-in TX 800-442-1564, FAX# 214-939-0328
Pres.: Charles Griffith, VP Sls: Jack Tucker
Products: accessories, equip. cabinets & enclosures

Diversified Case
34 Main St.
Whitesboro, NY 13492
(315) 736-3028, 800-258-1188, FAX# 315-736-2049
VP Mkt'g/Design: John Fitzsimmons Jr., Sls Mgr.: Charles Fisher

DUKANE
2900 Dukane Dr.

St. Charles, IL 60174
(312) 584-2300, FAX# 312-584-2370
Pres.: J. McWilliams Stone Jr., Group VP: William Finnegan, Div. G. Mgr.: Steven Deppe, Nat'l Sls Mgr.: Warren Anderson, Svce Mgr.: Cliff Carlson
Wally Smutts, Toronto-Ont, CD, 312-584-2300
Doug Fellabaum, Sycamore, IL, 815-895-7573
Don Mouritzen, Beecher, IL, 312-946-9655
Ken Lind, St. Charles, IL, 312-584-2300
Pete Kendal, Jacksonville, FL, 904-262-6025
Ed Nuhring, Portland, OR, 503-244-4262
Jim Lacey, Moreno Valley, CA, 714-243-1160
Jack Brown, Dallas, TX, 214-943-7528
Products: consoles, equipment cabinets & enclosures

EAR/Caraway Audio
1775 Old Country Rd., Ste. 19
Belmont, CA 94002
(415) 594-1790

ELMA Electronic
41440 Christy St.
Fremont, CA 94538
(415) 656-3400, FAX# 415-656-3783
Sls Mgr.: Kris Holla, Sls Eng.: Howard Anderson
Products: accessories, chassis, computer consoles, electronic racks, instrument cabinets, modular boxes

EMCOR Products/Crenlo
1600 Fouth Ave. NW
Rochester, MN 55901
(507) 289-3371
Sls Mgr.: John Horton

East Coast Lighting and Sound
PO Box 385
Wyckoff, NJ 07481
(201) 891-1886
P.: Michael Warmuth, Sls Mgr.: Kevin Campbell

Eastboard Consoles
2200 Richmond St.
Philadelphia, PA 19125
(215) 425-3121

Electrorack Products
1443 S. Sunkist St.
Anaheim, CA 92806
(714) 776-5420
Pres.: Yvonne Rumbles, Sec./Treas.: Wayne Rumbles, Op. Mgr.: Ken Seidel, Sls Mgr.: Mike Deming, VP Eng.: Allen Benson

Electro Space Fabricators
PO Box 67
Topton, PA 19562-0067
(215) 682-7181, FAX# 215-682-2133

ELENEX (WEST)
7392 Trade St.
San Diego, CA 92121
(619) 566-7515, 800-225-3113, in-state 800-in CA 800-225-8037, FAX# 619-586-1484
VP: Dennis Berglund, Eng.: Al Bitarafan, Sls: Lou Hennequin
Products: enclosure systems, custom cabinets & consoles

Equipto Electronics
351 Woodlawn Ave.
Aurora, IL 60506

18 CABINETS, FURNITURE, CASES & RACKS

(312) 897-4691
Dir. Sls/Mkt'g: Kent Jamig

FM Tubecraft
1121-20 Lincoln Ave.
Holbrook, NY 11741
(516) 567-8588, 800-553-0051, FAX# 516-563-1390
Pres.: Frank Maiella
Products: computer consoles, consoles, electronic racks, furniture systems, portable tables, shelves, rack-mounts, stands, tables

Flight Case
681 Main St., Bldg #1
Belleville, NJ 07109
(201) 759-4175, 694-6655

Flight Form Cases
PO Box 3248
Arlington, WA 98223
(206) 435-6688, FAX# 206-435-6512
Pres.: Dale Lorang, VP: Glenn Stenson, Sec./Treas.: Pat Kaminske, Sls & Design: Donald Cole

FOSTEX CORP. OF AMERICA
15431 Blackburn Ave.
Norwalk, CA 90650
(213) 921-1112, FAX# 213-802-1964
Exec. VP: Fred Huang, VP Sls/Mkt'g: Mark Cohen
Products: ATA cases & racks, shelves, rack-mounts

Four Designs
6531 Gross Ave.
Canoga Park, CA 91307
(818) 716-8540, 800-544-3746
Pres.: Dave Riddle



GEMINI
103 Mensing Way
Cannon Falls, MN 55009-0018
(507) 263-3957, 800-533-3631, FAX# 507-263-5987
Sls: Bob Ourdahl



General Devices
PO Box 39100
Indianapolis, IN 46239
(317-) 897-7000, FAX# 317-898-2917
Pres.: Maxwell Fall, Nat'l Sls Mgr.: Jack Bradford, Dir. Mkt'g: Ron Stalze
Coakley Boyd & Abbott, Needham Heights, MA, 617-444-5470
GROH Assoc., Irvine, CA, 714-837-9871
Arnold Tech. Sls, San Jose, CA, 408-954-0400
Henry Richter, Mountainside, NJ, 201-233-4615
Howard Benjamin Assoc., Northbrook, IL, 312-272-2900
Products: chassis, electronic racks, enclosure systems, custom cabinets & consoles, equipment cabinets & encl-

tures, hardware, rack fans, rack hardware, shelves, rack-mounts, slides

GEPCO INT'L
1863 W. Carroll
Chicago, IL 60612
(312) 733-9555, FAX# 312-733-6416
Pres.: Gary Geppert, Asst. To Pres.: Larry Smith Sr., Sls Mgr.: Larry Smith Jr., Op. Mgr.: Mike Geppert, Purch. Mgr.: Kathie Geary
Products: accessories, equipment cabinets & enclosures, hardware, instrument cabinets, panels, shelves, rack-mounts, stands

Good Foundations
6747 Valjean Ave.
Van Nuys, CA 91406
(818) 786-8696, 800-257-8727, FAX# 818-376-1166
Pres.: Larry Weisberg, VP: Paula Weisberg, VP Mkt'g: Bud Martin, Nat'l Sls Mgr.: Andrew Hamilton
Products: stands

The Great American Market
826 N. Cole Ave.
Hollywood, CA 90038
(213) 461-0200, FAX# 213-461-4308
G. Mgr.: Joseph Tawil, Sls Mgr.: Mofid Bissada, Op. Mgr.: Jeffrey Lind

HSA Heather Sound
212 Lincolnway W.
Mishawaka, IN 46544
(219) 255-6100

Adam Hall Supplies
120 Lawlins Pk.
Wyckoff, NJ 07481
(201) 891-1886

Hammond Mfg.
1690 Walden Ave.
Buffalo, NY 14225
(716) 894-5710

Harnel Case Manufacturers
1600 Marshall SE
Grand Rapids, MI 49507
(616) 452-4522, FAX# 616-452-5514
Pres.: Ralph Teichert, Sls/Mkt'g Mgr.: Michael Moore, Op. Mgr.: Tim Teichert
Products: ATA cases & racks, flight cases, shock mount racks & cases, soft cases & bags

Hi Lo Fabrication & Mfg.
PO Box 509
Rio Vista, TX 76093
(817) 373-2247
Pres.: C. Caro, Prod. Eng.: Cecil Caro, VP Mkt'g: Bridget Caro
Products: enclosure systems, custom cabinets & consoles, equipment cabinets & enclosures, instrument cabinets, molded racks & cases, panels, stands

House of Metal Enclosures
500 W. Ninth St.
Hermann, MO 65041
(314) 486-3111

Hybrid Cases
1121-20 Lincoln Ave.
Holbrook, NY 11741
(516) 563-1181, 800-645-1707, FAX# 516-563-1390
Pres.: Frank Maiella, Sls: Bruce Papa, Sls: Charles Northington

Products: ATA cases & racks, electronic racks, flight cases, shock mount racks & cases, soft cases & bags

Impact Industries
333 Plumer St.
Wausau, WI 54401
(715) 842-1651, FAX# 715-845-1605
Pres.: Terry Thirion

Jan-AI Cases
3339 Union Pacific Ave.
Los Angeles, CA 90023
(213) 260-7212, FAX# 213-260-4696
Pres.: Jan Michael Alevandro, VP: "Muffie" Alevandro, Design/Mkt'g Dir.: Todd Morgan, G. Mgr.: Magi Lujan
Products: ATA cases & racks, flight cases, shock mount racks & cases, storage racks & cases, tool cases

Javelin Electronics
PO Box 2033
Torrance, CA 90502
(213) 327-7440, 800-421-2716, in-state 800-528-9200, FAX# 213-327-5405
Pres.: Graham Nallis, VP Sls & Mkt'g: John Schulte, VP Eng.: Ray Payne, Sls Mgr.: Roy Schaub, Mkt'g Mgr.: Fred Vogel
Arlington, VA, 703-522-1131
Products: enclosure systems, custom cabinets & consoles

KALAMAZOO TECHNICAL FURNITURE
PO Box 1165
Kalamazoo, MI 49005-1165
(616) 385-2255, 800-832-5227, FAX# 616-385-2112
Pres.: Lawrence Draves, Sls Mgr.: Bruce Smith, Sys. Eng.: John Sweezy, Inside Sls: Matthew Murphy

Karibu Sound Industries
1310 Racquet Rd.
Baltimore, MD 21209
(301) 583-7253, FAX# 301-337-2679
Pres.: Lawrence Kirchner, VP/Credit Mgr.: Ralph Rizzo Jr., VP Sls: Thomas Scott Dunbar
Taub Sls, Silver Springs, MD, 301-622-9100

Knight Industries
90 Junius St.
Brooklyn, NY 11212
(718) 342-6400, 800-782-6389, FAX# 718-485-8551

**TELL YOUR
SUPPLIERS
YOU FOUND THEM
IN THE
BLUE BOOK**

ready to go



Series VI

CONSOLES • RACKS • ENCLOSURES

Series VI factory assembled configurations, or individual stacking frame modules and components, are manufactured of 14 gauge CRS, welded, and shipped ready for equipment installation. No misalignments or unattractive hardware as often experienced with local assembly.

Five standard console system models, and a selection of mix and match accessories, assure the most cost-efficient task oriented flexibility for 19" width individual project requirements.

Enclosures for housing and protecting electronic equipment in audio, CCTV, communications, security, process control, training, laboratory, and energy management installations.

Five modern factories throughout the United States, ready to provide you with prompt service, realistic prices and assured customer satisfaction.

For free catalog, please call 1-800-ENCLOSE (363-5673), Industrial Sales Department, Atlas / Soundolier. FAX: 314-349-1251.



Professional Sound Loudspeakers

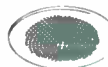

Ceiling Baffles and Enclosures



Omni-Purpose Speakers

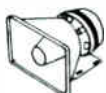

Electronic Siren Loudspeakers



Microphone and Equipment Stands



Visual Call Systems



Voice/Tone Loudspeakers



ATLAS / SOUNDOLIER

DIVISION OF AMERICAN TRADING AND PRODUCTION CORPORATION
1859 INTERTECH DRIVE / FENTON, MISSOURI 63028 U.S.A.
TEL: (314) 349-3110 / TELEX: 910-760-1650 / FAX: (314) 349-1251

Pres.: Al Solomon
 Givan Assoc., W. Boylston, MA, 508-835-3161
 Sigmat, Valley Forge, PA, 215-783-6666
 Reptronics, New Madison, OH, 513-996-0530
 William Linz Assoc., Deerfield, IL, 312-945-9600
 Dimension Point IX, Lewisville, TX, 214-436-3706
Products: accessories, electronic racks, enclosure systems, custom cabinets & consoles, equipment cabinets & enclosures, hardware, instrument cabinets, modular boxes, panels., rack hardware, shelves, rack-mounts, shock mount racks & cases, slides, stands

LM Engineering
 660 W. Evergreen St.
 Youngstown, OH 44511
 (800) 874-8326

Lenco
 PO Box 348
 Jackson, MO 63755
 (314) 243-0271, 800-325-8494, FAX# 314-243-7122

Lowell Mfg.
 3030 Laclede Sta. Rd.
 St. Louis, MO 63143
 (314) 781-9058, 800-325-9660, FAX# 314-645-4852

Chairman: Ben Lowell, Pres.: Dorothy Lowell, Sls Mgr.: John Lowell, Op.: Wilhelm Lowell, Eng.: Karl Schneider, Credit Mgr.: Mary Tiepelman
 Design Factors, Hacienda Heights, CA, 213-697-7576
 Meyer Mkt'g, Deerfield Beach, FL, 305-481-9250
 Peregrine SW Reps, Houston, TX, 713-589-8481
 H.W. Phillips, Roswell, GA, 404-992-3070
 Pusecker Sls, Upper Montclair, NJ, 201-744-1834
Products: accessories, shelves, rack-mounts

MIDDLE ATLANTIC PRODUCTS

PO Box 96
 Haskell, NJ 07420
 (201) 839-1011, FAX# 201-839-1976
 Op. Mgr.: Scott Mathews
Products: accessories, chassis, panels., rack hardware, shelves, rack-mounts, slides

PAR Products
 1260 Atlantic Ave.
 Brooklyn, NY 11216
 (718) 774-5900

Parsons Mfg.
 1055 O'Brien Dr.
 Menlo Park, CA 94025-1476
 (415) 324-4726
 Pres.: A.R. Parsons, VP: C.E. Plummer

Peerless Sales
 1950 Hawthorne Ave.
 Melrose Pk., IL 60160
 (312) 865-8870, FAX# 312-865-2941
 VP: Walter Snodell, Mkt'g Mgr.: Frank R. Briggs
Products: accessories

Penn Fabrication (USA)
 PO Box 506
 Hawthorne, NJ 07506
 (201) 423-4404
 Sls Dir.: Mike Panasuk, G. Mgr.: Richard Stratford, G. Mgr.: Gavin Naismith
Products: accessories, hardware, rack fans, rack hardware, shelves, rack-mounts

Platt Luggage
 2301 S. Prairie Ave.
 Chicago, IL 60616-2495
 (312) 225-6670, 800-222-1555, FAX# 312-225-2900
 Pres.: Dennis Platt, VP: Mark Platt

Precision Fabrication Technologies
 Hwy 16 W.
 Monon, IN 47959
 (219) 253-6666, 800-558-7297, FAX# 219-253-6570
 Pres.: Joseph Rogers, VP: Roger Hollar, Treas.: Jerry Horner, Sls Eng.: Jim Mann, Distrib. Specialist: Duane Nagel
 Edward King Assoc., Saratoga, CA, 408-741-0434

Lessing Assoc., Valencia, CA, 805-295-0225
 Bob Burns Assoc., Park Ridge, IL, 312-823-9360
 Bacha, Greenleaf Assoc., Westlake, OH, 216-892-1770
 FJS Sls, Old Saybrook, CT, 203-388-5374
Products: accessories, chassis, electronic racks, enclosure systems, custom cabinets & consoles, equipment cabinets & enclosures, instrument cabinets, modular boxes, panels., rack fans, rack hardware, shelves, rack-mounts

Premier Metal Products
 381 Canal Pl.
 Bronx, NY 10451
 (212) 993-9200
 Pres.: Stanley Kwasnicki, Sls Mgr.: Anthony Bozza, Design Eng.: Frank Sonanno



PROTO-TEC
 108 Fairlane Dr.
 Joliet, IL 60435
 (815) 744-7173

Products: enclosure systems, custom cabinets & consoles, equipment cabinets & enclosures, hardware, instrument cabinets, modular boxes, panels., shelves, rack-mounts

Quickset Int'l
 3650 Woodhead Dr.
 Northbrook, IL 60062-1895
 (312) 498-0700, 800-247-6563, FAX# 312-295-8553
 VP Mkt'g: Rudy L. Merz
Products: stands

Racware (Rackmounted Computers)
 13773 N. Central Expressway, Ste. 1444
 Dallas, TX 75243
 (214) 690-8480

Roadrunner Cases
 447 E. Gardena Blvd.
 Gardena, CA 90248
 (213) 770-4444, FAX# 213-538-9560
 Pres.: Howard Chart

Ruslang
 320 Dewey St.
 Bridgeport, CT 06605
 (203) 384-1266
Products: consoles

Schroff
 170 Commerce Dr.
 Warwick, RI 02886
 (401) 732-3770, FAX# 401-738-7988
 Sls Mgr.: Sam Hopp, Reg. Sls NE: Bill Bottis, Reg. Sls MidW: Fred Nelson, Reg. Sls S.: Herb Williams, Reg. Sls W.: Marc Tessier, Reg. Sls Can.: Bill Cabral

Scientific Atlanta/OPTIMA Div.
 2166 Mountain Ind'l Blvd.
 Tucker, GA 30084
 (404) 496-4000, FAX# 404-496-4041

Silver Eagle Designs
 6747 Valjean Ave.
 Van Nuys, CA 91406

Precision designed & engineered in Europe

...the easiest solution to your installation problems

Complete your installations easily and efficiently. The TEI A/V Mounting System does the work for you, beautifully. Providing flexible solutions to those difficult space and viewing/listening problems. Handsomely finished hardware in Black/Dark Brown finished steel, TEI's versatile line of mounting units (load capacity to 175 lbs.) are ideally suited to home and apartment use.

So when you're ready to "hang it up" the easy way - install with TEI.

Audio Visual Mounting Systems

TEI Electronics, Inc., Dept. EH
 570 West 18th St., Hialeah, Florida 33010

... for catalog and price list call TOLL-FREE 800-327-8611 and ask for operator #101

Circle 63 on Reader Response Card

(818) 786-8696, 800-257-8727, FAX# 818-376-1166
 Pres.: Lawrence Weisberg, VP: Aleda Weisberg, Sec./Treas.: Paula Weisberg, Int'l Sls Mgr.: Rene Arnault, Nat'l Sls Dir.: Andrew Hamilton, Mkt'g Dir.: Larry Knight
 Silver Eagle Accessories, Van Nuys, CA, 818-786-8696
 Products: soft cases & bags

Skydyne
 21 River Rd.
 Port Jarvis, NY 12771
 (914) 856-6655, 800-428-CASE, FAX# 914-856-8378
 Sls Mgr.: M. Timney

Sound Tech
 230 Lexington Dr.
 Buffalo Grove, IL 60089
 (312) 541-3520, 800-877-6863, FAX# 312-541-3616
 Pres.: Rudy Schlacher, Gen. Sls Mgr.: David Beirut, Exp. Sls Mgr.: William Robinson, Sls Dir.: Todd Peren
 Products: ATA cases & racks

Standtastic
 1325 Meridian St.
 Anderson, IN 46016
 (317) 642-5205, 800-876-6923, FAX# 317-641-1205
 Pres.: Larry Mechem, V.: L.J. Mechem, Nat'l Sls Mgr.: Mike Fox, Cust. Svce: Kim Keown

Stantron-Unit of Zero
 6900 Beck Ave.
 N. Hollywood, CA 91605
 (213) 875-0990

Star Case
 648 Superior
 Munster, IN 46321
 (219) 922-4440, 800-822-STAR, FAX# 219-922-4442
 Pres.: Dennis Toma, VP Sls/Mkt'g: Bernard Fryman, Dir. Mfg.: Roger Hallberg
 Products: ATA cases & racks

TA Instrument Case
 4625 Alger St., Dept. EE
 Los Angeles, CA 90039
 (818) 242-8855
 Mkt'g Mgr.: Lisa La Croix

Teclab
 310 Perkstok Rd.
 Kalamazoo, MI 49001
 (800) 832-5227
 Pres.: J. Draves, Sls Mgr.: B. Smith, Cust. Svce: J. Savan

Thermodyne Int'l
 20850 S. Alameda St.
 Long Beach, CA 90810
 (213) 603-1976, FAX# 213-603-1929
 VP: Gary Ackerman
 Products: ATA cases & racks, flight cases, molded racks & cases, shock mount racks & cases

Viking Cases
 10480 Oak St. NE
 St. Petersburg, FL 33716
 (813) 577-1216, 800-237-8560, FAX# 813-577-2082

VP Sls: William Strickland
 Products: ATA cases & racks, flight cases, shock mount racks & cases

Winsted
 10901 Hampshire Ave. S
 Minneapolis, MN 55438
 (612) 944-8556, 800-447-2257, FAX# 612-944-1546
 VP: Jerry Hoska, Sls: Randy Smith, Sls Mgr.: Judy Ruzek

Wyle Labs/Electronic Enclosures Div.
 225 S. Aviation Blvd.
 El Segundo, CA 90245
 (213) 643-8181, FAX# 213-643-8565
 Exec. V.: Mel Greenberg, VP G. Mgr.-West: Hillard Sorey, VP G. Mgr.-East: Tom Keller, VP Mkt'g: Jack Swing, Sls Mgr.-East: Ron Pache, Sls Mgr.-West: Burt Lipson

Zonk & Assoc., Richardson, TX, 214-238-7651
 Carlson Assoc., Campbell, CA, 408-370-1284
 Imagitron Sls, Monkton, MD, 800-638-3592
 Tesco, Needham Heights, MA, 617-444-7925
 C-Tron, St. Charles, MO, 314-928-8078
 Products: chassis, computer consoles, consoles, electronic racks, enclosure systems, custom cabinets & consoles, equipment cabinets & enclosures, instrument cabinets, panels, shelves, rack-mounts

Zero Corp., Zero-W. Div.
 PO Box 509
 Burbank, CA 91503
 (818) 846-4191, FAX# 818-841-5618
 Pres./CEO: Woody Godbold Jr., VP: Jim Hermanson, VP: Ron Hess, Pres./Zero-W. Div.: Bill Wood, VP Sls: Douglas Griffith
 Products: accessories, ATA cases & racks, chassis, computer consoles, consoles, electronic racks, enclosure systems, custom cabinets & consoles, equipment cabinets & enclosures, flight cases, furniture systems, hardware, instrument cabinets, modular boxes, molded racks & cases, panels, portable tables, rack AC power, rack fans, rack hardware, shelves, rack-mounts, shock mount racks & cases, slides, soft cases & bags, stands, storage racks & cases, tables, technical workbenches, tool cases

**CUSTOM PANELS
 COMPUTER ENGRAVING**

TO YOUR SPECIFICATIONS

Panels. cabinets. enclosures to your specifications. Anodized aluminum. photo aluminum. photo plastic. elegant brass. Engraving or silk screening for control panels and connector termination. Rack rails. hardware. Custom machining.

FROM ONE TO ANY QUANTITY



(815) 744-7173

108 Fairlane Dr., Joliet, IL 60435

New! Extruded breakout boxes: headphone boxes. Designed and used for Summer Olympics (NBC.) Any color. any length.

NEW SERVICE FROM PROTO-TEC:
Custom Logo and Artwork Scanning
 Computer Precision enables intricate detail, such as flow chart on panels. *Ask us!*

Circle 45 on Reader Response Card

HARDWARE & TOOLS

A-1 Business Supplies

PO Box 405
Pine Brook, NJ 07058
(201) 882-1066, 800-631-3421
Sls Mgr.: Dick Birnbaum

AVA Electronics

4000 Bridge St.
Drexel Hill, PA 19026
(215) 284-2500
Products: connectors

Alarm Accessory

501 Silverside Rd.
Wilmington, DE 19809
(302) 792-3620, 800-441-7082, FAX# 302-792-7713
Pres.: William Holt Sr., Op. Supervisor: Angela Bopp
Products: cable clamps, raceways, stands

All Electronics

PO Box 567
Van Nuys, CA 91408
(818) 904-0524, 800-826-5432, FAX# 818-781-2653
Mgr. Sls: Harold Oliver
Products: clamps, chemicals, connectors, lamps

Brim Electronics

PO Box 3365
Fairlawn, NJ 07410
(201) 796-2886, FAX# 201-778-2792
S.M.: B. Brown
GH Assoc., Stow, MA, 508-897-3534
Macronix, Phoenix, AZ, 602-998-1848
Boerger & Assoc., MN, 612-560-3435
Products: cable clamps, wire terminations

Cabletronix

PO Box 3003
Newburgh, NY 12550
(914) 565-7570, 800-431-9473, in-state 800-in NY 800-942-WIRE, FAX# 914-564-5332
P.: S. Roth, VP: Len Ellentuch, Sls: Tom Martirano

CAL SWITCH

13717 S. Normandie Ave.
Gardenia, CA 90249
(213) 538-9830, 800-225-7924, FAX# 213-327-2741
Pres.: Irwin Perlman, VP: Bob Andrade, VP: Herb Poncher, Mkt'g Mgr.: Gayle Danielson
Products: connectors, knobs, lamps

D.J. Associates

8411 S. Zero, Unit 5
Ft. Smith, AR 72903-7097
(501) 452-3987, FAX# 501-452-7752
Pres.: I. Jean Beck, VP: Michael Beck

Daburn Electronics and Cable

224 Pegasus Ave.
Northvale, NJ 07647
(201) 768-5400, FAX# 201-768-9642
Pres.: Howard Danziger, Sls Mgr.: Ed Rothenstein
Products: cable clamps, wire terminations

J.W. DAVIS & CO.

PO Box 26177
Dallas, TX 75226
(214) 651-7341, 800-527-5705, in-state 800-in TX 800-442-1564, FAX# 214-939-0328
Pres.: Charles Griffith, VP Sls: Jack Tucker
Products: cabinet hardware, knobs, speaker hardware, wire pulling devices,

GEPCO INT'L

1863 W. Carroll
Chicago, IL 60612

(312) 733-9555, FAX# 312-733-6416

P.: Gary Geppert, Larry Smith Sr., Sls: Larry Smith Jr.,
Op.: Mike Geppert, Purch.: Kathie Geary
Products: cabinet hardware, cable clamps, cleaning chemicals, connectors, fabrication supplies, hanging systems, knobs, lamps, panels, speaker hardware, wire terminations

HARRIS/DRACON DIV.

809 Calle Plano
Camarillo, CA 93010
(805) 987-9511, 800-4-DRACON, FAX# 805-987-2547
VP/G. Mgr.: John Mason, VP Sls/Mkt'g.: Jack McGuigan, Dir. Sls: Tom Erdmann, VP Eng.: Tom Durston, Mgr. Mkt'g Comm.: G. Eric Slayton, Prod. Mgr. Paging: Tom Johnson
Duncan Way, El Toro, CA, 714-859-9932
John Muller, Chesapeake Beach, MD, 301-257-3686
Gary Foster, Columbia, MO, 314-442-2288
Bob Lincoln, Inidan Rock Beach, FL, 813-595-3055
Don Bivens, Lake Elsinore, CA, 714-244-8808
Sam Biasi, Alexandria, BA, 703-971-5095
Bill Boone, Libertyville, IL, 312-816-1080
Margaret Giambalvo, Short Hills, NJ, 201-564-8508
Mark Skilowitz, New Field, NJ, 609-697-4580
Dave Whalen, Houston, TX, 713-974-4373

Jensen Tools

7815 S. 46th St
Phoenix, AZ 85044
(602) 968-6241
Pres.: Arnold Schwartz, Sls: Herb Oberman, Prod. Eng.: Sherman Jensen
Products: tool kits

Labor Saving Devices

1355 Harlan St.
Denver, CO 80214
800-648-4714, FAX# 303-233-8769

Mag-Tags

2531 W. Tharpe
Tallahassee, FL 32303
(904) 386-5611, FAX# 904-385-5710
Alan Pippenger, Carolyn Pippenger
Products: markers

Miller-Stephenson Chemical

PO Box 950
Danbury, CT 06813
(203) 743-4447, 800-992-2424, FAX# 203-791-8702
CEO/Pres.: G.M. Stephenson, Op. Mgr.: W.J. Brennan,
Adv. Mgr.: D.V. O'Donnell, Office Mgr.: F. Bodnar
MS, Sylmar, CA, 818-896-4714
MS, Morton Grove, IL, 312-966-2022
MS, Ontario, Canada, 416-675-3204

Omnimount Systems

10850 Vanowen St.
N. Hollywood, CA 91605
(818) 766-9000, FAX# 818-711-9669
Pres.: Alex Cyrell, VP: Susan Michelson, VP Mkt'g: Bruce Chantra, Sls: John Hix
Sigmat, Freehold, NJ, 201-462-1221
New West Audio, Burbank, CA, 818-955-9700
Benscik Assoc., Ocala, FL, 904-732-7775
Sound Mkt'g, Palos Hills, IL, 312-598-6888
Pro Audio Assoc., Burlington, MA, 617-229-6050
Products: hanging systems

Paladin

3543 Old Conejo Rd., Ste #102
Newbury Park, CA 91320
(805) 499-0318

Panduit

17301 Ridgeland
Tinley Park, IL 60477

800-777-3300, FAX# 708-532-1811

Peavey Electronics

711 A St.
Meridian, MS 39302
(601) 483-5365, FAX# 601-484-4278
Pres.: Hartley Peavey
Products: cabinet hardware, cleaning chemicals, connectors, knobs, lamps, speaker hardware

Penn Fabrication (USA)

PO Box 506
Hawthorne, NJ 07506
(201) 423-4404
Sls Dir.: Mike Panasuk, G. Mgr.: Richard Stratford, G. Mgr.: Gavin Naismith
Products: cabinet hardware, connectors, knobs, lamps, speaker hardware

PROTO-TEC

108 Fairlane Dr.
Joliet, IL 60435
(815) 744-7173
Products: panels

Seal-O-Matic

900 Passaic Ave.
East Newark, NJ 07029
(201) 481-6500, 800-631-2072

J.H. Sessions & Son

PO Box 609
Bristol, CT 06010
(203) 582-3127, FAX# 203-582-2574
Pres.: Paul Sessions, VP & Sls Mgr.: Donald Sessions
Products: cabinet hardware, speaker hardware

TEI Electronics

PO Box 246
Hialeah, FL 33011
(305) 888-3980, 800-327-8811, FAX# 305-885-4950
Pres.: Danny Alonso, VP: Mireya Muniz, Nat'l Sls Mgr.: Walter McNulty, Cust. Svce: John Tembras, Sls: Orlando Pineda, Sls: Jose Hurcades
Products: cabinet hardware, cleaning chemicals, connectors, fabrication supplies, hanging systems, lamps, speaker hardware, tool kits, wire terminations

TARGET TECHNOLOGY

PO Box 609
Penn Valley, CA 95946
(916) 639-2102
Pres.: Peter Hughes, VP: Sherri Douglas
Products: wire terminations

Texwipe

650 E. Crescent Ave.
Upper Saddle River, NJ 07458
(201) 327-9100, FAX# 201-327-5945

Vaco Products

7200 McCormick Blvd.
Chicago, IL 60645
(312) 677-9500, FAX# 312-677-4476

Yale Audio of Florida

PO Box 2661
Tampa, FL 33601
(813) 876-6789
Pres.: Y. Brevda, Sls Mgr.: David Kentwood
Products: markers

HEADPHONES & HEADSETS

ACS Communications

250 Technology Circle
Scotts Valley, CA 95066
(408) 438-3833 (in CA), 800-538-0742
Pres.: Al Butcher, Exec VP: Phil Gattley, VP Sls: Kurt Siem, VP Consumer: George Poston
Products: boom-mic headsets, communications headsets

AKG ACOUSTICS

77 Selleck St.
Stamford, CT 06902
(203) 348-2121, 800-243-7885, FAX# 203-324-1942
Pres.: S. Richard Ravich, VP Op.: Derek Pilkington, VP Fin.: Bob Netter
Products: communications headsets, intercommunications headsets, isolation headsets, personal/stereo headphones, telecommunications headsets

Accusonics Systems

2101 Jericho Turnpike
New Hyde Park, NY 11040
(516) 328-3300
G. Mgr.: Dennis Goodman
Products: boom-mic headsets, communications headsets, intercommunications headsets, isolation headsets, telecommunications headsets

Alaun Engineering

2305 Florencita Dr.
Montrose, CA 91020
(818) 957-0618
Owner/Pres.: Al Braun, VP: M. Antoniate

Anixter Bros.

4711 Golf Rd.
Skokie, IL 60076
(312) 677-2600, 800-323-8167
Products: boom-mic headsets

Audiosears

2 South St.
Stamford, NY 12167
(607) 652-7305
Products: boom-mic headsets

Auditel Systems

396 Porter Ave.
Buffalo, NY 14201
(716) 886-0019, FAX# 716-886-1615
Pres.: David Langtry, Prod. Mgr.: Tony Roberson, Mkt'g Dir.: Jim Wood
Products: boom-mic headsets

Beyer Dynamic

5-05 Burns Ave.
Hicksville, NY 11801
(516) 935-8000, FAX# 516-935-8018
VP/G. Mgr.: Paul Murphy, Mkt'g Mgr.: Mike Solomon
Derek Allen, Burbank, CA, 818-840-8327
Bruce Marlin, Irving, TX, 214-869-0669
Tom Parnell, Bannockburn, IL, 312-234-6500
Bob Edsall, Asheville, NC, 800-999-9313
Dave Henderson, Burlington, MA, 617-229-6050
Products: boom-mic headsets, communications headsets, intercommunications headsets, isolation headsets, personal/stereo headphones, telecommunications headsets

BOSE—PRO PRODUCTS

The Mountain
Framingham, MA 01701
(508) 879-7330, FAX# 508-872-6541
G. Mgr.: David Bell, Nat'l Field Sls Mgr.: Timothy Dorwart, E. Reg. Mgr.: Robin Sibucan, W. Reg Rep: Michael Schneider
Products: intercommunications headsets

David Clark

PO Box 15054
Worcester, MA 01615
(617) 756-6216, FAX# 508-753-5827
Prod. Mgr. Comm.: George Conlon

Danavox/Telecommunications Div.

6400 Flying Cloud Dr.
Minneapolis, MN 55344
(612) 941-0690
Products: boom-mic headsets, communications headsets, telecommunications headsets

Dayton Industrial

126 Westpark Rd.
Dayton, OH 45459
(513) 236-3591

VP Sls/Mkt'g: Robert McDougall, VP Eng.: Kurt Farmer, Sr. Tech.: Frank Jaros
Products: personal/stereo headphones, telecommunications headsets

FOSTEX CORP. OF AMERICA

15431 Blackburn Ave.
Norwalk, CA 90650
(213) 921-1112, FAX# 213-802-1964
Exec. VP: Fred Huang, VP Sls/Mkt'g: Mark Cohen
Products: boom-mic headsets, personal/stereo headphones

HM Electronics

6675 Mesa Ridge Rd.
San Diego, CA 92121
(619) 535-6060, FAX# 619-452-7207
VP Mkt'g: J. Michael Hughes, Pro Audio Sls Mgr.: Eunice Davis, Ind'l Sls Mgr.: Bruce Slemmer, Cust. Svce Mgr.: Bill Kranzush, Mkt'g Coord.: Matt Riches
Derek Allen Assoc., Toluca Lake, CA, 818-843-6919
John Anthony, Stamford, CT, 203-322-9202
Applied Audio Mkt'g, Asheville, NC, 704-252-9313
A/V Mkt'g, Carmel, IN, 317-846-1034
Products: boom-mic headsets, communications headsets, intercommunications headsets, telecommunications headsets

Koss

4129 N. Port Washington Ave.
Milwaukee, WI 53212

DROP IT!

Until Headsets and Belt-Packs become lighter than air, they're going to be dropped. And if damage occurs, you can bet it will be in mid-performance. Production Intercom Headsets and Belt-Packs are built to keep communicating. Even after they are dropped. Ask us to prove it.



Production Intercom

Technical Projects, Inc
P.O. Box 3247 Barrington, IL 60010
(312) 381-5350 Fax: (312) 381-4360
1 (800) 562-5872

Circle 64 on Reader Response Card

THE STANDARD OF QUALITY

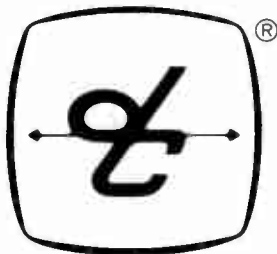

in Noise-Attenuating Headsets and Communication Systems.

For over 30 years, David Clark Company has been the leader in the development of innovative ideas in NOISE-ATTENUATING (Reducing) HEADSETS for use in high noise areas.

When these headsets are combined with one of our OFF-THE-SHELF systems, your communication problems are solved.

Choice of Systems:

- Permanently Installed
- Portable
- Voice-Powered — No Batteries or A/C Power
- Two-Way Radio Headsets and VOX Adapters
- Telephone-Compatible Headsets

Write or call for Catalog and name of nearest local dealer.

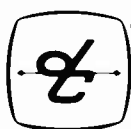

David Clark
COMPANY INCORPORATED
Box 15054, Worcester, MA 01615-0054
(508) 756-6216 FAX: (508) 753-5827

(414) 964-5000, 800-USA-KOSS, FAX# 414-974-8615

CEO/Chairman/Pres.: John Koss, Exec. V.P.: Michael Koss, VP Mkt'g: Don Wagner, VP Sls: John Koss, Jr., Sec./Corp. Legal Coun.: Michael Moore

Products: isolation headsets, personal/stereo headphones

Metragen

3701 Chesswood Dr., #309

Downsview, Ontario, Canada M3J 2P6

(416) 635-9212, FAX# 416-635-8266

Mgr.: Edward Wigdor

Products: communications headsets

Nady Systems

1145 65th St.

Oakland, CA 94608

(415) 652-2411, FAX# 415-652-5075

Sls Mgr.: Royce Krilanovich, Mkt'g/Comm.: Chris Calder

Products: boom-mic headsets, intercommunications headsets

Nakamichi America

19701 S. Vermont Ave.

Torrance, CA 90502

(213) 538-8150, 800-421-2313, FAX# 213-324-7614

Pres.: Yas Yamazaki, Exec. VP/G. Mgr.: Dean Miller, VP Sls: Jett Logan, VP Op.: Ray Privette, Mkt'g Mgr.: Jun Sakamoto

Products: personal/stereo headphones

Panasonic/Ramsa

6550 Katella Ave.

Cypress, CA 90630

(714) 373-7277, FAX# 714-373-7242

Sls/Mkt'g Mgr.: Steve Wooley, Mkt'g Mgr.: Chris Foreman, W. Sls Mgr.: James Murray, Central Sls Mgr.: Greg Braithwaite, Telemkt'g Mgr.: Carla Campbell

James Murray, Cypress, CA, 714-373-7389

Greg Braithwaite, Arlington Heights, IL, 312-981-7329

Pusecker Sls, Upper Montclair, NJ, 201-744-1834

David Bros., Finksburg, MD, 301-833-0920

Pro Audio Assoc., Burlington, MA, 617-229-6050

World Wide Electronics, Pembroke Pines, FL, 305-584-7024

Evans Sls & Mkt'g, Nashville, TN, 615-297-7997

New Horizons, Bannockburn, IL, 312-234-6500

Laker Assoc., Wauzata, MN, 612-475-2642

A/V Mkt'g, Carmel, IN, 317-846-1034

Innovative Audio, Pontiac, MI, 313-673-2280

J.B. Parent, Dublin, OH, 614-764-0064

Essential Mkt'g, St. Joseph, MO, 816-279-0776

Teneckit Assoc., Houston, TX, 713-528-2005

New West Audio, Burbank, CA, 818-955-9700

Brian Trankle Assoc., Belmont, CA, 415-595-4004

Northmar, Seattle, WA, 206-524-5170

Pearson & Pearson, Denver, CO, 303-722-6996

Plantronics

345 Encinal St.

Santa Cruz, CA 95060

(408) 426-5858, 800-538-0748

Products: boom-mic headsets, communications headsets, intercommunications headsets, telecommunications headsets

Roanwell

180 Varick St.

New York, NY 10014

(212) 989-1090, FAX# 212-989-3285

Contract Mgr./Sls: Ray Lefebvre

Sennheiser Electronic

PO Box 987
Old Lyme, CT 06371
(203) 434-9190, FAX# 203-434-1759

Products: boom-mic headsets, communications headsets, personal/stereo headphones

Setcom

1400 N. Shoreline Blvd.
Mountain View, CA 94043
(415) 965-8020, FAX# 415-965-1193
Sls Mgr.: Steve Kilczewski

SHURE BROTHERS

222 Hartrey Ave.
Evanston, IL 60202-3696
(312) 866-2200, FAX# 312-866-2279

Pres.: James Kogen, VP Sls: Lottie Morgan, Dir. Tech. Mkt'g: John Phelan, Dir. Wired Mics: Alan Shirley, Dir. Wireless Mics: Sandy Schroeder, Dir. Sls: Al Hershner
Products: boom-mic headsets, communications headsets

Sony Professional Audio

1600 Queen Anne Rd.
Teaneck, NJ 07666
(201) 833-5200, 800-635-SONY, FAX# 201-833-9645
Nat'l Sls Mgr.: Bob Ott, Prod. Mgr.: Art Gonzales, Mkt'g Mgr.: David Kawakami
Sony Pro Audio, Paramus, NJ, 201-368-5185
Sony Pro Audio, Nashville, TN, 615-883-8140
Sony Pro Audio, Burbank, CA, 818-841-8711
Products: personal/stereo headphones

SOUND POWERED COMMUNICATIONS

PO Box 5569
Trenton, NJ 08638
(609) 883-1180, 800-431-0033
G. Mgr.: Harry Mosle

TOA ELECTRONICS

PO Box 2047
S. San Francisco, CA 94080
(415) 588-2538, 800-843-4750, in-state 800-in CA 800-632-2157, FAX# 415-588-3349
Pres.: Yoshiro Ishida, Nat'l Sls Mgr./Communications Pro.: Richard Krochmal, Nat'l Sls Mgr./Pro. Music & Ent.: Rick Kamlet, Nat'l Sls Mgr./Intercom: Al Burns
Products: boom-mic headsets, personal/stereo headphones

TECHNICAL PROJECTS

PO Box 3247
Barrington, IL 60010
(312) 381-5350, 800-562-5872, FAX# 312-381-4360
Pres.: Glenn Mullis, Sec./Treas.: Sibbelina Mullis, Tech.: Mike Barrett
Professional Audio Mkt'g, Melville, NY, 516-367-8620
Watt Mkt'g, Allentown, PA, 215-820-7586
Audio Mkt'g Assoc., Brecksville, OH, 216-526-2426
Professional Sound & Lighting, Lakewood, CO, 303-986-5999
Design Factors, Hacienda Heights, CA, 213-6917-7576
Products: boom-mic headsets, communications headsets, intercommunications headsets, personal/stereo headphones, telecommunications headsets

Television Equipment Associates

PO Box 393

S. Salem, NY 10590

(914) 763-8893
Pres.: Bill Pegler, Mgr.: Steve Tocidowski
Products: telecommunications headsets

Telex Communications

9600 Aldrich Ave. S.
Minneapolis, MN 55420
(612) 884-4051, FAX# 612-884-0043
Pres.: Jeffrey Wetherell, VP Mkt'g: James Arrington, VP Sls: Dan Dantzler, Dir. Mkt'g: Dond Meeeen, Dir Adv.: Ronald Taylor
Westech/Lichtenauer, Culver City, CA, 213-870-9286
Bencsik Assoc., Ocala, FL, 904-732-9775
Burcaw & Assoc., Warren, MI, 313-573-4605
SAGA, Oswego, NY, 315-343-5739
Monfort Electronic Mkt'g, Ind., IN, 317-872-8877
Murphy & Cota, Atlanta, GA, 404-875-2525
Northland Assoc., Moorhead, MN, 218-233-4616
Rancilio Assoc., St. Louis, MO, 314-845-0202
J.Y. Schoonmaker, Dallas, TX, 214-349-1650
Sigmet, Valley Forge, PA, 215-783-6666
Weiler Electronic Sls, Worthington, OH, 614-885-7819
Ziskind Assoc., Rolling Meadows, IL, 312-577-1624
White Radio, Burlington-Ont., Canada, 416-632-6894
Silver Peak Mkt'g, Denver, CO, 303-467-9042
Pacnor Mkt'g, Lynnwood, WA, 206-771-6016
Products: boom-mic headsets, communications headsets, intercommunications headsets, isolation headsets, personal/stereo headphones, telecommunications headsets

UNEX

PO Box 574
Westford, MA 01886
(800-345-8639, FAX# 508-692-9409)

Unex

PO Box 574
Westford, MA 01886
(508) 692-9505, FAX# 508-692-9409
Cust. Svce Mgr.: Catherine Koch, Nat'l Acct Mgr.: John Balisteri, Reg. Sls Mgr.: Ken Fox, Pres.: John D. Ela
Group IV, Pacifica, CA, 415-755-4521
PSA, Roswell, GA, 404-587-3187
RepNet, Lisle, IL, 312-963-0087

Vidicraft

0704 SW Bancroft St.
Portland, OR 97201
800-547-1491, FAX# 503-243-1995
Mgr.: Steve Johnson, Sls: Dave Landis, Prod.: Glenn Olson
Products: personal/stereo headphones

Yamaha Music Corp. of America/Prof. Audio Div.

PO Box 6600
Buena Park, CA 90662
(714) 522-9011, FAX# 714-522-9312
Products: boom-mic headsets

BEAT IT!

Headsets and Belt-Packs take a beating. It's in their job description. Production Intercom Headsets and Belt-Packs are 'survivors'. Ask us to prove it.



Production Intercom
Technical Projects, Inc
P.O. Box 3247 Barrington, IL 60010
(312) 381-5350 Fax: (312) 381-4360
1 (800) 562-5872

Circle 66 on Reader Response Card

POWER PROTECTION/CONDITIONERS

Aris/Eta
1710 Enterprise Pkwy
Twinsburg, OH 44087
(216) 425-3388, FAX# 216-425-9700
Mkt'g: Bob Harris

Cabletronix
PO Box 3003
Newburgh, NY 12550
(914) 565-7570, 800-431-9473, in-state 800-in NY 800-942-WIRE, FAX# 914-564-5332
Pres.: Stephen Roth, VP: Leonard Ellentuch, Sls Mgr.: Tom Martirano

CAL SWITCH
13717 S. Normandie Ave.
Gardenia, CA 90249
(213) 538-9830, 800-225-7924, FAX# 213-327-2741
Products: line isolators, line protectors, outlet strips, uninterrupted power

Dynamote
1200 W. Nickerson
Seattle, WA 98119
(206) 282-1000

Eneractive Group
25416 C.R. 6, Ste. 313
Elkhart, IL 46514
(219) 264-1393

Ethereal Concepts
754 46th Ave.
San Francisco, CA 94121
(415) 750-0431
Pres.: Lonnie Domnitz
Products: power control

Juice Goose, Div. of Whitenton Industries
7320 Ashcroft, #302
Houston, TX 77081
(713) 772-1404, FAX# 713-772-9124
Pres.: Richard Whitenton
Products: line isolators, line protectors, noise suppression, outlet strips, power control, power conversion, power relays, transformers, uninterrupted power

Linear & Digital Systems
46 Marco Ln.
Centerville, OH 45459
(513) 439-1758

Lumitrol
110 Bi-County Blvd.
Farmingdale, NY 11735
(516) 752-1411

LynTec
7030 Grandview
Merriam, KS 66204

(913) 722-4047
Pres.: Lynn J. Potter
Products: power control

Omni Q
1122 Fur Ave., Bldg. A
Blaine, WA 98230
(206) 384-1750

Perma Power Electronics
5601 W. Howard Ave.
Chicago, IL 60648
(312) 647-9414, FAX# 312-647-1472
Pres.: Norman Ackerman, Mkt'g Mgr.: Jay Goldstein, Sls Mgr.: Mike Shatz
Products: line protectors, noise suppression, outlet strips, uninterrupted power

Polyphaser
PO Box 1237
Gardnerville, NY 89410
(702) 782-2511, 800-325-7170, FAX# 702-782-4476

Powermark
3855 Ruffin Rd.
San Diego, CA 92123
(619) 565-8363

RTE Deltec
2727 Kurtz Rd.
San Diego, CA 92110
(619) 291-4211

Shape Magntronics
901 DuPage Ave.
Lombard, IL 60148
(312) 620-8394, 800-367-5811, FAX# 312-620-0784
Products: transformers

Sola, A Unit of General Signal
1717 Busse Rd.
Elk Grove Village, IL 60007
(312) 439-2800, 800-243-8160, in-state 800-in IL 800-228-8937, FAX# 800-626-6269
Prod. Mgr. UPS: Kevin McGowan, Prod. Mgr. PS: Wayne Boese

Superior Electric
383 Middle St.
Bristol, CT 06010
(203) 582-9561

Taylor-Simtec Digital
PO Box 1328
Taylors, SC 29687
(803) 268-7592, FAX# 803-268-7596

Topaz
9192 Topaz Way
San Diego, CA 92123
(619) 279-0831, FAX# 619-335-1556

Tripp Lite
500 N. Orleans
Chicago, IL 60610
(312) 329-1777, FAX# 312-644-6505
Music Div. Head: Kris Billenstein
Products: inverters, line isolators, line protectors, noise suppression, outlet strips, power control, power conversion, uninterrupted power

Whitenton Industries
7320 Ashcroft, Ste. 302
Houston, TX 77081
(713) 772-1404

IF YOU WANT TO GAMBLE, GO TO VEGAS.



IF YOU DON'T, COME TO ARIS.

ARIS Power Distribution Systems will end your worries about voltage spikes and power surges. No more unwanted line-noise. No more complicated AC power connections. Just clean, noise-filtered power and protection for all your electronic equipment. Insist on a sure thing, call ARIS today!

ARIS™ 1716 ENTERPRISE PKWY.,
TWINSBURG, OH 44087
216-425-3388 FAX: 216-425-9700



Circle 43 on Reader Response Card

ALARM/SECURITY PRODUCTS

ALARM & SECURITY

AES Corp.
PO Box 2093
Peabody, MA 01960
(508) 535-7310, FAX# 508-535-7313
Pres.: Michael Sherman, Managing Dir.: Philip Huntley,
Mkt'g Dir.: Brian Rockett, Sls Dir.: Joseph Bonavita

AMSECO
228 E. Star of India Ln.
Carson, CA 90746
(213) 538-4670, 800-421-1096

ASC—Tube Traps
PO Box 1189
Eugene, OR 97440
(503) 343-9727, 800-ACS-TUBE, FAX# 503-343-9245
Pres.: Arthur Noxon, Sls: Doug Martin, Tech.: Michael Nemeth, Canadian Factory: Larry Moore, Italian Factory: Alfredo Gallacci, Japan: Gary Douglas Rich Lomax, Hollywood, CA, 818-763-9587
Octavio Brito, Boston, MA, 617-924-0660
Sam Lynn, Chicago, IL, 312-657-7787
John Nolan, St. Louis, MO, 314-343-4765
Joe deBuglio, Toronto, Canada, 416-241-4240
Products: intrusion detection

Adpro Pty.
PO Box 324
Chester, NJ 07930
(201) 879-4159

AIPHONE INTERCOM SYSTEMS
PO Box 90075
Bellevue, WA 98009
(206) 455-0510, 800-692-0200, FAX# 206-455-0071
Pres.: Jun Matsumoto, Sls Mgr.: Jim Morrison,
Mkt'g/Adv. Mgr.: Harry Quanz
Aiphone NE, Randolph, NJ, 201-328-1790
Aiphone Midwest, Westmont, IL, 312-323-5222
Aiphone SE, Douglasville, GA, 404-920-2811
Products: access control, announcement systems, audio surveillance, intercom, video surveillance

Alarm Accessory
501 Silverside Rd.
Wilmington, DE 19809
(302) 792-3620, 800-441-7082, FAX# 302-792-7713
Pres.: William Holt Sr., Op. Supervisor: Angela Bopp
Products: burglar alarms, vibration sensing

Alarm Controls
PO Box 280
Deer Park, NY 11729
(516) 586-4220, 800-645-5538, FAX# 516-586-6500
Pres.: Howard Berger, Sls Mgr.: John Benedetto
Products

Alarmco
PO Box 343
Canadaiqua, NY 14424

(716) 398-2510, FAX# 716-394-8861
Mkt'g: Ron Cook

All Electronics
PO Box 567
Van Nuys, CA 91408
(818) 904-0524, 800-826-5432, FAX# 818-781-2653
Mgr. Sls: Harold Oliver
Products: access control, ancillary components, announcement systems, burglar alarms, sirens

Allsafe
1105 Broadway
Buffalo, NY 14212
(716) 896-4515, 800-828-7162, FAX# 716-896-4241
Mkt'g: Edwin Pokornowski
Products: access control

Alphametrics Controls
4865 Pasadena Ave., Ste. 9
Sacramento, CA 95841
(916) 485-4050, FAX# 916-485-8354
Pres.: Harry Berndt, VP: Dennis Marchut
Products: door-lock systems

Ambeti
PO Box 593
Plymouth, MI 48170
(313) 455-6410, 800-223-5274
Pres.: Ed Grzanowski
Security Components Int'l, Wayne, NJ, 201-942-7771
E.J. Machnik & Assoc., Snellville, GA, 404-972-4814
Emil Kirik & Assoc., Cleveland, OH, 216-581-7722
Allen Fishman & Assoc. Int'l, Oxford, CT, 203-888-9372
Pacvid, Los Angeles, CA, 213-650-7373
Products: signalling devices

Amtel Security Systems
1421 N.W. 165th St.
Miami, FL 33169
(305) 621-3100, 800-222-6835, FAX# 305-623-0613
Pres.: Suresh Gajwani, Dir. Mkt'g: Moe Weiner
Products: access control, door-lock systems, intercom

ATLAS/SOUNDOLIER
1859 Intertech Dr.
Fenton, MO 63026
(314) 349-3110, 800-876-7337, FAX# 314-349-1251
VP/GM: Pete Marsac, VP/Mkt'g: Herbert Jaffe, W. Reg./Sls Mgr.: Bud Waters, W. Reg./Ass. Sls Mgr.: Jim Edwards, E. Reg./Ass. Sls Mgr.: Walter Best, Order Entry Dept. Mgr.: Dale McIntyre
Atlas/Soundolier, Parsippany, NJ, 201-887-7800
Atlas Electronics, Toronto, Canada, 416-789-7761
Atlas/Ind'l, Fenton, MO, 800-362-5673
Atlas/Exp. Dept., Fenton, MO, 314-349-3110
Products: announcement systems, audio surveillance, intercom, signalling devices, sirens, strobes,

The Auth Co.
505 Acorn St.

Deer Park, NY 11729
(516) 667-9000, FAX# 516-667-9887
Chairman: George May, VP/General Mgr.: Joel Kahn,
VP Finance: Richard Nelson, Nat'l Sls Mgr.: Steven Weil, Dir. of Op: Kenneth Gmora
Products: fire alarm, intercom, intrusion detection, smoke detectors, strobes, video surveillance

Autocall
PO Box 496
Shelby, OH 44875
(419) 347-2400, FAX# 419-347-3070

Floyd Bell
897 Higgs Ave.
Columbus, OH 43212
(614) 488-3193

Bogen Communications
PO Box 575
Ramsey, NJ 07446
(201) 934-8500, FAX# 201-934-9832
Pres.: John Ochtera, VP Sls/Mkt'g: James Orr, Nat'l Sls Dir.: David Chambers
Products: audio surveillance, intercom

C&K Systems
2040 Fortune Dr.
San Jose, CA 95131
(408) 434-1149, 800-227-8065

C & K Systems
2040 Fortune Dr.
San Jose, CA 95131
(408) 434-1149, 800-227-8065, FAX# 408-434-6707
Pres.: Larry Tracy, VP: Rick Johnson, VP Sls/Mkt'g: Dave Green
Products: burglar alarms, duress, fire alarm, intrusion detection, signalling devices, vibration sensing

Cepco
21515 Parthenia St.
Canoga Park, CA 91304
(818) 998-7315

Clever Devices
PO Box 2002
Port Washington, NY 11050
(516) 767-0682, FAX# 516-767-3635
Pres.: William Long, Mkt'g Mgr.: Una Neary, Tech. Supp.: Mike Kafulas
Products: announcement systems

Coherent Communications
13756 Glenoaks Blvd.
Sylmar, CA 91342
(818) 362-9393, FAX# 818-362-7045
Products: CCTV, video surveillance, wireless systems

Communications Equipment
6443 Western Ave., Box 700
Glen Arbor, MI 49636

(616) 334-3081, FAX# 616-334-3661

Pres.: Darrell Thomas, Sls Mgr.: Thomas Garmhausen
Products: audio surveillance, intercom

Communications Products

4911 W. Good Hope Rd.
Milwaukee, WI 53223
(414) 351-4660

Products: door-lock systems

Computer Application Systems

552 NW 77th St.
Boca Raton, FL 33431
(305) 997-9660

Com-Tec

PO Box 965

Appleton, WI 54912

(414) 734-7105, FAX# 414-734-0493

Pres./Co-Owner: Ken McLellan, Exec. VP/Co-Owner:
Anthony Leslie

Products: access control, audio surveillance, CCTV, door-lock systems, duress, fire alarm, intercom, intrusion detection, signalling devices, smoke detectors, strobes, vibration sensing, video motion detection, video surveillance

Continental Instruments

70 Hopper St.

Westbury, NY 11590

(516) 334-0900, FAX# 516-334-0235

Pres.: Michael Morgenstern, VP: John Banks
CIC, Germantown, MD, 301-428-9541
CIC, Tarzana, CA, 818-345-7440

Products: access control

Cornell Electronics Products

PO Box 23411

Milwaukee, WI 53223

(414) 351-4660, 800-541-946, FAX# 414-351-4657

Pres.: Donald Glaubitz, VP: Gary Butler, Sls Mgr.:
Pauline Haack, Mkt'g: Randy Archer, SE Reg Sls Mgr.:
William Ellinger, Controller: Thelma Plunkett
Shamrock Electronic Sls, Dayton, OH, 513-258-1227
LSM Assoc., Phelps, NY, 315-548-4891
W.A. Hendrickson, North Scituate, MA, 617-545-0652
Kingston Sls, Indianapolis, IN, 317-876-2545
Avcom, North Olmsted, OH, 216-777-2060
Richard S. Pass Assoc., Langhorne, PA, 215-757-6100
R & S Sls, Rockville Centre, NY, 516-678-6887
Cavendish & Winchester, Atlanta, GA, 404-422-4531
Cartwright & Bean, Orlando, FL, 407-422-4531
Kodo Assoc., Minneapolis, MN, 612-881-1255
Vector, Seattle, WA, 206-322-4343
Rancilio Assoc., St. Louis, MO, 314-845-0202
Dick Bellew Sls, Dallas, TX, 214-644-7881
Bidwell-Schwartz Assoc., Gardena, CA, 213-770-0300
Yocum Mkt'g., Mesa, AZ, 834-3334
Awrest, Fountain Hills, AZ, 602-946-1811

Products: access control, intrusion detection, signalling devices

DIA General

47 Kearney Rd.

Needham, MA 02192

(617) 449-1533

Dayton Industrial

126 Westpark Rd.

Dayton, OH 45459

(513) 236-3591

VP Sls/Mkt'g: Robert McDougall, VP Eng.: Kurt
Farmer, Sr. Tech.: Frank Jaros

Products: strobes,

De-Tech Systems

3407 Rose Ave.

Ocean, NJ 07712

(201) 918-0800

Detection Systems

130 Perinton Pkwy.
Fairport, NY 14450
(716) 223-4060, 800-521-0096

Detector Systems

11650 Seaboard Circle
Stanton, CA 90680

(714) 895-6366, 800-828-7775, FAX# 714-895-6145

Sls Mgr.: Ron Miller, Inside Sls: Jill Herbel, Mkt'g: Carl
Zabel, VP: Bill Russell

Products: access control

Door Alarm Devices

20 Lucon Dr.

Deer Park, NY 11719

(516) 586-2400, 800-323-2669

Anderson Sales Co., Braintree, MA (617) 848-9184

Products: wireless systems

Doorking

929 W. Hyde Pk Blvd.

Inglewood, CA 90302

(213) 673-3299, 800-826-74923

Dorado Systems

1842 Sabre St.

Hayward, CA 94521

(415) 783-2000

Edwards, A Unit of General Signal

195 Farmington Ave.

Farmington, CT 06032

(203) 678-0410, FAX# 203-677-5881

Mkt'g Mgr.: Jerry Jenkins

Products: fire alarm

Electrohome

809 Wellington St. N.

Kitchener, Ontario, Canada N2G 4J6

(519) 744-7111, FAX# 519-749-3131

Chairman/CEO/Pres.: J.R. Pollock, VP Electronics:
W.M. Nobbs, VP Motors: K.G. Hansen, VP
Broadcasting: W.D. McGregor, VP Finance: J.R.
Gingerich, Dir. Human Res.: J.R. Boehmer
Electrohome USA, Ontario, CA, 714-983-5660

Products: video motion detection

Electro-Vox

2626 Bates Rd.

Montreal, Quebec, Canada H3S 1B2

(514) 731-3771, FAX# 514-731-3193

Pres.: Denis Lafreniere, Dir.: Francois Lafreniere
EV, Toronto-Ont., Canada, 416-626-5053
EV, Quebec City, Canada, 418-687-4313
EV, Richmond, BC, 604-273-9062
EV, Ottawa-Ont., Canada, 613-596-0120
EV, Victoria, BC, 604-383-2131

Products: fire alarm

ELENEX (WEST)

7392 Trade St.

San Diego, CA 92121

(619) 566-7515, 800-225-3113, in-state 800-in CA
800-225-8037, FAX# 619-586-1484

VP: Dennis Berglund, Eng.: Al Bitarafan, Sls: Lou
Hennequin

Products: access control, audio surveillance, door-lock systems, duress, wireless systems

Eltrex Int'l

2 Columbia Dr.

Amherst, NH 03031

(603) 886-3500, 800-432-7631, FAX# 603-886-3508

Sls Mgr.: Bill Ryan

Products: announcement systems, burglar alarms, fire alarm, intrusion detection, signalling devices

Emergency Products

10 Bloomfield Ave.

Pinebrook, NJ 07058

(201) 882-8010, 800-631-8054

Pres.: Willard Nix, G. Sls Mgr.: Norman Carlo, Chief
Eng.: Ken Bergstorm

Encom Products

502 Lower Hopewell Rd.

Oxford, PA 19363

(215) 932-9600, FAX# 215-932-9999

Products: intercom

Faraday

805 S. Maumee St.

Tecumseh, MI 49286

(517) 423-2111, FAX# 517-423-2320

Sls Mgr.: Ron Miller, Mkt'g Mgr.: Dave Hall, Midwest
Reg. Mgr.: Dave Archibald
Ted Turczyn, Carlsbad, CA, 619-729-2560
Standard Electric Time (SET), Springfield, MA, 413-739-5263

SET, Aston, PA, 215-494-1950

SET, Fairfield, NJ, 201-227-9190

SET, Richmond, VA, 804-276-6776

Products: fire alarm, intercom, signalling devices, sirens,
smoke detectors, strobes,

Federal Signal

4974A Scioto Darby Rd.

Hilliard, OH 43026

(614) 876-6677, 800-521-8219, FAX# 614-876-6975

G. Mgr.: Robert Rankin, Sls/Mkt'g Coord.: Gregory
Davis, E. Reg. Mgr.: James Belshe, W. Reg. Mgr.: Hal
Light

Fire Burglary Instruments

50 Engineers Rd.

Hauppauge, NY 11788

(516) 582-6161

Firecom/Auth

39-27 59th St.

Woodside, NY 11377

(718) 899-6100, FAX# 718-899-1932

Fire-Lite/Notifier

PO Box 823

New Haven, CT 06504

(203) 777-7861

Mkt'g: Betsy Donnelly

Products: fire alarm, smoke detectors

Franklin Instrument

PO Box 2949

Warminster, PA 18974

(215) 355-7942, 800-321-2353, FAX# 215-322-1022

Gentex

10985 Chicago Dr.

Zeeland, MI 49464

(616) 392-7195, FAX# 616-392-4219



MINI



STANDARD



LARGE

Solving wiring problems is a snap with NICE-DUC.[®]

NICE-DUC[®] plastic conduit introduces 2 new sizes and a new 2-piece style.

We designed our original, standard, 1-piece tamper-proof NICE-DUC plastic conduit for solving most wiring problems with the experienced installer in mind. It's the best all-purpose conduit for fast, professional installations of alarm, telephone, CCTV wires and cables.

For those not-so-standard jobs, we've added two new sizes, mini and large as well as a whole new, more versatile style, two-piece NICE-DUC with a "snap-on" top. NICE-DUC products are perfect for wiring runs on windows, walls, ceilings, woodwork, metal door frames or virtually anywhere.

5 custom colors with matching corners & connectors.

All three sizes and both styles come in 5 custom colors: white, off-white, beige, brown and gray with a complete line of matching corners and connectors for standard and large sizes.

New 2-piece "snap-on" available in standard (as shown) and new large size.

Premium quality materials including 3M[®] brand acrylic adhesive.

All styles are premium quality, easy-to-cut thinwall PVC with advanced 3M brand acrylic adhesive for easy application and long-term holding power. Our 1-piece style has a slit-open option and the two-piece style has a screw-mounting option.

Handy carrying packs.

Our "ND-5" carrying pack of (5) 53" pieces (22') or "ND-50" economy box of (50) 53" pieces (220') make NICE-DUC easy to order, pack or box, in any color, any style. Keep a pack of each color in your installation vehicle so you can solve problems instantly, easily and professionally.

Make NICE-DUC a standard part of your installation kit. Just ask your distributor for NICE-DUC[®] or call 1-800-441-7082 for more information.

Handy "5U5" corners and connectors make angles easy.

NICE-DUC[®] ... Saves Time ... Solves Problems ... Looks Great ... Keep Some Handy!



ALARM ACCESSORY LTD.

P.O. BOX 212 CLAYMONT, DE 19703

1-800-441-7082

Circle 221 on Reader Response Card

Made in USA

T.S.K. Electronics

PO Box 190
Tonawanda, NY 14151-0191
(716) 693-3916, FAX# 716-692-6433
Pres.: Theodore Kedzierski, Chief Eng.: Kevin Kedzierski
Products: ancillary components, audio surveillance, duress, intercom

TALK-A-PHONE

5013 N. Kedzie Ave.
Chicago, IL 60625
(312) 539-1100, FAX# 312-539-1241
Pres.: Z. Liberman, VP: S. Shanes, Sls Mgr.: Dan Kagan
Products: access control, announcement systems, intercom, signalling devices

Telex Communications

9600 Aldrich Ave. S.
Minneapolis, MN 55420
(612) 884-4051, FAX# 612-884-0043
Pres.: Jeffrey Wetherell, VP Mkt'g: James Arrington, VP Sls: Dan Dantzler, Dir. Mkt'g: Dond Mereen, Dir Adv.: Ronald Taylor
WesTech/Lichtenauer, Culver City, CA, 213-870-9286
Bencsik Assoc., Ocala, FL, 904-732-9775
Burcaw & Assoc., Warren, MI, 313-573-4605
SAGA, Oswego, NY, 315-343-5739
Monfort Electronic Mkt'g, Indianapolis, IN, 317-872-8877
Murphy & Cota, Atlanta, GA, 404-875-2525
Northland Assoc., Moorhead, MN, 218-233-4616

Rancilio Assoc., St. Louis, MO, 314-845-0202
J.Y. Schoonmaker, Dallas, TX, 214-349-1650
Sigmat, Valley Forge, PA, 215-783-6666
Weller Electronic Sls, Worthington, OH, 614-885-7819
Ziskind Assoc., Rolling Meadows, IL, 312-577-1624
White Radio, Burlington-Ont., Canada, 416-632-6894
Silver Peak Mkt'g, Denver, CO, 303-467-9042
Pacnor Mkt'g, Lynnwood, WA, 206-771-6016
Products: wireless systems

Tel-tron (Div. Radio Manufacturers)

220 Fentress Blvd.
Daytona Beach, FL 32014
(904) 255-1921, 800-874-5622

Thorn Automated Systems

835 Sharon Dr.
Westlake, OH 44145
(216) 871-9900, FAX# 216-871-8320
Pres.: Warren Vodak, VP Sls/Mkt'g: Ayman Ashour, Mgr. R&D: Richard Evans, VP Op.: Joe Martini, Dir. Human Res.: Mary Berges, VP Finance: Nell Jacques
Thorn, Detroit, MI, 313-853-5050
Thorn, Chicago, IL, 312-272-8012
Thorn, Randolph, NJ, 201-989-0141
Thorn, Gardenia, CA, 213-327-7640
Thorn, Houston, TX, 713-580-4800
Products: access control, announcement systems, audio surveillance, CCTV, door-lock systems, fire alarm, intercom, intrusion detection, signalling devices, smoke detectors, strobes, video motion detection, wireless systems

Time & Sound

14120 Live Oak Ave.
Baldwin Park, CA 91706
(818) 960-7781, 800-423-4765

Trancience

179 Ludlow St.
Stamford, CT 06902
(203) 327-7810, 800-243-3494, FAX# 203-353-8431
Pres.: Donald Bosak
Products: wireless systems

Trigon Electronics

1220 N. Batavia St.
Orange, CA 92661
(714) 633-7442
Mkt'g: Joan Richardson
Products: access control

VICON INDUSTRIES

525 Broad Hollow Rd.
Melville, NY 11747-370
(516) 293-2200, 800-645-9116, FAX# 516-293-2627
CEO: Donald N. Horn, Exec. VP: Arthur Wallace, Sr. VP Mkt'gs: Ronald J. Teixeira, VP Dom. Sls: Donald T. Heckel, VP Int'l Sls: Richard P. Adam
US Reg. Office-W., Brea, CA, 714-990-3858
US Reg. Office-S., Norcross, GA, 404-449-0499
Gov't Sls Office, Arlington, VA, 703-553-785-
European, Hampshire, UK, 44-0705-665-3
Products: CCTV, video motion detection, video surveillance

Vikonics

210 Meadowlands Pkwy.
Secaucus, NJ 07094
(201) 863-6868, FAX# 201-863-0413
Products: access control

Visual Methods

PO Box 644
Westwood, NJ 07675
(201) 666-3950, FAX# 201-666-7931
Pres.: Ted Sandin, VP: H. Kruegle
Products: access control, CCTV, video surveillance

Wheelock

273 Branchport Ave.
Long Branch, NJ 07740
(201) 222-6880, 800-631-2148, FAX# 201-222-8707
Pres.: P.W. Tarlton, VP Mkt'g: W.L. Goldstein, VP Eng.: S.W. Andrews, Mkt'g Mgr./Tel-Paging: A. Arlan, Mkt'g Mgr./Life Safe.-Ind.: R. Haus
Products: signalling devices, sirens, strobes,

Xetron

217 N Hwy 81
Devine, TX 78016
(512) 663-3661, FAX# 512-663-4838
Pres.: Mike Cady, Op. Mgr.: Robert Gardner, Chief Eng.: Ray Deasy, Nat'l Dealer Sls Mgr.: Larry Kuni, Nat'l OEM Sls Mgr.: Don Roberts
Products: access control

**ONE
IS
NOT
ENOUGH**

Additional copies of the 1989/90 Blue Book are available at \$12 each. Please send your check or money order to:
Bob Evans
Circulation Director
25 Willowdale Ave.
Port Washington, NY 11050

LIFE-SAFETY & VOICE EVACUATION SYSTEMS

Atis

6025 Atlantic Blvd., Ste. D
Norcross, GA 30071
(404) 446-7234, FAX# 404-446-7237

VP Tech Svcs: Peter Lorenz, Nat'l Sls Mgr.: Tony Vespoli

Products: audio, message announce

ATLAS/SOUNDOLIER

1859 Intertech Dr.
Fenton, MO 63026
(314) 349-3110, 800-876-7337, FAX# 314-349-1251

VP/GM: Pete Marsac, VP/Mkt'g: Herbert Jaffe, W. Reg./Sls Mgr.: Bud Waters, W. Reg./Ass. Sls Mgr.: Jim Edwards, E. Reg./Ass. Sls Mgr.: Walter Best, Order Entry Dept. Mgr.: Dale McIntyre
Atlas/Soundolier, Parsippany, NJ, 201-887-7800
Atlas Electronics, Toronto, Canada, 416-789-7761
Atlas/Ind'l, Fenton, MO, 800-362-5673

Atlas/Exp. Dept., Fenton, MO, 314-349-3110
Products: audio, emergency intercom, handset, message announce, tone, visual

Clever Devices

PO Box 2002
Port Washington, NY 11050
(516) 767-0682, FAX# 516-767-3635

Pres.: William Long, Mkt'g Mgr.: Una Neary, Tech. Supp.: Mike Kafulas

Products: audio, DC battery supply, message announce

DUKANE

2900 Dukane Dr.
St. Charles, IL 60174
(312) 584-2300, FAX# 312-584-2370

Pres./CEO: J. McWilliams Stone Jr., Group VP: William Finnegan, Div. G. Mgr.: Steven Deppe, Nat'l Sls Mgr.: Warren Anderson, Svce Mgr.: Cliff Carlson
Wally Smutts, Toronto-Ont, Canada, 312-584-2300
Doug Fellabaum, Sycamore, IL, 815-895-7573
Don Mouritzen, Beecher, IL, 312-946-9655
Ken Lind, St. Charles, IL, 312-584-2300
Pete Kendal, Jacksonville, FL, 904-262-6025
Ed Nuhring, Portland, OR, 503-244-4262
Jim Lacey, Moreno Valley, CA, 714-243-1160
Jack Brown, Dallas, TX, 214-943-7528

Products: audio, DC battery supply, emergency intercom, handset, message announce, tone, visual

Eltrex Int'l

2 Columbia Dr.
Amherst, NH 03031
(603) 886-3500, 800-432-7631, FAX# 603-886-3508

Sls Mgr.: Bill Ryan

Products: audio, message announce

Encom Products

502 Lower Hopewell Rd.

Oxford, PA 19363
(215) 932-9600, FAX# 215-932-9999
Products: emergency intercom, handset

IED Innovative Electronic Designs

9701 Taylorsville Rd.
Louisville, KY 40299
(502) 267-7436, FAX# 502-267-9070

VP Mkt'g & Sls: Tom Roseberry, Mkt'g Asst.: Robin Lasley, Sls App. Eng.: Jeff White, Mkt'g Adm.: Wanda R. Martin, VP Eng.: Ed Young, Pres.: Hardy Martin
Repworks, Chicopee, MA, 413-533-0845
Darmstedter Assoc., Baldwinsville, NY, 315-638-1261
John Anthony., Stamford, CT, 203-322-9202
Sigmet, Valley Forge, PA, 215-783-6666
Secom Systems, Atlanta, GA, 404-455-0672
Bencsik Assoc., Ocala, FL, 904-732-9775
C.L. Pugh, Cleveland, OH, 216-238-1777
Monford Electronics Mkt'g., Indianapolis, IN, 317-872-8877

C.M. Sls, Farmington Hills, MI, 313-553-8070
Ludwig Mkt'g., Kenosha, WI, 414-697-9355
B.C. Electronic Sls, Mission, KS, 913-262-1720
Mkt'g Concepts, Irving, TX, 214-869-0669
Yora, White Bear Lake, MN, 612-770-9760
Torbett/Keiser Group, Loveland, CO, 303-669-1008
Derek Allen Assoc., Toluca Lake, CA, 818-840-8327
Plus Four Mkt'g, Walnut Creek, CA, 415-937-0650
North Shore Mkt'g, Seattle, WA, 206-284-9699
Island Instruments, Kaneohe, HI, 808-235-7544
Products: audio, message announce

Lowell Mfg.

3030 Laclede Sta. Rd.
St. Louis, MO 63143
(314) 781-9058, 800-325-9660, FAX# 314-645-4852

Chairman: Ben Lowell, Pres.: Dorothy Lowell, Sls Mgr.: John Lowell, Op.: Wilhelm Lowell, Eng.: Karl Schneider, Credit Mgr.: Mary Tiepelman
Design Factors, Hacienda Heights, CA, 213-697-7576
Meyer Mkt'g, Deerfield Beach, FL, 305-481-9250
Peregrine SW Reps, Houston, TX, 713-589-8481
H.W. Phillips, Roswell, GA, 404-992-3070
Pusecker Sls, Upper Montclair, NJ, 201-744-1834
Products: audio

MACKENZIE LABORATORIES

PO Box 3029
Arcadia, CA 91006
(818) 579-0440, 800-423-4147, FAX# 818-448-7131

Pres.: Addison Taylor, VP/Chief Eng: Nagy Khattar, Sls Supervisor: Joe Vitale, Mkt'g/Training: Emory Straus
Avwest, Phoenix, AZ, 602-946-1811
Lex Lawson Assoc., Dallas, TX, 214-272-8482
Avcom, N. Olmstead, OH, 216-777-2060
Rancilio Assoc., St. Louis, MO, 314-845-0202
Rancilio Assoc., Kansas City, KS, 913-491-9883

Warren Assoc., Santa Clara, CA, 408-988-7762
Piper Assoc., Needham, MA, 617-449-1144
Bencsik Assoc., Ocala, FL, 904-732-9775
Design Factors, Los Angeles, CA, 213-697-7576
Riley & Petchell Sls, Detroit, MI, 313-937-3000
Monfort Electronics, Indianapolis, IN, 317-872-8877
Gustafson Systems Sls, Chicago, IL, 315-358-2505
Chuck Olson Assoc., Renton, WA, 206-255-8692
RWR, Rock Hill, SC, 803-324-5111
RWR, Norcross, GA, 404-263-9349
RWR, Alabaster, AL, 206-663-2744
Northland Assoc., Moorehead, MN, 218-233-4616
Products: audio, message announce

Neutrik USA

1600 Malone St.
Millville, NJ 08332
(609) 327-3113, FAX# 609-825-4804

G. Mgr.: James Cowan, Prod.t Mgr.: William Dorman,
Prod. Mgr.: Kenneth Smalley
Products: message announce

Powertronix

10623 Lawson River Ave.
Fountain Valley, CA 92708
(714) 963-5411

Pres.: Robert Gehlke, Sls Mgr.: Bill Organ

Protech Audio

Flowerfield, Bldg. #1
St. James, NY 11780
(516) 584-5855, FAX# 516-584-5904

Sls Mgr.: Bill Murphy, VP Eng.: Joseph Giambone
Peregrine SW Reps, Houston, TX, 713-589-8481
Products: audio, tone

TALK-A-PHONE

5013 N. Kedzie Ave.
Chicago, IL 60625
(312) 539-1100, FAX# 312-539-1241

P.: Z. Liberman, VP: S. Shanes, Sls.: Dan Kagan
Products: emergency intercom

VICON INDUSTRIES

525 Broad Hollow Rd.
Melville, NY 11747-370
(516) 293-2200, 800-645-9116, FAX# 516-293-2627

CEO: Donald N. Horn, Exec. VP: Arthur Wallace, Sr.
VP Mkt'gs: Ronald J. Teixeira, VP Dom. Sls: Donald T. Heckel, VP Int'l Sls: Richard P. Adam
US Reg. Office-W., Brea, CA, 714-990-3858
US Reg Office-S., Norcross, GA, 404-449-0499
Gov't Sls Office, Arlington, VA, 703-553-785-
European Hdqtrs, Hampshire, UK, 44-0705-665-3
Products: message announce

CCTV/VIDEO COMPONENTS & SYSTEMS

Advanced Video Assoc.

400 Walnut St., Ste. 101
Redwood City, CA 94063

(415) 792-8684, FAX# 415-791-0271

Pres.: Nobue Atchison, Dir.: Michelle Greene
Advanced Video Assoc., Redwood City, CA, 415-792-8684

AIPHONE INTERCOM SYSTEMS

PO Box 90075

Bellevue, WA 98009

(206) 455-0510, 800-692-0200, FAX# 206-455-0071

Pres.: Jun Matsumoto, Sls Mgr.: Jim Morrison,
Mkt'g/Adv. Mgr.: Harry Quanz
Aiphone NE, Randolph, NJ, 201-328-1790
Aiphone Midwest, Westmont, IL, 312-323-5222
Aiphone SE, Douglasville, GA, 404-920-2811
Products: monitors, specialty cameras

Alaun Engineering

2305 Florencita Dr.

Montrose, CA 91020

(818) 957-0618

Owner/Pres.: Al Braun, VP: M. Antoniate

American Dynamics

10 Corporate Dr.

Orangeburg, NY 10962

(914) 365-1000, FAX# 914-365-1007

VP Mkt'g: Vic Houk, Mgr. Sls: Joe McDevitt, App.
Specialist: Dave DeLisser
FM Valenti, Nahant, MA, 617-592-5300
Cartwright & Beam, Norcross, GA, 404-368-0160
Seevid, Huntington Beach, CA, 714-898-6100
Keith Parker & Assoc., Northbrook, IL, 312-498-0353
RW Kunz & Assoc., St. Louis, MO, 314-966-4977
Products: accessories, multiplexers, remote controls, signal distribution, switchers, transmission systems

American Fibertek

1662 63rd St.

Brooklyn, NY 11204-2713

(718) 236-3739

Pres.: Robert Klein, VP: Jim McLaughlin, VP: Jack Krol

American Laser Systems

751 South Kellogg Ave.

Goleta, GA 93117

(805) 967-0423, FAX# 805-683-4382

Pres.: Jackie Parker, Mkt'g Mgr.: Lorraine
Shallenberger, Eng.: Paul Hartloff, Production Mgr.:
Greg Vincent
AAT Communications, Staten Island, NY, 718-351-4782
Wiltonix, Washington Grove, MD, 301-258-7676
New England Digital Distr., Beverly, MA, 508-927-8172
Tap Advanced Communications, Arlington, TX, 817-640-6699
Video Media, Sunnyvale, CA, 408-745-1700
Products: transmission systems

AmPro

42 Fourth Ave.

Waltham, MA 02154

(617) 890-1245, 800-556-7733, FAX# 617-890-7027

Anderson Mfg.

1293 East 65th N.

Idaho Falls, ID 83401

(208) 523-6460, FAX# 208-523-6562

Products: transmission systems

Antennacraft

PO Box 1005

Burlington, IA 52601

(319) 754-7575

G. Mgr.: George Kollar, Prod. Mgr.: Charles Goff,
Sls/Svce Coordinator: Jean Harwood, Traffic Mgr.:
Shelly Moyers, Chief Eng.: Howard Whitcomb

Antenna Specialist

30500 Bruce Ind. Pkwy

Cleveland, OH 44139-3996

(216) 349-8400

Dir. Nat'l Sls: Robert Levy, VP Prod. Mkt'g/Sls: Larry
Kline, W. Reg. Mgr.: Patricia Fritz, E. Reg. Mgr.: Ray
Ditomas

ATLAS/SOUNDOLIER

1859 Intertech Dr.

Fenton, MO 63026

(314) 349-3110, 800-876-7337, FAX# 314-349-1251

VP/GM: Pete Marsac, VP/Mkt'g: Herbert Jaffe, W.
Reg./Sls Mgr.: Bud Waters, W. Reg./Ass. Sls Mgr.: Jim
Edwards, E. Reg./Ass. Sls Mgr.: Walter Best, Order
Entry Dept. Mgr.: Dale McIntyre
Atlas/Soundolier, Parsippany, NJ, 201-887-7800
Atlas Electronics, Toronto, Canada, 416-789-7761
Atlas/Int'l, Fenton, MO, 800-362-5673
Atlas/Exp. Dept., Fenton, MO, 314-349-3110
Products: accessories, enclosures

Audio Video Supply

4674 Cardin St., Ste. D

San Diego, CA 92111

(619) 565-1101

Pres.: R.T. Moore

Audisar

PO Box 1561

Bellevue, WA 98009

(206) 454-2040, 868-5217

Owner: Robert Munger

Products: accessories, connectors, hardware

Blonder-Tongue Laboratories

1 Jake Brown Rd.

Old Bridge, NJ 08857

(201) 679-4000, FAX# 201-679-4353

Chair. of the Board: I.S. Blonder, Pres.: B.H. Tongue,
Sr. VP: D.J. Altieri, VP: G.H. Tongue, VP: A.J. Bruno

Broadcast Tech. of Colorado

PO Box 1310

Gunnison, CO 81230

(303) 641-5503, FAX# 303-641-3094

Mkt'g: Barb Dowman

Products: effects generators

Burle Industries

1000 New Holland Ave.

Lancaster, PA 17601-5688

(717) 295-6000, FAX# 717-295-6097

CEO/Pres.: Dr. Erick Burlefinger, Exec. VP: John
Cook, Exec. VP: Randolph Rose, Exec. VP: Don
Carter, Exec. VP: Carlton Rintz, Exec. VP: Reginald
Pattay

Products: accessories, cameras, dummy cameras, enclosures, fiber optics, lenses, modulators, monitors, multiplex-

ers, pan/tilts, remote controls, signal distribution, specialty cameras, surveillance, switchers, time-lapse recorders, transmission systems, video mixers, VTRs

CCTV

315 Hudson St.

New York, NY 10013

(212) 989-4433, 800-GBC-CCTV, FAX# 212-463-9758

VP: Steve Lefkowitz, Sls Mgr.: Gary Perlin, Export
Mgr.: Sydelle Ranzman

Products: accessories, cameras, dummy cameras, enclosures, fiber optics, lenses, monitors, pan/tilts, remote controls, signal distribution, specialty cameras, surveillance, switchers, time-lapse recorders, transmission systems, VTRs

Carol Products

1750 Brielle Ave.

Ocean, NJ 07712

(201) 918-0800, 800-922-2765

Catel Telecommunications

4050 Technology Pl.

Fremont, CA 94537

(415) 659-8988, 800-827-2722, FAX# 415-651-8437

Pres.: Jim Hood, Dir. CATV/Telco Div.: Jim Caldwell,
G. Mgr. Broadband/Int'l Div.: Ron Todd, VP Mkt'g/Sls:
Rick Green, VP Eng.: Mircho Davidov, VP Mfg.: Kurt
Meier
Bruce Dawson & Assoc., Louisville, KY, 502-896-2266
Carey & Assoc., Houston, TX, 713-460-1111
Cavendish & Winchester, Atlanta, GA, 404-449-5104
Gustafson Systems Sls, Palatine, IL, 312-358-2505
Piper Assoc., Needham, MA, 617-449-1144
Piper Mkt'g, Moorestown, NJ, 609-449-1144
SAC Communications, Fairfax Station, VA, 703-643-2344
Seevid, Huntington Beach, CA, 714-898-6100
Turner Technology, Sunnyvale, CA, 408-734-3231
UR Assoc., Seattle, WA, 206-723-6622
Cabletel Communications, Markham-Ont., Canada,
416-475-1030

Centro

369 Billy Mitchell Rd.

Salt Lake City, UT 84116

(801) 537-7779, FAX# 801-537-7513

Pres.: Don Skaggs, VP Mkt'g/Product Dev.: Curtis
Chan, VP Sls/Op.: Bob Strout

Channel Master, Div. of Avnet

Industrial Pk Dr.

Smithville, NC 27577

(919) 934-9711

Channelmatic

821 Tavern Rd.

Alpine, CA 92001

(619) 445-2691, 800-231-1618

Closed Circuit Systems

11261 Sunrise Pk Dr.

Rancho Cardova, CA 95742

(916) 638-4400

Mkt'g: Dan Lackey

Cohu, Electronics Div.

PO Box 85623

San Diego, CA 92138

Genlock Input.
Separate BNC connector allows external synchronization of camera to composite video or composite sync.

Phase Adjustable Line Lock.
Compensates for power line phase differentials to permit easy synchronization of multi-camera systems for roll free video switching.

Shutter Speed Enabler.
Easily accessible switches permit selection of 8 shutter speeds for "photo-finish" clarity of fast-moving objects.

Automatic Gain Defeat.
On/Off Switch enables camera AGC to maximize video gain when viewing low light level scenes.

Automatic Gain Control (AGC).
Built-in 20dB amplifier produces usable video down to .2 lux scene illumination. No other 1/2" CCD offers greater sensitivity or better picture quality.

Lens Mount Selection.
Flip a switch to easily adapt the camera to use either the new CS lens technology or a wide range of industry standard C-mount lenses.

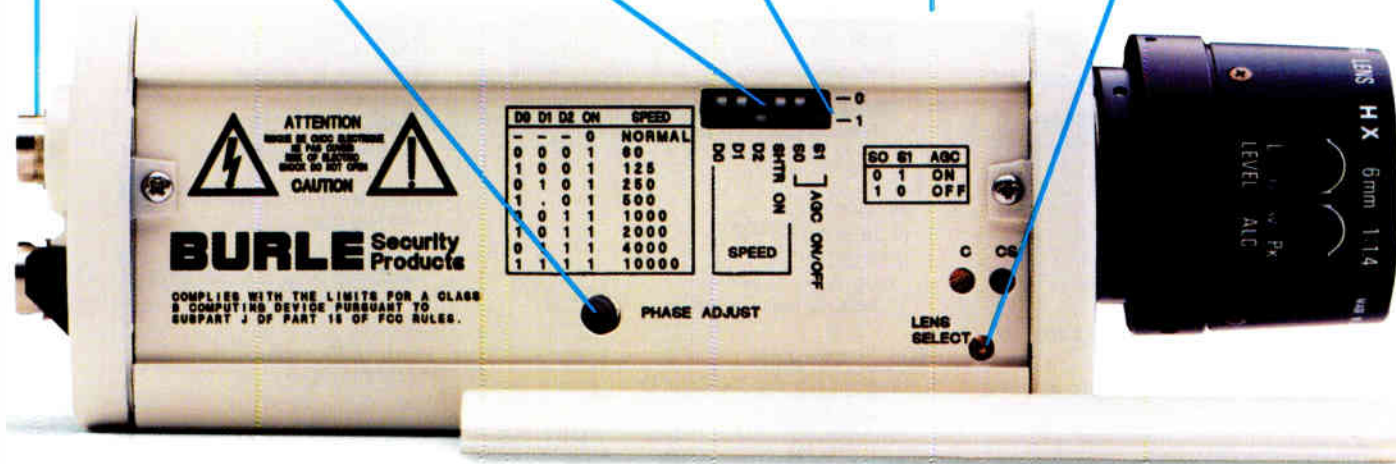

Check the styling, then pop the hood.

BURLE's new high performance CCD.

BURLE presents the best all-around camera in its class. The new TC650 series. The new design blends well into all environments. The TC650's compact size and rugged build are evident at a glance. Engineered specifically for compatibility with multi-camera systems, the TC650 offers unsurpassed ease of installation, flexibility in operation and dependable service. For instance, our camera's

Solid State Imager uses the latest CCD chip technology which virtually eliminates transfer smear, image lag and retention. We incorporated advanced 4-layer printed circuit board technology to pack more features into a smaller, more powerful unit. The TC650 camera is designed and manufactured in Lancaster, PA, comes in universal power supply options, and meets the standards set by UL, CSA,

TUV and the FCC. Contact your BURLE representative or BURLE INDUSTRIES, INC., 1000 New Holland Avenue, Lancaster, PA 17601-5688. Telephone: (717) 295-6123.

BURLE
SECURITY PRODUCTS

The solution is a

BURLE SYSTEM

Circle 213 on Reader Response Card

World Radio History

(619) 277-6700, FAX# 619-277-0221

Pres./G.M.: James Brown, Mkt'g Mgr.: John Foster,
Nat'l Sls Mgr.: R. Jeffrey Tyler, Dir. Eng.: William
Steger, Mgr. Mkt'g Comm.: Fred Holmshaw, Mfg. Mgr.:
Gerald Samuel
Gary Kuntz, Danville, CA, 415-736-0224
Summer Spector, Laguna Hills, CA, 714-768-8585
Ray Benck, Binghamton, NY, 607-775-4437
William Bryant, Duluth, GA, 404-279-1190

Comlux

453 Ravendale Dr., Ste. F
Mountain View, CA 94043
(415) 964-9628, FAX# 415-964-0968

Pres.: Joseph Hawkins, VP Mkt'g/Sls: H. Kenneth
Regnier Jr., VP Eng.: Thomas Reynolds
MSC Electronics, Richmond Hill-Ont., Canada, 416-
731-9500
Western CATV Dist., Torrance, CA, 213-539-8030
Broadcast Plus, Bowman Field, Louisville, KY, 502-
452-2777
RIA, Salt Lake City, UT, 801-486-8822
Products: fiber optics

Compression Labs

2860 Junction Ave.
San Jose, CA 95134
(408) 435-3000, 800-538-7542, FAX# 408-922-
5429

Pres.: John Tyson, Exec. VP/Sls & Mkt'g: John Walsh,
VP Sls: Ted Augustine, VP Int'l Sls: Carl Marszewski,
VP Mkt'g: Kathy Reavis
Products: transmission systems

Crest Electronics

4921 Exposition Blvd.
Los Angeles, CA 90016
(213) 731-1105, 800-234-0119, FAX# 213-731-
1417

Chairman/CEO: Irv Rossman, Pres.: Dennis Castelli,
Sr. VP: Hope Borows, Sec./Treas.: Eleanor Rossman
Crest Electronics, Greensboro, NC, 800-873-2121
Irving Brown, Brooklyn, NY, 718-493-1379
Henry Phillips, Roswell, GA, 404-992-3070
John Wilkens Assoc., Hillsboro, OH, 513-393-1137
Pacnor Mkt'g, Lynwood, WA, 206-771-6016

Products: accessories, cameras, channel converters, com-
puter interfaces, connectors, dummy cameras, effects gen-
erators, enclosures, fiber optics, hardware, lenses, message
generators, modulators, monitors, multiplexers, pan/tilts, re-
mote controls, specialty cameras, surveillance, switchers,
time-lapse recorders, transmission systems, video mixers,
VTRs

J.W. DAVIS & CO.

PO Box 26177
Dallas, TX 75226
(214) 651-7341, 800-527-5705, in-state 800-in TX
800-442-1564, FAX# 214-939-0328

Pres.: Charles Griffith, VP Sls: Jack Tucker
Products: accessories, cameras, connectors, enclosures,
lenses, monitors, surveillance, switchers, time-lapse record-
ers

Diamond Electronics

PO Box 200
Lancaster, OH 43130
(614) 756-9222, FAX# 614-756-4237

Exec. VP: A. Robert Moore, Mkt'g Mgr.: Phil
Hendershot, Prod. Mgr.: David Mitchell, Sls Eng.: Mike
Conkey
Products: accessories, cameras, enclosures, fiber optics,
lenses, monitors, multiplexers, pan/tilts, remote controls, sur-
veillance, switchers, transmission systems, VTRs

Digi-Spec

9510 Jefferson Blvd.
Culver City, CA 90232
800-222-9510, FAX# 213-204-1015

Dynair Electronics

PO Box 85020
San Diego, CA 92138
(619) 263-7711, 800-854-2831

Pres.: E.G. Gramman, VP Mkt'g: D. Castellini, Systems
Mgmt: R.A. Jacobs, VP Eng.: T.R. Meyer, Mkt'g
Comm. Mgr.: L. Davis

EMI (Electro-Mechanical

Imagineering)
11411 Bradley Ave.
Pacoima, CA 91331
(818) 896-6700, 800-628-5858, FAX# 818-899-
1599

Pres.: Gary Rutberg, Sec./Treas.: Eileen Rutberg,
Nat'l Sls/Mkt'g: Michael Moll, Dir. Adv./Pub.: Annetta J.
Crocker
Products: accessories, enclosures, hardware, pan/tilts

E.S.E.

142 Sierra St.
El Segundo, CA 90245
(213) 322-2136
Mkt'g: Robert Mayers
Products: time-lapse recorders

Elbex America

Bradley Corp. Pk, 300 Corp. Dr.
Blauvelt, NY 10913
(914) 353-0600, 800-952-9528, FAX# 914-353-
0657

CEO: David Elberbaum, E. Coast Sls Mgr.: Christopher
LoCascio, W. Coast Sls Mgr.: Rob Crane, E. Coast
Gen. Mgr.: Steven Shaki, W. Coast Gen. Mgr.:
Mohammad Bigdeli
Elbex W. Coast, Carson, CA
Elbex Japan, Shinagawa kc, Tokyo
Elbex, Regensburg, West Germany
Elbex Scandinavian, Brondby, Denmark
Elbex Australia, Mentone, Victoria
Products: accessories, cameras, connectors, dummy cam-
eras, enclosures, monitors, pan/tilts, signal distribution,
specialty cameras, surveillance, switchers

Electrohome

809 Wellington St. N.
Kitchener, Ontario, Canada N2G 4J6
(519) 744-7111, FAX# 519-749-3131
Chairman/CEO/Pres.: J.R. Pollock, VP Electronics:
W.M. Nobbs, VP Motors: K.G. Hansen, VP
Broadcasting: W.D. McGregor, VP Finance: J.R.
Gingerich, Dir. Human Res.: J.R. Boehmer
Electrohome USA, Ontario, CA, 714-983-5660
Products: effects generators, video projectors

Fiber Optek Interconnect

232 New Hackensack Rd.
Wappinger Falls, NY 12590
(914) 462-6356, FAX# 914-462-1780

Gaslight Video

479 N. Tustin St., Ste. 8
Orange, CA 92667
(714) 744-4190

Grass Valley Group

PO Box 1114
Grass Valley, CA 95945
(916) 478-3000, FAX# 916-478-3187
Pres.: Dan Wright, Exec. VP: Dave Mayfield, VP Mkt'g:
Bob Cobler, Dir. Sls/Mkt'g: Bob Natwick
GVG, Paramus, NJ, 201-845-7988
GVG, Elkhart, IN, 219-264-0931
GVG, Woodland Hills, CA, 818-999-2303
GVG, Kowloon, Hong Kong, 852-3-7396632
GVG, Winchester, Hampshire U.K., 44-962-843939

Products: computer interfaces, effects generators, fiber
optics, hardware, modulators, multiplexers, remote controls,
signal distribution, surveillance, switchers, transmission sys-
tems, video mixers

Gyrr, Div. of Odetics

1515 S. Manchester Ave
Anaheim, CA 92802
(714) 772-1000, 800-854-6854, FAX# 714-776-
6363
Bus. Mgr.: Richard Alexander, Dir. Mkt'g: Terry
Tetrick, Nat'l Sls Mgr.: Tom Pappageorge

H.O.M.E.

PO Box 225
Hermann, MO 65041
(314) 486-3111
Mkt'g: Arthur Brigham
Products: enclosures

Hirschmann of America

PO Box 229
Riverdale, NJ 07457
(201) 835-5002, 800-225-0524
Sls Mgr.: Andy Swenson

Hitachi Denshi America

175 Crossway Pk W.
Woodbury, NY 11797
(516) 921-7200, 800-824-9751, FAX# 516-921-
0993
Hitachi, Torrance, CA, 213-328-6116
Hitachi, Dallas, TX, 214-233-7623
Hitachi, Itasca, IL, 312-250-8050

Hoodman

PO Box 816
Hermosa Beach, CA 90254
(213) 379-6391, FAX# 213-372-6420
Pres.: Mike Schmidt, VP Sls: Bob Schmidt, VP Mkt'g:
Lou Schmidt
Pacific Group, Pasadena, CA, 213-681-3217
Applied Electronics, Toronto-On., Canada, 416-252-
3761

ISS Engineering

104 Constitution Dr., #4
Menlo Park, CA 94025
(800) 227-6288
VP Mkt'g.: Lydia Gillaspie, VP Sls: John Coiro

Ikegami Electronics (USA)

37 Brook Ave.
Maywood, NJ 07607
(201) 368-9171, FAX# 201-569-1626
Dir. Sls & Mkt'g: Howard Winch, Nat'l Sls Mgr. CCTV:
Ray Sooley, Mkt'g Mgr. CCTV: Aaron Chesler, Comm.
Mgr.: Robert Estony
Products: accessories, cameras, monitors, pan/tilts, signal
distribution, specialty cameras, surveillance, switchers,
time-lapse recorders

Intec Video Systems

23301 Vista Grande
Laguna Hills, CA 92653
(714) 859-3800, 800-237-3314, FAX# 714-859-
3178

JVC Co. of America

41 Slater Dr.
Elmwood Park, NJ 07407
(201) 794-3900, 800-526-5308, FAX# 201-523-
3601

Javelin Electronics

PO Box 2033
Torrance, CA 90502
(213) 327-7440, 800-421-2716, in-state 800-528-9200, FAX# 213-327-5405
Pres.: Graham Nallis, VP Sls & Mkt'g: John Schulte, VP Eng.: Ray Payne, Sls Mgr.: Roy Schaub, Mkt'g Mgr.: Fred Vogel
Arlington, VA, 703-522-1131

Jaydik Communications

19831 Magellan Dr.
Torrance, CA 90502
(213) 327-7440
Mkt'g: John Schulte
Products: surveillance

Koyo Int'l of America

325 Marcus Blvd.
Hauppauge, NY 11788
(516) 434-8484, 800-645-9818, FAX# 516-434-8488
Pres.: Tom Wada, VP Sls: Al Gold, Adm. Mgr.: Kim Mizuno, Sls: Scott Nagy, Sls Desk: Joan Sheperd, Sls Desk: Carole Fuchs
W.B. Pray Sls, Northboro, MA, 508-393-3434
Hi-Tech Industries, Albany, NY, 518-456-7751
Heitne Reps, Marietta, GA, 404-578-0102
Florida/Recco, N. Palm Beach, FL, 407-622-7555
Admiral Sls, Dallas, TX, 214-357-9212

LEE DAN COMMUNICATIONS

155 Adams Ave.
Hauppauge, NY 11788-3699
(516) 231-1414, 800-533-3261, in-state 800-231-1414, FAX# 516-231-1498
Pres.: Leon Goldberg, VP Op.: Lawrence Goldberg, VP Finance/Admin.: David Goldberg, Sr. Sls Associate: Susan Leon, Office Mgr.: Rita Kaplan, Sr. Tech.: Sandy Hoffman
Products: accessories, cameras, enclosures, hardware, lenses, monitors, pan/tilts, specialty cameras, surveillance, switchers, time-lapse recorders, VTRs

Lightwave Communications

650 Danbury Rd.
Ridgefield, CT 06877
(203) 438-3591, FAX# 203-431-3001
VP Mkt'g/Sls: John Makuch, G. Mgr.: Mike Canestri, Dir. Eng.: Kevin Keif, Prod. Mgr.: Brian McNair, Sls: Philip Franceschini

MFJ Enterprises

921 Louisville Rd.
Starkville, MS 39759
(601) 323-5869, 800-647-1800, FAX# 601-323-6551
Controller: Eddie Richey

MPO Videotronics

2580 Turquoise Circle
Newbury Park, CA 91320
(805) 499-8513, FAX# 805-499-8206
Reg. Mgr.: Mark Barker

MATH ASSOCIATES

2200 Shames Dr.
Westbury, NY 11590
(516) 334-6800, FAX# 516-334-6473
Pres.: Ellen Math, CEO/Dir. R & D: Irwin Math, Exec. VP: Howard Oboler, Exec. VP: Martin Rein
Products: accessories, fiber optics, transmission systems

Microframe

8236 E. 71st St., Ste. 356

Tulsa, OK 74133
(918) 250-4839, 800-635-3811
Products: accessories

MIDDLE ATLANTIC PRODUCTS

PO Box 96
Haskell, NJ 07420
(201) 839-1011, FAX# 201-839-1976
Op. Mgr.: Scott Mathews
Products: accessories

Mikrolab Video

4121 Redwood Ave., Ste. 215
Los Angeles, CA 90066
(213) 306-0120

Mitsubishi Electric Sales America

110 New England Ave. W
Piscataway, NJ 08854
(201) 981-1414, FAX# 201-981-9492

Multiplex Technology

251 Imperial Hwy
Fullerton, CA 92635
(714) 680-5848, 800-423-0584, FAX# 714-680-0645
Pres.: Philip Strauss, VP Eng.: John Crosby, VP Mfg.: Richard Foye, VP Sls.: Frank White, Ass. Sls Mgr.: Brian Prusinski, Office Mgr.: Karin de Riszner
Products: message generators, modulators, multiplexers, signal distribution, transmission systems

NEC America

4936 Rosecrans Ave.
Hawthorne, CA 90250
(213) 973-2071

NEC Professional Systems Div.

1255 Michael Dr.
Wood Dale, IL 60191-1094
(312) 860-9500, 800-562-5200 Ext. NEC
Nat'l Sls Mgr.: Hank Evers, Prod. Mgr.: Mark Dzeikan, Prod. Specialist: Mike Faletti

Northern Information Technology

262 Carlton Dr.
Carol Stream, IL 60188
(312) 690-1457, 800-528-4343, FAX# 312-665-0443
Pres.: Ed Polanek
Products: transmission systems

Panasonic Ind.

50 Meadowlands Pwy, M.S. 2A-8
Secaucus, NJ 07094
(201) 392-4050, FAX# 201-392-4436
Mgr.: Frank Orrow, Res. Mgr.: Art Hagiwara, Tech. Sup.: George Lidlow, Accts: Howard Anderson

Peerless Sales

1950 Hawthorne Ave.
Melrose Pk., IL 60160
(312) 865-8870, FAX# 312-865-2941
VP: Walter Snodell, Mkt'g Mgr.: Frank R. Briggs
Products: accessories, hardware

Pelco Sales

300 W. Pontiac Way
Clovis, CA 93612
(209) 292-1981, 800-289-9100, FAX# 800-289-9150

Sr. VP/Sls & Mkt'g: Tom Grogan, Sls Mgr.: Bill Reece, Sls Mgr.: Alan Jorm
S & F Northwest, Seattle, WA, 206-525-5203
Pro Rep, Foster City, CA, 415-570-5055
Intermountain Mkt'g, Larkspur, CO, 303-681-2506
The Crockett Sls, Dallas, TX, 214-350-3377
Cartwright & Bean, Norcross, GA, 404-368-0160

PROTO-TEC

108 Fairlane Dr.
Joliet, IL 60435
(815) 744-7173
Products: accessories, enclosures

RCA, New Products Div. (Closed-Circuit Video Equip.)

New Holland Ave.
Lancaster, PA 17604-3140
(717) 295-6123

Racon

12628 Interurban Ave. S.
Seattle, WA 98168-3383
(206) 241-1110, 800-426-5245, FAX# 206-246-9306
VP Sls: Robert Kirkaldie, Tech Svcs Mgr./Micropass: Mike Quigley, Inside Sls Rep: Kay Best
Products: transmission systems

Richardson Electronics

3030 River Rd.
River Grove, IL 60171
(312) 625-2288, FAX# 312-452-3450
Products: surveillance

Robot Research

5636 Ruffin Rd.
San Diego, CA 92123
(619) 279-9430, FAX# 619-279-7931
Pres.: John Stahler, VP Sls/Mkt'g: David Hartley, Dir. Sls: Joseph Olmstead, Mkt'g Comm.: Michael Fell, Tech. Rep: Steven Wilber
Products: accessories, surveillance, transmission systems

Sanyo Fisher

21314 Lassen St.
Chatsworth, CA 91311
(818) 998-7322, 800-421-5013, FAX# 818-701-4149

Sony Security

15 Essex Rd.
Paramus, NJ 07652
(201) 368-5018, FAX# 201-368-3514
Pres.: John Garrison, Nat'l Sls Dir.: Ken La Marca
Products: accessories, cameras, monitors, pan/tilts, specialty cameras, surveillance, switchers, time-lapse recorders, transmission systems, video mixers, video projectors, VTRs

Surveillance Video Systems

PO Box 1349
Ashland, OR 97520
(503) 482-4500
Pres.: Bud Wilkey
Products: accessories, cameras, dummy cameras, enclosures, hardware, lenses, monitors, pan/tilts, surveillance, switchers, time-lapse recorders

Symco

29 Poplar Dr.
Stirling, NJ 07980

(201) 647-6262, FAX# 201-647-4904

Sls: Robert Forster, Sls: Kevin McDonald, Sls: Joe Grossman, Sls: Burt Feldman, Sls: Frank Culotta
Products: accessories, cameras, computer interfaces, connectors, effects generators, enclosures, hardware, lenses, message generators, modulators, monitors, multiplexers, pan/tilts, remote controls, signal distribution, specialty cameras, surveillance, switchers, time-lapse recorders, transmission systems, video mixers, video projectors, VTRs

TEI Electronics

PO Box 246
 Hialeah, FL 33011
 (305) 888-3980, 800-327-8811, FAX# 305-885-4950

Pres.: Danny Alonso, VP: Mireya Muniz, Nat'l Sls Mgr.: Walter McNulty, Cust. Svce: John Tembras, Sls: Orlando Pineda, Sls: Jose Hircades
Products: accessories, connectors, effects generators, signal distribution, switchers, video mixers

TARGET TECHNOLOGY

PO Box 609
 Penn Valley, CA 95946
 (916) 639-2102

Pres.: Peter Hughes, VP: Sherri Douglas
Products: switchers

Telemetrics

7 Valley St.
 Hawthorne, NJ 07506
 (201) 423-0347, FAX# 201-423-5635

UHF Associates

5625 State Farm Dr., Ste. 4
 Rohnert Park, CA 94928

(707) 584-7844

Eng.: M. Hill, Mgr.: M. Sides

Usatco (Universal Satellite Corp.)

300 E. 59th St.
 New York, NY 10022
 (718) 786-1510

VCS

262 Carlton Dr.
 Carol Stream, IL 60188
 (312) 690-1400, 800-323-2613, FAX# 312-665-0443
 Pres.: Robert Stanko, VP: Ed Polanek
Products: accessories, cameras, monitors

Ventronic

94 Galli Dr.
 Novato, CA 94949
 (415) 382-9480, FAX# 415-382-0414
Products: fiber optics

VICON INDUSTRIES

525 Broad Hollow Rd.
 Melville, NY 11747-370
 (516) 293-2200, 800-645-9116, FAX# 516-293-2627

CEO: Donald N. Horn, Exec. VP: Arthur Wallace, Sr. VP Mkt'gs: Ronald J. Teixeira, VP Dom. Sls: Donald T. Heckel, VP Int'l Sls: Richard P. Adam
 US Reg. Office-W., Brea, CA, 714-990-3858
 US Reg Office-S., Norcross, GA, 404-449-0499
 Gov't Sls Office, Arlington, VA, 703-553-785-
 European Hdqtrs, Hampshire, UK, 44-0705-665-3

Products: accessories, cameras, computer interfaces, connectors, enclosures, fiber optics, hardware, lenses, message generators, modulators, monitors, multiplexers, pan/tilts, re-

mote controls, signal distribution, specialty cameras, surveillance, switchers, time-lapse recorders, transmission systems, video mixers, video projectors, VTRs

Video Accessory

2450 Central Ave.
 Boulder, CO 80301
 (303) 443-1319, 800-821-0426
 Pres.: Dr. Jack Baird, CEO: Norm Baer
Products: accessories, effects generators, signal distribution

Videolarm

PO Box 802
 Lithonia, GA 30058
 (404) 482-1313, 800-554-1124, FAX# 404-482-1963
 Pres.: Raymond Pagano, G. Mgr.: Nathan Schroeder
Products: accessories, enclosures

Videoplex

2 World's Fair Dr.
 Somerset, NJ 08873
 (201) 469-9038
 Pres.: Martin Horak, Exec. VP: Gerald Kalb, Chief Eng.: Bruce Fogelstrum

Video Resources

21 Castle Ave.
 Fairfield, CT 06430
 (203) 334-3233, 800-243-2878, FAX# 203-332-7093
 Pres.: Stanley Rosoff, VP Sls: John Cossman, G. Mgr.: Tom Marino

Visual Methods

PO Box 644
 Westwood, NJ 07675
 (201) 666-3950, FAX# 201-666-7931
 Pres.: Ted Sandin, VP: H. Kruegle
Products: accessories, cameras, enclosures, fiber optics, lenses, pan/tilts, specialty cameras, surveillance, transmission systems

Visual Communication Specialists

8586 Miramar Rd.
 San Diego, CA 92121
 (619) 455-7252, FAX# 619-455-7324
 Pres.: C.P. Murray

York Controls

1111 S. Sherman, Ste. 101
 Richardson, TX 75081
 (214) 234-2126, FAX# 214-234-2176
 COO: Peter York, Pres.: Bruce Christianson, CFO: Majors Harris, Sls Mgr.: Chris Monck, Mkt'g Mgr.: Paul Seif, Dir. Eng.: Woody Pope
 Milanese Assoc., Philadelphia, PA, 215-763-2138
 B.L. Repps, Milwaukee, WI, 414-277-7600
 Marketline, Atlanta, GA, 404-972-9048
 D & B Mkt'g, Plano, TX, 214-423-3447
 PMP Mkt'g, West Jordan, UT, 801-561-1968

...the easiest solution to your installation problems

Complete your installations easily and efficiently.

The TEI A/V Mounting System does the work for you, beautifully. Providing flexible solutions to those difficult space and viewing/listening problems. Handsomely finished hardware in Black/Dark Brown finished steel, TEI's versatile line of mounting units (load capacity to 175 lbs.) are ideally suited to home and apartment use.

So when you're ready to "hang it up" the easy way - install with TEI.

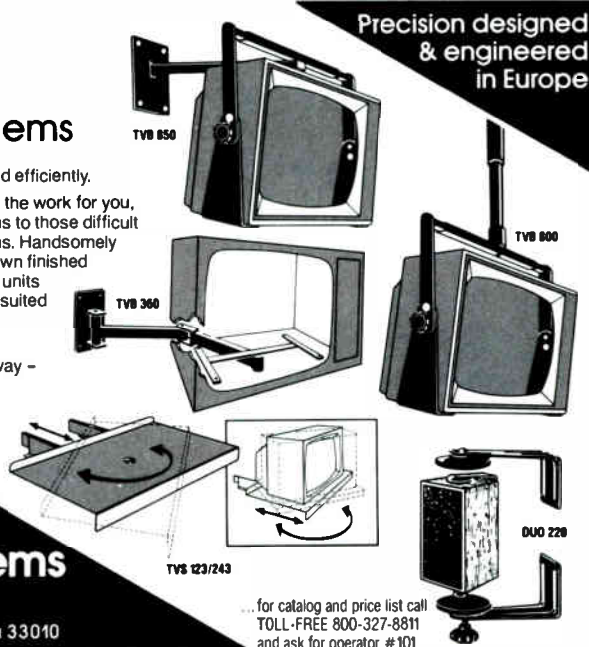

...for catalog and price list call TOLL-FREE 800-327-8811 and ask for operator #101

Audio Visual Mounting Systems

TEI Electronics, Inc., Dept. EH
 570 West 18th St., Hialeah, Florida 33010

Circle 63 on Reader Response Card

TELL YOUR SUPPLIERS YOU FOUND THEM IN THE BLUE BOOK

Designed For Today, Tomorrow And Yesterday.

Panasonic CCD Cameras.



WV-BL200 Shown
With Optional Lens



WV-CL300 Shown
With Optional Lens

Whether you're upgrading a security system or starting one from scratch, there's one line of CCD Cameras designed to meet all your needs today, tomorrow and yesterday. The WV-BL200 and WV-CL300 Series CCD Cameras from Panasonic®

Because the Panasonic WV-BL200 and WV-CL300 Series CCD Cameras represent a technological breakthrough that can amount to big savings for you. While delivering high performance and maximum versatility.

Take their optical versatility for example. With eleven high-quality, low cost CS-mount lenses, you can select just the right one for your specific application. From wide angle to super-wide to telephoto. From manual to ALC (Automatic Light Compensation).

The WV-BL200 and WV-CL300 Series CCD Cameras also feature a new lens mount configuration that accepts both C-mount lenses and our line of CS-mount lenses. Including DC and video controlled ALC lenses. So you can use both the lenses you may already own or our CS-mount lenses.

But that's not all that makes these cameras special. They tolerate extreme temperature variances (+144°F to -22°F) virtually

eliminating the need for costly cooling and heating systems (WV-BL200 Series). All with the exceptional performance of 1/2 inch CCD chips.

The WV-BL200 and WV-CL300 Series CCD Cameras. They'll perform for you today. Grow with you tomorrow. And allow you to utilize equipment you purchased yesterday. And they're only from Panasonic.

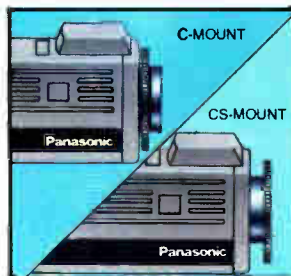

Find out more about Panasonic's CCD Cameras. For more information and your local dealer, call your nearest regional office.
Northeast: (201) 348-7303,
Midwest: (312) 981-4826,
Southeast: (404) 925-6835, Southwest:
(817) 685-1117, West: (714) 373-7265.

Panasonic

Closed Circuit Video Equipment

Circle 250 on Reader Response Card

42 AUDIO AMPLIFIERS

Clarity

1111 Industry Ave. SE
Roanoke, VA 24013
(703) 982-7003, 800-962-6009, FAX# 703-982-7032
Sls Mgr.: Linda Bishop, App. Eng.: John Spencer,
Cust. Svce Rep.: Robin Hale, Pres.: John Mason
Bill Bailey, Chester, VA, 804-748-4149

Communications Co.

3490 Noell St.
San Diego, CA 92110
(619) 297-3261, FAX# 619-297-3279
Exec. VP: Michael Jordan, Eng./Mfg.: David Johnson,
Order Desk: Bobby Willis, Order Desk: Laura
McCullough, Shipping: Ritchie Willis, Pres.: Peter
Jordan
Audio Mkg Assoc., Brecksville, OH, 216-526-2426
Bencsik Assoc., Ocala, FL, 904-732-9775
Secom Systems, Dorville, GA, 800-241-9409
Brian Trankie & Assoc., Belmont, CA, 415-595-4004
Western Audio Sls, Glendale, CA, 818-246-3806
Products: signal processing amps

Comutronic

18627 Brookhurst #305
Fountain Valley, CA 92708
(714) 963-7454, FAX# 714-963-7815
Dir. Mkt'g: Robert Gehike
Products: 25/70-volt amps, mixer amps, portable, single-
channel, zone-paging amps

Crest Audio

150 Florence Ave.
Hawthorne, NJ 07506
(201) 423-1300, FAX# 201-423-2977
Pres.: John Lee, Div. Mgr.: Craig Hannabury, Mkt'g
Mgr.: Bill Reventos

Crown Int'l

PO Box 1000
Elkhart, IN 46517
(219) 294-8000, FAX# 219-294-8329
Pres./CEO: Clyde Moore, Crown Div. Head: Gil
Nichols, Amplifier Prod. Dir.: Verne Searer, Sls Mgr.:
Jim Beattie, Mkt'g Svces: Gerry Barclay, Mic. Prod.
Line Mgr.: Bob Herrold
Products: 25/70-volt amps

DAX Audio Group

1231 S.E. Gideon St.
Portland, OR 97202
(503) 232-4445
Pres.: Rich Stevenson, Eng. Mgr.: Bob Herb

DCS Audio Products

335 E 21st St.
New York, NY 10010
(212) 9823654
Jeff Descombes

J.W. DAVIS & CO.

PO Box 26177
Dallas, TX 75226
(214) 651-7341, 800-527-5705, in-state 800-in TX 800-
442-1564, FAX# 214-939-0328
Pres.: Charles Griffith, VP Sls: Jack Tucker
Products: 25/70-volt amps, mixer amps, modular amps,
portable, single-channel, telephone paging amps, zone-pag-
ing amps

Dayton Industrial

126 Westpark Rd.
Dayton, OH 45459
(513) 236-3591
VP Sls/Mkt'g: Robert McDougall, VP Eng.: Kurt
Farmer, Sr. Tech.: Frank Jaros
Products: 25/70-volt amps, zone-paging amps

Delta Magnetics

16782 Hale Ave.
Irvine, CA 92714
(714) 863-1537

Drum Workshop

2697 Lavery Ct., #16
Newbury Park, CA 91320
(805) 499-6863, 800-453-7867, FAX# 805-498-7392

DUKANE

2900 Dukane Dr.
St. Charles, IL 60174
(312) 584-2300, FAX# 312-584-2370
Pres./CEO: J. McWilliams Stone Jr., Group VP: William
Finnegan, Div. G. Mgr.: Steven Deppe, Nat'l Sls Mgr.:
Warren Anderson, Svce Mgr.: Cliff Carlson
Wally Smutts, Toronto-Ont, Canada, 312-584-2300
Doug Fellabaum, Sycamore, IL, 815-895-7573
Don Mouritzen, Beecher, IL, 312-946-9655
Ken Lind, St. Charles, IL, 312-584-2300
Pete Kendal, Jacksonville, FL, 904-262-6025
Ed Nuhring, Portland, OR, 503-244-4262
Jim Lacey, Moreno Valley, CA, 714-243-1160
Jack Brown, Dallas, TX, 214-943-7528
Products: mixer amps, modular amps, portable, telephone
paging amps

Dyma Engineering

PO Box 1535
Los Lunas, NM 87031
(505) 865-6700

Dynasound

6439 Atlantic Blvd.
Norcross, GA 30071
(404) 242-8176, FAX# 404-242-8858

EMS/MUSIC

EMS/Music

2264 15th Ave. W.
Seattle, WA 98119
(206) 281-8686, 800-666-6874, FAX# 206-281-0936
Pres.: R. Kilroy Hughes, VP Sls/Mkt'g: Bernard Kron,
Nat'l Sls Mgr./Con. Dist. Rep: Berg Baylin, Nat'l Sls
Rep-N.: Shawn Rohrbach, Nat'l Sls Rep-S.: David
Pearson, Tech. Supp. Rep: Doug Sanders
Products: dual-channel, modular amps, signal processing
amps, zone-paging amps

Eddor

1948 East Pomona
Santa Ana, CA 92705
(714) 258-0777, 800-854-0259, FAX# 714-258-7117
Pres.: Larry Weston
Products: 25/70-volt amps, mixer amps, modular amps, tel-
ephone paging amps, zone-paging amps

Electro Force

727 Oaksone Way
Anaheim, CA 92806
(714) 774-3666
Pres.: Phillip Lindberg
Products: dual-channel, portable

Electro-Voice

600 Cecil St.
Buchanan, MI 49107

(616) 695-6831, 800-527-6701, FAX# 616-695-1304
Pres.: Robert Pabst, VP Sls & Mkt'g: Paul McGuire,
Dir. Mkt'g: Jim Long, Chief Eng.: Earl Harris
Products: portable

ELENEX (WEST)

7392 Trade St.
San Diego, CA 92121
(619) 566-7515, 800-225-3113, in-state 800-in CA 800-
225-8037, FAX# 619-586-1484
VP: Dennis Berglund, Eng.: Al Bitarafan, Sls: Lou
Hennequin
Products: signal processing amps

FM Acoustics Limited (USA)

PO Box 854
Benicia, CA 94510
(707) 745-4444
Pres.(LTD): Manuel Huber, Dir.(USA): Gene Michalski

Len Finkler

80 Alexdon Rd.
Downsview, Ontario M3J2B4
(416) 630-9103

Gentner Electronics

PO Box 27647
Salt Lake City, UT 84127
(801) 975-7200, FAX# 801-977-0087
Pres./CEO: Russell Gentner, COO: William
Trowbridge, VP Eng.: William Gillman, Dir. Mkt'g/Sls-
Bus.: Elaine Jones, Dir. Mkt'g/Sls-Audio/Best: Gary
Crowder, Mkt'g Coord.: Kelli Maag
Products: mixer amps

H & E Micro-Trak

165 Front St.
Chicopee, MA 01013
(413) 733-8743, 800-253-0570

Hacoustic Sound & Communications

of America
3963 Magnolia Ln.
Buford, GA 30518
(404) 945-3142, FAX# 404-945-6174
Pres.: Raleigh Perry

David Hafler/Rockford

5910 Crescent Blvd.
Pennsauken, NJ 08109
(609) 662-6355, 800-932-0730, FAX# 609-662-9173
Dir. Mkt'g/Prod. Div.: R. Tucker
Products: dual-channel, monitor amps

Hill Audio

5002B N. Royal Atlanta Dr.
Tucker, GA 30084
(404) 934-1851, FAX# 404-934-1840
Sls Mgr.: Bob Allen, Svce Mgr.: Rick Rogers
Products: dual-channel

Holophonics

1120 Ave. of the Americas, Ste. 4270
New York, NY 10036
(212) 787-7767

**TELL YOUR
SUPPLIERS
YOU FOUND THEM
IN THE
BLUE BOOK**

Warning: To Avoid Risk Of Shock,

Ignore This Amp-To-Amp Confrontation.

Let's be frank. We're out to change your idea of what — and who — makes a professional power amplifier. So if you just bought a Crown MacroTech, turn the page — this comparison won't be a polite one. But it will stick to the facts.

A look inside these two amps will give you a better idea of why BGW amps like the GTB Grand Touring Amplifier are built like no others in the world. And raise some questions about Crown MacroTechs.

mass of metal absorbs thermal transients without straining the fan. And without quick changes in transistor temperature. That's important: Transient musical loads put the worst kind of stress on power transistors. The effects of thermal cycling fatigue may not show up until after the warranty, but they can destroy lesser amps. Meanwhile, BGWs keep right on delivering clean, reliable power.

BGW pioneered DC speaker protection in 1971. We stopped using relays years ago, when they no longer met our reliability standards for BGW amps. The GTB, like all BGWs over 200 Watts, uses solid-state Thyristor Crow Bars to keep DC from ever reaching your valuable speaker cones or compression drivers.

REAL SPEAKER PROTECTION

Most amps today are direct coupled, so a blown output transistor (the most common failure) connects the power supply directly to the speakers. Earlier MacroTechs had no protection against DC. Now Crown has learned their lesson — or have they? The sensing circuit and relay they now use shuts off the power transformer, but allows the filter capacitors to discharge stored DC energy directly into your drivers — risking real damage.

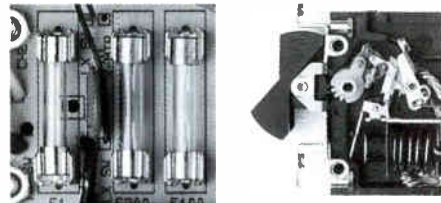

Left: Time is money, and with Crown's MacroTech you can lose plenty of both: You have to pull it out of the rack every time a fuse blows.

Right: The GTB's power switch is also a rocker-actuated magnetic circuit breaker. You can reset it in a second if power lines hiccup.

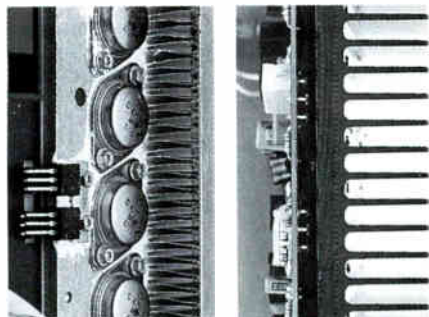

Left: The MacroTech uses mostly air to dissipate heat, not metal. The closely spaced fins are vulnerable to airborne dust and dirt.

Right: BGW uses ten pounds of aluminum to absorb thermal transients, extending power transistor life.

TAKING THE HEAT

If the MacroTech heat exchanger reminds you of an air conditioner, you've grasped its design. This approach works, at least until dust and dirt clog the fins. But as soon as the air flow slows or stops, temperature rises. Soon after that, the Crown shuts off — it could even fail.

The GTB uses massive extruded aluminum heat sinks with widely spaced fins. The

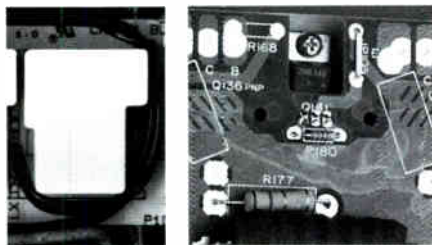

Left: Crown uses a slow-acting, less reliable relay. It can allow the filter capacitors to discharge stored energy directly into your drivers.

Right: BGW's modular power output section protects your speakers against DC damage with an instantaneous Thyristor Crow Bar. And the module is easily replaced in the unlikely event of failure.

MAKE YOUR OWN COMPARISON

Before you buy or spec your next power amp, call us at **800-468-AMPS** (213-973-8090 in CA). We'll send you tech info on BGW amps and the name of your nearest dealer: He can arrange a demo of any BGW model against any amp you choose. Then you'll be able to appreciate the advantages of BGW engineering with your ears, as well as your eyes.



13130 Yukon Avenue, P.O. Box 5042
Hawthorne, CA 90251-5042
Tel 213-973-8090 • Fax 213-676-6713

IED Innovative Electronic Designs

9701 Taylorsville Rd.

Louisville, KY 40299

(502) 267-7436, FAX# 502-267-9070

VP Mkt'g & Sls: Tom Roseberry, Mkt'g Asst.: Robin Lasley, Sls App. Eng.: Jeff White, Mkt'g Adm.: Wanda R. Martin, VP Eng.: Ed Young, Pres.: Hardy Martin
Repworks, Chicopee, MA, 413-533-0845
Darmstedter Assoc., Baldwinsville, NY, 315-638-1261
John Anthony., Stamford, CT, 203-322-9202
Sigmet, Valley Forge, PA, 215-783-6666
Secom Systems, Atlanta, GA, 404-455-0672
Bencsik Assoc., Ocala, FL, 904-732-9775
C.L. Pugh, Cleveland, OH, 216-238-1777
Monford Electronics Mkt'g., Indianapolis, IN, 317-872-8877

C.M. Sls, Farmington Hills, MI, 313-553-8070

Ludwig Mkt'g., Kenosha, WI, 414-697-9355

B.C. Electronic Sls, Mission, KS, 913-262-1720

Mkt'g Concepts, Irving, TX, 214-869-0669

Yora, White Bear Lake, MN, 612-770-9760

Torbett/Keiser Group, Loveland, CO, 303-669-1008

Derek Allen Assoc., Toluca Lake, CA, 818-840-8327

Plus Four Mkt'g, Walnut Creek, CA, 415-937-0650

North Shore Mkt'g, Seattle, WA, 206-284-9699

Island Instruments, Kaneohe, HI, 808-235-7544

Products: 25/70-volt amps, modular amps, portable, zone-paging amps

Ibanez/Hoshino (USA)

1726 Winchester Rd.

Bensalem, ID 19020

(215) 638-8670, 800-669-8262, FAX# 215-245-8583

Industrial Research Products

415 Busse Rd.

Elk Grove Village, IL 60007

(312) 439-3600, 800-255-6993, FAX# 312-640-9607

G. Mgr.: Brian Benn, Mkt'g Mgr.: Roger Carroll, Sr. Sls

Eng.: Gayle Campbell, Chief Eng.: Dick Peters

Piper Assoc., Needham, MA, 617-449-1144

Sigmet, Freehold, NJ, 201-462-1221

Richard Pass Assoc., Langhorne, PA, 215-757-6100

Starin Mkt'g, Chesterton, IN, 219-929-4127

Bencsik Assoc., Ocala, FL, 904-732-9775

EESSCO Systems, Los Angeles, CA, 213-666-9601

Products: 25/70-volt amps, dual-channel

Industry West Electronics

270 N. Geneva Rd.

Orem, UT 84057

(801) 226-1000

JBL PROFESSIONAL

PO Box 2200

Northridge, CA 91329

(818) 893-8411, FAX# 818-893-3639

Pres.: Ronald Means, VP Sls: Ken Lopez, VP Mkt'g:

Mark Gander, Mkt'g Mgr.: Hector Martinez, Mkt'g Mgr.:

Steve Romeo

Jim Chase, Hermosa Beach, CA, 213-374-2128

Bill Hamilton, Folsom, PA, 215-543-4677

Bill Schuermann, St. Louis, MO, 314-644-2083

Tom Walter, N. Barrington, IL, 312-382-4925

Products: 25/70-volt amps, dual-channel, low-freq. amps, monitor amps, portable, signal processing amps

Johnson Electronics

4301 Metric Dr.

Winter Park, FL 32792

(407) 677-4030, FAX# 407-679-1288

Pres./CEO: A.J. Schell, VP Mkt'g: Robert Peters,

VP/Eng.: Ken St. John

Products: 25/70-volt amps, telephone paging amps, zone-paging amps

KDM Electronics

705 Progress Ave., Unit #59

Scarborough, Ontario, Canada M1H 2X1

(416) 439-7158, FAX# 416-439-7232

Pres.: Ron Bull, Sls Mgr.: Tom Bandini

Givan Assoc., W. Boylston, MA, 508-835-3161

Sigmet, Valley Forge, PA, 215-783-6666

Henry Phillips, Roswell, GA, 404-992-3070

Repronics, New Madison, OH, 513-996-0530

William Linz Assoc., Deerfield, IL, 312-945-9600

Products: portable, signal processing amps, zone-paging amps

LVW Electronics

2400 Naegle Rd.

Colorado Springs, CO 80904

(719) 471-8430, FAX# 719-471-8027

Leitch Video Ltd.

10 Dyas Rd.

Don Mills, Ontario, Canada M3B1V5

(416) 445-9640, 800-387-0233

MCGOHAN ELECTRONICS

1033 Fairway Dr.

Bensenville, IL 60106

(312) 595-2342, FAX# 312-595-2919

Pres.: Jim McGohan, VP: Ron Johnston, Sec./Treas.:

Helen McGohan, Chief Eng.: Bill Everhart

Products: 25/70-volt amps, mixer amps, monitor amps, single-channel, telephone paging amps, zone-paging amps

McMartin Int'l

111 Camino Dil Rio

Gunnison, CO 81230

(303) 641-5500

Pres.: Ray McMartin, Fin'l Adm.: Robert McMartin, Dir.

Eng.: Robert German, Dir. Mfg.: Wayne Allen, Dir.

Supplies/Prod.: Louise Rundock

Meyer Sound Laboratories

2832 San Pablo Ave.

Berkeley, CA 94702

(415) 486-1166, FAX# 415-486-8356

Dir. Int'l Sls/Mkt'g: George Douglas, Dir. Tech. Mkt'g:

Mark Johnson, Nat'l Sls Mgr.: Cindy Ramos, Cust.

Svcs Mgr.: Herb Heinz

Products: dual-channel

MICROAUDIO

4438 S.W. Hewett

Portland, OR 97221

(503) 292-8896, 800-445-1248, FAX# 503-292-8896

Pres.: Eugene Rimkeit, VP: David Eisbernd, Dir. Sls:

Jim Bryant, Dir. Eng.: Richard Schomburg

Sigmet, Valley Forge, PA, 215-783-6666

Professional Sound, Lakewood, CO, 303-986-5999

Western Audio, Glendale, CA, 818-246-3806

Powerlines, Evanston, IL, 312-864-1147

Worldwide, Fort Lauderdale, FL, 305-584-7095

Products: 25/70-volt amps

Millbank Electronics Group

Bellbrook Ind'l Estate

Uckfield, East Sussex, England TN22 1QL

() 0825-4811

Chair./Chief Exec.: A. E. Walker, Sls/Mkt'g Dir.: D. H.

Eaton, App. Eng. Dir.: D. G. G. Edworthy, Dir. - CTSD:

B. A. Skinner, App. Eng.: C. K. Pike

Panasonic Ind.

50 Meadowlands Pwy, M.S. 2A-8

Secaucus, NJ 07094

(201) 392-4050, FAX# 201-392-4436

Dept. Mgr.: Frank Orrow, Res. Mgr.: Art Hagiwara,

Tech. Sup. Supervisor: George Lidlow, Accts Mgr.:

Howard Anderson

Panasonic/Ramsa

6550 Katella Ave.

Cypress, CA 90630

(714) 373-7277, FAX# 714-373-7242

Sls/Mkt'g Mgr.: Steve Wooley, Mkt'g Mgr.: Chris

Foreman, W. Sls Mgr.: James Murray, Central Sls

Mgr.: Greg Braithwaite, Telemkt'g Mgr.: Carla

Campbell

James Murray, Cypress, CA, 714-373-7389

Greg Braithwaite, Arlington Heights, IL, 312-981-7329

Pusecker Sls, Upper Montclair, NJ, 201-744-1834

David Bros., Finksburg, MD, 301-833-0920

Pro Audio Assoc., Burlington, MA, 617-229-6050

World Wide Electronics, Pembroke Pines, FL, 305-

584-7024

Evans Sls & Mkt'g, Nashville, TN, 615-297-7997

New Horizons, Bannockburn, IL, 312-234-6500

Laker Assoc., Wauzata, MN, 612-475-2642

A/V Mkt'g, Carmel, IN, 317-846-1034

Innovative Audio, Pontiac, MI, 313-673-2280

J.B. Parent, Dublin, OH, 614-764-0064

Essential Mkt'g, St. Joseph, MO, 816-279-0776

Teneckt Assoc., Houston, TX, 713-528-2005

New West Audio, Burbank, CA, 818-955-9700

Brian Trankle Assoc., Belmont, CA, 415-595-4004

Northmar, Seattle, WA, 206-524-5170

Pearson & Pearson, Denver, CO, 303-722-6996

Products: 25/70-volt amps, dual-channel, low-freq. amps,

single-channel,

Parasound Products

950 Battery St.

San Francisco, CA 94111

(415) 397-7100, FAX# 415-397-0144

Pres.: Richard Schram, Dir. Tech. Svcs: Rich Rogers,

Dir. Sls & Mkt'g: Bonnie Perella, Adm. Mgr./Credit:

Kimberly Fink

Products: dual-channel, monitor amps

Peavey Electronics

711 A St.

Meridian, MS 39302

(601) 483-5365, FAX# 601-484-4278

Pres.: Hartley Peavey

Products: 25/70-volt amps, bi-amp systems, dual-channel,

low-freq. amps, mixer amps, monitor amps, signal process-

ing amps, single-channel, telephone paging amps, tri-amp

systems

Perreux/GMI Distributors

5000 Birch St, Ste. 3000, W. Tower

Newport Beach, CA 92660

(no Listing)

Power Solutions

10681 Haddington, # 190

Houston, TX 77043

(713) 932-9847, 800-345-9130

Pres.: Peter Cole, Mkt'g Mgr.: Glenn Messerschmitt

Powertronix

10623 Lawson River Ave.

Fountain Valley, CA 92708

(714) 963-5411

Pres.: Robert Gehlke, Sls Mgr.: Bill Organ

Precision Electronics

9101 King St.

Franklin Park, IL 60131

(312) 678-5350, 800-323-0228, FAX# 312-678-0511

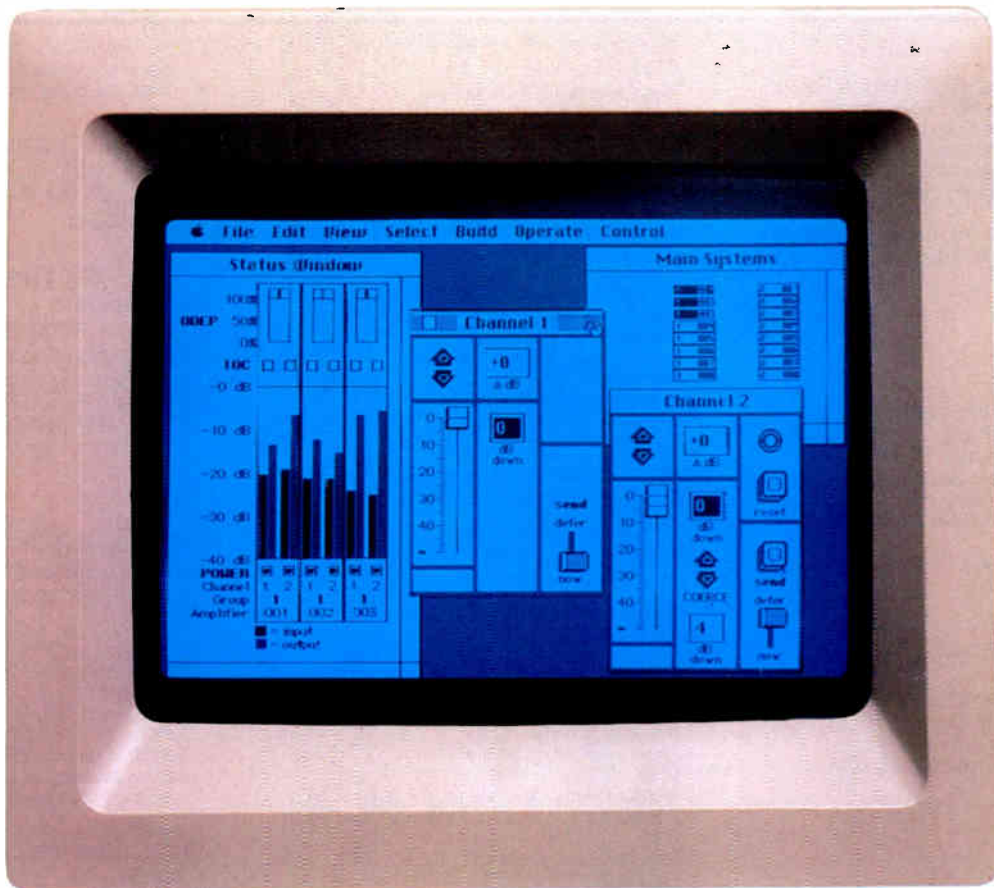

Test Our IQ.

Install Crown's new IQ System 2000,[™]
the smartest way *ever* to monitor and control amplifiers.

You're looking at something that no sound contractor has ever seen, or possibly even *imagined*, before. A system that can digitally monitor and control each channel of up to 2,000 remote amplifiers at once. All from one cost-saving location.

It's the incredible new IQ System 2000 from Crown. Using a common personal computer, easy-to-install IQ components, and Com-Tech[™] amplifiers, you can now do in *minutes* what used to take days.



IQ Interface, Software & P.I.P. Module

Simultaneously adjust levels, power up, change polarity, monitor features (like Crown's exclusive IOC[®] and ODEP[™]), do diagnostics, and more. No running back and forth to each remote location. No expensive, long runs of speaker cable.

With the IQ System 2000, you're free to locate amps *anywhere* you like—even in previously impossible remote locations.

To learn more about this innovative new system, contact Crown today. Because when it comes to combining advanced technology with surprising cost efficiency, the Crown IQ System 2000 just could be the smartest choice you'll ever make.



1718 W. Mishawaka Road, Elkhart, IN 46517
219/294-8000

Circle 215 on Reader Response Card

World Radio History

Pres.: William Grommes, VP/Chief Eng.: Al Hart, G.
Mgr.: G. Hussain, Office Mgr.: Rose Johnson
Pass Assoc., Langhorne, PA, 215-757-6100
Vans Sound Equipment, Ashtabula, OH, 216-998-0723
Raven Sls, Dallas, TX, 214-490-8230
Sheldon Goodman & Assoc., Oswego, NY, 315-343-5839
Tortech Mkt'g, West Hill-Ont., Canada, 416-282-1011
Products: 25/70-volt amps, dual-channel, mixer amps, telephone paging amps

Protech Audio

Flowerfield, Bldg. #1
St. James, NY 11780
(516) 584-5855, FAX# 516-584-5904
Sls Mgr.: Bill Murphy, VP Eng.: Joseph Giambone
Peregrine SW Reps, Houston, TX, 713-589-8481
Products: 25/70-volt amps, dual-channel, mixer amps, modular amps, monitor amps, signal processing amps, single-channel, telephone paging amps, zone-paging amps

QSC Audio Products

1926 Placentia Ave.
Costa Mesa, CA 92627
(714) 645-2540, 800-854-4079, FAX# 714-645-7927
CEO: Barry Andrews, COO: John Andrews, VP Eng.: Patrick Quilter, Dir. Mkt'g: Greg McVeigh, Nat'l Sls Mgr.: Peter Kaimen, Sls Eng.: Andy Murray
S.F. Mkt'g, Montreal, Canada, 514-733-5344

RTS SYSTEMS

1100 W. Chestnut St.
Burbank, CA 91506
(818) 566-6700, FAX# 818-843-7953
Pres.: Robert Smith, VP Mkt'g: Doug Leighton, VP Eng./Tech.: Stan Hubler, Sls Mgr.: Shelley Harrison

Ramko Research

11355 "A" Folsom Blvd.
Rancho Cordova, CA 95670
(916) 635-3600

Randall

PO Box 51327
New Berlin, WI 53151
(414) 784-3730, 800-854-0529, FAX# 414-784-9258
Pres.: Chuck Faas, Nat'l Sls Mgr.: Bill Acton, Reg. Mgr.: Jody Carver, Reg. Mgr.: Bill McDaniel, Reg. Mgr.: Bob Seidman, Reg. Mgr.: B & B Mkt'g
Products

Rane

10802 49th Ave. W.
Everett, WA 98204
(206) 355-6000, FAX# 206-347-7757
VP Mkt'g: Larry Winter, Dir. Mkt'g: Terry Pennington, Nat'l Sls Mgr.: Ray Bloom
Products: 25/70-volt amps, bi-amp systems

Raymer

13278 Ralston Ave.
Sylmar, CA 91342
(818) 362-9516, FAX# 818-367-5292
Pres.: Hugh T. Wilcox, Sls Support Rep: Michelle Price, Sls Coord.: Jean Hurst
Products: 25/70-volt amps, mixer amps, modular amps, monitor amps, signal processing amps, single-channel, telephone paging amps, zone-paging amps

Rickenbacker Int'l

3895 S. Main St.
Santa Ana, CA 92707
(714) 545-5574, 800-535-2400, FAX# 714-754-

0135

Pres.: John Hall, VP: Derek Davis

RING COMMUNICATIONS

57 Trade Zone Dr.
Ronkonkoma, NY 11779
(516) 585-7464, FAX# 516-585-7410
Pres.: Paul McLean, VP Sls: Craig Krsanac, V.P. Tech.: Kjell (Ken) Solem, Tech Support: Charlie Kulins
Klumpff Sls, Jacksonville, FL, 904-287-5205
Corrigan Agencies, 504-893-7455
Gustafson Sls, 612-388-4277
Allwest Electronics, 805-388-1789
Pacnor, 206-771-6016
J.C. Electronics, 808-943-8514
Products: 25/70-volt amps

Round & Bidnick Assoc.

2631 Rocky Trail Rd.
Diamond Bar, CA 91765
(714) 861-3928

Russo Electronics Mfg.

5690 E. Shields Ave.
Fresno, CA 93727
(209) 291-5591
Pres./G. Mgr.: Russell Friend, Sls: Vicky Jarrett, Design Eng.: Michael Vink
Allied Broadcast Systems, Richmond, IN, 317-962-8596
Broadcast Supply W., Tacoma, WA, 206-565-2301
Professional Audio Supply, Ft. Worth, TX, 817-483-7474
Singer Products, Hialeah, FL, 305-558-3000
Electrex, FL, 305-651-5752
Products: low-freq. amps

SCS/Sound Code Systems

PO Box 2198
Garden Grove, CA 92643
(714) 554-0903, FAX# 714-554-5643
Pres.: Marvin Halverson, VP: Kevin Halverson, Sls Mgr.: Tim Edwards

SWR Engineering

12734 Branford St. #7
Pacoima, CA 91331
(818) 899-3061, FAX# 818-896-8385
Pres.: Steve Rabe, Sls/Mkt'g Mgr.: Rick Carlson

St. Louis Music

1400 Ferguson Ave.
St. Louis, MO 63133
(314) 727-4512, 800-325-8148, FAX# 314-727-8929
Sls Training Dir.: Tony Moscal, Prod. Mgr.: Gary Byers, Dir. Op.: John Karpowicz, Pres.: Gene Kornblum

Semco

3782 Westridge Ave.
W. Vancouver, B.C., Canada V7V 3H5
(604) 922-0526
G. Mgr.: Elk Ebert
Products: mixer amps, modular amps, signal processing amps

Senior Technology

13431 Pumice St.
Norwalk, CT 06650
(213) 802-9942, FAX# 213-802-9945
Pres.: Steve P.Y. Kim, VP: Fred K.H. Kim, Nat'l Sls Mgr.: Irv Weisman
EESCO Systems, Los Angeles, CA, 213-666-9601
Elrep Sls, Tucker, GA, 404-938-7109
Forti & Assoc., Kensington, MD, 301-949-1706
Dobbs Stanford, Dallas, TX, 214-358-0800
Mkt'g Insights, Glenview, IL, 312-729-2047
Products: 25/70-volt amps, dual-channel, mixer amps, mo-

onitor amps, portable, single-channel, telephone paging amps, zone-paging amps

Sequential Circuits

3051 N. First St.
San Jose, CA 95134
(408) 946-5240

SHURE BROTHERS

222 Hartrey Ave.
Evanston, IL 60202-3696
(312) 866-2200, FAX# 312-866-2279
Pres.: James Kogen, VP Sls: Lottie Morgan, Dir. Tech. Mkt'g: John Phelan, Dir. Wired Mics: Alan Shirley, Dir. Wireless Mics: Sandy Schroeder, Dir. Sls: Al Hershner
Products: mixer amps, monitor amps, portable, single-channel,

Sonance

32992 Calle Perfecto
San Juan Capistrano, CA 92675
(714) 661-7558, 800-582-7777, FAX# 714-240-4995
Pres.: Scott Struthers, VP: Geoff Spencer, Nat'l Sls Mgr.: Dave Donald, Asst. Nat'l Sls Mgr.: Caroline Kelly Bach, New York, NY, 212-727-0404
Morris-Tait, N. Hollywood, CA, 213-877-4424
Tandem Mkt'g, Schaumburg, IL, 312-605-1960
Vestco, Merrit Island, FL, 407-454-9051
Balaton, Washington, DC, 202-471-1764
Products: bi-amp systems, dual-channel, low-freq. amps

Sontec Electronics

Audio Dr.
Goldbond, VA 24094
(703) 626-7256
Sls Mgr.: Burgess Macneal
Products: mixer amps, modular amps, signal processing amps

Soundcraftsmen

2200 S. Ritchey
Santa Ana, CA 92705
(714) 556-6191, FAX# 714-662-0750
VP Sls: Roger Hagemeyer, Chief Eng.: Paul Rolles
Products: 25/70-volt amps, bi-amp systems, dual-channel, low-freq. amps, monitor amps, tri-amp systems

Sound Tech

230 Lexington Dr.
Buffalo Grove, IL 60089
(312) 541-3520, 800-877-6863, FAX# 312-541-3616
Pres.: Rudy Schlacher, Gen. Sls Mgr.: David Beirut, Exp. Sls Mgr.: William Robinson, Sls Dir.: Todd Peren
Products: bi-amp systems, dual-channel, low-freq. amps, mixer amps, monitor amps, tri-amp systems

Speco Div. Components Specialties

PO Box 624
Lindenhurst, NY 11757
(516) 957-8700, 800-645-5516, FAX# 516-956-9142
Pres.: Louis Keller, VP G. Mgr.: James Ganci, V.P. Sls: Mel Hulkower, Sls Mgr.: Eric Forman, Sls Expeditor: Bernice Zachman
Products: 25/70-volt amps

Spectra Sonics

3750 Airport Rd.
Ogden, UT 84405
(801) 392-7531
Pres./Owner: William Dillely, Eng./Sls: Gregory Dillely

Today's most intelligent sound system is the one you won't outgrow tomorrow.



FLEXIBLE.

Four integrated amps, four power amps, thirty-seven interchangeable plug-in modules, two in-wall amps, AM FM and SCA tuners, mixer, monitor panel and equalizer give you limitless system design and expansion capability. Adapting to changing needs is as easy as plugging any of Toa's remarkable modules into our 900 Series. It's fast, easy, smart.



THE 900 SERIES FROM TOA.

Legendary flexibility and reliability. And with 37 plug-in modules — it grows along with you. Smart today, even smarter tomorrow.



ACCOMMODATING.

Toa's been voted the #1 company to do business with — four years running. That's a partner you can grow with.

CONVENIENT.
Toa's plug-in modules mean installation and system expansion take minutes, not hours. Because they anticipate change, it's neither costly nor time consuming.

REVOLUTIONARY.

Introducing the F-01R Sonic Maximizer BBE module. It breaks a signal into three bands and conditions it to offset inherent short-comings in speakers and mic's ... without adding harmonics or noise. The result is the most "hearable" advance in clarity, depth and intelligibility since high fidelity itself. With Toa, you just plug it in.

UNFORGETTABLE.
Dedicated modules let you tailor sound character — unforgettable sound at a very smart price.

TRUSTWORTHY.
The Toa 900 Series is fantastically reliable. Indeed, it can make callbacks a thing of the past. Specify it. Install it. Forget it.



TOA ELECTRONICS, INC.
161 GATEWAY BLVD. SO SAN FRANCISCO, CA
94102 (415) 588-2538 FAX (415) 588-2349

TO LAST FOR CENTURIES

Centuries ago the Dutch built their windmills to help them with their fight against sea and water. Hundreds of them are still working today. With the same craftsmen and topquality materials, now they build HACOUSTIC amplifiers which are designed to give years of troublefree operation.

HACOUSTIC
 Sound & Communications of America
 3963 Magnolia Lane, Buford GA 30518
 telephone: (404) 945 - 3142 fax: (404) 945 - 6174

Circle 70 on Reader Res.

Stewart Electronics
 11460 Sunrise Gold, Ste. B
 Rancho Cordova, CA 95742
 (916) 635-3011, 800-367-7945, FAX# 916-635-1787
 Owner: Wade Stewart, Adm.: Michelle Horan
 Products: dual-channel, monitor amps

Sunn Musical Equipment
 1130 Columbia St.
 Brea, CA 92621
 (714) 990-0909, 800-854-6230, FAX# 714-990-3986
 Pres.: Bill Schultz, Dir. Mkt'g: Joe Green
 Products: dual-channel, mixer amps, monitor amps, portable

TEI Electronics
 PO Box 246
 Hialeah, FL 33011
 (305) 888-3980, 800-327-8811, FAX# 305-885-4950
 Pres.: Danny Alonso, VP: Mireya Muniz, Nat'l Sis Mgr.: Walter McNulty, Cust. Svce: John Tembras, Sis: Orlando Pineda, Sis: Jose Hurcades
 Products: 25/70-volt amps, zone-paging amps

TOA ELECTRONICS
 PO Box 2047
 S. San Francisco, CA 94080
 (415) 588-2538, 800-843-4750, in-state 800-in CA 800-632-2157, FAX# 415-588-3349
 Pres.: Yoshiro Ishida, Nat'l Sis Mgr/Comm. Pro.: Richard Krochmal, Nat'l Sis Mgr./Pro. Music & Ent.: Rick Kamlet, Nat'l Sis Mgr./Intercom: Al Burns

Tape-Athon
 13633 Crenshaw Blvd.
 Hawthorne, CA 90250
 (213) 676-6752, FAX# 213-676-9532
 Pres.: Leon "Lee" Tate, G. Mgr.: Robert Haller, Dir. Eng.: Bernard Sayers, Sis Mgr.: Rick Bottom, Mfg. Supervisor: E.W. Stokes
 Chuck Olson Assoc., WA, 206-271-5416
 Bencsik Assoc., FL, 800-342-0197
 Murphy & Cota, NC, SC, 404-875-2525
 ASR Enter., MD, VA, 301-893-0001
 Design Factors, SC, 213-676-6752
 Products: 25/70-volt amps, monitor amps, single-channel.

TARGET TECHNOLOGY
 PO Box 609
 Penn Valley, CA 95946
 (916) 639-2102
 Pres.: Peter Hughes, VP: Sherri Douglas
 Products: 25/70-volt amps, dual-channel, single-channel.

Times One Technology
 22937 Arlington Ave.
 Torrance, CA 90501(213) 325-5200, FAX# 714-554-0903
 G. Mgr.: Leo Young, CEO, Dir. Eng.: Brahm Segal
 App. Eng.: Chris Calnan, Sis: Tim Edwards

TELL YOUR SUPPLIERS YOU FOUND THEM IN THE BLUE BOOK

NEW McGOHAN WALL MOUNTED AMPS



Model	Watts
MSWM-103	10
MSWM-103L	10
MSWM-203	20
MSWM-203L	20
MSWM-403	40
MSWM-403L	40

All amplifiers feature three mixer inputs with separate bass & treble controls and have outputs of 8 ohm, 25 volts or 70 volts. Other features include circuit breaker protection, music muting, a switched convenience outlet, and screwdriver adjustable controls with covers provided to prevent tampering once desired settings are made.

The MSWM series have provisions on the page input for either balanced microphone or telephone paging.

The MSWM-L series is identical in features to the MSWM series with the exception that the page input is designed for telephone paging only.

McGohan Electronics, Inc.
 1033 Fairway Drive Bensenville, IL 60106
 Phone; 1-312-595-2342



Circle 35 on Reader Response Card

UREI

PO Box 2200
Northridge, CA 91329
(818) 893-8411, FAX# 818-893-3639
Pres.: Ronald Means, VP Sls: Ken Lopez, VP Mkt'g:
Mark Gander, Mkt'g Mgr.: Hector Martinez, Mkt'g Mgr.:
Steve Romeo
Jim Chase, Hermosa Beach, Ca, 213-374-2128
Bill Hamilton, Folsom, PA, 215-543-4677
Bill Schuermann, St. Louis, MO, 314-644-2083
Tom Walter, N. Barrington, IL, 312-382-4925
Products: 25/70-volt amps, dual-channel, low-freq. amps,
monitor amps, portable, signal processing amps

US Audio

PO Box 1075
Rochester, NY 14603
(716) 663-8820, 800-733-9473, FAX# 716-865-
8930
Pres.: Michael Laiacona, VP: Bonnie Gardner

Van Etten Audio Labs

P.O. Drawer 667
Shelby, NC 28151-0667
(704) 434-9365
Pres.: David Cantrell



VIBRATION TECHNOLOGY

1950 Ellesmere Rd., Unit #12
Scarborough, ONT, Canada M1H 2V8
(416) 438-9320, FAX# 416-439-1937
Pres.: Adrian Ball, VP: Harry Gandhi
Products: 25/70-volt amps, bi-amp systems, dual-channel,
low-freq. amps, mixer amps, modular amps, monitor amps,
portable, signal processing amps, single-channel, telephone
paging amps, tri-amp systems, zone-paging amps

Wheelock

273 Branchport Ave.
Long Branch, NJ 07740
(201) 222-6880, 800-631-2148, FAX# 201-222-
8707
Pres.: P.W. Tarlton, VP Mkt'g: W.L. Goldstein, VP
Eng.: S.W. Andrews, Mkt'g Mgr./Tel-Paging: A. Arian,
Mkt'g Mgr./Life Safe.-Ind.: R. Haus
Products: 25/70-volt amps, telephone paging amps, zone-
paging amps

Yamaha Music Corp. of America/Prof.

Audio Div.
PO Box 6600
Buena Park, CA 90662
(714) 522-9011, FAX# 714-522-9312
Products: 25/70-volt amps, bi-amp systems, dual-channel,
mixer amps, monitor amps, signal processing amps

YOU ARE ABOUT TO BE SEDUCED BY POWER AND MONEY



PHYSICAL ATTRIBUTES

1100A/500 WATTS PER CH AT 8 OHMS
775 WATTS PER CH AT 4 OHMS
1,050 WATTS PER CH AT 2 OHMS
SUGGESTED RETAIL \$1,199.00

900A/325 WATTS PER CH AT 8 OHMS
525 WATTS PER CH AT 4 OHMS
725 WATTS PER CH AT 2 OHMS
SUGGESTED RETAIL \$999.00

CONTACT AB INTERNATIONAL FOR FULL FEATURES AND DEALER INFORMATION



AB INTERNATIONAL ELECTRONICS, INC.

1830-6 Vernon Street, P.O. Box 1105
Roseville, CA 95678
(916) 783-7800 (So. Cal: 714/951-7435)

Circle 40 on Reader Response Card

IT'LL COST YOU \$560* TO READ THIS AD.

When you hear about our four input by four output mixer/buffer amplifier, you'll definitely want to buy one. Or maybe a dozen.

Internal jumper blocks let you assign any of four inputs to any or all of the four outputs.

Channels can be mixed before or after ± 15 dB of gain adjustment.

And the Oxmoor 4x4 delivers +24dBm levels on balanced XLR connectors.

Write or call us at (205) 942-6779. And we'll tell you where to send the money. *SUGGESTED PRO USER NET.



THE OXMOOR 4X4 BUFFER AMPLIFIER

Oxmoor Corporation, 237 Oxmoor Circle, Birmingham, AL 35209

TELL YOUR
SUPPLIERS
YOU FOUND THEM
IN THE
BLUE BOOK

World Radio **Circle 42** on Reader Response Card

AUDIO-VISUAL PRODUCTS/CONTROL SYSTEMS

AUDIO-VISUAL EQUIPMENT/SYSTEMS

AIPHONE INTERCOM SYSTEMS;

PO Box 90075
Bellevue, WA 98009
(206) 455-0510, 800-692-0200, FAX# 206-455-0071
Pres.: Jun Matsumoto, Sls Mgr.: Jim Morrison,
Mkt'g/Adv. Mgr.: Harry Quanz
Aiphone NE, Randolph, NJ, 201-328-1790
Aiphone Midwest, Westmont, IL, 312-323-5222
Aiphone SE, Douglasville, GA, 404-920-2811
Products: intercom

Anchor Audio

913 West 223rd St.
Torrance, CA 90502
(213) 533-5984, 800-262-4671, FAX# 213-533-6050
Pres.: Jim Van Waay, VP Mkt'g: Jon Peirson, Reg. Sls
Mgr.: Maggie Keleher, Reg. Sls Mgr.: Brad Carrl, Cust.
Svce: Brian Van Waay, Svce Dept.: David Halperson

ARGOS PRODUCTS

600 S. Sycamore St.
Genoa, IL 60135
(815) 784-5118
Pres.: Donald MacLaughlin, Sls/V.P.: Ron Evers,
Credit Mgr.: Rosella Johnson, Chief Eng.: Loren
Schrader, Purch. Agent: Ray Melton
Ted Firaneck Sls, Pontiac, MI, 313-373-9595
Nevco, Crestwood, MO, 314-843-7406
W.A. Hendrickson, N. Scituate, MA, 617-545-0652
Maish Sls, Mulberry, IN, 317-296-2322
TMC Sls, Ft. Lee, NJ, 201-944-8340
Shamrock Sls, Dayton, OH, 513-258-1227
Pacnor Mkt'g, Lynwood, WA, 206-771-6016
Murphy & Cota, Atlanta, GA, 404-875-2525
Mel Foster Tech. Sls, Edina, MN, 612-941-9800
Bencsik Assoc., Ocala, FL, 904-732-9775
Stinson Assoc., Havertown, PA, 215-446-8585
Lewis & Dunnigan, Syracuse, NY, 315-446-5522
Arch Hoyne, Arlington Heights, IL, 312-398-1681
Wes Tech Mkt'g, Culver City, CA, 213-837-1398
Meyer & Ross, Burlingame, CA, 415-348-6800
Products: lectures

ATLAS/SOUNDOLIER

1859 Intertech Dr.
Fenton, MO 63026
(314) 349-3110, 800-876-7337, FAX# 314-349-1251
VP/GM: Pete Marsac, VP/Mkt'g: Herbert Jaffe, W.
Reg./Sls Mgr.: Bud Waters, W. Reg./Ass. Sls Mgr.: Jim
Edwards, E. Reg./Ass. Sls Mgr.: Walter Best, Order
Entry Dept. Mgr.: Dale McIntyre
Atlas/Soundolier, Parsippany, NJ, 201-887-7800

Atlas Electronics, Toronto, Canada, 416-789-7761
Atlas/Ind'l, Fenton, MO, 800-362-5673
Atlas/Exp. Dept., Fenton, MO, 314-349-3110

Audisar

PO Box 1561
Bellevue, WA 98009
(206) 454-2040, 868-5217
Owner: Robert Munger
Products: A/V speakers, audio for A/V
, boardroom sound systems, closed-loop audio systems, in-
terface units

Auditel Systems

396 Porter Ave.
Buffalo, NY 14201
(716) 886-0019, FAX# 716-886-1615
Pres.: David Langtry, Prod. Mgr.: Tony Roberson,
Mkt'g Dir.: Jim Wood
Products: audio for A/V
, boardroom sound systems, closed-loop audio systems,
computer control, electronic displays, intercom, interface
units, multi-media controls

Avtec Industries

5 Audrey Place
Fairfield, NJ 07006
(201) 882-9460, FAX# 201-882-9468
VP Sls/Mkt'g: Gary McAuliffe

Bogen Communications

PO Box 575
Ramsey, NJ 07446
(201) 934-8500, FAX# 201-934-9832
Pres.: John Ochtera, VP Sls/Mkt'g: James Orr, Nat'l
Sls Dir.: David Chambers

BOSE—PROFESSIONAL PRODUCTS

The Mountain
Framingham, MA 01701
(508) 879-7330, FAX# 508-872-6541
G. Mgr.: David Bell, Nat'l Field Sls Mgr.: Timothy
Dorwart, E. Reg. Mgr.: Robin Sibucuo, W. Reg Rep:
Michael Schneider
Products: interface units

Bretford Mfg.

9715 Soreng Ave.
Schiller Park, IL 60176
(312) 678-2545, FAX# 312-678-0852
Pres.: Edward Petrick, VP: David Petrick, Dir. Sales:
Robert Redding

Califone Int'l

21300 Superior St.
Chatsworth, CA 91311
(818) 407-2438, 800-722-0500, in-state 800-682-
5300, FAX# 818-407-2405
Pres.: Michael Custer, VP Sls/Mkt'g: Chuck Stone,
Mkt'g Mgr.: Loretta Blinn
Califone Industries, Vancouver B.C., Canada, 604-254-
5148

Communications Co.

3490 Noell St.
San Diego, CA 92110
(619) 297-3261, FAX# 619-297-3279
P: Peter Jordan, Exec. VP: Michael Jordan, Eng./Mfg.:
David Johnson, Orders: Bobby Willis, Orders: Laura
McCullough, Shipping: Ritchie Willis,
Audio Mkg Assoc., Brecksville, OH, 216-526-2426
Bencsik Assoc., Ocala, FL, 904-732-9775
Secom Systems, Dorville, GA, 800-241-9409
Brian Trankle & Assoc., Belmont, CA, 415-595-4004
Western Audio Sls, Glendale, CA, 818-246-3806
Products: intercom

Community Light & Sound

333 E 5th St.
Chester, PA 19013
(215) 876-3400, 800-523-4934, FAX# 215-874-
0190
Pres.: Bruce Howze, VP Eng.: John Wiggins, VP Exp.
Sls: Christine Howze, Nat'l Field Sls Mgr.: Chris Berger
Cordial-Riley Mkt'g, Sterling Heights, MI, 313-826-8980
Mel Foster Tech. Sls, Edina, MN, 612-941-9800
Rob Welles, San Francisco, CA, 415-334-4477
Pacific Audio Group, Torrance, CA, 213-719-1383
New Resource, Norwell, MA, 617-659-1463
Sigmat, Freehold, NJ, 201-462-1221
Audio Mkt'g Assoc., Breckville, OH, 216-526-2426
Powerline Mkt'g, Evanston, IL, 312-864-1147
Evans Sls & Mkt'g, Nashville, TN, 615-297-7997
Bencsik Assoc., Ocala, FL, 904-732-9775
R.J. Throckmorton Sls, Ballwin, MO, 314-227-7222
Rep Tech, Terrell, TX, 214-222-2131
Pearson & Pearson, Denver, CO, 303-722-6996
Victor Corp., Seattle, WA, 206-322-4343
Products: A/V speakers

Cornell Electronics Products

PO Box 23411
Milwaukee, WI 53223
(414) 351-4660, 800-541-946, FAX# 414-351-
4657
Pres.: Donald Glaubitz, VP: Gary Butler, Sls Mgr.:
Pauline Haack, Mkt'g: Randy Archer, SE Reg Sls Mgr.:
William Ellinger, Controller: Thelma Plunkett

Shamrock Electronic Sls, Dayton, OH, 513-258-1227
 LSM Assoc., Phelps, NY, 315-548-4891
 W.A. Hendrickson, North Scituate, MA, 617-545-0652
 Kingston Sls, Indianapolis, IN, 317-876-2545
 Avcom, North Olmsted, OH, 216-777-2060
 Richard S. Pass Assoc., Langhorne, PA, 215-757-6100
 R & S Sls, Rockville Centre, NY, 516-678-6887
 Cavendish & Winchester, Atlanta, GA, 404-422-4531
 Cartwright & Bean, Orlando, FL, 407-422-4531
 Kodo Assoc., Minneapolis, MN, 612-881-1255
 Vector, Seattle, WA, 206-322-4343
 Rancilio Assoc., St. Louis, MO, 314-845-0202
 Dick Bellew Sls, Dallas, TX, 214-644-7881
 Bidwell-Schwartz Assoc., Gardena, CA, 213-770-0300
 Yocum Mkt'g., Mesa, AZ, 834-3334
 Awrest, Fountain Hills, AZ, 602-946-1811
Products: electronic displays

J.W. DAVIS & CO.
 PO Box 26177
 Dallas, TX 75226
 (214) 651-7341, 800-527-5705, in-state 800-in TX
 800-442-1564, FAX# 214-939-0328
Pres.: Charles Griffith, VP Sls: Jack Tucker
Products: AV speakers, audio for AV
 , boardroom sound systems, intercom

Broadcasting: W.D. McGregor, VP Finance: J.R. Gingerich, Dir. Human Res.: J.R. Boehmer
 Electrohome USA, Ontario, CA, 714-983-5660
Products: image projectors

DUKANE
 2900 Dukane Dr.
 St. Charles, IL 60174
 (312) 584-2300, FAX# 312-584-2370
Pres./CEO: J. McWilliams Stone Jr., Group VP: William Finnegan, Div. G. Mgr.: Steven Deppe, Nat'l Sls Mgr.: Warren Anderson, Svce Mgr.: Cliff Carlson
 Wally Smutts, Toronto-Ont, Canada, 312-584-2300
 Doug Fellabaum, Sycamore, IL, 815-895-7573
 Don Mourizen, Beecher, IL, 312-946-9655
 Ken Lind, St. Charles, IL, 312-584-2300
 Pete Kendal, Jacksonville, FL, 904-262-6025
 Ed Nuhning, Portland, OR, 503-244-4262
 Jim Lacey, Moreno Valley, CA, 714-243-1160
 Jack Brown, Dallas, TX, 214-943-7528

FSR
 220 Little Falls Rd.
 Cedar Grove, NJ 07009
 (201) 239-0988, 800-332-FSR-1, FAX# 201-239-7708
Pres.: William Fitzsimmons, VP: Janice Sandri, Eng. Mgr.: Joseph Fischer, Proj. Mgr.: John Macaluso, Metal Shop Mgr.: Joseph Amico, Inside Sls: Marilyn Cullen
Design Factors, Hacienda Heights, CA, 213-697-7576
 Sigmat, Freehold, NJ, 201-462-1221
 Richard Pass Assoc., Langhorne, PA, 215-757-6100
 Peregrine SW, Houston, TX, 713-589-8481
 Henry Phillips, Roswell, GA, 404-992-3070
 Piper Assoc., Needham, MA, 617-449-1144
 Brian Trankle & Assoc., Belmont, CA, 415-595-4004
 Ziskind Assoc., Rolling Meadows, IL, 312-577-1624
 Meyer Mkt'g, Deerfield Beach, FL, 305-481-9250
 Awrest, Fountain Hills, AZ, 602-946-1811
 Burcaw, Warren, MI, 313-573-4605
Products: multi-media controls, wireless control

D.O. Industries
 317 East Chestnut St.
 E. Rochester, NY 14445
 (716) 385-4920

Da-Lite Screen
 PO Box 137
 Warsaw, IN 46580
 (219) 267-8101, FAX# 219-267-7804
Pres.: Richard Lundin, VP Controller: Joe Gere, Dir. Mkt'g: Bruce McCullough, Dir. Sls: Judy Loughran

Electrohome
 809 Wellington St. N.
 Kitchener, Ontario, Canada N2G 4J6
 (519) 744-7111, FAX# 519-749-3131
Chairman/CEO/Pres.: J.R. Pollock, VP Electronics: W.M. Nobbs, VP Motors: K.G. Hansen, VP

FOSTEX CORP. OF AMERICA
 15431 Blackburn Ave.
 Norwalk, CA 90650
 (213) 921-1112, FAX# 213-802-1964
Exec. VP: Fred Huang, VP Sls/Mkt'g: Mark Cohen
Products: AV speakers

MODEL VA-16
1-in/16-out Video/Audio Distribution System



Size 10"x12"x5" Deep
 "Halliburton" Alum Case
 Wt 8 lbs Price \$750

DESCRIPTION—
 The Model VA-16 1-in 16-out Video Audio Distribution System is useful as a network feed for courtroom or as a classroom feed for up to 16 monitors and audio amplifiers

SPECIFICATIONS—

VIDEO BNC Connectors
 DC to 8 MHz (-1db)
 Diff Gain 0.1%
 Diff Phase 0.2 deg
 Tilt & Overshoot < 1%
 Hum & Noise -60db
 Isolation -40db at 3.58 MHz
 R: 75 Ohms
 L: 75 Ohms
 Unity Gain
 In-Phase

AUDIO XL-Type Connectors
 Bal-in (10K), Bal-out (600 Ohms)
 30 HZ to 15 KHZ (-1db)
 Output Level +18 dbm
 THD 0.05%
 Signal Noise >70db

MODEL A-24/2ML
2-in/24-out (mic/line) Audio Press Box



Size 13"x18"x6" Deep
 "Halliburton" Alum Case
 Wt 16 lbs Price \$950

DESCRIPTION—
 The Model A-24/2ML Audio Press Box is a high quality transformer isolated versatile unit for conferences meetings courtroom, auditoriums, etc. it is a portable unit mounted in a Halliburton aluminum case

SPECIFICATIONS—

INPUTS
 Two Balanced microphone (switchable to line inputs at 10K ohms)
 Gain controls
 Vu Meter

OUTPUTS-24 SEPARATE OUTPUTS EACH ONE
 Transformer isolated
 "XLR" PhoneJack RCA and 3.5mm Jack
 Mic/Line Switch
 +18 dbm Output capability
 Ground Floating (Does not require ground lift)
 50HZ-15KHZ (-2db)
 50 db Channel isolation

POWER
 105-125V 50-60 HZ 5 Watts



COVER PLATES INCLUDED

Size 14"H x 19"W x 6"D
 Wt 5 lbs

MODEL V-44
4-Channel Video Dist. Amplifier

DESCRIPTION
 The Model V-44 Video Distribution Amplifier consists of a Model 512 Power Supply 4 Model 404 Video Distribution Amplifiers mounted on a Model H-5 V Panel Chassis. The back panel has a loop-thru BNC input connection and 4 output BNC connectors for each of the 4 channels

SPECIFICATION (per channel)
 DC to 8 MC (-1db)
 DC to 4.2 MC (-1db)
 Diff Gain 0.1%
 Diff Phase 0.2 deg
 Tilt & Overshoot < 1%
 Hum & Noise -60 db
 Isolation -40 db at 3.58 MC

PRICE: \$400

MODEL A-44
4-Channel Audio Dist. Amplifier

DESCRIPTION
 The Model A-44 Audio Distribution Amplifier consists of a Model 520 Power Supply 4 Model 422B Audio Distribution Amplifiers mounted on a Model H-5 A Panel Chassis. The back panel has four 12-terminal barrier stripe for input-outputs. There is one electronic balanced input and four balanced outputs for each of the 4-channels

SPECIFICATION (per channel)
 Bal (Electronic) Input Imp 20K Ohms
 Freq Resp 20CY to 20KC (-1db)
 Gain Unity (0 dbm) THD 0.05%
 Output Imp (600Ω) for 600Ω load
 Output Level +24 dbm

PRICE: \$440



OPAMP LABS INC.
 1033 N. SYCAMORE AVENUE
 LOS ANGELES, CA 90038
 (213) 934-3566

MANUFACTURERS OF AMPLIFIERS (MIC, MAG, PHONO, LINE, POWER, VIDEO, RGB)-OSCILLATORS-AUDIO TRANSFORMERS -POWER SUPPLIES-AUDIO/VIDEO ROUTING SWITCHERS-AUDIO CONSOLES-AUDIO MATRICES

FREE CATALOG WITH OVER 80 APPLICATIONS

Circle 288 on Reader Response Card

54 AUDIO-VISUAL EQUIPMENT/SYSTEMS

GBE Group

PO Box 118
Fair Oaks, CA 95628
(916) 967-5946

Pres.: Robert Bird, VP: George Anderson

Gemco Electronics

PO Box 993
Gallatin, TN 37066
(615) 452-5960, FAX# 615-451-0026

Pres.: Jerry Graves, Sls Mgr.: Byron Graves

Gentner Electronics

PO Box 27647
Salt Lake City, UT 84127
(801) 975-7200, FAX# 801-977-0087

Pres./CEO: Russell Gentner, COO: William Trowbridge, VP Eng.: William Gillman, Dir. Mkt'g/Sls-Bus.: Elaine Jones, Dir. Mkt'g/Sls-Audio/Best: Gary Crowder, Mkt'g Coord.: Kelli Maag
Products: interface units

Graham-Patten Systems

PO Box 1960
Grass Valley, CA 95945
(916) 273-8412, 800-547-2489, FAX# 916-273-7458

R.A. Gray

529 Hahn Ave.
Glendale, CA 91203
(818) 500-9698, FAX# 818-500-9628

Hudson Photographic Industries

Irvington-On-Hudson
, NY 10533
(914) 591-8700

IED Innovative Electronic Designs

9701 Taylorsville Rd.
Louisville, KY 40299
(502) 267-7436, FAX# 502-267-9070
VP Mkt'g & Sls: Tom Roseberry, Mkt'g Asst.: Robin Lasley, Sls App. Eng.: Jeff White, Mkt'g Adm.: Wanda R. Martin, VP Eng.: Ed Young, Pres.: Hardy Martin Repworks, Chocopee, MA, 413-533-0845
Darmstedter Assoc., Baldwinsville, NY, 315-638-1261
John Anthony., Stamford, CT, 203-322-9202
Sigmet, Valley Forge, PA, 215-783-6666
Secom Systems, Atlanta, GA, 404-455-0672
Bencsik Assoc., Ocala, FL, 904-732-9775
C.L. Pugh, Cleveland, OH, 216-238-1777
Monford Electronics Mkt'g., Indianapolis, IN, 317-872-8877
C.M. Sls, Farmington Hills, MI, 313-553-8070
Ludwig Mkt'g., Kenosha, WI, 414-697-9355
B.C. Electronic Sls, Mission, KS, 913-262-1720
Mkt'g Concepts, Irving, TX, 214-869-0669
Yora, White Bear Lake, MN, 612-770-9760
Torbett/Keiser Group, Loveland, CO, 303-669-1008
Derek Allen Assoc., Toluca Lake, CA, 818-840-8327
Plus Four Mkt'g, Walnut Creek, CA, 415-937-0650
North Shore Mkt'g, Seattle, WA, 206-284-9699
Island Instruments, Kaneohe, HI, 808-235-7544
Products: boardroom sound systems, computer control

JBL PROFESSIONAL

PO Box 2200
Northridge, CA 91329
(818) 893-8411, FAX# 818-893-3639
Pres.: Ronald Means, VP Sls: Ken Lopez, VP Mkt'g:

Mark Gander, Mkt'g Mgr.: Hector Martinez, Mkt'g Mgr.:

Steve Romeo
Jim Chase, Hermosa Beach, CA, 213-374-2128
Bill Hamilton, Folsom, PA, 215-543-4677
Bill Schuermann, St. Louis, MO, 314-644-2083
Tom Walter, N. Barrington, IL, 312-382-4925

Lectrosonics

PO Box 15900
Rio Rancho, NM 87174
(505) 892-4501, 800-821-1121, FAX# 505-892-6243
Pres.: John Arasim, VP MKT'g: Bruce Jones

LEE DAN COMMUNICATIONS

155 Adams Ave.
Hauppauge, NY 11788-3699
(516) 231-1414, 800-533-3261, in-state 800-231-1414, FAX# 516-231-1498
Pres.: Leon Goldberg, VP Op.: Lawrence Goldberg, VP Finance/Admin.: David Goldberg, Sr. Sls Associate: Susan Leon, Office Mgr.: Rita Kaplan, Sr. Tech.: Sandy Hoffman
Products: intercom, lectures

Mag-Tags

2531 W. Tharpe
Tallahassee, FL 32303
(904) 386-5611, FAX# 904-385-5710
Owner: Alan Pippenger, CEO: Carolyn Pippenger
Products: supplies

MATH ASSOCIATES

2200 Shames Dr.
Westbury, NY 11590
(516) 334-6800, FAX# 516-334-6473
Pres.: Ellen Math, CEO/Dir. R & D: Irwin Math, Exec. VP: Howard Oboler, Exec. VP: Martin Rein
Products: intercom, interface units

Nasca System

103 W. Broad St.
Falls Church, VA 22046
(703) 237-0680, FAX# 703-237-1726
Products: image projectors

Niles Audio

12331 SW 130th St.
Miami, FL 33116
(305) 238-4373, FAX# 305-238-0185
Pres.: Ivan Zuckerman

Omni Q

1122 Fur Ave., Bldg. A
Blaine, WA 98230
(206) 384-1750

Opamp Labs

1033 N. Sycamore Ave.
Los Angeles, CA 90038
(213) 934-3566, FAX# 213-464-0977
Mgr.: B. Losmandy

P/H Electronics

117 E. Helena St.
Dayton, OH 45404
(513) 461-5898, 800-336-2219
Sls Coord.: Donna Martin

Panasonic/Ramsa

6550 Katella Ave.
Cypress, CA 90630
(714) 373-7277, FAX# 714-373-7242
Sls/Mkt'g Mgr.: Steve Wooley, Mkt'g Mgr.: Chris Foreman, W. Sls Mgr.: James Murray, Central Sls Mgr.: Greg Braithwaite, Telemkt'g Mgr.: Carla Campbell
James Murray, Cypress, CA, 714-373-7389
Greg Braithwaite, Arlington Heights, IL, 312-981-7329
Pusecker Sls, Upper Montclair, NJ, 201-744-1834
David Bros., Finksburg, MD, 301-833-0920
Pro Audio Assoc., Burlington, MA, 617-229-6050
World Wide Electronics, Pembroke Pines, FL, 305-584-7024
Evans Sls & Mkt'g, Nashville, TN, 615-297-7997
New Horizons, Bannockburn, IL, 312-234-6500
Laker Assoc., Wauzata, MN, 612-475-2642
A/V Mkt'g, Carmel, IN, 317-846-1034
Innovative Audio, Pontiac, MI, 313-673-2280
J.B. Parent, Dublin, OH, 614-764-0064
Essential Mkt'g, St. Joseph, MO, 816-279-0776
Teneckit Assoc., Houston, TX, 713-528-2005
New West Audio, Burbank, CA, 818-955-9700
Brian Trankle Assoc., Belmont, CA, 415-595-4004
Northmar, Seattle, WA, 206-524-5170
Pearson & Pearson, Denver, CO, 303-722-6996
Products: A/V speakers, audio for A/V

Protech Audio

Flowerfield, Bldg. #1
St. James, NY 11780
(516) 584-5855, FAX# 516-584-5904
Sls Mgr.: Bill Murphy, VP Eng.: Joseph Giambone
Peregrine SW Reps, Houston, TX, 713-589-8481
Products: audio for A/V, boardroom sound systems

PROTO-TEC

108 Fairlane Dr.
Joliet, IL 60435
(815) 744-7173
Products: lectures, supplies

Sharp Electronics/Prof. Products Div.

PO Box 650
Mahwah, NJ 07430-2135
(201) 529-8731, FAX# 201-529-9636
Pres.: S. Hirooka, G. Mgr.: Robert Garbutt, Sls Mgr.: Ron Colgan, Mkt'g Mgr.: Bruce Pollack, Prod. Eng. Mgr.: Peter Gloeggler, Svce Mgr.: Jeff Cohen

SHURE BROTHERS

222 Hartrey Ave.
Evanston, IL 60202-3696
(312) 866-2200, FAX# 312-866-2279
Pres.: James Kogen, VP Sls: Lottie Morgan, Dir. Tech. Mkt'g: John Phelan, Dir. Wired Mics: Alan Shirley, Dir. Wireless Mics: Sandy Schroeder, Dir. Sls: Al Hershner
Products: A/V speakers, audio for A/V, boardroom sound systems

Sony Professional Audio

1600 Queen Anne Rd.
Teaneck, NJ 07666
(201) 833-5200, 800-635-SONY, FAX# 201-833-9645
Nat'l Sls Mgr.: Bob Ott, Prod. Mgr.: Art Gonzales, Mkt'g

Want to stay on top of this aggressively competitive industry?

*Read Sound & Communications'
Special Features*

Every April, our *Contracting Business In-Depth Market Report*
tells you what's happening now and what's on the horizon for the
sound & communications market.



December we bring you our *Economic Report*,
keeping you aware of economic trends and
developments on their effect on this industry.



Every August is *Blue Book* month,
this industry's only complete directory of manufacturers,
their products and key personnel.



Special pull-out sections —
on everything from mixing consoles to alarm and security devices — that
provide the sound contractor with the concise and definitive information
needed for intelligent and informed product selection.



***Look for these special features and
more in upcoming issues of
Sound & Communications.***

FSR inc.

LEADERS IN:

- Hotel Ballroom Combining Systems
- Digital Boardroom Control Systems
- Teleconferencing Equipment
- Remote Control Modules For All Audio Visual Equipment
- Deluxe Conference Room Floor Boxes
- Custom Panels
- Custom Engineering
- Audio & Video Switching Units
- Infrared Control Equipment

FSR inc.

creators of innovative
products for AV systems

220 Little Falls Road
Cedar Grove, NJ 07009
201/783-3966 ■ 201/239-0988

Circle 39 on Reader Response Card

Mgr.: David Kawakami
Sony Pro Audio, Paramus, NJ, 201-368-5185
Sony Pro Audio, Nashville, TN, 615-883-8140
Sony Pro Audio, Burbank, CA, 818-841-8711

Sound Control Technologies

114A Washington St.
Norwalk, CT 06854
(203) 854-5701, FAX# 203-854-5703

Pres.: Adolph Neaderland, Sls: David Neaderland
Powerlines Mkt'g, Chicago, IL, 312-864-1147
Franklin Comm., Philadelphia, PA, 215-643-3031
KBZ Comm.s, NY Metro, 215-348-9481
Total Mkt'g, Fort Worth, TX, 817-560-3970
Meyer Mkt'g, Deerfield Beach, FL, 305-481-9250
Visitec Mkt'g, Minneapolis, MN, 612-925-2691
Products: boardroom sound systems

Sound Craft Systems

Rte 3, Box 319
Morrilton, AR 72110-9532
(501) 727-5476, 800-643-8747, FAX# 501-727-5402

Sls Mgr.: Hank Shaw, Pres.: Earle Love
Products: lecturns

Speco Div. Components Specialties

PO Box 624
Lindenhurst, NY 11757
(516) 957-8700, 800-645-5516, FAX# 516-956-9142

Pres.: Louis Keller, VP G. Mgr.: James Ganci, V.P. Sls:
Mel Hulkower, Sls Mgr.: Eric Forman, Sls Expeditor:
Bernice Zachman

Stewart Filmscreen

1161 Sepulveda Blvd.
Torrance, CA 90502
(213) 326-1422, 800-762-4999, FAX# 213-326-6870

Exec. VP: Don Stewart, Sls Eng.: Frank Freeman, Sls
Eng.: Steve Goss
Products: screens

TOA ELECTRONICS

PO Box 2047
S. San Francisco, CA 94080
(415) 588-2538, 800-843-4750, in-state 800-in CA
800-632-2157, FAX# 415-588-3349

Pres.: Yoshiro Ishida, Nat'l Sls Mgr./Comm. Pro.:
Richard Krochmal, Nat'l Sls Mgr./Pro. Music & Ent.:
Rick Kamlet, Nat'l Sls Mgr./Intercom: Al Burns
Products: AV speakers, audio for AV

TARGET TECHNOLOGY

PO Box 609
Penn Valley, CA 95946
(916) 639-2102

Pres.: Peter Hughes, VP: Sherri Douglas
Products: audio for AV

Technical Acoustics

8933 Western Way, Ste. 20
Jacksonville, FL 32256
(904) 363-0833, FAX# 904-363-0848

Pres.: Donald Bowers, VP: Sheldon Glick, Office Mgr.:
Maria Hammarlund
Robert Christopher Sls., Yonkers, NY, 904-237-0343

Marketline, Snellville, GA, 404-972-9048
Lex Lawson, Garland, TX, 214-272-8482
Loomis & Assoc., Fremont, CA, 415-797-3500
Products: boardroom sound systems

Telephone Components

3180 Expressway Dr. S.
Central Islip, NY 11722
(516) 582-4745

Products: intercom

Telex Communications

9600 Aldrich Ave. S.
Minneapolis, MN 55420
(612) 884-4051, FAX# 612-884-0043

Pres.: Jeffrey Wetherell, VP Mkt'g: James Arrington,
VP Sls: Dan Dantzler, Dir. Mkt'g: Dond Meeßen, Dir
Adv.: Ronald Taylor
WesTech/Lichtenauer, Culver City, CA, 213-870-9286
Bencsik Assoc., Ocala, FL, 904-732-9775
Burcaw & Assoc., Warren, MI, 313-573-4605
SAGA, Oswego, NY, 315-343-5739
Monfort Electronic Mkt'g, Indianapolis, IN, 317-872-8877
Murphy & Cota, Atlanta, GA, 404-875-2525
Northland Assoc., Moorhead, MN, 218-233-4616
Rancilio Assoc., St. Louis, MO, 314-845-0202
J.Y. Schoonmaker, Dallas, TX, 214-349-1650
Sigmat, Valley Forge, PA, 215-783-6666
Weller Electronic Sls, Worthington, OH, 614-885-7819
Ziskind Assoc., Rolling Meadows, IL, 312-577-1624
White Radio, Burlington-Ont., Canada, 416-632-6894
Silver Peak Mkt'g, Denver, CO, 303-467-9042
Pacnor Mkt'g, Lynnwood, WA, 206-771-6016
Products: audio for AV
, image projectors, intercom

Valcom

1111 Industry Ave.
Roanoke, VA 24013
(703) 982-3900, FAX# 703-983-7032
Mktg: Donald Buck, Cust. Svce.: Gordon Bailey

VanSan

16735 E. Johnson Dr.
City of Industry, CA 91745
(818) 961-7211, 800-423-1829, FAX# 818-369-9510
Pres.: Mark Vanlandingham, VP Sls: Chris Forbes, VP
Eng.: Ron Dain

Video Design Pro

749 Carver Rd.
Las Cruces, NM 88005
(505) 524-3921, FAX# 505-524-9669
Pres.: Dr. Walter Black

York Controls

1111 S. Sherman, Ste. 101
Richardson, TX 75081
(214) 234-2126, FAX# 214-234-2176
COO: Peter York, Pres.: Bruce Christianson, CFO:
Majors Harris, Sls Mgr.: Chris Monck, Mkt'g Mgr.: Paul
Seif, Dir. Eng.: Woody Pope
Milanese Assoc., Philadelphia, PA, 215-763-2138
B.L. Reps, Milwaukee, WI, 414-277-7600
Marketline, Atlanta, GA, 404-972-9048
D & B Mkt'g, Plano, TX, 214-423-3447
PMP Mkt'g, West Jordan, UT, 801-561-1968
Products: interface units, multi-media controls, wireless
control

REMOTE CONTROLS

AMX

12506 Forestgate Dr.
Dallas, TX 75243
(214) 644-3048, 800-222-0193, FAX# 214-907-2053
Pres.: Scott Miller, Mkt'g Mgr.: Chuck Cram, Sls Mgr.: Ken Sclater
Visitec Mkt'g, Elburn, IL, 312-584-9090
Franklin Comm., Maple Glen, PA, 215-643-3031
Total Mkt'g, Fort Worth, TX, 817-560-3970
Wes Tech Mkt'g, Culver City, CA, 213-870-9286
Jim Freeman Assoc., Lilburn, GA, 404-921-8687

Advantage

14270 NW Science Pk Dr.
Portland, OR 97229
(503) 641-7287, FAX# 503-622-0281

Audio Access

363-A Vintage Pk Dr.
Foster City, CA 94404
(415) 341-9620, FAX# 415-341-0168
Mkt'g: Chris Stevens
Products: AV

Audio Systems

PO Box 1174
Bismarck, ND 58502
(701) 223-3800, 800-852-6522, in-state 800-932-8975, FAX# 701-222-8102
Pres./Eng: Lynn Mader, VP/Sls: Lyle Mader
Products: audio level, custom, DTMF, hardwired, microprocessor

Auditel Systems

396 Porter Ave.
Buffalo, NY 14201
(716) 886-0019, FAX# 716-886-1615
Pres.: David Langtry, Prod. Mgr.: Tony Roberson,
Mkt'g Dir.: Jim Wood
Products: audio level, boardroom, custom, hardwired, microprocessor, remote monitoring

AUTOPATCH A/V SYSTEMS

PO Box 3002
Spokane, WA 99202
(509) 747-1246
VP Mkt'g: Dick Myers, VP Eng.: Jay Turkovsky

BSM Systems

PO Box 19007
Spokane, WA 99219
(509) 838-0110, FAX# 509-328-0510
Sls Mgr.: Marceen Zappone, Pres.: Bruce Morse

Crestron Electronics

101 Broadway
Cresskill, NJ 07626
(201) 894-0660, 800-237-2041, FAX# 201-894-1192
Sls Mgr.: George Herbert, Dealer Sls Dir.: Patricia Large
Products: A/V, boardroom, custom, hardwired, microprocessor, wireless

Crown Int'l

PO Box 1000
Elkhart, IN 46517
(219) 294-8000, FAX# 219-294-8329
Pres./CEO: Clyde Moore, Crown Div. Head: Gil Nichols, Amplifier Prod. Dir.: Verne Searer, Sls Mgr.: Jim Beattie, Mkt'g Svcs: Gerry Barclay, Mic. Prod. Line Mgr.: Bob Herold

FSR

220 Little Falls Rd.
Cedar Grove, NJ 07009
(201) 239-0988, 800-332-FSR-1, FAX# 201-239-7708
Pres.: William Fitzsimmons, VP: Janice Sandri, Eng. Mgr.: Joseph Fischer, Proj. Mgr.: John Macaluso, Metal Shop Mgr.: Joseph Amico, Inside Sls: Marilyn Cullen
Design Factors, Hacienda Heights, CA, 213-697-7576
Sigmat, Freehold, NJ, 201-462-1221
Richard Pass Assoc., Langhorne, PA, 215-757-6100
Peregrine SW, Houston, TX, 713-589-8481
Henry Phillips, Roswell, GA, 404-992-3070
Piper Assoc., Needham, MA, 617-449-1144
Brian Trankle & Assoc., Belmont, CA, 415-595-4004
Ziskind Assoc., Rolling Meadows, IL, 312-577-1624
Meyer Mkt'g, Deerfield Beach, FL, 305-481-9250
Awwest, Fountain Hills, AZ, 602-946-1811
Burcaw, Warren, MI, 313-573-4605
Products: AV, boardroom, custom, hardwired, microprocessor, video, wireless

Gentner Electronics

PO Box 27647
Salt Lake City, UT 84127
(801) 975-7200, FAX# 801-977-0087
Pres./CEO: Russell Gentner, COO: William Trowbridge, VP Eng.: William Gillman, Dir. Mkt'g/Sls-Bus.: Elaine Jones, Dir. Mkt'g/Sls-Audio/Best: Gary Crowder, Mkt'g Coord.: Kelli Maag
Products: remote monitoring

Gentner RF Products

PO Box 32550
San Jose, CA 95152
(408) 926-3400, FAX# 408-926-6699
Pres.: John Leonard Jr.

IED Innovative Electronic Designs

9701 Taylorsville Rd.
Louisville, KY 40299
(502) 267-7436, FAX# 502-267-9070
VP Mkt'g & Sls: Tom Roseberry, Mkt'g Asst.: Robin Lasley, Sls App. Eng.: Jeff White, Mkt'g Adm.: Wanda R. Martin, VP Eng.: Ed Young, Pres.: Hardy Martin
Repworks, Chicopee, MA, 413-533-0845
Darmstedter Assoc., Baldwinville, NY, 315-638-1261
John Anthony., Stamford, CT, 203-322-9202
Sigmat, Valley Forge, PA, 215-783-6666
Secom Systems, Atlanta, GA, 404-455-0672
Censik Assoc., Ocala, FL, 904-732-9775
C.L. Pugh, Cleveland, OH, 216-238-1777
Monford Electronics Mkt'g., Indianapolis, IN, 317-872-8877
C.M. Sls, Farmington Hills, MI, 313-553-8070
Ludwig Mkt'g., Kenosha, WI, 414-697-9355
B.C. Electronic Sls, Mission, KS, 913-262-1720

Mkt'g Concepts, Irving, TX, 214-869-0669
Yora, White Bear Lake, MN, 612-770-9760
Torbett/Keiser Group, Loveland, CO, 303-669-1008
Derek Allen Assoc., Toluca Lake, CA, 818-840-8327
Plus Four Mkt'g, Walnut Creek, CA, 415-937-0650
North Shore Mkt'g, Seattle, WA, 206-284-9699
Island Instruments, Kaneohe, HI, 808-235-7544
Products: audio level, boardroom, microprocessor, remote monitoring

Intelix

5618 Odana Rd.
Madison, WI 53719-1208
(608) 273-6333, FAX# 608-273-6336
G. Mgr.: Steven Cohan, Dir. R & D: Michael Konkle
Products: A/V, audio level, boardroom, custom, hardwired, microprocessor, remote monitoring

Monroe Electronics

100 HouseI Ave.
Lyndonville, NY 14098
(716) 765-2254, FAX# 716-765-9330
Dir. Mkt'g: Brian Ives, App. Eng.: Roland Phillips, Sls Rep.: Robert Caines

Moseley Assoc.

111 Castilian Dr.
Santa Barbara, CA 93117-3093
(805) 968-9621, FAX# 805-685-9638
Products: remote monitoring

Musically Intelligent Devices

3 Brian St.
Commack, NY 11725
(516) 864-1683

OXMOOR

237 Oxmoor Circle
Birmingham, AL 35209
(205) 942-6779, FAX# 205-942-9633
Nat'l Sls Mgr.: Richard Mitchell, Dir. Prod. Dev.: Joe Hanson, Prod. Mgr.: Jim Watson
ASR Enter., Lansdowne, PA, 215-259-8513
Dimension IX Mkt'g, Lewisville, TX, 214-436-3706
Evans Sls & Mkt'g, Nashville, TN, 615-297-7997
John Anthony, Stamford, CT, 212-585-2027
Yora, White Bear Lake, MN, 612-770-9760
Allwest Electronics, Camarillo, CA, 805-388-1789
Loomis & Assoc., Fremont, CA, 415-797-3500
Loppnow & Assoc., Issaquah, WA, 206-392-3936
World Wide Electronics, Pembroke Pines, FL, 305-584-7024
Repworks, Chicopee, MA, 413-533-0845
Products: audio level

Preh Electronic Industries

470 E. Main St.
Lake Zurich, IL 60047-2578
(312) 438-4000
Pres.: Marcel Didier
Products: A/V, custom, hardwired, wireless

Protech Audio

Flowerfield, Bldg. #1
St. James, NY 11780

(516) 584-5855, FAX# 516-584-5904

Sls Mgr.: Bill Murphy, VP Eng.: Joseph Giambone
Peregrine SW Reps, Houston, TX, 713-589-8481
Products: AV, audio level, boardroom, hardwired, remote monitoring

Sonance

32992 Calle Perfecto
San Juan Capistrano, CA 92675
(714) 661-7558, 800-582-7777, FAX# 714-240-4995

Pres.: Scott Struthers, VP: Geoff Spencer, Nat'l Sls Mgr.: Dave Donald, Asst. Nat'l Sls Mgr.: Caroline Kelly
Bach, New York, NY, 212-727-0404
Morris-Tait, N. Hollywood, CA, 213-877-4424
Tandem Mkt'g, Schaumburg, IL, 312-605-1960
Vestco, Merrit Island, FL, 407-454-9051
Balaton, Washington, DC, 202-471-1764
Products: audio level, hardwired

Sontec Electronics

Audio Dr.
Goldbond, VA 24094
(703) 626-7256

Sls Mgr.: Burgess Macneal
Products: audio level, EQ/remote

Sound Stream Technology

120 Blue Ravine Rd.
Folsom, CA 95630
(916) 351-1188, FAX# 916-351-0414
Products: AV

Teatronics/Lighting Innovations

3100 McMillan Rd.
San Luis Obispo, CA 93401
(805) 544-3555, 800-235-4107, FAX# 805-544-3703

Utah Scientific

1685 W. 2200 S.
Salt Lake City, UT 84119
(801) 973-6840, 800-453-8782, FAX# 801-973-0255

VP Sls/Mkt'g: Dave Spindle, Dir. Prod. Mgmt: Scott Bosen, NE Reg Sls Mgr.: Dan Antonellis, SE Reg Sls Mgr.: Eric King, Midwest Reg Sls Mgr.: Tom Harmon, SW Reg Sls Mgr.: Eloy Chairez

VICON INDUSTRIES

525 Broad Hollow Rd.
Melville, NY 11747-370
(516) 293-2200, 800-645-9116, FAX# 516-293-2627

CEO: Donald N. Horn, Exec. VP: Arthur Wallace, Sr. VP Mkt'gs: Ronald J. Teixeira, VP Dom. Sls: Donald D. Heckel, VP Int'l Sls: Richard P. Adam
US Reg. Office-W., Brea, CA, 714-990-3858
US Reg Office-S., Norcross, GA, 404-449-0499
Gov't Sls Office, Arlington, VA, 703-553-785-
European Hdqtrs, Hampshire, UK, 44-0705-665-3
Products: hardwired, microprocessor, video

Video Link, Div. of Xantech

12950 Bradley Ave.

Sylmar, CA 91342

(818) 362-0353, FAX# 818-362-9506
Pres.: Herb Seymour, Nat'l Sls Mgr.: David Lorsch, VP Op.: Jim Barthell, Sls Coord.: Leslie Pierce
Products: audio level, hardwired, video, wireless

Vidicraft

0704 SW Bancroft St.
Portland, OR 97201
(503) 223-4884, 800-547-1491, FAX# 503-243-1995
G. Mgr.: Steve Johnson, Nat'l Sls Mgr.: Dave Landis, Prod. Mgr.: Glenn Olson

Yamaha Music Corp. of America/Prof.

Audio Div.
PO Box 6600
Buena Park, CA 90662
(714) 522-9011, FAX# 714-522-9312
Products: EQ/remote

York Controls

1111 S. Sherman, Ste. 101
Richardson, TX 75081
(214) 234-2126, FAX# 214-234-2176
COO: Peter York, Pres.: Bruce Christianson, CFO: Majors Harris, Sls Mgr.: Chris Monck, Mkt'g Mgr.: Paul Seif, Dir. Eng.: Woody Pope
Milanese Assoc., Philadelphia, PA, 215-763-2138
B.L. Reps, Milwaukee, WI, 414-277-7600
Marketline, Atlanta, GA, 404-972-9048
D & B Mkt'g, Plano, TX, 214-423-3447
PMP Mkt'g, West Jordan, UT, 801-561-1968
Products: AV, audio level, boardroom, custom, hardwired, remote monitoring, video, wireless

EIGHT TIMES BETTER THAN REMOTE CONTROL.

1. Puts precise volume control anywhere without degrading audio signals.

2. LED's indicate attenuator level.

3. Knob has no mechanical stops so it can't be twisted off.

4. Remotes on the same control loop accurately track each other.

5. Can be unplugged or turned off without affecting levels.

6. Independent preset and priority controls.

7. 1.5 dB steps including a 90 dB off position.

8. Can be mounted in standard electrical boxes.

Actually, when the RC-16 is hooked up to our DCA-2 Digital Control Attenuator it's ten, maybe twelve times better. For the whole scoop, just give us a call. (205) 942-6779.

THE OXMOOR RC-16 REMOTE CONTROL

Oxmoor Corporation, 237 Oxmoor Circle, Birmingham AL 35209

Circle 41 on Reader Response Card

World Radio History

ATTENTION!

The editors of *Sound & Communications* are always looking for qualified contributors who'd like to write for us on a freelance basis. Contractors, consultants, manufacturers — if you are involved in the sound and communications industry and would like to write for the magazine bearing its name, please send an outline of your experience and particular interests to:

Managing Editor
Sound & Communications
25 Willowdale Avenue
Port Washington, NY 11050

TELECONFERENCING SYSTEMS

Ansett Technologies

7595 E. Gray Rd.
Scottsdale, AZ 85260
(602) 483-2956, FAX# 602-998-8805

Auditel Systems

396 Porter Ave.
Buffalo, NY 14201
(716) 886-0019, FAX# 716-886-1615
Pres.: David Langtry, Prod. Mgr.: Tony Roberson,
Mkt'g Dir.: Jim Wood
Products: automixing, manual

Bozak

326 South St.
New Britain, CT 06051-3721
(203) 225-0555
Pres.: Donald Bowers, Dir. Mkt'g: William Kietlyka,
Chief Eng.: Sheldon Glick

CMX

1111 Industry Ave.
Roanoke, VA 24013
(703) 982-3900, FAX# 408-986-0452
Mkt'g: Charlie Rowland
Products: telephone interface

Colorado Video

PO Box 928
Boulder, CO 80306
(303) 530-9580

Compression Labs

2860 Junction Ave.
San Jose, CA 95134
(408) 435-3000, 800-538-7542, FAX# 408-922-5429
Pres.: John Tyson, Exec. VP/Sls & Mkt'g: John Walsh,
VP Sls: Ted Augustine, VP Int'l Sls: Carl Marszewski,
VP Mkt'g: Kathy Reavis

DIS-USA

2831 15th St. NW
Washington, DC 20009
(202) 387-7934
Pres.: Jack Cassell, VP: Michael Bier

Eby Co.

2751 Southampton Rd.
Philadelphia, PA 19154
(215) 969-4200

FSR

220 Little Falls Rd.
Cedar Grove, NJ 07009
(201) 239-0988, 800-332-FSR-1, FAX# 201-239-7708
Pres.: William Fitzsimmons, VP: Janice Sandri, Eng. Mgr.: Joseph Fischer, Proj. Mgr.: John Macaluso, Metal Shop Mgr.: Joseph Amico, Inside Sls: Marilyn Cullen
Design Factors, Hacienda Heights, CA, 213-697-7576
Sigmat, Freehold, NJ, 201-462-1221
Richard Pass Assoc., Langhorne, PA, 215-757-6100
Peregrine SW, Houston, TX, 713-589-8481
Henry Phillips, Roswell, GA, 404-992-3070

Piper Assoc., Needham, MA, 617-449-1144
Brian Trankle & Assoc., Belmont, CA, 415-595-4004
Ziskind Assoc., Rolling Meadows, IL, 312-577-1624
Meyer Mkt'g, Deerfield Beach, FL, 305-481-9250
Avwest, Fountain Hills, AZ, 602-946-1811
Burcaw, Warren, MI, 313-573-4605
Products: telephone interface

Gentner Electronics

PO Box 27647
Salt Lake City, UT 84127
(801) 975-7200, FAX# 801-977-0087
Pres./CEO: Russell Gentner, COO: William Trowbridge, VP Eng.: William Gillman, Dir. Mkt'g/Sls: Elaine Jones, Dir. Mkt'g/Sls-Audio/Best: Gary Crowder, Mkt'g Coord.: Kelli Maag
Products: telephone interface

IED Innovative Electronic Designs

9701 Taylorsville Rd.
Louisville, KY 40299
(502) 267-7436, FAX# 502-267-9070
VP Mkt'g & Sls: Tom Roseberry, Mkt'g Asst.: Robin Lasley, Sls App. Eng.: Jeff White, Mkt'g Adm.: Wanda R. Martin, VP Eng.: Ed Young, Pres.: Hardy Martin Repworks, Chicopee, MA, 413-533-0845
Darmstedter Assoc., Baldwinsville, NY, 315-638-1261
John Anthony, Stamford, CT, 203-322-9202
Sigmat, Valley Forge, PA, 215-783-6666
Secom Systems, Atlanta, GA, 404-455-0672
Bencsik Assoc., Ocala, FL, 904-732-9775
C.L. Pugh, Cleveland, OH, 216-238-1777
Montford Electronics Mkt'g., Indianapolis, IN, 317-872-8877
C.M. Sls, Farmington Hills, MI, 313-553-8070
Ludwig Mkt'g., Kenosha, WI, 414-697-9355
B.C. Electronic Sls, Mission, KS, 913-262-1720
Mkt'g Concepts, Irving, TX, 214-869-0669
Yora, White Bear Lake, MN, 612-770-9760
Torbett/Keiser Group, Loveland, CO, 303-669-1008
Derek Allen Assoc., Toluca Lake, CA, 818-840-8327
Plus Four Mkt'g, Walnut Creek, CA, 415-937-0650
North Shore Mkt'g, Seattle, WA, 206-284-9699
Island Instruments, Kaneohe, HI, 808-235-7544
Products: automixing, microprocessor

Industrial Research Products

415 Busse Rd.
Elk Grove Village, IL 60007
(312) 439-3600, 800-255-6993, FAX# 312-640-9607
G. Mgr.: Brian Benn, Mkt'g Mgr.: Roger Carroll, Sr. Sls Eng.: Gayle Campbell, Chief Eng.: Dick Peters
Piper Assoc., Needham, MA, 617-449-1144
Sigmat, Freehold, NJ, 201-462-1221
Richard Pass Assoc., Langhorne, PA, 215-757-6100
Starin Mkt'g, Chesterton, IN, 219-929-4127
Bencsik Assoc., Ocala, FL, 904-732-9775
EESCO Systems, Los Angeles, CA, 213-666-9601

Microvoice

1 Vanderbilt
Irvine, CA 92718
(714) 859-1091, FAX# 714-951-7405
Pres.: Gregory Peacock, VP Sls: Mike Bugg

Protech Audio

Flowerfield, Bldg. #1
St. James, NY 11780
(516) 584-5855, FAX# 516-584-5904
Sls Mgr.: Bill Murphy, VP Eng.: Joseph Giambone
Peregrine SW Reps, Houston, TX, 713-589-8481

Products: microphone specific

SHURE BROTHERS

222 Hartrey Ave.
Evanston, IL 60202-3696
(312) 866-2200, FAX# 312-866-2279
Pres.: James Kogen, VP Sls: Lottie Morgan, Dir. Tech. Mkt'g: John Phelan, Dir. Wired Mics: Alan Shirley, Dir. Wireless Mics: Sandy Schroeder, Dir. Sls: Al Hershner
Products: automixing, microphone specific, telephone interface

Solid State Systems

1300 Shiloh Rd.
Kennesaw, GA 30144
(404) 423-2229, 800-962-0967, FAX# 404-423-2228

Sound Control Technologies

114A Washington St.
Norwalk, CT 06854
(203) 854-5701, FAX# 203-854-5703
Pres.: Adolph Neaderland, Sls: David Neaderland
Powerlines Mkt'g, Chicago, IL, 312-864-1147
Franklin Comm., Philadelphia, PA, 215-643-3031
KBZ Comm.s, NY Metro, 215-348-9481
Total Mkt'g, Fort Worth, TX, 817-560-3970
Meyer Mkt'g, Deerfield Beach, FL, 305-481-9250
Visitec Mkt'g, Minneapolis, MN, 612-925-2691

Studer Revox America

1425 Elm Hill Pike
Nashville, TN 37210
(615) 254-5651, FAX# 615-256-7619
Products: telephone interface

Technical Acoustics

8933 Western Way, Ste. 20
Jacksonville, FL 32256
(904) 363-0833, FAX# 904-363-0848
Pres.: Donald Bowers, VP: Sheldon Glick, Office Mgr.: Maria Hammarlund
Robert Christopher Sls., Yonkers, NY, 904-237-0343
Marketline, Snellville, GA, 404-972-9048
Lex Lawson, Garland, TX, 214-272-8482
Loomis & Assoc., Fremont, CA, 415-797-3500
Products: telephone interface

Teleconferencing Systems Int'l

925 Tonne Rd.
Elk Grove Village, IL 60007
(312) 228-5444
Pres.: Fred Toussaint, VP Sls: Tom O'Malley, VP Eng.: Gerard Deinzer, Sec.: Shaun McGuire
Products: manual

Telos Systems

1729 Superior Ave.
Cleveland, OH 44114
(216) 241-7225, FAX# 216-241-4103
Products: microprocessor, telephone interface

Westell

7630 Quincy St.
Willowbrook, IL 60521
(800) 323-6883

BACK/FOREGROUND SYSTEMS & LIBRARIES

BACK/FOREGROUND SYSTEMS & LIBRARIES

AEI Music Network

900 E. Pine
Seattle, WA 98122
(206) 329-1400, 800-831-8001, FAX# 206-329-9952
CEO: Michael Malone, VP Dealer Sls: Mark Smock

Audiocom

8100 Oak Ln., Penthouse 401
Miami Lakes, FL 33016
(305) 825-4653, 800-272-0555, FAX# 305-558-8799
Pres./CEO: Ron Deblinger, VP Operations: Art Hecht, Dir. Mkt'g: Stu Ginsberg
Products: music libraries, stock & custom, music services, tape systems

BGM Int'l

PO Box 8057
Pensacola, FL 32505
(904) 434-1953
Owner: F.T.C. Brewer, Nat'l Sls Dir.: Fritz Brewer

Casco Background Sound

PO Box 115
Charlestown, MA 02129
(617) 242-2093, FAX# 617-242-5209
Pres.: Samuel Blengs

Dayton Industrial

126 Westpark Rd.
Dayton, OH 45459
(513) 236-3591
VP Sls/Mkt'g: Robert McDougall, VP Eng.: Kurt Farmer, Sr. Tech.: Frank Jaros
Products: SCA equipment

EMS/MUSIC

EMS/Music

2264 15th Ave. W.
Seattle, WA 98119
(206) 281-8686, 800-666-6874, FAX# 206-281-0936
Pres.: R. Kilroy Hughes, VP Sls/Mkt'g: Bernard Kron, Nat'l Sls Mgr./Con. Dist. Rep: Berg Baylin, Nat'l Sls Rep-N.: Shawn Rohrbach, Nat'l Sls Rep-S.: David Pearson, Tech. Supp. Rep: Doug Sanders
Products: music libraries, stock & custom, music services, tape systems

HARRIS/DRACON DIV.

809 Calle Plano
Camarillo, CA 93010
(805) 987-9511, 800-4-DRACON, FAX# 805-987-2547
VP/G. Mgr.: John Mason, VP Sls/Mkt'g.: Jack McGuigan, Dir. Sls: Tom Erdmann, VP Eng.: Tom Durston, Mgr. Mkt'g Comm.: G. Eric Slayton, Prod. Mgr. Paging: Tom Johnson
Duncan Way, El Toro, CA, 714-859-9932
John Muller, Chesapeake Beach, MD, 301-257-3686
Gary Foster, Columbia, MO, 314-442-2288
Bob Lincoln, Inidan Rock Beach, FL, 813-595-3055
Don Bivens, Lake Elsinore, CA, 714-244-8808
Sam Biasi, Alexandria, VA, 703-971-5095
Bill Boone, Libertyville, IL, 312-816-1080
Margaret Giambalvo, Short Hills, NJ, 201-564-8508
Mark Skilowitz, New Field, NJ, 609-697-4580
Dave Whalen, Houston, TX, 713-974-4373
Products

IED Innovative Electronic Designs

9701 Taylorsville Rd.
Louisville, KY 40299
(502) 267-7436, FAX# 502-267-9070
VP Mkt'g & Sls: Tom Roseberry, Mkt'g Asst.: Robin Lasley, Sls App. Eng.: Jeff White, Mkt'g Adm.: Wanda R. Martin, VP Eng.: Ed Young, Pres.: Hardy Martin
Repworks, Chicopee, MA, 413-533-0845
Darmstedter Assoc., Baldwinville, NY, 315-638-1261
John Anthony., Stamford, CT, 203-322-9202
Sigmet, Valley Forge, PA, 215-783-6666
Secom Systems, Atlanta, GA, 404-455-0672
Bencsik Assoc., Ocala, FL, 904-732-9775
C.L. Pugh, Cleveland, OH, 216-238-1777
Monford Electronics Mkt'g., Indianapolis, IN, 317-872-8877
C.M. Sls, Farmington Hills, MI, 313-553-8070
Ludwig Mkt'g., Kenosha, WI, 414-697-9355
B.C. Electronic Sls, Mission, KS, 913-262-1720
Mkt'g Concepts, Irving, TX, 214-869-0669
Yora, White Bear Lake, MN, 612-770-9760
Torbett/Keiser Group, Loveland, CO, 303-669-1008
Derek Allen Assoc., Toluca Lake, CA, 818-840-8327
Plus Four Mkt'g, Walnut Creek, CA, 415-937-0650
North Shore Mkt'g, Seattle, WA, 206-284-9699
Island Instruments, Kaneohe, HI, 808-235-7544
Products: automatic mixers

Int'l Satellite Systems

104 Constitution Dr. #4
Menlo Park, CA 94025
(415) 853-0833, 800-227-6288, FAX# 415-853-0908

Johnson Electronics

4301 Metric Dr.
Winter Park, FL 32792
(407) 677-4030, FAX# 407-679-1288
Pres./CEO: A.J. Schell, VP Mkt'g: Robert Peters, VP/Eng.: Ken St. John

Products: SCA equipment

Magne-Tronics

93 Broad St.
Matawan, NJ 07747
(201) 566-9600, FAX# 201-566-4304
Pres.: John Bolenz, VP: Gloria Bolenz

MUSIC PROGRAMMING

265 Concord St.
Framingham, MA 01701
(508) 875-3530
Pres./Music Dir.: Raymond Regis, Exec. VP: Dutch Blue
Products: music libraries, stock & custom, music services

Muzak

915 Yale Ave. N.
Seattle, WA 98109
(206) 682-3737, 800-331-3340, FAX# 206-624-4299
Pres.: John Jester, Sr. VP: Jim Harrison, VP Nat'l Sls: John Neal, VP Affiliate Relations: Jack Craig, VP Prog.: Bruce Funkhouser, Sys. Eng.: Gary Larson
Muzak, New York, NY, 718-361-1880
Muzak, Chicago, IL, 312-685-7850
Muzak, Los Angeles, CA, 818-767-1802
Muzak, Boston, MA, 617-890-5503
Muzak, San Francisco, CA, 415-871-1900

Pentagon Industries

5115 N. Sheridan Rd.
Chicago, IL 60640
(312) 271-8300, 800-621-3867, FAX# 312-271-0027
G. Mgr.: John Vinci

Revere Industries

1101 Bienville St.
New Orleans, LA 70112
(504) 523-3503, 800-843-8321, FAX# 504-525-6361
VP Sls: Lori Kanelos, Dir. Mkt'g: Richard Harris

Rowe Int'l

75 Troy Hills Rd.
Whippany, NJ 07981
(201) 887-0400, FAX# 201-887-2851
Sls Mgr.: Beverly LaForte
Products: music libraries, stock & custom

SCA Data Systems

3000 Ocean Pk, #3002
Santa Monica, CA 90405
(213) 452-2506, FAX# 213-450-5307

The Benefit is Easy to See – the Ceiling Baffle is Not!

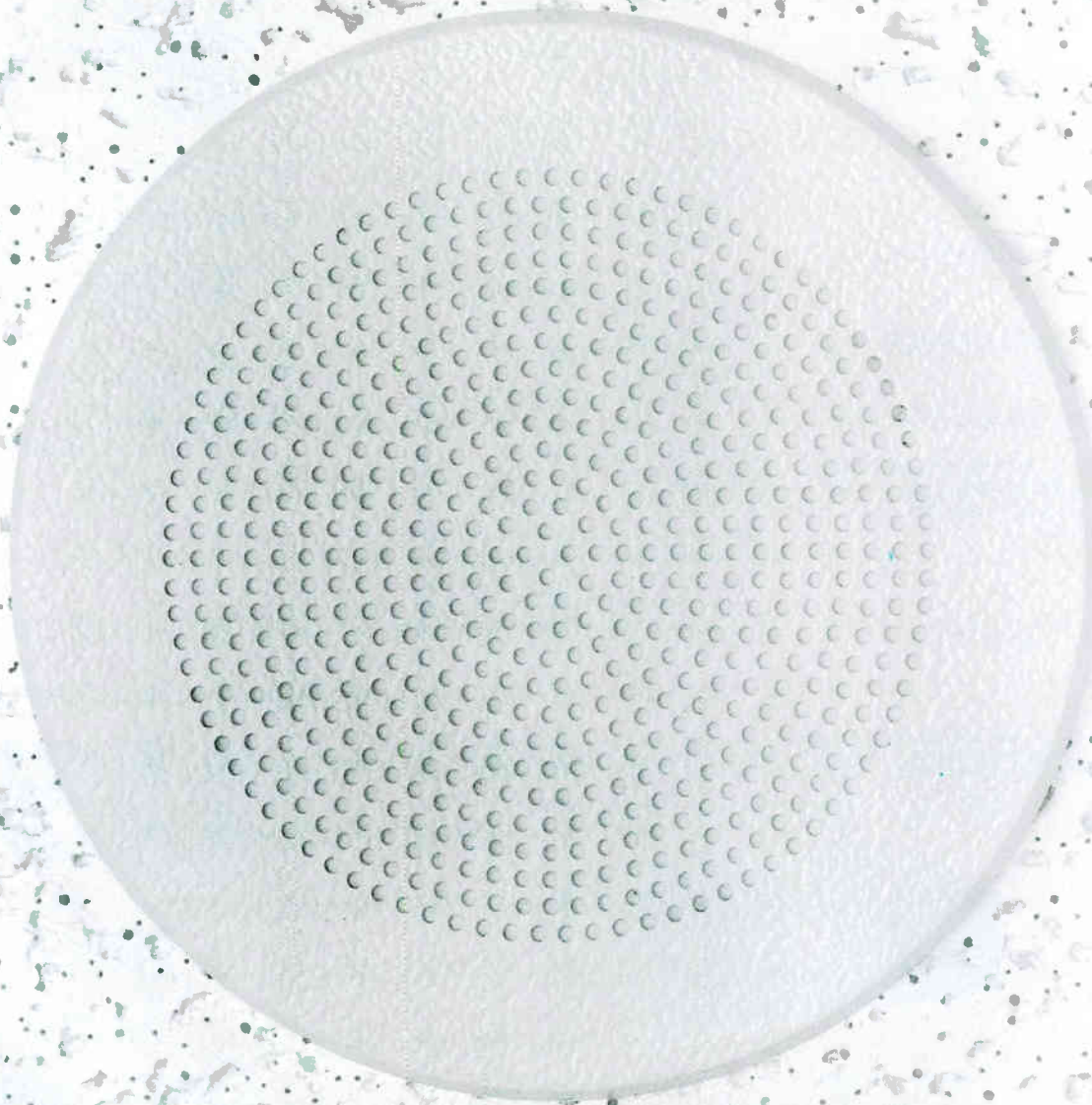

You asked for baffles that would be as unobtrusive as possible on the ceiling. Quam listened . . . and responded with a complete new baffle concept, with:

- A third less surface area than conventional 8" speaker baffles
- No visible hardware
- Made from steel textured to match popular contemporary ceiling tiles
- Quick and easy installation

A complete assembly . . . a complete solution . . . a complete demonstration of the Quam philosophy: **We hear you!**

Quam has earned its position as preferred supplier to commercial sound contractors through responsiveness in product design and in service. A broad line to meet your needs. Inventory on *our* shelves, so you don't need it on yours . . . incoming WATS for quick efficient order-processing.

Call today for your free copy of the **Quam Commercial Sound Catalog and Tech Spec 33** on the new **BR8-10WS** unobtrusive baffles.

Quam

The Sound
Decision
since 1930

Quam-Nichols Company • 234 E. Marquette Road • Chicago, Illinois 60637 • Phone: (312) 488-5800 • Fax: (312) 488-6944

Circle 205 on Reader Response Card

World Radio History

Dir. Sls/Mkt'g.: Robert Peters

SMC Int'l

2505 N. 24th St., Ste. 501
Omaha, NE 68110
(402) 453-0332, 800-456-9107, FAX# 402-451-2876

Pres.: Jay McMartin, VP Sls: Lawrence Wiedman, Dir. Eng.: Rick Diercks
RCA Commercial Svcs, Vancouver B.C. Canada, 604-291-7145
Cavendish & Winchester, Atlanta, GA, 404-449-5104
SRT Mkt'g, Tampa, FL, 813-884-4805
Products: SCA equipment

Seeburg

1105 Westwood Ave.
Addison, IL 60101
(312) 543-1270, 800-527-3723, FAX# 312-543-0549

Seeburg Music Satellite Network

5706 New Chapel Hill Rd.
Raleigh, NC 27607
(919) 851-5823, 800-334-1561, FAX# 919-851-9198

G. Mgr.: William Fox, VP: Steve Grissom, Nat'l Sls/Dis. Network: Bonnie Sullivan, Nat'l Sls/Dis. Network: Don Nicholson, Nat'l Sls/Direct Sales: Joe White, Nat'l Sls/Direct Sales: John Waff

Semco

3782 Westridge Ave.
W. Vancouver, B.C., Canada V7V 3H5

(604) 922-0526

G. Mgr.: Elk Ebert
Products: automatic mixers

Seven Systems

2602 Artie St.
Huntsville, AL 35805
(205) 533-2193

Products: SCA equipment

Sight & Sound Entertainment

1751 Dexter Ave. N
Seattle, WA 98019
(206) 775-9888, 800-538-2054, FAX# 206-286-1961

Pres.: Michael Dukane, Nat'l Mkt'g Mgr.: Steve Nini, Mkt'g Admin.: Monika Skibeness
Products: CATV, music libraries, stock & custom, music services, tape systems

Sound Products/3M

3M Center 225-S-10
St. Paul, MN 55144-1000
(612) 733-0447
Mkt'g Mgr.: Don Rada, Sls Mgr.: Don Sluder

TOA ELECTRONICS

PO Box 2047
S. San Francisco, CA 94080
(415) 588-2538, 800-843-4750, in-state 800-in CA 800-632-2157, FAX# 415-588-3349

Pres.: Yoshiro Ishida, Nat'l Sls Mgr/Comm. Pro.: Richard Krochmal, Nat'l Sls Mgr./Pro. Music & Ent.: Rick Kamlet, Nat'l Sls Mgr./Intercom: Al Burns
Products: automatic mixers

Tape-Athon

13633 Crenshaw Blvd.
Hawthorne, CA 90250
(213) 676-6752, FAX# 213-676-9532

Pres.: Leon "Lee" Tate, G. Mgr.: Robert Haller, Dir. Eng.: Bernard Sayers, Sls Mgr.: Rick Bottom, Mfg. Supervisor: E.W. Stokes
Chuck Olson Assoc., WA, 206-271-5416
Bencsik Assoc., FL, 800-342-0197
Murphy & Cota, NC, SC, 404-875-2525
ASR Enter., MD, VA, 301-893-0001
Design Factors, SC, 213-676-6752
Products: automatic mixers, CATV, music libraries, stock & custom, music services, SCA equipment, tape systems

3M SOUND PRODUCTS

551-1W, 3M Center
St. Paul, MI 55144-1000
(612) 733-9214, FAX# 612-736-7614

Mkt'g Mgr.: Richard Barker
Products: music libraries, stock & custom, music services, SCA equipment, tape systems

Yesco Foreground Music

915 Yale Ave. N.
Seattle, WA 98109
(206) 682-3737, 800-426-9248

CASSETTE CHANGER

for background music

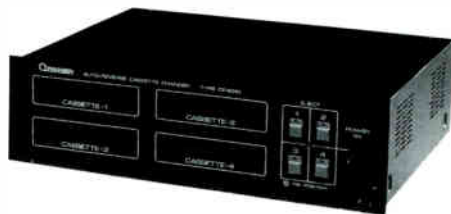

4 auto reversing cassette players for continuous play.

CP4010 Stereo/Mono Selectable

Create the ideal mood for—

- Restaurants
- Doctors & Business Offices
- Factories
- Retail Stores
- Super Markets

Low initial cost, easy installation and compatibility with existing or new public address or paging systems makes this unit ideal for your sound system.

To operate the unit, simply insert the cassettes and everything is automatic thereafter. The Auto-Reverse Cassette Changer plays both sides of the cassette, then advances to the next cassette. Each cassette position has an individual eject switch and LED indicator. If a position doesn't contain a cassette, the position will be bypassed to the next position. Simple two-cable connection to an external amplifier. Superior performance and styling will meet your needs. End more.

FEATURES/SPECIFICATIONS:

- Logic controlled endless playback deck
- Auto advance to next cassette, three (3) seconds
- Automatic Gain Control
- Lighted cassette eject buttons
- Frequency Response 40-12,000 Hz
- DIN and RCA line out connectors
- Dimensions 14.9" x 11.2" x 6.3"
- Switchable 110/220 VAC, 50/60 Hz power supply
- Net Weight 18.75 lbs.

ADDITIONAL SPECIFICATIONS:

- Head Configuration
- Frequency Response 40-12,000Hz ± 3db
- Line Output
- Signal to Noise Ratio
- Wow & Flutter
- Front Panel
- Back Panel
- Color
- Power Consumption
- Speed Regulation
- Accessories
- Four track in line head
- 500 mill volt
- Better than 45db
- Less than 0.02% WRMS
- Power ON/OFF switch
- Lighted cassette eject buttons
- Line voltage select switch
- Stereo/Mono select switch
- Auto Gain level control
- Black cabinet with black front panel with white silk screen lettering, including Pentagon logo
- 28.8 VA
- Better than .5%
- Power Cord - Twin RCA type cable



5115 NORTH SHERIDAN ROAD
CHICAGO, ILLINOIS 60640
PHONE: (312) 271-4300
WATTS: 1-800-621-3867
TELEX: 5101012952

Circle 37 on Reader Response Card

USE

the

1989/90

Sound & Communications

BLUE BOOK

Directory

for all your purchases throughout the year. For additional copies, contact:

Sound & Communications
25 Willowdale Avenue
Port Washington, NY 11050

IN/OUT REGISTERS

Audio Systems

PO Box 1174

Bismarck, ND 58502

(701) 223-3800, 800-852-6522, in-state 800-932-8975, FAX# 701-222-8102

Pres./Eng: Lynn Mader, VP/Sls: Lyle Mader

Products: manual personnel, medical

Cornell Electronics Products

PO Box 23411

Milwaukee, WI 53223

(414) 351-4660, 800-541-946, FAX# 414-351-4657

Pres.: Donald Glaubitz, VP: Gary Butler, Sls Mgr.:

Pauline Haack, Mkt'g: Randy Archer, SE Reg Sls Mgr.:

William Ellinger, Controller: Thelma Plunkett

Shamrock Electronic Sls, Dayton, OH, 513-258-1227

LSM Assoc., Phelps, NY, 315-548-4891

W.A. Hendrickson, North Scituate, MA, 617-545-0652

Kingston Sls, Indianapolis, IN, 317-876-2545

Avcom, North Olmsted, OH, 216-777-2060

Richard S. Pass Assoc., Langhorne, PA, 215-757-6100

R & S Sls, Rockville Centre, NY, 516-678-6887

Cavendish & Winchester, Atlanta, GA, 404-422-4531

Cartwright & Bean, Orlando, FL, 407-422-4531

Kodo Assoc., Minneapolis, MN, 612-881-1255

Vector, Seattle, WA, 206-322-4343

Rancilio Assoc., St. Louis, MO, 314-845-0202

Dick Bellew Sls, Dallas, TX, 214-644-7881

Bidwell-Schwartz Assoc., Gardena, CA, 213-770-0300

Yocum Mkt'g., Mesa, AZ, 834-3334

Avwest, Fountain Hills, AZ, 602-946-1811

Products: access control, intercom, manual personnel, medical, visual

Fisher-Berkeley—Ektacom

PO Box 24303

Oakland, CA 94623

(415) 835-7575, FAX# 415-271-8297

Pres: Robert Fisher, Sr. VP: Wood Wymond, VP Eng.:

Robert Shipley, Sls Coord. Mgr.: Richard Flanagan, Sls

Eng.: Michael Lagrimas, Sls Eng.: Kenneth

Jorgensen

Arthur Tilley, Fayetteville, PA, 717-352-8432

Walter Radner, Westfield Center, OH, 216-887-5646

Jerom Electronic Systems

1743 W. Rosehill Dr.

Chicago, IL 60660

(312) 275-1900, 800-621-1903, FAX# 312-275-0283

Pres.: Jerome Chesnul, VP Sls: John Charczuk

Admiral Sls, Richardson, TX, 214-357-9212

ASR Enter., Fallston, MD, 301-893-0001

Bi-State Marketers, Ridgefield, NJ, 201-943-5888

Burcaw & Assoc., Warren, MI, 313-573-4605

Central Mkt'g Group, Kansas City, MO, 816-741-7460

Greg Dzubay & Assoc., Peoria, AZ, 602-979-2358

Greg Dzubay & Assoc., Denver, CO, 303-393-7047

Gustafson Sls, Red Wing, MN, 612-388-4277

Gerald Horne & Assoc., Stow, MA, 508-897-7146

J.W. Lehner, Stow, OH, 216-686-1965

Meyer Mkt'g, Deerfield Beach, FL, 305-481-9250

Meyer & Ross, Burlingame, CA, 415-348-6800

New West Agency, La Mesa, CA, 619-299-3269

Pat Norman Sls, Indianapolis, IN, 317-842-5611

Pacific West Mkt'g, Kailua, HI, 808-261-7558

Henry Philips, Roswell, GA, 404-992-3070

Tortech Electronics, Scarborough/Ontario, Canada,

416-282-1011

John S. Wilkin & Assoc., Hillsboro, OH, 513-393-1137

Products: manual personnel, medical, monitor reporting, visual

LEE DAN COMMUNICATIONS

155 Adams Ave.

Hauppauge, NY 11788-3699

(516) 231-1414, 800-533-3261, in-state 800-231-1414, FAX# 516-231-1498

Pres.: Leon Goldberg, VP Op.: Lawrence Goldberg, VP

Finance/Admin.: David Goldberg, Sr. Sls Associate:

Susan Leon, Office Mgr.: Rita Kaplan, Sr. Tech.:

Sandy Hoffman

Products: intercom, manual personnel, medical, visual

Radionics

920 Holt Rd.

Webster, NY 14580

(716) 872-2100

Pres.: A.J. Ozminkowski, Eng.: Frank Laciak, Dir.

Comm'l Prod.: Ken O'Brien, Dist./Sls Mgr.: Roger

Moore

Products: manual personnel, medical, telephone reporting, terminal reporting, visual

TALK-A-PHONE

5013 N. Kedzie Ave.

Chicago, IL 60625

(312) 539-1100, FAX# 312-539-1241

Pres.: Z. Liberman, VP: S. Shanes, Sls Mgr.: Dan

Kagan

Products: access control, intercom

Personnel Register Designed by People who have installed the others!!!



*"We Can Easily Customize
To Replace Your Existing Systems"*

CALL TOLL FREE

1-800-852-6522

AUDSCO

Audio Systems Co. • 1815 Michigan Ave. • Bismarck, ND 58504

INTERCOMMUNICATIONS EQUIPMENT

INTERCOM—APARTMENT/RESIDENTIAL

ATC Supply

106 Hobart St.
Hackensack, NJ 07601
(201) 488-0776, FAX# 201-488-6975
Pres.: Sonny Greco

AIPHONE INTERCOM SYSTEMS

PO Box 90075
Bellevue, WA 98009
(206) 455-0510, 800-692-0200, FAX# 206-455-0071

Pres.: Jun Matsumoto, Sls Mgr.: Jim Morrison,
Mkt'g/Adv. Mgr.: Harry Quanz
Aiphone NE, Randolph, NJ, 201-328-1790
Aiphone Midwest, Westmont, IL, 312-323-5222
Aiphone SE, Douglasville, GA, 404-920-2811
Products: access control, apt station, custom, duplex, lobby, mailbox panels, microprocessor, panel/entrance, simplex, talk-back, telephone, video

Alpha Communications

89-D Cabot Ct.
Hauppauge, NY 11788-3717
(516) 434-8080, 800-666-4800, FAX# 516-434-8334
Pres.: Mark Goldberg, VP: Madelyn Goldberg, Office Mgr.: Rose Tassone

Products: access control, apt station, custom, duplex, lobby, mailbox panels, microprocessor, music combination, panel/entrance, simplex, talk-back, telephone, video

Alternative Telecommunications

110 Williams St.
New York, NY 10038
(212) 693-1440, FAX# 212-693-1448
Pres.: Alan R. Fitzpatrick, Exec. VP: Sonny Greco

Altronic

191 Oneida Dr.
Pointe Claire, Montreal Quebec, Canada H9R 1A9
(514) 694-0168
Pres.: A. D. Grunberg, VP: T. Pohoryles

Amplivox Communication Products

1833 N. 105th
Seattle, WA 98133
(206) 523-6170, FAX# 206-526-1529
Pres.: Gerard Mooyman, Sls Mgr.: Jeff Groth
Frechette Communications, Quebec, Canada, 819-562-1297

Amtel Security Systems

1421 N.W. 165th St.
Miami, FL 33169
(305) 621-3100, 800-222-6835, FAX# 305-623-0613
Pres.: Suresh Gajwani, Dir. Mkt'g: Moe Weiner

Products: access control, telephone

Bogen Communications

PO Box 575
Ramsey, NJ 07446
(201) 934-8500, FAX# 201-934-9832
Pres.: John Ochtera, VP Sls/Mkt'g: James Orr, Nat'l Sls Dir.: David Chambers
Products: access control, apt station, duplex, lobby, talk-back, telephone

Communications Co.

3490 Noell St.
San Diego, CA 92110
(619) 297-3261, FAX# 619-297-3279
Exec. VP: Michael Jordan, Eng./Mfg.: David Johnson,
Order Desk: Bobby Willis, Order Desk: Laura McCullough, Shipping: Ritchie Willis, Pres.: Peter Jordan
Audio Mkg Assoc., Brecksville, OH, 216-526-2426
Bencsik Assoc., Ocala, FL, 904-732-9775
Secom Systems, Dorrvile, GA, 800-241-9409
Brian Trankle & Assoc., Belmont, CA, 415-595-4004
Western Audio Sls, Glendale, CA, 818-246-3806

Cornell Electronics Products

PO Box 23411
Milwaukee, WI 53223
(414) 351-4660, 800-541-946, FAX# 414-351-4657
Pres.: Donald Glaubitz, VP: Gary Butler, Sls Mgr.: Pauline Haack, Mkt'g: Randy Archer, SE Reg Sls Mgr.: William Ellinger, Controller: Thelma Plunkett
Shamrock Electronic Sls, Dayton, OH, 513-258-1227
LSM Assoc., Phelps, NY, 315-548-4891
W.A. Hendrickson, North Scituate, MA, 617-545-0652
Kingston Sls, Indianapolis, IN, 317-876-2545
Avcom, North Olmsted, OH, 216-777-2060
Richard S. Pass Assoc., Langhorne, PA, 215-757-6100
R & S Sls, Rockville Centre, NY, 516-678-6887
Cavendish & Winchester, Atlanta, GA, 404-422-4531
Cartwright & Bean, Orlando, FL, 407-422-4531
Kodo Assoc., Minneapolis, MN, 612-881-1255
Vector, Seattle, WA, 206-322-4343
Rancilio Assoc., St. Louis, MO, 314-845-0202
Dick Bellew Sls, Dallas, TX, 214-644-7881
Bidwell-Schwartz Assoc., Gardena, CA, 213-770-0300
Yocum Mkt'g, Mesa, AZ, 834-3334
Avwest, Fountain Hills, AZ, 602-946-1811
Products: access control, apt station, talk-back

DUKANE

2900 Dukane Dr.
St. Charles, IL 60174
(312) 584-2300, FAX# 312-584-2370
Pres./CEO: J. McWilliams Stone Jr., Group VP: William Finnegan, Div. G. Mgr.: Steven Deppe, Nat'l Sls Mgr.: Warren Anderson, Svce Mgr.: Cliff Carlson
Wally Smutts, Toronto-Ont, Canada, 312-584-2300
Doug Fellabaum, Sycamore, IL, 815-895-7573
Don Mouritzen, Beecher, IL, 312-946-9655
Ken Lind, St. Charles, IL, 312-584-2300

Pete Kendal, Jacksonville, FL, 904-262-6025
Ed Nuhring, Portland, OR, 503-244-4262
Jim Lacey, Moreno Valley, CA, 714-243-1160
Jack Brown, Dallas, TX, 214-943-7528

Dayton Industrial

126 Westpark Rd.
Dayton, OH 45459
(513) 236-3591
VP Sls/Mkt'g: Robert McDougall, VP Eng.: Kurt Farmer, Sr. Tech.: Frank Jaros
Products: music combination, telephone

E.R.L. Electronic Products

65-50 Austin St.
Rego Park, NY 11374
(718) 275-7700, FAX# 718-997-7645
VP: Steve Faulhaber, Dir. Sls: Martin Salliel

ELENEX (WEST)

7392 Trade St.
San Diego, CA 92121
(619) 566-7515, 800-225-3113, in-state 800-in CA 800-225-8037, FAX# 619-586-1484
VP: Dennis Berglund, Eng.: Al Bitarafan, Sls: Lou Hennequin

Fisher-Berkeley—Ektacom

PO Box 24303
Oakland, CA 94623
(415) 835-7575, FAX# 415-271-8297
Pres: Robert Fisher, Sr. VP: Wood Wymond, VP Eng.: Robert Shipley, Sls Coord. Mgr.: Richard Flanagan, Sls Eng.: Michael Lagrimas, Sls Eng.: Kenneth Jorgensen
Arthur Tilley, Fayetteville, PA, 717-352-8432
Walter Radner, Westfield Center, OH, 216-887-5646

Florence Mfg.

2101 N. Elston Ave.
Chicago, IL 60614
(312) 384-3310, FAX# 312-384-3460
Pres.: Michael Gioseffi, VP Sls: Donald Cannella, Prod. Mgr.: Frank Mack, Mgr./Eng. R & D: Ray Cozzens

Housing Devices

407R Mystic Ave.
Medford, MA 02155
(617) 395-5200, 800-392-5200, FAX# 617-395-3793
Pres.: Tom Richardson, Sls: Len Noris, Credit: Laurie Buchino
Metrocom Systems, Brooklyn, NY, 718-821-5800
Products: apt station, custom, mailbox panels, microprocessor, telephone

Innovations In Communications™

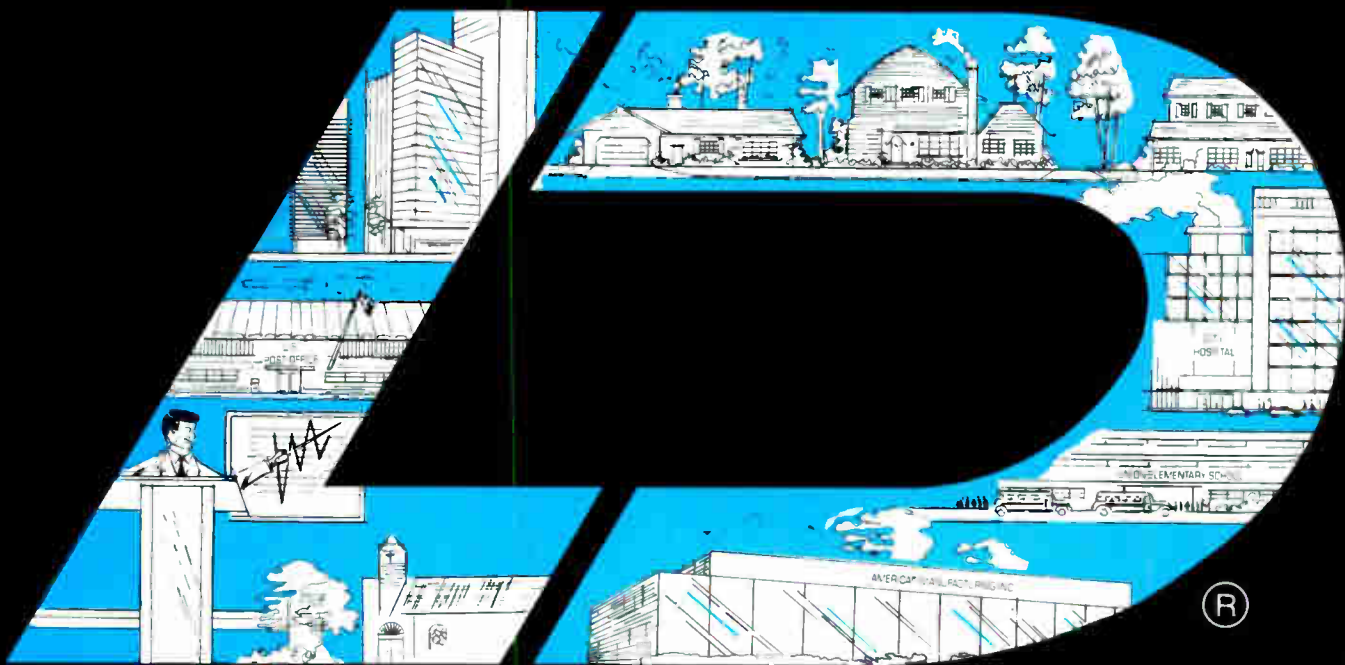

Since 1955

Wherever people have the need for better communications, safety and convenience, you'll find a **LEE DAN®** intercom system hard at work.

For over 34 years, we've been manufacturing intercoms for homes, apartments, townhouses, offices, factories, schools and hospitals. Our experience can help you turn a complicated specification into a simple, profitable solution.

Our large product line, teamed with our quick, affordable, customizing abilities, can help you meet your equipment needs, schedules, and profit margins.

Next time you need an intercom, call **LEE DAN®**. Our sales staff will assist you in equipment selection. We'll provide a detailed written quotation (not a lump sum price) with literature, spec sheets, wiring information, and anything else you need to put together a great system and a winning proposal.

Circle 228 on Reader Response Card

ENTERCOM® Multi-Unit Intercoms	VAN-GUARD® Custom Lotby Panels	ENTERLOK™ Door Answering Intercoms	INTERVIEW™ Audio/Visual Intercoms

We're here to help. Call us toll-free.

N.Y. (800) 231-1414
U.S.A. (800) LEE DAN-1

(516) 231-1414
FAX (516) 231-1498

155 Adams Avenue, Hauppauge, New York 11788-3699

INTERCOMS • NURSE-CALL • MAILBOXES • DIRECTORIES • ANNUNCIATORS • WIRE & CABLE • CCTV

LEE DAN
COMMUNICATIONS INC



FLORENCE MANUFACTURING CO.

A UNIT OF FLORENCE CORPORATION

Designers & Manufacturers of

- **NURSE CALLS**
- **EMERGENCY CALLS**
- **MAIL BOXES**
- **APARTMENT COMMUNICATIONS SYSTEMS**

DESIGN

Functional, built to work units show 50 years of design refinements — you get tough, reliable performance.

QUALITY

Our quality control starts with raw materials and doesn't stop until you're satisfied for a long, long time.

PRICE

Value and cost meet for competitively priced units ... we offer exceptional products at a fair price.

DELIVERY

Florence delivers promptly, even rush orders, custom designs and large shipments. We specialize in meeting your schedule with fast response to your needs.

SERVICE

We respond — in force and in depth to your every service need, from replacement parts to special shipments.

DESIGNING & MANUFACTURING QUALITY PRODUCTS SINCE 1934

**FLORENCE
MANUFACTURING CO.**
A UNIT OF FLORENCE CORPORATION

2101 N. Elston Avenue
Chicago, IL 60614

312/384-3310

FAX: 312/384-3460



F-885

ITT/DES

20 Mayfield Ave.
Edison, NJ 07607
(201) 225-6121, 800-524-1646
VP: Donald Duthaler, Chief Eng.: Jeffrey Stellman



JERON

electronic systems, inc.

Jeron Electronic Systems

1743 W. Rosehill Dr.
Chicago, IL 60660
(312) 275-1900, 800-621-1903, FAX# 312-275-0283

Pres.: Jerome Chesnul, VP Sls: John Charczuk
Admiral Sls, Richardson, TX, 214-357-9212
ASR Enter., Fallston, MD, 301-893-0001
Bi-State Marketers, Ridgefield, NJ, 201-943-5888
Burcaw & Assoc., Warren, MI, 313-573-4605
Central Mkt'g Group, Kansas City, MO, 816-741-7460
Greg Dzubay & Assoc., Peoria, AZ, 602-979-2358
Greg Dzubay & Assoc., Denver, CO, 303-393-7047
Gustafson Sls, Red Wing, MN, 612-388-4277
Gerald Horne & Assoc., Stow, MA, 508-897-7146
J.W. Lehner, Stow, OH, 216-686-1965
Meyer Mkt'g, Deerfield Beach, FL, 305-481-9250
Meyer & Ross, Burlingame, CA, 415-348-6800
New West Agency, La Mesa, CA, 619-299-3269
Pat Norman Sls, Indianapolis, IN, 317-842-5611
Pacific West Mkt'g, Kailua, HI, 808-261-7558
Henry Philips, Roswell, GA, 404-992-3070
Tortech Electronics, Scarborough/Ontario, Canada, 416-282-1011

John S. Wilkin & Assoc., Hillsboro, OH, 513-393-1137
Products: access control, apt station, custom, duplex, lobby, microprocessor, panel/entrance, simplex, talk-back, telephone, video



LEE DAN COMMUNICATIONS

155 Adams Ave.
Hauppauge, NY 11788-3699
(516) 231-1414, 800-533-3261, in-state 800-231-1414, FAX# 516-231-1498

Pres.: Leon Goldberg, VP Op.: Lawrence Goldberg, VP Finance/Admin.: David Goldberg, Sr. Sls Associate: Susan Leon, Office Mgr.: Rita Kaplan, Sr. Tech.: Sandy Hoffman

Products: apt station, custom, duplex, lobby, mailbox panels, microprocessor, music combination, panel/entrance, simplex, talk-back, telephone, video

M & S Systems

2861 Congressman Ln.
Dallas, TX 75220
(214) 358-3196, 800-877-6631, FAX# 214-350-1913

Pres.: Bill Reid, VP Sls/Mkt'g: Don Stillely, VP Eng.: Greg Sloat, Mkt'g Mgr.: Bruce Benter

Products: duplex, music combination

Marlee Electronics

Front and Porter Sts.
Philadelphia, PA 19148
() , 800-368-7243, FAX# 215-755-7877

Nat'l Sls Mgr.: T. Mike Bevan, Pres.: B. Scott Holloway, Adm. Asst: Keila Conte, VP Prod.: Nadene Uhart
Associated Sys., Manchester, NH, 603-472-2297
Dimension Point IX, Lewisville, TX, 214-436-3706
Multi-Technical Reps, New Prague, MN, 612-758-2273
Steve Dilsworth, Norcross, GA, 404-491-7343
George Pettit, Berkeley, IL, 312-449-8007
Products: access control, microprocessor, telephone

Marsh Products

336 McKee St.
Batavia, IL 60510
(312) 879-8008, FAX# 312-879-8072

Mircom Communication & Security

429 Ainess St.
Downsview, Toronto, Ontario, Canada M3J 2H4
(416) 665-4301, FAX# 416-665-2825
Pres.: Larry Letofsky, Nat'l Sls Mgr.: Art Petrilli, Mkt'g Specialist: David Ito, Int'l Sls Mgr.: Tony Falbo
Design Products Group, Clinton, NJ, 201-730-7360
Gustafson Sls, Red Wing, MN
Easton Electronics, Dedham, MA, 617-326-5690
Saf-Com Supply, San Dimas, CA, 818-914-1854

Multi-Vox Ltd.

9967 St. Michel Blvd.
Montreal-Nord, Quebec, Canada H1H 5G7
(514) 321-3131

Pres.: Jean Lajoire, Eng.: Dominique Malenfant, Op. Mgr.: Georges Morissette, Sls/Tech Coord.: Antoine Krelio

RING COMMUNICATIONS

57 Trade Zone Dr.
Ronkonkoma, NY 11779
(516) 585-7464, FAX# 516-585-7410

Pres.: Paul McLean, VP Sls: Craig Krsanac, V.P. Tech.: Kjell (Ken) Solem, Tech Support: Charlie Kulins
Klumpp Sls, Jacksonville, FL, 904-287-5205
Corrigan Agencies, 504-893-7455
Gustafson Sls, 612-388-4277
Allwest Electronics, 805-388-1789
Pacnor, 206-771-6016
J.C. Electronics, 808-943-8514

Ritron

505 W. Carmel Dr.
Carmel, IN 46032
(317) 846-1201, 800-872-1872, FAX# 317-846-4978

Sentex Systems

20732 Lassen St.
Chatsworth, CA 91311
(818) 700-9800, FAX# 818-407-5647

Pres.: William Davis, Exec. VP: Richard Greenthal, Mgr. Admin.: Frances Butler, Sls: Andrew Greenthal, Op.: Sharon Dawson

Siedle Intercom

780 Pkwy
Broomall, PA 19008
(215) 353-9595, 800-874-3353, FAX# 215-353-9716
Pres.: Earl Zausmer

Soundsmith

13510 Vargon St.
Dallas, TX 75243
(214) 437-3534

Circle 34 on Reader Response Card

Video doorbell.



Instead of just ringing, this 21st century doorbell allows you to hear and see who's at the door.

It's name: Video Sentry.

On guard 24-hours-a-day, its CCD infrared camera can see equally well at noon or midnight. Rather than use

bulky, expensive coaxial cable, Video Sentry runs on 2-wires. Which means it'll work in old as well as new homes.

For a free brochure, use the reader circle card. But if you can't wait to see and hear it with your own eyes and ears, call us at (206) 455-0510 for your nearest Aiphone representative.

AIPHONE®
*Intercom systems for
business, home & industry.*

Stentofon Communications

6119 Connecticut Ave.
Kansas City, MO 64120
(816) 231-7200, FAX# 816-231-7203
Mkt'g Mgr.: Douglas Caldwell
Tom Reilly, Rye, NY, 914-933-2554
Linda Wick, Chicago, IL, 312-981-5136
Mike Wilcock, Los Angeles, CA, 818-335-0543

Speco Div. Components Specialties

PO Box 624
Lindenhurst, NY 11757
(516) 957-8700, 800-645-5516, FAX# 516-956-9142
Pres.: Louis Keller, VP G. Mgr.: James Ganci, V.P. Sls:
Mel Hulkower, Sls Mgr.: Eric Forman, Sls Expeditor:
Bernice Zachman
Products: telephone, video

TOA ELECTRONICS

PO Box 2047
S. San Francisco, CA 94080
(415) 588-2538, 800-843-4750, in-state 800-in CA
800-632-2157, FAX# 415-588-3349
Pres.: Yoshiro Ishida, Nat'l Sls Mgr./Comm. Pro.:
Richard Krochmal, Nat'l Sls Mgr./Pro. Music & Ent.:
Rick Kamlet, Nat'l Sls Mgr./Intercom: Al Burns
Products: access control, custom, duplex, lobby, microprocessor, music combination, panel/entrance, simplex, talk-back, telephone

T.S.K. Electronics

PO Box 190
Tonawanda, NY 14151-0191
(716) 693-3916, FAX# 716-692-6433
Pres.: Theodore Kedzierski, Chief Eng.: Kevin Kedzierski

TALK-A-PHONE

5013 N. Kedzie Ave.
Chicago, IL 60625
(312) 539-1100, FAX# 312-539-1241
Pres.: Z Liberman, VP: S. Shanes, Sls Mgr.: Dan Kagan

Klump Sls, Jacksonville, FL, 904-287-5205
Alvan Chaney & Assoc., Hialeah, FL, 305-558-3933
Ziskind & Assoc., Rolling Meadow, IL, 312-577-1624
Wm. B. Allen Supply, New Orleans, LA, 504-525-8222
R.W. Sls, St. Paul, MN, 612-646-2710
Mountain Reps, Denver, CO, 303-623-0972
Westech Mkt'g, Culver City, CA, 213-870-9286
B & B Sls, Oakland, CA, 415-534-1725
Chuck Olson Assoc., Renton, WA, 206-271-5416
Alpha Communications, Hauppauge, NY, 516-434-8080
Fairfax Electronics, Los Angeles, CA, 213-731-2561
Midtekcom, Olmsted Twp, OH, 216-243-4840
Products: access control, apt station, custom, duplex, lobby, mailbox panels, microprocessor, music combination, panel/entrance, simplex, talk-back, telephone, video

Telephone Components

3180 Expressway Dr. S.
Central Islip, NY 11722
(516) 582-4745

Ultrak

660 Compton St.
Broomfield, CO 80020
(303) 466-7333, FAX# 303-469-8336
Products: video

TekTone®

TekTone Sound & Signal Mfg.

PO Box 12427
Lake Park, FL 33403
(407) 844-2383, 800-327-8466, FAX# 407-845-1587
G. Mgr.: Carlos Mira, Dir. Sls/Mkt'g: Tom Hendricks
Dardon & Assoc., Olmsted Twp, OH, 216-234-4555
Lee Dan Comm., Hauppauge, NY, 516-231-1414

We're on both ends of every innovative intercom system.

TekTone®

Investigate our wide variety of high quality communications products which can add new vistas to your business opportunities.

- A. VIDEO INTERCOM** with modern styling and the flexibility of additional on-board function keys.
- B. MICRO-PROCESSOR NURSE CALL SYSTEMS** with all the "state of the art" features/benefits.
- C. TELEPHONE ACCESS** with double E-prom memory and built in battery back-up for voice communications.
- D. HOME ENTERTAINMENT/INTERCOM** with a new look for todays modern homes and offices.

These and other products manufactured domestically by TekTone Sound & Signal Mfg., Inc.



TekTone Sound & Signal Mfg., Inc. • 1331 S. Killian Dr., P.O. Box 12427
Lake Park, FL 33403-0427 • Telephone (407) 844-2383
Outside Florida place your order toll free (800) 327-8466 • FAX (407) 845-1587

Circle 287 on Reader Response Card

YES! I WANT TO STAY ON TOP OF THE INDUSTRY BY RECEIVING
A COPY OF **SOUND & COMMUNICATIONS** EVERY MONTH

- NEW RENEWAL
 1 Year \$15.00 3 Years \$37.50 (Savings \$7.50)
 Payment Enclosed Bill My Credit Card Visa MC AE
 (Foreign: Add \$5 for delivery) Card # _____ Expires: _____
 FOR A FREE SUBSCRIPTION, COMPLETE BELOW:

Signature _____
 Name _____
 Company _____
 Address _____
 City _____ State _____

- | | | |
|--|--|---|
| <p>(1) Do you wish to receive Sound & Communications?
 <input type="checkbox"/> Yes <input type="checkbox"/> No</p> <p>(2) Primary Job Function (only one):
 <input type="checkbox"/> A Management/Owner
 <input type="checkbox"/> B Engineering/Technical Mgt
 <input type="checkbox"/> C Sales/Marketing
 <input type="checkbox"/> D In-House Maintenance/Service
 <input type="checkbox"/> E Field Installation/Maintenance
 <input type="checkbox"/> F Consultant
 <input type="checkbox"/> G Advertising/Promotion
 <input type="checkbox"/> H Other _____</p> | <p>(3) Primary business of company (only one):
 <input type="checkbox"/> 1 Contractor—Engineered Sound/Acoustical
 <input type="checkbox"/> 2 Contractor—Interconnect/intercom
 <input type="checkbox"/> 3 Contractor—Fire/Alarm/Safety
 <input type="checkbox"/> 4 Electrical Contractor
 <input type="checkbox"/> 5 Pro Audio/Studio/Reinforcement
 <input type="checkbox"/> 6 Architect/Designer
 <input type="checkbox"/> 7 Engineering/Acoustical Consulting
 <input type="checkbox"/> 8 Maintenance/Service
 <input type="checkbox"/> 9 Dealer/Distributor/Rep
 <input type="checkbox"/> M Manufacturer
 <input type="checkbox"/> O Other _____</p> | <p>(4) Your purchasing authority is:
 <input type="checkbox"/> Final approval/Buyer
 <input type="checkbox"/> Recommend/Specifier
 <input type="checkbox"/> No Direct Authority/User</p> <p>(5) Intensity of your product need:
 <input type="checkbox"/> Have salesman call
 <input type="checkbox"/> Need within 3-6 months
 <input type="checkbox"/> Future projects</p> <p>(6) Number of employees at your company:
 <input type="checkbox"/> 1-3 <input type="checkbox"/> 4-10 <input type="checkbox"/> 11-25
 <input type="checkbox"/> 26-100 <input type="checkbox"/> Over 100</p> |
|--|--|---|

YES! I WANT TO STAY ON TOP OF THE INDUSTRY BY RECEIVING
A COPY OF **SOUND & COMMUNICATIONS** EVERY MONTH

- NEW RENEWAL
 1 Year \$15.00 3 Years \$37.50 (Savings \$7.50)
 Payment Enclosed Bill My Credit Card Visa MC AE
 (Foreign: Add \$5 for delivery) Card # _____ Expires: _____
 FOR A FREE SUBSCRIPTION, COMPLETE BELOW:

Signature _____
 Name _____
 Company _____
 Address _____
 City _____ State _____

- | | | |
|--|--|---|
| <p>(1) Do you wish to receive Sound & Communications?
 <input type="checkbox"/> Yes <input type="checkbox"/> No</p> <p>(2) Primary Job Function (only one):
 <input type="checkbox"/> A Management/Owner
 <input type="checkbox"/> B Engineering/Technical Mgt
 <input type="checkbox"/> C Sales/Marketing
 <input type="checkbox"/> D In-House Maintenance/Service
 <input type="checkbox"/> E Field Installation/Maintenance
 <input type="checkbox"/> F Consultant
 <input type="checkbox"/> G Advertising/Promotion
 <input type="checkbox"/> H Other _____</p> | <p>(3) Primary business of company (only one):
 <input type="checkbox"/> 1 Contractor—Engineered Sound/Acoustical
 <input type="checkbox"/> 2 Contractor—Interconnect/intercom
 <input type="checkbox"/> 3 Contractor—Fire/Alarm/Safety
 <input type="checkbox"/> 4 Electrical Contractor
 <input type="checkbox"/> 5 Pro Audio/Studio/Reinforcement
 <input type="checkbox"/> 6 Architect/Designer
 <input type="checkbox"/> 7 Engineering/Acoustical Consulting
 <input type="checkbox"/> 8 Maintenance/Service
 <input type="checkbox"/> 9 Dealer/Distributor/Rep
 <input type="checkbox"/> M Manufacturer
 <input type="checkbox"/> O Other _____</p> | <p>(4) Your purchasing authority is:
 <input type="checkbox"/> Final approval/Buyer
 <input type="checkbox"/> Recommend/Specifier
 <input type="checkbox"/> No Direct Authority/User</p> <p>(5) Intensity of your product need:
 <input type="checkbox"/> Have salesman call
 <input type="checkbox"/> Need within 3-6 months
 <input type="checkbox"/> Future projects</p> <p>(6) Number of employees at your company:
 <input type="checkbox"/> 1-3 <input type="checkbox"/> 4-10 <input type="checkbox"/> 11-25
 <input type="checkbox"/> 26-100 <input type="checkbox"/> Over 100</p> |
|--|--|---|



FREE!

FREE!

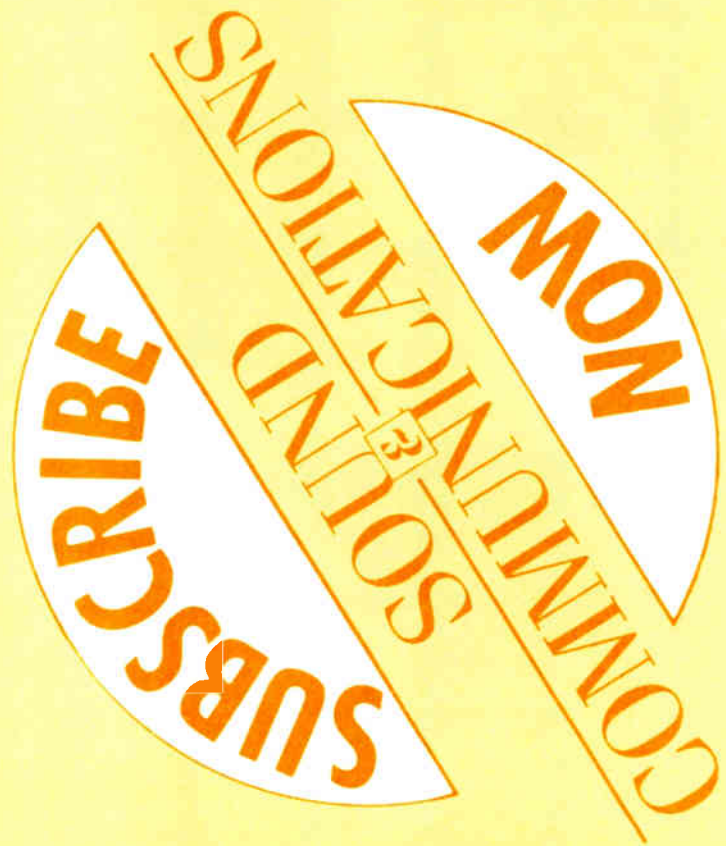

Place
Stamp
Here

**SOUND
&
COMMUNICATIONS**
25 WILLOWDALE AVENUE
PORT WASHINGTON, NY 11050

Place
Stamp
Here

**SOUND
&
COMMUNICATIONS**
25 WILLOWDALE AVENUE
PORT WASHINGTON, NY 11050

CARILLONS & CHIMES

Clever Devices

PO Box 2002
Port Washington, NY 11050
(516) 767-0682, FAX# 516-767-3635
Pres.: William Long, Mkt'g Mgr.: Una Neary, Tech.
Supp.: Mike Kafulas
Products: analog & digital tones for time & signalling, music playback-type

Maas-Rowe Carillons

2255 Meyers Ave.
Escondido, CA 92025

(619) 743-1311

Schulmerich Carillons

Carillon Hill
Sellersville, PA 18960
(215) 257-2771
Mkt'g Sec.: Sally Mandes
Products: analog & digital tones for time & signalling, music playback-type

Tape-Athon

13633 Crenshaw Blvd.

Hawthorne, CA 90250

(213) 676-6752, FAX# 213-676-9532
Pres.: Leon "Lee" Tate, G. Mgr.: Robert Haller, Dir.
Eng.: Bernard Sayers, Sls Mgr.: Rick Bottom, Mfg.
Supervisor: E.W. Stokes
Chuck Olson Assoc., WA, 206-271-5416
Bencsik Assoc., FL, 800-342-0197
Murphy & Cota, NC, SC, 404-875-2525
ASR Enter., MD, VA, 301-893-0001
Design Factors, SC, 213-676-6752
Products: analog & digital tones for time & signalling, music playback-type

INTERCOM—DUPLX

ATC Supply

106 Hobart St.
Hackensack, NJ 07601
(201) 488-0776, FAX# 201-488-6975
Pres.: Sonny Greco
Products: digital, loudspeaking, microprocessor, multi-channel, programmable, VOX

AIPHONE INTERCOM SYSTEMS

PO Box 90075
Bellevue, WA 98009
(206) 455-0510, 800-692-0200, FAX# 206-455-0071
Pres.: Jun Matsumoto, Sls Mgr.: Jim Morrison,
Mkt'g/Adv. Mgr.: Harry Quanz
Aiphone NE, Randolph, NJ, 201-328-1790
Aiphone Midwest, Westmont, IL, 312-323-5222
Aiphone SE, Douglasville, GA, 404-920-2811
Products: drive-thru, loudspeaking, microprocessor, multi-channel, programmable, tel-ephone, telephone, video/audio, VOX

Alpha Communications

89-D Cabot Ct.
Hauppauge, NY 11788-3717
(516) 434-8080, 800-666-4800, FAX# 516-434-8334
Pres.: Mark Goldberg, VP: Madelyn Goldberg, Office Mgr.: Rose Tassone
Products: digital, tel-ephone, telephone, video/audio

Alternative Telecommunications

110 Williams St.
New York, NY 10038
(212) 693-1440, FAX# 212-693-1448
Pres.: Alan R. Fitzpatrick, Exec. VP: Sonny Greco
Products: digital, loudspeaking, microprocessor, multi-channel, programmable, VOX

Atkinson Dynamics

10 W. Orange Ave.
S. San Francisco, CA 94080
(415) 583-9845

Bogen Communications

PO Box 575
Ramsey, NJ 07446
(201) 934-8500, FAX# 201-934-9832
Pres.: John Ochtera, VP Sls/Mkt'g: James Orr, Nat'l

Sls Dir.: David Chambers
Products: multi-channel, telephone

Cambridge Electronics Labs

20 Chester St.
Sommerville, MA 02144-3005
(617) 629-2805
Pres.: Dr. Jeffrey Race, Sls Mgr.: Charlotte Bissell

Columbia Scientific

PO Box 203190
Austin, TX 78720
(512) 258-5191

Communications Co.

3490 Noell St.
San Diego, CA 92110
(619) 297-3261, FAX# 619-297-3279
Exec. VP: Michael Jordan, Eng./Mfg.: David Johnson,
Order Desk: Bobby Willis, Order Desk: Laura McCullough, Shipping: Ritchie Willis, Pres.: Peter Jordan
Audio Mkg Assoc., Brecksville, OH, 216-526-2426
Bencsik Assoc., Ocala, FL, 904-732-9775
Secom Systems, Dorville, GA, 800-241-9409
Brian Trankle & Assoc., Belmont, CA, 415-595-4004
Western Audio Sls, Glendale, CA, 818-246-3806
Products: drive-thru, VOX

Communications Equipment

6443 Western Ave., Box 700
Glen Arbor, MI 49636
(616) 334-3081, FAX# 616-334-3661
Pres.: Darrell Thomas, Sls Mgr.: Thomas Garmhausen



Comtek

357 W. 2700 S.
Salt Lake City, UT 84115
(801) 466-3463, FAX# 801-484-6906
Pres.: Ralph Belgique, Eng. Dir.: Steve Kartchner,
Mkt'g Dir.: Steve Dupaux, Svce Mgr.: Laurel Robertson,

Credit Mgr.: Dana Pelletier, Cust. Svce: Stacey Hayes-Garcia
Products: wireless

Cornell Electronics Products

PO Box 23411
Milwaukee, WI 53223
(414) 351-4660, 800-541-946, FAX# 414-351-4657
Pres.: Donald Glaubitz, VP: Gary Butler, Sls Mgr.: Pauline Haack, Mkt'g: Randy Archer, SE Reg Sls Mgr.: William Ellinger, Controller: Thelma Plunkett
Shamrock Electronic Sls, Dayton, OH, 513-258-1227
LSM Assoc., Phelps, NY, 315-548-4891
W.A. Hendrickson, North Scituate, MA, 617-545-0652
Kingston Sls, Indianapolis, IN, 317-876-2545
Avcom, North Olmsted, OH, 216-777-2060
Richard S. Pass Assoc., Langhorne, PA, 215-757-6100
R & S Sls, Rockville Centre, NY, 516-678-6887
Cavendish & Winchester, Atlanta, GA, 404-422-4531
Cartwright & Bean, Orlando, FL, 407-422-4531
Kodo Assoc., Minneapolis, MN, 612-881-1255
Vector, Seattle, WA, 206-322-4343
Rancilio Assoc., St. Louis, MO, 314-845-0202
Dick Bellew Sls, Dallas, TX, 214-644-7881
Bidwell-Schwartz Assoc., Gardena, CA, 213-770-0300
Yocum Mkt'g., Mesa, AZ, 834-3334
Awwest, Fountain Hills, AZ, 602-946-1811

DUKANE

2900 Dukane Dr.
St. Charles, IL 60174
(312) 584-2300, FAX# 312-584-2370
Pres./CEO: J. McWilliams Stone Jr., Group VP: William Finnegan, Div. G. Mgr.: Steven Deppe, Nat'l Sls Mgr.: Warren Anderson, Svce Mgr.: Cliff Carlson
Wally Smutts, Toronto-Ont, Canada, 312-584-2300
Doug Fellabaum, Sycamore, IL, 815-895-7573
Don Mountzen, Beecher, IL, 312-946-9655
Ken Lind, St. Charles, IL, 312-584-2300
Pete Kendal, Jacksonville, FL, 904-262-6025
Ed Nuhring, Portland, OR, 503-244-4262
Jim Lacey, Moreno Valley, CA, 714-243-1160
Jack Brown, Dallas, TX, 214-943-7528
Products: loudspeaking

Durcom

PO Box 315
Bristol, CT 06010
(203) 584-5955
Pres.: Robert Beyus, VP: Elizabeth Miller

Fisher-Berkeley—Ektacom

PO Box 24303
Oakland, CA 94623
(415) 835-7575, FAX# 415-271-8297

Pres: Robert Fisher, Sr. VP: Wood Wymond, VP Eng.:
Robert Shipley, Sls Coord. Mgr.: Richard Flanagan, Sls
Eng.: Michael Lagrimas, Sls Eng.: Kenneth
Jorgensen
Arthur Tilley, Fayetteville, PA, 717-352-8432
Walter Radner, Westfield Center, OH, 216-887-5646

Gilderfluke & Co.

820 Thompson Ave. #35
Glendale, CA 90212
(818) 546-1618, FAX# 818-546-1619

Mgr.: Mike Hopewell, Eng.: Doug Mobley, Tech.: Don
Watson, Office Mgr.: Rose Preto
Products: closed-circuit, custom, loudspeaking, micropro-
cessor, multi-channel, programmable

HM Electronics

6675 Mesa Ridge Rd.
San Diego, CA 92121
(619) 535-6060, FAX# 619-452-7207

VP Mkt'g: J. Michael Hughes, Pro Audio Sls Mgr.:
Eunice Davis, Ind'l Sls Mgr.: Bruce Slemmer, Cust.
Svce Mgr.: Bill Kranzush, Mkt'g Coord.: Matt Riches
Derek Allen Assoc., Toluca Lake, CA, 818-843-6919
John Anthony, Stamford, CT, 203-322-9202
Applied Audio Mkt'g, Ashville, NC, 704-252-9313
A/V Mkt'g, Carmel, IN, 317-846-1034

ITT/DES

20 Mayfield Ave.
Edison, NJ 07607
(201) 225-6121, 800-524-1646

VP: Donald Duthaler, Chief Eng.: Jeffrey Stellman

Jeron Electronic Systems

1743 W. Rosehill Dr.
Chicago, IL 60660
(312) 275-1900, 800-621-1903, FAX# 312-275-
0283

Pres.: Jerome Chesnul, VP Sls: John Charczuk
Admiral Sls, Richardson, TX, 214-357-9212
ASR Enter., Fallston, MD, 301-893-0001
Bi-State Marketers, Ridgefield, NJ, 201-943-5888
Burcaw & Assoc., Warren, MI, 313-573-4605
Central Mkt'g Group, Kansas City, MO, 816-741-7460
Greg Dzubay & Assoc., Peoria, AZ, 602-979-2358
Greg Dzubay & Assoc., Denver, CO, 303-393-7047
Gustafson Sls, Red Wing, MN, 612-388-4277
Gerald Home & Assoc., Stow, MA, 508-897-7146
J.W. Lehner, Stow, OH, 216-686-1965
Meyer Mkt'g, Deerfield Beach, FL, 305-481-9250
Meyer & Ross, Burlingame, CA, 415-348-6800
New West Agency, La Mesa, CA, 619-299-3269
Pat Norman Sls, Indianapolis, IN, 317-842-5611
Pacific West Mkt'g, Kailua, HI, 808-261-7558
Henry Phillips, Roswell, GA, 404-992-3070
Tortech Electronics, Scarborough/Ontario, Canada,
416-282-1011
John S. Wilkin & Assoc., Hillsboro, OH, 513-393-1137
Products: tel-e-phone

Johnson Electronics

4301 Metric Dr.
Winter Park, FL 32792
(407) 677-4030, FAX# 407-679-1288

Pres./CEO: A.J. Schell, VP Mkt'g: Robert Peters,
VP/Eng.: Ken St. John
Products: drive-thru

**LEE DAN COMMUNICATIONS**

155 Adams Ave.
Hauppauge, NY 11788-3699
(516) 231-1414, 800-533-3261, in-state 800-231-
1414, FAX# 516-231-1498

Pres.: Leon Goldberg, VP Op.: Lawrence Goldberg, VP
Finance/Admin.: David Goldberg, Sr. Sls Associate:
Susan Leon, Office Mgr.: Rita Kaplan, Sr. Tech.:
Sandy Hoffman

Products: custom, digital, drive-thru, loudspeaking, micro-
processor, multi-channel, programmable, tel-e-phone, vi-
deo/audio

MATH ASSOCIATES

2200 Shames Dr.
Westbury, NY 11590
(516) 334-6800, FAX# 516-334-6473

Pres.: Ellen Math, CEO/Dir. R & D: Irwin Math, Exec.
VP: Howard Oboler, Exec. VP: Martin Rein

Products: closed-circuit, custom, microprocessor, vi-
deo/audio

Norcon Electronics

1260 Ralph Ave.
Brooklyn, NY 11236
(718) 451-1112, FAX# 718-451-0606
VP: Steven Schlaif

ROH, Div. of Anchor Audio

93 W. 223rd St.
Torrance, CA 90502
(213) 533-1498, 800-262-4671, FAX# 213-533-
6050
Dir. Mkt'g: Dan Garrigan, Dir. Eng.: Saul Walker

RTS SYSTEMS

1100 W. Chestnut St.
Burbank, CA 91506
(818) 566-6700, FAX# 818-843-7953
Pres.: Robert Smith, VP Mkt'g: Doug Leighton, VP
Eng./Tech.: Stan Hubler, Sls Mgr.: Shelley Harrison

RING COMMUNICATIONS

57 Trade Zone Dr.
Ronkonkoma, NY 11779
(516) 585-7464, FAX# 516-585-7410
Pres.: Paul McLean, VP Sls: Craig Krsanac, V.P.
Tech.: Kjell (Ken) Solem, Tech Support: Charlie Kulins
Klump Sls, Jacksonville, FL, 904-287-5205
Corrigan Agencies, 504-893-7455
Gustafson Sls, 612-388-4277
Allwest Electronics, 805-388-1789
Pacnor, 206-771-6016
J.C. Electronics, 808-943-8514
Products: digital, microprocessor, multi-channel, program-
mable

Stentofon Communications

6119 Connecticut Ave.
Kansas City, MO 64120
(816) 231-7200, FAX# 816-231-7203
Mkt'g Mgr.: Douglas Caldwell
Tom Reilly, Rye, NY, 914-933-2554
Linda Wick, Chicago, IL, 312-981-5136
Mike Wilcock, Los Angeles, CA, 818-335-0543
Products: digital, loudspeaking, microprocessor, multi-chan-

nel, programmable, tel-e-phone, VOX

TOA ELECTRONICS

PO Box 2047
S. San Francisco, CA 94080
(415) 588-2538, 800-843-4750, in-state 800-in CA
800-632-2157, FAX# 415-588-3349
Pres.: Yoshiro Ishida, Nat'l Sls Mgr/Comm. Pro.:
Richard Krochmal, Nat'l Sls Mgr./Pro. Music & Ent.:
Rick Kamlet, Nat'l Sls Mgr./Intercom: Al Burns
Products: custom, digital, loudspeaking, microprocessor,
multi-channel, programmable, tel-e-phone, VOX

T.S.K. Electronics

PO Box 190
Tonawanda, NY 14151-0191
(716) 693-3916, FAX# 716-692-6433
P.: Theodore Kedzierski, Eng.: Kevin Kedzierski
Products: custom, loudspeaking, tel-e-phone, VOX

TALK-A-PHONE

5013 N. Kedzie Ave.
Chicago, IL 60625
(312) 539-1100, FAX# 312-539-1241
P.: Z. Liberman, VP: S. Shanes, Sls: Dan Kagan
Products: drive-thru, loudspeaking, VOX

TEKNICOM

470 Commercial Ave.
Palisades Park, NJ 07650
(201) 947-7010, FAX# 201-947-7069
Products: loudspeaking, microprocessor, multi-channel,
programmable

Telecall America

PO Box 70206
Bellevue, WA 98007
(206) 881-2742, FAX# 206-881-3075
Pres.: Hiko Shinoda, Asst: Nanci Brooks
Palmieri Assoc., Ridgefield, NJ, 201-943-5888
Henry Phillips, Roswell, GA, 404-922-3070
Steffey Mkt'g, Northbrook, IL, 312-480-3575
Dimension Point IX, Lewisville, TX, 214-436-3706
Bidwell Schwartz Assoc., Gardena, CA, 213-770-0300

Tele Communications

9600 Aldrich Ave. S.
Minneapolis, MN 55420
(612) 884-4051, FAX# 612-884-0043
Pres.: Jeffrey Wetherell, VP Mkt'g: James Arrington,
VP Sls: Dan Dantzler, Dir. Mkt'g: Dond Meehen, Dir
Adv.: Ronald Taylor
West Tech/Lichtenauer, Culver City, CA, 213-870-9286
Bencsik Assoc., Ocala, FL, 904-732-9775
Burcaw & Assoc., Warren, MI, 313-573-4605
SAGA, Oswego, NY, 315-343-5739
Monfort Electronic Mkt'g, Indianapolis, IN, 317-872-
8877
Murphy & Cota, Atlanta, GA, 404-875-2525
Northland Assoc., Moorhead, MN, 218-233-4616
Rancilio Assoc., St. Louis, MO, 314-845-0202
J.Y. Schoonmaker, Dallas, TX, 214-349-1650
Sigma, Valley Forge, PA, 215-783-6666
Weller Electronic Sls, Worthington, OH, 614-885-7819
Ziskind Assoc., Rolling Meadows, IL, 312-577-1624
White Radio, Burlington-Ont., Canada, 416-632-6894
Silver Peak Mkt'g, Denver, CO, 303-467-9042
Pacnor Mkt'g, Lynnwood, WA, 206-771-6016
Products: VOX

Ultrak

660 Compton St.
Broomfield, CO 80020
(303) 466-7333, FAX# 303-469-8336
Products: video/audio

Need complete state-of-the-art intercom systems?



World Radio History

Just Ring.

Sell an intercom installation and ordinarily your job is just beginning. You've got to select and assemble compatible amplifiers, baffles, speakers and more. Then, after installation, you've got to carefully check their individual performance.

Install RingMaster intercoms and your job is far quicker and simpler. Ring Communications supplies you not only with sophisticated microprocessor-controlled intercoms, but also the entire system. From perfectly matched amps, baffles and speakers down to the microphones.

The handfree intercoms are state of the art. Communications can be intercom point to point, or via paging systems, tie lines, pocket page or even telephone access. Features include group call, all call, group hunting, conferencing, and more. Models are available for jobs requiring as few as 2 stations to as many as 5,000—hospitals, brokerage houses, elevators and other applications included.

Ring also provides a broad range of sales aids: national advertising that generates leads in your market. Design, sales and technical assistance for any

size project. Plus sales, product training and customer site demonstration. And we're committed to the highest level of customer service.

Want help making your phone ring? Then call (516) 585-RING or contact Ring Communications, Inc., 57 Trade Zone Drive, Ronkonkoma, NY 11779. Fax: (516) 585-7410.

RING
COMMUNICATIONS, INC.

INTERCOM—HOSPITAL HEALTH CARE

Adaptive Micro Systems

7840 N. 86th St.
Milwaukee, WI 53224
(414) 357-2020, 800-558-7022, FAX# 414-357-2029

Products: visual

AIPHONE INTERCOM SYSTEMS

PO Box 90075
Bellevue, WA 98009
(206) 455-0510, 800-692-0200, FAX# 206-455-0071

Pres.: Jun Matsumoto, Sls Mgr.: Jim Morrison,
Mkt'g/Adv. Mgr.: Harry Quanz
Aiphone NE, Randolph, NJ, 201-328-1790
Aiphone Midwest, Westmont, IL, 312-323-5222
Aiphone SE, Douglasville, GA, 404-920-2811
Products: direct select, emergency call, microprocessor,
nurse-call, visual, voice paging

Alpha Communications

89-D Cabot Ct.
Hauppauge, NY 11788-3717
(516) 434-8080, 800-666-4800, FAX# 516-434-8334

Pres.: Mark Goldberg, VP: Madelyn Goldberg, Office
Mgr.: Rose Tassone
Products: AV, annunciators, direct select, emergency call,
microprocessor, nurse-call, pillow speakers, visual, voice
paging

American Zettler

16881 Hale Ave.
Irvine, CA 92714
(714) 660-1670
Nat'l Mkt'g Mgr.: Michael Nathanson

ATLAS/SOUNDOLIER

1859 Intertech Dr.
Fenton, MO 63026
(314) 349-3110, 800-876-7337, FAX# 314-349-1251

VP/GM: Pete Marsac, VP/Mkt'g: Herbert Jaffe, W.
Reg./Sls Mgr.: Bud Waters, W. Reg./Ass. Sls Mgr.: Jim
Edwards, E. Reg./Ass. Sls Mgr.: Walter Best, Order
Entry Dept. Mgr.: Dale McIntyre
Atlas/Soundolier, Parsippany, NJ, 201-887-7800
Atlas Electronics, Toronto, Canada, 416-789-7761
Atlas/Ind'l, Fenton, MO, 800-362-5673
Atlas/Exp. Dept., Fenton, MO, 314-349-3110
Products: AV, annunciators, visual, voice paging

The Auth Co.

505 Acorn St.
Deer Park, NY 11729
(516) 667-9000, FAX# 516-667-9887

Chairman: George May, VP/General Mgr.: Joel Kahn,
VP Finance: Richard Nelson, Nat'l Sls Mgr.: Steven
Weil, Dir. of Op: Kenneth Gmora
Products: AV, annunciators, emergency call, nurse-call, vi-
sual

Bunting

46 Bearice St.
Bridgeport, CT 06607
(203) 384-0081, FAX# 203-335-3003
CEO/Pres.: Lee Bunting, VP Mkt'g: John Larounis
John Larounis, St. Charles, IL, 312-584-1221
George Lytle, Cherry Hill, NJ, 609-751-0419
Products: nurse-call

CMX

1111 Industry Ave.
Roanoke, VA 24013
(703) 982-3900, FAX# 408-986-0452
Mkt'g: Charlie Rowland
Products: voice paging

Communications Equipment

6443 Western Ave., Box 700
Glen Arbor, MI 49636
(616) 334-3081, FAX# 616-334-3661
Pres.: Darrell Thomas, Sls Mgr.: Thomas Garmhausen
Products: AV, annunciators, direct select, emergency call,
nurse-call, visual, voice paging

Com-Tec

PO Box 965
Appleton, WI 54912
(414) 734-7105, FAX# 414-734-0493
Pres./Co-Owner: Ken McLellan, Exec. VP/Co-Owner:
Anthony Leslie
Products: AV, annunciators, direct select, emergency call,
microprocessor, nurse-call, pillow speakers, visual, voice
paging

Comell Electronics Products

PO Box 23411
Milwaukee, WI 53223
(414) 351-4660, 800-541-946, FAX# 414-351-4657
Pres.: Donald Glaubitz, VP: Gary Butler, Sls Mgr.:
Pauline Haack, Mkt'g: Randy Archer, SE Reg Sls Mgr.:
William Ellinger, Controller: Thelma Plunkett
Shamrock Electronic Sls, Dayton, OH, 513-258-1227
LSM Assoc., Phelps, NY, 315-548-4891
W.A. Hendrickson, North Scituate, MA, 617-545-0652
Kingston Sls, Indianapolis, IN, 317-876-2545
Avcom, North Olmsted, OH, 216-777-2060
Richard S. Pass Assoc., Langhorne, PA, 215-757-6100
R & S Sls, Rockville Centre, NY, 516-678-6887
Cavendish & Winchester, Atlanta, GA, 404-422-4531
Cartwright & Bean, Orlando, FL, 407-422-4531
Kodo Assoc., Minneapolis, MN, 612-881-1255
Vector, Seattle, WA, 206-322-4343
Rancilio Assoc., St. Louis, MO, 314-845-0202
Dick Bellew Sls, Dallas, TX, 214-644-7881
Bidwell-Schwartz Assoc., Gardena, CA, 213-770-0300
Yocum Mkt'g., Mesa, AZ, 834-3334
Avwest, Fountain Hills, AZ, 602-946-1811
Products: AV, annunciators, direct select, emergency call,
nurse-call, visual, voice paging

Crest Electronics

PO Box 384



JERON

THE 3 PRIORITY LEVEL VISUAL NURSE CALL . . . Jeron EC-300

3 Distinct Audible & Visual Signals



1	 ROUTINE (Room) Calls
2	 URGENT (Bath) Calls
3	 EMERGENCY (Code & Fire) Calls

- UL 1069 Listed
- Made in America

FOR COMPLETE DETAILS ON THE EC-300
FAX or CALL JERON TODAY!

JERON ELECTRONIC SYSTEMS, INC.
1743 W. Rosehill Drive Chicago, IL 60660 (312) 275-1900
Call us: 1-800-621-1903 FAX us: 1-312-275-0283

J-9-2

Circle 33 on Reader Response Card

Dassel, MN 55325
 (612) 275-3382, 800-328-8908, FAX# 612-275-2306
 Pres./CEO: James Holm, Tech Svcs Mgr.: Brian Torney, Prod. Mgr.: Jerry Kumpula, Dir. Op./Purch. Mgr.: Dwayne Kettenacker, Dir. Prod. Dev.: Bill LaFerty, VP: Robert Zahler
 Products: AV, annunciators, direct select, emergency call, microprocessor, nurse-call, pillow speakers, visual, voice paging

(312) 275-1900, 800-621-1903, FAX# 312-275-0283
 Pres.: Jerome Chesnul, VP Sls: John Charczuk
 Admiral Sls, Richardson, TX, 214-357-9212
 ASR Enter., Fallston, MD, 301-893-0001
 Bi-State Marketers, Ridgefield, NJ, 201-943-5888
 Burcaw & Assoc., Warren, MI, 313-573-4605
 Central Mkt'g Group, Kansas City, MO, 816-741-7460
 Greg Dzuby & Assoc., Peoria, AZ, 602-979-2358
 Greg Dzuby & Assoc., Denver, CO, 303-393-7047
 Gustafson Sls, Red Wing, MN, 612-388-4277
 Gerald Horne & Assoc., Stow, MA, 508-897-7146
 J.W. Lehner, Stow, OH, 216-686-1965

Meyer Mkt'g, Deerfield Beach, FL, 305-481-9250
 Meyer & Ross, Burlingame, CA, 415-348-6800
 New West Agency, La Mesa, CA, 619-299-3269
 Pat Norman Sls, Indianapolis, IN, 317-842-5611
 Pacific West Mkt'g, Kailua, HI, 808-261-7558
 Henry Phillips, Roswell, GA, 404-992-3070
 Tortech Electronics, Scarborough/Ontario, Canada, 416-282-1011
 John S. Wilkin & Assoc., Hillsboro, OH, 513-393-1137
 Products: annunciators, emergency call, microprocessor, nurse-call, visual, voice paging

Komtek Communications
 11 White Lakes Rd.

Delta Communications
 7852 78th Ave., S.W.
 Tacoma, WA 98498
 (206) 582-2201, FAX# 206-588-1588
 Owner/Pres.: Sid Flothe
 Products: nurse-call, voice paging

DUKANE
 2900 Dukane Dr.
 St. Charles, IL 60174
 (312) 584-2300, FAX# 312-584-2370
 Pres./CEO: J. McWilliams Stone Jr., Group VP: William Finnegan, Div. G. Mgr.: Steven Deppe, Nat'l Sls Mgr.: Warren Anderson, Svce Mgr.: Cliff Carlson
 Wally Smutts, Toronto-Ont, Canada, 312-584-2300
 Doug Fellabaum, Sycamore, IL, 815-895-7573
 Don Mountzen, Beecher, IL, 312-946-9655
 Ken Lind, St. Charles, IL, 312-584-2300
 Pete Kendal, Jacksonville, FL, 904-262-6025
 Ed Nuhring, Portland, OR, 503-244-4262
 Jim Lacey, Moreno Valley, CA, 714-243-1160
 Jack Brown, Dallas, TX, 214-943-7528
 Products: AV, annunciators, direct select, emergency call, microprocessor, nurse-call, pillow speakers, visual, voice paging

Edstan Doctors Register, Div. of Time & Sound
 14120 Live Oak Ave.
 Baldwin Park, CA 91706
 (818-960-7781) 960-7781, 800-426-4765

Engineered Electronics
 PO Box 60
 Douglasville, GA 30133
 (404) 949-3290, 800-331-3541, FAX# 404-489-8905
 Pres.: Roy Caviness, Exec. VP: Anthony Bunch, Sls Mgr.: Larry Fortner
 Products: AV, annunciators, emergency call, nurse-call, pillow speakers, visual, voice paging

Fisher-Berkeley—Ektacom
 PO Box 24303
 Oakland, CA 94623
 (415) 835-7575, FAX# 415-271-8297
 Pres: Robert Fisher, Sr. VP: Wood Wymond, VP Eng.: Robert Shipley, Sls Coord. Mgr.: Richard Flanagan, Sls Eng.: Michael Lagrimas, Sls Eng.: Kenneth Jorgensen
 Arthur Tilley, Fayetteville, PA, 717-352-8432
 Walter Radner, Westfield Center, OH, 216-887-5646

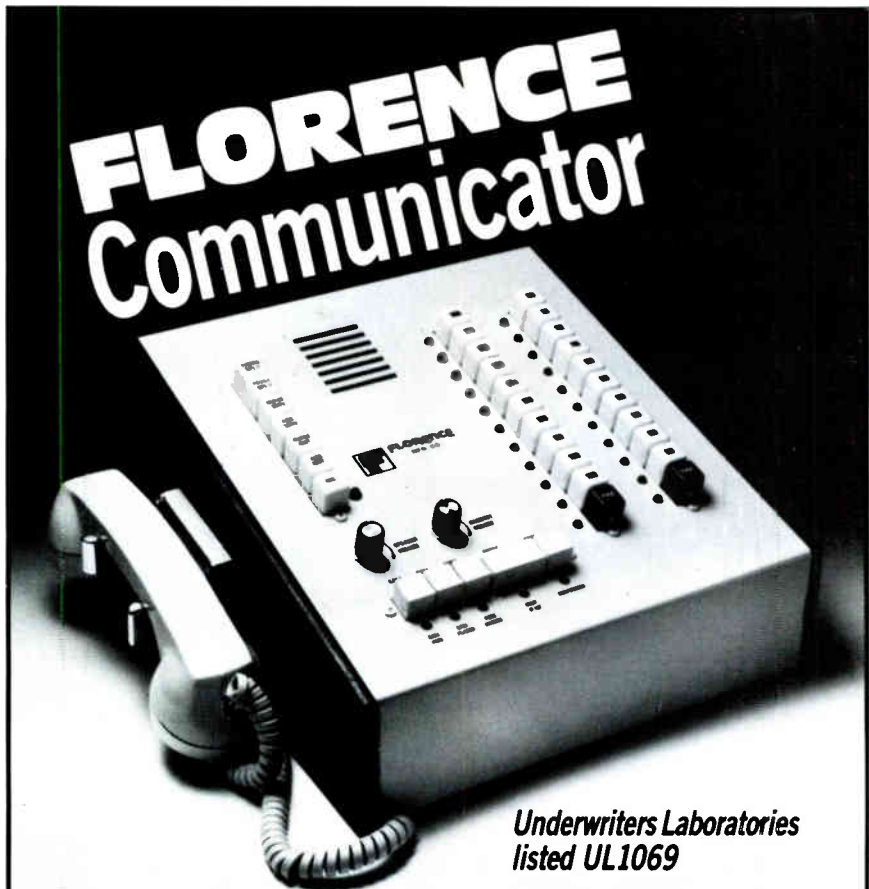

Underwriters Laboratories listed UL1069

Audio Visual Nurse Call System

Features of the Master Station

- Annunciation of normal and emergency calls
- Audio communications with remote stations
- Visual display of calls
- Convenient, single button station selection
- Room numbers on button caps
- Group page
- Call forward
- Call hold
- Tone silence
- Press-to-talk bar
- Call cancel
- Handset for privacy with voice switching
- Listen controls for handset and speaker
- Panel speaker-microphone



FOR CATALOG CALL, FAX, WRITE

FLORENCE
MANUFACTURING CO.
 A UNIT OF FLORENCE CORPORATION

2101 N. ELSTON AVENUE, CHICAGO, ILLINOIS 60614
 312-384-3310 • FAX-312-384-3460

Circle 286 on Reader Response Card

 **JERON**
 electronic systems, inc.

Jeron Electronic Systems
 1743 W. Rosehill Dr.
 Chicago, IL 60660

Stanley, NM 87056
 (505) 832-6236, 800-545-7000
 Pres.: Bill Patterson
 Products: annunciators, emergency call, microprocessor, nurse-call, visual



LEE DAN COMMUNICATIONS

155 Adams Ave.
 Hauppauge, NY 11788-3699
 (516) 231-1414, 800-533-3261, in-state 800-231-1414, FAX# 516-231-1498
 Pres.: Leon Goldberg, VP Op.: Lawrence Goldberg, VP Finance/Admin.: David Goldberg, Sr. Sls Associate: Susan Leon, Office Mgr.: Rita Kaplan, Sr. Tech.: Sandy Hoffman
 Products: AV, annunciators, emergency call, microprocessor, nurse-call, pillow speakers, visual, voice paging

MACKENZIE LABORATORIES

PO Box 3029
 Arcadia, CA 91006
 (818) 579-0440, 800-423-4147, FAX# 818-448-7131
 Pres.: Addison Taylor, VP/Chief Eng: Nagy Khattar, Sls Supervisor: Joe Vitale, Mkt'g/Training: Emory Straus
 Avwest, Phoenix, AZ, 602-946-1811
 Lex Lawson Assoc., Dallas, TX, 214-272-8482
 Avcom, N. Olmstead, OH, 216-777-2060
 Rancilio Assoc., St. Louis, MO, 314-845-0202
 Rancilio Assoc., Kansas City, KS, 913-491-9883
 Warren Assoc., Santa Clara, CA, 408-988-7762
 Piper Assoc., Needham, MA, 617-449-1144
 Bencsik Assoc., Ocala, FL, 904-732-9775
 Design Factors, Los Angeles, CA, 213-697-7576
 Riley & Petchell Sls, Detroit, MI, 313-937-3000
 Monfort Electronics, Indianapolis, IN, 317-872-8877
 Gustafson Systems Sls, Chicago, IL, 315-358-2505
 Chuck Olson Assoc., Renton, WA, 206-255-8692
 RWR, Rock Hill, SC, 803-324-5111
 RWR, Norcross, GA, 404-263-9349
 RWR, Alabaster, AL, 206-663-2744
 Northland Assoc., Moorehead, MN, 218-233-4616
 Products: emergency call, voice paging

MATH ASSOCIATES

2200 Shames Dr.
 Westbury, NY 11590
 (516) 334-6800, FAX# 516-334-6473
 Pres.: Ellen Math, CEO/Dir. R & D: Irwin Math, Exec. VP: Howard Oboler, Exec. VP: Martin Rein
 Products: microprocessor

MED-TEK

1335 S. Claudina St.
 Anaheim, CA 92805-6235
 (714) 774-8484, 800-654-3270, FAX# 714-774-7388
 Pres.: William Haines, VP Sls: William Haines, VP Operations: Daniel Haines, Asst. Sls Mgr.: Bo Buchanan
 Products: nurse-call, pillow speakers

Mehlich Electronics

PO Box 33276
 Raleigh, NC 27636
 (919) 832-4292
 Pres.: Karl Mehlich, VP: Leonard Mehlich, Sec./Treas.: Carolyn Mehlich
 Products: AV, emergency call, nurse-call

Microframe
 8236 E. 71st St., Ste. 356
 Tulsa, OK 74133
 (918) 250-4839, 800-635-3811
 Products: visual

Multi-Vox Ltd.

9967 St. Michel Blvd.
 Montreal-Nord, Quebec, Canada H1H 5G7
 (514) 321-3131
 Pres.: Jean Lajoire, Eng.: Dominique Malenfant, Op. Mgr.: Georges Morissette, Sls/Tech Coord.: Antoine Krelio

Portland Instrument

1101A Air Way
 Glendale, CA 91201
 (818) 500-0137, 800-999-5260, FAX# 818-240-1828
 Pres.: Ron Fuller, G. Mgr.: Jack Sympton, Sls Mgr.: John Batson, Asst. Sls Mgr.: Lisa Fuller, Sr. Tech.: Patrick Gratner, Ship./Rec.: Dave Johnson
 Products: voice paging

Powertronix

10623 Lawson River Ave.
 Fountain Valley, CA 92708
 (714) 963-5411
 Pres.: Robert Gehlke, Sls Mgr.: Bill Organ

Rauland-Borg

3450 W. Oakton St.
 Skokie, IL 60076-2951
 (312) 679-0900, FAX# 312-679-0625/312-679-6219
 Pres./CEO: William Krucks, Exec. VP: Kenneth T. James, VP Sls/Mkt'g: Rick Blunt, Nat'l Sls Mgr.: Harry B. Hahn

RING COMMUNICATIONS

57 Trade Zone Dr.
 Ronkonkoma, NY 11779
 (516) 585-7464, FAX# 516-585-7410
 Pres.: Paul McLean, VP Sls: Craig Krsanac, V.P. Tech.: Kjell (Ken) Solem, Tech Support: Charlie Kulins
 Klumpp Sls, Jacksonville, FL, 904-287-5205
 Corrigan Agencies, 504-893-7455
 Gustafson Sls, 612-388-4277
 Allwest Electronics, 805-388-1789
 Pacnor, 206-771-6016
 J.C. Electronics, 808-943-8514
 Products: annunciators

Stentofon Communications

6119 Connecticut Ave.
 Kansas City, MO 64120
 (816) 231-7200, FAX# 816-231-7203
 Mkt'g Mgr.: Douglas Caldwell
 Tom Reilly, Rye, NY, 914-933-2554
 Linda Wick, Chicago, IL, 312-981-5136
 Mike Wilcock, Los Angeles, CA, 818-335-0543
 Products: annunciators, direct select, emergency call, microprocessor

TOA ELECTRONICS

PO Box 2047
 S. San Francisco, CA 94080
 (415) 588-2538, 800-843-4750, in-state 800-in CA 800-632-2157, FAX# 415-588-3349
 Pres.: Yoshiro Ishida, Nat'l Sls Mgr./Comm. Pro.: Richard Krochmal, Nat'l Sls Mgr./Pro. Music & Ent.: Rick Kamlet, Nat'l Sls Mgr./Intercom: Al Burns
 Products: annunciators, direct select, emergency call, microprocessor, visual, voice paging

TALK-A-PHONE

5013 N. Kedzie Ave.
 Chicago, IL 60625
 (312) 539-1100, FAX# 312-539-1241
 Pres.: Z. Liberman, VP: S. Shanes, Sls Mgr.: Dan Kagan
 Products: annunciators, direct select, voice paging

TekTone®

Tektone Sound & Signal Mfg.

PO Box 12427
 Lake Park, FL 33403
 (407) 844-2383, 800-327-8466, FAX# 407-845-1587
 G. Mgr.: Carlos Mira, Dir. Sls/Mkt'g: Tom Hendricks
 Dardon & Assoc., Olmsted Twp, OH, 216-234-4555
 Lee Dan Comm., Hauppauge, NY, 516-231-1414
 Klumpp Sls, Jacksonville, FL, 904-287-5205
 Alvan Chaney & Assoc., Hialeah, FL, 305-558-3933
 Ziskind & Assoc., Rolling Meadow, IL, 312-577-1624
 Wm. B. Allen Supply, New Orleans, LA, 504-525-8222
 R.W. Sls, St. Paul, MN, 612-646-2710
 Mountain Reps, Denver, CO, 303-623-0972
 Westech Mkt'g, Culver City, CA, 213-870-9286
 B & B Sls, Oakland, CA, 415-534-1725
 Chuck Olson Assoc., Renton, WA, 206-271-5416
 Alpha Communications, Hauppauge, NY, 516-434-8080
 Fairfax Electronics, Los Angeles, CA, 213-731-2561
 Midtekcom, Olmsted Twp, OH, 216-243-4840
 Products: AV, annunciators, emergency call, microprocessor, nurse-call, pillow speakers, visual, voice paging

3M SOUND PRODUCTS

551-1W, 3M Center
 St. Paul, MI 55144-1000
 (612) 733-9214, FAX# 612-736-7614
 Mkt'g Mgr.: Richard Barker

T.S.K. Electronics

PO Box 190
 Tonawanda, NY 14151-0191
 (716) 693-3916, FAX# 716-692-6433
 Pres.: Theodore Kedzierski, Chief Eng.: Kevin Kedzierski

Ultrak

660 Compton St.
 Broomfield, CO 80020
 (303) 466-7333, FAX# 303-469-8336
 Products: AV

Wescom

4800 Dellwood Ave.
 Jacksonville, FL 32205
 (904) 384-0712, FAX# 904-384-0758
 Pres.: Charles Bell, Dir. Sls/Mkt'g: Bill Simpson
 Westside Communications, Jacksonville, FL, 904-389-6801
 Wescom, Birmingham, AL, 205-823-9333
 Products: nurse-call

INTERCOM—INDUSTRIAL

ATC Supply
106 Hobart St.
Hackensack, NJ 07601
(201) 488-0776, FAX# 201-488-6975
Pres.: Sonny Greco

AIPHONE INTERCOM SYSTEMS
PO Box 90075
Bellevue, WA 98009
(206) 455-0510, 800-692-0200, FAX# 206-455-0071
Pres.: Jun Matsumoto, Sls Mgr.: Jim Morrison,
Mkt'g/Adv. Mgr.: Harry Quanz
Aiphone NE, Randolph, NJ, 201-328-1790
Aiphone Midwest, Westmont, IL, 312-323-5222
Aiphone SE, Douglasville, GA, 404-920-2811
Products: drive-thru, loudspeaking, telephone

Alpha Communications
89-D Cabot Ct.
Hauppauge, NY 11788-3717
(516) 434-8080, 800-666-4800, FAX# 516-434-8334
Pres.: Mark Goldberg, VP: Madelyn Goldberg, Office
Mgr.: Rose Tassone
Products: headset/handset, loudspeaking, telephone

Alternative Telecommunications
110 Williams St.
New York, NY 10038
(212) 693-1440, FAX# 212-693-1448
Pres.: Alan R. Fitzpatrick, Exec. VP: Sonny Greco

Atkinson Dynamics
10 W. Orange Ave.
S. San Francisco, CA 94080
(415) 583-9845

ATLAS/SOUNDOLIER
1859 Intertech Dr.
Fenton, MO 63026
(314) 349-3110, 800-876-7337, FAX# 314-349-1251
VP/GM: Pete Marsac, VP/Mkt'g: Herbert Jaffe, W.
Reg./Sls Mgr.: Bud Waters, W. Reg./Ass. Sls Mgr.: Jim
Edwards, E. Reg./Ass. Sls Mgr.: Walter Best, Order
Entry Dept. Mgr.: Dale McIntyre
Atlas/Soundolier, Parsippany, NJ, 201-887-7800
Atlas Electronics, Toronto, Canada, 416-789-7761
Atlas/Ind'l, Fenton, MO, 800-362-5673
Atlas/Exp. Dept., Fenton, MO, 314-349-3110
Products: environmentally protected, loudspeaking, tele-
phone

Bogen Communications
PO Box 575
Ramsey, NJ 07446
(201) 934-8500, FAX# 201-934-9832
Pres.: John Ochtera, VP Sls/Mkt'g: James Orr, Nat'l
Sls Dir.: David Chambers
Products: loudspeaking, telephone

Communications Co.
3490 Noell St.
San Diego, CA 92110
(619) 297-3261, FAX# 619-297-3279
Exec. VP: Michael Jordan, Eng./Mfg.: David Johnson,
Order Desk: Bobby Willis, Order Desk: Laura
McCullough, Shipping: Ritchie Willis, Pres.: Peter
Jordan
Audio Mkg Assoc., Brecksville, OH, 216-526-2426
Bencsik Assoc., Ocala, FL, 904-732-9775
Secom Systems, Dorrvile, GA, 800-241-9409
Brian Trankle & Assoc., Belmont, CA, 415-595-4004
Western Audio Sls, Glendale, CA, 818-246-3806
Products: drive-thru

Communications Equipment
6443 Western Ave., Box 700
Glen Arbor, MI 49636
(616) 334-3081, FAX# 616-334-3661
Pres.: Darrell Thomas, Sls Mgr.: Thomas Garmhausen
Products: drive-thru, headset/handset, loudspeaking

Are you
moving?
Don't miss an issue.

PLACE MAILING LABEL HERE

Name _____
Address _____
City _____
State _____ Zip _____

Return to:
Sound & Communications
25 Willowdale Avenue
Port Washington, NY 11050

STEP ON IT!

Today's Headsets and Belt-Packs all provide high quality communications. Some are even comfortable and convenient to use. Production Intercom Headsets and Belt-Packs add 'survivability'. Even when you step on them. Ask us to prove it.



**Production
Intercom**

Technical Projects, Inc
P.O. Box 3247 Barrington, IL 60010
(312) 381-5350 Fax: (312) 381-4360
1 (800) 562-5872

Circle 65 on Reader Response Card

Comtek
357 W. 2700 S.
Salt Lake City, UT 84115
(801) 466-3463, FAX# 801-484-6906
Pres.: Ralph Belgique, Eng. Dir.: Steve Kartchner,
Mkt'g Dir.: Steve Dupaix, Svce Mgr.: Laurel Robertson,
Credit Mgr.: Dana Pelletier, Cust. Svce: Stacey Hayes-
Garcia

Cornell Electronics Products
PO Box 23411
Milwaukee, WI 53223
(414) 351-4660, 800-541-946, FAX# 414-351-
4657

Pres.: Donald Glaubitz, VP: Gary Butler, Sls Mgr.:
Pauline Haack, Mkt'g: Randy Archer, SE Reg Sls Mgr.:
William Ellinger, Controller: Thelma Plunkett
Shamrock Electronic Sls, Dayton, OH, 513-258-1227
LSM Assoc., Phelps, NY, 315-548-4891
W.A. Hendrickson, North Scituate, MA, 617-545-0652
Kingston Sls, Indianapolis, IN, 317-876-2545
Avcom, North Olmsted, OH, 216-777-2060
Richard S. Pass Assoc., Langhorne, PA, 215-757-6100
R & S Sls, Rockville Centre, NY, 516-678-6887
Cavendish & Winchester, Atlanta, GA, 404-422-4531
Cartwright & Bean, Orlando, FL, 407-422-4531
Kodo Assoc., Minneapolis, MN, 612-881-1255
Vector, Seattle, WA, 206-322-4343
Rancilio Assoc., St. Louis, MO, 314-845-0202
Dick Bellow Sls, Dallas, TX, 214-644-7881
Bidwell-Schwartz Assoc., Gardena, CA, 213-770-0300
Yocum Mkt'g., Mesa, AZ, 834-3334
Avwest, Fountain Hills, AZ, 602-946-1811

Dayton Industrial
126 Westpark Rd.
Dayton, OH 45459
(513) 236-3591
VP Sls/Mkt'g: Robert McDougall, VP Eng.: Kurt
Farmer, Sr. Tech.: Frank Jaros
Products: drive-thru, telephone

Delta Communications
7852 78th Ave., S.W.
Tacoma, WA 98498
(206) 582-2201, FAX# 206-588-1588
Owner/Pres.: Sid Flothe
Products: loudspeaking

Detector Systems
11650 Seaboard Circle
Stanton, CA 90680
(714) 895-6366, 800-828-7775, FAX# 714-895-
6145
Sls Mgr.: Ron Miller, Inside Sls: Jill Herbel, Mkt'g: Carl
Zabel, VP: Bill Russell
Products: drive-thru

Drive-Thru Intercoms
2500 New Hwy-287
Mansfield, TX 76063
(817) 572-3177, FAX# 817-478-2506
Products: drive-thru

DUKANE
2900 Dukane Dr.
St. Charles, IL 60174
(312) 584-2300, FAX# 312-584-2370
Pres./CEO: J. McWilliams Stone Jr., Group VP: William
Finnegan, Div. G. Mgr.: Steven Deppe, Nat'l Sls Mgr.:
Warren Anderson, Svce Mgr.: Cliff Carlson
Wally Smutts, Toronto-Ont, Canada, 312-584-2300
Doug Fellabaum, Sycamore, IL, 815-895-7573
Don Mountizen, Beecher, IL, 312-946-9655
Ken Lind, St. Charles, IL, 312-584-2300
Pete Kendal, Jacksonville, FL, 904-262-6025
Ed Nuhning, Portland, OR, 503-244-4262

Jim Lacey, Moreno Valley, CA, 714-243-1160
Jack Brown, Dallas, TX, 214-943-7528

ELENEX (EAST)
7 Wayland St.
N. Cohocton, NY 14868
(716) 534-5280, 800-356-8433, FAX# 716-534-
5950
Prod Mgr.: David J. Arseneau, Sls: Linda Sabo
Cavendish & Winchester, Atlanta, GA, 404-449-5104
Earl & Brown, Redmond, WA, 206-885-5064
Products: drive-thru, headset/handset, loudspeaking, tele-
phone

ELENEX (WEST)
7392 Trade St.
San Diego, CA 92121
(619) 566-7515, 800-225-3113, in-state 800-in CA
800-225-8037, FAX# 619-586-1484
VP: Dennis Berglund, Eng.: Al Bitarafan, Sls: Lou
Hennequin
Products: drive-thru, environmentally protected,
headset/handset, loudspeaking

Encom Products
502 Lower Hopewell Rd.
Oxford, PA 19363
(215) 932-9600, FAX# 215-932-9999
Products: environmentally protected, headset/handset, tel-
ephone

Fisher-Berkeley—Ektacom
PO Box 24303
Oakland, CA 94623
(415) 835-7575, FAX# 415-271-8297
Pres: Robert Fisher, Sr. VP: Wood Wymond, VP Eng.:
Robert Shipley, Sls Coord. Mgr.: Richard Flanagan, Sls
Eng.: Michael Lagrimas, Sls Eng.: Kenneth
Jorgensen
Arthur Tilley, Fayetteville, PA, 717-352-8432
Walter Radner, Westfield Center, OH, 216-887-5646

Gai-Tronics
PO Box 31
Reading, PA 19603
(215) 372-5151, 800-492-1212, FAX# 215-374-
1474
Pres.: Timothy Cobb, Dir. Sls/Mkt'g: G. Edward Smith,
Controller: Jeffrey Jones, Nat'l Sls Mgr.: Daniel Peters,
Int'l Sls Mgr.: Timothy Moyer, Mfg Mgr.: William Moore
Gai-Tronics, Reading, PA, 215-372-5151
Gai-Tronics, St. Rose, LA, 504-466-1666
Gai-Tronics, Houston, TX, 713-680-1980
Gai-Tronics, Toledo, OH, 419-893-5700
Products: environmentally protected, headset/handset, tel-
ephone

HM Electronics
6675 Mesa Ridge Rd.
San Diego, CA 92121
(619) 535-6060, FAX# 619-452-7207
VP Mkt'g: J. Michael Hughes, Pro Audio Sls Mgr.:
Eunice Davis, Int'l Sls Mgr.: Bruce Slemmer, Cust.
Svce Mgr.: Bill Kranzush, Mkt'g Coord.: Matt Riches
Derek Allen Assoc., Toluca Lake, CA, 818-843-6919
John Anthony, Stamford, CT, 203-322-9202
Applied Audio Mkt'g, Ashville, NC, 704-252-9313
AV Mkt'g, Carmel, IN, 317-846-1034
Products: drive-thru, headset/handset, loudspeaking

ITT/DES
20 Mayfield Ave.
Edison, NJ 07607
(201) 225-6121, 800-524-1646
VP: Donald Duthaler, Chief Eng.: Jeffrey Stellman

Jeron Electronic Systems
1743 W. Rosehill Dr.
Chicago, IL 60660
(312) 275-1900, 800-621-1903, FAX# 312-275-
0283
Pres.: Jerome Chesnul, VP Sls: John Charczuk
Admiral Sls, Richardson, TX, 214-357-9212
ASR Enter., Fallston, MD, 301-893-0001
Bi-State Marketers, Ridgely, NJ, 201-943-5888
Burcaw & Assoc., Warren, MI, 313-573-4605
Central Mkt'g Group, Kansas City, MO, 816-741-7460
Greg Dzubay & Assoc., Peoria, AZ, 602-979-2358
Henry Philipps & Assoc., Denver, CO, 303-393-7047
Gustafson Sls, Red Wing, MN, 612-388-4277
Gerald Home & Assoc., Stow, MA, 508-897-7146
J.W. Lehner, Stow, OH, 216-686-1965
Meyer Mkt'g, Deerfield Beach, FL, 305-481-9250
Meyer & Ross, Burlingame, CA, 415-348-6800
New West Agency, La Mesa, CA, 619-299-3269
Pat Norman Sls, Indianapolis, IN, 317-842-5611
Pacific West Mkt'g, Kailua, HI, 808-261-7558
Henry Philipps, Roswell, GA, 404-992-3070
Tortech Electronics, Scarborough/Ontario, Canada,
416-282-1011
John S. Wilkin & Assoc., Hillsboro, OH, 513-393-1137

Johnson Electronics
4301 Metric Dr.
Winter Park, FL 32792
(407) 677-4030, FAX# 407-679-1288
Pres./CEO: A.J. Schell, VP Mkt'g: Robert Peters,
VP/Eng.: Ken St. John
Products: drive-thru

LEE DAN COMMUNICATIONS
155 Adams Ave.
Hauppauge, NY 11788-3699
(516) 231-1414, 800-533-3261, in-state 800-231-
1414, FAX# 516-231-1498
Pres.: Leon Goldberg, VP Op.: Lawrence Goldberg, VP
Finance/Admin.: David Goldberg, Sr. Sls Associate:
Susan Leon, Office Mgr.: Rita Kaplan, Sr. Tech.:
Sandy Hoffman
Products: drive-thru, loudspeaking

MATH ASSOCIATES
2200 Shames Dr.
Westbury, NY 11590
(516) 334-6800, FAX# 516-334-6473
Pres.: Ellen Math, CEO/Dir. R & D: Irwin Math, Exec.
VP: Howard Oboler, Exec. VP: Martin Rein
Products: environmentally protected

Metragen
3701 Chesswood Dr., #309
Downsview, Ontario, Canada M3J 2P6
(416) 635-9212, FAX# 416-635-8266
Mgr.: Edward Wigdor
Products: headset/handset

Microframe
8236 E. 71st St., Ste. 356
Tulsa, OK 74133
(918) 250-4839, 800-635-3811

Powertronix
10623 Lawson River Ave.
Fountain Valley, CA 92708
(714) 963-5411
Pres.: Robert Gehlke, Sls Mgr.: Bill Organ

RTS SYSTEMS
1100 W. Chestnut St.
Burbank, CA 91506
(818) 566-6700, FAX# 818-843-7953

Pres.: Robert Smith, VP Mkt'g: Doug Leighton, VP Eng./Tech.: Stan Hubler, Sls Mgr.: Shelley Harrison

S. San Francisco, CA 94080
(415) 588-2538, 800-843-4750, in-state 800-in CA
800-632-2157, FAX# 415-588-3349
Pres.: Yoshiro Ishida, Nat'l Sls Mgr./Comm. Pro.:
Richard Krochmal, Nat'l Sls Mgr./Pro. Music & Ent.:
Rick Kamlet, Nat'l Sls Mgr./Intercom: Al Burns
Products: drive-thru, environmentally protected,
headset/handset, loudspeaking, telephone

Audio Mkt'g Assoc., Brecksville, OH, 216-526-2426
Professional Sound & Lighting, Lakewood, CO, 303-986-5999
Design Factors, Hacienda Heights, CA, 213-6917-7576
Products: headset/handset, loudspeaking, telephone

RING COMMUNICATIONS

57 Trade Zone Dr.
Ronkonkoma, NY 11779
(516) 585-7464, FAX# 516-585-7410
Pres.: Paul McLean, VP Sls: Craig Krsanac, V.P.
Tech.: Kjell (Ken) Solem, Tech Support: Charlie Kulins
Klumpp Sls, Jacksonville, FL, 904-287-5205
Corrigan Agencies, 504-893-7455
Gustafson Sls, 612-388-4277
Allwest Electronics, 805-388-1789
Pacnor, 206-771-6016
J.C. Electronics, 808-943-8514

Telex Communications

9600 Aldrich Ave. S.
Minneapolis, MN 55420
(612) 884-4051, FAX# 612-884-0043
Pres.: Jeffrey Wetherell, VP Mkt'g: James Arrington,
VP Sls: Dan Dantzler, Dir. Mkt'g: Dond Meeoen, Dir
Adv.: Ronald Taylor
WesTech/Lichtenauer, Culver City, CA, 213-870-9286
Bencsik Assoc., Ocala, FL, 904-732-9775
Burcaw & Assoc., Warren, MI, 313-573-4605
SAGA, Oswego, NY, 315-343-5739
Monfort Electronic Mkt'g, Indianapolis, IN, 317-872-8877
Murphy & Cota, Atlanta, GA, 404-875-2525
Northland Assoc., Moorhead, MN, 218-233-4616
Rancilio Assoc., St. Louis, MO, 314-845-0202
J.Y. Schoonmaker, Dallas, TX, 214-349-1650
Sigmat, Valley Forge, PA, 215-783-6666
Weller Electronic Sls, Worthington, OH, 614-885-7819
Ziskind Assoc., Rolling Meadows, IL, 312-577-1624
White Radio, Burlington-Ont., Canada, 416-632-6894
Silver Peak Mkt'g, Denver, CO, 303-467-9042
Pacnor Mkt'g, Lynnwood, WA, 206-771-6016
Products: headset/handset, loudspeaking, telephone

SOUND POWERED COMMUNICATIONS

PO Box 5569
Trenton, NJ 08638
(609) 883-1180, 800-431-0033
G. Mgr.: Harry Mosie

T.S.K. Electronics

PO Box 190
Tonawanda, NY 14151-0191
(716) 693-3916, FAX# 716-692-6433
Pres.: Theodore Kedzierski, Chief Eng.: Kevin
Kedzierski
Products: environmentally protected, headset/handset,
loudspeaking, telephone

TALK-A-PHONE

5013 N. Kedzie Ave.
Chicago, IL 60625
(312) 539-1100, FAX# 312-539-1241
Pres.: Z. Liberman, VP: S. Shanes, Sls Mgr.: Dan
Kagan
Products: drive-thru, environmentally protected,
headset/handset, loudspeaking

Swintek Enterprises

PO Box 160617
Cupertino, CA 95016
(408) 727-4889, FAX# 408-727-3025
Pres.: William Swintek, VP: Les Underwood, Sls Mgr.:
Darisa Hill
Cinequip, Toronto-Ont., Canada, 416-467-7700
Alan Gordon Enter., Hollywood, CA, 213-466-3561
Midwest Comm., Edgewood, KY, 606-331-0048

TECHNICAL PROJECTS

PO Box 3247
Barrington, IL 60010
(312) 381-5350, 800-562-5872, FAX# 312-381-4360
Pres.: Glenn Mullis, Sec./Treas.: Sibbelina Mullis,
Tech.: Mike Barrett
Professional Audio Mkt'g, Melville, NY, 516-367-8620
Wait Mkt'g, Allentown, PA, 215-820-7586

3M SOUND PRODUCTS

551-1W, 3M Center
St. Paul, MI 55144-1000
(612) 733-9214, FAX# 612-736-7614
Mkt'g Mgr.: Richard Barker
Products: drive-thru, headset/handset, loudspeaking

TOA ELECTRONICS

PO Box 2047

INTERCOM—INSTITUTIONAL/SCHOOL

AIPHONE INTERCOM SYSTEMS

PO Box 90075
Bellevue, WA 98009
(206) 455-0510, 800-692-0200, FAX# 206-455-0071
Pres.: Jun Matsumoto, Sls Mgr.: Jim Morrison,
Mkt'g/Adv. Mgr.: Harry Quanz
Aiphone NE, Randolph, NJ, 201-328-1790
Aiphone Midwest, Westmont, IL, 312-323-5222
Aiphone SE, Douglasville, GA, 404-920-2811
Products: clock, microprocessor, multi-channel, paging, talk-
back, telephone, video

Cornell Electronics Products

PO Box 23411
Milwaukee, WI 53223
(414) 351-4660, 800-541-946, FAX# 414-351-4657
Pres.: Donald Glaubitz, VP: Gary Butler, Sls Mgr.:
Pauline Haack, Mkt'g: Randy Archer, SE Reg Sls Mgr.:
William Ellinger, Controller: Thelma Plunkett
Shamrock Electronic Sls, Dayton, OH, 513-258-1227
LSM Assoc., Phelps, NY, 315-548-4891
W.A. Hendrickson, North Scituate, MA, 617-545-0652
Kingston Sls, Indianapolis, IN, 317-876-2545
Avcom, North Olmsted, OH, 216-777-2060
Richard S. Pass Assoc., Langhorne, PA, 215-757-6100
R & S Sls, Rockville Centre, NY, 516-678-6887
Cavendish & Winchester, Atlanta, GA, 404-422-4531
Cartwright & Bean, Orlando, FL, 407-422-4531
Kodo Assoc., Minneapolis, MN, 612-881-1255
Vector, Seattle, WA, 206-322-4343
Rancilio Assoc., St. Louis, MO, 314-845-0202
Dick Bellow Sls, Dallas, TX, 214-644-7881
Bidwell-Schwartz Assoc., Gardena, CA, 213-770-0300
Yocum Mkt'g., Mesa, AZ, 834-3334
Awwest, Fountain Hills, AZ, 602-946-1811
Products: paging, talkback

Dayton, OH 45459

(513) 236-3591
Sls: R. McDougall, Eng.: Kurt Farmer, Tech.: F. Jaros
Products: paging, telephone

Delta Communications

7852 78th Ave., S.W.
Tacoma, WA 98498
(206) 582-2201, FAX# 206-588-1588
Owner/Pres.: Sid Flothe
Products: console, multi-channel, paging, talkback, tel.

Alpha Communications

89-D Cabot Ct.
Hauppauge, NY 11788-3717
(516) 434-8080, 800-666-4800, FAX# 516-434-8334
Pres.: Mark Goldberg, VP: Madelyn Goldberg, Office
Mgr.: Rose Tassone
Products: console, microprocessor, paging, talkback, tele-
phone, video

DUKANE

2900 Dukane Dr.
St. Charles, IL 60174
(312) 584-2300, FAX# 312-584-2370
Pres./CEO: J. McWilliams Stone Jr., Group VP: William
Finnegan, Div. G. Mgr.: Steven Deppe, Nat'l Sls Mgr.:
Warren Anderson, Svce Mgr.: Cliff Carlson
Wally Smutts, Toronto-Ont, Canada, 312-584-2300
Doug Fellabaum, Sycamore, IL, 815-895-7573
Don Mountzen, Beecher, IL, 312-946-9655
Ken Lind, St. Charles, IL, 312-584-2300
Pete Kendal, Jacksonville, FL, 904-262-6025
Ed Nuhring, Portland, OR, 503-244-4262
Jim Lacey, Moreno Valley, CA, 714-243-1160
Jack Brown, Dallas, TX, 214-943-7528
Products: clock, console, microprocessor, multi-channel,
paging, talkback

Amtel Security Systems

1421 N.W. 165th St.
Miami, FL 33169
(305) 621-3100, 800-222-6835, FAX# 305-623-0613
Pres.: Suresh Gajwani, Dir. Mkt'g: Moe Weiner
Products: telephone

J.W. DAVIS & CO.

PO Box 26177
Dallas, TX 75226
(214) 651-7341, 800-527-5705, in-state 800-in TX
800-442-1564, FAX# 214-939-0328
Pres.: Charles Griffith, VP Sls: Jack Tucker
Products: console, multi-channel, paging, talkback

Bogen Communications

PO Box 575
Ramsey, NJ 07446
(201) 934-8500, FAX# 201-934-9832
P: John Ochtera, Sls: James Orr, Sls.: David Chambers
Products: clock, console, µ-processor, multi-channel, pag-
ing, talkback, tel.

Dayton Industrial

126 Westpark Rd.

HM Electronics

6675 Mesa Ridge Rd.
San Diego, CA 92121
(619) 535-6060, FAX# 619-452-7207
VP Mkt'g: J. Michael Hughes, Pro Audio Sls Mgr.:

INTRODUCING OUR NEW BP325

USER PROGRAMMABLE.

MICROPROCESSOR ASSISTED.

LIGHTWEIGHT CONTOURED BODY.

KILLER CIRCUITRY.

GREAT SOUNDING.

AFFORDABLE REVOLUTIONARY.

PORTABLE INTERCOM USER STATION.

OR. IN A WORD:

WOW!

MODEL BP325 PORTABLE USER STATION

...PLEASE CALL OR WRITE FOR THE BROCHURE.

RTS SYSTEMS
INCORPORATED

1100 WEST CHESTNUT STREET

BURBANK, CALIFORNIA 91506

PHONE 818 566-6700 FAX 818 843-7953

Circle 248 on Reader Response Card

World Radio History

Eunice Davis, Ind'l Sls Mgr.: Bruce Slemmer, Cust. Svce Mgr.: Bill Kranzush, Mkt'g Coord.: Matt Riches
 Derek Allen Assoc., Toluca Lake, CA, 818-843-6919
 John Anthony, Stamford, CT, 203-322-9202
 Applied Audio Mkt'g, Ashville, NC, 704-252-9313
 A/V Mkt'g, Carmel, IN, 317-846-1034
 Products: multi-channel, talkback

Ieron Electronic Systems
 1743 W. Rosehill Dr.

Chicago, IL 60660
 (312) 275-1900, 800-621-1903, FAX# 312-275-0283
 Pres.: Jerome Chesnul, VP Sls: John Charczuk
 Admiral Sls, Richardson, TX, 214-357-9212
 ASR Enter., Fallston, MD, 301-893-0001
 Bi-State Marketers, Ridgefield, NJ, 201-943-5888
 Burcaw & Assoc., Warren, MI, 313-573-4605
 Central Mkt'g Group, Kansas City, MO, 816-741-7460
 Greg Dzubay & Assoc., Peoria, AZ, 602-979-2358
 Greg Dzubay & Assoc., Denver, CO, 303-393-7047
 Gustafson Sls, Red Wing, MN, 612-388-4277
 Gerald Home & Assoc., Stow, MA, 508-897-7146
 J.W. Lehner, Stow, OH, 216-686-1965
 Meyer Mkt'g, Deerfield Beach, FL, 305-481-9250
 Meyer & Ross, Burlingame, CA, 415-348-6800
 New West Agency, La Mesa, CA, 619-299-3269
 Pat Norman Sls, Indianapolis, IN, 317-842-5611
 Pacific West Mkt'g, Kailua, HI, 808-261-7558
 Henry Philips, Roswell, GA, 404-992-3070
 Torteck Electronics, Scarborough/Ontario, Canada, 416-282-1011
 John S. Wilkin & Assoc., Hillsboro, OH, 513-393-1137
 Products: console, paging



LEE DAN COMMUNICATIONS

155 Adams Ave.
 Hauppauge, NY 11788-3699
 (516) 231-1414, 800-533-3261, in-state 800-231-1414,
 FAX# 516-231-1498
 Pres.: Leon Goldberg, VP Op.: Lawrence Goldberg, VP
 Finance/Admin.: David Goldberg, Sr. Sls Associate:
 Susan Leon, Office Mgr.: Rita Kaplan, Sr. Tech.:
 Sandy Hoffman
 Products: microprocessor, multi-channel, paging, talkback,
 telephone, video

MATH ASSOCIATES

2200 Shames Dr.
 Westbury, NY 11590
 (516) 334-6800, FAX# 516-334-6473
 Pres.: Ellen Math, CEO/Dir. R & D: Irwin Math, Exec.
 VP: Howard Oboler, Exec. VP: Martin Rein
 Products: microprocessor

MaxiVox

438 Papin
 Ste Foy, QC, Canada G1P 3T9
 (418) 657-2220, FAX# 418-657-7977
 G. Mgr.: Denis Paquet, Mkt'g Mgr.: Alain Turcot,
 Montreal Branch Mgr.: Normand Pelletier
 Maxivox, Montreal, 514-321-3131

Petcom

461 Manitou Dr.
 Kitchener, Ontario N2C 1L5
 (519) 748-5352, FAX# 519-748-9221
 Pres.: B.W. Poetker, Sls Mgr.: Grant Ertel
 Products: clock, console, microprocessor, multi-channel,
 paging, talkback, telephone

Portland Instrument
 1101A Air Way



**how to untie the knots in
 internal
 communications**

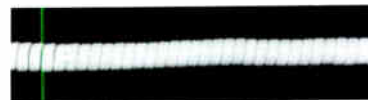

specify a **Rauland** system

for complete
 management of
SCHOOL
 and institutional
 communications
 specify

TELECENTER[®]



TELECENTER IV, the cost-justified system, provides:
Instant 2-way Voice Communications (up to 500
 station capacity); **FCC-Approved Interconnect** (up to
 10 lines available for outside calls); **Emergency Call
 Priority** (distinctive tone signals, "EMER" readout on
 digital displays); **User-Programmable Features**
 (room numbering, zone call, authorized phone
 assignments); **Easy Installation, Operation, Mainte-
 nance** (built-in diagnostics).

for staff-oriented
 full control of
**HEALTH
 CARE**
 communications
 specify

RESPONDER[®]



Since its introduction, the choice of more hospitals
 nationwide than any other nurse call system. Now
 with these innovative features: **Activities Printout** to
 record all nurse call activities; **Pocket Page Interface**
 for instant staff notification; **Local Area Networking**
 to permit control of multiple systems from a single
 station, **PLUS** unparalleled nurse call operation,
 performing more than 60 staff-oriented functions,
 many of which may be user-programmed to serve
 the hospital's own special needs.

CALL TOLL-FREE 1-800-752-7725 FOR FULL DETAILS.



RAULAND-BORG CORPORATION

3450 W. Oakton St., Skokie, IL 60076 • (312) 679-0900

In Canada: Rauland-Borg (Canada) Inc. • 6535 Millcreek Drive, Unit 5, Mississauga, Ont., Can. L5N 2M2

Glendale, CA 91201
(818) 500-0137, 800-999-5260, FAX# 818-240-1828
P: Ron Fuller, Mgr.: Jack Sympton, Sls.: John Batson,
Sls.: Lisa Fuller, Tech.: Patrick Gratner
Products: paging, talkback

Rauland-Borg
3450 W. Oakton St.
Skokie, IL 60076-2951
(312) 679-0900, FAX# 312-679-0625/312-679-6219
P: W. Krucks, VP: K. James, Sls.: R. Blunt, Sls.: H Hahn

TOA ELECTRONICS
PO Box 2047
S. San Francisco, CA 94080
(415) 588-2538, 800-843-4750, in-state 800-in CA 800-
632-2157, FAX# 415-588-3349
P.: Yoshiro Ishida, Sls.: Al Burns
Products: console, microprocessor, multi-channel, paging,
talkback, telephone

TALK-A-PHONE
5013 N. Kedzie Ave.
Chicago, IL 60625
(312) 539-1100, FAX# 312-539-1241
Pres.: Z. Liberman, VP: S. Shanes, Sls Mgr.: Dan
Kagan
Products: multi-channel, paging, talkback

TECHNICAL PROJECTS
PO Box 3247
Barrington, IL 60010
(312) 381-5350, 800-562-5872, FAX# 312-381-4360
Pres.: Glenn Mullis, Sec./Treas.: Sibbelina Mullis,
Tech.: Mike Barrett
Professional Audio Mkt'g, Melville, NY, 516-367-8620
Watt Mkt'g, Allentown, PA, 215-820-7586
Audio Mkt'g Assoc., Brecksville, OH, 216-526-2426
Professional Sound & Lighting, Lakewood, CO, 303-
986-5999
Design Factors, Hacienda Heights, CA, 213-6917-7576
Products: multi-channel, paging, talkback, telephone

TELECOR
1114 Westport Crescent
Mississauga, Ontario, Canada L5T 1G1
(416) 564-0801, FAX# 416-564-0806
Pres.: Peter Jova, Sls Mgr.: Keith Moore, Credit Mgr.:
Eva Geczi
Av-West, Fountain Hills, AZ, 602-946-1811
Bencsik Assoc., Ocala, FL, 904-732-9775
EESCO System, Los Angeles, CA, 213-666-9601
Gustafson System Sls, Palatine, IL, 312-358-2505
J.W. Lehner, Stow, OH, 216-686-1965
Peregrine SW Reps, Houston, TX, 713-589-8481
Protech Mkt'g, Salt Lake City, UT, 801-943-8331
Rancillio Assoc., Inc., St. Louis, MO, 314-845-0202
Palmieri Assoc., Inc., Ridgefield, NJ, 201-943-5888
Repworks, Chicopee, MA, 413-533-0845
Roger Ponto Assoc., Kirkland Lake, WA, 206-821-2996
Rohr Wanger Roberts, Rockhill, SC, 803-324-5111
Richard S. Pass Assoc., Langhorne, PA, 215-757-6100
Warren Assoc., Santa Clara, CA, 408-988-7762
Products: clock, console, microprocessor, multi-channel,
paging, talkback, telephone

INTERCOM—PRODUCTION & THEATRICAL

AIPHONE INTERCOM SYSTEMS
PO Box 90075
Bellevue, WA 98009
(206) 455-0510, 800-692-0200, FAX# 206-455-
0071
Pres.: Jun Matsumoto, Sls Mgr.: Jim Morrison,
Mkt'g/Adv. Mgr.: Harry Quanz
Aiphone NE, Randolph, NJ, 201-328-1790
Aiphone Midwest, Westmont, IL, 312-323-5222
Aiphone SE, Douglasville, GA, 404-920-2811

BBE SOUND
5500 Bolsa Ave., Ste. 245
Huntington Beach, CA 92649
(714) 897-6766, 800-233-8346, FAX# 714-895-
6728
Chairman: John McLaren, VP: Scott Anderson, Op
Mgr.: Jennifer Drescher, Nat'l Sls Mgr.: Fred Coyner,
Mkt'g Dev. Mgr.: Jim Lucas, Tech Svces Mgr.: Ryan
Couits
Products: processors

David Clark
PO Box 15054
Worcester, MA 01615
(617) 756-6216, FAX# 508-753-5827
Prod. Mgr. Comm.: George Conlon

Clear-Com Intercom Systems
945 Camelia St.
Berkeley, CA 94710
(415) 527-6666, FAX# 415-527-6699
Nat'l Sls Mgr.: Michael Goddard
Products: handset, headset, IFB, loudspeaker, micro-
processor, multi-channel, processors, radio interface, wire-
less

Communications Co.
3490 Noell St.
San Diego, CA 92110
(619) 297-3261, FAX# 619-297-3279
Exec. VP: Michael Jordan, Eng./Mfg.: David Johnson,
Order Desk: Bobby Willis, Order Desk: Laura
McCullough, Shipping: Ritchie Willis, Pres.: Peter
Jordan
Audio Mkg Assoc., Brecksville, OH, 216-526-2426
Bencsik Assoc., Ocala, FL, 904-732-9775
Secom Systems, Dorrvile, GA, 800-241-9409

Brian Trankle & Assoc., Belmont, CA, 415-595-4004
Western Audio Sls, Glendale, CA, 818-246-3806
Products: handset, headset, VOX



Comtek
357 W. 2700 S.
Salt Lake City, UT 84115
(801) 466-3463, FAX# 801-484-6906
Pres.: Ralph Belgique, Eng. Dir.: Steve Karchner,
Mkt'g Dir.: Steve Dupaix, Svce Mgr.: Laurel Robertson,
Credit Mgr.: Dana Pelletier, Cust. Svce: Stacey Hayes-
Garcia
Products: IFB, wireless

HM Electronics
6675 Mesa Ridge Rd.
San Diego, CA 92121
(619) 535-6060, FAX# 619-452-7207
VP Mkt'g: J. Michael Hughes, Pro Audio Sls Mgr.:
Eunice Davis, Ind'l Sls Mgr.: Bruce Stiemmer, Cust.
Svce Mgr.: Bill Krantzush, Mkt'g Coor.: Matt Riches
Derek Allen Assoc., Toluca Lake, CA, 818-843-6919
John Anthony, Stamford, CT, 203-322-9202
Applied Audio Mkt'g, Ashville, NC, 704-252-9313
A/V Mkt'g, Carmel, IN, 317-846-1034
Products: handset, headset, IFB, loudspeaker, multi-
channel

Nady Systems
1145 65th St.
Oakland, CA 94608
(415) 652-2411, FAX# 415-652-5075
Sls Mgr.: Royce Krilanovich, Mkt'g/Comm.: Chris
Calder

RTS SYSTEMS
1100 W. Chestnut St.
Burbank, CA 91506
(818) 566-6700, FAX# 818-843-7953
Pres.: Robert Smith, VP Mkt'g: Doug Leighton, VP
Eng./Tech.: Stan Hubler, Sls Mgr.: Shelley Harrison

Sennheiser Electronic
PO Box 987
Old Lyme, CT 06371
(203) 434-9190, FAX# 203-434-1759

TECHNICAL PROJECTS
PO Box 3247
Barrington, IL 60010
(312) 381-5350, 800-562-5872, FAX# 312-381-
4360
Pres.: Glenn Mullis, Sec./Treas.: Sibbelina Mullis,
Tech.: Mike Barrett
Professional Audio Mkt'g, Melville, NY, 516-367-8620
Watt Mkt'g, Allentown, PA, 215-820-7586
Audio Mkt'g Assoc., Brecksville, OH, 216-526-2426
Professional Sound & Lighting, Lakewood, CO, 303-
986-5999
Design Factors, Hacienda Heights, CA, 213-6917-7576
Products: handset, headset, loudspeaker, multi-chan-
nel, radio interface

Telex Communications
9600 Aldrich Ave. S.
Minneapolis, MN 55420
(612) 884-4051, FAX# 612-884-0043
Pres.: Jeffrey Wetherell, VP Mkt'g: James Arrington,
VP Sls: Dan Dantzler, Dir. Mkt'g: Dond Meroen, Dir
Adv.: Ronald Taylor
WesTech/Lichtenauer, Culver City, CA, 213-870-9286
Bencsik Assoc., Ocala, FL, 904-732-9775
Burcaw & Assoc., Warren, MI, 313-573-4605
SAGA, Oswego, NY, 315-343-5739
Monfort Electronic Mkt'g, Indianapolis, IN, 317-872-
8877
Murphy & Cota, Atlanta, GA, 404-875-2525
Northland Assoc., Moorhead, MN, 218-233-4616
Rancillio Assoc., St. Louis, MO, 314-845-0202
J.Y. Schoonmaker, Dallas, TX, 214-349-1650
Sigma, Valley Forge, PA, 215-783-6666
Weller Electronic Sls, Worthington, OH, 614-885-7819
Ziskind Assoc., Rolling Meadows, IL, 312-577-1624
White Radio, Burlington-Ont., Canada, 416-632-6894
Silver Peak Mkt'g, Denver, CO, 303-467-9042
Pacnor Mkt'g, Lynnwood, WA, 206-771-6016
Products: handset, headset, IFB, loudspeaker, micropro-
cessor, multi-channel, VOX



HME Intercom Systems:

First for Performance, Built to Last.

HME intercoms are fast becoming the favorite of concert halls, theatres, churches and broadcast facilities.

It's well known that superior audio quality reduces fatigue and makes for less mistakes. Which is why HME's broadcast-quality audio means a lot to producers who care. We even have AGC on every mic line so everyone from shouters to whisperers are understood.

HME intercoms are truly built with the user in mind, from form-fitting belt-pacs to compact wireless transmitters, and from hands-off power stations to models with IFB, stage announce, telephone interface, and up to 6 x 12 matrix switching.

They're unbeatable for reliability. Current foldback in the power supplies eliminates damage to components from short circuits, and acts as an exclusive built-in fault locator to help you find a shorted cable quickly. HME's years of wireless microphone experience has helped develop the most rugged electronics packaging this side of space.

HME designs and manufactures 100% of our cabled and wireless intercom equipment, so custom designs and interfaces can be made much faster with the same high reliability as our standard products.

Call your HME dealer/distributor now for all the details.



HM ELECTRONICS, INC.

6675 Mesa Ridge Road
San Diego, CA 92121, USA
Phone: (619) 535-6060
Telex: 350-771
FAX: 619-452-7207

HME Products are distributed internationally:
In Canada—GERRAUDIO Distribution Inc. • PH: (416) 868-0528 FAX: 416-868-6419
In Central America—Servicios Electronicos al Espectaculo • PH: (505) 544-1345 FAX: (905) 549-6509
All other countries—Global Representatives, Inc. • PH: (201) 492-8140 FAX: 201-492-2568

World Radio History

Circle 232 on Reader Response Card

Why Is This Man Smiling?



Hiko Shinoda,
President Telecall America

Hiko Shinoda has been a major factor in the U.S. intercom market for 18 years. He knows the industry's many trends and individual desires. He is very aware of the need for immediate response and supply.

So why is he smiling? Mr. Shinoda has just become president of Telecall America. Now he directs the resources of a corporation with 40 years of experience designing and manufacturing intercom systems.

Telecall is leading the intercom industry with new products such as the three on this page. They are also renowned the world over for their consistently prompt customer response.

Call us for more information.



A Leader in Intercom Technology for 40 Years

(206)881-2742 Fax (206)881-3085 14620 N.E. 95th St., Redmond, WA 98052



Telecall's TD Video Entry Security System gives you exactly what its name says—security. The door station has an MOS chip camera which prevents ghost images and flare on the monitor's 5" LCD black & white screen. The monitor has an alarm built-in which can be connected to various types of sensors. Communication is through the handset-type intercom. This system is complete as it stands, but you can also add the optional security sensor panel which allows monitoring of fire, gas and burglary.



Telecall's MN-70 built-in micro-processor system gives you the ability to know who is calling with its digital display feature. Other features include hands-free reply, group paging, all call and conference call. With three communication channels, there is very little chance of a busy line, even at the system's maximum of 70 units.

Telecall's MF-20 System is a micro-processor based system, without the costly expense of a CEU, it's built-in. The MF-20 demonstrates its versatility with functions such as All-Call, Conference Call and Door Station Communication. The system can be expanded with single line telephone interconnect, and can be integrated into our TD Video Entry System.

Circle 256 on Reader Response Card

INTERCOM—SIMPLEX

APHONE INTERCOM SYSTEMS

PO Box 90075
Bellevue, WA 98009
(206) 455-0510, 800-692-0200, FAX# 206-455-0071

Pres.: Jun Matsumoto, Sls Mgr.: Jim Morrison,
Mkt'g/Adv. Mgr.: Harry Quanz
Aiphone NE, Randolph, NJ, 201-328-1790
Aiphone Midwest, Westmont, IL, 312-323-5222
Aiphone SE, Douglasville, GA, 404-920-2811
Products: custom, loudspeaking, microprocessor, tele-
phone, video/audio, VOX

Alpha Communications

89-D Cabot Ct.
Hauppauge, NY 11788-3717
(516) 434-8080, 800-666-4800, FAX# 516-434-8334

Pres.: Mark Goldberg, VP: Madelyn Goldberg, Office
Mgr.: Rose Tassone
Products: loudspeaking, microprocessor

Bogen Communications

PO Box 575
Ramsey, NJ 07446
(201) 934-8500, FAX# 201-934-9832

Pres.: John Ochtera, VP Sls/Mkt'g: James Orr, Nat'l
Sls Dir.: David Chambers
Products: loudspeaking, multi-channel, telephone

Communications Co.

3490 Noell St.
San Diego, CA 92110
(619) 297-3261, FAX# 619-297-3279
Exec. VP: Michael Jordan, Eng./Mfg.: David Johnson,
Order Desk: Bobby Willis, Order Desk: Laura
McCullough, Shipping: Ritchie Willis, Pres.: Peter
Jordan
Audio Mkg Assoc., Brecksville, OH, 216-526-2426
Bencsik Assoc., Ocala, FL, 904-732-9775
Secom Systems, Dorrville, GA, 800-241-9409
Brian Trankle & Assoc., Belmont, CA, 415-595-4004
Western Audio Sls, Glendale, CA, 818-246-3806
Products: pro-grammable

ELENEX (WEST)

7392 Trade St.
San Diego, CA 92121
(619) 566-7515, 800-225-3113, in-state 800-in CA
800-225-8037, FAX# 619-586-1484
VP: Dennis Berglund, Eng.: Al Bitarafan, Sls: Lou
Hennequin
Products: custom

Fisher-Berkeley—Ektacom

PO Box 24303
Oakland, CA 94623
(415) 835-7575, FAX# 415-271-8297
Pres.: Robert Fisher, Sr. VP: Wood Wymond, VP Eng.:
Robert Shipley, Sls Coord. Mgr.: Richard Flanagan, Sls
Eng.: Michael Lagrimas, Sls Eng.: Kenneth
Jorgensen
Arthur Tilley, Fayetteville, PA, 717-352-8432
Walter Radner, Westfield Center, OH, 216-887-5646

HM Electronics

6675 Mesa Ridge Rd.
San Diego, CA 92121
(619) 535-6060, FAX# 619-452-7207
VP Mkt'g: J. Michael Hughes, Pro Audio Sls Mgr.:

Eunice Davis, Ind'l Sls Mgr.: Bruce Slemmer, Cust.
Svce Mgr.: Bill Kranzush, Mkt'g Coord.: Matt Riches
Derek Allen Assoc., Toluca Lake, CA, 818-843-6919
John Anthony, Stamford, CT, 203-322-9202
Applied Audio Mkt'g, Ashville, NC, 704-252-9313
AV Mkt'g, Carmel, IN, 317-846-1034
Products: IFB, loudspeaking, multi-channel, wireless

Jeron Electronic Systems

1743 W. Rosehill Dr.
Chicago, IL 60660
(312) 275-1900, 800-621-1903, FAX# 312-275-0283

Pres.: Jerome Chesnul, VP Sls: John Charczuk
Admiral Sls, Richardson, TX, 214-357-9212
ASR Enter., Fallston, MD, 301-893-0001
Bi-State Marketers, Ridgefield, NJ, 201-943-5888
Burcaw & Assoc., Warren, MI, 313-573-4605
Central Mkt'g Group, Kansas City, MO, 816-741-7460
Greg Dzubay & Assoc., Peona, AZ, 602-979-2358
Greg Dzubay & Assoc., Denver, CO, 303-393-7047
Gustafson Sls, Red Wing, MN, 612-388-4277
Gerald Horne & Assoc., Stow, MA, 508-897-7146
J.W. Lehner, Stow, OH, 216-686-1965
Meyer Mkt'g, Deerfield Beach, FL, 305-481-9250
Meyer & Ross, Burlingame, CA, 415-348-6800
New West Agency, La Mesa, CA, 619-299-3269
Pat Norman Sls, Indianapolis, IN, 317-842-5611
Pacific West Mkt'g, Kailua, HI, 808-261-7558
Henry Philips, Roswell, GA, 404-992-3070
Tortech Electronics, Scarborough/Ontario, Canada,
416-282-1011
John S. Wilkin & Assoc., Hillsboro, OH, 513-393-1137
Products: custom, digital, loudspeaking, telephone, vi-
deo/audio, VOX



LEE DAN COMMUNICATIONS

155 Adams Ave.
Hauppauge, NY 11788-3699
(516) 231-1414, 800-533-3261, in-state 800-231-1414, FAX# 516-231-1498
Pres.: Leon Goldberg, VP Op.: Lawrence Goldberg, VP
Finance/Admin.: David Goldberg, Sr. Sls Associate:
Susan Leon, Office Mgr.: Rita Kaplan, Sr. Tech.:
Sandy Hoffman
Products: custom, loudspeaking, microprocessor, multi-
channel, telephone, video/audio

Marsh Products

336 McKee St.
Batavia, IL 60510
(312) 879-8008, FAX# 312-879-8072

Petcom

461 Manitou Dr.
Kitchener, Ontario N2C 1L5
(519) 748-5352, FAX# 519-748-9221
Pres.: B.W. Poetker, Sls Mgr.: Grant Ertel
Products: closed-circuit, custom, loudspeaking, micropro-
cessor

Ritron

505 W. Carmel Dr.
Carmel, IN 46032

(317) 846-1201, 800-872-1872, FAX# 317-846-4978

Stentofon Communications

6119 Connecticut Ave.
Kansas City, MO 64120
(816) 231-7200, FAX# 816-231-7203
Mkt'g Mgr.: Douglas Caldwell
Tom Reilly, Rye, NY, 914-933-2554
Linda Wick, Chicago, IL, 312-981-5136
Mike Wilcock, Los Angeles, CA, 818-335-0543
Products: loudspeaking, microprocessor

TOA ELECTRONICS

PO Box 2047
S. San Francisco, CA 94080
(415) 588-2538, 800-843-4750, in-state 800-in CA
800-632-2157, FAX# 415-588-3349
Pres.: Yoshiro Ishida, Nat'l Sls Mgr/Comm. Pro.:
Richard Krochmal, Nat'l Sls Mgr./Pro. Music & Ent.:
Rick Kamlet, Nat'l Sls Mgr./Intercom: Al Burns
Products: custom, digital, loudspeaking, microprocessor,
multi-channel, pro-grammable, telephone, VOX

T.S.K. Electronics

PO Box 190
Tonawanda, NY 14151-0191
(716) 693-3916, FAX# 716-692-6433
Pres.: Theodore Kedzierski, Chief Eng.: Kevin
Kedzierski
Products: custom, loudspeaking, multi-channel, telephone,
VOX

TALK-A-PHONE

5013 N. Kedzie Ave.
Chicago, IL 60625
(312) 539-1100, FAX# 312-539-1241
Pres.: Z. Liberman, VP: S. Shanes, Sls Mgr.: Dan
Kagan
Products: loudspeaking, multi-channel, VOX

Telex Communications

9600 Aldrich Ave. S.
Minneapolis, MN 55420
(612) 884-4051, FAX# 612-884-0043
Pres.: Jeffrey Wetherell, VP Mkt'g: James Arrington,
VP Sls: Dan Dantzler, Dir. Mkt'g: Dond Meeen, Dir
Adv.: Ronald Taylor
Westech/Lichtenauer, Culver City, CA, 213-870-9286
Bencsik Assoc., Ocala, FL, 904-732-9775
Burcaw & Assoc., Warren, MI, 313-573-4605
SAGA, Oswego, NY, 315-343-5739
Monfort Electronic Mkt'g, Indianapolis, IN, 317-872-8877
Murphy & Cota, Atlanta, GA, 404-875-2525
Northland Assoc., Moorhead, MN, 218-233-4616
Rancilio Assoc., St. Louis, MO, 314-845-0202
J.Y. Schoonmaker, Dallas, TX, 214-349-1650
Sigmet, Valley Forge, PA, 215-783-6666
Weller Electronic Sls, Worthington, OH, 614-885-7819
Ziskind Assoc., Rolling Meadows, IL, 312-577-1624
White Radio, Burlington-Ont., Canada, 416-632-6894
Silver Peak Mkt'g, Denver, CO, 303-467-9042
Pacnor Mkt'g, Lynnwood, WA, 206-771-6016
Products: closed-circuit, IFB, loudspeaking, microproces-
sor, multi-channel, pro-grammable, telephone, VOX

Ultrak

660 Compton St.
Broomfield, CO 80020
(303) 466-7333, FAX# 303-469-8336
Products: video/audio

SIGNALING SYSTEMS

Adaptive Micro Systems

7840 N. 86th St.
Milwaukee, WI 53224
(414) 357-2020, 800-558-7022, FAX# 414-357-2029
Products: visual

AIPHONE INTERCOM SYSTEMS

PO Box 90075
Bellevue, WA 98009
(206) 455-0510, 800-692-0200, FAX# 206-455-0071
Pres.: Jun Matsumoto, Sis Mgr.: Jim Morrison,
Mkt'g/Adv. Mgr.: Harry Quanz
Aiphone NE, Randolph, NJ, 201-328-1790
Aiphone Midwest, Westmont, IL, 312-323-5222
Aiphone SE, Douglasville, GA, 404-920-2811
Products: annunciator, audio, call-light, tone, visual

Alpha Communications

89-D Cabot Ct.
Hauppauge, NY 11788-3717
(516) 434-8080, 800-666-4800, FAX# 516-434-8334
P: Mark Goldberg, VP: Madelyn Goldberg, Rose Tassone

Ambeti

PO Box 593
Plymouth, MI 48170
(313) 455-6410, 800-223-5274
Pres.: Ed Grzanowski
Security Components Int'l, Wayne, NJ, 201-942-7771
E.J. Machnik & Assoc., Snellville, GA, 404-972-4814
Emil Kirik & Assoc., Cleveland, OH, 216-581-7722
Allen Fishman & Assoc. Int'l, Oxford, CT, 203-888-9372
Pacvid, Los Angeles, CA, 213-650-7373
Products: annunciator

ATLAS/SOUNDOLIER

1859 Intertech Dr.
Fenton, MO 63026
(314) 349-3110, 800-876-7337, FAX# 314-349-1251
VP/GM: Pete Marsac, VP/Mkt'g: Herbert Jaffe, W. Reg./Sis Mgr.: Bud Waters, W. Reg./Ass. Sis Mgr.: Jim Edwards, E. Reg./Ass. Sis Mgr.: Walter Best, Order Entry Dept. Mgr.: Dale McIntyre
Atlas/Soundolier, Parsippany, NJ, 201-887-7800
Atlas Electronics, Toronto, Canada, 416-789-7761

Atlas/Int'l, Fenton, MO, 800-362-5673
Atlas/Exp. Dept., Fenton, MO, 314-349-3110
Products: alarm, annunciator, audio, bell, call-light, tone, visual

Audiosone

335 Benton St.
Stratford, CT 06497
(203) 377-4475, FAX# 203-377-3374

The Auth Co.

505 Acorn St.
Deer Park, NY 11729
(516) 667-9000, FAX# 516-667-9887
Chairman: George May, VP/General Mgr.: Joel Kahn,
VP Finance: Richard Nelson, Nat'l Sis Mgr.: Steven Weil, Dir. of Op: Kenneth Gmora
Products: alarm, annunciator, call-light, visual

Clever Devices

PO Box 2002
Port Washington, NY 11050
(516) 767-0682, FAX# 516-767-3635
Pres.: William Long, Mkt'g Mgr.: Una Neary, Tech. Supp.: Mike Kafulas
Products: annunciator

Communications Co.

3490 Noell St.
San Diego, CA 92110
(619) 297-3261, FAX# 619-297-3279
Exec. VP: Michael Jordan, Eng./Mfg.: David Johnson,
Order Desk: Bobby Willis, Order Desk: Laura McCullough, Shipping: Ritchie Willis, Pres.: Peter Jordan
Audio Mkg Assoc., Brecksville, OH, 216-526-2426
Bencsik Assoc., Ocala, FL, 904-732-9775
Secom Systems, Dorville, GA, 800-241-9409
Brian Trankle & Assoc., Belmont, CA, 415-595-4004
Western Audio Sis, Glendale, CA, 818-246-3806
Products: call-light

Cornell Electronics Products

PO Box 23411
Milwaukee, WI 53223
(414) 351-4660, 800-541-946, FAX# 414-351-4657
Pres.: Donald Glaubitz, VP: Gary Butler, Sis Mgr.: Pauline Haack, Mkt'g: Randy Archer, SE Reg Sis Mgr.: William Ellinger, Controller: Thelma Plunkett
Shamrock Electronic Sis, Dayton, OH, 513-258-1227

LSM Assoc., Phelps, NY, 315-548-4891
W.A. Hendrickson, North Scituate, MA, 617-545-0652
Kingston Sis, Indianapolis, IN, 317-876-2545
Avcom, North Olmsted, OH, 216-777-2060
Richard S. Pass Assoc., Langhorne, PA, 215-757-6100
R & S Sis, Rockville Centre, NY, 516-678-6887
Cavendish & Winchester, Atlanta, GA, 404-422-4531
Cartwright & Bean, Orlando, FL, 407-422-4531
Kodo Assoc., Minneapolis, MN, 612-881-1255
Vector, Seattle, WA, 206-322-4343
Rancilio Assoc., St. Louis, MO, 314-845-0202
Dick Bellew Sis, Dallas, TX, 214-644-7881
Bidwell-Schwartz Assoc., Gardena, CA, 213-770-0300
Yocum Mkt'g., Mesa, AZ, 834-3334
Awwest, Fountain Hills, AZ, 602-946-1811
Products: alarm, annunciator, audio, bell, call-light, tone, visual

Diversatronics

620 Pkwy
Broomall, PA 19008
(215) 356-3995, 800-345-1244, FAX# 215-356-5222
Tech. Applications: Mark Minassian

Door Alarm Devices

20 Lucon Dr.
Deer Park, NY 11729
(516) 586-2400, 800-DADCONY, FAX# 516-242-0611
Prod. Eng.: Richard Rand
Anderson Sis, Braintree, MA, 617-848-9184
Products: annunciator, tone

ELENEX (WEST)

7392 Trade St.
San Diego, CA 92121
(619) 566-7515, 800-225-3113, in-state 800-in CA
800-225-8037, FAX# 619-586-1484
VP: Dennis Berglund, Eng.: Al Bitarafan, Sis: Lou Hennequin
Products: alarm, annunciator, audio

FSR

220 Little Falls Rd.
Cedar Grove, NJ 07009
(201) 239-0988, 800-332-FSR-1, FAX# 201-239-7708
Pres.: William Fitzsimmons, VP: Janice Sandri, Eng. Mgr.: Joseph Fischer, Proj. Mgr.: John Macaluso, Metal Shop Mgr.: Joseph Amico, Inside Sis: Marilyn Cullen
Design Factors, Hacienda Heights, CA, 213-697-7576
Sigmat, Freehold, NJ, 201-462-1221
Richard Pass Assoc., Langhorne, PA, 215-757-6100
Peregrine SW, Houston, TX, 713-589-8481
Henry Phillips, Roswell, GA, 404-992-3070
Piper Assoc., Needham, MA, 617-449-1144
Brian Trankle & Assoc., Belmont, CA, 415-595-4004
Ziskind Assoc., Rolling Meadows, IL, 312-577-1624
Meyer Mkt'g, Deerfield Beach, FL, 305-481-9250
Awwest, Fountain Hills, AZ, 602-946-1811
Burcaw, Warren, MI, 313-573-4605
Products: annunciator

GBE Group

PO Box 118
Fair Oaks, CA 95628
(916) 967-5946
Pres.: Robert Bird, VP: George Anderson
Products: call-light

New Large Display Countdown Timer for timing speakers, events and live broadcast.

We'll send you a FREE brochure telling how the Visual-Pager Model 604 large display Dual Count up/ Countdown Timer will help you start and stop speakers, events and broadcast on time. Large 5.5 inch remote readout display clock(s) can be seen from 150 feet. Send for a free brochure today describing the timer and easy installation. Discount to dealers.

- Two timers in one package
- Multiple output displays
- Large easy-to-read displays
- Satisfaction Guaranteed

Free Brochure Call Toll Free 1-800-635-3811

Microframe Corp. 8236 E. 71 Street Suite 356 Tulsa Ok. 74133

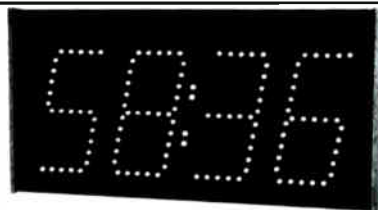

\$598

TB4

DON'T MISS YOUR NEXT ISSUE!

DJ Times has been written, designed and edited for you, the working professional in the mobile & club DJ market. Never before has there been a magazine so totally and exclusively dedicated to covering your interests and your needs. It's been created for you!

Now that you've got your own.... Don't lose it!

DJ TIMES

MUSIC • LIGHTING • SOUND • VIDEO

I want to continue to receive DJ TIMES

PLEASE ENTER MY SUBSCRIPTION FOR

- 1 year . . for \$30.00 (A savings of \$6.00 off the newsstand price.)
 2 years . for \$57.00 (A savings of \$9.00 off the newsstand price.)

PRIMARY JOB FUNCTION:

- A) Disc Jockey — NIGHTCLUB
 B) Disc Jockey — MOBILE
 C) Club Manager
 D) Retailer — Record Store
 E) Retailer — Musical Instruments/Sound Equipment
 F) Sound & Video Installer
 G) Consultant/Designer
 H) Distributor: 1) Records; 2) Video; 3) Equipment
 I) Manufacturer: 1) Audio; 2) Video; 3) Lighting
 J) Other (Please Specify): _____

PRIMARY MUSICAL EMPHASIS:

- 1) Dance Music
 2) Rap Music
 3) Hard Rock
 4) Heavy Metal
 5) Classic Rock
 6) Oldies
 7) Rhythm & Blues
 8) Other
 (Please Specify): _____

ENTER MY SUBSCRIPTION PAYMENT ENCLOSED BILL ME BILL MY CREDIT CARD: VISA MC AI

CARD # _____ EXP. DATE _____

SIGNATURE _____

NAME _____

BUSINESS NAME _____

ADDRESS _____

CITY _____ STATE _____ ZIP _____

Add \$6.00 per year for subscriptions outside the U.S.

DJ TIMES

MUSIC • LIGHTING • SOUND • VIDEO

I want to continue to receive DJ TIMES

PLEASE ENTER MY SUBSCRIPTION FOR

- 1 year . . for \$30.00 (A savings of \$6.00 off the newsstand price.)
 2 years . for \$57.00 (A savings of \$9.00 off the newsstand price.)

PRIMARY JOB FUNCTION:

- A) Disc Jockey — NIGHTCLUB
 B) Disc Jockey — MOBILE
 C) Club Manager
 D) Retailer — Record Store
 E) Retailer — Musical Instruments/Sound Equipment
 F) Sound & Video Installer
 G) Consultant/Designer
 H) Distributor: 1) Records; 2) Video; 3) Equipment
 I) Manufacturer: 1) Audio; 2) Video; 3) Lighting
 J) Other (Please Specify): _____

PRIMARY MUSICAL EMPHASIS:

- 1) Dance Music
 2) Rap Music
 3) Hard Rock
 4) Heavy Metal
 5) Classic Rock
 6) Oldies
 7) Rhythm & Blues
 8) Other
 (Please Specify): _____

ENTER MY SUBSCRIPTION PAYMENT ENCLOSED BILL ME BILL MY CREDIT CARD: VISA MC AI

CARD # _____ EXP. DATE _____

SIGNATURE _____

NAME _____

BUSINESS NAME _____

ADDRESS _____

CITY _____ STATE _____ ZIP _____

Add \$6.00 per year for subscriptions outside the U.S.

DJ TIMES
MUSIC • LIGHTING • SOUND • VIDEO

25 Willowdale Avenue
Port Washington, NY 11050

Place
Stamp
Here

Place
Stamp
Here

DJ TIMES
MUSIC • LIGHTING • SOUND • VIDEO

25 Willowdale Avenue
Port Washington, NY 11050

DON'T MISS YOUR NEXT ISSUE . . .
SUBSCRIBE!

1 year for \$30.00
(A Savings of \$6.00 off the newsstand price)
2 years for \$57.00
(A Savings of \$9.00 off the newsstand price)

Komtek Communications

11 White Lakes Rd.
Stanley, NM 87056
(505) 832-6236, 800-545-7000
Pres.: Bill Patterson
Products: annunciator, audio, bell, call-light, tone, visual

Lathem Time

200 Selig Dr. SW
Atlanta, GA 30378
(404) 691-0400, 800-241-4990, FAX# 404-696-6048
Exec. VP: Bill Lathem, Nat'l Sls Mgr.: Gary Henry, Systems Sls: Jack Callahan
LT, Santa Fe, CA, 800-352-4314
LT, Montreal, Canada, 514-937-2307
Products: audio, bell, tone

LEE DAN COMMUNICATIONS

155 Adams Ave.
Hauppauge, NY 11788-3699
(516) 231-1414, 800-533-3261, in-state 800-231-1414, FAX# 516-231-1498
Pres.: Leon Goldberg, VP Op.: Lawrence Goldberg, VP Finance/Admin.: David Goldberg, Sr. Sls Associate: Susan Leon, Office Mgr.: Rita Kaplan, Sr. Tech.: Sandy Hoffman
Products: annunciator, audio, bell, call-light, tone, visual

MG Electronics

32 Ranick Rd.
Hauppauge, NY 11788
(516) 582-3400, FAX# 516-582-3229
Pres.: Louis Maltz, VP: Elliott Maltz, Sls Mgr.: Stan Grey
Miller Assoc., Stamford, CT, 203-869-7793
Miller Assoc., Flushing, NY, 718-464-0617
Forti Assoc., Kensington, MD, 301-949-1706
Raymar Assoc., Duncanville, TX, 214-296-9833
Products: annunciator

MACKENZIE LABORATORIES

PO Box 3029
Arcadia, CA 91006
(818) 579-0440, 800-423-4147, FAX# 818-448-7131
Pres.: Addison Taylor, VP/Chief Eng: Nagy Khattar, Sls Supervisor: Joe Vitale, Mkt'g/Training: Emory Straus
Awwest, Phoenix, AZ, 602-946-1811
Lex Lawson Assoc., Dallas, TX, 214-272-8482
Avcom, N. Olmstead, OH, 216-777-2060
Rancilio Assoc., St. Louis, MO, 314-845-0202
Rancilio Assoc., Kansas City, KS, 913-491-9883
Warren Assoc., Santa Clara, CA, 408-988-7762
Piper Assoc., Needham, MA, 617-449-1144
Bencsik Assoc., Ocala, FL, 904-732-9775
Design Factors, Los Angeles, CA, 213-697-7576
Riley & Petchell Sls, Detroit, MI, 313-937-3000
Monfort Electronics, Indianapolis, IN, 317-872-8877
Gustafson Systems Sls, Chicago, IL, 315-358-2505
Chuck Olson Assoc., Renton, WA, 206-255-8692
RWR, Rock Hill, SC, 803-324-5111
RWR, Norcross, GA, 404-263-9349
RWR, Alabaster, AL, 206-663-2744

Northland Assoc., Moorehead, MN, 218-233-4616
Products: alarm, audio

Mallory Capacitor

PO Box 1284
Indianapolis, IN 46206
(317) 856-3731, FAX# 317-856-2500
Pres.: Steve Murray, VP Mfg.: Tom Arnold, Dir. Eng. & QA: Len Ziska, Dir. of Field Sls: Tom Green, Sls/Mkt'g Svcs Mgr.: Tom Pilcher, Adv. Mgr.: Sherry Garner
Products: audio

MED-TEK

1335 S. Claudina St.
Anaheim, CA 92805-6235
(714) 774-8484, 800-654-3270, FAX# 714-774-7388
Pres.: William Haines, VP Sls: William Haines, VP Operations: Daniel Haines, Asst. Sls Mgr.: Bo Buchanan

Microframe

8236 E. 71st St., Ste. 356
Tulsa, OK 74133
(918) 250-4839, 800-635-3811
Products: annunciator, call-light, visual

Protech Audio

Flowerfield, Bldg. #1
St. James, NY 11780
(516) 584-5855, FAX# 516-584-5904
Sls Mgr.: Bill Murphy, VP Eng.: Joseph Giambone
Peregrine SW Reps, Houston, TX, 713-589-8481
Products: annunciator, audio, tone

Sanming Sound

17921 Lyons Circle
Huntington Beach, CA 92647
(714) 842-9969, FAX# 714-842-9571
Sls/Mkt'g: Leon Hsieh, Pres./G. Mgr.: Hugh Hsieh, Chief Eng.: S.W. Hsu
Design Factors, Hacienda Heights, CA, 213-697-7576
Forti Assoc., Kensington, MD, 301-949-1706
George Pettitco, Berkeley, IL, 312-261-0342
Repworks, Chicopee, MA, 413, 533-0845
Weller Electronic, Worthington, OH, 614-885-7819
Products: alarm

Signacom

1032 Edwards Rd.
Burlingame, CA 94010
(415) 348-1188
Pres.: Werner Yee

TALK-A-PHONE

5013 N. Kedzie Ave.
Chicago, IL 60625
(312) 539-1100, FAX# 312-539-1241
Pres.: Z. Liberman, VP: S. Shanes, Sls Mgr.: Dan Kagan
Products: alarm, annunciator, audio, bell, call-light, tone

visACOM

517 E. 132nd St.
Bronx, NY 10454
(212) 402-4444
G. Mgr.: Arthur Rich
Products: annunciator, call-light

Wheelock

273 Branchport Ave.
Long Branch, NJ 07740
(201) 222-6880, 800-631-2148, FAX# 201-222-8707
Pres.: P.W. Tarlton, VP Mkt'g: W.L. Goldstein, VP Eng.: S.W. Andrews, Mkt'g Mgr./Tel-Paging: A. Arlan, Mkt'g Mgr./Life Safe-Ind.: R. Haus
Products: alarm, audio, bell, call-light, tone, visual

Whelen Engineering

Rte. 145, Winthrop Rd.
Chester, CT 06412-0684
(203) 526-9504, 800-423-0564, FAX# 203-526-4078
Pres.: John Olson, VP, Auto/Indust. Prod.: Howard Berke, Int'l Sls Mgr.: Keith Nelson, Adv. Dir.: Wendy Roulier, VP High Power Sirens: Skip Phelps, VP Aviation Prod.: Fred Frazier
Products: alarm, visual

Visual-Pager for Churches, Auditoriums and Restaurants

The **VISUAL-PAGER** system quickly pages an individual from a waiting room, restaurant or a large audience without disturbance. **VISUAL-PAGER** by Microframe Corp. is used in hundreds of churches all over America for quietly paging mothers to the nursery when needed. Send for a free brochure today describing easy installation. Discount to qualified system installers.



Visual-Pager Systems from \$398
2, 3, and 4 Digit versions available

FREE Brochure "B2"- CALL TOLL FREE 1-800-635-3811

Microframe Corp. 8236 E. 71 Street Suite 356 Tulsa Ok. 74133

B2

LOUDSPEAKER PRODUCTS

LOUDSPEAKER ACCESSORIES

Acoustone Grille Cloth

80 Wythe Ave.
Brooklyn, NY 11211

(718) 782-5560, FAX# 718-782-7367

Pres.: George Backer, Prod. Mgr.: Larry Lubliner,
Office Mgr.: Al Allentoff, Order Dept.: Inge, Order
Dept.: Judy

Products: grille cloth

AIPHONE INTERCOM SYSTEMS

PO Box 90075

Bellevue, WA 98009

(206) 455-0510, 800-692-0200, FAX# 206-455-0071

Pres.: Jun Matsumoto, Sls Mgr.: Jim Morrison,
Mkt'g/Adv. Mgr.: Harry Quanz
Aiphone NE, Randolph, NJ, 201-328-1790
Aiphone Midwest, Westmont, IL, 312-323-5222
Aiphone SE, Douglasville, GA, 404-920-2811

Products: baffles, enclosure

ATLAS/SOUNDOLIER

1859 Intertech Dr.

Fenton, MO 63026

(314) 349-3110, 800-876-7337, FAX# 314-349-1251

VP/GM: Pete Marsac, VP/Mkt'g: Herbert Jaffe, W.
Reg./Sls Mgr.: Bud Waters, W. Reg./Ass. Sls Mgr.: Jim
Edwards, E. Reg./Ass. Sls Mgr.: Walter Best, Order
Entry Dept. Mgr.: Dale McIntyre
Atlas/Soundolier, Parsippany, NJ, 201-887-7800
Atlas Electronics, Toronto, Canada, 416-789-7761
Atlas/Ind'l, Fenton, MO, 800-362-5673
Atlas/Exp. Dept., Fenton, MO, 314-349-3110

Products: attenuators, baffles, enclosure hardware, enclosure, grilles, mounting hardware, stands, transformers

Audisar

PO Box 1561

Bellevue, WA 98009

(206) 454-2040, 868-5217

Owner: Robert Munger

Products: attenuators, baffles, connectors, crossovers, enclosure hardware, enclosure, mounting hardware, transformers

Bogen Communications

PO Box 575

Ramsey, NJ 07446

(201) 934-8500, FAX# 201-934-9832

Pres.: John Ochtera, VP Sls/Mkt'g: James Orr, Nat'l
Sls Dir.: David Chambers

Products: attenuators, baffles, grilles, transformers

BrystonVermont

979 Franklin Ln.

Maple Glen, PA 19002

(215) 628-4255, 800-673-7899

Pres.: John Russell, VP: Martin Bartelstone

Products: crossovers

Case Component Network

PO Box 41185

Chicago, IL 60641

FAX# 312-772-6586

El-Com/Cabletek, Santa Ana, CA, 714-432-6630
MDS/Music Dealer Svce, Chicago, IL, 800-722-3027
Umbra USA, Lackawanna, NY, 800-387-5122

Products

Cerwin-Vega

555 E. Easy St.

Simi Valley, CA 93065

(805) 584-9332, FAX# 805-583-0865

Pres.: Gene Czerwinski, VP: Connie Czerwinski, Nat'l
Sls Mgr.: Rich Mandella, Tech. Sls: John Davies

Products: attenuators, baffles, connectors, crossovers, grilles, mounting hardware, transformers

J.W. DAVIS & CO.

PO Box 26177

Dallas, TX 75226

(214) 651-7341, 800-527-5705, in-state 800-in TX

800-442-1564, FAX# 214-939-0328

Pres.: Charles Griffith, VP Sls: Jack Tucker

Products: attenuators, baffles, connectors, enclosure

Electro-Voice

600 Cecil St.

Buchanan, MI 49107

(616) 695-6831, 800-527-6701, FAX# 616-695-1304

Pres.: Robert Pabst, VP Sls & Mkt'g: Paul McGuire,
Dir. Mkt'g: Jim Long, Chief Eng.: Earl Harris

Products: attenuators, baffles, connectors, crossovers, grilles, mounting hardware, stands, transformers

EMILAR

4570 E. Eisenhower Circle

Anaheim, CA 92807

(714) 779-8394, 800-421-7071, FAX# 714-779-6696

CEO: Norman Collins-Tooth, Sls Mgr.: Marcia
Cardenas, Prod. Mgr.: Stan Severinis

Products: crossovers

FOSTEX CORP. OF AMERICA

15431 Blackburn Ave.

Norwalk, CA 90650

(213) 921-1112, FAX# 213-802-1964

Exec. VP: Fred Huang, VP Sls/Mkt'g: Mark Cohen

Products: stands

Fourjay Industries

PO Box 14617

Dayton, OH 45413-0617

(513) 890-6444, FAX# 513-890-1692

Pres.: J.M. (Jay) Fulkerson, Dir. Sls: M.W. (Bud)
Frawley, Eng./Mkt'g Mgr.: John Henley

Products: baffles, enclosure hardware, enclosure, grilles,

mounting hardware, transformers

Gemco Electronics

PO Box 993

Gallatin, TN 37066

(615) 452-5960, FAX# 615-451-0026

Pres.: Jerry Graves, Sls Mgr.: Byron Graves

H.O.M.E.

PO Box 225

Hermann, MO 65041

(314) 486-3111

Mkt'g: Arthur Brigham

Products: enclosure hardware

HARRIS/DRACON DIV.

809 Calle Plano

Camarillo, CA 93010

(805) 987-9511, 800-4-DRACON, FAX# 805-987-2547

VP/G. Mgr.: John Mason, VP Sls/Mkt'g.: Jack
McGuigan, Dir. Sls: Tom Erdmann, VP Eng.: Tom
Durstun, Mgr. Mkt'g Comm.: G. Eric Slayton, Prod.
Mgr. Paging: Tom Johnson

Duncan Way, El Toro, CA, 714-859-9932
John Muller, Chesapeake Beach, MD, 301-257-3686
Gary Foster, Columbia, MO, 314-442-2288
Bob Lincoln, Inidan Rock Beach, FL, 813-595-3055
Don Bivens, Lake Elsinore, CA, 714-244-8808
Sam Biasi, Alexandria, BA, 703-971-5095
Bill Boone, Libertyville, IL, 312-816-1080
Margaret Giambalvo, Short Hills, NJ, 201-564-8508
Mark Skilowitz, New Field, NJ, 609-697-4580
Dave Whalen, Houston, TX, 713-974-4373

Hi Lo Fabrication & Mfg.

PO Box 509

Rio Vista, TX 76093

(817) 373-2247

Pres.: C. Caro, Prod. Eng.: Cecil Caro, VP Mkt'g:
Bridget Caro

Products: baffles, crossovers, enclosure, stands

Int'l Components Corp.

105 Maxess Rd.

Melville, NY 11747

(516) 293-1500, 800-645-9154, FAX# 516-293-4983

Exec. VP: Irwin Friedman, VP: Harvey Grossman

Products: attenuators, crossovers, enclosure hardware, transformers

JBL PROFESSIONAL

PO Box 2200

Northridge, CA 91329

(818) 893-8411, FAX# 818-893-3639

Pres.: Ronald Means, VP Sls: Ken Lopez, VP Mkt'g:
Mark Gander, Mkt'g Mgr.: Hector Martinez, Mkt'g Mgr.:
Steve Romeo

Jim Chase, Hermosa Beach, CA, 213-374-2128
Bill Hamilton, Folsom, PA, 215-543-4677
Bill Schuermann, St. Louis, MO, 314-644-2083

Tom Walter, N. Barrington, IL, 312-382-4925
 Products: crossovers, mounting hardware, stands

LEE DAN COMMUNICATIONS

155 Adams Ave.
 Hauppauge, NY 11788-3699
 (516) 231-1414, 800-533-3261, in-state 800-231-1414, FAX# 516-231-1498
 Pres.: Leon Goldberg, VP Op.: Lawrence Goldberg, VP Finance/Admin.: David Goldberg, Sr. Sls Associate: Susan Leon, Office Mgr.: Rita Kaplan, Sr. Tech.: Sandy Hoffman
 Products: attenuators, baffles, grilles, transformers

Lowell Mfg.

3030 Laclede Sta. Rd.
 St. Louis, MO 63143
 (314) 781-9058, 800-325-9660, FAX# 314-645-4852
 Chairman: Ben Lowell, Pres.: Dorothy Lowell, Sls Mgr.: John Lowell, Op.: Wilhelm Lowell, Eng.: Karl Schneider, Credit Mgr.: Mary Tiepelman
 Design Factors, Hacienda Heights, CA, 213-697-7576
 Meyer Mkt'g, Deerfield Beach, FL, 305-481-9250
 Peregrine SW Repts, Houston, TX, 713-589-8481
 H.W. Phillips, Roswell, GA, 404-992-3070
 Puscecker Sls, Upper Montclair, NJ, 201-744-1834
 Products: attenuators, baffles, connectors, enclosure hardware, enclosure, grilles, mounting hardware, transformers

MG Electronics

32 Ranick Rd.
 Hauppauge, NY 11788
 (516) 582-3400, FAX# 516-582-3229
 Pres.: Louis Maltz, VP: Elliott Maltz, Sls Mgr.: Stan Grey
 Miller Assoc., Stamford, CT, 203-869-7793
 Miller Assoc., Flushing, NY, 718-464-0617
 Forti Assoc., Kensington, MD, 301-949-1706
 Raymar Assoc., Duncanville, TX, 214-296-9833
 Products: attenuators, baffles, crossovers, grilles

MISCO Minneapolis Speaker

3806 Grand Ave. S.
 Minneapolis, MN 55409
 (612) 825-1010, FAX# 612-825-7010
 Products: baffles

McCauley Sound

13608 94th Ave. E.
 Puyallup, WA 98373
 (206) 848-0363, FAX# 206-841-3050
 Pres./Sls Mgr.: Tom McCauley, VP/Prod.: Pete McCauley

MIDDLE ATLANTIC PRODUCTS

PO Box 96
 Haskell, NJ 07420
 (201) 839-1011, FAX# 201-839-1976
 Op. Mgr.: Scott Mathews
 Products: grilles

Mortronics

2567 38th Ave.
 Oakland, CA 94601
 (415) 533-3340, 800-962-1962
 Owner: Kenneth Floyd
 Products: attenuators

Neutrik USA

1600 Malone St.
 Millville, NJ 08332
 (609) 327-3113, FAX# 609-825-4804
 G. Mgr.: James Cowan, Prod.t Mgr.: William Dorman, Prod. Mgr.: Kenneth Smalley

Products: connectors

Oaktron Industries

1000 30th St.
 Monroe, WI 53566
 (800) 257-4538
 Pres./CEO: Jerry Disch, Exec. VP: Bob Taller, VP Sls: Jim Hendrickson

Peavey Electronics

711 A St.
 Meridian, MS 39302
 (601) 483-5365, FAX# 601-484-4278
 Pres.: Hartley Peavey
 Products: connectors, crossovers, enclosure hardware, grille cloth, mounting hardware, stands

Peerless Sales

1950 Hawthorne Ave.
 Melrose Pk., IL 60160
 (312) 865-8870, FAX# 312-865-2941
 VP: Walter Snodell, Mkt'g Mgr.: Frank R. Briggs
 Products: mounting hardware

Penn Fabrication (USA)

PO Box 506
 Hawthorne, NJ 07506
 (201) 423-4404
 Sls Dir.: Mike Panasuk, G. Mgr.: Richard Stratford, G. Mgr.: Gavin Naismith
 Products: connectors, enclosure hardware, grille cloth, grilles, mounting hardware

Q-Line

PO Box 20037
 Oklahoma City, OK 73120
 (405) 751-3294
 Pres.: John Quade
 Products: enclosure

Quam-Nichols

234 E. 67th
 Chicago, IL 60637
 (312) 488-5800, 800-633-3669, FAX# 312-488-6944
 Pres.: William Little, VP: Donald Boyer, Sls Mgr.: Greg Johns, Mkt'g Mgr.: Randy Moore, Comptroller: James Ryan, Cust. Svcs.: Vivian Merrills
 R&S Sls, Rockville Center, NY, 516-678-6887
 Levy Lasser & Grams, Chicago, IL, 312-364-7800
 Bidwell Schwartz Assoc., Gardena, CA, 213-770-0300
 J.Y. Schoonmaker, Dallas, TX, 214-349-1650
 Cartwright & Beam, Atlanta, GA, 404-368-0160

Radian Audio Engineering

162 E. Orangethorpe
 Placentia, CA 92670
 (714) 961-1213, FAX# 714-961-0869
 VP Prod.: Richard Stambaugh, Dir. Mkt'g/Sls: Richard Guy, Nat'l Sls Mgr.: Paul Shiner
 Gary Semonian, Marietta, GA, 404-642-7827
 Steven Taub, Silver Springs, MD, 301-622-9100
 Richard Geisler, Westerville, OH, 614-890-7788
 Tom Carlile, Woodland Hills, CA, 818-710-9580
 Dennis Dwinell, Spooner, WI, 715-635-2722
 John Caporale, Redmond, WA, 206-868-5577
 Carl Schwartz, Evanston, IL, 312-761-3771
 Michael Welsh, Orlando, FL, 407-843-0471
 John Fly, Lakewood, CO, 303-986-5999
 George Markunas, Avon, MA, 508-588-8043
 Wane Fuday, Fairfax, CA, 415-459-6880
 Neal Hunter, Syracuse, NY, 315-437-2992
 Marc Johnson, St. Charles, MO, 314-723-0400
 Ronald Coll, Fairlawn, NJ, 201-791-3738
 Bill Coons, Scarborough-Ont., Canada, 416-287-1144

MULTI-BAFFLE SYSTEM



The Industrial and Commercial Music/Paging System That Works!

Up to now, there has never been a satisfactory music/paging system for industrial and commercial areas. Metallic speaker baffles and high intensity sound were more annoying than effective.

But, the Fourjay Multi-Baffle system solves the problems. Now, a larger number of baffles, each directed to a small area, and operating at low level provides effective, echoless paging and enjoyable background music.

The secret is in the specially designed, low cost Fourjay Baffle. Lightweight and molded of polyethylene, it may be hung from chain, stem, or mounting bracket. Thousands already in use for industrial and commercial applications. It's available with or without special moisture-resistant speaker.

Write for Multi-Baffle System sheet and see for yourself how effective music/paging can be accomplished in industrial and commercial locations.



FOURJAY INDUSTRIES

3400 Stop Eight Road
 P. O. Box 14617
 Dayton, Ohio 45413-0617
 Telephone: (513) 890-6444
 FAX: (513) 890-1692

LOUDSPEAKERS

A.E.S.

6400 Youngerman Circle
Jacksonville, FL 32244
(904) 777-0700, FAX# 904-771-7793
Sls/Mkt'g Mgr.: Russ Wells, Credit Mgr.: Carol Ozinga,
Svce Mgr.: Brian Miller
CMI, Leonia, NJ, 201-947-9300
Audio Resources, Westmont, IL, 312-655-1180
AMH Sls, Palos Verdes Est., CA, 213-373-2034
Golden Mkt'g, Framington Hills, MI, 313-553-7077
Nothmar, Seattle, WA, 206-524-5170
Products: custom, flush-mount, full-range, high-frequency
drivers, noise masking, omni-directional, sub-woofer, tweeters

Accusonics Systems

2101 Jericho Turnpike
New Hyde Park, NY 11040
(516) 328-3300
G. Mgr.: Dennis Goodman

AIPHONE INTERCOM SYSTEMS

PO Box 90075
Bellevue, WA 98009
(206) 455-0510, 800-692-0200, FAX# 206-455-0071
Pres.: Jun Matsumoto, Sls Mgr.: Jim Morrison,
Mkt'g/Adv. Mgr.: Harry Quanz
Aiphone NE, Randolph, NJ, 201-328-1790
Aiphone Midwest, Westmont, IL, 312-323-5222
Aiphone SE, Douglasville, GA, 404-920-2811
Products: flush-mount, full-range, paging horns, paging,
voice communications



ALTEC LANSING

PO Box 26105
Oklahoma City, OK 73126-010
(405) 324-5311, FAX# 405-324-8981
Pres.: Dave Merrey, VP Mkt'g: Chuck Lange, Dir. Mkt'g
Dev.: Ted Uzzle, Nat'l Sls Mgr.: Jerry Spriggs,
Mgr./Export Mkt'g: John Sexton, Tech. Svces Mgr.:
Gary Jones
Products: ceiling, compact, components, foreground, full-
range, high-frequency drivers, high-power, horns, low-fre-
quency drivers, mid-bass, monitor panels, multi-way/high-
powered, music system speakers, noise masking, paging
horns, paging, stage monitors, studio/reference monitors,
sub-woofer, systems

Apogee Sound

1150 Industrial Ave, Ste. C
Petaluma, CA 94952
(707) 778-8887, FAX# 707-778-6923
VP Sls/Mkt'g: Joe Manning, Nat'l Sls Mgr.: Mark
Ockenfels
RPM Mkt'g, Carrollton, TX, 214-446-9277
New Horizons, Bannockburn, IL, 312-234-6500
Crescendo Assoc., Inc., Mirimar, FL, 305-961-0886
Creative Audio, Marietta, GA, 404-642-7827
Watt Mkt'g, Allentown, PA, 215-820-7586
Products: paging horns, processor controlled, stage moni-
tors, sub-woofer



ARGOS PRODUCTS

600 S. Sycamore St.
Genoa, IL 60135
(815) 784-5118
Pres.: Donald MacLaughlin, Sls/V.P.: Ron Evers,
Credit Mgr.: Rosella Johnson, Chief Eng.: Loren
Schrader, Purch. Agent: Ray Melton
Ted Firaneck Sls, Pontiac, MI, 313-373-9595
Nevco, Crestwood, MO, 314-843-7406
W.A. Hendrickson, N. Scituate, MA, 617-545-0652
Maish Sls, Mulberry, IN, 317-296-2322
TMC Sls, Ft. Lee, NJ, 201-944-8340
Shamrock Sls, Dayton, OH, 513-258-1227
Pacnor Mkt'g, Lynwood, WA, 206-771-6016
Murphy & Cota, Atlanta, GA, 404-875-2525
Mel Foster Tech. Sls, Edina, MN, 612-941-9800
Bencsik Assoc., Ocala, FL, 904-732-9775
Stinson Assoc., Havertown, PA, 215-446-8585
Lewis & Dunnigan, Syracuse, NY, 315-446-5522
Arch Hoyne, Arlington Heights, IL, 312-398-1681
Wes Tech Mkt'g, Culver City, CA, 213-837-1398
Meyer & Ross, Burlingame, CA, 415-348-6800
Products: columns, full-range, music system speakers,
outdoor, portable, surface-mount

ATLAS/SOUNDOLIER

1859 Intertech Dr.
Fenton, MO 63026
(314) 349-3110, 800-876-7337, FAX# 314-349-1251
VP/IGM: Pete Marsac, VP/Mkt'g: Herbert Jaffe, W.
Reg./Sls Mgr.: Bud Waters, W. Reg./Ass. Sls Mgr.: Jim
Edwards, E. Reg./Ass. Sls Mgr.: Walter Best, Order
Entry Dept. Mgr.: Dale McIntyre
Atlas/Soundolier, Parsippany, NJ, 201-887-7800
Atlas Electronics, Toronto, Canada, 416-789-7761
Atlas/Ind'l, Fenton, MO, 800-362-5673
Atlas/Exp. Dept., Fenton, MO, 314-349-3110
Products: ceiling, columns, compact, components, custom,
decorative, environment protected, explosion-proof, flush-
mount, foreground, full-range, high-frequency drivers, high-
power, horns, low-frequency drivers, monitor panels, music
system speakers, noise masking, omni-directional, outdoor,
paging horns, paging, surface-mount, systems, talkback,
voice communications

Audiotech

410 S. Cedar
Lansing, MI 48912
(517) 371-4148
Pres.: Dave MacPherson, Prod.: Mike Cosgrove, Sls:
Dave Arnold

Audisar

PO Box 1561
Bellevue, WA 98009
(206) 454-2040, 868-5217
Owner: Robert Munger
Products: compact, components, custom, full-range, high-
frequency drivers, high-power, low-frequency drivers, moni-
tor panels, multi-way/high-powered, music system speakers,
powered, studio/reference monitors, sub-woofer, systems

Auernheimer Labs & Co.

4561 E. Florence Ave.
Fresno, CA 93725
(209) 442-1048
Owner: Curly Auernheimer

Aural

4724 Apple St.
Charleston Heights, SC 29405
(803) 747-4782
Sls Eng.: Chuck King
Products: high-power, horns, low-frequency drivers, port-
able, sub-woofer

Auratone

PO Box 698
Coronado, CA 92118
(619) 297-2820, FAX# 619-296-8734

B.E.S.T. Int'l

12753 Moore St.
Cerritos, CA 90701
(213) 926-0201, 800-592-4644, FAX# 213-926-5265
Pres.: Jose Bertagni, Exec. VP: Jose Perewozki, VP
Op.: Luis Gutierrez, VP Mkt'g/Sales: Robert
Hagemann, VP Eng.: Alex Bertagni
Products: ceiling, components, custom, decorative, envi-
ronment protected, flush-mount, foreground, full-range,
multi-way/high-powered, music system speakers, noise
masking, omni-directional, outdoor, paging, surface-mount,
systems, voice communications

Bag End

PO Box 488
Barrington, IL 60010
(312) 382-4550, FAX# 312-382-4551
Pres.: James Wischmeyer, Sls Mgr.: Bob Lowther, Dir.
Eng.: Henry Heine

Bogen Communications

PO Box 575
Ramsey, NJ 07446
(201) 934-8500, FAX# 201-934-9832
Pres.: John Ochtera, VP Sls/Mkt'g: James Orr, Nat'l
Sls Dir.: David Chambers
Products: ceiling, columns, compact, environment protect-
ed, flush-mount, foreground, full-range, horns, music sys-
tem speakers, outdoor, paging horns, paging, powered, sur-
face-mount, systems, talkback, voice communications

BOSE—PRO PRODUCTS

The Mountain
Framingham, MA 01701
(508) 879-7330, FAX# 508-872-6541
G. Mgr.: David Bell, Nat'l Field Sls Mgr.: Timothy
Dorwart, E. Reg. Mgr.: Robin Sibucan, W. Reg Rep:
Michael Schneider
Products: ceiling, compact, flush-mount, foreground, full-
range, high-power, music system speakers, paging, port-
able, powered, processor controlled, stage monitors, studio-
reference monitors, sub-woofer, surface-mount, systems

BOSTON ACOUSTICS

70 Broadway
Lynnfield, MA 01940
(617) 592-9000
Designer Series Sls Mgr.: Rob Harris
Products: ceiling, custom, flush-mount, foreground, music
system speakers, sub-woofer

Bozak

326 South St.
New Britain, CT 06051-3721
(203) 225-0555
Pres.: Donald Bowers, Dir. Mkt'g: William Kielyka,
Chief Eng.: Sheldon Glick
Products: ceiling, columns, environment protected, music
system speakers, omni-directional, outdoor

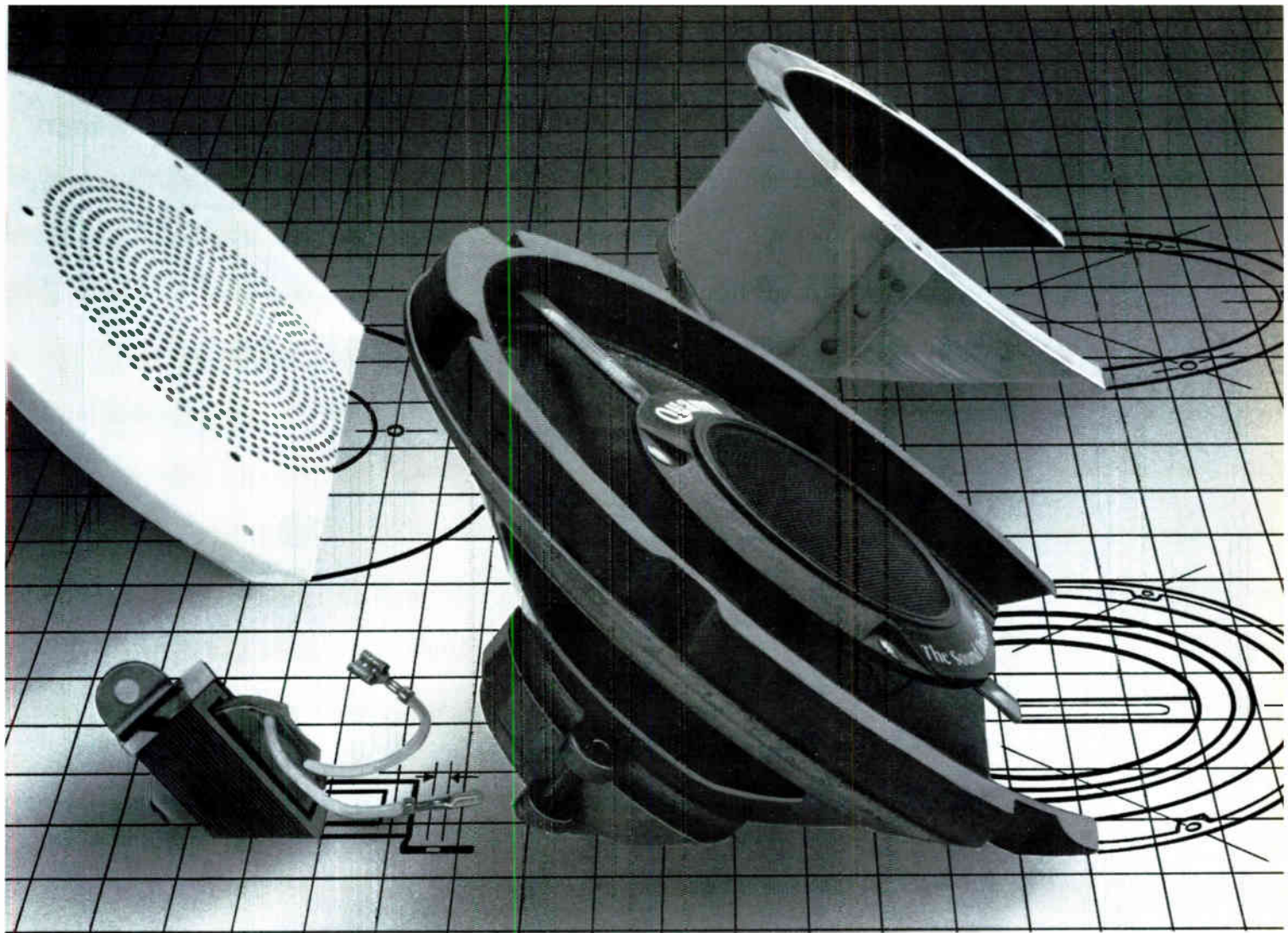

If you take us apart, you'll take us on.

When we decided to expand the Quam line to include ceiling baffles, backbox enclosures and assemblies, we wanted to do more than just complement our loudspeaker offerings. We wanted to give the contractor another choice. Judging from the growing list of contractors who have switched to Quam, we did just that, with an unbeatable combination of quality, price and service.

Take us apart for a side-by-side comparison of ceiling baffles, for

example. From the heavier gauge metal to the more durable epoxy finish, Quam baffles are made in our own plant to look, install and perform better. The same is true of the entire Quam line, from enclosures to transformers to 8" speakers.

You don't pay a premium for this higher quality, because as always, Quam's prices are very competitive. Nor do you pay the hidden cost of maintaining inventory. All catalogued

items, including assemblies, are ready to ship on receipt of order from our 70,000-piece warehouse stock. You buy Quam only as you need the parts.

Take us apart. Then take the competition apart. You'll see that Quam is your best choice. Call or write for your free Quam commercial sound products catalog, and take us on. It's the sound decision.

Quam: The Sound Decision

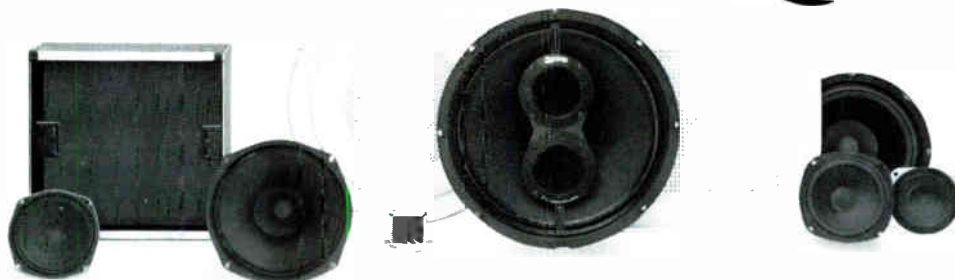

QUAM-NICHOLS COMPANY • 234 E. Marquette Road • Chicago, Illinois 60637 • (312) 488-5800

Circle 222 on Reader Response Card

World Radio History

emilar

4570 E. Eisenhower Circle
Anaheim CA 92807

- A Full Range Of Sound Reinforcement Products
- Hand Crafted For Quality
- Complete Systems Available
- Genuine Replacement Diaphragms
- Written Product Warranty
- Same Day Shipping
- Full Service Facilities

WRITE or CALL

TEL (800) 421-7071

FAX (714) 779-6696

EXCELLENCE IN SOUND

Circle 84 on Reader Response Card

INTERVOX™

FROM BOOM TO BUZZ

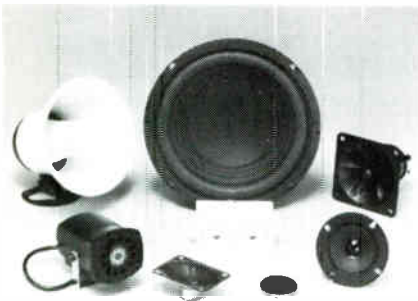

Our worldwide manufacturing facilities can fill virtually any sound requirement you have. Voice quality, Hi-Fi music quality and low profile miniature speakers, Piezo sounders, buzzers and tiny alarms. So give us a buzz and we'll meet your design, quality and budget specifications.

INTERVOX
International ©
International Components Corporation

105 Maxess Rd., Melville, NY 11747

Toll Free 800-645-9154

N Y State 516-293-1500

FAX 516-293-4983 • Telex 221576

Circle 81 on Reader Response Card

LOUDSPEAKERS

Calibration Standard Instruments

PO Box 2727

Oakland, CA 94602

(415) 531-8725

Owner: Edward M. Long

Products: studio/reference monitors, sub-woofer

Celestion Industries

89 Doug Brown Way

Holliston, MA 01746

(508) 429-6706, FAX# 508-429-2426

Pres.: Peter Wellikoff, Dir. Sls/Mkt'g: Barry Fox, Cust.

Svce: Danielle Jacques, Svce Mgr.: Steve King

Cerwin-Vega

555 E. Easy St.

Simi Valley, CA 93065

(805) 584-9332, FAX# 805-583-0865

Pres.: Gene Czerwinski, VP: Connie Czerwinski, Nat'l Sls Mgr.: Rich Mandella, Tech. Sls: John Davies

Products: compact, components, environment protected, flush-mount, foreground, full-range, high-frequency drivers, high-power, low-frequency drivers., mid-bass, music system speakers, noise masking, omni-directional, outdoor, portable, stage monitors, studio/reference monitors, sub-woofer, systems, tweeters



Community Light & Sound

333 E 5th St.

Chester, PA 19013

(215) 876-3400, 800-523-4934, FAX# 215-874-0190

Pres.: Bruce Howze, VP Eng.: John Wiggins, VP Exp.

Sls: Christine Howze, Nat'l Field Sls Mgr.: Chris Berger

Cordial-Riley Mkt'g, Sterling Heights, MI, 313-826-8980

Mel Foster Tech. Sls, Edina, MN, 612-941-9800

Rob Welles, San Francisco, CA, 415-334-4477

Pacific Audio Group, Torrance, CA, 213-719-1383

New Resource, Norwell, MA, 617-659-1463

Sigmat, Freehold, NJ, 201-462-1221

Audio Mkt'g Assoc., Breckville, OH, 216-526-2426

Powerline Mkt'g, Evanston, IL, 312-864-1147

Evans Sls & Mkt'g, Nashville, TN, 615-297-7997

Bencsik Assoc., Ocala, FL, 904-732-9775

R.J. Throckmorton Sls, Ballwin, MO, 314-227-7222

Rep Tech, Terrell, TX, 214-222-2131

Pearson & Pearson, Denver, CO, 303-722-6996

Vector Corp., Seattle, WA, 206-322-4343

Products: compact, environment protected, foreground, full-range, high-frequency drivers, high-power, horns, low-frequency drivers., mid-bass, multi-way/high-powered, music system speakers, omni-directional, outdoor, paging horns, paging, portable, processor controlled, stage monitors, studio/reference monitors, sub-woofer, tweeters, voice communications

Compact Monitor Systems

PO Box 1965

Studio City, CA 91604

(818) 763-8000

DCL

6340 S.W. 145th St.

Miami, FL 33158

(305) 232-2199

J.W. DAVIS & CO.

PO Box 26177

Dallas, TX 75226

(214) 651-7341, 800-527-5705, in-state 800-in TX

800-442-1564, FAX# 214-939-0328

Pres.: Charles Griffith, VP Sls: Jack Tucker

Products: ceiling, columns, compact, components, environment protected, explosion-proof, flush-mount, foreground, full-range, high-frequency drivers, high-power, horns, low-frequency drivers., monitor panels, music system speakers, noise masking, paging horns, paging, portable, stage monitors, sub-woofer, surface-mount, systems, talkback, underwater, voice communications

Design Direct Sound

9320 15th Ave. S, Ste. C-E

Seattle, WA 98108

(206) 527-4371

Pres.: Bob Rice, VP: Marc Hall

Products: high-power, horns

DUKANE

2900 Dukane Dr.

St. Charles, IL 60174

(312) 584-2300, FAX# 312-584-2370

Pres./CEO: J. McWilliams Stone Jr., Group VP: William

Finnegan, Div. G. Mgr.: Steven Deppe, Nat'l Sls Mgr.:

Warren Anderson, Svce Mgr.: Cliff Carlson

Wally Smutts, Toronto-Ont, Canada, 312-584-2300

Doug Fellabaum, Sycamore, IL, 815-895-7573

Don Mouritzen, Beecher, IL, 312-946-9655

Ken Lind, St. Charles, IL, 312-584-2300

Pete Kendal, Jacksonville, FL, 904-262-6025

Ed Nuhring, Portland, OR, 503-244-4262

Jim Lacey, Moreno Valley, CA, 714-243-1160

Jack Brown, Dallas, TX, 214-943-7528

Products: ceiling, columns, components, environment protected, flush-mount, full-range, high-frequency drivers, horns, low-frequency drivers., music system speakers, omni-directional, outdoor, paging horns, paging, portable, voice communications

Dynasound

6439 Atlantic Blvd.

Norcross, GA 30071

(404) 242-8176, FAX# 404-242-8858

EASTERN ACOUSTICS WORKS

One Main St.

Whitinsville, MA 01588

(508) 234-6158, 800-992-5013, FAX# 508-234-8251

Pres.: Kenneth Berger, VP Mkt'g: Frank Loyko, VP

Eng.: Kenton Forsythe

Eden Electronics

PO Box 338

Montrose, MN 55363

(612) 675-3650

Pres.: David Nordschow

Edge Distribution/Turbosound

144C Milewood Rd.

Millbrook, NY 12545

(914) 567-1400, FAX# 914-677-6477

VP Sls/Mkt'g: Daniel Abelson, VP OP.: Hilary

Michener, VP Sls: Dave Talbot

JND, Fairfax, CA, 415-459-3186

Western Audio Sls, Colendale, CA, 818-246-3806

Tenicki & Assoc., Houston, TX, 713-528-2005

Mike Chafee Ent., Sarasota, FL, 813-921-4294

Steffey Mkt'g, Chicago, IL, 312-480-3575

Electronic Systems Group

4405 Vineland Rd., Ste. C-8

Orlando, FL 32811

(305) 423-2363

Arrays, Arcs & Point Sources

Sound reinforcement systems use multiple loudspeakers to increase the power of sounds, so that artists can communicate with large audiences.

To perform accurately, a reinforcement system must act like a single sound source, radiating a coherent arc of sonic energy. The only way to do this is with a *curved array* in which the speakers combine acoustically to produce a single wavefront.

Coherence By Design

In 1980, Meyer Sound created the first curved loudspeaker arrays. And spawned a host of imitations. Today, curved arrays are everywhere. After all, arranging loudspeakers in an arc is a pretty simple chore.

But making a loudspeaker array perform coherently requires extremely complicated engineering. The intricate dynamics of arrays dictate absolutely linear phase and frequency response from every component. Horns must be designed to work together smoothly and efficiently. Crossover frequencies must be selected to preserve consistent directivity within tight tolerances. And each unit in the system must combine seamlessly with the others under all circumstances.

When every one of these conditions is met, the curved array becomes a virtual point source. And only one manufacturer has mastered all of these criteria — Meyer Sound.

Theory & Practice

Every audio professional knows the difference between promotion and real-world performance. With so

many manufacturers claiming arrayability, how do you judge the truth of our claims? The same way that you should judge everyone else's: with your trained ears. When you walk across the hall, does the sound of the loudspeaker system change? Do you hear phasing, flanging or comb filtering? Does the sonic image shift dramatically? Are the lyrics drowned in a sea of reverberation? If so, then the array is not functioning as a coherent point source.

Meyer Sound's proven loudspeaker arraying techniques have resulted from the most thorough research and analysis in the industry. They produce dependable point-source arrays in environments ranging from free-field to the most difficult performance venues.

So set your stage with confidence. Meyer Sound loudspeaker systems are built from the ground up to preserve coherent propagation of sonic energy.

And the proof is in the sound: clear and consistent. Everywhere you need it.

Both the UPA-1A and MSL-3 deliver high sound pressure levels with ultra-low distortion, for maximum intelligibility and fidelity. Efficient, high-powered, rugged and reliable, their specifications meet the most demanding professional needs.

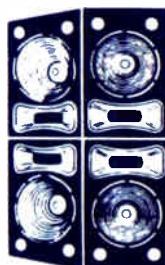

The compact UPA-1A allows controlled coverage of wide areas in theaters, clubs and concerts.

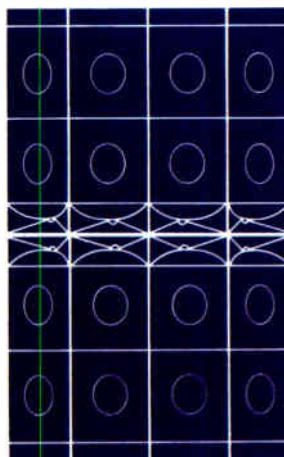

The MSL-3 covers a broad range of large-scale reinforcement applications.



Carnegie Hall A coherent array of UPA-1A loudspeakers, supplemented by MSL-3s and 650-R2 subwoofers (not pictured), is permanently installed for live performance reinforcement..

Sound engineering for the art and science of sound.

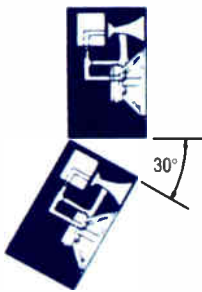

UPA-1A in typical vertical configuration.



Meyer Sound Laboratories, Inc.
2832 San Pablo Avenue
Berkeley, CA 94702
(415) 486-1166
FAX (415) 486-8356

Electro-Voice

600 Cecil St.
Buchanan, MI 49107
(616) 695-6831, 800-527-6701, FAX# 616-695-1304

Pres.: Robert Pabst, VP Sls & Mkt'g: Paul McGuire,
Dir. Mkt'g: Jim Long, Chief Eng.: Earl Harris

Products: ceiling, columns, compact, components, environment protected, explosion-proof, flush-mount, foreground, full-range, high-frequency drivers, high-power, horns, low-frequency drivers,, mid-bass, multi-way/high-powered, music system speakers, outdoor, paging horns, paging, portable, processor controlled, stage monitors, studio/reference monitors, sub-woofer, surface-mount, systems, tweeters

EMILAR

4570 E. Eisenhower Circle
Anaheim, CA 92807
(714) 779-8394, 800-421-7071, FAX# 714-779-6696

CEO: Norman Collins-Tooth, Sls Mgr.: Marcia Cardenas, Prod. Mgr.: Stan Severins

Products: components, full-range, high-power, horns, low-frequency drivers,, mid-bass, music system speakers, stage monitors, systems

Environmental Sound

31220 La Baya Dr., Ste. 110
Westlake Village, CA 91362
(818) 706-0228, FAX# 818-889-5605

Pres.: Pascal Delbuck, Mkt'g Dir.: Ron Glathoffer, Plant Mgr.: Bill Ward
Factory Direct

Fane

1316 East Lancaster St.
Fort Worth, TX 76102

(817) 336-5114

Len Finkler

80 Alexdon Rd.
Downsview, Ontario M3J2B4
(416) 630-9103

Formula Audio

Rte. 5, Box 440-3, Hwy 39
Zebulon, NC 27597
(919) 269-6441

Pres.: Jeffrey Forsburg, Sec.: Susan Forsburg
Hank Dunn Assoc., Doylestown, PA, 800-243-6875
Raleigh Perry & Assoc., Buford, GA, 404-945-3142
DBG Mkt'g, Montreal, Quebec, 514-488-9564
ProTek, Plano, TX, 214-596-6065

Products: compact, components, custom, full-range, high-frequency drivers, high-power, horns, low-frequency drivers,, mid-bass, portable, powered, stage monitors, studio/reference monitors, sub-woofer, tweeters

Foster

15000 Calvert St.
Van Nuys, CA 91411
(213) 994-0686

FOSTEX CORP. OF AMERICA

15431 Blackburn Ave.
Norwalk, CA 90650
(213) 921-1112, FAX# 213-802-1964

Exec. VP: Fred Huang, VP Sls/Mkt'g: Mark Cohen
Products: full-range, high-frequency drivers, horns, low-frequency drivers,, music system speakers, stage monitors, studio/reference monitors, sub-woofer, tweeters

Fourjay Industries

PO Box 14617

Dayton, OH 45413-0617

(513) 890-6444, FAX# 513-890-1692

Pres.: J.M. (Jay) Fulkerson, Dir. Sls: M.W. (Bud) Frawley, Eng./Mkt'g Mgr.: John Henley

Products: ceiling, compact, components, environment protected, flush-mount, foreground, full-range, music system speakers, noise masking, outdoor, paging horns, paging, portable, surface-mount, talkback, voice communications

Frazier

Route 3, Box 319
Morrilton, AR 72110-9532
(501) 727-5543, 800-643-8747, FAX# 501-727-5402

Pres.: Earle Love, VP Sls/Mkt'g.: James Truelsen, VP Mfg./Eng.: Hugh Donnell
Henry Phillips, Roswell, GA, 404-992-3070
Dick Bellow Sls, North Olmsted, OH, 214-644-7881
SRT Mkt'g, Tampa, FL, 813-884-4805
Design Factors, La Habra, CA, 213-697-7576
Palmieri Assoc., Ridgefield, NJ, 201-943-5888

Products: columns, compact, components, decorative, environment protected, foreground, full-range, high-frequency drivers, high-power, low-frequency drivers,, portable, stage monitors, studio/reference monitors, sub-woofer, surface-mount, systems, voice communications

GLI

1227 Walt Whitman Rd.
Melville, NY 11747
(516) 351-2100

Galaxy Audio

625 East Pawnee Ave.
Wichita, KS 67211
(316) 263-2852

Chief Eng.: Brock Jabara, P.E., Eng.: Monte Ballard,
Sls Mgr.: Jim Pearce
Products: stage monitors



"...SOUNDSPHERE LOUDSPEAKERS ARE THE REASON FOR THE CLARITY OF SOUND!"

Don Hartley/President • Dynamic Sound • Exeter, NH

Comments Mr. Hartley on the Sun Foods store, "The Lowell store has approximately 76,000 square feet and is the largest supermarket in New England. It contains 24 checkout counters....

... This store is owned by Hannaford Brothers and they basically have three or four names that they use for different stores. In 1984, they built a store similar to this, with a 22-foot ceiling and at that time we were just completing a new installation at their warehouse, which comprised of twelve 250-watt amplifiers and approximately 80 Soundspheres. Since the ceiling in their new store was going to be 22-feet high, we strongly recommended Soundsphere #110's and guaranteed equal sound in each and every part of the store. This installation was completed; and last year when another store was planned in Lowell, they called us for an installation similar to Keene....

...The size of the store and the use of Soundspheres have caused many supermarket competitors throughout the United States to evaluate this store, and we have received numerous phone calls about the sound system since it works so efficiently and about its clarity where you have all concrete walls, concrete floors and open girders in the ceiling. We have given all of them the same answer that it is very obvious the Soundspheres are the reason for the clarity of sound!"

We strongly recommended Soundsphere #110's.

Write or call direct for further information.

SOUNDSPHERE A PRODUCT OF
SONIC SYSTEMS, INC.

737 Canal Street • Bldg 23B • Stamford, CT 06902 • USA • Tel (203) 356-1136



Great innovations start with simple ideas. RAMSA speaker enclosures are designed for modularity, portability and expandability. They're compact and rugged, with special coupling exteriors for sturdy stacking. Broad bandwidth and flat response enable RAMSA speakers

to perform well in a multitude of applications. The A10, A80, A200, and A240 subwoofer come in a choice of black or white, with mounting hardware for support systems.

Visit the nearest RAMSA dealer and compare our speaker systems with *any* in the store. And find out how effective a simple idea can be.

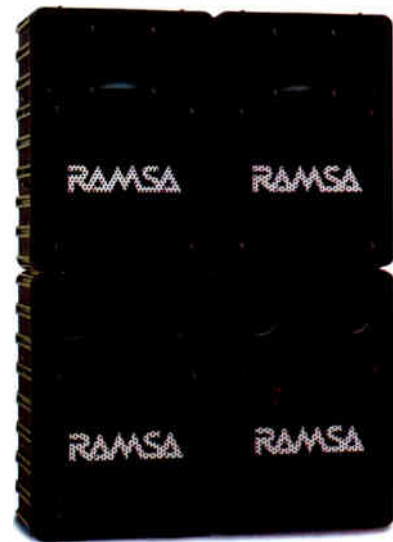

RAMSA

Panasonic
Industrial Company

Circle 244 on Reader Response Card

Gauss
 9130 Glenoaks Blvd.
 Sun Valley, CA 91352
 (213) 875-1900, FAX# 818-767-4479
 Pres.: James Williams, Cust. Svce Mgr./Dup.: Joe O'Conner, Nat'l Sls Mgr./Speakers: Paul Hugo, Chief Eng./Speakers: Walter Dick, Cust. Svce/Speakers: Bonnie Armstrong, Cust. Svce/Dup.: Don King
 Brian Frankie & Assoc., Belmont, CA, 415-595-4004
 Peter Schmitt, Leonia, NJ, 201-944-2806
 Hustling Ent., Yakima, WA, 509-966-2574
 Richard Pass, Langhorne, PA, 215-757-6100
 Master Recording Supply, Burbank, CA, 818-841-7500
 Products: high-frequency drivers, high-power, low-frequency drivers., mid-bass

Gemco Electronics
 PO Box 993
 Gallatin, TN 37066
 (615) 452-5960, FAX# 615-451-0026
 Pres.: Jerry Graves, Sls Mgr.: Byron Graves
 Products: ceiling, columns, paging horns

Gollehon Industries
 3105 Madison Ave. SE
 Grand Rapids, MI 49508
 (616) 247-8231

HARRIS/DRACON DIV.
 809 Calle Plano
 Camarillo, CA 93010
 (805) 987-9511, 800-4-DRACON, FAX# 805-987-2547
 VP/G. Mgr.: John Mason, VP Sls/Mkt'g.: Jack McGuigan, Dir. Sls: Tom Erdmann, VP Eng.: Tom Durston, Mgr. Mkt'g Comm.: G. Eric Slayton, Prod. Mgr. Paging: Tom Johnson
 Duncan Way, El Toro, CA, 714-859-9932
 John Muller, Chesapeake Beach, MD, 301-257-3686
 Gary Foster, Columbia, MO, 314-442-2288
 Bob Lincoln, Inidan Rock Beach, FL, 813-595-3055
 Don Bivens, Lake Elsinore, CA, 714-244-8808
 Sam Biasi, Alexandria, BA, 703-971-5095
 Bill Boone, Libertyville, IL, 312-816-1080
 Margaret Giambalvo, Short Hills, NJ, 201-564-8508

Mark Skilowitz, New Field, NJ, 609-697-4580
 Dave Whalen, Houston, TX, 713-974-4373

Hi Lo Fabrication & Mfg.
 PO Box 509
 Rio Vista, TX 76093
 (817) 373-2247
 Pres.: C. Caro, Prod. Eng.: Cecil Caro, VP Mkt'g.: Bridget Caro
 Products: columns, compact, components, custom, decorative, environment protected, horns, monitor panels, outdoor, portable, stage monitors, systems, voice communications

Hill Audio Products
 510 Charlotte St.
 Longwood, FL 32750-6370
 (407) 339-9100, FAX# 407-339-8901
 Mkt'g Coor.: Tony Kenney, Billings/Credit Pro.: Jan Gilliland, VP Mkt'g: Lindsay Baker
 Products: outdoor

Hirschmann of America
 PO Box 229
 Riverdale, NJ 07457
 (201) 835-5002, 800-225-0524
 Sls Mgr.: Andy Swenson

Int'l Components Corp.
 105 Maxess Rd.
 Melville, NY 11747
 (516) 293-1500, 800-645-9154, FAX# 516-293-4983
 Exec. VP: Inwin Friedman, VP: Harvey Grossman
 Products: ceiling, components, environment protected, flush-mount, foreground, full-range, high-frequency drivers, high-power, horns, low-frequency drivers., mid-bass, music system speakers, outdoor, paging horns, paging, talkback, tweeters, voice communications

Int'l Music Co. (I. M. C.)
 PO Box 2344
 Ft. Worth, TX 76113-2344
 (817) 336-5114, 800-433-5627, FAX# 817-870-1271
 Chairman of the Bd./CEO: Tommy Moore, Pres.: Jerry Freed, VP Sls: C.H. Murray, Dir. Akai EMI: Mike McRoberts, Akai Prod. Specialist: Kevin Kennedy

Intersonics
 3453 Commercial Ave.
 Northbrook, IL 60062-1818
 (312) 272-1772, FAX# 312-272-9324
 Sls Mgr.: Tom Melzer, Prod. Mgr.: Dayton Nash, Shop Supervisor: John Halliburton, Acoustic Eng: Thomas Danley
 Sigmat, Freehold, NJ, 201-462-1221
 Innovative Sls, Irvine, CA, 714-975-1130
 New England Technical, New Haven, CT, 203-467-8100
 Audio Mkt'g, Brecksville, OH, 216-526-2426
 Sherwood Assoc., Endicott, NY, 607-785-1590

ALL TERRAIN VEHICLE
 THE OAP COMPOSITE SERIES

Our boxes are made to go the distance whether we're talking about 365 days a year on the road, on the wall, or flying. We build our loudspeaker systems the old fashioned way, because our customers have some old fashioned ideas about sound quality and reliability. We use road tested components and 3/4" plywood construction with all internal joints braced and glued. We warranty our products for five years.

OAP Audio. A name you can depend on!

OAP Audio Products, Inc.
 310 Peachtree Industrial Blvd.
 Buford, GA 30518
 404.945-1028
 World Radio History



JBL PROFESSIONAL
 PO Box 2200
 Northridge, CA 91329
 (818) 893-8411, FAX# 818-893-3639
 Pres.: Ronald Means, VP Sls: Ken Lopez, VP Mkt'g: Mark Gander, Mkt'g Mgr.: Hector Martinez, Mkt'g Mgr.:

Music made Beautiful



Sonance makes music more beautiful with "Architectural Audio." Custom in-wall stereo speakers and controls that blend unobtrusively into your home's most discriminating decor.

All Sonance speakers and controls can be painted or cloth covered to aesthetically match any room's delicate design. Precision flush mounting insures excellent high fidelity response and consistent decorative perfection.

To experience "Architectural Audio" we invite you to call your local Custom Audio/Video Specialist.



32992 CALLE PERFECTO, SAN JUAN CAPISTRANO
CALIFORNIA 92675 (714) 661-7558
Outside CA (800) 582-7777 FAX (714) 240-4995

Canadian Distributor: Avelyn Acoustics Ltd., 3111 39th Ave.
Vancouver, B.C. V5V 2M9 (604) 871-4475

Sonance Products include Five variations of Speakers,
One Passive & One Active Subwoofer, a Speaker Distribution System
and Five different Volume Controls & A/B Selectors.
(All Built-in Products fit in "2x4" wall)

Circle 204 on Reader Response Card

World Radio History

Steve Romeo

Jim Chase, Hermosa Beach, CA, 213-374-2128

Bill Hamilton, Folsom, PA, 215-543-4677

Bill Schuermann, St. Louis, MO, 314-644-2083

Tom Walter, N. Barrington, IL, 312-382-4925

Products: ceiling, compact, components, foreground, full-range, high-frequency drivers, high-power, horns, low-frequency drivers, mid-bass, multi-way/high-powered, music system speakers, outdoor, stage monitors, studio/reference monitors, sub-woofer, systems, tweeters

Joe's Sound and Salami

303 Clymer Ave.

Morrisville, PA 19067

(215) 736-0811, FAX# 215-736-1262

Dir. Mkt'g: Corinne S. Gately, Dir. Adv.: Doris

Morgenfruh

Taub Sls, Silver Springs, MD, 301-622-4764

Harry Rosenblum, White Plains, NY, 914-428-0811

Chris Ross, Natick, MA, 508-650-3628

KDM Electronics

705 Progress Ave., Unit #59

Scarborough, Ontario, Canada M1H 2X1

(416) 439-7158, FAX# 416-439-7232

Pres.: Ron Bull, Sls Mgr.: Tom Bandini

Givan Assoc., W. Boylston, MA, 508-835-3161

Sigmat, Valley Forge, PA, 215-783-6666

Henry Phillips, Roswell, GA, 404-992-3070

Reptronics, New Madison, OH, 513-996-0530

William Linz Assoc., Deerfield, IL, 312-945-9600

Products: environment protected, full-range, multi-way/high-powered, omni-directional, underwater, voice communications

KLIPSCH & ASSOCIATES

PO Box 688

Hope, AR 71801

(501) 777-6751, FAX# 501-777-6753

Nat'l Sls Mgr.: Kent W. Sheldon

J.B. Parent, Dublin, OH, 614-764-0064

Sherwood Assoc., Endicott, NY, 607-785-1590

Audio Assoc., Verona, NJ, 201-239-3727

RPM, Carrollton, TX, 214-446-3010

Michael Chalee Enter., Sarasota, FL, 813-921-4294

Northmar, Seattle, WA, 206-524-5170

Aim Mkt'g Group, Ann Arbor, MI, 313-662-6101

PCM Mkt'g, Walnut Creek, CA, 415-935-0900

Bob Bailey, Lincoln, NE, 501-777-6751

Audio Assoc., Fulton, MD, 301-604-7223

New England Tech. Assoc.(NETA), New Haven, CT, 203-467-8010

Starin Mkt'g, Chesterton, IN, 219-929-4127

Morris-Tait Assoc., North Hollywood, CA, 213-877-4424

Applied Audio Mkt'g, Asheville, NC, 704-252-9313

B.T.W., Honolulu, HI, 808-841-0655

LAR Sound

718 Ninth St.

Niagara Falls, NY 14301-1802

(716) 242-2442

Owner: Larry Kutner, Prod. Mgr.: David Rowland

Sigmat, Valley Forge, PA, 215-783-6666

Reptronics, New Madison, OH, 513-996-0530

Klumpp Sls, Jacksonville, FL, 904-287-5205

William Linz Assoc.

Henry Phillips, Roswell, GA, 404-992-3070

Products: compact, components, custom, decorative, foreground, multi-way/high-powered, music system speakers, outdoor, studio/reference monitors, surface-mount, systems

LEE DAN COMMUNICATIONS

155 Adams Ave.

Hauppauge, NY 11788-3699

(516) 231-1414, 800-533-3261, in-state 800-231-

1414, FAX# 516-231-1498

Pres.: Leon Goldberg, VP Op.: Lawrence Goldberg, VP

Finance/Admin.: David Goldberg, Sr. Sls Associate:

Susan Leon, Office Mgr.: Rita Kaplan, Sr. Tech.:

Sandy Hoffman

Products: ceiling, flush-mount, horns, music system speakers, outdoor, paging horns, paging, portable, surface-mount, voice communications

E.M. Long Assoc.

4107 Oakmore Rd.

Oakland, CA 94602

(415) 531-8725

Products: powered, processor controlled, studio/reference monitors, sub-woofer

Lowell Mfg.

3030 Laclede Sta. Rd.

St. Louis, MO 63143

(314) 781-9058, 800-325-9660, FAX# 314-645-4852

Chairman: Ben Lowell, Pres.: Dorothy Lowell, Sls Mgr.:

John Lowell, Op.: Wilhelm Lowell, Eng.: Karl

Schneider, Credit Mgr.: Mary Tiepelman

Design Factors, Hacienda Heights, CA, 213-697-7576

Meyer Mkt'g, Deerfield Beach, FL, 305-481-9250

Peregrine SW Reps, Houston, TX, 713-589-8481

H.W. Phillips, Roswell, GA, 404-992-3070

Pusecker Sls, Upper Montclair, NJ, 201-744-1834

Products: ceiling, environment protected, flush-mount, foreground, full-range, high-frequency drivers, low-frequency drivers, noise masking, talkback

M.B. America (Master Blaster

America)

215 Tremont St.

Rochester, NY 14608

(716) 436-2720

**THE HIGH QUALITY,
ALL-TERRAIN,
WEATHER-RESISTANT,
OUTDOOR SPEAKER
SYSTEM.**



SoundScape®

P.O. Box 1563
Windermere, Florida, 34786

407-876-6884



**We want to hear
about your
latest
installation!**

**Tell us about it so we
can tell everyone else in
Contracting Close-Up.**

Write to:
Sound & Communications
25 Willowdale Avenue
Port Washington, NY 11050
or call: (516) 767-2500

Bose® ProFiles

“When I went after this job, I looked at several manufacturers. But when I examined cost vs. performance and considered ease of installation, Bose was the clear choice.”

*—Phil Thorne
Taft Broadcasting Company*

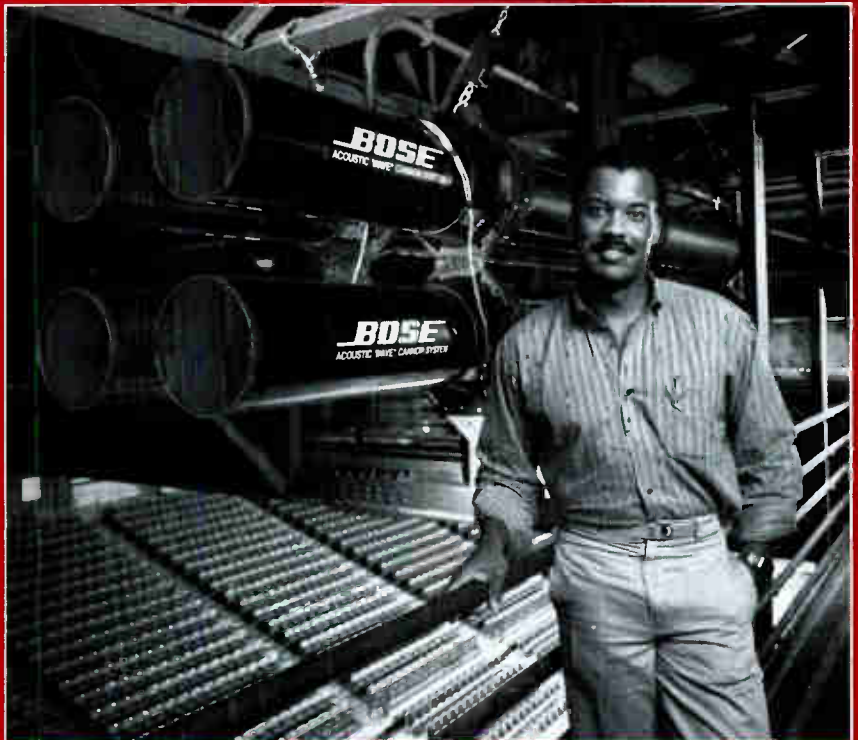

The Site: Health & Physical Education Building
Texas Southern University, Houston, Texas

The Challenge: Provide a quality sound installation for 12,000 seat enclosed basketball arena with anticipated crowd noise level exceeding 95dB

The Contractor: Phil Thorne—Taft Broadcasting Company

The Tools: Bose® Sound System® Software

The Products: Bose 802®-II/Acoustic Wave® Cannon Central Speaker Cluster
Bose 802-II Distributed-Delayed Speaker System

The Result: “Using Bose Sound System Software, I was able to show my customer a graphic representation of what their system would look like, and a computer projection of how it would perform. My customer was very impressed with the professionalism and in-depth analysis of the presentation, and they’re just as impressed with the final product. When you first look at the size of the Bose 802-II speakers, you wonder if they’ll really produce enough sound to fill an area as large as an arena effectively. When you use them the sound is complete and sound pressure levels are consistent over the whole area. My end users are happy I chose Bose products.”



For more information on Bose products, call 508-879-7330, or write;
Bose Corporation, Dept SC, The Mountain, Framingham, MA 01701-9168

BOSE
Better sound through research.

Circle 235 on Reader Response Card

MG Electronics

32 Ranick Rd.
Hauppauge, NY 11788
(516) 582-3400, FAX# 516-582-3229

Pres.: Louis Maltz, VP: Elliott Maltz, Sls Mgr.: Stan Grey

Miller Assoc., Stamford, CT, 203-869-7793
Miller Assoc., Flushing, NY, 718-464-0617
Forti Assoc., Kensington, MD, 301-949-1706
Raymar Assoc., Duncanville, TX, 214-296-9833

Products: ceiling, compact components, custom, environment protected, flush-mount, foreground, full-range, high-frequency drivers, high-power, low-frequency drivers, mid-bass, music system speakers, outdoor, paging horns, paging, surface-mount, talkback, tweeters

MacPherson Speakers

3351 Remy Dr.
Lansing, MI 48906
(517) 321-0700, FAX# 517-321-638-

Pres.: Dave MacPherson, VP: Tom Cooley, Prod. Mgr.: Dan Stapelwran

Mark IV Cinema Systems

600 Cecil St.
Buchanan, MI 49107
(616) 695-6831

Dean Markley Strings & Electronics

3350 Scott Blvd., Ste. 45
Santa Clara, CA 95054
(408) 988-2456, 800-538-8330, FAX# 988-0441
Pres.: Dean Markley, Exec. VP: Bari Wilson, Nat'l Sls Mgr.: Tom Dreibelbis

Martin America

PO Box 3248
, CA Chatsworth
(818) 718-1031, FAX# 818-718-2886
Pres.: Ted Telesky, VP: Dave Martin, Sls Mgr.: Linda Frank

McCauley Sound

13608 94th Ave. E.
Puyallup, WA 98373
(206) 848-0363, FAX# 206-841-3050
Pres./Sls Mgr.: Tom McCauley, VP/Prod.: Pete McCauley

Meyer Sound Laboratories

2832 San Pablo Ave.
Berkeley, CA 94702
(415) 486-1166, FAX# 415-486-8356
Dir. Int'l Sls/Mkt'g: George Douglas, Dir. Tech. Mkt'g: Mark Johnson, Nat'l Sls Mgr.: Cindy Ramos, Cust. Svce Mgr.: Herb Heinz
Products: full-range, multi-way/high-powered, portable, processor controlled, stage monitors, studio/reference monitors, sub-woofer

Misco/Minneapolis Speaker

3806 Grand Ave. S.
Minneapolis, MN 55409
(612) 825-1010, FAX# 612-825-7010
Pres.: Dan Digre, Sls Mgr.: Don Ringham
Audio Mkt'g, Brecksville, OH, 216-526-2426
Bellew Sls, Dallas, TX, 214-644-7881
Hendrickson, North Scituate, MA, 617-545-0652
Pacnor Mkt'g, Lynnwood, WA, 206-771-6016
Miller Assoc., Greenwich, CT, 203-869-7793

Products: ceiling, components, custom, decorative, environment protected, explosion-proof, flush-mount, foreground, full-range, high-frequency drivers, low-frequency drivers, mid-bass, music system speakers, noise masking, omni-directional, outdoor, paging, sub-woofer, surface-mount, tweeters, voice communications

LOUDSPEAKER LISTINGS CONTINUE ON PAGE 122

McCAULEY

... Pure Performance



The quality of McCauley loudspeaker systems goes far beyond cabinetry and exterior decor. Inside every McCauley system is what our company is all about, the driving force behind every system—its components. Not just a collection of pieces and parts that you find in so many other companies' boxes, but a precisely matched set of transducers that have been designed, engineered, and manufactured at McCauley and by



McCauley to deliver a signature of pure professional performance to the term "State of the Art."



To experience the sheer power of a McCauley speaker system is reward enough for some; but to lay your claim puts you in a world of "Pure Performance." Tame the Series 800 system at an authorized McCauley dealer. Call or write the factory for detailed product specifications.



McCauley Sound, Inc.

13608 94th Ave. E., Puyallup, Washington, USA 98373 (206) 848-0363



Coaxial Transducers

and Time Offset Correction (TOC™) Accessories

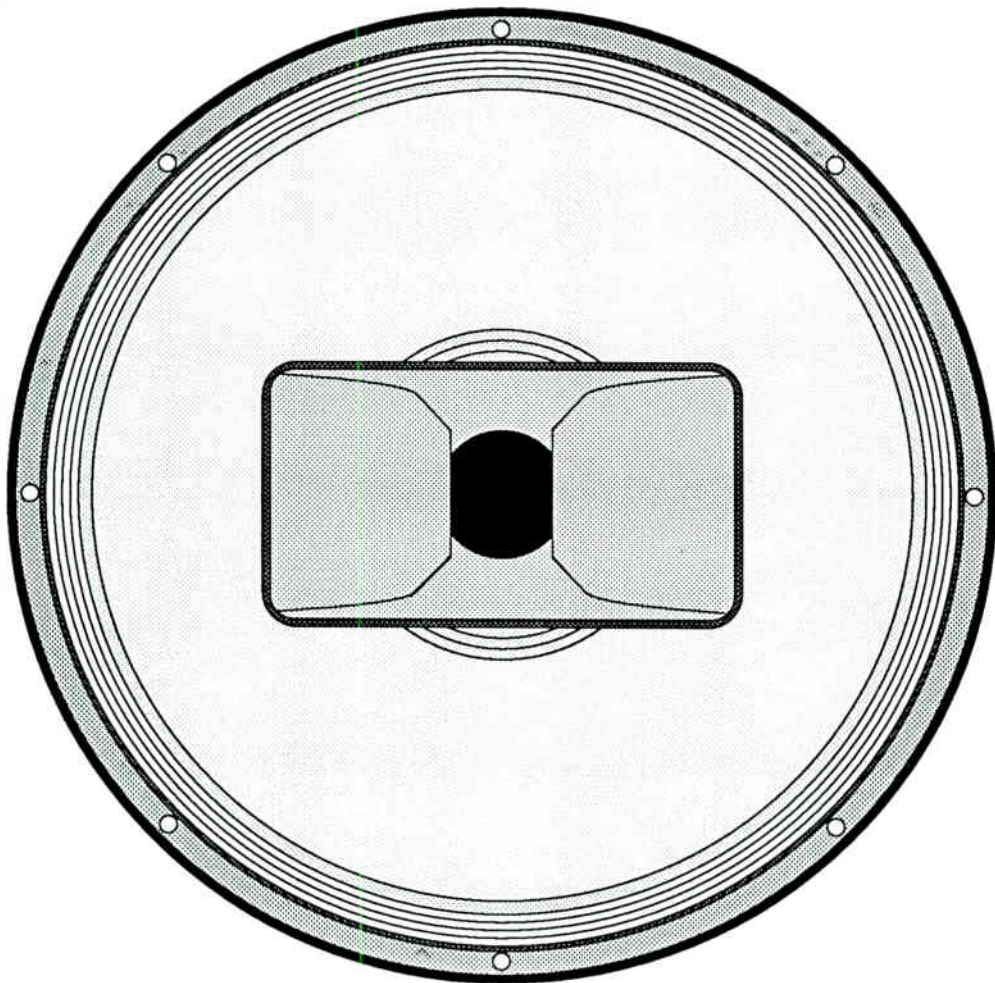

Contents

Introduction	2
Theory of Operation	3
Products	
J-1.2k, R-1.2k	5
CX-1280C	6
CX-1580C	8
CXL-1580C	10
CXL-2580C	12
TOC-23	14
Price List	16

Introduction

PAS Coaxial Transducer Systems answer the need for compact high-performance two-way loudspeaker systems in a wide variety of exacting monitoring and sound reinforcement applications.

Coaxial design radiates lows and highs through one acoustic 'window', resulting in precise imaging and stereo localization. PAS coaxial transducers feature a unique constant coverage high frequency horn that overcomes high frequency beaming without coloration and distortion. Smooth, phase-coherent response is obtained with PAS's exclusive Time Offset Correction (TOC™), which normalizes acoustic centers of the low and high frequency sources.

PAS coaxial loudspeakers are available in 12 inch and 15 inch versions. Three models of 15 inch transducers are available: all come less the high frequency compression driver, allowing designers and users to tailor the performance of the high frequency component to the specific application, budget or listening preference. True versatility.

When combined with PAS-developed Time Offset Correction™ technology, PAS coaxial

loudspeakers demonstrate virtually ripple-free, monotonic phase response from 100 Hz to 10 kHz.

The 15 inch coaxial systems are a logical choice for applications that call for extended low frequency response. The CXL-1580C is an extended-bass version of the CX-1580C, incorporating a voice coil and magnetic circuit designed for large cone excursions with high linearity. The CXL-2580C is a high power transducer, featuring a large, four-inch LF voice coil and a constant coverage horn designed to accept large-format two-inch throat compression drivers.

The 12 inch coaxial loudspeaker, model CX-1280C, provides an extension of mid-frequency power response in exchange for a slight reduction in low frequency output, and is ideally suited for vocal-range systems and three-way installations when augmented with subwoofers.

All PAS coaxial loudspeakers incorporate a Constant Coverage horn design for 30 by 60 degree dispersion. The horn configuration, unique in coaxial loudspeakers, assures a smooth, interference-free transition from (wide angle) low frequencies to controlled distribution at high frequencies. Slightly larger than other coaxial horns, the PAS horns provide more useful loading to low frequencies, enabling the crossover frequency to be lowered to 1200 Hz. This reduces dependence upon the cone transducer for upper mid-frequency output, resulting in smoother power response. Careful attention to throat geometry results in constant angular coverage to beyond the audible frequency range in one-inch throat versions, with almost imperceptible narrowing above 10 kHz in the two-inch.

PAS manufactures three frequency dividing networks for coaxial system use—two passive and one active—all with Time Offset Correction. The passive systems differ only in their Time Offset Correction, which is optimized for either shallow or deep structure compression drivers. The TOC-23 active frequency dividing processor includes a wealth of functions and operator features with which to optimize and control system performance for the most demanding of applications.

(TOC™)

TIME OFFSET CORRECTION THEORY OF OPERATION

The PAS model CXL-2580C coaxial loudspeaker is illustrated at right (shown with a JBL 2450 compression driver). Note that the effective acoustic centers of the low and high frequency transducers are separated by a finite distance. This distance in feet, divided by the speed of sound (1128 ft./second), is the time offset between the transducers.

This means that a low frequency signal will arrive at the listener's ears before the high frequency signal. In conventional two-way loudspeaker systems, the offset is usually sufficient to result in smearing and loss of transient integrity.

PAS-developed Time Offset Correction™ delays the low frequency signal equal to the time offset, thereby making both loudspeakers effectively radiate from the same acoustic center. Coaxial loudspeaker systems are the only two-way sources that can be completely time-corrected for offset acoustic centers.

In conventional two-way systems that employ separate low and high frequency loudspeakers, Time Offset Correction will substantially improve coherency along the primary axis in the direct field. Figure 2 illustrates this configuration. Note that the time offset between low and high frequency sources changes, however, depending upon the angle of observation. Along the primary axis, observation angle 'A', the LF is slightly ahead of the HF source. Below the system, observation angle 'B', the LF is advanced further, while above the system, observation angle 'C', the order is reversed, and the HF leads the LF source. In contrast, because low and high frequency energy radiates from a common 'acoustic window' in coaxial loudspeaker systems, Time Offset Correction will be virtually absolute. Coaxial systems with TOC™ have virtually ripple free, monotonic phase response from 100 Hz to 10 kHz.

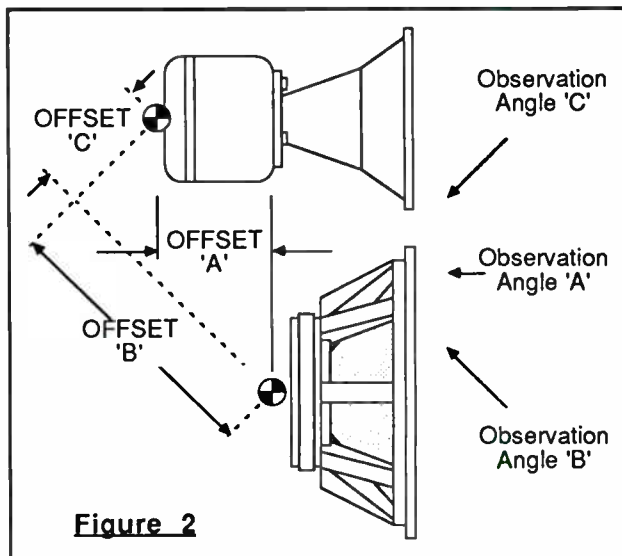
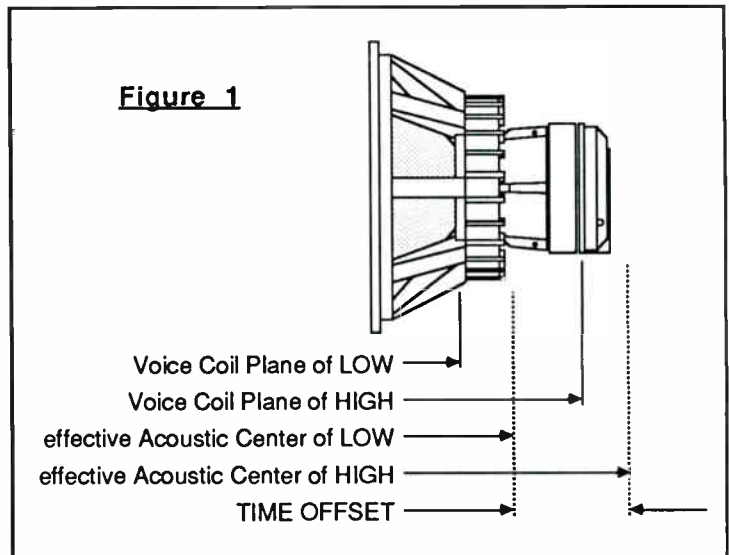

With Time Offset Correction™, low and high frequency acoustic signals will be coherent in phase and amplitude at crossover frequency, which requires a special frequency dividing network. At the crossover point, the high pass and low pass filters should be 6 dB below the respective passband amplitudes. For ripple-free performance, their outputs must sum coherently in magnitude and phase at all frequencies.

PAS passive frequency dividing networks are 2nd-order Bessel filters, while the active TOC-23 employs 4th-order linear phase filters. Both types result in seamless acoustic transition from low to high frequency loudspeaker components.

TOC-23 Systems

Figure 3 shows a typical TOC-23 application. The TOC-23 input is electronically balanced, and will bridge balanced or unbalanced lines. Balanced and unbalanced outputs are provided.

The output of the HF amplifier is returned to the TOC-23 to sense and control the average power delivered to the high frequency driver. The high frequency limiter provides a 4:1 compression ratio with a 'soft-knee' characteristic. Attack time is 5 ms, slow enough to ignore transient peaks in high frequency program with large crest factors, yet fast enough to protect from low frequencies and excessive heating. Limiting is undetectable in normal operation, although it can be defeated. A recessed front panel control is provided to set the threshold of limiting for the particular high frequency transducer and application.

A DC blocking capacitor is recommended between the amplifier and HF driver. Capacitors should be non-polarized with a voltage rating at least twice that of the DC rail voltage of the power amplifier. A value of 50 μF will give 6 dB per octave roll-off below 400 Hz at 8 ohms.

The TOC-23 provides an input limiter with similar characteristics except for a 10 ms attack time and without amplifier sensing. The longer integration time optimizes limiter response to the weighting of typical wide-range program material. Limiting is subtle and inaudible in normal operation.

Crossover filters are 4th-order Linear Phase. High and low pass sections sum coherently in amplitude and phase, with crossover at minus 6 dB. When used in the 2-way mode, the TOC-23

provides a low pass output for driving subwoofer amplifiers.

Outputs are grounded when the TOC-23 is off. A delay circuit lifts the ground 3 seconds after switching the AC power on. Outputs are immediately grounded upon interruption of AC power. Any high quality, non-bridged amplifier may be used with the TOC-23.

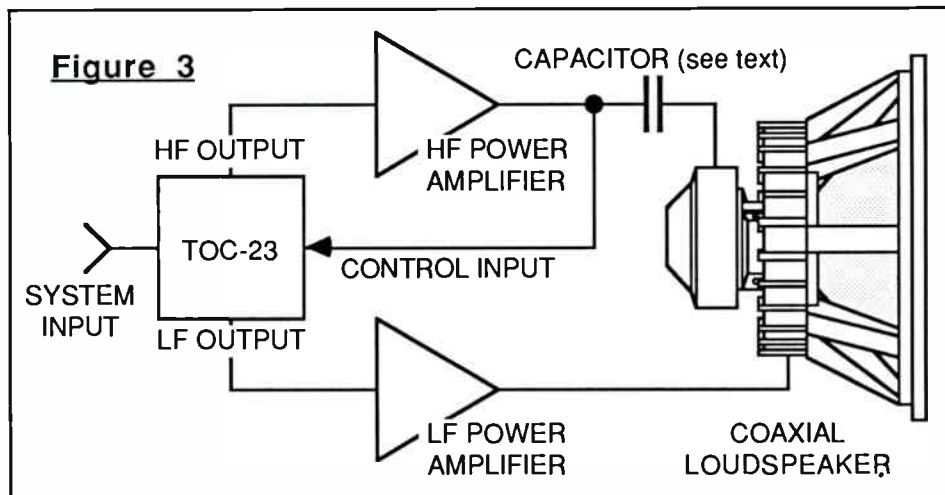

Passive Crossover Systems

The CX-1280C, CX-1580C and CXL-1580C provide outstanding performance when used with PAS TOC™ passive crossover networks.

The J-1.2k and R-1.2k are identical except for the Time Offset Correction. Model J-1.2k has delay correction for deep-structured one-inch drivers—the JBL 2425/2426, TAD TD-2001 and all Alnico products. The R-1.2k has a slightly shorter delay optimized for shallow-structured drivers, including the Renkus Heinz 1800, Emilar EK-175B and late vintage Altec one-inch drivers.

Because Time Offset Correction aligns the low and high frequency transducers to radiate from the same effective acoustic center, the passive

crossovers must meet rigid performance criteria. The J-1.2k and R-1.2k are 2nd-order Bessel filters (12 dB/octave) with a crossover frequency of 1200 Hz. This results in high pass and low pass sections that sum coherently in phase and amplitude at all frequencies, with crossover at minus 6 dB.

Passive TOC™ crossovers use only the highest quality components throughout to insure that exacting acoustic performance will be realized with PAS coaxial transducers. There are no controls and no field adjustments are needed for proper operation.

J-1.2k and R-1.2k

passive TIME OFFSET CORRECTION (TOC™) FREQUENCY DIVIDING NETWORKS

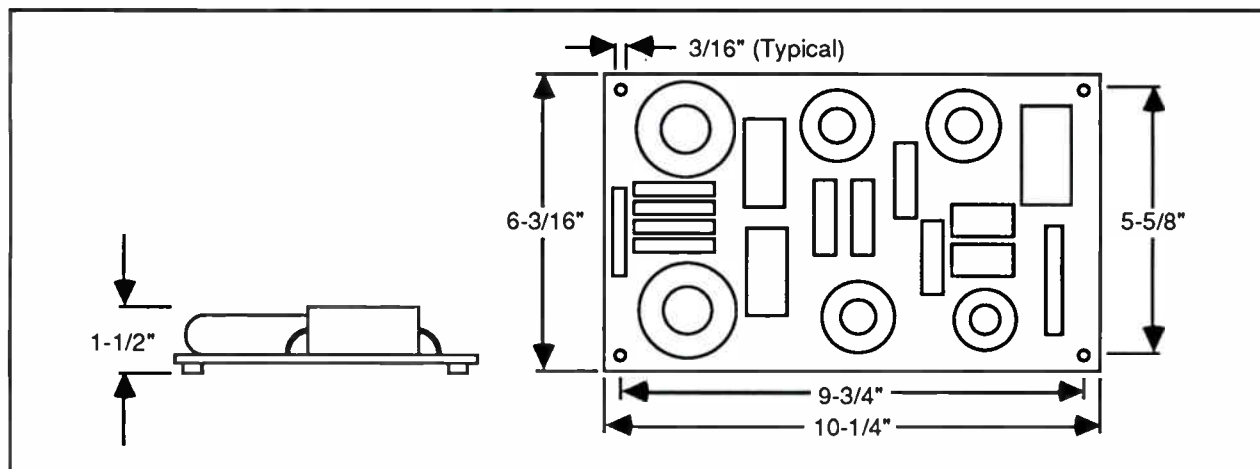

The J-1.2k and R-1.2k are passive frequency dividing networks with TOC™ (Time Offset Correction) for PAS models CX-1280C, CX-1580C and CXL-1580C coaxial transducers.

Both models provide second-order linear phase high and low pass filters that cross over at 1200 Hz, when used with the recommended transducers and 8 ohm compression drivers. Both incorporate equal group delay in their respective high pass and low pass filters due to their filter topology, and shelving equalization to optimize the HF response of the compression driver for the constant coverage horn.

Because coaxial transducers have a common LF and HF radiation axis, the signal to the low frequency component can be delayed for phase coherent, time corrected performance.

The R-1.2k includes Time Offset Correction for one-inch 'pancake' compression drivers, such as the Emilar EK-175-8B and Renkus Heinz 1800. The J-1.2k Time Offset Correction is optimized for deep-structured one-inch compression drivers, including the JBL 2425, 2426 and the TAD TD-2001. Both are designed for 8 ohm low and high frequency load impedances.

The J-1.2k and R-1.2k are constructed on thick glass-epoxy printed circuit boards using massive copper traces for conductors. Only the highest quality components are used. Inductors are precision wound, individually calibrated air-core type; capacitors are non-polarized and selected for high current capacity.

SPECIFICATIONS

Type:	Passive frequency dividing network with TOC™ (Time Offset Correction)	TOC™ (Time Offset Correction):	<u>Model J-1.2k:</u> for JBL 2425, 2426, TAD TD-2001 <u>Model R-1.2k:</u> for RH 1800 Emilar EK-175B
Crossover:	1.2 kHz, 12 dB/octave crossover at -6 dB	Special Features:	Driver power response EQ
Filter Type:	Bessel	Dimensions:	260 mm (10-1/4) long 157 mm (6-3/16) wide 38 mm (1-1/2) high
Power Capacity:	300 watts	Weight:	2.7 kg (6 lb) net 3.2 kg (7 lbs) shipping
Nominal Impedance:	8 ohms, input 8 ohms, LF & HF loads		

CX-1280C

COAXIAL TRANSDUCER SYSTEM

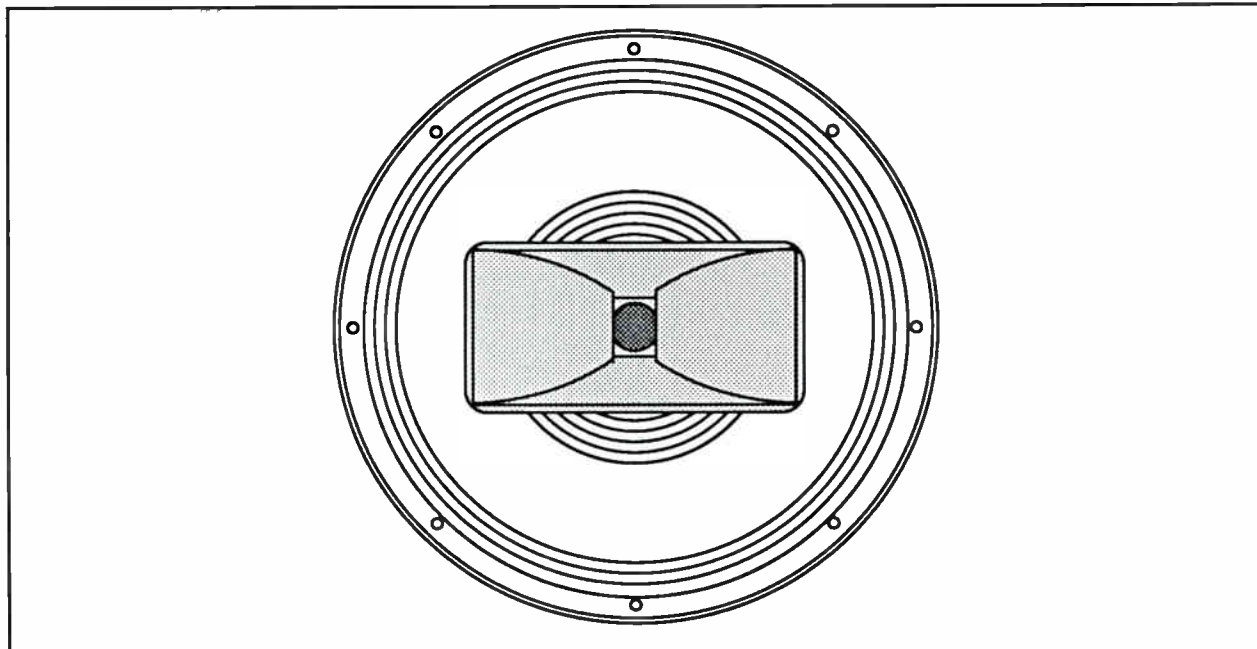

The CX-1280C system combines a high power, high efficiency, twelve-inch low frequency driver with a constant coverage high frequency horn that will accept standard high performance one-inch compression drivers. This versatility allows the high frequency component of the coaxial system to be tailored to specific applications, budgets or listener preferences. Drivers are easily changed in the field with simple hand tools.

The low frequency section of the CX-1280C employs an edge-wound copper ribbon voice coil, coated with Kapton as an insulator and chemically bonded to a Kapton voice coil form, using a patented winding technique. This results in an exceptionally rugged voice coil assembly that won't de-bond when heated to extreme temperatures under very high power.

The magnetic structure is energized by high output ferrite, assembled from precision blanchard ground components of high permeability and joined to a rigid cast aluminum frame. The pole piece is machined through for coaxial mounting of the HF horn, which joins a cast aluminum magnet cover that is machined to accept standard two and three bolt pattern high performance compression drivers.

The cone and suspension components were designed with low moving mass for high efficiency and excellent transient characteristics, yet high internal stiffness for good damping and distortion performance. The transducer starts when the music starts, and stops when it is supposed to.

The loudspeaker's Thiele-Small parameters have been chosen to yield extended and linear low frequency performance in compact enclosures.

Because low and high frequency transducers share a common axis of radiation, the signal to the low frequency component can be delayed to achieve a phase coherent, time corrected loudspeaker system. PAS manufactures both passive and active crossovers for the CX-1280C, incorporating TOC™ (Time Offset Correction) for the most popular one-inch compression drivers. All PAS crossovers with TOC™ incorporate linear-phase low and high pass filters that have equal group delay characteristics.

The CX-1280C delivers a level of performance and versatility that is unsurpassed for a wide variety of high level sound reinforcement, on-stage monitoring and demanding music playback applications.

The graph at right shows the -6 dB coverage of the CX-1280C high frequency horn. Horizontal coverage is smooth and uniform from 3.5 kHz to above 16.5 kHz. Below 3.5 kHz, the coverage gradually widens until the 1.2 kHz crossover is reached, resulting in a virtually seamless transition to the LF transducer. In the vertical direction, the horn's directivity is a mirror of the power response of high quality one-inch compression drivers, enabling smooth, uniform response within 60° horizontal and 30° vertical included angles.

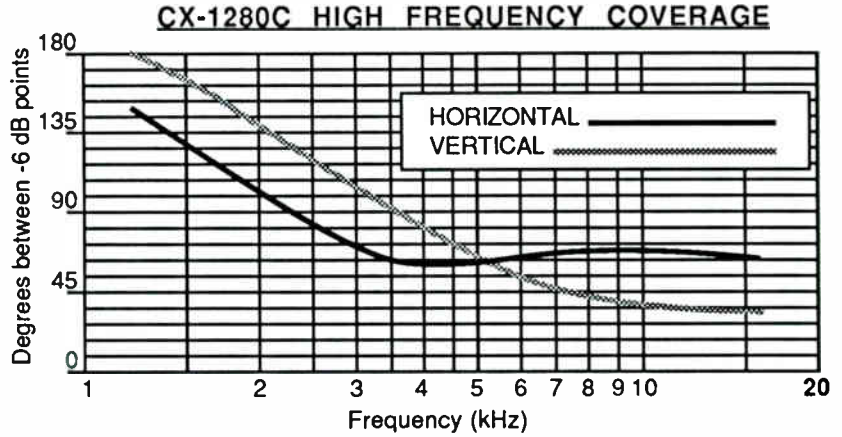

PERFORMANCE SPECIFICATIONS

Type:	Low frequency transducer with coaxially-mounted constant coverage high frequency horn
Amplitude Response:	± 3 dB, 40 Hz to 16.5 kHz ¹
Pressure Sensitivity:	LF: 98 dB (1w, 1m, half-space) HF: 112 dB ¹
LF Power Capacity:	200 watts (EIA RS-426A)
LF Impedance:	8 ohms (nominal)
HF Coverage angles:	Horizontal: 60 degrees (-6 dB points, nom.) Vertical: 30 degrees
HF Axial Directivity:	11 dB, 2 kHz—16 kHz (+1, -3 dB)
Recommended Crossover:	1.2 kHz with Time Offset Correction (TOC™)

THIELE-SMALL PARAMETERS

f_s :	59 Hz
Q_{ts} :	0.24
Q_{ms} :	10.1
Q_{es} :	0.25
V_{as} :	47 L (1.7 ft ³)
η_0 (half space):	3.8 %
S_D :	0.047 m ² (73 in ²)
X_{max} :	1.8 mm (0.07 in)
V_D :	84 cm ³ (5.2 in ³)

PHYSICAL SPECIFICATIONS

Dimensions:	313 mm (12-5/16) diameter 143 mm (5-5/8) deep
Weight:	11.4 kg (25 lb) net; 12.7 kg (28 lbs) shipping

¹ Performance specifications for HF section are with JBL 2426 compression driver.

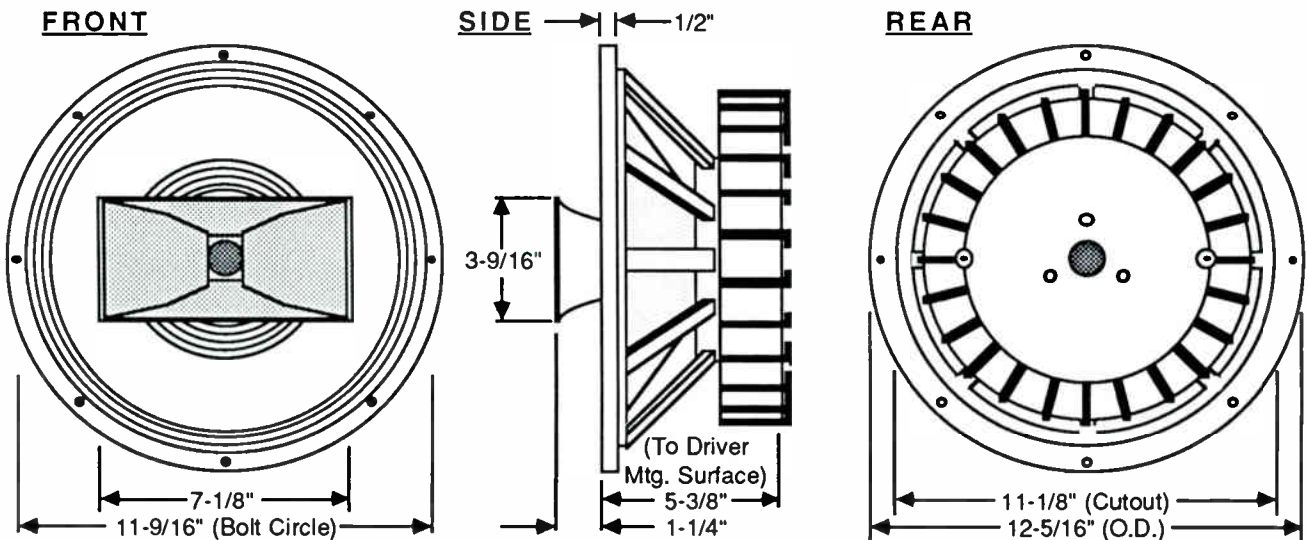

CX-1580C

COAXIAL TRANSDUCER SYSTEM

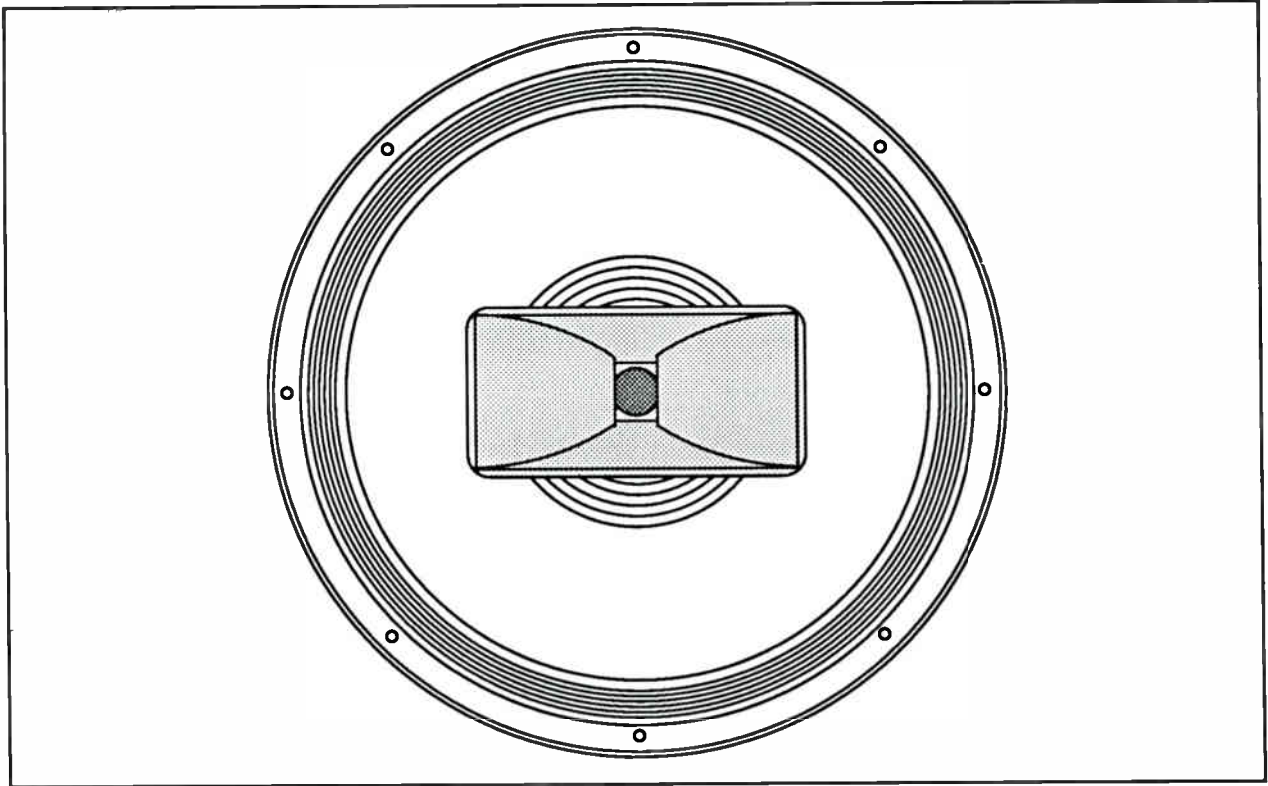

The CX-1580C system consists of a high power, high efficiency, fifteen-inch low frequency driver and a coaxially-mounted constant coverage high frequency horn that will accept standard high performance one-inch compression drivers. The option of various high frequency components allows the coaxial system to be custom-tailored to specific applications, budgets or listener preferences. Simple hand tools are the only requirement to change compression drivers in the field.

The low frequency section of the CX-1580C employs an edge-wound copper ribbon voice coil, coated with Kapton as an insulator, then chemically bonded to a Kapton voice coil form. This patented technique creates an exceptionally rugged voice coil assembly that won't come apart when heated to extreme temperatures under very high power.

A high-output ferrite ring is sandwiched between precision blanchard ground plates of high permeability and joined to a rigid cast aluminum frame. The pole piece is precision machined to

coaxially mount the HF horn, which terminates in a removable cast aluminum magnet cover. The cover is machined to accept standard two and three bolt pattern compression drivers.

The cone was designed with low moving mass for high efficiency, while maintaining high internal stiffness for low distortion performance. The suspension components retain precise centering of the voice coil assembly and provide an optimal balance with the electromotive forces to achieve exceptional transient attack and decay characteristics.

Because low and high frequency transducers share a common axis of radiation, the signal to the low frequency component can be delayed to achieve a phase coherent, time corrected loudspeaker system. PAS manufactures both passive and active crossovers for the CX-1580C, incorporating TOC™ (Time Offset Correction) for the most popular one-inch compression drivers. All PAS crossovers with TOC™ incorporate linear-phase low and high pass filters that have equal group delay characteristics.

The graph at right shows coverage between -6 dB points of the high frequency horn. Horizontal coverage is smooth and uniform from 3.5 kHz to above 16.5 kHz. Below 3.5 kHz, the coverage gradually widens until the 1.2 kHz crossover, where directivity smoothly transitions to that of the LF transducer. In the vertical direction, the horn's directivity is a mirror of the power response of high quality one inch compression drivers, enabling smooth and uniform response within the horn's nominal 60° horizontal by 30° vertical coverage angles.

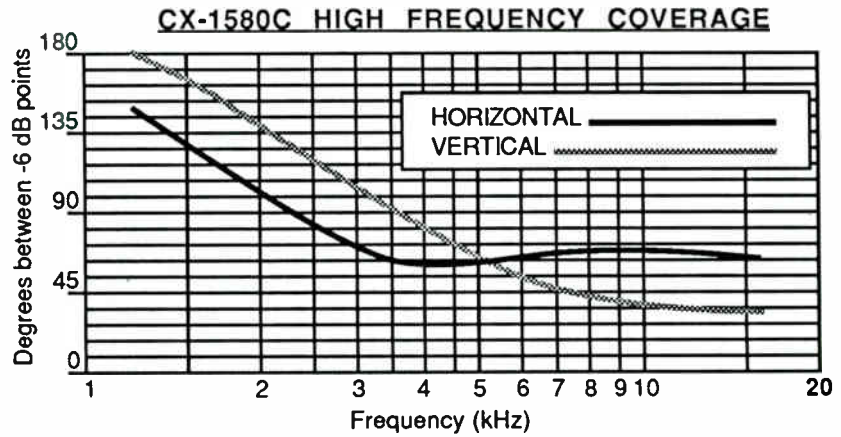

PERFORMANCE SPECIFICATIONS

Type:	Low frequency transducer with coaxially-mounted constant coverage high frequency horn
Amplitude Response:	± 3 dB, 35 Hz to 16.5 kHz ¹
Pressure Sensitivity: (1w, 1m, half-space)	LF: 97 dB HF: 112 dB ¹
LF Power Capacity:	200 watts (EIA RS-426A)
LF Impedance:	8 ohms (nominal)
HF Coverage angles: (-6 dB points, nom.)	Horizontal: 60 degrees Vertical: 30 degrees
HF Axial Directivity:	11 dB, 2 kHz—16 kHz (+1, -3 dB)
Recommended Crossover:	1.2 kHz with Time Offset Correction (TOC™)

THIELE-SMALL PARAMETERS

f_s :	38 Hz
Q_{ts} :	0.33
Q_{ms} :	17.2
Q_{es} :	0.34
V_{as} :	225 L (8.0 ft ³)
η_0 (half space):	4.0 %
S_D :	0.073 m ² (113 in ²)
X_{max} :	2.3 mm (0.09 in)
V_D :	100 cm ³ (6.2 in ³)

PHYSICAL SPECIFICATIONS

Dimensions:	389 mm (15-5/16) diameter 184 mm (7-1/4) deep
Weight:	12.3 kg (27 lb) net; 13.6 kg (30 lbs) shipping

¹ Performance specifications for HF section are with JBL 2426 compression driver.

REAR

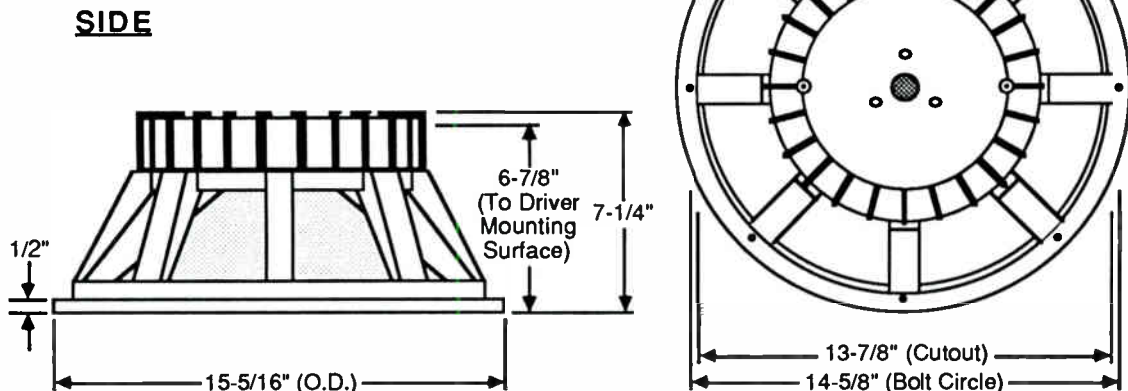

CXL-1580C

COAXIAL TRANSDUCER SYSTEM

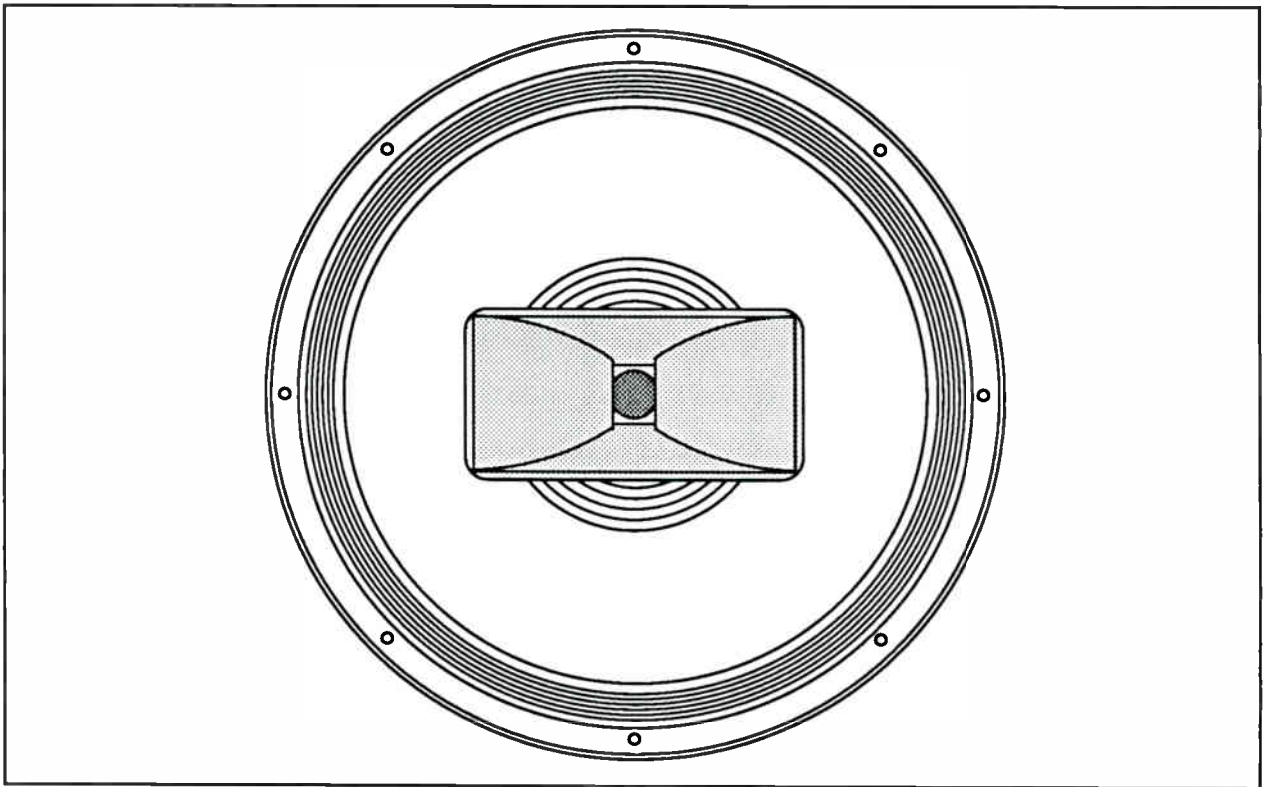

The CXL-1580C system consists of a high power, extended-bass 15-inch transducer and a coaxially-mounted constant coverage horn that will mount high performance 1-inch compression drivers. Versatility to mount different high frequency drivers allows the coaxial system to be tailored to specific applications, budgets or listener preferences. Simple hand tools only are required to change drivers in the field.

The LF transducer uses an over-hung voice coil to maintain a constant amount of wire in the magnetic gap under long cone excursions for extended linear low frequency output. The edge-wound copper ribbon coil is coated with Kapton as an insulator, then chemically bonded to a Kapton voice coil form. This patented technique makes an exceptionally rugged voice coil assembly that won't come apart, even when heated to extreme temperatures at very high power.

The magnetic circuit consists of a high-output ferrite ring sandwiched between blanchard ground plates of high permeability, joined to a rigid cast aluminum frame. The pole piece coaxially mounts the HF horn, which extends through the magnet assembly to a removable cast aluminum magnet cover. The cover is machined to accept standard two and three bolt pattern compression drivers.

The cone was designed with high internal stiffness for extended and linear low frequency performance. In spite of this, moving mass remains moderately low for a transducer of the CXL-1580C's linearity, resulting in an exceptional balance of efficiency, transient attack and decay characteristics and linear low frequency output capability.

Because low and high frequency transducers share a common axis of radiation, the signal to the low frequency component can be delayed to achieve a phase coherent, time corrected loudspeaker system. PAS manufactures both passive and active crossovers for the CXL-1580C, incorporating TOC™ (Time Offset Correction) for the most popular one-inch compression drivers. All PAS crossovers with TOC™ incorporate linear-phase low and high pass filters that have equal group delay characteristics.

The PAS CXL-1580C was designed for smooth and extended low frequency alignments in enclosures of moderate dimensions. Its linear response, efficiency, high power capacity and versatility of compression driver selection, when combined with PAS's exclusive TOC™ crossovers result in performance that is incomparable

The graph at right shows coverage between -6 dB points of the high frequency horn. Horizontal coverage is smooth and uniform from 3.5 kHz to above 16.5 kHz. Below 3.5 kHz, the coverage gradually widens until the 1.2 kHz crossover, where directivity smoothly transitions to that of the LF transducer. In the vertical direction, the horn's directivity is a mirror of the power response of high quality one inch compression drivers, enabling smooth and uniform response within the horn's nominal 60° horizontal by 30° vertical coverage angles.

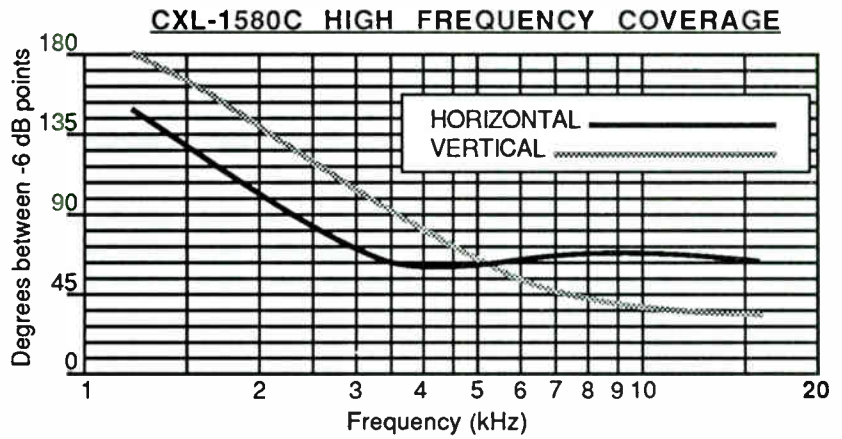

PERFORMANCE SPECIFICATIONS

Type:	Low frequency transducer with coaxially-mounted constant coverage high frequency horn
Amplitude Response:	± 3 dB, 30 Hz to 16.5 kHz ¹
Pressure Sensitivity: (1w, 1m, half-space)	LF: 98 dB HF: 112 dB ¹
LF Power Capacity:	300 watts (EIA RS-426A)
LF Impedance:	8 ohms (nominal)
HF Coverage angles: (-6 dB points, nom.)	Horizontal: 60 degrees Vertical: 30 degrees
HF Axial Directivity:	11 dB, 2 kHz—16 kHz (+1, -3 dB)
Recommended Crossover:	1.2 kHz with Time Offset Correction (TOC™)

THIELE-SMALL PARAMETERS

f_s :	36 Hz
Q_{ts} :	0.34
Q_{ms} :	16.7
Q_{es} :	0.35
V_{as} :	304 L (10.7 ft ³)
η_0 (half space):	3.9 %
S_D :	0.073 m ² (113 in ²)
X_{max} :	6.4 mm (0.25 in)
V_D :	278 cm ³ (17.5 in ³)

PHYSICAL SPECIFICATIONS

Dimensions:	389 mm (15-5/16) diameter 184 mm (7-1/4) deep
Weight:	12.3 kg (27 lb) net; 13.6 kg (30 lbs) shipping

¹ Performance specifications for HF section are with JBL 2426 compression driver.

SIDE

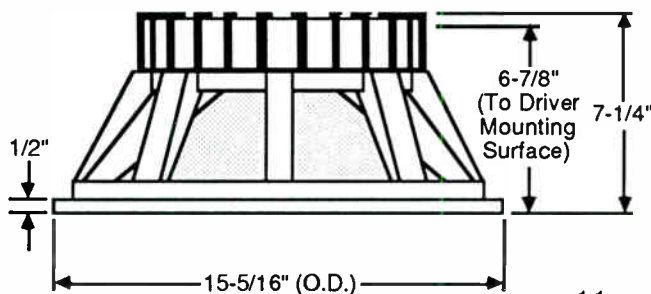

REAR

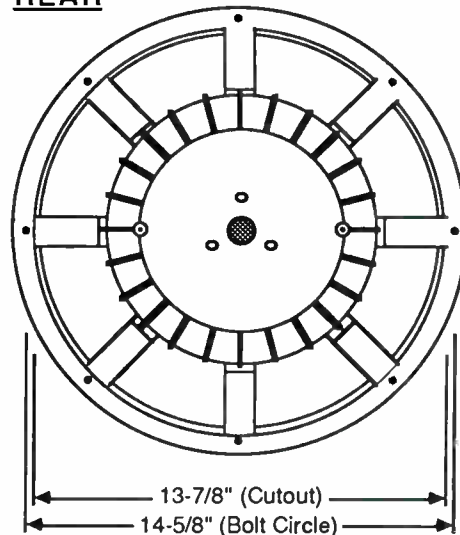

CXL-2580C

COAXIAL TRANSDUCER SYSTEM

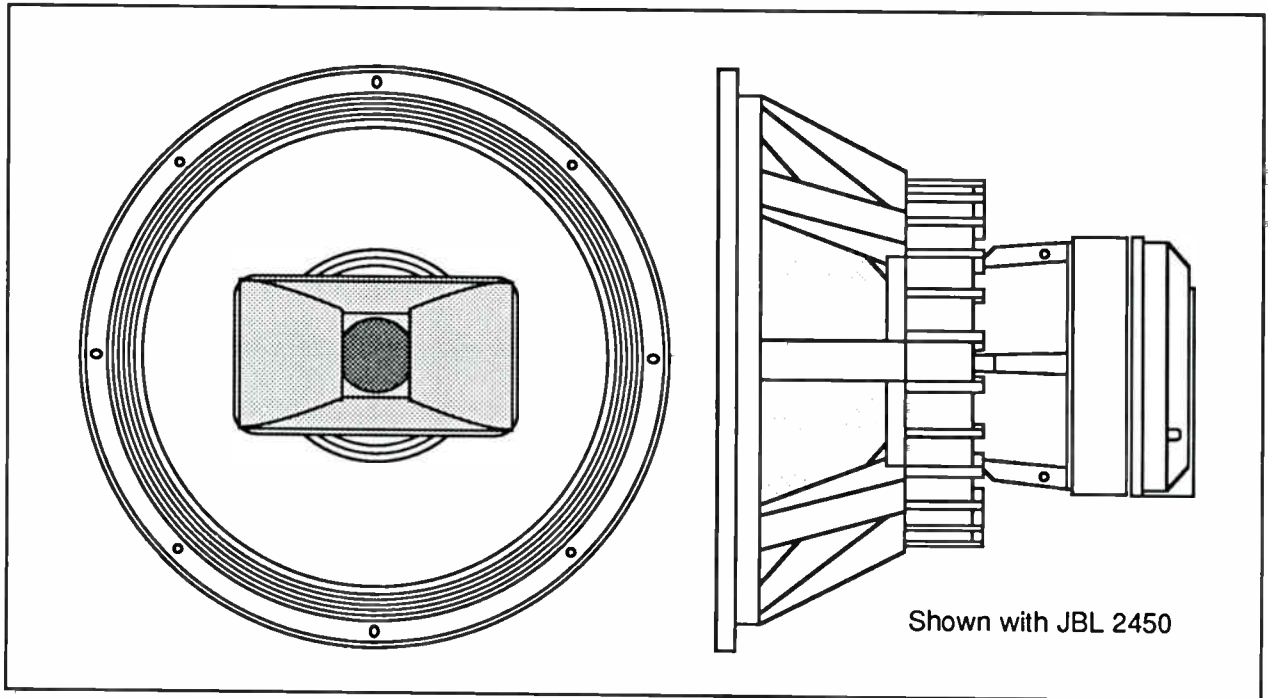

Coaxial systems offer the advantage of point-source time-coherent location of low and high frequency components. But for demanding high-level sound reinforcement and monitoring applications, coaxial systems have lacked sufficient acoustic power output capability, especially in the critical middle frequency range. That is, until the PAS CXL-2580C.

The CXL-2580C system consists of a high power 15-inch bass driver and a constant-coverage high frequency horn with a 2-inch throat aperture that will accept standard four bolt large format compression drivers, allowing the high frequency component of the coaxial system to be tailored to specific applications, budgets or listener preferences. Drivers are easily changed in the field with simple hand tools.

This unique combination of acoustic elements enables greater overall acoustic output, a lowering of the crossover frequency for smoother mid-frequency power response, substantially reduced distortion and improved overall system reliability.

The low frequency section employs a robust 4-inch edge-wound copper ribbon voice coil, coated with Kapton as an insulator and chemically bonded to a Kapton voice coil form, using a patented winding technique. This results in an exceptionally rugged voice coil assembly that won't de-bond when heated to extreme temperatures under very high power. The magnetic structure is energized by high output ferrite,

assembled from precision blanchard ground components of high permeability and joined to a rigid cast aluminum frame. The unique pole piece provides coaxial mounting of the large-throat horn, while maintaining uniformly high magnetic flux along the entire voice coil gap for efficient, linear operation.

Along with the magnetic system, the cone and suspension components have been designed to allow very large and linear cone displacement for extended low frequency response, while providing complete freedom from cone breakup, even when driven to extremely high output levels.

Because low and high frequency transducers share a common axis of radiation, the signal to the low frequency component can be delayed to achieve a phase coherent, time corrected loudspeaker system. PAS builds both passive and active crossovers for the CXL-2580C, incorporating TOC™ (Time Offset Correction) for the most popular two-inch drivers. All PAS crossovers with TOC™ incorporate linear-phase low and high pass filters that have equal group delay characteristics.

The CXL-2580C delivers a level of performance and versatility that is unsurpassed in two-way systems. For critical high-level applications, it will play louder, sound better, and be more reliable than any other coaxial system available.

The CXL-2580C HF horn coverage, nominally 60° horizontal by 30° vertical, is shown at right. At the lower frequencies, where pattern control is governed by dimensional constraints, the horn makes a nearly monotonic transition to the directivity of the LF driver. Above 10 kHz, the coverage has been allowed to gradually narrow to 45° by 22.5° (an artifact of the large throat aperture), rather than introduce convolutions in the throat to control short wavelength coverage at the expense of added distortion and sound coloration.

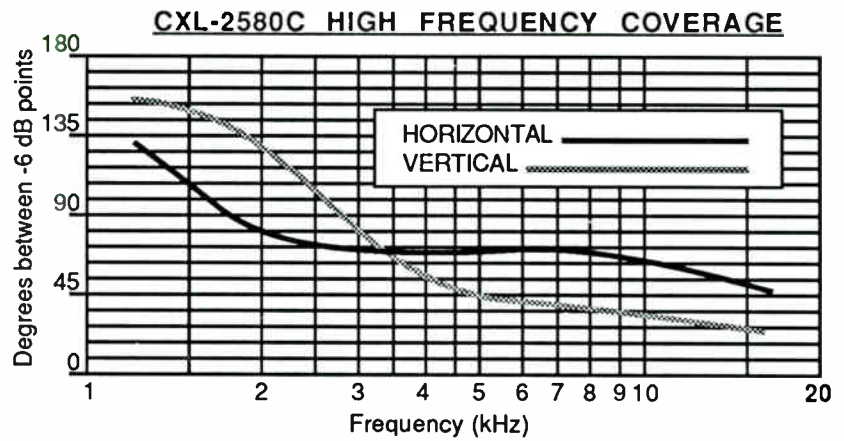

PERFORMANCE SPECIFICATIONS

Type: Low frequency transducer with coaxially-mounted constant coverage high frequency horn

Amplitude Response: ± 3 dB, 35 Hz to 16.5 kHz¹

Pressure Sensitivity: LF: 98 dB
 (1w, 1m, half-space) HF: 114 dB¹

LF Power Capacity: 400 watts (EIA RS-426A)

LF Impedance: 8 ohms (nominal)

HF Coverage angles: Horizontal: 60 degrees
 (-6 dB points, nom.) Vertical: 30 degrees

HF Axial Directivity: 11 dB, 1.2 kHz—16 kHz
 (± 3 dB)

Recommended Crossover: 1.2 kHz with Time Offset Correction (TOC™)

THIELE-SMALL PARAMETERS

f_s : 48 Hz

Q_{ts} : 0.34

Q_{ms} : 14.0

Q_{es} : 0.35

V_{as} : 100 L (3.5 ft³)

η_0 (half space): 3.1 %

S_D : 0.085 m² (132 in²)

X_{max} : 6.4 mm (0.25 in)

V_D : 539 cm³ (33 in³)

PHYSICAL SPECIFICATIONS

Dimensions: 387 mm (15-1/4" diameter)
 184 mm (7-1/4" deep)

Weight: 12.3 kg (27 lb) net; 13.6 kg (30 lbs) shipping

¹ Performance specifications for HF section are with JBL 2445J compression driver.

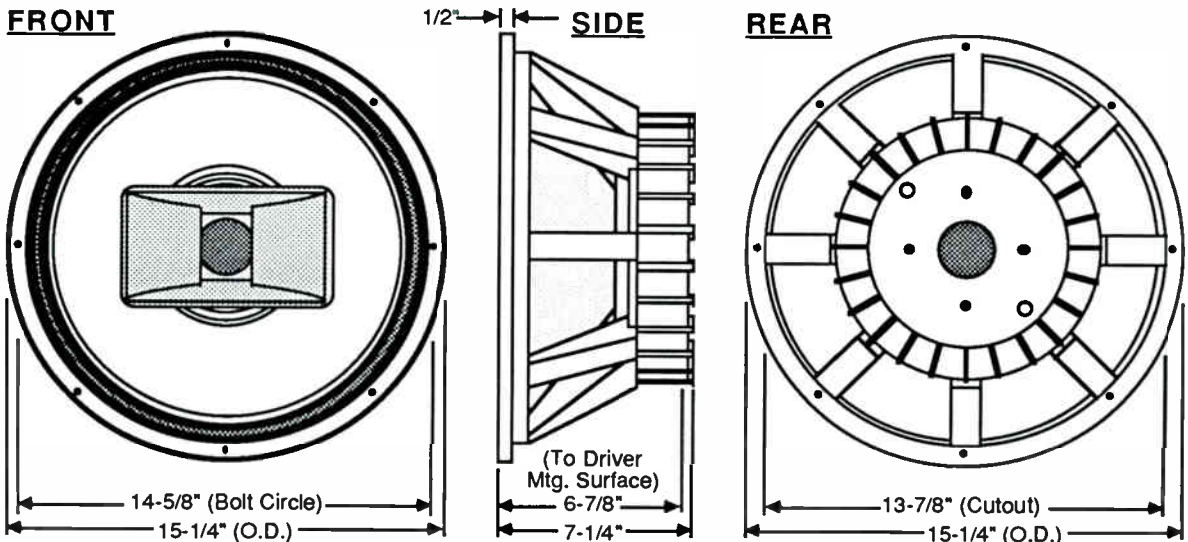

TOC-23

active TIME OFFSET CORRECTION (TOC™) COAXIAL SYSTEM PROCESSOR

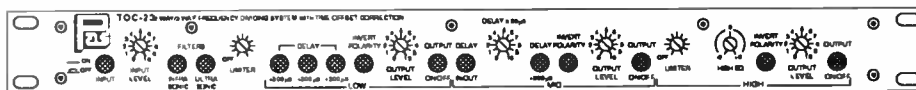

The TOC-23 is a line-level dividing network and system processor for use with loudspeaker systems in bi-amplified and tri-amplified applications. The TOC-23 includes two-way and three-way 4th-order linear phase active crossover circuitry with constant group delay, adjustable Time Offset Correction (TOC™), turn-on/turn-off transient protection relays, infrasonic and ultrasonic high pass/low pass filters, adjustable input and high frequency output limiters.

Crossovers are at the minus 6 dB points, and the outputs sum coherently in magnitude and phase at all frequencies. For coaxial system use, the TOC-23 may be used in the two-way operating mode, with or without subwoofers. The TOC-23 provides the recommended crossover frequency of 1200 Hz, which is selected by DIP switches accessible from the top of the instrument. Both balanced and unbalanced inputs and outputs are provided.

A wealth of controls have been included to aid in system alignment, testing and trouble-shooting. The input limiter is adjustable with a front panel threshold control, which includes an 'off' position. The high frequency output limiter derives a sense input from the output of the high frequency power amplifier to control the average power level delivered to the high frequency driver. A front panel control adjusts the threshold of high frequency output limiting. Output level controls for low, mid and high outputs are also installed on the TOC-23 control panel. Level controls are recessed screwdriver adjust type. Controls include:

Input controls: input muting switch; input level potentiometer; system high pass switch; system low pass switch, limiter threshold /off potentiometer.

Low frequency output controls: adjustable Time Offset Correction™ (3) two-position switches; polarity reverse switch; output level potentiometer; output muting switch.

Mid frequency controls: adjustable Time Offset Correction™ (1) two-position switch, (1) 10-position rotary switch; TOC™ in/out switch; polarity reverse switch; output level potentiometer; output muting switch.

High frequency controls: limiter threshold/off potentiometer; high frequency EQ boost/cut potentiometer; polarity reverse switch; output level potentiometer; output muting switch.

The TOC-23 includes a turn-on/turn-off protection circuit, which grounds the outputs the moment AC power is de-energized. A delay circuit maintains this condition for approximately 3 seconds after power is applied to protect systems from transients which could occur in equipment ahead of the TOC-23.

The TOC-23 combines two-way and three-way loudspeaker sources into a time and phase-coherent, high definition reinforcement or playback system of unsurpassed transient accuracy and overall sonic excellence.

TOC-23 SIGNAL FLOW

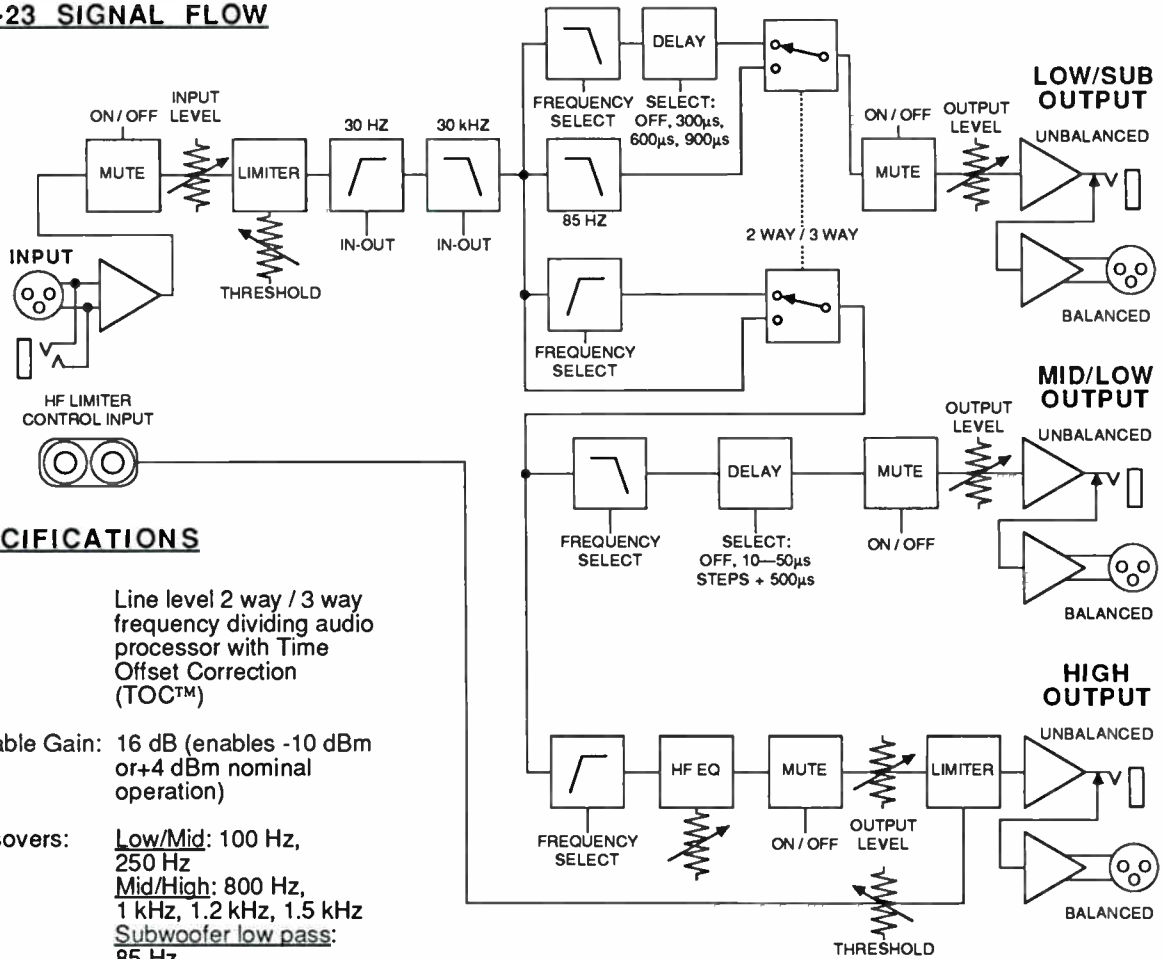

SPECIFICATIONS

Type: Line level 2 way / 3 way frequency dividing audio processor with Time Offset Correction (TOC™)

Available Gain: 16 dB (enables -10 dBm or +4 dBm nominal operation)

Crossovers:
Low/Mid: 100 Hz, 250 Hz
Mid/High: 800 Hz, 1 kHz, 1.2 kHz, 1.5 kHz
Subwoofer low pass: 85 Hz

Crossover Filters: 4th order (24 dB/octave) Linear Phase. Crossover occurs at -6 dB.

Bandpass Filters: 30 Hz and 30 kHz, 2nd order (12 dB/octave)

Time Offset Correction (TOC™):
Low: 900µs, in 300µs increments
Mid: (low in 2-way mode): up to 1000µs in ten 50µs steps and one 500µs step

Inputs: XLR and 1/4-inch RTS selectable -10 or +4 dBm, balanced or unbalanced 10 k ohm, +26 dBm (max.)

Outputs: XLR balanced or 1/4-inch unbalanced -10 or +4 dBm nominal, +20 dBm (max)

Limiters:
Input Limiter: "soft-knee" type, 10 ms. attack time, 50 ms. release, 4:1 ratio
HF Output: "soft-knee" type, 5 ms. attack time, 20 ms. release, 4:1 ratio.

Hum and Noise: Better than -86 dBm at unity gain.

Transient Protection: NC relays ground outputs until energized 3s after power is applied—closure is immediate when power is removed.

Power Requirements: 120/240 V, 50/60 Hz AC, 6 watts.

Mechanical: Black anodized aluminum chassis and panel.

Dimensions: 483 mm (19 in) wide
 44 mm (1-3/4 in) high
 241 mm (9-1/2 in) deep

Weight: 2 kg (4-1/2 lbs) net
 3.2 kg (7 lbs) shipping

TOC-23 REAR PANEL

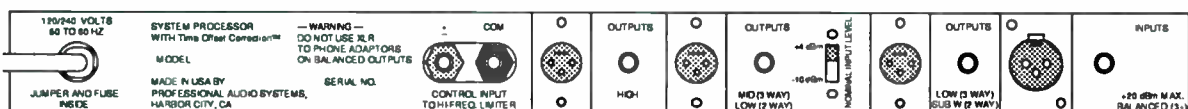

Coaxial Transducers

and Time Offset Correction (TOC™) Accessories

November 1, 1989 PRICE LIST

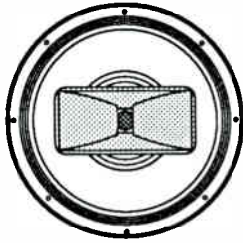

CX-1280C.....\$210.00
 12-inch Coaxial Transducer System for one-inch compression driver, less driver and frequency dividing network.

Shipping weight: 12.7 kg (28 lbs)

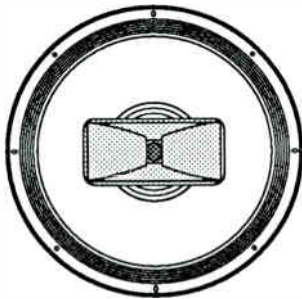

CX-1580C.....\$228.00
 15-inch Coaxial Transducer for one-inch compression driver, less driver and frequency dividing network.

Shipping weight: 13.6 kg (30 lbs)

CXL-1580C.....\$228.00
 15-inch Extended-Bass Coaxial Transducer, as above.

Shipping weight: 13.6 kg (30 lbs)

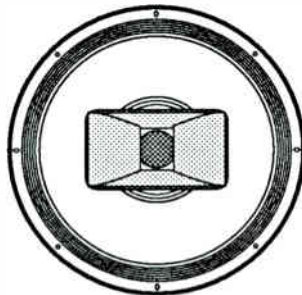

CXL-2580C.....\$300.00
 15-inch High Power Coaxial Transducer for two-inch compression driver, less driver and frequency dividing network.

Shipping weight: 13.6 kg (30 lbs)



TOC-23.....\$775.00
 Active Frequency Dividing System with TOC™ processing features, subsonic/supersonic filters, subwoofer output, limiters and turn-on/turn-off relay protection.

Shipping weight: 3.2 kg (7 lbs)

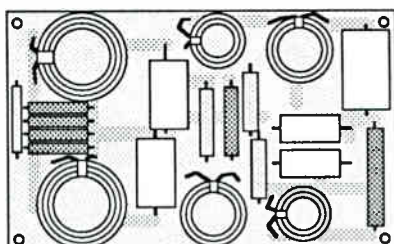

J-1.2k.....\$125.00
 Passive crossover for CX-1280C, CX-1580C, CXL-1580C, with TOC™ (JBL 2425, 2426, TAD TD-2001 drivers)

Shipping weight: 3.2 kg (7 lbs)

R-1.2k.....\$125.00
 Passive crossover for CX-1280C, CX-1580C, CXL-1580C, with TOC™ (Renkus Heinz 1800, Emilar EK-175B drivers)

Shipping weight: 3.2 kg (7 lbs)

The AES Heyser Scholarship Fund



The Richard C. Heyser Scholarship Loan Fund has been set up to honor Dick Heyser, a highly gifted, loved and respected engineer, with a lasting memorial. The scholarship loan will financially assist promising graduate engineering students in the field who, otherwise, could not continue with their studies.

In March of 1987 Dick died, just a few months before he would have assumed the office of AES President. He not only was active in AES but he contributed greatly to the audio field through his Time Delay Spectrometry discoveries. He gave of himself on a personal level as well. Carolyn Davis, Co-Founder of Synergetic Audio Concepts, said of the fund, "Dick, himself, gave so much to all those with whom he came in contact, especially those just starting out; we feel Dick would have been pleased to know he is being remembered in this way."

In conjunction with this memorial, a major update of The PHD Program[†] will be dedicated to Dick Heyser and all the proceeds will go to the Richard C. Heyser Scholarship Loan Fund.

You may obtain a program for a donation of \$300.00 or more; prior owners may upgrade for a donation of \$50.00 or more. Make your check payable to the Richard C. Heyser Scholarship Loan Fund. Send to the Richard C. Heyser Scholarship Loan Fund, c/o *Sound and Communications*, 25 Willowdale Avenue, Port Washington, NY 11050.

[†] Trademark of Ambassador College.

Mitek
 One Mitek Plaza
 Winslow, IL 61089
 (815) 367-3000, 800-CALL MTX, FAX# 815-367-3851
 Exec.VP/G. Mgr.: Rod Boyer, Nat'l/Int'l Sls Dir.: Dave Armon, E. Reg. Sls Dir.: Rob Landsberg, W. Reg. Sls Dir.: Mike Roberts, PRO/Com. Prod.: Mikol Hess
 Mitek W., Chandler, AZ, 602-892-8500

Modular Sound Systems
 One Mitek Plaza
 Winslow, IL 61089
 (815) 367-3000
 Pres./CEO: Loyd Ivey, VP Mkt'g: Rod Boyer, Reg. Sls: Rob Landsberg, Int'l Sls: Dave Armon, Dir. PR: James Terhark

Motorola/Ceramic Products
 4800 Alameda Blvd.
 Albuquerque, NM 87113
 (505) 822-8801, FAX# 505-822-8812
 Dir. of Op.: Dr. D.R. Bosomworth, Sls/Mkt'g Mgr.: T. Gilder, Prod. Mgr.: J.R. Bost, Mat'l Mgr.: G. Wegman
 Motorola, Albuquerque, NM, 505-822-8801

Music Dealer Service
 4700 W. Fullerton
 Chicago, IL 60639
 (312) 282-8171, 800-722-3027, FAX# 312-772-6586

Music Supply
 809 N. Madison
 Dallas, TX 75208

(214) 946-8450, 800-527-1522, FAX# 214-946-9155
 Pres.: W.E. Brown, Sls: Betty Brown

N.E.A.R. New England Audio Resource
 1450 Hanover Ave.
 Meriden, CT 06450
 (203) 630-3400, FAX# 203-630-3600
 Products: custom, environment protected

OAP Audio Products
 310 Peachtree Industrial Blvd.
 Buford, GA 30518
 (404) 945-1028, FAX# 404-945-1843
 Pres.: Mike O'Rourke, Sls Mgr.: George Meals, Credit Mgr.: Dana Hunter
 Products: high-power, horns, low-frequency drivers,, mid-bass, processor controlled, stage monitors, sub-woofer

OWI
 1160 Mahalo Pl.
 Compton, CA 90220
 (213) 638-4732, 800-638-10WI, FAX# 213-638-8347
 Dir. Mkt'g: Ned Morioka, VP: Hiroi Okayama, Cust. Svce: Kristin Morioka, Credit Mgr.: June Morioka
 Products: ceiling, decorative, flush-mount, foreground, full-range, music system speakers, omni-directional, outdoor, paging, sub-woofer, surface-mount

Oaktron Industries
 1000 30th St.
 Monroe, WI 53566
 (800) 257-4538
 Pres./CEO: Jerry Disch, Exec. VP: Bob Tallor, VP Sls:

Jim Hendrickson

Olson Acoustics
 920 Grayson St.
 Berkeley, CA 94710
 (415) 644-2500

Orevox
 PO Box 1046
 Auburn, WA 98002
 (206) 735-0220, 800-237-0700, FAX# 206-251-9142
 CEO: Daniel Wu, Sls Mgr.: Russ Stanford
 Products: components, custom, foreground, full-range, high-frequency drivers, high-power, horns, low-frequency drivers,, mid-bass, music system speakers, outdoor, paging horns, paging, sub-woofer, talkback, tweeters

PA Concepts
 450 Taft Dr.
 South Holland, IL 60473
 (312) 339-8014

PAS Professional Audio Systems
 1224 W. 252nd St.
 Harbor City, CA 90710
 (213) 534-3570, FAX# 213-530-2384
 Pres.: Larry Doran, Prod. Mgr.: John Kirkland
 Products: full-range, low-frequency drivers,, mid-bass, multi-way/high-powered, processor controlled, stage monitors, studio/reference monitors, sub-woofer, systems

COMPARE SPECS AND PRICES

The 1989-90 Music & Sound Buyer's Guide
 It's the handiest reference you will find for model numbers, specs and list prices.

- Speakers
 - Signal Processors
 - Power Amps
 - Mixing Consoles
 - Microphones
 - Sound Projection
- ... and musical instruments, too!

YES. I want the 1990 MUSIC&SOUND BUYER'S GUIDE for \$3.95, plus \$1.00 for postage and handling.

Payment enclosed

Bill my credit card Visa MC AmEx

Card # _____ Exp. Date _____

Name _____

Address _____

City _____ State _____ Zip _____

Signature _____

Easy Comparison

ORDER TODAY!

Mail to:
MUSIC&SOUND BUYER'S GUIDE
 25 Willowdale Avenue
 Port Washington, NY 11050
 att: Bob Evans

TANNOY[®]
The Name for Loudspeakers

TANNOY NORTH AMERICA INC.
300 Gage Ave., Unit 1
Kitchener, Ont., Canada N2M 2C8
519/745-1158
Telex 069-55328
Fax #519-745-2364

Circle 223 on Reader Response Card

The message needs to be clear. Whether it is delivered by the singers in the choir, the gentle voices of the flutes in the orchestra, the crisp, clean notes of the piano or the spoken word. And the message must be just as clear in the back row of the balcony as it is in the front, without being loud, harsh or irritating. Tannoy loudspeakers possess a significant advantage. Their unique, world-renowned Dual Concentric drive units deliver sound which is smooth, pleasant and musical. Great sound makes all the difference in the world. And Tannoy is making that difference for the people at World Harvest Church, Bethany World Prayer Centers, Jimmy Swaggert Ministries and countless others worldwide. For natural, transparent sound reinforcement, from a whisper to a joyful noise — Tannoy.

**FAITH COMES BY
HEARING**



Panasonic/Ramsa

6550 Katella Ave.

Cypress, CA 90630

(714) 373-7277, FAX# 714-373-7242

Sls/Mkt'g Mgr.: Steve Wooley, Mkt'g Mgr.: Chris Foreman, W. Sls Mgr.: James Murray, Central Sls Mgr.: Greg Braithwaite, Telemkt'g Mgr.: Carla Campbell

James Murray, Cypress, CA, 714-373-7389

Greg Braithwaite, Arlington Heights, IL, 312-981-7329

Pusecker Sls, Upper Montclair, NJ, 201-744-1834

David Bros., Finksburg, MD, 301-833-0920

Pro Audio Assoc., Burlington, MA, 617-229-6050

World Wide Electronics, Pembroke Pines, FL, 305-584-7024

Evans Sls & Mkt'g, Nashville, TN, 615-297-7997

New Horizons, Bannockburn, IL, 312-234-6500

Laker Assoc., Wauzata, MN, 612-475-2642

A/V Mkt'g, Carmel, IN, 317-846-1034

Innovative Audio, Pontiac, MI, 313-673-2280

J.B. Parent, Dublin, OH, 614-764-0064

Essential Mkt'g, St. Joseph, MO, 816-279-0776

Teneckit Assoc., Houston, TX, 713-528-2005

New West Audio, Burbank, CA, 818-955-9700

Brian Trankle Assoc., Belmont, CA, 415-595-4004

Northmar, Seattle, WA, 206-524-5170

Pearson & Pearson, Denver, CO, 303-722-6996

Products: compact, foreground, full-range, high-power, multi-way/high-powered, music system speakers, portable, stage monitors, studio/reference monitors, sub-woofer, systems

Paramount Sound Systems

5555 Melrose Ave.

Los Angeles, CA 90038

(213) 468-4601

Parasound Products

950 Battery St.

San Francisco, CA 94111

(415) 397-7100, FAX# 415-397-0144

Pres.: Richard Schram, Dir. Tech. Svcs: Rich Rogers,

Dir. Sls & Mkt'g: Bonnie Perella, Adm. Mgr./Credit:

Kimberly Fink

Products: compact, decorative, environment protected,

flush-mount, foreground, music system speakers, surface-mount

Paso Sound Products

14 First St.

Pelham, NY 10803-1495

(914) 738-4800, 800-231-3034, FAX# 914-738-3954

Pres.: Paul Mastrangelo, Sls Mgr.: David Moore, Prod Mgr.: Ken O'Brien

Peavey Electronics

711 A St.

Meridian, MS 39302

(601) 483-5365, FAX# 601-484-4278

Pres.: Hartley Peavey

Products: components, environment protected, full-range high-frequency drivers, high-power, horns, low-frequency drivers, mid-bass, multi-way/high-powered, music system speakers, outdoor, powered, studio/reference monitors, sub-woofer, tweeters

Poly-Planar

50 Graphic Pl.

Warminster, NJ 07074

(201) 641-2206, FAX# 215-794-0263

Pres.: Norm Lange

Portland Instrument

1101A Air Way

Glendale, CA 91201

(818) 500-0137, 800-999-5260, FAX# 818-240-1828

Pres.: Ron Fuller, G. Mgr.: Jack Sympson, Sls Mgr.:

John Batson, Asst. Sls Mgr.: Lisa Fuller, Sr. Tech.:

Patrick Gratner, Ship./Rec.: Dave Johnson

Products: ceiling, custom, decorative, environment protected, flush-mount, foreground, paging, voice communications

Projected Sound

PO Box 112

Plainfield, IN 46168

(317) 839-4111, FAX# 317-839-2476

Pres.: Thomas Hilligoss Sr., VP: Forrest Hilligoss,

Sec./Treas.: J. Mark Hilligoss

Products: ceiling, music system speakers, outdoor, paging

Pyle Industries

PO Box 620

Huntington, IN 46750

(219) 356-1200, FAX# 210-356-2830

Pres.: Frank Pyle, VP: Kent Pyle, Distrib. Sls Mgr.:

Mark Pyle, Dir. Int'l Sls: Don Krajecki, Chief Eng.:

Dennis Crosson, Treas.: Reid Boultsbee

Adams & Assoc., Greensboro, NC, 919-272-6838

Steve Fisher Sls, Teaneck, NJ, 201-837-1200

Don Forth Assoc., City of Industry, CA, 818-333-8009

McKinney Sls, Dallas, TX, 214-631-9450

Mark Petty Assoc., Schaumburg, IL, 312-884-9096

Quam-Nichols

234 E. 67th

Chicago, IL 60637

(312) 488-5800, 800-633-3669, FAX# 312-488-6944

Pres.: William Little, VP: Donald Boyer, Sls Mgr.: Greg

Johns, Mkt'g Mgr.: Randy Moore, Comptroller: James

Ryan, Cust. Svcs.: Vivian Merrills

R&S Sls, Rockville Center, NY, 516-678-6887

Levy Lasser & Grams, Chicago, IL, 312-364-7800

Bidwell Schwartz Assoc., Gardena, CA, 213-770-0300

J.Y. Schoonmaker, Dallas, TX, 214-349-1650

Cartwright & Beam, Atlanta, GA, 404-368-0160

ROR

55 Sloane Ave.

Staten Island, NY 10306

Meet the New Community



RS880 and VBS415

While you were out doing tours and installations, Community's engineers were developing the next generation of trapezoidal Wavefront Coherent™ flying array speaker systems. These systems incorporate the latest in dynamically controlled, feedback-loop sensing circuitry in a single rack space.

Give us a call and find out how easy flying can be!



PROFESSIONAL SOUND SYSTEMS

333 East Fifth Street • Chester, PA 19013 • (215) 876-3400 • FAX (215) 874-0190

Are You Losing Money By Using Cheap Speakers?



\$237 Bid, Installed*

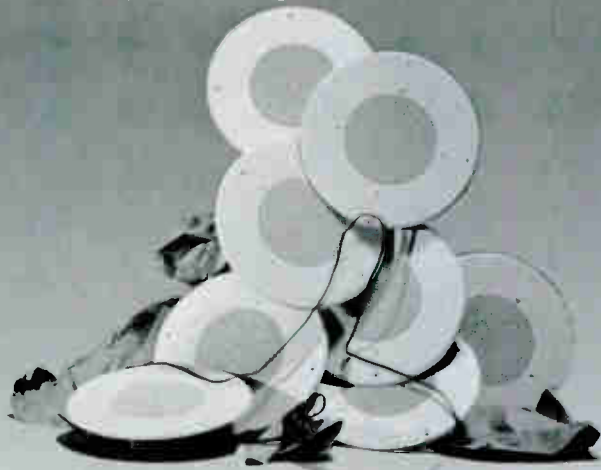

\$460 Bid, Installed*

You could lower your bid by up to 49% or increase your profit, in this example,* where two B.E.S.T. transducers would do the job of eight cone speakers! You could also get B.E.S.T.'s exceptional intelligibility, sound quality, coverage and aesthetics.

- B.E.S.T. disperses both lows *and* highs omnidirectionally.
- Requires fewer units for superior coverage and uniformity.
- Conventional speaker replacement ratios of 3:1, 4:1, 5:1 or more are common.
- Allows significant reductions in installed costs.
- Call us and we will estimate the savings on your next job.
- Most items available for shipment within 48 hours.

With B.E.S.T., you get superior performance and aesthetics at a reduced cost. So, why are you still using conventional speakers?

B.E.S.T.'s larger transducers look exactly like ceiling tiles, install just as easily, and are ideal for foreground music systems, especially DBS, and for paging.



* End user assembly cost of \$91 for B.E.S.T. CT12EHT's and \$30 for 8" cones. \$55/hr end user labor charge. Installation of two assemblies/hr, uniformity of ± 3 dB @ 3.5' ear level, 10' ceiling, edge-to-edge layout, 140° B.E.S.T. and 90° cone spacing for uniformity @ 2kHz

Get clean, open sound with B.E.S.T.'s flat transducer technology.

B.E.S.T.



Bertagni Electronic Sound Transducers, Int'l Corp.

12753 Moore Street, Cerritos, CA 90701

800/592-4644, in CA

213/926-0201,

FAX 213/926-5265

© Copyright 1989 — B.E.S.T. Int'l Corp.

Circle 241 on Reader Response Card

World Radio History

WE'LL TAKE YOU THERE

VIDEO CASSETTES NOW AVAILABLE WITH FULL COVERAGE OF ALL THE INDUSTRY TRADE SHOWS IMPORTANT TO YOUR BUSINESS.

You and your key personnel can travel to the trade show on your VCR. Each video cassette contains 3 full days of on-the-spot show coverage of the people, products, and hottest news in the industry.

**DON'T MISS A THING!
ORDER YOUR TAPES TODAY.**

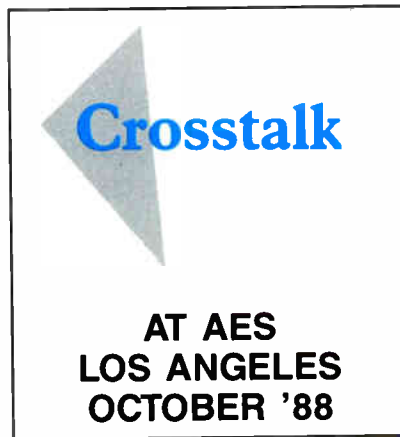
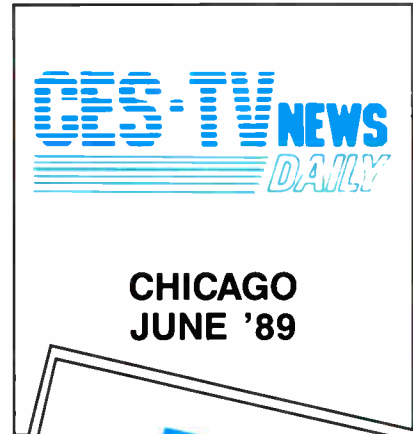

Please check the Show(s) you want.
First tape **\$49.95**; Additional tapes just **\$24.98** each

- NSCA-TV NEWS — Nashville**
Nat'l Sound & Communications Assn
Contractors Expo '89
- NAB-TV NEWS — Las Vegas**
Nat'l Assn. of Broadcasters Show
- NAMM-TV NEWS — Chicago**
Nat'l Assn. of Music Merchants Expo
- CROSSTALK, A Television Symposium**
Audio Engineering Society Convention, LA
- CES-TV NEWS — Chicago**
Consumer Electronics Show

Please send _____ tape(s).
1 Tape, **\$49.95**; 2 for **\$74.93**; 3 for **\$99.91**; 4 for **\$124.89**;
All Five for **\$149.87**.

Name _____

Company _____

Address _____

City _____ State _____ Zip _____

Telephone: _____

Indicate payment method: (prepayment required)

Credit Card # _____

Visa MC AmEx Check Enclosed

Expiration Date _____

Signature _____

All shows are independently produced by **Testa Communications**

Mail to: **TV TAPES**, 25 Willowdale Avenue, Port Washington, N.Y. 11050

(212) 979-5396
Dir. R&D/V.P.: Ted Rothstein



Radian Audio Engineering

162 E. Orangethorpe
Placentia, CA 92670
(714) 961-1213, FAX# 714-961-0869
VP Prod.: Richard Stambaugh, Dir. Mkt'g/Sls: Richard Guy, Nat'l Sls Mgr.: Paul Shiner
Gary Semonian, Marietta, GA, 404-642-7827
Steven Taub, Silver Springs, MD, 301-622-9100
Richard Geisler, Westerville, OH, 614-890-7788
Tom Carlile, Woodland Hills, CA, 818-710-9580
Dennis Dwinnell, Spooner, WI, 715-635-2722
John Caporale, Redmond, WA, 206-868-5577
Carl Schwartz, Evanston, IL, 312-761-3771
Michael Welsh, Orlando, FL, 407-843-0471
John Fly, Lakewood, CO, 303-986-5999
George Markunas, Avon, MA, 508-588-8043
Wane Fuday, Fairfax, CA, 415-459-6880
Neal Hunter, Syracuse, NY, 315-437-2992
Marc Johnson, St. Charles, MO, 314-723-0400
Ronald Coll, Fairlawn, NJ, 201-791-3738
Bill Coons, Scarborough-Ont., Canada, 416-287-1144
Products: ceiling, compact, components, custom, environment protected, foreground, full-range, high-frequency drivers, high-power, low-frequency drivers, mid-bass, music system speakers, outdoor, stage monitors, studio/reference monitors, sub-woofer, systems, tweeters

Ramsdell Audio

PO Box 76186
FL St. Petersburg
(813) 823-8037
Owner: Richard Ramsdell, Co-Owner: Pamela Ramsdell, Prod. Mgr.: Rick Goodin, Electronic Eng.: Mike Conklin
Products: low-frequency drivers, multi-way/high-powered, stage monitors, sub-woofer

Red Acoustics (USA)

PO Box 13006
Lansing, MI 48901
(517) 694-3618
Pres.: Thomas Cooley, Chairman of the Bd.: D. Bruce Stratton, Prod. Mgr.: Kevin West
Products: full-range, music system speakers, powered

Renkus-Heinz

17191 Armstrong Ave.
Irvine, CA 92714
(714) 250-0166, FAX# 714-250-1035
Pres: Harro Heinz, Nat'l Sls/Mkt'g Mgr.: Steve Armstrong, Sls/Mkt'g. Coord.: Russ Farrell
S.F. Mkt'g. St. Laurent Quebec, Canada, 514-733-5344
Renkus Heinz Europe A.S., Oslo, Norway, +47-2-711880
Products: components, custom, full-range, high-frequency drivers, high-power, horns, low-frequency drivers, mid-bass, multi-way/high-powered, portable, processor controlled, stage monitors, sub-woofer, systems

RING COMMUNICATIONS

57 Trade Zone Dr.
Ronkonkoma, NY 11779
(516) 585-7464, FAX# 516-585-7410
Pres.: Paul McLean, VP Sls: Craig Krsanac, V.P. Tech.: Kjell (Ken) Solem, Tech Support: Charlie Kulins
Klump Sls, Jacksonville, FL, 904-287-5205
Corrigan Agencies, 504-893-7455
Gustafson Sls, 612-388-4277

Specify the Best...



CAT™ 40 w/o grille
85 Watts (AES std.)
17 5/8" x 17 5/8" x 8 1/2"

the CAT™ 40 family will do the rest.

- Controlled Directivity 90° x 90° Pattern
- CAT™ Design—Coincident Aligned Transducers
- Full Range Systems, 40-17 khz ± 3dB (F1450)
- Isobar tabular data available for Phd/CAD
- Optional Furniture Grade finishes in Oak & Walnut
- Compact cabinets 17 5/8" wide



CAT™ 46 w/o grille
250 Watts (AES)
31 1/8" x 17 5/8" x 14 1/8"

F1450
250 Watts (AES)
41 7/8" x 17 5/8" x 14"

If natural, intelligible speech reinforcement as well as full-range music reproduction is important to your church, school or auditorium customer...FAX or call TOLL-FREE **NOW** for complete data on these state-of-the-art **FRAZIER** systems.



Route 3, Box 319 • Morrilton, AR 72110
(501) 727-5543

Toll Free 1-800-643-8747 • FAX (501) 727-5402

Circle 274 on Reader Response Card



Allwest Electronics, 805-388-1789
 Pacnor, 206-771-6016
 J.C. Electronics, 808-943-8514
 Products: ceiling, paging horns, paging

Rockustics
 720-F Billings St.
 Aurora, CO 80011
 (303) 363-6161, FAX# 303-363-0011
 Pres.: Anthony Mule, VP: Bruce Marcel, Sec.: Thomas Maxey
 Sigmet, Freehold, NJ
 Bencsik Assoc., Ocala, FL
 Design Factors, Hacienda Heights, CA
 New Resource, Norwell, MA
 Cavendish & Winchester, Atlanta, GA

Ross Systems/IMC
 PO Box 2344
 Ft. Worth, TX 76113
 (817) 336-5114, FAX# 817-870-1271

St. Louis Music
 1400 Ferguson Ave.
 St. Louis, MO 63133
 (314) 727-4512, 800-325-8148, FAX# 314-727-8929
 Sls Training Dir.: Tony Moscal, Prod. Mgr.: Gary Byers,
 Dir. Op.: John Karpowicz, Pres.: Gene Kornblum

Sanctuary Sound Systems
 113 Newport Dr.
 Oak Ridge, TN 37830
 (615) 482-9242
 Mkt'g: Barry Boseman
 Products: custom

Sanming Sound
 17921 Lyons Circle
 Huntington Beach, CA 92647
 (714) 842-9969, FAX# 714-842-9571
 Sls/Mkt'g: Leon Hsieh, Pres./G. Mgr.: Hugh Hsieh,
 Chief Eng.: S.W. Hsu
 Design Factors, Hacienda Heights, CA, 213-697-7576
 Fort Assoc., Kensington, MD, 301-949-1706
 George Pettico, Berkeley, IL, 312-261-0342
 Repworks, Chicopee, MA, 413, 533-0845
 Weller Electronic, Worthington, OH, 614-885-7819
 Products: high-power, horns, paging horns, portable, talk-back

SHURE BROTHERS
 222 Hartrey Ave.
 Evanston, IL 60202-3696
 (312) 866-2200, FAX# 312-866-2279
 Pres.: James Kogen, VP Sls: Lottie Morgan, Dir. Tech.
 Mkt'g: John Phelan, Dir. Wired Mics: Alan Shirley, Dir.
 Wireless Mics: Sandy Schroeder, Dir. Sls: Al Hershner
 Products: full-range, outdoor, paging horns, paging, portable

Sonance
 32992 Calle Perfecto
 San Juan Capistrano, CA 92675
 (714) 661-7558, 800-582-7777, FAX# 714-240-4995
 Pres.: Scott Struthers, VP: Geoff Spencer, Nat'l Sls
 Mgr.: Dave Donald, Asst. Nat'l Sls Mgr.: Caroline Kelly
 Bach, New York, NY, 212-727-0404
 Morris-Tait, N. Hollywood, CA, 213-877-4424
 Tandem Mkt'g, Schaumburg, IL, 312-605-1960
 Vestico, Merrit Island, FL, 407-454-9051
 Balaton, Washington, DC, 202-471-1764
 Products: ceiling, environment protected, flush-mount, foreground, music system speakers, outdoor, sub-woofer, sur-

face-mount, systems

SOUNDSPHERE

Sonic Systems
 737 Canal St., Bldg. 23B
 Stamford, CT 06902
 (203) 356-1136, FAX# 203-324-0893
 Pres.: Peter Hamilton, VP Mkt'g: John Karamon
 Products: flush-mount, full-range, music system speakers, omni-directional, outdoor, paging

Sony Professional Audio
 1600 Queen Anne Rd.
 Teaneck, NJ 07666
 (201) 833-5200, 800-635-SONY, FAX# 201-833-9645
 Nat'l Sls Mgr.: Bob Ott, Prod. Mgr.: Art Gonzales, Mkt'g
 Mgr.: David Kawakami
 Sony Pro Audio, Paramus, NJ, 201-368-5185
 Sony Pro Audio, Nashville, TN, 615-883-8140
 Sony Pro Audio, Burbank, CA, 818-841-8711
 Products: studio/reference monitors

Soundscape Speakers
 PO Box 1563
 Windermere, FL 34786
 (407) 876-6884
 Sls Mgr.: Susan Collins
 Products: outdoor

Sound Tech
 230 Lexington Dr.



“THE SETTING IS A KNOCKOUT”

The New York Times, Friday, October 23, 1987

DINER'S JOURNAL

The forbidding Black Rock, as the CBS Building on Avenue of the Americas at 53rd Street is dubbed, has sprouted an exotic flower called China Grill, an offshoot of Chinoise on Main in Santa Monica, California.

The setting is a knockout—a soaring block-long space with pale jade-colored walls, huge eggshell-colored light shades suspended from the ceiling and a gleaming open kitchen.

This restaurant originally had forty twelve-inch coaxial speakers in its 30 ft. high ceiling. They have been replaced with six #168 black Soundsphere loudspeakers which are deftly hidden between the eggshell light shades. The manager and staff state that the background music is even and “delightful!”

Steven M. Rosstad of United States Communications, New York City, is impressed by the sound quality and cost-saving installation. Steven looks forward to using Soundspheres as a “problem solver” in future challenging situations.

Write or call direct for further information.

SOUNDSPHERE A PRODUCT OF
SONIC SYSTEMS, INC.

737 Canal Street • Bldg 23B • Stamford, CT 06902 • USA • Tel (203) 356-1136

Circle 291 on Reader Response Card

Gauss.

The World's Greatest Woofers

At Gauss, we make low frequency transducers, not just bass guitar speakers. And we make them to be the best. Every Gauss loudspeaker is designed to perform at rated output levels where others *only survive*.

Gauss woofers are the greatest because they're *engineered* to be the best. They have the largest voice coil in the industry, 4.125 inches. It is directly wound on a unique metal former for maximum heat dissipation and efficiency. Our innovative double spider insures that the voice coil stays centered under high power operating conditions. Even our cast aluminum frames are thicker and heavier to make them more robust.

The result of these innovations is a line of woofers that are superior to all others. Bar none. Best of all, they're built to survive in the real world.

gauss

a MARK IV company

9130 Glenoaks Blvd.

Sun Valley, CA 91352

(213) 875-1900

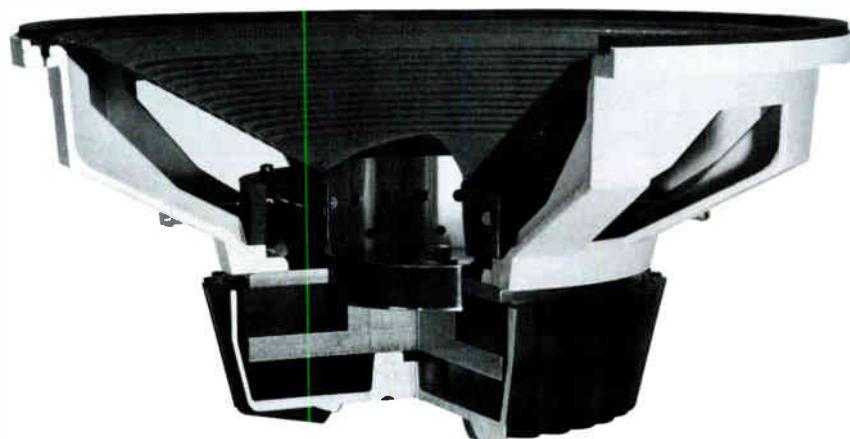

Circle 230 on Reader Response Card

World Radio History

Buffalo Grove, IL 60089
(312) 541-3520, 800-877-6863, FAX# 312-541-3616

Pres.: Rudy Schlacher, Gen. Sls Mgr.: David Beirut, Exp. Sls Mgr.: William Robinson, Sls Dir.: Todd Peren
Products: columns, compact, components, decorative, foreground, full-range, high-frequency drivers, high-power, low-frequency drivers, mid-bass, multi-way/high-powered, music system speakers, portable, stage monitors, sub-woofer, tweeters

SpeakerCraft
3615 Presley Ave.
Riverside, CA 92507
(714) 787-0543, FAX# 714-787-8747
Dir. Mkt'g: Randy Peede
Products: ceiling, decorative, environment protected, foreground, full-range, outdoor, surface-mount

Speco Div. Components Specialties
PO Box 624
Lindenhurst, NY 11757
(516) 957-8700, 800-645-5516, FAX# 516-956-9142

Pres.: Louis Keller, VP G. Mgr.: James Ganci, V.P. Sls: Mel Hulkower, Sls Mgr.: Eric Forman, Sls Expeditor: Bernice Zachman
Products: ceiling, columns, compact, components, decorative, environment protected, flush-mount, foreground, full-range, high-frequency drivers, high-power, horns, low-frequency drivers, music system speakers, omni-directional,

outdoor, paging horns, paging, portable, powered, systems, tweeters, voice communications

Spectra Sonics
3750 Airport Rd.
Ogden, UT 84405
(801) 392-7531
Pres./Owner: William Dilley, Eng./Sls: Gregory Dilley

Studer Revox America
1425 Elm Hill Pike
Nashville, TN 37210
(615) 254-5651, FAX# 615-256-7619
Products: studio/reference monitors

Sunn Musical Equipment
1130 Columbia St.
Brea, CA 92621
(714) 990-0909, 800-854-6230, FAX# 714-990-3986
Pres.: Bill Schultz, Dir. Mkt'g: Joe Green
Products: full-range, high-frequency drivers, horns, low-frequency drivers, music system speakers, outdoor, portable, stage monitors

TEI Electronics
PO Box 246
Hialeah, FL 33011
(305) 888-3980, 800-327-8811, FAX# 305-885-4950

Pres.: Danny Alonso, VP: Mireya Muniz, Nat'l Sls Mgr.: Walter McNulty, Cust. Svce: John Tembras, Sls: Orlando Pineda, Sls: Jose Hurcades
Products: ceiling, compact, components, flush-mount, full-range, horns, paging horns, portable, tweeters

TOA ELECTRONICS
PO Box 2047
S. San Francisco, CA 94080
(415) 588-2538, 800-843-4750, in-state 800-in CA 800-632-2157, FAX# 415-588-3349
Pres.: Yoshio Ishida, Nat'l Sls Mgr/Comm. Pro.: Richard Krochmal, Nat'l Sls Mgr./Pro. Music & Ent.: Rick Kamlet, Nat'l Sls Mgr./Intercom: Al Burns
Products: ceiling, compact, components, environment protected, flush-mount, foreground, full-range, high-frequency drivers, high-power, low-frequency drivers, monitor panels, multi-way/high-powered, music system speakers, outdoor, paging horns, paging, portable, stage monitors, studio/reference monitors, sub-woofer, surface-mount, tweeters

TALK-A-PHONE
5013 N. Kedzie Ave.
Chicago, IL 60625
(312) 539-1100, FAX# 312-539-1241
Pres.: Z. Liberman, VP: S. Shanes, Sls Mgr.: Dan Kagan
Products: ceiling, environment protected, flush-mount, horns, outdoor, paging horns, paging, talkback, voice communications

AES-TV

ON-THE-AIR IN N.Y.

DESIGNING LOUDSPEAKERS FOR LARGE SPACES

Day 1

What are the newest theories and the newest controversies? How applicable are signal processing speakers? A panel of designers, acousticians, and installers discusses the current wisdom.

3-D SOUND

Day 2

Is there a revolution in reproduced sound? Has video caused sound designers to think about the delivery of music in new ways? What's new in the coding, decoding and design of surround sound? How important is it? Designers, engineers and installers discuss the revolution for the home and for public places.

NEW ISSUES IN RECORDING

Day 3

1. Console Automation: Fad or Future?
2. Sampling and the Recording Engineer.
3. MIDI: New Applications

A panel of recording engineers discusses these issues and more

Crosstalk

A Television Symposium

Our New QM-300 Series Speakers Are This Easy To Install.



And almost as fast.

Simply push the twin metal mounting posts through any lift-out ceiling tile, then secure the QM-300 Series speaker in place with the Push-n-Lok[®] mounting system. The posts double as speaker leads, and special clips make wiring and installation one easy step.

What's more, you won't have to worry about panels sagging—thanks to the QM-300 Series' lightweight design. And when a system has to be taken out or moved, it's as easy as it was to install.

So put a ceiling on your installation time and costs. With the QM-300 Series speaker. For a complete listing of available sizes and features, ask your electronics distributor or contact GEMCO today.

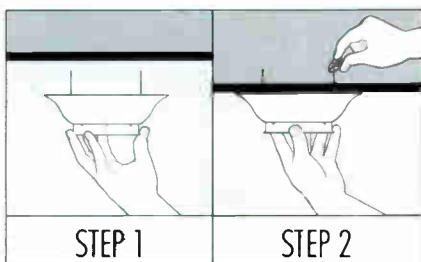

STEP 1

STEP 2



GEMCO Electronics, Inc. P.O. Box 993 Gallatin, TN 37066 615-452-5960

MADE IN THE
JSA

To install, simply puncture ceiling tiles with the mounting posts. Then secure in place and connect speaker leads with our Push-n-Lok[®] retaining clips. To remove, reverse procedure.

**If you are a
 manufacturer's
 representative —**

You Need This Book!

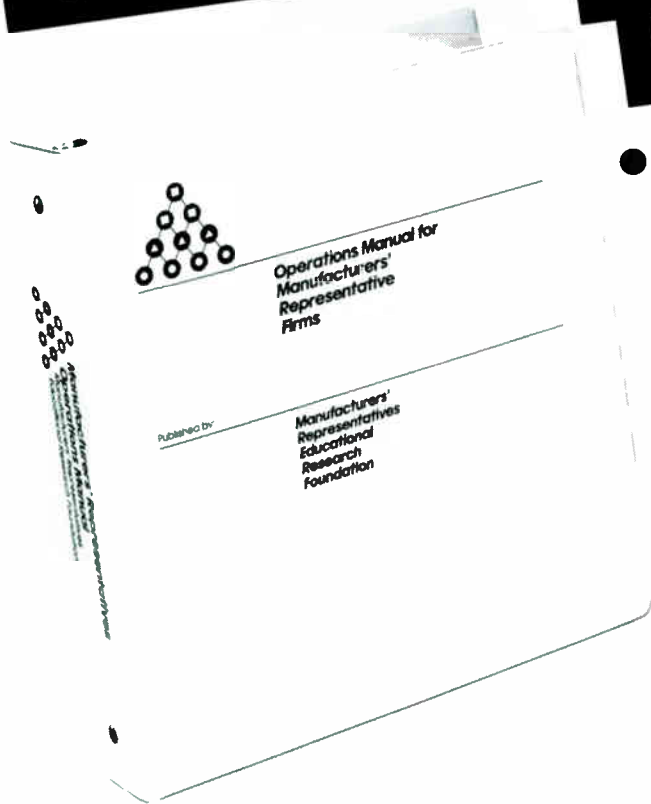

The indispensable guide and
 How-To book for operating
 as a sales representative

● "Hands-on" advice
 from 25 successful reps,
 plus consultants and academics
 who know the rep business
 inside-out

● Over 50 chapters —
 hundreds of pages —
 dozens of valuable forms,
 work-sheets, checklists

● Covers
 Organization and
 General Procedures
 Administration and
 Operations
 The People in Your
 Business
 Sales Management

Published for Your Profit by the Not-for-Profit
 Manufacturers' Representatives Educational Research Foundation

Order the Operations Manual today

RISK FREE

If not satisfied, you can
 return it in 15 days for a full refund
 Send back the coupon, or order by
 phone **(312) 208-1466,**
 for same-day shipment.

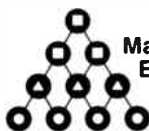

**Manufacturers' Representatives
 Educational Research Foundation**
 P.O. Box 247
 Geneva, Illinois 60134

Please rush me a copy of the

Operations Manual for Manufacturers' Representative Firms.

ERA/NEMRA Member price: \$84.95 plus \$5.00 postage & handling.

Non-member price: \$99.95 plus \$5.00 postage & handling.

I enclose my check for \$_____ payable to Manufacturers'
 Representatives Educational Research Foundation.
 (Sorry . . . at this low price we cannot bill you.)

Charge to my Visa Mastercard
 Account No. _____ Expires _____

Name: _____

ERA Member NEMRA Member Non-Member

Company: _____

Address: _____

City: _____ State: _____ Zip: _____

TANNOY®

Tannoy North America

300 Gage Ave, Unit 1
Kitchener, Ontario, Canada N2M 2C8
(519) 745-1158, FAX# 519-745-2364

Mkt'g Mgr.: Bill Calma, Inside Sls: Rob Hofkamp,
Credit Mgr.: Kathy Kent, Svce: Ivan Frivarski,
Ship./Rec.: Fred Baetz
Audio Assoc., Fulton, MD, 301-604-7223
Hot House Mkt'g, Highland, NY, 914-691-6077
Powerlines Mkt'g, Evanston, IL, 312-864-1147
Tech. Mkt'g, Atlanta, GA, 404-840-7893
WorldWide, Pembroke Pine, FL, 305-584-7024
TK Group, Loveland, CO, 801-298-8902
Kodo & Assoc., Minneapolis, MN, 612-881-1255
Blackhawk Mkt'g, Pacific Palisades, CA, 213-454-8196
Pro Musica Sls, Keene, NH, 603-352-4831
Bob White & Assoc., Solon, OH, 216-248-1317
Protech Mkt'g, Newport Beach, CA, 714-723-0498
JMS Mkt'g, Austin, TX, 512-266-1113
Centurian-Throckmorton, Glencoe, MO, 314-227-7222
Products: ceiling, components, custom, environment protected, explosion-proof, foreground, full-range, high-frequency drivers, high-power, low-frequency drivers, monitor panels, music system speakers, stage monitors, studio/reference monitors, sub-woofer, tweeters, voice communications

Technical Audio Devices (TAD)

Pioneer Electronics (USA)
2265 E. 220th St.

Long Beach, CA 90810
(213) 835-6177

VP Mkt'g: Mike Fidler, Sr. Mgr. Prod. Planning: Mark Makabe, Market Planner: Deanna Lee

Products: ceiling, components, custom, environment protected, explosion-proof, foreground, full-range, high-frequency drivers, high-power, low-frequency drivers, monitor panels, music system speakers, stage monitors, studio/reference monitors, sub-woofer, tweeters, voice communications

Turbosound

611 Broadway, #841
Millbrook, NY 10012

(212) 460-9940, FAX# 916-677-6287

Pres.: Alan Wick, VP Sls/Mkt'g: Dan Abelson, VP Elec. Prod.: Dave Talbot, App. Eng.: Tim Kalliches

Products: full-range, multi-way/high-powered, portable, stage monitors, sub-woofer, systems

UREI

PO Box 2200
Northridge, CA 91329

(818) 893-8411, FAX# 818-893-3639

Pres.: Ronald Means, VP Sls: Ken Lopez, VP Mkt'g: Mark Gander, Mkt'g Mgr.: Hector Martinez, Mkt'g Mgr.: Steve Romeo

Jim Chase, Hermosa Beach, Ca, 213-374-2128
Bill Hamilton, Folsom, PA, 215-543-4677
Bill Schuermann, St. Louis, MO, 314-644-2083
Tom Walter, N. Barrington, IL, 312-382-4925

Products: systems

Valcom

1111 Industry Ave.
Roanoke, VA 24013

(703) 982-3900, FAX# 703-983-7032

Mkt'g: Donald Buck, Cust. Svce.: Gordon Bailey

Waldom Electronics

4301 W. 69th St.

Chicago, IL 60629

(312) 585-1212, FAX# 312-585-7847

Pres.: Mario Vescovi, Prod. Mgr.: Mark Baumann,
Prom. Mgr.: Andrew Placco

Products: components, full-range, high-frequency drivers, horns, low-frequency drivers, mid-bass, music system speakers, tweeters

Westlake Audio/Prof. Prod. MFG

Group

2696 Lavery Ct., #18

Newbury Park, CA 91320

(805) 499-3686, FAX# 805-498-2571

David Wexler & Co.

3553 W. Peterson Ave.

Chicago, IL 60659

(312) 478-9800, FAX# 312-478-9095

Pres.: B.R. Wexler, VP: David Wexler, Mkt'g: Joan Morris

Products: ceiling, columns, compact, custom, environment protected, explosion-proof, flush-mount, full-range, high-frequency drivers, high-power, horns, low-frequency drivers, mid-bass, multi-way/high-powered, music system speakers, outdoor, paging horns, paging, portable, powered, stage monitors, studio/reference monitors, sub-woofer, surface-mount, systems, talkback, tweeters, underwater, voice communications

Wheelock

273 Branchport Ave.

Long Branch, NJ 07740

(201) 222-6880, 800-631-2148, FAX# 201-222-8707

Pres.: P.W. Tarlton, VP Mkt'g: W.L. Goldstein, VP Eng.: S.W. Andrews, Mkt'g Mgr./Tel-Paging: A. Arian, Mkt'g Mgr./Life Safe-Ind.: R. Haus

Products: ceiling, flush-mount, horns, outdoor, paging horns, paging, powered, talkback

Workman Electronic Products

PO Box 3828

Sarasota, FL 33578

(813) 371-4242

Yamaha Music Corp. of America/Prof.

Audio Div.

PO Box 6600

Buena Park, CA 90662

(714) 522-9011, FAX# 714-522-9312

Products: compact, full-range, high-power, music system speakers, powered, processor controlled, stage monitors, studio/reference monitors, sub-woofer, systems

Yorkville Sound

56 Harvester Ave.

Batavia, NY 14020

(716) 344-1978

Board Meeting!



The eyes have it! Ross RX mixing consoles offer unparalleled flexibility and cost effectiveness with features like electronically balanced inputs, individual channel patching inserts and low noise specs.

Ask your local dealer for a demonstration or contact Ross for a free catalog.

1316 E. Lancaster Ft. Worth, TX 76102 (817) 336-5114

ROSS
SYSTEMS

CAD SOFTWARE SUPPLIERS

In December 1988 an overview article on computer-aided sound system programs appeared in *Sound & Communications*, and since then we have been reviewing new software monthly. Locating and obtaining programs from a JBL or a Bose does not seem to be a challenge to our readers, but finding some of the smaller software publishers has been a problem. This month's "CAD Topics" includes a directory of software publishers whose programs might be of interest to sound engineers. If you have used, know of, or have developed a program that would be of use in sound contracting, please let us know.

In recent issues of *Sound & Communications*, we have reviewed: JBL's CADP 2.0, Bose Modeler 2.0, Bose Speaker CAD 1.0, North Star's Umbulus Mapper 3.0, North Star's Umbulus Array 3.0, Prohs and Harris PHD 4.0.

Future reviews will be on Mark IV's Acousta-CADD, JBL's CADP II, Source Phoenix's CASE, and the Bose Modeler 3.0. Our new column, "CAD Topics," will explore acoustical mapping techniques, mechanical CAD programs, intelligibility prediction software, reverb prediction software, cluster lobing simulation programs, flowcharting-block diagram software, computer bulletin boards, and more.

This directory listing of software programs useful for sound system engineering is limited to programs that we have already encountered. Again, if you know of others, please let us know.

SOUND SYSTEM DESIGN PROGRAMS

Altec Lansing Corporation
P.O. Box 26105
Oklahoma City, OK 73126
Contact: John Lanphere
(405) 324-5311

CALCULATOR UTILITIES

These programs include "Array" which generates a table of mapping points when used with Altec's array perspective graph paper, "Layout" for scaling a room in which a distributed system will be laid out, "Fitz" and "Sabine-Time," "Eyring," reverb time programs, "Ring" which compares the gain needed by a sound system to when the system will feedback, and more. The calculator programs are available at no charge on bar code for the HP 41, although they are also available in BASIC on disk for IBM compatibles (and other computers that run BASIC).

ACOUSTA-CADD

This program is a comprehensive sound system design program that runs on IBM compatibles.

Bose Corporation

The Mountain
Framingham, MA 01701
Contact: Mark Christensen
(415) 865-9370

MODELER

A comprehensive sound system design program that runs on the Macintosh computer.

Also available from Bose are Rackmaker and Speaker CAD. These are adjunct programs that aid in system layout of mechanical design elements.

Electro-Voice, Inc.
600 Cecil St.
Buchanan, MI 49107
(616) 695-6831

VAMP (Very-Accurate-Mapping-Program)

A sound system layout program intended for use with the HP41 calculator and overlays, but is now also available for use with IBM compatibles (in conjunction with the overlays).

Acousta-CADD

A comprehensive sound system design program that runs on IBM compatibles, available through both Altec and EV.

JBL Professional

8500 Balboa
Northridge, CA 91329
Contact: Steve Romeo
(818) 893-8411

CADP I

A comprehensive sound system design program for IBM compatibles. Version 4.0 will be released in August.

CADP II (available January 1990)

A new comprehensive sound system design program for IBM compatibles, with a version for the Mac to follow.

North Star Sound, Inc.

1406 First Avenue South
Minneapolis, Minnesota 55403
Contact: Tom McCarthy
(612) 871-6016

Umbulus Room Mapper Umbulus Array Builder

Sound System design programs work in conjunction with an IBM compatible and overlay transparencies.

PHD Program c/o Sound & Communications Magazine

Richard C. Heyser
Scholarship Loan Fund
25 Willowdale Avenue
Port Washington, NY 11050

A sound system design program for IBM compatibles. The program's distribution is facilitated by *Sound & Communications* and the AES, and technical support is provided by Ambassador College.

Source Phoenix

2041 West Butler Road
Phoenix, AZ 85021
Contact: David McNally
(602) 266-9294

CASE Computer Aided Sound Engineering (available later this year). A comprehensive sound system design program that runs on IBM compatibles.

G.R. Thurmond and Associates

1509 Brushy View Cove
Austin, TX 78754
Contact: G.R. Thurmond
(512) 837-7252

Horn Dispersion Layouts

This is a technique for laying out sound systems (especially when oblique angles are not required) and a useful tool for both visualization and initial cost estimation. The approach uses overlays and a computer is not required.

University Sound, Inc.

13278 Ralston Avenue
Sylmar, CA 91342
Contact: Advertising Department
(818) 362-9516

Easy-VAMP

A sound system layout technique somewhat similar in concept to the "Horn Dispersion Overlays" developed by G.R. Thurmond. Easy-VAMP uses floor plan iso-bar overlays without the need for a computer or calculator.

MECHANICAL DESIGN AND LAYOUT PROGRAMS

Auto CAD

2320 Marinship Way
Sausalito, CA 994965
(800) 445-5415

Auto CADD

The de facto standard of mechanical design programs, available for both IBM compatibles and the Macintosh computer.

Bose Corp.

The Mountain
Framingham, MA 01701
Contact: Mark Christensen
(415) 865-9370

Speaker CAD

Rack Maker

Sound system mechanical drawing programs (speaker clusters and equipment racks) that run on the Mac computer. Typically these programs are used with the Modeler sound system design program.

Generic Software

11911 North Creek Parkway So.
Bothell, WA 98011
(800) 228-3601

A mechanical drawing program available for the Mac and IBM compatibles.

VDP

749 Carver Rd.
Las Cruces, New Mexico 88005
Contact: Dr. Walter Black
(505) 524-9669

VIDCAD

AUDCAD

These programs are predrawn file libraries of equipment: for mechanical design and used as an adjunct to Auto CADD.

SPEAKER DESIGN SOFTWARE

The following programs aid in the design or selection of box volume and tuning, driver selection, crossover network design, etc.

Carvin

1155 Industrial Avenue
Escondido, CA 92025
Contact: John Murphy
(619) 747-1710

Audio CAD

A speaker box design program for the Mac.

CMS Electronics

P.O. Box 42389
Portland, OR 97242
(503) 231-7247

Leap

A speaker box design program, including multiple driver enclosures, for the IBM compatible computer.

Old Colony Sound Lab

P.O. Box 243
Peterborough, NH 03458
(603) 924-9467

Box Response

A speaker box design program, version available for the Apple II, Commodore, and IBM computer.

Loudspeaker Modeling Program

Full range frequency response prediction program for Apple II, Mac, IBM, and Commodore computers.

Scientific Design Software ('SDS')

Contact: Linda Telesky
P.O. Box 3248
Chatsworth, CA 91313
(818) 718-1201

CASD

A box design and crossover design program for IBM compatible and Apple II computers.

CACD

A sophisticated ('real world') crossover design program for IBM compatible and Mac computers.

CLUSTER LOBING PREDICTION SOFTWARE

Joseph G. Mitchell

1120 Stonehedge Drive
Schaumburg, IL 60194
(312) 882-7400

A Model (Array Model)

Interference effects between multiple drivers, column speakers, overlapping horns, etc., may be modeled. The program is in color, enabling more than one

frequency to be modeled simultaneously.

Renkus-Heinz

176191 Armstrong Ave.
Irvine, CA 92714
Contact: Russ Farrell
(714) 250-0166

ALS-1

A program that lets the user model interference effects at any one frequency or within a $\frac{1}{3}$ octave band of multiple drivers, column speakers, overlapping horns, and varying array techniques. Runs on IBM compatible computers.

AcousticsI Engineering Software

These programs are for estimation of reverberation time, noise leakage, articulation, and other acoustical factors.

R.J. Lemker and Associates

345 Montclair
Covington, KY 41016
(606) 261-9529

RT 60 Reverberation Program

A reverberation time calculation utility, useful for CADP, Umbulus and other sound system design programs that do not have reverberation utilities. For MS-DOS/IBM compatibles. Helpful for treating "what ifs" for room acoustics.

TPM Software

P.O. Box 77
Cabin John, Maryland 20818
(301) 229-4901

OPTORT60

A reverberation time calculation utility, useful for CADP, Umbulus and other sound system design programs that do not have reverberation utilities.

Helpful for "what ifs" in treating room acoustics.

AI

Articulation Index calculation utility, useful for Umbulus and other programs that do not have an intelligibility function.

STC

Sound transmission coefficient prediction (of sound leakage) through walls, etc.

TPM Software programs run on IBM compatibles.

PRINTER/ GRAPHICS UTILITIES PROGRAMS

Application Techniques, Inc.

10 Lomar Park Drive
Pepperell, MA 01463
(617) 433-5201

Piazazz

**Jewell Energy
Technologies, Inc.**
4302 Southwest Alaska St.
Seattle, WA 98116
(206) 937-1081

Grafplus

American Programers Guild, Ltd.

12 Mill Plain Road
Danbury, CT 06811
(203) 794-0396

Inset

All these programs are for screen capture to either printer or disk. These programs will enable you to capture graphics from various programs and insert into your reports, or print out in different sizes, or in color.

FLOW CHART PROGRAMS

Flow charting programs are typically developed for organization charts, but can be useful to the sound contractor in equipment signal flow diagrams, and quicker and easier to use than full scale CAD programs (such as Auto CAD).

Haventree Software Limited

P.O. Box 1039P
Thousand Island Park, NY 13692
(613) 544-6035

Easy Flow

Patton & Patton Software Corporation

81 Great Oaks Boulevard
San Jose, CA 95119
(408) 629-5044

Flow Charting II+

GRAPHICS PLOTING PROGRAMS

This program is useful for users with specialized needs, such as for graphically depicting polar response of speaker arrays, etc.

Amtec Engineering, Inc.

P.O. Box 3633
Bellview, WA 98009
(206) 827-3304

Techplot

—Compiled by Mike Klasco

MICROPHONES

MICROPHONES

ACO Pacific

2604 Read Ave.
Belmont, CA 94002
(415) 595-8588, FAX# 415-591-2891

Pres.: Noland Lewis, Dir. Mkt'g/Sls: Noland Lewis
Products: condenser, electret condenser, instrumentation, miniature, specialty

AKG ACOUSTICS

77 Selleck St.
Stamford, CT 06902
(203) 348-2121, 800-243-7885, FAX# 203-324-1942

Pres.: S. Richard Ravich, VP Op.: Derek Pilkington, VP Fin.: Bob Netter
Products: boundary, carbon, communications, condenser, contact pickups, dynamic, electret condenser, goosenecks, hand-held, headset boom, implant, instrumentation, miniature, podium, shotgun, specialty, stands, stereo

AMS Industries

PO Box 31864
Seattle, WA 98103
(206) 633-1956, FAX# 206-547-6890

Pres./G.M.: Nigel Branwell, Nat'l Sls Mgr.: Jim Stern, Tech. Supp. Mgr.: Graham Murray
Ordon & Co., Chicago, IL, 312-527-4569
Comlogic, Los Angeles, CA, 818-845-0199
Studio Consultants, New York, NY, 212-586-7376
Harris Audio, Miami, FL, 305-944-4448
Omni Technology, Nashville, TN, 615-451-9662
Products: condenser, instrumentation, specialty, stereo

Accusonics Systems

2101 Jericho Turnpike
New Hyde Park, NY 11040
(516) 328-3300

G. Mgr.: Dennis Goodman
Products: communications

AIPHONE INTERCOM SYSTEMS

PO Box 90075
Bellevue, WA 98009
(206) 455-0510, 800-692-0200, FAX# 206-455-0071

Pres.: Jun Matsumoto, Sls Mgr.: Jim Morrison, Mkt'g/Adv. Mgr.: Harry Quanz
Aiphone NE, Randolph, NJ, 201-328-1790
Aiphone Midwest, Westmont, IL, 312-323-5222
Aiphone SE, Douglasville, GA, 404-920-2811
Products: goosenecks

CTI/Astatic

Harbor & Jackson
Conneaut, OH 44030
(216) 593-1111, 800-421-3161, FAX# 216-593-5395

Pres.: Larry Phillips, Nat'l Sls Mgr.: Jim Edwards, Dir. Mkt'g: Jim Edwards, OEM Sls Mgr.: Ronald Ebersole
Products: communications, condenser, dynamic, electret condenser, goosenecks, hand-held, headset boom, miniature, podium, push-to-talk, specialty, stands

Audio Engineering Assoc.

1029 N. Allen Ave.
Pasadena, CA 91104
(213) 684-4461, FAX# 818-798-2378

Audio-Technica U.S.

1221 Commerce Dr.
Stow, OH 44224
(216) 686-2600, FAX# 216-688-3752

Pres.: Jon Kelly, VP Mkt'g: Ken Reichel, Nat'l Mkt'g Mgr.: Earl "Buzz" Goodwin, Sls Mgr.: Garry Elliott
Products: boundary, communications, condenser, dynamic, electret condenser, goosenecks, hand-held, headset boom, instrumentation, miniature, podium, shotgun, specialty, stereo

Auditel Systems

396 Porter Ave.
Buffalo, NY 14201
(716) 886-0019, FAX# 716-886-1615

Pres.: David Langtry, Prod. Mgr.: Tony Roberson, Mkt'g Dir.: Jim Wood
Products: condenser, dynamic, electret condenser, goosenecks, hand-held, headset boom, podium, specialty

Audix

5635 W. Las Positas
Pleasanton, CA 94566
(415) 463-1112, 800-888-9992, FAX# 415-463-2149

VP Sls: Cliff Castle, Nat'l Sls Mgr.: Michael Liebener
Products: condenser, dynamic, electret condenser, goosenecks, hand-held, instrumentation, miniature, podium, shotgun, specialty, stereo

Audra Int'l

PO Box 38
Silverado, CA 92676
(714) 649-2207, FAX# 714-649-3064
Owner: Algis Renkus

Barcus-Berry

5381 Production Dr.
Huntington Beach, CA 92649
(714) 898-9211, 800-854-6481, FAX# 714-898-7962
Exec. VP: John Berry

Beyer Dynamic

5-05 Burns Ave.
Hicksville, NY 11801



Telex is your one-stop for wired mics.

Telex is your source for the widest variety of wired mics. The Telex full line of quality miniature lapel, paging or sound reinforcement microphones fit into your sound system plans for churches, auditoriums, schools or wherever dependable wired mics are needed. Our mics make sense

Circle 30 on Reader Response Card

because of durable metal construction and full three-year warranties. Best of all, they're made right here in the U.S.A. For more information about Telex Wired Microphones, write to Telex Communications, Inc., 9600 Aldrich Avenue South, Minneapolis, MN 55420.

© 1989 Telex Communications, Inc.

TELEX®

World Radio History



AKG's C747. Small Size. Big Sound.

AKG's new C747 "pencil-type" condenser microphone sounds a lot bigger than it looks. In fact, its unique miniaturized transducer design and acoustically-tuned interference tube give the C747 sensitivity and uniform frequency response superior to mics many times its size. You'll like that on stage, TV, above a church choir or on a podium, where you need to capture performances without obscuring them. And you'll like it in the studio, where the C747 will go places other mics are just too big to follow. Clear lows, shimmering highs, tight pick-up pattern and mounting accessories that provide total convenience in any recording or sound reinforcement situation — with the C747 you get everything you need. Small size. Big sound.



Focusing on new technology.
77 Selleck St. Stamford, CT 06902
(203) 348-2121

AKG 1988 • Akustische und Kino-Geräte GmbH, Austria

(516) 935-8000, FAX# 516-935-8018

VP/G. Mgr.: Paul Murphy, Mkt'g Mgr.: Mike Solomon
Derek Allen, Burbank, CA, 818-840-8327
Bruce Marlin, Irving, TX, 214-869-0669
Tom Parnell, Bannockburn, IL, 312-234-6500
Bob Edsall, Asheville, NC, 800-999-9313
Dave Henderson, Burlington, MA, 617-229-6050

Products: boundary, communications, condenser, dynamic, electret condenser, goosenecks, hand-held, headset boom, instrumentation, miniature, podium, push-to-talk, ribbon, shotgun, specialty, stands

Bogen Communications

PO Box 575

Ramsey, NJ 07446

(201) 934-8500, FAX# 201-934-9832

Pres.: John Ochtera, VP Sls/Mkt'g: James Orr, Nat'l Sls Dir.: David Chambers

Products: dynamic, goosenecks, hand-held, push-to-talk, stands

Bruel & Kjaer Instruments

185 Forest St.

Marlborough, MA 01701

(508) 481-7000, FAX# 508-485-0519

Pres.: G. Perry, VP: G. Michel, VP Finance: B.

Benedict, Mkt'g Mgr.: G. Briggs

B & K, W. Caldwell, NJ, 201-227-6100

B & K, Livonia, MI, 313-522-8600

B & K, Hoffman Estates, IL, 312-358-7582

B & K, Marietta, GA, 404-422-5200

B & K, Orange, CA, 714-978-8066

Products: condenser

C-T Audio Mkt'g

3050 SW 14th Pl., Ste. 3

Boynton Beach, FL 33426

(407) 738-0622, 800-CT-AUDIO, FAX# 407-738-0319

Pres.: Andre Walton, Pub. Mgr.: Janet Page-Walton

Derek Allen Assoc., Toluca Lake, CA, 818-840-8327

Raleigh Perry & Assoc., Buford, GA, 404-945-3142

Wood Music Sls, Hurst, TX, 817-268-0015

Products

Coherent Communications

13756 Glenoaks Blvd.

Sylmar, CA 91342

(818) 362-9393, FAX# 818-362-7045

Products: electret condenser

Countryman Assoc.

417 Stanford Ave.

Redwood City, CA 94063

(415) 364-9988, 800-669-1422, FAX# 415-364-

2794

CEO: Carl Countryman, Sls Mgr.: Jay Morse, Office

Mgr.: Carolyn Countryman, Accounts Mgr.: Rosa

Pimental

Contact Distr., Ontario, Canada, 416-287-1144

Products: electret condenser, goosenecks, headset boom, miniature, podium, specialty

Crown Int'l

PO Box 1000

Elkhart, IN 46517

(219) 294-8000, FAX# 219-294-8329

Pres./CEO: Clyde Moore, Crown Div. Head: Gil

Nichols, Amplifier Prod. Dir.: Verne Searer, Sls Mgr.:

Jim Beattie, Mkt'g Svcs: Gerry Barclay, Mic. Prod.

Line Mgr.: Bob Herold

Products: boundary, goosenecks, hand-held

J.W. DAVIS & CO.

PO Box 26177

Dallas, TX 75226

(214) 651-7341, 800-527-5705, in-state 800-in TX

800-442-1564, FAX# 214-939-0328

Pres.: Charles Griffith, VP Sls: Jack Tucker

Products: communications, condenser, dynamic, electret condenser, goosenecks, hand-held, miniature, podium, push-to-talk,

DUKANE

2900 Dukane Dr.

St. Charles, IL 60174

(312) 584-2300, FAX# 312-584-2370

Pres./CEO: J. McWilliams Stone Jr., Group VP: William

Finnegan, Div. G. Mgr.: Steven Deppe, Nat'l Sls Mgr.:

Warren Anderson, Svce Mgr.: Cliff Carlson

Wally Smuts, Toronto-Ont, Canada, 312-584-2300

Doug Fellabaum, Sycamore, IL, 815-895-7573

Don Mouritzen, Beecher, IL, 312-946-9655

Ken Lind, St. Charles, IL, 312-584-2300

Pete Kendal, Jacksonville, FL, 904-262-6025

Ed Nuhring, Portland, OR, 503-244-4262

Jim Lacey, Moreno Valley, CA, 714-243-1160

Jack Brown, Dallas, TX, 214-943-7528

Products: communications, hand-held

Electro-Voice

600 Cecil St.

Buchanan, MI 49107

(616) 695-6831, 800-527-6701, FAX# 616-695-

1304

Pres.: Robert Pabst, VP Sls & Mkt'g: Paul McGuire,

Dir. Mkt'g: Jim Long, Chief Eng.: Earl Harris

Products: carbon, communications, condenser, dynamic,

electret condenser, goosenecks, hand-held, headset boom,

podium, push-to-talk, shotgun, stands

FOSTEX CORP. OF AMERICA

15431 Blackburn Ave.

Norwalk, CA 90650

**HEARD BY
MILLIONS BUT
SELDOM SEEN**

C-DUCER

**STUDIO QUALITY CONTACT
CONDENSER MICROPHONES**

- 42Hz to 22KHz Frequency response
- Superb clarity - true acoustic sound
- Complete isolation
- Easy to use
- More than 5000 systems in use world wide
- Systems from \$199



FOR MORE INFORMATION

OR YOUR NEAREST DEALER CALL:

1 - 800 CT AUDIO

C-T Audio,
3050 SW 14th Pl, Ste3, Boynton Beach,
FL 33426.

In Canada call: Reid King,
(604) 222 8190

**ONE
IS
NOT
ENOUGH**

Additional copies of the 1989/90 Blue Book are available at \$12 each. Please send your check or money order to:
Bob Evans
Circulation Director
25 Willowdale Ave.
Port Washington, NY 11050

How to make your best church sound systems disappear from sight!

Actual Size
Model AT853 Unidirectional
Condenser Choir Microphone

Install Audio-Technica UniPoint® miniature studio-quality microphones

Every congregation deserves the best possible sound, whether at the service or listening to broadcasts or tape. Now you can install superior sound without bulky microphones and awkward microphone stands that intrude on the services.

New Directional Choir Microphone

Audio-Technica engineers have broken new ground with our UniPoint design that delivers studio-quality sound from tiny, inconspicuous *directional* microphones. Our new choir microphone is so small and light that it can be suspended by its own slim cable, making it virtually invisible. Yet it offers controlled pickup of only the choir, sharply reducing room noise and reverberation.

Directional models for altar, lectern, pulpit, plus lavaliers

Four other UniPoint models for use at the lectern or pulpit offer the same clarity, full range, and directional pickup control. Our comprehensive approach to church sound also includes a surface-mounted directional microphone that lies flat on altar, table, or floor. We round out the selection with directional lavalier microphones that solve acoustic problems other lavaliers can't handle. The entire line provides



Model AT871
UniPlate Boundary Cardioid



Model AT857AM
Podium Cardioid

full freedom of movement to the participants, yet the microphone is almost unseen.

Better sound is now smaller, lighter, less visible

Whether your customer's sound system is solely for sound reinforcement, or is also used for radio/TV or tape recording of the service, UniPoint microphones improve the sound quality while remaining almost invisible.

Our experts are ready to help

If you ever need help with specific installations – whether large or small – our Audio-Technica church sound experts are ready with answers to your most difficult problems. To watch your toughest church sound installation problems disappear, call or write us today.

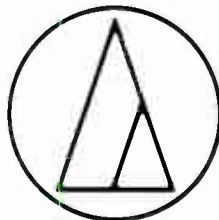

audio-technica.

1221 Commerce Drive, Stow, OH 44224
(216) 686-2600

(213) 921-1112, FAX# 213-802-1964
 Exec. VP: Fred Huang, VP Sls/Mkt'g: Mark Cohen
 Products: headset boom, podium, ribbon, stereo

Gotham Audio

1790 Bdwy, 8th floor
 New York, NY 10019-1412
 (212) 765-3410, FAX# 212-265-8459
 Pres.: Russell O. Hamm, VP Op.: Gail L. Smith,
 Contractor Sls Mgr.: Jerry Graham
 Gotham Audio, Van Nuys, CA, 818-785-2211

HM Electronics

6675 Mesa Ridge Rd.
 San Diego, CA 92121
 (619) 535-6060, FAX# 619-452-7207
 VP Mkt'g: J. Michael Hughes, Pro Audio Sls Mgr.:
 Eunice Davis, Ind'l Sls Mgr.: Bruce Slemmer, Cust.
 Svce Mgr.: Bill Kranzush, Mkt'g Coord.: Matt Riches
 Derek Allen Assoc., Toluca Lake, CA, 818-843-6919
 John Anthony, Stamford, CT, 203-322-9202
 Applied Audio Mkt'g, Ashville, NC, 704-252-9313
 A/V Mkt'g, Carmel, IN, 317-846-1034
 Products: communications, condenser, dynamic, electret
 condenser

IQS

12812-J Garden Grove Blvd.
 Garden Grove, CA 92643
 (714) 539-7842, FAX# 714-556-8325
 Pres.: William Elder, VP: Douglas Evered
 Products: instrumentation

Int'l Music Co. (I. M. C.)

PO Box 2344
 Ft. Worth, TX 76113
 (817) 336-5114, 800-433-5627, FAX# 817-870-
 1271
 Chairman of the Bd./CEO: Tommy Moore, Pres.: Jerry
 Freed, VP Sls: C.H. Murray, Dir. Akai EMI: Mike
 McRoberts, Akai Prod. Specialist: Kevin Kennedy

Knowles Electronics

3100 N. Mannheim Rd.
 Franklin Park, IL 60131
 (312) 455-3600

Larson-Davis Labs

1681 W. 820 N.
 Provo, UT 84601
 (801) 375-0177, FAX# 801-375-0182
 Pres.: Brian Larson, VP Eng.: Larry Davis, Dir. Mkt'g:
 John Carey
 Ichirep, Sunnyvale, CA, 408-737-2220
 Parameter Measurement, Friendswood, TX, 713-482-
 8471
 Microspec, Lilburn, GA, 404-921-3840
 Electro Sls, Livonia, MI, 313-421-7500
 db Environmental, Fayetteville, NY
 Products: condenser, instrumentation

Lectrosonics

PO Box 15900
 Rio Rancho, NM 87174
 (505) 892-4501, 800-821-1121, FAX# 505-892-
 6243
 Pres.: John Arasim, VP Mkt'g: Bruce Jones
 Products: electret condenser, headset boom

MG Electronics

32 Ranick Rd.
 Hauppauge, NY 11788
 (516) 582-3400, FAX# 516-582-3229
 Pres.: Louis Maltz, VP: Elliott Maltz, Sls Mgr.: Stan
 Grey
 Miller Assoc., Stamford, CT, 203-869-7793

Miller Assoc., Flushing, NY, 718-464-0617
 Forti Assoc., Kensington, MD, 301-949-1706
 Raymar Assoc., Duncarville, TX, 214-296-9833
 Products: condenser

Milab

30 B Banli Plaza N.
 Farmingdale, NY 11735
 (516) 249-3660, FAX# 516-420-1863
 Pres.: Jack Kelly, Nat'l Sls Mgr.: Sam Spennacchio,
 Prod. Sls Rep.: Chris Fichera
 Products: boundary, condenser, dynamic

Milliphonics

Salina Star Rte., Logan Mill Rd.
 Boulder, CO 80302
 (303) 444-3167

The Music People

PO Box 648
 W. Hartford, CT 06107
 (203) 236-7134, 800-289-8889, FAX# 203-233-
 6888
 Pres.: James Hennessey, Dir. Sls: Earl "Buzz"
 Goodwin, Comptroller: John Gutowski, Purch. Mgr.:
 Robert Murray, Pub./Prom.: Lisa Radefeld

Panasonic/Ramsa

6550 Katella Ave.
 Cypress, CA 90630
 (714) 373-7277, FAX# 714-373-7242
 Sls/Mkt'g Mgr.: Steve Wooley, Mkt'g Mgr.: Chris
 Foreman, W. Sls Mgr.: James Murray, Central Sls
 Mgr.: Greg Braithwaite, Telemkt'g Mgr.: Carla
 Campbell
 James Murray, Cypress, CA, 714-373-7389
 Greg Braithwaite, Arlington Heights, IL, 312-981-7329
 Pusecker Sls, Upper Montclair, NJ, 201-744-1834
 David Bros., Finksburg, MD, 301-833-0920
 Pro Audio Assoc., Burlington, MA, 617-229-6050
 World Wide Electronics, Pembroke Pines, FL, 305-
 584-7024
 Evans Sls & Mkt'g, Nashville, TN, 615-297-7997
 New Horizons, Bannockburn, IL, 312-234-6500
 Laker Assoc., Wauzata, MN, 612-475-2642
 A/V Mkt'g, Carmel, IN, 317-846-1034
 Innovative Audio, Pontiac, MI, 313-673-2280
 J.B. Parent, Dublin, OH, 614-764-0064
 Essential Mkt'g, St. Joseph, MO, 816-279-0776
 Tenackit Assoc., Houston, TX, 713-528-2005
 New West Audio, Burbank, CA, 818-855-9700
 Brian Trankle Assoc., Belmont, CA, 415-595-4004
 Northmar, Seattle, WA, 206-524-5170
 Pearson & Pearson, Denver, CO, 303-722-6996
 Products: condenser, electret condenser, headset boom,
 miniature

Peavey Electronics

711 A St.
 Meridian, MS 39302
 (601) 483-5365, FAX# 601-484-4278
 Pres.: Hartley Peavey
 Products: condenser, dynamic, electret condenser, goose-
 necks, hand-held, instrumentation, podium, stands

Penn Fabrication (USA)

PO Box 506
 Hawthorne, NJ 07506
 (201) 423-4404
 Sls Dir.: Mike Panasuk, G. Mgr.: Richard Stratford, G.
 Mgr.: Gavin Naismith
 Products: stands

Philips Microphones

77 Selleck St.
 Stamford, CT 06902
 (203) 348-2121

Posthorn Recording

142 W. 26th St.
 New York, NY 10001
 (212) 242-3737
 Owner/Pres.: Jerry Bruck, Studio Mgr.: Michael Hesse,
 Personnel/PR: Louise Bloomfield
 Products: boundary, condenser, electret condenser, goose-
 necks, hand-held, miniature, podium, shotgun, specialty,
 stands, stereo

RING COMMUNICATIONS

57 Trade Zone Dr.
 Ronkonkoma, NY 11779
 (516) 585-7464, FAX# 516-585-7410
 Pres.: Paul McLean, VP Sls: Craig Krsanac, V.P.
 Tech.: Kjell (Ken) Solem, Tech Support: Charlie Kulins
 Klumpp Sls, Jacksonville, FL, 904-287-5205
 Corrigan Agencies, 504-893-7455
 Gustafson Sls, 612-388-4277
 Allwest Electronics, 805-388-1789
 Pacnor, 206-771-6016
 J.C. Electronics, 808-943-8514

THE SANDELL CO.

24808 Aden Ave.
 Santa Clarita, CA 91321
 (805) 254-4186, 259-0108
 Pres.: Cynthia Sandell, Dir. Op.: Lillian Cory

Sennheiser Electronic

PO Box 987
 Old Lyme, CT 06371
 (203) 434-9190, FAX# 203-434-1759
 Products: condenser, dynamic, electret condenser, goose-
 necks, hand-held, headset boom, implant, miniature, podi-
 um, shotgun, specialty, stands

SHURE BROTHERS

222 Hartrey Ave.
 Evanston, IL 60202-3696
 (312) 866-2200, FAX# 312-866-2279
 Pres.: James Kogen, VP Sls: Lottie Morgan, Dir. Tech.
 Mkt'g: John Phelan, Dir. Wired Mics: Alan Shirley, Dir.
 Wireless Mics: Sandy Schroeder, Dir. Sls: Al Hershner
 Products: boundary, carbon, communications, electret con-
 denser, goosenecks, hand-held, headset boom, instrumen-
 tation, miniature, podium, push-to-talk, shotgun, specialty,
 stands

Sony Professional Audio

1600 Queen Anne Rd.
 Teaneck, NJ 07666
 (201) 833-5200, 800-635-SONY, FAX# 201-833-
 9645
 Nat'l Sls Mgr.: Bob Ott, Prod. Mgr.: Art Gonzales, Mkt'g
 Mgr.: David Kawakami
 Sony Pro Audio, Paramus, NJ, 201-368-5185
 Sony Pro Audio, Nashville, TN, 615-883-8140
 Sony Pro Audio, Burbank, CA, 818-841-8711
 Products: condenser, dynamic, electret condenser, hand-
 held, miniature, podium, shotgun, stereo

Sound Control Technologies

114A Washington St.
 Norwalk, CT 06854
 (203) 854-5701, FAX# 203-854-5703
 Pres.: Adolph Neaderland, Sls: David Neaderland
 Powerlines Mkt'g, Chicago, IL, 312-864-1147
 Franklin Comm., Philadelphia, PA, 215-643-3031
 KBZ Comm.s, NY Metro, 215-348-9481
 Total Mkt'g, Fort Worth, TX, 817-560-3970
 Meyer Mkt'g, Deerfield Beach, FL, 305-481-9250
 Visitec Mkt'g, Minneapolis, MN, 612-925-2691
 Products: implant

Sennheiser Microphones



Excellence Needs No Explanation.

To learn more about the Sennheiser excellence in design and engineering,
please call or write.



6 Vista Drive, P.O. Box 987

Old Lyme, CT 06371

Tel # 203-434-9190 FAX # 203-434-1759

MICROPHONES • HEADPHONES • BOOM SETS • RF WIRELESS • INFRA-RED TECHNOLOGY

Manufacturing Plant: D-3002 Wedemark, Federal Republic of Germany

Circle 217 on Reader Response Card

Speco Div. Components Specialties
PO Box 624

Lindenhurst, NY 11757

(516) 957-8700, 800-645-5516, FAX# 516-956-9142

Pres.: Louis Keller, VP G. Mgr.: James Ganci, V.P. Sls: Mel Hulkower, Sls Mgr.: Eric Forman, Sls Expeditor: Bernice Zachman

Products: communications, goosenecks, hand-held, push-to-talk., stereo

Studio Technologies

5520 W. Touhy Ave.

Skokie, IL 60077

(312) 676-9177, FAX# 312-982-0747

Pres.: Gordon Kapes, Mkt'g Comm. Mgr.: Jennifer Shore

TEI Electronics

PO Box 246

Hialeah, FL 33011

(305) 888-3980, 800-327-8811, FAX# 305-885-4950

Pres.: Danny Alonso, VP: Mireya Muniz, Nat'l Sls Mgr.: Walter McNulty, Cust. Svce: John Tembras, Sls: Orlando Pineda, Sls: Jose Hurcades

Products: communications, condenser, dynamic, electret condenser, goosenecks, hand-held, push-to-talk., stands

TOA ELECTRONICS

PO Box 2047

S. San Francisco, CA 94080

(415) 588-2538, 800-843-4750, in-state 800-in CA

800-632-2157, FAX# 415-588-3349

Pres.: Yoshiro Ishida, Nat'l Sls Mgr/Comm. Pro.: Richard Krochmal, Nat'l Sls Mgr./Pro. Music & Ent.: Rick Kamlet, Nat'l Sls Mgr./Intercom: Al Burns

Products: condenser, dynamic, electret condenser, hand-held, headset boom, push-to-talk.

Tascam (TEAC Professional Division)

7733 Telegraph Rd.

Montibello, CA 90640

(213) 726-0303, FAX# 213-727-7656

Mkt'g Mgr: Bill Mohrhoff, Nat'l Sls Mgr.: Gregg Hildebrandt, W. Reg. Mgr.: Fred Allard, S. Reg. Mgr.: Bill Stevens, E. Reg. Mgr.: Chuck Prada

Products: condenser, dynamic, electret condenser, goosenecks

Technical Acoustics

8933 Western Way, Ste. 20

Jacksonville, FL 32256

(904) 363-0833, FAX# 904-363-0848

Pres.: Donald Bowers, VP: Sheldon Glick, Office Mgr.: Maria Hammarlund

Robert Christopher Sls., Yonkers, NY, 904-237-0343

Marketline, Snellville, GA, 404-972-9048

Lex Lawson, Garland, TX, 214-272-8482

Loomis & Assoc., Fremont, CA, 415-797-3500

Products: boundary, electret condenser, implant

Telex Communications

9600 Aldrich Ave. S.

Minneapolis, MN 55420

(612) 884-4051, FAX# 612-884-0043

Pres.: Jeffrey Wetherell, VP Mkt'g: James Arrington, VP Sls: Dan Dantzler, Dir. Mkt'g: Dond Meeßen, Dir Adv.: Ronald Taylor

WesTechLichtenauer, Culver City, CA, 213-870-9286

Bencsik Assoc., Ocala, FL, 904-732-9775

Burcaw & Assoc., Warren, MI, 313-573-4605

SAGA, Oswego, NY, 315-343-5739

Monfort Electronic Mkt'g, Indianapolis, IN, 317-872-8877

Murphy & Cota, Atlanta, GA, 404-875-2525

Northland Assoc., Moorhead, MN, 218-233-4616

Rancilio Assoc., St. Louis, MO, 314-845-0202

J.Y. Schoonmaker, Dallas, TX, 214-349-1650

Sigmat, Valley Forge, PA, 215-783-6666

Weller Electronic Sls, Worthington, OH, 614-885-7819

Ziskind Assoc., Rolling Meadows, IL, 312-577-1624

White Radio, Burlington-Ont., Canada, 416-632-6894

Silver Peak Mkt'g, Denver, CO, 303-467-9042

Pacnor Mkt'g, Lynnwood, WA, 206-771-6016

Products: communications, dynamic, electret condenser, goosenecks, hand-held, headset boom, instrumentation, miniature, podium, push-to-talk.

Uniprise Int'l

15 Hickory Dr.

Roslyn, NY 11576

(516) 621-6987

Sls Dir.: Stanley Hirsch

Products: goosenecks

Wright Microphones

2093 Faulkner Rd. N.E.

Atlanta, GA 30324

(404) 321-3886

Pres.: Tom Wright

Products: condenser, dynamic, electret condenser, specialty

Yamaha Music Corp. of America/Prof.

Audio Div.

PO Box 6600

Buena Park, CA 90662

(714) 522-9011, FAX# 714-522-9312

Products: dynamic, hand-held, headset boom, specialty

Want more information
on Blue Book Advertisers
Just fill out the

**FAST
ACTION CARD**

on page 52.

(OR — CALL THEM TODAY
AND MENTION THE BLUE BOOK.)

Reader Service Requests Must Be Received by 12/29/89

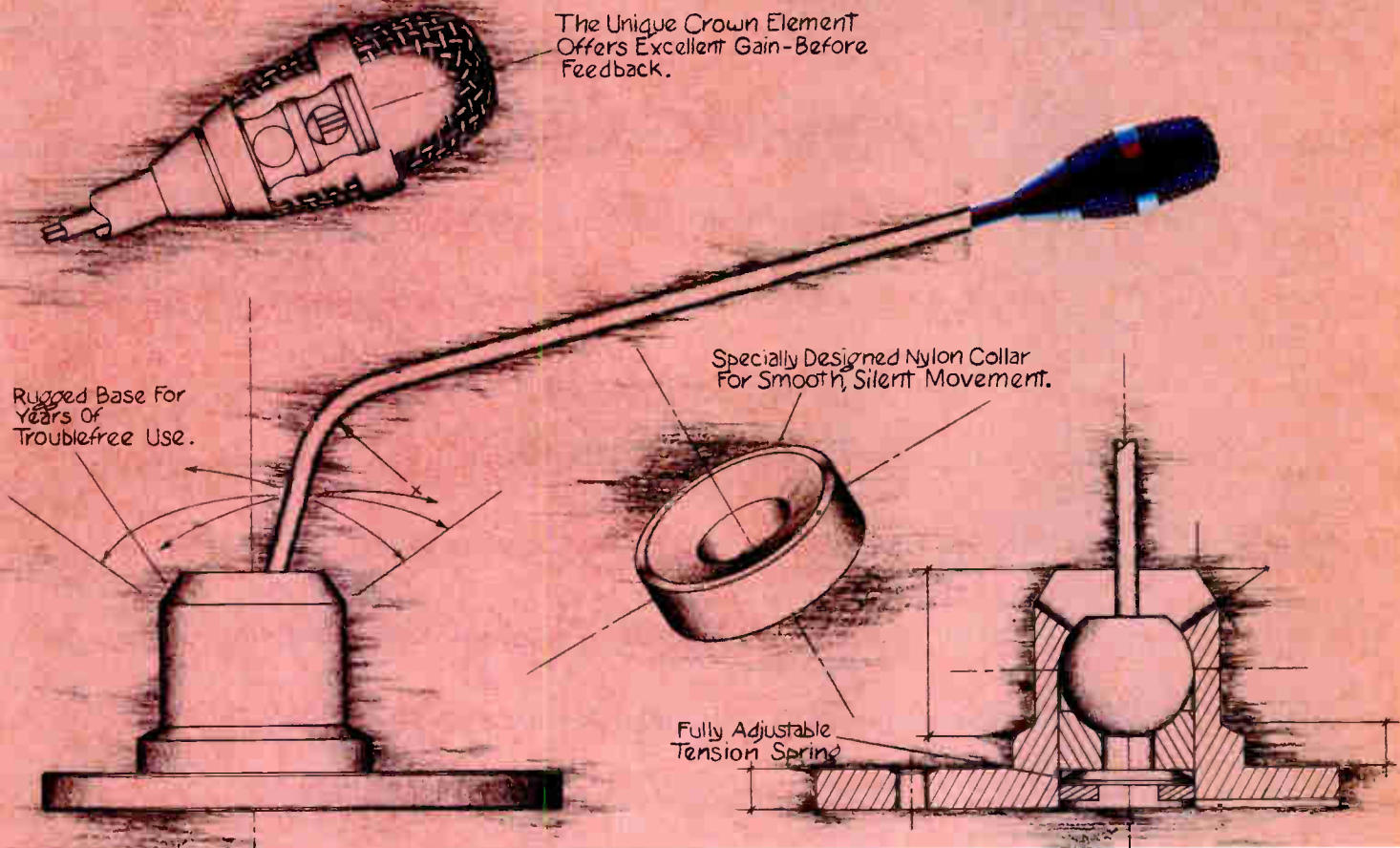

Specific problems demand simple, elegant solutions.

The most intelligent design, in any discipline, is often regarded as "inspired". The acclaim stems from the designer's ability to recognize and solve the problem at hand, simply.

Podium mikes have in the past exhibited a number of flaws to the installer and to the end user. Crown engineering set to the task of defining those flaws and eliminating them. Further, we wanted to incorporate new ideas necessary to make the LM™ series everything a podium mike must be.

In consulting experienced sound contractors, we determined that to be aesthetically appealing and unobtrusive in use solves only a part of

the problems of past designs; long-term client satisfaction and ease of installation and maintenance are as important as the need for excellent gain-before-feedback and natural, uncolored sound. So is meaningful shock isolation. And there is more . . .

In the LM series, a unique method of keeping proximity effect under control is employed for predictable performance and uniform intelligibility at all distances. Coupling this with thorough shielding and increased RF protection, the LM series is, as usual for Crown, at the forefront of this technology. That's where we want to be, that's our inspiration.



"After 30 years and thousands of church installations, we finally found what we really wanted all along. Thanks Crown for listening, we should have spoken with you first."

Per Haugen
General Communications



CROWN® INTERNATIONAL, INC.
1718 W. MISHAWAKA ROAD, ELKHART, IN 46517

Circle 216 on Reader Response Card

World Radio History

MICROPHONES (WIRELESS)

AKG ACOUSTICS

77 Selleck St.
Stamford, CT 06902
(203) 348-2121, 800-243-7885, FAX# 203-324-1942
Pres.: S. Richard Ravich, VP Op.: Derek Pilkington, VP
Fin.: Bob Netter
Products: hand-held

Audio-Technica U.S.

1221 Commerce Dr.
Stow, OH 44224
(216) 686-2600, FAX# 216-688-3752
Pres.: Jon Kelly, VP Mkt'g: Ken Reichel, Nat'l Mkt'g
Mgr.: Earl "Buzz" Goodwin, Sls Mgr.: Garry Elliott
Products: body packs, hand-held

Beyer Dynamic

5-05 Burns Ave.
Hicksville, NY 11801
(516) 935-8000, FAX# 516-935-8018
VP/G. Mgr.: Paul Murphy, Mkt'g Mgr.: Mike Solomon
Derek Allen, Burbank, CA, 818-840-8327
Bruce Marlin, Irving, TX, 214-869-0669
Tom Parnell, Bannockburn, IL, 312-234-6500
Bob Edsall, Asheville, NC, 800-999-9313
Dave Henderson, Burlington, MA, 617-229-6050
Products: body packs, hand-held

Coherent Communications

13756 Glenoaks Blvd.
Sylmar, CA 91342
(818) 362-9393, FAX# 818-362-7045
Products: body packs, hand-held



Comtek

357 W. 2700 S.
Salt Lake City, UT 84115
(801) 466-3463, FAX# 801-484-6906
Pres.: Ralph Belgique, Eng. Dir.: Steve Kartchner,
Mkt'g Dir.: Steve Dupaix, Svce Mgr.: Laurel Robertson,
Credit Mgr.: Dana Pelletier, Cust. Svce: Stacey Hayes-Garcia
Products: body packs, hand-held

HM Electronics

6675 Mesa Ridge Rd.
San Diego, CA 92121
(619) 535-6060, FAX# 619-452-7207
VP Mkt'g: J. Michael Hughes, Pro Audio Sls Mgr.:

Eunice Davis, Ind'l Sls Mgr.: Bruce Slemmer, Cust.
Svce Mgr.: Bill Kranzush, Mkt'g Coord.: Matt Riches
Derek Allen Assoc., Toluca Lake, CA, 818-843-6919
John Anthony, Stamford, CT, 203-322-9202
Applied Audio Mkt'g, Asheville, NC, 704-252-9313
A/V Mkt'g, Carmel, IN, 317-846-1034
Products: body packs, hand-held

Lectrosonics

PO Box 15900
Rio Rancho, NM 87174
(505) 892-4501, 800-821-1121, FAX# 505-892-6243
Pres.: John Arasim, VP Mkt'g: Bruce Jones
Products: body packs, hand-held

NADY SYSTEMS

1145 65th St.
Oakland, CA 94608
(415) 652-2411, FAX# 415-652-5075
Sls Mgr.: Royce Krilanovich, Mkt'g/Comm.: Chris
Calder
Products: body packs, hand-held

Peavey Electronics

711 A St.
Meridian, MS 39302
(601) 483-5365, FAX# 601-484-4278
Pres.: Hartley Peavey
Products: body packs, hand-held

WIRELESS TECHNOLOGY

Microphones Headphones/Headsets

See our Special Report
in the November '89 issue of

SOUND & COMMUNICATIONS

SAMSON Technologies Corp.

Samson Technologies

485-19 S. Bdwy.
Hicksville, NY 11801
(516) 932-3810, 800-328-2882, FAX# 516-932-3815
VP Sls/Mkt'g: Scott Goodman, VP Eng.: Doug Bryant,
Exp. Mgr.: Kevin Moran, Sls: Mike Hennessey, Sls:
Dave Olivier, Sls: Mike Vallerella
Image Mkt'g, Fountain Valley, CA, 714-957-0630
Jamm Dist., Flossmoor, IL, 312-799-0550
Audio Assoc., Fulton, MD, 301-604-1645
Reflex Mkt'g, Hempstead, NY, 516-565-2323
JMS Mkt'g, Austin, TX, 512-266-1113
Products: body packs, hand-held

Schell Electronics

120 N. Lincoln
Chanute, KS 66720
(316) 431-2350, FAX# 316-431-2365
Sls Mgr.: Janice Schell
Products: body packs, hand-held

Sennheiser Electronic

PO Box 987
Old Lyme, CT 06371
(203) 434-9190, FAX# 203-434-1759
Products: body packs, hand-held

SHURE BROTHERS

222 Hartrey Ave.
Evanston, IL 60202-3696

Today's most intelligent wireless microphones aren't the most expensive.

A battery life breakthrough and interference-free performance make Toa modular wireless systems first choice among smart contractors.

INVENTIVE.

Toa's revolutionary tone-key circuit uses a guardian "password" frequency for interference-free transmission. In a word. Smart.

VIBRANT.

Unique compander circuits deliver extended dynamic range and S:N ratios unheard of at Toa's installed cost.

CONSIDERATE.

A simple tab-stop keeps the mic from rolling off tabletops and lecterns. An obvious convenience, perhaps, but another Toa feature.

THOUGHTFUL.

LED's warn of low battery power not minutes, but hours before replacement is due.

REVOLUTIONARY.

Toa's mics deliver 40 hours or more from a single AA battery.

FLEXIBLE.

Both diversity and non-diversity systems allow you to add multiple mics by simply plugging in receiver modules. No tools. No fuss.



COMPACT.

Lightweight, 2.8 oz. body pac and lavalier microphone for clear, reliable, hands-free presentation.

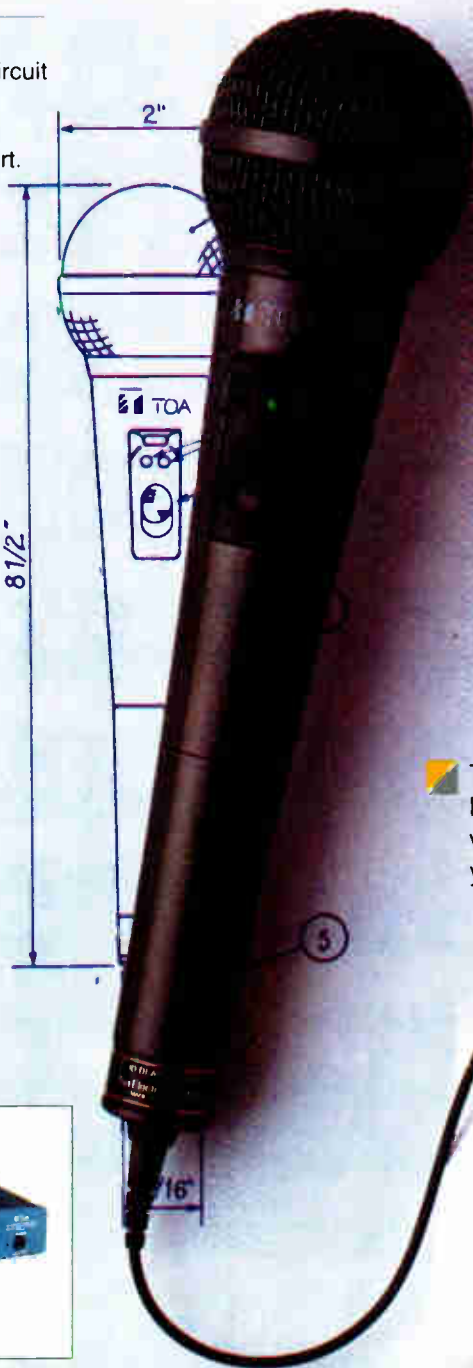

PORTABLE.

Toa's lightweight wireless amplifier accommodates twin non-diversity receivers. A model with an auto-reverse cassette is available.

Toa wireless microphone systems. Leading edge performance at a very intelligent price. Just what you'd expect from Toa.

Circle 245 on Reader Response Card



TOA ELECTRONICS, INC.
401 GATEWAY BLVD., SO. SAN FRANCISCO
CA 94080 (415) 566-2538 FAX (415) 568-5348

Williams

is wireless

wireless hearing assist
wireless microphones
wireless tour guide
wireless interpretation
wireless intercoms
wireless paging
wireless cueing

when you think of wireless- prompting

think of Williams. From wireless microphones to wireless intercoms to our endless list of wireless applications, we have a product to fit your wireless needs.

When you order a Williams wireless product, we go out of our way to make sure you're satisfied. We give you friendly and helpful service; quick, on-time shipments; unlimited technical support; reliable

products that are engineered to last; and our standard three-year warranty.

When you need wireless, you need Williams Sound.



Williams Sound Corp.

5929 Baker Road, Minnetonka, MN 55345-5997
U.S.A. 612-931-0291 / 800-328-6190 / FAX: 612-931-0620



(312) 866-2200, FAX# 312-866-2279
 Pres.: James Kogen, VP Sls: Lottie Morgan, Dir. Tech.
 Mkt'g: John Phelan, Dir. Wired Mics: Alan Shirley, Dir.
 Wireless Mics: Sandy Schroeder, Dir. Sls: Al Hershner
 Products: body packs, hand-held

Sony Professional Audio

1600 Queen Anne Rd.
 Teaneck, NJ 07666
 (201) 833-5200, 800-635-SONY, FAX# 201-833-9645
 Nat'l Sls Mgr.: Bob Ott, Prod. Mgr.: Art Gonzales, Mkt'g
 Mgr.: David Kawakami
 Sony Pro Audio, Paramus, NJ, 201-368-5185
 Sony Pro Audio, Nashville, TN, 615-883-8140
 Sony Pro Audio, Burbank, CA, 818-841-8711
 Products: body packs, hand-held

Swintek Enterprises

PO Box 160617
 Cupertino, CA 95016
 (408) 727-4889, FAX# 408-727-3025
 Pres.: William Swintek, VP: Les Underwood, Sls Mgr.:
 Darisa Hill
 Cinequip, Toronto-Ont., Canada, 416-467-7700
 Alan Gordon Enter., Hollywood, CA, 213-466-3561
 Midwest Comm., Edgewood, KY, 606-331-0048
 Products: body packs, hand-held

TOA ELECTRONICS

PO Box 2047
 S. San Francisco, CA 94080
 (415) 588-2538, 800-843-4750, in-state 800-in CA 800-
 632-2157, FAX# 415-588-3349
 Pres.: Yoshiro Ishida, Nat'l Sls Mgr./Comm. Pro.:
 Richard Krochmal, Nat'l Sls Mgr./Pro. Music & Ent.:
 Rick Kamlet, Nat'l Sls Mgr./Intercom: Al Burns
 Products: body packs, hand-held

Telex Communications

9600 Aldrich Ave. S.
 Minneapolis, MN 55420
 (612) 884-4051, FAX# 612-884-0043
 Pres.: Jeffrey Wetherell, VP Mkt'g: James Arrington,
 VP Sls: Dan Dantzier, Dir. Mkt'g: Dond Meeeen, Dir
 Adv.: Ronald Taylor
 WesTech/Lichtenauer, Culver City, CA, 213-870-9286
 Bencsik Assoc., Ocala, FL, 904-732-9775
 Burcaw & Assoc., Warren, MI, 313-573-4605
 SAGA, Oswego, NY, 315-343-5739
 Monfort Electronic Mkt'g, Indianapolis, IN, 317-872-
 8877
 Murphy & Cota, Atlanta, GA, 404-875-2525
 Northland Assoc., Moorhead, MN, 218-233-4616
 Rancilio Assoc., St. Louis, MO, 314-845-0202
 J.Y. Schoonmaker, Dallas, TX, 214-349-1650
 Sigmat, Valley Forge, PA, 215-783-6666
 Weller Electronic Sls, Worthington, OH, 614-885-7819
 Ziskind Assoc., Rolling Meadows, IL, 312-577-1624
 White Radio, Burlington-Ont., Canada, 416-632-6894
 Silver Peak Mkt'g, Denver, CO, 303-467-9042
 Pacnor Mkt'g, Lynnwood, WA, 206-771-6016
 Products: body packs, hand-held

Vega (A Mark IV Co.)

600 Cecil St.
 Buchanan, MI 49107
 (616) 695-6831, FAX# 616-695-9626
 Wireless Mkt'g Mgr.: Claude Kleinman, Dir. of Mkt'g:
 Jim Long, Exec. VP: Paul McGuire
 Products: body packs, hand-held

Williams Sound

5929 Baker Rd.
 Minnetonka, MN 55345-5997
 (612) 931-0291, 800-328-6190, FAX# 612-931-0620
 Nat'l Sls Mgr.: Todd Bergum, VP Mkt'g: Paul
 Ingebrigtsen, VP Eng.: Jay Kershaw, Cust. Svce Mgr.:
 Terry Roushar, Pres.: James M. Broz
 Products: body packs, hand-held



Nady 101/201 Wireless Systems: The ultimate price/performance breakthrough in VHF Wireless Systems. 120 dB Dynamic Range. 250 foot operation. True Diversity and single-channel. Lavahier, Hand-Held, and Instrument Transmitters available. Receivers rack mount. List prices start at \$279.

The Systems Approach. Nady Wireless. Nady Infrared.

Maybe the problem is a small facility with an even smaller budget - but you need wireless microphones.

Your requirements may be for a very complicated multi-channel wireless installation. It has to sound great and work flawlessly.

Or your plans call for a Large-Area Infrared installation. Complete coverage, user-friendly receivers - the works. And you don't want to break the bank.

Only one resource provides a total, integrated solution: The Nady Professional Audio Line.

We give you choices - systems solutions - that no one else can. Our 101/201 VHF Wireless Systems start at \$279 list for a Nady 101 LT lavaliere system. Wireless doesn't get more affordable than that.

And the Nady 1200 Series Wireless sets the industry standard for full-feature, top-end wireless performance.

Wireless manufacturers make many confusing claims regarding system specifications. Take our suggestion: listen to a Nady 101/201 or a Nady 1200 side-by-side with any other wireless on the market - regardless of the claimed specs - and you'll be impressed with the extra 15 dB dynamic range you get with Nady Wireless.

The Nady IR-300 is a Large-Area Infrared system with a unique modular design for easy, efficient installation in any size facility. You don't have to run AC to power the emitters. And you can add to the system as needed in the future. Best of all, you can have a Nady IR-300 infrared package for one-third to one-half less than the competition gets for the same area coverage.

So, the next time you need wireless or infrared, try the systems approach. The Nady Systems Professional Audio Line.

Nady Systems, Inc., 1145 65th St.,
 Oakland, CA. Phone 415/652-2411



Nady 1200 Wireless System. The newest generation of top-end Nady Wireless Systems, with the best specs in the business. Full output features for total flexibility. Sophisticated front-end circuitry for maximum multi-channel capability, and True Diversity for drop-out free performance. Features a completely redesigned Hand-Held Transmitter with user-servicable elements. Receiver rack-mounts. List price from \$1,599.



Nady IR-300 Large-Area Infrared Systems. Unique modular design for easy, efficient installation in any size facility. You don't have to run AC to power the emitters. And you can add to the system as needed in the future. Choice of user-friendly receivers. Best of all, you can have a Nady IR-300 infrared package for one-third to one-half less than the competition gets for the same area coverage.

Circle 272 on Reader Response Card

MIXERS & MIXING CONSOLES

ADM Technology
1626 E. Big Beaver Rd.
Troy, MI 48084
(313) 524-2100

AMS Industries
PO Box 31864
Seattle, WA 98103

(206) 633-1956, FAX# 206-547-6890
Pres./G.M.: Nigel Branwell, Nat'l Sls Mgr.: Jim Stern,
Tech. Supp. Mgr.: Graham Murray
Ordon & Co., Chicago, IL, 312-527-4569
Comlogic, Los Angeles, CA, 818-845-0199
Studio Consultants, New York, NY, 212-586-7376
Harris Audio, Miami, FL, 305-944-4448
Omni Technology, Nashville, TN, 615-451-9662
Products: broadcast, custom, digital, ENG, modular, portable., powered, production, rack-mount, recording, theatrical, VCA

API Audio Products
7951 Twist Ln.
Springfield, VA 22153
(703) 455-8188, FAX# 703-455-4240

Advantage
14270 NW Science Pk Dr.
Portland, OR 97229
(503) 641-7287, FAX# 503-622-0281
Products: gated

Alesis
3630 Holdrege Ave.
Los Angeles, CA 90016
(213) 467-8000, FAX# 213-836-9192
Pres./COO: Russell Palmer, CEO: Keith Barr, VP
Sls/Mkt'g.: Ralph Goldheim, VP Adv./Prom.: Allen
Wald, Reg. Sls Mgr.: Ted Keffalo, VP Finance: Barbara
Brown
Products: combo, monitor, portable., rack-mount, recording

Allen and Heath
5 Connair Rd.
Orange, CT 06477
(203) 795-3594, FAX# 203-795-6814
VP/Sls Mgr.: Charles Augustowski, Eng: John
Petrucelli, Svce Mgr.: Joseph Boerst, Office Mgr.:
Maryann Nuccini, Account: Kathy De Santo, Prod.
Mgr.: John Rizzo
AMH Sls, Palos Verdes, CA, 213-373-2034
Audio Assoc., Glenwood, MD, 301-604-7223
Cordial Riley Mkt'g, Sterling Heights, MI, 313-826-8980
Cambridge, Westerville, OH, 614-890-7788
GMI/New England, Avon, MA, 617-588-8043
JMS Mkt'g, Austin, TX, 512-266-1113
Lopponow & Assoc., Issaquah, WA, 206-392-3936
Metropolis Mkt'g, Edison, NJ, 201-225-0085
Ron Tunk Sls, Tamarac, FL, 305-722-2803
Sherwood Assoc., Endicott, NY, 607-785-1590
Starin Mkt'g, Chesterton, IN, 219-929-4127
Products: broadcast, microprocessor, MIDI, modular, monitor, portable., production, rack-mount, recording, theatrical

Amek/TAC US Operations
10815 Burbank Blvd.
N. Hollywood, CA 91601
(818) 508-9788, FAX# 818-508-8619
Op. Mgr.: Sue Jones, Sls Mgr.: Steve Harvey, Nat'l
Svce Mgr.: Ray Dillfield, Traffic Mgr.: Bill Kaylor,
Account: Brigitte Burns, Office: Lisa Budworth
Lon Lemaster, N. Hollywood, CA, 818-508-9788
Bedford Audio, Atlanta, GA, 404-636-0070
Professional Audio, Burlington, MA, 617-229-6050
Mkt'g Concepts, Irving, TX, 214-869-0669
Peter Schmitt, Leonia, NJ, 201-944-2806
Products: automatic, broadcast, compressor/leveler, custom, gated, microprocessor, MIDI, modular, monitor, portable., production, rack-mount, recording, theatrical, VCA

Aries America
22122 S. Vermont Ave., Ste. E
Torrance, CA 90502
(213) 533-5112, FAX# 513-533-6883

Audioarts Engineering
Five Collins Rd.
Bethany, CT 06525
(203) 393-0887

Audio Logic
5639 S. Riley Ln.
Salt Lake City, UT 84107

Why our first stage monitor



(801) 268-8400, 800-453-7484, FAX# 801-262-4966
 Pres.: John Johnson, VP Financa: Jay Fuller, Int'l Sls: Wayne Morris, W. Sls: Scott Grow, Mkt'g Comm.: Dean Stubbs
 Products: broadcast, ENG, production, rack-mount, recording, theatrical

Bogen Communications
 PO Box 575
 Ramsey, NJ 07446
 (201) 934-8500, FAX# 201-934-9832
 Pres.: John Ochtera, VP Sls/Mkt'g: James Orr, Nat'l Sls Dir.: David Chambers
 Products: modular, paging, rack-mount

(514) 672-8862, FAX# 514-672-3399
 Pres.: Pierre Pare, VP Eng.: Shane Morris, Eng. R&D: Denis Lambert

DAX Audio Group
 1231 S.E. Gideon St.
 Portland, OR 97202
 (503) 232-4445
 Pres.: Rich Stevenson, Eng. Mgr.: Bob Herb

Auditel Systems
 396 Porter Ave.
 Buffalo, NY 14201
 (716) 886-0019, FAX# 716-886-1615
 Pres.: David Langtry, Prod. Mgr.: Tony Roberson, Mkt'g Dir.: Jim Wood
 Products: automatic, gated, modular, rack-mount, VCA

Bozak
 326 South St.
 New Britain, CT 06051-3721
 (203) 225-0555
 Pres.: Donald Bowers, Dir. Mkt'g: William Kieltyka, Chief Eng.: Sheldon Glick

DDA-Div. of Klark Teknik
 30B Banfi Plaza N
 Farmingdale, NY 11735
 (516) 249-3660, FAX# 516-420-1863
 Pres.: Jack Kelly, Nat'l Sls Mgr.: Sam Spennacchio, Prod. Sls Rep.: Chris Fichera
 Chris Fichera, Marina Del Rey, CA, 213-306-8823
 Products: monitor, portable., powered, production, recording, theatrical, VCA

Auditronics
 3750 Old Getwell Rd.
 Memphis, TN 38118
 (901) 362-1350, 800-638-0977, FAX# 901-365-8629

Broadcast Audio
 11306 Sunco Dr.
 Rancho Cordova, CA 95670
 (916) 635-1048, FAX# 916-638-5012
 Pres.: John Fernandez, CEO: David Evans, Prod. Mgr.: Gary Maggiore
 Broadcast Audio Sls, Carson City, NV, 702-885-8405

DOD Electronics
 5639 South Riley Ln.
 Salt Lake City, UT 84107
 (801) 268-8400, 800-453-7484, FAX# 801-262-4966
 Pres.: John Johnson, Int'l Sls: Wayne Morris, W. Sls: Scott Grow, VP Finances: Jay Fuller, Comm.: Dean Stubbs
 Products: broadcast, ENG, production, rack-mount, recording

Autogram
 PO Box 456
 Plano, TX 75074
 (214) 424-8585, 800-327-6901
 Pres.: Ernest Andele Jr.

Broadcast Electronics
 PO Box 3606
 Quincy, IL 62305
 (217) 224-9600, FAX# 217-224-9607
 Pres.: Larry Cervon, VP Mkt'g: Curtis Kring, VP Eng.: Geoff Mendenhall, VP Treas.: Bob Weaver, VP Op.: Tom Ash, VP Prod. Mgmt: John Burtie
 Products: broadcast, modular

D & R USA
 1720 Chip N Dale Dr.
 Arlington, TX 76012

Biamp Systems
 PO Box 2160
 Portland, OR 97208
 (503) 641-7287, 800-826-1457, FAX# 503-626-0281
 Sls Mgr.: Ron Camden

Creative Audio Design & Development
 1875 Rue Panama, Ste. D
 Brossard, Que., CD J4W2S8

console may well be your last.



In a world where today's hits often become tomorrow's Muzak™, it's refreshing to find the Yamaha PM2800M Monitor Console.

Because it has what it takes for a long stage life. Like 14 mixes. Four matrix outputs. Meters for each primary output. Four band variable EQ. 20 to 400 HZ pass filter. And it's available in either 32 or 40 input versions.

To improve your stage presence, it has Programmable Mute Groups. They let you switch large groups of channels on or off, silently.

The PM2800M also lets you change your act without changing consoles. Because it's a stage mixer that also can double as a house mixer.

And, it's a Yamaha. Built with a commitment to reliability that'll make it one of the few things on stage that isn't temperamental.

For an audition, just stop by any Yamaha Professional Audio dealer.

But do it soon. Because even though the PM2800M is built to last, it tends to go quickly in the showroom.

Yamaha Corporation of America, Professional Audio Division, P.O. Box 6600, Buena Park, CA 90622-6600. In Canada, Yamaha Canada Music Ltd., 135 Milner Avenue, Scarborough, Ontario M1S3R1. Muzak™ is a registered trademark of Muzak.

YAMAHA
 Engineering Imagination™

Circle 1 on Reader Response Card

Any console with this much flexibility deserves a closer look.

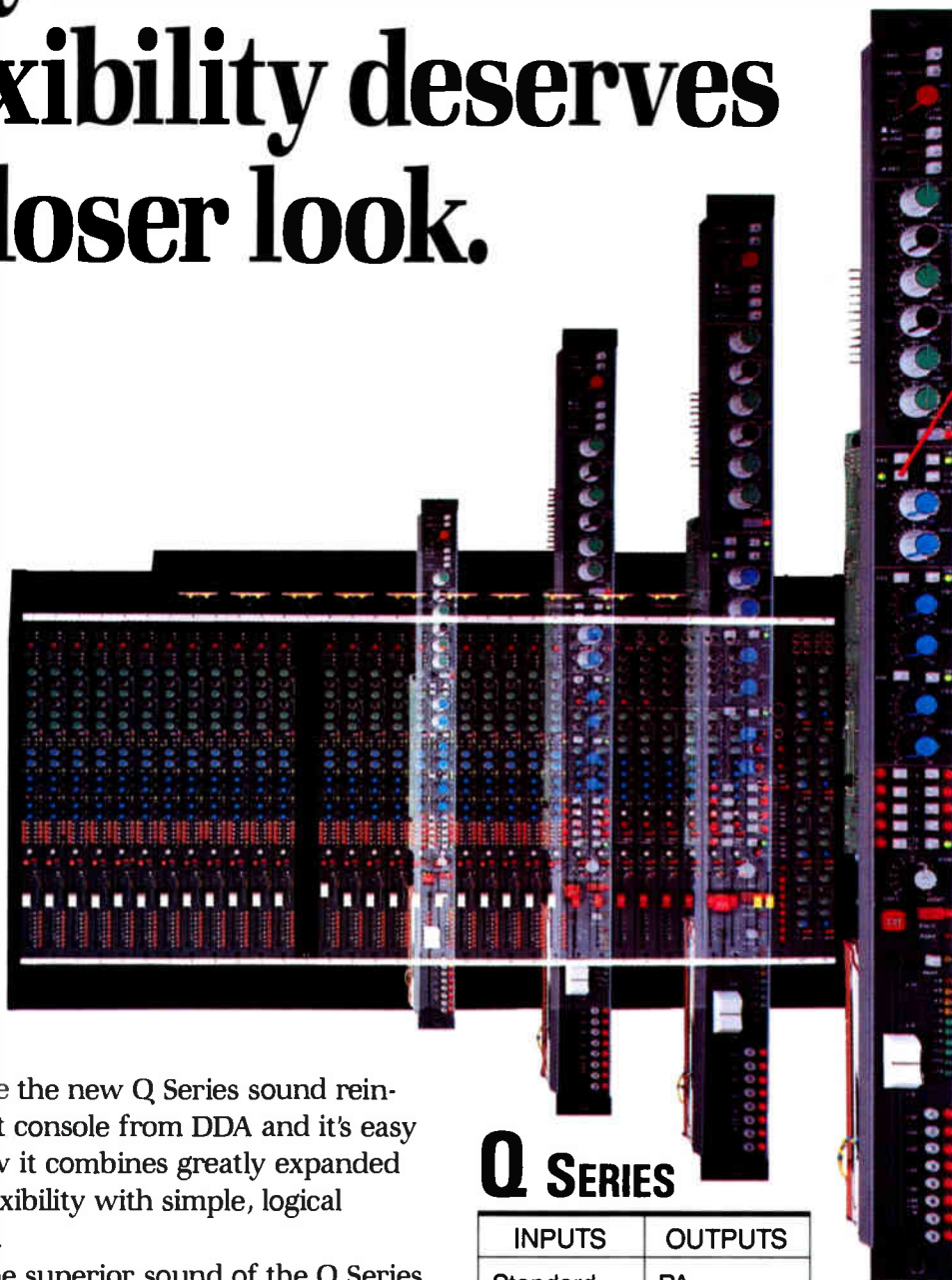

Q Series features a Direct Output with level control on every input, a unique design from DDA.

Q Series provides 8 Aux Buses from every input with 3-Band EQ on the Aux Master Sends.

Input Level Metering with a 10 segment L.E.D. indicator (Q-Mute Input version).

8 Mute Groups (Q-Mute Input Version).

Q SERIES

INPUTS	OUTPUTS
Standard Mute	PA Matrix

Any Input can be used with either Output version.

optional. The Q-PA Output version features 3-stage Equalization on the Group Outputs. And the versatile Q-Matrix Output version includes 8 Group Outs, 4 Matrix Outs and 8 Aux Returns with EQ.

Q Series. So much flexibility, you can't help taking a closer look.



Examine the new Q Series sound reinforcement console from DDA and it's easy to see how it combines greatly expanded mixing flexibility with simple, logical operation.

From the superior sound of the Q Series mic inputs to its versatile EQ section, every aspect of this powerful console reflects the quiet, transparent audio quality DDA is famous for. Immune to noise and hum at every stage, the Q Series offers sonic performance 20 dB quieter than the leading competitor.

All of the main inputs and outputs are electronically balanced with transformers

DDA: Exclusively distributed by Klark-Teknik Electronics Inc.,
30B Banfi Plaza North, Farmingdale, NY 11735 Tel: (516) 249-3660 Fax: (516) 420-1863

Dearden Davies Associates Limited: Unit 1, Irwood Business Park,
Whitton Road, Hounslow, Middlesex, TW3 2EB, England, Tel: (01) 570 7161 Fax: (01) 577 3677 Telex: 932905 LARCH G ATT.DDA 322

(817) 548-1677, FAX# 817-277-6066
 Nat'l Sls Dir.: Paul Westbrook

Dynasound
 6439 Atlantic Blvd.
 Norcross, GA 30071
 (404) 242-8176, FAX# 404-242-8858

Electro-Voice
 600 Cecil St.
 Buchanan, MI 49107
 (616) 695-6831, 800-527-6701, FAX# 616-695-1304
 Pres.: Robert Pabst, VP Sls & Mkt'g: Paul McGuire,
 Dir. Mkt'g: Jim Long, Chief Eng.: Earl Harris
 Products: portable,, powered

Europa Technology
 1638 W. Washington Blvd.
 Venice, CA 90291
 (213) 392-4985

FOSTEX CORP. OF AMERICA
 15431 Blackburn Ave.
 Norwalk, CA 90650
 (213) 921-1112, FAX# 213-802-1964
 Exec. VP: Fred Huang, VP Sls/Mkt'g: Mark Cohen
 Products: rack-mount, recording

Furman Sound
 30 Rich St.
 Greenbrae, CA 94904
 (415) 927-1225, FAX# 415-927-4548
 Sls Mgr.: Joseph Desmond, Credit Mgr.: Susan
 Furman, Chief Eng.: Jim Murphy, Op. Mgr.: Ed Specht
 Metropolis Mkt'g, Edison, NJ, 201-225-0085
 Professional Audio Assoc., Burlington, MA, 617-229-
 6050
 Secom Systems, Atlanta, GA, 404-455-0672
 New Horizons, Bannockburn, IL, 312-234-6590
 Pacific Audio Group, Gardena, CA, 213-719-1383
 Products: rack-mount

Hill Audio
 5002B N. Royal Atlanta Dr.
 Tucker, GA 30084
 (404) 934-1851, FAX# 404-934-1840
 Sls Mgr.: Bob Allen, Svce Mgr.: Rick Rogers
 Products: modular, monitor, rack-mount, recording

Howe Technologies
 2300 Central Ave., Ste. E
 Boulder, CO 80301
 (303) 444-4693, 800-525-7520, FAX# 303-444-
 8447
 Pres.: George Pappas, VP Sls: Terry Sweeney, VP
 Prod.: Steve Gonzales, VP Mkt'g: Bill Laletin, VP Eng.:
 Jim Gilbert
 Products: broadcast

IED Innovative Electronic Designs
 9701 Taylorsville Rd.
 Louisville, KY 40299
 (502) 267-7436, FAX# 502-267-9070
 VP Mkt'g & Sls: Tom Roseberry, Mkt'g Asst.: Robin
 Lasley, Sls App. Eng.: Jeff White, Mkt'g Adm.: Wanda
 R. Martin, VP Eng.: Ed Young, Pres.: Hardy Martin
 Repworks, Chicopee, MA, 413-533-0845
 Darmstedter Assoc., Baldwinville, NY, 315-638-1261
 John Anthony., Stamford, CT, 203-322-9202
 Sigmat, Valley Forge, PA, 215-783-6666
 Secom Systems, Atlanta, GA, 404-455-0672
 Bencsik Assoc., Ocala, FL, 904-732-9775
 C.L. Pugh, Cleveland, OH, 216-238-1777
 Monford Electronics Mkt'g., Indianapolis, IN, 317-872-
 8877

C.M. Sls, Farmington Hills, MI, 313-553-8070
 Ludwig Mkt'g., Kenosha, WI, 414-697-9355
 B.C. Electronic Sls, Mission, KS, 913-262-1720
 Mkt'g Concepts, Irving, TX, 214-869-0669
 Yora, White Bear Lake, MN, 612-770-9760
 Torbett/Keiser Group, Loveland, CO, 303-669-1008
 Derek Allen Assoc., Toluca Lake, CA, 818-840-8327
 Plus Four Mkt'g, Walnut Creek, CA, 415-937-0650
 North Shore Mkt'g, Seattle, WA, 206-284-9699
 Island Instruments, Kaneohe, HI, 808-235-7544
 Products: automatic, gated, microprocessor, modular, pag-
 ing, rack-mount, VCA

ITT/DES
 20 Mayfield Ave.
 Edison, NJ 07607
 (201) 225-6121, 800-524-1646
 VP: Donald Duthaler, Chief Eng.: Jeffrey Stellman

Industrial Research Products
 415 Busse Rd.
 Elk Grove Village, IL 60007
 (312) 439-3600, 800-255-6993, FAX# 312-640-
 9607
 G. Mgr.: Brian Benn, Mkt'g Mgr.: Roger Carroll, Sr. Sls
 Eng.: Gayle Campbell, Chief Eng.: Dick Peters
 Piper Assoc., Needham, MA, 617-449-1144
 Sigmat, Freehold, NJ, 201-462-1221
 Richard Pass Assoc., Langhorne, PA, 215-757-6100
 Starin Mkt'g, Chesterton, IN, 219-929-4127
 Bencsik Assoc., Ocala, FL, 904-732-9775
 EESCO Systems, Los Angeles, CA, 213-666-9601
 Products: automatic, gated, modular, paging, powered,
 rack-mount

Intelix
 5618 Odana Rd.
 Madison, WI 53719-1208
 (608) 273-6333, FAX# 608-273-6336
 G. Mgr.: Steven Cohan, Dir. R & D: Michael Konkle
 Products: automatic, microprocessor

Johnson Electronics
 4301 Metric Dr.
 Winter Park, FL 32792
 (407) 677-4030, FAX# 407-679-1288
 Pres./CEO: A.J. Schell, VP Mkt'g: Robert Peters,
 VP/Eng.: Ken St. John
 Products: modular, paging, rack-mount

LPB
 28 Bacton Hill Rd.
 Frazer, PA 19355
 (215) 644-1123
 Pres.: Richard Crompton, Sls Mgr.: John Tiedeck
 Products: broadcast

Lectrosonics
 PO Box 15900
 Rio Rancho, NM 87174
 (505) 892-4501, 800-821-1121, FAX# 505-892-
 6243
 Pres.: John Arasim, VP Mkt'g: Bruce Jones
 Products: automatic, compressor/leveler, modular, rack-
 mount

Logitek
 3320 Bering Dr.
 Houston, TX 77057
 (713) 782-4592, 800-231-5870, FAX# 713-782-
 7597
 Pres.: Tag Borland
 Products: broadcast, custom, ENG, portable,, rack-mount,
 VCA

Midas Audio Systems
 54-56 Stanhope St.

London, UK NW1 3EX
 (01) 388-7060
 Managing Dir.: John Grumbridge, Sls Mgr.: Peter
 Cornell
 Products: monitor, portable,, production, theatrical

Neotek
 1154 West Belmont Ave.
 Chicago, IL 60657
 (312) 929-6699, FAX# 312-975-1700
 Pres.: Craig Connally, Sls/Cust. Sup.: Tom Der, Sls
 Coord.: Laura Chase

Neve
 Berkshire Ind'l Pk.
 Bethel, CT 06801
 (203) 744-6230, FAX# 203-792-7863
 Pres.: Barry Roche, VP Sls: Tony Langley, Mgr. Eng.:
 Geoff Langdon, E. Reg Sls Mgr.: Phil Wagner, SE Reg
 Sls Mgr.: Tom Semmes, W. Reg Mgr.: Rick Plushner
 Neve, Bethel, CT, 203-744-6230
 Neve, New York, NY, 212-956-6464
 Neve, Nashville, TN, 615-329-9584
 Neve, Hollywood, CA, 213-461-6383
 Neve, Toronto, Canada, 416-365-3363
 Products: automatic, broadcast, custom, digital, portable,,
 rack-mount, recording

Numark Electronics
 PO Box 493
 Edison, NJ 08818
 (201) 225-3222, FAX# 201-287-2155
 Pres.: Harry Kotovsky, VP: Robert Kotovsky, Int'l Sls
 Mgr.: Steve Schiffman, Inside Sls Coord.: Arthur Genatt
 W. Coast Branch, Simi Valley, CA, 805-522-3550

Panasonic/Ramsa
 6550 Katella Ave.
 Cypress, CA 90630
 (714) 373-7277, FAX# 714-373-7242
 Sls/Mkt'g Mgr.: Steve Wooley, Mkt'g Mgr.: Chris
 Foreman, W. Sls Mgr.: James Murray, Central Sls
 Mgr.: Greg Braithwaite, Telemkt'g Mgr.: Carla
 Campbell
 James Murray, Cypress, CA, 714-373-7389
 Greg Braithwaite, Arlington Heights, IL, 312-981-7329
 Pusecker Sls, Upper Montclair, NJ, 201-744-1834
 David Bros., Finksburg, MD, 301-833-0920
 Pro Audio Assoc., Burlington, MA, 617-229-6050
 World Wide Electronics, Pembroke Pines, FL, 305-
 584-7024
 Evans Sls & Mkt'g, Nashville, TN, 615-297-7997
 New Horizons, Bannockburn, IL, 312-234-6500
 Laker Assoc., Wauzata, MN, 612-475-2642
 A/V Mkt'g, Carmel, IN, 317-846-1034
 Innovative Audio, Pontiac, MI, 313-673-2280
 J.B. Parent, Dublin, OH, 614-764-0064
 Essential Mkt'g, St. Joseph, MO, 816-279-0776
 Teneckit Assoc., Houston, TX, 713-528-2005
 New West Audio, Burbank, CA, 818-955-9700
 Brian Trankle Assoc., Belmont, CA, 415-595-4004
 Northmar, Seattle, WA, 206-524-5170
 Pearson & Pearson, Denver, CO, 303-722-6996
 Products: broadcast, disco, modular, monitor, portable,,
 production, rack-mount, recording, theatrical

Peavey Electronics
 711 A St.
 Meridian, MS 39302
 (601) 483-5365, FAX# 601-484-4278
 Pres.: Hartley Peavey
 Products: disco, modular, monitor, powered, production,
 rack-mount, recording, theatrical

Professional Sound
 5707 Cahuenga Blvd.
 N. Hollywood, CA 91601
 (818) 760-6544, FAX# 818-980-9911
 Pres.: Al Krist, Chief Eng.: Ron Meyer

Protech Audio

Flowerfield, Bldg. #1
St. James, NY 11780
(516) 584-5855, FAX# 516-584-5904
Sls Mgr.: Bill Murphy, VP Eng.: Joseph Giambone
Peregrine SW Repts, Houston, TX, 713-589-8481
Products: broadcast, compressor/leveler, monitor, paging,
rack-mount, VCA

Quantam Audio Labs

2752 Walnut Ave.
Tustin, CA 92680
(714) 838-8833, FAX# 714-838-9619
Sls Eng.: David Rollins
Products: broadcast

Rane

10802 49th Ave. W.
Everett, WA 98204
(206) 355-6000, FAX# 206-347-7757
VP Mkt'g: Larry Winter, Dir. Mkt'g: Terry Pennington,
Nat'l Sls Mgr.: Ray Bloom
Products: custom, modular

Recordex

1935 Delk Ind'l Blvd.
Marietta, GA 30067

Richmond Sound Design

1234 W. 6th Ave.
Vancouver, Canada V6H 1A5
(604) 734-1217, FAX# 604-734-3901
Pres.: Charlie Richmond, G. Mgr.: Damon Wootton,
Project Mgr.: Marilyn Williams
W3 Mkt'g., Atlanta, GA, 404-981-7021

RolandCorp. US

7200 Dominion Circle
Los Angeles, CA 90040
(213) 685-5141, FAX# 213-722-0911
Pres.: Tom Beckman, Dir. Comm.: Nancy Kewin,
Comm.: Barbi Clark

Rupert Neve

Berkshire Industrial Pk.
Bethel, CT 06801
(203) 744-6230, FAX# 203-792-7863
Pres.: Barry Roche, VP Sls: Anthony Langley, E. Reg.
Sls Mgr.: Phil Wagner, S.E. Reg. Sls Mgr.: Tom
Semmes, W. Reg. Sls Mgr.: Rick Plushner

Russco Electronics Mfg.

5690 E. Shields Ave.
Fresno, CA 93727
(209) 291-5591
Pres./G. Mgr.: Russell Friend, Sls: Vicky Jarrett,
Design Eng.: Michael Vink
Allied Broadcast Systems, Richmond, IN, 317-962-
8596
Broadcast Supply W., Tacoma, WA, 206-565-2301
Pro Audio Supply, Ft Worth, TX, 817-483-7474
Singer Products, Hialeah, FL, 305-558-3000
Electrex, FL, 305-651-5752
Products: broadcast

St. Louis Music

1400 Ferguson Ave.
St. Louis, MO 63133
(314) 727-4512, 800-325-8148, FAX# 314-727-8929
Sls Training Dir.: Tony Moscal, Prod. Mgr.: Gary Byers,
Dir. Op.: John Karpowicz, Pres.: Gene Kornblum

Sanctuary Sound Systems

113 Newport Dr.
Oak Ridge, TN 37830
(615) 482-9242
Mkt'g: Barry Boseman

SECK

SECK/DIV. OF JBL

PO Box 2200
Northridge, CA 91329
(818) 893-4351, FAX# 818-893-3639
P.: Ron Means, VP Sls: Ken Lopez, VP Mkt'g: Mark
Gander, Nat'l Sls Mgr.: David Kimm, Tech.: Gary Lynn
Jim Chase, Hermosa Beach, CA, 213-374-2128
Bill Hamilton, Folsom, PA, 215-543-4677
Bill Schuermann, St. Louis, MO, 314-644-2083
Tom Walter, N. Barrington, IL, 312-382-4925
Products: portable., production, recording, theatrical

Senior Technology

13431 Pumice St.
Norwalk, CT 90650
(213) 802-9942, FAX# 213-802-9945
Pres.: Steve P. Y. Kim, VP: Fred K.H. Kim, Nat'l Sls
Mgr.: Irv Weisman
EESCO Systems, Los Angeles, CA, 213-666-9601
Elrep Sls, Tucker, GA, 404-938-7109
Forti & Assoc., Kensington, MD, 301-949-1706
Dobbs Stanford, Dallas, TX, 214-358-0800
Mkt'g Insights, Glenview, IL, 312-729-2047
Products: combo, paging, portable., powered, rack-mount,
recording

Sennheiser Electronic

PO Box 987
Old Lyme, CT 06371
(203) 434-9190, FAX# 203-434-1759
Products: ENG

SHURE BROTHERS

222 Hartrey Ave.
Evanston, IL 60202-3696
(312) 866-2200, FAX# 312-866-2279
Pres.: James Kogen, VP Sls: Lottie Morgan, Dir. Tech.
Mkt'g: John Phelan, Dir. Wired Mics: Alan Shirley, Dir.
Wireless Mics: Sandy Schroeder, Dir. Sls: Al Hershner
Products: automatic, broadcast, compressor/leveler, ENG,
gated, modular, portable., powered, rack-mount

Sontec Electronics

Audio Dr.
Goldbond, VA 24094
(703) 626-7256
Sls Mgr.: Burgess Macneal
Products: broadcast, custom, portable., recording

Sony Professional Audio

1600 Queen Anne Rd.
Teaneck, NJ 07666
(201) 833-5200, 800-635-SONY, FAX# 201-833-9645
Nat'l Sls Mgr.: Bob Ott, Prod. Mgr.: Art Gonzales, Mkt'g
Mgr.: David Kawakami
Sony Pro Audio, Paramus, NJ, 201-368-5185
Sony Pro Audio, Nashville, TN, 615-883-8140
Sony Pro Audio, Burbank, CA, 818-841-8711
Products: broadcast, portable., rack-mount

Soundcraft

SOUNDCRAFT-DIV. OF JBL

PO Box 2200
Northridge, CA 91329

(818) 893-4351, FAX# 818-893-3639
P.: Ron Means, VP Sls: Ken Lopez, VP Mkt'g: Mark
Gander, Nat'l Sls Mgr.: David Kimm, Tech.: Gary Lynn
Jim Chase, Hermosa Beach, CA, 213-374-2128
Bill Hamilton, Folsom, PA, 215-543-4677
Bill Schuermann, St. Louis, MO, 314-644-2083
Tom Walter, N. Barrington, IL, 312-382-4925
Products: broadcast, monitor, portable., production, rack-
mount, recording, theatrical

Sound Tech

230 Lexington Dr.
Buffalo Grove, IL 60089
(312) 541-3520, 800-877-6863, FAX# 312-541-3616
Pres.: Rudy Schlacher, Gen. Sls Mgr.: David Beirut,
Exp. Sls Mgr.: William Robinson, Sls Dir.: Todd Peren
Products: combo, portable., powered

Soundtracs, Div. of Samson Technologies

485-19 S. Broadway
Hicksville, NY 11801
(516) 932-3810
VP Mkt'g/Sls: Scott Goodman, VP Eng.: Doug Bryant,
Exp. Mgr.: Kevin Moran, Sls: Mike Hennesey, Sls:
Dave Olivier, Sls: Mike Vallerella
Products: production, recording, theatrical

Sound Workshop Professional Audio Products, Inc.

50 Werman Ct.
Plainview, NY 11803
(516) 756-0140, FAX# 516-756-9622
Pres.: Michael Tapes, Sls Mgr.: Lee Pomerantz
Products: custom, modular, production, recording, thea-
trical, VCA

Spatial Sound

743 Center Blvd.
Fairfax, CA 94930
(415) 457-8114, FAX# 415-457-6250
Sls Mgr.: Dave Yancey, Pres.: Mahanta Devias
Products: automatic, disco, microprocessor, MIDI, porta-
ble., recording, theatrical

Sphere Electronics

20201 A Praire
Chatsworth, CA 91311
(213) 349-4747

Stewart Electronics

11460 Sunrise Gold, Ste. B
Rancho Cordova, CA 95742
(916) 635-3011, 800-367-7945, FAX# 916-635-1787
Owner: Wade Stewart, Adm.: Michelle Horan
Products: rack-mount, recording

Studer Revox America

1425 Elm Hill Pike
Nashville, TN 37210
(615) 254-5651, FAX# 615-256-7619
Products: broadcast, custom, portable., recording, theatri-

Studiomaster

3941 E. Miraloma Ave.
Anaheim, CA 92807
(714) 524-2227, FAX# 714-524-5096
VP: Paul Reeve, US Nat'l Sls Mgr.: Jim Giordano

Sunn Musical Equipment

1130 Columbia St.
Brea, CA 92621
(714) 990-0909, 800-854-6230, FAX# 714-990-3986
Pres.: Bill Schultz, Dir. Mkt'g: Joe Green
Products: combo, portable., powered, theatrical

TAC/Amek Consoles

10815 Burbank Blvd.
N. Hollywood, CA 91601
(818) 508-9788

TOA ELECTRONICS

PO Box 2047
S. San Francisco, CA 94080
(415) 588-2538, 800-843-4750, in-state 800-in CA 800-632-2157, FAX# 415-588-3349
Pres.: Yoshiro Ishida, Nat'l Sls Mgr/Comm. Pro.:
Richard Krochmal, Nat'l Sls Mgr./Pro. Music & Ent.:
Rick Kamlet, Nat'l Sls Mgr./Intercom: Al Burns
Products: automatic, modular, paging, production, recording

Tascam (TEAC Pro Division)

7733 Telegraph Rd.
Montibello, CA 90640
(213) 726-0303, FAX# 213-727-7656
Mkt'g Mgr: Bill Mohrhoff, Nat'l Sls Mgr.: Gregg
Hildebrandt, W. Reg. Mgr.: Fred Allard, S. Reg. Mgr.:
Bill Stevens, E. Reg. Mgr.: Chuck Prada
Products: combo, portable, production, recording

Television Technology

PO Box 1385
Broomfield, CO 80020-8385
(303) 665-8000, FAX# 303-673-9900
Pres.: William Kitchen, Exec. VP: Michael Lehrman,
VP Mkt'g: Dirk Freeman, Low Power Sls Mgr.: Marvin
Berdemeier, Radio Sls Mgr.: Gordon Allison, Sls
Admin.: Alex De Lay
Products: broadcast

Total Audio Concepts

10815 Burbank Blvd.
N. Hollywood, CA 91601
(818) 508-9788, FAX# 818-508-8619

Trident Audio USA

2720 Monterey St., Ste. 403
Torrence, CA 90503
(213) 533-8900, FAX# 213-533-7072
Pres.: Wayne Freeman, Sls Mgr.: Lon LeMaster

Vidicraft

0704 SW Bancroft St.
Portland, OR 97201
(503) 223-4884, 800-547-1491, FAX# 503-243-1995
G. Mgr.: Steve Johnson, Nat'l Sls Mgr.: Dave Landis,
Prod. Mgr.: Glenn Olson
Products: recording

Ward-Beck Systems

841 Progress Ave.
Scarborough-Ont., Canada M1H 2X4
(416) 438-6550, FAX# 416-438-3865
Pres.: Ronald Ward, VP: Rodger Beck, Dir. Eng.:
Arthur Schubert, Canadian Sls Mgr.: Eugene Johnson,
Sls Coord.: Sylvia Fantin-Napper

Wheatstone

6720 VIP Pkwy
Syracuse, NY 13211
(315) 455-7740, FAX# 315-454-8104
Pres.: Gary Snow, VP: Andrew Calvanese, Sls Mgr.:
Ray Esparolini, Mkt'g Dir.: Michael Shane, Sls: Tim
Guhl, Mkt'g Coord.: Patty Bagshaw

Yamaha

PO Box 6600
Buena Park, CA 90662
(714) 522-9011, FAX# 714-522-9312
Products: broadcast, combo, compressor/leveler, digital,
disco, gated, monitor, powered, production, rack-mount, re-
cording, theatrical, VCA

Notes:

Board Meeting!



The eyes have it! Ross RX mixing consoles offer unparalleled flexibility and cost effectiveness with features like electronically balanced inputs, individual channel patching inserts and low noise specs.

Ask your local dealer for a demonstration or contact Ross for a free catalog.

1316 E. Lancaster Ft. Worth, TX 76102 (817) 336-5114

ROSS
SYSTEMS

AUDIO SIGNAL PROCESSORS

AKG ACOUSTICS

77 Selleck St.
Stamford, CT 06902
(203) 348-2121, 800-243-7885, FAX# 203-324-1942

Pres.: S. Richard Ravich, VP Op.: Derek Pilkington, VP
Fin.: Bob Netter
Products: digital effects, digital reverbs, digital delays, digital signal processors

AMS Industries

PO Box 31864
Seattle, WA 98103
(206) 633-1956, FAX# 206-547-6890

Pres./G.M.: Nigel Branwell, Nat'l Sls Mgr.: Jim Stern,
Tech. Supp. Mgr.: Graham Murray
Ordon & Co., Chicago, IL, 312-527-4569
Comlog, Los Angeles, CA, 818-845-0199
Studio Consultants, New York, NY, 212-586-7376
Harris Audio, Miami, FL, 305-944-4448
Omni Technology, Nashville, TN, 615-451-9662

ART—Applied Research & Technology;

215 Tremont St.
Rochester, NY 14808
(716) 436-2720, FAX# 716-436-2720

Pres.: Phil Betette, Nat'l Sls/Mkt'g Mgr.: Jim Bonis, VP
Eng.: Tony Gambacurta, VP Eng.: Richard Neatrou
Hudson Mkt'g, NY, NY, 718-380-5561
Ron Tunks Sls, Tamarac, FL, 305-722-2803
Audio Assoc., Fulton, MD, 301-604-7223
JMS Mkt'g, Austin, TX, 512-266-1113
Jamm Dist., Chicago, IL, 312-799-0550

Products: 1/3 octave EQs, automatic EQs, preamps, digital effects, digital reverbs, digital delays, digital signal processors, EQs, compressors, graphic EQs, interface units, limiters, noise gates, signal enhancers

ARX Systems

PO Box 842
Silverado, CA 92676
(714) 649-2346, FAX# 714-649-3064

Major Sound Mkt'g, Richmond, VA, 804-740-3550
Rep Tech, Terrell, TX, 214-222-2131
Dave Spaulding, Haverhill, MA, 508-372-5526
Elrep Sls, Tucker, GA, 404-938-3001
Fred Reitz, Flint, MI, 313-239-2648

ASC—Tube Traps

PO Box 1189
Eugene, OR 97440
(503) 343-9727, 800-ACS-TUBE, FAX# 503-343-9245

Pres.: Arthur Noxon, Sls: Doug Martin, Tech.: Michael Nemeth, Canadian Factory: Larry Moore, Italian Factory: Alfredo Gallacci, Japan: Gary Douglas
Rich Lomax, Hollywood, CA, 818-763-9587
Octavio Brito, Boston, MA, 617-924-0660
Sam Lynn, Chicago, IL, 312-657-7787
John Nolan, St. Louis, MO, 314-343-4765
Joe deBuglio, Toronto, Canada, 416-241-4240
Products: signal enhancers

Advanced Music Systems

Billington Rd.
Burnley, Lancashire, UK BB11 5ES
(0282) 57011

Managing Dir.: Mark Crabtree, Sls/Mkt'g Mgr.: Stuart Nevison, Sls Mgr.: John Gluck

Advantage

14270 NW Science Pk Dr.
Portland, OR 97229
(503) 641-7287, FAX# 503-622-0281
Products: EQs

Alesis

3630 Holdrege Ave.
Los Angeles, CA 90016
(213) 467-8000, FAX# 213-836-9192

Pres./COO: Russell Palmer, CEO: Keith Barr, VP Sls/Mkt'g: Ralph Goldheim, VP Adv./Prom.: Allen Wald, Reg. Sls Mgr.: Ted Keffalo, VP Finance: Barbara Brown
Products: 1/3 octave EQs, automatic EQs, preamps, digital effects, digital reverbs, digital delays, digital signal processors, EQs, compressors, graphic EQs, limiters, noise gates, parametric EQs, signal enhancers

ALTEC LANSING

PO Box 26105
Oklahoma City, OK 73126-010
(405) 324-5311, FAX# 405-324-8981

Pres.: Dave Merrey, VP Mkt'g: Chuck Lange, Dir. Mkt'g Dev.: Ted Uzzle, Nat'l Sls Mgr.: Jerry Spriggs, Mgr./Export Mkt'g: John Sexton, Tech. Svcs Mgr.: Gary Jones
Products: 1/3 octave EQs, automatic EQs, preamps, cross-overs, EQs, compressors, graphic EQs, limiters, signal metering

Aphex Systems

10688 Randall St.
Sun Valley, CA 91352
(818) 767-2929, 800-76-APHEX, FAX# 818-767-2641
Pres.: Marvin Caesar, Sls Dir.: Paula Lintz, Sls Mgr.: Arnie Christensen, Chief Eng.: Donn Werrbach

Apogee Electronics

1517 20th St.
Santa Monica, CA 90404
(213) 828-1930, FAX# 213-828-9720
Mkt'g Dir.: Grace Gehman
Products: digital signal processors

ASHLY

ASHLY AUDIO

100 Fernwood Ave.
Rochester, NY 14621
(716) 544-5191, 800-828-6308, FAX# 716-266-4589

Pres.: William Thompson, Sr. VP: Bob French, VP: David Malloy, Office Mgr.: Ellen Price
Products: 1/3 octave EQs, crossovers, de-essers, EQs, compressors, graphic EQs, limiters, noise gates, notch filters, parametric EQs

Audio/Digital

1000 South Bertelsen Rd., Suite #4
Eugene, OR 97402

New from *White*

DIGITALLY
CONTROLLED

Model 4700 1/3 OCTAVE EQUALIZER

One or two channels in one rack space.

• 28 one-third octave filters from 31.5Hz through 16kHz, 0.5dB steps. High and low-pass filters. Output level adjustment. All functions digitally controlled. • Ten non-volatile memories require no battery back-up. Ten presets with remote control access. • Easy to setup. Instant and silent switching between memories and presets. • Tamper-proof with PASSWORD SECURITY. • Servo-balanced differential input and output. Great specifications. Affordable price. • Output muting during power up and down. • Hard wired by-pass switch. • Optional RS232/EIA422 remote control

White
instruments
Division of C. VAN R INC

P.O. Box 90099, Austin, TX 78709
Phone: (512) 892-0752
FAX: (512) 892-0855

In compressor-limiters, peak reversion equals audible pumping. One major reason for dissatisfaction with limiters in sound systems is the way many of them initiate limiting action at inappropriate times: they change the sound level unexpectedly, when the signal dynamics don't require it. This false triggering is called pumping, and is very audible.

The problem of audible pumping is a complex one, and its cause is often not apparent on the test bench. It is sometimes impossible to duplicate the triggering heard in dynamic sound system use, with tones or with pink noise. And yet the pumping goes on.

Altec Lansing research has discovered the cause of pumping in many contemporary limiters, and prevented it in the new model 1712A.

Compressor-limiters use detector circuits that monitor the envelope of the audio signal passing through. Limiting action is controlled by this detector. Not only must the frequency response of the audio circuit in the limiter be flat, but the detector itself must have a flat frequency response. Otherwise, it would trigger limiting action at different levels for different frequencies. If the unit is excessively sensitive at some frequencies, signals at levels that the limiter should ignore cause unwanted action.

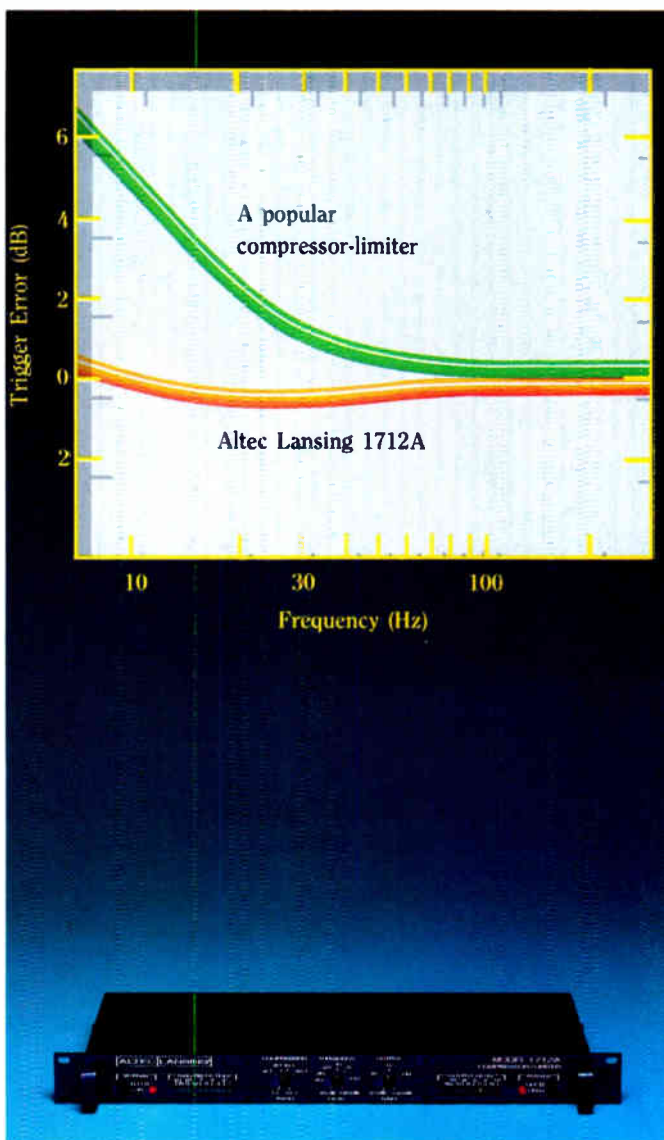

The popular limiter shown in the graph has an excellent frequency response for the audio signal passing through it. However, its triggering is more sensitive at all frequencies below 100 Hz, and 5 dB more sensitive at 10 Hz. It has reverted from r.m.s. to peak detection: peak reversion. Who cares about 10 Hz? You will, if subsonic junk is making your limiter attenuate all frequencies at unexpected and unwanted times.

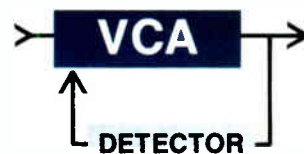

When envelope detection comes after limiting action, tracking accuracy suffers.

Altec Lansing engineers also decided to control the limiter by detecting the incoming signal. Many limiters detect the signal after their own limiting action. These limiters must detect tenths of decibels to control tens of decibels. The new Altec Lansing 1712A compressor-limiter uses the much more robust feedforward system.

In compressor-limiters, the benefit of peak reversion correction is reduced false triggering and audible pumping. The benefit of feedforward control design is greater tracking accuracy.

Fact.

In Compressor-Limiters, Peak Reversion = Audible Pumping



P.O. Box 26105 · Oklahoma City, Oklahoma 73126-0105 USA · 405-324-5311
© 1989 Altec Lansing Corporation

Circle 229 on Reader Response Card

worldradiohistory.com

THE POSSIBILITIES

The Flex System from Rane: A Powerful New Approach to Modular Signal Processing



FLEX

Flexibility, no matter how you spell it, means power. It's the power to meet varied needs. To meet budgets with optimum performance. To efficiently accommodate system growth. Long into the future.

Flexibility is the essence of Rane's new FLEX System. The first universally compatible, cost effective, modular approach to signal processing and routing. With no special requirements. And no dead ends.

Each Flex module is an HR (Half Rack) compatible, UL/CSA/VDE approved, self-contained processing unit. Each capable of being EIA rack-mounted either horizontally or vertically, with inexpensive, readily available hardware. Or simply set on a shelf, stand-alone fashion.

HIGH-POWERED COMPATIBILITY. Using standard 3-pin, 1/4" or barrier strip connectors, FLEX modules are directly compatible with professional audio gear. And since they are remote powered—via Rane's proposed power supply standard—troublesome ground loops, hum and agency approval problems are solved up front by design.

ENDLESS POSSIBLE COMBINATIONS FOR CUSTOM DESIGNS. The FLEX non-exclusive modular concept makes it inherently expandable



ARE STAGGERING!

and upgradeable. It boasts a large and growing number of functions and components to choose from. Mixers. Preamps. Splitters. Crossovers. Dynamic controllers. Equalizers. Amplifiers. Line drivers. And much more under development.

And thanks to Rane's efficient bus design, system wiring is greatly simplified in even complex mixing and splitting layouts.

COST EFFECTIVE CAPABILITIES. Modular flexibility. Uncompromising performance. All without a premium price. That's the FLEX System manifesto. There is no expensive main-frame to buy; you only pay for the functions you want, when you want them.

Say, for example, you only need a 3 channel mixer with one channel of crossover. The FLEX System delivers. And when your needs expand, just add more modules. No need to obsolete old equipment for a loss.

Whether you use two modules or twenty modules, the FLEX System remains cost effective. And supremely flexible. Year after year.

SUPERLATIVE PERFORMANCE, RANE RELIABILITY. The design and performance of each and every Flex module is, in a word, superlative. Every model carries top-grade studio specifications, utilizing the best components available. The result is unsurpassed performance and reliability.

Our HR compatible modules may be compact, but they're stuffed with more top-notch features than you would have thought possible. For example, the **FMI 14 Mixer Input module** measures only 1.75" x 10.5", yet it boasts a -128dB EIN mic stage, switchable phantom power, true 20dB pad, powerful 3-way EQ section, insert loop, two source-selectable Aux sends and balanced master channel outputs. A single DIN cable, supplied with each module, routes the Master and Aux buses from unit to unit for quick and clean hook-up.

+15/-20dB boost/cut, 2-octave down to 1/30th-octave bandwidth range for notch capability, and a full 10Hz-20kHz frequency sweep range for unprecedented flexibility.

The **FME 15 MicroGraphic Equalizer** brings Interpolating Constant-Q filter performance to the Flex line, pioneered by our full-sized GE 30

current balanced outputs, and you've got a powerful, flexible new crossover standard.

This is but a sampling of the innovative Flex Modules to be released this year. We encourage you to obtain separate, detailed data sheets on the many FLEX System modules. Then compare these with the best standard equipment available. You'll discover that FLEX offers the best of all worlds: compact, cost effective, flexible, uncompromising performance.

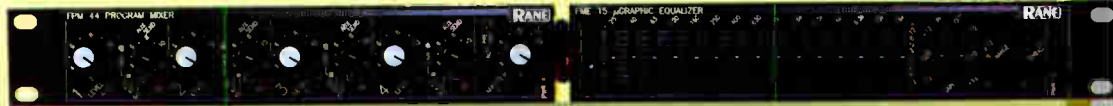

The **FMM 42 Master Module** not only provides Aux returns and mixing, but features extra mic and stereo line inputs with ducking capability for paging and other applications.

For even more mixing flexibility, the **FPM 44 Program Mixer** allows 4 separate mic or line inputs to be mixed to 4 output programs, with pre or post fade switch selection for the Aux sends. Both the direct balanced/unbalanced terminal strip and the DIN Flex bus inputs and outputs can be used simultaneously for easy expansion and integration into larger systems.

Carrying on a fine tradition of innovative equalizer technology, Rane sets yet more new standards with the Flex Series. The **FPE 13 Parametric Equalizer** provides 3 separate bands, each capable of

model which has set new industry standards. Minimized filter interaction, smooth combined response and fully balanced three-pin and terminal strip input/output are but a few of the features. Both the FME 15 and the FPE 13 also provide an exclusive Patch I/O jack which allows direct connection to an insert loop jack with a single 1/4" TRS patch cable.

The **FAC 24 Active Crossover** is the next generation to follow in the respected footsteps of our AC 22 and AC 23 designs. In addition to the proven 24dB/octave Linkwitz-Riley performance, the FAC 24 features a true 24-position frequency selector switch to provide plug-in card accuracy and repeatability with the convenience of a knob. Add to this a built-in CD Horn EQ section, electronic phase alignment, summing LF input and three-pin high-

FLEX MODULAR SIGNAL PROCESSORS Series

RANE

10802-47th Ave. W.
Everett, WA 98204
(206) 355-6000

(503) 687-8412, 800-423-1082, FAX# 503-687-0632
 Pres./Dir. of Eng: Gary Hardesty, Office Mgr.: Kathleen Gallagher
 Products: crossovers, digital encoding, digital delays, digital signal processors, interface units,

Audio Logic

5639 S. Riley Ln.
 Salt Lake City, UT 84107
 (801) 268-8400, 800-453-7484, FAX# 801-262-4966
 Pres.: John Johnson, VP Finance: Jay Fuller, Int'l Sls: Wayne Morris, W. Sls: Scott Grow, Mkt'g Comm.: Dean Stubbs
 Products: 1/3 octave EQs, crossovers, de-essers, digital delays, EQs, compressors, graphic EQs, interface units., limiters, noise gates, signal enhancers

Audio Systems

PO Box 1174
 Bismarck, ND 58502
 (701) 223-3800, 800-852-6522, in-state 800-932-8975, FAX# 701-222-8102
 Pres./Eng: Lynn Mader, VP/Sls: Lyle Mader
 Products: ambient noise controlled level controllers, crossovers, limiters, VCAs

Azden

147 New Hyde Pk Rd.
 Franklin Square, NY 11010
 (516) 328-7500
 Mkt'g: Den Bush

BBE SOUND

5500 Bolsa Ave., Ste. 245
 Huntington Beach, CA 92649
 (714) 897-6766, 800-233-8346, FAX# 714-895-6728
 Chairman: John McLaren, VP: Scott Anderson, Op Mgr.: Jennifer Drescher, Nat'l Sls Mgr.: Fred Coyner, Mkt'g Dev. Mgr.: Jim Lucas, Tech Svcs Mgr.: Ryan Coultts
 Products: signal enhancers

BSS Audio/Edge Distribution

RR-2, Box 144C Milewood Rd.
 Millbrook, NY 12545
 (914) 567-1400, FAX# 914-677-6873
 VP Sls/Electronics: David Talbot, VP Op.: Hilary Michener, Pres.: Alan Wick
 Products: ambient noise controlled level controllers, crossovers, de-essers, compressors, levelers, limiters, noise gates

BOSE—PROFESSIONAL PRODUCTS

The Mountain
 Framingham, MA 01701
 (508) 879-7330, FAX# 508-872-6541
 G. Mgr.: David Bell, Nat'l Field Sls Mgr.: Timothy Dorwart, E. Reg. Mgr.: Robin Sibucuo, W. Reg Rep: Michael Schneider
 Products: EQs

Brooks Electronic System Technology

4061 E. La Palma Ave., Ste. B
 Anaheim, CA 92807
 (714) 630-2383, 800-323-1188, in-state 800-in CA 800-523-8486

CADD Creative Audio Design & Development

1875-D Panama St.
 Brossard, Que., Canada J4W 2S8
 (514) 466-1691, FAX# 514-672-3399
 Pres.: Pierre Pare, Eng. Sls: Shane Morris, Eng. Sls: Denis Lambert
 Products: de-essers, digital signal processors

Calibration Standard Instruments

PO Box 2727
 Oakland, CA 94602
 (415) 531-8725
 Owner: Edward M. Long
 Products: crossovers

Carvin

1155 Industrial Ave.
 Escondido, CA 92025
 (619) 747-1710, 800-854-2235, FAX# 619-747-9065
 Pres.: Carson Keisel, Sls Mgr.: Neal Taylor

Chandler Industries

590 19th St.
 San Francisco, CA 94107
 (415) 626-1742, FAX# 415-626-0671
 CEO: Paul Chandler, VP: Adrian Chandler, Credit Mgr.: Leisa Mock, E. Coast Rep: Michael Rain, W. Coast Rep: Ross Wright, Cust. Svce: Chris Chandler
 Products: automatic EQs, preamps, signal enhancers



HOW TO LEVEL A HOTEL FOR UNDER \$350.

DOD graphic equalizers are veritable workhorses for improving public address sound quality in airports, shopping malls, hotels and public buildings.

That's because DOD makes more configurations of quality graphic EQs for more professional applications, than any other company in the world. For a lot less than you'd expect.

For a demonstration, see your professional audio dealer or sound contractor.

He'll recommend DOD with no reservations.



©1988 DOD Electronics Corporation. 5639 So. Riley Lane, Salt Lake City, Utah 84107. (801) 268-8400.



R-431 Graphic Equalizer (top) R-830 Graphic Equalizer (bottom)

Circle 211 on Reader Response Card

90 ways to depart from the straight and narrow.



Prepare to expand your horizons. With the Yamaha DEQ7, the completely digital equalizer. With not one but 30 different EQ and filter configurations, in stereo.

To be specific, it has 11 graphic EQs, four parametric, three tone configurations, five band pass/band reject filters, six dynamic filters and one multi-notch filter configuration, plus up to 738 ms of delay per channel.

But, in the Yamaha tradition of never leaving well enough alone, we did some expanding of our own.

Like memory. The DEQ7 has sixty user-programmable memory locations, so you can store and title your favorite curves, and recall them any time manually or via MIDI. There are digital I/Os for direct connection to other digital components, as well as analog inputs and outputs.

Since we're on the subject of output, it's equally important to mention that, in the opinion of many critical users, the DEQ7 produces an open, natural-sounding EQ. Which means that you can create extreme EQ settings without creating extreme anxiety.

The Yamaha DEQ7 Digital Equalizer.

It'll throw you a few new curves. Catch one at your nearby Yamaha Professional Audio dealer.

Yamaha Music Corporation, Professional Audio Division, P.O. Box 6600, Buena Park, CA 90622. In Canada, Yamaha Canada Music Ltd., 135 Milner Avenue, Scarborough, Ontario M1S 3R1.

YAMAHA
Engineering Imagination™

Circuit Research Labs

2522 W. Geneva Dr.
Tempe, AZ 85282
(602) 438-0888, 800-535-7648, FAX# 602-438-8227
Pres.: Ronald Jones, CFO: Kym Kippes, Eng. Mgr.: Chuck Adams
Bill Ammons, Tempe, AZ, 800-535-7648
Doug Charette, Tempe, AZ, 800-535-7648
Products: signal enhancers

Clever Devices

PO Box 2002
Port Washington, NY 11050
(516) 767-0682, FAX# 516-767-3635
Pres.: William Long, Mkt'g Mgr.: Una Neary, Tech. Supp.: Mike Kafulas
Products: digital effects, digital encoding, digital signal processors

Creative Audio Design & Development

1875 Rue Panama, Ste. D
Brossard, Que., CD J4W2S8
(514) 672-8862, FAX# 514-672-3399
Pres.: Pierre Pare, VP Eng.: Shane Morris, Eng. R&D: Denis Lambert

Crown Int'l

PO Box 1000
Elkhart, IN 46517
(219) 294-8000, FAX# 219-294-8329
Pres./CEO: Clyde Moore, Crown Div. Head: Gil Nichols, Amplifier Prod. Dir.: Verne Searer, Sls Mgr.: Jim Beattie, Mkt'g Svcs: Gerry Barclay, Mic. Prod. Line Mgr.: Bob Herrold
Products: crossovers, de-essers

DAX Audio Group

1231 S.E. Gideon St.
Portland, OR 97202
(503) 232-4445
Pres.: Rich Stevenson, Eng. Mgr.: Bob Herb

dbx, Div. of BSR North America

PO Box 100C
Newton, MA 02195
(617) 964-3210, FAX# 617-527-5288
Nat'l Sls Mgr.(Pro): Scott Berdell, Int'l Sls Mgr.: Ilisa Aronow, OEM Sls Eng.: Ken Nevard, VP Mkt'g: John Stierberg, Sr. Prod. Specialist: Bob Accettullo, Pres.: Mike Kelly
Products: 1/3 octave EQs, automatic EQs, preamps, de-essers, digital signal processors, EQs, compressors, graphic EQs, limiters, noise gates, notch filters, parametric EQs, octave EQs, signal enhancers, VCAs

DOD Electronics

5639 South Riley Ln.
Salt Lake City, UT 84107
(801) 268-8400, 800-453-7484, FAX# 801-262-4966
Pres.: John Johnson, Int'l Sls: Wayne Morris, W. Sls: Scott Grow, VP Finances: Jay Fuller, Comm.: Dean Stubbs
Products: 1/3 octave EQs, crossovers, digital delays, digital signal processors, EQs, compressors, graphic EQs, limiters, signal enhancers

Digidesign

1360 Willow Rd., Ste. 101
Menlo Park, CA 94025
(415) 327-8811, FAX# 415-327-0777
Pres.: Peter Gotcher, COO: Paul Lago, Prod. Mkt'g Mgr.: Suz Howells
Products: audio/video synchronizers, digital effects, digital signal processors

Digitech

5639 South Riley Ln.
Salt Lake City, UT 84107
(801) 268-8400, FAX# 801-262-4966
Pres.: John Johnson, VP Finance: Jay Fuller, Int'l Sls: Wayne Morris, W. Sls: Scott Grow, Corp. Comm.: Dean Stubbs
Products: 1/3 octave EQs, digital effects, digital reverbs, digital delays, digital signal processors, EQs, graphic EQs

Dolby Laboratories

100 Polero Ave.
San Francisco, CA 94103
(415) 558-0200, FAX# 415-863-1373
Chairman: Ray Dolby, Pres.: Bill Jasper, VP: Joan Allen, VP Sls & Mkt'g: Ed Schummer, US Sls Mgr.: George Douglas

Dynasound

6439 Atlantic Blvd.
Norcross, GA 30071
(404) 242-8176, FAX# 404-242-8858
Products: EQs, levelers

Edge Distribution/Turbosound

144C Milewood Rd.
Millbrook, NY 12545
(914) 567-1400, FAX# 914-677-6477
VP Sls/Mkt'g: Daniel Abelson, VP OP.: Hilary Michener, VP Sls: Dave Talbot
JND, Fairfax, CA, 415-459-3186
Western Audio Sls, Colendale, CA, 818-246-3806
Tenick & Assoc., Houston, TX, 713-528-2005
Mike Chafee Ent., Sarasota, FL, 813-921-4294
Steffey Mkt'g, Chicago, IL, 312-480-3575

Editron USA

748 N. Seward St.
Hollywood, CA 90038
(213) 464-8723, FAX# 213-464-5786

Electro-Voice

600 Cecil St.
Buchanan, MI 49107
(616) 695-6831, 800-527-6701, FAX# 616-695-1304
Pres.: Robert Pabst, VP Sls & Mkt'g: Paul McGuire, Dir. Mkt'g: Jim Long, Chief Eng.: Earl Harris
Products: crossovers, graphic EQs

Eltrex Int'l

2 Columbia Dr.
Amherst, NH 03031
(603) 886-3500, 800-432-7631, FAX# 603-886-3508
Sls Mgr.: Bill Ryan
Products: digital delays, VCAs

Eventide

One Alsan Way
Little Ferry, NJ 07643
(201) 641-1200, FAX# 201-641-1640
Sls Mgr.: Gil Griffith
Innovative Sls/Mkt'g, Irvine, CA, 714-975-1130
Products: digital effects, digital delays, digital signal processors, compressors, limiters, signal enhancers

FOSTEX CORP OF AMERICA

15431 Blackburn Ave.
Norwalk, CA 90650
(213) 921-1112, FAX# 213-802-1964
Exec. VP: Fred Huang, VP Sls/Mkt'g: Mark Cohen
Products: audio/video synchronizers, graphic EQs

Furman Sound

30 Rich St.
Greenbrae, CA 94904
(415) 927-1225, FAX# 415-927-4548
Sls Mgr.: Joseph Desmond, Credit Mgr.: Susan Furman, Chief Eng.: Jim Murphy, Op. Mgr.: Ed Specht
Metropolis Mkt'g, Edison, NJ, 201-225-0085
Professional Audio Assoc., Burlington, MA, 617-229-6050
Secom Systems, Atlanta, GA, 404-455-0672
New Horizons, Bannockburn, IL, 312-234-6590
Pacific Audio Group, Gardena, CA, 213-719-1383
Products: 1/3 octave EQs, crossovers, de-essers, digital reverbs, EQs, compressors, graphic EQs, limiters, noise gates, parametric EQs, signal metering

Gaines Audio

PO Box 17888
Rochester, NY 14609
(716) 266-0780, 800-442-0780
Ownr: Jon Gaines

Gentner Electronics

PO Box 27647
Salt Lake City, UT 84127
(801) 975-7200, FAX# 801-977-0087
Pres./CEO: Russell Gentner, COO: William Trowbridge, VP Eng.: William Gillman, Dir. Mkt'g/Sls: Elaine Jones, Dir. Mkt'g/Sls-Audio/Best: Gary Crowder, Mkt'g Coord.: Kelli Maag
Products: compressors, limiters

Hybrid Arts

8522 National Blvd.
Los Angeles, CA 90232
(213) 841-0340, FAX# 213-841-0346
Pres.: Rainer Poertner, VP Sls/Mkt'g: Steve Cunningham

IED Innovative Electronic Designs

9701 Taylorsville Rd.
Louisville, KY 40299
(502) 267-7436, FAX# 502-267-9070
VP Mkt'g & Sls: Tom Roseberry, Mkt'g Asst.: Robin Lasley, Sls App. Eng.: Jeff White, Mkt'g Adm.: Wanda R. Martin, VP Eng.: Ed Young, Pres.: Hardy Martin
Repworks, Chicopee, MA, 413-533-0845
Darmstedter Assoc., Baldwinville, NY, 315-638-1261
John Anthony, Stamford, CT, 203-322-9202
Sigmat, Valley Forge, PA, 215-783-6666
Secom Systems, Atlanta, GA, 404-455-0672
Bencsik Assoc., Ocala, FL, 904-732-9775
C.L. Pugh, Cleveland, OH, 216-238-1777
Monford Electronics Mkt'g., Indianapolis, IN, 317-872-8877
C.M. Sls, Farmington Hills, MI, 313-553-8070
Ludwig Mkt'g., Kenosha, WI, 414-697-9355
B.C. Electronic Sls, Mission, KS, 913-262-1720
Mkt'g Concepts, Irving, TX, 214-869-0669
Yora, White Bear Lake, MN, 612-770-9760
Torbett/Keiser Group, Loveland, CO, 303-669-1008
Derek Allen Assoc., Toluca Lake, CA, 818-840-8327
Plus Four Mkt'g, Walnut Creek, CA, 415-937-0650
North Shore Mkt'g, Seattle, WA, 206-284-9699
Island Instruments, Kaneohe, HI, 808-235-7544
Products: ambient noise controlled level controllers, compressors, levelers, noise gates, signal metering

ITT/DES

20 Mayfield Ave.
Edison, NJ 07607
(201) 225-6121, 800-524-1646
VP: Donald Duthaler, Chief Eng.: Jeffrey Stellman

Industrial Research Products

415 Busse Rd.
Elk Grove Village, IL 60007
(312) 439-3600, 800-255-6993, FAX# 312-640-9607
G. Mgr.: Brian Benn, Mkt'g Mgr.: Roger Carroll, Sr. Sls

THE IEQ WITH Smartcurve™

Not Just Another Programmable Equalizer With MIDI™

The IEQ with Smartcurve™ is a programmable, high performance graphic equalizer that includes a video output. For those who wish to enjoy the video output of the IEQ, ART makes the IEQ Video Monitor.* Smartcurve™, proprietary software developed by ART gives you instant actual frequency response as easy as the push of a button. The IEQ Family consists of both the 2/3 octave and the 1/3 octave graphic equalizers. Both types come in two varieties, Controllers and Satellites. A Controller is a self-contained programmable intelligent graphic equalizer capable of controlling 15 satellites at once. IEQ Satellites are exactly the same unit except the front panel controls are eliminated.*

IEQ Model Specifications:

Controller & Satellite

- 128 battery backed presets
- MIDI
- Frequency Response 20Hz-20kHz \pm 0.5dB
- THD \leq .009% @ 1kHz, 0dBm typical
- Dynamic Range \geq 100dB typical
- Balanced inputs and outputs

*IEQ Video Monitor Features

- 19" rack mountable
- NTSC compatible monochrome monitor
- 4 Selectable inputs
- Standard RCA jacks for easy connections

It Has To Be A Work Of . . .



Applied Research & Technology

215 Tremont Street
Rochester, NY 14608
(716) 436-2720

TELEX 4949793 ARTROC
FAX (716) 436-3942

For more information see your local dealer.

Circle 224 on Reader Response Card

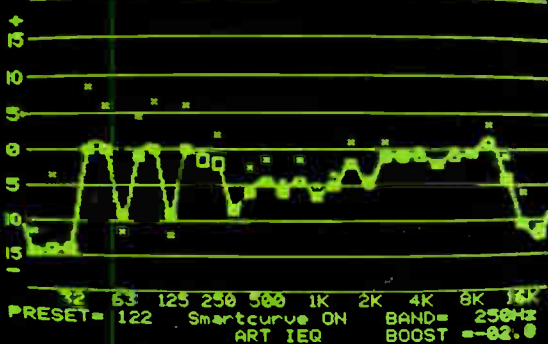
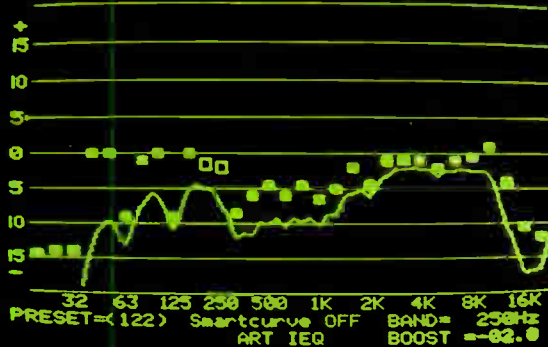
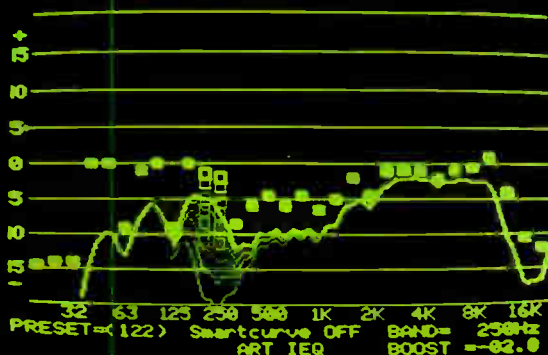

1 See the Sound

This is a video output of the IEQ as the unit is being adjusted. The sliders can be moved \pm 15dB in 1/2dB steps to get the exact response you need. With the simple push of a button, complex equalization can be done in seconds with incredible accuracy.

2 Hear the Sound

The power of the IEQ readily becomes apparent as the video display plots the frequency response due to the slider settings. The IEQ offers high quality constant "Q" equalization. The video graphic display shows the correlation between the sliders and the frequency response.

3 Perfect Sound

Turn Smartcurve™ on and perfect equalization is at your fingertips. Note the difference between the second frame (Smartcurve™ OFF) and this frame. The position of the sliders represent the actual frequency response of the EQ. Interaction between bands is virtually eliminated. Incredible! Just think, now when you adjust the EQ you get exactly what you need. The "perfect" EQ? Let your eyes and ears decide.

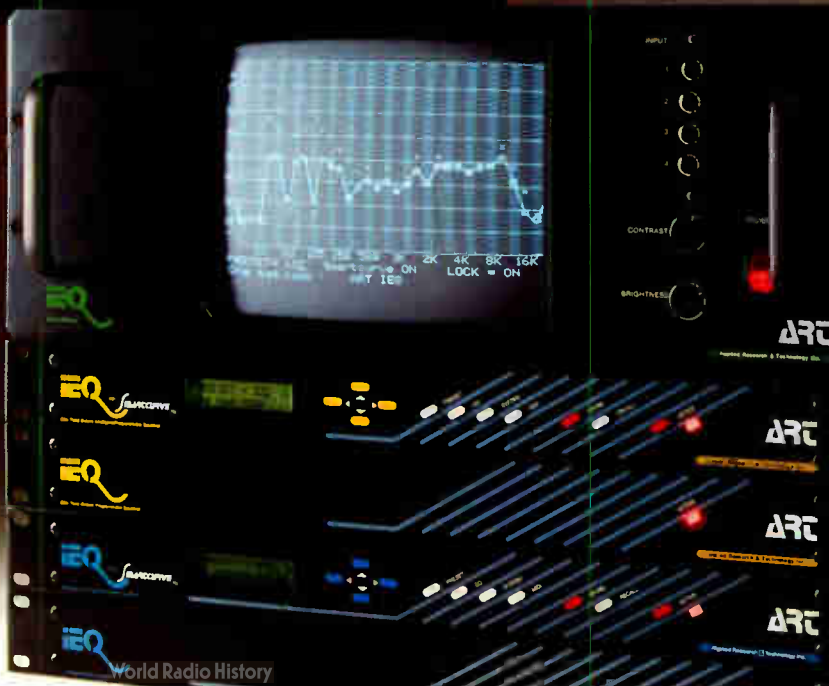

Audio processing and wireless...

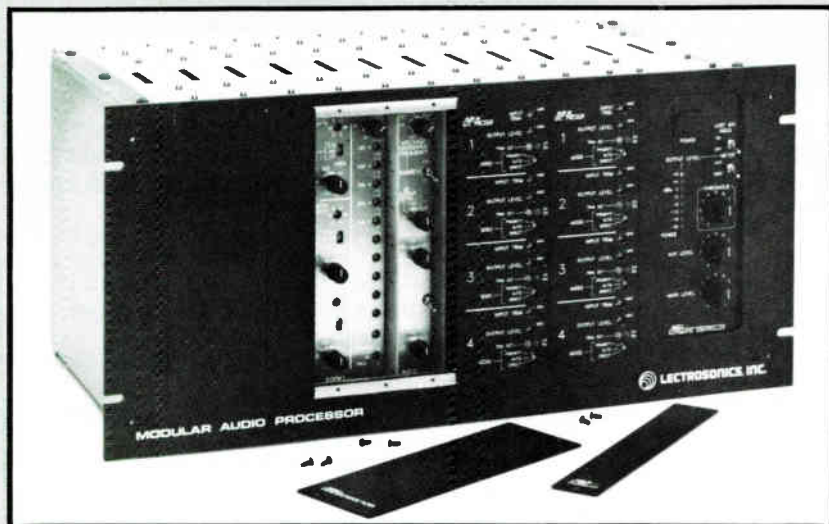

...all in one

Modular audio processing is a relatively new concept, and a much needed component in professional sound system design. In the past, contractors and consultants have had to specify a variety of different components from a number of different sources in order to meet the needs of their customers, with inherent duplication (power supplies for example) and the addition of "superfluous" features which complicated the system.

The MAP system approach breaks down the various functions into specialized plug-in modules, and provides a single 19" rack mounted component with the exact functions needed. This creates a much more cost-effective final package without sacrificing quality or limiting future system expansion. This is the future in audio signal processing. Complex, fully automatic sound systems just became a whole lot simpler.

A complete modular audio processing system

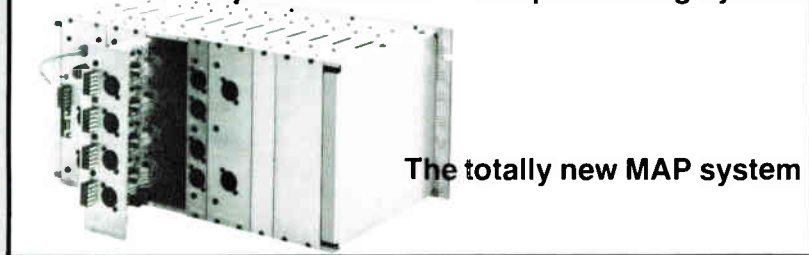

The totally new MAP system

Plug-in circuit cards allow you to customize a 19" rack mounted component that meets your customer's exact needs. Modules are available for automatic mixing, equalization and notch filtering, active crossover networks and RF transmission and receiving. Of course, the system is expandable and easily interfaced with other audio processing in a single, customized package.

For more information: 1-800-821-1121



LECTROSONICS, INC.

581 Laser Rd. NE • Rio Rancho, NM • 87124
 (505) 892-4501 • (800) 821-1121

Colantonio & Sons, Lansdale, PA, 215-584-1350

RolandCorp. US

7200 Dominion Circle
 Los Angeles, CA 90040
 (213) 685-5141, FAX# 213-722-0911

Pres.: Tom Beckman, Dir. Comm.: Nancy Kewin,
 Comm.: Barbi Clark

SCV

1101-A Air Way
 Glendale, CA 91201
 (818) 500-0137

Semco

3782 Westridge Ave.
 W. Vancouver, B.C., Canada V7V 3H5
 (604) 922-0526

G. Mgr.: Elk Ebert

Products: crossovers, digital delays, EQs, compressors,
 graphic EQs, interface units., limiters, notch filters, paramet-
 ric EQs, octave EQs, VCAs

Senior Technology

13431 Pumice St.
 Norwalk, CT 90650
 (213) 802-9942, FAX# 213-802-9945

Pres.: Steve P.Y. Kim, VP: Fred K.H. Kim, Nat'l Sls

Mgr.: Irv Weisman

EESCO Systems, Los Angeles, CA, 213-666-9601

Elrep Sls, Tucker, GA, 404-938-7109

Forti & Assoc., Kensington, MD, 301-949-1706

Dobbs Stanford, Dallas, TX, 214-358-0800

Mkt'g Insights, Glenview, IL, 312-729-2047

Products: 1/3 octave EQs, crossovers, octave EQs

Sescom

2100 Ward Dr.
 Henderson, NV 89015
 (702) 565-3400, 800-634-3457, FAX# 702-565-
 4828

Pres.: Franklin Miller

Products: crossovers, de-essers, compressors, levelers, li-
 miters, noise gates, parametric EQs, signal metering, tran-
 scription preamps

Sonic Research Assoc.

PO Box 13744
 Arlington, TX 76094-0744
 (817) 792-2061

Pres./Mkt'g: Kyle A. Holbrook, VP Tech.: Michael J.
 Yacovone, Op. Mgr.: Olvy L. Johnson

Sontec Electronics

Audio Dr.
 Goldbond, VA 24094
 (703) 626-7256

Sls Mgr.: Burgess Macneal

Products: EQs, compressors, interface units., limiters, pa-
 rametric EQs, transcription preamps

Sony Professional Audio

1600 Queen Anne Rd.
 Teaneck, NJ 07666
 (201) 833-5200, 800-635-SONY, FAX# 201-833-
 9645

Nat'l Sls Mgr.: Bob Ott, Prod. Mgr.: Art Gonzales, Mkt'g
 Mgr.: David Kawakami

Sony Pro Audio, Paramus, NJ, 201-368-5185

Sony Pro Audio, Nashville, TN, 615-883-8140

Sony Pro Audio, Burbank, CA, 818-841-8711

Products: 1/3 octave EQs, digital reverbs, compressors

SPECIFIED EQ.



Orban's equalizers excel because they offer unsurpassed flexibility and because they sound *more musical* on a wider range of program material than any other equalizer. Our parametric designs are capable of creating broad, gentle EQ curves with minimum phase-shift and with less ringing than graphic equalizers. Their extraordinary range and versatility allows Orban parametrics to solve a wide range of recording, production, and system problems that graphics and ordinary parametrics typically can't handle effectively.

642B Parametric Equalizer/Notch Filter: Orban's newest, elegant, "constant-Q" parametric. Four bands per channel (can be switched at the front panel to dual 4-band or single-channel 8-band). Features infinite-depth notching made more convenient by a vernier on the frequency control for fine tuning. Continuously-tunable 18dB/octave high-pass and 12dB/octave "Automatic Sliding Besselworth"TM low-pass filter. Noise and distortion specs better than 16-bit digital.

674A/672A Graphic Parametric Equalizers: Combines eight bands of "reciprocal" parametric EQ with tunable high and low-pass filters (12dB/octave). Graphic-type controls simplify set-up and operation. Can be used as a full electronic crossover cascaded with the main EQ in one cost-effective package. Ideal for room and system tuning as well as a wide range of production chores.

787A Programmable Mic Processor: Combines 3-band, "constant-Q" parametric EQ with a compressor, de-esser, and compressor/noise gate in a fully programmable package. Designed for both mic and line-level inputs, the unit can be used to store 99 commonly-used instrumental and vocal settings for instantaneous recall. MIDI, RS-232, and remote control interface options.

Security Covers: Attractive, acrylic security covers are available to fit all standard 19" rack-mount products—from one to four rack spaces, in opaque white, clear, and transparent blue.

CONSULTANTS

Orban Specification Language
is available free as text or on disk.

orban

A Division of AKG Acoustics, Inc.
645 Bryant St., San Francisco, CA 94107 (415) 957-1067 Telex: 17-1480 FAX: (415) 957-1070

Circle 249 on Reader Response Card

Sound Tech

230 Lexington Dr.
Buffalo Grove, IL 60089
(312) 541-3520, 800-877-6863, FAX# 312-541-3616

Pres.: Rudy Schlacher, Gen. Sls Mgr.: David Beirut,
Exp. Sls Mgr.: William Robinson, Sls Dir.: Todd Peren
Products: 1/3 octave EQs, crossovers, compressors, graphic EQs, limiters

Spectra Sonics

3750 Airport Rd.
Ogden, UT 84405
(801) 392-7531

Pres./Owner: William Dilley, Eng./Sls: Gregory Dilley

Studio Master

PO Box 2344
Ft. Worth, FL 76113
(817) 336-5114
Dale Peterson

Studio Technologies

5520 W. Touhy Ave.
Skokie, IL 60077
(312) 676-9177, FAX# 312-982-0747

Pres.: Gordon Kapes, Mkt'g Comm. Mgr.: Jennifer Shore

Sunn Musical Equipment

1130 Columbia St.
Brea, CA 92621
(714) 990-0909, 800-854-6230, FAX# 714-990-3986

Pres.: Bill Schultz, Dir. Mkt'g: Joe Green
Products: 1/3 octave EQs, crossovers, graphic EQs, octave EQs

Symetrix

4211 24th Ave. W.
Seattle, WA 98199
(206) 282-2555, 800-288-8855, FAX# 206-283-5504

Pres.: Dane Butcher, Dir. Mkt'g/Dev.: Doug Schauer,
Dir. Sls/Mkt'g: Will Lewis, Mkt'g/Sls Coord.: Lavina Speer, Acct. Mgr.: Julie Newton, Sparkplug: Valerie Stiles

Applied Audio, Asheville, NC, 704-252-9313
Jamm Dist., Flossmoor, IL, 312-747-6363
Derek Allen Assoc., Toluca Lake, CA, 818-840-8327
Michael Chafee Ent., Sarasota, FL, 813-921-4294
Loppnow & Assoc., Issaquah, WA, 206-392-3936
Tenicki & Assoc., Houston, TX, 713-528-2005
Audio Assoc., Fulton, MD, 301-604-7223
On the Road Mkt'g, Upper Montclair, NJ, 201-746-0501

Trankle & Assoc., Belmont, CA, 415-595-4004
Silver Peak Mktg, Wheatridge, CO, 303-467-9042
Cambridge Mkt'g, S. Euclid, OH, 216-291-9234
Essential Mktg, St. Joseph, MO, 816-279-0776
Darmstedter Assoc., Baldwinsville, NY, 315-638-1261
Products: ambient noise controlled level controllers, de-essers, EQs, compressors, interface units, limiters, noise gates, notch filters, parametric EQs, signal metering

Systems Design Associates

411 Lakeshore Rd.
Denton, TX 76205
(817) 497-6185
Pres.: Daniel Cody

T.C. Electronics

1 Serpentine Rd.
Tenafly, NJ 07670
(201) 568-1820, FAX# 201-871-0455

TDM Design

PO Box 573
Hillsboro, OR 97124
(503) 647-5957
Pres.: Tim Miller

TEI Electronics

PO Box 246
Hialeah, FL 33011
(305) 888-3980, 800-327-8811, FAX# 305-885-4950

Pres.: Danny Alonso, VP: Mireya Muniz, Nat'l Sls Mgr.:
Walter McNulty, Cust. Svce: John Tembras, Sls:
Orlando Pineda, Sls: Jose Hurdades
Products: 1/3 octave EQs, crossovers, graphic EQs

TOA ELECTRONICS

PO Box 2047
S. San Francisco, CA 94080
(415) 588-2538, 800-843-4750, in-state 800-in CA
800-632-2157, FAX# 415-588-3349

Pres.: Yoshiro Ishida, Nat'l Sls Mgr/Comm. Pro.:
Richard Krochmal, Nat'l Sls Mgr./Pro. Music & Ent.:
Rick Kamlet, Nat'l Sls Mgr./Intercom: Al Burns
Products: 1/3 octave EQs, crossovers, digital delays, EQs,
compressors, graphic EQs, parametric EQs, octave EQs,
signal enhancers

360 Systems

18740 Oxnard St.
Tarzana, CA 91356
(818) 342-3127, FAX# 818-342-4372
Dir. Mkt'g: Don Bird, Dir. Sls: David Geoghegan



UREI

PO Box 2200
Northridge, CA 91329
(818) 893-8411, FAX# 818-893-3639
Pres.: Ronald Means, VP Sls: Ken Lopez, VP Mkt'g:
Mark Gander, Mkt'g Mgr.: Hector Martinez, Mkt'g Mgr.:
Steve Romeo
Jim Chase, Hermosa Beach, Ca, 213-374-2128
Bill Hamilton, Folsom, PA, 215-543-4677
Bill Schuermann, St. Louis, MO, 314-644-2083
Tom Walter, N. Barrington, IL, 312-382-4925
Products: 1/3 octave EQs, ambient noise controlled level
controllers, crossovers, digital delays, EQs, compressors,
graphic EQs, limiters, parametric EQs, octave EQs

Voyetra Technologies

333 Fifth Ave.
Pelham, NY 10803
(914) 738-4500, FAX# 914-738-6946
Pres.: Carmine Bananno, VP: Frederick Romano,
Chief Software Eng: Bruce Frazer

Valley Int'l

PO Box 40306
Nashville, TN 37204
(615) 383-4737, FAX# 615-269-5441
Pres.: Norman Baker, Sls Mgr.: Tom Irby, Chief Eng:
Michael Morgan

WHITE INSTRUMENTS

PO Box 90099
Austin, TX 78709
(512) 892-0752, FAX# 512-892-0855
Pres.: Carl Van Ryswyk, Sls Supervisor: Alan R. Vest,
Dir. Eng.: Richard Bocock
Audio Mkt'g, Brecksville, OH, 216-832-7189
Awwest, Fountain Hills, AZ, 602-946-1811
Bencsik Assoc., Ocala, FL, 904-732-9775
CB Electronics, Arvada, CO, 303-422-0561
Design Factors, La Habra Heights, CA, 213-697-7576
LSM, Phelps, NY, 315-548-4891
Monfort Electronics, Indianapolis, IN, 317-872-8877
New Resources, Norwell, MA, 617-659-4579
Rancilio Assoc., St. Louis, MO, 314-845-0202
Rep Tech, Terrell, TX, 214-563-7663
Richard S. Pass Assoc., Huntingdon Valley, PA, 215-757-6100
Sigmat, Valley Forge, PA, 215-783-6666
Shalco, Ferndale, MI, 313-547-4771
Vector, Edmonds, WA, 206-322-4343
Warren Assoc., Santa Clara, CA, 408-988-7762
Wilson Audio Sls, Nashville, TN, 615-646-4477
Ziskind Assoc., Rolling Meadows, IL, 312-577-1624
Products: 1/3 octave EQs, crossovers, EQs, graphic EQs,
notch filters, octave EQs

YAMAHA MUSIC CORP. OF AMERICA/PROF. AUDIO DIV.

PO Box 6600
Buena Park, CA 90662
(714) 522-9011, FAX# 714-522-9312
Products: 1/3 octave EQs, crossovers, de-essers, digital effects, digital reverbs, digital delays, digital signal processors, EQs, compressors, graphic EQs, interface units, levelers, limiters, noise gates, notch filters, parametric EQs, octave EQs

Zeta Music Systems

2230 Livingston St.
Oakland, CA 94606
(415) 261-1702, 800-622-6434, FAX# 415-261-1708
Pres.: Michael Maia, VP Eng.: Keith McMillan, Prod. Mgr.: Michael Lyon, Sls Mgr.: David Gonden
Zeta Canada, Alberta, Canada, 403-226-0808
Intertune (Japan), El Cerrito, CA
Sound Svce, Berlin, W. Germany
Musicians Tech, Vasteras, Sweden

**TELL YOUR
SUPPLIERS
YOU FOUND THEM
IN THE
BLUE BOOK**

WE'LL TAKE YOU THERE

VIDEO CASSETTES NOW AVAILABLE WITH FULL COVERAGE OF ALL THE INDUSTRY TRADE SHOWS IMPORTANT TO YOUR BUSINESS.

You and your key personnel can travel to the trade show on your VCR. Each video cassette contains 3 full days of on-the-spot show coverage of the people, products, and hottest news in the industry.

DON'T MISS A THING! ORDER YOUR TAPES TODAY.



Please check the Show(s) you want.
First tape \$49.95; Additional tapes just \$24.98 each

- NSCA-TV NEWS — Nashville**
Nat'l Sound & Communications Assn
Contractors Expo '89
- NAB-TV NEWS — Las Vegas**
Nat'l Assn. of Broadcasters Show
- NAMM-TV NEWS — Chicago**
Nat'l Assn. of Music Merchants Expo
- CROSSTALK, A Television Symposium**
Audio Engineering Society Convention, LA
- CES-TV NEWS — Chicago**
Consumer Electronics Show

Please send _____ tape(s).
1 Tape, \$49.95; 2 for \$74.93; 3 for \$99.91; 4 for \$124.89;
All Five for \$149.87.

Name _____
 Company _____
 Address _____
 City _____ State _____ Zip _____
 Telephone: _____
 Indicate payment method: (prepayment required)
 Credit Card # _____
 Visa MC AmEx Check Enclosed
 Expiration Date _____
 Signature _____

NSCA-TV NEWS

Video Tapes Now Available!

**See the latest products,
and the people behind them**

SPECIAL SEGMENTS ON:

- **Signal Processing**
- **Security**
- **Microphones**
- **Mixing Boards**
- **CAD Software**
- **Wire & Cable**
- **Intercoms**
- **Power Amplifiers**

. . . and much, much more!



TV TAPES

25 Willowdale Ave.
Port Washington, NY 11050

... AND WATCH FOR NEW SHOWS
ON-THE-AIR
 EVERY DAY IN YOUR HOTEL ROOM
 AT YOUR NEXT CONVENTION

1989

★ **AES-TV CROSSTALK** — October in New York

1990

- ★ **CES-TV NEWS** — Las Vegas in January
- ★ **NAMM-TV NEWS** — Anaheim in January
- ★ **NAB-TV NEWS** — Atlanta in March/April
- ★ **NSCA-TV NEWS** — Las Vegas in April
- ★ **NAMM-TV NEWS** — Chicago in June
- ★ **CES-TV NEWS** — Chicago in June
- ★ **AES-TV CROSSTALK** —

STAY TUNED!

MIDI

Allen and Heath

5 Connair Rd.
 Orange, CT 06477
 (203) 795-3594, FAX# 203-795-6814

VP/Sls Mgr.: Charles Augustowski, Eng: John Petrucelli, Svce Mgr.: Joseph Boerst, Office Mgr.: Maryann Nuccini, Account: Kathy De Santo, Prod. Mgr.: John Rizzo
 AMH Sls, Palos Verdes, CA, 213-373-2034
 Audio Assoc., Glenwood, MD, 301-604-7223
 Cordial Riley Mkt'g, Sterling Heights, MI, 313-826-8980
 Cambridge, Westerville, OH, 614-890-7788
 GMI/New England, Avon, MA, 617-588-8043
 JMS Mkt'g, Austin, TX, 512-266-1113
 Loppnow & Assoc., Issaquah, WA, 206-392-3936
 Metropolis Mkt'g, Edison, NJ, 201-225-0085
 Ron Tunk Sls, Tamarac, FL, 305-722-2803
 Sherwood Assoc., Endicott, NY, 607-785-1590
 Starin Mkt'g, Chesterton, IN, 219-929-4127

Alesis

3630 Holdrege Ave.
 Los Angeles, CA 90016
 (213) 467-8000, FAX# 213-836-9192
 Pres./COO: Russell Palmer, CEO: Keith Barr, VP

Sls/Mkt'g.: Ralph Goldheim, VP Adv./Prom.: Allen Wald, Reg. Sls Mgr.: Ted Keffalo, VP Finance: Barbara Brown

Products: signal processing, hardware

Apple Computer

20525 Mariani Ave.
 Cupertino, CA 95014
 (408) 996-1010

Bacchus Software Systems

2210 Wilshire Blvd. #330
 Santa Monica, CA 90403
 (213) 820-9145

Eric Bloom, Darwin Foye
 Products: software

Conquest Sound

PO Box 268
 Monee, IL 60444
 (312) 534-0390, 800-323-7671, FAX# 312-534-0398

Pres.: Robert Jares Jr., VP: Larry Spalla, Sls Mgr.: Ken Bernd, Purch.: Sue Condon, Plant Mgr.: Debbie Hawtrey, Office Mgr.: Janet Jares

Products: hardware

JL Cooper Electronics

13478 Beach Ave.
 Marina del Rey, CA 90292
 (213) 306-4131, FAX# 213-822-2252

VP Sls: Bob Rentrup, Pres.: Jim Cooper, Nat'l Sls Mgr.: Chuck Thompson, Sls/Mkt'g Coord.: Becky David, Tech. Supp. Mgr.: Eli Slawson, Artist Relations: Trevor Rabin

Reflex Mkt'g, NYC, NY, 516-565-2323
 Fuday Assoc., San Francisco, CA, 415-459-6880
 Audio Assoc., Glenwood, MD, 301-604-7223
 Ocean Mkt'g, St. Petersburg, FL, 813-347-4867
 J.W. Stamey, Clemson, SC, 803-653-6434

Products: signal processing, system controllers, software

Covox

675-D Conger St.
 Eugene, OR 97402
 (503) 342-1271

DOD Electronics

5639 South Riley Ln.
 Salt Lake City, UT 84107

(801) 268-8400, 800-453-7484, FAX# 801-262-4966

Pres.: John Johnson, Int'l Sls: Wayne Morris, W. Sls: Scott Grow, VP Finances: Jay Fuller, Comm.: Dean Stubbs

DSP Development

One Kendall Square
Cambridge, MA 02139
(617) 577-1133, FAX# 617-577-8211

Pres.: Morris Samit, Dir. Eng.: Randy Race

Digital Music

5312-J Derry Ave.
Agoura Hills, CA 91301
(818) 991-3881, FAX# 818-991-4185
VP Mkt'g.: Gene Barkin

Digitech

5639 South Riley Ln.
Salt Lake City, UT 84107
(801) 268-8400, FAX# 801-262-4966

Pres.: John Johnson, VP Finance: Jay Fuller, Int'l Sls: Wayne Morris, W. Sls: Scott Grow, Corp. Comm.: Dean Stubbs

Products: signal processing

Dr. T's Music Software

220 Boylston St., #206
Chestnut Hill, MA 02167
(617) 244-6954, FAX# 617-244-5243

Pres.: Emile Tobenfeld, CEO: A.L. Hospers, VP Op.: Ann O'Donnell, Dir. Nat'l Sls: Oz Barron, Dir. Int'l Sls: Jeff Pucci

Products: software

Dynaware

1163 Chess Dr., Ste J
Foster City, CA 94404
(415) 349-5700, 800-444-DYNA, FAX# 415-249-5879

Products: software

Electronic Arts

1810 Gateway Dr.
San Mateo, CA 94404
(415) 571-7995

Forte Music

897 Independence, #4D
Mountain View, CA 94043
(415) 965-8880, FAX# 415-965-0508

Pres.: Steve Salani

Imagine Computers & Software

751 South Kellogg, Ste. A
Goleta, CA 93117
(805) 683-1183, FAX# 805-683-7749

Intelligent Music

116 N. Lake Ave.
Albany, NY 12206
(518) 434-4110, 800-344-2086, FAX# 518-434-0308

Pres.: Joel Chadabe, Dir. Software: David Zicarelli, Prod. Specialist: Antony Widoff, Tech. Dir.: Richard Lainhart, Office Mgr.: Peter Swank, Mkt'g/Comm.:

Caroline Meyers

Korg USA

89 Frost St.
Westbury, NY 11590
(516) 333-9100, 800-645-3188, FAX# 516-333-9108

Sr. VP: Michael Kovins

Products: signal processing, software, hardware

Lake Butler Sound

5331 W. Lake Butler Rd.
Windermere, FL 32786
(407) 656-5515
Pres.: Emmett Bradford
West Coast Mkt'g, Los Angeles, CA, 714-998-4969
New York Reps, New York, NY, 516-724-5485

Lync Systems

14 Walker Way
Albany, NY 12205
(518) 452-0891, FAX# 518-462-9637

Oberheim-ECC

2015 Davie Ave.
Commerce, CA 90040-1704
(213) 725-7870, FAX# 213-888-2874
Exec. VP: Robert Selan, VP Sls: Mike Papa, VP Eng.: Jim Letts, Prod. Mgr.: Faye Fitzgerald, Mkt'g/Promotions: Beth Letts, Cust. Svce Mgr.: Tom Dunn

Products: system controllers, hardware

Peavey Electronics

711 A St.
Meridian, MS 39302
(601) 483-5365, FAX# 601-484-4278
Pres.: Hartley Peavey

Products: signal processing, system controllers

Quiet Lion

PO Box 219
Sun Valley, CA 91353
(818) 765-6224, FAX# 818-767-6821
Pres.: John Fitzpatrick, VP: Susan Fitzpatrick

Products: software

Rane

10802 49th Ave. W.
Everett, WA 98204
(206) 355-6000, FAX# 206-347-7757
VP Mkt'g: Larry Winter, Dir. Mkt'g: Terry Pennington, Nat'l Sls Mgr.: Ray Bloom

Products: signal processing

RolandCorp. US

7200 Dominion Circle
Los Angeles, CA 90040
(213) 685-5141, FAX# 213-722-0911
Pres.: Tom Beckman, Dir. Comm.: Nancy Kewin, Comm.: Barbi Clark

Scientific Design Software

PO Box 3248
Chatsworth, CA 91313
(818) 718-1201, FAX# 818-718-2886

Products: software

Sound Advice

PO Box 278
Cazadero, CA 95421
(707) 632-5911

Swanson Analysis

PO Box 65
Houston, PA 15342
(412) 746-3304, FAX# 412-746-9494

Systems Design Associates

411 Lakeshore Rd.
Denton, TX 76205
(817) 497-6185
Pres.: Daniel Cody

360 Systems

18740 Oxnard St.
Tarzana, CA 91356
(818) 342-3127, FAX# 818-342-4372
Dir. Mkt'g: Don Bird, Dir. Sls: David Geoghegan
Products: system controllers, hardware

Voyetra Technologies

333 Fifth Ave.
Pelham, NY 10803
(914) 738-4500, FAX# 914-738-6946
Pres.: Carmine Bananno, VP: Frederick Romano, Chief Software Eng: Bruce Frazer
Products: software, hardware

Yamaha Music Corp. of America/Prof.

Audio Div.
PO Box 6600
Buena Park, CA 90662
(714) 522-9011, FAX# 714-522-9312
Products: signal processing, system controllers

York Controls

1111 S. Sherman, Ste. 101
Richardson, TX 75081
(214) 234-2126, FAX# 214-234-2176
COO: Peter York, Pres.: Bruce Christianson, CFO: Majors Harris, Sls Mgr.: Chris Monck, Mkt'g Mgr.: Paul Seif, Dir. Eng.: Woody Pope
Milanese Assoc., Philadelphia, PA, 215-763-2138
B.L. Reps, Milwaukee, WI, 414-277-7600
Marketline, Atlanta, GA, 404-972-9048
D & B Mkt'g, Plano, TX, 214-423-3447
PMP Mkt'g, West Jordan, UT, 801-561-1968
Products: system controllers

Zeta Music Systems

2230 Livingston St.
Oakland, CA 94606
(415) 261-1702, 800-622-6434, FAX# 415-261-1708
Pres.: Michael Maia, VP Eng.: Keith McMillan, Prod. Mgr.: Michael Lyon, Sls Mgr.: David Gonden
Zeta Canada, Alberta, Canada, 403-226-0808
Intertune (Japan), El Cerrito, CA
Sound Svce, Berlin, W. Germany
Musicians Tech, Vasteras, Sweden
Products: signal processing, system controllers

PATCH BAYS & ROUTING SWITCHERS

ADC Telecommunications
4900 W. 78th St.
Minneapolis, MN 55435
(612) 835-6800, FAX# 612-893-3138

Audio Accessories
Mill St.
Marlow, NH 03456
(603) 446-3335, FAX# 603-446-7543
Op. Mgr.: Timothy Symonds
Products: audio/video, components, pre-wired

Audio Systems
PO Box 1174
Bismarck, ND 58502
(701) 223-3800, 800-852-6522, in-state 800-932-8975,
FAX# 701-222-8102
Pres./Eng.: Lynn Mader, VP/Sls: Lyle Mader
Products: matrix, microprocessor, remote controllable

Audio Visual Systems
725 Lorraine Blvd.
Los Angeles, CA 90005
(213) 934-3006

Auditel Systems
396 Porter Ave.
Buffalo, NY 14201
(716) 886-0019, FAX# 716-886-1615
Pres.: David Langtry, Prod. Mgr.: Tony Roberson,
Mkt'g Dir.: Jim Wood
Products: microprocessor, pre-wired, remote controllable

AUTOPATCH A/V SYSTEMS
PO Box 3002
Spokane, WA 99202
(509) 747-1246
VP Mkt'g: Dick Myers, VP Eng.: Jay Turkovsky
Products: audio/video

BSM Systems
PO Box 19007
Spokane, WA 99219
(509) 838-0110, FAX# 509-328-0510
Sls Mgr.: Marceen Zappone, Pres.: Bruce Morse
Products: audio/video, digital, matrix, microprocessor, re-
mote controllable

Benchmark Media Systems
3817 Brewerton Rd.
N. Syracuse, NY 13212
(315) 452-0400
Pres.: Allen Burdick

CAL SWITCH
13717 S. Normandie Ave.
Gardenia, CA 90249
(213) 538-9830, 800-225-7924, FAX# 213-327-2741
Products: components, pre-wired, telephone type

Conex Electro-Systems
PO Box 1342
Bellingham, WA 98227
(206) 734-4323, FAX# 206-676-4822
Eng. Dir.: Bill Hamelin, G. Mgr.: John Plattner, Svce
Mgr.: Jerry Huddle

Conquest Sound
PO Box 268
Monee, IL 60444

(312) 534-0390, 800-323-7671, FAX# 312-534-0398
Pres.: Robert Jares Jr., VP: Larry Spalla, Sls Mgr.: Ken
Bernd, Purch.: Sue Condon, Plant Mgr.: Debbie
Hawtrey, Office Mgr.: Janet Jares
Products: audio/video, mic splitters

H.M. Dyer Electronics
2982 Wixom Rd.
Milford, MI 48042
(313) 685-2560

EECO
1601 E. Chestnut Ave.
Santa Ana, CA 92702
(714) 835-6000, FAX# 714-953-3747
Mkt'g Mgr.: Dorothy Morris

FSR
220 Little Falls Rd.
Cedar Grove, NJ 07009
(201) 239-0988, 800-332-FSR-1, FAX# 201-239-7708
Pres.: William Fitzsimmons, VP: Janice Sandri, Eng.
Mgr.: Joseph Fischer, Proj. Mgr.: John Macaluso,
Metal Shop Mgr.: Joseph Amico, Inside Sls: Marilyn
Cullen
Design Factors, Hacienda Heights, CA, 213-697-7576
Sigmat, Freehold, NJ, 201-462-1221
Richard Pass Assoc., Langhorne, PA, 215-757-6100
Peregrine SW, Houston, TX, 713-589-8481
Henry Phillips, Roswell, GA, 404-992-3070
Piper Assoc., Needham, MA, 617-449-1144
Brian Trankle & Assoc., Belmont, CA, 415-595-4004
Ziskind Assoc., Rolling Meadows, IL, 312-577-1624
Meyer Mkt'g, Deerfield Beach, FL, 305-481-9250
Awrest, Fountain Hills, AZ, 602-946-1811
Burcaw, Warren, MI, 313-573-4605
Products: audio/video, digital, matrix, microprocessor, re-
mote controllable

i.FOSTEX CORP. OF AMERICA
15431 Blackburn Ave.
Norwalk, CA 90650
(213) 921-1112, FAX# 213-802-1964
Exec. VP: Fred Huang, VP Sls/Mkt'g: Mark Cohen
Products: audio/video

GBE Group
PO Box 118
Fair Oaks, CA 95628
(916) 967-5946
Pres.: Robert Bird, VP: George Anderson
Products: audio/video

Gentner Electronics
PO Box 27647
Salt Lake City, UT 84127
(801) 975-7200, FAX# 801-977-0087
Pres./CEO: Russell Gentner, COO: William
Trowbridge, VP Eng.: William Gillman, Dir. Mkt'g/Sls-
Bus.: Elaine Jones, Dir. Mkt'g/Sls-Audio/Best: Gary
Crowder, Mkt'g Coord.: Kelli Maag
Products: audio/video, pre-wired, telephone type

GEPCO INT'L
1863 W. Carroll
Chicago, IL 60612
(312) 733-9555, FAX# 312-733-6416
Pres.: Gary Geppert, Asst. To Pres.: Larry Smith Sr.,
Sls Mgr.: Larry Smith Jr., Op. Mgr.: Mike Geppert,
Purch. Mgr.: Kathie Geary
Products: audio/video, components, digital, matrix, pre-wir-
ed, telephone type

Ghielmetti
5341 Derry Ave, Unit J

Agora Hills, CA 91301
(818) 707-1134, 800-228-1097, FAX# 818-707-1754
Sls Eng.: Rick Odorfer
Products: audio/video, matrix

Grass Valley Group
PO Box 1114
Grass Valley, CA 95945
(916) 478-3000, FAX# 916-478-3187
Pres.: Dan Wright, Exec. VP: Dave Mayfield, VP Mkt'g:
Bob Cobler, Dir. Sls/Mkt'g: Bob Natwick
GVG, Paramus, NJ, 201-845-7988
GVG, Elkhart, IN, 219-264-0931
GVG, Woodland Hills, CA, 818-999-2303
GVG, Kowloon, Hong Kong, 852-3-7396632
GVG, Winchester, Hampshire U.K., 44-962-843939
Products: components

Hedco
PO Box 1985
Grass Valley, CA 95945
(916) 273-9524, 800-433-2648, FAX# 916-273-6948
CEO: Don Thompson, VP Op.: Steve Miller, Mkt'g/Sls
Mgr.: Ross Shelton

Hughes Electronic Devices
PO Box 1985

CUSTOM AUDIO SWITCHING

WE MANUFACTURE AND ASSEMBLE CUSTOM-AUDIO SWITCHING SYSTEMS FOR:

- ★ JAILS
- ★ MEETING ROOMS
- ★ AIRPORTS
- ★ LEGISLATIVE CHAMBERS
- ★ ARENAS

WE MANUFACTURE:

CIRCUIT BOARDS

- AUDIO SWITCHING
- VOLTAGE CONTROLLED AMPLIFIERS
- PREAMPS
- LIMITERS

CONTROL PANELS

- GRAPHIC
- ANODIZED ALUMINUM
- ENGRAVED PLASTIC
- BRASS

FOR INFORMATION CALL TOLL-FREE:

1-800-852-6522

AUDSCO

Audio-Systems Company, P.O. Box 1174
Bismarck, ND 58502-1174

Circle 89 on Reader Response Card

Notes:

Grass Valley, CA 95945
(916) 273-9524, 800-HEDCO GV, FAX# 916-273-6948

IED Innovative Electronic Designs

9701 Taylorsville Rd.
Louisville, KY 40299
(502) 267-7436, FAX# 502-267-9070
VP Mkt'g & Sls: Tom Roseberry, Mkt'g Asst.: Robin Lasley, Sls App. Eng.: Jeff White, Mkt'g Adm.: Wanda R. Martin, VP Eng.: Ed Young, Pres.: Hardy Martin
Repworks, Chicopee, MA, 413-533-0845
Darmstedter Assoc., Baldwinsville, NY, 315-638-1261
John Anthony., Stamford, CT, 203-322-9202
Sigmat, Valley Forge, PA, 215-783-6666
Secom Systems, Atlanta, GA, 404-455-0672
Bencsik Assoc., Ocala, FL, 904-732-9775
C.L. Pugh, Cleveland, OH, 216-238-1777
Monford Electronics Mkt'g., Indianapolis, IN, 317-872-8877
C.M. Sls, Farmington Hills, MI, 313-553-8070
Ludwig Mkt'g., Kenosha, WI, 414-697-9355
B.C. Electronic Sls, Mission, KS, 913-262-1720
Mkt'g Concepts, Irving, TX, 214-869-0669
Yora, White Bear Lake, MN, 612-770-9760
Torbett/Keiser Group, Loveland, CO, 303-669-1008
Derek Allen Assoc., Toluca Lake, CA, 818-840-8327
Plus Four Mkt'g, Walnut Creek, CA, 415-937-0650
North Shore Mkt'g, Seattle, WA, 206-284-9699
Island Instruments, Kaneohe, HI, 808-235-7544
Products: digital, matrix, microprocessor, mic splitters, remote controllable

Industry West Electronics

270 N. Geneva Rd.
Orem, UT 84057
(801) 226-1000
Products: mult boxes

Int'l Music Co. (I. M. C.)

PO Box 2344
Ft. Worth, TX 76113
(817) 336-5114, 800-433-5627, FAX# 817-870-1271
Chairman of the Bd./CEO: Tommy Moore, Pres.: Jerry Freed, VP Sls: C.H. Murray, Dir. Akai EMI: Mike McRoberts, Akai Prod. Specialist: Kevin Kennedy

Jaydik Communications

PO Box 3002
Spokane, WA 99220
(509) 747-1246
Mkt'g: Dick Myers

LynTec

7030 Grandview
Merriam, KS 66204
(913) 722-4047
Pres.: Lynn J. Potter
Products: matrix

Moseley Assoc.

111 Castilian Dr.
Santa Barbara, CA 93117-3093
(805) 968-9621, FAX# 805-685-9638
Products: matrix, microprocessor, remote controllable

Patch Bay Designation

4742 San Fernando Rd.
Glendale, CA 91204
(818) 241-5585, FAX# 818-507-5050
Pres.: Scott Lookholder, Op. Mgr.: Charlie Schufer, Shop Foreman: Kevin Duhart, Artist: Rosie Gloria, Art Coord.: Joaquin Serrano

Protech Audio

Flowerfield, Bldg. #1
St. James, NY 11780
(516) 584-5855, FAX# 516-584-5904
Sls Mgr.: Bill Murphy, VP Eng.: Joseph Giambone
Peregrine SW Repts, Houston, TX, 713-589-8481

Products: audio/video, components, matrix, remote controllable

PROTO-TEC

108 Fairlane Dr.
Joliet, IL 60435
(815) 744-7173
Products: mic splitters, mult boxes

Semco

3782 Westridge Ave.
W. Vancouver, B.C., Canada V7V 3H5
(604) 922-0526
G. Mgr.: Elk Ebert
Products: audio/video, remote controllable

TARGET TECHNOLOGY

PO Box 609
Penn Valley, CA 95946
(916) 639-2102
Pres.: Peter Hughes, VP: Sherri Douglas
Products: audio/video, components, remote controllable

Tascam (TEAC Professional Division)

7733 Telegraph Rd.
Montibello, CA 90640
(213) 726-0303, FAX# 213-727-7656
Mkt'g Mgr: Bill Mohrhoff, Nat'l Sls Mgr.: Gregg Hildebrandt, W. Reg. Mgr.: Fred Allard, S. Reg. Mgr.: Bill Stevens, E. Reg. Mgr.: Chuck Prada
Products: audio/video

360 Systems

18740 Oxnard St.
Tarzana, CA 91356
(818) 342-3127, FAX# 818-342-4372
Dir. Mkt'g: Don Bird, Dir. Sls: David Geoghegan
Products: matrix, microprocessor, remote controllable

Trimm

PO Box 489
Libertyville, IL 60048
(312) 362-3700, FAX# 312-680-3888
Pres.: G. Wallace Newton, Plant Mgr.: Reuben Beilke, Eng.: Aurel Seiceanu, Sls: Harry Lewis, Purch.: Nancy Calkins, Personnel: Rhea Peterson
Win-Cor Electronic Sls, Manhasset, NY, 516-627-9474
Liberty Electro Mkt'g, Topsfield, MA, 617-887-6655
Len Jackson Sls, Camano Island, WA, 206-387-6767

Utah Scientific

1685 W. 2200 S.
Salt Lake City, UT 84119
(801) 973-6840, 800-453-8782, FAX# 801-973-0255
VP Sls/Mkt'g: Dave Spindle, Dir. Prod. Mgmt: Scott Bosen, NE Reg Sls Mgr.: Dan Antonellis, SE Reg Sls Mgr.: Eric King, Midwest Reg Sls Mgr.: Tom Harmon, SW Reg Sls Mgr.: Eloy Chairez

Vidicraft

0704 SW Bancroft St.
Portland, OR 97201
(503) 223-4884, 800-547-1491, FAX# 503-243-1995
G. Mgr.: Steve Johnson, Nat'l Sls Mgr.: Dave Landis, Prod. Mgr.: Glenn Olson
Products: audio/video, matrix

Yamaha Music Corp. of America/Prof.

Audio Div.
PO Box 6600
Buena Park, CA 90662
(714) 522-9011, FAX# 714-522-9312
Products: matrix, remote controllable

SOUND SYSTEM PRODUCTS

DISCO COMPONENTS & SYSTEMS

AKG ACOUSTICS

77 Selleck St.
Stamford, CT 06902
(203) 348-2121, 800-243-7885, FAX# 203-324-1942
Pres.: S. Richard Ravich, VP Op.: Derek Pilkington, VP
Fin.: Bob Netter
Products: headphones

Aris/Eta

1710 Enterprise Pkwy
Twinsburg, OH 44087
(216) 425-3388, FAX# 216-425-9700
Mkt'g: Bob Harris
Products: lighting controls & effects

BBE SOUND

5500 Bolsa Ave., Ste. 245
Huntington Beach, CA 92649
(714) 897-6766, 800-233-8346, FAX# 714-895-6728
Chairman: John McLaren, VP: Scott Anderson, Op
Mgr.: Jennifer Drescher, Nat'l Sls Mgr.: Fred Coyner,
Mkt'g Dev. Mgr.: Jim Lucas, Tech Svcs Mgr.: Ryan
Coutts
Products: processors

BOSE—PROFESSIONAL PRODUCTS

The Mountain
Framingham, MA 01701
(508) 879-7330, FAX# 508-872-6541
G. Mgr.: David Bell, Nat'l Field Sls Mgr.: Timothy
Dorwart, E. Reg. Mgr.: Robin Sibucac, W. Reg Rep:
Michael Schneider
Products: sub-woofers

Bozak

326 South St.
New Britain, CT 06051-3721
(203) 225-0555
Pres.: Donald Bowers, Dir. Mkt'g: William Kieiltyka,
Chief Eng.: Sheldon Glick

Cerwin-Vega

555 E. Easy St.
Simi Valley, CA 93065
(805) 584-9332, FAX# 805-583-0865
Pres.: Gene Czerwinski, VP: Connie Czerwinski, Nat'l
Sls Mgr.: Rich Mandella, Tech. Sls: John Davies
Products: sub-woofers

Community Light & Sound

333 E 5th St.
Chester, PA 19013
(215) 876-3400, 800-523-4934, FAX# 215-874-0190
Pres.: Bruce Howze, VP Eng.: John Wiggins, VP Exp.
Sls: Christine Howze, Nat'l Field Sls Mgr.: Chris Berger
Cordial-Riley Mkt'g, Sterling Heights, MI, 313-826-8980
Mel Foster Tech. Sls, Edina, MN, 612-941-9800
Rob Welles, San Francisco, CA, 415-334-4477
Pacific Audio Group, Torrance, CA, 213-719-1383
New Resource, Norwell, MA, 617-659-1463
Sigmet, Freehold, NJ, 201-462-1221
Audio Mkt'g Assoc., Breckville, OH, 216-526-2426
Powerline Mkt'g, Evanston, IL, 312-864-1147
Evans Sls & Mkt'g, Nashville, TN, 615-297-7997
Bencsik Assoc., Ocala, FL, 904-732-9775
R.J. Throckmorton Sls, Bailwin, MO, 314-227-7222
Rep Tech, Terrell, TX, 214-222-2131

Pearson & Pearson, Denver, CO, 303-722-6996
Vector Corp., Seattle, WA, 206-322-4343
Products: sub-woofers

Dyna-Might Sound & Lighting

3119-A S. Scenic
Springfield, MO 65807
(417) 883-4549

Fairlight Instruments

2945 Westwood Blvd.
Los Angeles, CA 90064
(213) 470-6280, FAX# 213-474-9716

GLI/Integrated Sound Systems

1227 Wait Whitman Rd.
Melville, NY 11747
(516) 351-2100
Products: DJ mixers, headphones

Lighting and Electronics

Market St. Industrial Pk.
Wappingers Falls, NY 12590
(914) 297-1244, FAX# 914-297-9270

O'Ryan Industries

9400-A NE 130th Ave.
Vancouver, WA 98682
(206) 892-0447, 800-426-4311, FAX# 206-892-6742
Int'l Sls Mgr.: David Gilroy, Laser Sls: David Hampton
Innovative Sls & Mkt'g, Irvine, CA, 714-975-1130
Vector, Seattle, WA, 206-322-4343
Dobbs Standford, Dallas, TX, 214-358-0800
Mkt'g Insights, Glenview, IL, 312-729-2047
Vespoli Entertainment, Ashtabula, OH, 216-992-9792
Drew & Assoc., Amherst, NY, 716-262-9300
Thom Enterprises, Charlotte, NC, 704-343-9234
C & T Sls & Mkt'g, Wichita, KS, 316-681-2293
Mitch Gyles, Pueblo, CO, 719-542-4325

Peavey Electronics

711 A St.
Meridian, MS 39302
(601) 483-5365, FAX# 601-484-4278
Pres.: Hartley Peavey
Products: DJ mixers, lighting controls & effects, processors

Pioneer Laser Entertainment

22010 S. Wilmington Ave., #201
Carson, CA 90745
(213) 518-4531, FAX# 213-518-9809
Pres.: Ted Karasawa, VP Sls/Mkt'g: Mark Makabe,
Adm. Mgr.: Pam MacPherson, Reg. Sls Mgr.: Eddie
Hiramoto
Neil Altneu, Fort Lee, NJ, 201-461-3355
Mark Atwood, San Ramon, CA, 415-866-2240
Steve Boucher, Rosemont, IL, 312-318-8800

Rane

10802 49th Ave. W.
Everett, WA 98204
(206) 355-6000, FAX# 206-347-7757
VP Mkt'g: Larry Winter, Dir. Mkt'g: Terry Pennington,
Nat'l Sls Mgr.: Ray Bloom
Products: DJ mixers, processors

Roctronics Lighting, Lasergraphics &

Special Effects
100 SAC Roctronics Pk.
Pembroke, MA 02359
(617) 826-8888
Pres.: Dr. Richard Iacobucci, Bus. Mgr.: David Grees
250 dealers worldwide. Call for nearest one.
Products: lighting controls & effects

Russco Electronics Mfg.

5690 E. Shields Ave.
Fresno, CA 93727
(209) 291-5591
Pres./G. Mgr.: Russell Friend, Sls: Vicky Jarrett,
Design Eng.: Michael Vink
Allied Broadcast Systems, Richmond, IN, 317-962-
8596
Broadcast Supply W., Tacoma, WA, 206-565-2301
Professional Audio Supply, Ft. Worth, TX, 817-483-
7474
Singer Products, Hialeah, FL, 305-558-3000
Electrex, FL, 305-651-5752
Products: turntable cartridges, & accs., turntables

Sennheiser Electronic

PO Box 987
Old Lyme, CT 06371
(203) 434-9190, FAX# 203-434-1759
Products: headphones

Skytronics Electrical

PO Box 52-0504
Miami, FL 33166
(305) 594-3909, FAX# 305-594-0786
Pres.: Oscar Mederos, Mkt'g: Mike Uruski
Products: DJ mixers, sub-woofers

Sound Tech

230 Lexington Dr.
Buffalo Grove, IL 60089
(312) 541-3520, 800-877-6863, FAX# 312-541-3616
Pres.: Rudy Schlacher, Gen. Sls Mgr.: David Beirut,
Exp. Sls Mgr.: William Robinson, Sls Dir.: Todd Peren
Products: sub-woofers

Spatial Sound

743 Center Blvd.
Fairfax, CA 94930
(415) 457-8114, FAX# 415-457-6250
Sls Mgr.: Dave Yancey, Pres.: Mahanta Devlas
Products: DJ mixers, lighting controls & effects, processors

Stagecraft Lighting Products

PO Box 566
Jackson, MO 63755
(314) 800-234-5789, FAX# 314-243-1384
Pres.: Ron Lorenz, VP: Tim Quigley

Stanton Magnetics

101 Sunnyside Blvd.
Plainview, NY 11803
(516) 349-0235, FAX# 516-349-0230
Nat'l Sls Mgr.: G.L. "Pete" Bidwell III, Office Mgr.:
Lucretia Tindall
Allied Broadcast, Richmond, TN, 317-962-8596



MAKE TIME STAND STILL

With Numark's DM-1775 sampling mixers you can capture a moment in time and play it back the way you want.

For CD-quality sound reproduction, the DM-1775 and DM-1975 both feature advanced, 16-bit digital sampling technology. You can sample up to four seconds of program material from any input source and remix it with live or recorded material...on the fly.

The DM-1975 features four separate memory banks enabling you to store multiple samples that you can play back individually or collectively. Program assignable equalization and cueing provide custom sound tailoring and monitoring with any source input. Balanced outputs insure low-noise performance, even with long cable runs.

Get Numark's DM-1775 or DM-1975 sampling mixers and make time stand still. When you do, you won't sit still for conventional mixers again.

and DM-1975
ture a musical
when you want...

Numark PPD

503 Newfield Ave., Raritan Center, Edison, NJ 08837
Tel: (201) 225-3222 Telex: 287-249 Edla, Fax: (201) 287-2155

Broadcast Supply W., Tacoma, WA, 206-565-2301
Pro Audio Supply, Ft. Worth, TX, 817-483-7474
NE Broadcast Lab, S. Glens Falls, NY, 518-793-2181
Telexport, Hialeah, FL, 305-887-5197
Products: headphones, turntable cartridges, & accs.

Summa Technologies

2179 Stone Ave., Ste. 23
San Jose, CA 95125
(408) 293-3657

Products: lighting controls & effects

TEI Electronics

PO Box 246
Hialeah, FL 33011
(305) 888-3980, 800-327-8811, FAX# 305-885-4950
P.: Danny Alonso, VP: Mireya Muniz, Sls: Walter McNulty, Svc: John Tembras, Sls: Orlando Pineda, Sls: Jose Hurcades

Products: DJ mixers, headphones, lighting controls & effects, processors, turntable cartridges, & accs.

TOA ELECTRONICS

PO Box 2047
S. San Francisco, CA 94080
(415) 588-2538, 800-843-4750, in-state 800-in CA 800-632-2157, FAX# 415-588-3349
Pres.: Yoshiro Ishida, Nat'l Sls Mgr/Comm. Pro.: Richard Krochmal, Nat'l Sls Mgr./Pro. Music & Ent.: Rick Kamlet, Nat'l Sls Mgr./Intercom: Al Burns

Products: sub-woofers

TECHNICAL PROJECTS

PO Box 3247
Barrington, IL 60010
(312) 381-5350, 800-562-5872, FAX# 312-381-4360
Glenn Mullis, Sibbelina Mullis, Mike Barrett
Professional Audio Mkt'g, Melville, NY, 516-367-8620
Watt Mkt'g, Allentown, PA, 215-820-7586
Audio Mkt'g Assoc., Brecksville, OH, 216-526-2426
Pro Sound & Lighting, Lakewood, CO, 303-986-5999
Design Factors, Hacienda Heights, CA, 213-6917-7576

Products: headphones

Telex Communications

9600 Aldrich Ave. S.
Minneapolis, MN 55420
(612) 884-4051, FAX# 612-884-0043
P.: Jeffrey Wetherell, Mkt'g: J. Arrington, Sls: Dan Dantzer, Dir. Mkt'g: Dond Meree
WesTech/Lichtenauer, Culver City, CA, 213-870-9286
Bencsik Assoc., Ocala, FL, 904-732-9775
Burcaw & Assoc., Warren, MI, 313-573-4605
SAGA, Oswego, NY, 315-343-5739
Monfort Electronic Mkt'g, Ind., IN, 317-872-8877
Murphy & Coia, Atlanta, GA, 404-875-2525
Northland Assoc., Moorhead, MN, 218-233-4616
Rancilio Assoc., St. Louis, MO, 314-845-0202
J.Y. Schoonmaker, Dallas, TX, 214-349-1650
Sigmat, Valley Forge, PA, 215-783-6666
Weller Electronic Sls, Worthington, OH, 614-885-7819
Ziskind Assoc., Rolling Meadows, IL, 312-577-1624
White Radio, Burlington-Ont., Canada, 416-632-6894
Silver Peak Mkt'g, Denver, CO, 303-467-9042
Pacnor Mkt'g, Lynnwood, WA, 206-771-6016

Products: headphones

VIBRATION TECHNOLOGY

1950 Ellesmere Rd., Unit #12
Scarborough, ONT, Canada M1H 2V8
(416) 438-9320, FAX# 416-439-1937
Pres.: Adrian Ball, VP: Harry Gandhi

Products: mixers, subs, cartridges, & accs., turntables

Yamaha

PO Box 6600
Buena Park, CA 90662
(714) 522-9011, FAX# 714-522-9312

Products: DJ mixers, headphones

Meet an
entertainer
who plays
all the best
nightclubs,
puts in a full
week of school,
and still finds
time to sing
in the choir
on Sundays.





Laser Karaoke. Only from Pioneer.

Suddenly, every facility is a potential customer once again. Because Pioneer has just introduced Laser Karaoke™, the newest and most phenomenal entertainment system yet.

Laser Karaoke is a one-of-a-kind sing-along system with music for all generations and every occasion. Music-video style pictures and superimposed lyrics immediately sweep everyone into the fun. And there are hundreds of hits for them to sing, all fully orchestrated and



reproduced by laser optics for lasting audio-video quality. Laser Karaoke plays right into your hands, because it comes

as a complete system or as individual components. Which means you not only expand existing systems, but your business, too.



To get in on the act, contact Pioneer Laser Entertainment, Inc., 22010 South Wilmington Avenue, #201, Carson, CA., 90745. Or call (213) 518-4531.

Laser Karaoke™
PIONEER

Circle 220 on Reader Response Card

MESSAGE REPEATERS/STORECASTERS

Automation Electronics

11501 Dublin Blvd.
Dublin, CA 94568
(415) 828-2880, 800-232-4653, FAX# 415-828-1686
Mkt'g Svc Mgr.: Evelyn Elkins
Products: digital systems, digital voice recording

Adaptive Micro Systems

7840 N. 86th St.
Milwaukee, WI 53224
(414) 357-2020, 800-558-7022, FAX# 414-357-2029
Products: sign systems

Atis

6025 Atlantic Blvd., Ste. D
Norcross, GA 30071
(404) 446-7234, FAX# 404-446-7237
VP Tech Svcs: Peter Lorenz, Nat'l Sls Mgr.: Tony Vespoli
Products: digital systems, message units, digital voice recording

Audi-Cord

1845 W. Hovey Ave.
Normal, IL 61761
(309) 452-9461

Audiocom

8100 Oak Ln., Penthouse 401
Miami Lakes, FL 33016
(305) 825-4653, 800-272-0555, FAX# 305-558-8799
Pres./CEO: Ron Deblinger, VP Operations: Art Hecht,
Dir. Mkt'g: Stu Ginsberg
Products: digital systems, message units, digital voice recording

Automation Devices

Automation Pk. Box AD
Fairview, VA 16415-0904
(814) 474-5561

Benjamin Int'l

1460 Old Country Rd.
Plainview, NY 11803
(516) 753-0700, 800-572-8989, FAX# 516-753-0839
Pres.: Joseph Benjamin, VP: Charles Tanner

Clever Devices

PO Box 2002
Port Washington, NY 11050
(516) 767-0682, FAX# 516-767-3635
Pres.: William Long, Mkt'g Mgr.: Una Neary, Tech.
Supp.: Mike Kafulas

Products: digital systems, message units, digital voice recording

CompuSonics Video

2345 Yale St.
Palo Alto, CA 94306
(415) 494-1208, FAX# 415-494-3040
Pres.: John Stautner

Eltrex Int'l

2 Columbia Dr.
Amherst, NH 03031
(603) 886-3500, 800-432-7631, FAX# 603-886-3508
Sls Mgr.: Bill Ryan
Products: digital systems, message units, digital voice recording

Fidelipac

PO Box 808
Moorestown, NJ 08057
(609) 235-3900, FAX# 609-235-7779
Pres.: Roger Thanhauser, Mkt'g Dir.: Larry Lamoray,
Sls Dir.: Jack Ducart, Eng. Dir.: Bill Franklin, Dom. Sls:
Joanne Donahue, Int'l Sls: Rosemary Jukes

New from MacKenzie Laboratories, the leader in digital message repeaters

Random Access Digital Audio

MacKenzie's Random Access Digital Audio (RADA) is an audio message repeater system with multiple-message capability. It is designed to serve as the voice playback section of alarm systems in applications such as:

- Life-safety announcements
- Fire evacuation
- "Code Blue" messages
- Security warnings

Messages are digitized, stored in removable EPROM memory chips and controlled by the system's built-in microprocessors. The voice is entirely natural, just like a tape recording.

RADA provides the various levels of supervision required in life-safety systems, as well as continuous digital self-check and voice-check. Message prioritization and FIFO are standard features. Power interruptions won't affect the system's memory. The highly reliable, all-solid-state RADA system has *no moving parts*, so it requires *no maintenance*.

RADA is furnished in standard 19-inch equipment rack configuration. The basic unit provides up to 80 messages. Building-block expansion via sub-chassis



RADA unit shown with front cover removed.

provides capacities of more than 500 messages. Message lengths can be as short as 7.5 seconds or as long as 30 seconds. For more information about the versatile new RADA system, call MacKenzie Laboratories toll-free:

800-423-4147

MACKENZIE MacKenzie Laboratories, Inc.

5507 Peck Road □ Arcadia, California 91006 USA □ (818) 579-0440

Notes:

GSC General Security/Benjamin
1460 Old Country Rd.
Plainview, NY 11803
(516) 753-0700, 800-572-8989, FAX# 516-753-0839

Gilderfluke & Co.
820 Thompson Ave. #35
Glendale, CA 90212
(818) 546-1618, FAX# 818-546-1619
Mgr.: Mike Hopewell, Eng.: Doug Mobley, Tech.: Don Watson, Office Mgr.: Rose Preto
Products: digital systems

Heliotrope General
3733 Kenora Dr.
Spring Valley, CA 92077
(619) 460-3930, 800-854-2674, FAX# 619-460-9211
VP: Barry Brunye, Office Mgr.: Barbara Smith, Sls: Mark Albert
Products: digital systems, message units, digital voice recording

IED Innovative Electronic Designs
9701 Taylorsville Rd.
Louisville, KY 40299
(502) 267-7436, FAX# 502-267-9070
VP Mkt'g & Sls: Tom Roseberry, Mkt'g Asst.: Robin Lasley, Sls App. Eng.: Jeff White, Mkt'g Adm.: Wanda R. Martin, VP Eng.: Ed Young, Pres.: Hardy Martin Repworks, Chicopee, MA, 413-533-0845
Darmstedter Assoc., Baldwinsville, NY, 315-638-1261
John Anthony., Stamford, CT, 203-322-9202
Sigmet, Valley Forge, PA, 215-783-6666
Secom Systems, Atlanta, GA, 404-455-0672
Bencsik Assoc., Ocala, FL, 904-732-9775
C.L. Pugh, Cleveland, OH, 216-238-1777
Monford Electronics Mkt'g., Indianapolis, IN, 317-872-8877
C.M. Sls, Farmington Hills, MI, 313-553-8070
Ludwig Mkt'g., Kenosha, WI, 414-697-9355
B.C. Electronic Sls, Mission, KS, 913-262-1720
Mkt'g Concepts, Irving, TX, 214-869-0669
Yora, White Bear Lake, MN, 612-770-9760
Torbett/Keiser Group, Loveland, CO, 303-669-1008
Derek Allen Assoc., Toluca Lake, CA, 818-840-8327
Plus Four Mkt'g, Walnut Creek, CA, 415-937-0650
North Shore Mkt'g, Seattle, WA, 206-284-9699
Island Instruments, Kaneohe, HI, 808-235-7544

Infonics
2302 E. Michigan Blvd.
Michigan City, IN 46360
(219) 879-3381
Pres.: Carol Lant, VP: David Smith

MACKENZIE LABORATORIES
PO Box 3029
Arcadia, CA 91006
(818) 579-0440, 800-423-4147, FAX# 818-448-7131
Pres.: Addison Taylor, VP/Chief Eng: Nagy Khattar, Sls Supervisor: Joe Vitale, Mkt'g/Training: Emory Straus
Avwest, Phoenix, AZ, 602-946-1811
Lex Lawson Assoc., Dallas, TX, 214-272-8482
Avcom, N. Olmstead, OH, 216-777-2060
Rancilio Assoc., St. Louis, MO, 314-845-0202
Rancilio Assoc., Kansas City, KS, 913-491-9883
Warren Assoc., Santa Clara, CA, 408-988-7762
Piper Assoc., Needham, MA, 617-449-1144
Bencsik Assoc., Ocala, FL, 904-732-9775
Design Factors, Los Angeles, CA, 213-697-7576
Riley & Petchell Sls, Detroit, MI, 313-937-3000
Monfort Electronics, Indianapolis, IN, 317-872-8877
Gustafson Systems Sls, Chicago, IL, 315-358-2505
Chuck Olson Assoc., Renton, WA, 206-255-8692

RWR, Rock Hill, SC, 803-324-5111
 RWR, Norcross, GA, 404-263-9349
 RWR, Alabaster, AL, 206-663-2744
 Northland Assoc., Moorehead, MN, 218-233-4616
 Products: digital systems, cart machines, message units, digital voice recording

Pres.: Gary Zebrowski, Dir. Op.: Bill Seaman, Sls Mgr.,
 Consumer: Dan Reynolds, Sls Mgr., Sys./OEM:
 Michael Morgan

Murphy & Cota, NC, SC, 404-875-2525
 ASR Enter., MD, VA, 301-893-0001
 Design Factors, SC, 213-676-6752
 Products: message units

Portac
 108 Aero Camino
 Santa Barbara, CA 93117
 (805) 685-2960

3M SOUND PRODUCTS
 551-1W, 3M Center
 St. Paul, MI 55144-1000
 (612) 733-9214, FAX# 612-736-7614
 Mkt'g Mgr.: Richard Barker
 Products: cart machines

Sierra Video Systems
 PO Box 2462
 Grass Valley, CA 95945
 (916) 273-9331

360 Systems
 18740 Oxnard St.
 Tarzana, CA 91356
 (818) 342-3127, FAX# 818-342-4372
 Dir. Mkt'g: Don Bird, Dir. Sls: David Geoghegan
 Products: digital systems, message units

TOA ELECTRONICS
 PO Box 2047
 S. San Francisco, CA 94080
 (415) 588-2538, 800-843-4750, in-state 800-in CA
 800-632-2157, FAX# 415-588-3349
 Pres.: Yoshio Ishida, Nat'l Sls Mgr./Comm. Pro.:
 Richard Krochmal, Nat'l Sls Mgr./Pro. Music & Ent.:
 Rick Kamlet, Nat'l Sls Mgr./Intercom: Al Burns
 Products: message units

VICON INDUSTRIES
 525 Broad Hollow Rd.
 Melville, NY 11747-370
 (516) 293-2200, 800-645-9116, FAX# 516-293-2627
 CEO: Donald N. Horn, Exec. VP: Arthur Wallace,
 Sr. VP Mkt'gs: Ronald J. Teixeira, VP Dom. Sls:
 Donald T. Heckel, VP Int'l Sls: Richard P. Adam
 US Reg. Office-W., Brea, CA, 714-990-3858
 US Reg Office-S., Norcross, GA, 404-449-0499
 Gov't Sls Office, Arlington, VA, 703-553-785-
 European, Hampshire, UK, 44-0705-665-3

Tape-Athon
 13633 Crenshaw Blvd.
 Hawthorne, CA 90250
 (213) 676-6752, FAX# 213-676-9532
 Pres.: Leon "Lee" Tate, G. Mgr.: Robert Haller, Dir.
 Eng.: Bernard Sayers, Sls Mgr.: Rick Bottom, Mfg.
 Supervisor: E.W. Stokes
 Chuck Olson Assoc., WA, 206-271-5416
 Bencsik Assoc., FL, 800-342-0197

Nel-Tech Labs
 PO Box 1030
 Londonderry, NH 03053
 (603) 434-8234, FAX# 603-434-1265
 Exec. VP: Ken Ritter
 Products: digital systems, digital voice recording

Neutrik USA
 1600 Malone St.
 Millville, NJ 08332
 (609) 327-3113, FAX# 609-825-4804
 G. Mgr.: James Cowan, Prod.t Mgr.: William Dorman,
 Prod. Mgr.: Kenneth Smalley
 Products: digital systems, digital voice recording

Otari
 378 Vintage Pk Dr.
 Foster City, CA 94404
 (415) 341-5900, FAX# 415-341-7200
 Pres.: Jack Soma, Mkt'g Mgr.: John Carey, Controller:
 Jim Pierce

PHI Technologies
 4605 N. Stiles
 Oklahoma City, OK 73105-3328
 (405) 521-9000

STOP FEEDBACK!



The MacKenzie Feedback Eliminator (model FE-1) is a solid-state, digital record/play unit which has no moving parts and requires no maintenance. It is designed to be installed between the power amplifier and the paging system. When a paging station is actuated, the message is digitized on a real-time basis and stored in memory. When the paging station deactuates, the recorded page is played over the paging system speakers. Since the open microphone has been eliminated, amplifiers can be turned up to any desired level without any feedback at all.

Voice reproduction is entirely natural-sounding. Message length is up to 30 seconds. The on-board microprocessor senses message termination and automatically switches from the *Record* mode to the *Page Playback* mode with no "dead time."

HOW THE FE-1 WORKS:

- 1) When the paging station is actuated, a contact closure furnished by the paging system actuates the *Record* mode.
- 2) The user makes the page.
- 3) When the paging system releases the contact closure, the FE-1 automatically switches from the *Record* to the *Play* mode and sends out the page.

For additional information about the FE-1 Digital Feedback Eliminator, call MacKenzie Laboratories toll-free: **800-423-4147**

MACKENZIE MacKenzie Laboratories, Inc.
 5507 Peck Road, Arcadia, California 91006 USA, 818/579-0440 FAX: 818/448-7131

MAGNETIC TAPE SYSTEMS & SUPPLIES

AGFA-Gevaert, Magnetic Tape Div.

100 Challenger Rd.
Ridgefield Park, NJ 07660
(201) 440-2500, FAX# 201-342-4742
VP G. Mgr.: Maria Curry, Nat'l Sls Mgr.: Andrew Da
Puzzo, Audio Prod. Mgr.: Joe Tibensky, Video Prod.
Mgr.: Chris Emery, Mkt'g. Comm. Mgr.: Teri Sosa

AVSCO

1880 Embarcadero Rd.
Palo Alto, CA 94303
(415) 493-3814
Pres.: Richard Wilson, G. Mgr.: Veldon Leverich, Office
Mgr.: Diane Leverich

Accurate Sound

3515 Edison Way
Menlo Park, CA 94025
(415) 365-2843, FAX# 415-365-3057
Pres.: Ronald Newdell, VP Sls: Don O'Bella

Akai Professional/IMC

PO Box 2344
Fort Worth, TX 76113
(817) 336-5114, FAX# 817-870-1271
CEO: Tommy Moore, Pres.: Jerry Freed, CFO: Jay
McKim, Credit Mgr.: Bob Sanford, VP Sls: John Maher
John Chez, Ringos, NJ, 201-788-5151
Jerry Sehi, Ft. Lauderdale, FL, 305-525-0872
Grendal Hanks, Lake Forest, CA, 714-768-2633
Tom Steuckert, Santa Clara, CA, 408-249-6136
Bill Thompson, Lake Villa, IL, 312-356-8818

American Recorder Technologies

PO Box 3592
Simi Valley, CA 93063
(805) 527-9580, 800-782-6911, FAX# 805-527-
1433
Pres.: Alan Adelstein

Ampex Recording Media Corp.

401 Broadway, M/S 22-02
Redwood City, CA 94063
(415) 367-3809, FAX# 415-367-4132
Pres.: Thomas Wheeler, VP Sls/Cust. Svce US:
Richard Antonio, G. Mgr./Instr. Prod.: George Armes,
Corp. Controller: Clara Munley, VP Op.: Eugene
Nyland, G. Mgr.-A/V Prod.: Phillip Ritti
Ampex RMC, San Fernando, CA, 818-365-8627
Ampex RMC, Arlington Heights, IL, 312-593-6000
Ampex RMC, Carrollton, TX, 214-960-1162
Ampex RMC, Allendale, NJ, 201-825-9600
Ampex RMC, Nashville, TN, 615-242-0022

R.B. Annis

1101 N. Delaware St.
Indianapolis, IN 46202
(317) 637-9282, FAX# 317-637-9282
Pres.: R.B. Annis, Mgr.: R.D. Hudson
Products: degaussers, demagnetizers

Apex Machine

3000 N.E. 12th Terrace
Ft. Lauderdale, FL 33334
(305) 566-1572, FAX# 305-563-2844
Sls Exec.: Alfred Coningsby III, Sls Exec.: Todd
Coningsby

Atis

6025 Atlantic Blvd., Ste. D

Norcross, GA 30071

(404) 446-7234, FAX# 404-446-7237
VP Tech Svcs: Peter Lorenz, Nat'l Sls Mgr.: Tony
Vespoli
Products: cassette recorders, reel-to-reel recorders & play-
ers, transcription systems

Audico

219 Crossen Ave.
Elk Grove, IL 60007
(312) 640-1030
Pres.: Bill Hinkle, VP: Norm Deletzke

Audiocom

8100 Oak Ln., Penthouse 401
Miami Lakes, FL 33016
(305) 825-4653, 800-272-0555, FAX# 305-558-
8799
Pres./CEO: Ron Deblinger, VP Operations: Art Hecht,
Dir. Mkt'g: Stu Ginsberg
Products: cassette players & changers, cassette recorders,
cassette tape

Audiolab Electronics

5831 Rosebud Ln., Bldg C
Sacramento, CA 95841
(916) 348-0200, FAX# 916-348-1512
VP Mkt'g: Ronald Stefan
Products: degaussers, demagnetizers

BASF, Information Systems

19 Crosby Dr.
Bedford, MA 01730-1471
(617) 271-6642, FAX# 617-275-2708

Benjamin Int'l

1460 Old Country Rd.
Plainview, NY 11803
(516) 753-0700, 800-572-8989, FAX# 516-753-
0839
Pres.: Joseph Benjamin, VP: Charles Tanner
Products: degaussers, demagnetizers

Bonneville Media Communications

130 Social Hall Ave.
Salt Lake City, UT 84111
(801) 237-2400
Products: cassette tape

Burlington Audio/Video Tapes

106 Mott St.
Oceanside, NY 11572
(516) 678-4414, 800-331-3191, FAX# 516-678-
8959
Pres.: Ruth Schwartz, VP: Rudy Schwartz, Jr. VP/Sls:
Jan Schwartz, Sls Mgr.: Ray Colon
Products

Capitol Magnetic Products

6902 Sunset Blvd.
Hollywood, CA 90028
(213) 461-2701
Pres.: Edward C. Khoury, Sr. VP/Sls: H. J. "Bud"
Jackson, VP Int'l Sls: Larry Krutsinger, Managing
Dir./U.K.: Steve Castle, Dir./Tech. Mkt'g: Joseph
Kempier

Chemtronics

681 Old Willets Path

Hauppauge, NY 11788

(516) 582-3322

EI Mar Plastics

821 E. Walnut St.
Carson, CA 90746
(213) 327-3180, 800-255-5210, FAX# 213-327-
0491
Pres.: Allen Schor, Sls Mgr.: Maxine Hesse
Products: cassette tape

Electronic Specialists

PO Box 389
Natick, MA 01760
(617) 655-1532

Fidelipac

PO Box 808
Moorestown, NJ 08057
(609) 235-3900, FAX# 609-235-7779
Pres.: Roger Thanhauser, Mkt'g Dir.: Larry Lamoray,
Sls Dir.: Jack Ducart, Eng. Dir.: Bill Franklin, Dom. Sls:
Joanne Donahue, Int'l Sls: Rosemary Jukes

FOSTEX CORP. OF AMERICA

15431 Blackburn Ave.
Norwalk, CA 90650
(213) 921-1112, FAX# 213-802-1964
Exec. VP: Fred Huang, VP Sls/Mkt'g: Mark Cohen
Products: cassette recorders, multi-tracks, reel-to-reel re-
corders & players, test tapes

Gauss

9130 Glenoaks Blvd.
Sun Valley, CA 91352
(213) 875-1900, FAX# 818-767-4479
Pres.: James Williams, Cust. Svce Mgr./Dup.: Joe
O'Conner, Nat'l Sls Mgr./Speakers: Paul Hugo, Chief
Eng./Speakers: Walter Dick, Cust. Svce/Speakers:
Bonnie Armstrong, Cust. Svce/Dup.: Don King
Brian Trankle & Assoc., Belmont, CA, 415-595-4004
Peter Schmitt, Leonia, NJ, 201-944-2806
Hustling Ent., Yakima, WA, 509-966-2574
Richard Pass, Langhorne, PA, 215-757-6100
Master Recording Supply, Burbank, CA, 818-841-7500
Products: high-speed duplicators

GSC General Security/Benjamin

1460 Old Country Rd.
Plainview, NY 11803
(516) 753-0700, 800-572-8989, FAX# 516-753-
0839

Geneva Group of Companies

7255 Flying Cloud Dr.
Eden Prairie, MN 55344
(612) 829-1724
Pres.: Edward Griffin, Sls Mgr.: Bruce Bowen

IGM Communications

4041 Home Rd.
Bellingham, WA 98226
(206) 733-4567, FAX# 206-734-7939
Pres.: Jim Wells, Sls: Carl Peterson, Op. Mgr.: Rick
Sawyer
Products: cart recorders/players, carts, reel-to-reel record-
ers & players

Infonics

2302 E. Michigan Blvd.

Michigan City, IN 46360
(219) 879-3381
Pres.: Carol Lant, VP: David Smith

(415) 221-2000

Lincolnwood, IL 60646-168
(708) 677-3000, 800-323-7520, FAX# 708-677-1311
VP Sls: Thomas Tisch
Products: cleaners

Int'l Electro-Magnetics
350 N. Eric Dr.
Palatine, IL 60067
(312) 358-4622

Microtran
PO Box 236
Valley Stream, NY 11582
(516) 561-6050, FAX# 516-561-1117
Pres.: Albert Eisenberg, VP Sls: Walter Benschler, Chief Eng.: Vulf Ozechov, Purch. Agent: Belle Moskowitz, Prod. Mgr.: Charles Meyer, Adv. Mgr.: Lou Anne O'Conner
Products: degaussers, demagnetizers

Saki Magnetics
26600 Agoura Rd.
Calabasas, CA 91302
(818) 880-4054, FAX# 818-880-6242
Pres.: Eugene Sakasagawa, Dir./Sls & Mkt'g: Trevor Boyer

Int'l Music Co. (I. M. C.)
PO Box 2344
Ft. Worth, TX 76113
(817) 336-5114, 800-433-5627, FAX# 817-870-1271
Chairman of the Bd./CEO: Tommy Moore, Pres.: Jerry Freed, VP Sls: C.H. Murray, Dir. Akai EMI: Mike McRoberts, Akai Prod. Specialist: Kevin Kennedy
Products

Nakamichi America
19701 S. Vermont Ave.
Torrance, CA 90502
(213) 538-8150, 800-421-2313, FAX# 213-324-7614
Pres.: Yas Yamazaki, Exec. VP/G. Mgr.: Dean Miller, VP Sls: Jett Logan, VP Op.: Ray Privette, Mkt'g Mgr.: Jun Sakamoto
Products: cassette recorders, cassette tape, demagnetizers

Sony Professional Audio
1600 Queen Anne Rd.
Teaneck, NJ 07666
(201) 833-5200, 800-635-SONY, FAX# 201-833-9645
Nat'l Sls Mgr.: Bob Ott, Prod. Mgr.: Art Gonzales, Mkt'g Mgr.: David Kawakami
Sony Pro Audio, Paramus, NJ, 201-368-5185
Sony Pro Audio, Nashville, TN, 615-883-8140
Sony Pro Audio, Burbank, CA, 818-841-8711
Products: cassette recorders

Int'l Tapetronics/3M
PO Box 241
Bloomington, IL 61702
(309) 828-1381, 800-447-0414, FAX# 309-828-1386
Sls Rep.: Tom Becker, Sls Rep.: John Schaab, Sls Rep.: Jim Woodworth, Prod. Specialist: Chuck Kelly
Products: cart recorders/players, carts

Nortronics
8101 Tenth Ave. N.
Minneapolis, MN 55427
(612) 545-0401, FAX# 612-540-8678
Pres.: John Yngve, Mkt'g Oper. Mgr.: Karen Nickolauson, Eng. Mgr.: Mike Drees
Products: heads

SOUND CRAFT-DIV. OF JBL
PO Box 2200
Northridge, CA 91329
(818) 893-4351, FAX# 818-893-3639
Pres.: Ron Means, VP Sls: Ken Lopez, VP Mkt'g: Mark Gander, Nat'l Sls Mgr.: David Kimm, Tech. App.: Gary Lynn
Jim Chase, Hermosa Beach, CA, 213-374-2128
Bill Hamilton, Folsom, PA, 215-543-4677
Bill Schuermann, St. Louis, MO, 314-644-2083
Tom Walter, N. Barrington, IL, 312-382-4925
Products: multi-tracks, reel-to-reel recorders & players

JRF Magnetic Sciences
101 Landing Rd.
Landing, NJ 07850
(201) 398-7426, FAX# 201-579-6021

Otari
378 Vintage Pk Dr.
Foster City, CA 94404
(415) 341-5900, FAX# 415-341-7200
Pres.: Jack Soma, Mkt'g Mgr.: John Carey, Controller: Jim Pierce

Sprague Magnetics
15720 Stagg St.
Van Nuys, CA 91406
(818) 994-6602, 800-553-8712, FAX# 818-994-2153

MACKENZIE LABORATORIES
PO Box 3029
Arcadia, CA 91006
(818) 579-0440, 800-423-4147, FAX# 818-448-7131

PHI Technologies
4605 N. Stiles
Oklahoma City, OK 73105-3328
(405) 521-9000
Pres.: Gary Zebrowski, Dir. Op.: Bill Seaman, Sls Mgr., Consumer: Dan Reynolds, Sls Mgr., Sys./OEM: Michael Morgan

Standard Tape Laboratory
26120 Eden Landing Rd., Ste. 5
Hayward, CA 94545
(415) 786-3546
Pres.: Frank Lennert

Pres.: Addison Taylor, VP/Chief Eng: Nagy Khattar, Sls Supervisor: Joe Vitale, Mkt'g/Training: Emory Straus
Avwest, Phoenix, AZ, 602-946-1811
Lex Lawson Assoc., Dallas, TX, 214-272-8482
Avcom, N. Olmstead, OH, 216-777-2060
Rancilio Assoc., St. Louis, MO, 314-845-0202
Rancilio Assoc., Kansas City, KS, 913-491-9883
Warren Assoc., Santa Clara, CA, 408-988-7762
Piper Assoc., Needham, MA, 617-449-1144
Bencsik Assoc., Ocala, FL, 904-732-9775
Design Factors, Los Angeles, CA, 213-697-7576
Riley & Petchell Sls, Detroit, MI, 313-937-3000
Monfort Electronics, Indianapolis, IN, 317-872-8877
Gustafson Systems Sls, Chicago, IL, 315-358-2505
Chuck Olson Assoc., Renton, WA, 206-255-8692
RWR, Rock Hill, SC, 803-324-5111
RWR, Norcross, GA, 404-263-9349
RWR, Alabaster, AL, 206-663-2744
Northland Assoc., Moorehead, MN, 218-233-4616
Products: cart recorders/players

Peavey Electronics
711 A St.
Meridian, MS 39302
(601) 483-5365, FAX# 601-484-4278
Pres.: Hartley Peavey
Products: cassette recorders

Studer Revox America
1425 Elm Hill Pike
Nashville, TN 37210
(615) 254-5651, FAX# 615-256-7619
Products: cassette recorders, reel-to-reel recorders & players

Magnefax Int'l
Route 1 Box 764
Rogers, AR 72756
(501) 925-1818, FAX# 501-925-1841
Pres.: Dennis W. Tallakson
Products: degaussers, high-speed duplicators

Projector Recorder Belt
PO Box 176
Whitewater, WI 53115
(414) 473-2151

Sunkyoung Int'l, Audio Div.
17106 S. Avalon Blvd.
Carson City, CA 90746
(213) 327-5010, 800-237-8372, FAX# 213-327-0276
Mkt'g: Tony Kim

Magnetic Reference Lab (MRL)
229 Polaris Ave., Ste. 4
Mountain View, CA 94043
(415) 965-8187, FAX# 415-965-8548
Pres.: John McKnight, Prod. Mgr.: Charles Booye, Adm. Assistant: M. Marlana Govaars

Quantam Audio Labs
2752 Walnut Ave.
Tustin, CA 92680
(714) 838-8833, FAX# 714-838-9619
Sls Eng.: David Rollins
Products: degaussers

Taber Mfg. & Eng. Co./AVSC
1880 Embarcadero Rd.
Palo Alto, CA 94303
(415) 493-3814

Mann Endless Cassette Industries
PO Box 1347
San Francisco, CA 94101

Recortec
1290 Lawrence Station Rd.
Sunnyvale, CA 94089
(408) 737-3443, FAX# 408-734-2140
Dir. Mkt'g: R. Ronald Truxell, VP: Eldon Corl, Pres.: Lester Lee

Tape-Athon
13633 Crenshaw Blvd.
Hawthorne, CA 90250
(213) 676-6752, FAX# 213-676-9532
Pres.: Leon "Lee" Tate, G. Mgr.: Robert Haller, Dir.

Research Technology Int'l
4700 W. Chase Ave.

Eng.: Bernard Sayers, Sls Mgr.: Rick Bottom, Mfg. Supervisor: E.W. Stokes
 Chuck Olson Assoc., WA, 206-271-5416
 Bencsik Assoc., Fl, 800-342-0197
 Murphy & Cota, NC, SC, 404-875-2525
 ASR Enter., MD, VA, 301-893-0001
 Design Factors, SC, 213-676-6752
 Products: cassette players & changers, multi-tracks, reel-to-reel recorders & players

Tascam (TEAC Professional Division)
 7733 Telegraph Rd.
 Montibello, CA 90640
 (213) 726-0303, FAX# 213-727-7656
 Mkt'g Mgr: Bill Mohrhoff, Nat'l Sls Mgr.: Gregg Hildebrandt, W. Reg. Mgr.: Fred Allard, S. Reg. Mgr.: Bill Stevens, E. Reg. Mgr.: Chuck Prada
 Products: cassette recorders, cleaners, demagnetizers, high-speed duplicators, multi-tracks, reel tape, reel-to-reel recorders & players, test tapes

Technics Professional
 One Panasonic Way

Secaucus, NJ 07094
 (201) 348-7000
 Products: reel-to-reel recorders & players

VIF Int'l
 PO Box 1555
 Mountain View, CA 94042
 (408) 739-9740
 Pres.: Nancy Mackechnie, Advisor/Int'l Op.: Gordon Mackechnie

Versadyne Int'l
 504-D Vandell Way
 Campbell, CA 95008
 (408) 379-0900, FAX# 408-379-0902
 Pres.: Robert Kratt
 Products: high-speed duplicators

Weircliffe
 2752 Walnut Ave.
 Tustin, CA 92680

(714) 838-8833, FAX# 714-838-9619
 Chair./CEO: Roger Bailey, G. Mgr./US Op.: Stuart Dunford, Sls: Jim Owen
 Weircliffe UK, Exwick Exeter, UK, 44-3-927-2132
 Paltex Europe, Haarlem, Netherlands, 31-2-332-7845
 Com Logic, Burbank, CA, 818-845-0199
 Landy Assoc., Waltham, MA, 617-890-6325
 Products: degaussers

Xedit
 133 S. Terrace Ave.
 Mount Vernon, NY 10550
 (914) 668-0388, 800-431-8900

Yamaha Music Corp. of America/Prof. Audio Div.
 PO Box 6600
 Buena Park, CA 90662
 (714) 522-9011, FAX# 714-522-9312
 Products: cassette recorders, multi-tracks

PA SYSTEMS

ADA Amplification Systems
 7303 Unit D Edgewater Dr.
 Oakland, CA 94621-3095
 (415) 632-1323, 800-241-8888, FAX# 415-632-9358
 W. Sls: Lisa Carrell-Gonden, E. Sls: Eric Schultheis, Int'l Sls: Lorry Marcus

ATI - Audio Technologies
 328 W. Maple Ave.
 Horsham, PA 19044
 (215) 443-0330, FAX# 215-443-0394
 Pres.: Samuel Wenzel, VP: Edward Mullin

AIPHONE INTERCOM SYSTEMS
 PO Box 90075
 Bellevue, WA 98009
 (206) 455-0510, 800-692-0200, FAX# 206-455-0071
 Pres.: Jun Matsumoto, Sls Mgr.: Jim Morrison, Mkt'g/Adv. Mgr.: Harry Quanz
 Aiphone NE, Randolph, NJ, 201-328-1790
 Aiphone Midwest, Westmont, IL, 312-323-5222
 Aiphone SE, Douglasville, GA, 404-920-2811
 Products: mixer/amp, music distribution, signalling, telephone, zoned

ALTEC LANSING
 PO Box 26105
 Oklahoma City, OK 73126-010
 (405) 324-5311, FAX# 405-324-8981
 Pres.: Dave Merrey, VP Mkt'g: Chuck Lange, Dir. Mkt'g Dev.: Ted Uzzie, Nat'l Sls Mgr.: Jerry Spriggs, Mgr./Export Mkt'g: John Sexton, Tech. Svcs Mgr.: Gary Jones

ASHLY

ASHLY AUDIO
 100 Fernwood Ave.
 Rochester, NY 14621
 (716) 544-5191, 800-828-6308, FAX# 716-266-4589

Pres.: William Thompson, Sr. VP: Bob French, VP: David Malloy, Office Mgr.: Ellen Price
 Products: mixer/preamps, signalling

Audio Systems
 PO Box 1174
 Bismarck, ND 58502
 (701) 223-3800, 800-852-6522, in-state 800-932-8975, FAX# 701-222-8102
 Pres./Eng: Lynn Mader, VP/Sls: Lyle Mader
 Products: modular, zoned

Auditel Systems
 396 Porter Ave.
 Buffalo, NY 14201
 (716) 886-0019, FAX# 716-886-1615
 Pres.: David Langtry, Prod. Mgr.: Tony Roberson, Mkt'g Dir.: Jim Wood
 Products: mixer/preamps, modular

Bogen Communications
 PO Box 575
 Ramsey, NJ 07446
 (201) 934-8500, FAX# 201-934-9832
 Pres.: John Ochtera, VP Sls/Mkt'g: James Orr, Nat'l Sls Dir.: David Chambers
 Products: mixer/amp, mixer/preamps, modular, music distribution, telephone, zoned

Community Light & Sound
 333 E 5th St.
 Chester, PA 19013
 (215) 876-3400, 800-523-4934, FAX# 215-874-0190
 Pres.: Bruce Howze, VP Eng.: John Wiggins, VP Exp. Sls: Christine Howze, Nat'l Field Sls Mgr.: Chris Berger
 Cordial-Riley Mkt'g, Sterling Heights, MI, 313-826-8980
 Mel Foster Tech. Sls, Edina, MN, 612-941-9800
 Rob Welles, San Francisco, CA, 415-334-4477
 Pacific Audio Group, Torrance, CA, 213-719-1383
 New Resource, Norwell, MA, 617-659-1463
 Sigmet, Freehold, NJ, 201-462-1221
 Audio Mkt'g Assoc., Breckville, OH, 216-526-2426
 Powerline Mkt'g, Evanston, IL, 312-864-1147
 Evans Sls & Mkt'g, Nashville, TN, 615-297-7997
 Bencsik Assoc., Ocala, FL, 904-732-9775
 R.J. Throckmorton Sls, Ballwin, MO, 314-227-7222
 Rep Tech, Terrell, TX, 214-222-2131
 Pearson & Pearson, Denver, CO, 303-722-6996
 Vector Corp., Seattle, WA, 206-322-4343

Products: modular

Crown Int'l
 PO Box 1000
 Elkhart, IN 46517
 (219) 294-8000, FAX# 219-294-8329
 Pres./CEO: Clyde Moore, Crown Div. Head: Gil Nichols, Amplifier Prod. Dir.: Verne Searer, Sls Mgr.: Jim Beattie, Mkt'g Svcs: Gerry Barclay, Mic. Prod. Line Mgr.: Bob Herrold

J.W. DAVIS & CO.
 PO Box 26177
 Dallas, TX 75226
 (214) 651-7341, 800-527-5705, in-state 800-in TX 800-442-1564, FAX# 214-939-0328
 Pres.: Charles Griffith, VP Sls: Jack Tucker
 Products: mixer/amp, mixer/preamps, modular, music distribution, signalling, telephone, zoned

Dayton Industrial
 126 Westpark Rd.
 Dayton, OH 45459
 (513) 236-3591
 VP Sls/Mkt'g: Robert McDougall, VP Eng.: Kurt Farmer, Sr. Tech.: Frank Jaros
 Products: music distribution, telephone

DUKANE
 2900 Dukane Dr.
 St. Charles, IL 60174
 (312) 584-2300, FAX# 312-584-2370
 Pres./CEO: J. McWilliams Stone Jr., Group VP: William Finnegan, Div. G. Mgr.: Steven Deppa, Nat'l Sls Mgr.: Warren Anderson, Svce Mgr.: Cliff Carlson
 Wally Smutts, Toronto-Ont, Canada, 312-584-2300
 Doug Fellabaum, Sycamore, IL, 815-895-7573
 Don Mouritzen, Beecher, IL, 312-946-9655
 Ken Lind, St. Charles, IL, 312-584-2300
 Pete Kendal, Jacksonville, FL, 904-262-6025
 Ed Nuhring, Portland, OR, 503-244-4262
 Jim Lacey, Moreno Valley, CA, 714-243-1160

“Wheelock Add-Ons Increased My Profits.”

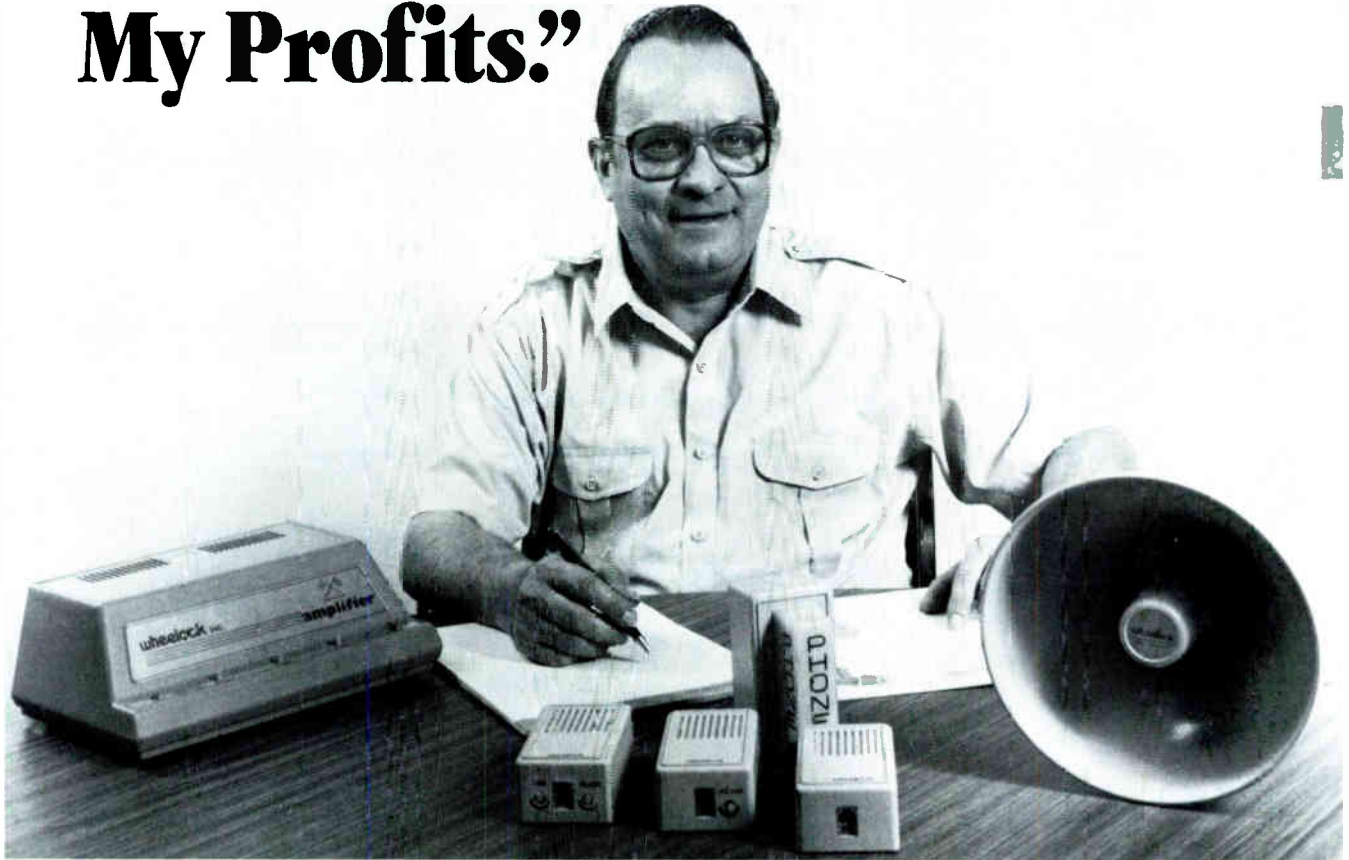

“My sales of telephone systems increased when I started selling Wheelock alert and paging products.”

With Wheelock telephone extension alerts and paging products, I'm able to win more bids because I sell total communication systems, that are easy-to-sell, easy-to-install and have an outstanding record for reliability and performance.

Only Wheelock offers me both . . .

- A complete line of telephone call alerting signals and . . .
- An innovative telephone integrated voice paging product line

The visual, audible and combination alerts solve the problem of missed phone calls in virtually any business, industrial or institutional environment.

The amplified speakers and centralized (70V) amplifier systems fulfill a wide variety of applications, and their innovative design allows me to sell the customer only what is needed, while providing for easy future expansion.

I'm able to meet my customer's requirements because of Wheelock's wide range of products, for example the new modular TelBell, is a loud, attention getting alert ideal for noisy locations and/or

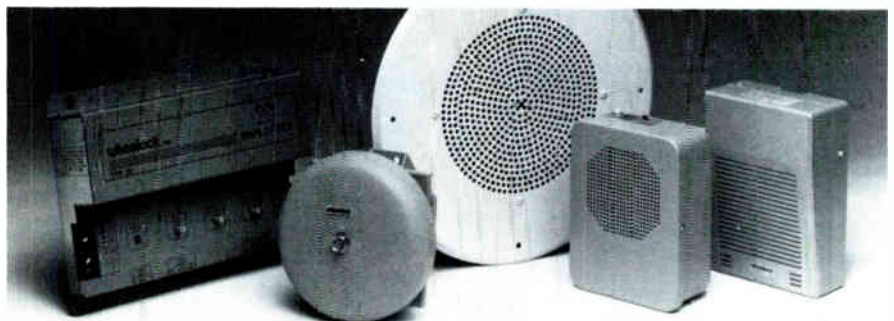

for medium to large area coverage indoors or outdoors. Zone controls have separate zones of paging plus all call, and can control one way paging speakers and talk back speakers and horns. The paging amplifiers conveniently mount on shelf or wall, and have automatic level control for telephone and microphone inputs — which maintains rated output without distortion. Voice operated background music mute is also a standard feature.

And when I call Wheelock their experienced customer service representatives expedite my orders with computerized order entry system.

For more information and a catalog on alert and paging products contact Wheelock, Inc. 273 Branchport Ave., Long Branch, NJ 07740. Telephone (201) 222-6880.

And to help you be more competitive on potential jobs you may be working on, and to save you more money contact Wheelock's Customer Service Department and ask about our current product promotion.

wheelock
INC.

Jack Brown, Dallas, TX, 214-943-7528
 Products: mixer/amp, mixer/preamps, modular, music distribution

ELENEX (WEST)

7392 Trade St.
 San Diego, CA 92121
 (619) 566-7515, 800-225-3113, in-state 800-in CA
 800-225-8037, FAX# 619-586-1484
 VP: Dennis Berglund, Eng.: Al Bitaratan, Sls: Lou Hennequin

EMS/Music

2264 15th Ave. W.
 Seattle, WA 98119
 (206) 281-8686, 800-666-6874, FAX# 206-281-0936
 Pres.: R. Kilroy Hughes, VP Sls/Mkt'g: Bernard Kron, Nat'l Sls Mgr./Con. Dist. Rep: Berg Baylin, Nat'l Sls Rep-N.: Shawn Rohrbach, Nat'l Sls Rep-S.: David Pearson, Tech. Supp. Rep: Doug Sanders

Edcor

1948 East Pomona
 Santa Ana, CA 92705
 (714) 258-0777, 800-854-0259, FAX# 714-258-7117
 Pres.: Larry Weston
 Products: mixer/amp, mixer/preamps, modular, telephone

Electro-Voice

600 Cecil St.
 Buchanan, MI 49107
 (616) 695-6831, 800-527-6701, FAX# 616-695-1304
 Pres.: Robert Pabst, VP Sls & Mkt'g: Paul McGuire, Dir. Mkt'g: Jim Long, Chief Eng.: Earl Harris
 Products: mixer/amp, mixer/preamps

Fanon Courier

14811 Myford Rd.
 Tustin, CA 92680
 (714) 669-9890, 800-345-1354, FAX# 714-669-1081
 Pres.: Frank Blaha, Dir. Sls/Mkt'g: Murray Trotiner, Dir. Eng.: Miguel Santana

Fender Musical Instruments

1130 Columbia St.
 Brea, CA 92621
 (714) 990-0909, FAX# 714-990-3986
 VP Electronic Prod.: Steve Grom

Formula Audio

Rte. 5, Box 440-3, Hwy 39
 Zebulon, NC 27597
 (919) 269-6441
 Pres.: Jeffrey Forsburg, Sec.: Susan Forsburg
 Hank Dunn Assoc., Doylestown, PA, 800-243-6875
 Raleigh Perry & Assoc., Buford, GA, 404-945-3142
 DBG Mkt'g, Montreal, Quebec, 514-488-9564
 ProTek, Plano, TX, 214-596-6065
 Products: modular

Gallien-Krueger

1355 Dell Ave.
 Campbell, CA 95008
 (408) 379-3344, FAX# 408-379-0247
 Pres.: Bob Gallien, VP Sls/Mkt'g: Rich Krueger, Mkt'g Mgr.: John Griesel, Prod. Mgr.: Bill Apfel, Controller: Lana Brown, Eng.: Michael Johns

Gilderfluke & Co.

820 Thompson Ave. #35

Glendale, CA 90212
 (818) 546-1618, FAX# 818-546-1619
 Mgr.: Mike Hopewell, Eng.: Doug Mobley, Tech.: Don Watson, Office Mgr.: Rose Preto
 Products: mixer/preamps, modular, music distribution, zoned



HARRIS/DRACON DIV.

809 Calle Plano
 Camarillo, CA 93010
 (805) 987-9511, 800-4-DRACON, FAX# 805-987-2547
 VP/G. Mgr.: John Mason, VP Sls/Mkt'g.: Jack McGuigan, Dir. Sls: Tom Erdmann, VP Eng.: Tom Durston, Mgr. Mkt'g Comm.: G. Eric Slayton, Prod. Mgr. Paging: Tom Johnson
 Duncan Way, El Toro, CA, 714-859-9932
 John Muller, Chesapeake Beach, MD, 301-257-3686
 Gary Foster, Columbia, MO, 314-442-2288
 Bob Lincoln, Inidan Rock Beach, FL, 813-595-3055
 Don Bivens, Lake Elsinore, CA, 714-244-8808
 Sam Biasi, Alexandria, BA, 703-971-5095
 Bill Boone, Libertyville, IL, 312-816-1080
 Margaret Giambalvo, Short Hills, NJ, 201-564-8508
 Mark Skilowitz, New Field, NJ, 609-697-4580
 Dave Whalen, Houston, TX, 713-974-4373

Hill Audio

5002B N. Royal Atlanta Dr.
 Tucker, GA 30084
 (404) 934-1851, FAX# 404-934-1840
 Sls Mgr.: Bob Allen, Svce Mgr.: Rick Rogers
 Products: mixer/amp

IED Innovative Electronic Designs

9701 Taylorsville Rd.
 Louisville, KY 40299
 (502) 267-7436, FAX# 502-267-9070
 VP Mkt'g & Sls: Tom Roseberry, Mkt'g Asst.: Robin Lasley, Sls App. Eng.: Jeff White, Mkt'g Adm.: Wanda R. Martin, VP Eng.: Ed Young, Pres.: Hardy Martin
 Repworks, Chicopee, MA, 413-533-0845
 Darmstedter Assoc., Baldwinville, NY, 315-638-1261
 John Anthony, Stamford, CT, 203-322-9202
 Sigmat, Valley Forge, PA, 215-783-6666
 Sacom Systems, Atlanta, GA, 404-455-0672
 Bencsik Assoc., Ocala, FL, 904-732-9775
 C.L. Pugh, Cleveland, OH, 216-238-1777
 Monford Electronics Mkt'g., Indianapolis, IN, 317-872-8877
 C.M. Sls, Farmington Hills, MI, 313-553-8070
 Ludwig Mkt'g., Kenosha, WI, 414-697-9355
 B.C. Electronic Sls, Mission, KS, 913-262-1720
 Mkt'g Concepts, Irving, TX, 214-869-0669
 Yora, White Bear Lake, MN, 612-770-9760
 Torbett/Keiser Group, Loveland, CO, 303-669-1008
 Derek Allen Assoc., Toluca Lake, CA, 818-840-8327
 Plus Four Mkt'g, Walnut Creek, CA, 415-937-0650
 North Shore Mkt'g, Seattle, WA, 206-284-9699
 Island Instruments, Kaneohe, HI, 808-235-7544
 Products: mixer/amp, mixer/preamps, modular, signalling, zoned

Industrial Research Products

415 Busse Rd.
 Elk Grove Village, IL 60007
 (312) 439-3600, 800-255-6993, FAX# 312-640-9607
 G. Mgr.: Brian Benn, Mkt'g Mgr.: Roger Carroll, Sr. Sls Eng.: Gayle Campbell, Chief Eng.: Dick Peters
 Piper Assoc., Needham, MA, 617-449-1144

Sigmat, Freehold, NJ, 201-462-1221
 Richard Pass Assoc., Langhorne, PA, 215-757-6100
 Stanin Mkt'g, Chesterion, IN, 219-929-4127
 Bencsik Assoc., Ocala, FL, 904-732-9775
 EESCO Systems, Los Angeles, CA, 213-666-9601
 Products: mixer/amp, mixer/preamps, modular

Industry West Electronics

270 N. Geneva Rd.
 Orem, UT 84057
 (801) 226-1000

JBL PROFESSIONAL

PO Box 2200
 Northridge, CA 91329
 (818) 893-8411, FAX# 818-893-3639
 Pres.: Ronald Means, VP Sls: Ken Lopez, VP Mkt'g: Mark Gander, Mkt'g Mgr.: Hector Martinez, Mkt'g Mgr.: Steve Romeo
 Jim Chase, Hermosa Beach, CA, 213-374-2128
 Bill Hamilton, Folsom, PA, 215-543-4677
 Bill Schuermann, St. Louis, MO, 314-644-2083
 Tom Walter, N. Barrington, IL, 312-382-4925

Johnson Electronics

4301 Metric Dr.
 Winter Park, FL 32792
 (407) 677-4030, FAX# 407-679-1288
 Pres./CEO: A.J. Schell, VP Mkt'g: Robert Peters, VP/Eng.: Ken St. John

KDM Electronics

705 Progress Ave., Unit #59
 Scarborough, Ontario, Canada M1H 2X1
 (416) 439-7158, FAX# 416-439-7232
 Pres.: Ron Bull, Sls Mgr.: Tom Bandini
 Givan Assoc., W. Boylston, MA, 508-835-3161
 Sigmat, Valley Forge, PA, 215-783-6666
 Henry Phillips, Roswell, GA, 404-992-3070
 Repronics, New Madison, OH, 513-996-0530
 William Linz Assoc., Deerfield, IL, 312-945-9600
 Products: mixer/amp, mixer/preamps, modular, music distribution, zoned

MCGOHAN ELECTRONICS

1033 Fairway Dr.
 Bensenville, IL 60106
 (312) 595-2342, FAX# 312-595-2919
 Pres.: Jim McGohan, VP: Ron Johnston, Sec./Treas.: Helen McGohan, Chief Eng.: Bill Everhart
 Products: mixer/amp, mixer/preamps, music distribution, signalling, telephone, zoned

McMartin Int'l

111 Camino Dil Rio
 Gunnison, CO 81230
 (303) 641-5500
 Pres.: Ray McMartin, Fin'l Adm.: Robert McMartin, Dir. Eng.: Robert German, Dir. Mfg.: Wayne Allen, Dir. Supplies/Prod.: Louise Rundock

Midwest Electronics Industries

4945 W. Belmont
 Chicago, IL 60641
 (312) 685-3500

Multi-Vox Ltd.

9967 St. Michel Blvd.
 Montreal- Nord, Quebec, Canada H1H 5G7
 (514) 321-3131
 Pres.: Jean Lajoire, Eng.: Dominique Malenfant, Op. Mgr.: Georges Morissette, Sls/Tech Coord.: Antoine Krelio

Why Should You Take a New Look at One of The Oldest Names in Commercial Sound?



Founded in 1936, University Sound holds over 100 patents and builds a broad line of commercial sound and interconnect products. As a leader in this industry, we are constantly improving existing products, and working hard to better serve our customers in every way.

Team up with University's Innovative Product Line

University products are solid and practical. Take the new PA430, a constant-directivity paging projector. It's unique because the specially-designed swivel-base can be instantly aimed and locked to distribute sound in the 2 kHz to 10 kHz range *exactly* to the desired 60° x 40° area, reducing the number of horns needed for an installation. With less materials and less time needed, you can be more competitive and more profitable at the same time.

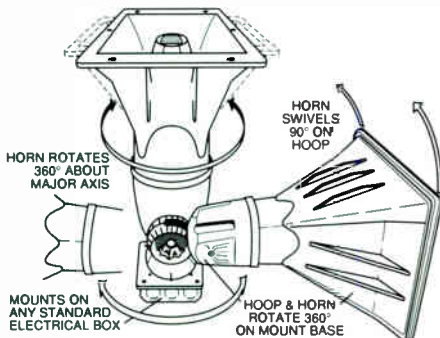

PA430 Universal Mounting System

University has also broken new ground with the US690 cardioid dynamic *gooseneck* microphone, the first commercial microphone using the N/DYM™ magnetic structure. Its super-strong Neodymium delivers 6 dB more sensitivity and permits a capsule geometry with lower peak distortion than the best of ordinary dynamic mics.

A Single Supplier Tackles Most of Your Applications

When you handle more than one type of sound system, it's easier (and more profitable) to become familiar with a single manufacturer's products. That's why we continue to expand our broad product line, which covers such diverse applications as:

- Audio Visual
- Entertainment
- Foreground/ Background Music
- Hazardous Environments
- Houses of Worship
- Motion Picture
- Music
- Paging
- Sports
- Telephone Interconnect

Get Your Hands on our Products Quickly and Economically

University products are available when you need them, directly from us or our nationwide network of Master Distributors who stock local inventory.

We Can Help You Work Smarter. Learn How...

Request our free 48-page full-line catalog, a price list, and enroll for a free subscription to **Contact**, our monthly newsletter full of useful technical information and tips to help you perfect your art. Graduate to University Sound, Inc., an institution of higher earning.



University Sound Inc.

a MARK IV company
13278 Ralston Street
Sylmar, California 91342-7607
FAX (818) 367-5292
PHONE (818) 362-9516

OXMOOR

237 Oxmoor Circle
Birmingham, AL 35209
(205) 942-6779, FAX# 205-942-9633
Nat'l Sls Mgr.: Richard Mitchell, Dir. Prod. Dev.: Joe Hanson, Prod. Mgr.: Jim Watson
ASR Enter., Lansdowne, PA, 215-259-8513
Dimension IX Mkt'g, Lewisville, TX, 214-436-3706
Evans Sls & Mkt'g, Nashville, TN, 615-297-7997
John Anthony, Stamford, CT, 212-585-2027
Yore, White Bear Lake, MN, 612-770-9760
Allwest Electronics, Camarillo, CA, 805-388-1789
Loomis & Assoc., Fremont, CA, 415-797-3500
Loppnow & Assoc., Issaquah, WA, 206-392-3936
World Wide Electronics, Pembroke Pines, FL, 305-584-7024
Repworks, Chicopee, MA, 413-533-0845
Products: music distribution

Panasonic Ind.

50 Meadowlands Pwy, M.S. 2A-8
Secaucus, NJ 07094
(201) 392-4050, FAX# 201-392-4436
Dept. Mgr.: Frank Orrow, Res. Mgr.: Art Hagiwara,
Tech. Sup. Supervisor: George Lidlow, Accts Mgr.:
Howard Anderson

Panasonic/Ramsa

6550 Katella Ave.
Cypress, CA 90630
(714) 373-7277, FAX# 714-373-7242
Sls/Mkt'g Mgr.: Steve Wooley, Mkt'g Mgr.: Chris
Foreman, W. Sls Mgr.: James Murray, Central Sls
Mgr.: Greg Braithwaite, Telemkt'g Mgr.: Carla
Campbell
James Murray, Cypress, CA, 714-373-7389
Greg Braithwaite, Arlington Heights, IL, 312-981-7329
Pusecker Sls, Upper Montclair, NJ, 201-744-1834
David Bros., Finksburg, MD, 301-833-0920

Pro Audio Assc., Burlington, MA, 617-229-6050
World Wide Electronics, Pembroke Pines, FL, 305-584-7024
Evans Sls & Mkt'g, Nashville, TN, 615-297-7997
New Horizons, Bannockburn, IL, 312-234-6500
Laker Assoc., Wauzata, MN, 612-475-2642
A/V Mkt'g, Carmel, IN, 317-846-1034
Innovative Audio, Pontiac, MI, 313-673-2280
J.B. Parent, Dublin, OH, 614-764-0064
Essential Mkt'g, St. Joseph, MO, 816-279-0776
Tenackit Assoc., Houston, TX, 713-528-2005
New West Audio, Burbank, CA, 818-955-9700
Brian Trankle Assoc., Belmont, CA, 415-595-4004
Northmar, Seattle, WA, 206-524-5170
Pearson & Pearson, Denver, CO, 303-722-6996
Products: mixer/amp, mixer/preamps

Peavey Electronics

711 A St.
Meridian, MS 39302
(601) 483-5365, FAX# 601-484-4278
Pres.: Hartley Peavey
Products: mixer/amp, mixer/preamps

Protech Audio

Flowerfield, Bldg. #1
St. James, NY 11780
(516) 584-5855, FAX# 516-584-5904
Sls Mgr.: Bill Murphy, VP Eng.: Joseph Giambone
Peregrine SW Repts, Houston, TX, 713-589-8481
Products: mixer/amp, mixer/preamps, modular, music distribution, signalling, telephone, zoned

RANE

10802 49th Ave. W.
Everett, WA 98204
(206) 355-6000, FAX# 206-347-7757
VP Mkt'g: Larry Winter, Dir. Mkt'g: Terry Pennington,

Nat'l Sls Mgr.: Ray Bloom
Products: modular

Raymer

13278 Ralston Ave.
Sylmar, CA 91342
(818) 362-9516, FAX# 818-367-5292
Pres.: Hugh T. Wilcox, Sls Support Rep: Michelle
Price, Sls Coord.: Jean Hurst
Products: mixer/amp, mixer/preamps, modular, music distribution, signalling, telephone, zoned

Senior Technology

13431 Pumice St.
Norwalk, CT 06650
(213) 802-9942, FAX# 213-802-9945
Pres.: Steve P.Y. Kim, VP: Fred K.H. Kim, Nat'l Sls
Mgr.: Irv Weisman
EESCO Systems, Los Angeles, CA, 213-666-9601
Elrep Sls, Tucker, GA, 404-938-7109
Forti & Assoc., Kensington, MD, 301-949-1706
Dobbs Stanford, Dallas, TX, 214-358-0800
Mkt'g Insights, Glenview, IL, 312-729-2047
Products: mixer/amp, music distribution, telephone, zoned

Sontec Electronics

Audio Dr.
Goldbond, VA 24094
(703) 626-7256
Sls Mgr.: Burgess Macneal
Products: modular

Sound Tech

230 Lexington Dr.
Buffalo Grove, IL 60089

				
SPEAKER ASSEMBLY WITH GRILLES	WALL BAFFLES	TRANSFORMERS	SOUND COLUMNS	ATTENUATORS & VOLUME CONTROLS
				
MOBILE PA AMPLIFIER	SOUND ENHANCER	PA AMPLIFIERS	INTERCOMS	DRIVERS
				
PA SPEAKERS & PROJECTION HORNS	BACKGROUND SOUND	MICROPHONES	SPECIALTY SPEAKERS	MEGAPHONES

Quality PA Systems,
priced to let you win the bid!

SPECO

A Totally Sound Company

1172 Route 109, P.O. Box 624 • LINDENHURST, N.Y. 11757

TOLL FREE
1-800-645-5516
IN NEW YORK
516-957-8700

(312) 541-3520, 800-877-6863, FAX# 312-541-3616
 Pres.: Rudy Schlacher, Gen. Sls Mgr.: David Beirut, Exp. Sls Mgr.: William Robinson, Sls Dir.: Todd Peren
 Products: mixer/amp, mixer/preamps

Stewart Electronics
 11460 Sunrise Gold, Ste. B
 Rancho Cordova, CA 95742
 (916) 635-3011, 800-367-7945, FAX# 916-635-1787
 Owner: Wade Stewart, Adm.: Michelle Horan
 Products: mixer/preamps

Sunn Musical Equipment
 1130 Columbia St.
 Brea, CA 92621
 (714) 990-0909, 800-854-6230, FAX# 714-990-3986
 Pres.: Bill Schultz, Dir. Mkt'g: Joe Green
 Products: mixer/amp

TOA ELECTRONICS
 PO Box 2047
 S. San Francisco, CA 94080
 (415) 588-2538, 800-843-4750, in-state 800-in CA 800-632-2157, FAX# 415-588-3349
 Pres.: Yoshiro Ishida, Nat'l Sls Mgr./Comm. Pro.: Richard Krochmal, Nat'l Sls Mgr./Pro. Music & Ent.: Rick Kamlet, Nat'l Sls Mgr./Intercom: Al Burns
 Products: mixer/amp, mixer/preamps, modular, music distribution, signalling, zoned

Tape-Athon
 13633 Crenshaw Blvd.
 Hawthorne, CA 90250
 (213) 676-6752, FAX# 213-676-9532
 Pres.: Leon "Lee" Tate, G. Mgr.: Robert Haller, Dir. Eng.: Bernard Sayers, Sls Mgr.: Rick Bottom, Mfg. Supervisor: E.W. Stokes
 Chuck Olson Assoc., WA, 206-271-5416
 Bencsik Assoc., Fl, 800-342-0197
 Murphy & Cota, NC, SC, 404-875-2525
 ASR Enter., MD, VA, 301-893-0001
 Design Factors, SC, 213-676-6752
 Products: mixer/amp, music distribution

Tascam (TEAC Professional Division)
 7733 Telegraph Rd.
 Montibello, CA 90640
 (213) 726-0303, FAX# 213-727-7656
 Mkt'g Mgr: Bill Mohrhoff, Nat'l Sls Mgr.: Gregg Hildebrandt, W. Reg. Mgr.: Fred Allard, S. Reg. Mgr.: Bill Stevens, E. Reg. Mgr.: Chuck Prada
 Products: mixer/preamps

Telephone Components
 3180 Expressway Dr. S.
 Central Islip, NY 11722
 (516) 582-4745
 Products: telephone

Uher of America
 7067 Vineland Ave.
 N. Hollywood, CA 91605

(818) 764-1120
 Pres.: John Belgiorno, G. Mgr.: Patricia Belgiorno

University Sound
 13278 Raiston St.
 Sylmar, CA 91342
 (818) 362-9516, 800-366-9516, FAX# 818-367-5292
 Mkt'g Mgr.: Jeffrey Pallin, Mat'ls Mgr.: Ann LaFontaine, Dir. Op.: Hugh Wilcox, Pres.: Bob Sandell, Prod. Mgr.: Miles Harris, Eng. Mgr.: Ken Dickson

Wheelock
 273 Branchport Ave.
 Long Branch, NJ 07740
 (201) 222-6880, 800-631-2148, FAX# 201-222-8707
 Pres.: P.W. Tarlton, VP Mkt'g: W.L. Goldstein, VP Eng.: S.W. Andrews, Mkt'g Mgr./Tel-Paging: A. Arlan, Mkt'g Mgr./Life Safe-Ind.: R. Haus
 Products: mixer/amp, mixer/preamps, signalling, telephone, zoned

Yamaha Music Corp. of America/Prof. Audio Div.
 PO Box 6600
 Buena Park, CA 90662
 (714) 522-9011, FAX# 714-522-9312
 Products: mixer/amp, mixer/preamps

PORTABLE SOUND SYSTEMS

Acoustic
 8054 Lankershim Blvd.
 N. Hollywood, CA 91605
 (818) 765-0866, FAX# 818-765-7048

ALTEC LANSING
 PO Box 26105
 Oklahoma City, OK 73126-010
 (405) 324-5311, FAX# 405-324-8981
 Pres.: Dave Merrey, VP Mkt'g: Chuck Lange, Dir. Mkt'g Dev.: Ted Uzzle, Nat'l Sls Mgr.: Jerry Spriggs, Mgr./Export Mkt'g: John Sexton, Tech. Svces Mgr.: Gary Jones

Amplified Music Products
 9829 Independence Ave.
 Chatsworth, CA 91311
 (818) 709-0518
 Pres.: Russell Allee, VP: Roger Smith, Sls Mgr.: Harvey Gerst
 Rich Armstrong, Raleigh, NC, 919-782-0274
 Bob Bryan Enter., Ft. Worth, TX, 800-367-7985
 David Lee, Bayshore, NY, 516-665-1512
 Alan Gaynor, Hanalei, Kauai, HI, 808-845-4447
 Silver Eagle, Van Nuys, CA, 818-786-8696
 Products: amps, speakers

Anchor Audio
 913 West 223rd St.
 Torrance, CA 90502
 (213) 533-5984, 800-262-4671, FAX# 213-533-6050
 Pres.: Jim Van Waay, VP Mkt'g: Jon Peirson, Reg. Sls Mgr.: Maggie Keleher, Reg. Sls Mgr.: Brad Carr, Cust. Svce: Brian Van Waay, Svce Dept.: David Halperson
 Products: DC battery powered, lecturns, megaphones, mixer amps, mixers, powered speakers, speakers

ARGOS PRODUCTS
 600 S. Sycamore St.
 Genoa, IL 60135
 (815) 784-5118
 Pres.: Donald MacLaughlin, Sls/V.P.: Ron Evers, Credit Mgr.: Rosella Johnson, Chief Eng.: Loren Schrader, Purch. Agent: Ray Melton
 Ted Firaneck Sls, Pontiac, MI, 313-373-9595
 Nevco, Crestwood, MO, 314-843-7406
 W.A. Hendrickson, N. Scituate, MA, 617-545-0652
 Maish Sls, Mulberry, IN, 317-296-2322
 TMC Sls, Ft. Lee, NJ, 201-944-8340
 Shamrock Sls, Dayton, OH, 513-258-1227
 Pacnor Mkt'g, Lynwood, WA, 206-771-6016
 Murphy & Cota, Atlanta, GA, 404-875-2525
 Mel Foster Tech. Sls, Edina, MN, 612-941-9800
 Bencsik Assoc., Ocala, FL, 904-732-9775
 Stinson Assoc., Havertown, PA, 215-446-8585
 Lewis & Dunnigan, Syracuse, NY, 315-446-5522
 Arch Hoynce, Arlington Heights, IL, 312-398-1681
 Wes Tech Mkt'g, Culver City, CA, 213-837-1398
 Meyer & Ross, Burlingame, CA, 415-348-6800
 Products: columns, DC battery powered, lecturns, speakers

BOSE—PROFESSIONAL PRODUCTS
 The Mountain
 Framingham, MA 01701
 (508) 879-7330, FAX# 508-872-6541
 G. Mgr.: David Bell, Nat'l Field Sls Mgr.: Timothy Dorwart, E. Reg. Mgr.: Robin Sibucuo, W. Reg Rep: Michael Schneider
 Products: lecturns, powered speakers, speakers

Califone Int'l
 21300 Superior St.
 Chatsworth, CA 91311
 (818) 407-2438, 800-722-0500, in-state 800-682-5300, FAX# 818-407-2405
 Pres.: Michael Custer, VP Sls/Mkt'g: Chuck Stone, Mkt'g Mgr.: Loretta Blinn
 Califone Industries, Vancouver B.C., Canada, 604-254-5148
 Products: amps, DC battery powered, lecturns, megaphones, mixer amps, powered speakers, speakers

Celestion Industries
 89 Doug Brown Way
 Holliston, MA 01746
 (508) 429-6706, FAX# 508-429-2426
 Pres.: Peter Wellikoff, Dir. Sls/Mkt'g: Barry Fox, Cust. Svce: Danielle Jacques, Svce Mgr.: Steve King
 Products: amps, powered speakers, speakers, weatherproof speakers

Cerwin-Vega
 555 E. Easy St.
 Simi Valley, CA 93065
 (805) 584-9332, FAX# 805-583-0865
 Pres.: Gene Czerwinski, VP: Connie Czerwinski, Nat'l Sls Mgr.: Rich Mandella, Tech. Sls: John Davies



ASHLY AUDIO
 100 Fernwood Ave.
 Rochester, NY 14621
 (716) 544-5191, 800-828-6308, FAX# 716-266-4589
 Pres.: William Thompson, Sr. VP: Bob French, VP: David Malloy, Office Mgr.: Ellen Price
 Products: amps

Products: speakers

Community Light & Sound

333 E 5th St.

Chester, PA 19013

(215) 876-3400, 800-523-4934, FAX# 215-874-0190

Pres.: Bruce Howze, VP Eng.: John Wiggins, VP Exp. Sls: Christine Howze, Nat'l Field Sls Mgr.: Chris Berger Cordial-Riley Mkt'g, Sterling Heights, MI, 313-826-8980
Mel Foster Tech. Sls, Edina, MN, 612-941-9800
Rob Welles, San Francisco, CA, 415-334-4477
Pacific Audio Group, Torrance, CA, 213-719-1383
New Resource, Norwell, MA, 617-659-1463
Sigmat, Freehold, NJ, 201-462-1221
Audio Mkt'g Assoc., Breckville, OH, 216-526-2426
Powerline Mkt'g, Evanston, IL, 312-864-1147
Evans Sls & Mkt'g, Nashville, TN, 615-297-7997
Bencsik Assoc., Ocala, FL, 904-732-9775
R.J. Throckmorton Sls, Ballwin, MO, 314-222-7222
Rep Tech, Terrell, TX, 214-222-2131
Pearson & Pearson, Denver, CO, 303-722-6996
Vector Corp., Seattle, WA, 206-322-4343
Products: speakers, weatherproof speakers

Crown Int'l

PO Box 1000

Elkhart, IN 46517

(219) 294-8000, FAX# 219-294-8329

Pres./CEO: Clyde Moore, Crown Div. Head: Gil Nichols, Amplifier Prod. Dir.: Verne Searer, Sls Mgr.: Jim Beattie, Mkt'g Svcs: Gerry Barclay, Mic. Prod. Line Mgr.: Bob Herold

J.W. DAVIS & CO.

PO Box 26177

Dallas, TX 75226

(214) 651-7341, 800-527-5705, in-state 800-in TX 800-442-1564, FAX# 214-939-0328

Pres.: Charles Griffith, VP Sls: Jack Tucker

Products: amps, columns, DC battery powered, megaphones, mixer amps, mixers, powered speakers, speakers, weatherproof speakers, wireless

DUKANE

2900 Dukane Dr.

St. Charles, IL 60174

(312) 584-2300, FAX# 312-584-2370

Pres./CEO: J. McWilliams Stone Jr., Group VP: William Finnegan, Div. G. Mgr.: Steven Deppe, Nat'l Sls Mgr.: Warren Anderson, Svce Mgr.: Cliff Carlson
Wally Smutts, Toronto-Ont, Canada, 312-584-2300
Doug Fellabaum, Sycamore, IL, 815-895-7573
Don Mourtzen, Beecher, IL, 312-946-9655
Ken Lind, St. Charles, IL, 312-584-2300
Pete Kendal, Jacksonville, FL, 904-262-6025
Ed Nuhning, Portland, OR, 503-244-4262
Jim Lacey, Moreno Valley, CA, 714-243-1160
Jack Brown, Dallas, TX, 214-943-7528

Products: amps, columns, DC battery powered, mixer amps, mixers, powered speakers, speakers, weatherproof speakers

ELENEX (WEST)

7392 Trade St.

San Diego, CA 92121

(619) 566-7515, 800-225-3113, in-state 800-in CA

800-225-8037, FAX# 619-586-1484

VP: Dennis Berglund, Eng.: Al Bitarafan, Sls: Lou Hennequin

EMS/Music

2264 15th Ave. W.

Seattle, WA 98119

(206) 281-8686, 800-666-6874, FAX# 206-281-0936

Pres.: R. Kilroy Hughes, VP Sls/Mkt'g: Bernard Kron, Nat'l Sls Mgr./Con. Dist. Rep: Berg Baylin, Nat'l Sls Rep-N.: Shawn Rohrbach, Nat'l Sls Rep-S.: David Pearson, Tech. Supp. Rep: Doug Sanders

Eddor

1948 East Pomona

Santa Ana, CA 92705

(714) 258-0777, 800-854-0259, FAX# 714-258-7117

Pres.: Larry Weston

Electro-Voice

600 Cecil St.

Buchanan, MI 49107

(616) 695-6831, 800-527-6701, FAX# 616-695-1304

Pres.: Robert Pabst, VP Sls & Mkt'g: Paul McGuire, Dir. Mkt'g: Jim Long, Chief Eng.: Earl Harris

Fanon Courier

14811 Myford Rd.

Tustin, CA 92680

(714) 669-9890, 800-345-1354, FAX# 714-669-1081

Pres.: Frank Blaha, Dir. Sls/Mkt'g: Murray Trotiner, Di Eng.: Miguel Santana

PORTABLE SOUND

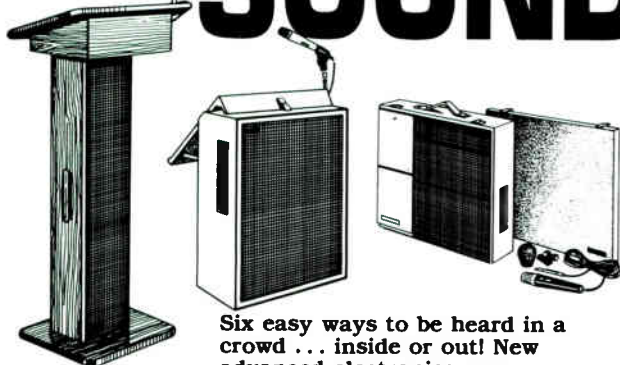

Six easy ways to be heard in a crowd... inside or out! New advanced electronics mean you simply plug-in the microphone, turn on the volume, and you're ready to go! Simple, fast, easy to use, and lightweight. Total freedom of movement with durability and dependability.

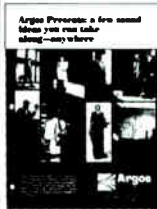

Get your new catalog of SIX different Argos portable sound systems. Simply phone or write:



Argos
SOUND

600 S. Sycamore St.
Genoa, IL 60135
phone 1-800-356-5240

A Division of Argos Products Company

Circle 61 on Reader Response Card

PAGING/TALKBACK HORN SPEAKERS

With Built-in Transformers For Indoor/Outdoor Use
Rugged Beige ABS Housings—Top Quality
Super Competitive Prices For Volume Users



MODEL #HS-12T

11" x 6-5/8" x 10-1/4" Depth
Input: 25/70 Volt Transformer & 8 OHMS Direct
Power Handling: 32 Watts
Frequency Response: 300-14,000 HZ
Sound Level: 125 DB/32W/4FT.
Impedance Taps: 2500/1250/625/312/156/83/42 OHMS
Wattage Taps: 70V 2/4/8/16/32 Watts
Dispersion Angle: 120 Degrees (Horizontal)
90 Degrees (Vertical)

MODEL #HS-17T

7-5/8" Bell Diameter x 9" Depth
Input: 25/70 Volt Transformer & 8 OHMS Direct
Power Handling: 18 Watts
Frequency Response: 350-14,000 HZ
Sound Level: 120 DB/18W/4FT.
Impedance Taps: 5000/1250/625/312.156 83 OHMS
Wattage Taps: 70V 1/2/4/8/18 Watts
Dispersion Angle: 130 Degrees



ELECTRONICS
Quality Loudspeaker Products

32 Ranick Rd.
Hauppauge, NY 11788

516-582-3400

Fax: 516-582-3229

Circle 67 on Reader Response Card

Formula Audio
 Rte. 5, Box 440-3, Hwy 39
 Zebulon, NC 27597
 (919) 269-6441

Pres.: Jeffrey Forsburg, Sec.: Susan Forsburg
 Hank Dunn Assoc., Doylestown, PA, 800-243-6875
 Raleigh Perry & Assoc., Buford, GA, 404-945-3142
 DBG Mkt'g, Montreal, Quebec, 514-488-9564
 ProTek, Plano, TX, 214-596-6065
 Products: powered speakers, speakers

Galaxy Audio
 625 East Pawnee Ave.
 Wichita, KS 67211
 (316) 263-2852

Chief Eng.: Brock Jabara, P.E., Eng.: Monte Ballard,
 Sls Mgr.: Jim Pearce
 Products: powered speakers

Gentner Electronics
 PO Box 27647

Salt Lake City, UT 84127
 (801) 975-7200, FAX# 801-977-0087

Pres./CEO: Russell Gentner, COO: William
 Trowbridge, VP Eng.: William Gillman, Dir. Mkt'g/Sls-
 Bus.: Elaine Jones, Dir. Mkt'g/Sls-Audio/Best: Gary
 Crowder, Mkt'g Coor.: Kelli Maag
 Products: mixers

Industry West Electronics
 270 N. Geneva Rd.
 Orem, UT 84057
 (801) 226-1000

JBL PROFESSIONAL

PO Box 2200
 Northridge, CA 91329
 (818) 893-8411, FAX# 818-893-3639

Pres.: Ronald Means, VP Sls: Ken Lopez, VP Mkt'g:
 Mark Gander, Mkt'g Mgr.: Hector Martinez, Mkt'g Mgr.:
 Steve Romeo
 Jim Chase, Hermosa Beach, CA, 213-374-2128
 Bill Hamilton, Folsom, PA, 215-543-4677
 Bill Schuermann, St. Louis, MO, 314-644-2083
 Tom Walter, N. Barrington, IL, 312-382-4925
 Products: amps, mixers, speakers

KDM Electronics

705 Progress Ave., Unit #59
 Scarborough, Ontario, Canada M1H 2X1
 (416) 439-7158, FAX# 416-439-7232

Pres.: Ron Bull, Sls Mgr.: Tom Bandini
 Givan Assoc., W. Boylston, MA, 508-835-3161
 Sigmat, Valley Forge, PA, 215-783-6666
 Henry Phillips, Roswell, GA, 404-992-3070
 Repronics, New Madison, OH, 513-996-0530
 William Linz Assoc., Deerfield, IL, 312-945-9600
 Products: amps, mixer amps, speakers, weatherproof
 speakers

Lectrosonics

PO Box 15900
 Rio Rancho, NM 87174
 (505) 892-4501, 800-821-1121, FAX# 505-892-
 6243

Pres.: John Arasim, VP Mkt'g: Bruce Jones
 Products: DC battery powered, lecturns, wireless

LEE DAN COMMUNICATIONS

155 Adams Ave.
 Hauppauge, NY 11788-3699
 (516) 231-1414, 800-533-3261, in-state 800-231-
 1414, FAX# 516-231-1498

Pres.: Leon Goldberg, VP Op.: Lawrence Goldberg, VP
 Finance/Admin.: David Goldberg, Sr. Sls Associate:
 Susan Leon, Office Mgr.: Rita Kaplan, Sr. Tech.:

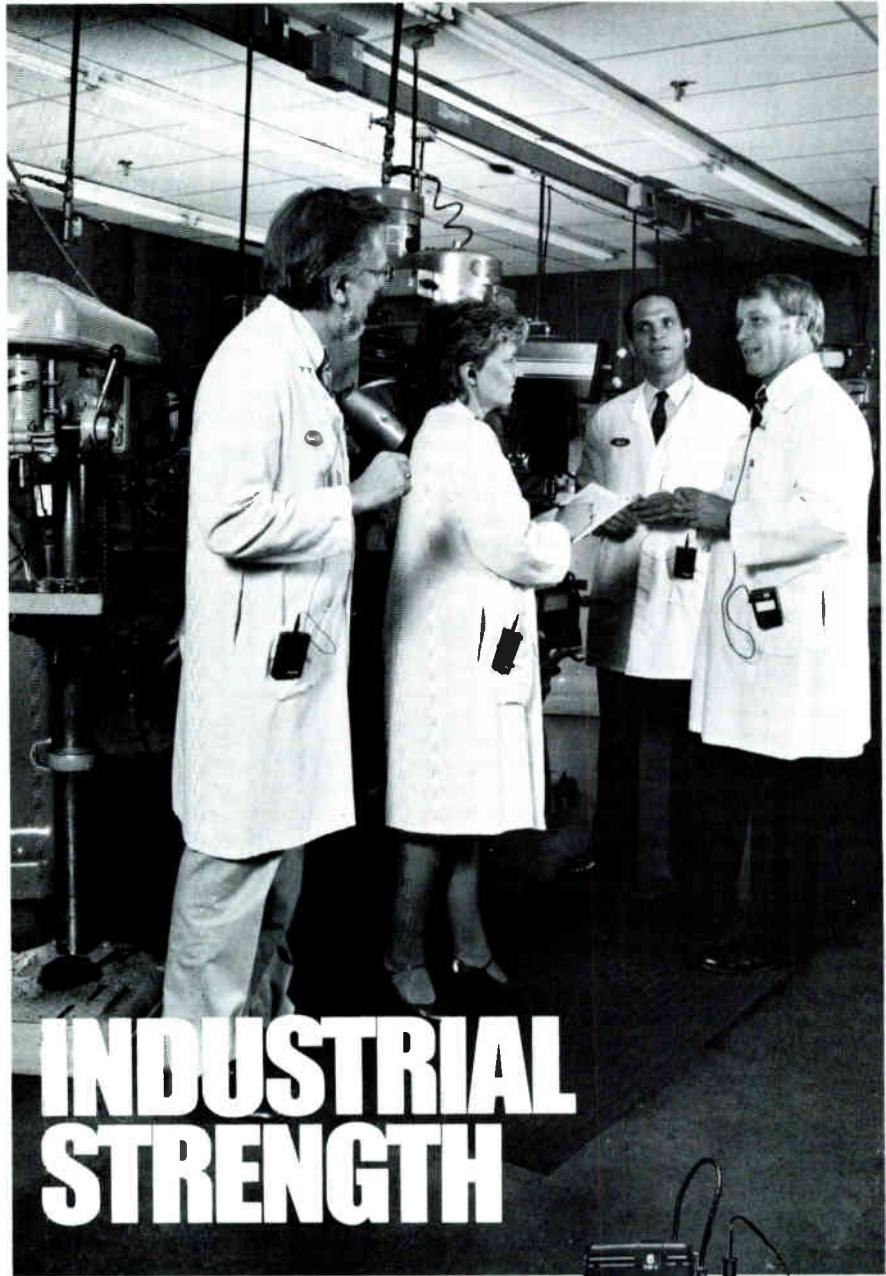

INDUSTRIAL STRENGTH

Sound Enhancement For Tours

For personal, portable communications with small or large groups, especially industrial tours and training presentations in areas surrounded by high machine noise, affordable Telex Sound Enhancement is a necessity. Crystal clear communications, even in adverse conditions, are now possible with the Telex direct-to-the-ear wireless Sound Enhancement System.

The tour guide wears the TW-6AA wireless beltpack transmitter with attached lapel microphone and the spoken message is transmitted to any number of pocket-sized, single channel or tunable personal receivers. Sound then travels from the personal receiver

directly to the listener's ear via a comfortable foam cushioned ear button.

If your plan calls for a portable sound enhancement system for any tour application, make Telex part of the plan.

For more information, contact the Professional Audio Department, Telex Communications, Inc., 9600 Aldrich Avenue South, Minneapolis, MN 55420.

© Copyright Telex Communications, Inc.

TELEX

World Radio History

Circle 271 on Reader Response Card

Sandy Hoffman

Products: amps, columns, DC battery powered, lecturns, megaphones, weatherproof speakers, wireless

MG Electronics

32 Ranick Rd.

Hauppauge, NY 11788

(516) 582-3400, FAX# 516-582-3229

Pres.: Louis Maltz, VP: Elliott Maltz, Sls Mgr.: Stan Grey

Miller Assoc., Stamford, CT, 203-869-7793

Miller Assoc., Flushing, NY, 718-464-0617

Forti Assoc., Kensington, MD, 301-949-1706

Raymar Assoc., Duncanville, TX, 214-296-9833

Products: weatherproof speakers

Magna-Sound

108-02 Otis Ave.

Corona, NY 11368

(718) 271-5200

Pres.: Ben Frankenstein, Sls/Mkt'g Mgr.: Neil Howard

Products: DC battery powered

McCauley Sound

13608 94th Ave. E.

Puyallup, WA 98373

(206) 848-0363, FAX# 206-841-3050

Pres./Sls Mgr.: Tom McCauley, VP/Prod.: Pete McCauley

MCGOHAN ELECTRONICS

1033 Fairway Dr.

Bensenville, IL 60106

(312) 595-2342, FAX# 312-595-2919

Pres.: Jim McGohan, VP: Ron Johnston, Sec./Treas.:

Helen McGohan, Chief Eng.: Bill Everhart

Nady Systems

1145 65th St.

Oakland, CA 94608

(415) 652-2411, FAX# 415-652-5075

Sls Mgr.: Royce Krilanovich, Mkt'g/Comm.: Chris Calder

Products: mixer amps, speakers, wireless

Panasonic Ind.

50 Meadowlands Pwy, M.S. 2A-8

Secaucus, NJ 07094

(201) 392-4050, FAX# 201-392-4436

Dept. Mgr.: Frank Orrow, Res. Mgr.: Art Hagiwara,

Tech. Sup. Supervisor: George Lidlow, Accts Mgr.:

Howard Anderson

Panasonic/Ramsa

6550 Katella Ave.

Cypress, CA 90630

(714) 373-7277, FAX# 714-373-7242

Sls/Mkt'g Mgr.: Steve Wooley, Mkt'g Mgr.: Chris

Foreman, W. Sls Mgr.: James Murray, Central Sls

Mgr.: Greg Braithwaite, Telemkt'g Mgr.: Carla

Campbell

James Murray, Cypress, CA, 714-373-7389

Greg Braithwaite, Arlington Heights, IL, 312-981-7329

Pusecker Sls, Upper Montclair, NJ, 201-744-1834

David Bros., Finksburg, MD, 301-833-0920

Pro Audio Assoc., Burlington, MA, 617-229-6050

World Wide Electronics, Pembroke Pines, FL, 305-

584-7024

Evans Sls & Mkt'g, Nashville, TN, 615-297-7997

New Horizons, Bannockburn, IL, 312-234-6500

Laker Assoc., Wauzata, MN, 612-475-2642

A/V Mkt'g, Carmel, IN, 317-846-1034

Innovative Audio, Pontiac, MI, 313-673-2280

J.B. Parent, Dublin, OH, 614-764-0064

Essential Mkt'g, St. Joseph, MO, 816-279-0776

Teneckit Assoc., Houston, TX, 713-528-2005

New West Audio, Burbank, CA, 818-955-9700

Brian Trankle Assoc., Belmont, CA, 415-595-4004

Northmar, Seattle, WA, 206-524-5170

Pearson & Pearson, Denver, CO, 303-722-6996

Products: amps, mixer amps, mixers, speakers

Peavey Electronics

711 A St.

Meridian, MS 39302

(601) 483-5365, FAX# 601-484-4278

Pres.: Hartley Peavey

Products: amps, columns, mixer amps, mixers, powered

speakers, speakers, weatherproof speakers

Perma Power Electronics

5601 W. Howard Ave.

Chicago, IL 60648

(312) 647-9414, FAX# 312-647-1472

Pres.: Norman Ackerman, Mkt'g Mgr.: Jay Goldstein,

Sls Mgr.: Mike Shatz

Products: columns, DC battery powered, lecturns, megaphones, weatherproof speakers

Protech Audio

Flowerfield, Bldg. #1

St. James, NY 11780

(516) 584-5855, FAX# 516-584-5904

Sls Mgr.: Bill Murphy, VP Eng.: Joseph Giambone

Peregrine SW Reps, Houston, TX, 713-589-8481

Products: amps, mixers

Radian Audio Engineering

162 E. Orangethorpe

Placentia, CA 92670

(714) 961-1213, FAX# 714-961-0869

VP Prod.: Richard Stambaugh, Dir. Mkt'g/Sls: Richard

Guy, Nat'l Sls Mgr.: Paul Shiner

Gary Semonian, Marietta, GA, 404-642-7827

Steven Taub, Silver Springs, MD, 301-622-9100

Richard Geisler, Westerville, OH, 614-890-7788

Tom Carille, Woodland Hills, CA, 818-710-9580

Dennis Dwinell, Spooner, WI, 715-635-2722

John Caporale, Redmond, WA, 206-868-5577

Carl Schwartz, Evanston, IL, 312-761-3771

Michael Welsh, Orlando, FL, 407-843-0471

John Fly, Lakewood, CO, 303-986-5999

George Markunas, Avon, MA, 508-588-8043

Wane Fuday, Fairfax, CA, 415-459-6880

Neal Hunter, Syracuse, NY, 315-437-2992

Marc Johnson, St. Charles, MO, 314-723-0400

Ronald Coll, Fairlawn, NJ, 201-791-3738

Bill Coors, Scarborough-Ont., Canada, 416-287-1144

Products: speakers

Sanming Sound

17921 Lyons Circle

Huntington Beach, CA 92647

(714) 842-9969, FAX# 714-842-9571

Sls/Mkt'g: Leon Hsieh, Pres./G. Mgr.: Hugh Hsieh,

Chief Eng.: S.W. Hsu

Design Factors, Hacienda Heights, CA, 213-697-7576

Forti Assoc., Kensington, MD, 301-949-1706

George Petitto, Berkeley, IL, 312-261-0342

Repworks, Chicopee, MA, 413-533-0845

Weller Electronic, Worthington, OH, 614-885-7819

Products: megaphones

SHURE BROTHERS

222 Hartrey Ave.

Evanston, IL 60202-3696

(312) 866-2200, FAX# 312-866-2279

Pres.: James Kogen, VP Sls: Lottie Morgan, Dir. Tech.

Mkt'g: John Phelan, Dir. Wired Mics: Alan Shirley, Dir.

Wireless Mics: Sandy Schroeder, Dir. Sls: Al Hershner

Products: amps, mixer amps, mixers, speakers, weatherproof speakers

Sieler Design Products

PO Box 2128

Gardenia, CA 90247

(213) 324-9663

Pres.: Patrice Sieler

Sound Craft Systems

Rte 3, Box 319

Morrilton, AR 72110-9532

(501) 727-5476, 800-643-8747, FAX# 501-727-

5402

Sls Mgr.: Hank Shaw, Pres.: Earle Love

Products: lecturns, powered speakers, wireless

Sound Tech

230 Lexington Dr.

Buffalo Grove, IL 60089

(312) 541-3520, 800-877-6863, FAX# 312-541-

3616

Pres.: Rudy Schlacher, Gen. Sls Mgr.: David Beirut,

Exp. Sls Mgr.: William Robinson, Sls Dir.: Todd Peren

Products: amps, mixer amps, mixers, speakers

Speco Div. Components Specialties

PO Box 624

Lindenhurst, NY 11757

(516) 957-8700, 800-645-5516, FAX# 516-956-

9142

Pres.: Louis Keller, VP G. Mgr.: James Ganci, V.P. Sls:

Mel Hulkower, Sls Mgr.: Eric Forman, Sls Expeditor:

Bernice Zachman

Products: amps, megaphones, powered speakers, speakers, weatherproof speakers

Studer Revox America

1425 Elm Hill Pike

Nashville, TN 37210

(615) 254-5651, FAX# 615-256-7619

Products: mixers

Sunn Musical Equipment

1130 Columbia St.

Brea, CA 92621

(714) 990-0909, 800-854-6230, FAX# 714-990-

3986

Pres.: Bill Schultz, Dir. Mkt'g: Joe Green

Products: amps, mixer amps, mixers, speakers

TOA ELECTRONICS

PO Box 2047

S. San Francisco, CA 94080

(415) 588-2538, 800-843-4750, in-state 800-in CA

800-632-2157, FAX# 415-588-3349

Pres.: Yoshiro Ishida, Nat'l Sls Mgr/Comm. Pro.:

Richard Krochmal, Nat'l Sls Mgr./Pro. Music & Ent.:

Rick Kamlet, Nat'l Sls Mgr./Intercom: Al Burns

Products: amps, DC battery powered, megaphones, mixer

amps, speakers, weatherproof speakers, wireless

Wissco

1599 Superior Ave., A-1

Costa Mesa, CA 92627

(714) 645-1281, 800-854-6280, in-state 800-992-

1599

Pres.: Jeanne Wanlass

Products: amps, columns, DC battery powered, lecturns,

megaphones, mixer amps, mixers, powered speakers,

speakers, weatherproof speakers, wireless

Yamaha Music Corp. of America/Prof.

Audio Div.

PO Box 6600

Buena Park, CA 90662

(714) 522-9011, FAX# 714-522-9312

Products: amps, mixer amps, mixers

PRO-AUDIO SOUND SYSTEMS & PRODUCTS

Audio Services
4210 Lankershim Blvd.
Hollywood, CA 91602
(818) 980-9891

Auditel Systems
396 Porter Ave.
Buffalo, NY 14201
(716) 886-0019, FAX# 716-886-1615
Pres.: David Langtry, Prod. Mgr.: Tony Roberson,
Mkt'g Dir.: Jim Wood
Products: distribution systems

BBE SOUND
5500 Bolsa Ave., Ste. 245
Huntington Beach, CA 92649
(714) 897-6766, 800-233-8346, FAX# 714-895-6728
Chairman: John McLaren, VP: Scott Anderson, Op Mgr.: Jennifer Drescher, Nat'l Sls Mgr.: Fred Coyner, Mkt'g Dev. Mgr.: Jim Lucas, Tech Svcs Mgr.: Ryan Coutts
Products: auxiliary accs.

BEL Electronics
745 109th St.
Arlington, TX 76011
(817) 640-6447

CAL SWITCH
13717 S. Normandie Ave.
Gardenia, CA 90249
(213) 538-9830, 800-225-7924, FAX# 213-327-2741
Products: auxiliary accs.

Carvin
1155 Industrial Ave.
Escondido, CA 92025
(619) 747-1710, 800-854-2235, FAX# 619-747-9065
Pres.: Carson Keisel, Sls Mgr.: Neal Taylor

Celestion Industries
89 Doug Brown Way
Holliston, MA 01746
(508) 429-6706, FAX# 508-429-2426
Pres.: Peter Wellikoff, Dir. Sls/Mkt'g: Barry Fox, Cust Svce: Danielle Jacques, Svce Mgr.: Steve King
Products: auxiliary accs., interface devices

Clarity
Nelson Ln.
Garrison, NY 10524
(914) 424-4071, FAX# 914-424-3467
Mkt'g Mgr.: Terry Tegarden
Products: interface devices

Communications Co.
3490 Noell St.
San Diego, CA 92110
(619) 297-3261, FAX# 619-297-3279
Exec. VP: Michael Jordan, Eng./Mfg.: David Johnson,
Order Desk: Bobby Willis, Order Desk: Laura

McCullough, Shipping: Ritchie Willis, Pres.: Peter Jordan
Audio Mkg Assoc., Brecksville, OH, 216-526-2426
Bencsik Assoc., Ocala, FL, 904-732-9775
Secom Systems, Dorrvile, GA, 800-241-9409
Brian Trankle & Assoc., Belmont, CA, 415-595-4004
Western Audio Sls, Glendale, CA, 818-246-3806
Products: auxiliary accs., distribution systems, interface devices

Communication Equipment Brokers
1500 W. Carroll Ave.
Chicago, IL 60607
(312) 829-8810, 800-621-4397
Pres.: Mark Hastings, Dir.: John Presti

Crown Int'l
PO Box 1000
Elkhart, IN 46517
(219) 294-8000, FAX# 219-294-8329
Pres./CEO: Clyde Moore, Crown Div. Head: Gil Nichols, Amplifier Prod. Dir.: Verne Searer, Sls Mgr.: Jim Beattie, Mkt'g Svcs: Gerry Barclay, Mic. Prod. Line Mgr.: Bob Herold

Datacraft
13714 S. Normandie
Gardena, CA 90249
(213) 321-2320, 800-421-2289, FAX# 213-532-9521

Decoustics
65 Disco Rd.
Toronto, Ontario, Canada M9W 1M2
(416) 675-3983, 800-387-3809, FAX# 416-675-5546
Pres.: Roy Hints, Nat'l Sls Mgr.: Steve Wilson, Mgr./Acoustic Control Sys.: Ed Romaniuk
Sls Reps in all principal cities in the U.S. and Canada

Digidesign
1360 Willow Rd., Ste. 101
Menlo Park, CA 94025
(415) 327-8811, FAX# 415-327-0777
Pres.: Peter Gotcher, COO: Paul Lego, Prod. Mkt'g Mgr.: Suz Howells

E and E Instruments Int'l
PO Box 1313
Laguna Beach, CA 92651
(714) 494-0231, FAX# 714-494-2594
VP: Ursula (Uschi) Eastman, Exp. Mgr.: Tom Brady

Electron Processing
PO Box 708
Medford, NY 11763
(516) 764-9798

Electro Rent
4209 Vanowen Pl.
Burbank, CA 91505
(818) 843-1221
CEO: Dan Greenberg, Pres.: William Weitzman

FGS Intergalactical Cartel and Holding Co.
PO Box 619
Topanga, CA 90290-0619
(213) 455-2802
Pres./CEO: Boris D. Gato, Sr. Scientist: Dennis Fink, Sr. Mkt'g: Mark Gander, Sr. Eng.: Neil Shaw

Formula Audio
Rte. 5, Box 440-3, Hwy 39
Zebulon, NC 27597
(919) 269-6441
Pres.: Jeffrey Forsburg, Sec.: Susan Forsburg
Hank Dunn Assoc., Doylestown, PA, 800-243-6875
Raleigh Perry & Assoc., Buford, GA, 404-945-3142
DBG Mkt'g, Montreal, Quebec, 514-488-9564
ProTek, Plano, TX, 214-596-6065
Products: auxiliary accs., distribution systems, interface devices

Gentner Electronics
PO Box 27647
Salt Lake City, UT 84127
(801) 975-7200, FAX# 801-977-0087
Pres./CEO: Russell Gentner, COO: William Trowbridge, VP Eng.: William Gilman, Dir. Mkt'g/Sls-Bus.: Elaine Jones, Dir. Mkt'g/Sls-Audio/Best: Gary Crowder, Mkt'g Coord.: Kelli Maag
Products: distribution systems

GEPCO INT'L
1863 W. Carroll
Chicago, IL 60612
(312) 733-9555, FAX# 312-733-6416
Pres.: Gary Geppert, Asst. To Pres.: Larry Smith Sr., Sls Mgr.: Larry Smith Jr., Op. Mgr.: Mike Geppert, Purch. Mgr.: Kathie Geary
Products: auxiliary accs., distribution systems, interface devices

Heil Ltd.
#2 Heil Dr.
Marissa, IL 62257
(618) 295-3000
Pres.: Bob Heil

Henry Engineering
503 Key Vista Dr.
Sierra Madre, CA 91024
(818) 355-3656
Owner: Hank Landsberg

IED Innovative Electronic Designs
9701 Taylorsville Rd.
Louisville, KY 40299
(502) 267-7436, FAX# 502-267-9070
VP Mkt'g & Sls: Tom Roseberry, Mkt'g Asst.: Robin Lasley, Sls App. Eng.: Jeff White, Mkt'g Adm.: Wanda R. Martin, VP Eng.: Ed Young, Pres.: Hardy Martin
Repworks, Chicopee, MA, 413-533-0845
Darmstedter Assoc., Baldwinsville, NY, 315-638-1261
John Anthony., Stamford, CT, 203-322-9202
Sigmat, Valley Forge, PA, 215-783-6666
Secom Systems, Atlanta, GA, 404-455-0672
Bencsik Assoc., Ocala, FL, 904-732-9775
C.L. Pugh, Cleveland, OH, 216-238-1777
Monford Electronics Mkt'g., Indianapolis, IN, 317-872-8877

C.M. Sis, Farmington Hills, MI, 313-553-8070
 Ludwig Mkt'g., Kenosha, WI, 414-697-9355
 B.C. Electronic Sis, Mission, KS, 913-262-1720
 Mkt'g Concepts, Irving, TX, 214-869-0669
 Yora, White Bear Lake, MN, 612-770-9760
 Torbett/Keiser Group, Loveland, CO, 303-669-1008
 Derek Allen Assoc., Toluca Lake, CA, 818-840-8327
 Plus Four Mkt'g, Walnut Creek, CA, 415-937-0650
 North Shore Mkt'g, Seattle, WA, 206-284-9699
 Island Instruments, Kaneohe, HI, 808-235-7544

Owner: Alan Pippenger, CEO: Carolyn Pippenger
 Products: auxiliary accs.

Products: auxiliary accs.

Ineptronics
 214 Wilder St.
 Philadelphia, PA 19147
 (215) 336-7747

Pres.: So Sumi, VP: Hiram Levity
 Products: interface devices

Intelix
 5618 Odana Rd.
 Madison, WI 53719-1208
 (608) 273-6333, FAX# 608-273-6336
 G. Mgr.: Steven Cohan, Dir. R & D: Michael Konkle
 Products: distribution systems

Jensen Transformers
 10735 Burbank Blvd.
 North Hollywood, AZ 91601
 (213) 876-0059, FAX# 818-763-4574
 Pres.: Deane Jensen, VP Eng.: Steve Hogan, Sis Mgr.:
 Dave Hill

Mag-Tags
 2531 W. Tharpe
 Tallahassee, FL 32303
 (904) 386-5611, FAX# 904-385-5710

Markertek Video Supply
 145 Ulster Ave.
 Saugerties, NY 12477
 (914) 246-3036, 800-522-2025, FAX# 914-246-1757

Modular Audio Products
 PO Box 488
 Barrington, IL 60011
 (312) 382-4550
 Pres.: Jim Wischmeyer
 Products: auxiliary accs., distribution systems, interface devices

Ocean Audio
 Dave Hadler
 (213) 459-2743, FAX# 213-454-6043
 Products: audio equipment broker

Opamp Labs
 1033 N. Sycamore Ave.
 Los Angeles, CA 90038
 (213) 934-3566, FAX# 213-464-0977
 Mgr.: B. Losmandy

Orban/Div. of AKG Acoustics
 645 Bryant St.
 San Francisco, CA 94107
 (415) 957-1067, FAX# 415-957-1070
 Chief Eng.: Robert Orban, G. Mgr.: John Delantoni,
 Mkt'g Mgr.: David Roudebush, Order Adm.: Gareth Paredes

OXMOOR
 237 Oxmoor Circle
 Birmingham, AL 35209
 (205) 942-6779, FAX# 205-942-9633
 Nat'l Sis Mgr.: Richard Mitchell, Dir. Prod. Dev.: Joe Hanson, Prod. Mgr.: Jim Watson
 ASR Enter., Lansdowne, PA, 215-259-8513
 Dimension IX Mkt'g, Lewisville, TX, 214-436-3706
 Evans Sis & Mkt'g, Nashville, TN, 615-297-7997
 John Anthony, Stamford, CT, 212-585-2027
 Yore, White Bear Lake, MN, 612-770-9760
 Allwest Electronics, Camarillo, CA, 805-388-1789
 Loomis & Assoc., Fremont, CA, 415-797-3500
 Loppnow & Assoc., Issaquah, WA, 206-392-3936
 World Wide Electronics, Pembroke Pines, FL, 305-584-7024
 Repworks, Chicopee, MA, 413-533-0845
 Products: distribution systems

Pacific Recorders & Engineering
 2070 Las Palmas Dr.
 Carlsbad, CA 92009
 (619) 438-3911
 Pres.: Jack Williams, Sis Mgr.: Anders Madsen, Reg. Sis Mgr.: Sandy Berenics, Reg. Sis Mgr.: Michael Uhl, Reg. Sis Mgr.: Vince Basse
 Products: distribution systems, interface devices

Panasonic/Ramsa
 6550 Katella Ave.
 Cypress, CA 90630
 (714) 373-7277, FAX# 714-373-7242
 Sis/Mkt'g Mgr.: Steve Wooley, Mkt'g Mgr.: Chris

AUDIO PRODUCTS



ES 212 — HYBRID TELEPHONE INTERFACE
\$995.



70 SERIES CONSOLE MOUNT CLOCKS AND TIMERS
\$174-\$570.

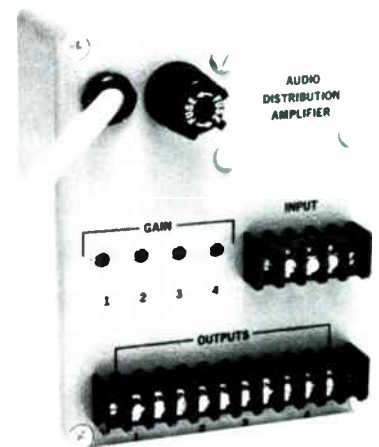

ES 217 AUDIO DISTRIBUTION AMPLIFIER \$129.

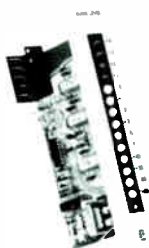

ES 214
\$ 131

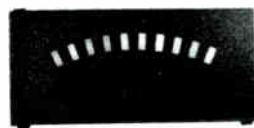

ES 216 \$63.

AUDIO LEVEL INDICATORS

142 SIERRA ST. EL SEGUNDO, CALIFORNIA 90245
 (213) 322-2136



Foreman, W. Sls Mgr.: James Murray, Central Sls Mgr.: Greg Braithwaite, Telemkt'g Mgr.: Carla Campbell
 James Murray, Cypress, CA, 714-373-7389
 Greg Braithwaite, Arlington Heights, IL, 312-981-7329
 Pusecker Sls, Upper Montclair, NJ, 201-744-1834
 David Bros., Finksburg, MD, 301-833-0920
 Pro Audio Assoc., Burlington, MA, 617-229-6050
 World Wide Electronics, Pembroke Pines, FL, 305-584-7024
 Evans Sls & Mkt'g, Nashville, TN, 615-297-7997
 New Horizons, Bannockburn, IL, 312-234-6500
 Laker Assoc., Wauzata, MN, 612-475-2642
 A/V Mkt'g, Carmel, IN, 317-846-1034
 Innovative Audio, Pontiac, MI, 313-673-2280
 J.B. Parent, Dublin, OH, 614-764-0064
 Essential Mkt'g, St. Joseph, MO, 816-279-0776
 Teneckit Assoc., Houston, TX, 713-528-2005
 New West Audio, Burbank, CA, 818-955-9700
 Brian Trankle Assoc., Belmont, CA, 415-595-4004
 Northmar, Seattle, WA, 206-524-5170
 Pearson & Pearson, Denver, CO, 303-722-6996

Brea, CA 92621
 (714) 990-0909, 800-854-6230, FAX# 714-990-3986
 Pres.: Bill Schultz, Dir. Mkt'g: Joe Green

Switchcraft
 5555 N. Elston Ave.
 Chicago, IL 60630
 (312) 792-2700, FAX# 312-792-2129
 Dir. Mkt'g: Terry Leen, Mkt'g Prod. Mgr./Audio: William Kysiak, Mkt'g Prod. Mgr./Telecomm.: R. Neidl
 Products: auxiliary accs., interface devices

Waldom Electronics
 4301 W. 69th St.
 Chicago, IL 60629
 (312) 585-1212, 800-552-1639, FAX# 312-585-7847
 P: Mario Vescovi, Sound Prod. Mgr.: Mark Baumann, Promo. Mgr.: Andrew Placco

Yamaha Music Corp. of America/Prof. Audio Div.
 PO Box 6600
 Buena Park, CA 90662
 (714) 522-9011, FAX# 714-522-9312

Touch Technologies/Gerr Electroacoustics
 363 Adelaide St. E.
 Toronto, Ontario, Canada M5A 1N3
 (416) 361-1667, FAX# 416-868-6419
 VP: Frank Pimiskern, Sls/E. Canada: Bob Vonesh, Sls/W. Canada: Reid King

Portasound-Div. of Soundcraft Systems
 PO Box 319
 Morrilton, AR 72110
 (501) 727-5543, 800-643-8747

Protech Audio
 Flowerfield, Bldg. #1
 St. James, NY 11780
 (516) 584-5855, FAX# 516-584-5904
 Sls Mgr.: Bill Murphy, VP Eng.: Joseph Giambone
 Peregrine SW Reps, Houston, TX, 713-589-8481
 Products: distribution systems

Rainbow Sound & Lighting Sales and Service
 2322 S. 64th Ave.
 Omaha, NE 68106
 (402) 554-0123
 Pres.: Nils Anders Erickson, Credit Mgr.: M.A. Thomsen, Audio Sls Mgr.: J.E. Van Horne

Sontec Electronics
 Audio Dr.
 Goldbond, VA 24094
 (703) 626-7256
 Sls Mgr.: Burgess Macneal

Spatial Sound
 743 Center Blvd.
 Fairfax, CA 94930
 (415) 457-8114, FAX# 415-457-6250
 Sls Mgr.: Dave Yancey, Pres.: Mahanta Devlas
 Products: auxiliary accs.

Spectra Sonics
 3750 Airport Rd.
 Ogden, UT 84405
 (801) 392-7531
 Pres./Owner: William Dille, Eng./Sls: Gregory Dille

Stewart Electronics
 11460 Sunrise Gold, Ste. B
 Rancho Cordova, CA 95742
 (916) 635-3011, 800-367-7945, FAX# 916-635-1787
 Owner: Wade Stewart, Adm.: Michelle Horan
 Products: interface devices

Sunn Musical Equipment
 1130 Columbia St.

The One Source Company

Brighten your future with IED's reliable, state-of-the-art total systems that can save you time and earn you money.

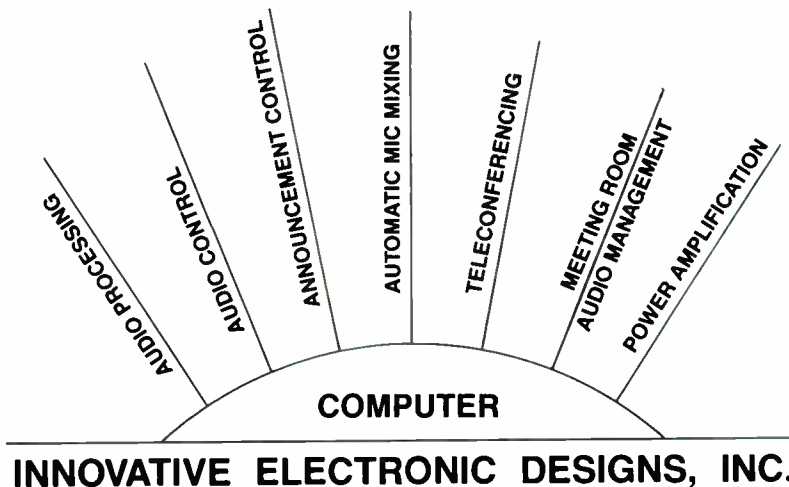

Building block structure allows custom designs for:

AIRPORTS, RACETRACKS, CONVENTION CENTERS, MEETING ROOMS, EXHIBITION HALLS, STADIUMS, ARENAS, COURTROOMS, LEGISLATIVE ASSEMBLIES, BOARDROOMS, THEATERS, SCHOOLS, CHURCHES, HOSPITALS...

IED Model 500 Audio Control System
 IED Model 500ACS Announcement Control System
 IED Model 4000 Automatic Mixer System
 IED Model 5000 Audio Processing System
 IED Model 6000 Power Amplifier System
 IED Meeting Room Audio Management System

EARN MORE TODAY WITH THE TECHNOLOGY OF TOMORROW - IED

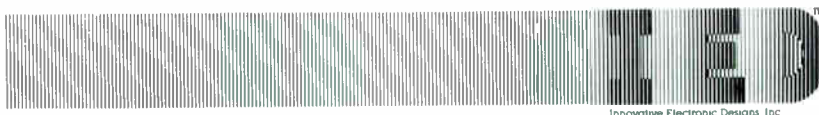

9701 Taylorsville Road
 Louisville, Kentucky 40299

For more information contact Tom Roseberry
 (502) 267-7436 Fax (502) 267-9070

Circle 284 on Reader Response Card

TUNERS & CD PLAYERS

Aiphone Intercom Systems

PO Box 90075
Bellevue, WA 98009
(206) 455-0510, 800-692-0200, FAX# 206-455-0071
Pres.: Jun Matsumoto, Sls Mgr.: Jim Morrison, Mkt'g/Adv. Mgr.: Harry Quanz
Aiphone NE, Randolph, NJ, 201-328-1790
Aiphone Midwest, Westmont, IL, 312-323-5222
Aiphone SE, Douglasville, GA, 404-920-2811
Products:AM, FM

Audio Access

363-A Vintage Pk Dr.
Foster City, CA 94404
(415) 341-9620, FAX# 415-341-0168
Mkt'g: Chris Stevens
Products:changers

Bogen Communications

PO Box 575
Ramsey, NJ 07446
(201) 934-8500, FAX# 201-934-9832
Pres.: John Ochtera, VP Sls/Mkt'g: James Orr, Nat'l Sls Dir.: David Chambers
Products:AM, FM, tuner-amps

J.W. DAVIS & CO.

PO Box 26177
Dallas, TX 75226
(214) 651-7341, 800-527-5705, in-state 800-in TX 800-442-1564, FAX# 214-939-0328
Pres.: Charles Griffith, VP Sls: Jack Tucker
Products:FM, tuner-amps

Johnson Electronics

4301 Metric Dr.
Winter Park, FL 32792
(407) 677-4030, FAX# 407-679-1288
Pres./CEO: A.J. Schell, VP Mkt'g: Robert Peters, VP/Eng.: Ken St. John
Products:FM, tuner-amps

Nakamichi America

19701 S. Vermont Ave.
Torrance, CA 90502

(213) 538-8150, 800-421-2313, FAX# 213-324-7614
Pres.: Yas Yamazaki, Exec. VP/G. Mgr.: Dean Miller, VP Sls: Jett Logan, VP Op.: Ray Privette, Mkt'g Mgr.: Jun Sakamoto

Panasonic/Ramsa

6550 Katella Ave.
Cypress, CA 90630
(714) 373-7277, FAX# 714-373-7242
Sls/Mkt'g Mgr.: Steve Wooley, Mkt'g Mgr.: Chris Foreman, W. Sls Mgr.: James Murray, Central Sls Mgr.: Greg Braithwaite, Telemkt'g Mgr.: Carla Campbell
James Murray, Cypress, CA, 714-373-7389
Greg Braithwaite, Arlington Heights, IL, 312-981-7329
Pusecker Sls, Upper Montclair, NJ, 201-744-1834
David Bros., Finksburg, MD, 301-833-0920
Pro Audio Assoc., Burlington, MA, 617-229-6050
World Wide Electronics, Pembroke Pines, FL, 305-584-7024
Evans Sls & Mkt'g, Nashville, TN, 615-297-7997
New Horizons, Bannockburn, IL, 312-234-6500
Laker Assoc., Wauzata, MN, 612-475-2642
A/V Mkt'g, Carmel, IN, 317-846-1034
Innovative Audio, Pontiac, MI, 313-673-2280
J.B. Parent, Dublin, OH, 614-764-0064
Essential Mkt'g, St. Joseph, MO, 816-279-0776
Teneckit Assoc., Houston, TX, 713-528-2005
New West Audio, Burbank, CA, 818-955-9700
Brian Trankle Assoc., Belmont, CA, 415-595-4004
Northmar, Seattle, WA, 206-524-5170
Pearson & Pearson, Denver, CO, 303-722-6996

Raymer

13278 Ralston Ave.
Sylmar, CA 91342
(818) 362-9516, FAX# 818-367-5292
Pres.: Hugh T. Wilcox, Sls Support Rep: Michelle Price, Sls Coord.: Jean Hurst
Products:AM, FM, tuner-amps

Sony Professional Audio

1600 Queen Anne Rd.
Teaneck, NJ 07666
(201) 833-5200, 800-635-SONY, FAX# 201-833-9645
Nat'l Sls Mgr.: Bob Ott, Prod. Mgr.: Art Gonzales, Mkt'g Mgr.: David Kawakami
Sony Pro Audio, Paramus, NJ, 201-368-5185
Sony Pro Audio, Nashville, TN, 615-883-8140

Sony Pro Audio, Burbank, CA, 818-841-8711

Studer Revox America

1425 Elm Hill Pike
Nashville, TN 37210
(615) 254-5651, FAX# 615-256-7619
Products:FM

TOA ELECTRONICS

PO Box 2047
S. San Francisco, CA 94080
(415) 588-2538, 800-843-4750, in-state 800-in CA 800-632-2157, FAX# 415-588-3349
Pres.: Yoshiro Ishida, Nat'l Sls Mgr./Comm. Pro.: Richard Krochmal, Nat'l Sls Mgr./Pro. Music & Ent.: Rick Kamlet, Nat'l Sls Mgr./Intercom: Al Burns
Products:AM, FM

Tascam (TEAC Professional Division)

7733 Telegraph Rd.
Montibello, CA 90640
(213) 726-0303, FAX# 213-727-7656
Mkt'g Mgr: Bill Mohrhoff, Nat'l Sls Mgr.: Gregg Hildebrandt, W. Reg. Mgr.: Fred Allard, S. Reg. Mgr.: Bill Stevens, E. Reg. Mgr.: Chuck Prada

Technics Professional

One Panasonic Way
Secaucus, NJ 07094
(201) 348-7000

Uher of America

7067 Vineland Ave.
N. Hollywood, CA 91605
(818) 764-1120
Pres.: John Belgiorno, G. Mgr.: Patricia Belgiorno

Yamaha Music Corp. of America/Prof.

Audio Div.
PO Box 6600
Buena Park, CA 90662
(714) 522-9011, FAX# 714-522-9312

HEARING ASSISTANCE SYSTEMS

ASC—Tube Traps

PO Box 1189
Eugene, OR 97440
(503) 343-9727, 800-ACS-TUBE, FAX# 503-343-9245
Pres.: Arthur Noxon, Sls: Doug Martin, Tech.: Michael Nemeth, Canadian Factory: Larry Moore, Italian Factory: Alfredo Gallacci, Japan: Gary Douglas
Rich Lomax, Hollywood, CA, 818-763-9587
Octavio Brito, Boston, MA, 617-924-0660
Sam Lynn, Chicago, IL, 312-657-7787
John Nolan, St. Louis, MO, 314-343-4765
Joe deBuglio, Toronto, Canada, 416-241-4240

Alaun Engineering

2305 Florencita Dr.
Montrose, CA 91020
(818) 957-0618
Owner/Pres.: Al Braun, VP: M. Antoniate

Auditel Systems

396 Porter Ave.
Buffalo, NY 14201
(716) 886-0019, FAX# 716-886-1615
Pres.: David Langtry, Prod. Mgr.: Tony Roberson, Mkt'g Dir.: Jim Wood
Products: closed loops inductive, infrared systems, multi-

channel

Brahler USA

12073 Tech Rd.
Silver Spring, MD 20904
(301) 680-9658, FAX# 301-680-9245
Pres.: Jack Cassell, VP: Michael Bier
Taub Sls, Silver Spring, MD

Coherent Communications

13756 Glenoaks Blvd.
Sylmar, CA 91342
(818) 362-9393, FAX# 818-362-7045

Products: closed loops inductive



Comtek
357 W. 2700 S.
Salt Lake City, UT 84115
(801) 466-3463, FAX# 801-484-6906
Pres.: Ralph Belgique, Eng. Dir.: Steve Kartchner,
Mkt'g Dir.: Steve Dupaix, Svce Mgr.: Laurel Robertson,
Credit Mgr.: Dana Pelletier, Cust. Svce: Stacey Hayes-Garcia
Products: wireless systems AM/FM

Dayton Industrial
126 Westpark Rd.
Dayton, OH 45459
(513) 236-3591
VP Sis/Mkt'g: Robert McDougall, VP Eng.: Kurt Farmer, Sr. Tech.: Frank Jaros
Products: infrared systems

LPB
28 Bacton Hill Rd.
Frazer, PA 19355
(215) 644-1123
Pres.: Richard Crompton, Sis Mgr.: John Tiedeck
Products: wireless systems AM/FM

Lectrosionics
PO Box 15900
Rio Rancho, NM 87174
(505) 892-4501, 800-821-1121, FAX# 505-892-6243
Pres.: John Arasim, VP Mkt'g: Bruce Jones
Products: wireless systems AM/FM

Nady Systems
1145 65th St.
Oakland, CA 94608
(415) 652-2411, FAX# 415-652-5075
Sis Mgr.: Royce Krilanovich, Mkt'g/Comm.: Chris Calder
Products: infrared systems

Oval Window Audio
78 Main St.
Yarmouth, ME 04096
(207) 846-6250
Dir. R & D: Norman Lederman, Mkt'g Dir.: Robert Gilmore, Ed. Dir.: Paula Hendricks
Products: closed loops inductive

Phonic Ear
250 Camino Alto
Mill Valley, CA 94941
(415) 383-4000, 800-227-0735, FAX# 415-332-3085
Pres.: James Mulford, VP: Richard Pimentel, Mgr./Business Dev.: Richar Steighner, Int'l VP: Graham Twomey, Canada Sis Mgr.: Janice Coburn, Mgr./App. Eng.: Robert Mendoza
Products: wireless systems AM/FM

Schell Electronics
120 N. Lincoln
Chanute, KS 66720
(316) 431-2350, FAX# 316-431-2365

Sis Mgr.: Janice Schell
Products: wireless systems AM/FM

Sennheiser Electronic
PO Box 987
Old Lyme, CT 06371
(203) 434-9190, FAX# 203-434-1759
Products: infrared systems, multi-channel

Siemens Hearing Instruments
10 Corporate Place S.
Piscataway, NJ 08854
(201) 562-6600, 800-345-0183, FAX# 201-562-6696
Mkt'g: Ann Wallace

Sound Craft Systems
Rte 3, Box 319
Morriton, AR 72110-9532
(501) 727-5476, 800-643-8747, FAX# 501-727-5402
Sis Mgr.: Hank Shaw, Pres.: Earle Love
Products: wireless systems AM/FM

Stewart Electronics
11460 Sunrise Gold, Ste. B
Rancho Cordova, CA 95742
(916) 635-3011, 800-367-7945, FAX# 916-635-1787
Owner: Wade Stewart, Adm.: Michelle Horan
Products: multi-channel

Telex Communications
9600 Aldrich Ave. S.
Minneapolis, MN 55420
(612) 884-4051, FAX# 612-884-0043
Pres.: Jeffrey Wetherell, VP Mkt'g: James Arrington, VP Sis: Dan Dantzer, Dir. Mkt'g: Dond Meeen, Dir Adv.: Ronald Taylor
Wes Tech/Lichtenauer, Culver City, CA, 213-870-9286
Bencsik Assoc., Ocala, FL, 904-732-9775
Burcaw & Assoc., Warren, MI, 313-573-4605
SAGA, Oswego, NY, 315-343-5739
Monfort Electronic Mkt'g, Indianapolis, IN, 317-872-8877
Murphy & Cota, Atlanta, GA, 404-875-2525
Northland Assoc., Moorhead, MN, 218-233-4616
Rancilio Assoc., St. Louis, MO, 314-845-0202
J.Y. Schoonmaker, Dallas, TX, 214-349-1650
Sigmat, Valley Forge, PA, 215-783-6666
Weller Electronic Sis, Worthington, OH, 614-885-7819
Ziskind Assoc., Rolling Meadows, IL, 312-577-1624
White Radio, Burlington-Ont., Canada, 416-632-6894
Silver Peak Mkt'g, Denver, CO, 303-467-9042
Pacnor Mkt'g, Lynnwood, WA, 206-771-6016
Products: multi-channel, wireless systems AM/FM

Vista Communications
PO Box 1622
Darien, CT 06820
(203) 656-1818, FAX# 203-655-2113
Products: closed loops inductive, infrared, multi-channel

Williams Sound
5929 Baker Rd.
Minnetonka, MN 55345-5997
(612) 931-0291, 800-328-6190, FAX# 612-931-0620
Nat'l Sis Mgr.: Todd Bergum, VP Mkt'g: Paul Ingebrigtsen, VP Eng.: Jay Kershaw, Cust. Svce Mgr.: Terry Roushar, Pres.: James M. Broz

Introducing the best in easy listening . . .



This new lightweight and inexpensive hearing assistance system is easy to install and operate.

For more information about the new Phonic Ear Easy Listener and our Dealer Support Program, call Phonic Ear – the Choice of Professionals.

800-227-0735 U.S. / 800-772-3374 CA. / 800-387-3158 Canada

))))Phonic Ear

250 Camino Alto, Mill Valley, California 94941

TEST EQUIPMENT

TEST EQUIPMENT

ACO Pacific

2604 Read Ave.

Belmont, CA 94002

(415) 595-8588, FAX# 415-591-2891

Pres.: Noland Lewis, Dir. Mkt'g/Sls: Noland Lewis

Products: bench-top instrumentation, noise & vibration analyzers, sound intensity measurement equipment & microphones

A & D Engineering

1555 McCandless Dr.

Milpitas, CA 95035

(408) 263-5333

ASC—Tube Traps

PO Box 1189

Eugene, OR 97440

(503) 343-9727, 800-ACS-TUBE, FAX# 503-343-9245

Pres.: Arthur Noxon, Sls: Doug Martin, Tech.: Michael

Nemeth, Canadian Factory: Larry Moore, Italian

Factory: Alfredo Gallacci, Japan: Gary Douglas

Rich Lomax, Hollywood, CA, 818-763-9587

Octavio Brito, Boston, MA, 617-924-0660

Sam Lynn, Chicago, IL, 312-657-7787

John Nolan, St. Louis, MO, 314-343-4765

Joe deBuglio, Toronto, Canada, 416-241-4240

Products: audio tape diagnostics, speech transmission analysis

AVNC/Instrument Div.

250 Shagbark Dr., RD #1

Cheswick, PA 15024

(412) 265-4444

Acoustilog

19 Mercer St.

New York, NY 10013

(212) 925-1365

Aegis

2115 Pico Blvd.

Santa Monica, CA 90405

(213) 392-9972, 800-345-9871, FAX# 213-392-6445

All Electronics

PO Box 567

Van Nuys, CA 91408

(818) 904-0524, 800-826-5432, FAX# 818-781-2653

Mgr. Sls: Harold Oliver

Altair Electronics

1694 Calle Zocalo

Thousand Oaks, CA 91360

(805) 529-2496

Amber Electro Design

3391 Griffith St.

St. Laurent, Quebec, Canada H4T 1W5

(514) 735-4105, 800-361-3697, FAX# 514-340-1468

Pres.: Wayne Jones, Op. Mgr.: Jacques Lagace, App.

Eng.: Michael Chang, Sr. R & D Eng.: David Hudson

Allan Crawford Assoc., Mississauga, Ontario, 416-890-

2010

Scientific Devices-W., Hn'tg. Beach, CA, 714-840-3501

RTI, Great Neck, NY, 516-829-3770

Pat Jenks Assoc., Beverly, MA, 508-921-4600

Comtel Midwest, Arlington Heights, IL, 312-392-4040

American Reliance

9241 E. Valley Blvd.

Rosemead, CA 91770

(818) 287-8400

R.B. Annis

1101 N. Delaware St.

Indianapolis, IN 46202

(317) 637-9282, FAX# 317-637-9282

Pres.: R.B. Annis, Mgr.: R.D. Hudson

Products: SPL meters

Apogee Electronics

1517 20th St.

Santa Monica, CA 90404

(213) 828-1930, FAX# 213-828-9720

Mkt'g Dir.: Grace Gehman

ARIEL

433 River Rd.

Highland Park, NJ 08904

(201) 249-2900, FAX# 201-249-2123

VP: M. Clayton, Pres.: A. Agnelio

Asaca/Shibasokui

12509 Beatrice St.

Los Angeles, CA 90066

(213) 827-7144, 800-423-6347

Audio Control Industrial

22313 70th Ave. W.

Mountlake Terrace, WA 98043

(206) 775-8461, FAX# 206-778-3166

Sls/Mkt'g Mgr.: Rick Chinn, Pres.: Thomas Walker

Audio Precision

PO Box 2209

Beaverton, OR 97075

(503) 627-0832, 800-231-7350, FAX# 503-641-8906

Pres.: Bob Metzler

Products: audio tape diagnostics, bench-top instrumentation, distortion analyzers, DSP hardware, DSP software, FFT-spectrum analyzers, FM stereo testing, MTS test equipment, realtime analyzers

BBC-Metrawatt/Goerz

2150 W. 6th Ave.

Broomfield, CO 80020

(303) 469-5231, 800-821-6327

G. Mgr.: Deric Jarvis, Mkt'g Mgr.: Brad Seavoy, Sls

Mgr.: Erik Pfanku

Banner

PO Box 1803

Shelby, NC 28150

(704) 487-7012

Barcus-Berry

5381 Production Dr.

Huntington Beach, CA 92649

(714) 898-9211, 800-854-6481, FAX# 714-898-7962

Exec. VP: John Berry

Beckman Ind'V/Instr. Prod. Div.—An

Affiliate of Emerson Electric

3883 Ruffin Rd.

San Diego, CA 92123-1898

(619) 495-3200, FAX# 619-268-0172

Pres.: R.M. Buchanan, VP Mkt'g: Jim Bordin, VP

Sales: J. McGrath, CFO/Contr.: B. Succetti, VP Op.

Int'l: G. deRisner

Stewart Hopkins, Bridgeport, NJ, 609-467-4220

Ron Roia, Dallas, TX, 214-450-5845

Michael Latham, San Diego, CA, 619-495-3200

Tom Abrahamson, Schaumburg, IL, 312-397-9390

Boonton Electronics

791 Rt. 10

Randolph, NJ 07869

(201) 584-1077, FAX# 201-584-3037

Bruel & Kjaer Instruments

185 Forest St.

Marlborough, MA 01701

(508) 481-7000, FAX# 508-485-0519

Pres.: G. Perry, VP: G. Michel, VP Finance: B.

Benedict, Mkt'g Mgr.: G. Briggs

B & K, W. Caldwell, NJ, 201-227-6100

B & K, Livonia, MI, 313-522-8600

B & K, Hoffman Estates, IL, 312-358-7582

B & K, Marietta, GA, 404-422-5200

B & K, Orange, CA, 714-978-8066

Products: bench-top instrumentation, distortion analyzers, dual-channel spectrum analyzers, FFT-spectrum analyzers, noise & vibration analyzers, precision amps, realtime analyzers, sound intensity measurement equipment & microphones, speech transmission analysis

CG Instruments

434 Windsor Park Dr.

Dayton, OH 45459

(513) 434-6952, FAX# 513-434-7643

CEO: Rob Kreyms, G. Mgr.: Greg Mann, Sls Mgr.: Dale

Mann, Inside Sls: Mary Sherman

SW Mkt'g Assoc., Dallas, TX, 214-341-8631

Adams & Assoc., Greensboro, NC, 919-272-6838

Promar Enter., Northbrook, IL, 312-564-3510

Instrumentation Specialties, Philadelphia, PA, 215-742-

0898

Pacific Coast Sls, Anaheim, CA, 714-773-1030

Products: analog multimeters, bench-top instrumentation,

cable testers, digital multimeters, oscilloscopes

Cabletronix

PO Box 3003

Newburgh, NY 12550

(914) 565-7570, 800-431-9473, in-state 800-in NY 800-

942-WIRE, FAX# 914-564-5332

Pres.: Stephen Roth, VP: Leonard Ellentuch, Sls Mgr.:

Tom Martirano

CAL SWITCH

13717 S. Normandie Ave.

Gardenia, CA 90249

(213) 538-9830, 800-225-7924, FAX# 213-327-2741

Products: bench-top instrumentation, cable testers, digital multimeters

SYSid™

The Complete Acoustic Test Instrument

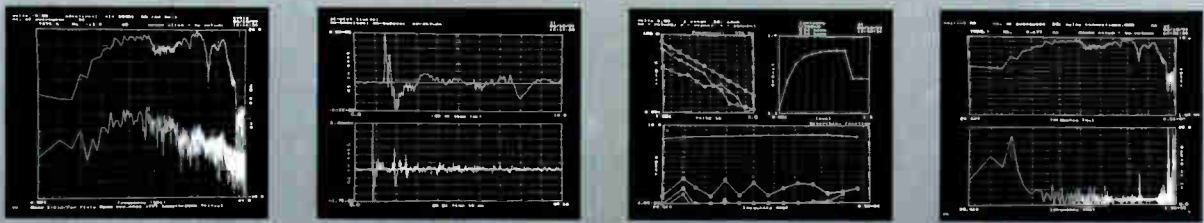

TEST SIGNAL (STIMULUS)

SYSTEM RESPONSE

SYSTEM RESPONSE

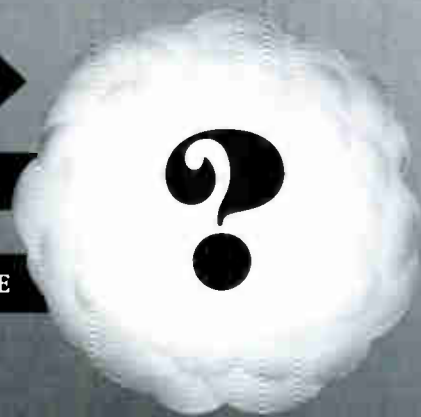

True system identification requires complete characterization of an unknown system's response. SYSid™ is the inexpensive, accurate instrument for characterizing any system operating from DC to 25kHz.

Developed in conjunction with AT&T Bell Labs, SYSid quickly does the work that used to require several costly instruments. In seconds, SYSid measures and displays:

- Impulse and time domain response
- Transfer function
- Harmonic distortion
- Intermodulation distortion
- Noise floor measurements
- Ratiometric measurements
- Complex impedance measurements

SYSid's 16-bit, 50kHz converters, double precision integer averaging and floating point signal analysis ensure consistent and precise measurements.

- Unbeatable price/performance ratio
- Self-contained within your PC
- Completely portable for field testing

When used to study or test transducers, measure room acoustics, perform structural analysis, or analyze any other audio bandwidth system, SYSid is the cost effective, complete acoustic test instrument.

Ariel

Call Today For More Information:

201-249-2900

Ariel Corporation, 433 River Road, Highland Park, NJ 08904
FAX: 201-249-2123 / DSP BBS: 201-249-2124 / Telex: 4997279 ARIEL

SYSid requires an IBM compatible PC with floating point coprocessor and graphics capability.
IBM is a registered trademark of International Business Machines Inc.

Circle 214 on Reader Response Card

world radio history

Celestial Software
125 University Ave.
Berkeley, CA 94710
(415) 420-0300

Chadwick Helmuth
4601 N. Arden Dr.
El Monte, CA 91731
(818) 575-6161

Computational Systems
835 Innovation Dr., Ste. 110
Knoxville, TN 37932
(615) 675-2110, FAX# 615-675-3100
Dir. Mkt'g: E. Forrest Pardue, Sls Mgr.: David Petersen, Inside Sls Mgr.: David Murray, Int'l Sls Mgr.: Joe Petersen
Bob Bryan, Union, MS, 314-583-3698
Terry Marsh, Knoxville, TN, 615-675-2110
Bob Martin, Berkley, MI, 313-541-3333
Dave Zimny, Knoxville, TN, 615-675-2110
Products: dual-channel spectrum analyzers, FFT-spectrum analyzers, noise & vibration analyzers

Contact East
335 Willow St. S.
N. Andover, MA 01845
(508) 682-2000, 800-225-5370, FAX# 508-688-7829
Pres.: Kai Juel, Cust Svcs. Mgr.: Jayne Handscom
Contact East, Wallingford, CT, 203-265-9333

Creteac Signal Computer USA
3337 Kifer Rd.
Santa Clara, CA 95051
(408) 738-3744, 800-222-2688, FAX# 408-749-8172
App. Eng.: Robert Campbell, Sls Mgr.: Paula Nelson
Advanced Product Sls, Westlake Village, CA, 818-706-8351
Saber Assoc., Melbourne, FL, 800-327-0853
Scientific Devices, Richardson, TX, 214-231-8106
ByTech Assoc., Hunt Valley, MD, 301-584-2528
Mark Robert Assoc., Mt. Arlington, NJ, 201-398-8425
Products: bench-top instrumentation, digital multimeters, digital storage oscilloscopes

Cyborg
94 Bridge St.
Newton, MA 02158
(617) 964-9020, FAX# 617-332-8819

DSP Development
One Kendall Square
Cambridge, MA 02139
(617) 577-1133, FAX# 617-577-8211
Pres.: Morris Samit, Dir. Eng.: Randy Race

Dallas Instruments
10205 Plano Rd.
Dallas, TX 75238
(214) 349-1180, 800-527-7071, FAX# 214-348-7044

Data Check
9918 Via Pasar
San Diego, CA 92126
(619) 578-0101, FAX# 619-566-2014

Data Physics
1210 S. Bascom Ave., Ste. 224
San Jose, CA 95128
(408) 977-0800, FAX# 408-977-0801
Pres.: Sri Welaratna, Chairman: Dave Snyder, Dir.

Mkt'g: Bill Nilsson
SPSI, Laurel, MD, 301-953-0110
WKM Assoc., Dayton, OH, 513-434-7500
Beckrep, Saugerties, NY, 914-246-3031
Keyser Tech, Albuquerque, NM, 505-828-1111
K-Rep, San Diego, CA, 619-457-9654

Data Precision, Div. Analogic
8 Centennial Dr.
Peabody, MA 01961
(617) 246-1600

Davis Instruments Mfg.
513 E. 36th St.
Baltimore, MD 21218
(301) 243-4301, 800-368-2516, FAX# 301-889-3442

Dorough Electronics
5221 Collier Pl.
Woodland Hills, CA 91364
(818) 999-1132, FAX# 818-998-1507
CEO: Mike Dorough

Dunegan Div., Physical Acoustics
19-B Thomas St.
Irvine, CA 92718
(714) 380-1544, FAX# 714-951-1269

Dynamic Software Systems
6272 Guyson Ct.
Pleasanton, CA 94566
(415) 484-1111

Dynasound
6439 Atlantic Blvd.
Norcross, GA 30071
(404) 242-8176, FAX# 404-242-8858
Products: function generators

Endevco
30700 Rancho Viejo Rd.
San Juan Capistrano, CA 92675
(714) 493-8181, FAX# 714-661-7231

John Fluke Mfg.
PO Box 9090
Everett, WA 98206
(206) 347-6100, 800-426-0361

GHI Systems
916 N. Western Ave., 201
San Pedro, CA 90732
(213) 548-6544

GenRad
300 Baker Ave.
Concord, MA 01742
(617) 369-4400

Gold Line
PO Box 500
W. Redding, CT 06896
(203) 938-2588, FAX# 203-938-8740
Pres.: Martin Miller, VP: Lennart Landelius, VP Sls: Marj Miller, Customer Svcs.: Lynette Falls
Pro Musica, Keene, NH, 603-352-4831
George Connaen, Springfield, PA, 215-544-5884
Pro Musica, Jersey City, NJ, 201-434-5516

Grozier Technical Systems
157 Salisbury Rd.

Brookline, MA 02146
(617) 277-1133
Pres.: Richard Cann

Gulton Industries/Servonic Div.
1644 Whittier Ave.
Costa Mesa, CA 92627
(714) 642-2400

HARRIS/DRACON DIV.
809 Calle Plano
Camarillo, CA 93010
(805) 987-9511, 800-4-DRACON, FAX# 805-987-2547
VPG, Mgr.: John Mason, VP Sls/Mkt'g.: Jack McGuigan, Dir. Sls: Tom Erdmann, VP Eng.: Tom Durston, Mgr. Mkt'g Comm.: G. Eric Slayton, Prod. Mgr. Paging: Tom Johnson
Duncan Way, El Toro, CA, 714-859-9932
John Muller, Chesapeake Beach, MD, 301-257-3686
Gary Foster, Columbia, MO, 314-442-2288
Bob Lincoln, Inidan Rock Beach, FL, 813-595-3055
Don Bivens, Lake Elsinora, CA, 714-244-8808
Sam Biasi, Alexandria, BA, 703-971-5095
Bill Boone, Libertyville, IL, 312-816-1080
Margaret Giambalvo, Short Hills, NJ, 201-564-8508
Mark Skilowitz, New Field, NJ, 609-697-4580
Dave Whalen, Houston, TX, 713-974-4373

Harrison Systems
PO Box 22964
Nashville, TN 37202
(615) 834-1184, FAX# 615-834-1365
VP Sls/Mkt'g: Claude Hill, VP Mkt'g Comm.: Brad Harrison, VP Broadcast Sls: Dave Purple, Broadcast Prod. Mgr: Martin Burns, Eric Johnson

Hewlett-Packard
3000 Hanover St.
Palo Alto, CA 94304
(415) 857-1501, FAX# 415-857-5518

Hoffend & Sons
34 E. Main St.
Honeoye, NY 14471
(716) 229-5998, FAX# 716-229-2746

Honeywell Test Instruments Div.
PO Box 5227
Denver, CO 80217
(303) 773-4700, 800-231-8202, FAX# 303-773-4762

IQS
12812-J Garden Grove Blvd.
Garden Grove, CA 92643
(714) 539-7842, FAX# 714-556-8325
Pres.: William Elder, VP: Douglas Evered
Products: DSP hardware, DSP software, FFT-spectrum analyzers

Ivie
1366 W. Center
Orem, UT 84057
(801) 224-1800, FAX# 801-224-7526
Pres.: Craig Berry, Prod. Mgr.: Larry Driskill, Mkt'g Mgr.: Glen Meyer, Prod. Mgr.: Bob Greene, Sls Coord.: Georgia Hall, Cust. Svcs.: Lou Brown
Products: bench-top instrumentation, noise & vibration analyzers, realtime analyzers, RT60 meters, sound intensity measurement equipment & microphones, SPL meters

Iwatsu America
430 Commerce Blvd.
Carlstadt, NJ 07072

(201) 935-8580

Kay Elemetrics

12 Maple Ave.

Pine Brook, NJ 07058

(201) 227-2000, FAX# 201-227-7760

Pres.: John Crump, Sls Mgr.: Stephen Crump, Dir.
Eng.: Bill Harbeson, Purch. Agent: Marsden Shaw,
Controller: George Zolnowski, Dir. Adv.: Cathy Ditzig

Keithley Instruments Div.

28775 Aurora Rd.

Cleveland, OH 44139

(216) 248-0400, 800-552-1115

Kinometrics/TrueTime

3243 Santa Rosa Ave.

Santa Rosa, CA 95407

(707) 528-1230

VP/G. Mgr.: John vanGroos, Sls Mgr.: Rick Dielman,
Eng. Mgr.: Ed Petroka, Prod. Mgr.: Gerry Wilson,
Purch. Agent: Chuck Hundley

Krohn-Hite

255 Bodwell St.

Avon, MA 02322

(617) 580-1660, 800-582-1660, FAX# 508-583-8989

LEQ Measurements

175 Advance Blvd.

Brampton, Ontario, Canada L6T 4J1

(416) 791-3440

Larson-Davis Labs

1681 W. 820 N.

Provo, UT 84601

(801) 375-0177, FAX# 801-375-0182

Pres.: Brian Larson, VP Eng.: Larry Davis, Dir. Mkt'g:
John Carey
Ichirop, Sunnyvale, CA, 408-737-2220
Parameter Measurement, Friendswood, TX, 713-482-8471
Microspec, Lilburn, GA, 404-921-3840
Electro Sls, Livonia, MI, 313-421-7500
db Environmental, Fayetteville, NY
Products: dual-channel spectrum analyzers, FFT-spectrum analyzers, noise & vibration analyzers, realtime analyzers, RT60 meters, sound intensity measurement equipment & microphones, SPL meters

Leader Instruments

380 Oser Ave.

Hauppauge, NY 11788

(516) 231-6900, 800-645-5104, FAX# 516-231-5295

Pres.: S. Hirota, VP: R. Sparks
Products: analog multimeters, bench-top instrumentation, digital multimeters, digital storage oscilloscopes, function generators, oscilloscopes, RF signal generators, vector scopes, video test signal generators, waveform recorders

Leasametric Instrument Rental

Division

1164 Triton Dr.

Foster City, CA 94404

(800) 553-2255, 800-553-2255

G. Mgr.: Rick Warp, Prod. Mgr.: Mike Nelson

MG Electronics

32 Ranick Rd.

Hauppauge, NY 11788

(516) 582-3400, FAX# 516-582-3229

Pres.: Louis Maltz, VP: Elliott Maltz, Sls Mgr.: Stan Grey

Miller Assoc., Stamford, CT, 203-869-7793
Miller Assoc., Flushing, NY, 718-464-0617
Forti Assoc., Kensington, MD, 301-949-1706
Raymar Assoc., Duncanville, TX, 214-296-9833

MetraByte

440 Myles Standish Blvd.

Taunton, MA 02780

(508) 880-3000, FAX# 508-880-0179

Pres.: John Powderly, Chairman: Barry Phillips, VP
Mkt'g: Bob Judd, VP Sls: Bendrix Bailey, VP Eng.:
Richard Robbins

Metrosonics

PO Box 23075

Rochester, NY 14692

(716) 334-7300

Meyer Sound Laboratories

2832 San Pablo Ave.

Berkeley, CA 94702

(415) 486-1166, FAX# 415-486-8356

Dir. Int'l Sls/Mkt'g: George Douglas, Dir. Tech. Mkt'g:
Mark Johnson, Nat'l Sls Mgr.: Cindy Ramos, Cust.
Svce Mgr.: Herb Heinz

MICROAUDIO

4438 S.W. Hewett

Portland, OR 97221

(503) 292-8896, 800-445-1248, FAX# 503-292-8896

Pres.: Eugene Rimkeit, VP: David Elsbernd, Dir. Sls:
Jim Bryant, Dir. Eng.: Richard Schomburg
Sigmat, Valley Forge, PA, 215-783-6666
Professional Sound, Lakewood, CO, 303-986-5999
Western Audio, Glendale, CA, 818-246-3806
Powerlines, Evanston, IL, 312-864-1147
Worldwide, Fort Lauderdale, FL, 305-584-7095
Products: realtime analyzers

Micro-Trak

620 Race St.

Holyoke, MA 01040

(413) 594-8501

Multigon Industries

559 Gramatan Ave.

Mt. Vernon, NY 10522

(914) 664-7300

VP: William Stern, Norman Fayne, Robert Frumm,
Fishel Botnick, Bernard Miller

Music Supply

809 N. Madison

Dallas, TX 75208

(214) 946-8450, 800-527-1522, FAX# 214-946-9155

Pres.: W.E. Brown, Sls: Betty Brown

Neutrik USA

1600 Malone St.

Millville, NJ 08332

(609) 327-3113, FAX# 609-825-4804

G. Mgr.: James Cowan, Prod. Mgr.: William Dorman,
Prod. Mgr.: Kenneth Smalley

Products: bench-top instrumentation, sound intensity measurement equipment & microphones

Nicolet, Test Equipment

PO Box 4288

Madison, WI 53711

(608) 273-5008, 800-356-3090, FAX# 608-273-5061

Non-Linear Systems/Div. of Kaypro

533 Stevens Ave.

Solana Beach, CA 92075

(619) 481-4300, FAX# 619-755-6029

G. Mgr.: Ben Fisher, Sls Mgr.: Jeanne Simmons
Products: bench-top instrumentation, digital multimeters, metering systems, oscilloscopes

Norland

Norland Dr.

Fort Atkinson, WI 53538

(414) 563-8456, 800-333-8456, FAX# 414-563-8456 ext. 339

North America Soar

1126 Cornell Ave.

Cherry Hill, NJ 08002

(609) 488-1060

Panasonic Ind.

50 Meadowlands Pwy, M.S. 2A-8

Secaucus, NJ 07094

(201) 392-4050, FAX# 201-392-4436

Dept. Mgr.: Frank Orrow, Res. Mgr.: Art Hagiwara,
Tech. Sup. Supervisor: George Lidlow, Accts Mgr.:
Howard Anderson

Panasonic Ind./Instrumentation Dept.

Two Panasonic Way

Secaucus, NJ 07094

(201) 392-4050, FAX# 201-392-4436

G. Mgr.: Milton Landau, Nat'l Sls Mgr.: Joseph Goetz,
Tech Sup. Mgr.: Robert Klein

Princeton Applied Research

PO Box 2565

Princeton, NJ 08550

(609) 452-2111

Progressive Electronics

325 S. El Dorado

Mesa, AZ 85202

(602) 966-2931, 800-528-8224, FAX# 602-967-8602

Sls Mgr.: Scott Anderson, Mkt'g/Sls: Lisa M. Rudy,
Distr. Mgr.: Michael J. Horn, Sls Rep.: RJ Anderson,
Pres./CEO: Richard L. Anderson

Quest Electronics

510 S. Worthington St.

Oconomowoc, WI 53066

(414) 567-9157, 800-558-9526, FAX# 414-567-4047

Nat'l Sls Mgr.: James Banach, Asst. Mgr.: Riita
Suechting

RAG Electronics

21418 Parthenia St.

Canoga Park, CA 91304

(818) 998-6500

Prod. Mgr.: Peter Kesselman, VP: Keith Gertzman

R.C. Electronics

5386 Hollister Ave.

Santa Barbara, CA 93111

(805) 964-6708

Pres.: Richard Renck, VP Mkt'g: Chao-Sun Pang, VP:
Brian Scarminach

RE Instruments

31029 Center Ridge Rd.

Westlake, OH 44145

(216) 871-7617

Pres.: Joergen Voldby, AE Steve Watts, Adv. Mgr.: T. Zavesky

Rapid Systems

433 N. 34th St.
Seattle, WA 98103
(206) 547-8311

Pres.: John Overbeck, Chief Eng.: Mark Casebolt, VP
Mkt'g: Bo Ray, App. Eng.: Mark Olsen

Rion Instrument Div., Mott Assoc.

PO Box 42546
Houston, TX 77042
(713) 777-5509, FAX# 713-777-3126

Riser-Bond Instruments

PO Box 188
Aurora, NE 68818
(402) 694-5201, FAX# 402-694-2386

Pres.: Marshall Borchert, Dir. Op.: Jannie Borchert, Dir.
Sls/Mkt'g: Walter Campbell, Tech. Svcs: Douglas
Hartzell, Sls/Mkt'g Svcs: Linda Fangman

Rockland Scientific

10 Volvo Dr.
Rockleigh, NJ 07647
(201) 767-7900, FAX# 201-767-1890

Rohde & Schwarz-Polarad

5 Delaware Dr.
Lake Success, NY 11042
(516) 328-1100

SPM Instrument

359 N. Main St.
Marlborough, CT 06447
(203) 295-8241, FAX# 203-295-0182

Scantek

51 Monroe St., #1606
Rockville, MD 20850
(301) 279-9308, FAX# 301-279-9309
Pres.: Richard Peppin P.E.
ESC, St. Louis, MO, 314-725-0933
Klaveness & Assoc., Fair Oaks, CA, 916-967-6312
Lee Assoc. Mid South, Huntsville, AL, 205-633-6312
Geneq, Toronto, Canada, 416-747-9889

Schlumberger Instruments

20 North Ave.
Burlington, MA 01803
(617) 229-4825, 800-225-5765, FAX# 617-229-4885
VP G. Mgr.: Kent Morgan, E. Instr. Sls Mgr.: John
Jansen, W. Instr. Sls Mgr.: Floyd Grissler, Nat'l Sls
Mgr.: Dick Hamel

Scientific-Atlanta, Spectral Dynamics

Div.
PO Box 23575
San Diego, CA 92123
(619) 268-7100, 800-231-6753, FAX# 619-268-7047
Products: dual-channel spectrum analyzers, FFT-spectrum
analyzers

Scott Instrument Lab., Div. of Lindley

40 Roselle St.
Mineola, NY 11501
(516) 746-6505, FAX# 516-746-6510

Sencore

3200 Sencore Dr.
Souix Falls, SD 57107
(605) 339-0100, 800-843-3338, FAX# 605-335-6379
Pres.: Al Bowden, Exec. VP/Sls & Mkt'g: Doug
Bowden, Merch. Mgr.: Rob Barden, Telemkt'g Mgr.:

Garrett Carter

Products: bench-top instrumentation, cable testers, digital
multimeters, FM stereo testing, function generators, MTS
test equipment, oscilloscopes, RF signal generators, sound
intensity measurement equipment & microphones, video test
signal generators

Sharp Electronics, Instrumentation

Div.
PO Box 588
Paramus, NJ 07652
(201) 529-8200

Shigma/Ono Soki C. Ltd.

80 Martin Ln.
Elk Grove Village, IL 60007
(312) 640-8640, 800-323-0315, FAX# 312-640-1276

SIGNology

1750 Silacci Dr.
Campbell, CA 95008
(408) 374-6464
Pres.: Bill Huber, Sls Mgr.: Dick Benson

Simpson Electric

853 Dundee Ave.
Elgin, IL 60120
(312) 697-2260, FAX# 312-697-2272
Pres.: H.B. Washburn, Sec./Treas.: D.S. Anderson,
Dir. Mkt'g: M.J. Scala, Dir. Eng.: J.C. Reich
Products: analog multimeters, bench-top instrumentation,
digital multimeters, function generators, sound intensity
measurement equipment & microphones, SPL meters, video
test signal generators

Soltec

Sol Vista Pk.
San Fernando, CA 91340
(818) 365-0800
Pres.: Marvin Solomon, VP Sls E. Reg.: Byron
McIntire, VP Sls W. Reg.: Gary Paiser

Sound Technology

1400 Dell Ave.
Campbell, CA 95008
(408) 378-6540, 800-359-5080, FAX# 408-378-6847
Pres.: Bud Rees, Sls: Ester Fruittos
Atlantic Mkt'g Svcs, Charlotte, NC, 704-542-3380
Keiser & Assoc., Bountiful, UT, 801-298-8902
Dave Daniels Sls, Cypress, CA, 714-891-5048
Charles Lucas Sls, Dallas, TX, 214-330-8181

Speco Div. Components Specialties

PO Box 624
Lindenhurst, NY 11757
(516) 957-8700, 800-645-5516, FAX# 516-956-9142
Pres.: Louis Keller, VP G. Mgr.: James Ganci, V.P. Sls:
Mel Hulkower, Sls Mgr.: Eric Forman, Sls Expeditor:
Bernice Zachman
Products: analog multimeters, digital multimeters

A.W. Sperry Instruments

245 Marcus Blvd.
Hauppauge, NY 11788
(516) 231-7050
Pres.: Fred Malawista, VP Sls/Mkt'g: Dennis Carroll,
Controller: Rebecca Bellinato, Eng. Mgr.: Ed Grenzti,
Asst. to VP: Roseann Bedell

Structural/Kinematics

950 Maplelawn
Troy, MI 48084
(313) 643-4622
TECHRON, DIV. OF CROWN INT'L
1718 W. Mishawaka Rd.
Elkhart, IN 46517
(219) 294-8300, FAX# 219-294-8329

TEF Mkt'g: Larry Shank, TEF Mkt'g Mgr.: Bill Landow,
TEF Sls Sec.: Linda Jervis
Products: dual-channel spectrum analyzers, FFT-spectrum
analyzers, RT60 meters, speech transmission analysis

Tektronix, Signal Analysis Unit

1350 Dell Ave., Unit 104
Campbell, CA 95008
(408) 374-6464, 800-234-1256, FAX# 408-374-6467
Bus. Unit Mgr.: Bill Huber, Mkt'g Mgr.: Rick Wills, App.
Eng. Mgr.: Loren Enochson
Dave Gamari, Boston, MA, 617-861-6800
Tom Villano, Washington, DC, 301-948-7151
Chris Tuft, Knoxville, TN, 615-690-6422
Gordon Bruch, Detroit, MI, 313-478-5200
Jon Milbrandt, Chicago, IL, 312-259-7580
Bill Davis, Dallas, TX, 214-550-0525
Dick Baldrige, Santa Clara, CA, 408-496-0800
Hans Hellsund, Irvine, CA, 714-660-8080
Jeff Smith, Los Angeles, CA, 818-999-1711
Products: distortion analyzers, DSP hardware, DSP soft-
ware, dual-channel spectrum analyzers, FFT-spectrum
analyzers, function generators, noise & vibration analyzers,
realtime analyzers, waveform recorders

TeleMatic (division of UXL Corp.)

108-02 Otis Ave.
Corona, NY 11368
(718) 271-5200
Pres.: Ben Frankenstein, Sls Mgr.: Neil Howard, CE
Salverio Guardi, Office Mgr.: Dorothy Davis

Tentel

1506 Dell Ave.
Campbell, CA 95008
(408) 379-1881, 800-538-6894, FAX# 916-939-4114

VIZ Test Equipment

335 E. Price St.
Philadelphia, PA 19144
(215) 844-2626, FAX# 215-844-4410

Vertigo Recording Products

12115 Magnolia Blvd., #116
N. Hollywood, CA 91607
(818) 907-5161
Chief Eng.: Charles Bolois, Asst Sls: Kevin Kaiser

Wavetek San Diego

9045 Balboa Ave.
San Diego, CA 92123
(619) 279-2200, FAX# 619-565-9558

Westpark Communications.

2408 Superior Dr.
Arlington, TX 76013
(817) 469-1144
Pres.: Jim Burke, VP Mkt'g: Sam Smith, VP Eng.: Larry
Norris

Zonic A & D

2000 Ford Circle
Milford, OH 45150
(513) 248-1911, FAX# 513-248-1589
G. Mgr.: Bill Ashton
Products: DSP hardware, DSP software, dual-channel spec-
trum analyzers, FFT-spectrum analyzers, noise & vibration
analyzers, realtime analyzers, sound intensity measure-
ment equipment & microphones

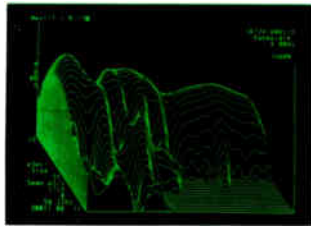

3-D (TEF)



Production Testing



TEF Rapid Speech
Transmission Index

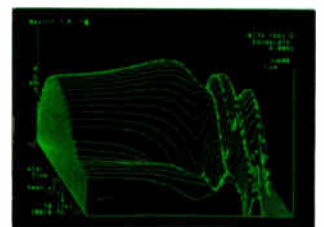

Log 3-D (TEF)



Frequency Response,
Phase Response, Group Delay



Polar



Polar Cylinder

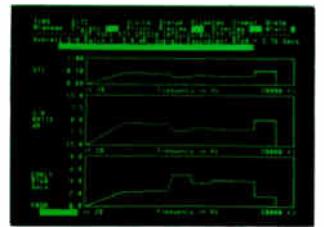

TEF STI



SPL Meter

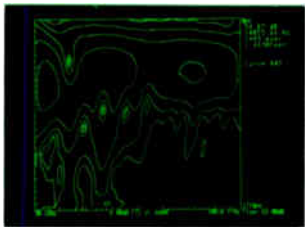

FTC (Frequency Time Curve)



Polar ETC



Octave Noise Measurement

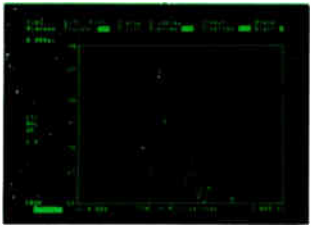

ETC (Energy Time Curve)



Phase Response



Nyquist Display

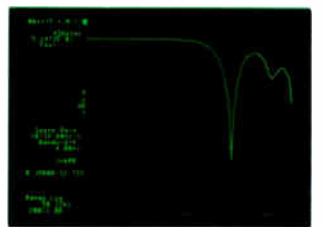

Frequency Response

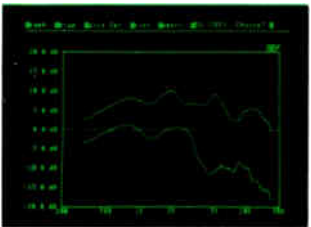

Graph

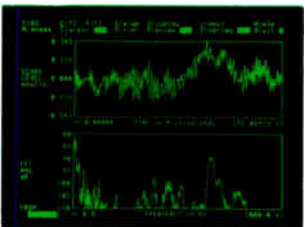

Single Channel FFT

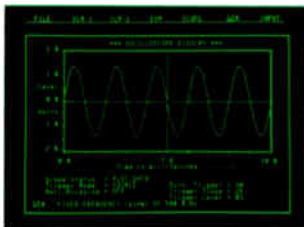

Oscilloscope

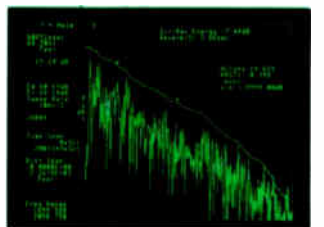

ALcons (Articulation Loss
of Consonants)

TEF.[®] Seeing is believing.

From simulation of anechoic chamber measurements to concert hall evaluations, TEF is the one instrument that shows you more ways of looking at sound than any other single analyzer.

Believe it. Contact Techron for a TEF demonstration.

TECHRON[®]

1718 W. Mishawaka Road, Elkhart, Indiana 46517 • (219) 294-8300

Techron is a division of Crown[®] International, Inc.

WIRE & CABLE

WIRE/CABLE COMPONENTS

AMP Netcon
PO Box 1776
Southeastern, PA 19482
(215) 647-1000

Ac-cetera
PO Box 8070
Pittsburgh, PA 15216
(412) 344-1520, 800-537-3491, FAX# 412-344-0818
Pres.: Susan Stamm
Products: adapters

Alarm Accessory
501 Silverside Rd.
Wilmington, DE 19809
(302) 792-3620, 800-441-7082, FAX# 302-792-7713
Pres.: William Holt Sr., Op. Supervisor: Angela Bopp
Products: accs., conduits, raceways

All Electronics
PO Box 567
Van Nuys, CA 91408
(818) 904-0524, 800-826-5432, FAX# 818-781-2653
Mgr. Sls: Harold Oliver
Products: accs., adapters, computer cable & peripherals, connectors, plugs, pre-wired systems, terminals, XLR connectors

Alpha Wire
711 Lidgerwood Ave.
Elizabeth, NJ 07207
(201) 925-8000, 800-52A-LPHA, FAX# 201-925-7429

Amphenol Products
4300 Commerce Ct.
Lisle, IL 60532
(312) 983-3500

Atlas Wire & Cable
133 S. Van Norman Rd.
Montebello, CA 90640
(213) 723-2401
Mkt'g: Tom Coubayre

Audio Quest
PO Box 940
N. Chicago, IL 60064
(312) 473-1200, 800-457-4579
Pres.: Matt Coleman, Mkt'g Mgr.: Kimberly Heeres

Belden Wire & Cable
PO Box 1980
Richmond, IN 47375
(317) 983-5200, 800-BELDEN-1, FAX# 317-983-5294
Pres.: Roger Cornett, Dir. Sls/Mkt'g: Rick Guipe, Dir. Mkt'g: John Valentine, Mkt'g Comm. Mgr.: John Hitch Ron Madsen, Atlanta, GA, 404-934-6767
Jerry Novak, Naperville, IL, 312-717-7300
Chuck Parker, Dallas, TX, 214-788-4300
Joe Germani, Shrewsbury, MA, 508-845-5000
John Lund, Irvine, CA, 714-474-1200
Products: alarm, audio, computer cable & peripherals, connectors, control, data, fiber optics, low-capacitance, plenum cable, shielded, telecommunications, video, XLR connectors

Berk-Tek
132 White Oak Rd.
New Holland, PA 17557
(717) 354-6200, 800-237-5835, FAX# 717-354-7944
Chairman/CEO: Joseph Boscov, Pres./COO: Harold Syer, VP Sls/Mkt'g: Steve Fritz, VP Finance: Steven Bright, VP Eng.: John Gibson, Purch. Mgr.: Allan Schoonover
Brad Hubinek, Downingtown, PA, 215-873-7139
Arnold Harris, New Holland, PA, 717-354-6200
Jerry Petty, Dallas, TX, 214-386-3809
Frank Smith, Huntingdon, MD, 301-855-1258

Bi-Tronics
PO Box 125
Tuckahoe, NY 10707
(914) 961-2004, 800-666-0996, FAX# 914-961-4244
Pres.: Joel Schwartz, VP: Ellen Schwartz, Sls Mgr.: Ron Huppert
Products: connectors, video, XLR connectors

Brim Electronics
PO Box 3365
Fairlawn, NJ 07410
(201) 796-2886, FAX# 201-778-2792
S.M.: B. Brown
GH Assoc., Stow, MA, 508-897-3534
Macronix, Phoenix, AZ, 602-998-1848
Boerger & Assoc., MN, 612-560-3435
Products: accs., audio, computer cable & peripherals, control, data, hardware, jacks, low-capacitance, markers, plenum cable, plugs, shielded, sleeving, specials, telecommunications, tubing

CZ Labs
55 Railroad Ave.
Garnerville, NY 10923
(914) 268-5056

Cabletronix
PO Box 3003
Newburgh, NY 12550
(914) 565-7570, 800-431-9473, in-state 800-in NY 800-942-WIRE, FAX# 914-564-5332
Pres.: Stephen Roth, VP: Leonard Ellentuch, Sls Mgr.: Tom Maritano

Calrad Engineered Electronic Products
819 No. Highland Ave.
Los Angeles, CA 90038
(213) 465-2131

CAL SWITCH
13717 S. Normandie Ave.
Gardenia, CA 90249
(213) 538-9830, 800-225-7924, FAX# 213-327-2741

Products: accs., adapters, audio, computer cable & peripherals, connectors, fiber optics, fuses & holders, hardware, jacks, plenum cable, plugs, pre-wired systems, raceways, security, shielded, sleeving, specials, switches, terminals, transformers, tubing, XLR connectors

Canare Cable
511 Fifth St. #G
San Fernando, CA 91340
(818) 365-2446, FAX# 818-365-0479
G. Mgr.: Barry Brenner

Products: accs., audio, computer cable & peripherals, connectors, control, data, jacks, low-capacitance, panels, plugs, pre-wired systems, shielded, video, XLR connectors

Champlain Cable
PO Box 7
Winooski, VT 05404

When You Need It
We've Got It

Switchcraft®
A Raytheon Company

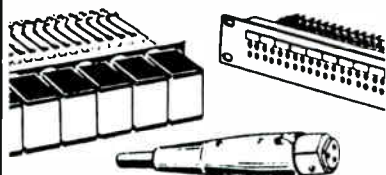

- JACK PANELS
- AUDIO CONNECTORS
- PLUGS AND PATCH CORDS
- MULTI-SWITCH® SWITCHES



WE STOCK THE COMPLETE
SWITCHCRAFT LINE

Cal Switch
(800) CAL-SWCH

13717 S. Normandie Avenue
Gardena, California 90249

Circle 80 on Reader Response Card

(802) 655-2121, 800-451-5162, FAX# 802-655-2025
Mkt'g Mgr.: Clayton Vaughn

Clifford of Vermont
PO Box 51

Bethel, VT 05032
(802) 234-9921, 800-451-4381, FAX# 802-234-5006

Pres.: J.L. McNulty, Prod./Sls Mgr.: Stan Capron
Products: accs., adapters, alarm, audio, computer cable & peripherals, connectors, control, data, fiber optics, hardware, jacks, plenum cable, plugs, security, shielded, telecommunications, terminals, video



Conquest Sound
PO Box 268

Monee, IL 60444
(312) 534-0390, 800-323-7671, FAX# 312-534-0398

Pres.: Robert Jares Jr., VP: Larry Spalla, Sls Mgr.: Ken Bernd, Purch.: Sue Condon, Plant Mgr.: Debbie Hawtrey, Office Mgr.: Janet Jares
Products: accs., audio, connectors, jacks, low-capacitance, panels, plenum cable, plugs, pre-wired systems, shielded, transformers, video, XLR connectors



Consolidated Electronic Wire & Cable
11044 King St.

Franklin Park, IL 60131-1412
(312) 455-8830, 800-621-4278, FAX# 312-455-8837

Pres.: T. Mann, VP: K. Rankin, Sls Op.: S. Boynton, Cust. Svce: M. Braden, VP Mkt'g: M. Abramson
Products: alarm, audio, computer cable & peripherals, control, data, low-capacitance, plenum cable, shielded, sleeving, tubing, video

Current Cable

2610 W. Chicago Ave.
Chicago, IL 60622
(312) 486-7100, 800-821-2432

Pres.: Arthur Shaiman, Sls Mgr.: Bernard Lewis, Chief Eng.: John Rudd

D.J. Assoc.

8411 S. Zero, Unit 5
Ft. Smith, AR 72903-7097
(501) 452-3987, FAX# 501-452-7752

Pres.: I. Jean Beck, VP: Michael Beck
Products: accs., connectors, hardware

Dabum Electronics and Cable

224 Pegasus Ave.
Northvale, NJ 07647
(201) 768-5400, FAX# 201-768-9642

Pres.: Howard Danziger, Sls Mgr.: Ed Rothenstein
Products: accs., alarm, audio, computer cable & peripherals, conduits, fiber optics, hardware, jacks, low-capaci-

...tance, plenum cable, raceways, security, shielded, sleeving, specials, switches, telecommunications, tubing

Dekoron, Div. of Fluorocarbon

1199 S. Chillicothe Rd.
Aurora, OH 44202
(216) 562-9111, 800-342-6630, in-state 800-in OH 800-562-5151, FAX# 216-562-5717

Prod. Mgr.: Gary Ward, Mkt'g Mgr.: James Krejsa, Cust. Svce Mgr.: John Miles
LCA Sls, Tuckahoe, NY, 914-961-4700
Monfort Electronics, Indianapolis, IN, 317-872-8877
Roger Ponto Assoc., Kirkland, WA, 206-821-2996

Delta Wire & Cable

PO Box 833
N. Chicago, IL 60064
(312) 473-4990, FAX# 312-473-2425
Pres.: Matt Coleman, Sls Mgr.: Perry Stein, VP
Connectors: Jon Kron

Duncan Electronics

2865 Fairview Rd.
Costa Mesa, CA 92626
(714) 545-8261

EVG

1 Lee Pl.
Freeport, NY 11520
(516) 536-5000

GNWC WIRE CABLE & NETWORK PRODUCTS

1401 Brook Dr.
Downers Grove, IL 60515
(312) 627-1777, 800-468-2121, FAX# 312-932-4342
Pres.: David Bemoras, CEO: Thomas Katsoulis, Dir.
Sls: Bob Swanson, Dir. Purch.: Mark Winkel
GNWC W. Reg., Colorado Springs, CO, 800-627-9473

**Looking Around
For NEC Listed Cable?**

Make Your Move To WEST PENN WIRE!

There's only one company that specializes in electronic cable that meets all of the new requirements of the National Electric Code... **WEST PENN WIRE.**

Whether it be *CL2, FPL, CM, plenum or non-plenum* electronic cable, make your move to **WEST PENN WIRE...a company with all the right connections.**

**WPW
WEST PENN WIRE**

P.O. Box 762 • 2833 West Chestnut Street • Washington, PA 15301
412-222-7060 • **800-245-4964** (OUTSIDE PA) • 800-222-8883 (PA ONLY)
FAX NO. 412-222-6420

210 WIRE/CABLE COMPONENTS

GNWC SE Reg., Birmingham, AL, 800-234-4692
GNWC SW Reg., Richardson, TX, 214-680-9830
GNWC NE Reg., Randolph, MA, 800-888-9949
GNWC SE Reg., Greensboro, NC, 800-347-8127

General Instrument Network Cable
Div.
PO Box 1729
Hickory, NC 28602
(704) 324-2200, 800-982-1708

Georgia Cable and Wire
463 Commerce Pk Dr.
Marietta, GA 30060
(404) 423-0705, 800-421-9473, FAX# 404-423-1980
G. Mgr.: William Kelly Jr., Nat'l Sls Mgr.: Robert Delano

GEPCO INT'L

1863 W. Carroll
Chicago, IL 60612
(312) 733-9555, FAX# 312-733-6416

Pres.: Gary Geppert, Asst. To Pres.: Larry Smith Sr.,
Sls Mgr.: Larry Smith Jr., Op. Mgr.: Mike Geppert,
Purch. Mgr.: Kathie Geary
Products: accs., adapters, alarm, audio, computer cable &
peripherals, connectors, control, data, fiber optics, fuses &
holders, hardware, hybrids, jacks, low-capacitance, mar-
kers, panels, plenum cable, plugs, pre-wired systems, race-
ways, security, shielded, sleeving, specials, switches, tele-
communications, terminals, transformers

Great Northern Wire & Cable
1401 Brook Dr.
Downers Grove, IL 60515
(312) 627-1777, FAX# 312-932-4342
Mkt'g: Bob Swanson

Hamilton Standard Controls
131 Godfrey St.

Logansport, IN 46947
(219) 722-2244

HOSA Technology
13042 Moore St.
Cerritos, CA 90701
(213) 926-0808, 800-255-7527, FAX# 213-404-3487
Pres.: Sho Sato

ITT Pomona Electronics
PO Box 2767
Pomona, CA 91769
(714) 623-3463, FAX# 714-629-3317
G. Mgr.: Thomas Barber, Controller: Harold Andrews,
Eng. Dir.: Ken Baldwin, Mkt'g Mgr.: Roy Harju, Purch.
Woody Hartman
Gerber Sls, Waltham, MA, 617-890-3334
Darco, Burbank, CA, 818-504-2425
Vale Electronic, Irvine, CA, 714-551-4004
Eclipse Mkt'g, Redmond, WA, 206-883-9481
William Linz, Palatine, IL, 708-705-8555

Ideal Wire Products
Lorum St.
Tewksbury, MA 01876
(617) 851-4541, 800-762-7668
Pres.: Robert T. Leahy
Products: audio, control, data, security, shielded, telecom-
munications

Int'l Electronic Wire & Cable
520 Business Ctr Dr.
Mt Prospect, IL 60056
(312) 299-0021, 800-323-0210, FAX# 312-298-8433

Kable King
PO Box 2646
Savannah, GA 31402
(912) 233-8959

King Wire & Cable
179-45 110th Ave.
Jamaica, NY 11433
(718) 657-4422, 800-221-0144, FAX# 718-739-7138
Products: computer cable & peripherals, fiber optics, low-
capacitance, plenum cable, shielded

Kulka-Smith
1913 Atlantic Ave.
Manasquan, NJ 08736
(201) 223-9400, FAX# 201-223-8788

Lemo USA
335 Tesconi Circle
Santa Rosa, CA 95401
(707) 578-8811
G. Mgr.: Samuel Sokolik, Nat'l Sls Mgr.: David
Battaglia, Sr. App. Eng.: Bill Lee P.E., Mat'l's Con.
Mgr.: John Connolly, Controller: Cheryl Powers
Products

Marietta Wire & Cable
463 Commerce Pk Dr.
Marietta, GA 30067
(404) 422-5708, 800-692-9473

Marshall
89 Frost St.
Westbury, CA 11590
(213) 390-6608, FAX# 213-391-8926
Pres.: Henry Schultz, VP/G. Mgr.: Leonard Marshall,
Mgr. Cust Svce/Mkt'g: Leroy Ellingworth



TAPPAN WIRE & CABLE HOME OF THE WIREMAN 800-247-9099

MANUFACTURERS OF UL CABLE FOR:

- INTERCONNECT
- INTERCOM
- PAGING
- SOUND
- FIRE ALARM
- BURGLAR ALARM
- SECURITY
- COMMUNICATIONS

INTERCOM
& AUDIO
SHIELDED &
UNSHIELDED

BELDEN EQUALS

**NEW NEC CABLES
CL2-CL3-CM
FPL-PLTC**



TAPPAN WIRE & CABLE INC.

Circle 281 on Reader Response Card

256 OAK TREE ROAD, TAPPAN, NY 10983

914-359-9300

800-247-9099

FAX# 914-359-9369

MATH ASSOCIATES

2200 Shames Dr.
Westbury, NY 11590
(516) 334-6800, FAX# 516-334-6473
Pres.: Ellen Math, CEO/Dir. R & D: Irwin Math, Exec.
VP: Howard Oboler, Exec. VP: Martin Rein
Products: fiber optics

Music Supply

809 N. Madison
Dallas, TX 75208
(214) 946-8450, 800-527-1522, FAX# 214-946-9155
Pres.: W.E. Brown, Sls: Betty Brown

National Electric Cable

1730 Elmhurst Rd.
Elk Grove Village, IL 60007
(312) 593-8100

Nemal Electronics Int'l

12240 NE 14th Ave.
N. Miami, FL 33161
(305) 899-0900, 800-327-5999, FAX# 305-895-8178
Pres: Benjamin Nemser
Nemal Electronics NY, Tappan, NY, 914-359-3333

Neutrik USA

1600 Malone St.
Millville, NJ 08332
(609) 327-3113, FAX# 609-825-4804
G. Mgr.: James Cowan, Prod.t Mgr.: William Dorman,
Prod. Mgr.: Kenneth Smalley
Products: connectors

Noramco Wire & Cable

4185 Dawson St.
Vancouver, B.C., Canada V5C 4B3
(604) 298-2133, 800-663-8434, FAX# 604-298-9115
Mkt'g: Russ Good

North Hills Electronics

1 Alexander Pl.
Glen Cove, NY 11542
(516) 671-5700, FAX# 516-759-3327
Prod. Mgr.: Joseph Barbuto
Miles Tek, Dallas, TX, 800-683-7444
Rayma, Laurel, MD, 800-44-RAYMA

Offlex Wire & Cable

30 Plymouth St.
Fairfield, NJ 07006
(201) 575-1101

Penn Fabrication (USA)

PO Box 506
Hawthorne, NJ 07506
(201) 423-4404
Sls Dir.: Mike Panasuk, G. Mgr.: Richard Stratford, G.
Mgr.: Gavin Naismith
Products: accs., connectors, fuses & holders, jacks, video

Penny & Giles

2716 Ocean Pk Blvd., Ste. 1005
Santa Monica, CA 90405
(213) 452-4995, FAX# 213-450-9860
Pres.: Bob Rose, VP: David McLein, Sls Person: C.J.
Melechlin
Products: accs., adapters, audio, conduits, connectors,
control, jacks, pre-wired systems, transformers, video

Preh Electronic Industries

470 E. Main St.
Lake Zurich, IL 60047-2578
(312) 438-4000
Pres.: Marcel Didier
Products: connectors, switches

PROTO-TEC

108 Fairlane Dr.
Joliet, IL 60435
(815) 744-7173
Products: panels

RMS Electronics

50 Antin Pl.
Bronx, NY 10462
(212) 892-6700, 800-223-8312
Chairman: Joseph Bradway Jr., Pres.: Roger Nejes,
Nat'l Sls Mgr.: Lee Heller

R-Columbia Products

2008 St. Johns Ave.
Highland Park, IL 60035
(312) 432-7915

Remee Products

41 Bridge St.
Florida, NY 10921
(914) 651-4431, 800-431-3864, FAX# 914-651-4160
Pres.: Al Muhirad, VP Sls: Ken Pimental, Nat'l Sls
(Remfo): Mary Galbraith
Products: alarm, audio, computer cable & peripherals, con-
nectors, data, fiber optics, low-capacitance., plenum cable,
plugs

Resco

PO Box 2244
Newburgh, NY 12550
(914) 565-7570, 800-942-WIRE, FAX# 914-564-5332
Pres.: Stephen Roth, VP: Leonard Eilentuch

Saxton Wire & Cable Products

215 N. Rt. 303
Congers, NY 10920
(914) 268-6846

• EZ INSTALLATION • EZ STRIPABILITY •

**FLEXIBILITY
IS OUR
STRENGTH**

We've got the muscle it takes to get the job done right and keep installation time down to a minimum . . . New EZ-Flex plenum cable from GNWC. More pliable than other plenum cable, EZ-Flex works with you for fast and EZ installations. And its EZ stripability saves you even more time and energy. Plus, our EZ out packaging makes it easy to handle, giving you more freedom and mobility when the need arises. EZ-Flex also meets the July 1988 NEC Codes—CL2P approval for added quality assurance.

If your next installation requires a little muscle, remember . . . EZ does it with EZ-Flex plenum cable. Only from GNWC.

gnwc
www.gnwc.com and network products

GNWC Corporate Headquarters
1401 Brook Drive
Downers Grove, IL 60515
Call: 312-627-1777
In IL: 1-800-825-2962
Outside IL: 1-800-468-2121
Fax No.: 1-312-932-4342

Circle 283 on Reader Response Card

• EZ OUT BOXES • MEETS NEC CODES •
World Radio History

212 WIRE/CABLE COMPONENTS

Signal Cable

2500 Commonwealth Ave.
North Chicago, IL 60064
(312) 689-9090, 800-323-9355
Sls Mgr.: Don Prochilo, VP Sls: Kerry Glicken

Stancor

131 Godfrey St.
Logansport, IN 46947
(219) 722-2244, FAX# 219-722-5189
Mkt'g/Sls Mgr.: Terry Smith, Prod. Mgr.: Rich Noel
Products: transformers

TEI Electronics

PO Box 246
Hialeah, FL 33011
(305) 888-3980, 800-327-8811, FAX# 305-885-4950
Pres.: Danny Alonso, VP: Mireya Muniz, Nat'l Sls Mgr.:
Walter McNulty, Cust. Svce: John Tembras, Sls:
Orlando Pineda, Sls: Jose Hurcades
Products: accs., adapters, alarm, audio, connectors, fuses
& holders, jacks, plugs, switches, telecommunications, ter-
minals, video, XLR connectors

TMB Assoc.

3416 W. Burbank Blvd.
Burbank, CA 91505
(818) 842-9652, FAX# 818-842-1064

Tag-It Div./Peter Mangione

12687 W. Cedar Dr., #100
Lakewood, CO 80228
(303) 986-5447, 800-338-2448, FAX# 303-989-1207
Mkt'g: Kelly Williams, Sls Associate: Debi Hughes, Sls
Associate: Debrah Lupo
Products: markers

TARGET TECHNOLOGY

PO Box 609
Penn Valley, CA 95946
(916) 639-2102
Pres.: Peter Hughes, VP: Sherri Douglas
Products: video

SL Waber

520 Fellowship Rd.
Mt. Laurel, NJ 08054
(609) 866-8888, 800-257-8384, FAX# 609-866-
1945
Sls/Mkt'g Mgr.: Scott Hammill, Sls Asst: Edward Brown

Wesflex

1880 Garden Tract Rd.
Richmond, CA 94801
(415) 233-6670



WEST PENN WIRE

2833 W. Chestnut St.
Washington, PA 15301
(412) 222-7060, 800-245-4964, in-state 800-222-8883,
FAX# 412-222-6420
VP Sls: Louis Valente, Exec. VP: Donald Hastings,
Reg Sls Mgr.: Richard Tovornik, Reg Sls Mgr.: Dan
Hastings, Reg Sls Mgr.: Robert Bruno
Products: alarm, audio, computer cable & peripherals, data,
low-capacitance, plenum cable, security, shielded, specials,
transformers, video

Zippertubing

13000 S. Bdw
Los Angeles, CA 90061
(213) 321-3901
Pres.: Terry Plummer, Exec. VP: Bruce Hoffine, Dir.
Mkt'g: Michael Sullivan, Ziplape Sls Mgr.: Ed Hackett,
SW Sls Mgr.: Don Emewien

WIRE/CABLE SYSTEMS

All Electronics

PO Box 567
Van Nuys, CA 91408
(818) 904-0524, 800-826-5432, FAX# 818-781-
2653
Mgr. Sls: Harold Oliver
Products: audio, cable reels

Atlas Wire & Cable

133 S. Van Norman Rd.
Montebello, CA 90640
(213) 723-2401
Mkt'g: Tom Coubayre

B & B Systems

28111 N. Ave. Stanford
Valencia, CA 91355
(805) 257-4853, FAX# 805-257-8065
VP Sls/Mkt'g: Michael Shore, District Mgr.: Mike Ward,
OEM Mgr.: William McKinley

Bi-Tronics

PO Box 125
Tuckahoe, NY 10707
(914) 961-2004, 800-666-0996, FAX# 914-961-
4244
Pres.: Joel Schwartz, VP: Ellen Schwartz, Sls Mgr.:
Ron Huppert
Products: a audio, video,

Brim Electronics

PO Box 3365
Fairlawn, NJ 07410
(201) 796-2886, FAX# 201-778-2792
S.M.: B. Brown
GH Assoc., Stow, MA, 508-897-3534
Macronix, Phoenix, AZ, 602-998-1848
Boerger & Assoc., MN, 612-560-3435
Products: a audio, custom, data, instrument, microphone
cable snakes, multi-pair, speaker, video,

Cabletronix

PO Box 3003
Newburgh, NY 12550
(914) 565-7570, 800-431-9473, in-state 800-in NY
800-942-WIRE, FAX# 914-564-5332
Pres.: Stephen Roth, VP: Leonard Ellentuch, Sls Mgr.:
Tom Martirano

CAL SWITCH

13717 S. Normandie Ave.
Gardena, CA 90249
(213) 538-9830, 800-225-7924, FAX# 213-327-
2741
Products: a audio, custom, data, fiber optics, instrument,
microphone cable snakes, MIDI, multi-pair, speaker

Chester Cable/Division of Alcatel NA

15 Oakland Ave.
Chester, NY 10918
(914) 469-2141, FAX# 914-469-2141
VP Mkt'g/Sls: Yves Bonnamour, Sls Eng.: Nancy
Werner, Account Rep: Kim Beissel
G.W. Thelen, Fort Mitchell, KY, 606-341-8181
Wyant Tech. Sls, Sherwood, MI, 517-741-3472

Connectronics

652 Glenbrook Rd.
Stamford, CT 06906
(203) 324-2889, 800-322-2537, FAX# 203-324-
7027
Pres.: Richard Chilvers
Pacific Audio Group, Gardena, CA, 213-719-1383
New Horizons, Bannockburn, IL, 312-234-5911
Mkt'g Concepts, Irving, TX, 214-869-0669
Worldwide Electronics, Ft. Lauderdale, FL, 305-584-
7024 or 904-287-7666
N. Coast Mkt'g, Erie, PA, 814-456-6435



Conquest Sound

PO Box 268
Monee, IL 60444
(312) 534-0390, 800-323-7671, FAX# 312-534-
0398
Pres.: Robert Jares Jr., VP: Larry Spalla, Sls Mgr.: Ken
Bernd, Purch.: Sue Condon, Plant Mgr.: Debbie
Hawtrej, Office Mgr.: Janet Jares
Products: a audio, custom, instrument, microphone cable
snakes, MIDI, multi-pair, multi-pin disconnect, panels,
speaker, splitting, stage boxes, video,

Consolidated Electronic Wire & Cable

11044 King St.
Franklin Park, IL 60131-1412
(312) 455-8830, 800-621-4278, FAX# 312-455-
8837
Pres.: T. Mann, VP: K. Rankin, Sls Op.: S. Boynton,
Cust. Svce: M. Braden, VP Mkt'g: M. Abramson
Products: a audio, custom, data, instrument, microphone
cable snakes, MIDI, multi-pair, multi-pin disconnect, speak-
er, video,

DTG (Development Technologies Group)

5743 Corsa Ave., Ste. 207
Westlake Village, CA 91362
(818) 706-3338, FAX# 818-706-3392
Pres.: Peter Madnick, VP: Patrick Dalton

Daburn Electronics and Cable

224 Pegasus Ave.
Northvale, NJ 07647

(201) 768-5400, FAX# 201-768-9642
 Pres.: Howard Danziger, Sls Mgr.: Ed Rothenstein
 Products: a video,

otec
 529 Main St.
 Boston, MA 02129
 (617) 241-7810, 800-537-8254, FAX# 617-241-8616
 Pres.: James Hayes, VP: George Shinopoulos, Sls Mgr.: William Pierce, Eng./Sls App.: Kevin Collins
 Products: a audio., custom, data, fiber optics, instrument

NWC WIRE CABLE & NETWORK PRODUCTS
 1401 Brook Dr.
 Downers Grove, IL 60515
 (312) 627-1777, 800-468-2121, FAX# 312-932-4342
 Pres.: David Bemoras, CEO: Thomas Katsoulis, Dir. Sls: Bob Swanson, Dir. Purch.: Mark Winkel
 GNWC W. Reg., Colorado Springs, CO, 800-627-9473
 GNWC SE Reg., Birmingham, AL, 800-234-4692
 GNWC SW Reg., Richardson, TX, 214-680-9830
 GNWC NE Reg., Randolph, MA, 800-888-9949
 GNWC SE Reg., Greensboro, NC, 800-347-8127

EPCO INT'L
 1863 W. Carroll
 Chicago, IL 60612
 (312) 733-9555, FAX# 312-733-6416
 Pres.: Gary Geppert, Asst. To Pres.: Larry Smith Sr., Sls Mgr.: Larry Smith Jr., Op. Mgr.: Mike Geppert, Purch. Mgr.: Kathie Geary
 Products: a audio., cable reels, custom, data, fiber optics, instrument, microphone cable snakes, MIDI, multi-pair, multi-pin disconnect, panels, speaker, splitting, stage boxes, video,

i Lo Fabrication & Mfg.
 PO Box 509
 Rio Vista, TX 76093
 (817) 373-2247
 Pres.: C. Caro, Prod. Eng.: Cecil Caro, VP Mkt'g: Bridget Caro
 Products: a audio., cable reels, custom, microphone cable snakes, panels, stage boxes, video,

and L Sales
 PO Box 238
 Madison, TN 37116
 (615) 868-6976
 Pres.: George Lewis, VP: Mona Lewis, P.R.: Kimberly Lewis, Op. Mgr.: Lisa Gifford

EE DAN COMMUNICATIONS
 155 Adams Ave.
 Hauppauge, NY 11788-3699
 (516) 231-1414, 800-533-3261, in-state 800-231-1414, FAX# 516-231-1498
 Pres.: Leon Goldberg, VP Op.: Lawrence Goldberg, VP Finance/Admin.: David Goldberg, Sr. Sls Associate: Susan Leon, Office Mgr.: Rita Kaplan, Sr. Tech.: Sandy Hoffman
 Products: a audio., multi-pair, speaker, video,

IATH ASSOCIATES
 2200 Shames Dr.
 Westbury, NY 11590
 (516) 334-6800, FAX# 516-334-6473

Pres.: Ellen Math, CEO/Dir. R & D: Irwin Math, Exec. VP: Howard Oboler, Exec. VP: Martin Rein
 Products: a fiber optics

Monster Cable Products
 101 Townsend St.
 San Francisco, CA 94107
 (415) 777-1355, FAX# 415-896-1745
 Dir. Special Proj.: Gary Reber, Pres.: Noel Lee, Mkt'g Mgr.: Rita Geary

Mystery Electronics
 707 Kendall Dr.
 Nashville, TN 37209
 (615) 352-1322
 Nat'l Sls Mgr.: W. John Ryan, Account Mgr.: Debbie Ryan
 ASR Enter., Ltd., Fallston, MD, 301-893-0001
 Henry Phillips, Roswell, GA, 404-992-3070
 Monfort Electronics Mkt'g, Indianapolis, IN, 317-872-8877
 Northshore Mkt'g, Seattle, WA, 206-284-9699
 Shalco, Fernadale, MI, 313-547-4471
 Products: a stage boxes

Pearson Technologies
 18656 Merrydill St.
 Northridge, CA 91324-1503
 (818) 885-7191
 Pres.: Eric Pearson
 Products: a data, fiber optics, video,

Peavey Electronics
 711 A St.
 Meridian, MS 39302
 (601) 483-5365, FAX# 601-484-4278
 Pres.: Hartley Peavey
 Products: a instrument, microphone cable snakes, MIDI, speaker, stage boxes

PROTO-TEC
 108 Fairlane Dr.
 Joliet, IL 60435
 (815) 744-7173
 Products: a panels, stage boxes, video,

Quabbin Wire & Cable
 10 Maple St.
 Ware, MA 01082
 (413) 967-6281, 800-368-3311, FAX# 413-967-7564
 Pres.: Paul Engel, Mgr. Sls/Mkt'g: Thomas Russell, Op. Mgr.: George Melnik, Buyer: Melissa Delargy
 Southern States Wire, Norcross, GA, 404-441-2231
 McCoy Assoc., Richardson, TX, 214-864-1838
 R.F. Mayo Assoc., Boulder, CO, 303-442-2155
 R.F.C. Sls, Brea, CA, 714-990-9695
 John Jaso & Assoc., Sarasota, FL, 813-371-3814
 Products: a audio., custom, data, instrument, multi-pair

R & R Audio Products
 RD #1, Box 77
 Strattanville, PA 16258
 (814) 764-5289, 800-344-0033, FAX# 215-735-4355
 Pres.: James Rennis

Rapco Cable & Lighting
 Rte. 1, Box 50
 Jackson, MO 63755
 (314) 243-1433, 800-325-0266, FAX# 314-243-1384

"Hear the Difference"

**OXYGEN-FREE
 SPEAKER CABLES
 by
 SOUND RUNNER**

- OFC QUAD 13-Awg**
4x16 Awg/105-Strands
- 10-Awg/238-Strands**
- 12-Awg/168-Strands**
- 16-Awg/67-Strands**
- PLENUM OR PVC**



Sound Runner Div.
MARSHALL ELECTRONICS
INC.
 P.O. Box 2027
 Culver City, CA 90230
Phone 213/390-6608
24-Hr. Fax 213/391-8926

Circle 88 on Reader Response Card

FREE!

NEW 1990 INSTALLER CATALOG FULL LINE...

- **Audio**
- **Video**
- **Data**
- **RF**
- **Communications**

Connectors and Adaptors in stock plus exclusive Connector Locator Service*
 Hi quality bulk cable featuring Mogami Superflexible and Ultraminiature Tools and Accessories Hundreds of new items

For professional installers of Electronics Systems of every kind.

Ask about our 5% discount for your first catalog order...celebrating our 23rd Year.

CALL TODAY! 800-666-0996;

For catalog, price list, engineering assistance and quotes. ALL FREE with obligation.

Bi-Tronics Is The Answer.
 Circle 82 on Reader Response Card

BI-TRONICS, INC.
 Box 125, Tuckahoe, NY 10707

Remeo Products

41 Bridge St.
Florida, NY 10921
(914) 651-4431, 800-431-3864, FAX# 914-651-4160
Pres.: Al Muhlrad, VP Sls: Ken Pimental, Nat'l Sls (Remfo): Mary Galbraith
Products: a audio., custom, data, fiber optics, instrument, microphone cable snakes, multi-pair, speaker

Standard Wire & Cable

2345 Alaska Ave.
El Segundo, CA 90245

Tappan Wire & Cable

256 Oak Tree Rd.
Tappan, NY 10983
(914) 359-9300, 800-247-9099, FAX# 914-359-9300
Pres.: Sidney Grant, VP: Michael Ressa, Inside Sls: Dianna Lopez, Acct Rep: Darren Keych

TARGET TECHNOLOGY

PO Box 609
Penn Valley, CA 95946
(916) 639-2102
Pres.: Peter Hughes, VP: Sherri Douglas
Products: a video,

Trompeter Electronics

PO Box 5069
Westlake Village, CA 91359
(818) 707-2020, FAX# 818-706-1040
Pres.: E. Trompeter, G.I Mgr.: J.T. Roling, Sls/Mkt'g Mgr.: Hap Gladish, Adv.Mkt'g: G. Thalberg
Products: a audio., data, instrument, panels, splitting, video,

VICON INDUSTRIES

525 Broad Hollow Rd.
Melville, NY 11747-370
(516) 293-2200, 800-645-9116, FAX# 516-293-2627
CEO: Donald N. Horn, Exec. VP: Arthur Wallace, Sr. VP Mkt'gs: Ronald J. Teixeira, VP Dom. Sls: Donald T. Heckel, VP Int'l Sls: Richard P. Adam
US Reg. Office-W., Brea, CA, 714-990-3858
US Reg Office-S., Norcross, GA, 404-449-0499
Gov't Sls Office, Arlington, VA, 703-553-785-
European Hdqtrs, Hampshire, UK, 44-0705-665-3
Products: a fiber optics, video,

Whirlwind

PO Box 1075
Rochester, NY 14603
(716) 663-8820, 800-733-9473, FAX# 716-865-8930
Pres.: Michael Laiacona, VP: Bonnie Gardner

Wilco Communications

PO Box 60579
Sunnyvale, CA 90061
(408) 746-3993
Pres.: Charles Wirf
Products: a custom, data, fiber optics, multi-pair, panels

Wireworks

380 Hillside Ave.
Hillside, NJ 07205
(201) 686-7400, 800-624-0061, FAX# 201-686-0483
Pres.: Gerald Krulewicz, Treas.: Larry Williams, Cust. Svce Mgr.: Angela DiCicco

Notes:

INDEX OF MANUFACTURER'S REPRESENTATIVES

ALABAMA

Lee Assoc. Mid-South
Huntsville, 205-533-5896
Jack Cota
Murphy & Cota
Atlanta, 404-875-2525
Raleigh Perry & Assoc.
Buford, 404-945-3142
REMCO
Huntsville, 205-533-3763

ALASKA

David BeLusko
Jos. BeLusko
Portland, 503-223-2241
Skip Hill
Lonoke, 501-843-7310
Loppnow & Assoc.
Issaquah, 206-392-3936

ARIZONA

James Umstead
Awwest
Fountain Hills, 602-946-1811
Bidwell Sales Assoc. of AZ
Mesa, 602-265-2029
Greg Dzubay & Assoc.
Peoria, 602-979-2358
MORDY FOODYM
MEYER & ROSS
Burlingame, 415-348-6800
JR Morgan Agency
Phoenix, 602-268-3464
TIM SCHAEFFER
NEW WEST AUDIO
Burbank, 818-955-9706
CHUCK OLSON
CHUCK OLSON ASSOC.
Renton, 206-271-5416
Jeff Steen
Phoenix, 602-431-1206
WES ALDERSON
WESTECH
Fountain Valley, 714-962-2545
Don Yocum
Yocum Mkt'g

Mesa, 602-265-5056

ARKANSAS

Chris Jones
Jones Audio Sales
Plano, 214-867-0202

CALIFORNIA

AMH Sales
Palos Verdes Estates, 213-373-2034
Advanced Communications
Mkt'g
Laguana Niguel, 714-582-5167
Derek Allen Assoc.
Toluca Lake, 818-840-8327
Larry Lupo
Allwest Electronics
Camarillo, 805-388-1789
Steve Armstrong
Northridge, 818-707-2529
Asoteric Mkt'g
Pasadena, 714-964-4433
Joseph Bass
Atlas Electronics Ltd.
Toronto; Ontario, 416-789-7761
B & E Assoc.
San Leandro, 415-351-1550
Lyle Bailey
Canoga Park, 818-704-5601
Balzer-Wolf Assoc.
Irvine, 714-261-6877
Ray Baragary
Lakewood, 213-633-5820
Bassett Sales
N. Hollywood, 818-766-2117
Berman-Gravley
Costa Mesa, 714-549-2122
Bidwell-Schwartz Assoc.
Gardena, 213-770-0300
Don Bivens
Lake Elsinore, 714-672-2168
Blackhawk Mkt'g
Pacific Palisades, 213-454-8196
Burden Assoc.

Canoga Park, 818-340-4590
Carlson & Assoc.
Campbell, 408-370-1284
Dan Castro
Irvine, 714-261-6304
Gabiella Chambers
Westminster, 714-839-8835
Roy Colen Sales
Mill Valley, 415-383-8700
Bob Connelly
Woodland Hills, 818-999-4854
Geoffrey Keleher
Design Factors
LaHebra Heights, 213-697-7576
Estle Finney
Jerry Heaton
Esoteric Mkt'g
Pasadena, 714-964-4433
Don Forth Assoc.
W. Covina, 818-919-2322
City of Industry, 818-333-8009
R.W. Fuday & Assoc.
Fairfax, 415-459-6880
Funke & Assoc.
Campbell, 408-866-0648
Futura
Lomita, 213-539-1710
Future Sales
Fairfax, 415-459-6880
Steve Gleason
Burbank, 818-848-7512
Gravley & Assoc.
Irvine, 714-852-9994
HMC
Arcadia, 818-447-0958
Ken Hyer
Burbank, 818-841-8711
Robert Rufkahr
Image Mkt'g
Fountain Valley, 714-957-0630
Innovative Sales & Mkt'g
Irvine, 714-549-7770
San Francisco, 415-952-0943
Interconnect Sales Group
Santa Clara, 408-980-1166
Jacobson & Assoc.
Newark, 415-791-2336

EB King & Assoc.
Saratoga, 408-867-2111
Klaveness & Assoc.
Fair Oaks, 916-966-1227
Gary Kuntz
Cupertino, 415-326-0280
L.P. Mkt'g
Oakland, 415-532-5600
Lakeside Assoc.
Irvine, 714-730-1333
LaVigne-Muffie
Santa Fe Springs, 213-692-9074
Kristi LeBlanche
Cardiss By the Sea, 619-463-2662
Lessing Assoc.
Newhall, 805-254-0274
Lessing & Assoc.
Valencia, 805-295-0225
Lichtenauer & Assoc.
Antioch, 415-757-1200
Rich Lomax
N. Hollywood, 818-763-9587
Loomis & Assoc.
Alameda, 415-865-2200
Dan Lopez
213-327-0001
Mark V
Mountainview, 415-964-6275
Norman Marshank
Los Angeles, 213-559-2591
McKinley Sales
San Diego, 619-271-7221
MORDY FOODYM
MEYER & ROSS
Burlingame, 415-348-6800
Moulthrop
Pleasanton, 415-463-0450
New West Agency
San Diego, 619-299-3269
TIM SCHAEFFER
NEW WEST AUDIO
Burbank, 818-955-9706
John Oehler
Maraga, 415-283-5244
Robert Karadizian
Pacific Group
Pasadena, 818-577-0738

ASR Enterprises, Ltd.
Manufacturers Representatives

PHILIP WALTER
403 FIELDSTONE COURT
FALLSTON, MARYLAND 21047-2619
(301) 893-0001
FAX (301) 877-3204

MAIL:
P.O. BOX 10
BENSON, MD 21018

Electronics Representatives Association Southern California Chapter

A major force in the nation's most diversified electronics center.

For information or a free copy of our Electronic Products Directory and Marketing Guide, contact:



ERA Southern California Chapter
3685 Motor Ave., Suite 240
Los Angeles, CA 90034
(213) 287-1218 FAX: (213) 287-1851

Pass Assoc.
Sunnyvale, 408-735-9040
Hank Plaisier
El Toro, 714-837-2626
Plus 4 Mkt'g
Pleasant Hill, 415-937-0650
Pro Tech Mkt'g
Newport Beach, 714-650-5633
Prorepco
Foster City, 415-570-5055
R.F.C. Sales
Brea, 714-990-9695
Don Otomo
Radon & Assoc.
Sacramento, 916-923-2524
Ruppert Sales & Eng.
San Jose, 408-998-8717
SLK Tech Rep
San Francisco, 415-822-4884
Hayward, 415-785-4531
Scott Sampson
Encino, 818-996-5484
Jerry Smith
Los Angeles, 818-763-2349
Sumner Spector
Laguna Hills, 714-768-8585
Scott Sylvester
San Diego, 619-267-4143
T.C. Mkt'g
Woodland Hills, 818-710-9580
MEL ZEITLIN
TAURUS 3 INT'L
Manalapan, 201-780-7114
Tele-MIDI
Pasadena, 800-888-MIDI
Teqni Rep Assoc.
Sun Valley, 818-768-4223
Brian Trankle & Assoc.
Belmont, 415-595-4004
Vision Video
Los Gatos, 408-356-1286
Wagners S.P.D.
Anaheim, 714-630-6671
Warren Assoc.
Santa Clara, 408-988-7762
Gregory Pardue
West Coast Mkt'g/Music
Forecast
San Diego, 714-998-4969
WES ALDERSON
WESTECH
Fountain Valley, 714-962-2545
Culver City, 213-870-9286
Michael Klickstein

Western Audio Sales
Glendale, 818-246-3806

COLORADO

AMH Sales
Denver, 303-429-2203
Larry Bickford/Chuck Bickford
CB Electronic Mkt'g
Arvada, 303-422-0561
Rod Cur
Denver, 303-322-3646
R.F. Mayo Assoc.
Denver, 303-442-2155
Pier Vidoni
Mountain Reps
Denver, 303-623-0972
John Paonessa
Denver, 303-986-3600
Pearson & Pearson
Denver, 303-722-6996
Pro Sound & Light
Lakewood, 303-986-5999
Terry Robinson
Silver Peak Mkt'g
Wheat Ridge, 303-467-9042
Stan Sliz Assoc.
Broomfield, 800-525-2670
Chuck Stieff & Assoc.
Plattsville, 303-587-2500
The TK Group
Loveland, 801-298-8902
Technical Products Corp.
Denver, 303-333-1141
Torbett & Assoc.
Loveland, 303-532-3313
Larry Wilson
Englewood, 303-779-8686

CONNECTICUT

Abbott Allison Co.
Branford, 203-481-0405
John B. Anthony Co.
Stamford, 203-322-9202
ROB HENDRICKSON
W.A. HENDRICKSON CO.
N. Scituate, 617-545-0652
Miller Assoc.
Stamford, 203-869-7793
Greenwich, 212-840-2866
Anthony Cafiero
New England Tech. Assoc.
New Haven, 203-467-8010
Chris Pelzar
N. Canton, 203-693-1501

Piper Assoc.
Needham, 617-449-1144
PAUL WINKLEY
W.B. PRAY SALES
Northboro, 617-393-3434
Ted Curtin
Repworks
Chicopee, 413-533-0845
The Smith Co.
Hartford, 203-523-0512

DELAWARE

PHILLIP WALTER
ASR ENTERPRISES
Fallston, 301-893-0001
Joseph Ciotti
Claymont, 302-798-6558
Mike McMahon
312-843-8800
JOHN GALLICE
R.J. MKT'G
Rockville, 301-251-0330

DISTRICT OF COLUMBIA

PHILLIP WALTER
ASR ENTERPRISES
Fallston, 301-893-0001
Alan Brothers
David H. Brothers
Finksburg, 301-833-0920
Al Gray
202-479-2242
JOHN GALLICE
R.J. MKT'G
Rockville, 301-251-0330

FLORIDA

American General Dist.
Miami, 305-649-5408
Bencsik Assoc.
Ocala, 904-732-9775
Brennan Assoc.
Clearwater, 216-439-3265
Cartwright & Bean
Orlando, 407-422-4531
Cavendish & Winchester
Hollywood, 305-927-3870
Cell Communications
Miami, 305-584-8331
Michael Chafee Assoc.
Sarasota, 813-921-4294
Aivan C. Chaney & Assoc.

Hialeah, 305-558-3933
Col-Ins-Co.
Orlando, 305-423-7615
Hustling Enter.
Redington Beach, 813-393-8982
Pete Kendall
Jacksonville, 904-262-6025(#2306)
Klumpp Sales
Jacksonville, 904-287-5205
Rob Lincoln
Melbourne, 407-259-0991
Miguel Lopez
Hialeah, 305-822-6853
Meyer Mkt'g
Deerfield Beach, 305-481-9250
Joseph Rodimak
Pro-Assoc.
St. Petersburg, 813-525-5552
Pro Sound Assoc.
Jacksonville, 904-744-1170
Richard Sulman
Row & Sons
Fort Myers, 813-481-2949
Lynn Sandefur
Tampa, 813-391-1231
Seacom Sales
Lauderdale Lakes, 305-486-0260
Jerry Sehi
Ft. Lauderdale, 305-525-0872
Bob Seidman
Ft. Lauderdale, 305-581-5666
MEL ZEITLIN
TAURUS 3 INT'L
Manalapan, 201-780-7114
Ron Tunks Sales
Tamarac, 305-722-2803
Worldwide Electronics
Miramar, 305-966-6622
Pembroke Pines, 305-584-7024
William Zophy
Ft. Myers, 813-433-4766

GEORGIA

De Witt Aust'n
Alpharetta, 404-442-1326
David McCoy
Cartwright & Bean
Norcross, 404-233-2939
Marc Winchester

(201) 305-8331

FAX (201) 305-9832

PUSECKER SALES

PAUL PUSECKER

P.O. BOX 609
131 BEAVERBROOK ROAD
LINCOLN PARK, NJ 07035

 Murphy and Cota inc.



JACK COTA

500 PLASAMOUR DRIVE, N.E. (404) 875-2525
ATLANTA, GEORGIA 30324

vendish & Winchester
Atlanta, 404-449-5104
eative Audio Mkt'g
Marietta, 404-642-7827
n Darrah
Atlanta, 404-395-6611
na-Systems
Atlanta, 404-429-1570
rep
Atlanta, 404-938-7108
A. Garreau Assoc.
Atlanta, 404-458-8030
R. Fanning
ady Duckett Sales Co.
Atlanta
ollingsworth & Still
Norcross, 800-241-5712
ank Malloy
404-394-8813
arketline
Snellville, 404-972-9048
eve McGrew
Kennesaw, 404-422-4608
illar Electronics
Atlanta, 404-634-3350
ck Cota
urphy & Cota
Atlanta, 404-875-2525
aleigh Perry & Assoc.
Buford, 404-945-3142
enry W. Phillips
Roswell, 404-992-3070
ill Ray Assoc.
Atlanta, 404-351-6367
ill Roberts
Norcross, 404-263-9349
ward Wolfe
ecom Systems
Atlanta, 404-455-0672
m Sims
Cumming, 404-889-9300
uce Ward
ound Assoc.
Lawrenceville, 404-963-8701
outhern States Wire
Atlanta, 404-455-4075
echnical Mkt'g
Atlanta, 404-457-0988
tephen B. Goot
id Wolf
Atlanta, 404-455-0672

HAWAII

idwell-Schwartz Assoc.
Gardena, 213-770-0300
ames K.C. Chang PE
l.C. Electronics
Honolulu, 808-841-5526
MORDY FOODYM
MEYER & ROSS
Burlingame, 415-348-6800
GIM SCHAEFFER
NEW WEST AUDIO
Burbank, 818-955-9706
acific West Mkt'g
Honolulu, 808-261-7558
rorep Hawaii
Honolulu, 808-847-4038

DAHO

David BeLusko
Jos. V. BeLusko
Portland, 503-223-2241
Jim Loppnow
Loppnow & Assoc.

Issaquah, 206-392-3936
CHUCK OLSON
CHUCK OLSON ASSOC.
Renton, 206-271-5416

ILLINOIS

Wayne Hrabak
Audio Resources
Westmont, 312-655-1180
Raymond Bailey
Granville, 815-339-6789
Bill Boone
Libertyville, 312-816-1080
Brainard-Wiwon Mkt'g
Arlington Hts., 312-437-2700
Bob Burns & Assoc.
Park Ridge, 312-823-9360
Cambridge Co.
Niles, 312-647-8100
David Skrudland
Classic Visual Communications
Bloomington
Denning Electronics
Hinsdale, 312-920-1488
Gordy Duval
Chicago, 312-774-5115
Thom Fehrman
Winslow, 815-367-3000
Doug Fellabaum
Sycamore, 800-445-0152(#2301)
Gustafson System Sales
Palatine, 312-358-2505
Norm Hagemann
Batavia, 312-584-2300
F.F./Hill-Gray
Elmhurst, 312-832-4101
Dick Kemar
McHenry, 312-699-8656
Kevin Koehler
Batvia, 312-879-6871
Monte Lamb
Hinsdale, 312-323-0530
Frank Lintern Assoc.
Naperville, 312-983-0935
Bob Bechstein
William M. Linz Assoc.
Palatine, 312-945-9600
Sam Lynn
Chicago, 312-657-7787
G. MCL Cole
Parkridge, 312-692-6040
Majestic Sales
Chicago, 312-582-4300
Joseph McCaffrey
312-790-2898
Don Mouritzen
Beecher, 800-445-0152(2303#)
Garreth Nelson
Chicago, 312-773-6001
New Horizons Electronics
Bannockburn, 312-234-5911
Parcom
Elk Grove, 312-228-6360
Keith Parker & Assoc.
Northbrook, 312-498-0353
Vern Pearson
800-255-2255 ext 8874
George Pettitt Co.
Berkeley, 312-261-0342
Powerlines Mkt'g
Evanston, 312-864-1147
Pro Audio LTD
Chicago, 312-526-1660
Pyramid Audio
South Holland, 312-339-8014

Raines & Assoc.
Northbrook, 312-498-0890
Doug Randle
Carpentersville, 800-445-0152(2301#)
R.M. Puzerewski Jr.
RMP/McBride Corp.
Lombard, 312-932-9090
Sound Mkt'g
Palos Heights, 312-448-6715
William Steffey
Steffey Mkt'g
Northbrook, 312-480-3575
Stiffler Mkt'g
Chicago, 312-480-3575
Paul Bunker
Sunrise Sales
La Moille, 815-638-2660
Tom Walter
Barrington, 312-382-4925
Ward Mkt'g
Chicago, 312-409-3635
William Warnock
Barrington, 312-382-4550
David Zaabel
Schaumburg, 312-980-8805
Burt Ziskind
Ziskind & Assoc.
Rolling Meadow, 312-577-1624

INDIANA

Kurt Gish
AV Mkt'g
Carmel, 317-846-1034
Aim Mkt'g Group
Mishawaka, 219-256-2025
BRUCE HAGEN
AUDIO MKT'G ASSOC.
Brecksville, 216-526-2426
Electronic Reps
Indianapolis, 317-894-1414
Ronald Cox
Elmarcon
Indianapolis, 317-846-0221
R. Jeff Kingston
Kingston Sales
Indianapolis, 317-876-2545
Charles Maish
Maish Sales
Mulberry, 317-296-2322
Bill McDaniel
Indianapolis, 317-823-4206
Kenneth Reinhardt
Midstates Mkt'g
Indianapolis, 317-639-9999
Robert Milsk Co.
Indianapolis, 317-842-3400
Monfort Electronics
Indianapolis, 317-872-8877
Pat Norman Sales
Indianapolis, 317-842-5611
Pete Finney
Pro-Mkt'g Systems
Indianapolis, 317-846-9591
R.C.S.
Zionsville, 317-873-4740
Dennis Ramer
Walton, 219-626-3115
SEA
Carmel, 317-846-2591
Kevin Talmant Assoc.
Madison, 812-866-5533
Charlie Winkler & Assoc.
Uniontown, 216-699-9511

IOWA

Beams Co.
Des Moines, 515-255-1148

KANSAS

Thomas Ostermann
B.C. Electronic Sales
Mission, 913-262-1720
Thomas L. Dowell & Assoc.
Overland Park, 913-648-7373
Harry Hahn
Olathe, 913-829-9427
R.W. Kunz & Assoc.
Prairie Village, 913-648-3535
Kenneth Reinhardt
Midstates Mkt'g
Indianapolis, 317-639-9999
Midtec Assoc.
Lenexa, 913-541-0505
Nead & Assoc.
Shawnee Mission, 913-268-8763

KENTUCKY

BRUCE HAGEN
AUDIO MKT'G ASSOC.
Brecksville, 216-526-2426
Bruce Dawson & Assoc.
Louisville, 502-896-2266
MICK MANDABACH
LMS MKT'G
Columbus, 614-457-2288
William Lewis
Louisville, 502-491-4273
G. Thelen & Assoc.
Ft. Mitchell, 606-341-8181
Charlie Winkler & Assoc.
Uniontown, 216-699-9511

LOUISIANA

Corrigan Agency
Covington, 504-893-7455
Jones Audio Sales
Plano, 214-867-0202
Tim Lawson
Baton Rouge, 504-291-0371
Metro Joe's Mkt'g
Metairie, 504-887-1885

MAINE

ROB HENDRICKSON
W.A. HENDRICKSON CO.
N. Scituate, 617-545-0652
Piper Assoc.
Needham, 617-449-1144
PAUL WINKLEY
W.B. PRAY SALES
Northboro, 617-393-3434
Ted Curtin
Repworks
Chicopee, 413-533-0845
Harry Starbird
Portland, 207-774-8448

MARYLAND

PHILLIP WALTER
ASR ENTERPRISES
Fallston, 301-893-0001
Audio Assoc.
Baltimore, 301-854-6122

Boggs & Assoc.
Ft. Washington, 301-292-2047

Alan Brothers
David H. Brothers
Finksburg, 301-833-0920

Craig Davidson
Gaithersburg, 301-670-0022

EIL Instruments
Sparks, 301-771-4800

Ken Forti
Forti Assoc.
Kensington, 301-949-1706

Gary Foster
Columbia, 314-442-2288

Imagitron Sales
Upperco, 301-374-5600

Judkins Assoc.
Baltimore, 301-234-0010

Hubert Vaughn
Lienau Assoc.
Columbia, 301-621-4113

S.K. Macdonald
Lisbon, 301-982-1088

Marketline Ltd.
Baltimore, 301-944-2111

Mike McMahon
Baltimore, 301-563-5390

Mechtronics Sales
Rockville, 301-340-2130

Music America
Columbia, 301-995-1578

JOHN GALLICE
R.J. MKT'G
Rockville, 301-251-0330

Frank Smith
Huntingtown, 301-855-1258

Phil Kaylor
Sound Sales
Lanham, 301-731-6355

Sturgill Assoc.
Columbia, 301-995-1578

Taub Sales
Silver Springs, 301-622-9100

Tom Villano
Gaithersburg, 301-948-7151

WD Mkt'g
Silver Spring, 301-585-5311

Frank White
Severna Park, 301-647-0995

MASS.

Dana Ahern
Quincy, 617-770-9914

Anderson Sales
Braintree, 617-848-9194

Gary Angell
Wellesley, 617-235-1110

Crawford Assoc.
Andover, 617-470-2122

Double Edge Audio
Haverhill, 617-372-5526

Frank Assoc.
Sudbury, 617-443-5131

GMI/New England
Avon, 617-588-8043

John Hamilton Givan
Givan Assoc.
W. Boylston, 508-835-3161

Philip Markham
Hanoud & Assoc.
Rehobath, 617-252-3735

Arnold Harris
Clinton, 617-365-6364

ROB HENDRICKSON
W.A. HENDRICKSON CO.

N. Scituate, 617-545-0652

Gerald Horne Assoc.
Stow, 617-897-1741

Intersell
Burlington, 617-273-3844

Ken Lind
Wellesley Hills, 617-235-6817

MBK
Boston, 617-269-0629

Tom Maguire & Assoc.
Norwood, 617-551-0500

George Markunas Industries
Avon, 617-588-8043

William McFadden
Danvers, 617-777-7228

Chet Flynn/Sandy Duffy
New Resource
Norwell, 617-659-1463

Piper Assoc.
Needham, 617-449-1144

PAUL WINKLEY
W.B. PRAY SALES
Northboro, 617-393-3434

Pro Audio Assoc.
Burlington, 617-229-6050

R.G. Assoc.
Stow, 617-897-7146

Ted Curtin
Repworks
Chicopee, 413-533-0845

Dave Whelan
W. Springfield, 413-731-9552

Zieco
Boston, 617-861-8300

MICHIGAN

ASI Assoc.
Ann Arbor, 313-663-3733

Lynn Toussaint
Burcaw Co. & Assoc.
Warren, 313-573-4605

C.M. Sales
Farmington Hills, 313-553-8070

CRM
Sterling Heights, 313-826-8980

Andy Combs
Pontiac, 313-673-2280

Cordial/Riley Mkt'g; II
Sterling Heights, 313-826-8980

Ted Firaneck Sales
Pontiac, 313-373-9595

Dick Moore
J. Malcolm Flora
Plymouth,
Innovative Audio Sales
Pontiac, 313-673-2280

H.Y. James
Framington Hills, 313-471-0027

Glen Cordial
Key Mkt'g
Plymouth, 313-459-6040

Robert Milsk Co.
Southfield, 313-354-3310

Thomas Petchell
Riley & Petchell Sales
Detroit, 313-937-3000

Rittner Products
Rochester, 313-651-1333

William McCall
Jack Thorpe
E. Detroit, 313-779-6363

MINNESOTA

John Anderson
Minneapolis, 612-823-6459

Mel Foster Tech. Sales
Edina, 612-941-9800

Gustafson Sales
Red Wing, 612-388-4277

Hanna-Lind
Edina, 612-925-5700

Kodo Assoc.
Minneapolis, 612-881-1255

McManus Music Sales
612-432-5321

Erwin Wolter
Northland Assoc.
Moorhead, 218-233-4616

Presentation Sales
Minneapolis, 612-925-2691

R.W. Sales
St. Paul, 612-646-2710

Rouzer Sales
Minneapolis, 612-544-3145

Universal Agents & Assoc.
Bloomington, 612-894-3660

Yore Co.
White Bear Lake, 612-770-9760

MISSISSIPPI

Jeffrey Corkren
Broadcast Equip. Sales & Eng.
Jackson
Jones Audio Sales
Plano, 214-867-0202

Murphy & Cota
Atlanta, 404-875-2525

MISSOURI

Broadway
Kansas City, 816-474-1771

Cadon Technical Sales
St. Louis, 314-645-8670

Central Mkt'g Group
Kansas City, 816-741-7460

Centurian Mkt'g
Ballwin, 314-227-7229

Cor-rell Communications
St. Louis, 314-997-7000

Donald Geders
Thomas L. Dowell Assoc.
St. Louis, 314-849-4234

ESC
St. Louis, 314-725-0933

Erich Uhlhorn
Essential Mkt'g
St. Joseph, 816-279-0776

KKB Assoc.
St. Louis, 314-647-2400

Pete Kallaos
Creve Coeur, 314-878-3365

Lowall-Kangas
St. Louis, 314-821-4050

Marc Johnson
MJA Mkt'g
St. Charles, 314-723-0400

Music Interventions & Assoc.
Kansas City, 816-453-4448

Chuck Day
Nevco
Independence, 816-478-4582

Chuck Rancilio Assoc.
St. Louis, 314-845-0202

RJ Throckmorton Sales
Ballwin, 314-227-7222

MONTANA

David BeLusko
Jos. BeLusko
Portland, 503-223-2241

Loppnow & Assoc.
Issaquah, 206-392-3936

CHUCK OLSON
CHUCK OLSON ASSOC.
Renton, 206-271-5416

NEVADA

Ron Schwartz
Bidwell-Schwartz Assoc.
Gardena, 213-770-0300

MORDY FOODYM
MEYER & ROSS
Burlingame, 415-348-6800

TIM SCHAEFFER
NEW WEST AUDIO
Burbank, 818-955-9706

WES ALDERSON
WESTECH
Fountain Valley, 714-962-2545

NEW HAMPSHIRE

Associated Systems
Manchester, 603-473-2297

Bell Controls
Nashua, 603-882-6984

CompRep Systems
Nashua, 603-883-1212

ROB HENDRICKSON
W.A. HENDRICKSON CO.
N. Scituate, 617-545-0652

James Piper
Piper Assoc.
Needham, 617-449-1144

PAUL WINKLEY
W.B. PRAY SALES
Northboro, 617-393-3434

Pro Musica Sales
Keene, 603-352-4831

Ted Curtin
Repworks
Chicopee, 413-533-0845

NEW JERSEY

PHILLIP WALTER
ASR ENTER.
Fallston, 301-893-0001

Dan Antonellis
Metuchen, 201-494-1019

Audio Assoc.
Verona, 201-239-3727

Austin Assoc.
Willingboro, 609-871-9290

Bob Bernstein
201-882-8010

Bi-State Marketers
Ridgefield, 201-943-5888

John Chez
Ringos, 201-788-5151

Component Marketers
Leonia, 201-947-9300

Dolan Assoc.
Watchung, 201-753-2671

Freedman & Assoc.
Cherry Hill, 609-751-0157

Harold Gray Assoc.
Englewood, 201-894-0894

Dennis Hansen
Piscataway, 201-463-3827

Hartmann Assoc.
 Union, 201-850-3750
 John Hoover
 Cherry Hill, 609-667-1297
 Michael Phillips
 Hudson Mkt'g
 Roslyn Heights, 718-352-7365
 Paul Friedman
 Metropolis Audio Mkt'g
 Edison, 201-225-0085
 On the Road Mkt.
 Upper Montclair, 201-746-0501
 Palmieri Assoc.
 Ridgefield, 201-943-5888
 Pusecker Sales
 Upper Montclair, 201-305-8331
JOHN GALLICE
R.J. MKTG
 Rockville, 301-251-0330
 Bob Brennan/John McFadden
 Reflex Mkt'g
 Hempstead
 Gary Rosen
 Paramus, 201-368-5185
 Art Sbrilli
 Edison, 800-445-0152(#2302)
 M. Schlarman
 Wanaque, 201-839-2243
 Jim Schlott
 Ramsey, 201-934-7574
 Peter Schmitt
 Leonia, 201-944-2806
 SESCO-Mid Atlantic
 Toms River, 201-929-1705
 Sigmat
 Freehold, 201-462-1221
 Mark Skilowitz
 Newfield, 609-697-4580
 Walt Spencer
 Ramsey, 201-934-8500
 Sprung-Nussbaum
 Englewood, 201-569-5666
 Tom Marchiano
 TMC Sales
 Ft. Lee, 201-944-8340
MEL ZEITLIN
TAURUS 3 INT'L
 Manalapan, 201-780-7114
 Paul Ackel
 Triad Mkt'g
 Wayne, 201-696-8625

NEW MEXICO

Tremblay Assoc.
 Albuquerque, 505-266-8616

NEW YORK

ABS Technologies
 Islip, 516-277-7101
 ALI
 NYC, 212-620-3086
 Audio Assoc.
 Verona, 201-239-3727
 Auteri Assoc.
 Miller Place, 516-331-5022
 Ray Benck
 Binghamton, 607-775-4437
 Bob Brennan
 Hempstead, 516-565-2323
 Irv Brown Co.
 Brooklyn, 718-493-1379
 Julius Zimmerman

Jack Brown Electronic Sales
 Whitestone, 214-943-7528(#2305)
 Canavan-Scanlon Assoc.
 Syracuse, 315-437-1271
 Jody Carver
 Somers, 914-248-5806
 Cascade Control
 Oyster Bay, 516-922-0071
 Thomas Principale
 Christy Ind.
 Brooklyn, 718-236-0211
 Clearview Mkt'g
 Forest Hills, 718-592-0710
 Alby Currant Sales
 Pittsford, 716-586-1100
 DB Mkt'g
 E. Rockway, 516-596-1244
 B. Darmstedter Assoc.
 Baldwinsville, 315-638-1261
 Sheldon A. Goodman Assoc.
 Oswego, 315-343-5739
 Michael Phillips
 Hudson Mkt'g
 Roslyn Heights, 718-352-7365
 Neal Hunter & Assoc.
 Syracuse
 Jayso Electronics
 Bronx, 212-798-1050
 Joel Schwartz; LCA Sales
 Tuckahoe, 914-961-4700
 Gordon Le Roy; LSM Assoc.
 Phelps, 315-548-4891
 Michael Langie
 Langie Audio Visual Co.
 E. Rochester, 716-385-4880
 Stan Seymour/Pat Dunnigan
 Lewis & Dunnigan
 Syracuse, 315-446-5522
 Liebel & Merle Sales
 Rochester, 716-385-3961
 Robert McAll
 516-966-8000
 Jack Mesnick Sales
 Liverpool, 315-622-3211
 Ouzunoff & Assoc.
 Yorktown Heights, 914-245-6452
 Paston-Hunter
 Syracuse, 315-437-2992
 Pinz Sales Corp.
 Rockville Centre, 516-678-6887
 David Prinzi
 Webster, 716-671-9266
 Stan Somers; Pro Audio Mkt'g
 Melville, 516-367-8620
 R.C.S.
 Yorktown Heights, 914-245-2866
 Peter Berns; Roburn Agencies
 Yonkers, 914-968-1016
 SAGA
 Oswego, 315-343-5739
 Alan Sarfaty & Assoc.
 Great Neck, 516-466-6770
 Schmitt Industrial Mktg
 W. Hempstead, 516-486-3510; Islandia, 516-582-5888
 Sherwood Assoc.
 Endicott, 607-785-1590
 James Somers
 Geneva, 315-789-7938
 William Stern
 Mt. Vernon, 914-664-7300
 Paul Ackel; Triad Mkt'g Assoc.
 Wayne, 201-696-8625

Upstate Mkt'g
 Burnt Hills, 518-399-6311
 William Watkins
 Merrick, 516-546-5374
 Wood & Co.
 Buffalo, 716-886-0019

NORTH CAROLINA

Thomas Adams; Adams & Assoc.
 Greensboro, 919-272-6838
 Applied Audio Mkt'g
 Asheville, 704-252-9313
 Atlantic Mkt'g Services
 Matthews, 704-542-3380
 Crest Electronics
 Greensboro, 919-288-2787
 Bob Edsall
 Ashville, 704-252-9313
 Murphy & Cota
 Atlanta, 404-875-2525
 Pace Sales
 Charlotte, 704-365-3216
 Raleigh Perry & Assoc.
 Buford, 404-945-3142
 Mark Motsinger; Wallace Sales
 Kernersville, 919-996-2742

OHIO

BRUCE HAGEN
AUDIO MKT'G ASSOC.
 Brecksville, 216-526-2426
 James Umstead
 Avcom
 N. Olmsted, 216-777-2060
 Cambridge Mkt'g
 S. Euclid, 614-890-7788
 Cambridge Pro Sales
 Westerville, 614-890-8144
 Don Sniff
 Dardon & Assoc.
 Olmstead Township, 216-234-4555
 Wm. J. Davis Co.
 Cincinnati, 513-271-7999
 Tom Harmon
 N. Royalton, 216-237-9642
 K/T Depco
 Cleveland, 216-442-6200
MICK MANDABACH
LMS MKT'G
 Columbus, 614-457-2288
 J.W. Lehner Co.
 Stow, 216-686-1965
 Tim McDonnell
 Willoughby, 216-942-2429
 James Hager Jr.
 McFadden Sales & Mkt'g
 Columbus, 614-761-3177
 Kenneth Reinhardt
 Midstates
 Indianapolis, 317-639-9999
 J.B. Parent
 Dublin, 614-764-0064
 Bob Martin
 C.L. Pugh & Assoc.
 Cleveland, 216-238-1777
 Walter Radner
 Westfield Center, 216-887-5646
 Jim Church Mkt'g
 Reptronics
 New Madison, 513-996-0530
 800-888-0530
 W.C. Harding

Shamrock Electronic Sales
 Dayton, 513-258-1227
 Teplitz Assoc.
 Cleveland, 216-439-3265
 Ralph Wright
 Weller Sales
 Worthington, 614-885-7819
 Bob White & Assoc.
 Solon, 216-248-1317
 John S. Wilkin & Assoc.
 Hillboro, 513-393-1137
 Charlie Winkler & Assoc.
 Uniontown, 216-699-9511

PENNSYLVANIA

PHILLIP WALTER
ASR ENTERPRISES
 Fallston, 301-893-0001
BRUCE HAGEN
AUDIO MKT'G ASSOC.
 Brecksville, 216-526-2426
 George M. Conneen
 Springfield, 215-544-5884
 John Carter
 Control Assembly Co.
 Pittsburgh, 412-561-0293
 FMA Assoc.
 King of Prussia, 215-337-9211
 Franklin Comm.
 N. Whales, 215-643-3031
 GMC
 Springfield, 215-544-5884
 Bill Hamilton
 Folsom, 215-543-4677
 Jacobson Assoc.
 Horsham, 215-674-2937
 KBZ Comm.
 Furlaong, 215-348-9481
MICK MANDABACH
LMS MKT'G
 Columbus, 614-457-2288
 Richard Lewis Sales
 Glenside, 215-886-1555
 Lienau Assoc.
 New Town, 215-860-2100
 William Sylvester
 L.D. Lowery
 Broomall, 215-356-5300
 MBT Sounds
 Pittsburgh, 412-344-1360
 Milanese Assoc.
 Phila., 215-763-2138
 CH Newson & Assoc.
 Flourtown, 215-233-0333
 North Coast Mkt'g
 Erie, 814-456-6435
 PMC Packaging
 Warrington, 215-628-0560
RICHARD S. PASS
 Langhorne, 215-757-6100
JOHN GALLICE
R.J. MKTG
 Rockville, 301-251-0330
 Bob Brennan/John McFadden
 Ed Portko
 Sigmat
 Valley Forge, 215-783-6666
 Susan Stamm
 Pittsburgh, 412-344-1360
 Stinson Assoc.
 Havertown, 215-446-8585
 Arthur Tilley Jr.
 Fayetteville, 717-352-8432
 Martin Weinberg Assoc.
 Glenside, 215-885-4244
 Charlie Winkler & Assoc.

220 INDEX OF MANUFACTURER'S REPRESENTATIVES

Uniontown, 216-699-9511

RHODE ISLAND

ROB HENDRICKSON
W.A. HENDRICKSON CO.
N. Scituate, 617-545-0652
Piper Assoc.
Needham, 617-449-1144
PAUL WINKLEY
W.B. PRAY SALES
Northboro, 617-393-3434
Ted Curtin
Repworks
Chicopee, 413-533-0845
KEVIN MURPHY
Wakefield

SOUTH CAROLINA

Murphy & Cota
Atlanta, 404-875-2525
Raleigh Perry & Assoc.
Buford, 404-945-3142
Rohr Wanger & Roberts
Rock Hill, 803-324-5111

TENNESSEE

Evans Sales & Mkt'g
Nashville, 615-297-7997
Graeme Goodall
Nashville, 615-883-8140
James McFarren
Nashville, 615-227-5027
Murphy & Cota
Atlanta, 404-875-2525
Rob Payne
Knoxville, 615-966-3786
Raleigh Perry & Assoc.
Buford, 404-945-3142
Wilson Audio Sales
Nashville, 615-646-4477

TEXAS

A/V Mkt'g
Ft. Worth, 817-246-7166
Art Petty
Admiral Sales Co.
Dallas, 214-357-9212
Audio Visual Mkt'g
Ft. Worth, 817-246-7166
Bruce Barrett
Garland, 214-530-0467
Dick Bellew Sales
Dallas, 214-644-7881
Bob Bryan Enter.
Ft. Worth, 817-237-6039
Neil Conly
Bedford, 817-540-3066
The Crockett Sales Co.

Dallas, 214-350-3377
Designed Performance
Dallas, 214-458-1655
Harold De Vaney
Dickinson, 713-337-1040
Dimension IX Mkt'g
Dallas, 214-348-9657
Dobbs-Stanford
Dallas, 214-358-0800
Graham/Davis
Houston, 713-558-8662
Hite Electronics
Mansfield, 817-483-7077
Jim Hughes Co.
Dallas, 214-221-1536
JMS Mkt'g
Austin, 512-266-1443
J.Y.S. Comm.
Dallas, 214-349-1650
Jones Audio Sales
Plano, 214-867-0202
Peter Koehler
214-350-1232
Lex Lawson & Assoc.
Garland, 214-272-8482
R.E. LeBoeuf & Assoc.
Richardson, 214-231-3190
Charles Lucas Sales
Dallas, 214-330-8181
Mkt'g Concepts
Irving, 214-869-0669
McCoy Assoc.
Richardson, 214-864-1838
Glenn McDaniel
Dallas, 214-385-3322
Duke McLane
Dallas, 214-247-5999
Miller & Assoc.
Richardson, 214-437-5733
P.A.S.
Ft. Worth, 817-483-7474
Dan Speegle
Peregrine Southwest Reps
Houston, 713-589-8481
Jerry Petty
Dallas, 214-386-3809
Ed Proctor
Ft. Worth, 817-535-2771
John Reed
RPM Sales
Carrollton, 214-446-3010
Larry Burkhart
Raven Sales
Dallas, 214-490-8230
Raymar Assoc.
Duncanville, 214-296-9833
Repcoa
Dallas, 214-363-0977
Bobb Partridge
Rep-Tech
Terrell, 214-563-7663
David Allen
J.Y. Schoonmaker
Dallas, 214-349-1650

Sandra Sheppard
Carrollton, 214-394-8472
Spectra Sales
Richardson, 214-234-3600
Spivey-Leboeuf Assoc.
Richardson, 214-231-3190
Summit Sales
Houston, 713-890-5333
Wylie, 214-442-6052
Tenicki & Assoc.
Houston, 713-528-2005
Texas Pro Reps
Ft. Worth, 817-847-0625
Zonk & Assoc.
Richardson, 214-238-7651

UTAH

Larry Bickford
CB Electronic Mkt'g
Arvada, 303-422-0561
Harold Coleman
Coleman's
Salt Lake, 801-484-5238
General Communications
Murray, 801-266-5731
Keiser & Assoc.
Bountiful, 801-298-8902
H. Jerry Huro
PMP Mkt'g
Park City, 801-649-6030
Pro Tech Mkt'g
Salt Lake, 801-943-8331
Jay Sample
Sandy, 801-942-1059

VERMONT

ROB HENDRICKSON
W.A. HENDRICKSON CO.
N. Scituate, 617-545-0652
Piper Assoc.
Needham, 617-449-1144
PAUL WINKLEY
W.B. PRAY SALES
Northboro, 617-393-3434
Ted Curtin
Repworks
Chicopee, 413-533-0845

VIRGINIA

PHILLIP WALTER
ASR ENTERPRISES
Fallston, 301-893-0001
BRUCE HAGEN
AUDIO MKT'G ASSOC.
Brecksville, 216-526-2426
Bill Bailey
Hopewell, 804-748-4149
Alan & David H. Brothers
Finksburg, 301-833-0920
Eric King

Lynchburg, 804-384-7001
Pantech
Springfield, 703-451-5700
JOHN GALLICE
R.J. MKTG
Rockville, 301-251-0330
SAC Comm.
Vienna, 703-281-2558
Richard Smith
Herndon, 703-834-3600

WASHINGTON

David & Jos. V. BeLusko
Portland, 503-223-2241
Carlland Alarm & Comm.
S. Federal Way, 206-839-8433
Jim Fetterer
Seattle, 206-243-7762
John Caporale
Future Sales
Redmond, 206-868-5577
Gemini Electronic Mkt'g
Edmonds, 206-776-3121
Loppnow & Assoc.
Issaquah, 206-392-3936
Seattle, 206-524-5170
Northshore Mkt'g
Seattle, 206-284-9699
NW Sales Firm
Tacoma, 206-759-9995
CHUCK OLSON
CHUCK OLSON ASSOC.
Renton, 206-271-5416
C.S. Scott
Pacnor Mkt'g
Lynnwood, 206-771-6016
Roger Ponto Assoc.
Kirkland, 206-821-2996
RIK Assoc.
Tacoma, 206-759-0833
S & F NW
Seattle, 206-525-5203
Terminal Sales
Seattle, 206-441-9610
Harold Kephart
Vector
Seattle, 206-322-4343
Vince Ward
Redmond, 206-643-1074
Vince Ward
Vashon Island, 206-463-5582

WEST VIRGINIA

MICK MANDABACH
LMS MKT'G
Columbus, 614-457-2288
Charlie Winkler & Assoc.
Uniontown, 216-699-9511

INDEX OF TRADE NAMES

- Acoustic Control Systems**
(Decoustics)
- Advantage Division** (Biamp Systems)
- Akai** (Int'l Music Co. — I. M. C.)
- AMP** (Amplified Music Products)
- AMR** (Peavey Electronics)
- American Acoustics** (Mitek)
- Architectural Acoustics** (Peavey Electronics)
- Atlas Sound** (Atlas/Soundolier)
- Atos** (Audio-Technica U.S.)
- Audio Centron** (St. Louis Music)
- Audio Spectrum** (The Music People)
- Audsco** (Audio Systems)
- BCE/Edcom** (Telecor)
- Beseler** (Da-Lite Screen)
- Blackjack** (Dean Markley Strings & Electronics)
- Boss** (Roland Corp. US)
- Bozak** (Portland Instruments)
- BSS Audio** (Edge Distribution/Turbosound)
- C-ducer** (C-T Audio Mkt'g)
- CardAccess** (Continental Instruments)
- Cartographer** (Intelligent Music)
- CRL Systems** (Circuit Research Labs)
- Design Acoustics** (Audio-Technica U.S.)
- Dynamite** (Valley Int'l)
- Ektacom** (Fisher-Berkeley—Ektacom)
- Electrocolor** (Blonder-Tongue Laboratories)
- Electronic Enclosures** (Wyle Labs/Electronic Enclosures Div.)
- Excalibur Cases** (The Great American Market)
- F.O.S.** (Faraday)
- Flexible Arm Co.** (Uniprise Int'l)
- Forsythe** (Eastern Acoustics Works — EAW)
- Fox** (Dayton Industrial)
- Gamble Consoles** (Crest Audio)
- Gatex** (Valley Int'l)
- GBC** (CCTV)
- Graystone Intercom** (Elbex America)
- Grommes Precision** (Precision Electronics)
- Guardman** (Blonder-Tongue Labs)
- Intervox** (Int'l Components Corp.)
- ITC** (Int'l Tapetronics/3M)
- Loft** (Gold Line)
- McKenzie Speakers** (Waldom Electronics)
- Med-Tek** (Engineered Electronics)
- M.E.S.A.** (Roland Corp US)
- MMC** (Fisher-Berkeley—Ektacom)
- Mogami** (Marshall)
- MRL** (Magnetic Reference Lab)
- MTX** (Mitek)
- Multivox** (MaxiVox)
- Norwegian Electronics/Rion** (Scantek)
- Omnicraft** (CT-Audio Mkt'g)
- On-Stage Stands** (The Music People)
- Paramount Pictures** (Portland Instrument)
- Petcom** (Poetker Communications)
- Posh** (Portland Instrument)
- Proforce** (The Music People)
- Ramsa** (Panasonic)
- RCF** (Eastern Acoustics Works — EAW)
- Ross** (Int'l Music Co. — I M C)
- S.H. Couch** (Faraday)
- Schoeps** (Posthorn Recording)
- SCV Audio** (Portland Instrument)
- Seck** (JBL Professional)
- Sentinel** (American Zettler)
- Shuttle Cases** (Silver Eagle Designs)
- Sitefones** (Metragen)
- Soar** (CG Instruments)
- Sonalert** (Mallory Capacitor)
- Sonex Acoustical Foam** (Alpha Audio)
- Sonosax** (Professional Sound)
- Sonotrim** (Posthorn Recording)
- Soundcraft** (JBL Professional)
- Soundolier** (Atlas/Soundelier)
- Soundsphere** (Sonic Systems)
- Standard Electric Time** (Faraday)
- Starforce USA** (Skytronics Electrical)
- SUNN** (Fender Musical Instruments)
- TAD** (Technical Audio Devices/Pioneer Electronics)
- TEAC** (Tascam — TEAC Professional Division)
- Tect** (Audix)
- 3rd Generation Pro-Audio** (Tektrak)
- TMW Tajimi** (Marshall)
- Toki Tape Light Systems** (Capitol Lighting Products)
- Tube Driver Preamps** (Chandler Industries)
- Turbosound** (Edge Distribution/Turbosound)
- UREI** (JBL Professional)
- Visonik** (Hirschmann of America)
- Wireless Sound** (Wissco)

AD INDEX

Company	Page	RS #	Company	Page	RS #	Company	Page	RS #
AB International (916) 783-7800	49	40	Gauss (213) 875-1900	129	230	Pioneer Laser Entertainment (213) 518-4531	181,182	220
Aiphone Intercom Systems (206) 455-0510	67	203	Gemco (615) 452-5960	131	207	Professional Audio Systems (213) 534-3570	105-120	
AKG Acoustics (203) 348-2121	143		GNWC (800) 468-2121	211	283	Proto-Tec (815) 744-7173	21	45
Alarm Accessory (800) 441-7082	29	221	Hacoustic (404) 945-3142	48	70	Quam-Nichols (312) 488-5800	61	205
Altec Lansing (405) 324-5311	161	229	HM Electronics (619) 535-6092	83	232	Radian Audio Engineering (714) 961-1213	92	4
Applied Research & Technology (716) 436-2720	167	224	Hi-Lo Fabrication (817) 373-2247	12	83	Ramsa (See Panasonic)		
Argos Sound (815) 784-5118	194	61	Industrial Research Products (312) 439-3600	3	206	Rane Corporation (206) 774-7309	162	225
Ariel Corp. (201) 249-2900	203	214	Innovative Electronic Design (502) 267-7136	119	284	Rauland-Borg (312) 679-0900	81	270
Aris (216) 425-3388	26	43	International Components Corp. (516) 293-1500	96	81	Ring Communications (516) 585-RING	73	243
Atlas/Soundolier (314) 349-3110	19	210	JBL Professional (818) 893-8411	CIV	201	Ross Systems (817) 336-5114	133	71
Audio Systems AUDSCO (800) 852-6522	63	62	Jensen Transformers (213) 876-0059	13	282	RTS Systems (818) 566-6700	159	70
Audio-Technica (216) 686-2600	177	89	Jeron Electronic (312) 275-1900	74	33	Samson Technologies (516) 932-3810	80	248
BBE Sound (714) 897-6766	145	238	Lectrosonics (800) 821-1121	170	273	Sennheiser Electronics (203) 434-9190	5	240
B.E.S.T. (213) 926-0201	169	242	Lee Dan (516) 231-1414	65	228	Sonance (714) 661-7558	147	217
BGW Systems (213) 973-8090	125	241	Mackenzie Laboratories (800) 423-4147	183	3	Sonic Systems (203) 356-1136	101	204
Bi-Tronics (800) 666-0996	43	208	Mfrs. Representatives Educ. Rshc. Fndn. 185	132	44	Soundcraftsmen (714) 556-6191	98	290
Bose Corp. (508) 879-7330	213	82	Marshall Electronics (213) 390-6608	213	88	SoundScape (407) 876-6864	128	291
Burle Industries (717) 295-6123	103	235	McCauley Sound (206) 848-0363	104	289	Speco (800) 645-5516	40	253
Cal-Switch (800) CAL-SWCH	35	213	McGohan Electronics (312) 595-2342	48	35	Tannoy North America (519) 745-1158	102	60
Community Light & Sound (215) 876-3400	208	80	Meyer Sound (415) 486-1166	97	231	Tappan Wire & Cable (800) 247-9099	192	293
Crown International (219) 294-8000	124	292	MG Electronics (516) 582-3400	93	247	Techron (219) 294-8300	210	281
CT-Audio (800) CT AUDIO	45	215	Microframe (800) 635-3811	194	67	Technical Projects (800) 562-5872	207	246
DDA/Klark-Teknik (516) 249-3660	144	87	Nady Systems (415) 652-2411	86	85	TEI Electronics (800) 327-8811	23,25	64
David Clark (508) 756-6216	156	239	Numark Electronics (201) 225-3222	89	90	TekTone Sound & Signal (407) 844-2383	77	
DOD Electronics (801) 268-8400	24	285	OAP Audio Products (404) 945-1028	153	272	Telecall (206) 881-2742	68	287
Electro-Voice (616) 695-6831	164	211	Opamp Labs (213) 934-3566	180	275	Telex Communications (800) 328-3771	84	256
Emilar (800) 421-7071	CII	202	Orban (415) 957-1067	100	2	TOA Electronics (800) 843-4753	195	271
ESE (213) 322-2136	96	84	Oxmoor (205) 942-6779	53	288	T-S-K Electronics (716) 693-3916	151	245
Florence (312) 384-3310	171	249	Pacific Transformer FAX (714) 779-0718	49	42	University Sound (818) 362-9516	31	31
John Fluke Mfg (206) 356-5400	75	286	Panasonic/CCVED (201) 348-7303	58	41	West Penn Wire (800) 245-4964	191	233
Fourjay Industries (513) 890-6444	66	34	Panasonic/Ramsa (714) 373-7277	14	86	Wheelock (201) 222-6880	209	280
Frazier (800) 643-8747	CVRIII	254	Pentagon (312) 271-8300	39	250	White Instruments (512) 892-0752	189	218
FSR Inc. (201) 239-0988	91	32	Phonic Ear (800) 227-0735	99	244	Williams Sound (612) 931-0291	160	36
	127	274		62	37	Yamaha Pro Audio (714) 522-9011	152	236
	56	39		201	38		165	226
							11	227

- 360 Systems 170, 176, 178, 184
- 3M Sound Products 62, 76, 79, 184
- A & D Engineering 202
- A & S Case 17
- A-1 Business Supplies 21
- A.E.S. 92
- A.W. Sperry Instruments 205
- Aarmor Case 17
- AB International 41
- Ac-cetera 208
- Accurate Sound 186
- Accusonics Systems 23, 92, 142
- ACO Pacific 142, 202
- Acoustic 191
- Acoustiflex 14
- Acoustilog 202
- Acoustone Grille Cloth 14, 89
- ACS Communications 23
- ADA Amplification Systems 41, 188
- Adam Hall Supplies 18
- Adams-Smith 41
- Adaptive Micro Systems 74, 86, 183
- ADC Telecommunications 177
- ADM Technology 154
- Adpro Pty. 27
- Advanced Music Systems 159
- Advanced Video Assoc. 34
- Advantage 57, 154, 159
- Aegis 202
- AEI Music Network 60
- Aerocoustic 14
- AES Corp. 27
- AGFA-Gevaert, Magnetic Tape Div. 186
- Aiphone Intercom Systems 27, 34, 41, 50, 64, 71, 74, 77, 79, 81, 85, 86, 89, 92, 142, 188, 200
- Akai Professional/IMC 186
- AKG Acoustics 23, 142, 149, 159, 179
- Alarm Accessory 21, 27, 208
- Alarm Controls 27
- Alarmco 27
- Alaun Engineering 23, 34, 200
- Alesis 41, 154, 159, 175
- All Electronics 21, 27, 202, 208, 212
- Allen and Heath 154, 175
- Allsafe 27
- Alpha Audio 14
- Alpha Communications 64, 71, 74, 77, 79, 85, 86
- Alpha Omega Case 17
- Alpha Recording 14
- Alpha Wire 208
- Alphametrics Controls 27
- Altair Electronics 202
- Altec Lansing 41, 92, 159, 188, 191
- Alternative Telecommunications 64, 71, 77
- Altronic 64
- Amber Electro Design 202
- Ambeti 27, 86
- Amco Engineering 17
- Amek/TAC US Operations 154
- American Acoustic Products 14
- American Dynamics 34
- American Fibertek 34
- American Laser Systems 34
- American Recorder Technologies 186
- American Reliance 202
- American Zettler 74
- AMP Netcon 208
- Ampex Recording Media Corp. 186
- Amphenol Products 208
- Amplified Music Products 191
- Amplivox Communication Products 64
- AmPro 34
- AMS Industries 142, 154, 159
- AMSECO 27
- Amtel Security Systems 27, 64, 79
- AMX 57
- Anchor Audio 50, 192
- Anderson Mfg. 34
- Anixter Bros. 23
- Ansett Technologies 59
- Antenna Specialist 34
- Antennacraft 34
- Anvil Cases 17
- Apex Machine 186
- Aphex Systems 159
- API Audio Products 154
- Apogee Electronics 159, 202
- Apogee Sound 92
- Apple Computer 175
- Argos Products 50, 92, 192
- Ariel 202
- Aries America 154
- Aris/Eta 12, 17, 26, 179
- Armstrong Cork 14
- ART—Applied Research & Technology 159
- ARX Systems 159
- Asaca/Shibasokui 202
- ASC—Tube Traps 14, 27, 159, 200, 202
- Ashly Audio 41, 159, 188, 192
- ATC Supply 64, 71, 77
- ATI - Audio Technologies 41, 188
- Atis 40, 183, 186
- Atkinson Dynamics 71, 77
- Atlas Wire & Cable 208, 212
- Atlas/Soundolier 17, 27, 34, 40, 50, 74, 77, 86, 89, 93
- Audi-Cord 183
- Audico 186
- Audio Access 57, 200
- Audio Accessories 177
- Audio Control Industrial 202
- Audio Design Assoc. 41
- Audio Engineering Assoc. 142
- Audio Logic 154, 163
- Audio Precision 202
- Audio Quest 208
- Audio Services 197
- Audio Systems 39, 57, 163, 177, 188
- Audio Technology 41
- Audio Video Supply 34
- Audio Visual Systems 177
- Audio-Technica U.S. 142, 149
- Audio/Digital 159
- Audioarts Engineering 154
- Audiocom 60, 183, 186
- Audiolab Electronics 186
- Audiosears 23
- Audiosone 86
- Audiotech 93
- Audisar 12, 34, 50, 89, 93
- Auditel Systems 23, 50, 57, 59, 142, 154, 177, 188, 197, 200
- Auditronics 154
- Audix 142
- Audra Int'l 142
- Auernheimer Labs & Co. 93
- Aural 93
- Auratone 93
- Autocall 27
- Autogram 154
- Automation Devices 183
- Automation Electronics 183
- Autopatch A/V Systems 57, 177

- AVA Electronics 21
 AVL Systems 14
 AVNC/Instrument Div. 202
 AVSC 186
 Avtec Industries 50
 Azden 163
 B & B Systems 212
 B.E.S.T. Int'l 93
 Bacchus Software Systems 175
 Bag End 93
 BAL 17
 Banner 202
 Barcus-Berry 142, 202
 BASF, Information Systems 186
 BBC-Metrawatt/Goerz 202
 BBE Sound 81, 163, 179, 197
 Beckman Ind'l/Instr. Prod. Div.—An Affiliate of Emerson Electric 202
 BEL Electronics 197
 Belden Wire & Cable 208
 Benchmark Media Systems 177
 Benjamin Int'l 183, 186
 Berk-Tek 208
 Beyer Dynamic 23, 142, 149
 BGM Int'l 60
 BGW Systems 41
 Bi-Tronics 208, 212
 Biamp Systems 154
 Black Audio Devices 12
 BLI 14
 Blonder-Tongue Laboratories 34
 Bobadilla Cases 17
 Bogen Communications 27, 41, 50, 64, 71, 77, 79, 85, 89, 93, 143, 154, 188, 200
 Bonneville Media Communications 186
 Boonton Electronics 202
 Bose—Pro Products 23, 93
 Bose—Professional Products 50, 163, 179, 192
 Bostick 14
 Boston Acoustics 93
 Boulder Amplifiers 41
 Bourns/Trimpot Div. 12
 Bozak 59, 93, 154, 179
 Brahler USA 200
 Brejtfus Business Environments 14
 Bretford Mfg. 50
 Brim Electronics 21, 208, 212
 Broadcast Audio 154
 Broadcast Electronics 154
 Broadcast Tech. of Colorado 34
 Brooks Electronic System Technology 163
 Bruel & Kjaer Instruments 143, 202
 BrystonVermont 41, 89
 BSM Systems 57, 177
 BSS Audio/Edge Distribution 163
 Bud Industries 17
 Bunting 74
 Burle Industries 34
 Burlington Audio/Video Tapes 186
 C & K Systems 27
 C&K Systems 27
 C-Audio 41
 C-T Audio Mkt'g 143
 Cabletronix 21, 26, 202, 208, 212
 Cabtron Systems 17
 CADD Creative Audio Design & Development 163
 Cal Switch 17, 21, 26, 177, 197, 202, 208, 212
 Calibration Standard Instruments 94, 163
 Califone Int'l 50, 192
 Calrad Engineered Electronic Products 208
 Calzone Case 17
 Cambridge Electronics Labs 71
 Canare Cable 208
 Capaul 14
 Capitol Lighting Products 12
 Capitol Magnetic Products 186
 Carol Products 34
 Carver 41
 Carvin 41, 163, 197
 Casco Background Sound 60
 Case Component Network 89
 Cases 17
 Caseworks of Chicago 17
 Catel Telecommunications 34
 CBM Metal Products 17
 CCTV 34
 Celestial Software 203
 Celestion Industries 94, 192, 197
 Celotex 14
 Centro 34
 Cepco 27
 Cerwin-Vega 89, 94, 179, 192
 CG Instruments 202
 Chadwick Helmuth 203
 Champlain Cable 208
 Chandler Industries 163
 Channel Master, Div. of Avnet 34
 Channelmatic 34
 Chemtronics 186
 Chester Cable/Division of Alcatel NA 212
 Circuit Research Labs 164
 Clarity 42, 197
 Clarostat Mfg. 12
 Clear-Com Intercom Systems 81
 Clever Devices 27, 40, 71, 86, 164, 183
 Clifford of Vermont 208
 Closed Circuit Systems 34
 CMX 59, 74
 Coherent Communications 27, 143, 149, 200
 Cohu, Electronics Div. 34
 Colorado Video 59
 Columbia Scientific 71
 Com-Tec 28, 74
 Comlux 36
 Communication Equipment Brokers 197
 Communications Co. 12, 42, 50, 64, 71, 77, 81, 85, 86, 197
 Communications Equipment 27, 71, 74, 77
 Communications Products 28
 Community Light & Sound 50, 94, 179, 188, 192
 Compact Monitor Systems 94
 Compression Labs 36, 59
 CompuSonics Video 183
 Computational Systems 203
 Computer Application Systems 28
 Comtek 71, 77, 81, 149, 201
 Comutronix 42
 Conex Electro-Systems 177
 Connectronics 212
 Conquest Sound 12, 175, 177, 208, 212
 Consolidated Electronic Wire & Cable 209, 212
 Contact East 203
 Continental Instruments 28
 Controlled Acoustics 14
 Cornell Electronics Products 28, 39, 50, 64, 71, 74, 77, 79, 86
 Countryman Assoc. 12, 143
 Covox 175
 Createc Signal Computer USA 203
 Creative Audio Design & Development 154, 164
 Crest Audio 42
 Crest Electronics 36, 74
 Crestron Electronics 57
 Crown Int'l 42, 57, 143, 164, 188, 192, 197

ATI/Astatic 142
 Current Cable 209
 Cyborg 203
 CZ Labs 208
 C & R USA 155
 C.J. Assoc. 209
 C.J. Associates 21
 C.O. Industries 53
 Ca-Lite Screen, 53
 Jaburn Electronics and Cable 21, 209, 212
 Dallas Instruments 203
 Danavox/Telecommunications Div. 23
 Data Check 203
 Data Physics 203
 Data Precision, Div. Analogic 203
 Datacraft 197
 David Clark 23, 81
 David Hafner/Rockford 42
 David Wexler & Co. 129
 Davis Instruments Mfg. 203
 DAX Audio Group 42, 155, 164
 Dayton Industrial 23, 28, 42, 60, 64, 77, 79, 188, 201
 dbx, Div. of BSR North America 164
 DCL 94
 DCS Audio Products 42
 DDA-Div. of Klark Teknik 155
 De-Tech Systems 28
 Dean Markley Strings & Electronics 98
 Decoustics 14, 197
 Dekoron, Div. of Fluorocarbon 209
 Delta Communications 74, 77, 79
 Delta Magnetics 42
 Delta Wire & Cable 209
 Design Direct Sound 94
 Detection Systems 28
 Detector Systems 28, 77
 DIA General 28
 Diamond Electronics 36
 Digi-Spec 36
 Digidesign 164, 197
 Digital Music 176
 Digitech 164, 176
 DIS-USA 59
 Diversatronics 86
 Diversified Case 17
 DOD Electronics 12, 155, 164, 175
 Dolby Laboratories 164
 Door Alarm Devices 28, 86
 Doorking 28
 Dorado Systems 28
 Dorrrough Electronics 203
 Doug Biron Assoc. 14
 Dr. T's Music Software 176
 Drive-Thru Intercoms 77
 Drum Workshop 42
 DSP Development 176, 203
 DTG (Development Technologies Group) 212
 Dukane 17, 40, 42, 53, 64, 72, 74, 77, 79, 94, 143, 188, 192
 Duncan Electronics 209
 Dunegan Div., Physical Acoustics 203
 Duracote 14
 Durcom 72
 Dyma Engineering 42
 Dyna-Might Sound & Lighting 179
 Dynair Electronics 36
 Dynamic Software Systems 203
 Dynamote 26
 Dynasound 42, 94, 156, 164, 203
 Dynaware 176
 E and E Instruments Int'l 197

E.M. Long Assoc. 97, 166
 E.R.L. Electronic Products 64
 E.S.E. 36
 EAR/Caraway Audio 17
 East Coast Lighting and Sound 17
 Eastboard Consoles 17
 Eastern Acoustics Works 94
 Eby Co. 59
 Eckel Industries—Acoustic Div. 14
 Eddor 42, 189, 192
 Eden Electronics 94
 Edge Distribution/Turbosound 94, 164
 Editron USA 164
 Edstan Doctors Register, Div. of Time & Sound 74
 Edwards, A Unit of General Signal 28
 EECO 177
 El Mar Plastics 186
 Elbex America 36
 Electro Force 42
 Electro Rent 197
 Electro Space Fabricators 17
 Electro-Voice 12, 42, 89, 95, 143, 156, 164, 189, 192
 Electro-Vox 28
 Electrohome 28, 36, 53
 Electron Processing 197
 Electronic Arts 176
 Electronic Specialists 186
 Electronic Systems Group 94
 Electrorack Products 17
 Elenex (East) 77
 Elenex (West) 17, 28, 42, 64, 77, 85, 189, 192
 ELMA Electronic 17
 Eitrex Int'l 28, 40, 164, 183
 Emcor Products/Crenlo 12, 17
 Emergency Products 28
 EMI (Electro-Mechanical Imaging) 36
 Emilar 89, 95
 EMS/Music 42, 60, 189, 192
 Encom Products 28, 40, 77
 Endevco 203
 Eneractive Group 26
 Engineered Electronics 74
 Environmental Sound 95
 Equipto Electronics 17
 Ethereal Concepts 26
 Europa Technology 156
 Eventide 164
 EVG 209
 Fairlight Instruments 179
 Fane 95
 Fanon Courier 189, 192
 Faraday 28
 Federal Signal 28
 Fender Musical Instruments 189 -
 FGS Intergalactical Cartel and Holding Co. 197
 Fiber Optek Interconnect 36
 Fidelipac 183, 186
 Fire Burglary Instruments 28
 Fire-Lite/Notifier 28
 Firecom/Auth 28
 Fisher-Berkeley—Ektacom 39, 64, 72, 74, 77, 85
 Flight Case 18
 Flight Form Cases 18
 Florence Mfg. 64
 Floyd Bell 27
 FM Acoustics Limited (USA) 42
 FM Tubecraft 18
 Formula Audio 95, 189, 192, 197
 Forte Music 176
 Foster 95

- FOSTEX CORP OF AMERICA 164
 Fostex Corp. of America 18, 23, 53, 89, 95, 143, 156, 186
 Fotec 212
 Four Designs 18
 Fourjay Industries 89, 95
 Franklin Instrument 28
 Frazier 95
 FSR 12, 53, 57, 59, 86, 177
 Furman Sound 156, 164
 Gai-Tronics 77
 Gaines Audio 164
 Galaxy Audio 95, 192
 Gallien-Krueger 189
 Gaslight Video 36
 Gauss 96, 186
 GBE Group 54, 86, 177
 Gemco Electronics 54, 89, 96
 Gemini 18
 General Design Group 14
 General Devices 18
 General Instrument Network Cable Div. 209
 Geneva Group of Companies 186
 GenRad 203
 Gentex 28
 Gentner Electronics 42, 54, 57, 59, 164, 177, 192, 197
 Gentner RF Products 57
 Georgia Cable and Wire 209
 Gepco Int'l 18, 21, 177, 197, 209, 212
 GHI Systems 203
 Ghielmetti 177
 Gilderfluke & Co. 72, 183, 189
 GLI 95
 GLI/Integrated Sound Systems 179
 GNWC Wire Cable & Network Products 209, 212
 Gold Line 203
 Gollehon Industries 96
 Good Foundations 18
 Gotham Audio 145
 Graham-Patten Systems 54
 Grass Valley Group 36, 177
 Great Northern Wire & Cable 209
 Grozier Technical Systems 203
 GSC General Security/Benjamin 183, 186
 Gulton Industries/Servonic Div. 203
 Gyyr, Div. of Odetics 36
 H & E Micro-Trak 42
 H.M. Dyer Electronics 177
 H.O.M.E. 36, 89
 Hacoustic Sound & Communications of America 42
 Hamilton Standard Controls 209
 Hammond Mfg. 18
 Harnel Case Manufacturers 18
 Harris/Dracon Div. 21, 60, 89, 96, 189, 203
 Harrison Systems 203
 Heath 12
 Hedco 177
 Heil Ltd. 197
 Heliotrope General 183
 Henry Engineering 12, 197
 Hewlett-Packard 203
 Hi Lo Fabrication & Mfg. 18, 89, 96, 212
 Hill Audio 42, 156, 189
 Hill Audio Products 96
 Hirschmann of America 36, 96
 Hitachi Denshi America 36
 Hitachi Sales/Security Prod. Div. 30
 HM Electronics 23, 72, 78, 79, 81, 85, 145, 149
 Hoffend & Sons 203
 Holophonics 43
 Home Safeguard Industries 30
 Honeywell Test Instruments Div. 203
 Hoodman 36
 HOSA Technology 209
 House of Metal Enclosures 18
 Housing Devices 64
 Howe Technologies 156
 HSA Heather Sound 18
 Hudson Photographic Industries 54
 Hughes Electronic Devices 177
 Hybrid Arts 164
 Hybrid Cases 18
 Ibanez/Hoshino (USA) 43
 Ideal Wire Products 209
 IED Innovative Electronic Designs 12, 40, 43, 54, 57, 59, 60, 156, 164, 178, 183, 189, 197
 IGM Communications 186
 Ikegami Electronics (USA) 36
 Imagine Computers & Software 176
 Impact Industries 18
 Impart 12
 Industrial Acoustics 14
 Industrial Research Products 43, 59, 156, 164, 189
 Industry West Electronics 43, 178, 189, 193
 Ineptronics 198
 Infonics 183, 186
 Inovonics 166
 Int'l Components Corp. 89, 96
 Int'l Electro-Magnetics 187
 Int'l Electronic Wire & Cable 209
 Int'l Music Co. (I. M. C.) 96, 145, 166, 178, 187
 Int'l Satellite Systems 60
 Int'l Tapetronics/3M 187
 Intec Video Systems 36
 Intelix 57, 156, 198
 Intelligent Controls 30
 Intelligent Music 176
 Interior Acoustics 14
 Intersonics 96
 IQS 145, 203
 ISS Engineering 36
 ITT Pomona Electronics 209
 ITT/DES 66, 72, 78, 156, 164
 Ivie 203
 Iwatsu America 203
 J.H. Sessions & Son 21
 J.W. Davis & Co 17
 J.W. Davis & Co. 12, 21, 36, 42, 53, 79, 89, 94, 143, 188, 192, 200
 Jan-AI Cases 18
 Javelin Electronics 18, 30, 37
 Jaydik Communications 37, 178
 JBL Professional 43, 54, 89, 96, 166, 189, 193
 Jensen Tools 21
 Jensen Transformers 12, 198
 Jensen Video Sonics 30
 Jeron Electronic Systems 39, 66, 72, 75, 78, 80, 85
 JL Cooper Electronics 175
 JNS Electronics 166
 Joe's Sound and Salami 97
 John Fluke Mfg. 203
 Johnson Electronics 43, 60, 72, 78, 156, 189, 200
 JRF Magnetic Sciences 187
 Juice Goose, Div. of Whitenton Industries 26
 JVC Co. of America 36
 Kable King 209
 Kalamazoo Technical Furniture 18
 Karibu Sound Industries 18
 Kay Elemetrics 204
 KDM Electronics 43, 97, 189, 193
 Keithley Instruments Div. 204
 Kinematics/TrueTime 204

King Wire & Cable 209
 Klark-Teknik Electronics 166
 Klipsch & Associates 97
 Knight Industries 18
 Knowles Electronics 145
 Knox Security Engineering 30
 Komtek Communications 75, 88
 Korfund Dynamics 14
 Korg USA 176
 Koss 23
 Koyo Int'l of America 37
 Krohn-Hite 204
 Kulka-Smith 209
 L and L Sales 212
 Labor Saving Devices 21
 Lake Butler Sound 176
 LAR Sound 97
 Larson-Davis Labs 145, 204
 Lathem Time 88
 Leader Instruments 204
 Leasametric Instrument Rental Division 204
 Lectrosonics 54, 145, 149, 156, 166, 193, 201
 Lee Dan Communications 30, 37, 39, 54, 66, 72, 75, 78, 80, 85, 88, 89, 97, 193, 212
 LeFebure 30
 Leitch Video Ltd. 43
 Lemo USA 209
 Len Finkler 42, 95
 Lenco 19
 LEQ Measurements 204
 Lexicon 166
 Lighting and Electronics 179
 Lightronics 13
 Lightwave Communications 37
 Linear & Digital Systems 26
 Littlite/CAE 13
 LM Engineering 19
 Logitek 156
 Louroe Electronics 30
 Lowell Mfg. 13, 19, 30, 40, 89, 97
 LPB 156, 201
 Lumitrol 26
 LVW Electronics 43
 Lync Systems 176
 LynTec 26, 166, 178
 M & S Systems 66
 M.B. America (Master Blaster America) 97
 Maas-Rowe Carillons 71
 MacKenzie Laboratories 30, 40, 75, 88, 183, 187
 MacPherson Speakers 98
 Mag-Tags 21, 54, 198
 Magna-Sound 194
 Magne-Tronics 60
 Magnefax Int'l 187
 Magnetic Reference Lab (MRL) 187
 Mallory Capacitor 88
 Mann Endless Cassette Industries 187
 Marcom/The Scotts Valley Group 166
 Marietta Wire & Cable 210
 Mark IV Cinema Systems 98
 Markertek Video Supply 198
 Marlee Electronics 30, 66
 Marsh Products 66, 85
 Marshall 210
 Martin America 98
 Mason Industries 14
 Math Associates 30, 37, 54, 72, 75, 78, 80, 210, 212
 MaxiVox 80
 McCauley Sound 90, 98, 194
 McGohan Electronics 43, 189, 194

McMartin Int'l 43, 189
 Med-Tek 75, 88
 Mehlich Electronics 75
 Mellotone 15
 MetraByte 204
 Metragen 24, 78
 Metrosonics 204
 Meyer Sound Laboratories 43, 98, 166, 204
 MFJ Enterprises 37
 MG Electronics 30, 88, 89, 98, 145, 194, 204
 Micro-Trak 204
 MicroAudio 43, 166, 204
 Microframe 37, 76, 78, 88
 Microtran 13, 187
 Microvoice 59
 Midas Audio Systems 156
 Middle Atlantic Products 19, 37, 90
 Midwest Electronics Industries 189
 Mikrolab Video 37
 Milab 145
 Millbank Electronics Group 43
 Miller-Stephenson Chemical 21
 Milliphonics 145
 Mircom Communication & Security 66
 MISCO Minneapolis Speaker 99
 Misco/Minneapolis Speaker 98
 Mitek 122
 Mitsubishi Electric Sales America 37
 Modular Audio Products 198
 Modular Sound Systems 122
 Monroe Electronics 57
 Monster Cable Products 212
 Mortronics 90
 Moseley Assoc. 57, 178
 Motorola/Ceramic Products 122
 MPO Videotronics 37
 Multi-Vox Ltd. 66, 76, 189
 Multigon Industries 204
 Multiplex Technology 37
 Music Dealer Service 122
 Music Programming 60
 Music Supply 122, 204, 210
 Musically Intelligent Devices 57
 Muzak 60
 Mystery Electronics 213
 N.E.A.R. New England Audio Resource 122
 Nady Systems 24, 81, 149, 194, 201
 Nakamichi America 24, 187, 200
 Napco Security System 30
 Nasca System 54
 National Electric Cable 210
 Navco Security Systems 30
 NEC America 37
 NEC Professional Systems Div. 37
 Nel-Tech Labs 183
 Nema Electronics Int'l 210
 Neotek 156
 Neutrik USA 40, 90, 183, 204, 210
 Neve 156
 Nicolet, Test Equipment 204
 Niles Audio 54
 Non-Linear Systems/Div. of Kaypro 204
 Noramco Wire & Cable 210
 Norcon Electronics 72
 Norland 204
 North America Soar 204
 North Hills Electronics 210
 Northern Information Technology 37
 Northern Sound 15
 Nortronics 187

- Notifier 30
 Numark Electronics 156
 O'Brien Partition 15
 O'Ryan Industries 179
 Oaktron Industries 90, 122
 OAP Audio Products 122
 Oberheim-ECC 176
 Ocean Audio 198
 Olflex Wire & Cable 210
 Olson Acoustics 122
 Omni Q 26, 54
 Omnimount Systems 21
 Opamp Labs 54, 198
 Orban/Div. of AKG Acoustics 166, 198
 Orevox 30, 122
 Otari 183, 187
 Oval Window Audio 201
 Owens-Corning Fiberglas, Acoustic Prod. Div. 15
 OWI 122
 Oxmoor 57, 166, 190, 198
 P/H Electronics 54
 PA Concepts 122
 Pacific Recorders & Engineering 198
 Pacific Transformer 13
 Paladin 21
 Panasonic Ind. 37, 43, 190, 194, 204
 Panasonic Ind./Instrumentation Dept. 204
 Panasonic/Ramsa 24, 43, 54, 123, 145, 156, 166, 190, 194, 198, 200
 Panduit 21
 PAR Products 19
 Paramount Sound Systems 123
 Parasound Products 43, 123
 Parsons Mfg. 19
 PAS Professional Audio Systems 122
 Paso Sound Products 123
 Patch Bay Designation 178
 Pearson Technologies 213
 Peavey Electronics 13, 21, 43, 90, 123, 145, 149, 156, 166, 176, 179, 187, 190, 194, 213
 Peerless Sales 19, 37, 90
 Pelco Sales 37
 Penn Fabrication (USA) 13, 15, 19, 21, 90, 145, 210
 Penny & Giles 210
 Pentagon Industries 60
 Perma Power Electronics 26, 194
 Perreux/GMI Distributors 43
 Petcom 80, 85
 Peter Mangone (Tag-It Div.) 13
 PHI Technologies 183, 187
 Philips Microphones 145
 Phonic Ear 201
 Pinkerton Controls System 30
 Pioneer Laser Entertainment 179
 Pittsburgh Corning 15
 Plantronics 24
 Platt Luggage 19
 Poly-Planar 123
 Polyphaser 26
 Portac 184
 Portasound-Div. of Soundcraft Systems 199
 Portland Instrument 76, 80, 123
 Posthorn Recording 145
 Power Solutions 43
 Powermark 26
 Powertronix 30, 40, 43, 76, 78
 Precision Electronics 44
 Precision Fabrication Technologies 19
 Preh Electronic Industries 57, 210
 Premier Metal Products 19
 Princeton Applied Research 204
 Pro Co Sound 13
 Professional Sound 156
 Progressive Electronics 204
 Projected Sound 123
 Projector Recorder Belt 187
 Protech Audio 13, 40, 44, 54, 57, 59, 88, 157, 166, 178, 190, 194, 199
 Proto-Tec 19, 21, 37, 54, 178, 210, 213
 Proudfoot 15
 Pulnix America 30
 Pyle Industries 123
 Pyrok 15
 Pyrotronics 30
 Q-Line 90
 QSC Audio Products 44
 Quabbin Wire & Cable 213
 Quam-Nichols 90, 123
 Quantam Audio Labs 157, 187
 Quest Electronics 204
 Quickset Int'l 19
 Quiet Lion 176
 R & R Audio Products 213
 R-Columbia Products 210
 R.A. Gray 54
 R.B. Annis 186, 202
 R.C. Electronics 204
 R.S.P. Technologies 166
 Racon 37
 Racware (Rackmounted Computers) 19
 Radian Audio Engineering 90, 125, 194
 Radio Design Labs 91
 Radionics 39
 RAG Electronics 204
 Rainbow Sound & Lighting Sales and Service 199
 Ramko Research 44
 Ramsdell Audio 125
 Randall 44
 Rane 44, 157, 166, 176, 179, 190
 Rapco Cable & Lighting 213
 Rapid Systems 205
 Rauland-Borg 76, 81
 Raymer 44, 190, 200
 RCA, New Products Div. (Closed-Circuit Video Equip.) 37
 RE Instruments 204
 Recordex 157
 Recortec 187
 Red Acoustics (USA) 125
 Reliable Security System 30
 Remeo Products 210, 213
 Renkus-Heinz 125
 Resco 210
 Research Technology Int'l 187
 Revere Industries 60
 Richardson Electronics 37
 Richmond Sound Design 157
 Rickenbacker Int'l 44
 Ring Communications 44, 66, 72, 76, 78, 125, 145
 Rion Instrument Div., Mott Assoc. 205
 Riser-Bond Instruments 205
 Ritron 66, 85
 RMS Electronics 210
 Roadrunner Cases 19
 Roanwell 24
 Robot Research 30, 37
 Rockland Scientific 205
 Rocktron 166
 Rockustics 127
 Rocketronics Lighting, Lasergraphics & Special Effects 179
 Rofu Int'l 31
 ROH, Div. of Anchor Audio 72
 Rohde & Schwarz-Polarad 205

RolandCorp. US 157, 168, 176
 ROR 123
 Ross Systems/IMC 127
 Round & Bidnick Assoc. 44
 Rowe Int'l 60
 RPG Diffusor Systems 15
 RTE Deltec 26
 RTS Systems 44, 72, 78, 81
 Runco Int'l 13
 Rupert Neve 157
 Ruslang 19
 Russco Electronics Mfg. 13, 44, 157, 179
 Saki Magnetics 187
 Sammi Sound Technology "America" 15
 Samson Technologies 149
 Sanctuary Sound Systems 127, 157
 Sanming Sound 31, 88, 127, 194
 Sanyo Fisher 37
 Saxton Wire & Cable Products 210
 SCA Data Systems 60
 Scantek 205
 Schell Electronics 149, 201
 Schlumberger Instruments 205
 Schroff 19
 Schulmerich Carillons 71
 Scientific Atlanta/OPTIMA Div. 19
 Scientific Design Software 176
 Scientific-Atlanta, Spectral Dynamics Div. 205
 Scott Instrument Lab., Div. of Lindley 205
 SCS/Sound Code Systems 44
 SCV 168
 Seal-O-Matic 21
 Securitron Magnalock 31
 Security Intercom 31
 Security Resources 31
 Seeburg 62
 Seeburg Music Satellite Network 62
 Select Engineered Systems 31
 Semco 44, 62, 168, 178
 Sencore 205
 Senior Technology 44, 157, 168, 190
 Sennheiser Electronic 24, 81, 145, 149, 157, 179, 201
 Sensor Engineering 31
 Sentex Systems 66
 Sequential Circuits 44
 Sescom 168
 Setcom 24
 Seven Systems 62
 Shalco 13
 Shape Magnetronics 26
 Sharp Electronics, Instrumentation Div. 205
 Sharp Electronics/Prof. Products Div. 54
 Shigma/Ono Soki C. Ltd. 205
 Shure Brothers 24, 44, 54, 59, 127, 145, 149, 157, 194
 Siedle Intercom 66
 Sieler Design Products 194
 Siemens Hearing Instruments 201
 Sierra Video Systems 184
 Sight & Sound Entertainment 62
 Signacom 88
 Signal Cable 210
 SiGnology 205
 Silent Watchman 31
 Silver Eagle Designs 19
 Simpson Electric 205
 Sims Vibration Dynamics 15
 Skydyne 20
 Skytronics Electrical 179
 SL Waber 210
 SMC Int'l 62

Sola, A Unit of General Signal 26
 Solid State Systems 59
 Soltec 205
 Sonance 44, 58, 91, 127
 Sonic Research Assoc. 168
 Sonic Systems 127
 Sonitrol 31
 Sontec Electronics 44, 58, 157, 168, 190, 199
 Sony Professional Audio 24, 54, 127, 145, 151, 157, 168, 187, 200
 Sony Security 31, 37
 Sound Absorbent Materials 15
 Sound Advice 176
 Sound Control Technologies 56, 59, 145
 Sound Craft Systems 56, 194, 201
 Sound Powered Communications 24, 78
 Sound Products/3M 62
 Sound Stream Technology 58
 Sound Tech 20, 44, 127, 157, 170, 179, 190, 194
 Sound Technology 205
 Sound Workshop Professional Audio Products, Inc. 157
 Soundcoat 15
 SOUNDCRAFT-DIV. OF JBL 157, 187
 Soundcraftsmen 44
 Soundforms 15
 Soundscape Speakers 127
 Soundsmith 66
 Soundtracs, Div. of Samson Technologies 157
 Southwest Microwave 31
 Spatial Sound 157, 179, 199
 SpeakerCraft 128
 Speco Div. Components Specialties 31, 44, 56, 67, 91, 128, 147, 194, 205
 Spectra Sonics 45, 128, 170, 199
 Spectronics 31
 Sphere Electronics 157
 SPM Instrument 205
 Sprague Magnetics 187
 St. Louis Music 44, 127, 157
 Stagecraft Lighting Products 179
 Stancor 210
 Standard Tape Laboratory 187
 Standard Wire & Cable 213
 Standtastic 20
 Stanton Magnetics 179
 Stantron-Unit of Zero 20
 Star Case 20
 Stentofon Communications 31, 67, 72, 76, 85
 Stewart Electronics 13, 45, 157, 191, 199, 201
 Stewart Filmscreen 56
 Structural/Kinematics 205
 Studer Revox America 59, 128, 157, 187, 194, 200
 Studio Master 170
 Studio Technologies 147, 170
 Studiomasster 157
 Summa Technologies 180
 Sunkyong Int'l, Audio Div. 187
 Sunn Musical Equipment 45, 128, 157, 170, 191, 194, 199
 Superior Electric 26
 Surveillance Video Systems 31, 37
 Swanson Analysis 176
 Swintek Enterprises 78, 151
 Switchcraft 199
 SWR Engineering 44
 Symco 37
 Symetrix 170
 Synergistics 31
 Systems Design Associates 170, 176
 T.C. Electronics 170
 T.S.K. Electronics 31, 67, 72, 76, 78, 85
 TA Instrument Case 20
 Taber Mfg. & Eng. Co./AVSC 187

230 INDEX OF MANUFACTURERS

- TAC/Amek Consoles 159
Tag-It Div/Peter Mangione 212
Talk-A-Phone 33, 68, 72, 76, 79, 82, 85, 89, 130
Tannoy North America 92, 132
Tape-A-Thon 48, 62, 71, 185, 187, 193
Tappan Wire & Cable 214
Target Technology 38, 48, 56, 178, 212, 214
Tascam (TEAC Professional Div.) 147, 158, 178, 188, 191, 200
Taylor-Simtec Digital 26
TDM Design 170
Teatronics/Lighting Innovations 58
TEC 13
Technical Acoustics 56, 59, 147
Technical Audio Devices (TAD) Pioneer Electronics (USA) 129
Technical Projects 13, 24, 78, 81, 180
Technics Professional 188, 200
Techron, Div. of Crown Int'l 205
Teclab 20
TEI Electronics 21, 38, 45, 91, 128, 147, 170, 180, 210
Teknicom 72
Tektone Sound & Signal Mfg. 67, 76
Tektronix, Signal Analysis Unit 205
Tel-tron (Div. Radio Manufacturers) 32
Telecall America 72
Teleconferencing Systems Int'l 59
Telecor 81
TeleMatic (division of UXL Corp.) 205
Telemetry 38
Telephone Components 56, 67, 191
Television Equipment Associates 24
Television Technology 158
Telex Communications 25, 31, 56, 73, 79, 81, 85, 147, 151, 180, 201
Telos Systems 59
Tentel 205
Texwipe 21
The Auth Co. 27, 74, 86
The Great American Market 18
The Music People 145
The Sandell Co. 145
Thermocon Products 15
Thermodyne Int'l 20
Thorn Automated Systems 32
Time & Sound 32
Times One Technology 45
TMB Assoc. 210
TOA Electronics 13, 24, 31, 45, 56, 62, 67, 72, 76, 78, 81, 85, 91, 128, 147, 151, 158, 170, 180, 184, 191, 194, 200
Topaz 26
Total Audio Concepts 158
Touch Technologies/Gerr Electroacoustics 199
Transcience 32
Trident Audio USA 158
Trigon Electronics 32
Trimm 178
Tripp Lite 26
Trompeter Electronics 213
Turbosound 129
Uher of America 191, 200
UHF Associates 38
Ultimate Support Systems 91
Ultrak 67, 73, 76, 85
UNEX 25
Uniprise Int'l 147
United States Gypsum 15
University Sound 191
UREI 45, 129, 170
US Audio 45
Usatco (Universal Satellite Corp.) 38
USG Interiors 15
Utah Scientific 58, 178
Vaco Products 21
Valcom 56, 129
Valley Int'l 170
Van Etten Audio Labs 45
VanSan 56
VCS 38
Vega (A Mark IV Co.) 151
Ventronic 38
Versadyne Int'l 188
Vertigo Recording Products 205
Vibration Specialty 15
Vibration Technology 45, 180
Vicon Industries 32, 38, 40, 58, 184, 213
Video Accessory 38
Video Design Pro 56
Video Link, Div. of Xantech 58
Video Resources 38
Videolarm 38
Videoplex 38
Vidicraft 25, 58, 158, 178
VIF Int'l 188
Viking Cases 20
Vikonics 32
visAcom 88
Vista Communications 201
Visual Communication Specialists 38
Visual Methods 32, 38
VIZ Test Equipment 205
Voyetra Technologies 170, 176
Waldom Electronics 91, 129, 199
Ward-Beck Systems 158
Wavetek San Diego 205
Weircliffe 188
Wenger 15
Wescom 76
Westflex 210
West Penn Wire 210
Westell 59
Westlake Audio/Prof. Prod. MFG Group 129
Westpark Communications. 205
Wheatstone 158
Wheelock 32, 45, 88, 91, 129, 191
Whelen Engineering 88
Whirlwind 213
White Instruments 170
Whitenton Industries 26
Wilco Communications 213
Williams Sound 151, 201
Winsted 20
Wireworks 213
Wissco 194
Workman Electronic Products 129
Wright Microphones 147
Wyle Labs/Electronic Enclosures Div. 20
Xedit 188
Xetron 32
Yale Audio of Florida 21
Yamaha 13, 25, 45, 58, 91, 129, 147, 158, 170, 176, 178, 180, 188, 191, 194, 199, 200
Yesco Foreground Music 62
York Controls 38, 56, 58, 176
Yorkville Sound 129
Zero Corp., Zero-W. Div. 20
Zeta Music Systems 170, 176
Zippertubing 210
Zonic A & D 205

SEE...

TRADE NAME INDEX — Page 221

INDEX OF ADVERTISERS — Page 222

FLUKE



PHILIPS

Other meters show half the picture

The new Fluke 45 has dual display versatility.

With 2 multifunction displays and 16 different measurement capabilities, the new Fluke 45 does virtually everything you want a meter to do. And for a surprisingly affordable price.



Get everything you've ever wanted.

Dual displays. 16 functions. Even the security of an optional two-year warranty extension for only \$35. For all the information on the new Fluke 45, contact your local distributor. Or call toll-free 1-800-44-FLUKE, ext. 33.

The 5-digit, 100,000 count dual displays give you more information in less time — and with less effort. For example, measure the VDC output of a power supply while measuring the VAC ripple. Or check the amplitude and frequency of an AC signal. From a single test connection!

And the Fluke 45 is designed to make complex measurements easier, with standard features like a 1 MHz frequency counter, Min Max, limits testing (Hi/Low/Pass), Touch Hold® and Relative modes. There are 21 different reference impedances for dB measurements; in the 2 Ω to 16 Ω ranges, audio power can be automatically displayed in watts.

Accuracy to get the job done right.

The Fluke 45 is a true-rms meter, with 0.02% basic dc voltage accuracy and 100,000 count resolution on both displays. Basic dc current accuracy is 0.05%, making the 45 ideal for servicing 4-20 mA current loops. Closed-case calibration simplifies the calibration process and increases uptime.

Even an RS-232 interface is standard.

Connecting the Fluke 45 to PCs, RS-232 printers and modems is as easy as attaching the cable. An IEEE-488.2 interface and rechargeable batteries are available as options.

FLUKE 45 DUAL DISPLAY MULTIMETER

\$595*	Compare and Relative functions
Dual Display	Min Max and Touch Hold® functions
True-rms voltage and current, including ac + dc	Optional PC software for RS-232 applications
0.02% basic dc voltage accuracy	Optional IEEE-488.2 interface, battery pack
0.05% basic dc current accuracy	One year warranty
1 MHz frequency counter	Optional two year warranty extension \$35*
RS-232 interface standard	
dB, with 21 reference impedances, and audio power calculations.	
*Suggested U.S. List Price	

John Fluke Mfg. Co., Inc. P.O. Box C9090 M/S 250C Everett, WA 98206
U.S.: 206-356-5400 Canada: 416-890-7600 Other Countries: 206-356-5500

© Copyright 1989 John Fluke Mfg. Co., Inc. All rights reserved. IBM PC is a registered trademark of International Business Machines Corporation. Ad No. 0591-F45.

FLUKE

Power. Play.



Loudspeaker design: To achieve high power handling capability, sensitivity suffered. You could get more power, but you had to accept less play.

Another Advance From JBL

Ever since Jim Lansing flattened voice coil wire in the early thirties, JBL has continually edged loudspeaker design closer and closer to perfection. The introduction of our new 2200 Series models marks another JBL advance in transducer technology.

Vented Gap Cooling™

As a voice coil's temperature rises, so does its impedance, causing power compression. Every dB of power compression translates into one less dB of output.



To reduce power compression and gain overall sensitivity, JBL created vents from the voice coil, through the magnet structure, to the rear of the loudspeaker. As the cone travels, heat is dispersed and cool air returned to the voice coil.

The result, a true 600 watt loudspeaker with high sensitivity. You get twice the power handling plus greater output.



New SFG™ Magnet Structure.

Through computer modeling and simulation, the 2200 Series SFG magnet structure achieves optimum flux density and significantly lower distortion while realizing up to 20% weight reduction.

We Heard You Loud And Clear.

Whether you're looking for a mega-watt touring loudspeaker, or for a low distortion critical listening device, JBL has the model for you. All with the new SFG magnet structure with Vented Gap Cooling. The new 2200 Series models give you the best of both worlds. Power, and play.



JBL Professional
8500 Balboa Boulevard, Northridge, CA 91329 USA

A Harman International Company

Circle 201 on Reader Response Card