

**SOUND & COMMUNICATIONS**

**BLUE**

**1988  
1989**

**FOR CONTRACTORS, SYSTEM MANAGERS AND SPECIFIERS**

**BOOK**

**28th EDITION**

# Large scale concert sound reinforcement has a smaller future.

## MT-4

### Concert Sound System 50,000-Watt Array

**Manifold Technology™  
delivers...twice the output  
in half the space!**

Concert sound is getting smaller. System size, that is, not tour dollars! In fact, the high-level sound market is stronger than ever. But high transportation and setup costs are forcing lighter, smaller and more efficient speaker systems. While audiences demand better fidelity.

That's why we've made Manifold Technology *systems twice as loud in half the space*. The two-box, 4-way active MT-4 uses 4 (four!) drivers in each bandpass for unequalled acoustic output. Now, your system can be one quarter the size or four times as loud compared to other designs.

The MTA-42 Manifold Technology adapter combines four compression drivers without added distortion. And without the phase cancellations of Y-adapters! That's 4 supertweeter and 4 upper-midrange compression drivers on identical 60° x 40° constant-directivity horns. To complete the MTH-4 "high" box, four DL10X woofers use proprietary phase plugs to provide seamless vocals from 160-1600 Hz. The result is flawless 138-dB midbass at 1 meter!

The MTL-4 "low" box combines four 18-inch woofers in an ultra compact 36" x 36" x 30" cabinet. More efficient than horn-loaded subwoofers, Manifold Technology design prevents woofer "bottoming" even at 40 Hz with 1,600 watts input!

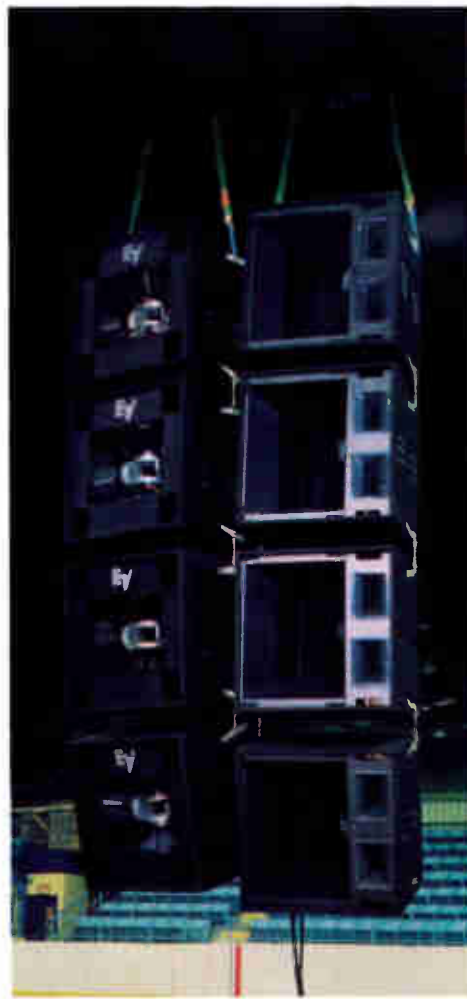

World Radio History

**High output plus high  
fidelity**

To produce high-level sound, most concert systems aim many horns at the same seating area. Unfortunately, this approach causes peaky frequency response, decreased sensitivity and ragged coverage patterns. With four drivers on each horn, a large-scale MT-4 system has fewer independent sources. For fewer phase-cancellation problems. Frequency response is smoother, sensitivity increased, and coverage perfectly constant.

**A flying system that's  
second to none**

MT-4 cabinets are optionally equipped with a unique two-point flying system that allows true point-source arrays. Tilt angle adjustment is easy because track positions are pre-engineered for popular array configurations. Trial-and-error guesswork is a thing of the past. Nothing is as easy as an MT-4.

You don't have to wait for the system of the future. It's here now! For a free MT-4 brochure, see your EV Professional Audio Dealer or write: Electro-Voice, Inc., Dept. SC-4, 600 Cecil St., Buchanan, MI 49107.

Electro-Voice®  
  
a MARK IV company

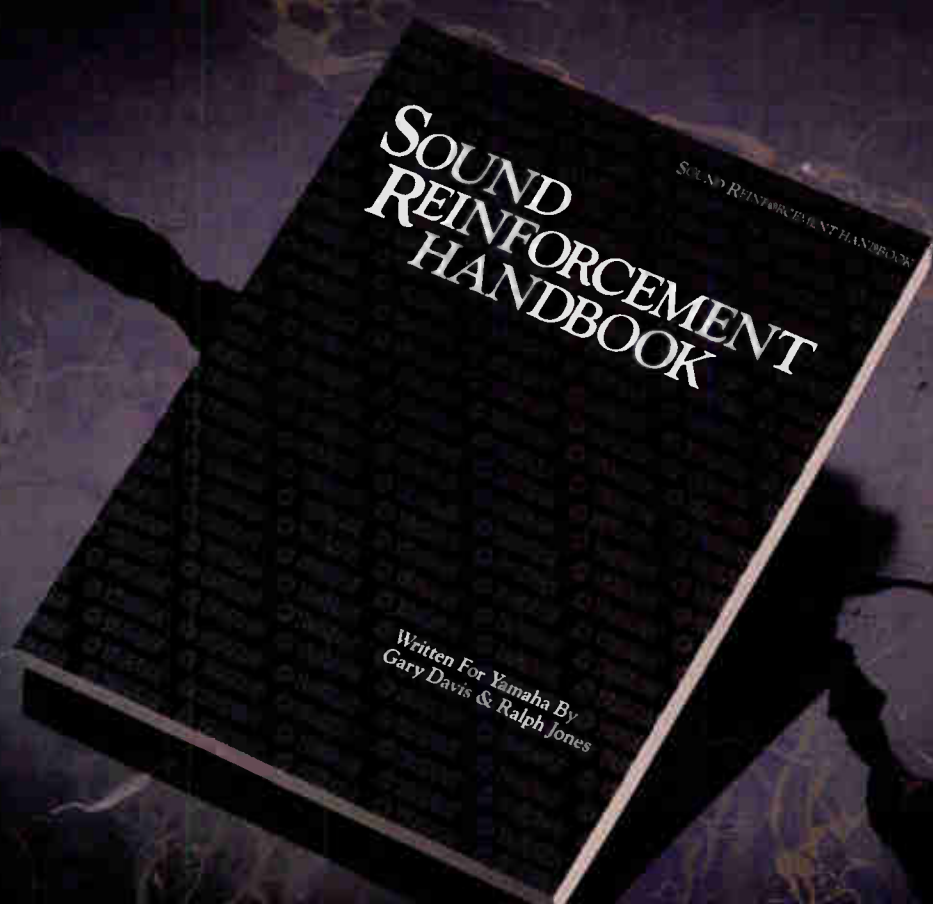

# Here's the only plug you'll see on our new product.

At Yamaha, we've been putting all our sound reinforcement expertise into our equipment for years. Now we've put it all into words.

Presenting the Yamaha Sound Reinforcement Handbook. Without a doubt the only volume of its kind.

In it you'll find nearly 400 pages of explanations, definitions, diagrams and answers about sound. Covering everything from "What is a sound System?" to "Putting it all Together," plus every component and variable in between.

Which makes it perfect for the newcomer to audio. And a welcome refresher for the seasoned professional.

The Yamaha Sound Reinforcement Handbook. Available at your nearby Yamaha Professional Audio Dealer, college, university and technical bookstores. Published by Hal Leonard Publishing Corporation, P.O. Box 13819, Milwaukee, WI 53213.

Pick one up today. It just may be the best source material you ever get to work with.

Yamaha Music Corporation, Professional Audio Division, P.O. Box 6600, Buena Park, CA 90622. In Canada, Yamaha Canada Music Ltd., 135 Milner Avenue, Scarborough, Ontario M1S 3R1.

**YAMAHA**  
Engineering Imagination™

Circle 208 on Reader Response Card



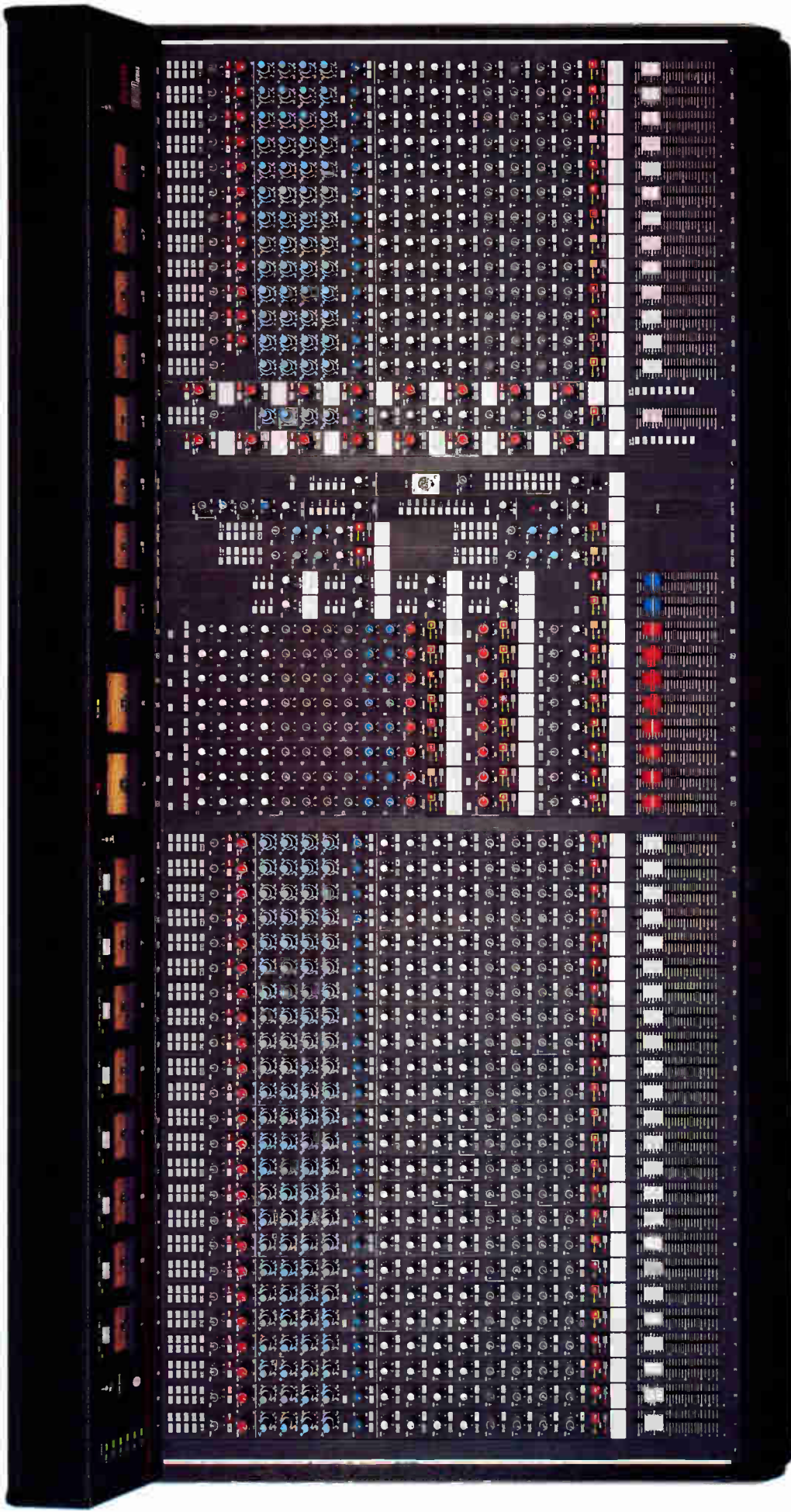

Our house... is a very very fine house.

**RAMSA**

**Panasonic**  
Industrial Company

WR-S8-40 Series console in "house" configuration. For more information call us at 714 895-7278, or write: Ramsa, 6550 Katella Ave., Cypress, CA 90630. "Our House" — Words and Music by Graham Nash.

Circle 226 on Reader Response Card



- 6 Contractor's Notebook**
- 8 The 1988 Blue Book Products Directory & Index**
- 10 Editorial**
- 11 Accessory Products/Hardware/Tools**
  - 11 Accessories
  - 15 Acoustical treatment
  - 17 Cabinets, furniture, cases & racks
  - 24 Hardware, tools
  - 26 Headphones, headsets
  - 31 Power protection, conditioners
- 33 Alarm/Security Products**
  - 33 Alarm, security
  - 42 CCTV/Video components, systems
  - 49 In-out registers
  - 51 Life-safety, voice evacuation systems
- 53 Audio Amplification**
  - 53 Audio amplifiers
- 67 Audio-Visual Products/Control Systems**
  - 67 Audio-visual equipment/systems
  - 71 Remote controls
  - 73 Teleconferencing/systems
- 75 Background/Foreground Systems**
  - 75 Background/foreground systems & libraries
- 81 Intercommunications Equipment**
  - 81 Carillons, chimes
  - 81 Intercoms: Apt, residential
  - 87 Intercoms: Duplex
  - 90 Intercoms: Hospital, health care
  - 95 Intercoms: Industrial
  - 97 Intercoms: Institutional, school
  - 99 Intercoms: Production, theatrical
  - 102 Intercoms: Simplex
  - 106 Signaling systems
- 108 Loudspeaker Products**
  - 108 Loudspeaker accessories
  - 112 Loudspeakers
- 155 Microphones**
  - 155 Microphones
  - 168 Microphones (wireless)
- 174 Mixers/Mixing Consoles**
  - 174 Mixers, mixing consoles
- 183 Signal Processing**
  - 183 Audio signal processors
  - 201 MIDI
  - 203 Patch bays & routing switchers
  - 206 Sound masking products
- 207 Sound System Products**
  - 207 Disco components
  - 210 Message repeaters, storecasters
  - 212 Magnetic tape systems & supplies
  - 218 PA systems
  - 224 Portable sound systems
  - 228 Pro-audio sound systems
  - 232 Tuners, CD players
  - 233 Hearing assistance systems
- 235 Test Equipment**
  - 235 Test equipment & tools
- 243 Used/Rebuilt/Rental Equipment**
  - 243 Used, rebuilt equipment & brokers
- 244 Wire & Cable**
  - 244 Wire/cable components
  - 252 Wire/cable systems
- 254 Index of Manufacturer's Representatives**
- 257 Index of Manufacturers**
- 263 Index of Brand Names**
- 264 Index of Advertisers**

## ASSOCIATIONS

### American Institute of Architects (AIA)

1735 New York Avenue, NW  
Washington, DC 20006  
(202) 626-7300

### Audio Engineering Society (AES)

60 East 42nd St., Suite 2520  
New York, NY 10165  
(212) 661-8528

### American National Standard Institute (ANSI)

1430 Broadway  
New York, NY 10018  
(212) 354-3300

### Electronics Industries Association (EIA)

2001 Eye Street, NW  
Washington, DC 20006  
(202) 457-4900

### Electronic Technicians Associations (ETA)

Iowa State University Station  
PO Box 1258  
Ames, IO 50010  
(515) 294-5060

### International Association of Auditorium Managers (IAAM)

325 Central Ave., Suite 225  
White Plains, NY 10606  
(312) 661-1700

### International Business Music Association (IBMA)

280 Federal Avenue NW  
Massillon, OH 44646  
(216) 883-4164

### International Communications Industries Association (ICIA)

3150 Spring Street  
Fairfax, VA 220031  
(703) 273-7200

### Institute of Electrical & Electronics Engineers (IEEE)

345 East 47th Street  
New York, NY 10017  
(212) 705-7900

### International Society of Certified Electronic Technicians (ISCET)

2708 West Berry Street  
Forth Worth, TX 76109  
(817) 921-9101

### National Association of Broadcasters (NAB)

1771 N Street NW  
Washington, DC 20036  
(202) 429-5300

### National Association of Business & Educational Radio (NABER)

1501 Duke Street  
Alexandria, VA 22314  
(703) 739-0300

SEPTEMBER						
S	M	T	W	T	F	S
				1	2	3
4	5	6	7	8	9	10
11	12	13	14	15	16	17
18	19	20	21	22	23	24
25	26	27	28	29	30	

OCTOBER						
S	M	T	W	T	F	S
						1
2	3	4	5	6	7	8
9	10	11	12	13	14	15
16	17	18	19	20	21	22
23	24	25	26	27	28	29
30	31					

NOVEMBER						
S	M	T	W	T	F	S
		1	2	3	4	5
6	7	8	9	10	11	12
13	14	15	16	17	18	19
20	21	22	23	24	25	26
27	28	29	30			

DECEMBER						
S	M	T	W	T	F	S
				1	2	3
4	5	6	7	8	9	10
11	12	13	14	15	16	17
18	19	20	21	22	23	24
25	26	27	28	29	30	31

JANUARY						
S	M	T	W	T	F	S
1	2	3	4	5	6	7
8	9	10	11	12	13	14
15	16	17	18	19	20	21
22	23	24	25	26	27	28
29	30	31				

FEBRUARY						
S	M	T	W	T	F	S
			1	2	3	4
5	6	7	8	9	10	11
12	13	14	15	16	17	18
19	20	21	22	23	24	25
26	27	28				

## EVENTS

### SEPTEMBER 1988

ISC East  
New York, NY  
8/30 - 9/1

ICIA  
Westchester, NY  
9/1 - 9/3

SBE  
Denver, Co  
9/22 - 9/25

### OCTOBER 1988

IBMA  
Fort Lauderdale, FL  
10/12 - 10/15

NECA  
New Orleans, LA  
10/23 - 10/25

### NOVEMBER 1988

AES  
Los Angeles, CA  
11/3 - 11/5

### DECEMBER 1988

*Sound & Communications  
Annual Economic Report*

### JANUARY 1989

NAMM  
Anaheim, CA  
1/20 - 1/22

### FEBRUARY 1989

ISA South  
Orlando, FL  
2/16 - 2/18



## EVENTS

### APRIL 1989

ISC West  
Anaheim, CA  
4/25 - 4/27

### MAY 1989

Sound & Communications  
Annual Contracting Report

EDS  
Las Vegas, NV  
5/9 - 5/11

NSCA  
Nashville, TN  
5/25 - 5/27

### JUNE 1989

NAMM  
Chicago, IL  
6/17 - 6/20

ISC Central  
Dallas, TX  
6/27 - 6/29

### JULY 1989

Deadline for Blue Book forms

IAAM  
Reno, NV  
7/29 - 8/1

### AUGUST 1989

Sound & Communications  
Annual  
Blue Book Directory

ISC East  
New York, NY  
8/29 - 8/31

MARCH						
S	M	T	W	T	F	S
			1	2	3	4
5	6	7	8	9	10	11
12	13	14	15	16	17	18
19	20	21	22	23	24	25
26	27	28	29	30	31	

APRIL						
S	M	T	W	T	F	S
						1
2	3	4	5	6	7	8
9	10	11	12	13	14	15
16	17	18	19	20	21	22
23	24	25	26	27	28	29
30						

MAY						
S	M	T	W	T	F	S
	1	2	3	4	5	6
7	8	9	10	11	12	13
14	15	16	17	18	19	20
21	22	23	24	25	26	27
28	29	30	31			

JUNE						
S	M	T	W	T	F	S
				1	2	3
4	5	6	7	8	9	10
11	12	13	14	15	16	17
18	19	20	21	22	23	24
25	26	27	28	29	30	

JULY						
S	M	T	W	T	F	S
						1
2	3	4	5	6	7	8
9	10	11	12	13	14	15
16	17	18	19	20	21	22
23	24	25	26	27	28	29
30	31					

AUGUST						
S	M	T	W	T	F	S
		1	2	3	4	5
6	7	8	9	10	11	12
13	14	15	16	17	18	19
20	21	22	23	24	25	26
27	28	29	30	31		

## ASSOCIATIONS

### National Association of Music Merchants (NAMM)

5140 Avenida Encinas  
Carlsbad, CA 92008  
(619) 438-8001

### National Association of Radio & Telecommunications Engineers (NARTE)

PO Box 15029  
Salem, OR 97309  
(503) 581-3336

### National Council of Acoustical Consultants (NCAC)

66 Morris Avenue  
Springfield, NJ 07081  
(201) 379-1100

### National Electronics Contractors Association (NECA)

7315 Wisconsin Avenue  
Bethesda, MD 20814  
(301) 657-3110

### National Federation of Local Cable Programmers (NFLCP)

PO Box 27290  
Washington, DC 20038-7290  
(202) 829-7186

### National Fire Protection Association (NFPA)

Batterymarch Park  
Quincy, MA 02269  
(617) 770-3000

### National Sound & Communications Association (NSCA)

10400 S. Roberts Rd., Suite D  
Palos Hills, IL 60465  
(312) 598-7070

### National Society of Professional Engineers (NSPE)

1420 King Street  
Alexandria, VA 22314  
(703) 684-2800

### Society of Broadcast Engineers (SBE)

7002 Graham Rd., Suite 216  
Indianapolis, IN 46220  
(317) 842-0836

### Security Equipment Industry Association (SEIA)

2800 28th St., Suite 124  
Santa Monica, CA 90405  
(213) 450-4141

### Society of Motion Picture & Television Engineers (SMPTE)

595 West Hartsdale Avenue  
White Plains, NY 10607  
(914) 761-1100

# THE 1988/1989 BLUE BOOK

This is an alphabetical listing of the 45 product categories in this year's Blue Book. We've indicated the page number on which each category begins, and a description of the systems and products supplied by the manufacturers appearing in that category.

<b>ACCESSORIES</b> .....	11	<b>CCTV/VIDEO COMPONENTS &amp; SYSTEMS</b> .....	42
direct boxes, audio interfaces, transformers, lights		accessories, cameras, channel converters, computer inter-	
<b>ACOUSTICAL TREATMENT</b> .....	15	faces, connectors, dummy cameras, effects generators,	
absorption, absorptive partitions, ceiling panels, dampening		enclosures, fiber optics, hardware, lenses, message	
material, diffusion, grille cloth, noise control panels, and		generators, modulators, monitors, multiplexers, pan/tilts,	
enclosures, spray-on absorption materials, vibration isolation		remote controls, signal distribution, specialty cameras,	
materials, systems, and devices, wall coverings, wall panels		surveillance, switchers, time-lapse recorders, transmission	
<b>ALARM &amp; SECURITY</b> .....	33	systems, video mixers, video projectors, VTRs	
access control, ancillary components, announcement		<b>DISCO COMPONENTS &amp; SYSTEMS</b> .....	207
systems, audio surveillance, burglar alarms, CCTV, door-lock		DJ mixers, headphones, lighting controls & effects, pro-	
systems, duress, fire alarm, intercom, intrusion detection,		cessors, sub-woofers, turntable cartridges, and accessories,	
signalling devices, sirens, smoke detectors, strobes, vibra-		turntables	
tion sensing, video motion detection, video surveillance,		<b>HARDWARE &amp; TOOLS</b> .....	24
wireless systems		cabinet hardware, cable clamps, cleaning chemicals, con-	
<b>AUDIO AMPLIFIERS</b> .....	53	nectors, fabrication supplies, hanging systems, knobs, lamps,	
70-volt amplifiers, bi-amp systems, dual-channel, low-		linemen's test sets, markers, panels, raceways, stands,	
frequency amplifiers, mixer amplifiers, modular amplifiers,		speaker hardware, tool kits, wire pulling devices, wire	
monitor amplifiers, portable, signal processing amplifiers,		terminations	
single-channel, telephone paging amplifiers, tri-amp systems,		<b>HEADPHONES &amp; HEADSETS</b> .....	26
zone-paging amplifiers		boom-mic headsets, communications headsets, intercom-	
<b>AUDIO SIGNAL PROCESSORS</b> .....	183	munications headsets, isolation headsets, personal/stereo	
octave equalizers, ambient noise controlled level controllers,		headphones, telecommunications headsets	
audio/video synchronizers, automatic equalizers, preamps,		<b>HEARING ASSISTANCE SYSTEMS</b> .....	233
crossovers, de-essers, digital effects, digital encoding, digital		closed loops inductive, infrared systems, multi-channel, pro-	
reverbs, digital delays, digital signal processors, equalizers,		cessors, programmable, wireless systems AM/FM	
compressors, graphic equalizers, interface units, levelers,		<b>IN/OUT REGISTERS</b> .....	50
limiters, noise gates, notch filters, parametric equalizers, oc-		access control, intercom, manual personnel, medical, moni-	
tave equalizers, signal enhancers, signal metering, transcrip-		tor reporting, PC-based, telephone reporting, terminal repor-	
tion preamps, VCAs		ting, visual	
<b>AUDIO-VISUAL EQUIPMENT/SYSTEMS</b> .....	67	<b>INTERCOM—APARTMENT/RESIDENTIAL</b> .....	81
speakers, audio for A/V, boardroom sound systems, closed-		access control, apartment station, custom, duplex, lobby,	
loop audio systems, computer control, electronic displays,		mailbox panels, microprocessor, music combination,	
image projectors, intercom, interface units, lecturns, multi-		panel/entrance, simplex, talk-back, telephone, video	
media controls, screens, supplies, wireless control		<b>INTERCOM—DUPLEX</b> .....	87
<b>BACK/FOREGROUND SYSTEMS &amp; LIBRARIES</b> .....	75	closed-circuit, custom, digital, drive-thru, loudspeaking,	
automatic mixers, CATV, CD changers, music libraries, stock		microprocessor, multi-channel, programmable, telephone,	
and custom, music services, SCA equipment, tape systems		telephone, video/audio, VOX, wireless	
<b>CABINETS, FURNITURE, CASES, &amp; RACKS</b> .....	17	<b>INTERCOM—HOSPITAL HEALTH CARE</b> .....	90
accessories, ATA cases and racks, chassis, computer con-		annunciators, direct select, emergency call, microprocessor,	
soles, consoles, electronic racks, enclosure systems, custom		nurse-call, pillow speakers, visual, voice paging	
cabinets & consoles, equipment cabinets & enclosures, flight		<b>INTERCOM—INDUSTRIAL</b> .....	95
cases, furniture systems, hardware, instrument cabinets,		drive-thru, environmentally protected, headset/handset,	
modular boxes, molded racks & cases, panels, portable		loudspeaking, telephone	
tables, rack AC power, rack fans, rack hardware, shelves, rack-		<b>INTERCOM—INSTITUTIONAL/SCHOOL</b> .....	97
mounts, shock-mount racks & cases, slides, soft cases &		clock, console, microprocessor, multi-channel, paging, talk-	
bags, specialty cases, stands, storage racks & cases, tables,		back, telephone, video	
technical workbenches, tool cases		<b>INTERCOM—PRODUCTION &amp; THEATRICAL</b> .....	99
<b>CARILLONS &amp; CHIMES</b> .....	81	handset, headset, IFB, loudspeaker, microprocessor, multi-	
analog & digital tones for time and signalling, music		channel, processors, radio interface, VOX, wireless	
play-back-type			



# PRODUCTS DIRECTORY & INDEX

- INTERCOM—SIMPLEX** ..... 102  
closed-circuit, custom, digital, IFB, loudspeaking, micro-processor, multi-channel, programmable, telephone, video/audio, VOX, wireless
- LIFE-SAFETY & VOICE EVACUATION SYSTEMS** ..... 51  
audio, DC battery supply, emergency intercom, handset, message announce, tone, visual
- LOUDSPEAKER ACCESSORIES** ..... 108  
attenuators, baffles, connectors, crossovers, enclosure hardware, enclosure, grille cloth, grilles, mounting devices, mounting hardware, stands, transformers
- LOUDSPEAKERS** ..... 112  
ceiling, columns, compact, components, custom, decorative, environment protected, explosion-proof, flush-mount, foreground, full-range, high-frequency drivers, high-power, horns, low-frequency drivers, mid-bass, monitor panels, multi-way/high-powered, music system speakers, noise masking, omni-directional, outdoor, PA horns, paging horns, paging, portable, powered, processor controlled, stage monitors, studio/reference monitors, sub-woofer, surface-mount, systems, talkback, tweeters, underwater, voice communications
- MAGNETIC TAPE SYSTEMS & SUPPLIES** ..... 212  
cart recorders/players, carts, cassette players & changers, cassette recorders, cassette tape, cleaners, degaussers, demagnetizers, heads, high-speed duplicators, labeling systems, multi-tracks, reel tape, reel-to-reel recorders & players, tape splicers, test tapes, transcription systems, videotape
- MESSAGE REPEATERS/STORECASTERS** ..... 210  
digital systems, cart machines, message units, digital voice recording, sign systems
- MICROPHONES** ..... 150  
boundary, carbon, communications, condenser, contact pickups, dynamic, electret condenser, goosenecks, hand-held, headset boom, implant, instrumentation, miniature, podium, push-to-talk, ribbon, shotgun, specialty, stands, stereo
- MICROPHONES, WIRELESS** ..... 168  
body packs, hand-held
- MIDI** ..... 201  
signal processing, system controllers, software, hardware
- MIXERS & MIXING CONSOLES** ..... 174  
automatic, broadcast, combo, compressor/leveler, computer controlled, custom, digital, disco, ENG, gated, microprocessor, MIDI, modular, monitor, paging, portable, powered, production, rack-mount, recording, theatrical, VCA
- PA SYSTEMS** ..... 218  
mixer/amplifier, mixer/preamps, modular, music distribution, processors, signalling, telephone, zoned
- PATCH BAYS & ROUTING SWITCHERS** ..... 203  
audio/video, cleaners, components, digital, matrix, microprocessor, mic splitters, mult boxes, pre-wired, remote controllable, telephone type
- PORTABLE SOUND SYSTEMS** ..... 224  
amplifiers, columns, DC battery powered, lecturns, megaphones, mixer amplifiers, mixers, powered lecturns, powered speakers, processors, speakers, weatherproof speakers, wireless
- POWER PROTECTION/CONDITIONERS** ..... 31  
inverters, line isolators, line protectors, noise suppression, outlet strips, power control, power conversion, power relays, transformers, uninterrupted power
- PRO-AUDIO SOUND SYSTEMS & PRODUCTS** ..... 228  
audio processors, auxiliary accessories, distribution systems, interface devices
- REMOTE CONTROLS** ..... 71  
audio level, boardroom, custom, DTMF, EQ/remote, hard-wired, microprocessor, remote monitoring, video, wireless
- SIGNALING SYSTEMS** ..... 106  
alarm, annunciator, audio, bell, call-light, tone, visual
- SOUND MASKING PRODUCTS & SYSTEMS** ..... 206  
central, graphic equalizers, loudspeakers, noise generators, processors, programmable, self-contained, zoned
- TELECONFERENCING SYSTEMS** ..... 73  
automixing, manual, microphone specific, microprocessor, telephone interface
- TEST EQUIPMENT & TOOLS** ..... 235  
analog multimeters, audio tape diagnostics, bench-top instrumentation, cable testers, data acquisition, digital multimeters, digital storage oscilloscopes, distortion analyzers, DSP hardware, DSP software, dual-channel spectrum analyzers, electronic tools, FFT-spectrum analyzers, filter sets, FM stereo testing, frequency-domain acquisition/analysis, function generators, hand-held instruments, linemen's test sets, logic analyzers, metering systems, mic cable testers, microprocessor systems, MTS test equipment, noise & vibration analyzers, oscilloscopes, PC systems, software, plotters, precision amplifiers, realtime analyzers, RF signal generators, RT60 meters, sound intensity measurement equipment & microphones, speech transmission analysis, SPL meters, tool kits, transducers, transmission link testing, vector scopes, video test signal generators, waveform recorders
- TUNERS & CD PLAYERS** ..... 232  
AM, changers, FM, tuner-amplifiers
- USED/REBUILT EQUIPMENT & BROKERS** ..... 243  
audio, lease, locating services, refurbishing, telecommunications
- WIRE/CABLE COMPONENTS** ..... 244  
accessories, adapters, alarm, audio, computer cable & peripherals, conduits, connectors, control, data, fiber optics, fuses and holders, hardware, hybrids, jacks, low-capacitance, markers, panels, plenum cable, plugs, pre-wired systems, raceways, security, shielded, sleeving, solid, specials, stranded, switches, telecommunications, terminals, transformers, tubing, video, XLR connectors
- WIRE/CABLE SYSTEMS** ..... 252  
audio, cable reels, custom, data, fiber optics, instrument, microphone cable, snakes, MIDI, multi-pair, multi-pin disconnect, panels, speaker, splitting, stageboxes, video

# Welcome

Welcome to the 28th edition of the *Sound & Communications Blue Book!*

This year's Blue Book is more than 25 percent bigger than last year's—packed with more information than ever on the companies that supply the products you spec and install every day. Of course, we list virtually every major company supplying today's contracting market—who they are, where they're located, and what they manufacture. You'd expect that of any product directory. But we bring you something no other directory delivers: people. The people who run the companies, design and market the products, plus their rep networks and district offices. The Blue Book helps you get in touch with the people most qualified to provide the information you need.

We've tried to make the Blue Book easier to use. There are 45 product categories grouped under 14 major headings (described on the following page). At the beginning of the products directory, you'll find a listing of the 45 categories, with a breakdown of the products and systems listed under each. There is an index of manufacturers, followed by an index of brand names.

You can use the Blue Book in a variety of ways: if you know what type of equipment you want, check the product directory/index to find the category where the manufacturers of that equipment are listed; if you know of a certain company, but aren't sure if they manufacture the equipment you need, check the manufacturers index and you'll find the product categories they're listed under; if you know the brand name of a product, but not the manufacturer, simply turn to the brand name index at the back of the book, match the brand name to the company and turn to the manufacturers index for the page in the products directory where that company is listed.

In addition to the directory and indexes, we've again included the contractor's notebook, a handy calendar of coming events and list of associations. And this year we've added an index of manufacturers' representatives. We know these reps are often your only links with a manufacturer.

You've told us that the Blue Book is an important business tool, one you refer to constantly throughout the year. Use it well, and it will help make your purchasing decisions easier, and help you stay on top of this volatile market.

*Bill Intemann*

Bill Intemann  
Managing Editor

*Please note: the editors of Sound & Communications have made every effort to ensure that the 1988/1989 Blue Book Directory is complete and accurate. They cannot be held responsible for errors or omissions due to late or unreturned questionnaires, or due to incomplete or inaccurate information provided by the companies listed.*

## SOUND & COMMUNICATIONS

Editorial Director/Publisher  
Vincent P. Testa

Managing Editor  
Bill Intemann

Technical Editor  
Jesse Klapholz

Contributing Editors  
Marc L. Beningson, Gary D. Davis  
Ted Uzzle

Contributors  
Daniel G. Fraas, Valerie Kellogg

Consulting Editors  
Jerome J. Brookman, Chris Foreman

Technical Council  
Dr. Mort Altshuler, *Professor Audiology, Hahneman University, Chief of Audiology, V.A. Hospital, Phila, PA*; Mike Biegel, *EPD Technology Corporation*; C. Leroy James, *Rees Associates, Inc.*; Richard N. Jamieson, *Jamieson and Associates, Inc.*; Russell Johnson, *Artec Consultants, Inc.*; Richard Negus, *Purcell Noppe Associates, Inc.*; William Parry, *Maryland Sound Industries, Inc.*; Daniel Queen, *Daniel Queen Associates*; Jon Sank, *Cross Country Consultants*; William R. Thornton, *Phd, PE*.

Art Director  
Andrew Elias

Assistant Art Director  
Karen Waibel

Staff Artist  
Gerard Caramannello

Typesetting  
Leo Ancona, Hannah Klapholz

Circulation Director  
Deborah A. Droge

Advertising Director  
Thomas Soevyn

Vice President/Editorial  
Judith Morrison

Editorial and Sales Office  
Sound & Communications  
25 Willowdale Avenue  
Port Washington, New York 11050  
(516) 767-2500

Copyright © 1988 SOUND & COMMUNICATIONS PUBLISHING, INC. Reprint of any part of contents without permission forbidden. Titles Registered in the U.S. Patent Office. Sound & Communications (U.S. P.S. 943-140) is published monthly by Sound & Communications Publications, Inc., 25 Willowdale Avenue, Port Washington, N.Y. 11050. 516-767-2500. President, Vincent P. Testa. Subscription rates: U.S.—3 years \$37.50, 1 year \$15.00. Canada and Mexico—3 years \$48.00, 1 year \$18.00. Foreign and South America—3 years \$60.00, 1 year \$25.00. Second-class postage paid at Port Washington, NY and at additional mailing office. POSTMASTER: Send address changes to Sound & Communications, 25 Willowdale Avenue, Port Washington, NY 11050.

BPA MEMBERSHIP  
APPLIED FOR MAY 1988



Sound & Communications • Music & Sound Output  
The Music & Sound Buyer's Guide  
NSCA-TV News • NAMM-TV News  
The Music & Sound Retailer • Home Entertainment  
CES-TV News



# ACCESSORY PRODUCTS/HARDWARE/TOOLS

## ACCESSORIES

- Aris/Eta**  
1710 Enterprise Parkway  
Twinsburg, OH 44087  
(216) 425-3388, FAX# 216-425-9700  
Mkt'g: Bob Harris  
Products: lights
- Atlas/Soundolier**  
1859 Intertech Dr.  
Fenton, MO 63026  
(314) 349-3110, FAX# 314-349-1251  
V.P. Sales: Tom Erickson  
E. Region/Sales: Andy Musci  
W. Region/Sales: Bud Waters  
V.P./Mkt'g Consultant: Herbert Jaffe  
Products: transformers
- Audisar**  
PO Box 1561  
Bellevue, WA 98009  
(206) 454-2040  
Owner: R. Munger  
Products: audio interfaces,  
transformers
- BBE Sound, Inc.**  
5500 Bolsa Avenue, Suite 245  
Huntington Beach, CA 92649  
(714) 897-6766, 800-233-8346, FAX#  
714-895-6728  
CEO: John C. McLaren  
CFO.: Scott Anderson  
Nat'l Sales: Jim Lucas  
Operations Mgr.: Jennifer Drescher  
Director of Engineering: Robert Crooks  
Tech Svces Sup.: Ryan Coutts  
Products: direct boxes
- Bi-Tronics, Inc.**  
PO Box 125  
76 Main Street  
Tuckahoe, NY 10707  
(914) 793-3221, 800-522-7377, FAX#  
914-961-4244  
Pres.: J. Schwartz  
Sales Mgr.: Ron Huppert  
Products: transformers
- Bourns, Inc./Trimpot Div.**  
1200 Columbia Ave.  
Riverside, CA 92507  
(714) 781-5690, FAX# 714-781-5174
- Capitol Lighting Products**  
159 Alexander St.  
Yonkers, NY 10701  
(914) 969-3400, 800-LIGHT-ON, FAX#  
914-968-6567  
V.P. Sales: Colin Gaines  
Products: lights
- Clarostat Mfg. Co., Inc.**  
1 Washington St  
Dover, NH 03820  
(603) 742-1120, FAX# 603-742-0481
- COMMUNICATIONS CO., INC.**  
3490 Noell St.  
San Diego, CA 92110  
(619) 297-3261, FAX# 619-297-3279  
Pres.: Peter Jordan  
V.P.: Michael Jordan  
Chief Engineer: David Johnson
- The logo for Conquest USA Products features the word "Conquest" in a stylized, outlined font, with "USA" in a similar font below it, and "PRODUCTS" in a smaller font at the bottom. The entire logo is enclosed in a rectangular border with "AUDIO" on the left and "WINING" on the right.
- CONQUEST SOUND, INC.**  
PO Box 757  
7319 Duvan Dr.  
Tinley Park, IL 60477  
(312) 429-1770, 800-323-7671, FAX#  
312-429-4688  
Pres.: Robert Jares, Jr.  
V.P.: Larry Spalla  
Sales Engineer: Ron Wirth  
Sales Engineer: Ken Bernd  
Sales Engineer: Mike Sanfilippo  
Credit Mgr.: Norm Corsi  
Products: direct boxes, audio  
interfaces, transformers
- DOD Electronics Corp.**  
5639 South Riley La.  
Salt Lake City, UT 84107  
(801) 268-8400, 800-453-7484, FAX#  
801-262-4966  
Pres.: John Johnson  
V. P.: David DiFrancesco  
Finances: Jay Fuller  
Int'l: Wayne Morris  
Western Sales: Scott Grow  
Communications: Dean Stubbs  
Products: direct boxes
- J. W. DAVIS & CO.**  
PO Box 26177  
3030 Canton Street  
Dallas, TX 75226  
(214) 651-7341, 800-527-5705, in TX  
800-442-1564, FAX# 214-939-0328  
Pres.: Charles Griffith  
V.P. Sales: Jack W. Tucker  
Chief Engineer: Mike Lamm  
Products: transformers
- Edcor**  
1948 East Pomona  
Santa Ana, CA 92705  
(714) 648-0292, 800-854-0259, FAX#  
714-648-0117  
Pres.: Larry Weston  
Office Mgr.: Phyllis Weston  
Sales Mgr.: Deanna Weston  
Products: direct boxes, transformers
- Electro-Voice, Inc.**  
600 Cecil Street  
Buchanan, MI 49107  
(616) 695-6831, 800-527-6701, FAX#  
616-695-1304  
Pres.: Robert D. Pabst  
V.P. Sales & Mkt'g: Paul McGuire  
Director of Mkt'g: Jim Long  
Chief Engineer: Earl Harris  
George M. Conneen Co., Inc.,  
Springfield, PA, 215-544-5884  
Metropolis Audio Marketing, Inc.,  
Edison, NJ, 201-225-0085  
R.J. Marketing Ltd., Rockville, MD,  
301-251-0330  
The Smith Company, Hartford, CT,  
203-523-0512  
Ron Tunks Sales, Inc., Tamarac, FL,

- 305-722-2803  
Wilson Audio Sales, Nashville, TN, 615-646-4477  
Audio Resources, Westmont, IL, 312-655-1180  
B.C. Electronic Sales, Inc., Mission, KS, 913-262-1720  
Jones Audio Sales, Plano, TX, 214-867-0202  
C.L. Pugh & Assoc., Inc., Columbus, OH, 614-486-9678  
Riley & Petchell Sales, Inc., Detroit, MI, 313-937-300  
Loppnow & Assoc., Redmond, WA, 206-883-3205  
Radon & Assoc., Sacramento, CA, 916-923-2524  
Silver Peak Marketing Ltd., Wheat Ridge, CO, 303-467-9042  
Western Audio Sales, Glendale, CA, 818-246-3806 x  
Products: audio interfaces, transformers
- Ethereal Concepts  
210 Golden Gate Drive  
Dayton, OH 45459-4329  
(513) 433-8610  
Owner: Lonnie Domnitz  
Admin. Ass.: Jackie Rice  
Products: audio interfaces
- FSR, INC.**  
220 Little Falls Road  
Cedar Grove, NJ 07009  
(201) 239-0988, FAX# 201-239-7708  
Pres.: William Fitzsimmons  
V.P.: Janice Sandri  
Engineering Mgr.: Joseph Fischer  
Applications Engineer: George Braen  
Design Factors, LaHebra Heights, CA, 213-697-7576  
Brian Trankle, Belmont, CA, 415-595-4004  
Ziskind Assoc., Rolling Meadows, IL, 312-577-1624  
Richard Pass Assoc., Langhorne, PA, 215-757-6100  
Henry W. Phillips Co., Roswell, GA, 404-992-3070  
Avwest, Inc., Fountain Hills, AZ, 602-946-1811  
Burcaw Co., Warren, MI, 313-573-4605  
Sigmet Corp., Freehold, NJ, 201-462-1221
- Meyer Marketing, Deerfield Beach, FL, 305-481-9250  
Monfort Electronics, Indianapolis, IN, 317-872-8877  
Pancor Marketing, Lynnwood, WA, 206-771-6010  
Peregrine Southwest, Houston, TX, 713-589-8481  
Piper Assoc., Needham, MA, 617-449-1144  
Products: audio interfaces, transformers
- Gaines Audic  
PO Box 17888  
1237 E. Main Street  
Rochester, Ny 14609  
(716) 266-0780  
Owner: Jon Gaines  
Products: direct boxes, audio interfaces
- Henry Engineering Co.  
503 Key Vista Dr.  
Sierra Madre, CA 91024  
(818) 355-3656  
Owner: Hank Landsberg  
Products: audio interfaces
- Jensen Transformers, Inc.  
10735 Burbank Blvd.  
North Hollywood, AZ 91601  
(213) 876-0059, FAX# 818-763-4574  
Pres.: Deane Jensen  
Applications Engineer: Steve Hogan  
Office Mgr.: Dave Hill  
Order Desk: Kris Ellis  
Products: transformers
- Lightronics  
789 Seahawk Circle  
Virginia Beach, VA 23452  
(804) 427-0852  
Products: lights
- MG Electronics  
32 Ranick Rd.  
Hauppauge, NY 11788  
(516) 582-3400, FAX# 516-582-3229  
Pres.: Louis Maltz  
V.P.: Elliott Maltz  
Sales Mgr.: Stan Grey  
Miller Assoc., Stamford, CT, 203-869-7793  
Forti Assoc., Kensington, MD, 301-949-1706  
Cavendish & Winchester, Atlanta, GA, 404-449-5104
- Raymar Associates, Duncanville, TX, 214-296-9833  
Products: transformers
- Microtran  
PO Box 236  
145 East Mineola Ave.  
Valley Stream, NY 11582-0236  
(516) 561-6050, FAX# 516-561-1117  
Pres.: Albert J. Eisenberg  
V.P. Sales: Walter Benschler  
Chief Engineer: Vulf Ozechov  
Purchasing Agent: Belle Moskowitz  
Production Mgr.: Charles Meyer  
Advertising Mgr.: Lou Anne O'Conner  
Products: transformers
- Paso Sound Products  
14 First St  
Pelham, NY 10803-1495  
(914) 738-4800, FAX# 914-738-3954  
Executive V.P.: Paul Mastrangelo  
Sales Mgr.: David Moore  
Product Mgr.: Ken Obrien  
Credit Mgr.: Marilyn Beckerson  
Operations Mgr.: Anthony Sgueglia  
All West Electronics, Camarillo, CA, 805-388-1789  
Anderson Sales, Braintree, MA, 617-848-9194  
Pace Sales, Charlotte, NC, 704-365-3216  
De Witt Austin Co., Alpharetta, GA, 404-442-1326  
Dowell Assoc., St. Louis, MO, 314-849-4234  
Mountain Representatives, Denver, CO, 303-623-0972  
J.Y.S. Comm. Co., Dallas, TX, 214-349-1650  
Lienau Assoc., Inc., Columbia, MD, 301-621-4113  
Lienau Assoc., Inc., New Town, PA, 215-860-2100  
SLK Tech Rep, San Francisco, CA, 415-822-4884  
Miguel Lopez, Hialeah, FL, 305-822-6853  
Marketline, Snellville, GA, 404-972-9048  
Messnick Sales, Liverpool, NY, 315-622-3211  
Miller Assoc., Ltd., Greenwich, CT, 212-840-2866  
Robert Milsk Co., Inc., Southfield, MI, 313-354-3310



# Audio Transformers

Choose from a wide variety of types and packages

**Computer optimized design**

**100% tested – consistent quality**

**Low distortion**

**Wide bandwidth**

**Minimum transient distortion (overshoot & ringing)**

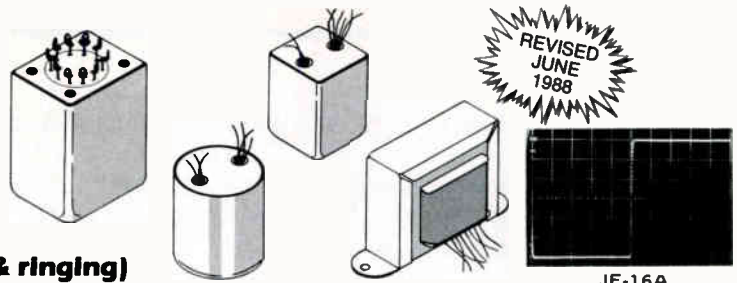

REVISED  
JUNE  
1988

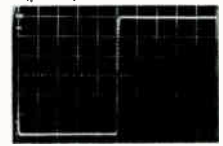

JE-16A  
2 kHz Square Wave

## INPUT TRANSFORMERS AND SPECIAL TYPES

Model	Application	Impedance Ratio Pri:Sec	Turns Ratio Pri:Sec	20Hz Max Input Level <sup>1</sup>	Typical THD Below Saturation (%) 20 Hz / 1 kHz	Frequency Response (dB ref. 1 kHz) 20 Hz / 20 kHz	Band-Width <sup>2</sup> -3 dB @ (kHz)	20 kHz Phase <sup>3</sup> (degrees)	Over-Shoot (%)	Noise Figure (dB)	Magnetic Shield <sup>4</sup> (dB)	Number of Faraday <sup>4</sup> Shields	Package <sup>5</sup>	PRICES		
														1-19	100-249	1000

### MICROPHONE INPUT

JE-16-A	Mic in for 990 opamp	150-600	1:2	+8	0.036/0.003	-0.08/-0.05	230	<1	<1	1.7	-30	1	A=1 B=2	79.19	52.36	36.12
JE-16-B	Mic in for 990 or I.C.	150-3750	1:5	+8	0.036/0.003	-0.09/-0.21	85	<1	<2	2.3	-30	1	1	79.19	52.36	36.12
JE-115K-E (Improved)	Mic in for I.C. opamp	150-15 K	1:10	-2.5	0.125/0.010	-0.25/-0.06	95	<1	<1	1.5	-30	1	3	57.55	38.05	29.81

### LINE INPUT

JE-11P-9	Line in	15 K-15 K	1:1	+26	0.025/0.003	-0.03/-0.30	52	<1	<3		-30	1	1	128.33	84.86	58.54
JE-11P-1	Line in	15 K-15 K	1:1	+17	0.045/0.003	-0.03/-0.25	85	<1	<1		-30	1	3	54.93	36.32	28.46
JE-6110K-B	Line in bridging	36 K-2200 (10 K-600)	4:1	+24	0.005/0.002	-0.02/-0.09	125	<1	<1		-30	1	1	77.65	51.34	37.68
JE-10KB-C	Line in bridging	30 K-1800 (10 K-600)	4:1	+19	0.033/0.003	-0.11/-0.08	160	<1	<2		-30	1	3	55.83	36.91	25.76
JE-11SSP-8M	Line in / repeat coil	600/150-600/150	1:1 split	+22	0.035/0.003	-0.03/-0.00	120	<1	<3.5		-30	1	4	204.36	135.12	93.22
JE-11SSP-6M	Line in / repeat coil	600/150-600/150	1:1 split	+17	0.035/0.003	-0.25/-0.00	160	<1	<3		-30	1	5	103.31	68.31	47.13

### SPECIAL TYPES

JE-MB-C	2-way <sup>3</sup> mic split	150-150	1:1	+1	0.050/0.003	-0.16/-0.13	100	<1	<1		-30	2	3	47.09	31.14	24.41
JE-MB-D	3-way <sup>3</sup> mic split	150-150-150	1:1:1	+2	0.044/0.003	-0.14/-0.16	100	<1	<1		-30	3	3	79.99	52.89	41.39
JE-MB-E	4-way <sup>3</sup> mic split	150-150-150-150	1:1:1:1	+10	0.050/0.002	-0.10/-1.00	40	<1	<1		-30	4	1	120.12	79.42	54.79
JE-DB-E	Direct box for guitar	20 K-150	12:1	+19	0.096/0.005	-0.20/-0.20	80	<1	<1		-30	2	6	57.29	37.88	29.64

1. (dBu) Max input level = 1% THD; dBu = dBv ref. 0.775 V

2. With recommended secondary termination

3. Specifications shown are for max. number of secondaries terminated in 1000 ohm (typical mic preamp)

4. Separate lead supplied for case and for each faraday shield

5. Except as noted, above transformers are cased in 80% nickel mu-metal cans with wire leads.

6. Deviation from linear phase, referenced to 1 kHz.

### PACKAGE DIMENSIONS:

	W	L	H
1	1 1/16" Diam.		1 1/16"
2	1 3/16" x 1 3/16"		1 1/8"
3	1 1/8" Diam.		1 1/16"
4	1 1/2" x 1 3/4"		2 1/2" w/ solder terminals
5	1 5/8" Diam.		1 3/4"
6	1 1/8" Diam.		1 3/16"

## NICKEL CORE OUTPUT TRANSFORMERS<sup>7</sup>

Model	Construction	Nominal Impedance Ratio Pri:Sec	Turns Ratio Pri:Sec	20 Hz Max Output Level <sup>8</sup> across (n) windings (dBu)	600 Ω Load Loss (dB)	DC Resistance per Winding	Typical THD Below Saturation (%) 20 Hz / 1 kHz	Frequency Response (dB ref. 1 kHz) 20 Hz / 20 kHz	Band-Width -3 dB @ (kHz)	20 kHz Phase <sup>9</sup> (degrees)	Over-Shoot (%)	Package <sup>11</sup>	PRICES			
													1-19	100-249	1000	
JE-11-BMCF	Bifilar 80% nickel	600-600	1:1	+26	1	-1.1	40 Ω	0.002/0.002	-0.02/-0.00	>10MHz	<0.5	<1 <sup>10</sup>	7	85.62	56.62	39.65
JE-11-DMCF	Bifilar 80% nickel	600-600	1:1	+21	1	-1.0	38 Ω	0.004/0.002	-0.02/-0.00	>10MHz	<0.5	<1 <sup>10</sup>	8	59.13	39.10	26.97
JE-123-BLCF	Quadfilar	600-600 150-600	1:1 1:2	+32	2	-1.1	20 Ω	0.041/0.003	-0.02/-0.01	>450 170	<0.5 <1	<1 <sup>9</sup>	7	77.55	45.29	31.25
JE-11SS-DLCF	Bifilar split/split	600-600 150-600	1:1 1:2	+27	2	-1.0	19 Ω	0.065/0.003	-0.02/-0.01	>10MHz 245	<0.5 <0.5	<1 <sup>9</sup>	8	56.30	37.22	25.68
JE-11-ELCF	Bifilar	600-600	1:1	+23.5	1	-1.1	40 Ω	0.088/0.003	-0.03/-0.00	>10MHz	<0.5	<1 <sup>10</sup>	9	38.18	25.24	17.41
JE-11-FLCF	Bifilar	600-600	1:1	+20.4	1	-1.6	58 Ω	0.114/0.003	-0.03/-0.00	>10MHz	<0.5	<1 <sup>10</sup>	10	28.72	18.99	13.10
JE-112-LCF	Quadfilar	600-600 150-600	1:1 1:2	+20.4	2	-1.6	29 Ω	0.114/0.003	-0.03/-0.01	>450 205	<0.5 <1	<1 <sup>9</sup>	10	34.44	22.77	15.71
JE-123-ALCF	Quadfilar	66.7-600	1:3	+26.5	3	-1.3	8 Ω	0.125/0.003	-0.04/+0.06	190	<1	<6 <sup>9</sup>	8	70.01	35.38	24.41
JE-11S-LCF	Bifilar w/ split pri.	600-600 150-600	1:1 1:2	+30	1 (sec)	-1.7	63 Ω	0.058/0.002	-0.02/+0.01 -0.02/-0.05	>10MHz 155	<0.5 <1	<1 <sup>9</sup>	8	70.01	35.38	24.41

7. Multifilar construction has no faraday shield; cannot be used as input transformer. All specifications are for 0 Ω source, 600 Ω load.

8. Max output level = 1% THD; dBu = dBv ref. 0.775 V

9. Source amplifier -3 dB @ 100 kHz

10. Source amplifier -3 dB @ 200 kHz

11. Output transformers are horizontal channel frame type with wire leads, vertical channel frames available. PC types available.

### PACKAGE DIMENSIONS:

	W	L	H	Mounting Centers
7	1 1/2" x 2 5/16"		1 15/16"	2 13/16"
8	1 3/16" x 1 15/16"		1 3/8"	2 3/8"
9	1 1/8" x 1 11/16"		1 3/8"	2"
10	1 1/16" x 1 7/16"		1 3/16"	1 3/4"

These charts include the most popular types which are usually available from stock. Many other types are available from stock or custom designs for OEM orders of 100 pieces or more can be made to order. Certified computer testing is available for OEM orders. Call or write for applications assistance and/or detailed data sheets on individual models.

Prices shown are effective 1/11/88 and are subject to change without notice. Packing, shipping, and applicable sales taxes additional.

**jensen transformers**  
INCORPORATED

10735 Burbank Boulevard • North Hollywood, California 91601  
TELEX via WUI 6502919207 MCI UW • FAX (818) 763-4574  
PHONE (213) 876-0059

Closed Fridays, visitors by appointment only.

Robert Milsk Co., Indianapolis, IN, 317-842-3400

Weller Electronic Sales, Worthington, OH, 614-885-7819

Frank Lintern Assoc., Naperville, IL, 312-983-0935

Products: transformers

Peavey Architectural Acoustics Division

PO Box 2898

711 A Street

Meridian, MS 39301

(601) 483-5376, FAX# 601-484-4278

Prod Mgr.: Ken Valentine

Products: transformers

Peavey Electronics Corp.

PO Box 2898

711 A Street

Meridian, MS 39301

(601) 483-5365, FAX# 601-484-4278

Prod Mgr.: Ken Valentine

Products: direct boxes

Penn Fabrication (USA), Inc.

PO Box 506

29B Ethel Ave.

Hawthorne, NJ 07506

(201) 423-4404

Sales Director: Mike Panasuk

General Mgr.: Richard Stratford

General Mgr.: Gavin Naismith

Products: lights

QSC Audio Products, Inc.

1926 Placentia Ave

Costa Mesa, CA 92627

(714) 645-2540, 800-854-4079, FAX#

714-645-7927

Director of Mkt'g: Greg McVeigh

Nat'l Sales Mgr.: Peter Kalmen

Sales Engineer: Andy Murray

Products: transformers

Richmond Sound Design, Ltd.

1234 West 6th Ave.

Vancouver, Canada V6H 1A5

(604) 734-1217, FAX# 604-734-3901

Systems/Sales Mgr.: Damon Wootten

Accounts Mgr.: Marilyn Williams

Project Coordinator: Linda Pearson

Full Compass Systems, Madison, WI,

Products: audio interfaces

Sescom, Inc.

2100 Ward Dr.

Henderson, NV 89015

(702) 565-3400, FAX# 702-565-4828

Products: direct boxes, audio

interfaces, transformers

Shallco, Inc.

PO Box 1089

Smithfield, NC 27577

(919) 934-3135, FAX# 919-934-3298

Speco Div., Components Specialties, Inc.

PO Box 624

1172 Rt. 109

Lindenhurst, NY 11757

(516) 957-8700, 800-645-5516, FAX#

516-956-9142

V.P./Sales: Mel Hulkower

V.P./General Mgr.: Jim Ganci

Sales Mgr.: Eric Forman

Products: transformers

Stewart Electronics Corp.

11460 Sunrise Gold Circle, Suite B

Rancho Cordova, CA 95742

(916) 635-3011, FAX# 916-635-1787

Nat'l Sales/Mkt'g Mgr.: James M.

Ruse

Applied Audio, Asheville, NC, 704-252-9313

Cambridge Pro Sales, Westerville, OH, 614-890-8144

GMC, Springfield, PA, 215-544-5884

Pacific Audio Group, Torrance, CA,

213-375-2611

Future Sales, Redmond, WA, 206-868-5577

JAMM Dist., Flossmoor, IL, 312-799-0550

McManus Music Sales, MN, 612-432-5321

On the Road Mrkt., Upper Montclair, NJ, 201-746-0501

Pro Sound & Light, Lakewood, CO, 303-986-5999

RPM Sales, Carrollton, TX, 214-446-3010

B. Trankle & Assoc., Belmonti, CA, 415-595-4004

Pro Sound Assoc., Jacksonville, FL, 904-744-1170

Products: direct boxes, audio interfaces

**UREI**

8500 Balboa Blvd.

Northridge, CA 91329

(818) 893-8411, FAX# 818-893-3639

Pres.: Ron Means

V.P. Sales: Ken Lopez

V.P. Mkt'g: Mark Gander

Applications Engineer: Drew Daniels

Mkt'g Mgr. Sound Contracting: Steve

Romeo

Neil Conly, Bedford, TX, 817-540-3066

Bill Hamilton, Folsom, PA, 215-543-4677

Steve Armstrong, Northridge, CA, 818-707-2529

Tom Walter, Barrington, IL, 312-382-4925

Products: direct boxes

**PROFESSIONAL AUDIO DIVISION,  
YAMAHA MUSIC CORPORATION, USA**

PO Box 6600

6600 Orangethorpe Ave.

Buena Park, CA 90622

(714) 522-9011, FAX# 714-739-2680

Products: transformers

# USE the 1988/89 Sound & Communications BLUE BOOK Directory

for all your purchases throughout the year. For additional copies, contact:

Deborah Droge

Sound & Communications

25 Willowdale Avenue

Port Washington, NY 11050

# ACOUSTICAL TREATMENT

- ASC Acoustic Sciences Corp.  
PO Box 1189 (ZIP 97440)  
385 Lawrence St.  
Eugene, OR 97401  
(503) 343-9727, 800-272-8823, FAX#  
503-343-9245  
Pres.: Arthur M. Noxon  
NW Rep: Paul Stubblebine  
SW Rep: Rich Lomax  
Central Rep: Sam Lynn  
Canadian Factory: Larry Moore  
European Factory: Alfredo Gallacci  
Products: absorption, absorptive  
partitions, ceiling panels, diffusion,  
wall panels
- AVL Systems, Inc.  
PO Box 2267  
Orlando, FL 32802  
(305) 298-9111  
Products: absorptive partitions, wall  
panels
- Acoustiflex Corp.  
1300 Division St.  
Plainfield, IL 60544  
(815) 436-4640, 800-421-8368, FAX#  
815-436-1912
- Acoustone Grille Cloth  
80 Wythe Ave  
Brooklyn, NY 11211  
(718) 782-5560, FAX# 718-782-7367  
Pres.: George Backer  
Production Mgr.: Larry Lubliner  
Office Mgr.: Al Allentoff  
Order Dept.: Inge  
Order Dept.: Judy
- Aerocoustic Corp.  
4876 Victor St.  
Jacksonville, FL 32207  
(904) 731-3577, FAX# 904-739-5680
- Alpha Audio  
2049 W. Broad St.  
Richmond, VA 23220  
(804) 358-3852, FAX# 804-358-9496  
Sales Admin.: Kathy Fitzgerald  
Sales: Bobbie Winn  
Products: absorption, ceiling panels,  
dampening material, noise control  
panels, and enclosures, wall  
coverings, wall panels
- American Acoustic Products  
9 Cochituate St.  
Natick, MA 01760  
(508) 237-4223, FAX# 508-651-1306
- Armstrong Cork Co.  
333 Liberty St.  
Lancaster, PA 17603  
(717) 397-0611, 800-233-3823
- BLI Corp.  
507 Canal St.  
Stamford, CT 06902  
(203) 325-3883, FAX# 203-359-8597
- Doug Biron Assoc., Inc.  
PO Box 413  
Buford, GA 30518  
(404) 945-2929
- Bostick  
Boston St.  
Middleton, MA 01949  
(617) 777-0100, 800-343-8178, FAX#  
508-774-7376
- Capaul Corp.  
1300 Division St.  
Plainfield, IL 60544  
(815) 436-8500, 800-421-8368  
V.P. Sales: Craig Lindblad  
Products: ceiling panels
- Celotex Corp.  
PO Box 31602  
Tampa, FL 33631-3602  
(813) 871-4811, FAX# 813-871-4787
- Controlled Acoustics Corp.  
12 Wilson St.  
Hartsdale, NY 10530  
(914) 428-7740
- Duracote Corp.  
PO Box 512  
350 N. Diamond St.  
Ravenna, OH 44266  
(216) 296-3486, 800-321-2252, in OH  
800-362-0588, FAX# 216-296-5102
- Eckel Industries, Inc.-Acoustic Div.  
155 Fawcett St.  
Cambridge, MA 02138  
(617) 491-3221, FAX# 617-547-2171
- Pres.: Alan Eckel  
V. P.: John W. Flood  
Sales Coordinator: Joseph McDonough  
Products: absorption, ceiling panels,  
noise control panels, and enclosures,  
wall panels
- FM Tubecraft  
1121-26 Lincoln Ave.  
Holbrook, NY 11741  
(516) 567-8588  
Pres.: Frank Maiella  
Sales & Mkt'g: Bruce Papa  
Products: absorption, absorptive  
partitions, dampening material, noise  
control panels, and enclosures, wall  
panels
- General Design Group  
3664 W. 2100 Street  
Salt Lake City, UT 84120  
(801) 973-6497  
Pres.: Per Haugen  
V.P.: Perry Haugen  
Sec./Treas.: Harold Haugen  
Designer: Mark Vought  
Designer: Kari Nielson
- Industrial Acoustics Company  
1160 Commerce Ave.  
Bronx, NY 10462  
(212) 931-8000
- Insul-Art Acoustics Corp.  
107 Allen Blvd.  
Farmingdale, NY 11735  
(516) 694-0002, 800-526-0908  
Pres.: Jack D. Leonard  
V.P.: Harold Goldstein  
Tech Sales Mgr.: Johnathan Leonard  
Int'l Sales Mgr.: Marge Lohr  
Sales Coordinator: Elaine Sak  
Installation Mgr.: Brian Leonard  
Products: ceiling panels, noise control  
panels, and enclosures, wall panels
- Korfund Dynamics Corp.  
PO Box 235  
Westbury, NY 11590  
(516) 752-2453, FAX# 516-694-6558
- Mason Industries, Inc.  
350 Rabro Dr.  
Hauppauge, NY 11788



## 16 ACOUSTICAL TREATMENT

- (516) 348-0282, FAX# 516-348-0279  
Pres.: Norm Mason  
V.P.: Pat Lama  
Nat'l Sales Mgr.: Rick Sabilia  
Mason Industries, Inc., Anaheim, CA,  
714-535-5738  
Products: absorptive partitions, ceiling  
panels, vibration isolation  
materials, systems, and devices
- Mellotone  
PO Box 145  
108 E. Church St.  
Blacksburg, SC 29702  
(803) 839-6341, FAX# 803-839-2911  
Pres.: Allan H. Silverman  
V.P.: Alan W. Silverman  
V.P./General Mgr.: Robert S. Silverman  
Mellotone Coordinator: Sylvia B. Grigg  
Products: grille cloth
- Northern Sound  
2401 Lowry Ave. NE, Ste 201  
Minneapolis, MN 55418  
(612) 788-9296
- O'Brien Partition Co.  
5301 E. 59th Street  
Kansas City, MO 64130  
(816) 361-2334
- Owens-Corning Fiberglas, Corp., Acoustic  
Products Div.  
Fiberglas Tower  
Toledo, OH 43659  
(419) 248-8000
- Penn Fabrication (USA), Inc.  
PO Box 506  
29B Ethel Ave.  
Hawthorne, NJ 07506  
(201) 423-4404  
Sales Director: Mike Panasuk  
General Mgr.: Richard Stratford  
General Mgr.: Gavin Naismith  
Products: dampening material, grille  
cloth, noise control panels, and  
enclosures, wall coverings, wall  
panels
- Pittsburgh Corning Corp.  
800 Presque Isle Dr.  
Pittsburgh, PA 15239  
(412) 327-6100, 800-245-1217, FAX#  
412-733-4815  
Robert V. DeGusipe
- Proudfoot Co., Inc.  
PO Box 1537  
Greenwich, CT 06836  
(203) 869-9031, FAX# 203-869-9574
- Pyrok, Inc.  
136 Prospect Park West  
Brooklyn, NY 11215  
(718) 788-1225  
Pres.: Phil Malarkey  
Mgr.: Howard Podolsky  
Products: absorption, noise control  
panels, and enclosures, spray-on  
absorption materials
- RPG Diffusor Systems, Inc.  
12003 Wimbledon St.  
Largo, MD 20772  
(301) 249-5647, FAX# 301-249-3912  
Pres./CEO: Dr. Peter D'Antonio  
V.P.: Dr. John Konnert  
Production Mgr.: Doug Morgan  
Accounting: Dr. Judy Konnert
- Sammi Sound Technology  
39 Menlo Place  
Berkeley, CA 94707  
(415) 528-1277  
Pres.: Mike Klasco
- Sims Vibration Dynamics  
17724 15th Ave. N.E.  
Seattle, WA 98155  
(206) 362-0700
- Sound Absorbent Materials Company,  
Inc.  
PO Box 837  
Westwood, NJ 07675  
(201) 742-7078  
Pres.: Andy Munteanu  
V.P. Sales: John Lugano  
Products: absorption, absorptive  
partitions, dampening material, noise  
control panels, and enclosures
- Soundcoat Co., Inc.  
One Burt Drive  
Deer Park, NY 11729  
(516) 242-2200, FAX# 516-242-2246  
Director Sales/Mkt'g: Carl Wolaver
- Soundforms  
1128 Oceanic Drive  
Encinitas, CA 92024  
(619) 753-4634, FAX# 619-753-4634  
Mkt'g Mgr.: Lee Benelli  
Products: noise control panels, and  
enclosures
- Thermocon Products Co.  
2508 Marlin Hwy.  
Waco, TX 76705  
(817) 756-3713, FAX# 817-753-5622
- USG Interiors, Inc.  
101 S. Wacker Dr.  
Chicago, IL 60606  
(312) 606-3865, FAX# 312-606-5864  
General Mgr.: H.A. Rowe  
General Mgr.: A. Descrescenzo  
General Mgr.: J.H. Meister  
Group V.P.: S.R. Sax  
Product Mgr.: J.H. Dobby
- United States Gypsum Company  
101 S. Walker Drive  
Chicago, IL 60606  
(312) 606-3865  
Mgr. Mkt'g/Prod. Dev.: D.E. Powers  
Exec. V.P.: G.E. Murphy  
Prod. Mkt'g Mgr.: R.R. Erickson
- Vibration Specialty Corp.  
100 Geiger Rd.  
Philadelphia, PA 19115  
(215) 698-0800
- Wenger Corp.  
PO Box 448  
Owatonna, MN 55060-0448  
(507) 455-4100, 800-533-0393, FAX#  
507-455-4258

# CABINETS, FURNITURE, CASES & RACKS

A & S Case Company  
1111 N. Gordon Street  
Hollywood, CA 90038  
(213) 466-6181

Aarmor Case Co.  
2100 Lapo Road  
Lake Odessa, MI 48849  
(616) 374-5651, 800-RACK-POD  
Pres.: Steven J. Catlin  
Sales: David Hall

Products: ATA cases and racks, electronic racks, flight cases, hardware, molded racks & cases, shock-mount racks & cases, specialty cases, storage racks & cases, tool cases

Alpha Omega Case Company  
3130 Martin St., Ste 200  
East Point, GA 30344  
(404) 761-2900, 800-241-1129  
Products: ATA cases and racks

Amco Engineering Co.  
3801 Rose St.  
Schiller Park, IL 60648  
(312) 671-6670

Anvil Cases, Inc.  
4128 Temple City Blvd.  
Rosemead, CA 91770  
(818) 575-8614

Aris/Eta  
1710 Enterprise Parkway  
Twinsburg, OH 44087  
(216) 425-3388, FAX# 216-425-9700  
Mkt'g: Bob Harris  
Products: shelves, rack-mounts, stands

Atlas/Soundolier  
1859 Intertech Dr.  
Fenton, MO 63026  
(314) 349-3110, FAX# 314-349-1251  
V.P. Sales: Tom Erickson  
E. Region/Sales: Andy Musci  
W. Region/Sales: Bud Waters  
V.P./Mkt'g Consultant: Herbert Jaffe  
Products: accessories, chassis, consoles, electronic racks, enclosure systems, custom cabinets & consoles, equipment cabinets & enclosures, panels, rack AC power,

rack fans, rack hardware, shelves, rack-mounts, storage racks & cases

BAL Corporation  
PO Box 875  
947 Newark Ave.  
Elizabeth, NJ 07207  
(201) 354-9625  
Mgr.: Les Weinstock  
Robert C. Schwarz

Bobadilla Cases, Inc.  
2302 E. 38th St.  
Los Angeles, CA 90058-9990  
(213) 589-5214, FAX# 213-589-5268

Bud Industries, Inc.  
4605 E. 355th St  
Willoughby, OH 44094  
(216) 946-3200, FAX# 216-951-4015

Cabtron Systems, Inc.  
200 Anets Dr.  
Northbrook, IL 60062  
(312) 498-6090, FAX# 312-272-1095

Calzone Case Company  
225 Black Rock Ave.  
Bridgeport, CT 06605  
(203) 367-5766, 800-243-5152, FAX# 203-336-4406  
Pres.: Joseph E. Calzone  
V.P. Sales: Vincent J. Calzone  
Product Engineer: Tom McChno  
Regional Sales Mgr.: Gary Pelfrey  
Products: ATA cases and racks, equipment cabinets & enclosures, flight cases, portable tables, rack fans, rack hardware, shock-mount racks & cases, tool cases

Case Component Network  
4700 W. Fullerton  
Chicago, IL 60639  
(800) 722-3027, FAX# 312-772-6586  
Mkt'g: Don Sessions  
Products: hardware

Cases, Inc.  
1745 W. 134th St.  
Gardenia, CA 90249  
(818) 575-8614

Contact East, Inc.  
PO Box 786  
335 Willow St. South  
N. Andover, MA 01845  
(508) 682-2000, 800-225-5370, FAX# 508-688-7829  
Products: accessories, electronic racks, furniture systems, modular boxes, molded racks & cases, technical workbenches, tool cases

## LEE DAN COMMUNICATIONS

155 Adams Ave.  
Hauppauge, NY 11788-3699  
(516) 231-1414, 800-533-3261, FAX# 516-231-1498

Pres.: Leon Goldberg  
V.P. Operations: Lawrence J. Goldberg  
V.P. Finance/Admin.: David H. Goldberg  
Sr. Technician: Sandy Hoffman  
Customer Svce: Linda E. Scaturro  
Production Sup.: Gabriel Figueroa  
Products: equipment cabinets & enclosures

## J. W. DAVIS & CO.

PO Box 26177  
3030 Canton Street  
Dallas, TX 75226  
(214) 651-7341, 800-527-5705, in TX 800-442-1564, FAX# 214-939-0328  
Pres.: Charles Griffith  
V.P. Sales: Jack W. Tucker  
Chief Engineer: Mike Lamm

Diversified Case Co.  
34 Main Street  
Whitesboro, NY 13492  
(315) 736-3028, 800-258-1188, FAX# 315-736-2049  
V.P. Mkt'g/Design: John Fitzsimmons, Jr.  
Sales Mgr.: Charles Fisher  
ABS Technologies, Islip, NY, 516-277-7101  
Abbott Allison Company, Branford, CT, 203-481-0405  
Liebel & Merle Sales, Rochester, NY, 716-385-3961  
Pantech, Inc., Springfield, VA, 703-451-5700  
PMC Packaging Co., Warrington, PA, 215-628-0560

# WE CAN SOLVE YOUR RACK MOUNTING PROBLEMS

## CUSTOM RACK SHELF



This unique method of rack mounting lets you put anything into a rack, without modifying the unit. The rackmount brings your equipment up to the next even rack space, eliminating unsightly gaps. Different cutouts available for various units. Textured, black, brushed and anodized finish. To order, all we need is the manufacturers name and model number.

## RACK STORAGE DRAWERS



Our family of storage drawers has features that nobody else offers:

- Fully enclosed top
- Full extension slides
- Attractive flush latch
- Operates smoothly
- Brushed & anodized finish

## RACK MOUNTED DISK HOLDER

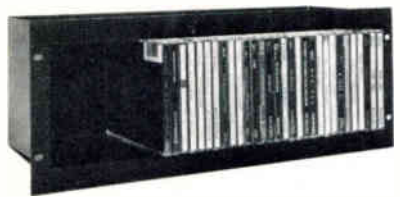

This holder allows up to 42 compact discs to be stored in a rack. New tip petitions prevent discs from falling over. Attractive brush & anodized finish.



## OUR PRODUCTS ARE THE FINEST AVAILABLE

Inquire about the other products we have, like our Utility Shelves, Blank Panels, Vent Panels, Security Covers, Rails, and other great items.

## middle atlantic audio products

P.O. Box 96 □ Haskell, NJ 07420 □ 201-839-1011

### DUKANE CORPORATION

2900 Dukane Dr.  
St. Charles, IL 60174  
(312) 584-2300, FAX# 312-584-2370  
Pres.: J. McWilliams Stone, Jr.  
Group V.P.: William P. Finnegan  
Division General Mgr.: Steve Deppe  
Mkt'g Mgr.: Derek Podobas  
Nat'l Sales Mgr.: Warren Anderson  
Service Mgr.: Cliff Carlson  
Doug Fellabaum, Sycamore, IL, 800-445-0152(#2301)  
Don Mouritzen, Beecher, IL, 800-445-0152(2303#)  
Art Sbrilli, Edison, NJ, 800-445-0152(#2302)  
Pete Kendall, Jacksonville, FL, 904-262-6025(#2306)  
Jack Brown, Dallas, TX, 214-943-7528(#2305)  
Ed Nuhring, Portland, OR, 800-445-0152(#2307)  
Wally Smutts, Toronto, Ontario, Canada, 312-584-2300  
Ken Lind, Wellesley Hills, MA, 617-235-6817  
Products: consoles, equipment cabinets & enclosures

### EAR/Caraway Audio

1775 Old Country Road, Suite 19  
Belmont, CA 94002  
(415) 594-1790

### ELMA Electronic, Inc.

41440 Christy St.  
Fremont, CA 94538  
(415) 656-3400, FAX# 415-656-3783  
Sales Mgr.: Kris R. Holla  
Sales Engineer: Howard C. Anderson  
Products: accessories, chassis, computer consoles, electronic racks, instrument cabinets, modular boxes

### EMCOR Products/Crenlo, Inc.

1600 Fouth Ave. NW  
Rochester, MN 55901  
(507) 289-3371  
Sales Mgr.: John Horton

### East Coast Lighting and Sound Corp.

PO Box 385  
120 Lawlins Road  
Wyckoff, NJ 07481  
(201) 891-1886  
Pres.: Michael Warmuth  
V.P.: Keith Berger



Nat'l Sales Mgr.: Kevin Campbell

Eastboard Consoles  
2200 Richmond St.  
Philadelphia, PA 19125  
(215) 425-3121

El Mar Plastics, Inc.  
821 E. Artesia Blvd.  
Carson, CA 90746  
(213) 327-3180

Electrorack Products Co.  
1443 S. Sunkist St.  
Anaheim, CA 92806  
(714) 776-5420  
Pres.: Yvonne Rumbles  
Sec./Treas.: Wayne Rumbles  
Operations Mgr.: Ken Seidel  
Sales Mgr.: Mike Deming  
V.P. Engineering: Allen Benson

Electro Space Fabricators  
PO Box 67  
Topton, PA 19562-0067  
(215) 682-7181, FAX# 215-682-2133

## ELENEX, INC. (WEST)

7392 Trade St.  
San Diego, CA 92121  
(619) 566-7515, 800-225-3113, in CA  
800-225-8037, FAX# 619-586-1484  
V.P.: Dennis Berglund  
Engineering: Al Bitarafan  
Sales: Lou Hennequin  
Products: enclosure systems, custom  
cabinets & consoles

Equipto Electronics Corp.  
351 Woodlawn Ave.  
Aurora, IL 60506  
(312) 897-4691  
Director of Sales/Mkt'g: Kent Jarnig

Flight Case Co.  
681 Main St., Bldg #1  
Belleville, NJ 07109  
(201) 759-4175, 694-6655

Flight Form Cases, Inc.  
PO Box 3248  
5950 192nd Street NE  
Arlington, WA 98223  
(206) 435-6688, FAX# 206-435-6512  
Pres.: Dale J. Lorang  
V. P.: Glenn Stenson  
Comptroller: Pat Kaminske

Sales & Design: Don Cole  
Products: ATA cases and racks, flight  
cases, shock-mount racks & cases

Four Designs Co.  
6531 Gross Ave.  
Canoga Park, CA 91307  
(818) 716-8540, 800-544-3746  
Pres.: Dave Riddle

Gaines Audio  
PO Box 17888  
1237 E. Main Street  
Rochester, Ny 14609  
(716) 266-0780  
Owner: Jon Gaines  
Products: chassis

Gemini, Inc.  
103 Mensing Way  
Cannon Falls, MN 55009-0018  
(507) 263-3957

General Devices Co., Inc.  
PO Box 39100  
1410 S. Post Rd.  
Indianapolis, IN 46239  
(317) 897-7000, FAX# 317-898-2917  
Pres.: Maxwell Fall  
V.P.: Martin Fall  
V. P. Manufacturing: Ed Hansen  
Nat'l Sales Mgr.: Jack Bradford  
Director Mkt'g: Ronald Stalze  
Mgr. Sales Engineering: Glenn Feest

General Devices Company Inc.  
PO Box 39100  
1410 S. Post Road  
Indianapolis, IN 46239  
(317-) 897-7000, FAX# 317-898-2917  
Pres.: Maxwell Fall  
V.P.: Martin Fall  
V.P. Manufacturing: Ed Hansen  
Nat'l Sales Mgr.: Jack Bradford  
Director Mkt'g: Ron Stalze  
Mgr. Sales Engineering: Glenn Feest

Good Foundations, Inc.  
6747 Valjean Ave.  
Van Nuys, CA 91406  
(818) 786-8696, 800-257-8727, FAX#  
818-376-1166  
Pres.: Larry Weisberg  
V.P.: Paula Weisberg  
V.P. Mkt'g: Bud Martin  
Nat'l Sales Mgr.: Andrew Hamilton  
Products: stands

Great American Market, The  
826 N. Cole Ave.  
Hollywood, CA 90038  
(213) 461-0200, FAX# 213-461-4308  
General Mgr.: Joseph N. Tawil  
Sales Mgr.: Mofid Bissada  
Operations Mgr.: Jeffrey C. Lind

Grozier Technical Systems, Inc.  
157 Salisbury Rd.  
Brookline, MA 02146  
(617) 277-1133  
Pres.: Richard G. Cann

HSA Heather Sound  
212 Lincolnway W.  
Mishawaka, IN 46544  
(219) 255-6100

Adam Hall Supplies, Ltd.  
120 Lawlins Park  
Wyckoff, NJ 07481  
(201) 891-1886

Hammond Manufacturing Co., Inc.  
1690 Walden Ave.  
Buffalo, NY 14225  
(716) 894-5710



## HARRIS CORPORATION, DRACON DIVISION

809 Calle Plano  
Camarillo, CA 93010  
(805) 987-9511, 800-437-2266, FAX#  
805-987-2547  
V.P./General Mgr.: John R. Mason  
V.P. Sales & Mkt'g.: Jack McGuigan  
Director of Sales: Tom Erdmann  
Paging Prod. Mgr.: Tom Johnson  
Metals/Racks/Tools Prod. Mgr.: Terry  
Smith  
Test Sets Prod. Mgr.: John Akins  
Don Bivens, Lake Elsinore, CA, 714-  
672-2168  
Gary Foster, Columbia, MD, 314-442-  
2288  
Rob Lincoln, Melbourne, FL, 407-259-  
0991  
Mark Skilowitz, Newfield, NJ, 609-697-  
4580  
Jim Fetterer, Seattle, WA, 206-243-  
7762

# Want to stay on top of this aggressively competitive industry?

*Read Sound & Communications'  
Special Features.*

Every May, our **Contracting Business In-Depth Market Report** tells you what's happening now and what's on the horizon for the sound & communications market.



December we bring you our **Economic Report**, keeping you aware of economic trends and developments and their effect on this industry.



Every August is **Blue Book month**, this industry's only complete directory of manufacturers, their products and key personnel.



**Special pull-out sections** — on everything from mixing consoles to alarm and security devices — that provide the sound contractor with the concise and definitive information needed for intelligent and informed product selection.



***Look for these special features and more in upcoming issues of Sound & Communications.***

Bill Boone, Libertyville, IL, 312-816-1080

Dave Whelan, W. Springfield, MA, 413-731-9552

Products: electronic racks, hardware, panels, shelves, rack-mounts, stands, storage racks & cases

**Hi Lo Fabrication and Manufacturing**

PO Box 509

CR 1105

Rio Vista, TX 76093

(817) 373-2247

Pres.: Cecil Caro

Production Engineer: Cecil Caro

Sales/Secretary: Bridget Caro

Products: electronic racks, enclosure systems, custom cabinets & consoles, equipment cabinets & enclosures, instrument cabinets, molded racks & cases, panels, portable tables, rack AC power, rack fans, specialty cases, stands

**House of Metal Enclosures, Inc.**

500 W. Ninth St.

Hermann, MO 65041

(314) 486-3111

**Hybrid Cases**

1121 Lincoln Avenue

Holbrook, NY 11741

(516) 563-1181

Pres.: Frank Maiella

Sales Director: Charles Northington

Mkt'g Director: Bruce Papa

Products: ATA cases and racks, electronic racks, flight cases, rack hardware, shelves, rack-mounts, shock-mount racks & cases, soft cases & bags, specialty cases, storage racks & cases

**Impact Industries, Inc.**

333 Plumer St.

Wausau, WI 54401

(715) 842-1651

Pres.: Terry Thirion

Products: ATA cases and racks, flight cases

**Impart, Inc.**

2225 4th Ave.

Seattle, WA 98121

(206) 728-0184, 800-544-3343

General Mgr: Steven Corey

Mkt'g Director: Peter Sherwin

Sales Mgr.: Laird Laabs

Office Mgr.: Michelle Helmacy

**Jan-Al Cases**

3339 Union Pacific Ave.

Los Angeles, CA 90023

(213) 260-7212, FAX# 213-260-4696

Pres.: Jan Michael Alevandro

V.P.: "Muffie" Alevandro

Design/Mkt'g Dir.: Todd Morgan

General Mgr.: Magi Lujan

Products: ATA cases and racks, flight cases, shock-mount racks & cases, specialty cases, storage racks & cases, tool cases

**Joe's Sound and Salami Co.**

303 Clymer Ave.

Morrisville, PA 19067

(215) 736-0811

V.P. Director of Mkt'g: Corrine S. Gately

Manufacturer's Rep: Chris Ross

Manufacturer's Rep: Eric Schwartz

Dir. of Adv./SIs Ass.: Doris Morgenfruh

Products: electronic racks

**Kalamazoo Technical Furniture, Inc.**

PO Box 1165

Kalamazoo, MI 49005-1165

(616) 385-2255, 800-832-5227, FAX#

616-385-2112

**LM Engineering**

660 W. Evergreen ST.

Youngstown, OH 44511

(800) 874-8326

**Lenco, Inc.**

PO Box 348

300 N. Maryland

Jackson, MO 63755

(314) 243-0271, 800-325-8494, FAX#

314-243-7122

**MIDDLE ATLANTIC PRODUCTS**

PO Box 96

400 Union Ave.

Haskell, NJ 07420

(201) 839-1011, FAX# 201-839-1976

Pres.: Robert Schluter

Products: accessories, hardware, panels, rack hardware, shelves, rack-mounts, slides

**Numark Electronics**

503 Newfield Ave.

Edison, NJ 08837

(201) 225-3222, FAX# 201-287-2155

Pres.: Harry Kotovsky

V.P.: Robert Kotovsky

Numark/PPD, Simi Valley, CA, 805-522-3550

Products: equipment cabinets & enclosures

**PAR Products, Inc.**

1260 Atlantic Ave.

Brooklyn, NY 11216

(718) 774-5900

**Parsons Mfg. Corp.**

1055 O'Brien Dr.

Menlo Park, CA 94025-1476

(415) 324-4726

Pres.: A.R. Parsons

V.P.: C.E. Plummer

**Peerless Sales Co.**

1950 Hawthorne Ave.

Melrose Pk., IL 60160

(312) 865-8870, FAX# 312-865-2941

V.P.: Walter Snodell

Mkt'g Mgr.: Frank R. Briggs

Products: accessories

**Penn Fabrication (USA), Inc.**

PO Box 506

29B Ethel Ave.

Hawthorne, NJ 07506

(201) 423-4404

Sales Director: Mike Panasuk

General Mgr.: Richard Stratford

General Mgr.: Gavin Naismith

Products: accessories, hardware, rack fans, rack hardware, shelves, rack-mounts

**Platt Luggage**

2301 S. Prairie Ave.

Chicago, IL 60616-2495

(312) 225-6670, 800-222-1555, FAX#

312-225-2900

Pres.: Dennis Platt

V.P.: Mark Platt

**Precision Fabrication Technologies, Inc.**

Highway 16 West

Monon, IN 47959

(219) 253-6666, 800-558-7297, FAX#

219-253-6570

Pres.: Joseph W. Rogers

Chief Engineer: Roger Hollar

Nat'l Distribution Specialist: Duane Nagel

Sales Engineer: Jim Mann

Burlaw Co., Warren, MI, 313-573-4605

Bob Burns & Assoc., Park Ridge, IL,

312-823-9360



## 22 CABINETS, FURNITURE, CASES & RACKS

Lessing & Assoc., Valencia, CA, 805-295-0225

Rohr Wanger & Roberts, Rock Hill, SC, 803-324-5111

Schmitt Mkt'g, Islandia, NY, 516-582-5888

Products: accessories, chassis, electronic racks, enclosure systems, custom cabinets & consoles, equipment cabinets & enclosures, instrument cabinets, modular boxes, panels, rack AC power, rack fans, rack hardware, shelves, rack-mounts, slides

Premier Metal Products Co.

381 Canal Pl.

Bronx, NY 10451

(212) 993-9200

Pres.: Stanley F. Kwasnicki

Sales Mgr.: Anthony E. Bozza

Design Engineer: Frank Sonanno

Quickset International, Inc.

3650 Woodhead Drive

Northbrook, IL 60062-1895

(312) 498-0700, 800-247-6563, FAX#

312-295-8553

V.P. Mkt'g: Rudy L. Merz

Products: stands

Racware, Inc. (Rackmounted Computers)

13773 N. Central Expressway, Suite 1444

Dallas, TX 75243

(214) 690-8480

Research Technology International

4700 W. Chase Ave.

Lincolnwood, IL 60646-168

(312) 677-3000, 800-323-7520, FAX#

312-677-1300

Pres.: Ray L. Short, Jr.

Chairman: Howard Bowen

V.P. Sales: Thomas Tisch

CFO: Richard Peterson

V.P. Production: Ralph Fisher

Advertising Mgr.: Sherwin Berger

Products: furniture systems, storage racks & cases

Roadrunner Cases, Inc.

447 E. Gardena Blvd.

Gardena, CA 90248

(213) 770-4444

Pres.: Howard Chatt

Sales Mgr.: Tony Castillo

Ruslang Corp.

320 Dewey St.

Bridgeport, CT 06605

(203) 384-1266

Products: consoles

Schroff, Inc.

170 Commerce Dr.

Warwick, RI 02886

(401) 732-3770, FAX# 401-738-7988

Scientific Atlanta/OPTIMA Div.

2166 Mountain Industrial Blvd

Tucker, GA 30084

(404) 496-4000, FAX# 404-496-4041

Skydyne

21 River Road

Port Jervis, NY 12771

(914) 856-6655, 800-428-CASE, FAX#

914-856-8378

General Mgr.: James Rogers

Sales Mgr.: M. Timney

Solid Support Industries

2453 Chico St.

South El Monte, CA 91733

(818) 579-6063, 800-782-6377

Sales Mgr.: Richard Wilson

Products: electronic racks, equipment cabinets & enclosures, furniture systems, molded racks & cases, panels, shelves, rack-mounts, stands, storage racks & cases, tables

Soundtech

230 Lexington Dr.

Buffalo Grove, IL 60089

(312) 541-3520, 800-323-4173, FAX#

312-541-3616

Pres.: Rudy Schlacher

Sales Mgr.: Keith Brawley

Sales Director: Len Brawling

Products: ATA cases and racks

Standtastic

1325 Meridian St.

Anderson, IN 46016

(317) 642-5205, 800-876-6923

Pres.: Larry Mechem

V.P. Mkt'g: L.J. Mechem

Nat'l Sales Mgr.: Mike Fox

Products: stands

Stantron-Unit of Zero Corp.

6900 Beck Ave.

N. Hollywood, CA 91605

(213) 875-0990

Star Case

648 Superior

Munster, IN 46321

(219) 922-4440, 800-822-STAR, FAX#

219-922-4442

Pres.: Dennis Toma

V.P. Sales/Mkt'g: Bernard Fryman

Dir. of Manufacturing: Roger Hallberg

Products: ATA cases and racks

TA Instrument Case Co.

4625 Alger St., Dept. EE

Los Angeles, CA 90039

(818) 242-8855

Mkt'g Mgr.: Lisa La Croix

Teclab

310 Perkstok Road

Kalamazoo, MI 49001

(800) 832-5227

Pres.: J. Draves

Sales Mgr.: B. Smith

Customer Svce: J. Savan

Thermodyne International, Ltd.

20850 S. Alameda Street

Long Beach, CA 90810

(213) 603-1976

Ultimate Support Systems, Inc.

PO Box 470

2506 Zurich Dr.

Fort Collins, Co 80522

(303) 493-4488, 800-525-5628, FAX#

303-221-2274

Mkt'g Mgr.: Thomas B. Kellenberger

Nat'l Sales Mgr.: Glen Snider

Account Exec.: Tom Clagett

Account Exec.: Preston Glaude

Account Exec.: Monica Kadillac

Viking Cases

10480 Oak St. NE

St. Petersburg, FL 33716

(813) 577-1216, 800-237-8560, FAX#

813-577-2082

Pres.: Art Stemler

V.P.: William Strickland

V.P.: Bruce Stemler

Sales: Terry Duffy

Products: ATA cases and racks, flight cases, shock-mount racks & cases, specialty cases, tool cases

Winsted Corp.  
10901 Hampshire Ave. S  
Minneapolis, MN 55438  
(612) 944-8556, 800-447-2257, FAX#  
612-944-1546  
V.P. Mkt'g: Jerry Hoska  
Sales & Mkt'g Mgr.: Randy R. Smith  
Customer Svce: Judy Ruzek  
Products: ATA cases and racks

Wyle Laboratories/Electronic Enclosures  
Division  
6995 Airport Highway Ln., Dept. M  
Pennsauken, NJ 08109  
(609) 665-6810, FAX# 609-665-7261  
V.P.: T. F. Keller  
Sales Mgr.: Ron Pache  
Electronic Enclosures, El Segundo, CA,  
213-643-8181  
Imagitron Sales, Upperco, MD, 301-  
374-5600  
Zieco Inc., Lexington, MA, 617-861-  
8300  
Zonk & Assoc., Richardson, TX, 214-  
238-7651  
Carlson & Assoc., Campbell, CA, 408-  
370-1284  
Products: accessories, computer  
consoles, consoles, electronic racks,  
enclosure systems, custom cabinets  
& consoles, equipment cabinets &  
enclosures, hardware, panels, rack  
AC power, rack fans, rack hardware,  
shelves, rack-mounts, tables

**PROFESSIONAL AUDIO DIVISION,  
YAMAHA MUSIC CORPORATION, USA**  
PO Box 6600  
6600 Orangethorpe Ave.  
Buena Park, CA 90622  
(714) 522-9011, FAX# 714-739-2680  
Products: rack hardware, soft cases &  
bags

Zero Corporation, Zero-West Division  
PO Box 509  
777 Front St.  
Burbank, CA 91503  
(818) 846-4191, FAX# 818-841-5618  
Pres./CEO: Woody D. Godbold, Jr.  
V.P.: Jim Hermanson  
V.P.: Ron Hess  
Pres./Zero-West Div.: Bill Wood  
V.P. Sales: Douglas W. Griffith

## FORM & FUNCTION



### FULL LINE ENCLOSURES

From standard stock to custom fabrication...  
From economy racks to high end systems...  
Atlas/Soundolier has an enclosure that's just right  
for you.

Cabinets, consoles, desks and racks ● 14 and 16 gauge CRS ●  
5" to 77" panel openings ● 19", 24" and 30" widths ● 25" and 30"  
depths ● EIA Standard ● welded and knocked down models ●  
complete selection of electronic and convenience accessories.

### FULL SERVICE COMPANY

Whether your order is for 5 or 500...  
OEM or Commercial...  
It is supported by regional sales personnel, design/  
engineering professionals, 30 years experience and  
two complete manufacturing facilities to serve you.

FULL LINE...FULL SERVICE... ATLAS/SOUNDOLIER

4A



## ATLAS / SOUNDOLIER

DIVISION OF AMERICAN TRADING AND PRODUCTION CORPORATION  
1859 INTERTECH DRIVE / FENTON, MISSOURI 63026 U.S.A.  
TEL: (314) 349-3110 / TELEX: 910-760-1850 / FAX: (314) 349-1251

# HARDWARE, TOOLS

**A-1 Business Supplies, Inc.**

PO Box 405  
101 Route 46 East, #122  
Pine Brook, NJ 07058  
(201) 882-1066, 800-631-3421  
Sales Mgr.: Dick Birnbaum  
Products: markers

**AVA Electronics Corp.**

4000 Bridge St.  
Drexel Hill, PA 19026  
(215) 284-2500  
Products: connectors

**Alarm Accessory Ltd.**

PO Box 212  
Claymont, DE 19703  
(302) 792-3620, 800-441-7082, FAX#  
302-792-7713  
Pres.: William J. Holt  
Operations Supervisor: Angela M. Bopp  
Products: cable clamps, raceways,  
stands

**All Electronics Corp.**

PO Box 567  
6228 Sepulveda Blvd.  
Van Nuys, CA 91408  
(818) 904-0524, 800-826-5432, FAX#  
818-781-2653  
Mgr. Sales: Harold Oliver  
Products: cable clamps, cleaning  
chemicals, connectors, lamps

**Atlas/Soundolier**

1859 Intertech Dr.  
Fenton, MO 63026  
(314) 349-3110, FAX# 314-349-1251  
V.P. Sales: Tom Erickson  
E. Region/Sales: Andy Musci  
W. Region/Sales: Bud Waters  
V.P./Mkt'g Consultant: Herbert Jaffe  
Products: cabinet hardware, speaker  
hardware

**Bi-Tronics, Inc.**

PO Box 125  
76 Main Street  
Tuckahoe, NY 10707  
(914) 793-3221, 800-522-7377, FAX#  
914-961-4244  
Pres.: J. Schwartz

**Sales Mgr.: Ron Huppert**

Products: cable clamps, connectors,  
wire pulling devices

**Brim Electronics, Inc.**

120 S. Home Place  
Lodi, NJ 07644  
(201) 796-2886, FAX# 201-778-2792  
Pres.: B. Danziger  
GH Assoc., Stow, MA, 617-897-1741  
Products: cable clamps, wire  
terminations

**Cabletronix**

PO Box 3003  
366 Washington St.  
Newburgh, NY 12550  
(914) 565-7570, 800-431-9473, in NY  
800-942-WIRE, FAX# 914-564-5332  
Pres.: Stephen L. Roth  
V. P.: Leonard Ellentuch  
Sales Mgr.: Tom Martirano  
Products: cable clamps, connectors,  
fabrication supplies, hanging  
systems, linemen's test sets,  
markers, wire pulling devices, wire  
terminations

**Contact East, Inc.**

PO Box 786  
335 Willow St. South  
N. Andover, MA 01845  
(508) 682-2000, 800-225-5370, FAX#  
508-688-7829  
Products: cleaning chemicals,  
linemen's test sets, tool kits, wire  
pulling devices

**D. J. Associates, Inc.**

8411 S. Zero, Unit 5  
Ft. Smith, AR 72903  
(501) 452-3987  
Pres.: I. Jean Beck  
V.P.: Michael P. Beck  
Sec./Treas.: I. Jean Beck

**J. W. DAVIS & CO.**

PO Box 26177  
3030 Canton Street  
Dallas, TX 75226  
(214) 651-7341, 800-527-5705, in TX  
800-442-1564, FAX# 214-939-0328  
Pres.: Charles Griffith  
V.P. Sales: Jack W. Tucker

**Chief Engineer: Mike Lamm**

Products: linemen's test sets, wire  
pulling devices

**HARRIS CORPORATION, DRAGON  
DIVISION**

809 Calle Plano  
Camarillo, CA 93010  
(805) 987-9511, 800-437-2266, FAX#  
805-987-2547

V.P./General Mgr.: John R. Mason  
V.P. Sales & Mkt'g.: Jack McGuigan  
Director of Sales: Tom Erdmann  
Paging Prod. Mgr.: Tom Johnson  
Metals/Racks/Tools Prod. Mgr.: Terry  
Smith

Test Sets Prod. Mgr.: John Akins  
Don Bivens, Lake Elsinore, CA, 714-  
672-2168

Gary Foster, Columbia, MD, 314-442-  
2288

Rob Lincoln, Melbourne, FL, 407-259-  
0991

Mark Skilowitz, Newfield, NJ, 609-697-  
4580

Jim Fetterer, Seattle, WA, 206-243-  
7762

Bill Boone, Libertyville, IL, 312-816-  
1080

Dave Whelan, W. Springfield, MA, 413-  
731-9552

**Jensen Tools, Inc.**

7815 S. 46th St.  
Phoenix, AZ 85044  
(602) 968-6241  
Pres./Gen. Mgr.: Arnold Schwartz  
Sales Mgr.: Herb Oberman  
Prod. Engineer Mgr.: Sherman Jensen  
Products: tool kits

**Labor Saving Devices**

815 Benton St.  
Lakewood, CO 80214  
(303) 232-6341  
Pres.: Roy Bowling  
Sec.: Kathy Bowling

**Littlite Gooseneck Lamps/CAE**

10087 Industrial Drive  
Hamburg, MI 48139  
(313) 231-9373  
Pres: Jim Fackert



Sales Mgr: Fred Mikeska  
Mkt'g Mgr: Barb Burns

**MIDDLE ATLANTIC PRODUCTS**

PO Box 96  
400 Union Ave.  
Haskell, NJ 07420  
(201) 839-1011, FAX# 201-839-1976  
Pres.: Robert Schluter  
Products: panels

Miller-Stephenson Chemical Co., Inc.  
PO Box 950  
Danbury, CT 06813  
(203) 743-4447, 800-992-2424, FAX# 203-791-8702

Music Supply Co., Inc.  
809 N. Madison  
Dallas, TX 75208  
(214) 946-8450, 800-527-1522, FAX# 214-946-9155  
Pres.: W. E. Brown  
Sales: Betty Brown

Neutrik USA, Inc.  
1600 Malone St.  
Millville, NJ 08332  
(609) 327-3113, FAX# 609-825-4804  
General Mgr.: James E. Cowan  
Product Mgr.: William J. Dorman  
Cartwright & Bean, Atlanta, GA, 404-233-2939  
L.D. Lowery, Broomall, PA, 215-356-5300  
Moulthrop, Pleasanton, CA, 415-463-0450  
Electronic Representstives,  
Indianapolis, IN, 317-894-1414  
Lowall-Kangas, St. Louis, MO, 314-821-4050  
Products: connectors

Paladin Corp.  
3543 Old Conejo Road, Ste #102  
Newbury Park, CA 91320  
(805) 499-0318

Panduit Corp.  
17301 Ridgeland Ave.  
Tinley Park, IL 60477  
(312) 532-1800  
Nat'l Sales Mgr.: Paul Trunk  
Product Mgr./Wiring Duct: Tom Orton

Penn Fabrication (USA), Inc.  
PO Box 506  
29B Ethel Ave.  
Hawthorne, NJ 07506  
(201) 423-4404  
Sales Director: Mike Panasuk  
General Mgr.: Richard Stratford  
General Mgr.: Gavin Naismith  
Products: cabinet hardware, connectors, knobs, lamps, speaker hardware

Seal-O-Matic Co.  
900 Passaic Ave.  
East Newark, NJ 07029  
(201) 481-6500, 800-631-2072  
Pres.: Mel Ortner  
V.P.: Sam Ortner

Selco Products Co.  
7580 Stage Rd.  
Buena Park, CA 90621  
(714) 521-8673, FAX# 714-739-1507  
General Mgr.: Bill Wilkinson  
Product Mgr.: Diane Duquette  
Product Mgr.: Celeste Martinez  
Regional Mgr.: Bill Keneipp

J.H. Sessions & Son  
PO Box 609

273 Riverside Ave  
Bristol, CT 06010  
(203) 582-3127, FAX# 203-582-2574  
Pres.: Paul L. Sessions  
V.P. & Sales Mgr.: Donald C. Sessions  
Products: cabinet hardware, speaker hardware

Tektrak  
PO Box 431  
Route 165  
Voluntown, CT 06384  
(203) 376-0433  
Pres.: Michael Panasuk  
East Coast Lighting & Sound, Wyckoff, NJ, 201-652-7641  
Sound Marketing, Palos Heights, IL, 312-448-6715  
Sturgill Assoc., Columbia, MD, 301-995-1578  
Products: cabinet hardware, speaker hardware

Texwipe  
650 E. Crescent Ave.  
Upper Saddle River, NJ 07458  
(201) 327-9100, FAX# 201-327-5945

Vaco Products Co.  
7200 McCormick Blvd.  
Chicago, IL 60645  
(312) 677-9500, FAX# 312-677-4476

Yale Audio of Florida Corp.  
PO Box 2661  
2702 Azeele St.  
Tampa, FL 33601  
(813) 876-6789  
Pres.: Y. Brevda  
Sales Mgr.: David Kentwood  
Products: markers

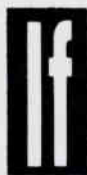

**you need to find out who makes paging systems, or who is the one person at an intercom company you really need to talk to...you'll find all the answers in the 1988/1989 *Sound & Communications Blue Book.***

# HEADPHONES, HEADSETS

ACS Communications  
250 Technology Circle  
Scotts Valley, CA 95066  
(408) 438-3833 (in CA), 800-538-0742  
Pres.: Al Butcher  
Executive V.P.: Phil Gattey  
V.P. Sales: Kurt Siem  
V.P. Consumer: George Poston

AKG Acoustics, Inc.  
77 Selleck St  
Stamford, CT 06902  
(203) 348-2121, 800-243-7885, FAX#  
203-243-1947  
Pres.: S. Richard Ravich  
V.P./Operations: Derek Pilkington  
V.P./Finance: Robert Netter  
Tech Sls Coordinator: Timothy  
Derwallis  
Products: boom-mic headsets,  
communications headsets,  
intercommunications headsets,  
isolation headsets, personal/stereo  
headphones, telecommunications  
headsets

Accusonics Systems Corp.  
2101 Jericho Turnpike  
New Hyde Park, NY 11040  
(516) 328-3300  
General Mgr.: Dennis Goodman  
Products: boom-mic headsets,  
communications headsets,  
intercommunications headsets,  
isolation headsets,  
telecommunications headsets

Anixter Brothers, Inc.  
4711 Golf Road  
Skokie, IL 60076  
(312) 677-2600, 800-323-8167

Audiosears Corp.  
2 South St.  
Stamford, NY 12167  
(607) 652-7305

Audio-Technica U.S., Inc.  
1221 Commerce Drive  
Stow, OH 44224  
(216) 686-2600, FAX# 216-688-3752  
Pres.: Jon R. Kelly  
Nat'l Sales Mgr.: Mike Wuellner  
Mkt'g Mgr./Pro Products: Greg Silsby

Sr. Transducer Engineer: Bob Herrold  
Products: personal/stereo headphones

Auditel Systems, Ltd.  
396 Porter Ave.  
Buffalo, NY 14201  
(716) 886-0019, FAX# 716-886-1615  
Pres.: David Langtry  
Prod. Mgr.: Tony Roberson  
Mkt'g Director: Jim Wood  
Products: boom-mic headsets

Beyer Dynamic, Inc.  
5-05 Burns Ave  
Hicksville, NY 11801  
(516) 935-8000, FAX# 516-935-8018  
V.P./General Mgr.: Paul Murphy  
Mkt'g Mgr.: Mike Solomon  
Products: boom-mic headsets,  
communications headsets,  
intercommunications headsets,  
isolation headsets, personal/stereo  
headphones, telecommunications  
headsets

David Clark Co., Inc.  
PO Box 15054  
360 Franklin St.  
Worcester, MA 01615-0054  
(617) 756-6216, FAX# 508-753-5827  
Product Mgr. Comm.: George R.  
Conlon  
Pres.: John E. Flagg  
Exec. V.P.: Richard P. Houlihan  
General Sales Mgr.: Robert J. Murphy  
Product Mgr./Comm.: George R.  
Conlan  
Products: boom-mic headsets,  
communications headsets,  
intercommunications headsets,  
isolation headsets

Clear-Corn Intercom Systems  
945 Camelia St.  
Berkeley, CA 94710  
(415) 527-6666, FAX# 415-527-6699  
Pres.: Robert Cohen  
Nat'l Sales Mgr.: Michael Goddard  
Products: boom-mic headsets,  
communications headsets,  
intercommunications headsets

Danavox Inc./Telecommunications Div.  
6400 Flying Cloud Dr.

Minneapolis, MN 55344  
(612) 941-0690

Koss Corporation  
4129 N. Port Washington Ave.  
Milwaukee, WI 53212  
(414) 964-5000, 800-USA-KOSS, FAX#  
414-974-8615  
CEO/Chairman/Prest.: John C. Koss  
Executive V.P.: Michael Koss  
V.P. Mkt'g: Don Wagner  
V.P. Sales: John C. Koss, Jr.  
Sec./Corp. Legal Coun.: Michael Moore

Metragen Ltd.  
3701 Chesswood Dr., #309  
Downsview, Ont., CD M3J 2P6  
(416) 635-9212, FAX# 416-635-8266  
Mgr.: Edward Wigdor  
Cambridge Co., Niles, IL, 312-647-  
8100

Nady Systems, Inc.  
1145 65th St.  
Oakland, CA 94641  
(415) 652-2411, FAX# 415-652-5075  
Adv. Director: Royce Krilanovich  
Mkt'g Director: Howard Zimmerman  
Mkt'g Ass.: Sharon Banke

Nakamichi America, Corp.  
19701 South Vermont Ave.  
Torrance, CA 90502  
(213) 538-8150, 800-421-2313, FAX#  
213-324-7614  
Pres.: Yas Yamazaki  
Exec. V.P./General Mgr.: Dean Miller  
V.P. Sales: Jett Logan  
V.P. Operations: Ray Privette  
Mkt'g Mgr.: Jun Sakamoto  
Professional Audio Assoc., Burlington,  
MA, 617-229-6050  
Rancilio Assoc., St. Louis, MO, 314-  
631-3326  
Applied Audio Marketing, Asheville,  
NC, 704-252-9313  
Tenicki & Assoc., Houston, TX, 713-  
528-2005  
Western Audio Sales, Glendale, CA,  
818-246-3806  
Audio Assoc. Corp., Verona, NJ, 201-  
239-3727  
Audio Resources, Inc., Westmont, IL,  
312-655-1180

Bencsik Assoc., Inc., Ocala, FL, 904-732-9775

C.M. Sales, Farmington Hills, MI, 313-553-8070

JB Parent Co., Dublin, OH, 614-764-0064

Keiser & Assoc., Bountiful, UT, 801-298-8902

L.P. Marketing, Inc., Oakland, CA, 415-532-5600

Northshore Marketing, Seattle, WA, 206-284-9699

Sigmat Corp., Valley Forge, PA, 215-783-6666

Products: personal/stereo headphones

**Numark Electronics**

503 Newfield Ave.

Edison, NJ 08837

(201) 225-3222, FAX# 201-287-2155

Pres.: Harry Kotovsky

V.P.: Robert Kotovsky

Numark/PPD, Simi Valley, CA, 805-522-3550

**Plantronics, Inc.**

345 Encinal St.

Santa Cruz, CA 95060

(408) 426-5858, 800-538-0748

**Sennheiser Electronic Corp. (CT)**

PO Box 987

6 Vista Drive

Old Lyme, NY 06371

(203) 434-9190, FAX# 203-434-1759

Pres.: Andrew Brakhan

V.P. Mkt'g: Tony Tudisco

Products: boom-mic headsets, intercommunications headsets, personal/stereo headphones

**Setcom Corp.**

1400 North Shoreline Blvd.

Mountain View, CA 94043

(415) 965-8020

Sales Mgr.: Steve Kilczewski

Products: boom-mic headsets, communications headsets, intercommunications headsets, isolation headsets, telecommunications headsets

**Sony Professional Audio**

1600 Queen Anne Road

Teaneck, NJ 07666

(201) 833-5200

Pres.: William G. Connolly

V.P.: Jerry Smith

Products: personal/stereo headphones

**SOUND POWERED COMMUNICATIONS CORP.**

PO Box 5569

335 Robbins Ave.

Trenton, NJ 08638

(609) 883-1180

Sales Mgr.: Harry Mosle

**Stanton Magnetics, Inc.**

200 Terminal Dr.

Plainview, NY 11803

(516) 349-0235, FAX# 516-349-0230

Pres.: Walter O. Stanton

V. P. of Mkt'g: Joseph S. Woodstock

Professional Sales Mgr.: Pete Bidwell

Products: personal/stereo headphones

**TOA ELECTRONICS, ENGINEERED SOUND & COMMUNICATIONS DIVISION**

PO Box 2047

601 Gateway Boulevard

South San Francisco, CA 94080

(415) 588-2538, 800-843-4750, in CA

800-632-2157, FAX# 415-588-3349

Pres.: Yoshiro Ishida

Director of Mkt'g: Fred Fredericks

Nat'l Sales Mgr.: Richard Krochmal

Nat'l Sales Mgr./Engineered Intercom &

Security Div.: Al Bums

Products: boom-mic headsets, personal/stereo headphones

**TECHNICAL PROJECTS, INC.**

PO Box 1449

449 Princeton Ave.

Barrington, IL 60011

(312) 381-5350, 800-562-5872, FAX#

312-381-4360

Pres.: Glenn Mullis

Sec./Treas.: Sibbelina Mullis

Professional Audio Mkt'g, New York,

NY, 516-367-8620

Sound Sales, Lanham, MD, 301-731-

6355

Audio Marketing Assoc., Brecksville,

OH, 216-526-2426

Wm. M. Linz & Assoc., Deerfield, IL,

312-945-9600

Design Factors, Hacienda Heights, CA,

213-697-7576

Products: boom-mic headsets,

communications headsets,

intercommunications headsets

Telex Communications, Inc., Pro Audio Dept.

9600 Aldrich Ave. S.

Minneapolis, MN 55420

(612) 884-4051, FAX# 612-884-0043

Chairman of the Board: Ansel Kleiman

Exec. V.P.: Jeffrey Wetherell

V.P. Mkt'g: James Arrington

Director of Mkt'g: Donald Mereen

Director of Advertising: Ronald Taylor

Wes-Tech Marketing, Culver City, CA,

213-870-9286

Bencsik Assoc., Ocala, FL, 904-732-

9775

Monfort Electronic Marketing,

Indianapolis, IN, 317-872-8877

Mountain Representatives, Inc.,

Denver, CO, 303-623-0972

Murphy & Cota, Inc., Atlanta, GA, 404-

875-2525

Northland Assoc., Moorhead, MN, 218-

233-4616

White Radio Ltd., Burlington, Ontario,

Canada, 416-632-6894

## ATTENTION!

The editors of *Sound & Communications* are always looking for qualified contributors who'd like to write for us on a freelance basis. Contractors, consultants, manufacturers — if you are involved in the sound and communications industry and would like to write for the magazine bearing its name, please send an outline of your experience and particular interests to:

Bill Intemann

Managing Editor

*Sound & Communications*

25 Willowdale Avenue

Port Washington, NY 11050



# THE STANDARD OF QUALITY

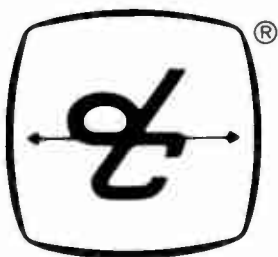

**in**  
**Noise-Attenuating Headsets  
and Communication Systems.**

For over 30 years, David Clark Company has been the leader in the development of innovative ideas in NOISE-ATTENUATING (Reducing) HEADSETS for use in high noise areas.

When these headsets are combined with one of our OFF-THE-SHELF systems, your communication problems are solved.

### **Choice of Systems:**

- Permanently Installed
- Portable
- Voice-Powered — No Batteries or A/C Power
- Two-Way Radio Headsets and VOX Adapters
- Telephone-Compatible Headsets

Write or call for Catalog and name of nearest local dealer.

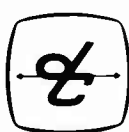

**David Clark**  
COMPANY INCORPORATED  
Box 15054, Worcester, MA 01615-0054  
(508) 756-6216 FAX: (508) 753-5827

Rancilio Assoc., Inc., St. Louis, MO,  
314-631-3326  
SAGA, Oswego, NY, 315-343-5739  
Sigmet Corporation, Valley Forge, PA,  
215-783-6666  
J.Y. Schoonmaker Co., Dallas, TX,  
214-349-1650  
Weller Electronic Sales, Worthington,  
OH, 614-885-7819  
Ziskind Assoc., Rolling Meadows, IL,  
312-577-1624  
Burcaw Company & Assoc., Warren,  
MI, 313-573-4605  
S&F Northwest, Seattle, WA, 206-622-  
6036  
Lichtenauer & Associates, Antioch, CA,  
415-757-1200  
Products: boom-mic headsets,  
communications headsets,  
intercommunications headsets,  
isolation headsets, personal/stereo  
headphones, telecommunications  
headsets

### **UNEX, A DYNATECH COMPANY**

PO Box 574  
3 Lyberty Way  
Westford, MA 01886  
(508) 692-9505, FAX# 508-692-9409  
Pres.: John D. Ela  
Nat'l Sales Mgr.: Robert L. Birch  
Customer Svce Mgr.: Catherine M.  
Koch  
Products: telecommunications  
headsets

### **Vidicraft, Inc.**

0704 SW Bancroft Street  
Portland, OR 97201  
(503) 223-4884, 800-547-1491, FAX#  
503-243-1995  
General Mgr.: Steve Johnson  
Nat'l Sales Mgr.: Dave Landis  
Product Mgr.: Glenn Olson  
Products: personal/stereo headphones

### **PROFESSIONAL AUDIO DIVISION, YAMAHA MUSIC CORPORATION, USA**

PO Box 6600  
6600 Orangethorpe Ave.  
Buena Park, CA 90622  
(714) 522-9011, FAX# 714-739-2680  
Products: boom-mic headsets,  
communications headsets,  
intercommunications headsets,  
personal/stereo headphones

## POWER PROTECTION, CONDITIONERS

### Aris/Eta

1710 Enterprise Parkway  
Twinsburg, OH 44087  
(216) 425-3388, FAX# 216-425-9700  
Mkt'g: Bob Harris

335 Willow St. South  
N. Andover, MA 01845  
(508) 682-2000, 800-225-5370, FAX#  
508-688-7829

Products: line protectors, outlet strips,  
uninterrupted power

Owner: Lonnie Dornitz  
Admin. Ass.: Jackie Rice  
Products: power control

### Cabletronix

PO Box 3003  
366 Washington St.  
Newburgh, NY 12550  
(914) 565-7570, 800-431-9473, in NY  
800-942-WIRE, FAX# 914-564-5332

Pres.: Stephen L. Roth  
V. P.: Leonard Ellentuch  
Sales Mgr.: Tom Martirano  
Products: inverters, line isolators, line  
protectors, outlet strips, power  
control, uninterrupted power

### Dynamote Corp.

1200 W. Nickerson  
Seattle, WA 98119  
(206) 282-1000

### Eneractive Group

25416 C.R. 6, Suite 313  
Elkhart, IL 46514  
(219) 264-1393

### Ethereal Concepts

210 Golden Gate Drive  
Dayton, OH 45459-4329  
(513) 433-8610

Juice Goose, A Division of Whitenton  
Industries, Inc.  
7320 Ashcroft, #302  
Houston, TX 77081  
(713) 772-1404, FAX# 713-772-9124  
Pres.: Richard Whitenton  
Products: line isolators, line protectors,  
noise suppression, outlet strips,  
power control, power conversion,  
power relays, transformers,  
uninterrupted power

### Linear & Digital Systems, Inc.

46 Marco Lane  
Centerville, OH 45459  
(513) 439-1758

Contact East, Inc.  
PO Box 786

**Q:** Wondering who makes an 1800-watt  
amplifier? And where you can find  
a rack to put it in?

**A:** You'll find the answers in the  
1988/89 *Sound & Communications*  
Blue Book Directory.

Lumitrol Corp.  
110 Bi-County Blvd.  
Farmingdale, NY 11735  
(516) 752-1411

Omni Q, Inc.  
1122 Fur Ave., Bldg. A  
Blaine, WA 98230  
(206) 384-1750

Perma Power Electronics, Inc.  
5601 W. Howard Ave.  
Chicago, IL 60648  
(312) 647-9414, FAX# 312-647-1472  
Pres.: Norman A. Ackerman  
Mkt'g Mgr.: Jay Goldstein  
Sales Mgr.: Mike Shatz  
Products: line protectors, noise  
suppression, outlet strips,  
uninterrupted power

Polyphaser Corporation  
PO Box 1237  
1425 Industrial Way  
Gardnerville, NY 89410-1237  
(702) 782-2511, 800-325-7170, FAX#  
702-782-4476

Powermark, Inc.  
3855 Ruffin Road  
San Diego, CA 92123  
(619) 565-8363

RTE Deltec Corp.  
2727 Kurtz Road  
San Diego, CA 92110  
(619) 291-4211

Shape Magnetronics, Inc.  
901 DuPage Avenue  
Lombard, IL 60148  
(312) 620-8394, 800-367-5811, FAX#  
312-620-0784  
Products: transformers

Sola, A Unit of General Signal  
1717 Busse Road  
Elk Grove Village, IL 60007  
(312) 439-2800, 800-243-8160, in IL  
800-228-8937, FAX# 800-626-6269  
Product Mgr. UPS: Kevin McGowan  
Product Mgr. PS: Wayne Boese

Superior Electric Co.  
383 Middle Street  
Bristol, CT 06010  
(203) 582-9561

Taylor-Simtec Digital, Inc.  
PO Box 1328  
221-A West Main St.  
Taylors, SC 29687  
(803) 268-7592, FAX# 803-268-7596

Topaz, Inc.  
9192 Topaz Way  
San Diego, CA 92123  
(619) 279-0831, FAX# 619-335-1556

Tripp Lite  
500 N. Orleans  
Chicago, IL 60610  
(312) 329-1777, FAX# 312-644-6505  
Mkt'g Mgr.: Christy Prosapio  
Sales Mgr.: Tom Crivalone  
Sales: Kris Billenstein  
Products: inverters, line isolators, line  
protectors, noise suppression, outlet  
strips, uninterrupted power

SL Waber Electric  
300 Harvard Ave.  
Westville, NJ 08093  
(609) 456-5400  
Pres.: John A. Ralston  
Dir. of Manufacturing: John Instone  
Dir. of Engineering: Jeff Wright  
Mkt'g Mgr.: Gary Oswald  
Advertising Mgr.: Barbara McNally

Whitenton Industries, Inc.  
7320 Ashcroft, Suite 302  
Houston, TX 77081  
(713) 772-1404

# IF YOU WANT TO GAMBLE, GO TO VEGAS.



## IF YOU DON'T, COME TO ARIS.

ARIS Power Distribution Systems will end your worries about voltage spikes and power surges. No more unwanted line-noise. No more complicated AC power connections. Just clean, noise-filtered power and protection for all your electronic equipment. Insist on a sure thing, call ARIS today!

**ARIS**™ 1716 ENTERPRISE PKWY.,  
TWINSBURG, OH 44087  
216-426-3380 FAX: 216-425-9700





# ALARM/SECURITY PRODUCTS

## ALARM, SECURITY

### AES Corp.

PO Box 2093  
285 Newbury St.  
Peabody, MA 01960  
(508) 535-7310, FAX# 508-535-7313  
Pres.: Michael J. Sherman  
Mkt'g: Brian Rockett  
Sales: Joseph Bonavita  
Sales: Tony Albano

### AMSECO

228 E. Star of India Lane  
Carson, CA 90746  
(213) 538-4670, 800-421-1096

### Adpro Pty. Ltd.

PO Box 324  
Chester, NJ 07930  
(201) 879-4159

### AIPHONE INTERCOM SYSTEMS

PO Box 90075  
1700 130th Ave. N.E.  
Bellevue, WA 98005  
(206) 455-0510, FAX# 206-455-0071  
Pres.: Hiko Shinoda  
Nat'l Sales: Jim Morrison  
Products: access control, audio surveillance, intercom, video surveillance

### Alarm Accessory Ltd.

PO Box 212  
Claymont, DE 19703  
(302) 792-3620, 800-441-7082, FAX# 302-792-7713  
Pres.: William J. Holt  
Operations Supervisor: Angela M. Bopp  
Products: vibration sensing

### Alarm Controls Corp.

PO Box 280  
19 Brandywine Dr.  
Deer Park, NY 11729  
(516) 586-4220, 800-645-5538, FAX# 516-586-6500  
Pres.: Howard Berger  
Sales Mgr.: John Benedetto

### Alarmco

PO Box 343  
Canadaiqua, NY 14424  
(716) 398-2510, FAX# 716-394-8861  
Mkt'g: Ron Cook

### All Electronics Corp.

PO Box 567  
6228 Sepulueda Blvd.  
Van Nuys, CA 91408  
(818) 904-0524, 800-826-5432, FAX# 818-781-2653  
Mgr. Sales: Harold Oliver  
Products: access control, ancillary components, announcement systems, burglar alarms, sirens

### Allsafe Co.

1105 Broadway  
Buffalo, NY 14212  
(716) 896-4515, 800-828-7162, FAX# 716-896-4241  
Mkt'g: Edwin Pokornowski  
Products: access control

### Alphametrics Controls Corp.

4865 Pasadena Ave., Suite 9  
Sacramento, CA 95841  
(916) 485-4050, FAX# 916-485-8354  
Pres.: Harry Berndt  
V.P.: Dennis Marchut  
Products: door-lock systems

### Ambeti Corp.

PO Box 395  
Westland, MI 48185  
(313) 455-6410, 800-223-5274  
Sales Mgr.: Teresa Grzanowski  
Products: signalling devices

### Amtel Security Systems, Inc.

8525 N.W. 53rd Terrace  
Miami, FL 33166  
(305) 591-8200

### Atlas/Soundolier

1859 Intertech Dr.  
Fenton, MO 63026  
(314) 349-3110, FAX# 314-349-1251  
V.P. Sales: Tom Erickson  
E. Region/Sales: Andy Musci  
W. Region/Sales: Bud Waters  
V.P./Mkt'g Consultant: Herbert Jaffe  
Products: access control, announcement systems, audio surveillance, fire alarm, intercom, signalling devices, sirens, strobes

### Auth Company

505 Acorn St.  
Deer Park, NY 11729  
(516) 667-9000

### BCE/Edcom, Division of CCS, Inc.

1585A Britannia RD. E., #7  
Mississauga, Ontario, Canada L4W 2M4  
(416) 678-0801, FAX# 416-678-0480  
Pres.: Peter Jova  
Sales Mgr.: Keith Moore  
Products: intercom

### Floyd Bell, Inc.

897 Higgs Ave.  
Columbus, OH 43212  
(614) 488-3193

### Bogen Communications, Inc.

PO Box 575  
50 Spring St.  
Ramsey, NJ 07446  
(201) 934-8500, FAX# 201-934-9832  
Pres.: John H. Ochtera  
V.P. Sales/Sound Prod.: David A. Chambers  
V.P. Sales/Telecomm. Prod.: Charles Ferreri  
Bruce Barrett, Garland, TX, 214-530-0467  
Kingston Sales Corp., Indianapolis, IN, 317-876-2545  
Kevin Koehler, Batvia, IL, 312-879-6871  
Tim McDonnell, Willoughby Hills, OH, 216-942-2429

Steve McGrew, Kennesaw, GA, 404-422-4608  
Meyer Mkt'g, Inc., Deerfield Beach, FL, 305-481-9250  
W.B. Pray Sales, Inc., Northboro, MA, 617-393-3434  
Jay Sample, Sandy, UT, 801-942-1059  
Scott Sampson, Encino, CA, 818-996-5484  
Mike Schneider, Baltimore, MD, 301-563-5390  
Walt Spencer, Ramsey, NJ, 201-934-8500  
White Radio Ltd., Burlington, ONT, Canada, 416-632-6894  
Roburn Agencies, Inc., Yonkers, NY, 914-968-1016  
Products: audio surveillance, intercom

C & K Systems, Inc.  
2040 Fortune Drive  
San Jose, CA 95131  
(408) 434-1149, 800-227-8065, FAX# 408-434-6707  
Pres.: Larry Tracy  
V.P.: Rick Johnson  
Nat'l Sales Mgr.: Duane Warehime  
Digital Prod. Mgr.: Jim Koelle  
Operations Mgr.: Howard Kelley  
Products: access control, burglar alarms, duress, fire alarm, intrusion detection, signalling devices, vibration sensing

Cambridge Electronics Laboratories  
20 Chester St.  
Sommerville, MA 02144-3005  
(617) 629-2805  
Pres.: Dr. Jeffrey Race  
Sales Mgr.: Charlotte Bissell

Cepco  
21515 Parthenia St.  
Canoga Park, CA 91304  
(818) 998-7315

Coherent Communications, Inc.  
13756 Glenoaks Blvd.  
Sylmar, CA 91342  
(818) 362-9393, FAX# 818-362-7045  
Products: CCTV, video surveillance, wireless systems

Cohu, Inc., Electronics Div.  
PO Box 85623  
5755 Kearny Villa Road  
San Diego, CA 92138-5623

(619) 277-6700, FAX# 619-277-0221  
Pres.: James M. Brown  
Mkt'g Mgr.: John R. Foster  
Nat'l Sales Mgr.: Jeff Tyler  
Int'l Sales Mgr.: Vijay Rana  
OEM Prod. Mgr.: Loren Whitley  
Mgr., Mkt'g Comm.: Fred Holmshaw  
Gary Kuntz, Cupertino, CA, 415-326-0280  
Sumner Spector, Laguna Hills, CA, 714-768-8585  
Ray Benck, Binghamton, NY, 607-775-4437  
Jim Sims, Cumming, GA, 404-889-9300  
Products: CCTV, video surveillance

Communications Products, Inc.  
4911 W. Good Hope Rd.  
Milwaukee, WI 53223  
(414) 351-4660  
Products: door-lock systems

Computer Application Systems, Inc.  
552 NW 77th St.  
Boca Raton, FL 33431  
(305) 997-9660

Com-Tec, Inc.  
PO Box 965  
639 Hickory Farm Lane  
Appleton, WI 54912-0965  
(414) 734-7105, FAX# 414-734-0493  
Pres./Co-Owner: Ken McLellan  
Exec. V.P./Co-Owner: Anthony Leslie  
Products: access control, audio surveillance, CCTV, door-lock systems, duress, fire alarm, intercom, intrusion detection, signalling devices, smoke detectors, strobes, vibration sensing, video motion detection, video surveillance

Cornell Electronics Products, Inc.  
PO Box 23411  
4911 West Good Hope Rd.  
Milwaukee, WI 53223-0411  
(414) 351-4660, 800-541-9946, FAX# 414-351-4657  
Pres.: Donald Glaubitz  
V.P.: Gary M. Butler  
Sales Mgr.: Pauline A. Haack  
SE Reg Sales Mgr.: William Ellinger  
SLK/Tech Rep, San Francisco, CA, 415-822-4885  
Gustafson System Sales, Inc., Palatine, IL, 312-358-2505

Bidwell-Schwartz Associates, Inc., Gardena, CA, 213-770-0300  
Pinz Sales Corp., Rockville Centre, NY, 516-678-6887  
Dick Bellew Sales, Inc., Dallas, TX, 214-644-7881  
Cavendish and Winchester, Inc., Atlanta, GA, 404-449-5104  
Avcom, Inc., N. Olmsted, OH, 216-777-2060  
Richard S. Pass Assoc., Langhorne, PA, 215-757-6100  
Kingston Sales Corp., Indianapolis, IN, 317-876-2545  
Rancillio Assocs., Inc., St. Louis, MO, 314-631-3326  
Shamrock Electronic Sales, Dayton, OH, 513-258-1227  
CB Electronic Marketing, Arvada, CO, 303-422-0561  
Cartwright & Bean, Inc., Orlando, FL, 407-422-4531  
Avwest, Inc., Fountain Hills, AZ, 617-545-0652  
LSM Associates, Phelps, NY, 315-548-4891  
W.A. Hendrickson Co., Inc., North Scituate, MA, 617-545-0652  
Kodo Associates, Inc., Minneapolis, MN, 612-881-1255  
Vector Corp., Seattle, WA, 206-322-4343  
Yocum Marketing, Inc., Mesa, AZ, 602-265-5056  
Products: intercom

DIA General, Inc.  
47 Kearney Rd.  
Needham, MA 02192  
(617) 449-1533

## LEE DAN COMMUNICATIONS

155 Adams Ave.  
Hauppauge, NY 11788-3699  
(516) 231-1414, 800-533-3261, FAX# 516-231-1498  
Pres.: Leon Goldberg  
V.P. Operations: Lawrence J. Goldberg  
V.P. Finance/Admin.: David H. Goldberg  
Sr. Technician: Sandy Hoffman  
Customer Svce: Linda E. Scaturro  
Production Sup.: Gabriel Figueroa  
Products: intercom, signalling devices, video motion detection, video surveillance

# NICE-DUC®

self-adhesive plastic conduit  
**FOR PROFESSIONAL  
SURFACE WIRING**



52" pieces  
packed 5 in  
a bag

## SOLVE WIRING PROBLEMS FAST...

Carry easy to use NICE-DUC® plastic conduit as a standard part of your installation kit... and watch how many ways it can help you solve problems and speed installations. Keep a handy pack of each color in your installation vehicles and you will be ready to solve time consuming wiring problems faster and better than ever before. Build your reputation with professional installations!

- **FIVE COLORS:** White, off-white, beige, brown, grey.
- **HANDY MINI-SIZE:** Low profile holds alarm, telephone, CCTV wires and cables. Approximately ½"W x ¼"H. One piece tamperproof design. 52" long pieces.
- **VERSATILE:** Use for professional looking wiring runs on walls, windows, ceilings, metal door frames, etc.
- **EASY TO USE:** Advanced adhesive system. Cuts easily to form corners and angles. U5 Universal Connectors available for corners T's, and ends.

**BE READY TO SOLVE PROBLEMS.  
CARRY NICE-DUC® PLASTIC CONDUIT.**

NICE-DUC ND5 PACK (5 pieces/one color)  
NEW 5-U5 CONNECTOR PAK (25 assorted connectors)

**ASK YOUR DISTRIBUTOR OR CALL 1-800-441-7082  
NICE-DUC®  
SAVES TIME. SOLVES PROBLEMS. LOOKS GOOD.  
KEEP SOME HANDY!**

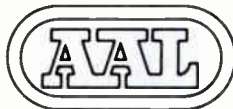

**ALARM ACCESSORY LTD.**

CLAYMONT, DE 19703

MADE IN U.S.A.

NICE-DUC® decorative plastic conduit U5® universal conduit connectors BARRIER BARS® BB-1 and BB-2XL basement window alarm protection M-7® all purpose window alarm trap MINI-BARS® window alarm protection

World Radio History



De-Tech Systems, Inc.  
3407 Rose Ave.  
Ocean, NJ 07712  
(201) 918-0800

Detection Systems, Inc.  
130 Perinton Pkwy.  
Fairport, NY 14450  
(716) 223-4060, 800-521-0096

Door Alarm Devices Corporation  
20 Lucon Drive  
Deer Park, NY 11719  
(516) 586-2400, 800-323-2669  
Products: wireless systems

Doorking  
929 W. Hyde Park Blvd.  
Inglewood, CA 90302  
(213) 673-3299, 800-826-74923

Dorado Systems Corp.  
1842 Sabre St.  
Hayward, CA 94521  
(415) 783-2000

Elbex America, Inc.  
131 Doughty Blvd.  
Inwood, NY 11696  
(516) 239-4005, 800-34ELBEX, FAX#  
516-239-4859  
Pres.: David Elberbaum  
Sr. V.P.: Dar Hyatt  
V.P. Finance: Mark Mirenberg

Electro-Vox Industries, Inc. (Santel Group)  
2626 Bates Rd.  
Montreal, Quebec, Canada H3S 1B2  
(514) 731-3771

**ELENEX, INC. (EAST)**  
7 Wayland St.  
N. Cohocton, NY 14868  
(716) 534-5280, 800-356-8433, FAX#  
716-534-5950  
Pres.: Sten Persson  
Product Mgr.: Dave Arseneau  
Sales: Geoffrey Spencer  
Products: door-lock systems, intercom,  
wireless systems

**ELENEX, INC. (WEST)**  
7392 Trade St.  
San Diego, CA 92121  
(619) 566-7515, 800-225-3113, in CA  
800-225-8037, FAX# 619-586-1484  
V.P.: Dennis Berglund  
Engineering: Al Bitarafan  
Sales: Lou Hennequin  
Products: access control, audio  
surveillance, door-lock systems,  
duress, wireless systems

**ELTREX INTERNATIONAL**  
2 Columbia Dr.  
Amherst, NH 03031  
(603) 886-3500, 800-432-7631, FAX#  
603-886-3508  
Sales Mgr.: Bill Ryan  
Products: announcement systems,  
burglar alarms, fire alarm, intrusion  
detection, signalling devices

Emergency Products Corp.  
10 Bloomfield Ave.  
Pinebrook, NJ 07058  
(201) 882-8010, 800-631-8054  
Pres.: Willard Nix  
Gen. Sales Mgr.: Norman S. Carlo  
Chief Engineer: Ken Bergstorm

Faraday, Inc.  
805 S. Maumee St.  
Tecumseh, MI 49286  
(517) 423-2111, FAX# 517-423-2320  
Nat'l Sales Mgr.: Chuck Stevens  
Mkt'g Mgr.: Dave Hall  
Products: announcement systems, fire  
alarm, intercom, signalling devices,  
smoke detectors, strobes

Federal Signal Corp., Commercial  
Products Group  
4974A Scioto Darby Road  
Hilliard, OH 43026  
(614) 876-6677  
Mkt'g: Robert Rankin  
Products: fire alarm

Fire Burglary Instruments, Inc.  
50 Engineers Road  
Hauppauge, NY 11788  
(516) 582-6161

Firecom/Auth Co.  
39-27 59th Street  
Woodside, NY 11377  
(718) 899-6100, FAX# 718-899-1932

**HOW BRIGHT  
IS YOUR PRESENT STROBE?**

**FARADAY'S NEW STROBE AVERAGES  
3.0 CANDELA PER U.L. STANDARD 1638**

**STAND ALONE  
STROBES**



**BELL/CHIME  
STROBES**



**HORN  
STROBES**



- U.L. LISTED • CSFM LISTED
- BSA APPROVED • 12, 24 VDC; 120 VAC
- CUSTOM LETTERING AVAILABLE
- WHITE, YELLOW, BLUE, RED LENS
- LOW CURRENT DRAIN

**FARADAY**

805 SOUTH MAUMEE STREET  
TECUMSEH, MICHIGAN 49286  
517-423-2111

THE ONE SOURCE FOR YOUR SIGNALING NEEDS.

Fire-Lite/Notifier  
 PO Box 823  
 New Haven, CT 06504  
 (203) 777-7861  
 Mkt'g: Betsy Donnelly  
 Products: fire alarm, smoke detectors

Florence Corp.  
 2101 N. Elston Ave.  
 Chicago, IL 60614  
 (312) 384-3310, FAX# 312-384-3460  
 Pres.: Lloyd A. Schooley  
 V.P. General Mgr.: John J. Martino  
 V.P. Sales: Donald A. Cannella  
 Nat'l Sales Mgr.: George Jans  
 Products: intrusion detection, signalling devices

Franklin Instrument Co., Inc.  
 PO Box 2949  
 Warminster, PA 18974  
 (215) 355-7942

Gentex Corp.  
 10985 Chicago Dr.  
 Zeeland, MI 49464  
 (616) 392-7195, FAX# 616-392-4219  
 Mkt'g Mgr.: Scott R. Edwards  
 Customer Svce: Karen Gunneman  
 West Coast Reg. Mgr.: Dennis Clair  
 NE Reg Mgr.: Peter Hilton  
 Midwest Reg Mgr.: Bob Zeiler  
 V.P.: Charles Buhrman  
 Products: fire alarm, signalling devices, smoke detectors, strobes

Gyyr Products, div. of Odetics, Inc.  
 1515 South Manchester Ave  
 Anaheim, CA 92802-2907  
 (714) 772-1000  
 General Mgr.: Dave Lewis  
 Dir. of Mkt'g/Audio: Robert Hageman  
 Dir. of Mkt'g/Video: Terry Tedrick  
 Nat'l Service Mgr.: Harvey Taylor

Home Safegaard Industries, Inc.  
 PO Box 4073  
 29706 Baden Place  
 Malibu, CA 90265  
 (213) 457-5813, FAX# 213-457-4862  
 Pres.: Leon Cooper  
 V.P.: Bill Haines  
 Products: intercom

Housing Devices, Inc.  
 407R Mystic Ave.  
 Medford, MA 02155

(617) 395-5200, 800-932-5200  
 Mkt'g: Tom Richardson

Intelligent Controls, Inc.  
 6825 216th St. SW  
 Lynnwood, WA 98036  
 (206) 771-8107, 800-842-0221, in  
 Canada 843-0221  
 Pres.: Robert Percival  
 V.P. Sales/Mkt'g.: Ronald I. Katzin  
 V.P. Eng.: Brian Mallabon  
 V.P. Finance: Jeff Kruse

Jensen Video Sonics  
 11 West Park Boulevard  
 Villa Park, IL 60181  
 (312) 833-1767, FAX# 312-833-7829  
 General Mgr.: Bob Williams  
 Superintendent: Al Kronberg  
 Chief Engineer: Joe Llorens  
 Purchasing Agent: John Borowicz  
 Office Mgr.: Rita Lalena  
 Products: access control, ancillary components, announcement systems, audio surveillance, burglar alarms, CCTV, door-lock systems, duress, fire alarm, intercom, intrusion detection, signalling devices, sirens, smoke detectors, strobes, vibration sensing, video motion detection, video surveillance, wireless systems

LeFebure  
 308 29th Street NE  
 Cedar Rapids, IA 52406  
 (319) 366-2771

Louroe Electronics  
 6158 Lemona Ave.  
 Van Nuys, CA 91411  
 (818) 994-6498, FAX# 818-994-6458  
 Pres./Owner: Louis F. Weiss  
 Sales/Mkt'g Mgr.: Robert L. Dedrick  
 Givan Assoc., West Boylston, MA, 617-835-3161  
 E. A. Garreau Assoc., Atlanta, GA, 404-458-8030  
 Repcoa, Dallas, TX, 214-363-0977  
 Warren Assoc., Santa Clara, CA, 408-988-7762  
 Eesco Systems, Los Angeles, CA, 818-242-8823  
 Products: audio surveillance, duress, intrusion detection, signalling devices

MG Electronics  
 32 Ranick Rd.  
 Hauppauge, NY 11788  
 (516) 582-3400, FAX# 516-582-3229  
 Pres.: Louis Maltz  
 V.P.: Elliott Maltz  
 Sales Mgr.: Stan Grey  
 Miller Assoc., Stamford, CT, 203-869-7793  
 Forti Assoc., Kensington, MD, 301-949-1706  
 Cavendish & Winchester, Atlanta, GA, 404-449-5104  
 Raymar Associates, Duncanville, TX, 214-296-9833  
 Products: sirens

Marlee Electronics Corp.  
 900 W. Olive St.  
 Englewood, CA 90301  
 (213) 568-8982

**MATH ASSOCIATES, INC.**  
 2200 Shames Dr.  
 Westbury, NY 11590  
 (516) 334-6800, FAX# 516-334-6473  
 Pres.: Ellen Math  
 V.P. Sales/Mkt'g: Edmund Henckel  
 Director R & D: Irwin Math  
 Products: CCTV

Mirtone Communication & Security, Inc.  
 425 Ainess St.  
 Downsview, Toronto, ONT, Canada  
 M3J 2H4  
 (416) 667-1211, FAX# 416-667-1731  
 Pres.: Larry Letofsky  
 Nat'l Sales Mgr.: Art Petrilli  
 Product Mgr.: David Ito  
 Customer Svce: Kwang Yoon  
 Products: access control, burglar alarms, fire alarm, intercom, intrusion detection, wireless systems

Napco Security System  
 6 DiTomas Court  
 Copiague, NY 11726  
 (516) 842-9400, 800-645-9445

Navco Security Systems  
 16600 Aston Street  
 Irvine, CA 92714  
 (714) 250-4352, 800-221-0819

## NEL-TECH LABS, INC.

PO Box 1030  
Londonderry, NH 03053  
(603) 434-8234, FAX# 603-434-1265  
Pres.: Gary Stapleford  
Exec. V.P.: Ken Ritter  
Products: announcement systems

## Orevox Corp.

PO Box 1046  
512 35th St. NE  
Auburn, WA 98002  
(206) 735-0220, 800-237-0700, FAX#  
206-251-9142  
CEO: Daniel Wu  
Sales Mgr.: Russ Stanford  
Products: signalling devices, sirens

## Paso Sound Products

14 First St.  
Pelham, NY 10803-1495  
(914) 738-4800, FAX# 914-738-3954  
Executive V.P.: Paul Mastrangelo  
Sales Mgr.: David Moore  
Product Mgr.: Ken Obrien  
Credit Mgr.: Marilyn Beckerson  
Operations Mgr.: Anthony Sgueglia  
All West Electronics, Camarillo, CA,  
805-388-1789  
Anderson Sales, Braintree, MA, 617-  
848-9194  
Pace Sales, Charlotte, NC, 704-365-  
3216  
De Witt Austin Co., Alpharetta, GA,  
404-442-1326  
Dowell Assoc., St. Louis, MO, 314-  
849-4234  
Mountain Representatives, Denver, CO,  
303-623-0972  
J.Y.S. Comm. Co., Dallas, TX, 214-  
349-1650  
Lienau Assoc., Inc., Columbia, MD,  
301-621-4113  
Lienau Assoc., Inc., New Town, PA,  
215-860-2100  
SLK Tech Rep, San Francisco, CA,  
415-822-4884  
Miguel Lopez, Hialeah, FL, 305-822-  
6853  
Marketline, Snellville, GA, 404-972-  
9048  
Messnick Sales, Liverpool, NY, 315-  
622-3211  
Miller Assoc., Ltd., Greenwich, CT,  
212-840-2866  
Robert Milsk Co., Inc., Southfield, MI,  
313-354-3310

Robert Milsk Co., Indianapolis, IN, 317-  
842-3400

Weller Electronic Sales, Worthington,  
OH, 614-885-7819

Frank Lintern Assoc., Naperville, IL,  
312-983-0935

Products: announcement systems,  
intercom

## Pinkerton Controls System Corp.

1123 E. Walnut Street  
Carson, CA 90746  
(213) 638-0400

## Portland Instrument

1101A Air Way  
Glendale, CA 91201  
(818) 500-0137, 800-621-5640, FAX#  
818-240-1828

Pres.: Ronald A. Fuller

Prod Mgr./In-Outdoor Sys.: Jack  
Sympson

Prod Mgr./Wire & Cable: Judy Gill  
Production Mgr.: Patrick T. Gratner

Tech Svces: Chris Norton

Controller: Ken Thiele

Products: announcement systems

## Powertronix

10623 Lawson River Ave.  
Fountain Valley, CA 92708  
(714) 963-5411

Pres.: Robert Gehlke

Sales Mgr.: Bill Organ

## Pulnix America, Inc.

770 Lucerne Drive  
Sunnyvale, CA 94086  
(408) 733-1560, 800-445-5444, FAX#  
408-737-2966

Pres.: Toshi Hori

Sales Mgr./Video: Richard Hofmeister

Sales Mgr./Security: Terry Crum

Mkt'g Comm. Mgr.: Janet Worthen

## Pyrotronics

13281 Barton Circle  
Whittier, CA 90605  
(213) 946-7646

## Reliable Security Systems, Inc.

10604 Beaver Dam Road  
Cockeysville, MD 21030  
(301) 785-3316, 800-638-5865  
Nat'l Sales/Mkt'g Mgr.: George  
Crowley

Mgr. of Engineering: David Krausman  
Products: access control, door-lock  
systems

## Robot Research, Inc.

5636 Ruffin Road  
San Diego, CA 92123  
(619) 279-9430, FAX# 619-279-7931

Pres.: John P. Stahler

V.P. Sales & Mkt'g: David B. Hartley

Director of Sales: Joseph H. Olmstead

Mkt'g Communications: Michael C. Fell

Technical Rep: Steven Wilber

Products: CCTV, video surveillance

## Rofu International Corp.

5331G Hempstead Way  
Springfield, VA 22151  
(800) 255-763

## Securitron Magnalock Corporation

1815 W. 205th Street, Suite 103  
Torrance, CA 90501  
(213) 618-0204, 800-MAG-LOCK, FAX#  
213-618-0144

Sales Mgr.: Scott Baker

## Security Intercom, Inc.

1833 No. 15th  
Seattle, WA 98133  
(206) 523-6170

## Security Resources

21 Castle Avenue  
Fairfield, CT 06430  
(203) 334-3233, 800-243-2878

## Select Engineered Systems

7991 W. 26th Ave.  
Hialeah, FL 33016  
(305) 823-5410  
CEO: John Sheppard  
Products: access control, ancillary  
components, audio surveillance,  
burglar alarms, CCTV, door-lock  
systems, duress, intercom, intrusion  
detection, signalling devices, video  
surveillance

## Sensor Engineering Co.

2155 State Street  
Hamden, CT 06517  
(203) 777-7443  
Sales & Mkt'g Mgr.: Leigh H. Hickcox  
Field Sales: James M. Frulla  
Products: access control





# TOA CCTV Products

## Another Commitment to Excellence

Technology for the future  
that you can see today.

Model CC-1150 color camera with advanced  
surface mount technology and a very unique metal housing.



Toa Electronics, Inc.  
601 Gateway Blvd., South San Francisco  
California 94080 (415) 588-2538

## Siedle Intercom

780 Parkway  
Broomall, PA 19008  
(215) 353-9595, 800-874-3353, FAX#  
215-353-9716  
Pres.: Earl Zausmer  
Products: access control, audio  
surveillance, CCTV, door-lock  
systems, intercom, video surveillance

## Silent Watchman

PO Box 07893  
2461 McGaw Road  
Columbus, OH 43207  
(614) 491-5200, FAX# 614-491-0015  
Products: access control, audio  
surveillance, burglar alarms, CCTV,  
door-lock systems, fire alarm,  
intrusion detection, signalling  
devices, sirens, smoke detectors,  
strobes, vibration sensing, video  
motion detection, video surveillance

## Sonitrol Corp.

6161 Lake Ellenor Drive  
Orlando, FL 32809  
(407) 859-3350, FAX# 407-859-5205  
V.P. Sales: Jeffrey J. Whirley  
Sonitrol Distributing Corp., Alexandria,  
VA, 703-549-3900  
Sonitrol of New Orleans, Inc., Metairie,  
LA, 504-837-7144  
Sonitrol Security, Inc., Fresno, CA,  
209-264-9739  
Sonitrol Distributing Company,  
Weatogue, CT, 203-651-3744  
Sonitrol Southeast, Inc., Clearwater,  
FL, 813-441-3999  
Products: audio surveillance, burglar  
alarms, duress, intrusion detection

## Sony Security

15 Essex Rd.  
Paramus, NJ 07652  
(201) 368-5000, 800-222-SONY, FAX#  
201-368-3514

## Speco Div., Components Specialties, Inc.

PO Box 624  
1172 Rt. 109  
Lindenhurst, NY 11757  
(516) 957-8700, 800-645-5516, FAX#  
516-956-9142  
V.P./Sales: Mel Hulkower  
V.P./General Mgr.: Jim Ganci  
Sales Mgr.: Eric Forman  
Products: access control, burglar  
alarms, fire alarm, intercom, sirens

## Stentofon Communications, Inc.

6119 Connecticut Ave.  
Kansas City, MO 64120  
(816) 231-7200, FAX# 816-231-7203  
Pres.: Kenneth P. Jensen  
V.P./Technical: James Pierce  
Nat'l Sales Mgr.: Frederick Hall  
Business Mgr.: Doug Caldwell  
Controller: Barbara Hernandez  
Products: duress, intercom, video  
surveillance

## Surveillance Video Systems

PO Box 1349  
258 "A" St.  
Ashland, OR 97520  
(503) 482-4500  
Pres.: Bud Wilkey  
Products: CCTV, video surveillance

## Synergistics, Inc.

9 Tech Circle  
Natick, MA 01760  
(508) 655-1340, FAX# 508-651-2902  
Pres.: William M. Tetrick  
Exec. V.P./Chief Engineer: David S.  
Longworth  
Sr. V.P./Government Sales: Richard C.  
Sullivan  
Sales Mgr.: Robert L. Pogorelc  
Tech Svcs Mgr.: Paul Donovan  
Mgr. Dealer Sales: Norman Link  
Products: access control, CCTV, door-  
lock systems, duress, intrusion  
detection

## TOA ELECTRONICS, INC./ENGINEERED INTERCOM & SECURITY DIVISION

PO Box 2047  
601 Gateway Blvd.  
South San Francisco, CA 94080  
(415) 588-2538, 800-843-4750, in CA  
800-632-2157, FAX# 415-588-3349  
Pres.: Yoshiro Ishida  
Director of Mkt'g: Fred Fredericks  
Nat'l Sales Mgr.: Al Burns  
Products: access control, audio  
surveillance, CCTV, intercom, video  
surveillance

## T.S.K. Electronics, Inc.

PO Box 190  
564 Young St.  
Tonawanda, NY 14151-0190  
(716) 693-3916  
Pres.: Theodore S. Kedzierski

Chief Engineer: Kevin T. Kedzierski  
Products: audio surveillance, intercom

## TEKTONE SOUND & SIGNAL MFG., INC.

PO Box 12427  
1331 S. Killian Dr.  
Lake Park, FL 33403  
(407) 844-2383, FAX# 407-845-1587  
Pres.: Manuel Mira  
General Mgr.: Carlos Mira  
Sales/Mkt'g Director: Tom Hendricks  
Chief Engineer: Jim Switzer  
Ziskind & Assoc., Rolling Meadow, IL,  
312-577-1624  
Wm. B. Allen Supply Co., New Orleans,  
LA, 504-525-8222  
Alvan C. Chaney & Assoc., Hialeah, FL,  
305-558-3933  
Dardon & Assoc., Olmstead Township,  
OH, 216-234-4555  
Klumpp Sales Co., Jacksonville, FL,  
904-287-5205  
Lee Dan Communications, Hauppauge,  
NY, 516-231-1414  
Lichtenauer & Assoc., Antioch, CA,  
415-757-1200  
R.W. Sales, Inc., St. Paul, MN, 612-  
646-2710  
Mountain Representatives, Denver, CO,  
303-623-0972  
Chuck Olson Assoc., Renton, WA, 206-  
271-5416  
Alpha Communications, Hauppauge,  
NY, 516-434-8080  
Westech Marketing, Culver City, CA,  
213-870-9286  
Products: burglar alarms, intercom,  
signalling devices

## Tel-tron (Division Radio Manufacturers, Inc.)

220 Fentress Blvd.  
Daytona Beach, FL 32014  
(904) 255-1921, 800-874-5622

## 3M SOUND PRODUCTS

223-5S-09, 3M Center  
St. Paul, MI 55144-1000  
(612) 733-9214, FAX# 612-736-9433  
Mkt'g Mgr.: Richard G. Barker  
Sales Mgr.: Don Sluder  
Products: announcement systems,  
intercom, signalling devices, wireless  
systems

# THE PANASONIC CCTV LINE...



## A strong foundation you can build in.

Whether you're a small retail business or a large manufacturing facility—no matter if you're looking for one piece of equipment or a complete system—Panasonic has you covered. With a full line of CCTV equipment to suit a host of different applications.

Like our wide array of B/W and color cameras and monitors—including one of the largest selections of tube and solid-state cameras. There's also a choice of Time-Lapse VCRs and B/W and color Quad Systems and pre-packaged, ready-to-install Mini-Systems. Plus all the Pan/Tilts, housings, switchers and accessories necessary to complement our full line.

And of course, every piece of CCTV equipment features the same Panasonic quality and reliability you've come to expect. Not to mention the support of a strong dealer network throughout the country. With the technical expertise to help you select and design a CCTV system to meet your particular specifications—regardless of how simple or complex.

What's more, all Panasonic equipment is backed by a nationwide service network. And each authorized service center is trained and fully equipped to handle the repair and maintenance of every CCTV product we sell.

So when it comes to CCTV equipment, take a look at the Panasonic line—a foundation strong enough to support the growth of your needs.

For more information, contact your nearest Panasonic Industrial Company Closed Circuit Video Equipment dealer or call your nearest regional office.

Northeast: (201) 348-7303, Midwest: (312) 981-4826, Southeast: (404) 925-6835, Southwest: (214) 257-0763, West: (714) 895-7265.

**Panasonic**  
Closed Circuit Video Equipment



Time & Sound Co., Inc.  
14120 Live Oak Ave.  
Baldwin Park, CA 91706  
(818) 960-7781, 800-423-4765

Transcience  
179 Ludlow St.  
Stamford, CT 06902  
(203) 327-7810, 800-243-3494, FAX#  
203-353-8431  
Pres.: Donald Bosak

Trigon Electronics, Inc.  
1220 N. Batavia St.  
Orange, CA 92667  
(714) 633-7442  
Mkt'g: Joan Richardson  
Products: access control

Tripp Lite  
500 N. Orleans  
Chicago, IL 60610  
(312) 329-1777, FAX# 312-644-6505  
Mkt'g Mgr.: Christy Prosapio  
Sales Mgr.: Tom Crivalone  
Sales: Kris Billenstein  
Products: signalling devices, sirens,  
strobes

Vicon Industries  
525 Broad Hollow Rd.  
Melville, NY 11747  
(516) 293-2200, 800-645-9116  
Pres.: Donald N. Horn  
Executive V.P.: Arthur Wallace  
V.P. Finance: Kenneth Darby  
V.P. Mkt'g/Sales: Ronald J. Teixeira  
Vicon Industries, Norcross, GA, 404-  
449-0499

Vicon Industries, Brea, CA, 714-990-  
3858  
Vicon Industries, Washington, D.C.,  
703-553-7580  
Products: CCTV, vibration sensing

Wheelock, Inc.  
273 Branchport Ave.  
Long Branch, NJ 07740  
(201) 222-6880, FAX# 201-222-8707  
Pres.: P. W. Tarlton  
V.P. Mkt'g/Sales: W.L. Goldstein  
Mkt'g Mgr./Telephone-Paging: Art  
Arlow  
Tech. Support Engineer: W. Best  
Products: burglar alarms, fire alarm,  
sirens, strobes

---

## CCTV/VIDEO COMPONENTS, SYSTEMS

---

Adams-Smith  
34 Tower St.  
Hudson, MA 01749  
(617) 562-3801, FAX# 617-568-0404  
Pres.: A. Simon  
V.P. Sales: H. Adams  
General Mgr.: Adams-Smith U.K. Ltd  
D. Godsmark

Pres.: Jackie Parker  
V.P. Mkt'g: Lorraine Shallenberger  
Chief Engineer: Charles Lytle

AmPro Corporation  
42 Fourth Avenue  
Waltham, MA 02154  
(617) 890-1245, 800-556-7733, FAX#  
617-890-7027

Atlas/Soundolier  
1859 Intertech Dr.  
Fenton, MO 63026  
(314) 349-3110, FAX# 314-349-1251  
V.P. Sales: Tom Erickson  
E. Region/Sales: Andy Musci  
W. Region/Sales: Bud Waters  
V.P./Mkt'g Consultant: Herbert Jaffe  
Products: accessories, enclosures

### AIPHONE INTERCOM SYSTEMS

PO Box 90075  
1700 130th Ave. N.E.  
Bellevue, WA 98005  
(206) 455-0510, FAX# 206-455-0071  
Pres.: Hiko Shinoda  
Nat'l Sales: Jim Morrison  
Products: cameras, monitors

Antennacraft  
PO Box 1005  
Burlington, IA 52601  
(319) 754-7575  
General Mgr.: George Kollar  
Production Mgr.: Charles Goff  
Sales/Svce Coordinator: Jean Harwood  
Traffic Mgr.: Shelly Moyers  
Chief Engineer: Howard Whitcomb

Audio Video Supply, Inc.  
4674 Cardin St., Ste. D  
San Diego, CA 92111  
(619) 565-1101  
Pres.: R.T. Moore

American Fibertek, Inc.  
1662 63rd St.  
Brooklyn, NY 11204-2713  
(718) 236-3739  
Pres.: Robert Klein  
V.P.: Jim McLaughlin  
V.P.: Jack Krol

Antenna Specialist Co.  
30500 Bruce Ind. Pkwy  
Cleveland, OH 44139-3996  
(216) 349-8400  
Dir. of Nat'l Sales: Robert Levy  
V. P. Product Mkt'g/Sales: Larry Kline  
W. Reg. Mgr.: Patricia Fritz  
E. Reg. Mgr.: Ray Ditomas

Audisar  
PO Box 1561  
Bellevue, WA 98009  
(206) 454-2040  
Owner: R. Munger  
Products: accessories, connectors,  
hardware

American Laser Systems, Inc.  
751 South Kellogg Ave.  
Goleta, GA 93117  
(805) 967-0423, FAX# 805-683-4382

Blonder-Tongue Laboratories, Inc.  
1 Jake Brown Rd.  
Old Bridge, NJ 08857  
(201) 679-4000.  
Chairman of the Board: I. S. Blonder  
Pres.: B. H. Tongue

# When you need a great CCD camera.



## Select from BURLE's full line of solid state, high performers.

For meaningful choices in CCD cameras turn to BURLE (formerly RCA, New Products Division). Black and white or color, BURLE CCD cameras, TC100, TC200, TC300, TC306 and TC600, offer you all the performance features you demand, plus, one that no one else can match — BURLE camera and systems expertise. A nationwide network of experienced applications specialists is backed by a technical service staff that's as close as your phone. Contact your local dealer, distributor, manufacturer's representative or BURLE INDUSTRIES, INC., 1000 New Holland Avenue, Lancaster, PA 17601-5688. (717) 295-6123. Because no matter what your surveillance requirement . . .

**BURLE**  
SECURITY PRODUCTS

formerly

**RCA**  
Closed-Circuit  
Video Equipment

## The solution is a

# BURLE SYSTEM



World Radio History

Sr. V.P.: D. J. Altieri  
V.P.: G. H. Tongue  
V.P.: A. J. Bruno

Broadcast Tech. of Colorado  
PO Box 1310  
Gunnison, CO 81230  
(303) 641-5503, FAX# 303-641-3094  
Mkt'g: Barb Dowman  
Products: effects generators

Burle Industries, Inc.  
1000 New Holland Ave.  
Lancaster, PA 17601-5688  
(717) 295-6123, FAX# 717-295-6297  
Products: cameras, switchers

CCTV Corporation  
315 Hudson St.  
New York, NY 10013  
(212) 989-4433, 800-GBC-CCTV, FAX#  
212-463-9758  
V.P.: Steve Lefkowitz  
Sales Mgr.: Gary Perlin  
Export Mgr.: Sydelle Ranzman  
Products: accessories, cameras,  
dummy cameras, enclosures, fiber  
optics, lenses, monitors, pan/tilts,  
remote controls, signal distribution,  
specialty cameras, surveillance,  
switchers, time-lapse recorders,  
transmission systems, VTRs

Catel Telecommunications, Inc.  
4050 Technology Plaza  
Fremont, CA 94537  
(415) 659-8988, 800-225-4046  
, FAX# 415-651-8437  
Pres.: Jim Hood  
Director/CATV Div.: Israel Levi  
General Mgr.: Ron Todd  
V.P. Int'l Mkt'g: Frank Genochio  
Sr. V.P. Finance: Guy Wright  
Mkt'g Mgr.: Corrine Sharp

Centro Corp.  
369 Billy Mitchell Rd.  
Salt Lake City, UT 84116  
(801) 537-7779, FAX# 801-537-7513  
Pres.: Don Skaggs  
V.P. Mkt'g/Product Dev.: Curtis Chan  
V.P. Sales/Operations: Bob Strout

Channel Master, Div. of Avnet, Inc.  
Industrial Park Drive  
Smithville, NC 27577  
(919) 934-9711

Channematic, Inc.  
821 Tavern Road  
Alpine, CA 92001  
(619) 445-2691, 800-231-1618

Closed Circuit Systems  
11261 Sunrise Park Drive  
Rancho Cardova, CA 95742  
(916) 638-4400  
Mkt'g: Dan Lackey

Cohu, Inc., Electronics Div.  
PO Box 85623  
5755 Kearny Villa Road  
San Diego, CA 92138-5623  
(619) 277-6700, FAX# 619-277-0221  
Pres.: James M. Brown  
Mkt'g Mgr.: John R. Foster  
Nat'l Sales Mgr.: Jeff Tyler  
Int'l Sales Mgr.: Vijay Rana  
OEM Prod. Mgr.: Loren Whitley  
Mgr., Mkt'g Comm.: Fred Holmshaw  
Gary Kuntz, Cupertino, CA, 415-326-  
0280  
Sumner Spector, Laguna Hills, CA,  
714-768-8585  
Ray Benck, Binghamton, NY, 607-775-  
4437  
Jim Sims, Cumming, GA, 404-889-  
9300  
Products: accessories, cameras,  
hardware, lenses, pan/tilts, remote  
controls, specialty cameras,  
surveillance, switchers

Compression Labs, Inc.  
2860 Junction Ave.  
San Jose, CA 95134  
(408) 435-3000, 800-538-7542, FAX#  
408-922-5429  
Pres.: John Tyson  
Exec. V.P./Sales & Mkt'g: John Walsh  
V.P. Sales: Ted Augustine  
V.P. Int'l Sales: Carl Marszewski  
V.P. Mkt'g: Kathy Reavis  
Products: transmission systems

Crest Electronics, Inc.  
4921 Exposition Blvd.  
Los Angeles, CA 90016  
(213) 731-1105  
Chairman & CEO: Irv Rossman  
Pres.: Hope Borows  
V.P. Mkt'g.: Dennis Castelli

## LEE DAN COMMUNICATIONS

155 Adams Ave.  
Hauppauge, NY 11788-3699  
(516) 231-1414, 800-533-3261, FAX#  
516-231-1498  
Pres.: Leon Goldberg  
V.P. Operations: Lawrence J. Goldberg  
V.P. Finance/Admin.: David H.  
Goldberg  
Sr. Technician: Sandy Hoffman  
Customer Svce: Linda E. Scaturro  
Production Sup.: Gabriel Figueroa  
Products: accessories, cameras,  
enclosures, hardware, lenses,  
monitors, pan/tilts, remote controls,  
surveillance, switchers, time-lapse  
recorders, VTRs

Diamond Electronics, Inc.  
PO Box 200  
Lancaster, OH 43130  
(614) 756-9222, FAX# 614-756-4237  
Pres.: William Muirhead III  
V.P.: A. Robert Moore  
V.P.: Eugene McKenzie  
Product Line Mgr.: David Mitchell  
Products: accessories, cameras,  
connectors, fiber optics, monitors,  
multiplexers; pan/tilts, specialty  
cameras, surveillance, switchers,  
transmission systems

Dynair Electronics, Inc.  
PO Box 85020  
5275 Market St.  
San Diego, CA 92138-5020  
(619) 263-7711, 800-854-2831  
Pres.: E.G. Gramman  
V. P. Mkt'g: D. Castellini  
Systems Mgmt: R.A. Jacobs  
V. P. Engineering: T.R. Meyer  
Mkt'g Comm. Mgr.: L. Davis  
Robert McAll, New York, 516-966-8000  
Al Wilson, California, 619-541-0859  
Vern Pearson, Illinois, 800-255-2255  
ext 8874

EMI, Inc. (Electro-Mechanical  
Imagineering, Inc.)  
11411 Bradley Ave.  
Arleta, CA 91331  
(818) 896-6700, 800-628-5858, FAX#  
818-899-1599  
Pres.: Joel Gary Rutberg  
Sec./Treas.: Eileen Rutberg  
Nat'l Mkt'g Mgr.: Michael Moll  
Dir. of Accounting: Debra Cota  
Products: accessories



## I want to keep pace with the POST production industry

Please send me POST...the Magazine for AUDIO/VIDEO/FILM Post Production Professionals

- 1 year \$40       2 years \$70      **Canada**       1 year \$55       2 years \$100      **International**       1 year \$75       2 years \$140

<b>Name</b> _____	<b>Method of Payment</b>
<b>Title</b> _____	<input type="checkbox"/> Payment Enclosed <input type="checkbox"/> Bill Me      No credit orders outside U.S.A.
<b>Company</b> _____	Charge my: <input type="checkbox"/> MC <input type="checkbox"/> VISA <input type="checkbox"/> Amer. Express
<b>Address</b> _____	Card No. _____      Expire Date _____
<b>City</b> _____ <b>State</b> _____ <b>Zip</b> _____	Signature _____

**TYPE OF BUSINESS:** Please check the one type of business, facility or operation that best describes your business classification (please check only one box):

- |  |   |
|--|---|
| A. <input type="checkbox"/> Post Production Facility (includes Production, Post Production, Full Service and Mobile)                             | F. <input type="checkbox"/> Corporate-Industrial TV, CCTV, Government TV and Non-Broadcast TV |
| B. <input type="checkbox"/> Broadcast Television Station (includes Network, Group, Local, Religious, Educational and Public TV)                  | G. <input type="checkbox"/> Audio Recording Studio  |
| C. <input type="checkbox"/> Advertising Agency   | H. <input type="checkbox"/> Motion Picture Production (includes Studio and Independent)       |
| D. <input type="checkbox"/> TV Program Production Company (includes Program Suppliers to Broadcast and Cable Networks, Syndicators, DBS and STV) | I. <input type="checkbox"/> Film Facility or Service  |
| E. <input type="checkbox"/> TV Commercial Production Company (includes Live Action, Animation, Special Effects and Music)                        | J. <input type="checkbox"/> Equipment Rental House  |
|  | K. <input type="checkbox"/> Equipment Dealers, Distributors, Exporters and Importers          |
|  | L. <input type="checkbox"/> Equipment Manufacturers   |
|  | M. <input type="checkbox"/> Other   |

**WHAT IS YOUR ANNUAL BUDGET FOR POST-PRODUCTION EQUIPMENT?**

- A.  Under \$250,000  
B.  \$250,000-\$499,999  
C.  \$500,000-\$999,999  
D.  Over \$1,000,000

**WHAT IS YOUR PURCHASING AUTHORITY FOR POST-PRODUCTION EQUIPMENT OR SERVICES? (please check only one box)**

- A.  I approve  
B.  I evaluate  
C.  I initiate

**JOB DESCRIPTION:** Please check the category that best describes your position (please check only one box).

- A.  Production Management (includes Production Manager, Director, Producer, Creative Director, etc.)  
B.  Technical Management and Engineering (includes Video Editor, Audio Engineer, Special Effects Supervisor, Production Manager, Technical Director)  
C.  Corporate Operations Management (includes President, General Manager, Operations Manager, Marketing Director, etc.)  
D.  Other \_\_\_\_\_  
(please specify)

No credit orders outside U.S.A. Payment must accompany order in U.S. currency.



Place stamp here

Testa Communications

# Post

25 Willowdale Avenue  
Port Washington, NY 11050

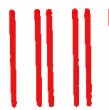

Place stamp here

Testa Communications

# Post

25 Willowdale Avenue  
Port Washington, NY 11050

## Post SUBSCRIPTION INFORMATION

want to keep pace with the POST production industry

Please send me POST...the Magazine for AUDIO/VIDEO/FILM Post Production Professionals

- 1 year \$40       2 years \$70       1 year \$50       2 years \$100       1 year \$75       2 years \$140

Name \_\_\_\_\_ Title \_\_\_\_\_  
 Company \_\_\_\_\_  
 Address \_\_\_\_\_  
 City \_\_\_\_\_ State \_\_\_\_\_ Zip \_\_\_\_\_

Method of Payment  
 Payment Enclosed       Bill Me      No credit orders outside U.S.A.  
 Charge my:  MC  VISA  Amer. Express  
 Card No. \_\_\_\_\_ Expire Date \_\_\_\_\_  
 Signature \_\_\_\_\_

**TYPE OF BUSINESS:** Please check the one type of business, facility or operation that best describes your business classification (please check only one box):

- Post Production Facility (includes Production, Post Production, Full Service and Mobile)
- Broadcast Television Station (includes Network, -Group, Local, Religious, Educational and Public TV)
- Advertising Agency
- TV Program Production Company (includes Program Suppliers to Broadcast and Cable Networks, Syndicators, DBS and STV)
- TV Commercial Production Company (includes Live Action, Animation, Special Effects and Music)
- Corporate-Industrial TV, CCTV, Government TV and Non-Broadcast TV
- Audio Recording Studio
- Motion Picture Production (includes Studio and Independent)
- Film Facility or Service
- Equipment Rental House
- Equipment Dealers, Distributors, Exporters and Importers
- Equipment Manufacturers
- Other \_\_\_\_\_

**WHAT IS YOUR ANNUAL BUDGET FOR POST-PRODUCTION EQUIPMENT?**

- A.  Under \$250,000
- B.  \$250,000-\$499,999
- C.  \$500,000-\$999,999
- D.  Over \$1,000,000

**WHAT IS YOUR PURCHASING AUTHORITY FOR POST-PRODUCTION EQUIPMENT OR SERVICES? (please check only one box)**

- A.  I approve
- B.  I evaluate
- C.  I initiate

**JOB DESCRIPTION:** Please check the category that best describes your position (please check only one box).

- A.  Production Management (includes Production Manager, Director, Producer, Creative Director, etc.)
- B.  Technical Management and Engineering (includes Video Editor, Audio Engineer, Special Effects Supervisor, Production Manager, Technical Director)
- C.  Corporate Operations Management (includes President, General Manager, Operations Manager, Marketing Director, etc.)
- D.  Other \_\_\_\_\_

(please specify)

No credit orders outside U.S.A. Payment must accompany order in U.S. currency.

World Radio History

- E.S.E.**  
 142 Sierra St.  
 El Segundo, CA 90245  
 (213) 322-2136  
 Mkt'g: Robert Mayers  
 Products: time-lapse recorders
- Elbex America**  
 20360 S. Leapwood Ave., Unit F  
 Carson, CA 90746  
 (213) 515-0854, 800-421-5206  
 V.P.: Harry Rosenblatt  
 Sales Administrator: Ken J. Gien  
 Sales Orders: Edith Gutierrez  
 Tech. Engineer: Mohammad H. Bigdeli  
 Graystone Systems Inc., Blauvelt, NY,  
 914-353-0600  
 Jayso Elect. Corp., Bronx, NY, 212-  
 798-1050  
 Exec. Sec. Inc., Nashville, TN, 615-  
 331-6700  
 Broadway Exec. Sec., Kansas City,  
 MO, 816-474-1771  
 Wagners S.P.D., Anaheim, CA, 714-  
 630-6671  
 Alarm Center, San Diego, CA, 619-571-  
 3535  
 American General Dist. Corp., Miami,  
 FL, 305-649-5408  
 Arizona Lock and Safe, Phoenix, AZ,  
 602-278-4582  
 Audio/Video, San Diego, CA, 619-565-  
 1101  
 Cartland Alarm & Comm., S. Federal  
 Way, WA, 206-839-8433  
 Futura, Lomita, CA, 213-539-1710  
 Row & Sons, Fort Myers, FL, 813-481-  
 2949  
 Save on Video, N. Hollywood, CA, 213-  
 875-1235  
 Vision Video, Los Gatos, CA, 408-356-  
 1286  
 Products: accessories, cameras,  
 lenses, monitors
- Engineering Mgr.: Joseph Fischer**  
 Applications Engineer: George Braen  
 Design Factors, LaHebra Heights, CA,  
 213-697-7576  
 Brian Trankle, Belmont, CA, 415-595-  
 4004  
 Ziskind Assoc., Rolling Meadows, IL,  
 312-577-1624  
 Richard Pass Assoc., Langhorne, PA,  
 215-757-6100  
 Henry W. Phillips Co., Roswell, GA,  
 404-992-3070  
 Avwest, Inc., Fountain Hills, AZ, 602-  
 946-1811  
 Burcaw Co., Warren, MI, 313-573-  
 4605  
 Sigmet Corp., Freehold, NJ, 201-462-  
 1221  
 Meyer Marketing, Deerfield Beach, FL,  
 305-481-9250  
 Monfort Electronics, Indianapolis, IN,  
 317-872-8877  
 Pancor Marketing, Lynnwood, WA,  
 206-771-6010  
 Peregrine Southwest, Houston, TX,  
 713-589-8481  
 Piper Assoc., Needham, MA, 617-449-  
 1144  
 Products: computer interfaces, remote  
 controls, switchers
- GYRR, A Division of Odetics**  
 1515 S. Manchester Ave.  
 Anaheim, CA 92802  
 (714) 772-1000, 800-854-6854, FAX#  
 714-535-8532
- H.O.M.E., Inc.**  
 PO Box 225  
 500 W. Ninth St.  
 Hermann, MO 65041  
 (314) 486-3111  
 Mkt'g: Arthur Brigham  
 Products: enclosures
- Hirschmann of America**  
 PO Box 229  
 Industrial Row  
 Riverdale, NJ 07457  
 (201) 835-5002, 800-225-0524  
 Sales Mgr.: Andy Swenson
- ISS Engineering, Inc.**  
 104 Constitution Dr., #4  
 Menlo Park, CA 94025
- (800) 227-6288  
 V.P. Mkt'g.: Lydia Gillaspie  
 V.P. Sales: John Coiro
- Ikegami Electronics (USA), Inc.**  
 37 Brook Ave.  
 Maywood, NJ 07607  
 (201) 368-9171, FAX# 201-569-1626  
 Director Sales & Mkt'g: Howard Winch  
 Nat'l Sales Mgr. CCTV: Ray Sooley  
 Mkt'g Mgr. CCTV: Aaron Chesler  
 Communications Mgr.: Robert J.  
 Estony  
 Products: accessories, cameras,  
 monitors, pan/tilts, signal  
 distribution, specialty cameras,  
 surveillance, switchers, time-lapse  
 recorders
- Intec Video Systems**  
 23301 Vista Grande  
 Laguna Hills, CA 92653  
 (714) 859-3800, 800-237-3314, FAX#  
 714-859-3178
- JBL PROFESSIONAL**  
 8500 Balboa Blvd  
 Northridge, CA 91329  
 (818) 893-8411, FAX# 818-893-3639  
 Pres.: Ron Means  
 V.P. Sales: Ken Lopez  
 V.P. Mkt'g: Mark Gander  
 Applications Engineer: Drew Daniels  
 Mkt'g Mgr./Sound Contracting: Steve  
 Romeo  
 Video Sales: Don Wilson  
 Neil Conly, Bedford, TX, 817-540-3066  
 Bill Hamilton, Folsom, PA, 215-543-  
 4677  
 Steve Armstrong, Northridge, CA, 818-  
 707-2529  
 Tom Walter, Barrington, IL, 312-382-  
 4925  
 Products: video projectors
- JVC Co. of America**  
 41 Slater Drive  
 Elmwood Park, NJ 07407  
 (201) 794-3900, 800-526-5308, FAX#  
 201-523-3601
- Javelin Electronics**  
 PO Box 2033  
 19831 Magellan Dr.  
 Torrance, CA 90502-1188  
 (213) 327-7440, FAX# 213-327-5405  
 V.P. Sales & Mkt'g: John W. Schulte
- Electrohome Ltd.**  
 809 Wellington St. N.  
 Kitchener, ONT N2G 4J6  
 (519) 744-7111
- FSR, INC.**  
 220 Little Falls Road  
 Cedar Grove, NJ 07009  
 (201) 239-0988, FAX# 201-239-7708  
 Pres.: William Fitzsimmons  
 V.P.: Janice Sandri



- Division Controller: Terry Muldowney  
V.P. Engineering: Ray Payne  
Mgr. Operations: Michael Burton
- Jaydik Communications  
PO Box 3002  
Spokane, WA 99202  
(509) 747-1246  
Mkt'g: John Schulte  
Products: Surveillance
- Koyo International, Inc. of America  
325 Marcus Boulevard  
Hauppauge, NY 11788  
(516) 434-8484, 800-645-9818, FAX#  
516-434-8488  
Pres.: Tom Wada  
V.P. Sales: Al Gold  
Mgr.: Kim Mizuno  
Products: monitors
- Lightwave Communications, Inc.  
650 Danbury Road  
Ridgefield, CT 06877  
(203) 438-3591
- MFJ Enterprises, Inc.  
921 Louisville Road  
Starkville, MS 39759  
(601) 323-5869, 800-647-1800
- MPO Videotronics  
2580 Turquoise Circle  
Newbury Park, CA 91320  
(805) 499-8513, FAX# 805-499-8206  
Regional Mgr.: Mark Barker
- MATH ASSOCIATES, INC.**  
2200 Shames Dr.  
Westbury, NY 11590  
(516) 334-6800, FAX# 516-334-6473  
Pres.: Ellen Math  
V.P. Sales/Mkt'g: Edmund Henckel  
Director R & D: Irwin Math  
Products: accessories
- Mikrolab Video, Inc.  
4121 Redwood Avenue, Suite 215  
Los Angeles, CA 90066  
(213) 306-0120
- Mitsubishi Electric Sales America, Inc.  
110 New England Ave. W  
Piscataway, NJ 08854  
(201) 981-1414, FAX# 201-981-9492  
Products: monitors
- NEC America, Inc.  
4936 Rosecrans Ave.  
Hawthorne, CA 90250  
(213) 973-2071  
Products: monitors
- Northern Information Technology  
262 Carlton Drive  
Carol Stream, IL 60188  
(312) 690-1457, 800-528-4343, FAX#  
312-665-0443  
Pres.: Ed Polanek  
Products: transmission systems
- Numark Electronics  
503 Newfield Ave.  
Edison, NJ 08837  
(201) 225-3222, FAX# 201-287-2155  
Pres.: Harry Kotovsky  
V.P.: Robert Kotovsky  
Numark/PPD, Simi Valley, CA, 805-  
522-3550  
Products: video mixers
- Panasonic Ind.  
50 Meadowlands Parkway, M.S. 2A-8  
Secaucus, NJ 07094  
(201) 392-4050, FAX# 201-392-4436  
Dept. Mgr.: Frank Orrow  
Resident Mgr.: Art Hagiwara  
Tech. Support Supervisor: George  
Lidlow  
Accts Mgr.: Howard Anderson
- Peerless Sales Co.  
1950 Hawthorne Ave.  
Melrose Pk., IL 60160  
(312) 865-8870, FAX# 312-865-2941  
V.P.: Walter Snodell  
Mkt'g Mgr.: Frank R. Briggs  
Products: accessories, hardware
- Pelco Sales  
300 W. Pontiac Way  
Clovis, CA 93612  
(209) 292-1981, 800-421-1146, FAX#  
800-356-4758
- Racon, Inc.  
12628 Interurban Ave. South  
Seattle, WA 98168-3383  
(206) 241-1110, 800-426-5245, FAX#  
206-246-9306  
V. P. Sales: Robert Kirkaldie  
Tech Svcs Mgr./Micropass: Mike  
Quigley  
Inside Sales Rep: Kay Best
- Col-Ins-Co., Orlando, FL, 305-423-7615  
Hite Electronics, Mansfield, TX, 817-  
483-7077  
SEA, Inc., Carmel, IN, 317-846-2591  
SAC Communications, Vienna, VA,  
703-281-2558  
DGH Communications, Scarborough,  
ON, 416-499-4746  
Products: transmission systems
- Research Technology International  
4700 W. Chase Ave.  
Lincolnwood, IL 60646-168  
(312) 677-3000, 800-323-7520, FAX#  
312-677-1300  
Pres.: Ray L. Short, Jr.  
Chairman: Howard Bowen  
V.P. Sales: Thomas Tisch  
CFO: Richard Peterson  
V.P. Production: Ralph Fisher  
Advertising Mgr.: Sherwin Berger  
Products: accessories
- Robot Research, Inc.  
5636 Ruffin Road  
San Diego, CA 92123  
(619) 279-9430, FAX# 619-279-7931  
Pres.: John P. Stahler  
V.P. Sales & Mkt'g: David B. Hartley  
Director of Sales: Joseph H. Olmstead  
Mkt'g Communications: Michael C. Fell  
Technical Rep: Steven Wilber  
Products: accessories, surveillance,  
transmission systems
- Sanyo Fisher, Inc.  
21314 Lassen St.  
Chatsworth, CA 91311  
(818) 998-7322, 800-421-5013, FAX#  
818-701-4149
- Siedle Intercom  
780 Parkway  
Broomall, PA 19008  
(215) 353-9595, 800-874-3353, FAX#  
215-353-9716  
Pres.: Earl Zausmer  
Products: lenses, monitors, remote  
controls
- Surveillance Video Systems  
PO Box 1349  
258 'A' St.  
Ashland, OR 97520  
(503) 482-4500  
Pres.: Bud Wilkey  
Products: accessories, cameras,

“!!✓X♠★#?☠”

Is this what you say about antiquated personnel register systems?

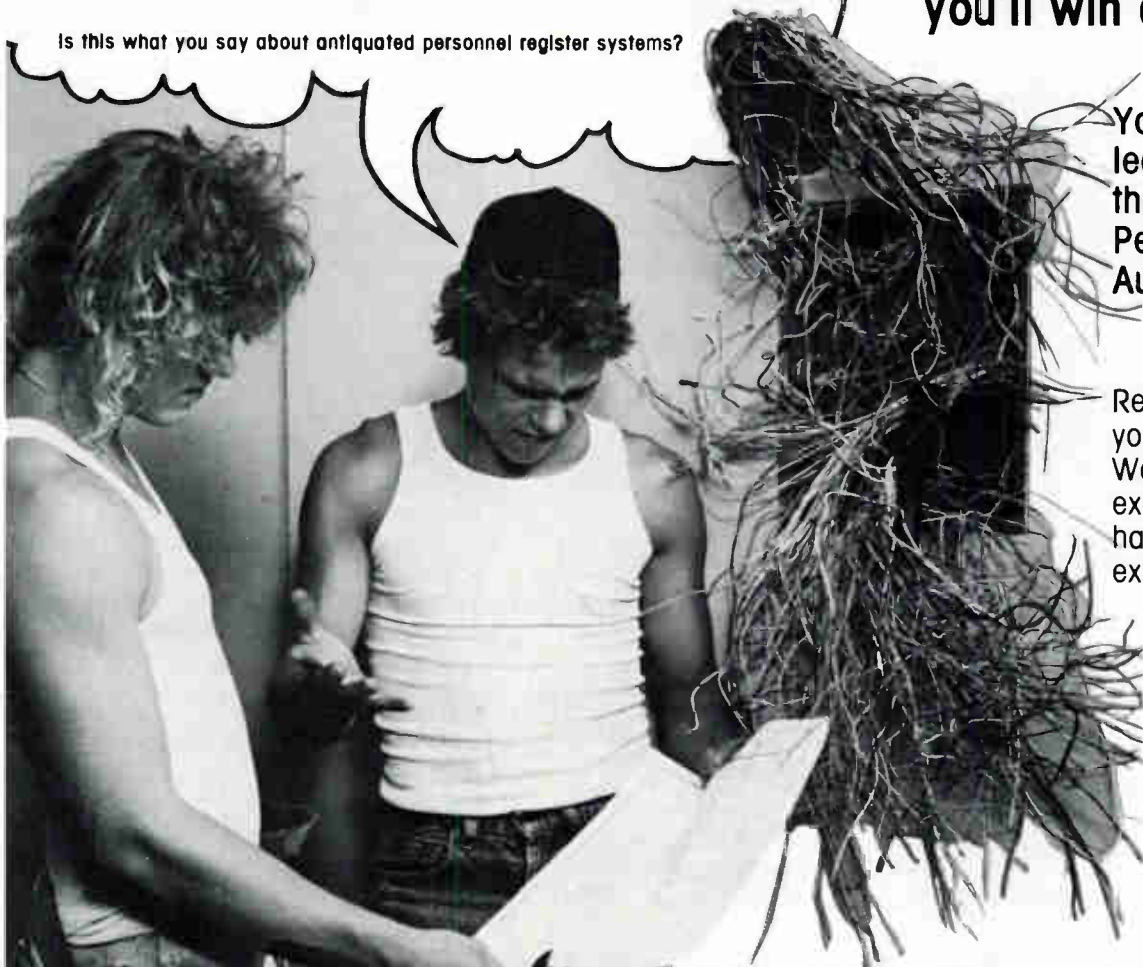

Tell us what this installer is saying. If your caption is the best (our choice), you'll win a new VCR!

You'll also win by learning more about the new state-of-the-art Personnel Register from Audio Systems Co.

Replace that old system you can't get parts for... We can use your existing back boxes and have adapters to use existing wiring.

## The Audio Systems Co. Personnel Register is designed by people who have installed the others.

### STATE-OF-THE-ART FEATURES:

- Parallel wiring and standard telephone connectors make installation and maintenance a snap.
- The surface mounted version has a total depth of only one inch.
- The flush surface makes it a breeze to clean.
- Audio Systems Co., can also design custom display panels to retrofit old systems.

*Enter our contest, or call me, and I'll send you more information about our new Personnel Register."*

*Sheila*



YES, SHEILA, I want a chance of winning a VCR. I've written my caption below.

YES, SHEILA, I'm tired of rats nests and other antiquated personnel register system problems. Send me more information about Audio System Co.'s new Personnel Register.

(Write your caption here, in no more than 15 words.)  
(Photocopies also acceptable.)

NAME \_\_\_\_\_

TITLE \_\_\_\_\_

COMPANY \_\_\_\_\_

ADDRESS \_\_\_\_\_

CITY \_\_\_\_\_

STATE \_\_\_\_\_

ZIP \_\_\_\_\_

MAIL TO: AUDIO SYSTEMS CO., 1815 Michigan Ave., P.O. Box 1174, Bismarck, ND 58502  
(701) 223-3800 OR TOLL FREE 1-800-852-6522

World Radio History

# AUDSCO

1815 Michigan Ave. P.O. Box 1174 Bismarck, ND 58502  
(701) 223-3800 or Toll Free 1-800-852-6522

dummy cameras, enclosures, hardware, lenses, monitors, pan/tilts, surveillance, switchers, time-lapse recorders

## **TOA ELECTRONICS, INC./ENGINEERED INTERCOM & SECURITY DIVISION**

PO Box 2047  
601 Gateway Blvd.  
South San Francisco, CA 94080  
(415) 588-2538, 800-843-4750, in CA  
800-632-2157, FAX# 415-588-3349  
Pres.: Yoshiro Ishida  
Director of Mkt'g: Fred Fredericks  
Nat'l Sales Mgr.: Al Burns  
Products: accessories, cameras, enclosures, lenses, monitors, pan/tilts, specialty cameras, surveillance, switchers

Usatco (Universal Satellite Corp.)  
300 E. 59th St.  
New York, NY 10022  
(718) 786-1510

VCS, Inc.  
262 Carlton Dr.  
Carol Stream, IL 60188  
(312) 690-1400, 800-323-2613, FAX#  
312-665-0443  
Pres.: Matt Tummillo  
V.P. Sales: Michael Jimenez-Wolfe

V.P. Finance: Dwight Dreger  
Nat'l Sales Admin.: Bob Rowland  
Customer Svce Supervisor: Jill Hampe

VCS (Visual Communications Specialists)  
8586 Miramar Place  
San Diego, CA 92121  
(619) 455-7252

Vicon Industries  
525 Broad Hollow Rd.  
Melville, NY 11747  
(516) 293-2200, 800-645-9116  
Pres.: Donald N. Horn  
Executive V.P.: Arthur Wallace  
V.P. Finance: Kenneth Darby  
V.P. Mkt'g/Sales: Ronald J. Teixeira  
Vicon Industries, Norcross, GA, 404-  
449-0499

Vicon Industries, Brea, CA, 714-990-  
3858

Vicon Industries, Washington, D.C.,  
703-553-7580

Products: cameras, enclosures, hardware, lenses, monitors, pan/tilts, remote controls, specialty cameras, surveillance, VTRs

Video Accessory Corp.  
2450 Central Avenue  
Boulder, CO 80301

(303) 443-1319, 800-821-0426  
Pres.: Dr. Jack Baird  
CEO: Norm Baer  
Products: accessories, effects generators, signal distribution

Videoplex, Inc.  
2 World's Fair Dr.  
Somerset, NJ 08873  
(201) 469-9038  
Pres.: Martin Horak  
Executive V.P.: Gerald Kalb  
Chief Engineer: Bruce Fogelstrum

Visual Methods, Inc.  
35 Charles Street  
Westwood, NJ 07675  
(201) 666-3950  
Products: accessories, cameras, computer interfaces, enclosures, fiber optics, lenses, remote controls, specialty cameras, surveillance, time-lapse recorders, transmission systems

Visual Communication Specialists  
8586 Miramar Road  
San Diego, CA 92121  
(619) 455-7252, FAX# 619-455-7324  
Pres.: C.P. Murray

## **IN-OUT REGISTERS**

Atlas/Soundolier  
1859 Intertech Dr.  
Fenton, MO 63026  
(314) 349-3110, FAX# 314-349-1251  
V.P. Sales: Tom Erickson  
E. Region/Sales: Andy Musci  
W. Region/Sales: Bud Waters  
V.P./Mkt'g Consultant: Herbert Jaffe  
Products: access control, intercom

Audio Systems Company  
PO Box 1174  
1815 Michigan Ave.  
Bismarck, ND 58502  
(701) 223-3800, 800-852-6522  
Pres.: Lynn Mader  
V.P.: Lyle Mader  
Sales Mgr.: Mark Schmidt  
Products: intercom, manual personnel, medical, visual

Cornell Electronics Products, Inc.  
PO Box 23411  
4911 West Good Hope Rd.  
Milwaukee, WI 53223-0411  
(414) 351-4660, 800-541-9946, FAX#  
414-351-4657  
Pres.: Donald Glaubitz  
V.P.: Gary M. Butler  
Sales Mgr.: Pauline A. Haack  
SE Reg Sales Mgr.: William Ellinger  
SLK/Tech Rep, San Francisco, CA,  
415-822-4885  
Gustafson System Sales, Inc., Palatine,  
IL, 312-358-2505  
Bidwell-Schwartz Associates, Inc.,  
Gardena, CA, 213-770-0300  
Pinz Sales Corp., Rockville Centre, NY,  
516-678-6887  
Dick Bellew Sales, Inc., Dallas, TX,  
214-644-7881

Cavendish and Winchester, Inc.,  
Atlanta, GA, 404-449-5104  
Avcom, Inc., N. Olmsted, OH, 216-777-  
2060  
Richard S. Pass Assoc., Langhorne,  
PA, 215-757-6100  
Kingston Sales Corp., Indianapolis, IN,  
317-876-2545  
Rancillio Assocs., Inc., St. Louis, MO,  
314-631-3326  
Shamrock Electronic Sales, Dayton,  
OH, 513-258-1227  
CB Electronic Marketing, Arvada, CO,  
303-422-0561  
Cartwright & Bean, Inc., Orlando, FL,  
407-422-4531  
Awest, Inc., Fountain Hills, AZ, 617-  
545-0652  
LSM Associates, Phelps, NY, 315-548-  
4891



W.A. Hendrickson Co., Inc., North  
Scituate, MA, 617-545-0652

Kodo Associates, Inc., Minneapolis,  
MN, 612-881-1255

Vector Corp., Seattle, WA, 206-322-  
4343

Yocum Marketing, Inc., Mesa, AZ,  
602-265-5056

Products: intercom, visual

## LEE DAN COMMUNICATIONS

155 Adams Ave.

Hauppauge, NY 11788-3699

(516) 231-1414, 800-533-3261, FAX#

516-231-1498

Pres.: Leon Goldberg

V.P. Operations: Lawrence J. Goldberg

V.P. Finance/Admin.: David H.

Goldberg

Sr. Technician: Sandy Hoffman

Customer Svce: Linda E. Scaturro

Production Sup.: Gabriel Figueroa

Products: intercom, manual personnel,  
medical

Fisher-Berkeley Corp.—Ektacom

5800 Christie Ave.

Emeryville, CA 94608

(415) 655-9696, FAX# 415-658-0674

Pres: Robert S. Fisher

V.P. Engineering: Robert T. Shipley

Sales Engineer: Michael D. Lagrimas

Sales Engineer: Roger E. Stewart

Jeron Electronic Systems, Inc.

1743 W. Rosehill Dr.

Chicago, IL 60660

(312) 275-1900, 800-621-1903, FAX#

312-275-0283

Pres.: Jerome Chesnul

V.P. Sales: John Charczuk

Admiral Sales Co., Richardson, TX,

214-357-9212

ASR Enterprises, Ltd., Fallston, MD,

301-893-0001

Burcaw Company & Assoc., Warren,  
MI, 313-573-4605

Central Marketing Group, Kansas City,  
MO, 816-741-7460

Bi-State Marketers, Ridgefield, NJ, 201-  
943-5888

Pat Norman Sales, Indianapolis, IN,  
317-842-5611

Greg Dzubay & Assoc., Peoria, AZ,  
602-979-2358

Pacnor Marketing, Inc., Lynwood, WA,  
206-771-6016

Gustafson Sales, Red Wing, MN, 612-  
388-4277

J.W. Lehner Co., Stow, OH, 216-686-  
1965

Meyer Marketing, Deerfield Beach, FL,  
305-481-9250

Meyer & Ross, Burlingame, CA, 415-  
348-6800

New West Agency, San Diego, CA,  
619-299-3269

Pacific West Marketing, Honolulu, HI,  
808-261-7558

Henry Philips Co., Roswell, GA, 404-  
992-3070

R.G. Associates, Stow, MA, 617-897-  
7146

Tortech Electronics, Inc., Scarborough,  
ONT, Canada, 416-282-1011

John S. Wilkin & Assoc., Hillboro, OH,  
513-393-1137

Products: manual personnel, medical,  
monitor reporting, visual

Radionics, Inc.

920 Holt Rd.

Webster, NY 14580

(716) 872-2100

Pres.: A.J. Ozminkowski

Engineer: Frank Laciak

Director of Comm'l Prod.: Ken O'Brien

Distributor/Sales Mgr.: Roger Moore

Products: manual personnel, medical,  
telephone reporting, terminal  
reporting, visual

Speco Div., Components Specialties, Inc.  
PO Box 624

1172 Rt. 109

Lindenhurst, NY 11757

(516) 957-8700, 800-645-5516, FAX#  
516-956-9142

V.P./Sales: Mel Hulkower

V.P./General Mgr.: Jim Ganci

Sales Mgr.: Eric Forman

Products: intercom

## TEKTONE SOUND & SIGNAL MFG., INC.

PO Box 12427

1331 S. Killian Dr.

Lake Park, FL 33403

(407) 844-2383, FAX# 407-845-1587

Pres.: Manuel Mira

General Mgr.: Carlos Mira

Sales/Mkt'g Director: Tom Hendricks

Chief Engineer: Jim Switzer

Ziskind & Assoc., Rolling Meadow, IL,  
312-577-1624

Wm. B. Allen Supply Co., New Orleans,  
LA, 504-525-8222

Alvan C. Chaney & Assoc., Hialeah, FL,  
305-558-3933

Dardon & Assoc., Olmstead Township,  
OH, 216-234-4555

Klumpp Sales Co., Jacksonville, FL,  
904-287-5205

Lee Dan Communications, Hauppauge,  
NY, 516-231-1414

Lichtenauer & Assoc., Antioch, CA,  
415-757-1200

R.W. Sales, Inc., St. Paul, MN, 612-  
646-2710

Mountain Representatives, Denver, CO,  
303-623-0972

Chuck Olson Assoc., Renton, WA, 206-  
271-5416

Alpha Communications, Hauppauge,  
NY, 516-434-8080

Westech Marketing, Culver City, CA,  
213-870-9286

Products: medical

# LIFE-SAFETY, VOICE EVACUATION SYSTEMS

Atis, Ltd.

6025 Atlantic Blvd., Suite D

Norcross, GA 30071

(404) 446-7234, FAX# 404-446-7237

V.P. Tech Svcs: Peter Lorenz

Nat'l Sales Mgr.: Tony Vespoli

Products: audio, message announce

Atlas/Soundolier

1859 Intertech Dr.

Fenton, MO 63026

(314) 349-3110, FAX# 314-349-1251

V.P. Sales: Tom Erickson

E. Region/Sales: Andy Musci

W. Region/Sales: Bud Waters

V.P./Mkt'g Consultant: Herbert Jaffe

Products: audio, emergency intercom,  
handset, tone, visual

BCE/Edcom, Division of CCS, Inc.  
1585A Britannia RD. E., #7  
Mississauga, Ontario, Canada L4W  
2M4  
(416) 678-0801, FAX# 416-678-0480  
Pres.: Peter Jova  
Sales Mgr.: Keith Moore  
Products: emergency intercom

Comutronic  
18627 Brookhurst #325  
Fountain Valley, CA 92708  
(714) 963-7454, FAX# 714-963-2105  
Director of Mkt'g: Robert Gehlke  
Products: audio, DC battery supply

### DUKANE CORPORATION

2900 Dukane Dr.  
St. Charles, IL 60174  
(312) 584-2300, FAX# 312-584-2370  
Pres.: J. McWilliams Stone, Jr.  
Group V.P.: William P. Finnegan  
Division General Mgr.: Steve Deppe  
Mkt'g Mgr.: Derek Podobas  
Nat'l Sales Mgr.: Warren Anderson  
Service Mgr.: Cliff Carlson  
Doug Fellabaum, Sycamore, IL, 800-445-445-0152(#2301)  
Don Mouritzen, Beecher, IL, 800-445-0152(2303#)  
Art Sbrilli, Edison, NJ, 800-445-0152(#2302)  
Pete Kendall, Jacksonville, FL, 904-262-6025(#2306)  
Jack Brown, Dallas, TX, 214-943-7528(#2305)  
Ed Nuhring, Portland, OR, 800-445-0152(#2307)  
Wally Smutts, Toronto, Ontario, Canada, 312-584-2300  
Ken Lind, Wellesley Hills, MA, 617-235-6817  
Products: audio, DC battery supply, emergency intercom, handset, message announce, tone, visual

Edcor  
1948 East Pomona  
Santa Ana, CA 92705  
(714) 648-0292, 800-854-0259, FAX# 714-648-0117  
Pres.: Larry Weston  
Office Mgr.: Phyllis Weston  
Sales Mgr.: Deanna Weston  
Products: audio, tone

**ELTREX INTERNATIONAL**  
2 Columbia Dr.  
Amherst, NH 03031  
(603) 886-3500, 800-432-7631, FAX# 603-886-3508  
Sales Mgr.: Bill Ryan  
Products: audio, message announce

IGM Communications, Inc.  
282 W. Kellogg Road  
Bellingham, WA 98226  
(206) 733-4567  
Sales: Carl Peterson

### MACKENZIE LABORATORIES, INC.

PO Box 3029  
5507 Peck Rd.  
Arcadia, CA 91006  
(818) 579-0440, 800-423-4147, FAX# 818-448-7131  
Pres.: Addison R. Taylor  
V.P./Chief Engineer: Nagy Khattar  
Sales & Sys.: Joe Vitale  
Products: message announce

### NEL-TECH LABS, INC.

PO Box 1030  
Londonderry, NH 03053  
(603) 434-8234, FAX# 603-434-1265  
Pres.: Gary Stapleford  
Exec. V.P.: Ken Ritter  
Products: message announce

Powertronix  
10623 Lawson River Ave.  
Fountain Valley, CA 92708  
(714) 963-5411  
Pres.: Robert Gehlke  
Sales Mgr.: Bill Organ



Rauland-Borg Corp.  
3535 W. Addison St.  
Chicago, IL 60618  
(312) 267-1300, FAX# 312-267-1127  
Pres.: William Krucks  
Sr. V.P./Sales & Mkt'g: Kenneth T. James  
Chief Engineer: Lawrence Gleason  
Nat'l Sales Mgr.: Rick Blunt  
Harry B. Hahn, Olathe, KN, 913-829-9427

William C. Zophy, Ft. Myers, FL, 813-433-4766  
Harold De Vaney, Dickinson, TX, 713-337-1040  
Hank Plaisier, El Toro, CA, 714-837-2626  
Vince Ward, Vashon Island, WA, 206-463-5582  
Joseph A. Ciotti, Claymont, DE, 302-798-6558  
William Lewis, Louisville, KY, 502-491-4273  
Raymond Bailey, Granville, IL, 815-339-6789  
Rauland-Borg Inc., Mississauga, ONT., CD, 416-821-2225  
Jim Welch, Scarborough, ONT., CD, 416-438-4756  
Products: audio, emergency intercom, handset

Vicon Industries  
525 Broad Hollow Rd.  
Melville, NY 11747  
(516) 293-2200, 800-645-9116  
Pres.: Donald N. Horn  
Executive V.P.: Arthur Wallace  
V.P. Finance: Kenneth Darby  
V.P. Mkt'g/Sales: Ronald J. Teixeira  
Vicon Industries, Norcross, GA, 404-449-0499  
Vicon Industries, Brea, CA, 714-990-3858  
Vicon Industries, Washington, D.C., 703-553-7580  
Products: message announce

Wheelock, Inc.  
273 Branchport Ave.  
Long Branch, NJ 07740  
(201) 222-6880, FAX# 201-222-8707  
Pres.: P. W. Tarlton  
V.P. Mkt'g/Sales: W.L. Goldstein  
Mkt'g Mgr./Telephone-Paging: Art Arlow  
Tech. Support Engineer: W. Best  
Products: audio, tone, visual

# AUDIO AMPLIFICATION

## AUDIO AMPLIFIERS

### AB International Electronics, Inc.

PO Box 1105  
1830-6 Vernon Street  
Roseville, CA 95678  
(916) 783-7800, FAX# 714-586-8229  
V. P.: Irwin Laskey

Products: 70-volt amplifiers, bi-amp systems, dual-channel, low-frequency amplifiers, mixer amplifiers, signal processing amplifiers, single-channel, telephone paging amplifiers, tri-amp systems, zone-paging amplifiers

### ADA Signal Processors, Inc.

7303 Unit D Edgewater Dr.  
Oakland, CA 94621-3095  
(415) 632-1323, 800-241-8888, FAX# 415-632-9358

V.P.: Lorry Marcus  
Sales Mgr.: Dave Gonden  
Sales Rep: Eric Schultheis  
Products: portable, signal processing amplifiers

### ATI - Audio Technologies, Inc.

328 W. Maple Ave.  
Horsham, PA 19044  
(215) 443-0330, FAX# 215-443-0394  
Pres.: S.B. Wenzel  
V.P.: E.M. Mullin

Products: dual-channel, low-frequency amplifiers, mixer amplifiers, modular amplifiers, monitor amplifiers, portable, signal processing amplifiers, single-channel

### AIPHONE INTERCOM SYSTEMS

PO Box 90075  
1700 130th Ave. N.E.  
Bellevue, WA 98005  
(206) 455-0510, FAX# 206-455-0071  
Pres.: Hiko Shinoda  
Nat'l Sales: Jim Morrison  
Products: 70-volt amplifiers, mixer amplifiers

### Alesis Corporation

3630 Holdrege Ave.  
Los Angeles, CA 90016

(213) 467-8000, FAX# 213-836-9192

Pres.: Keith Barr  
Exec. V.P./COO: Russell Palmer  
V.P. Mkt'g: Allen Wald  
Nat'l Sales Mgr.: Ralph Goldheim  
Reg. Sales Mgr.: Ted Keffalo  
Products: monitor amplifiers

### Altec Lansing Corp.

PO Box 26105  
Oklahoma City, OK 73126-0105  
(405) 324-5311, FAX# 405-324-8981  
Pres.: Dave Merrey

Dir. Mkt'g Dev.: Ted Uzzle  
Nat'l Sales Mgr.: Jerry Spriggs  
Mgr., Export Mkt'g: John Sexton  
Nat'l Accts Mgr.: Tim Smith  
Technical Svces Mgr.: Gary Jones  
Products: 70-volt amplifiers, dual-channel, mixer amplifiers, modular amplifiers, signal processing amplifiers, single-channel

### Amplified Music Products Corp.

9829 Independence Ave.  
Chatsworth, CA 91311  
(818) 709-0518

Pres.: Russell V. Allee  
V.P.: Roger F. Smith  
Products: dual-channel

# ASHLY

### ASHLY AUDIO, INC.

100 Fernwood Ave.  
Rochester, NY 14621  
(716) 544-5191, 800-828-6308, FAX# 716-266-4589

Pres.: William Thompson  
Senior V.P.: Bob French  
V.P.: David Malloy  
Office Mgr.: Ellen Price  
Products: low-frequency amplifiers, monitor amplifiers, portable

### Audio Design Associates

602-610 Mamaroneck Ave.  
White Plains, NY 10605  
(914) 946-9595, 800-423-AUDIO, FAX# 914-723-4642

### Audio Systems Company

PO Box 1174  
1815 Michigan Ave.  
Bismarck, ND 58502  
(701) 223-3800, 800-852-6522

Pres.: Lynn Mader  
V.P.: Lyle Mader  
Sales Mgr.: Mark Schmidt  
Products: mixer amplifiers, modular amplifiers, signal processing amplifiers, zone-paging amplifiers

### BCE/Edcom, Division of CCS, Inc.

1585A Britannia RD. E., #7  
Mississauga, Ontario, Canada L4W 2M4  
(416) 678-0801, FAX# 416-678-0480

Pres.: Peter Jova  
Sales Mgr.: Keith Moore  
Products: single-channel

### BGW Systems, Inc.

13130 S. Yukon Ave  
Hawthorne, CA 90250  
(213) 973-8090, 800-468-AMPS, FAX# 213-676-6713

Pres.: Brian Wachter  
V. P.: Barbara Wachter  
Controller: Jim Ebert  
Peter Schmitt Co., Leonia, NJ, 201-944-2806  
Lienau Assoc., Columbia, MD, 301-621-4113  
Evans Sales & Mkt'g, Nashville, TN, 615-297-7997  
Greg Dzubay & Assoc., Peoria, AZ, 602-979-2358  
Gravley & Assoc., Irvine, CA, 714-852-9994  
CRM, Sterling Heights, MI, 313-826-8980  
Gemini Electronic Mkt'g, Edmonds, WA, 206-322-4343

Meyer & Ross, Burlingame, CA, 415-348-6800

Meyer Mkt'g, Deerfield Beach, FL, 305-481-9250

Monfort Electronics Mkt'g,  
Indianapolis, IN, 317-872-8877

New Resource, Norwell, MA, 617-659-1463

North Coast Mkt'g, Erie, PA, 814-456-6435

Chuck Rancilio Assoc., Inc., St. Louis, MO, 314-631-3326

Sherwood Assoc., Endicott, NY, 607-785-1590

Products: 70-volt amplifiers, bi-amp systems, dual-channel, low-frequency amplifiers, modular amplifiers, monitor amplifiers, signal processing amplifiers, single-channel, tri-amp systems

Bogen Communications, Inc.

PO Box 575

50 Spring St.

Ramsey, NJ 07446

(201) 934-8500, FAX# 201-934-9832

Pres.: John H. Ochtera

V.P. Sales/Sound Prod.: David A. Chambers

V.P. Sales/Telecomm. Prod.: Charles Ferreri

Bruce Barrett, Garland, TX, 214-530-0467

Kingston Sales Corp., Indianapolis, IN, 317-876-2545

Kevin Koehler, Batavia, IL, 312-879-6871

Tim McDonnell, Willoughby Hills, OH, 216-942-2429

Steve McGrew, Kennesaw, GA, 404-422-4608

Meyer Mkt'g, Inc., Deerfield Beach, FL, 305-481-9250

W.B. Pray Sales, Inc., Northboro, MA, 617-393-3434

Jay Sample, Sandy, UT, 801-942-1059

Scott Sampson, Encino, CA, 818-996-5484

Mike Schneider, Baltimore, MD, 301-563-5390

Walt Spencer, Ramsey, NJ, 201-934-8500

White Radio Ltd., Burlington, ONT, Canada, 416-632-6894

Roburn Agencies, Inc., Yonkers, NY, 914-968-1016

Products: 70-volt amplifiers, mixer amplifiers, modular amplifiers,

telephone paging amplifiers, zone-paging amplifiers

Boulder Amplifiers

4850 Sterling Drive

Boulder, CO 80301

(303) 449-8220

Pres.: Jeff Nelson

Director of Mkt'g: Randy Gill

Dealer Support: Mark Adams

Technical Support: Steve Rockwell

BrystonVermont Ltd.

PO Box 2255

RFD #4

Montpelier, VT 05602

(802) 223-6159, 800-451-4160

Pres.: John Day Russell

C-Audio

PO Box 521

Kuniholm Dr.

Holliston, MA 01746

(617) 429-6706

Exec. V.P./Gen. Mgr.: Peter Willie Koff

Nat'l Sales Mgr.: David Deranian

Mkt'g/Sales Support Admn: Barry Fox

Credit Mgr.: Kathy Maguire

Carver Corp.

20121 48th Ave. W.

Lynnwood, WA 98036

(206) 775-1202, FAX# 206-778-9453

Nat'l. Sales Mgr./Pro: Will Lewis

Design Engineer: Dennis Griffiths

Carvin Corp.

1155 Industrial Ave.

Escondido, CA 92025

(619) 747-1710

Cetec Ivie

1366 West Center St.

Orem, UT 84057

(801) 224-1800, FAX# 801-224-7526

Pres.: Craig Berry

V.P.: Joel Zabriskie

Mkt'g Mgr.: Glen Meyer

Product Engineering Mgr.: Larry Driskill

Production Mgr.: Bob Greene

Products: 70-volt amplifiers, dual-channel, modular amplifiers, zone-paging amplifiers

**CETEC RAYMER**

13278 Ralston Ave.

Sylmar, CA 91342

(818) 362-9516, FAX# 818-367-5292

Pres.: Hugh T. Wilcox

Sales Support Rep: Michelle Price

Sales Coordinator: Jean Hurst

Products: 70-volt amplifiers, mixer amplifiers, modular amplifiers, monitor amplifiers, signal processing amplifiers, single-channel, telephone paging amplifiers, zone-paging amplifiers

Clarity, A Division of Valcom, Inc.

1111 Industry Ave. SW

Roanoke, VA 24013

(703) 982-7003, 800-962-6009, FAX#

703-982-7032

Products: 70-volt amplifiers, mixer amplifiers, telephone paging amplifiers

Comutronix

18627 Brookhurst #325

Fountain Valley, CA 92708

(714) 963-7454, FAX# 714-963-2105

Director of Mkt'g: Robert Gehlke

Products: 70-volt amplifiers, mixer amplifiers, modular amplifiers, monitor amplifiers, portable, signal processing amplifiers, single-channel, telephone paging amplifiers, zone-paging amplifiers

JL Cooper Electronics

1931 Pontius Avenue

Los Angeles, CA 90025

(213) 473-8771, FAX# 213-479-7606

Technical Support: Eli Slawson

Sales Coordinator: Anastasia Khan

Crest Audio

150 Florence Ave.

Hawthorne, NJ 07506

(201) 423-1300, FAX# 201-423-2977

Pres.: John Lee

Division Mgr.: Craig Hannabury

Products: 70-volt amplifiers, dual-channel, low-frequency amplifiers, modular amplifiers, monitor amplifiers, portable

Crown International, Inc.

1718 W. Mishawaka Road

Elkhart, IN 46517

(219) 294-8000, FAX# 219-294-8329

Pres./CEO: Mr. Clyde Moore

Mgr. Mkt'g Svcs: Dave McLaughlin

Director of P.R./Adv.: Margo Sousley



Sales Mgr.: Jim Beattie  
 Microphone Prod. Dir.: Bill Raventos  
 Amplifier Prod. Dir.: Verne Searer  
 Products: 70-volt amplifiers, bi-amp systems, dual-channel, low-frequency amplifiers, monitor amplifiers, signal processing amplifiers, single-channel

DAX Audio Group, Inc.  
 1231 S.E. Gideon St.  
 Portland, OR 97202  
 (503) 232-4445  
 Pres.: Rich Stevenson  
 Engineering Mgr.: Bob Herb

DCS Audio Products, Inc.  
 335 E 21st St  
 New York, NY 10010  
 (212) 9823654  
 Jeff Descombes

**J. W. DAVIS & CO.**  
 PO Box 26177  
 3030 Canton Street  
 Dallas, TX 75226  
 (214) 651-7341, 800-527-5705, in TX  
 800-442-1564, FAX# 214-939-0328

Pres.: Charles Griffith  
 V.P. Sales: Jack W. Tucker  
 Chief Engineer: Mike Lamm  
 Products: 70-volt amplifiers, mixer amplifiers, single-channel, telephone paging amplifiers

Delta Magnetics  
 16782 Hale Ave.  
 Irvine, CA 92714  
 (714) 863-1537

**DUKANE CORPORATION**  
 2900 Dukane Dr.  
 St. Charles, IL 60174  
 (312) 584-2300, FAX# 312-584-2370  
 Pres.: J. McWilliams Stone, Jr.  
 Group V.P.: William P. Finnegan  
 Division General Mgr.: Steve Deppe  
 Mkt'g Mgr.: Derek Podobas  
 Nat'l Sales Mgr.: Warren Anderson  
 Service Mgr.: Cliff Carlson  
 Doug Fellabaum, Sycamore, IL, 800-445-0152(#2301)  
 Don Mouritzen, Beecher, IL, 800-445-0152(2303#)

Art Sbrilli, Edison, NJ, 800-445-0152(#2302)  
 Pete Kendall, Jacksonville, FL, 904-262-6025(#2306)  
 Jack Brown, Dallas, TX, 214-943-7528(#2305)  
 Ed Nuhring, Portland, OR, 800-445-0152(#2307)  
 Wally Smutts, Toronto, Ontario, Canada, 312-584-2300  
 Ken Lind, Wellesley Hills, MA, 617-235-6817  
 Products: mixer amplifiers, modular amplifiers, portable, telephone paging amplifiers

Dyma Engineering  
 PO Box 1535  
 Los Lunas, NM 87031  
 (505) 865-6700

Edcor  
 1948 East Pomona  
 Santa Ana, CA 92705  
 (714) 648-0292, 800-854-0259, FAX#  
 714-648-0117  
 Pres.: Larry Weston

**FANON**

**PRO POWER SERIES . . .**

**PROFESSIONAL PA and  
 . . . BACKGROUND MUSIC AMPLIFIERS**



**PRO POWER 40T**

FANON'S years of sound engineering experience has produced the PRO POWER Series to meet the needs of the professional sound specialist. The PRO POWER line ranges from 20 to 120 watt P.A. Amplifiers including a 20 and 40 watt tuner/amplifier, plus multi-purpose paging and talk/back speakers to fill your system requirements.

Bid FANON PRO POWER, you're sure to be a winner. FANON means sound profits NOW! Want to know more? Call Murray Trotiner on our Toll Free line 1-800-345-1354 for details of our Sound Profits Program or visit us at the NSCA EXPO Show in Reno, Booth 1322.

**FANON COURIER** 14281 Chambers Rd. • Tustin, CA 92680 • (714) 669-9890 • TLX: 85-2263 • FAX: 714-669-1081  
 A Shelly Company

- Office Mgr.: Phyllis Weston  
Sales Mgr.: Deanna Weston  
Products: 70-volt amplifiers, bi-amp systems, dual-channel, mixer amplifiers, modular amplifiers, single-channel, telephone paging amplifiers, zone-paging amplifiers
- Electro Force Corp.  
727 Oaksone Way  
Anaheim, CA 92806  
(714) 774-3666  
Pres.: Phillip A. Lindberg  
Creative Audio Marketing, Marietta, GA, 404-642-7827  
Meyer & Ross, Burlingame, CA, 415-348-6800  
Products: portable
- Electro-Voice, Inc.  
600 Cecil Street  
Buchanan, MI 49107  
(616) 695-6831, 800-527-6701, FAX# 616-695-1304  
Pres.: Robert D. Pabst  
V.P. Sales & Mkt'g: Paul McGuire  
Director of Mkt'g: Jim Long  
Chief Engineer: Earl Harris  
George M. Conneen Co., Inc.,  
Springfield, PA, 215-544-5884  
Metropolis Audio Marketing, Inc.,  
Edison, NJ, 201-225-0085  
R.J. Marketing Ltd., Rockville, MD, 301-251-0330  
The Smith Company, Hartford, CT, 203-523-0512  
Ron Tunks Sales, Inc., Tamarac, FL, 305-722-2803  
Wilson Audio Sales, Nashville, TN, 615-646-4477  
Audio Resources, Westmont, IL, 312-655-1180  
B.C. Electronic Sales, Inc., Mission, KS, 913-262-1720  
Jones Audio Sales, Plano, TX, 214-867-0202  
C.L. Pugh & Assoc., Inc., Columbus, OH, 614-486-9678  
Riley & Petchell Sales, Inc., Detroit, MI, 313-937-300  
Loppnow & Assoc., Redmond, WA, 206-883-3205  
Radon & Assoc., Sacramento, CA, 916-923-2524  
Silver Peak Marketing Ltd., Wheat Ridge, CO, 303-467-9042
- Western Audio Sales, Glendale, CA, 818-246-3806 x  
Products: portable
- ELENEX, INC. (WEST)**  
7392 Trade St.  
San Diego, CA 92121  
(619) 566-7515, 800-225-3113, in CA 800-225-8037, FAX# 619-586-1484  
V.P.: Dennis Berglund  
Engineering: Al Bitarafan  
Sales: Lou Hennequin  
Products: signal processing amplifiers
- FM Acoustics Limited (USA)  
PO Box 854  
Benicia, CA 94510  
(707) 745-4444  
Pres.(FM Acoustics LTD): Manuel Huber  
Dir.(FM Acoustics USA): Gene Michalski
- Fanon Courier  
14281 Chambers Road  
Tustin, CA 92680  
(714) 669-9890, 800-345-1354, FAX# 714-669-1081  
Pres.: Frank Blaha  
Director Sales/Mkt'g: Murray Trotiner  
Director of Engineering: Miguel Santana  
Products: 70-volt amplifiers
- Fender Musical Instrument Corp.  
1130 Columbia Street  
Brea, CA 92621  
(714) 990-0909, FAX# 714-990-3986  
Mgr. Pro Audio: Cal Perkins
- Len Finkler Company  
80 Alexdon Road  
Downsview, Ontario M3J2B4  
(416) 630-9103
- Fostex Corp. of America  
15431 Blackburn Ave.  
Norwalk, CA 90650  
(213) 921-1112, FAX# 213-802-1964  
Pres.: Y. Abe  
Exec. V.P./General Mgr.: Fred Huang  
V.P. Sales/Mkt'g: Mark Cohen  
Products: bi-amp systems, dual-channel, monitor amplifiers
- Gallien-Krueger  
1355 Dell Ave.  
Campbell, CA 95008
- (408) 379-3344, FAX# 408-379-0247  
Pres./CEO: Bob Gallien  
Exec. V.P.: Rich Krueger  
Mkt'g Communications: John Griesel  
Artist Relations: Jim Ross  
Production Mgr.: Bill Apfel
- (HME) HM Electronics, Inc.  
PO Box 261669  
6675 Mesa Ridge Rd.  
San Diego, CA 92121  
(619) 535-6060, FAX# 619-452-7207  
Pres.: Harry Y. Miyahira  
V.P.: Donald Kutz  
Director of Mkt'g: J. Michael Hughes  
Nat'l Sales Mgr.: Randy Opela  
Mkt'g Coordinator: Tonnia B. Sills
- Hacoustic USA, Inc.  
209 August Rd  
N. Babylon, NY 11703  
(516) 242-6205  
Pres.: Bert Aarts  
Sales Ass.: Ursula Aarts
- David Hafler Company, Div. of Rockford Corp.  
5910 Crescent Blvd.  
Pennsauken, NJ 08109  
(609) 662-6355, 800-932-0730, FAX# 609-662-9173  
Direct. Mkt'g/Products Div.: R. Tucker  
Products: dual-channel, monitor amplifiers



**HARRIS CORPORATION, DRACON DIVISION**  
809 Calle Plano  
Camarillo, CA 93010  
(805) 987-9511, 800-437-2266, FAX# 805-987-2547  
V.P./General Mgr.: John R. Mason  
V.P. Sales & Mkt'g.: Jack McGuigan  
Director of Sales: Tom Erdmann  
Paging Prod. Mgr.: Tom Johnson  
Metals/Racks/Tools Prod. Mgr.: Terry Smith  
Test Sets Prod. Mgr.: John Akins  
Don Bivens, Lake Elsinore, CA, 714-672-2168  
Gary Foster, Columbia, MD, 314-442-2288

# No One Takes The Rigors Of The Road As Seriously As BGW.

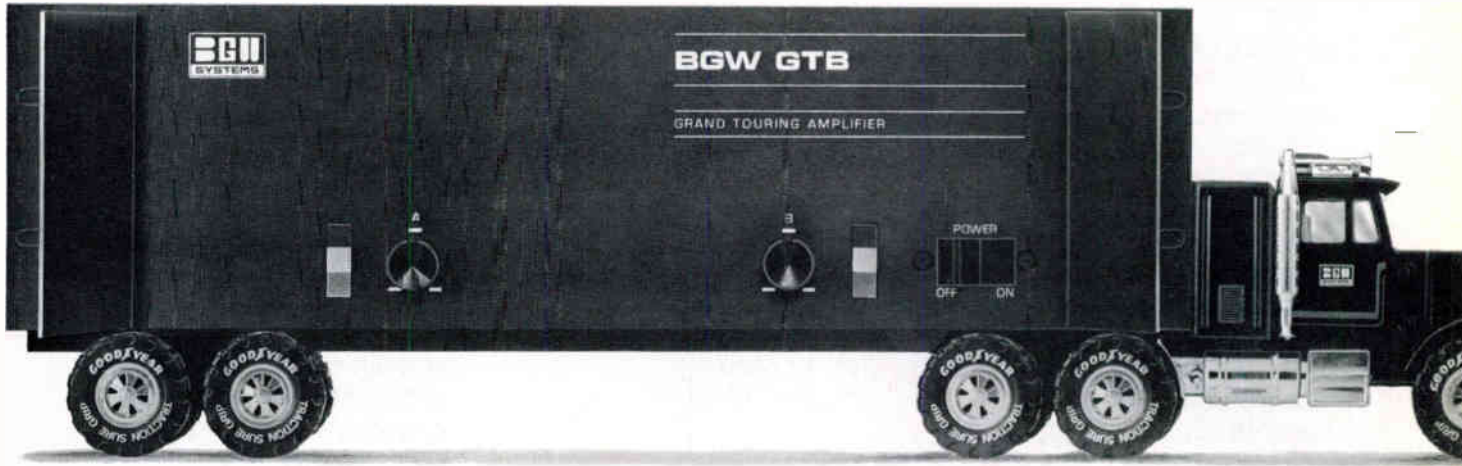

It's true. Next to BGW Grand Touring Amplifiers, other so-called touring amps are just "tourists." Our Grand Touring Amps deliver the power, performance and features you need on the road. And they're built to keep on doing the job under conditions that send other amps packing.

Take our new heavy-duty model **GTB**. You won't find this combination of road-ready features in a Crown Macro-Tech, a QSC Series III, or ANY other power amp (except our own flagship model **GTA**).

- One-piece welded steel chassis withstands rough rides and load-outs.
- Forced-air cooled, massive extruded aluminum heat sinks provide continuous operation in hot, crowded racks.
- Two ohm capability allows BGW amps to drive more speakers with fewer amps — saving money and rack space.
- Magnetic circuit breaker/front panel power switch affords instant overload protection. (You have to pull a Crown out of the rack to change a 20¢ fuse!)
- DC Crowbar speaker protection — a BGW first since 1971 — provides positive protection for expensive speakers, without relays.
- Modular construction means fast, easy field service.
- 100% discrete circuitry (no IC's) with low feedback delivers superb sonic performance.

- Active balanced inputs with looping XLR-type connectors provide greater than 70 dB common mode rejection — some of our competitors don't even spec this crucial parameter. Optional transformer-isolated inputs offer absolute isolation.
- Switchable subsonic filters protect low frequency drivers from excursion limit damage.
- Crossover capability — two BGW cross-over cards can be mounted in our touring amps, safe from abuse.
- Large LED indicators maintain readability across the stage.

A touring amp with all these essentials, plus legendary BGW reliability and sonic integrity, will make our competition nervous — especially since the GTB costs no more than their "comparable" amps. Too bad for them. But peace of mind for you, when you go with BGW Grand Touring Amplifiers.

You know a professional tour is no place for "tourists." (And neither is a fixed-location amp rack, right?) So call BGW Systems toll free at **1-800-468-AMPS** (in USA and Canada) to arrange a demo of our new "workhorse" model **GTB** or the "2.4 Horsepower" model **GTA**.



BGW SYSTEMS INC.  
13130 SOUTH YUKON AVE.  
HAWTHORNE, CA 90250  
Tel: 213-973-8090  
Fax: 213-676-6713

**ENGINEERED TO BE THE BEST**



Rob Lincoln, Melbourne, FL, 407-259-0991

Mark Skilowitz, Newfield, NJ, 609-697-4580

Jim Fetterer, Seattle, WA, 206-243-7762

Bill Boone, Libertyville, IL, 312-816-1080

Dave Whelan, W. Springfield, MA, 413-731-9552

Products: 70-volt amplifiers

#### Hill Audio, Inc.

5002B N. Royal Atlanta Dr.  
Tucker, GA 30084

(404) 934-1851, FAX# 404-934-1840

Sales Mgr.: Bob Allen

Svce Mgr.: Rick Rogers

Innovative Sales and Marketing, Irvine,  
CA, 714-549-7770

Ouzunoff and Assoc., Yorktown  
Heights, NY, 914-245-6452

Products: dual-channel

#### Holophonics

1120 Ave. of the Americas, Ste.4270  
New York, NY 10036

(212) 787-7767

#### IED Innovative Electronic Designs, Inc.

9701 Taylorsville Rd  
Louisville, KY 40299

(502) 267-7436, FAX# 502-267-9070

V.P. Mkt'g & Sales: Tom Roseberry

Mkt'g Assistant: Wanda R. Martin

Pres.: Hardy Martin

Sec./Treas.: Ray Allen

V.P. R & D: Robert Ponto

Derek Allen Assoc., Toluca Lake, CA,  
818-840-8327

Bensik Assoc., Ocala, FL, 904-732-9775

Plus 4 Marketing, Pleasant Hill, CA,  
415-937-0650

Yore Company, White Bear Lake, MN,  
612-770-9760

Products: 70-volt amplifiers, modular  
amplifiers, single-channel, zone-  
paging amplifiers

#### Ibanez/Hoshino (USA), Inc.

1726 Winchester Road  
Bensalem, ID 19020

(215) 638-8670, 800-669-8262, FAX#  
215-245-8583

#### Industrial Research Products, Inc.

321 Bond St.

Elk Grove Village, IL 60007

(312) 439-3600, 800-255-6993, FAX#  
312-640-9607

Pres.: Robert G. Roth

General Mgr.: Mahlon Burkhard

Mkt'g Mgr.: Roger Carroll

Chief Engineer: Richard Peters

Piper Assoc., Inc., Needham, MA, 617-  
449-1144

Products: 70-volt amplifiers, dual-  
channel

#### Industry West Electronics

270 N. Geneva Rd. .

Orem, UT 84057

(801) 226-1000

#### JBL PROFESSIONAL

8500 Balboa Blvd

Northridge, CA 91329

(818) 893-8411, FAX# 818-893-3639

Pres.: Ron Means

V.P. Sales: Ken Lopez

V.P. Mkt'g: Mark Gander

Applications Engineer: Drew Daniels

Mkt'g Mgr./Sound Contracting: Steve  
Romeo

Video Sales: Don Wilson

Neil Conly, Bedford, TX, 817-540-3066

Bill Hamilton, Folsom, PA, 215-543-  
4677

Steve Armstrong, Northridge, CA, 818-  
707-2529

Tom Walter, Barrington, IL, 312-382-  
4925

Products: dual-channel

#### Johnson Electronics, Inc.

4301 Metric Drive

Winter Park, FL 32792

(407) 677-4030, FAX# 407-679-1288

Pres./CEO: A.J. Schell

V.P. Mkt'g: Robert W. Peters

V. P./Engineering: Ken St. John

Products: 70-volt amplifiers, telephone  
paging amplifiers, zone-paging  
amplifiers

#### KDM Electronics, Inc.

705 Progress Ave., Unit #59

Scarborough, Ontario, Canada M7H  
2X1

(416) 439-7158

Pres.: Ron Bull

Products: portable, single-channel

#### LVW Electronics

2400 Naegele Road

Colorado Springs, CO 80904

(719) 471-8430

Mkt'g: Rusty Griffith

Products: signal processing amplifiers

#### Leitch Video Limited

10 Dyas Road

Don Mills, Ontario, Canada M3B1V5

(416) 445-9640, 800-387-0233

Leitch Video of America, Inc.,  
Chesapeake, VA 23320

Leitch Video of America, Inc., Grass  
Valley, CA, 95945

#### Magna-Sound

5501 108th St.

Corona, NY 11368

(718) 271-5200

Pres.: Ben Frankenstein

Sales Mgr.: J. Miner

Secretary: D. Shupack

Products: mixer amplifiers, portable

#### McGohan Electronics, Inc.

1033 Fairway Dr.

Bensenville, IL 60106

(312) 595-2342

Pres.: Jim McGohan

Sec./Treas.: Rosalie (McGohan) Monk

Chief Engineer: Bill Everhart

Production & Svcs: Ronald Johnston  
Austin Assoc., Willingboro, NJ, 609-  
871-9290

Irv Brown Company, Brooklyn, NY,  
718-493-1379

Ted Firaneck Sales Company, Pontiac,  
MI, 313-373-9595

Don Forth Assoc., City of Industry, CA,  
818-333-8009

Givan Associates, West Boylston, MA,  
617-835-3161

J. W. Lehner, Stow, OH, 216-686-1965

Maish Sales Company, Mulberry, IN,  
317-296-2322

Meyer Marketing, Deerfield Beach, FL,  
305-481-9250

Murphy & Cota, Inc., Atlanta, GA, 404-  
875-2525

Chuck Olson Assoc., Renton, WA, 206-  
226-2112

KC Marketers, Littleton, CO

Rancilio Assoc., St. Louis, MO, 314-  
631-3326

R.W. Sales, St. Paul, MN, 612-646-  
2710

# CAN AMERICA COMPETE?



## YOU BE THE JUDGE.

SPECIFICATIONS	RAYMER 9012	TOA A-912A	SPECIFICATIONS	RAYMER 9012	TOA A-912A
<b>OUTPUT POWER</b> 120 watts RMS.	Yes	Yes	<b>CONTROLS</b> 6 Input gain controls; 1 Bass tone control; 1 Power ON/OFF switch; 1 Tone defeat switch; 1 Master gain control; 1 Treble tone control; 1 Link switch; 1 Low-cut (60Hz/6dB octave). <i>Built-in locking of front panel controls.</i> 1 Adjustable EQ bypass control (rear panel). 1 Remote master volume (rear panel).	Yes	Yes
<b>POWER BAND WIDTH</b> Direct: 20 – 20,000Hz ± 1dB, 0.5% THD. Transformer: 50 – 20,000Hz ± 1dB, 0.5% THD.	Yes	Yes	<b>INTERNAL BUSS STRUCTURE</b> <i>Independent signal processing buss. Standard screw terminal mute connection (rear panel).</i> 2 Separate mute busses (rear panel). Full module compatibility.	Yes	No
<b>FREQUENCY RESPONSE</b> Direct: 20 – 20,000Hz ± 1dB. Transformer: 20 – 15,000Hz ± 1dB. Transformer: 20 – 20,000Hz + 1dB, -3dB.	Yes	Yes	<b>DIMENSIONS</b> 145mm high x 420mm wide x 315mm deep; 5.71" x 16.54" x 12.4". Rack-mounting space: 5.21".	Yes	Yes
<b>INPUTS</b> 6 Input Ports. 1 bridging Input/Output.	Yes	Yes	<b>COLOR</b>	Black	Silver
<b>OUTPUTS</b> Transformer: 8 ohms, 25 & 70 volts, balanced. Direct: 4 ohms, unbalanced. Aux: 10k ohms, (1 volt).	Yes	Yes	<b>OTHER FEATURES</b> 5-sec. delay of output connection after power switched on. <i>Automatic resetting thermal overload on power transformer.</i>	Yes	Yes
<b>SIGNAL TO NOISE RATIO</b> (BAND PASS 20 – 20,000Hz, TONE CONTROLS CENTERED) Master volume min: 90dB. Master volume max: 77dB. Power amplifier only: 105dB.	Yes	Yes		Yes	No
<b>TONE CONTROLS</b> Bass: ± 10dB at 100Hz. Treble: ± 10dB at 10kHz.	Yes	Yes			

TOA specifications per 833-61-702-80

### Raymer's 9012 vs. TOA's A-912A

Take a look at the six-channel 120 watt Raymer Model 9012 Modular Mixer Power Amplifier! It's TOA compatible. Interchangeable with TOA's A-912A in both installation and application. And it accepts *all* TOA 900 Series plug-in modules.

Compare them feature for feature, spec by spec: the made-in-the-USA Raymer 9012 not only competes — it *surpasses* the TOA import with *seven* unique engineering features for added performance and useability. Then check our pricing and compare the value — the Raymer 9012 is the clear competitive choice! For more information write or call today.

 **Cetec Raymer**

Commercial sound products division of Cetec Corporation

13278 Ralston Avenue  
Sylmar, CA 91342-7607  
818-362-9516  
FAX 818-367-5292

Sunrise Sales Company, Romeoville,  
IL, 815-886-6034  
Brian Trankle & Assoc., Belmont, CA,  
415-595-4004

McMartin International, Inc.  
111 Camino Dil Rio  
Gunnison, CO 81230  
(303) 641-5500  
Pres.: Ray R. McMartin  
Financial Adm.: Robert W. McMartin  
Dir. of Engineering: Robert German  
Dir. of Manufacturing: Wayne Allen  
Dir. of Supplies/Prod.: Louise Rundock

Meyer Sound Laboratories, Inc.  
2832 San Pablo Ave.  
Berkeley, CA 94702  
(415) 486-1166, FAX# 415-486-8356  
Pres.: John Meyer  
V.P.: Helen Meyer  
Mkt'g/Sales Mgr.: Gary Hudson

Millbank Electronics Group Ltd.  
Bellbrook Industrial Estate  
Uckfield, East Sussex, England TN22  
1QL  
(0) 0825-4811

Chairman/Chief Exec.: A. E. Walker  
Sales/Mkt'g Director: D. H. Eaton  
App. Engineer Dir.: D. G. G. Edworthy  
Director - CTSD: B. A. Skinner  
App. Engineer: C. K. Pike

Numark Electronics  
503 Newfield Ave.  
Edison, NJ 08837  
(201) 225-3222, FAX# 201-287-2155  
Pres.: Harry Kotovsky  
V.P.: Robert Kotovsky  
Numark/PPD, Simi Valley, CA, 805-  
522-3550  
Products: mixer amplifiers

Panasonic Ind.  
50 Meadowlands Parkway, M.S. 2A-8  
Secaucus, NJ 07094  
(201) 392-4050, FAX# 201-392-4436  
Dept. Mgr.: Frank Orrow  
Resident Mgr.: Art Hagiwara  
Tech. Support Supervisor: George  
Lidlow  
Accts Mgr.: Howard Anderson

Panasonic Industrial Company/Ramsa  
6550 Katella Ave

Cypress, CA 90630  
(714) 895-7278, FAX# 714-895-7242  
Nat'l Sales/Mkt'g: Steve Wooley  
Eastern Sales Mgr.: D.J. Bierut  
Central Sales Mgr.: Greg Braithwaite  
Western Sales Mgr.: James Murray  
Pusecker Sales, Upper Montclair, NJ,  
201-744-1834

Professional Audio Associates,  
Burlington, MA, 617-229-6050  
David Prinzi, Webster, NY, 716-671-  
9266

World Wide Electronics, Pembroke  
Pines, FL, 305-584-7024  
World Wide Electronics, Jacksonville,  
FL

Evans Sales & Mkt'g, Nashville, TN,  
615-297-7997  
A/V Mkt'g, Carmel, IN, 317-846-1034  
Key Mkt'g, Plymouth, MI, 313-459-  
6040

New Horizons Elec. Mkt'g,  
Bannockburn, IL, 312-234-5911  
J.B. Parent Co., Dublin, OH, 614-764-  
0064

Music Interventions & Assoc., Kansas  
City, MO, 816-453-4448  
Tenicki & Assoc., Houston, TX, 713-  
528-2005

New West Audio, Burbank, CA, 818-  
955-9706

Brian Trankle Assoc., Belmont, CA,  
415-595-4004

Brian Trankle Assoc., Sacramento, CA,  
916-369-7030

Northmar, Seattle, WA, 206-524-5170  
Pearson & Pearson, Denver, CO, 303-  
722-6996

Products: dual-channel, low-frequency  
amplifiers, portable, single-channel,  
telephone paging amplifiers

Parasound Products, Inc.  
945 Front St.  
San Francisco, CA 94111  
(415) 397-7100, FAX# 415-397-0144  
Pres.: Richard Schram  
Sales & Mkt'g: Bonnie Perella  
Technical Svcs: Rich Rogers

Paso Sound Products  
14 First St.  
Pelham, NY 10803-1495  
(914) 738-4800, FAX# 914-738-3954  
Executive V.P.: Paul Mastrangelo  
Sales Mgr.: David Moore  
Product Mgr.: Ken Obrien  
Credit Mgr.: Marilyn Beckerson

## YOU ARE ABOUT TO BE SEDUCED BY POWER AND MONEY



### PHYSICAL ATTRIBUTES

1100A/500 WATTS PER CH AT 8 OHMS  
775 WATTS PER CH AT 4 OHMS  
1,050 WATTS PER CH AT 2 OHMS  
SUGGESTED RETAIL \$1,149.00

900A/325 WATTS PER CH AT 8 OHMS  
525 WATTS PER CH AT 4 OHMS  
725 WATTS PER CH AT 2 OHMS  
SUGGESTED RETAIL \$959.00

CONTACT AB INTERNATIONAL FOR FULL FEATURES AND DEALER INFORMATION



**AB INTERNATIONAL ELECTRONICS, INC.**  
1830-6 Vernon Street, P.O. Box 1105  
Roseville, CA 95678  
(916) 783-7800 (So. Cal: 714/951-7435)





# Audio.

**I**t's the dawn of a new era in audio. U.S. Audio Products are high-quality, American-made audio tools designed with practicality and budget in mind. We proudly introduce them to you...

## PHMS-1 PERSONAL HEADPHONE MONITOR SYSTEM



The PHMS-1 Personal Headphone Monitor System is a modular monitor/mixing network that can grow according to your needs. Its two basic components, the PHMAS Master Module and the PHSAT Satellite module, give you everything you need for almost any application.

12 clean watts per channel allow the

PHMAS to power up to 32 sets of headphones, while its 4 inputs, complete with volume and pan controls provide you with total flexibility.

The PHSAT Satellite Module has 2 channels, each with 2 headphone outputs; separate L&R volume controls and stereo/mono switches for unequalled control.

If you need extra inputs, the PHEX-8 gives you 8 more, bringing the total to 12. It interfaces directly to the PHMAS via a special jack which provides power and audio signals for the PHEX-8.

The basic system is comprised of one PHMAS and one PHSAT, however all components are available separately.

## P40-2 40 WATT STEREO POWER AMPLIFIER



Our P40-2, is a 2-channel, 40 watt per-channel power amplifier designed for situations that don't require its high-powered relatives. Low noise, a conservative power rating, and it's one-

space rack size make the P40-2 one of the handiest power amplifiers on the market and one of the most useful audio tools you'll own.

## MIX-5 5 CHANNEL MIXER



The MIX-5 is U.S. Audio's single-space rack mountable five channel monophonic mixer. Four balanced low microphone or four high impedance/line level inputs and one summed stereo auxiliary input, plus a ten-segment LED level indicator combine to make the MIX-5 a welcome addition to anyone's "audio toolbox".

Brand New From...



**PRODUCTS**

Made in the USA  
By Whirlwind  
PO Box 1075 Rochester, NY 14603  
716-663-8820

Operations Mgr.: Anthony Sguelgia  
All West Electronics, Camarillo, CA,  
805-388-1789

Anderson Sales, Braintree, MA, 617-  
848-9194

Pace Sales, Charlotte, NC, 704-365-  
3216

De Witt Austin Co., Alpharetta, GA,  
404-442-1326

Dowell Assoc., St. Louis, MO, 314-  
849-4234

Mountain Representatives, Denver, CO,  
303-623-0972

J.Y.S. Comm. Co., Dallas, TX, 214-  
349-1650

Lienau Assoc., Inc., Columbia, MD,  
301-621-4113

Lienau Assoc., Inc., New Town, PA,  
215-860-2100

SLK Tech Rep, San Francisco, CA,  
415-822-4884

Miguel Lopez, Hialeah, FL, 305-822-  
6853

Marketline, Snellville, GA, 404-972-  
9048

Messnick Sales, Liverpool, NY, 315-  
622-3211

Miller Assoc., Ltd., Greenwich, CT,  
212-840-2866

Robert Milsk Co., Inc., Southfield, MI,  
313-354-3310

Robert Milsk Co., Indianapolis, IN, 317-  
842-3400

Weller Electronic Sales, Worthington,  
OH, 614-885-7819

Frank Lintern Assoc., Naperville, IL,  
312-983-0935

Products: 70-volt amplifiers, dual-  
channel, mixer amplifiers, modular  
amplifiers, portable, telephone paging  
amplifiers, zone-paging amplifiers

Peavey Architectural Acoustics Division  
PO Box 2898  
711 A Street  
Meridian, MS 39301  
(601) 483-5376, FAX# 601-484-4278  
Prod Mgr.: Ken Valentine  
Products: 70-volt amplifiers, mixer  
amplifiers

Peavey Electronics Corp.  
PO Box 2898  
711 A Street  
Meridian, MS 39301  
(601) 483-5365, FAX# 601-484-4278  
Prod Mgr.: Ken Valentine

Products: dual-channel, monitor  
amplifiers, portable, single-channel

Perreaux/GMI Distributors  
5000 Birch St, Ste.3000,W. Tower  
Newport Beach, CA 92660  
(no Listing)

Power Solutions, Inc.  
10681 Haddington, # 190  
Houston, TX 77043  
(713) 932-9847, 800-345-9130  
Pres.: Peter Cole  
Mkt'g Mgr.: Glenn Messerschmitt

Powertronix  
10623 Lawson River Ave.  
Fountain Valley, CA 92708  
(714) 963-5411  
Pres.: Robert Gehlke  
Sales Mgr.: Bill Organ

### PRECISION ELECTRONICS, INC.

9101 King St.  
Franklin Park, IL 60131  
(312) 678-5350  
Pres.: William S. Grommes  
CE A.A. Hart  
Sales Mgr.: William Stow  
General Mgr.: G. Hussain  
Products: 70-volt amplifiers, dual-  
channel, mixer amplifiers, monitor  
amplifiers, single-channel, telephone  
paging amplifiers

### PROTECH AUDIO CORP.

Flowerfield, Bldg. #1  
St. James, NY 11780  
(516) 584-5855  
Sales Mgr.: Bill Murphy  
Sales Engineering: Joe Giambone  
Peregrine Rep's, Houston, TX, 713-  
772-6765



QSC Audio Products, Inc.  
1926 Placentia Ave  
Costa Mesa, CA 92627  
(714) 645-2540, 800-854-4079, FAX#  
714-645-7927  
Director of Mkt'g: Greg McVeigh  
Nat'l Sales Mgr.: Peter Kalmen  
Sales Engineer: Andy Murray

Products: 70-volt amplifiers, bi-amp  
systems, dual-channel, mixer  
amplifiers, monitor amplifiers, signal  
processing amplifiers, single-channel,  
telephone paging amplifiers, tri-amp  
systems, zone-paging amplifiers

### RTS SYSTEMS, INC.

1100 West Chestnut St  
Burbank, CA 91506  
(818) 840-7119, FAX# 818-843-7953  
Pres.: Robert A. Smith  
V. P. Mkt'g: Douglas Leighton  
Sales Mgr.: Shelley Harrison  
Systems Engineer: Dave Brand  
Systems Engineer: Gene Behrend  
V.P. Engineering: Stan Hubler  
Products: dual-channel, mixer  
amplifiers, modular amplifiers,  
monitor amplifiers, portable

Ramko Research, Inc.  
11355 "A" Folsom Blvd.  
Rancho Cordova, CA 95670  
(916) 635-3600

Randall Corporation  
PO Box 51327  
1132 Duryea Ave.  
New Berlin, WI 53151  
(414) 784-3730, 800-854-0529, FAX#  
414-784-9258  
Pres.: Chuck Faas  
Nat'l Sales Mgr.: Bill Acton  
Regional Mgr.: Jody Carver  
Regional Mgr.: Bill McDaniel  
Regional Mgr.: Bob Seidman  
Regional Mgr.: B & B Marketing  
Bill McDaniel, Indianapolis, IN, 317-  
823-4206  
B & B Marketing, Concord, CA  
Jody Carver, Somers, NY, 914-248-  
5806  
Bob Seidman, Ft. Lauderdale, FL, 305-  
581-5666

### RANE CORP.

10802 49th Ave. W.  
Everett, WA 98204-3400  
(206) 355-6000, FAX# 206-347-7757  
V.P. Mkt'g: Larry Winter  
Dir. Tech. Mkt'g: Terry Pennington  
Sales Coordinator: Debbie Cooksey  
Products: 70-volt amplifiers



Richmond Sound Design, Ltd.  
 1234 West 6th Ave.  
 Vancouver, Canada V6H 1A5  
 (604) 734-1217, FAX# 604-734-3901  
 Systems/Sales Mgr.: Damon Wootten  
 Accounts Mgr.: Marilyn Williams  
 Project Coordinator: Linda Pearson  
 Full Compass Systems, Madison, WI,  
 Products: 70-volt amplifiers, modular  
 amplifiers, zone-paging amplifiers

SCS/Sound Code Systems  
 PO Box 2198  
 13932 Seaboard Circle  
 Garden Grove, CA 92643  
 (714) 554-0903, FAX# 714-554-5643  
 Pres.: Marvin Halverson  
 V.P.: Kevin Halverson  
 Sales Mgr.: Tim Edwards

**SMC INTERNATIONAL, INC.**  
 2505 N. 24th St.  
 Omaha, NE 68110  
 (402) 453-0332, 800-456-9107, FAX#  
 402-451-2876  
 Chief Op. Officer: Jay B. McMartin  
 Sales Mgr.: Larry Y. Wiedman  
 Dir. of Engineering: Richard L. Diercks  
 Miller & Associates, Richardson, TX,  
 214-437-5733  
 Central Mkt'g Group, Kansas City, MO,  
 816-741-7460  
 Products: 70-volt amplifiers, mixer  
 amplifiers, modular amplifiers, single-  
 channel, telephone paging amplifiers,  
 zone-paging amplifiers

SWR Engineering, Inc.  
 12734 Branford St. #7  
 Pacoima, CA 91331  
 (818) 899-3061, FAX# 818-896-8385  
 Pres.: Steve Rabe  
 Sales & Mkt'g Mgr.: Rick Carlson

St. Louis Music  
 1400 Ferguson Ave.  
 St. Louis, MO 63133  
 (314) 727-4512, 800-325-8148, FAX#  
 314-727-8929  
 Sales Training Dir.: Tony Moscal  
 Product Mgr.: Gary Byers  
 Dir. of Operations: John Karpowicz  
 Pres.: Gene Kornblum

Sescom, Inc.  
 2100 Ward Dr.  
 Henderson, NV 89015

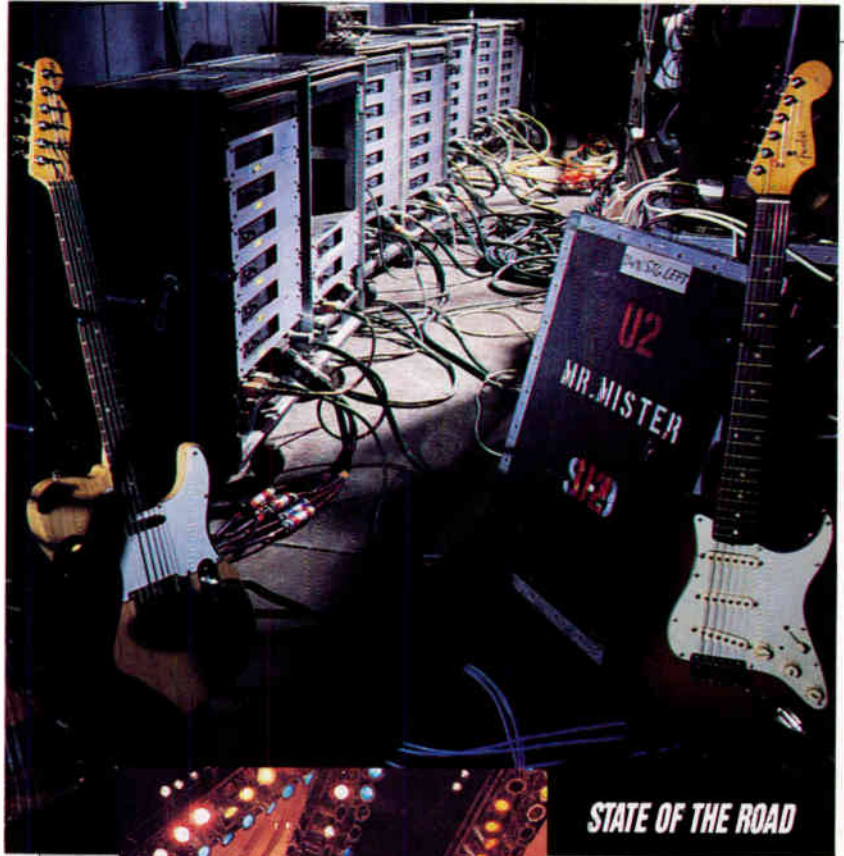

**STATE OF THE ROAD**

**T**here is no magic involved in Carver Professional's incredible power-to-weight ratio. But there is a great deal of intelligence.

## **CARVER PROFESSIONAL**



Please write or call for our new full color brochure:  
 20121 48th Avenue West • P.O. Box 1237 • Lynnwood, WA 98046 • (206) 775-1202



(702) 565-3400, FAX# 702-565-4828  
Products: monitor amplifiers, signal processing amplifiers

## Sontec Electronics, Inc.

Audio Dr.  
Goldbond, VA 24094  
(703) 626-7256  
Sales Mgr.: Burgess Macneal  
Products: mixer amplifiers, modular amplifiers, signal processing amplifiers

## Soundcraftsmen

2200 S. Ritchey  
Santa Ana, CA 92705  
(714) 556-6191, FAX# 714-662-0750  
Sales & Mkt'g Mgr.: Roger Hagemeyer  
Chief Engineer: Paul Rolfes  
Customer Svce Mgr.: Darryl Paulsen  
Component Marketers, Leonia, NJ, 201-947-9300  
Protech Marketing, Newport Beach, CA, 714-650-5633  
New Resource, Norwell, MA, 617-659-1463  
Mid America, Milwaukee, WI, 414-742-2211  
Summit Sales, Wylie, TX, 214-442-6052

## Soundtech

230 Lexington Dr.  
Buffalo Grove, IL 60089  
(312) 541-3520, 800-323-4173, FAX# 312-541-3616  
Pres.: Rudy Schlacher  
Sales Mgr.: Keith Brawley  
Sales Director: Len Brawling  
Products: bi-amp systems, dual-channel, mixer amplifiers

## Speco Div., Components Specialties, Inc.

PO Box 624  
1172 Rt. 109  
Lindenhurst, NY 11757  
(516) 957-8700, 800-645-5516, FAX# 516-956-9142  
V.P./Sales: Mel Hulkower  
V.P./General Mgr.: Jim Ganci  
Sales Mgr.: Eric Forman  
Products: 70-volt amplifiers

## Spectra Sonics

3750 Airport Rd.  
Ogden, UT 84405  
(801) 392-7531

Pres./Owner: William G. Dilley  
Engineer/Sales: Gregory D. Dilley  
William Watkins, Merrick, NY, 516-546-5374

## Stewart Electronics Corp.

11460 Sunrise Gold Circle, Suite B  
Rancho Cordova, CA 95742  
(916) 635-3011, FAX# 916-635-1787  
Nat'l Sales/Mkt'g Mgr.: James M. Ruse  
Applied Audio, Asheville, NC, 704-252-9313  
Cambridge Pro Sales, Westerville, OH, 614-890-8144  
GMC, Springfield, PA, 215-544-5884  
Pacific Audio Group, Torrance, CA, 213-375-2611  
Future Sales, Redmond, WA, 206-868-5577  
JAMM Dist., Flossmoor, IL, 312-799-0550  
McManus Music Sales, MN, 612-432-5321  
On the Road Mrkt., Upper Montclair, NJ, 201-746-0501  
Pro Sound & Light, Lakewood, CO, 303-986-5999  
RPM Sales, Carrollton, TX, 214-446-3010  
B. Trankle & Assoc., Belmonti, CA, 415-595-4004  
Pro Sound Assoc., Jacksonville, FL, 904-744-1170  
Products: monitor amplifiers

## Sunn Musical Equipment Corporation

1130 Columbia Street  
Brea, CA 92621  
(714) 990-0909, 800-854-6230, FAX# 714-990-3986  
Pres.: Bill Schultz  
Director of Mkt'g: Joe Green  
Products: dual-channel, mixer amplifiers, monitor amplifiers, portable

## Symetrix, Inc.

4211 24th Ave. West  
Seattle, WA 98199  
(206) 282-2555, 800-288-8855, FAX# 206-282-5504  
Pres.: Dane Butcher  
Mkt'g Director: Doug Schauer  
Mkt'g/Sales Admin: Lavina Speer  
Products: monitor amplifiers

## TOA ELECTRONICS, ENGINEERED SOUND & COMMUNICATIONS DIVISION

PO Box 2047  
601 Gateway Boulevard  
South San Francisco, CA 94080  
(415) 588-2538, 800-843-4750, in CA 800-632-2157, FAX# 415-588-3349  
Pres.: Yoshiro Ishida  
Director of Mkt'g: Fred Fredericks  
Nat'l Sales Mgr.: Richard Krochmal  
Nat'l Sales Mgr./Engineered Intercom & Security Div.: Al Burns  
Products: dual-channel, mixer amplifiers, modular amplifiers, portable, telephone paging amplifiers

## Tannoy North America, Inc.

300 Gage Ave, Unit 1  
Kitchener, Ontario, Canada N2M 2C8  
(519) 745-1158, FAX# 519-745-2364  
Managing Director: Wib Heuckroth  
Sales/Mkt'g Mgr.: Bill Calma  
Credit Mgr.: Kathy Kent  
Sales: Rob Hofkamp  
Parts/Svce Mgr.: Ivan Frivarski  
Audio Assoc., Glenwood, MD, 301-854-6122  
Hot House Productions, Highland, NY, 914-691-6077  
Disc Mastering, Nashville, TN, 615-254-8825  
Technical Marketing, Atlanta, GA, 404-457-0988  
The TK Group, Loveland, CO, 801-298-8902  
World Wide Electronics, Pembroke Pines, FL, 305-966-6622  
Protech Marketing, Newport Beach, CA, 714-723-0498  
Powerlines Marketing, Evanston, IL, 312-864-1147  
Blackhawk Marketing, Pacific Palisades, CA, 213-454-8196  
JMS Marketing, Austin, TX, 512-266-1113  
Bob White & Assoc., Solon, OH, 216-248-1317  
Pro Musica Sales, Keene, NH, 603-352-4831  
Products: bi-amp systems, dual-channel, monitor amplifiers, single-channel  
Tape-Athon Corp.  
13633 Crenshaw Blvd.  
Hawthorne, CA 90250  
(213) 676-6752  
Pres.: Leon E. "Lee" Tate

# When adequate is no longer good enough.

## MPS 2300



In today's highly competitive business environment you need every advantage you can get. Adequate is no longer good enough. Leading businesses are gaining an advantage by installing high performance foreground systems to provide their customers an enhanced listening environment. At QSC, we have brought our reputation as a leading manufacturer of amplifiers to the foreground. The MPS 2300 is the first professional music and paging system combining advanced mixer/preamp, signal processing, and power amplifier technology in a simple to use package. The MPS 2300 enables businesses to use high performance integrated music and paging systems to their full advantage.

So, when adequate is no longer good enough . . .

# QSC

A U D I O

QSC AUDIO PRODUCTS, INC.  
1926 PLACENTIA AVE.  
COSTA MESA, CA 92627 (714) 645-2540

General Mgr.: Robert Haller  
 Director Engineering: Bernard Sayers  
 Director Mkt'g: John Bagley  
 Sales Coordinator: Bob Mayfield  
 Sales Mgr.: Rick Bottom  
 Chuck Olson Assoc., Renton, WA, 206-271-5416  
 Warren Assoc., Santa Clara, CA, 408-988-7762  
 Greg Dzubay & Assoc., Peoria, AZ, 602-979-2358  
 Spivey-Leboeuf Assoc., Richardson, TX, 214-231-3190  
 Central Marketing Group, Kansas City, MO, 816-741-7460  
 John E. M. Anderson, Minneapolis, MN, 612-823-6459  
 Gustafson System Sales, Palatine, IL, 312-358-2505  
 Avcom, Inc., N. Olmsted, OH, 216-777-2060  
 Elmarcon, Inc., Indianapolis, IN, 317-846-0221  
 Saga, Oswego, NY, 315-343-5739  
 Pinz Sales Corp., Rockville Centre, NY, 516-678-6887  
 ASR Enterprises, LTD., Fallston, MD, 301-893-0001  
 Murphy & Cota, Atlanta, GA, 404-875-2525  
 Bencsik Assoc., Ocala, FL, 904-732-9775  
 Design Factors, La Habra Heights, CA, 213-697-7576  
 Products: 70-volt amplifiers, mixer amplifiers, monitor amplifiers, telephone paging amplifiers

Target Technology  
 PO Box 609  
 Penn Valley, CA 95946  
 (916) 639-2102

### 3M SOUND PRODUCTS

223-5S-09, 3M Center  
 St. Paul, MI 55144-1000  
 (612) 733-9214, FAX# 612-736-9433  
 Mkt'g Mgr.: Richard G. Barker  
 Sales Mgr.: Don Sluder  
 Products: 70-volt amplifiers, mixer amplifiers

### UREI

8500 Balboa Blvd.  
 Northridge, CA 91329  
 (818) 893-8411, FAX# 818-893-3639  
 Pres.: Ron Means

V.P. Sales: Ken Lopez  
 V.P. Mkt'g: Mark Gander  
 Applications Engineer: Drew Daniels  
 Mkt'g Mgr. Sound Contracting: Steve Romeo  
 Neil Conly, Bedford, TX, 817-540-3066  
 Bill Hamilton, Folsom, PA, 215-543-4677  
 Steve Armstrong, Northridge, CA, 818-707-2529  
 Tom Walter, Barrington, IL, 312-382-4925  
 Products: dual-channel

### UNIVERSITY SOUND, ELECTRO VOICE, INC.

600 Cecil St  
 Buchanan, MI 49107  
 (616) 695-6831  
 Pres.: Robert D. Pabst  
 V.P. Sales and Mkt'g: Paul McGuire  
 Chief Engineer: Alan Watson  
 Mkt'g Mgr./Comm. Products: W. Douglas Wilkens  
 George M. Conneen Co., Inc., Springfield, PA, 215-544-5884  
 Metropolis Audio Marketing, Inc., Edison, NJ, 201-225-0085  
 R.J. Marketing Ltd., Rockville, MD, 301-251-0330  
 The Smith Company, Hartford, CT, 203-523-0512  
 Ron Tunks Sales, Inc., Tamarac, FL, 305-722-2803  
 Wilson Audio Sales, Nashville, TN, 615-646-4477  
 Audio Resources, Westmont, IL, 312-655-1180  
 B.C. Electronic Sales, Inc., Mission, KS, 913-262-1720  
 Jones Audio Sales, Plano, TX, 214-867-0202  
 C.L. Pugh & Assoc., Inc., Columbus, OH, 614-486-9678  
 Riley & Petchell Sales, Inc., Detroit, MI, 313-937-3000  
 Loppnow & Assoc., Redmond, WA, 206-883-3205  
 Radon & Assoc., Sacramento, CA, 916-923-2524  
 Silver Peak Marketing Ltd., Wheat Ridge, CO, 303-467-9042  
 Western Audio Sales, Glendale, CA, 818-246-3806  
 Products: 70-volt amplifiers, bi-amp systems, mixer amplifiers

Van Etten Audio Labs  
 PO Box Drawer 667  
 P.O. Drawer 667  
 Shelby, NC 28151-0667  
 (704) 434-9365  
 Pres.: David Cantrell



### VIBRATION TECHNOLOGY, LTD.

1950 Ellesmere Road, Unit #12  
 Scarborough, ONT, Canada M1H 2V8  
 (416) 438-9320, FAX# 416-439-1937  
 Pres.: Adrian Ball  
 V.P.: Harry Gandhi  
 Products: 70-volt amplifiers, bi-amp systems, dual-channel, low-frequency amplifiers, mixer amplifiers, modular amplifiers, monitor amplifiers, portable, signal processing amplifiers, single-channel, telephone paging amplifiers, tri-amp systems, zone-paging amplifiers

Wheelock, Inc.  
 273 Branchport Ave.  
 Long Branch, NJ 07740  
 (201) 222-6880, FAX# 201-222-8707  
 Pres.: P. W. Tarlton  
 V.P. Mkt'g/Sales: W.L. Goldstein  
 Mkt'g Mgr./Telephone-Paging: Art Arlow  
 Tech. Support Engineer: W. Best  
 Products: 70-volt amplifiers, low-frequency amplifiers, telephone paging amplifiers, zone-paging amplifiers

### PROFESSIONAL AUDIO DIVISION, YAMAHA MUSIC CORPORATION, USA

PO Box 6600  
 6600 Orangethorpe Ave.  
 Buena Park, CA 90622  
 (714) 522-9011, FAX# 714-739-2680  
 Products: 70-volt amplifiers, bi-amp systems, dual-channel, low-frequency amplifiers, mixer amplifiers, monitor amplifiers, signal processing amplifiers, tri-amp systems



# AUDIO-VISUAL PRODUCTS/CONTROL SYSTEMS

## AUDIO-VISUAL EQUIPMENT/SYSTEMS

### AIPHONE INTERCOM SYSTEMS

PO Box 90075  
1700 130th Ave. N.E.  
Bellevue, WA 98005  
(206) 455-0510, FAX# 206-455-0071  
Pres.: Hiko Shinoda  
Nat'l Sales: Jim Morrison  
Products: intercom

### ARGOS PRODUCTS CO.

600 S. Sycamore St.  
Genoa, IL 60135  
(815) 784-5118  
Pres.: Donald C. MacLaughlin  
Sales/V.P.: Ron Evers  
Credit Mgr.: Rosella Johnson  
Chief Engineer: Loren Schrader  
Purchasing Agent: Ray Melton  
Ted Firaneck Sales, Pontiac, MI, 313-373-9595  
Nevco, Inc., Kansas City, MO, 816-421-1751  
W.A. Hendrickson Co., N. Scituate, MA, 617-545-0652  
Maish Sales, Mulberry, IN, 317-296-2322  
TMC Sales, Ft. Lee, NJ, 201-944-8340  
Shamrock Sales, Dayton, OH, 513-258-1227  
Pacnor Marketing, Lynwood, WA, 206-771-6016  
Murphy & Cota, Atlanta, GA, 404-875-2525  
Mel Foster Tech. Sales, Edina, MN, 612-941-9800  
Bensik Assoc., Ocala, FL, 904-732-9775  
Stinson Assoc, Havertown, PA, 215-446-8585  
Lewis & Dunnigan, Syracuse, NY, 315-446-5522  
G. MCL Cole Co., Parkridge, IL, 312-692-6040  
Wes Tech. Marketing, Culver City, CA, 213-837-1398  
Products: lecturns

### Atlas/Soundolier

1859 Intertech Dr.  
Fenton, MO 63026  
(314) 349-3110, FAX# 314-349-1251  
V.P. Sales: Tom Erickson  
E. Region/Sales: Andy Musci  
W. Region/Sales: Bud Waters  
V.P./Mkt'g Consultant: Herbert Jaffe  
Products: A/V speakers, intercom

### Audisar

PO Box 1561  
Bellevue, WA 98009  
(206) 454-2040  
Owner: R. Munger  
Products: A/V speakers, audio for A/V, boardroom sound systems, closed-loop audio systems, interface units

### Auditel Systems, Ltd.

396 Porter Ave.  
Buffalo, NY 14201  
(716) 886-0019, FAX# 716-886-1615  
Pres.: David Langtry  
Prod. Mgr.: Tony Roberson  
Mkt'g Director: Jim Wood  
Products: audio for A/V, boardroom sound systems, closed-loop audio systems, computer control, electronic displays, intercom, interface units, multi-media controls

Bretford Mfg. Co., Inc.  
9715 Soreng Ave.  
Schiller Park, IL 60176

Califone International, Inc.  
21300 Superior St.

## IT'LL COST YOU \$480\* TO READ THIS AD.

When you hear about our four input by four output mixer/buffer amplifier, you'll definitely want to buy one. Or maybe a dozen.

Internal jumper blocks let you assign any of four inputs to any or all of the four outputs.

Channels can be mixed before or after  $\pm 15$ dB of gain adjustment.

And the Oxmoor 4x4 delivers +24dBm levels on balanced XLR connectors.

Write or call us at (205) 942-6779. And we'll tell you where to send the money. \*SUGGESTED PRO USER NET.



### THE OXMOOR 4X4 BUFFER AMPLIFIER

Oxmoor Corporation, 237 Oxmoor Circle, Birmingham, AL 35209

Chatsworth, CA 91311  
 (800) 682-5300, 800-722-0500, FAX#  
 818-407-2414  
 Mkt'g: Loretta Blinn

Crestron Electronics, Inc.  
 101 Broadway  
 Cresskill, NJ 07626  
 (201) 894-0660, FAX# 201-894-1192  
 Sales Mgr.: George Herbert  
 Dealer Sales Director: Patricia Large  
 Products: image projectors, interface  
 units, multi-media controls, wireless  
 control

D.O. Industries  
 317 East Chestnut St.  
 E. Rochester, NY 14445  
 (716) 385-4920

Da-Lite Screen Co., Inc.  
 PO Box 137  
 Warsaw, IN 46580  
 (219) 267-8101, FAX# 219-267-7804

**LEE DAN COMMUNICATIONS**

155 Adams Ave.  
 Hauppauge, NY 11788-3699  
 (516) 231-1414, 800-533-3261, FAX#  
 516-231-1498  
 Pres.: Leon Goldberg  
 V.P. Operations: Lawrence J. Goldberg  
 V.P. Finance/Admin.: David H.  
 Goldberg  
 Sr. Technician: Sandy Hoffman  
 Customer Svce: Linda E. Scaturro  
 Production Sup.: Gabriel Figueroa  
 Products: intercom

**J. W. DAVIS & CO.**

PO Box 26177  
 3030 Canton Street  
 Dallas, TX 75226  
 (214) 651-7341, 800-527-5705, in TX  
 800-442-1564, FAX# 214-939-0328  
 Pres.: Charles Griffith  
 V.P. Sales: Jack W. Tucker  
 Chief Engineer: Mike Lamm  
 Products: A/V speakers

**Eddor**

1948 East Pomona  
 Santa Ana, CA 92705  
 (714) 648-0292, 800-854-0259, FAX#  
 714-648-0117  
 Pres.: Larry Weston  
 Office Mgr.: Phyllis Weston

Sales Mgr.: Deanna Weston  
 Products: audio for A/V, boardroom  
 sound systems

**FSR, INC.**

220 Little Falls Road  
 Cedar Grove, NJ 07009  
 (201) 239-0988, FAX# 201-239-7708  
 Pres.: William Fitzsimmons  
 V.P.: Janice Sandri  
 Engineering Mgr.: Joseph Fischer  
 Applications Engineer: George Braen  
 Design Factors, LaHebra Heights, CA,  
 213-697-7576  
 Brian Trankle, Belmont, CA, 415-595-  
 4004

Ziskind Assoc., Rolling Meadows, IL,  
 312-577-1624

Richard Pass Assoc., Langhorne, PA,  
 215-757-6100

Henry W. Phillips Co., Roswell, GA,  
 404-992-3070

Avwest, Inc., Fountain Hills, AZ, 602-  
 946-1811

Burcaw Co., Warren, MI, 313-573-  
 4605

Sigmat Corp., Freehold, NJ, 201-462-  
 1221

Meyer Marketing, Deerfield Beach, FL,  
 305-481-9250

Monfort Electronics, Indianapolis, IN,  
 317-872-8877

Pancor Marketing, Lynnwood, WA,  
 206-771-6010

Peregrine Southwest, Houston, TX,  
 713-589-8481

Piper Assoc., Needham, MA, 617-449-  
 1144

Products: computer control, interface  
 units, multi-media controls, wireless  
 control

**Florence Corp.**

2101 N. Elston Ave.  
 Chicago, IL 60614  
 (312) 384-3310, FAX# 312-384-3460  
 Pres.: Lloyd A. Schooley

V.P. General Mgr.: John J. Martino

V.P. Sales: Donald A. Cannella

Nat'l Sales Mgr.: George Jans intercom

**Fostex Corp. of America**

15431 Blackburn Ave.  
 Norwalk, CA 90650  
 (213) 921-1112, FAX# 213-802-1964

Pres.: Y. Abe  
 Exec. V.P./General Mgr.: Fred Huang  
 V.P. Sales/Mkt'g: Mark Cohen  
 Products: A/V speakers, audio for A/V

**GBE Group**

PO Box 118  
 Fair Oaks, CA 95628  
 (916) 967-5946  
 Pres.: Robert Bird  
 V.P.: George Anderson

**Hudson Photographic Industries**

Irvington-On-Hudson  
 , NY 10533  
 (914) 591-8700

**JBL PROFESSIONAL**

8500 Balboa Blvd  
 Northridge, CA 91329  
 (818) 893-8411, FAX# 818-893-3639

Pres.: Ron Means  
 V.P. Sales: Ken Lopez  
 V.P. Mkt'g: Mark Gander

Applications Engineer: Drew Daniels  
 Mkt'g Mgr./Sound Contracting: Steve  
 Romeo

Video Sales: Don Wilson

Neil Conly, Bedford, TX, 817-540-3066

Bill Hamilton, Folsom, PA, 215-543-  
 4677

Steve Armstrong, Northridge, CA, 818-  
 707-2529

Tom Walter, Barrington, IL, 312-382-  
 4925

Products: image projectors

**Niles Audio Corporation**

12331 SW 130th Street  
 Miami, FL 33116  
 (305) 238-4373, FAX# 305-238-0185  
 Pres.: Ivan Zuckerman

**Omni Q, Inc.**

1122 Fur Ave., Bldg. A  
 Blaine, WA 98230  
 (206) 384-1750

**Opamp Labs, Inc.**

1033 N. Sycamore Ave.  
 Los Angeles, CA 90038  
 (213) 934-3566  
 Chief Engineer: B. Losmandy

P/H Electronics, Inc.  
117 E. Helena St.  
Dayton, OH 45404  
(513) 461-5898, 800-336-2219  
Sales Coordinator: Donna C. Martin

Panasonic Industrial Company/Ramsa  
6550 Katella Ave  
Cypress, CA 90630  
(714) 895-7278, FAX# 714-895-7242  
Nat'l Sales/Mkt'g: Steve Wooley  
Eastern Sales Mgr.: D.J. Bierut  
Central Sales Mgr.: Greg Braithwaite  
Western Sales Mgr.: James Murray  
Pusecker Sales, Upper Montclair, NJ,  
201-744-1834

Professional Audio Associates,  
Burlington, MA, 617-229-6050  
David Prinzi, Webster, NY, 716-671-  
9266

World Wide Electronics, Pembroke  
Pines, FL, 305-584-7024

World Wide Electronics, Jacksonville,  
FL

Evans Sales & Mkt'g, Nashville, TN,  
615-297-7997

A/V Mkt'g, Carmel, IN, 317-846-1034  
Key Mkt'g, Plymouth, MI, 313-459-  
6040

New Horizons Elec. Mkt'g,  
Bannockburn, IL, 312-234-5911

J.B. Parent Co., Dublin, OH, 614-764-  
0064

Music Interventions & Assoc., Kansas  
City, MO, 816-453-4448

Tenicki & Assoc., Houston, TX, 713-  
528-2005

New West Audio, Burbank, CA, 818-  
955-9706

Brian Trankle Assoc., Belmont, CA,  
415-595-4004

Brian Trankle Assoc., Sacramento, CA,  
916-369-7030

Northmar, Seattle, WA, 206-524-5170

Pearson & Pearson, Denver, CO, 303-  
722-6996

Products: audio for A/V

Paso Sound Products

14 First St.  
Pelham, NY 10803-1495  
(914) 738-4800, FAX# 914-738-3954

Executive V.P.: Paul Mastrangelo

Sales Mgr.: David Moore

Product Mgr.: Ken Obrien

Credit Mgr.: Marilyn Beckerson

Operations Mgr.: Anthony Squeglia

All West Electronics, Camarillo, CA,  
805-388-1789

Anderson Sales, Braintree, MA, 617-  
848-9194

Pace Sales, Charlotte, NC, 704-365-  
3216

De Witt Austin Co., Alpharetta, GA,  
404-442-1326

Dowell Assoc., St. Louis, MO, 314-  
849-4234

Mountain Representatives, Denver, CO  
303-623-0972

J.Y.S. Comm. Co., Dallas, TX, 214-  
349-1650

Lienau Assoc., Inc., Columbia, MD,  
301-621-4113

Lienau Assoc., Inc., New Town, PA,  
215-860-2100

SLK Tech Rep, San Francisco, CA,  
415-822-4884

Miguel Lopez, Hialeah, FL, 305-822-  
6853

Marketline, Snellville, GA, 404-972-  
9048

Messnick Sales, Liverpool, NY, 315-  
622-3211

Miller Assoc., Ltd., Greenwich, CT,  
212-840-2866

Robert Milsk Co., Inc., Southfield, MI,  
313-354-3310

Robert Milsk Co., Indianapolis, IN, 317-  
842-3400

Weller Electronic Sales, Worthington,  
OH, 614-885-7819

Frank Lintern Assoc., Naperville, IL,  
312-983-0935

Products: boardroom sound systems,  
intercom, lecturns

QSC Audio Products, Inc.

1926 Placentia Ave  
Costa Mesa, CA 92627

(714) 645-2540, 800-854-4079, FAX#  
714-645-7927

Director of Mkt'g: Greg McVeigh  
Nat'l Sales Mgr.: Peter Kalmen

Sales Engineer: Andy Murray

Products: boardroom sound systems

-Research Technology International

4700 W. Chase Ave.

Lincolnwood, IL 60646-168

## **What else do Disney, LucasFilm, MGM and Universal have in common?**

*Stewart screens. The very best made. Now you can enjoy your programs on the screens that are specified by the best eyes in the business. Call your audio/visual dealer today for a quotation on your own custom Stewart screen. Put yourself in the director's chair and view your images the way they appear on the screens of the major studios.*

# **Stewart** Filmscreen Corp.

*Ask anyone who really knows.*

1161 W. Sepulveda, Torrance, CA 90502 • (213) 326-1422

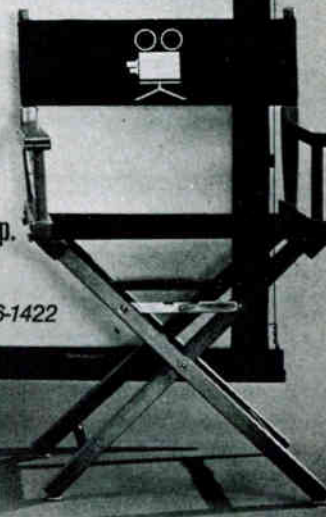



(312) 677-3000, 800-323-7520, FAX#  
312-677-1300

Pres.: Ray L. Short, Jr.  
Chairman: Howard Bowen  
V.P. Sales: Thomas Tisch  
CFO: Richard Peterson  
V.P. Production: Ralph Fisher  
Advertising Mgr.: Sherwin Berger  
Products: supplies

#### Sescom, Inc.

2100 Ward Dr.  
Henderson, NV 89015  
(702) 565-3400, FAX# 702-565-4828  
Products: interface units

#### Sharp Electronics Corp./Professional

Products Division  
PO Box 650  
Mahwah, NJ 07430-2135  
(201) 529-8731, FAX# 201-529-9636  
Pres.: S. Hirooka  
General Mgr.: Robert Garbutt  
Sales Mgr.: Ron Colgan  
Mkt'g Mgr.: Bruce Pollack  
Prod. Engineering Mgr.: Peter  
Gloeggler  
Svce Mgr.: Jeff Cohen

#### Stewart Filmscreen Corp.

1161 Sepulveda Blvd.  
Torrance, CA 90502  
(213) 326-1422, 800-762-4999, FAX#  
213-326-6870  
V.P. Mkt'g: Donald Stewart  
Customer Svce: Sue Beardsley  
CEO: Pat Stewart  
Products: screens

#### TOA ELECTRONICS, ENGINEERED SOUND & COMMUNICATIONS DIVISION

PO Box 2047  
601 Gateway Boulevard  
South San Francisco, CA 94080  
(415) 588-2538, 800-843-4750, in CA  
800-632-2157, FAX# 415-588-3349  
Pres.: Yoshiro Ishida  
Director of Mkt'g: Fred Fredericks  
Nat'l Sales Mgr.: Richard Krochmal  
Nat'l Sales Mgr./Engineered Intercom &  
Security Div.: Al Burns  
Products: A/V speakers, audio for A/V

#### Telephone Components, Inc.

3180 Expressway Dr., S.  
Central Islip, NY 11722

(516) 582-4745  
Products: intercom

#### Telex Communications, Inc., Pro Audio Dept.

9600 Aldrich Ave. S.  
Minneapolis, MN 55420  
(612) 884-4051, FAX# 612-884-0043  
Chairman of the Board: Ansel Kleiman  
Exec. V.P.: Jeffrey Wetherell  
V.P. Mkt'g: James Arrington  
Director of Mkt'g: Donald Mereen  
Director of Advertising: Ronald Taylor  
Wes-Tech Marketing, Culver City, CA,  
213-870-9286

Bencsik Assoc., Ocala, FL, 904-732-  
9775

Monfort Electronic Marketing,  
Indianapolis, IN, 317-872-8877

Mountain Representatives, Inc.,  
Denver, CO, 303-623-0972

Murphy & Cota, Inc., Atlanta, GA, 404-  
875-2525

Northland Assoc., Moorhead, MN, 218-  
233-4616

White Radio Ltd., Burlington, Ontario,  
Canada, 416-632-6894

Rancilio Assoc., Inc., St. Louis, MO,  
314-631-3326

SAGA, Oswego, NY, 315-343-5739

Sigmat Corporation, Valley Forge, PA,  
215-783-6666

J.Y. Schoonmaker Co., Dallas, TX,  
214-349-1650

Weller Electronic Sales, Worthington,  
OH, 614-885-7819

Ziskind Assoc., Rolling Meadows, IL,  
312-577-1624

Burcaw Company & Assoc., Warren,  
MI, 313-573-4605

S&F Northwest, Seattle, WA, 206-622-  
6036

Lichtenauer & Associates, Antioch, CA,  
415-757-1200

Products: audio for A/V, image  
projectors, intercom, wireless control

#### Telex Communications, Inc., Audio/Visual Dept.

9600 Aldrich Ave. S.  
Minneapolis, MN 55420  
(612) 887-5531, FAX# 612-884-0043  
Pres.: John Howe

Sales Mgr.: Jerry Hines

Sales Mgr.: John Serio

Director of Mkt'g: Dan Paulnock

Sales Mgr.: Jerry B. Wade

Touch Technologies, Inc./Gerr  
Electroacoustics Ltd.

363 Adelaide St. E.

Toronto, Ontario M5A 1N3

(416) 865-1877, FAX# 416-868-6419

Pres./Dir. of Engineering: W.R.

Snelgrove

#### UNIVERSITY SOUND, ELECTRO VOICE, INC.

600 Cecil St  
Buchanan, MI 49107

(616) 695-6831

Pres.: Robert D. Pabst

V.P. Sales and Mkt'g: Paul McGuire

Chief Engineer: Alan Watson

Mkt'g Mgr./Comm. Products: W.

Douglas Wilkens

George M. Conneen Co., Inc.,  
Springfield, PA, 215-544-5884

Metropolis Audio Marketing, Inc.,  
Edison, NJ, 201-225-0085

R.J. Marketing Ltd., Rockville, MD,  
301-251-0330

The Smith Company, Hartford, CT,  
203-523-0512

Ron Tunks Sales, Inc., Tamarac, FL,  
305-722-2803

Wilson Audio Sales, Nashville, TN, 615-  
646-4477

Audio Resources, Westmont, IL, 312-  
655-1180

B.C. Electronic Sales, Inc., Mission,  
KS, 913-262-1720

Jones Audio Sales, Plano, TX, 214-  
867-0202

C.L. Pugh & Assoc., Inc., Columbus,  
OH, 614-486-9678

Riley & Petchell Sales, Inc., Detroit, MI,  
313-937-3000

Loppnow & Assoc., Redmond, WA,  
206-883-3205

Radon & Assoc., Sacramento, CA,  
916-923-2524

Silver Peak Marketing Ltd., Wheat  
Ridge, CO, 303-467-9042

Western Audio Sales, Glendale, CA,  
818-246-3806

Products: A/V speakers, audio for A/V

#### PROFESSIONAL AUDIO DIVISION, YAMAHA MUSIC CORPORATION, USA

6600 Orangethorpe Ave.

Buena Park, CA 90622 PO Box 6600

(714) 522-9011, FAX# 714-739-2680

Products: A/V speakers, boardroom  
sound systems

# REMOTE CONTROLS

**AMX**  
 12506 Forestgate Dr.  
 Dallas, TX 75243  
 (214) 644-3048, 800-222-0193, FAX#  
 214-907-2053  
 Pres.: Scott Miller  
 Nat'l Sales Mgr.: Ron Suttle  
 Products: A/V, audio level, boardroom,  
 custom, hardwired, microprocessor,  
 video, wireless

**Audio Access**  
 363-A Vintage Park Drive  
 Foster City, CA 94404  
 (415) 341-9620, FAX# 415-341-0168  
 Mkt'g: Chris Stevens  
 Products: A/V

**Audio Systems Company**  
 PO Box 1174  
 1815 Michigan Ave.  
 Bismarck, ND 58502

(701) 223-3800, 800-852-6522  
 Pres.: Lynn Mader  
 V.P.: Lyle Mader  
 Sales Mgr.: Mark Schmidt  
 Products: audio level, boardroom,  
 custom, DTMF, EQ/remote,  
 microprocessor, remote monitoring

**Auditel Systems, Ltd.**  
 396 Porter Ave.  
 Buffalo, NY 14201  
 (716) 886-0019, FAX# 716-886-1615  
 Pres.: David Langtry  
 Prod. Mgr.: Tony Roberson  
 Mkt'g Director: Jim Wood  
 Products: audio level, boardroom,  
 custom, hardwired, microprocessor,  
 remote monitoring

**Crestron Electronics, Inc.**  
 101 Broadway  
 Cresskill, NJ 07626  
 (201) 894-0660, FAX# 201-894-1192

Sales Mgr.: George Herbert  
 Dealer Sales Director: Patricia Large  
 Products: A/V

**Ethereal Concepts**  
 210 Golden Gate Drive  
 Dayton, OH 45459-4329  
 (513) 433-8610  
 Owner: Lonnie Domnitz  
 Admin. Ass.: Jackie Rice  
 Products: custom

**FSR, INC.**  
 220 Little Falls Road  
 Cedar Grove, NJ 07009  
 (201) 239-0988, FAX# 201-239-7708  
 Pres.: William Fitzsimmons  
 V.P.: Janice Sandri  
 Engineering Mgr.: Joseph Fischer  
 Applications Engineer: George Braen  
 Design Factors, LaHebra Heights, CA,  
 213-697-7576

**Q:** Wondering who makes an 1800-watt amplifier? And where you can find a rack to put it in?

**A:** You'll find the answers in the 1988/89 *Sound & Communications Blue Book Directory.*

Brian Trankle, Belmont, CA, 415-595-4004

Ziskind Assoc., Rolling Meadows, IL, 312-577-1624

Richard Pass Assoc., Langhorne, PA, 215-757-6100

Henry W. Phillips Co., Roswell, GA, 404-992-3070

Avwest, Inc., Fountain Hills, AZ, 602-946-1811

Burcaw Co., Warren, MI, 313-573-4605

Sigmat Corp., Freehold, NJ, 201-462-1221

Meyer Marketing, Deerfield Beach, FL, 305-481-9250

Monfort Electronics, Indianapolis, IN, 317-872-8877

Pancor Marketing, Lynnwood, WA, 206-771-6010

Peregrine Southwest, Houston, TX, 713-589-8481

Piper Assoc., Needham, MA, 617-449-1144

Products: A/V, boardroom, custom, hardwired, microprocessor, video, wireless

#### Gentner RF Products

PO Box 32550

San Jose, CA 95152

(408) 926-3400, FAX# 408-926-6699

Pres.: John E. Leonard, Jr.

#### Monroe Electronics, Inc.

100 Housel Ave.

Lyndonville, NY 14098

(716) 765-2254

Pres.: W.E. Vosteen

Exec. V.P.: B.D. Ives

Applications Engineer: Roland Phillips

Products: DTMF, hardwired, microprocessor, remote monitoring, video

#### Musically Intelligent Devices

3 Brian St.

Commack, NY 11725

(516) 864-1683

#### OXMOOR CORPORATION

237 Oxmoor Circle

Birmingham, AL 35209

(205) 942-6779, FAX# 205-942-9633

Pres.: Lynn A. McCroskey

Production Mgr.: Jim Watson

Nat'l Sales Mgr.: Richard Mitchell

Allwest Electronics, Camaville, CA, 805-388-1789

Dimension IX Marketing, Dallas, TX, 214-348-9657

Loppnow & Assoc., Redmond, WA, 206-883-3205

Yore Company, White Bear Lake, MN, 612-770-9760

Repworks, Chicopee, MA, 413-533-0845

Products: audio level, boardroom, EQ/remote

#### PROTECH AUDIO CORP.

Flowerfield, Bldg. #1

St. James, NY 11780

(516) 584-5855

Sales Mgr.: Bill Murphy

Sales Engineering: Joe Giambone

Peregrine Rep's, Houston, TX, 713-772-6765

#### Sontec Electronics, Inc.

Audio Dr.

Goldbond, VA 24094

(703) 626-7256

Sales Mgr.: Burgess Macneal

Products: audio level, EQ/remote

#### Swintek Enterprises, Inc.

587 Division St.

Campbell, CA 95008

(408) 378-8091, FAX# 408-378-6980

Pres.: William P. Swintek

Cinequip, Inc., Toronto, Ont., CD, 416-920-5424

Maga Techtronics, Artarmon, NSW, Australia, 02-438-3377

Commercial Electronics, Vancouver B.C., CD, 604-669-5525

#### Teatronics, Inc./Lighting Innovations

3100 McMillan Road

San Luis Obispo, CA 93401

(805) 544-3555, 800-235-4107, FAX#

805-544-3703

## THE VITAL LINK



### The SP-3R

Our SP-3R unit is a solid state, fully wired AC Switcher which mounts in your equipment rack in just minutes and allows full sequencing on both power up and power down, unlimited expansion capability and full remote control. Just plug it in and it's ready to operate.

Other features of the SP-3R are:

- Self-contained 24V, 2.5 amp fully regulated power supply with short circuit protection
- Switched and unswitched 24V and ground available on five-way binding post
- Front panel circuit breakers for main and amplifier power
- All connections are pluggable
- LED indication of operation on front panel
- All electrical components are UL listed

**FSR inc.** **POWER PRODUCT GROUP**

creators of innovative products for AV systems

220 Little Falls Road ■ Cedar Grove, NJ 07009

201-239-0988 ■ FAX: 201-239-7708



Video Link, Division of Xantech Corp.  
 12950 Bradley Ave.  
 Sylmar, CA 91342  
 (818) 362-0353, FAX# 818-362-9506  
 Pres.: Herb Seymour  
 Nat'l Sales Mgr.: David B. Lorsch  
 V.P. Operations: Jim Barthell  
 Sales Coordinator: Leslie Pierce  
 Products: audio level, hardwired, video,  
 wireless

**PROFESSIONAL AUDIO DIVISION,  
 YAMAHA MUSIC CORPORATION, USA**  
 PO Box 6600  
 6600 Orangethorpe Ave.  
 Buena Park, CA 90622  
 (714) 522-9011, FAX# 714-739-2680  
 Products: EQ/remote

York Controls  
 1111 S. Sherman  
 Dallas, TX 75081  
 (214) 234-2126, FAX# 214-234-2176  
 Mkt'g: Bruce Christianson  
 Products: audio level, boardroom,  
 custom, wireless

## TELECONFERENCING SYSTEMS

Ansett Technologies, Inc.  
 7595 E. Gray Rd.  
 Scottsdale, AZ 85260  
 (602) 483-2956, FAX# 602-998-8805

Boulder, CO 80306  
 (303) 530-9580

Engineering Mgr.: Joseph Fischer  
 Applications Engineer: George Braen  
 Design Factors, LaHebra Heights, CA,  
 213-697-7576

Auditel Systems, Ltd.  
 396 Porter Ave.  
 Buffalo, NY 14201  
 (716) 886-0019, FAX# 716-886-1615  
 Pres.: David Langtry  
 Prod. Mgr.: Tony Roberson  
 Mkt'g Director: Jim Wood  
 Products: automixing, manual

Compression Labs, Inc.  
 2860 Junction Ave.  
 San Jose, CA 95134  
 (408) 435-3000, 800-538-7542, FAX#  
 408-922-5429  
 Pres.: John Tyson  
 Exec. V.P./Sales & Mkt'g: John Walsh  
 V.P. Sales: Ted Augustine  
 V.P. Int'l Sales: Carl Marszewski  
 V.P. Mkt'g: Kathy Reavis

Brian Trankle, Belmont, CA, 415-595-  
 4004

Ziskind Assoc., Rolling Meadows, IL,  
 312-577-1624

Richard Pass Assoc., Langhorne, PA,  
 215-757-6100

Henry W. Phillips Co., Roswell, GA,  
 404-992-3070

Avwest, Inc., Fountain Hills, AZ, 602-  
 946-1811

Burcaw Co., Warren, MI, 313-573-  
 4605

Sigmat Corp., Freehold, NJ, 201-462-  
 1221

Meyer Marketing, Deerfield Beach, FL,  
 305-481-9250

Monfort Electronics, Indianapolis, IN,  
 317-872-8877

Pancor Marketing, Lynnwood, WA,  
 206-771-6010

Peregrine Southwest, Houston, TX,  
 713-589-8481

Piper Assoc., Needham, MA, 617-449-  
 1144

Products: manual, microphone specific

Avtec Industries, Inc.  
 5 Audrey Place  
 Fairfield, NJ 07006  
 (201) 882-9460, FAX# 201-882-9468  
 Chairman: James Gore  
 V.P. Mkt'g: Gary McAuliffe  
 V.P. Engineering: Ron Henderson  
 Pres.: Dave Lipsky  
 V.P. Manufacturing: Richard Cramer  
 Account Exec.: Richard Wright

DIS-USA  
 2831 15th St. NW  
 Washington, DC 20009  
 (202) 387-7934  
 Pres.: Jack Cassell  
 V.P.: Michael E. Bier

Eby Co.  
 2751 Southampton Rd.  
 Philadelphia, PA 19154  
 (215) 969-4200

Bozak, Inc.  
 326 South St  
 New Britain, CT 06051-3721  
 (203) 225-0555  
 Pres.: Donald D. Bowers  
 Dir. of Mkt'g: William J. Kieltyka  
 Chief Engineer: Sheldon Glick

Eddor  
 1948 East Pomona  
 Santa Ana, CA 92705  
 (714) 648-0292, 800-854-0259, FAX#  
 714-648-0117

Pres.: Larry Weston  
 Office Mgr.: Phyllis Weston  
 Sales Mgr.: Deanna Weston  
 Products: automixing

CMX Communications  
 1111 Industry Ave.  
 Roanoke, VA 24013  
 (703) 982-3900  
 Mkt'g: Charlie Rowland  
 Products: telephone interface

**FSR, INC.**  
 220 Little Falls Road  
 Cedar Grove, NJ 07009  
 (201) 239-0988, FAX# 201-239-7708  
 Pres.: William Fitzsimmons  
 V.P.: Janice Sandri

Gentner Electronics Corporation  
 PO Box 27647  
 Salt Lake City, UT 84127-0647  
 (801) 975-7200, FAX# 801-977-0087  
 Pres.: Russell Gentner  
 Dir. of Mkt'g/Sales: Elaine Jones  
 Dir. of Engineering: William Gillman

Microvoice Corporation  
 1 Vanderbilt  
 Irvine, CA 92718  
 (714) 859-1091, FAX# 714-951-7405

Pres.: Gregory Peacock  
V.P. Sales: Mike Bugg



Rauland-Borg Corp.  
3535 W. Addison St.  
Chicago, IL 60618  
(312) 267-1300, FAX# 312-267-1127  
Pres.: William Krucks

Sr. V.P./Sales & Mkt'g: Kenneth T. James  
Chief Engineer: Lawrence Gleason  
Nat'l Sales Mgr.: Rick Blunt  
Harry B. Hahn, Olathe, KN, 913-829-9427  
William C. Zophy, Ft. Myers, FL, 813-433-4766  
Harold De Vaney, Dickinson, TX, 713-337-1040  
Hank Plaisier, El Toro, CA, 714-837-2626  
Vince Ward, Vashon Island, WA, 206-463-5582

Joseph A. Ciotti, Claymont, DE, 302-798-6558  
William Lewis, Louisville, KY, 502-491-4273  
Raymond Bailey, Granville, IL, 815-339-6789  
Rauland-Borg Inc., Mississauga, ONT., CD, 416-821-2225  
Jim Welch, Scarborough, ONT., CD, 416-438-4756  
Products: automixing, manual, microphone specific, microprocessor, telephone interface



## FAST LEARNER

The IRL-1 Infrared Learner from York Controls is an easy solution to a tough dilemma in the systems business — interfacing to infrared controlled equipment.

Designed to complete the connection between contact closures and virtually ANY infrared controlled equipment, the IRL-1 allows you to use a professional remote control system with consumer and industrial VCRs, tape decks and monitors without modifications, black boxes or hassles.

### IRL-1 Infrared Learner

- Learns infrared commands from the hand controls provided with the equipment.
- Stores up to 12 infrared functions from any number or type of devices.
- "Plays Back" commands using monetary contact closures from switches or relays.
- Uses fiber optic cable for low noise, no modification connection to controlled equipment.
- Multiple IRL-1s may be linked for unlimited command capability.
- Carries the exclusive York 3 Year Warranty.



1111 South Sherman Street • Richardson, Texas 75081 • 800-234-2126  
214-234-2126 • TELEX 204751 YORK-UR

A.V. TECHNOLOGY • SARNER AUDIO VISUAL • SOUTHAM AUDIO VISUAL GROUP  
AUSTRALIA UK CANADA  
61-3-836-7500 441-743-1288 416-533-6511

Sound Control Technologies, Inc.  
114A Washington Street  
Norwalk, CT 06854  
(203) 854-5701, FAX# 203-854-5703  
Pres.: Adolph Neaderland  
Sales: David Neaderland  
Meyer Marketing, Boca Raton, FL, 305-481-9250  
Powerlines Mkt'g, Evanston, IL, 312-864-1147  
Franklin Communications, N.Wholes, PA, 215-643-3031  
A/V Mkt'g, Ft. Worth, TX, 817-246-7166  
Repworks, Chicopee, MA, 413-533-0845  
KBZ Communications, Furlaong, PA, 215-348-9481

Studer Revox America, Inc.  
1425 Elm Hill Pike  
Nashville, TN 37210  
(615) 254-5651, FAX# 615-256-7619  
Dir./Prof. Dealer Prod.: David C. Bowman  
Mgr. Studer Direct Sales: Chris Ware  
New York, NY, 212-255-4462  
Dallas, TX, 214-943-2239  
Los Angeles, CA, 818-780-4234  
San Francisco, CA, 415-930-9866  
Pro Audio LTD, Chicago, IL, 312-526-1660  
Products: telephone interface

**UNEX, A DYNATECH COMPANY**  
PO Box 574  
3 Lyberty Way  
Westford, MA 01886  
(508) 692-9505, FAX# 508-692-9409  
Pres.: John D. Ela  
Nat'l Sales Mgr.: Robert L. Birch  
Customer Svce Mgr.: Catherine M. Koch  
Products: telephone interface

# BACKGROUND/FOREGROUND SYSTEMS

## BACKGROUND/FOREGROUND SYSTEMS & LIBRARIES

AEI Music Network, Inc.  
900 E. Pine St.  
Seattle, WA 98122  
(206) 329-1400, 800-831-8001  
V.P.: Jack D. Craig  
Reg. Mgr. Dealer Sales: Denny  
Thompson  
AEI, Chicago, IL, 312-337-7737  
AEI, San Francisco, CA, 415-821-9470  
AEI, Los Angeles, CA, 213-651-1260  
AEI, Orange, CA, 714-998-6880  
AEI, New York, 212-431-6655  
AEI, Columbus, OH, 614-855-2800

Amplivox Communication  
Products/Security Intercom, Inc.  
1833 N. 105th  
Seattle, WA 98133  
(206) 523-6170  
Pres.: Gerard H. Mooyman  
Director of Sales: Jeffrey L. Groth  
Sales Mgr.: Claudio Mazzola  
Nat'l Advertising: John Bernard  
Products: music services

BGM International  
PO Box 8057  
Pensacola, FL 32505  
(904) 434-1953

Casco/MTN Sound  
PO Box 115  
50 Terminal St.  
Charlestown, MA 02129  
(617) 242-2983, FAX# 617-242-5209  
Pres.: Samuel J. Blengs

Dayton Industrial Corp.  
4518 Taylorsville Road  
Dayton, OH 45424  
(513) 236-3591, FAX# 513-233-5805  
Mkt'g: Joy Steineman  
Products: SCA equipment

EMS/Music  
2264 15th Ave. W.  
Seattle, WA 98119  
(206) 281-8686

V.P. Nat'l. Music Svc. Sales: Bernard  
Kron  
Nat'l. Dealer Sales Desk: Mark Rubin  
Steve Ducharme  
Anne Walker

Edcor  
1948 East Pomona  
Santa Ana, CA 92705  
(714) 648-0292, 800-854-0259, FAX#  
714-648-0117  
Pres.: Larry Weston  
Office Mgr.: Phyllis Weston  
Sales Mgr.: Deanna Weston  
Products automatic mixers, SCA  
equipment

### HARRIS CORPORATION, DRACON DIVISION

809 Calle Plano  
Camarillo, CA 93010  
(805) 987-9511, 800-437-2266, FAX#  
805-987-2547

V.P./General Mgr.: John R. Mason  
V.P. Sales & Mkt'g.: Jack McGuigan  
Director of Sales: Tom Erdmann  
Paging Prod. Mgr.: Tom Johnson  
Metals/Racks/Tools Prod. Mgr.: Terry  
Smith  
Test Sets Prod. Mgr.: John Akins  
Don Bivens, Lake Elsinore, CA, 714-  
672-2168

Gary Foster, Columbia, MD, 314-442-  
2288  
Rob Lincoln, Melbourne, FL, 407-259-  
0991

Mark Skilowitz, Newfield, NJ, 609-697-  
4580

Jim Fetterer, Seattle, WA, 206-243-  
7762

Bill Boone, Libertyville, IL, 312-816-  
1080

Dave Whelan, W. Springfield, MA, 413-  
731-9552

Industrial Research Products, Inc.  
321 Bond St.  
Elk Grove Village, IL 60007

(312) 439-3600, 800-255-6993, FAX#  
312-640-9607

Pres.: Robert G. Roth  
General Mgr.: Mahlon Burkhard  
Mkt'g Mgr.: Roger Carroll  
Chief Engineer: Richard Peters  
Piper Assoc., Inc., Needham, MA, 617-  
449-1144

Products: automatic mixers

International Satellite Systems  
104 Constitution Dr. #4  
Menlo Park, CA 94025  
(415) 853-0833, 800-227-6288, FAX#  
415-853-0908

Johnson Electronics, Inc.  
4301 Metric Drive  
Winter Park, FL 32792  
(407) 677-4030, FAX# 407-679-1288  
Pres./CEO: A.J. Schell  
V.P. Mkt'g: Robert W. Peters  
V. P./Engineering: Ken St. John  
Products: SCA equipment

Magne-Tronics, Inc.  
93 Broad St.  
Matawan, NJ 07747  
(201) 566-9600  
Pres.: John Bolendz  
V.P.: Gloria Bolendz

### MUSIC PROGRAMMING, INC.

265 Concord St.  
Framingham, MA 01701  
(508) 875-3530  
Pres. & Music Dir.: Raymond J. Regis  
Exec. V.P.: Dutch Blue  
Products: music libraries, stock and  
custom, music services

### Muzak

915 Yale Ave. N.  
Seattle, WA 98109  
(206) 682-3737, 800-331-3340, FAX#  
206-624-4299  
Sr. V.P./Sales/Mkt'g: Jim Harrison  
V.P. Sales: Tom Evans



Mgr. Affiliate Relations: Julie McCullough

Products: music libraries, stock and custom, music services, SCA equipment, tape systems

#### Paso Sound Products

14 First St.

Pelham, NY 10803-1495

(914) 738-4800, FAX# 914-738-3954

Executive V.P.: Paul Mastrangelo

Sales Mgr.: David Moore

Product Mgr.: Ken Obrien

Credit Mgr.: Marilyn Beckerson

Operations Mgr.: Anthony Sgueglia

All West Electronics, Camarillo, CA,  
805-388-1789

Anderson Sales, Braintree, MA, 617-  
848-9194

Pace Sales, Charlotte, NC, 704-365-  
3216

De Witt Austin Co., Alpharetta, GA,  
404-442-1326

Dowell Assoc., St. Louis, MO, 314-  
849-4234

Mountain Representatives, Denver, CO,  
303-623-0972

J.Y.S. Comm. Co., Dallas, TX, 214-  
349-1650

Lienau Assoc., Inc., Columbia, MD,  
301-621-4113

Lienau Assoc., Inc., New Town, PA,  
215-860-2100

SLK Tech Rep, San Francisco, CA,  
415-822-4884

Miguel Lopez, Hialeah, FL, 305-822-  
6853

Marketline, Snellville, GA, 404-972-  
9048

Messnick Sales, Liverpool, NY, 315-  
622-3211

Miller Assoc., Ltd., Greenwich, CT,  
212-840-2866

Robert Milsk Co., Inc., Southfield, MI,  
313-354-3310

Robert Milsk Co., Indianapolis, IN, 317-  
842-3400

Weller Electronic Sales, Worthington,  
OH, 614-885-7819

Frank Lintern Assoc., Naperville, IL,  
312-983-0935

Products: tape systems

Pentagon Industries, Inc.

5115 N. Sheridan Rd.

Chicago, IL 60640

(312) 271-8300, 800-621-3867

Pres.: L. Khan

General Mgr.: John Vinci

QSC Audio Products, Inc.

1926 Placentia Ave

Costa Mesa, CA 92627

(714) 645-2540, 800-854-4079, FAX#

714-645-7927

Director of Mkt'g: Greg McVeigh

Nat'l Sales Mgr.: Peter Kalmen

Sales Engineer: Andy Murray

Products: automatic mixers

Quam-Nichols Co.

234 E. Marquette Rd.

Chicago, IL 60637

(312) 488-5800, FAX# 312-488-6944

Pres.: W.G. Little

Distributor Sales Mgr.: G.L. Johns

Chief Engineer: Oswald Rohrbacher

Vector Inc., Seattle, WA

Given-Flanagan Assoc., W. Boylston,  
MA



## INTERNATIONAL BUSINESS MUSIC ASSOCIATION

The Eighteenth Annual IBMA Convention

# "Great Expectations"

October 12-15, 1988

at the Marriott Harbor Beach Resort  
in Fort Lauderdale, Florida

*Keynote Speaker:*

**J. Peter Grace, President & CEO, W.R. Grace & Co.**

*Register now* for the most important and informative  
annual meeting for business music people.

***Early registration discounts end August 31!***

***For registration information call:***

**Joe Elum (216) 833-4164**

***For IBMA membership information call:***

**Jerry Anderson (617) 393-2591**

R.E. Breuer Co., Pt. Washington, NY  
Cartwright & Bean of Georgia, Atlanta, GA

The Lewis & Dunnigan Co., Inc.,  
Syracuse, NY

Mandabach-Lehner Co., Columbus, OH  
McBride Loudspeaker Source, Inc.,  
Waterloo, Ont., CD

Foster Technical Sales Co., Edina, MN  
Robert Milsk Co., Southfield, MI

Brian Trankle & Assoc., Belmont, CA  
Bidwell Sales Assoc., Gardena, CA

J.Y. Schoonmaker Co., Inc., Dallas, TX  
Ken Levy & Assoc., Chicago, IL

Lowery Assoc., Broomall, PA  
R.W. Kunz & Assoc., Prairie Village, KS

(312) 543-1270, 800-527-3723, FAX#  
312-543-0549

Seeburg Music Satellite Network  
5706 New Chapel Hill Rd.

Raleigh, NC 27607  
(919) 851-5823, 800-334-1561, FAX#  
919-851-9198

General Mgr.: William E. Fox  
V.P.: Steve Grissom

Nat'l Sales/Distr. Network: Bonnie  
Sullivan

Nat'l Sales/Distr. Network: Don  
Nicholson

Nat'l Sales/Direct Sales: Joe White  
Nat'l Sales/Direct Sales: John Waff

Tape-Athon Corp.

13633 Crenshaw Blvd.  
Hawthorne, CA 90250  
(213) 676-6752

Pres.: Leon E. "Lee" Tate

General Mgr.: Robert Haller

Director Engineering: Bernard Sayers

Director Mkt'g: John Bagley

Sales Coordinator: Bob Mayfield

Sales Mgr.: Rick Bottom

Chuck Olson Assoc., Renton, WA, 206-  
271-5416

Warren Assoc., Santa Clara, CA, 408-  
988-7762

Greg Dzubay & Assoc., Peoria, AZ,  
602-979-2358

Spivey-Leboeuf Assoc., Richardson,  
TX, 214-231-3190

Central Marketing Group, Kansas City,  
MO, 816-741-7460

John E. M. Anderson, Minneapolis,  
MN, 612-823-6459

Gustafson System Sales, Palatine, IL,  
312-358-2505

Avcom, Inc., N. Olmsted, OH, 216-777-  
2060

Revere Industries

1101 Bienville St.

New Orleans, LA 70112

(504) 523-3503, 800-843-8321, FAX#  
504-525-6361

V.P. Sales: Lori Kanelos

Director of Mkt'g: Richard Harris

Seven Systems, Inc.

2602 Artie St.

Huntsville, AL 35805

(205) 533-2193

Products: SCA equipment

Sight & Sound Entertainment, Inc.

1751 Dexter Ave. N

Seattle, WA 98019

(206) 775-9888, 800-538-2054, FAX#  
206-286-1961

Pres.: Michael Dukane

Nat'l Mkt'g Mgr.: Steve Nini

Mkt'g Admin.: Monika Skibeness

Products: CATV, music libraries, stock  
and custom, music services, tape  
systems

Sound Products/3M

3M Center 225-S-10

St. Paul, MN 55144-1000

(612) 733-0447

Mkt'g Mgr.: Don Rada

Sales Mgr.: Don Sluder

## TOA ELECTRONICS, ENGINEERED SOUND & COMMUNICATIONS DIVISION

PO Box 2047

601 Gateway Boulevard

South San Francisco, CA 94080

(415) 588-2538, 800-843-4750, in CA

800-632-2157, FAX# 415-588-3349

Pres.: Yoshiro Ishida

Director of Mkt'g: Fred Fredericks

Nat'l Sales Mgr.: Richard Krochmal

Nat'l Sales Mgr./Engineered Intercom &

Security Div.: Al Burns

Products: SCA equipment

Rowe International, Inc.

75 Troy Hills Road

Whippany, NJ 07981

(201) 887-0400, FAX# 201-887-2851

Sales Mgr.: Beverly LaForte

Products: music libraries, stock and  
custom

SCA Data Systems

3000 Ocean Park, #3002

Santa Monica, CA 90405

(213) 452-2506, FAX# 213-450-5307

Dir. of Sales/Mkt'g.: Robert W. Peters

## SMC INTERNATIONAL, INC.

2505 N. 24th St.

Omaha, NE 68110

(402) 453-0332, 800-456-9107, FAX#  
402-451-2876

Chief Op. Officer: Jay B. McMartin

Sales Mgr.: Larry Y. Wiedman

Dir. of Engineering: Richard L. Diercks

Miller & Associates, Richardson, TX,  
214-437-5733

Central Mkt'g Group, Kansas City, MO,  
816-741-7460

Products: SCA equipment

Seeburg Corp.

1105 Westwood Avenue

Addison, IL 60101

Are you  
**moving?**  
Don't miss a single issue.

PLACE MAILING LABEL HERE

Name \_\_\_\_\_  
Address \_\_\_\_\_  
City \_\_\_\_\_  
State \_\_\_\_\_ Zip \_\_\_\_\_

**Return to:**  
Deborah Droge  
*Sound & Communications*  
25 Willowdale Avenue  
Port Washington, NY 11050

# CASSETTE CHANGER

for background music



4 auto reversing cassette players for continuous play.

CP4010 Stereo/Mono Selectable

Create the ideal mood for—

- ♪ Restaurants
- ♪ Doctors & Business Offices
- ♪ Factories
- ♪ Retail Stores
- ♪ Super Markets

Low initial cost, easy installation and compatibility with existing or new public address or paging systems makes this unit ideal for your sound system. To operate the unit, simply insert the cassettes and everything is automatic thereafter. The Auto-Reverse Cassette Changer plays both sides of the cassette, then advances to the next cassette. Each cassette position has an individual eject switch and LED indicator. If a position doesn't contain a cassette, the position will be by-passed to the next position. Simple two-cable connection to an external amplifier...superb performance and styling will meet your needs...and more.

#### FEATURES/SPECIFICATIONS:

- Logic controlled endless playback deck
- Auto advance to next cassette, three (3) seconds
- Automatic Gain Control
- Lighted cassette eject buttons
- Frequency Response... 40-12,000 Hz
- DIN and RCA line out connectors
- Dimensions: 14.6" x 11.2" x 4.3"
- Switchable 110/220 VAC.
- 50/60 Hz power supply
- Net Weight... 18.75 lbs.

#### ADDITIONAL SPECIFICATIONS:

- Head Configuration... Four track in line head
- Frequency Response... 40-12,000Hz ± 3db
- Line Output... 500 mill volt
- Signal to Noise Ratio... Better than 45db
- Wow & Flutter... Less than 0.02% WRMS
- Front Panel... Power ON/OFF switch  
Lighted cassette eject buttons  
Line voltage select switch  
Stereo/Mono select switch  
Auto Gain level control
- Back Panel... Black cabinet with black front panel with white silk screen lettering, including Pentagon logo
- Color... 28.8 VA  
Better than .5%
- Power Consumption... Power Cord - Twin RCA type cable
- Speed Regulation... Better than .5%
- Accessories... Power Cord - Twin RCA type cable



5115 NORTH SHERIDAN ROAD  
CHICAGO, ILLINOIS 60640  
PHONE: (312) 271-8300  
WATTS: 1-800-821-3667  
TELEX: 5101012952

Elmarcon, Inc., Indianapolis, IN, 317-846-0221  
Saga, Oswego, NY, 315-343-5739  
Pinz Sales Corp., Rockville Centre, NY, 516-678-6887  
ASR Enterprises, LTD., Fallston, MD, 301-893-0001  
Murphy & Cota, Atlanta, GA, 404-875-2525  
Bencsik Assoc., Ocala, FL, 904-732-9775  
Design Factors, La Habra Heights, CA, 213-697-7576  
Products: automatic mixers, CATV, music libraries, stock and custom, music services, SCA equipment, tape systems

#### 3M SOUND PRODUCTS

223-5S-09, 3M Center  
St. Paul, MI 55144-1000  
(612) 733-9214, FAX# 612-736-9433  
Mkt'g Mgr.: Richard G. Barker  
Sales Mgr.: Don Sluder  
Products: music services, tape systems

#### UREI

8500 Balboa Blvd.  
Northridge, CA 91329  
(818) 893-8411, FAX# 818-893-3639  
Pres.: Ron Means  
V.P. Sales: Ken Lopez  
V.P. Mkt'g: Mark Gander  
Applications Engineer: Drew Daniels  
Mkt'g Mgr. Sound Contracting: Steve Romeo  
Neil Conly, Bedford, TX, 817-540-3066  
Bill Hamilton, Folsom, PA, 215-543-4677  
Steve Armstrong, Northridge, CA, 818-707-2529  
Tom Walter, Barrington, IL, 312-382-4925  
Products: automatic mixers

PROFESSIONAL AUDIO DIVISION,  
YAMAHA MUSIC CORPORATION, USA  
PO Box 6600  
6600 Orangethorpe Ave.  
Buena Park, CA 90622  
(714) 522-9011, FAX# 714-739-2680  
Products: automatic mixers

Yesco Foreground Music  
915 Yale Ave. N.  
Seattle, WA 98109  
(206) 682-3737, 800-426-9248

**ONE IS NOT ENOUGH**

Additional copies of the 1988/1989 Blue Book are available at \$12 each. Please send your check or money order to:  
Deborah Droge  
Circulation Director  
25 Willowdale Ave.  
Port Washington, NY 11050





# Charter Subscription Opportunity!

Please send me a sample issue of

**DJ TIMES**  
MUSIC • LIGHTING • SOUND • VIDEO

the magazine devoted to the needs and interests of the professional DJ market.

If I like my first issue and subscribe for 1 year, I will receive **6 XTRA ISSUES ABSOLUTELY FREE**  
**That's a total of 18 issues for**

**only \$30,**

**\$24 OFF THE COVER PRICE**  
**(A SAVINGS OF OVER 44%).**

- Please send me a sample issue of DJ TIMES to review.
- I want to begin my subscription to DJ TIMES and receive 6 XTRA ISSUES ABSOLUTELY FREE. That's 18 issues for only \$30.00 (A savings of over 44%).

**PRIMARY JOB FUNCTION:**

- A) Disc Jockey - NIGHTCLUB
- B) Disc Jockey - MOBILE
- C) Club Manager
- D) Retailer - Record Store
- E) Retailer - Musical Instruments/Sound Equipment
- F) Sound & Video Installer
- G) Consultant/Designer
- H) Distributor: 1)  Records; 2)  Video; 3)  Equipment
- I) Manufacturer: 1)  Audio; 2)  Video; 3)  Lighting
- J) Other (Please Specify): \_\_\_\_\_

**PRIMARY MUSICAL EMPHASIS:**

- 1) Dance Music
- 2) Rap Music
- 3) Hard Rock
- 4) Heavy Metal
- 5) Classic Rock
- 6) Oldies
- 7) Other (Please Specify): \_\_\_\_\_

ENTER MY SUBSCRIPTION  PAYMENT ENCLOSED  BILL ME  BILL MY CREDIT CARD:  VISA  MC  AE

CARD # \_\_\_\_\_ EXP. DATE \_\_\_\_\_

SIGNATURE Subscribe!

NAME \_\_\_\_\_

BUSINESS NAME \_\_\_\_\_

ADDRESS \_\_\_\_\_

CITY \_\_\_\_\_ STATE \_\_\_\_\_ ZIP \_\_\_\_\_

Add \$6.00 per year for subscriptions outside the U.S.

OFFER EXPIRES 6/89

*Call*

**TOLL FREE  
FOR YOUR  
CHARTER  
SUBSCRIPTION  
OPPORTUNITY  
1-800-6DJ-XTRA**

Place  
stamp  
here

**DJ TIMES**  
MUSIC • LIGHTING • SOUND • VIDEO

25 WILLOWDALE AVENUE  
PORT WASHINGTON, NY 11050

**DJ TIMES**  
MUSIC • LIGHTING • SOUND • VIDEO

# INTERCOMMUNICATIONS EQUIPMENT

## CARILLONS, CHIMES

Maas-Rowe Carillons  
2255 Meyers Ave  
Escondido, CA 92025  
(619) 743-1311

### NEL-TECH LABS, INC.

PO Box 1030  
Londonderry, NH 03053  
(603) 434-8234, FAX# 603-434-1265  
Pres.: Gary Stapleford  
Exec. V.P.: Ken Ritter  
Products: analog & digital tones for  
time and signaling, music playback

Schulmerich Carillons, Inc.

Carillon Hill  
Sellersville, PA 18960  
(215) 257-2771  
Mkt'g Secretary: Sally E. Mandes  
Products: analog & digital tones for  
time and signaling, music playback

Tape-Athon Corp.  
13633 Crenshaw Blvd.  
Hawthorne, CA 90250  
(213) 676-6752  
Pres.: Leon E. "Lee" Tate  
General Mgr.: Robert Haller  
Director Engineering: Bernard Sayers  
Director Mkt'g: John Bagley  
Sales Coordinator: Bob Mayfield  
Sales Mgr.: Rick Bottom  
Chuck Olson Assoc., Renton, WA, 206-  
271-5416  
Warren Assoc., Santa Clara, CA, 408-  
988-7762  
Greg Dzubay & Assoc., Peoria, AZ,  
602-979-2358  
Spivey-Leboeuf Assoc., Richardson,  
TX, 214-231-3190  
Central Marketing Group, Kansas City,  
MO, 816-741-7460  
John E. M. Anderson, Minneapolis,  
MN, 612-823-6459

Gustafson System Sales, Palatine, IL,  
312-358-2505  
Avcom, Inc., N. Olmsted, OH, 216-777-  
2060  
Elmarcon, Inc., Indianapolis, IN, 317-  
846-0221  
Saga, Oswego, NY, 315-343-5739  
Pinz Sales Corp., Rockville Centre, NY,  
516-678-6887  
ASR Enterprises, LTD., Fallston, MD,  
301-893-0001  
Murphy & Cota, Atlanta, GA, 404-875-  
2525  
Bencsik Assoc., Ocala, FL, 904-732-  
9775  
Design Factors, La Habra Heights, CA,  
213-697-7576  
Products: analog & digital tones for  
time and signaling, music playback

## INTERCOMS: APT, RESIDENTIAL

### AIPHONE INTERCOM SYSTEMS

PO Box 90075  
1700 130th Ave. N.E.  
Bellevue, WA 98005  
(206) 455-0510, FAX# 206-455-0071  
Pres.: Hiko Shinoda  
Nat'l Sales: Jim Morrison  
Products: access control, apartment  
station, duplex, lobby, mailbox  
panels, microprocessor,  
panel/entrance, simplex, telephone,  
video

Alpha Communications  
89-D Cabot Ct.  
Hauppauge, NY 11788-3717  
(516) 434-8080, 800-666-4800, FAX#  
516-434-8334

Pres.: Mark S. Goldberg  
V.P.: Madelyn R. Goldberg  
Office Mgr.: Rose Tassone  
Technician: Ted Jurgens

Altronic Co., Ltd.  
191 Oneida Dr.  
Pointe Claire, P. Q. H9R 1A9  
(514) 694-0168  
Pres.: A. D. Grunberg  
V.P.: T. Poloryles

BCE/Edcom, Division of CCS, Inc.  
1585A Britannia RD. E., #7  
Mississauga, Ontario, Canada L4W  
2M4  
(416) 678-0801, FAX# 416-678-0480  
Pres.: Peter Jova  
Sales Mgr.: Keith Moore

Products: apartment station, lobby,  
microprocessor, music combination,  
panel/entrance

Cambridge Electronics Laboratories  
20 Chester St.  
Sommerville, MA 02144-3005  
(617) 629-2805  
Pres.: Dr. Jeffrey Race  
Sales Mgr.: Charlotte Bissell

David Clark Co., Inc.  
PO Box 15054  
360 Franklin St.  
Worcester, MA 01615-0054  
(617) 756-6216, FAX# 508-753-5827  
Product Mgr. Comm.: George R.  
Conlon  
Pres.: John E. Flagg



Exec. V.P.: Richard P. Houlihan  
 General Sales Mgr.: Robert J. Murphy  
 Product Mgr./Comm.: George R. Conlan  
 Products: custom



### LEE DAN COMMUNICATIONS

155 Adams Ave.  
 Hauppauge, NY 11788-3699  
 (516) 231-1414, 800-533-3261, FAX# 516-231-1498  
 Pres.: Leon Goldberg  
 V.P. Operations: Lawrence J. Goldberg  
 V.P. Finance/Admin.: David H. Goldberg  
 Sr. Technician: Sandy Hoffman  
 Customer Svce: Linda E. Scaturro  
 Production Sup.: Gabriel Figueroa  
 Products: apartment station, custom, duplex, lobby, mailbox panels, microprocessor, panel/entrance,

simplex, talk-back, telephone, video  
 E.R.L. Electronic Products, Inc.  
 65-50 Austin St.  
 Rego Park, NY 11374  
 (718) 275-7700, FAX# 718-997-7645  
 V.P.: Steve Faulhaber  
 Director of Sales: Martin Saltiel

Fisher-Berkeley Corp.—Ektacom  
 5800 Christie Ave.  
 Emeryville, CA 94608  
 (415) 655-9696, FAX# 415-658-0674  
 Pres: Robert S. Fisher  
 V.P. Engineering: Robert T. Shipley  
 Sales Engineer: Michael D. Lagrimas  
 Sales Engineer: Roger E. Stewart

Florence Corp.  
 2101 N. Elston Ave.  
 Chicago, IL 60614  
 (312) 384-3310, FAX# 312-384-3460  
 Pres.: Lloyd A. Schooley  
 V.P. General Mgr.: John J. Martino  
 V.P. Sales: Donald A. Cannella  
 Nat'l Sales Mgr.: George Jans  
 Products: apartment station, duplex, lobby, mailbox panels, panel/entrance, talk-back

Gustafson Sales, Red Wing, MN, 612-388-4277  
 J.W. Lehner Co., Stow, OH, 216-686-1965  
 Meyer Marketing, Deerfield Beach, FL, 305-481-9250  
 Meyer & Ross, Burlingame, CA, 415-348-6800  
 New West Agency, San Diego, CA, 619-299-3269  
 Pacific West Marketing, Honolulu, HI, 808-261-7558  
 Henry Philips Co., Roswell, GA, 404-992-3070  
 R.G. Associates, Stow, MA, 617-897-7146  
 Tortech Electronics, Inc., Scarborough, ONT, Canada, 416-282-1011  
 John S. Wilkin & Assoc., Hillboro, OH, 513-393-1137  
 Products: access control, apartment station, custom, duplex, lobby, panel/entrance, simplex, talk-back, telephone, video

M & S Systems, Inc.  
 2861 Congressman Lane  
 Dallas, TX 75220  
 (214) 358-3196, 800-777-5129, FAX# 214-350-1913  
 Pres.: William Reid  
 V.P. Sales & Mkt'g: Don Stillely  
 Nat'l Accounts Mgr.: Barry Lawrence  
 Mkt'g Mgr.: Bruce Benter  
 Eastern Reg Sales Mgr.: Lee Lynn  
 Western Reg Mgr.: Guy Hart

Mirtone Communication & Security, Inc.  
 425 Alness St.  
 Downsview, Toronto, ONT, Canada M3J 2H4  
 (416) 667-1211, FAX# 416-667-1731  
 Pres.: Larry Letofsky  
 Nat'l Sales Mgr.: Art Petrilli  
 Product Mgr.: David Ito  
 Customer Svce: Kwang Yoon  
 Products: access control, apartment station, custom, duplex, lobby, panel/entrance, simplex, telephone, video

Multi-Vox Ltd.  
 9967 St. Michel Blvd.

## AIPHONE®

CWY ELECTRONICS IS THE MIDWEST'S IN-STOCK SOURCE FOR QUALITY AIPHONE PRODUCTS. OUR EXTENSIVE INVENTORY, SAME DAY SHIPPING, AND CENTRAL LOCATION SAVE YOU DAYS OF WAITING AND DOLLARS OF AIR FREIGHT. CWY ELECTRONICS, AIPHONE, AND YOU . . . AN UNBEATABLE TEAM!



CALL RANDY JESSUP AT INDIANA 1-800-382-7526  
 OUT OF STATE 1-800-428-7596  
 405 NORTH EARL AVENUE  
 LAFAYETTE, INDIANA 47903



Jeron Electronic Systems, Inc.  
 1743 W. Rosehill Dr.  
 Chicago, IL 60660  
 (312) 275-1900, 800-621-1903, FAX# 312-275-0283  
 Pres.: Jerome Chesnul  
 V.P. Sales: John Charczuk  
 Admiral Sales Co., Richardson, TX, 214-357-9212  
 ASR Enterprises, Ltd., Fallston, MD, 301-893-0001  
 Burcaw Company & Assoc., Warren, MI, 313-573-4605  
 Central Marketing Group, Kansas City, MO, 816-741-7460  
 Bi-State Marketers, Ridgefield, NJ, 201-943-5888  
 Pat Norman Sales, Indianapolis, IN, 317-842-5611  
 Greg Dzubay & Assoc., Peoria, AZ, 602-979-2358  
 Pacnor Marketing, Inc., Lynwood, WA, 206-771-6016

Montreal- Nord, Quebec, Canada H1H 5G7

(514) 321-3131

Pres.: Jean Lajoire

Engineer: Dominique Malenfant

Operations Mgr.: Georges Morissette

Sales/Technical Cdr.: Antoine Krelion

**Paso Sound Products**

14 First St.

Pelham, NY 10803-1495

(914) 738-4800, FAX# 914-738-3954

Executive V.P.: Paul Mastrangelo

Sales Mgr.: David Moore

Product Mgr.: Ken Obrien

Credit Mgr.: Marilyn Beckerson

Operations Mgr.: Anthony Sgueglia

All West Electronics, Camarillo, CA,

805-388-1789

Anderson Sales, Braintree, MA, 617-

848-9194

Pace Sales, Charlotte, NC, 704-365-

3216

De Witt Austin Co., Alpharetta, GA,

404-442-1326

Dowell Assoc., St. Louis, MO, 314-849-4234

Mountain Representatives, Denver, CO, 303-623-0972

J.Y.S. Comm. Co., Dallas, TX, 214-349-1650

Lienau Assoc., Inc., Columbia, MD, 301-621-4113

Lienau Assoc., Inc., New Town, PA, 215-860-2100

SLK Tech Rep, San Francisco, CA, 415-822-4884

Miguel Lopez, Hialeah, FL, 305-822-6853

Marketline, Snellville, GA, 404-972-9048

Messnick Sales, Liverpool, NY, 315-622-3211

Miller Assoc., Ltd., Greenwich, CT, 212-840-2866

Robert Milsk Co., Inc., Southfield, MI, 313-354-3310

Robert Milsk Co., Indianapolis, IN, 317-842-3400

Weller Electronic Sales, Worthington,

OH, 614-885-7819

Frank Lintern Assoc., Naperville, IL, 312-983-0935

Products: apartment station, custom, lobby, panel/entrance, simplex, telephone, video

**RING GROUP, INC.**

230 Community Drive

Great Neck, NY 11021

(516) 487-0250, 800-645-9690, FAX# 516-487-0256

Pres.: Paul Ruggieri

V.P.: Peter McLean

Product Mgr.: Joel Kahn

Technical Director: Kjell (Ken) Solem

Sales Support: Craig Krsanac

Tech Support: Charlie Kulins

Klumpp Sales, Jacksonville, FL, 904-287-5205

Gustafson Sales, Red Wing, MN, 612-388-4277

Allwest Electronics, Camarillo, CA, 805-388-1789

Corrigan Agency, Covington, LA, 504-893-7455

**BROADEN YOUR BUSINESS HORIZON!**

Four new products designed to keep you ahead in today's technology. To find out more about these and other **TekTone** products, contact the factory or your local **TekTone** distributor.

**NC300 SERIES**  
MICROPROCESSOR NURSE CALL SYSTEM

**TE SERIES MICROPROCESSOR**  
TELEPHONE ACCESS SYSTEM

**VM103**  
VIDEO INTERCOM SYSTEM

**EKB04AW**  
HOME ENTERTAINMENT AND INTERCOM SYSTEM

**TekTone**

**SOUND & SIGNAL MFG., INC.**  
1331 S. Killian Drive, Lake Park, FL 33403

(407) 844-2383 Toll free order (outside FL) 1-800-327-8466 TLX #513435 FAX #407-844-1337

# How an Aiphone can hear this bat

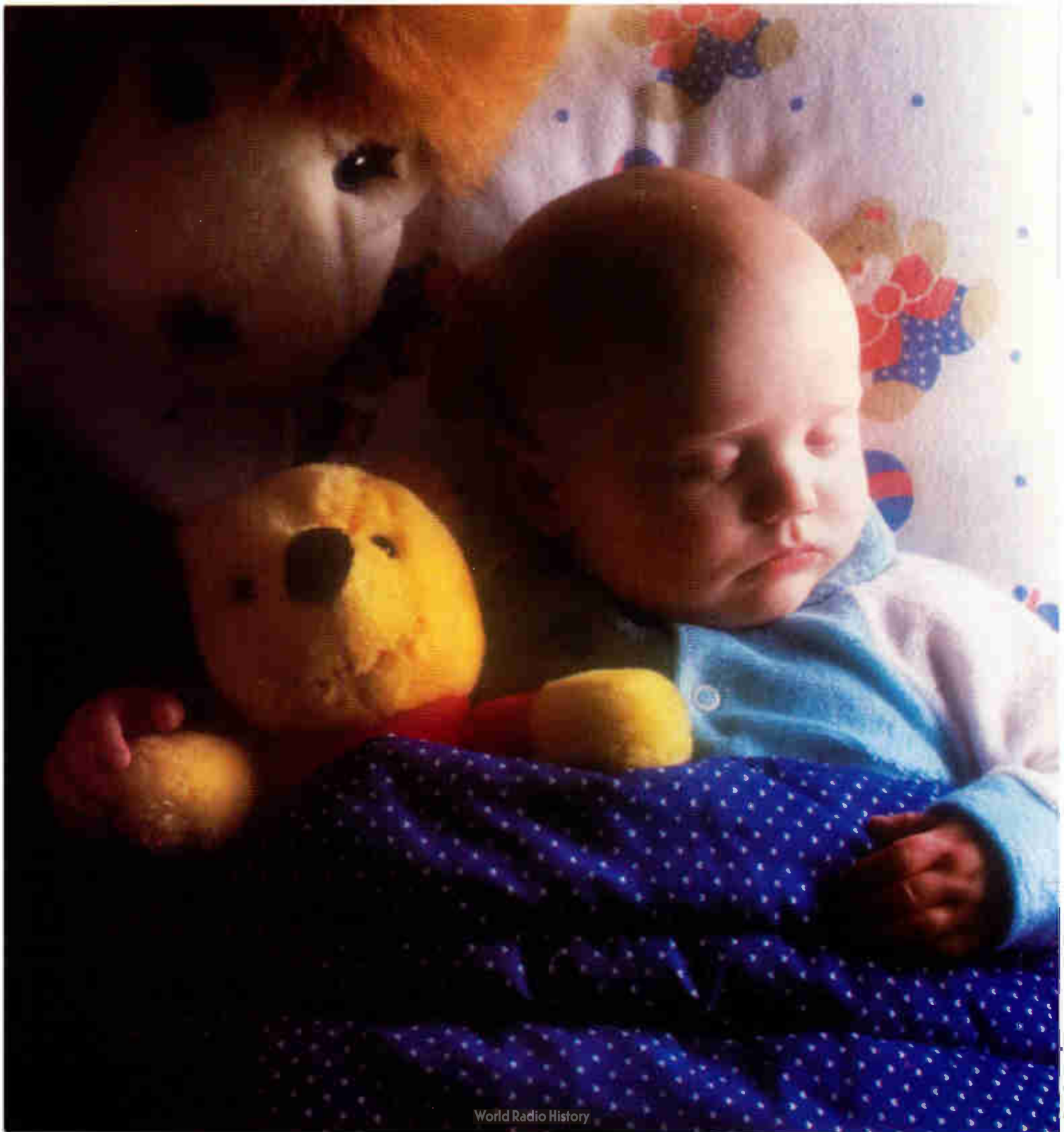



# intercom system y's every breath.

Meet Ryan, one of the cutest babies ever born.

When Ryan's parents first brought him home from the hospital, they were very concerned about SIDS—Sudden Infant Death Syndrome.

So, to make sure the whole family slept better at night, they installed an Aiphone intercom in the baby's room connected to stations throughout the house. Now when Ryan makes strange noises, or worse yet no noise at all, mom or dad can make a beeline to his bedroom in seconds.

If an Aiphone intercom system can help monitor this baby's activity and keep his parents relaxed, just imagine what it could do for your home or business.

For a free brochure or the name of your nearest Aiphone representative, call (206) 455-0510.

And tell 'em Ryan sent you.

 **AIPHONE®**

*Intercom systems for  
business, home & industry.*

J. C. Electronics, Honolulu, HI, 808-943-8514  
 Products: custom, duplex, microprocessor, music combination, talk-back

Sentex Systems, Inc.  
 20732 Lassen St.  
 Chatsworth, CA 91311  
 (818) 700-9800  
 Pres.: William R. Davis  
 Exec. V.P.: Richard P. Greenthal  
 Mgr. of Admin.: Frances H. Butler  
 Sales: Andrew M. Greenthal  
 Operations: Sharon A. Dawson  
 Bi-State Marketers, Ridgely, NJ, 201-943-5888  
 Austin Assoc., Willingboro, NJ, 609-871-9290  
 Coaxial Systems Assoc., Inc., Tequesta, FL, 305-746-6626  
 Denning Electronics, Hinsdale, IL, 312-920-1488  
 Technical Products Corp., Denver, CO, 303-333-1141

Siedle Intercom  
 780 Parkway  
 Broomall, PA 19008  
 (215) 353-9595, 800-874-3353, FAX# 215-353-9716

Pres.: Earl Zausmer  
 Products: access control, apartment station, lobby, mailbox panels, microprocessor, music combination, panel/entrance, simplex, talk-back, video

### TOA ELECTRONICS, INC./ENGINEERED INTERCOM & SECURITY DIVISION

PO Box 2047  
 601 Gateway Blvd.  
 South San Francisco, CA 94080  
 (415) 588-2538, 800-843-4750, in CA 800-632-2157, FAX# 415-588-3349  
 Pres.: Yoshiro Ishida  
 Director of Mkt'g: Fred Fredericks  
 Nat'l Sales Mgr.: Al Burns  
 Products: access control, duplex, microprocessor, talk-back, telephone



### TEKTONE SOUND & SIGNAL MFG., INC.

PO Box 12427  
 1331 S. Killian Dr.  
 Lake Park, FL 33403  
 (407) 844-2383, FAX# 407-845-1587  
 Pres.: Manuel Mira  
 General Mgr.: Carlos Mira  
 Sales/Mkt'g Director: Tom Hendricks  
 Chief Engineer: Jim Switzer  
 Ziskind & Assoc., Rolling Meadow, IL, 312-577-1624  
 Wm. B. Allen Supply Co., New Orleans, LA, 504-525-8222  
 Alvan C. Chaney & Assoc., Hialeah, FL, 305-558-3933  
 Dardon & Assoc., Olmstead Township, OH, 216-234-4555  
 Klumpp Sales Co., Jacksonville, FL, 904-287-5205  
 Lee Dan Communications, Hauppauge, NY, 516-231-1414  
 Lichtenauer & Assoc., Antioch, CA, 415-757-1200  
 R.W. Sales, Inc., St. Paul, MN, 612-646-2710  
 Mountain Representatives, Denver, CO, 303-623-0972  
 Chuck Olson Assoc., Renton, WA, 206-271-5416  
 Alpha Communications, Hauppauge, NY, 516-434-8080  
 Westech Marketing, Culver City, CA, 213-870-9286  
 Products: apartment station, custom, lobby, microprocessor, music combination, panel/entrance, simplex, telephone, video

Telephone Components, Inc.  
 3180 Expressway Dr., S.  
 Central Islip, NY 11722  
 (516) 582-4745

Valcom, Inc.  
 1111 Industry Ave.  
 Roanoke, VA 24013  
 (703) 982-3900  
 Mkt'g: Donald Buck  
 Products: talk-back

## WE'RE ALL TALK. ... BUT WE'RE NOT AFRAID TO LISTEN

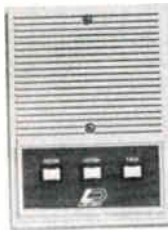

IR-204 APARTMENT STATION

Thirty years of manufacturing intercom systems has taught us a very valuable lesson. That is, that no two systems are created equal. This means that the manufacturer must listen and be responsive to the customer's critical job requirements. How well they meet these requirements determines how professional a communications company really is.

**LEE DAN** listens, and responds, with custom made intercom systems for buildings from one unit to a thousand units designed to be integrated with many brands of equipment. We're specialists in intercom and communication systems. Our design expertise enables us to utilize existing space limitations to the best possible advantage to meet your requirements (and your budget). We offer over thirty-five varieties of apartment stations and the technical assistance you need to make it work.

If your next job requires a communications system that's easy to use, easy to install and, above all, easy to afford, call or write us with your specs. When you're talking communications systems, **LEE DAN** is all ears.

### WHY NOT GIVE US A CALL!

N.Y. (800) 231-1414 U.S.A. (800) LEE DAN-1

155 ADAMS AVENUE  
 HAUPPAUGE, N.Y. 11788  
 (516) 231-1414



VAN-GUARD® LOBBY PANEL

# INTERCOMS: DUPLEX

ATC Supply Corp.  
106 Hobart St.  
Hackensack, NJ 07601  
(201) 488-0776, FAX# 201-488-6975  
Pres.: Sonny Greco  
ATC, Santa Monica, CA, 213-395-5055  
ATC, San Francisco, CA, 415-981-0880  
ATC, Chicago, IL, 312-321-7690  
Products: digital, loudspeaking,  
microprocessor, multi-channel,  
programmable, VOX

**AIPHONE**  
*Intercom systems for  
business, home & industry*

## AIPHONE INTERCOM SYSTEMS

PO Box 90075  
1700 130th Ave. N.E.  
Bellevue, WA 98005  
(206) 455-0510, FAX# 206-455-0071  
Pres.: Hiko Shinoda  
Nat'l Sales: Jim Morrison  
Products: drive-thru, loudspeaking,  
microprocessor, multi-channel,  
programmable, telephone,  
video/audio

Alpha Communications  
89-D Cabot Ct.  
Hauppauge, NY 11788-3717  
(516) 434-8080, 800-666-4800, FAX#  
516-434-8334  
Pres.: Mark S. Goldberg  
V.P.: Madelyn R. Goldberg  
Office Mgr.: Rose Tassone  
Technician: Ted Jurgens

Alternative Telecommunications Corp.  
110 Williams St.  
New York, NY 10038  
(212) 693-1440, FAX# 212-693-1448  
Pres.: Alan R. Fitzpatrick  
Executive V.P.: Sonny Greco  
ATC, Santa Monica, CA, 213-395-5055  
ATC, San Francisco, CA, 415-981-0880  
ATC, Chicago, IL, 312-321-7690  
Products: digital, loudspeaking,  
microprocessor, multi-channel,  
programmable, VOX

David Clark Co., Inc.  
PO Box 15054  
360 Franklin St.  
Worcester, MA 01615-0054  
(617) 756-6216, FAX# 508-753-5827  
Product Mgr. Comm.: George R.  
Conlon  
Pres.: John E. Flagg  
Exec. V.P.: Richard P. Houlihan  
General Sales Mgr.: Robert J. Murphy  
Product Mgr./Comm.: George R.  
Conlan  
Products: custom

Clear-Com Intercom Systems  
945 Camelia St.  
Berkeley, CA 94710  
(415) 527-6666, FAX# 415-527-6699  
Pres.: Robert Cohen  
Nat'l Sales Mgr.: Michael Goddard  
Products: closed-circuit, digital,  
loudspeaking, microprocessor, multi-  
channel, programmable, video/audio,  
wireless

Columbia Scientific, Inc.  
PO Box 203190  
Austin, TX 78720  
(512) 258-5191

Comtek, Inc.  
357 W. 2700 St. South  
Salt Lake City, UT 84115  
(801) 466-3463, FAX# 801-484-6906  
Pres.: Ralph Belgique  
Application Engineer: Steve Kartchner  
In-House Sales: Stacy Hayes-Garcia  
Products: wireless



## LEE DAN COMMUNICATIONS

155 Adams Ave.  
Hauppauge, NY 11788-3699  
(516) 231-1414, 800-533-3261, FAX#  
516-231-1498  
Pres.: Leon Goldberg  
V.P. Operations: Lawrence J. Goldberg  
V.P. Finance/Admin.: David H.  
Goldberg

Sr. Technician: Sandy Hoffman  
Customer Svce: Linda E. Scaturro  
Production Sup.: Gabriel Figueroa  
Products: closed-circuit, custom,  
digital, drive-thru, loudspeaking,  
microprocessor, multi-channel,  
video/audio

## DUKANE CORPORATION

2900 Dukane Dr.  
St. Charles, IL 60174  
(312) 584-2300, FAX# 312-584-2370  
Pres.: J. McWilliams Stone, Jr.  
Group V.P.: William P. Finnegan  
Division General Mgr.: Steve Deppe  
Mkt'g Mgr.: Derek Podobas  
Nat'l Sales Mgr.: Warren Anderson  
Service Mgr.: Cliff Carlson  
Doug Fellabaum, Sycamore, IL, 800-  
445-0152(#2301)  
Don Mouritzen, Beecher, IL, 800-445-  
0152(2303#)  
Art Sbrilli, Edison, NJ, 800-445-  
0152(#2302)  
Pete Kendall, Jacksonville, FL, 904-  
262-6025(#2306)  
Jack Brown, Dallas, TX, 214-943-  
7528(#2305)  
Ed Nuhring, Portland, OR, 800-445-  
0152(#2307)  
Wally Smutts, Toronto, Ontario,  
Canada, 312-584-2300  
Ken Lind, Wellesley Hills, MA, 617-  
235-6817  
Products: loudspeaking

Durcom, Inc.  
PO Box 315  
Bristol, CT 06010  
(203) 584-5955  
Pres.: Robert J. Beyus  
V.P.: Elizabeth Miller

Fisher-Berkeley Corp.—Ektacom  
5800 Christie Ave.  
Emeryville, CA 94608  
(415) 655-9696, FAX# 415-658-0674  
Pres: Robert S. Fisher  
V.P. Engineering: Robert T. Shipley  
Sales Engineer: Michael D. Lagrimas  
Sales Engineer: Roger E. Stewart



NEW FROM  
**Swintek**

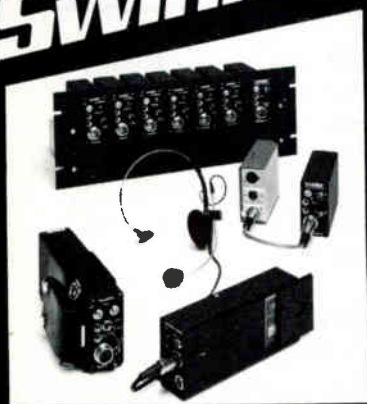

## Full Duplex Wireless HEADSET INTERCOMS

### Features

- Integrated Duplex Antenna, No Rat Tails!
- Any Frequency between 72 and 260 mHz
- Multi channel full duplex configurations available featuring 20 channel capability

*the WORLD'S SMALLEST  
pro video camera  
Wireless Microphone Systems*

*When you're  
really serious...*



Complete MARK QDC-50A-S system including receiver, lavalier transmitter and microphone... **\$1488.00**

*Manufactured in the United States in all metal cases. Demo units available on request.*

**Swintek**

587 DIVISION STREET/CAMPBELL, CA 95008  
(408) 378-8091 / TELEX 4970334 SWINTEK SUVL  
FAX # 408 378 6980

ITT/DES, Inc.  
20 Mayfield Ave.  
Edison, NJ 07607  
(201) 225-6121, 800-524-1646  
V.P.: Donald Duthaler  
Chief Engineer: Jeffrey Stellman

Johnson Electronics, Inc.  
4301 Metric Drive  
Winter Park, FL 32792  
(407) 677-4030, FAX# 407-679-1288  
Pres./CEO: A.J. Schell  
V.P. Mkt'g: Robert W. Peters  
V. P./Engineering: Ken St. John  
Products: drive-thru

ROH  
93 W. 223rd St.  
Torrance, CA 90502  
(213) 533-1498, 800-262-4671, FAX#  
213-533-6050  
Director of Mkt'g: Dan Garrigan  
Director of Engineering: Saul Walker  
Executive Audio, Ltd., Kingston, U. K.,  
01-541-0180

**RTS SYSTEMS, INC.**  
1100 West Chestnut St  
Burbank, CA 91506  
(818) 840-7119, FAX# 818-843-7953  
Pres.: Robert A. Smith  
V. P. Mkt'g: Douglas Leighton  
Sales Mgr.: Shelley Harrison  
Systems Engineer: Dave Brand  
Systems Engineer: Gene Behrend  
V.P. Engineering: Stan Hubler  
Products: custom, microprocessor,  
multi-channel, programmable



Rauland-Borg Corp.  
3535 W. Addison St.  
Chicago, IL 60618  
(312) 267-1300, FAX# 312-267-1127  
Pres.: William Krucks  
Sr. V.P./Sales & Mkt'g: Kenneth T.  
James  
Chief Engineer: Lawrence Gleason  
Nat'l Sales Mgr.: Rick Blunt  
Harry B. Hahn, Olathe, KN, 913-829-  
9427

William C. Zophy, Ft. Myers, FL, 813-  
433-4766  
Harold De Vaney, Dickinson, TX, 713-  
337-1040  
Hank Plaisier, El Toro, CA, 714-837-  
2626  
Vince Ward, Vashon Island, WA, 206-  
463-5582  
Joseph A. Ciotti, Claymont, DE, 302-  
798-6558  
William Lewis, Louisville, KY, 502-491-  
4273  
Raymond Bailey, Granville, IL, 815-339-  
6789  
Rauland-Borg Inc., Mississauga, ONT.,  
CD, 416-821-2225  
Jim Welch, Scarborough, ONT., CD,  
416-438-4756  
Products: digital, loudspeaking,  
microprocessor, multi-channel,  
programmable, VOX

Richmond Sound Design, Ltd.  
1234 West 6th Ave.  
Vancouver, Canada V6H 1A5  
(604) 734-1217, FAX# 604-734-3901  
Systems/Sales Mgr.: Damon Wootten  
Accounts Mgr.: Marilyn Williams  
Project Coordinator: Linda Pearson  
Full Compass Systems, Madison, WI,  
Products: custom, microprocessor

**RING GROUP, INC.**  
230 Community Drive  
Great Neck, NY 11021  
(516) 487-0250, 800-645-9690, FAX#  
516-487-0256  
Pres.: Paul Ruggieri  
V.P.: Peter McLean  
Product Mgr.: Joel Kahn  
Technical Director: Kjell (Ken) Solem  
Sales Support: Craig Krsanac  
Tech Support: Charlie Kulins  
Klumpp Sales, Jacksonville, FL, 904-  
287-5205  
Gustafson Sales, Red Wing, MN, 612-  
388-4277  
Allwest Electronics, Camarillo, CA, 805-  
388-1789  
Corrigan Agency, Covington, LA, 504-  
893-7455  
J. C. Electronics, Honolulu, HI, 808-  
943-8514  
Products: custom, digital,  
loudspeaking, microprocessor, multi-  
channel, programmable, VOX

# Better Products? Higher Margins? More Support?



As an internal communications dealer, you face questions every day. Finding the right answers can mean the difference between a profitable or unprofitable dealership. Stentofon Communications has been providing the right answers for dealers for more than 40 years.

Our engineering expertise develops state-of-the-art intercom equipment, with sound quality unmatched in the industry. Your customers will recognize Stentofon's superior technology—which means more sales and less service.

We back our equipment with the right kind of promotional support you'll need to maximize sales and minimize competition. Our central location in Kansas City means we can respond to your needs quickly and efficiently. And our regional sales offices across the country bring Stentofon expertise even closer.

To further assist you, we regularly run ads in national trade publications to generate qualified leads which we turn over to our dealers. And to help convert those leads into sales, we provide a full range of promotional and product literature.

Better products. Higher margins. More support. It all adds up to the right answer—Stentofon, the industry leader.

For more information on the full line of Stentofon intercom and paging equipment, call or write for our free brochure.

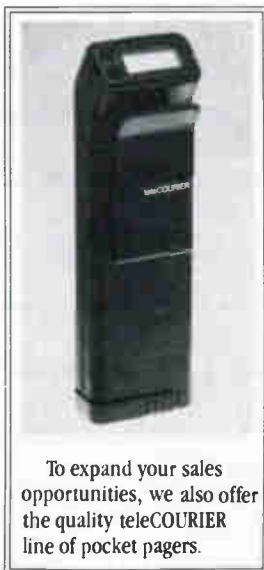

To expand your sales opportunities, we also offer the quality teleCOURIER line of pocket pagers.

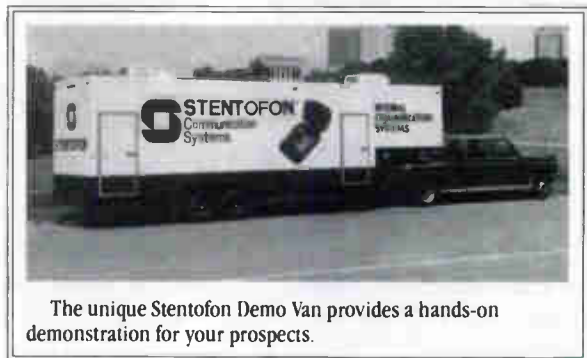

The unique Stentofon Demo Van provides a hands-on demonstration for your prospects.

 **STENTOFON**  
Communications Inc.

6119 Connecticut Ave. • Kansas City, Missouri 64120 • (816) 231-7200

# We've got the answers.

Speco Div., Components Specialties, Inc.  
PO Box 624  
1172 Rt. 109  
Lindenhurst, NY 11757  
(516) 957-8700, 800-645-5516, FAX#  
516-956-9142  
V.P./Sales: Mel Hulkower  
V.P./General Mgr.: Jim Ganci  
Sales Mgr.: Eric Forman  
Products: telephone

Stentofon Communications, Inc.  
6119 Connecticut Ave.  
Kansas City, MO 64120  
(816) 231-7200, FAX# 816-231-7203  
Pres.: Kenneth P. Jensen  
V.P./Technical: James Pierce  
Nat'l Sales Mgr.: Frederick Hall  
Business Mgr.: Doug Caldwell  
Controller: Barbara Hernandez  
Products: digital, loudspeaking,  
microprocessor, multi-channel,  
programmable, telephone, VOX

Swintek Enterprises, Inc.  
587 Division St.  
Campbell, CA 95008  
(408) 378-8091, FAX# 408-378-6980  
Pres.: William P. Swintek  
Cinequip, Inc., Toronto, Ont., CD, 416-  
920-5424  
Maga Techtronics, Artarmon, NSW,  
Australia, 02-438-3377  
Commercial Electronics, Vancouver  
B.C., CD, 604-669-5525

**TOA ELECTRONICS, INC./ENGINEERED  
INTERCOM & SECURITY DIVISION**  
PO Box 2047  
601 Gateway Blvd.  
South San Francisco, CA 94080  
(415) 588-2538, 800-843-4750, in CA  
800-632-2157, FAX# 415-588-3349  
Pres.: Yoshiro Ishida  
Director of Mkt'g: Fred Fredericks  
Nat'l Sales Mgr.: Al Burns  
Products: closed-circuit,

microprocessor, programmable,  
telephone

T.S.K. Electronics, Inc.  
PO Box 190  
564 Young St.  
Tonawanda, NY 14151-0190  
(716) 693-3916  
Pres.: Theodore S. Kedzierski  
Chief Engineer: Kevin T. Kedzierski  
Products: custom, telephone, VOX

Techron, div. of Crown International, Inc.  
1718 W. Mishawaka Rd.  
Elkhart, IN 46517  
(219) 294-8300, FAX# 219-294-8329  
TEF Product Specialist: Larry J. Shank  
Techron Sales Mgr.: Bill Landow  
Aim Marketing Group, Mishawaka, IN,  
219-256-2025  
Audio Marketing Assoc., Brecksville,  
OH, 216-526-2426  
Audio Resources, Westmont, IL, 312-  
655-1180  
Bensik Assoc., Inc., Ocala, FL, 904-  
732-9775  
Darmstedter Assoc., Baldwinville, NY,  
315-638-1261  
Dobbs-Stanford Corp., Dallas, TX, 214-  
358-0800  
GMI/New England, Avon, MA, 617-588-  
8043  
Kodo Assoc., Minneapolis, MN, 612-  
881-1255  
Lichtenauer & Assoc., Antioch, CA,  
415-757-1200  
Marshank Sales Co., Culver City, CA,  
213-559-2591  
Metrerep, Freehold, NJ, 201-462-1221  
Northshore Marketing, Seattle, WA,  
206-284-9699  
Pro Tech Marketing, Salt Lake City, UT,  
801-943-8331  
Secom Systems, Atlanta, GA, 404-455-  
0672  
R.J. Throckmorton, Ballwin, MO, 314-  
227-7222

### TEKNICOM SALES CO., INC.

PO Box 1056  
470 Commercial Ave.  
Palisades Park, NJ 07650  
(201) 947-7010, FAX# 201-947-7069  
Pres.: Don Duthaler  
Distributor Sales Mgr.: David Fried  
Systems Engineer: Tony Blazina  
Products: loudspeaking,  
microprocessor, multi-channel,  
programmable

### TEKTONE SOUND & SIGNAL MFG., INC.

PO Box 12427  
1331 S. Killian Dr.  
Lake Park, FL 33403  
(407) 844-2383, FAX# 407-845-1587  
Pres.: Manuel Mira  
General Mgr.: Carlos Mira  
Sales/Mkt'g Director: Tom Hendricks  
Chief Engineer: Jim Switzer  
Ziskind & Assoc., Rolling Meadow, IL,  
312-577-1624  
Wm. B. Allen Supply Co., New Orleans,  
LA, 504-525-8222  
Alvan C. Chaney & Assoc., Hialeah, FL,  
305-558-3933  
Dardon & Assoc., Olmstead Township,  
OH, 216-234-4555  
Klumpp Sales Co., Jacksonville, FL,  
904-287-5205  
Lee Dan Communications, Hauppauge,  
NY, 516-231-1414  
Lichtenauer & Assoc., Antioch, CA,  
415-757-1200  
R.W. Sales, Inc., St. Paul, MN, 612-  
646-2710  
Mountain Representatives, Denver, CO,  
303-623-0972  
Chuck Olson Assoc., Renton, WA, 206-  
271-5416  
Alpha Communications, Hauppauge,  
NY, 516-434-8080  
Westech Marketing, Culver City, CA,  
213-870-9286  
Products: digital, microprocessor,  
video/audio

## INTERCOMS: HOSPITAL, HEALTH CARE

Adaptive Micro Systems, Inc.  
7840 N. 86th St.  
Milwaukee, WI 53224  
(414) 357-2020, 800-558-7022, FAX#  
414-357-2029

Products: visual

### AIPHONE INTERCOM SYSTEMS

PO Box 90075  
1700 130th Ave. N.E.

Bellevue, WA 98005  
(206) 455-0510, FAX# 206-455-0071  
Pres.: Hiko Shinoda  
Nat'l Sales: Jim Morrison  
Products: direct select,



microprocessor, nurse-call, voice paging

## Alpha Communications

89-D Cabot Ct.  
Hauppauge, NY 11788-3717  
(516) 434-8080, 800-666-4800, FAX#  
516-434-8334

Pres.: Mark S. Goldberg  
V.P.: Madelyn R. Goldberg  
Office Mgr.: Rose Tassone  
Technician: Ted Jurgens

## Atlas/Soundolier

1859 Intertech Dr.  
Fenton, MO 63026  
(314) 349-3110, FAX# 314-349-1251

V.P. Sales: Tom Erickson  
E. Region/Sales: Andy Musci  
W. Region/Sales: Bud Waters  
V.P./Mkt'g Consultant: Herbert Jaffe  
Products: A/V, annunciators,  
emergency call, nurse-call, visual,  
voice paging

## Communications Equipment Co., Inc.

6443 Western Ave.  
Glen Arbor, MI 49636  
(616) 334-3081

Pres.: Darrell W. Thomas  
Sales Mgr.: Thomas A. Garmhausen

## Com-Tec, Inc.

PO Box 965  
639 Hickory Farm Lane  
Appleton, WI 54912-0965  
(414) 734-7105, FAX# 414-734-0493

Pres./Co-Owner: Ken McLellan  
Exec. V.P./Co-Owner: Anthony Leslie  
Products: A/V, annunciators, direct  
select, emergency call,  
microprocessor, nurse-call, pillow  
speakers, visual, voice paging



**CORNELL**  
ELECTRONIC PRODUCTS, INC.

## Cornell Electronics Products, Inc.

PO Box 23411  
4911 West Good Hope Rd.  
Milwaukee, WI 53223-0411  
(414) 351-4660, 800-541-9946, FAX#  
414-351-4657

Pres.: Donald Glaubit

V.P.: Gary M. Butler  
Sales Mgr.: Pauline A. Haack  
SE Reg Sales Mgr.: William Ellinger  
SLK/Tech Rep, San Francisco, CA,  
415-822-4885

Gustafson System Sales, Inc., Palatine,  
IL, 312-358-2505

Bidwell-Schwartz Associates, Inc.,  
Gardena, CA, 213-770-0300

Pinz Sales Corp., Rockville Centre, NY,  
516-678-6887

Dick Bellew Sales, Inc., Dallas, TX,  
214-644-7881

Cavendish and Winchester, Inc.,  
Atlanta, GA, 404-449-5104

Avcom, Inc., N. Olmsted, OH, 216-777-  
2060

Richard S. Pass Assoc., Langhorne,  
PA, 215-757-6100

Kingston Sales Corp., Indianapolis, IN,  
317-876-2545

Rancillio Assocs., Inc., St. Louis, MO,  
314-631-3326

Shamrock Electronic Sales, Dayton,  
OH, 513-258-1227

CB Electronic Marketing, Arvada, CO,  
303-422-0561

Cartwright & Bean, Inc., Orlando, FL,  
407-422-4531

Avwest, Inc., Fountain Hills, AZ, 617-  
545-0652

LSM Associates, Phelps, NY, 315-548-  
4891

W.A. Hendrickson Co., Inc., North  
Scituate, MA, 617-545-0652

Kodo Associates, Inc., Minneapolis,  
MN, 612-881-1255

Vector Corp., Seattle, WA, 206-322-  
4343

Yocum Marketing, Inc., Mesa, AZ,  
602-265-5056

Products: A/V, annunciators,  
emergency call, nurse-call, visual,  
voice paging

## Crest Electronics, Inc.

PO Box 384  
Simon at Third  
Dassel, MN 55325  
(612) 275-3382, 800-328-8908, FAX#  
612-275-2306

Pres./CEO: James H. Holm  
Tech Svcs Mgr.: Brian Torney  
Prod. Mgr.: Jerry Kumpula  
Dir. Oper./Purch. Mgr.: Dwayne  
Kettenacker  
Dir. of Prod. Dev.: Bill Lafferty

V.P.: Robert Zahler

Products: A/V, annunciators, direct  
select, emergency call,  
microprocessor, nurse-call, pillow  
speakers, visual, voice paging



## LEE DAN COMMUNICATIONS

155 Adams Ave.  
Hauppauge, NY 11788-3699  
(516) 231-1414, 800-533-3261, FAX#  
516-231-1498

Pres.: Leon Goldberg  
V.P. Operations: Lawrence J. Goldberg  
V.P. Finance/Admin.: David H.  
Goldberg

Sr. Technician: Sandy Hoffman  
Customer Svce: Linda E. Scaturro  
Production Sup.: Gabriel Figueroa  
Products: A/V, annunciators, direct  
select, emergency call,  
microprocessor, nurse-call, pillow  
speakers, visual, voice paging

## Diversatronics

620 Park Way  
Broomall, PA 19008  
(215) 356-3995, 800-345-1244, FAX#  
215-356-5222

Pres.: Will Klein  
Director Mkt'g: Eric Davies  
Finance Director: Shelly Klein  
Products: annunciators, emergency  
call, microprocessor, nurse-call

## DUKANE CORPORATION

2900 Dukane Dr.  
St. Charles, IL 60174  
(312) 584-2300, FAX# 312-584-2370

Pres.: J. McWilliams Stone, Jr.  
Group V.P.: William P. Finnegan  
Division General Mgr.: Steve Deppe  
Mkt'g Mgr.: Derek Podobas  
Nat'l Sales Mgr.: Warren Anderson  
Service Mgr.: Cliff Carlson  
Doug Fellabaum, Sycamore, IL, 800-  
445-0152(#2301)  
Don Mouritzen, Beecher, IL, 800-445-  
0152(2303#)  
Art Sbrilli, Edison, NJ, 800-445-  
0152(#2302)  
Pete Kendall, Jacksonville, FL, 904-  
262-6025(#2306)

Jack Brown, Dallas, TX, 214-943-7528(#2305)

Ed Nuhring, Portland, OR, 800-445-0152(#2307)

Wally Smutts, Toronto, Ontario, Canada, 312-584-2300

Ken Lind, Wellesley Hills, MA, 617-235-6817

Products: A/V, annunciators, direct select, emergency call, microprocessor, nurse-call, pillow speakers, visual, voice paging

Engineered Electronics, Inc.  
4301 Industrial Access Rd.  
Douglasville, GA 30134  
(404) 949-3290

Pres.: Roy J. Caviness

Exec. V.P.: Anthony W. Bunch

Products: annunciators, emergency call, nurse-call, pillow speakers

Fisher-Berkeley Corp.—Ektacom

5800 Christie Ave.

Emeryville, CA 94608

(415) 655-9696, FAX# 415-658-0674

Pres: Robert S. Fisher

V.P. Engineering: Robert T. Shipley  
Sales Engineer: Michael D. Lagrimas  
Sales Engineer: Roger E. Stewart

Florence Corp.

2101 N. Elston Ave.

Chicago, IL 60614

(312) 384-3310, FAX# 312-384-3460

Pres.: Lloyd A. Schooley

V.P. General Mgr.: John J. Martino

V.P. Sales: Donald A. Cannella

Nat'l Sales Mgr.: George Jans

Products: annunciators, emergency call, nurse-call, pillow speakers, visual



### JERON

electronic systems, inc.

Jeron Electronic Systems, Inc.

1743 W. Rosehill Dr.

Chicago, IL 60660

(312) 275-1900, 800-621-1903, FAX#

312-275-0283

Pres.: Jerome Chesnul

V.P. Sales: John Charczuk

Admiral Sales Co., Richardson, TX,  
214-357-9212

ASR Enterprises, Ltd., Fallston, MD,  
301-893-0001

Burcaw Company & Assoc., Warren,  
MI, 313-573-4605

Central Marketing Group, Kansas City,  
MO, 816-741-7460

Bi-State Marketers, Ridgefield, NJ, 201-943-5888

Pat Norman Sales, Indianapolis, IN,  
317-842-5611

Greg Dzuby & Assoc., Peoria, AZ,  
602-979-2358

Pacnor Marketing, Inc., Lynwood, WA,  
206-771-6016

Gustafson Sales, Red Wing, MN, 612-388-4277

J.W. Lehner Co., Stow, OH, 216-686-1965

Meyer Marketing, Deerfield Beach, FL,  
305-481-9250

Meyer & Ross, Burlingame, CA, 415-348-6800

New West Agency, San Diego, CA,  
619-299-3269

Pacific West Marketing, Honolulu, HI,  
808-261-7558

Henry Philips Co., Roswell, GA, 404-992-3070

R.G. Associates, Stow, MA, 617-897-7146

Tortech Electronics, Inc., Scarborough,  
ONT, Canada, 416-282-1011

John S. Wilkin & Assoc., Hillboro, OH,  
513-393-1137

#### MED-TEK

1335 S. Claudina St.

Anaheim, CA 92805-6235

(714) 774-8484, 800-654-3270, FAX#  
714-774-7388

V.P. Sales: Bill Haines Jr.

Asst. Sales Mgr.: Bo Buchanan

Credit Mgr.: David Law

Sales Tech.: Jeff Agent

Products: pillow speakers

Multi-Vox Ltd.

9967 St. Michel Blvd.

Montreal- Nord, Quebec, Canada H1H  
5G7

(514) 321-3131

Pres.: Jean Lajoire

Engineer: Dominique Malenfant

Operations Mgr.: Georges Morissette

Sales/Technical Cdr.: Antoine Krelio



## JERON NURSE CALL



#### AV-600 SYSTEM

Easy To Install

Easy To Use

Affordable

### Jeron Electronic Systems, Inc.

1743 W. Rosehill Drive, Chicago, IL 60660 (312) 275-1900

Call Us: 1-800-621-1903

**SOMEONE IS GOING TO SELL IT-  
WHY NOT YOU?  
YOU COULD BE MISSING  
SOME VERY  
PROFITABLE  
BUSINESS**

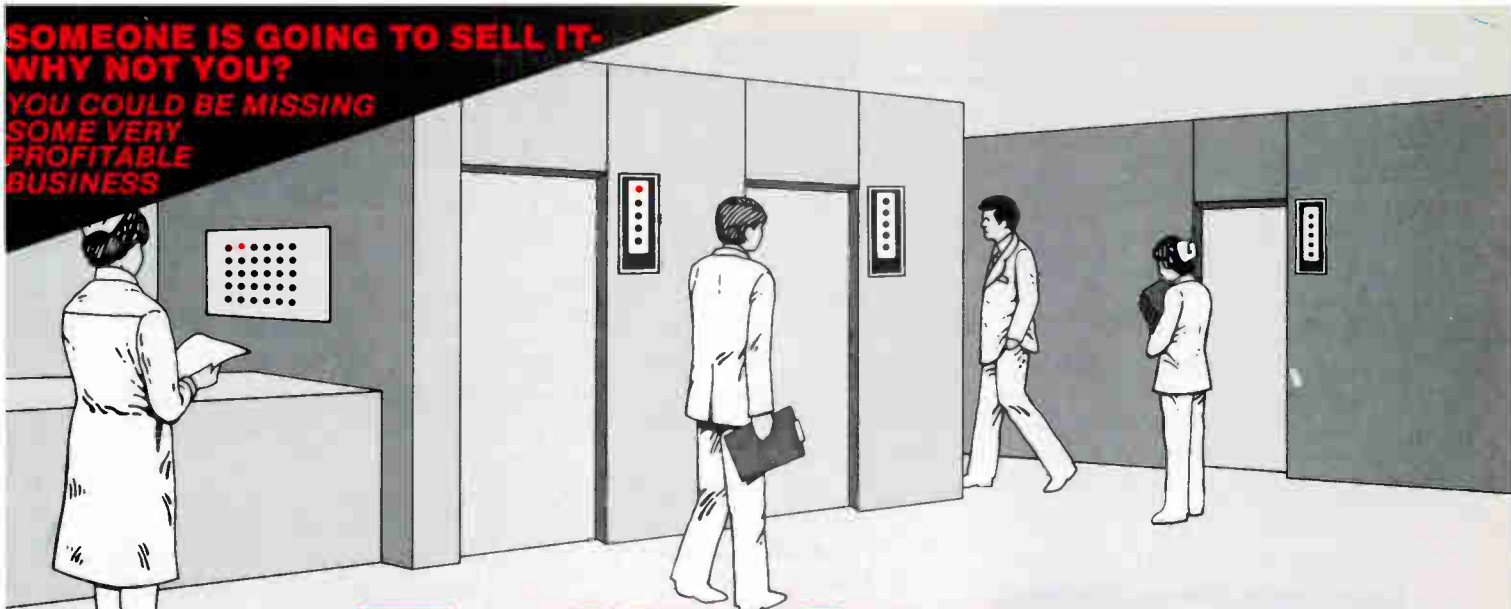

# Traffic Light

**It's amazing what a simple light system can do for a busy office.**

- You are automatically directed to your next patient.
- You can locate and call support personnel immediately, quietly.
- You can use your Call System to indicate the required procedure.
- You can significantly increase staff productivity and give your office a more professional atmosphere.

## Call System by diversatronics inc.

A Diversatronics Call System can be easily installed in your new or existing office. For full details on how a Call System can help you reclaim lost time and see more patients per day, call for our brochure 1-800-345-1244, PA residents call 215-356-3995 or write to Diversatronics Inc., 620 Parkway, Broomall, PA 19008

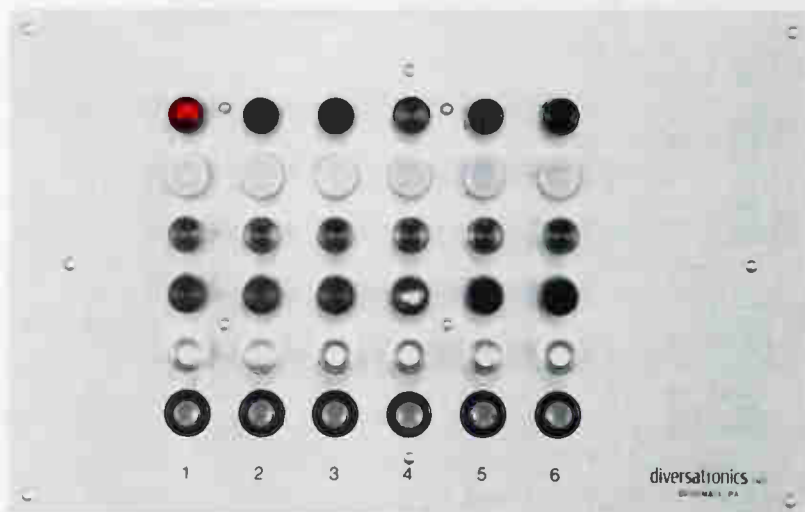

Above: Master Panel



Left:  
Exam Room  
Panel



Right:  
Monitor Panel



Portland Instrument  
 1101A Air Way  
 Glendale, CA 91201  
 (818) 500-0137, 800-621-5640, FAX#  
 818-240-1828  
 Pres.: Ronald A. Fuller  
 Prod Mgr./In-Outdoor Sys.: Jack  
 Sympson  
 Prod Mgr./Wire & Cable: Judy Gill  
 Production Mgr.: Patrick T. Gratner  
 Tech Svces: Chris Norton  
 Controller: Ken Thiele  
 Products: voice paging



Rauland-Borg Corp.  
 3535 W. Addison St.  
 Chicago, IL 60618  
 (312) 267-1300, FAX# 312-267-1127  
 Pres.: William Krucks  
 Sr. V.P./Sales & Mkt'g: Kenneth T.  
 James  
 Chief Engineer: Lawrence Gleason  
 Nat'l Sales Mgr.: Rick Blunt  
 Harry B. Hahn, Olathe, KN, 913-829-  
 9427  
 William C. Zophy, Ft. Myers, FL, 813-  
 433-4766  
 Harold De Vaney, Dickinson, TX, 713-  
 337-1040  
 Hank Plaisier, El Toro, CA, 714-837-  
 2626  
 Vince Ward, Vashon Island, WA, 206-  
 463-5582  
 Joseph A. Ciotti, Claymont, DE, 302-  
 798-6558  
 William Lewis, Louisville, KY, 502-491-  
 4273  
 Raymond Bailey, Granville, IL, 815-339-  
 6789  
 Rauland-Borg Inc., Mississauga, ONT.,  
 CD, 416-821-2225  
 Jim Welch, Scarborough, ONT., CD,  
 416-438-4756  
 Products: A/V, annunciators, direct  
 select, emergency call,  
 microprocessor, nurse-call, pillow  
 speakers, visual, voice paging

**RING GROUP, INC.**  
 230 Community Drive  
 Great Neck, NY 11021

(516) 487-0250, 800-645-9690, FAX#  
 516-487-0256  
 Pres.: Paul Ruggieri  
 V.P.: Peter McLean  
 Product Mgr.: Joel Kahn  
 Technical Director: Kjell (Ken) Solem  
 Sales Support: Craig Krsanac  
 Tech Support: Charlie Kulins  
 Klumpp Sales, Jacksonville, FL, 904-  
 287-5205  
 Gustafson Sales, Red Wing, MN, 612-  
 388-4277  
 Allwest Electronics, Camarillo, CA, 805-  
 388-1789  
 Corrigan Agency, Covington, LA, 504-  
 893-7455  
 J. C. Electronics, Honolulu, HI, 808-  
 943-8514  
 Products: annunciators, emergency  
 call, microprocessor, voice paging

Siedle Intercom  
 780 Parkway  
 Broomall, PA 19008  
 (215) 353-9595, 800-874-3353, FAX#  
 215-353-9716  
 Pres.: Earl Zausmer  
 Products: A/V, annunciators,  
 emergency call

Speco Div., Components Specialties, Inc.  
 PO Box 624  
 1172 Rt. 109  
 Lindenhurst, NY 11757  
 (516) 957-8700, 800-645-5516, FAX#  
 516-956-9142  
 V.P./Sales: Mel Hulkower  
 V.P./General Mgr.: Jim Ganci  
 Sales Mgr.: Eric Forman  
 Products: pillow speakers

Stentofon Communications, Inc.  
 6119 Connecticut Ave.  
 Kansas City, MO 64120  
 (816) 231-7200, FAX# 816-231-7203  
 Pres.: Kenneth P. Jensen  
 V.P./Technical: James Pierce  
 Nat'l Sales Mgr.: Frederick Hall  
 Business Mgr.: Doug Caldwell  
 Controller: Barbara Hernandez  
 Products: annunciators, direct select,  
 emergency call, microprocessor

Swintek Enterprises, Inc.  
 587 Division St.  
 Campbell, CA 95008  
 (408) 378-8091, FAX# 408-378-6980

Pres.: William P. Swintek  
 Cinequip, Inc., Toronto, Ont., CD, 416-  
 920-5424  
 Maga Techtronics, Artarmon, NSW,  
 Australia, 02-438-3377  
 Commercial Electronics, Vancouver  
 B.C., CD, 604-669-5525

## TOA ELECTRONICS, INC./ENGINEERED INTERCOM & SECURITY DIVISION

PO Box 2047  
 601 Gateway Blvd.  
 South San Francisco, CA 94080  
 (415) 588-2538, 800-843-4750, in-CA  
 800-632-2157, FAX# 415-588-3349  
 Pres.: Yoshiro Ishida  
 Director of Mkt'g: Fred Fredericks  
 Nat'l Sales Mgr.: Al Burns  
 Products: annunciators,  
 microprocessor, voice paging

## TEKTONE SOUND & SIGNAL MFG., INC.

PO Box 12427  
 1331 S. Killian Dr.  
 Lake Park, FL 33403  
 (407) 844-2383, FAX# 407-845-1587  
 Pres.: Manuel Mira  
 General Mgr.: Carlos Mira  
 Sales/Mkt'g Director: Tom Hendricks  
 Chief Engineer: Jim Switzer  
 Ziskind & Assoc., Rolling Meadow, IL,  
 312-577-1624  
 Wm. B. Allen Supply Co., New Orleans,  
 LA, 504-525-8222  
 Alvan C. Chaney & Assoc., Hialeah, FL,  
 305-558-3933  
 Dardon & Assoc., Olmstead Township,  
 OH, 216-234-4555  
 Klumpp Sales Co., Jacksonville, FL,  
 904-287-5205  
 Lee Dan Communications, Hauppauge,  
 NY, 516-231-1414  
 Lichtenauer & Assoc., Antioch, CA,  
 415-757-1200  
 R.W. Sales, Inc., St. Paul, MN, 612-  
 646-2710  
 Mountain Representatives, Denver, CO,  
 303-623-0972  
 Chuck Olson Assoc., Renton, WA, 206-  
 271-5416  
 Alpha Communications, Hauppauge,  
 NY, 516-434-8080  
 Westech Marketing, Culver City, CA,  
 213-870-9286  
 Products: A/V, annunciators, direct  
 select, emergency call,  
 microprocessor, nurse-call, pillow  
 speakers, visual, voice paging

# INTERCOMS: INDUSTRIAL

## AIPHONE INTERCOM SYSTEMS

PO Box 90075  
1700 130th Ave. N.E.  
Bellevue, WA 98005  
(206) 455-0510, FAX# 206-455-0071  
Pres.: Hiko Shinoda  
Nat'l Sales: Jim Morrison  
Products: drive-thru, loudspeaking,  
telephone

## Atlas/Soundolier

1859 Intertech Dr.  
Fenton, MO 63026  
(314) 349-3110, FAX# 314-349-1251  
V.P. Sales: Tom Erickson  
E. Region/Sales: Andy Musci  
W. Region/Sales: Bud Waters  
V.P./Mkt'g Consultant: Herbert Jaffe  
Products: environmentally protected,  
loudspeaking

## Bogen Communications, Inc.

PO Box 575  
50 Spring St.  
Ramsey, NJ 07446  
(201) 934-8500, FAX# 201-934-9832  
Pres.: John H. Ochtera  
V.P. Sales/Sound Prod.: David A.  
Chambers  
V.P. Sales/Telecomm. Prod.: Charles  
Ferrerri  
Bruce Barrett, Garland, TX, 214-530-  
0467  
Kingston Sales Corp., Indianapolis, IN,  
317-876-2545  
Kevin Koehler, Batavia, IL, 312-879-6871  
Tim McDonnell, Willoughby Hills, OH,  
216-942-2429  
Steve McGrew, Kennesaw, GA, 404-  
422-4608  
Meyer Mkt'g, Inc., Deerfield Beach, FL,  
305-481-9250  
W.B. Pray Sales, Inc., Northboro, MA,  
617-393-3434  
Jay Sample, Sandy, UT, 801-942-1059  
Scott Sampson, Encino, CA, 818-996-  
5484  
Mike Schneider, Baltimore, MD, 301-  
563-5390  
Walt Spencer, Ramsey, NJ, 201-934-  
8500  
White Radio Ltd., Burlington, ONT,  
Canada, 416-632-6894

Roburn Agencies, Inc., Yonkers, NY,  
914-968-1016  
Products: loudspeaking, telephone

## David Clark Co., Inc.

PO Box 15054  
360 Franklin St.  
Worcester, MA 01615-0054  
(617) 756-6216, FAX# 508-753-5827  
Product Mgr. Comm.: George R.  
Conlon  
Pres.: John E. Flagg  
Exec. V.P.: Richard P. Houlihan  
General Sales Mgr.: Robert J. Murphy  
Product Mgr./Comm.: George R.  
Conlan  
Products: environmentally protected,  
headset/handset

## Clear-Com Intercom Systems

945 Camelia St.  
Berkeley, CA 94710  
(415) 527-6666, FAX# 415-527-6699  
Pres.: Robert Cohen  
Nat'l Sales Mgr.: Michael Goddard  
Products: headset/handset,  
loudspeaking

## COMMUNICATIONS CO., INC.

3490 Noell St.  
San Diego, CA 92110  
(619) 297-3261, FAX# 619-297-3279  
Pres.: Peter Jordan  
V.P.: Michael Jordan  
Chief Engineer: David Johnson  
Products: drive-thru

## ELENEX, INC. (EAST)

7 Wayland St.  
N. Cohocton, NY 14868  
(716) 534-5280, 800-356-8433, FAX#  
716-534-5950  
Pres.: Sten Persson  
Product Mgr.: Dave Arseneau  
Sales: Geoffrey Spencer  
Products: drive-thru, environmentally  
protected, headset/handset,  
loudspeaking

## ELENEX, INC. (WEST)

7392 Trade St.  
San Diego, CA 92121  
(619) 566-7515, 800-225-3113, in CA  
800-225-8037, FAX# 619-586-1484

V.P.: Dennis Berglund  
Engineering: Al Bitarafan  
Sales: Lou Hennequin  
Products: drive-thru, environmentally  
protected, headset/handset,  
loudspeaking

## Encom Products Co., Inc.

502 Lower Hopewell Road  
Oxford, PA 19363  
(215) 932-9600, FAX# 215-932-9999  
Sales: Bob Mallalieu

## Fanon Courier

14281 Chambers Road  
Tustin, CA 92680  
(714) 669-9890, 800-345-1354, FAX#  
714-669-1081  
Pres.: Frank Blaha

Director Sales/Mkt'g: Murray Trotiner  
Director of Engineering: Miguel Santana  
Products: loudspeaking

## Fisher-Berkeley Corp.—Ektacom

5800 Christie Ave.  
Emeryville, CA 94608  
(415) 655-9696, FAX# 415-658-0674  
Pres: Robert S. Fisher  
V.P. Engineering: Robert T. Shipley  
Sales Engineer: Michael D. Lagrimas  
Sales Engineer: Roger E. Stewart

## RTS SYSTEMS, INC.

1100 West Chestnut St  
Burbank, CA 91506  
(818) 840-7119, FAX# 818-843-7953  
Pres.: Robert A. Smith  
V. P. Mkt'g: Douglas Leighton  
Sales Mgr.: Shelley Harrison  
Systems Engineer: Dave Brand  
Systems Engineer: Gene Behrend  
V.P. Engineering: Stan Hubler  
Products: environmentally protected,  
headset/handset

## Rauland-Borg Corp.

3535 W. Addison St.  
Chicago, IL 60618  
(312) 267-1300, FAX# 312-267-1127  
Pres.: William Krucks  
Sr. V.P./Sales & Mkt'g: Kenneth T.  
James  
Chief Engineer: Lawrence Gleason  
Nat'l Sales Mgr.: Rick Blunt

Harry B. Hahn, Olathe, KN, 913-829-9427

William C. Zophy, Ft. Myers, FL, 813-433-4766

Harold De Vaney, Dickinson, TX, 713-337-1040

Hank Plaisier, El Toro, CA, 714-837-2626

Vince Ward, Vashon Island, WA, 206-463-5582

Joseph A. Ciotti, Claymont, DE, 302-798-6558

William Lewis, Louisville, KY, 502-491-4273

Raymond Bailey, Granville, IL, 815-339-6789

Rauland-Borg Inc., Mississauga, ONT., CD, 416-821-2225

Jim Welch, Scarborough, ONT., CD, 416-438-4756

Products: loudspeaking, telephone

Speco Div., Components Specialties, Inc.

PO Box 624

1172 Rt. 109

Lindenhurst, NY 11757

(516) 957-8700, 800-645-5516, FAX# 516-956-9142

V.P./Sales: Mel Hulkower

V.P./General Mgr.: Jim Ganci

Sales Mgr.: Eric Forman

Products: loudspeaking

Swintek Enterprises, Inc.

587 Division St.

Campbell, CA 95008

(408) 378-8091, FAX# 408-378-6980

Pres.: William P. Swintek

Cinequip, Inc., Toronto, Ont., CD, 416-920-5424

Maga Techtronics, Artarmon, NSW, Australia, 02-438-3377

Commercial Electronics, Vancouver B.C., CD, 604-669-5525

**TOA ELECTRONICS, INC./ENGINEERED INTERCOM & SECURITY DIVISION**

PO Box 2047

601 Gateway Blvd.

South San Francisco, CA 94080

(415) 588-2538, 800-843-4750, in CA 800-632-2157, FAX# 415-588-3349

Pres.: Yoshiro Ishida

Director of Mkt'g: Fred Fredericks

Nat'l Sales Mgr.: Al Burns

Products: environmentally protected, loudspeaking, telephone

Talk-A-Phone Co.

5013 N. Kedzie Ave.

Chicago, IL 60625

(312) 539-1100, FAX# 312-539-1241

Sales Mgr.: Dan F. Kagen

Pres.: Z. Liberman

V.P.: S. Shanes

Products: drive-thru, loudspeaking

**TECHNICAL PROJECTS, INC.**

PO Box 1449

449 Princeton Ave.

Barrington, IL 60011

(312) 381-5350, 800-562-5872, FAX# 312-381-4360

Pres.: Glenn Mullis

Sec./Treas.: Sibbelina Mullis

Professional Audio Mkt'g, New York, NY, 516-367-8620

Sound Sales, Lanham, MD, 301-731-6355

Audio Marketing Assoc., Brecksville, OH, 216-526-2426

Wm. M. Linz & Assoc., Deerfield, IL, 312-945-9600

Design Factors, Hacienda Heights, CA, 213-697-7576

Products: headset/handset

**TEKTONE SOUND & SIGNAL MFG., INC.**

PO Box 12427

1331 S. Killian Dr.

Lake Park, FL 33403

(407) 844-2383, FAX# 407-845-1587

Pres.: Manuel Mira

General Mgr.: Carlos Mira

Sales/Mkt'g Director: Tom Hendricks

Chief Engineer: Jim Switzer

Ziskind & Assoc., Rolling Meadow, IL, 312-577-1624

Wm. B. Allen Supply Co., New Orleans LA, 504-525-8222

Alvan C. Chaney & Assoc., Hialeah, FL, 305-558-3933

Dardon & Assoc., Olmstead Township, OH, 216-234-4555

Klumpp Sales Co., Jacksonville, FL, 904-287-5205

Lee Dan Communications, Hauppauge, NY, 516-231-1414

Lichtenauer & Assoc., Antioch, CA, 415-757-1200

R.W. Sales, Inc., St. Paul, MN, 612-646-2710

Mountain Representatives, Denver, CO, 303-623-0972

Chuck Olson Assoc., Renton, WA, 206-271-5416

Alpha Communications, Hauppauge, NY, 516-434-8080

Westech Marketing, Culver City, CA, 213-870-9286

Products: headset/handset, loudspeaking

Telex Communications, Inc., Pro Audio Dept.

9600 Aldrich Ave. S.

Minneapolis, MN 55420

(612) 884-4051, FAX# 612-884-0043

Chairman of the Board: Ansel Kleiman

Exec. V.P.: Jeffrey Wetherell

V.P. Mkt'g: James Arrington

Director of Mkt'g: Donald Mereen

Director of Advertising: Ronald Taylor

Wes-Tech Marketing, Culver City, CA, 213-870-9286

Bencsik Assoc., Ocala, FL, 904-732-9775

Monfort Electronic Marketing, Indianapolis, IN, 317-872-8877

Mountain Representatives, Inc., Denver, CO, 303-623-0972

Murphy & Cota, Inc., Atlanta, GA, 404-875-2525

Northland Assoc., Moorhead, MN, 218-233-4616

White Radio Ltd., Burlington, Ontario, Canada, 416-632-6894

Rancilio Assoc., Inc., St. Louis, MO, 314-631-3326

SAGA, Oswego, NY, 315-343-5739

Sigmat Corporation, Valley Forge, PA, 215-783-6666

J.Y. Schoonmaker Co., Dallas, TX, 214-349-1650

Weller Electronic Sales, Worthington, OH, 614-885-7819

Ziskind Assoc., Rolling Meadows, IL, 312-577-1624

Burcaw Company & Assoc., Warren, MI, 313-573-4605

S&F Northwest, Seattle, WA, 206-622-6036

Lichtenauer & Associates, Antioch, CA, 415-757-1200

Products: headset/handset, loudspeaking, telephone

**3M SOUND PRODUCTS**

223-5S-09, 3M Center

St. Paul, MI 55144-1000

(612) 733-9214, FAX# 612-736-9433

Mkt'g Mgr.: Richard G. Barker

Sales Mgr.: Don Sluder

Products: drive-thru, headset/handset



# INTERCOMS: INSTITUTIONAL, SCHOOL

## AIPHONE INTERCOM SYSTEMS

PO Box 90075  
1700 130th Ave. N.E.  
Bellevue, WA 98005  
(206) 455-0510, FAX# 206-455-0071  
Pres.: Hiko Shinoda  
Nat'l Sales: Jim Morrison  
Products: console, microprocessor,  
paging, talkback, telephone

## Alpha Communications

89-D Cabot Ct.  
Hauppauge, NY 11788-3717  
(516) 434-8080, 800-666-4800, FAX#  
516-434-8334  
Pres.: Mark S. Goldberg  
V.P.: Madelyn R. Goldberg  
Office Mgr.: Rose Tassone  
Technician: Ted Jurgens

## BCE/Edcom, Division of CCS, Inc.

1585A Britannia RD. E., #7  
Mississauga, Ontario, Canada L4W  
2M4  
(416) 678-0801, FAX# 416-678-0480  
Pres.: Peter Jova  
Sales Mgr.: Keith Moore  
Products: clock, console,  
microprocessor, multi-channel,  
paging, talkback

## Bogen Communications, Inc.

PO Box 575  
50 Spring St.  
Ramsey, NJ 07446  
(201) 934-8500, FAX# 201-934-9832  
Pres.: John H. Ochtera  
V.P. Sales/Sound Prod.: David A.  
Chambers  
V.P. Sales/Telecomm. Prod.: Charles  
Ferreri  
Bruce Barrett, Garland, TX, 214-530-  
0467  
Kingston Sales Corp., Indianapolis, IN,  
317-876-2545  
Kevin Koehler, Batavia, IL, 312-879-6871  
Tim McDonnell, Willoughby Hills, OH,  
216-942-2429  
Steve McGrew, Kennesaw, GA, 404-  
422-4608  
Meyer Mkt'g, Inc., Deerfield Beach, FL,  
305-481-9250  
W.B. Pray Sales, Inc., Northboro, MA,  
617-393-3434

Jay Sample, Sandy, UT, 801-942-1059  
Scott Sampson, Encino, CA, 818-996-  
5484  
Mike Schneider, Baltimore, MD, 301-  
563-5390  
Walt Spencer, Ramsey, NJ, 201-934-  
8500  
White Radio Ltd., Burlington, ONT,  
Canada, 416-632-6894  
Roburn Agencies, Inc., Yonkers, NY,  
914-968-1016  
Products: clock, console,  
microprocessor, multi-channel,  
paging, talkback, telephone

## Clear-Com Intercom Systems

945 Camelia St.  
Berkeley, CA 94710  
(415) 527-6666, FAX# 415-527-6699  
Pres.: Robert Cohen  
Nat'l Sales Mgr.: Michael Goddard  
Products: microprocessor, multi-  
channel, paging, talkback, video

## Communications Equipment Co., Inc.

6443 Western Ave.  
Glen Arbor, MI 49636  
(616) 334-3081  
Pres.: Darrell W. Thomas  
Sales Mgr.: Thomas A. Garmhausen

## Com-Tec, Inc.

PO Box 965  
639 Hickory Farm Lane  
Appleton, WI 54912-0965  
(414) 734-7105, FAX# 414-734-0493  
Pres./Co-Owner: Ken McLellan  
Exec. V.P./Co-Owner: Anthony Leslie

## Cornell Electronics Products, Inc.

PO Box 23411  
4911 West Good Hope Rd.  
Milwaukee, WI 53223-0411  
(414) 351-4660, 800-541-9946, FAX#  
414-351-4657  
Pres.: Donald Glaubitz  
V.P.: Gary M. Butler  
Sales Mgr.: Pauline A. Haack  
SE Reg Sales Mgr.: William Ellinger  
SLK/Tech Rep, San Francisco, CA,  
415-822-4885  
Gustafson System Sales, Inc., Palatine,  
IL, 312-358-2505  
Bidwell-Schwartz Associates, Inc.,

Gardena, CA, 213-770-0300  
Pinz Sales Corp., Rockville Centre, NY,  
516-678-6887  
Dick Bellew Sales, Inc., Dallas, TX,  
214-644-7881  
Cavendish and Winchester, Inc.,  
Atlanta, GA, 404-449-5104  
Avcom, Inc., N. Olmsted, OH, 216-777-  
2060  
Richard S. Pass Assoc., Langhorne,  
PA, 215-757-6100  
Kingston Sales Corp., Indianapolis, IN,  
317-876-2545  
Rancillio Assocs., Inc., St. Louis, MO,  
314-631-3326  
Shamrock Electronic Sales, Dayton,  
OH, 513-258-1227  
CB Electronic Marketing, Arvada, CO,  
303-422-0561  
Cartwright & Bean, Inc., Orlando, FL,  
407-422-4531  
Avwest, Inc., Fountain Hills, AZ, 617-  
545-0652  
LSM Associates, Phelps, NY, 315-548-  
4891  
W.A. Hendrickson Co., Inc., North  
Scituate, MA, 617-545-0652  
Kodo Associates, Inc., Minneapolis,  
MN, 612-881-1255  
Vector Corp., Seattle, WA, 206-322-  
4343  
Yocum Marketing, Inc., Mesa, AZ,  
602-265-5056



## LEE DAN COMMUNICATIONS

155 Adams Ave.  
Hauppauge, NY 11788-3699  
(516) 231-1414, 800-533-3261, FAX#  
516-231-1498  
Pres.: Leon Goldberg  
V.P. Operations: Lawrence J. Goldberg  
V.P. Finance/Admin.: David H.  
Goldberg  
Sr. Technician: Sandy Hoffman  
Customer Svce: Linda E. Scaturro  
Production Sup.: Gabriel Figueroa  
Products: microprocessor, multi-  
channel, paging, talkback, video

## DUKANE CORPORATION

2900 Dukane Dr.  
St. Charles, IL 60174  
(312) 584-2300, FAX# 312-584-2370  
Pres.: J. McWilliams Stone, Jr.  
Group V.P.: William P. Finnegan  
Division General Mgr.: Steve Deppe  
Mkt'g Mgr.: Derek Podobas  
Nat'l Sales Mgr.: Warren Anderson  
Service Mgr.: Cliff Carlson  
Doug Fellabaum, Sycamore, IL, 800-445-0152(#2301)  
Don Mouritzen, Beecher, IL, 800-445-0152(2303#)  
Art Sbrilli, Edison, NJ, 800-445-0152(#2302)  
Pete Kendall, Jacksonville, FL, 904-262-6025(#2306)  
Jack Brown, Dallas, TX, 214-943-7528(#2305)  
Ed Nuhring, Portland, OR, 800-445-0152(#2307)  
Wally Smutts, Toronto, Ontario, Canada, 312-584-2300  
Ken Lind, Wellesley Hills, MA, 617-235-6817  
Products: clock, console, microprocessor, multi-channel, paging, talkback

Jeron Electronic Systems, Inc.  
1743 W. Rosehill Dr.  
Chicago, IL 60660  
(312) 275-1900, 800-621-1903, FAX# 312-275-0283  
Pres.: Jerome Chesnul  
V.P. Sales: John Charczuk  
Admiral Sales Co., Richardson, TX, 214-357-9212  
ASR Enterprises, Ltd., Fallston, MD, 301-893-0001  
Burcaw Company & Assoc., Warren, MI, 313-573-4605  
Central Marketing Group, Kansas City, MO, 816-741-7460  
Bi-State Marketers, Ridgefield, NJ, 201-943-5888  
Pat Norman Sales, Indianapolis, IN, 317-842-5611  
Greg Dzubay & Assoc., Peoria, AZ, 602-979-2358  
Pacnor Marketing, Inc., Lynwood, WA, 206-771-6016  
Gustafson Sales, Red Wing, MN, 612-388-4277  
J.W. Lehner Co., Stow, OH, 216-686-1965

Meyer Marketing, Deerfield Beach, FL, 305-481-9250  
Meyer & Ross, Burlingame, CA, 415-348-6800  
New West Agency, San Diego, CA, 619-299-3269  
Pacific West Marketing, Honolulu, HI, 808-261-7558  
Henry Philips Co., Roswell, GA, 404-992-3070  
R.G. Associates, Stow, MA, 617-897-7146  
Tortech Electronics, Inc., Scarborough, ONT, Canada, 416-282-1011  
John S. Wilkin & Assoc., Hillboro, OH, 513-393-1137  
Products: console, paging

## Multi-Vox Ltd.

9967 St. Michel Blvd.  
Montreal- Nord, Quebec, Canada H1H 5G7  
(514) 321-3131  
Pres.: Jean Lajoie  
Engineer: Dominique Malenfant  
Operations Mgr.: Georges Morissette  
Sales/Technical Cdr.: Antoine Krelio

## Paso Sound Products

14 First St.  
Pelham, NY 10803-1495  
(914) 738-4800, FAX# 914-738-3954  
Executive V.P.: Paul Mastrangelo  
Sales Mgr.: David Moore  
Product Mgr.: Ken O'Brien  
Credit Mgr.: Marilyn Beckerson  
Operations Mgr.: Anthony Sgueglia  
All West Electronics, Camarillo, CA, 805-388-1789  
Anderson Sales, Braintree, MA, 617-848-9194  
Pace Sales, Charlotte, NC, 704-365-3216  
De Witt Austin Co., Alpharetta, GA, 404-442-1326  
Dowell Assoc., St. Louis, MO, 314-849-4234  
Mountain Representatives, Denver, CO, 303-623-0972  
J.Y.S. Comm. Co., Dallas, TX, 214-349-1650  
Lienau Assoc., Inc., Columbia, MD, 301-621-4113  
Lienau Assoc., Inc., New Town, PA, 215-860-2100  
SLK Tech Rep, San Francisco, CA, 415-822-4884

Miguel Lopez, Hialeah, FL, 305-822-6853  
Marketline, Snellville, GA, 404-972-9048  
Messnick Sales, Liverpool, NY, 315-622-3211  
Miller Assoc., Ltd., Greenwich, CT, 212-840-2866  
Robert Milsk Co., Inc., Southfield, MI, 313-354-3310  
Robert Milsk Co., Indianapolis, IN, 317-842-3400  
Weller Electronic Sales, Worthington, OH, 614-885-7819  
Frank Lintern Assoc., Naperville, IL, 312-983-0935  
Products: multi-channel, paging, telephone

## Poetker Communications, Ltd.

461 Manitou Dr.  
Kitchner, Ont., Canada N2C1H3  
(519) 893-1010, FAX# 519-893-1731  
Pres.: B. W. Poetker  
Sales Mgr.: G. R. Ertel  
Ring Group of North America, Great Neck, NY, 800-645-9690

## Portland Instrument

1101A Air Way  
Glendale, CA 91201  
(818) 500-0137, 800-621-5640, FAX# 818-240-1828  
Pres.: Ronald A. Fuller  
Prod Mgr./In-Outdoor Sys.: Jack Sympton  
Prod Mgr./Wire & Cable: Judy Gill  
Production Mgr.: Patrick T. Gratner  
Tech Svces: Chris Norton  
Controller: Ken Thiele  
Products: paging, talkback

## RTS SYSTEMS, INC.

1100 West Chestnut St  
Burbank, CA 91506  
(818) 840-7119, FAX# 818-843-7953  
Pres.: Robert A. Smith  
V. P. Mkt'g: Douglas Leighton  
Sales Mgr.: Shelley Harrison  
Systems Engineer: Dave Brand  
Systems Engineer: Gene Behrend  
V.P. Engineering: Stan Hubler  
Products: microprocessor, multi-channel, talkback



Rauland-Borg Corp.  
 3535 W. Addison St.  
 Chicago, IL 60618  
 (312) 267-1300, FAX# 312-267-1127  
 Pres.: William Krucks  
 Sr. V.P./Sales & Mkt'g: Kenneth T. James  
 Chief Engineer: Lawrence Gleason  
 Nat'l Sales Mgr.: Rick Blunt  
 Harry B. Hahn, Olathe, KN, 913-829-9427  
 William C. Zophy, Ft. Myers, FL, 813-433-4766  
 Harold De Vaney, Dickinson, TX, 713-337-1040  
 Hank Plaisier, El Toro, CA, 714-837-2626  
 Vince Ward, Vashon Island, WA, 206-463-5582  
 Joseph A. Ciotti, Claymont, DE, 302-798-6558  
 William Lewis, Louisville, KY, 502-491-4273  
 Raymond Bailey, Granville, IL, 815-339-6789  
 Rauland-Borg Inc., Mississauga, ONT., CD, 416-821-2225  
 Jim Welch, Scarborough, ONT., CD, 416-438-4756  
 Products: clock, console, microprocessor, multi-channel, paging, talkback, telephone

Richmond Sound Design, Ltd.  
 1234 West 6th Ave.  
 Vancouver, Canada V6H 1A5  
 (604) 734-1217, FAX# 604-734-3901  
 Systems/Sales Mgr.: Damon Wootten  
 Accounts Mgr.: Marilyn Williams  
 Project Coordinator: Linda Pearson  
 Full Compass Systems, Madison, WI,  
 Products: microprocessor, paging

**RING GROUP, INC.**  
 230 Community Drive  
 Great Neck, NY 11021  
 (516) 487-0250, 800-645-9690, FAX# 516-487-0256  
 Pres.: Paul Ruggieri  
 V.P.: Peter McLean  
 Product Mgr.: Joel Kahn  
 Technical Director: Kjell (Ken) Solem  
 Sales Support: Craig Krsanac  
 Tech Support: Charlie Kulins  
 Klumpp Sales, Jacksonville, FL, 904-287-5205  
 Gustafson Sales, Red Wing, MN, 612-388-4277  
 Allwest Electronics, Camarillo, CA, 805-388-1789  
 Corrigan Agency, Covington, LA, 504-893-7455  
 J. C. Electronics, Honolulu, HI, 808-943-8514  
 Products: clock, console, microprocessor, paging, talkback

Siedle Intercom  
 780 Parkway  
 Broomall, PA 19008  
 (215) 353-9595, 800-874-3353, FAX# 215-353-9716  
 Pres.: Earl Zausmer  
 Products: microprocessor, multi-channel, paging, talkback

**SOUND POWERED COMMUNICATIONS CORP.**  
 PO Box 5569  
 335 Robbins Ave.  
 Trenton, NJ 08638  
 (609) 883-1180  
 Sales Mgr.: Harry Mosle

Speco Div., Components Specialties, Inc.  
 PO Box 624  
 1172 Rt. 109  
 Lindenhurst, NY 11757  
 (516) 957-8700, 800-645-5516, FAX# 516-956-9142  
 V.P./Sales: Mel Hulkower  
 V.P./General Mgr.: Jim Ganci  
 Sales Mgr.: Eric Forman  
 Products: paging

Swintek Enterprises, Inc.  
 587 Division St.  
 Campbell, CA 95008  
 (408) 378-8091, FAX# 408-378-6980  
 Pres.: William P. Swintek  
 Cinequip, Inc., Toronto, Ont., CD, 416-920-5424  
 Maga Techtronics, Artarmon, NSW, Australia, 02-438-3377  
 Commercial Electronics, Vancouver B.C., CD, 604-669-5525

**TOA ELECTRONICS, INC./ENGINEERED INTERCOM & SECURITY DIVISION**  
 PO Box 2047  
 601 Gateway Blvd.  
 South San Francisco, CA 94080  
 (415) 588-2538, 800-843-4750, in CA 800-632-2157, FAX# 415-588-3349  
 Pres.: Yoshiro Ishida  
 Director of Mkt'g: Fred Fredericks  
 Nat'l Sales Mgr.: Al Burns  
 Products: microprocessor, multi-channel, paging, talkback, telephone

## **INTERCOMS: PRODUCTION, THEATRICAL**

Alpha Communications  
 89-D Cabot Ct.  
 Hauppauge, NY 11788-3717  
 (516) 434-8080, 800-666-4800, FAX# 516-434-8334  
 Pres.: Mark S. Goldberg  
 V.P.: Madelyn R. Goldberg

Office Mgr.: Rose Tassone  
 Technician: Ted Jurgens  
 BBE Sound, Inc.  
 5500 Bolsa Avenue, Suite 245  
 Huntington Beach, CA 92649  
 (714) 897-6766, 800-233-8346, FAX# 714-895-6728

CEO: John C. McLaren  
 CFO.: Scott Anderson  
 Nat'l Sales: Jim Lucas  
 Operations Mgr.: Jennifer Drescher  
 Director of Engineering: Robert Crooks  
 Tech Svces Sup.: Ryan Coutts  
 Products: processors



**Rauland** the better choice in  
**communications systems**

**Rauland** **TELECENTER**<sup>®</sup> better for schools

**TELECENTER**<sup>®</sup> **IV** Provides multi-link *internal communications* between administrators and between administrators and classrooms, plus full *interconnect to outside lines*. Features: Conference call capability, instant schoolwide or "zone" paging, call display in order received, with priority for emergency calls. Includes a wealth of user-programmable features; simple touchpoint operation; fully expandable to meet growing needs. Unmatched for administrative communications management.



**TELECENTER**<sup>®</sup> **5000** This very affordable microprocessor-controlled system provides instant 2-way conversation between the Control Center Station and up to 48 classrooms. User-programmable features: room numbering, architectural or otherwise; "zone" or area assignment; distribution of optional program sources (cassette, phono, radio); built-in program clock to distribute class change signals. Simple touchpoint operation; classroom privacy; immunity to power failure—all at remarkable low cost.

**Rauland** **RESPONDER**<sup>®</sup> better for health care

**RESPONDER**<sup>®</sup> **III** Selected by more hospitals nationwide since 1982, than any other nurse call system. Offers 24 exclusive new features, including "hold" and "recall" capability, one-button automatic staff search, independent utility display, automatic staff "follow" in code blue, 14 priority levels; includes a host of user-programmable features; microprocessor-controlled; immune to power failure; simple positive touchpoint operation. Designed to be specified with complete confidence.



**RESPONDER**<sup>®</sup> **System 3000** Designed for smaller hospitals and nursing homes, to combine reliable, versatile communications with unmatched economy. Microprocessor design features user-programmable room numbering, room priority status, paging by specific "zone" or facility-wide. Includes staff "follow"; 7 levels of call priority; call display in order received, with priority for emergency calls; immunity to power failure, night service from a single floor control station. Maximum efficiency with economy.

**AT YOUR COMMAND:** One of our nationwide network of Authorized Rauland Communications Specialists with system design expertise and full installation and service facilities is available to you for consultation and demonstration without obligation. For full details about the systems and your nearest Rauland Specialist, write or call today, or use the reader service card.



**RAULAND-BORG CORPORATION**

3535 W. Addison St., Chicago, Ill. 60618 • 1-312-267-1300

In Canada: Rauland-Borg Corporation (Canada) Inc. • 6535 Millcreek Dr., Unit 5, Mississauga, Ont., Can. L5N 2M2

BCE/Edcom, Division of CCS, Inc.  
 1585A Britannia RD. E., #7  
 Mississauga, Ontario, Canada L4W  
 2M4  
 (416) 678-0801, FAX# 416-678-0480  
 Pres.: Peter Jova  
 Sales Mgr.: Keith Moore  
 Products: loudspeaker,  
 microprocessor, VOX

David Clark Co., Inc.  
 PO Box 15054  
 360 Franklin St.  
 Worcester, MA 01615-0054  
 (617) 756-6216, FAX# 508-753-5827  
 Product Mgr. Comm.: George R.  
 Conlan  
 Pres.: John E. Flagg  
 Exec. V.P.: Richard P. Houlihan  
 General Sales Mgr.: Robert J. Murphy  
 Product Mgr./Comm.: George R.  
 Conlan  
 Products: headset

Clear-Com Intercom Systems  
 945 Camelia St.  
 Berkeley, CA 94710  
 (415) 527-6666, FAX# 415-527-6699  
 Pres.: Robert Cohen  
 Nat'l Sales Mgr.: Michael Goddard  
 Products: handset, headset, IFB,  
 loudspeaker, microprocessor, multi-  
 channel, processors, radio interface,  
 VOX, wireless

**COMTEK**<sup>®</sup>  
 COMMUNICATIONS TECHNOLOGY, INC.

Comtek, Inc.  
 357 W. 2700 St. South  
 Salt Lake City, UT 84115  
 (801) 466-3463, FAX# 801-484-6906  
 Pres.: Ralph Belgique  
 Application Engineer: Steve Kartchner  
 In-House Sales: Stacy Hayes-Garcia  
 Products: wireless

**ELENEX, INC. (EAST)**  
 7 Wayland St.  
 N. Cohocton, NY 14868  
 (716) 534-5280, 800-356-8433, FAX#  
 716-534-5950  
 Pres.: Sten Persson  
 Product Mgr.: Dave Arseneau  
 Sales: Geoffrey Spencer  
 Products: wireless

# RING

## Even our name tells you you'll get calls for our products.



Whether you're in the majority of sound contractors selling intercom, or should be, Ring has the systems your customers want.

For school and institutional communications, the Ring 3000 is an economical, easy-to-use, two-channel system which can serve an unlimited number of classrooms or locations. For more sophisticated requirements, the MCS 250 offers extra versatility in a micro-processor-controlled, modular system.

Of course, the Ring CB 800, CB 910 and CB 901/2/3 central exchange intercom systems have set industry standards worldwide with great voice quality and advanced features.

To continue rounding out Ring's growing product line, there are quality commercial sound products including speakers, baffles, transformers, volume controls and amplifiers.

To be sure of cost effective installations and years of trouble-free service, Ring offers excellent technical

back-up, documentation, and assistance for special product applications.

With on-site warehousing and shipping, we can give fast turnaround to your orders. That's important, since our lead generating programs supply you with a steady stream of prospects.

Finally, there's Ring's competitive edge in pricing. You'll have increased profits while still offering your customers appealing prices.

**Give us a Ring. We know how to make  
your phone...and cash register...ring.**

See us at NSCA booth A2

**RING<sub>OO</sub>**  
COMMUNICATIONS  
A DIVISION OF RING GROUP, INC.

(HME) HM Electronics, Inc.  
PO Box 261669  
6675 Mesa Ridge Rd.  
San Diego, CA 92121  
(619) 535-6060, FAX# 619-452-7207  
Pres.: Harry Y. Miyahira  
V.P.: Donald Kutz  
Director of Mkt'g: J. Michael Hughes  
Nat'l Sales Mgr.: Randy Opela  
Mkt'g Coordinator: Tonnia B. Sills

## RTS SYSTEMS, INC.

1100 West Chestnut St  
Burbank, CA 91506  
(818) 840-7119, FAX# 818-843-7953  
Pres.: Robert A. Smith  
V. P. Mkt'g: Douglas Leighton  
Sales Mgr.: Shelley Harrison  
Systems Engineer: Dave Brand  
Systems Engineer: Gene Behrend  
V.P. Engineering: Stan Hubler  
Products: handset, headset, IFB,  
loudspeaker, microprocessor, multi-  
channel

## DELTA COM 2600

### School & Institutional Intercom Systems



- Solid State/Modular Design
- Dual-Channel Capability
- Two-Channel Telecom Option
- Selective Time-Tone Option
- Includes AM-FM Cassette
- Lightweight — Small Size
- No Hidden Extras—Completely  
Factory-Assembled

U.L. LISTED

**DELTA COMMUNICATIONS, INC.**  
7852 78th Avenue SW  
Tacoma, WA 98498  
(206) 582-2201

Dealer Inquiries Welcome

Swintek Enterprises, Inc.  
587 Division St.  
Campbell, CA 95008  
(408) 378-8091, FAX# 408-378-6980  
Pres.: William P. Swintek  
Cinequip, Inc., Toronto, Ont., CD, 416-  
920-5424  
Maga Techtronics, Artarmon, NSW,  
Australia, 02-438-3377  
Commercial Electronics, Vancouver  
B.C., CD, 604-669-5525

## TECHNICAL PROJECTS, INC.

PO Box 1449  
449 Princeton Ave.  
Barrington, IL 60011  
(312) 381-5350, 800-562-5872, FAX#  
312-381-4360  
Pres.: Glenn Mullis  
Sec./Treas.: Sibbelina Mullis  
Professional Audio Mkt'g, New York,  
NY, 516-367-8620  
Sound Sales, Lanham, MD, 301-731-  
6355  
Audio Marketing Assoc., Brecksville,  
OH, 216-526-2426  
Wm. M. Linz & Assoc., Deerfield, IL,  
312-945-9600  
Design Factors, Hacienda Heights, CA,  
213-697-7576  
Products: handset, IFB

Telex Communications, Inc., Pro Audio  
Dept.  
9600 Aldrich Ave. S.  
Minneapolis, MN 55420  
(612) 884-4051, FAX# 612-884-0043  
Chairman of the Board: Ansel Kleiman

Exec. V.P.: Jeffrey Wetherell  
V.P. Mkt'g: James Arrington  
Director of Mkt'g: Donald Mereen  
Director of Advertising: Ronald Taylor  
Wes-Tech Marketing, Culver City, CA,  
213-870-9286  
Bencsik Assoc., Ocala, FL, 904-732-  
9775  
Monfort Electronic Marketing,  
Indianapolis, IN, 317-872-8877  
Mountain Representatives, Inc.,  
Denver, CO, 303-623-0972  
Murphy & Cota, Inc., Atlanta, GA, 404-  
875-2525  
Northland Assoc., Moorhead, MN, 218-  
233-4616  
White Radio Ltd., Burlington, Ontario,  
Canada, 416-632-6894  
Rancilio Assoc., Inc., St. Louis, MO,  
314-631-3326  
SAGA, Oswego, NY, 315-343-5739  
Sigmet Corporation, Valley Forge, PA,  
215-783-6666  
J.Y. Schoonmaker Co., Dallas, TX,  
214-349-1650  
Weller Electronic Sales, Worthington,  
OH, 614-885-7819  
Ziskind Assoc., Rolling Meadows, IL,  
312-577-1624  
Burcaw Company & Assoc., Warren,  
MI, 313-573-4605  
S&F Northwest, Seattle, WA, 206-622-  
6036  
Lichtenauer & Associates, Antioch, CA,  
415-757-1200  
Products: handset, headset, IFB,  
loudspeaker, microprocessor, multi-  
channel, VOX

## INTERCOMS: SIMPLEX

### AIPHONE INTERCOM SYSTEMS

PO Box 90075  
1700 130th Ave. N.E.  
Bellevue, WA 98005  
(206) 455-0510, FAX# 206-455-0071  
Pres.: Hiko Shinoda  
Nat'l Sales: Jim Morrison  
Products: loudspeaking,  
microprocessor, multi-channel,  
telephone, video/audio

### Atlas/Soundolier

1859 Intertech Dr.  
Fenton, MO 63026  
(314) 349-3110, FAX# 314-349-1251  
V.P. Sales: Tom Erickson  
E. Region/Sales: Andy Musci  
W. Region/Sales: Bud Waters  
V.P./Mkt'g Consultant: Herbert Jaffe  
Products: loudspeaking, multi-channel,  
telephone



BCE/Edcom, Division of CCS, Inc.  
 1585A Britannia RD. E., #7  
 Mississauga, Ontario, Canada L4W  
 2M4  
 (416) 678-0801, FAX# 416-678-0480  
 Pres.: Peter Jova  
 Sales Mgr.: Keith Moore  
 Products: loudspeaking,  
 microprocessor, multi-channel,  
 programmable, VOX

Bogen Communications, Inc.  
 PO Box 575  
 50 Spring St.  
 Ramsey, NJ 07446  
 (201) 934-8500, FAX# 201-934-9832  
 Pres.: John H. Ochtera  
 V.P. Sales/Sound Prod.: David A.  
 Chambers  
 V.P. Sales/Telecomm. Prod.: Charles  
 Ferreri  
 Bruce Barrett, Garland, TX, 214-530-  
 0467  
 Kingston Sales Corp., Indianapolis, IN,  
 317-876-2545  
 Kevin Koehler, Batvia, IL, 312-879-6871  
 Tim McDonnell, Willoughby Hills, OH,  
 216-942-2429  
 Steve McGrew, Kennesaw, GA, 404-  
 422-4608  
 Meyer Mkt'g, Inc., Deerfield Beach, FL,  
 305-481-9250  
 W.B. Pray Sales, Inc., Northboro, MA,  
 617-393-3434  
 Jay Sample, Sandy, UT, 801-942-1059  
 Scott Sampson, Encino, CA, 818-996-  
 5484  
 Mike Schneider, Baltimore, MD, 301-  
 563-5390  
 Walt Spencer, Ramsey, NJ, 201-934-  
 8500  
 White Radio Ltd., Burlington, ONT,  
 Canada, 416-632-6894  
 Roburn Agencies, Inc., Yonkers, NY,  
 914-968-1016  
 Products: loudspeaking, multi-channel,  
 telephone

Clear-Com Intercom Systems  
 945 Camelia St.  
 Berkeley, CA 94710  
 (415) 527-6666, FAX# 415-527-6699  
 Pres.: Robert Cohen  
 Nat'l Sales Mgr.: Michael Goddard  
 Products: closed-circuit, digital, IFB,  
 loudspeaking, microprocessor, multi-

channel, programmable, video/audio,  
 VOX, wireless

Communications Equipment Co., Inc.  
 6443 Western Ave.  
 Glen Arbor, MI 49636  
 (616) 334-3081  
 Pres.: Darrell W. Thomas  
 Sales Mgr.: Thomas A. Garmhausen



**LEE DAN COMMUNICATIONS**

155 Adams Ave.  
 Hauppauge, NY 11788-3699  
 (516) 231-1414, 800-533-3261, FAX#  
 516-231-1498  
 Pres.: Leon Goldberg  
 V.P. Operations: Lawrence J. Goldberg  
 V.P. Finance/Admin.: David H.  
 Goldberg  
 Sr. Technician: Sandy Hoffman

Customer Svce: Linda E. Scaturro  
 Production Sup.: Gabriel Figueroa  
 Products: closed-circuit, custom,  
 digital, loudspeaking,  
 microprocessor, video/audio

**ELENEX, INC. (EAST)**

7 Wayland St.  
 N. Cohocton, NY 14868  
 (716) 534-5280, 800-356-8433, FAX#  
 716-534-5950  
 Pres.: Sten Persson  
 Product Mgr.: Dave Arseneau  
 Sales: Geoffrey Spencer  
 Products: closed-circuit, custom, VOX,  
 wireless

**ELENEX, INC. (WEST)**

7392 Trade St.  
 San Diego, CA 92121  
 (619) 566-7515, 800-225-3113, in CA  
 800-225-8037, FAX# 619-586-1484  
 V.P.: Dennis Berglund  
 Engineering: Al Bitarafan  
 Sales: Lou Hennequin  
 Products: custom

*Production  
 Intercom  
 Beltpack &  
 Headset...*



**NO KID GLOVES  
 REQUIRED.**

Virtually indestructible, our  
 Beltpacks & Headsets free  
 you from the worry of acci-  
 dental breakage. For reliabil-  
 ity...for price...for quality  
 that really lasts...Technical  
 Projects *Production Intercom.*

**Technical Projects, Inc.**

*Fully compatible with other popular 3-wire systems.*

**1-800-562-5872**

Fax: 312-381-4360

P.O. Box 1449, Barrington, IL 60010, 312-381-5350

## Fanon Courier

14281 Chambers Road  
Tustin, CA 92680  
(714) 669-9890, 800-345-1354, FAX#  
714-669-1081

Pres.: Frank Blaha

Director Sales/Mkt'g: Murray Trotiner  
Director of Engineering: Miguel Santana  
Products: loudspeaking, VOX, wireless

## Fisher-Berkeley Corp.—Ektacom

5800 Christie Ave.  
Emeryville, CA 94608  
(415) 655-9696, FAX# 415-658-0674

Pres: Robert S. Fisher

V.P. Engineering: Robert T. Shipley  
Sales Engineer: Michael D. Lagrimas  
Sales Engineer: Roger E. Stewart

## Jeron Electronic Systems, Inc.

1743 W. Rosehill Dr.  
Chicago, IL 60660  
(312) 275-1900, 800-621-1903, FAX#  
312-275-0283

Pres.: Jerome Chesnul

V.P. Sales: John Charczuk

Admiral Sales Co., Richardson, TX,  
214-357-9212

ASR Enterprises, Ltd., Fallston, MD,  
301-893-0001

Burcaw Company & Assoc., Warren,  
MI, 313-573-4605

Central Marketing Group, Kansas City,  
MO, 816-741-7460

Bi-State Marketers, Ridgefield, NJ, 201-  
943-5888

Pat Norman Sales, Indianapolis, IN,  
317-842-5611

Greg Dzubay & Assoc., Peoria, AZ,  
602-979-2358

Pacnor Marketing, Inc., Lynwood, WA,  
206-771-6016

Gustafson Sales, Red Wing, MN, 612-  
388-4277

J.W. Lehner Co., Stow, OH, 216-686-  
1965

Meyer Marketing, Deerfield Beach, FL,  
305-481-9250

Meyer & Ross, Burlingame., CA, 415-  
348-6800

New West Agency, San Diego, CA,  
619-299-3269

Pacific West Marketing, Honolulu, HI,  
808-261-7558

Henry Philips Co., Roswell, GA, 404-  
992-3070

R.G. Associates, Stow, MA, 617-897-  
7146

Tortech Electronics, Inc., Scarborough,  
ONT, Canada, 416-282-1011

John S. Wilkin & Assoc., Hillboro, OH,  
513-393-1137

Products: custom, telephone,  
video/audio

## Marsh Products, Inc.

336 McKee Street  
Batavia, IL 60510  
(312) 879-8008

## RTS SYSTEMS, INC.

1100 West Chestnut St  
Burbank, CA 91506  
(818) 840-7119, FAX# 818-843-7953

Pres.: Robert A. Smith

V. P. Mkt'g: Douglas Leighton

Sales Mgr.: Shelley Harrison

Systems Engineer: Dave Brand

Systems Engineer: Gene Behrend

V.P. Engineering: Stan Hubler

Products: IFB

## Siedle Intercom

780 Parkway  
Broomall, PA 19008  
(215) 353-9595, 800-874-3353, FAX#  
215-353-9716

Pres.: Earl Zausmer

Products: closed-circuit, video/audio

## Stentofon Communications, Inc.

6119 Connecticut Ave.  
Kansas City, MO 64120  
(816) 231-7200, FAX# 816-231-7203

Pres.: Kenneth P. Jensen

V.P./Technical: James Pierce

Nat'l Sales Mgr.: Frederick Hall

Business Mgr.: Doug Caldwell

Controller: Barbara Hernandez

Products: loudspeaking,  
microprocessor

## Swintek Enterprises, Inc.

587 Division St.  
Campbell, CA 95008  
(408) 378-8091, FAX# 408-378-6980

Pres.: William P. Swintek

Cinequip, Inc., Toronto, Ont., CD, 416-  
920-5424

*Production Intercom  
Beltpack &  
Headset...*



**YOU JUST CAN'T  
BEAT 'EM!**

For durability...for price...  
for reliability...for service...  
for quality that really lasts...  
you just can't beat Technical  
Projects *Production Intercom.*

**Technical Projects, Inc.**  
*Fully compatible with other popular 3-wire systems.*

**1-800-562-5872**  
Fax: 312-381-4360

P.O. Box 1449, Barrington, IL 60010, 312-381-5350



## “Intercoms Must Play A Supportive Role”

From the very beginning, we knew that intercoms were not meant to be the almighty communications instrument. They were designed to supplement major equipment like telephones and computers. There are numerous applications here that must be met.

That is exactly why Aiphone has designed so many different models. We don't think that one ALMIGHTY intercom can fulfill every possible need.

Our product line ranges from the very basic two-station analog circuit systems to the ultra sophisticated microprocessor based systems meeting your industry's communication requirements. Whatever the need, we've got a product designed to meet it.

The so-called almighty intercom might do the job, but more than likely, you'll end up paying a lot of money for features you'll never use.

With Aiphone, you pay only for what you need. You have my word on it!

Masahiko (Hiko) Shihoda  
*President*

 **AIPHONE®**

The world leader in internal communications  
systems for home, business & industry.

Aiphone Corporation • 1700 - 130th Ave. N.E., Bellevue, WA 98009 • (206)455-0510



Maga Techtronics, Artarmon, NSW,  
Australia, 02-438-3377  
Commercial Electronics, Vancouver  
B.C., CD, 604-669-5525

T.S.K. Electronics, Inc.  
PO Box 190  
564 Young St.  
Tonawanda, NY 14151-0190  
(716) 693-3916  
Pres.: Theodore S. Kedzierski  
Chief Engineer: Kevin T. Kedzierski  
Products: custom, loudspeaking,  
telephone, VOX

Telex Communications, Inc., Pro Audio  
Dept.  
9600 Aldrich Ave. S.  
Minneapolis, MN 55420  
(612) 884-4051, FAX# 612-884-0043  
Chairman of the Board: Ansel Kleiman  
Exec. V.P.: Jeffrey Wetherell  
V.P. Mkt'g: James Arrington

Director of Mkt'g: Donald Merein  
Director of Advertising: Ronald Taylor  
Wes-Tech Marketing, Culver City, CA,  
213-870-9286  
Bencsik Assoc., Ocala, FL, 904-732-  
9775  
Monfort Electronic Marketing,  
Indianapolis, IN, 317-872-8877  
Mountain Representatives, Inc.,  
Denver, CO, 303-623-0972  
Murphy & Cota, Inc., Atlanta, GA, 404-  
875-2525  
Northland Assoc., Moorhead, MN, 218-  
233-4616  
White Radio Ltd., Burlington, Ontario,  
Canada, 416-632-6894  
Rancilio Assoc., Inc., St. Louis, MO,  
314-631-3326  
SAGA, Oswego, NY, 315-343-5739  
Sigmet Corporation, Valley Forge, PA,  
215-783-6666  
J.Y. Schoonmaker Co., Dallas, TX,  
214-349-1650

Weller Electronic Sales, Worthington,  
OH, 614-885-7819  
Ziskind Assoc., Rolling Meadows, IL,  
312-577-1624  
Burcaw Company & Assoc., Warren,  
MI, 313-573-4605  
S&F Northwest, Seattle, WA, 206-622-  
6036  
Lichtenauer & Associates, Antioch, CA,  
415-757-1200  
Products: closed-circuit, IFB,  
loudspeaking, microprocessor, multi-  
channel, programmable, telephone,  
VOX

### 3M SOUND PRODUCTS

223-5S-09, 3M Center  
St. Paul, MI 55144-1000  
(612) 733-9214, FAX# 612-736-9433  
Mkt'g Mgr.: Richard G. Barker  
Sales Mgr.: Don Sluder  
Products: multi-channel, VOX, wireless

## SIGNALING SYSTEMS

Adaptive Micro Systems, Inc.  
7840 N. 86th St.  
Milwaukee, WI 53224  
(414) 357-2020, 800-558-7022, FAX#  
414-357-2029  
Products: visual

Alpha Communications  
89-D Cabot Ct.  
Hauppauge, NY 11788-3717  
(516) 434-8080, 800-666-4800, FAX#  
516-434-8334  
Pres.: Mark S. Goldberg  
V.P.: Madelyn R. Goldberg  
Office Mgr.: Rose Tassone  
Technician: Ted Jurgens

Atlas/Soundolier  
1859 Intertech Dr.  
Fenton, MO 63026  
(314) 349-3110, FAX# 314-349-1251  
V.P. Sales: Tom Erickson  
E. Region/Sales: Andy Musci  
W. Region/Sales: Bud Waters  
V.P./Mkt'g Consultant: Herbert Jaffe  
Products: alarm, annunciator, audio,  
bell, call-light, tone, visual

BCE/Edcom, Division of CCS, Inc.  
1585A Britannia RD. E., #7  
Mississauga, Ontario, Canada L4W  
2M4  
(416) 678-0801, FAX# 416-678-0480  
Pres.: Peter Jova  
Sales Mgr.: Keith Moore  
Products: alarm, annunciator, audio,  
call-light, tone, visual

Cornell Electronics Products, Inc.  
PO Box 23411  
4911 West Good Hope Rd.  
Milwaukee, WI 53223-0411  
(414) 351-4660, 800-541-9946, FAX#  
414-351-4657  
Pres.: Donald Glaubitz  
V.P.: Gary M. Butler  
Sales Mgr.: Pauline A. Haack  
SE Reg Sales Mgr.: William Ellinger  
SLK/Tech Rep, San Francisco, CA,  
415-822-4885  
Gustafson System Sales, Inc., Palatine,  
IL, 312-358-2505  
Bidwell-Schwartz Associates, Inc.,  
Gardena, CA, 213-770-0300  
Pinz Sales Corp., Rockville Centre, NY,  
516-678-6887

Dick Bellew Sales, Inc., Dallas, TX,  
214-644-7881  
Cavendish and Winchester, Inc.,  
Atlanta, GA, 404-449-5104  
Avcom, Inc., N. Olmsted, OH, 216-777-  
2060  
Richard S. Pass Assoc., Langhorne,  
PA, 215-757-6100  
Kingston Sales Corp., Indianapolis, IN,  
317-876-2545  
Rancilio Assocs., Inc., St. Louis, MO,  
314-631-3326  
Shamrock Electronic Sales, Dayton,  
OH, 513-258-1227  
CB Electronic Marketing, Arvada, CO,  
303-422-0561  
Cartwright & Bean, Inc., Orlando, FL,  
407-422-4531  
Avwest, Inc., Fountain Hills, AZ, 617-  
545-0652  
LSM Associates, Phelps, NY, 315-548-  
4891  
W.A. Hendrickson Co., Inc., North  
Scituate, MA, 617-545-0652  
Kodo Associates, Inc., Minneapolis,  
MN, 612-881-1255  
Vector Corp., Seattle, WA, 206-322-  
4343

Yocum Marketing, Inc., Mesa, AZ,  
602-265-5056  
Products: alarm, annunciator, call-light,  
visual

**LEE DAN COMMUNICATIONS**

155 Adams Ave.  
Hauppauge, NY 11788-3699  
(516) 231-1414, 800-533-3261, FAX#  
516-231-1498  
Pres.: Leon Goldberg  
V.P. Operations: Lawrence J. Goldberg  
V.P. Finance/Admin.: David H.  
Goldberg

Sr. Technician: Sandy Hoffman  
Customer Svce: Linda E. Scaturro  
Production Sup.: Gabriel Figueroa  
Products: annunciator, audio, bell, call-  
light, tone, visual

**ELENEX, INC. (WEST)**

7392 Trade St.  
San Diego, CA 92121  
(619) 566-7515, 800-225-3113, in CA  
800-225-8037, FAX# 619-586-1484  
V.P.: Dennis Berglund  
Engineering: Al Bitarafan  
Sales: Lou Hennequin  
Products: alarm, annunciator, audio

**Lathem Time Recorder Co.**

200 Selig Dr. SW  
Atlanta, GA 30378  
(404) 691-0400, 800-241-4990, FAX#  
404-696-6048  
Pres.: Louie P. Lathem, Jr.  
V.P.: William C. Lathem  
V.P. Finance: CalisteAnn Hooper  
Nat'l Sales Mgr.: Gary Henry  
Lathem Time Ca., Santa Fe Springs,  
CA, 800-352-4314

**MG Electronics**

32 Ranick Rd.  
Hauppauge, NY 11788  
(516) 582-3400, FAX# 516-582-3229  
Pres.: Louis Maltz  
V.P.: Elliott Maltz  
Sales Mgr.: Stan Grey  
Miller Assoc., Stamford, CT, 203-869-  
7793  
Forti Assoc., Kensington, MD, 301-  
949-1706  
Cavendish & Winchester, Atlanta, GA,  
404-449-5104  
Raymar Associates, Duncanville, TX,  
214-296-9833  
Products: annunciator

Mallory Capacitor Co.  
PO Box 1284  
4760 Kentucky Avenue  
Indianapolis, IN 46206  
(317) 856-3731, FAX# 317-856-2500  
Pres.: Steve Murray  
V.P. Manufacturing: Tom Arnold  
Dir. Engineering & QA: Len Ziska  
Dir. of Field Sales: Tom Green  
Sales/Mkt'g Svcs Mgr.: Tom Pilcher  
Advertising Mgr.: Sherry Garner  
Products: audio

**NEL-TECH LABS, INC.**

PO Box 1030  
Londonderry, NH 03053  
(603) 434-8234, FAX# 603-434-1265  
Pres.: Gary Stapleford  
Exec. V.P.: Ken Ritter  
Products: alarm, annunciator, audio,  
tone

**PROTECH AUDIO CORP.**

Flowerfield, Bldg. #1  
St. James, NY 11780  
(516) 584-5855  
Sales Mgr.: Bill Murphy  
Sales Engineering: Joe Giambone  
Peregrine Rep's, Houston, TX, 713-  
772-6765

**Speco Div., Components Specialties, Inc.**

PO Box 624  
1172 Rt. 109  
Lindenhurst, NY 11757  
(516) 957-8700, 800-645-5516, FAX#  
516-956-9142  
V.P./Sales: Mel Hulkower  
V.P./General Mgr.: Jim Ganci  
Sales Mgr.: Eric Forman  
Products: alarm

**TEKTONE SOUND & SIGNAL MFG., INC.**

PO Box 12427  
1331 S. Killian Dr.  
Lake Park, FL 33403  
(407) 844-2383, FAX# 407-845-1587  
Pres.: Manuel Mira  
General Mgr.: Carlos Mira  
Sales/Mkt'g Director: Tom Hendricks  
Chief Engineer: Jim Switzer  
Ziskind & Assoc., Rolling Meadow, IL,  
312-577-1624  
Wm. B. Allen Supply Co., New Orleans,  
LA, 504-525-8222  
Alvan C. Chaney & Assoc., Hialeah, FL,  
305-558-3933

Dardon & Assoc., Olmstead Township,  
OH, 216-234-4555  
Klump Sales Co., Jacksonville, FL,  
904-287-5205  
Lee Dan Communications, Hauppauge,  
NY, 516-231-1414  
Lichtenauer & Assoc., Antioch, CA,  
415-757-1200  
R.W. Sales, Inc., St. Paul, MN, 612-  
646-2710  
Mountain Representatives, Denver, CO,  
303-623-0972  
Chuck Olson Assoc., Renton, WA, 206-  
271-5416  
Alpha Communications, Hauppauge,  
NY, 516-434-8080  
Westech Marketing, Culver City, CA,  
213-870-9286  
Products: alarm, annunciator, call-light

**Vicon Industries**

525 Broad Hollow Rd.  
Melville, NY 11747  
(516) 293-2200, 800-645-9116  
Pres.: Donald N. Horn  
Executive V.P.: Arthur Wallace  
V.P. Finance: Kenneth Darby  
V.P. Mkt'g/Sales: Ronald J. Teixeira  
Vicon Industries, Norcross, GA, 404-  
449-0499  
Products: alarm, annunciator, audio,  
tone

**Wheelock, Inc.**

273 Branchport Ave.  
Long Branch, NJ 07740  
(201) 222-6880, FAX# 201-222-8707  
Pres.: P. W. Tarlton  
V.P. Mkt'g/Sales: W.L. Goldstein  
Mkt'g Mgr./Telephone-Paging: Art  
Arlow  
Tech. Support Engineer: W. Best  
Products: alarm, audio, bell, tone,  
visual

**Whelen Engineering Co., Inc.**

Rte. 145, Winthrop Rd.  
Chester, CT 06412-0684  
(203) 526-9504, 800-423-0564, FAX#  
203-526-4078  
Pres.: John Olson  
V.P., Auto/Indust. Prod.: Howard Berke  
Int'l Sales Mgr.: Keith Nelson  
Adv. Director: Wendy Roulier  
V.P. High Power Sirens: Skip Phelps  
V.P. Aviation Prod.: Fred Frazier  
Products: alarm, visual

# LOUDSPEAKER PRODUCTS

## LOUDSPEAKER ACCESSORIES

Acoustone Grille Cloth  
80 Wythe Ave  
Brooklyn, NY 11211  
(718) 782-5560, FAX# 718-782-7367  
Pres.: George Backer  
Production Mgr.: Larry Lubliner  
Office Mgr.: Al Allentoff  
Order Dept.: Inge  
Order Dept.: Judy  
Products: grille cloth

**AIPHONE INTERCOM SYSTEMS**

PO Box 90075  
1700 130th Ave. N.E.  
Bellevue, WA 98005  
(206) 455-0510, FAX# 206-455-0071  
Pres.: Hiko Shinoda  
Nat'l Sales: Jim Morrison  
Products: baffles, grilles, mounting devices

Atlas/Soundolier  
1859 Intertech Dr.  
Fenton, MO 63026  
(314) 349-3110, FAX# 314-349-1251  
V.P. Sales: Tom Erickson  
E. Region/Sales: Andy Musci  
W. Region/Sales: Bud Waters  
V.P./Mkt'g Consultant: Herbert Jaffe  
Products: attenuators, baffles, enclosure hardware, enclosure, grilles, mounting devices, mounting hardware, stands, transformers

Audisar  
PO Box 1561  
Bellevue, WA 98009  
(206) 454-2040  
Owner: R. Munger  
Products: attenuators, baffles, connectors, crossovers, enclosure hardware, enclosure, mounting devices, mounting hardware, transformers

Bogen Communications, Inc.  
PO Box 575  
50 Spring St.  
Ramsey, NJ 07446

(201) 934-8500, FAX# 201-934-9832  
Pres.: John H. Ochtera  
V.P. Sales/Sound Prod.: David A. Chambers  
V.P. Sales/Telecomm. Prod.: Charles Ferreri  
Bruce Barrett, Garland, TX, 214-530-0467  
Kingston Sales Corp., Indianapolis, IN, 317-876-2545  
Kevin Koehler, Batavia, IL, 312-879-6871  
Tim McDonnell, Willoughby Hills, OH, 216-942-2429  
Steve McGrew, Kennesaw, GA, 404-422-4608  
Meyer Mkt'g, Inc., Deerfield Beach, FL, 305-481-9250  
W.B. Pray Sales, Inc., Northboro, MA, 617-393-3434  
Jay Sample, Sandy, UT, 801-942-1059  
Scott Sampson, Encino, CA, 818-996-5484  
Mike Schneider, Baltimore, MD, 301-563-5390  
Walt Spencer, Ramsey, NJ, 201-934-8500  
White Radio Ltd., Burlington, ONT, Canada, 416-632-6894  
Roburn Agencies, Inc., Yonkers, NY, 914-968-1016  
Products: attenuators, baffles, grilles, transformers

**LEE DAN COMMUNICATIONS**

155 Adams Ave.  
Hauppauge, NY 11788-3699  
(516) 231-1414, 800-533-3261, FAX# 516-231-1498  
Pres.: Leon Goldberg  
V.P. Operations: Lawrence J. Goldberg  
V.P. Finance/Admin.: David H. Goldberg  
Sr. Technician: Sandy Hoffman  
Customer Svce: Linda E. Scaturro  
Production Sup.: Gabriel Figueroa  
Products: attenuators, baffles, grilles, transformers

**J. W. DAVIS & CO.**  
PO Box 26177  
3030 Canton Street  
Dallas, TX 75226  
(214) 651-7341, 800-527-5705, in TX 800-442-1564, FAX# 214-939-0328  
Pres.: Charles Griffith  
V.P. Sales: Jack W. Tucker  
Chief Engineer: Mike Lamm

**Eddcor**  
1948 East Pomona  
Santa Ana, CA 92705  
(714) 648-0292, 800-854-0259, FAX# 714-648-0117  
Pres.: Larry Weston  
Office Mgr.: Phyllis Weston  
Sales Mgr.: Deanna Weston  
Products: transformers

**Electro-Voice, Inc.**  
600 Cecil Street  
Buchanan, MI 49107  
(616) 695-6831, 800-527-6701, FAX# 616-695-1304  
Pres.: Robert D. Pabst  
V.P. Sales & Mkt'g: Paul McGuire  
Director of Mkt'g: Jim Long  
Chief Engineer: Earl Harris  
George M. Conneen Co., Inc., Springfield, PA, 215-544-5884  
Metropolis Audio Marketing, Inc., Edison, NJ, 201-225-0085  
R.J. Marketing Ltd., Rockville, MD, 301-251-0330  
The Smith Company, Hartford, CT, 203-523-0512  
Ron Tunks Sales, Inc., Tamarac, FL, 305-722-2803  
Wilson Audio Sales, Nashville, TN, 615-646-4477  
Audio Resources, Westmont, IL, 312-655-1180  
B.C. Electronic Sales, Inc., Mission, KS, 913-262-1720  
Jones Audio Sales, Plano, TX, 214-867-0202  
C.L. Pugh & Assoc., Inc., Columbus, OH, 614-486-9678



Riley & Petchell Sales, Inc., Detroit, MI,  
313-937-300

Loppnow & Assoc., Redmond, WA,  
206-883-3205

Radon & Assoc., Sacramento, CA,  
916-923-2524

Silver Peak Marketing Ltd., Wheat  
Ridge, CO, 303-467-9042

Western Audio Sales, Glendale, CA,  
818-246-3806 x

Products: attenuators, baffles,  
connectors, crossovers, grilles,  
mounting hardware, stands,  
transformers

Fourjay Industries, Inc.

3400 Stop Eight Road  
Dayton, OH 45414-0617

(513) 890-6444, FAX# 513-890-1692

Pres.: J.M. Fulkerson II

Director of Sales: M.W. (Bud) Frawley

Products: baffles, enclosure hardware,  
enclosure, grilles, mounting devices,  
mounting hardware, transformers

Gemco Electronics, Inc.

PO Box 993

550 Airport Rd.

Gallatin, TN 37066

(615) 452-5960

Pres.: Jerry A. Graves

Sales Mgr.: Byron Graves

Chief Engineer: Todd Adams

Office Mgr.: Mrs. Tiny Brown

H.O.M.E., Inc.

PO Box 225

500 W. Ninth St.

Hermann, MO 65041

(314) 486-3111

Mkt'g: Arthur Brigham

Products: enclosure hardware

 **HARRIS**  
**DRACON DIVISION**

**HARRIS CORPORATION, DRACON**  
**DIVISION**

809 Calle Plano

Camarillo, CA 93010

(805) 987-9511, 800-437-2266, FAX#

805-987-2547

V.P./General Mgr.: John R. Mason

V.P. Sales & Mkt'g.: Jack McGuigan

Director of Sales: Tom Erdmann

Paging Prod. Mgr.: Tom Johnson  
Metals/Racks/Tools Prod. Mgr.: Terry  
Smith

Test Sets Prod. Mgr.: John Akins  
Don Bivens, Lake Elsinore, CA, 714-  
672-2168

Gary Foster, Columbia, MD, 314-442-  
2288

Rob Lincoln, Melbourne, FL, 407-259-  
0991

Mark Skilowitz, Newfield, NJ, 609-697-  
4580

Jim Fetterer, Seattle, WA, 206-243-  
7762

Bill Boone, Libertyville, IL, 312-816-  
1080

Dave Whelan, W. Springfield, MA, 413-  
731-9552

Products: attenuators, baffles,  
connectors, crossovers, enclosure  
hardware, enclosure, grille cloth,  
grilles, mounting devices, mounting  
hardware

Hi Lo Fabrication and Manufacturing  
PO Box 509

CR 1105

Rio Vista, TX 76093

(817) 373-2247

Pres.: Cecil Caro

Production Engineer: Cecil Caro

Sales/Secretary: Bridget Caro

Products: baffles, connectors,  
crossovers, enclosure hardware,  
enclosure, stands

**JBL PROFESSIONAL**

8500 Balboa Blvd

Northridge, CA 91329

(818) 893-8411, FAX# 818-893-3639

Pres.: Ron Means

V.P. Sales: Ken Lopez

V.P. Mkt'g: Mark Gander

Applications Engineer: Drew Daniels

Mkt'g Mgr./Sound Contracting: Steve  
Romeo

Video Sales: Don Wilson

Neil Conly, Bedford, TX, 817-540-3066

Bill Hamilton, Folsom, PA, 215-543-  
4677

**IN STOCK**

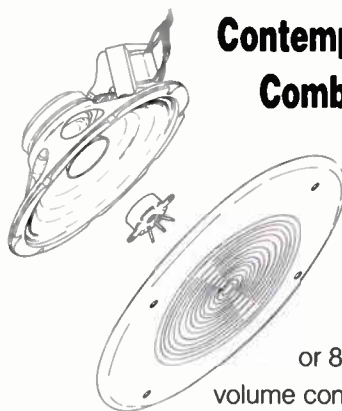

## Contemporary Trim Design Combination Package

Fourjay is combining its  
contemporary trim design  
CR8W Baffle with a  
standard 8" speaker,  
8" speaker/transformer  
or 8" speaker/transformer with  
volume control. All factory assembled,  
ready to install. Combinations will include:

- 8", 8-ohm, 5-oz. dual-cone speaker and the CR8W Baffle
- 8", 8-ohm, 5-oz. dual-cone speaker with 4-watt, 25/70.7-volt transformer, or with a 5-watt 70.7-volt transformer and the CR8W Baffle
- Plus a volume control model with a concealed screwdriver slot, 50-ohm control, with either the 4- or 5-watt transformer and the CR8W Baffle.



**FOURJAY INDUSTRIES, INC.**

3400 Stop Eight Road, Dayton, Ohio 45414  
Phone (513) 890-6444 • FAX (513) 890-1692

**IMMEDIATE DELIVERY**

See us at NSCA booth A22

Circle 255 on Reader Response Card

Steve Armstrong, Northridge, CA, 818-707-2529

Tom Walter, Barrington, IL, 312-382-4925

Products: attenuators, crossovers, transformers

**Lowell Manufacturing Co.**

3030 Laclede Sta. Road  
St. Louis, MO 63143

(314) 781-9058, 800-325-9660

Chairman: Ben W. Lowell

Pres.: Dorothy H. Lowell

Sales Mgr.: John J. Lowell

Sales: Wilhelm R. Lowell

Engineering: Karl R. Schneider

**MG Electronics**

32 Ranick Rd.

Hauppauge, NY 11788

(516) 582-3400, FAX# 516-582-3229

Pres.: Louis Maltz

V.P.: Elliott Maltz

Sales Mgr.: Stan Grey

Miller Assoc., Stamford, CT, 203-869-7793

Forti Assoc., Kensington, MD, 301-949-1706

Cavendish & Winchester, Atlanta, GA, 404-449-5104

Raymar Associates, Duncanville, TX, 214-296-9833

Products: attenuators, crossovers, grilles

**McCauley Sound, Inc.**

13608 94th Ave. E.

Puyallup, WA 98373

(206) 848-0363

Pres./Sales Mgr.: Tom McCauley

V.P./Production: Pete McCauley

**MIDDLE ATLANTIC PRODUCTS**

PO Box 96

400 Union Ave.

Haskell, NJ 07420

(201) 839-1011, FAX# 201-839-1976

Pres.: Robert Schluter

Products: grilles

**Oaktroni Industries, Inc.**

1000 30th St.

Monroe, WI 53566

(800) 257-4538

Pres./CEO: Jerry Disch

Executive V. P.: Bob Taller

V. P. Sales: Jim Hendrickson

**Omnimount Systems**

10850 Vanowen St.

N. Hollywood, CA 91605

(818) 766-9000, FAX# 818-766-9669

Pres.: Alex Cyrell

V.P.: Susan Michelson

Sales Mgr.: Jim Schaller

Products: mounting hardware

**Panasonic Industrial Company/Ramsa**

6550 Katella Ave

Cypress, CA 90630

(714) 895-7278, FAX# 714-895-7242

Nat'l Sales/Mkt'g: Steve Wooley

Eastern Sales Mgr.: D.J. Bierut

Central Sales Mgr.: Greg Braithwaite

Western Sales Mgr.: James Murray

Pusecker Sales, Upper Montclair, NJ, 201-744-1834

Professional Audio Associates,

Burlington, MA, 617-229-6050

David Prinzi, Webster, NY, 716-671-9266

World Wide Electronics, Pembroke Pines, FL, 305-584-7024

World Wide Electronics, Jacksonville, FL

Evans Sales & Mkt'g, Nashville, TN, 615-297-7997

A/V Mkt'g, Carmel, IN, 317-846-1034

Key Mkt'g, Plymouth, MI, 313-459-6040

New Horizons Elec. Mkt'g, Bannockburn, IL, 312-234-5911

J.B. Parent Co., Dublin, OH, 614-764-0064

Music Interventions & Assoc., Kansas City, MO, 816-453-4448

Tenicki & Assoc., Houston, TX, 713-528-2005

New West Audio, Burbank, CA, 818-955-9706

Brian Trankle Assoc., Belmont, CA, 415-595-4004

Brian Trankle Assoc., Sacramento, CA, 916-369-7030

Northmar, Seattle, WA, 206-524-5170

Pearson & Pearson, Denver, CO, 303-722-6996

Products: crossovers, mounting hardware

**Paso Sound Products**

14 First St.

Pelham, NY 10803-1495

(914) 738-4800, FAX# 914-738-3954

Executive V.P.: Paul Mastrangelo

Sales Mgr.: David Moore

Product Mgr.: Ken Obrien

Credit Mgr.: Marilyn Beckerson

Operations Mgr.: Anthony Sgueglia

All West Electronics, Camarillo, CA, 805-388-1789

Anderson Sales, Braintree, MA, 617-848-9194

Pace Sales, Charlotte, NC, 704-365-3216

De Witt Austin Co., Alpharetta, GA, 404-442-1326

Dowell Assoc., St. Louis, MO, 314-849-4234

Mountain Representatives, Denver, CO, 303-623-0972

J.Y.S. Comm. Co., Dallas, TX, 214-349-1650

Lienau Assoc., Inc., Columbia, MD, 301-621-4113

Lienau Assoc., Inc., New Town, PA, 215-860-2100

SLK Tech Rep, San Francisco, CA, 415-822-4884

Miguel Lopez, Hialeah, FL, 305-822-6853

Marketline, Snellville, GA, 404-972-9048

Messnick Sales, Liverpool, NY, 315-622-3211

Miller Assoc., Ltd., Greenwich, CT, 212-840-2866

Robert Milsk Co., Inc., Southfield, MI, 313-354-3310

Robert Milsk Co., Indianapolis, IN, 317-842-3400

Weller Electronic Sales, Worthington, OH, 614-885-7819

Frank Lintern Assoc., Naperville, IL, 312-983-0935

Products: baffles, connectors, enclosure hardware, grilles, mounting devices, mounting hardware, stands, transformers

**Peerless Sales Co.**

1950 Hawthorne Ave.

Melrose Pk., IL 60160

(312) 865-8870, FAX# 312-865-2941

V.P.: Walter Snodell

Mkt'g Mgr.: Frank R. Briggs

Products: mounting devices, mounting hardware

**Penn Fabrication (USA), Inc.**

PO Box 506

29B Ethel Ave.

Hawthorne, NJ 07506

(201) 423-4404  
 Sales Director: Mike Panasuk  
 General Mgr.: Richard Stratford  
 General Mgr.: Gavin Naismith  
 Products: connectors, enclosure hardware, grille cloth, grilles, mounting hardware

Q-Line Corp.  
 PO Box 20037  
 2808 Lakeside Dr.  
 Oklahoma City, OK 73120  
 (405) 751-3294  
 Pres.: John W. Quade  
 Products: enclosure

Radio Design Labs  
 PO Box 1286  
 5025 8th Street  
 Carpinteria, CA 93013  
 (805) 684-5415, FAX# 805-684-9316  
 Mkt'g: Jerry Clements  
 Products: attenuators, transformers

Speco Div., Components Specialties, Inc.  
 PO Box 624  
 1172 Rt. 109  
 Lindenhurst, NY 11757  
 (516) 957-8700, 800-645-5516, FAX# 516-956-9142  
 V.P./Sales: Mel Hulkower  
 V.P./General Mgr.: Jim Ganci  
 Sales Mgr.: Eric Forman  
 Products: attenuators, baffles, connectors, crossovers, enclosure, grilles, mounting devices, transformers

**TOA ELECTRONICS, ENGINEERED SOUND & COMMUNICATIONS DIVISION**  
 PO Box 2047  
 601 Gateway Boulevard  
 South San Francisco, CA 94080  
 (415) 588-2538, 800-843-4750, in CA 800-632-2157, FAX# 415-588-3349  
 Pres.: Yoshiro Ishida  
 Director of Mkt'g: Fred Fredericks  
 Nat'l Sales Mgr.: Richard Krochmal  
 Nat'l Sales Mgr./Engineered Intercom & Security Div.: Al Burns  
 Products: stands, transformers

**3M SOUND PRODUCTS**  
 223-5S-09, 3M Center  
 St. Paul, MI 55144-1000  
 (612) 733-9214, FAX# 612-736-9433

Mkt'g Mgr.: Richard G. Barker  
 Sales Mgr.: Don Sluder  
 Products: attenuators, baffles, transformers

**UNIVERSITY SOUND, ELECTRO VOICE, INC.**

600 Cecil St  
 Buchanan, MI 49107  
 (616) 695-6831  
 Pres.: Robert D. Pabst  
 V.P. Sales and Mkt'g: Paul McGuire  
 Chief Engineer: Alan Watson  
 Mkt'g Mgr./Comm. Products: W. Douglas Wilkens  
 George M. Conneen Co., Inc.,  
 Springfield, PA, 215-544-5884  
 Metropolis Audio Marketing, Inc.,  
 Edison, NJ, 201-225-0085  
 R.J. Marketing Ltd., Rockville, MD,  
 301-251-0330  
 The Smith Company, Hartford, CT,  
 203-523-0512  
 Ron Tunks Sales, Inc., Tamarac, FL,  
 305-722-2803  
 Wilson Audio Sales, Nashville, TN, 615-646-4477  
 Audio Resources, Westmont, IL, 312-655-1180  
 B.C. Electronic Sales, Inc., Mission, KS, 913-262-1720  
 Jones Audio Sales, Plano, TX, 214-867-0202  
 C.L. Pugh & Assoc., Inc., Columbus, OH, 614-486-9678  
 Riley & Petchell Sales, Inc., Detroit, MI, 313-937-3000

Loppnow & Assoc., Redmond, WA, 206-883-3205  
 Radon & Assoc., Sacramento, CA, 916-923-2524  
 Silver Peak Marketing Ltd., Wheat Ridge, CO, 303-467-9042  
 Western Audio Sales, Glendale, CA, 818-246-3806  
 Products: crossovers, enclosure hardware, enclosure, mounting hardware, stands, transformers

**WHITE INSTRUMENTS**

PO Box 698  
 5408 US Highway 290W  
 Austin, TX 78767  
 (512) 892-0752, FAX# 512-892-0855  
 Pres.: Carl Van Ryswyk  
 V.P.: Shirley Van Ryswyk

Mkt'g Mgr.: Emory Straus  
 Chief Engineer: Richard Bocock  
 Audio Mkt'g Assoc., Brecksville, OH,  
 216-526-2426

Avwest, Inc., Fountain Hills, AZ, 602-946-1811  
 Bensik Assoc., Inc., Ocala, FL, 904-732-9775  
 Design Factors, La Habra Heights, CA, 213-697-7576  
 Gemini Electronic Mkt'g, Edmonds, WA, 206-776-3121  
 L.S.M., Phelps, NY, 315-548-4891  
 Sigmet, Freehold, NJ, 201-462-1221  
 Monfort Electronics Mkt'g,  
 Indianapolis, IN, 317-872-8877  
 New Resources, Inc., Norwell, MA, 617-659-1463  
 Rancilio Assoc., St. Louis, MO, 314-631-3326  
 Rep Tech, Inc., Terrell, TX, 214-222-2131  
 Richard S. Pass Assoc., Inc.,  
 Langhorne, PA, 215-757-6100  
 Shalco, Inc., Ferndale, MI, 313-547-4771  
 Warren Associated Sales Reps, Santa Clara, CA, 408-988-7762  
 Wilson Audio Sales, Nashville, TN, 615-646-4477  
 CB Electronics Mkt'g, Arvada, CO, 303-422-0561  
 Ziskind Associates, Inc., Rolling Meadows, IL, 312-577-1624  
 Products: crossovers

**PROFESSIONAL AUDIO DIVISION, YAMAHA MUSIC CORPORATION, USA**

PO Box 6600  
 6600 Orangethorpe Ave.  
 Buena Park, CA 90622  
 (714) 522-9011, FAX# 714-739-2680  
 Products: crossovers  
 PO Box 624  
 1172 Rt. 109  
 Lindenhurst, NY 11757  
 (516) 957-8700, 800-645-5516, FAX# 516-956-9142  
 V.P./Sales: Mel Hulkower  
 V.P./General Mgr.: Jim Ganci  
 Sales Mgr.: Eric Forman  
 Products: attenuators, baffles, connectors, crossovers, enclosure, grilles, mounting devices, transformers



# LOUDSPEAKERS

Accusonics Systems Corp.  
2101 Jericho Turnpike  
New Hyde Park, NY 11040  
(516) 328-3300  
General Mgr.: Dennis Goodman

## AIPHONE INTERCOM SYSTEMS

PO Box 90075  
1700 130th Ave. N.E.  
Bellevue, WA 98005  
(206) 455-0510, FAX# 206-455-0071  
Pres.: Hiko Shinoda  
Nat'l Sales: Jim Morrison  
Products: ceiling, full-range, PA horns,  
paging horns, voice communications



Altec Lansing Corp.  
PO Box 26105  
Oklahoma City, OK 73126-0105  
(405) 324-5311, FAX# 405-324-8981  
Pres.: Dave Merrey  
Dir. Mkt'g Dev.: Ted Uzzle  
Nat'l Sales Mgr.: Jerry Spriggs  
Mgr., Export Mkt'g: John Sexton  
Nat'l Accts Mgr.: Tim Smith  
Technical Svces Mgr.: Gary Jones  
Products: ceiling, compact,  
components, foreground, full-range,  
high-frequency drivers, high-power,  
horns, low-frequency drivers, mid-  
bass, monitor panels, music system  
speakers, noise masking, outdoor,  
paging horns, paging, stage  
monitors, sub-woofer, systems

(815) 784-5118  
Pres.: Donald C. MacLaughlin  
Sales/V.P.: Ron Evers  
Credit Mgr.: Rosella Johnson  
Chief Engineer: Loren Schrader  
Purchasing Agent: Ray Melton  
Ted Firaneck Sales, Pontiac, MI, 313-  
373-9595  
Nevco, Inc., Kansas City, MO, 816-  
421-1751  
W.A. Hendrickson Co., N. Scituate,  
MA, 617-545-0652  
Maish Sales, Mulberry, IN, 317-296-  
2322  
TMC Sales, Ft. Lee, NJ, 201-944-8340  
Shamrock Sales, Dayton, OH, 513-258-  
1227  
Pacnor Marketing, Lynwood, WA, 206-  
771-6016  
Murphy & Cota, Atlanta, GA, 404-875-  
2525  
Mel Foster Tech. Sales, Edina, MN,  
612-941-9800  
Bensik Assoc., Ocala, FL, 904-732-  
9775  
Stinson Assoc, Havertown, PA, 215-  
446-8585  
Lewis & Dunnigan, Syracuse, NY, 315-  
446-5522  
G. MCL Cole Co., Parkridge, IL, 312-  
692-6040  
Wes Tech. Marketing, Culver City, CA,  
213-837-1398  
Products: columns, foreground, music  
system speakers, outdoor, paging,  
portable

American Acoustics, The Mitek Group  
One Mitek Plaza  
Winslow, IL 61089  
(815) 367-3000  
Pres.: Loyd Ivey  
V.P. Mkt'g: Rod Boyer  
Reg. Sales: Rob Landsberg  
Int'l Sales: Dave Armon  
Director PR: James Terharkf

Apogee Sound, Inc.  
1150 Industrial Ave, Suite C  
Petaluma, CA 94952  
(707) 778-8887, 800-528-3939, FAX#  
707-778-6923  
Pres.: Ken Deloria  
V.P. Mkt'g: Brian Glenn  
V.P. Sales: Joe Manning  
General Mgr.: Lynn Baker  
Production Mgr.: Jim Sides

Atlas/Soundolier  
1859 Intertech Dr.  
Fenton, MO 63026  
(314) 349-3110, FAX# 314-349-1251  
V.P. Sales: Tom Erickson  
E. Region/Sales: Andy Musci  
W. Region/Sales: Bud Waters  
V.P./Mkt'g Consultant: Herbert Jaffe  
Products: ceiling, columns, compact,  
components, custom, decorative,  
environment protected, explosion-  
proof, flush-mount, foreground, full-  
range, high-frequency drivers, high-  
power, horns, low-frequency drivers,  
mid-bass, monitor panels, music  
system speakers, noise masking,  
omni-directional, outdoor, PA horns,



ARGOS PRODUCTS CO.  
600 S. Sycamore St.  
Genoa, IL 60135



CWY ELECTRONICS IS  
YOUR IN-STOCK SOURCE  
FOR QUALITY **Electro-Voice®**  
SOUND PRODUCTS.

CWY ELECTRONICS IS THE  
MASTER DISTRIBUTOR FOR  
INDIANA AND KENTUCKY,  
SERVING YOUR NEEDS  
FOR OVER 30 YEARS.



CALL RANDY JESSUP AT  
INDIANA 1-800-382-7526  
KENTUCKY 1-800-428-7596  
405 NORTH EARL AVENUE  
LAFAYETTE, INDIANA 47903

# PROfile

## CUSTOM TOC™ MONITORS FOR THE COMPLEX STUDIO “B”



## Just What They Needed To Hear.

The Complex, a progressive and unique West Los Angeles recording studio facility, is co-owned and managed by rockin' Producer/Engineers Greg Ladayni and George Massenburg. The Complex has played host to Linda Ronstadt, The Church, Jimmy Buffet, Toto, Don Henley, James Taylor, Stevie Wonder, Randy Newman, Miles Davis, The Yellowjackets, Weather Report, Herbie Hancock and Little Feat among many others. Along with two film/video insert stages, which are also used for music recording and rehearsals, Lexicon's OPUS Digital Audio Editing demonstration room, Synclavier (Direct to Disk station) and the songwriter's Midi pre-production suite The Complex usually has a variety of interesting and technically demanding projects in house at any given time.

In the early planning stages of the new Complex Studio "A", Greg Ladayni and George Massenburg (a respected electronics and acoustical design engineer in his own right) decided that a totally new monitor system was needed. The increased size of the new control room required a system with the same or better accuracy and freedom from strain of the custom system he designed for the existing control rooms. A long time advocate of coaxial monitors, he heard from friend Doug Sax about a new coaxial monitor speaker with linear time delay electronic crossover.

Larry Doran of Professional Audio Systems was contacted about his TOC™ line of studio speakers. After several discussions it was decided that, under the supervision of Allan Sohl, a set of 15" drivers and x-overs would be installed along with existing sub woofer system in The Complex "B". Recently, George Massenburg has mixed the new Little Feat album utilizing the new TOC™ system.

Along with rumors of a new larger driver configuration.

### THE EXPERIMENT CONTINUES.

--The Complex--

Incorporating the technology of the TOC™ Studio Monitor 1, we were able to develop a custom product that would meet the stringent requirements of The Complex Studio B. High level monitoring without fatigue along with low level listening without loss of content was a primary consideration. A near perfect phase response when combining subwoofer, midrange, and high frequency components was paramount.



The Solution was a threeway tri-amplified loudspeaker system:

The existing subwoofer system was utilized. Double teen inch long excursion woofers in an infinite baffle enclosure were combined at the low/mid crossover point using TOC™ 23 active crossover networks.

The new PAS CX-2580C (Coaxial 15 inch loudspeaker and TAD 4001 (2 inch beryllium compression driver) were chosen for the mid/high frequency components. The extended high frequency response of the 4001 along with the 30X60 degree constant coverage of the CX 2580C provided high frequency control well beyond 15KHz.

We combined the mid/high frequency components with modified TOC™ Studio Monitor 1 crossover network. A near perfect phase response was achieved and the individual components became a coherent Reference Monitoring System with resulting pin point stereo imaging.

While measuring the Custom TOC™ Monitors in Studio B a combined problem between room and loudspeaker was uncovered not apparent with the previous monitors. Relocating the existing Quadratic Diffusers had a significant impact in correcting the combined acoustic anomaly in the mid bass region.

The Quadratic Diffusers are constructed of 3"X3" linear grain fir blocks of varied length combined in a computer generated pattern. The Quadratic Diffusion model used at The Complex was developed by George Massenburg at Northwestern University.

After scrutinizing component selection, tedious measurements in developing the proper crossover filters, and hours of critical listening, a Monitoring System was born worthy of the stringent requirements at The Complex Studio B. A progressive step towards the ultimate reference monitor.

--Professional Audio Systems--



## HAVE YOU BEEN SEARCHING FOR THE ULTIMATE STUDIO MONITOR!

Unfortunately It Doesn't Exist;

Never, The Ultimate Monitoring System Exists.

The Ultimate Monitoring System is an integrated design between your room acoustics and the loudspeaker chosen for your acoustical environment.

Professional Audio Systems can help you achieve your goals. Upon request we will send an Acoustical Consultant to your studio to evaluate and TEF™ the room. We will propose to you the Ultimate Monitoring System.

If you like our proposal and we proceed with the project Professional Audio Systems will absorb the cost of the analysis. If you don't proceed with our proposal your only expense will be a minimal consultation fee and you will now have an Acoustical Direction to proceed in the development of your studio.

For more information contact us directly at:  
534-3570

## TOC™ STUDIO MONITORS GAIN WIDE ACCEPTANCE

In November of 1988 the first TOC™ Studio Monitor 1s were introduced into the marketplace. In the months that followed the product awareness has intensified.

The user list is expanding daily from the resulting "word of mouth". All agree the TOC™ Studio Monitor 1 is JUST WHAT THEY NEEDED TO HEAR!

Special thanks to the following users: Art Institute of Music, Denton Productions, Morningstar Sound Studios, Sound Studios, Rose Studios, Sheffield Labs, Sound Studio Techniques, SuperTracs, The Complex, The Mastering Triad Studios.....

## SHEFFIELD LAB MODIFICATIONS

Hollywood, California: Sheffield Lab's Doug Sax and Bob Hazelton have developed some modifications to the TOC™ crossover network while using the Studio Monitor 1s Mid-field monitors at The Mastering Lab.

The Mastering Lab Network is a High Resolution device with reduced gain structure and unbalanced inputs and outputs.

The crossover filters and Time Offset Correction remain

unchanged. The phase response is "near perfect" as in the standard network.

The Mastering Lab version is available directly from Professional Audio Systems. We would like to thank Doug and Steve for the positive contribution to the development of the Studio Monitor Project.

## Just what you needed



## to hear.

The New Studio Monitor 1 with T.O.C.™ (Time Offset Correction), from Professional Audio Systems, is exactly what you need...to hear.

T.O.C. studio monitors, the only true constant coverage coaxial monitor system, employ beryllium diaphragm HF compression drivers, giving you resonance-free extended HF response to 20 kHz. The 15" LF transducers with large linear excursion capability, high sensitivity and power handling, provide ultra low distortion to below 35 Hz. The HF and LF are combined by fourth-order Linear Phase crossover filters with T.O.C.--providing near perfect phase response resulting in pinpoint stereo imaging. And, it's all neatly packaged in a hand-finished black oak enclosure rivaling fine furniture.

T.O.C. studio monitors give you good solid physics, sound engineering, meticulous attention to detail and clean, clear, unadulterated sound. When there is silence, you get silence. And, the fleeting transients that often create the difference between good sound and great sound are faithfully reproduced.

OK, listen. That's all we're asking you to do. Listen to the only studio monitoring system designed to give you just what you needed to hear. You can audition a pair of T.O.C. studio monitors at your favorite studio supply dealer, or may contact us directly.

# AUDISSEY CUSTOM INSTALLATION

Honolulu, Hawaii: Audissey Sound began as a sound rental company in 1972 servicing the Hawaiian music community. Paradise being some distance from the mainstream of sound reinforcement, Engineers Rick Parlee and Boyd Collings were forced to solve pressing problems with custom designs. Designs appropriate to the environmental conditions of Hawaii, Tahiti, and Guam.

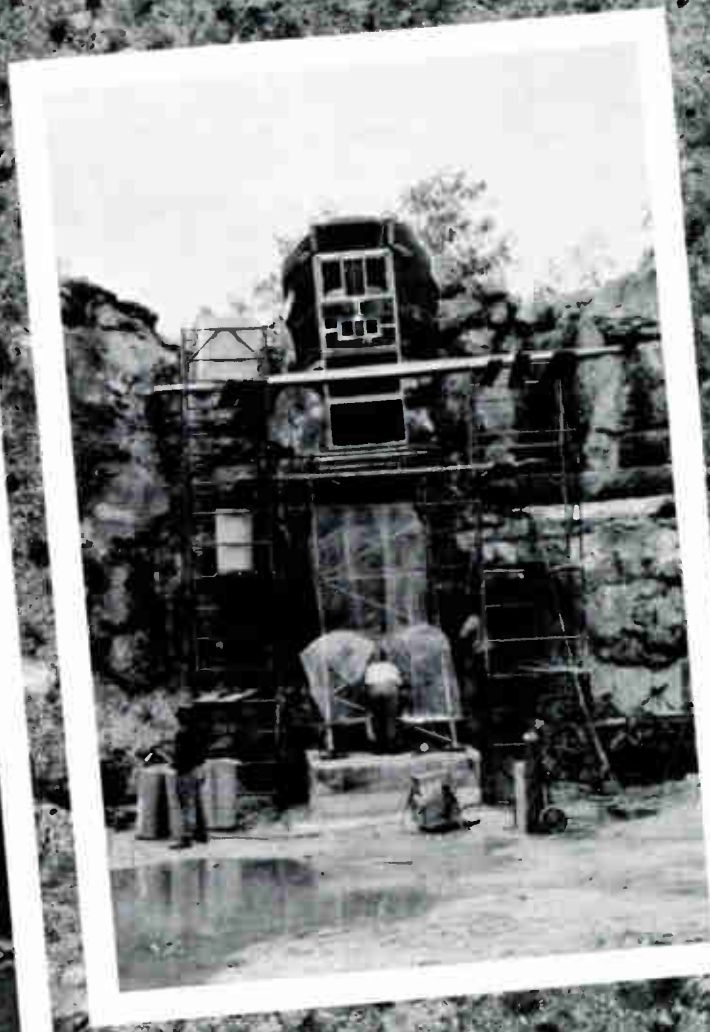
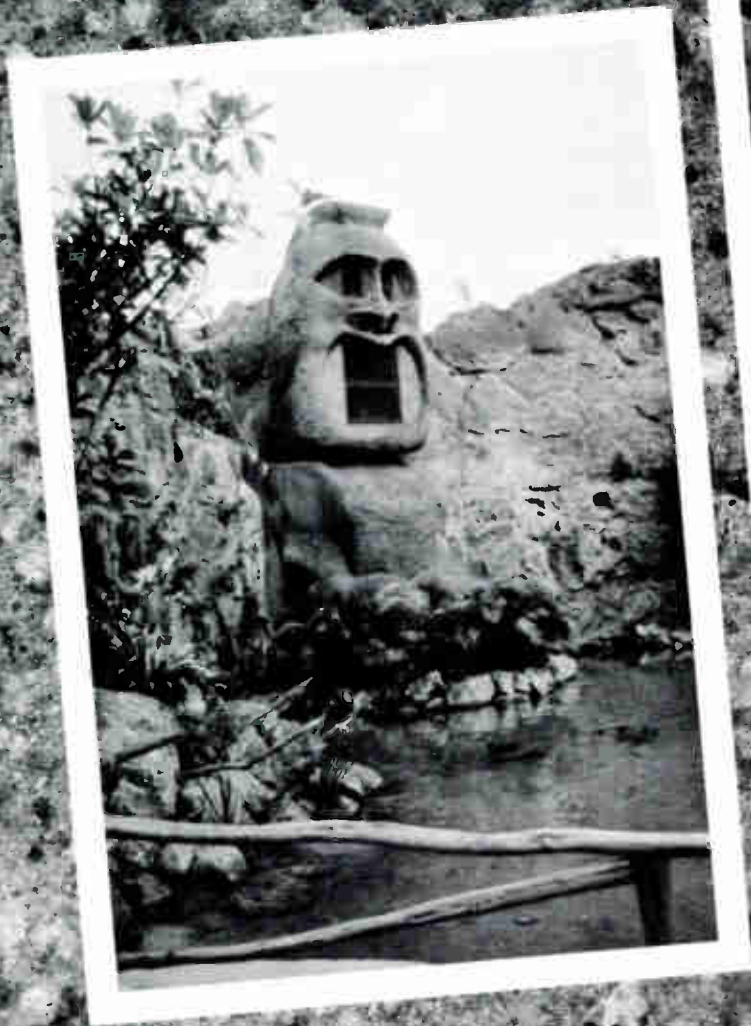

## OUT OF SIGHT SOUND

The "Menehune" Tiki is not a mere God of the Polynesian Cultural Center, but the voice of the Hale Aloha Amphitheatre. Housed within are PAS CX12-2M Coaxial monitors with Time Offset Correction and HL-1580C fifteen inch loudspeaker.



# AUDISSEY SOUND REINFORCEMENT

**WE WANT THEM TO SEE THE TOPS OF OUR SNEAKERS!**

Was the primary concern of the performers using one of Audissey's reinforcement systems. No problem with ultra low profile monitors developed by Boyd Collings. The PAS CX-1580C provided the minimum in enclosure size without sacrificing acoustical output.

For the audience Audissey's Custom 3 way Module using PAS-ER 1880C and G-1280C; as well as, newly patented NRG Prototype.

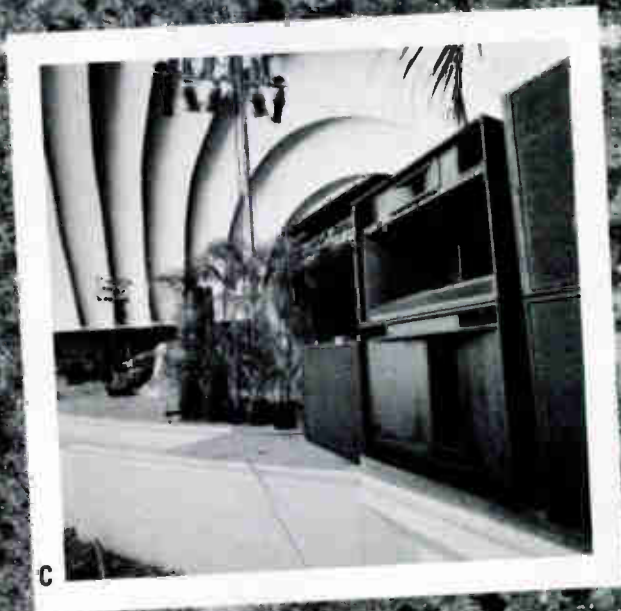

C

A Low Profile Monitors  
 B Low Profile Monitors  
 C Custom 3-way Module  
 D NRG Prototype

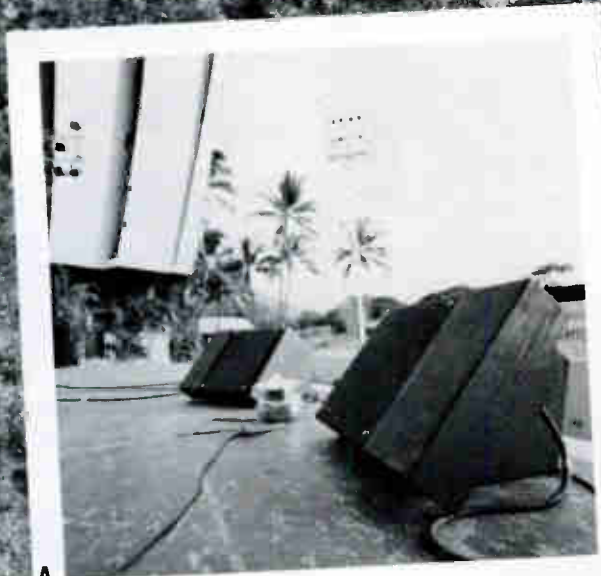

A



B



D



# L.A. Sound Co.

professional sound systems and equipment  
 12547 Sherman Way Unit F N Hollywood, Ca 91605 818-765-6900

January 13th 1988

Professional Audio Systems  
 1214 West 252nd Street  
 Harbor City, California 90710

Dear Marilyn,

Here's a few pictures from the 1988 Rose Parade floats. There are a total of three floats that we put sound systems on. Each float had four PAS Audio Model 15-2HC 2-way speakers. The systems were set up for stereo playback.

Each sound system is driven by one Crest Audio FA-800 power amplifier. Playback program is provided by a continuous Kenwood cassette deck though a Stereo Pre-Amp.

The floats that have our sound system are: Kodak, 1st Interstate Bank and Golden West Foods (Mc Donald's) Kodak and 1st Interstate were both award winners.

Sincerely,

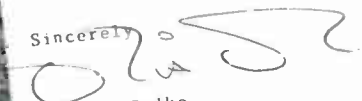

Richard Raik  
 L.A. Sound Co., Inc



**P.A.S. GOES TO  
 THE 1988  
 ROSE PARADE!**

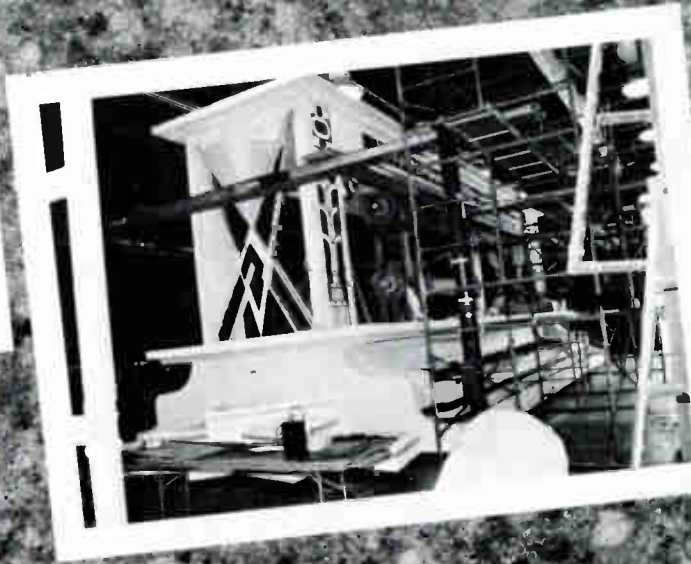
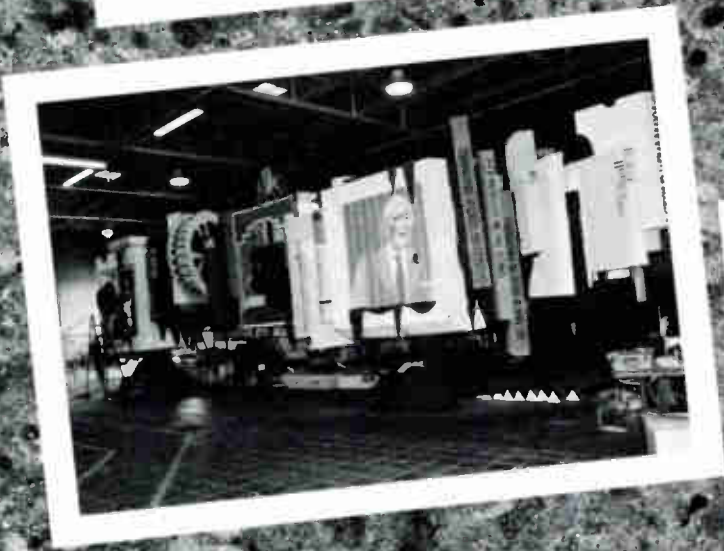



# MEET THE AUSTRALIAN (MONITOR)

**Custom Extrusions** – we've invested in tooling. Our simple yet rugged design guarantees long and durable life.

**Massive 2000VA Toroidal Transformer** gives higher efficiency and up to 25% less power drain from mains, excellent regulation, less crosstalk, won't go "soggy"!

**3 Unit Tall Custom Extruded** front panel offers maximum strength and resistance to chassis distortion, even when amp suspended alone in a rack. Anodised finish resists marking.

**Heatsink** is custom designed. The huge cooling area allows the mosfets to run up to 30°C cooler, improving efficiency and reliability.

**Chassis** – steel pan with top mounting plate are mounted onto front extrusion, distributing transformer weight evenly.



AM1600

**Front to Back Cooling** via dual fans directs air right over the heatsink and mosfets, prevents amp recirculating hot air. Fans last longer and the amplifier runs cooler.

**Handles** are carefully designed for human hands.

**Attenuators** are 21 position detented.

**Turnon Muted** for 2 seconds when power is first applied, avoiding noises from other devices turning on, and removes need to turn down attenuators. Helps if power interrupted unexpectedly.

**Mains Power Switch** extra heavy duty to avoid switch burnout.

**Thermal Shutdown Indicator** will display in the event of a shutdown due to badly obstructed airflow, or prolonged short circuit. After shutdown, the fans still run, and the unit will re-start when cooler.

**Power On** display works with Fault Indicator to show amplifier's status.

**Active Balanced Inputs** avoid transformer limitations. Front module can be removed direct from front of amplifier.

**Output Power Indication** shows actual power level below clipping, taking load into account, regardless of mains variation. Angled display for maximum visual contact, and to offset the top clip indicator. **Clip Indicator** is immediately visible due to angle of power indicator.

**Fault Indicator** shows blown rail fuse, or that short circuit protection is occurring. Unique design eliminates false sensing.

## HANDMADE-DOWN UNDER!

Seldom does a product come along that has distinctive audible advantages; as well as, structural integrity for long term performance. Julius Grafton Pty Ltd has accomplished this with the Australian Monitor 1600 high power Mosfet amplifier.

### AM1600

This power amplifier has Massive Protection: short circuit, DC, thermal, slow startup, and on demand fan cooling. The AM1600 is the most impressively constructed amplifier. You must check it out! It is "Built".

RMS power: 2 x 1,100W 2 ohm load  
2 x 800W 4 ohm load  
2 x 450W 8 ohm load

Bridged Mono: 1600W 8 ohm load  
2200W 4 ohm load

### AM900

450 + 450 Watts into 4 ohms--with protection, active bal-

anced inputs, full display module, and of course it will run both channels into a 2 ohm load. The AM900, like the whole range, is built with our custom extrusion to last forever.

### AM1200 Quad amplifier

Australia's only four channel MOSFET amplifier. 4 x 300W at 4 ohms, or switchable for 3 or 2 channel operation! How about 2 x 300W channels with one 800W channel for a subwoofer! Versatile switch applications, drive a foldback system, design a stereo disco system with huge, thundering mono subwoofers, etc, etc....

QUAD is efficient--3 rack units for 4 amplifier channels. It also features: Variable speed fans, slow mains turn on circuitry, protection circuitry, active balanced inputs, fault LED, and status LED for each channel, and of course, that unique Australian Monitor chassis.

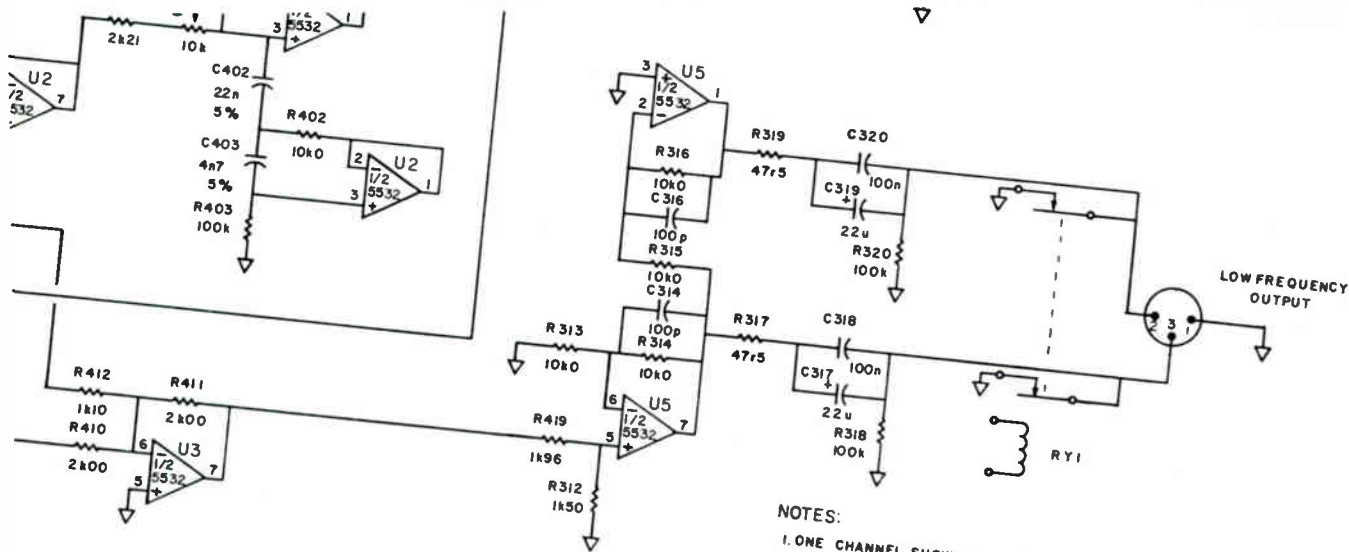

NOTES:  
1. ONE CHANNEL SHOWN. BOTH HAVE THE SAME REF. NUMBERS.

TOLERANCES		REVISIONS			PROFESSIONAL AUDIO SYSTEMS	
FRAC	±	NO	DATE	BY		
DECIMAL		1				
		2				
FRACTIONAL		3				
		4				
ANGULAR		5				
		6				

DRAWN BY Allen Sahl		SCALE	MATERIAL
CHK'D		DATE	DRAWING NO
TRACED		APP'D	

## P.A.S. NEW PRODUCTS

1988 has been a productive year for new product development. The CX-2580C (15" coaxial loudspeaker for 2" compression driver) has taken much longer to develop than expected; however, the reward will be well worth the wait.

The CX-2580C will incorporate a 30X60 degree constant coverage horn that will adapt to most commercially available 2" compression drivers. The low frequency component will be a 4" voice coil device with 400 watt power handling capability.

The CX-2580C along with a 4" voice coil 18 and 15 will be the nucleus for a new group of compact sound reinforcement systems to be completed towards the end of 1988. The new systems will redefine the idea of High Output Compact live reinforcement.

Both the low and high frequency sections will have current sensing circuits. For the low frequency this will extend the low bass, provide better transient behavior, and

protect from frequencies below the passband. The frequency sensing is configured to drive the diaphragm with a constant force. This helps to compensate for the linear compliance of the air between the diaphragm and phasing plug.

The CX-2580C is currently being utilized in the Cus TOC™ Monitoring System at The Complex Studio B. project is the genesis of the TOC™ Studio Monitor 2 has the ability to produce exceptionally high sound level without causing listener fatigue. The Studio Monitor 2 have three way capability with response 3 dB down at 2 in half space and above the boundary dependant region within 2 dB to 20KHz.

The Mastering Lab Network, developed by Sher Lab, is an enhancement to the TOC™ Studio Monitor. This exemplifies the ongoing development of studio products at Professional Audio Systems.



# INNOVATIVE PRODUCT DEVELOPMENT UPDATE

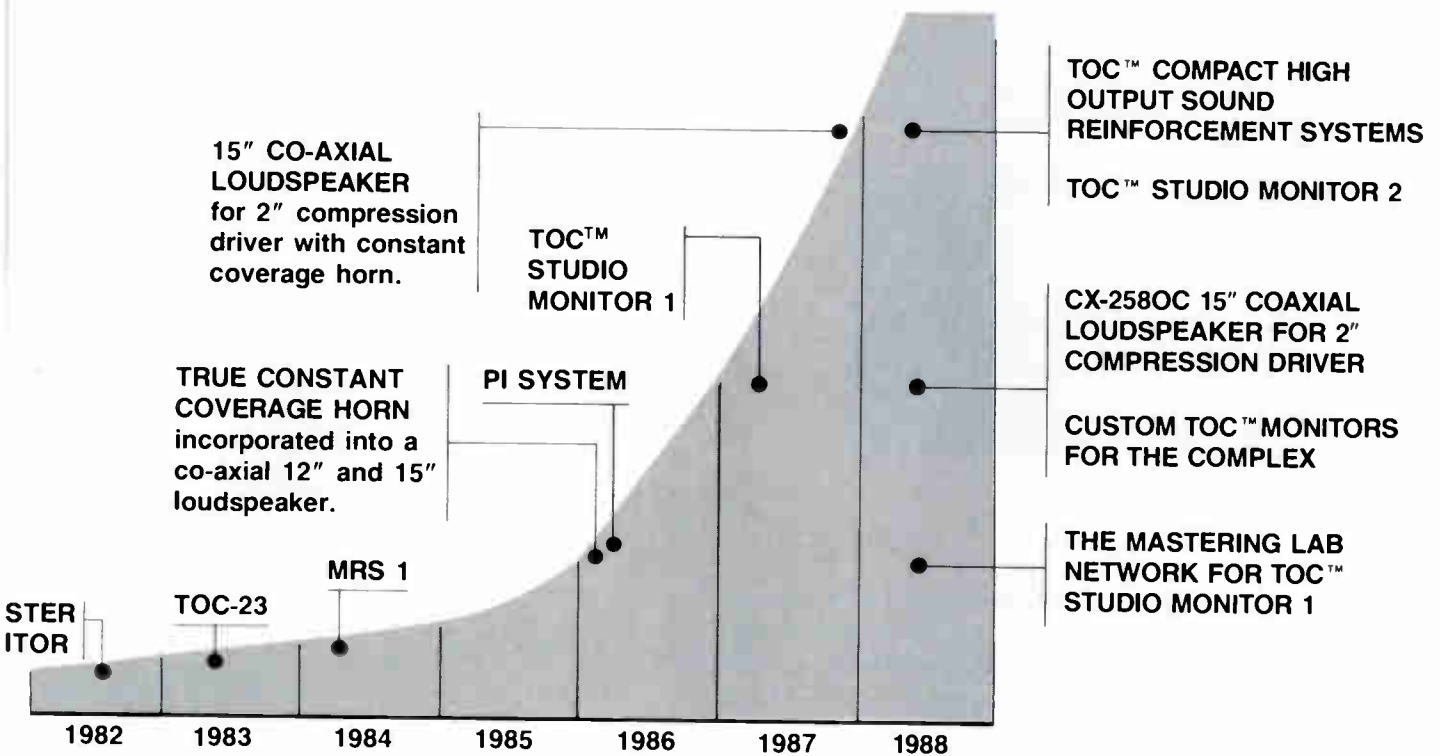

- 1982 Monster Monitor.** The First co-axial stage monitor with TOC™ (Time Offset Correction).
- 1983 TOC-23.** The First Electronic Crossover Network with active TOC™ and Linear Phase Filters.
- 1984 MRS-1.** PAS introduces Modular Reinforcement System with TOC™.
- 1986 PAS** was first to incorporate a True Constant Coverage Horn into a co-axial twelve and fifteen inch loudspeaker.
- 1986 PI Systems.** PAS Incorporates Co-axial Loudspeaker design into a permanent installation system for contractors.
- Summer 1987 TOC™ Studio Monitor 1.** Ultra performance control room monitor
- Spring 1988 The Mastering Lab Network for TOC™ Studio Monitor 1.**
- Summer 1988 Custom TOC™ Monitors for THE COMPLEX.**
- Summer 1988 CX-2580C 15" Co-axial Loudspeaker for 2" Compression Driver.** 3-way TOC™ Monitors using CX-2580C.
- Fall 1988 TOC™ Studio Monitor 2.**
- Fall 1988 TOC™ Compact High Output Sound Reinforcement Systems.**



**PI** *Ultra Performance Loudspeakers*  
**SYSTEM**

**PI SYSTEM  
 TO BE INSTALLED  
 AT TIVOLI  
 THEATRE**

**Chattanooga, Tennessee: General Contractors Raines Brother Inc. have been chosen for the rehabilitation of the Tivoli Theatre. The Tivoli originally constructed in 1907 has played host to the Performing Arts including the American Ballet Theatre.**

**The consulting firm of R.L. Kirkegaard & Associates, Inc. were commissioned to develop the first ever permanently installed House PA system at the Tivoli. The requirements included equal coverage of all seating areas; as well as, an invisible speaker system that will not detract from the unique decor of the Theatre.**

**Consultant James Gundlach chose 23 PI Systems PI12 2P for the Balcony coverage. They will be power by JBL amplifiers and will incorporate Audio Digital delay lines. The system will be installed by Pyramid Audio of South Holland, Illinois.**

**Harold Laatch, Project Engineer for Pyramid Audio has indicated that 105 dB will be achievable at each seating location.**

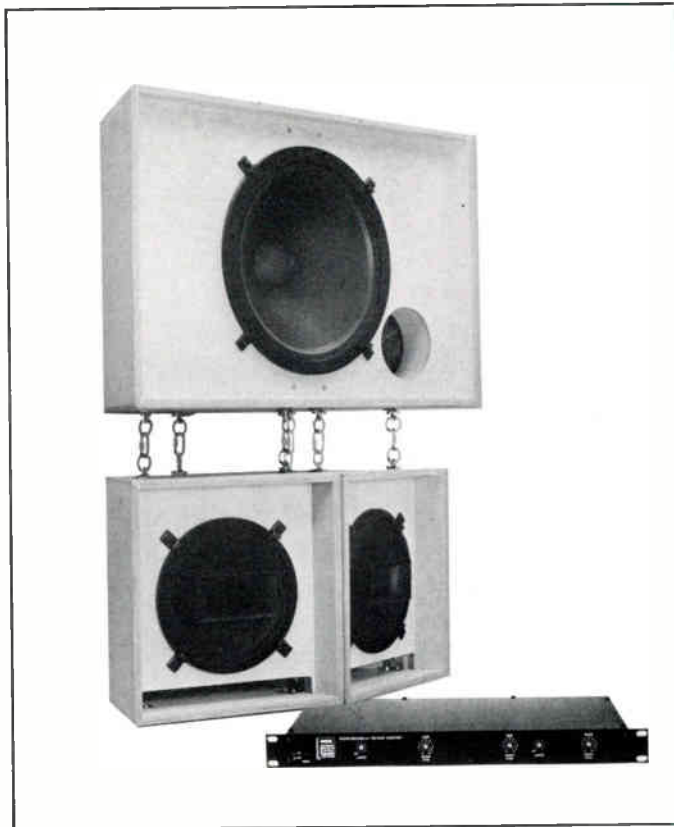

PAS offers an alternative to the ugly black box: a high performance loudspeaker system that will blend with the decor of your installation.

Finland birch enclosure with a foam grille can be stained or painted to match your interior. Cosmetically pleasing and craft flypoints provide a safe, painless installation.

Coaxial loudspeakers with "Constant Coverage" horn design provide extended high frequency control. Dedicated System Processor with TOC™ (Time Offset Correction) produces a near-perfect phase response.

Trapezoidal enclosures can be arranged for 360 degree coverage. The 30 x 60 degree coverage angle can be implemented in either the vertical or horizontal by merely rotating the coaxial loudspeaker 90 degrees.

PI Systems are available in either 12 inch (P112-2a/p), 15 inch (P115-2a/p) enclosures. An 18 inch sub-woofer (P118-a) can be used along with PI-1 System Processor.

Don't settle for the ugly black box when you can install the Ultra Performance PI System into your high-tech decor.

## P.A.S. U.S.A. REPRESENTATIVES

APPLIED AUDIO  
9 ELK MOUNTAIN ROAD  
ASHEVILLE, NC 28804

FUTURE SALES N.C.  
288 CASCADE DR.  
FAIRFAX, CA 94930

MUSIC SALES UNLIMITED  
PO BOX 3625  
ORLANDO, FL 32802

CHARLIE WINKLER  
13619 MOGADORE N.W.  
UNIONTOWN, OH 44685

INNOVATIVE AUDIO  
4370 FOREST AVE  
PONTIAC, MI 48054

PRO AUDIO ASSOC. INC.  
170 CAMBRIDGE ST  
BURLINGTON, MA 01803

CLEARVIEW MARKETING  
61 20 GRAND CENTRAL  
FOREST HILLS, NY 11375

INNOVATIVE SALES  
1570 BROOKHOLLOW #108B  
SANTA ANA, CA 92705

PRO TECH  
7105 S HIGHLAND #103  
SALT LAKE CITY, UT 84121

FUTURE SALES  
PO BOX 2077  
REDMOND, WA 98052

M.B.T.  
PO BOX 8054  
PITTSBURG, PA 15216

TENICKI & ASSOCIATES  
CORP. SQUARE I #814  
2600 S.W. FREEWAY  
HOUSTON, TX 77098

MIDWEST AUDIO GROUP  
3702 MORGAN CT.  
STEGER, IL 60475

## P.A.S. INTERNATIONAL DISTRIBUTORS

CASA DE MUSICA  
BOLIVAR NO 75  
06080 MEXICO DF  
MEXICO

MUSIK PRODUCTIV  
GILDESTRABE 60  
D 4530 IBENBUREN 1  
WEST GERMANY

SOUND POWER  
PO BOX 76766  
CARACAS 1070  
VENEZUELA

INTERNATIONAL TALKIE  
4, TATA ROAD #1  
SWADESHI MILLS COMP.  
BOMBAY 400 004, INDIA

PROPHON AUDIO & TEKNIK  
BIRGER JARLSGATAN 108  
S 114 20 STOCKHOLM  
SWEDEN

TAISHENG TRADING CORP.  
WANTAI BLDG, 4TH FLOOR  
24 JILIN RD, TAIPEI  
TAIWAN 10424, ROC

JULIUS GRAFTON PTY LTD  
175 CAMPBELL ST  
EAST SYDNEY NSW 2010  
AUSTRALIA

R. HAUSMANN SERVICE  
53 ARLOZOROV ST  
TEL AVIV  
ISRAEL 62646

YAMAHA MUSIC OF ASIA  
80 TANNERY LANE  
SINGAPORE 1334  
REPUBLIC OF SINGAPORE

SOUND STUDIO TECHNIQUE  
18 RUE DE DOUAI  
75009 PARIS  
FRANCE



## HOWIE DOES IT AGAIN!



## THE FIRST BAPTIST CHURCH OF PHENIX CITY, ALABAMA

Howie Davis of Davis Audio has a knack for PI Systems installations. In the last PROFILE Howie provided us with photos from his installation at St. Thomas the Apostle Catholic Church. In this issue we have another Davis Audio install, The First Baptist Church of Phenix City, Alabama.

In St. Thomas the PI15-2Ps were stained to match the Cedar woodwork on the walls and ceilings. As you can see in the current install a white stain was used. In both cases the PI cabinets appear to have been custom built for the churches.

Howie developed a hanging fixture for both applications. The fixture is manufactured with steel tubing

aligning the flying hardware provided on the PI cabinets. The hanging fixture is attractive, safe, and easy to use.

The fixture allows for flexibility in the hanging angle of each enclosure in the cluster. Considering the coverage angle of the constant coverage horn and the multiple hanging angles, Howie was able to cover the Sanctuary with three PI15-2Ps. An additional PI15-2P was used to cover the Choir.

Howie were your customers pleased with their PI System?

"Yes, They were very pleased!"

# The AES Heyser Scholarship Fund



The Richard C. Heyser Scholarship Loan Fund has been set up to honor Dick Heyser, a highly gifted, loved and respected engineer, with a lasting memorial. The scholarship loan will financially assist promising graduate engineering students in the field who, otherwise, could not continue with their studies.

In March of 1987 Dick died, just a few months before he would have assumed the office of AES President. He not only was active in AES but he contributed greatly to the audio field through his Time Delay Spectrometry discoveries. He gave of himself on a personal level as well. Carolyn Davis, Co-Founder of Synergetic Audio Concepts, said of the fund, "Dick, himself, gave so much to all those with whom he came in contact, especially those just starting out; we feel Dick would have been pleased to know he is being remembered in this way."

In conjunction with this memorial, a major update of The PHD Program<sup>†</sup> will be dedicated to Dick Heyser and all the proceeds will go to the Richard C. Heyser Scholarship Loan Fund.

You may obtain a program for a donation of \$300.00 or more; prior owners may upgrade for a donation of \$50.00 or more. Make your check payable to the Richard C. Heyser Scholarship Loan Fund. Send to the Richard C. Heyser Scholarship Loan Fund, c/o *Sound and Communications*, 25 Willowdale Avenue, Port Washington, NY 11050.

<sup>†</sup> Trademark of Ambassador College.

paging horns, paging, portable, surface-mount, systems, talkback, tweeters, voice communications

Products: columns, compact, music system speakers, surface-mount, systems

outdoor, PA horns, paging horns, paging, surface-mount, systems, talkback

## Audiotech

410 South Cedar  
Lansing, MI 48912  
(517) 371-4148  
Pres.: Dave MacPherson  
Production: Mike Cosgrove  
Sales: Dave Arnold

## Auratone Corp.

PO Box 698  
Coronado, CA 92118  
(619) 297-2820, FAX# 619-296-8734

## Bose Corporation-Professional Products

The Mountain  
Framingham, MA 01701  
(617) 879-7330, FAX# 617-872-6541  
General Mgr.: David H. Bell  
Nat'l Field Sales Mgr.: Tim Dorwart  
Eastern Reg Sales Mgr.: Robin Sibucan  
Western Reg Rep: Mark Christensen  
Product Mgr.: Jim Sanchez  
Market Area Mgr.: Mark Mayfield  
Products: ceiling, columns, compact, foreground, full-range, music system speakers, outdoor, portable, powered, processor controlled, stage monitors, sub-woofer, surface-mount, systems

## Audio-Technica U.S., Inc.

1221 Commerce Drive  
Stow, OH 44224  
(216) 686-2600, FAX# 216-688-3752  
Pres.: Jon R. Kelly  
Nat'l Sales Mgr.: Mike Wuellner  
Mkt'g Mgr./Pro Products: Greg Silsby  
Sr. Transducer Engineer: Bob Herrold  
Products: environment protected, foreground, full-range, omnidirectional, outdoor

## B.E.S.T. INT'L CORP.

12753 Moore St.  
Cerritos, CA 92715  
(213) 926-0201, 800-592-4644, FAX# 213-926-5265  
Pres.: Jose Bertagni  
V.P. Operations: Luis Gutierrez  
V.P. Mkt'g & Sales: Robert Hagemann  
Nat'l Accts Mgr.: Paul Shiner  
V.P. Engineering: Alex Bertagni

## Boston Acoustics

247 Lynnfield St.  
Peabody, MA 01960  
(617) 532-2111  
CEO: Frank Reed  
Pres.: Andy Petite  
Director of Product: Fred Pinkerton  
Nat'l Sales Mgr.: Len Provost  
Products: ceiling, compact, custom, environment protected, flush-mount, foreground, full-range, music system speakers

## Audisar

PO Box 1561  
Bellevue, WA 98009  
(206) 454-2040  
Owner: R. Munger  
Products: compact, components, custom, full-range, high-frequency drivers, high-power, horns, low-frequency drivers, monitor panels, multi-way/high-powered, music system speakers, powered, studio/reference monitors, sub-woofer, systems

## Bogen Communications, Inc.

PO Box 575  
50 Spring St.  
Ramsey, NJ 07446  
(201) 934-8500, FAX# 201-934-9832  
Pres.: John H. Ochtera  
V.P. Sales/Sound Prod.: David A. Chambers  
V.P. Sales/Telecomm. Prod.: Charles Ferreri  
Bruce Barrett, Garland, TX, 214-530-0467  
Kingston Sales Corp., Indianapolis, IN, 317-876-2545  
Kevin Koehler, Batavia, IL, 312-879-6871  
Tim McDonnell, Willoughby Hills, OH, 216-942-2429  
Steve McGrew, Kennesaw, GA, 404-422-4608  
Meyer Mkt'g, Inc., Deerfield Beach, FL, 305-481-9250  
W.B. Pray Sales, Inc., Northboro, MA, 617-393-3434  
Jay Sample, Sandy, UT, 801-942-1059  
Scott Sampson, Encino, CA, 818-996-5484  
Mike Schneider, Baltimore, MD, 301-563-5390  
Walt Spencer, Ramsey, NJ, 201-934-8500  
White Radio Ltd., Burlington, ONT, Canada, 416-632-6894  
Roburn Agencies, Inc., Yonkers, NY, 914-968-1016  
Products: ceiling, columns, flush-mount, foreground, full-range, horns, music system speakers,

## Bozak, Inc.

326 South St  
New Britain, CT 06051-3721  
(203) 225-0555  
Pres.: Donald D. Bowers  
Dir. of Mkt'g: William J. Kieltyka  
Chief Engineer: Sheldon Glick  
Products: ceiling, columns, environment protected, music system speakers, omnidirectional, outdoor

## Audra International

PO Box 38  
28271 Bond Way  
Silverado, CA 92676  
(714) 649-2207  
Owner: Algis Renkus  
Products: components, environment protected, full-range, high-frequency drivers, high-power, horns, low-frequency drivers, mid-bass, sub-woofer

## Calibration Standard Instruments

PO Box 2727  
Oakland, CA 94602  
(415) 531-8725  
Owner: Edward M. Long

## Auernheimer Labs and Co.

4561 E. Florence Ave.  
Fresno, CA 93725  
(209) 442-1048  
Owner: Curly Auernheimer

## Carvin Corp.

1155 Industrial Ave.  
Escondido, CA 92025  
(619) 747-1710



# Install Reliability. Install Gauss.

Quite honestly, at Gauss we don't make something for everyone. We don't make low cost products. We do make quality products that are reliable and cost effective. Products that protect your reputation.

**Loudspeakers**—a range from 10" to 18", 3" and 4" voice coils, all made with our exclusive double spider construction for unmatched reliability.

**Coaxial Loudspeakers**—a choice of two 12" or our original 15", all offering 400 watts of music power!

**Compression Drivers**—8 ohm and 16 ohm models with 1- and 2-inch throats to fit all your mid and high frequency needs.

**Horns**—a complete new line of constant directivity horns designed for your precise dispersion needs.

**Crossovers**—High level power handling 2-way models, ranging from 500Hz to 8kHz crossover frequencies, designed to fit virtually any need.

You've tried the others, now use the best. Contact your nearest representative to find out how you can profit with Gauss quality and reliability.

**gauss**  
by Cetec

**Committed to Your Business**  
9130 Glenoaks Boulevard  
Sun Valley, CA 91352  
(213) 875-1900 Telex: 194 989  
Fax: (818) 767-4479



## Celestion Industries, Inc.

89 Doug Brown Way  
Holliston, MA 01746  
(617) 429-6706, FAX# 508-429-2926  
V.P./Gen. Mgr.: Peter Wellikoff  
Mkt'g Mgr.: Barry Fox  
Nat'l Sales Mgr.: David Deranian  
Credit Mgr.: Kathy Maguire  
Customer Svce Mgr.: Kip Starrett  
Products: ceiling, compact, components, environment protected, explosion-proof, flush-mount, foreground, full-range, high-frequency drivers, high-power, horns, low-frequency drivers, mid-bass, multi-way/high-powered, music system speakers, outdoor, PA horns, paging horns, portable, powered, processor controlled, stage monitors, studio/reference monitors, sub-woofer, surface-mount, systems, tweeters

## Cerwin-Vega

555 E. Easy St.  
Simi Valley, CA 93065  
(805) 584-9332, FAX# 805-583-0865

Pres.: E.J. Czerwinski  
V.P.: Connie Czerwinski  
Dir. Prof. Prod. Div.: Richard G. Mandella  
Adv. Director: Jay Van Pelt

## Cetec Gauss

9130 Glenoaks Blvd.  
Sun Valley, CA 91352  
(213) 875-1900, FAX# 818-767-4479  
Pres.: Jim Williams  
Products: components, foreground, full-range, high-frequency drivers, high-power, horns, low-frequency drivers, mid-bass, multi-way/high-powered, music system speakers, PA horns, paging horns, stage monitors, studio/reference monitors, sub-woofer, systems, tweeters, voice communications

## Clarity, A Division of Valcom, Inc.

1111 Industry Ave. SW  
Roanoke, VA 24013  
(703) 982-7003, 800-962-6009, FAX# 703-982-7032

Products: ceiling, columns, paging horns



## Community Light & Sound, Inc.

PO Box D  
333 E 5th St.  
Chester, PA 19013  
(215) 876-3400, 800-523-4934, FAX# 215-874-0190  
Pres.: Bruce Howze  
V.P. Engineering: John T. Wiggins  
V.P./Overseas: Christine Howze  
New Resource, Norwell, MA, 617-659-1463  
Sigmat Corp., Freehold, NJ, 201-462-1221  
Audio Mkt'g Assoc., Breckville, OH, 216-526-2426  
Key Marketing, Plymouth, MI, 313-459-6040  
Powerlines Mkt'g, Evanston, IL, 312-864-1147

# YOU'VE GOT TO HEAR THE NEW FRAZIER'S.

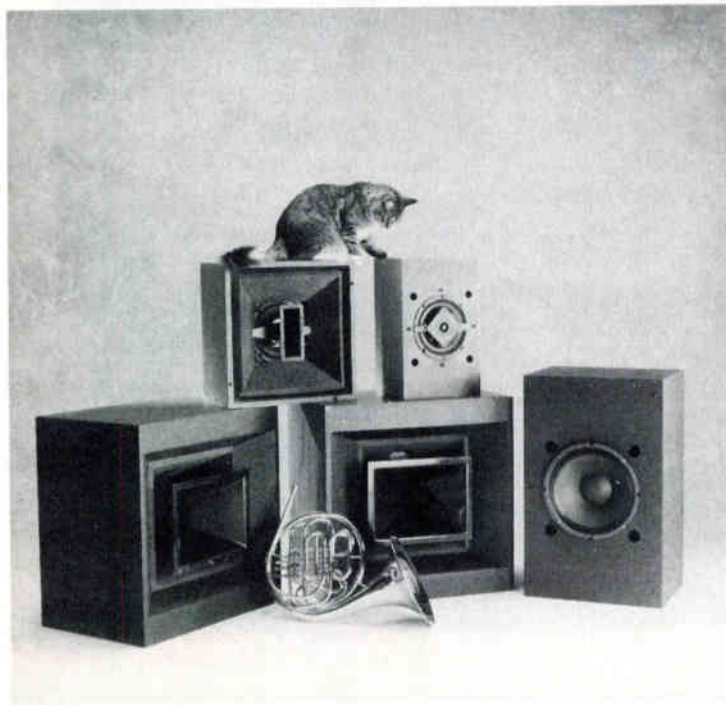

This year FRAZIER celebrates 60 years of service in meeting sound reinforcement needs of the sound contractor. Pride in craftsmanship and performance remain the focus at FRAZIER with economy in systems installation a new measurement of FRAZIER's leadership.

The new FRAZIER CAT™ designs re-define standards of performance in music and speech intelligibility by utilizing state-of-the-art Coincident-Aligned Transducer technology.

FRAZIER remains dedicated to the solid feel and pleasing aesthetics associated with real wood construction. Natural oak and walnut veneers are hand rubbed in the furniture making tradition.

FRAZIER's new compact designs are easier to install and adjust using a unique mounting system — a potential cost containment benefit where a modest budget is concerned.

Whether you are installing new systems or updating old, you deserve to benefit from FRAZIER's 60 years of dedicated service. For more information on FRAZIER's new systems and the requirements to become a FRAZIER dealer, write:

## FRAZIER

Route 3, Box 319 • Morrilton, AR 72110 • 1-800-643-8747  
In Arkansas: (501) 727-5543





# CONQUER SPACE, MASTER TIME, DEFY GRAVITY

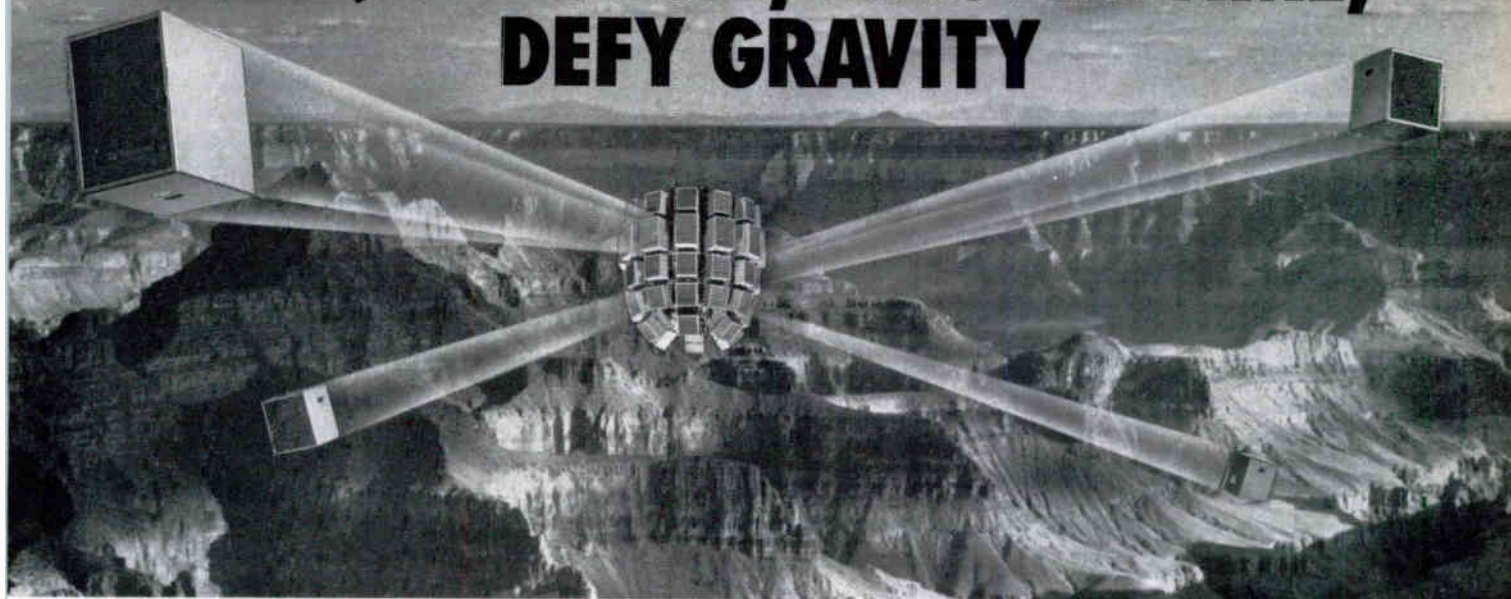

Some speaker systems attempt to conquer acoustic space with brute force—deploying massive cabinets, firing horns at everything that moves. Others resort to electronic trickery, which requires delicate racks of complex gadgetry.

## Innovative designs for effective performance

Turbosound Separated Enclosure installation systems achieve their superior performance without useless bulk or “clever” disguises. Instead, they employ unique, patented design principles proven on tours and installations worldwide.

## A true system is more than the sum of its parts

The TSE System focuses Turbosound thinking, outwardly radical yet intrinsically sensible, on the problems of fixed installations. TSE is more than a collection of cabinets: it's a true system, with all elements working together. A variety of straightforward designs, all producing distinguished sound with security and reliability.

## What goes up must not come down

In large venues, a point source cluster is often best. TSE flying hardware simplifies cluster design and installation: complete systems have been installed and tested in one day. Each component is load-certified by a UK government-approved testing organization. An expensive proposition, but you should know how your system will perform. Equally severe testing confirms the audio performance of TSE enclosures.

## Make full use of your skills

TSE components are made for each other. That makes it easy for you to optimize a TSE system for any installation, large or small. There's no easier way for you to bring your own ideas about sound reinforcement to reality: Dozens of different TSE systems in major venues worldwide prove the point.

TSE systems can't grant you supernatural powers, but they will give you superbly natural sound.

TSE Flying Frames remove load stress from the cabinet. Connected with Quicklinks, frames and cabinets pivot to form a smooth coverage arc. Vertical dispersion is easily adjusted with the TS-6 or TS-10 strap connected to the bottom flying frame and the suspension quadrant.

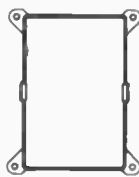

## TSE-111—10" TurboMid + HF horn/driver.

Fits the FF-111 Flying Frame, with a square frontal cross section to let you change dispersion patterns by rotating the frame.



Horizontal dispersion is provided by 90° Suspension Quadrants: each quadrant will hold any combination of TSE enclosures. Combining quadrants yields horizontal dispersion of 70°—360° and vertical dispersion of 50°—270°.

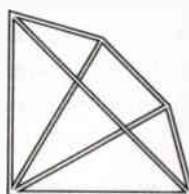

*TSE-211—2 x 10" TurboMid + V-2 HF unit.* Superior Mid and HF projection. Switchable active bi-amped or passive two-way operation. Dual vertically-coupled TurboMid devices double power handling. The V-2 extends frequency response, enhances intelligibility.

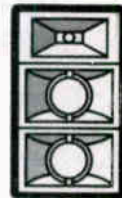

*TSE-260—V-2 HF unit.* Two HF drivers coupled with Turbo loading techniques, minimizing phase cancellation and distortion.



*TSE-215—2 x 15" TurboBass.* Balancing TSE frequency response is easy—LF units are separate from mid/high cabinets. With six units to choose from, generating the proper frequency response and coverage pattern for any venue can be as simple as laying dispersion angles over the blueprints.

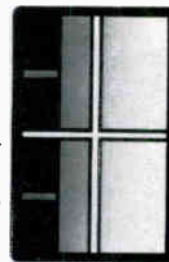

*Other bass enclosures available: TSE-115, and TSE-118.*



Only Turbosound is Turbosound.  
**Turbosound**  
 an EdgeTech company

Turbosound, Inc. 611 Broadway, New York, New York 10012 (212) 460-9940 Fax (212) 460-9947 Telex 230199 IMC TURBO-US

Turbosound Ltd. Star Road, Partridge Green, West Sussex RM13 5EZ (0403) 711447 Fax: (0403) 710155 Telex 878723 IMC TURBO-UK

In Canada: Omnimedia Corp. Ltd., 9653 Côte de Liesse, Dorval, Quebec H9P 1A3 (514) 636-9971 Fax: (514) 636-5347



Pro Marketing , Indianapolis, IN, 317-846-9591

Evans Sales & Mkt'g, Nashville, TN, 615-297-7997

Bencsik Assoc., Ocala, FL, 904-732-9775

Mel Foster Technical Sales, Edina, MN, 612-941-980

R.J. Throckmorton Sales, Ballwin, MO, 314-227-7222

Rep Tech, Terrell, TX, 214-222-2131

Pearson & Pearson, Denver, CO, 303-722-6996

Vector Corp., Seattle, WA, 206-322-4343

Tom Aye, San Jose, CA, 408-993-9428

Pacific Audio Group, Torrance, CA, 213-375-2611

Products: compact, environment protected, foreground, full-range , high-frequency drivers, high-power, horns, low-frequency drivers, mid-bass, multi-way/high-powered, music system speakers, omni-directional, outdoor, PA horns, paging horns, paging, portable, processor controlled, stage monitors,

studio/reference monitors, sub-woofer, tweeters, voice communications

Compact Monitor Systems Corp.

PO Box 1965  
Studio City, CA 91604  
(818) 763-8000

DCL Company

6340 S.W. 145th St.  
Miami, FL 33158  
(305) 232-2199

### LEE DAN COMMUNICATIONS

155 Adams Ave.  
Hauppauge, NY 11788-3699  
(516) 231-1414, 800-533-3261, FAX# 516-231-1498

Pres.: Leon Goldberg

V.P. Operations: Lawrence J. Goldberg

V.P. Finance/Admin.: David H.

Goldberg

Sr. Technician: Sandy Hoffman

Customer Svce: Linda E. Scaturro

Production Sup.: Gabriel Figueroa

Products: custom, flush-mount, horns, outdoor, PA horns, paging horns, paging, surface-mount, systems, talkback, voice communications

### J. W. DAVIS & CO.

PO Box 26177  
3030 Canton Street  
Dallas, TX 75226  
(214) 651-7341, 800-527-5705, in TX 800-442-1564, FAX# 214-939-0328

Pres.: Charles Griffith

V.P. Sales: Jack W. Tucker

Chief Engineer: Mike Lamm

Products: ceiling, columns, compact, components, environment protected, flush-mount, foreground, full-range , horns, music system speakers, noise masking, omni-directional, outdoor, PA horns, paging horns, paging, portable, stage monitors, surface-mount, talkback

Design Direct Sound

6850 35th N.E., Suite 1

Seattle, WA 98115

(206) 527-4371

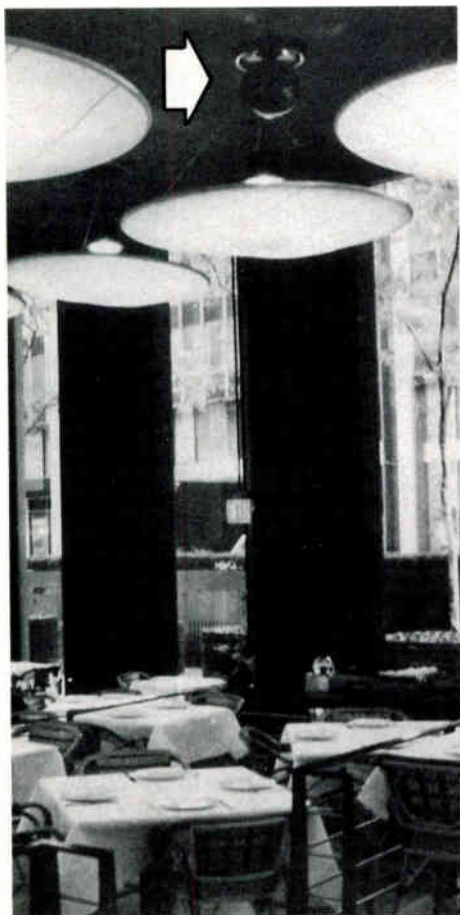

## “THE SETTING IS A KNOCKOUT”

*The New York Times, Friday, October 23, 1987*

### DINER'S JOURNAL

The forbidding Black Rock, as the CBS Building on Avenue of the Americas at 53rd Street is dubbed, has sprouted an exotic flower called China Grill, an offshoot of Chinoise on Main in Santa Monica, California.

The setting is a knockout—a soaring block-long space with pale jade-colored walls, huge eggshell-colored light shades suspended from the ceiling and a gleaming open kitchen.

This restaurant originally had forty twelve-inch coaxial speakers in its 30 ft. high ceiling. They have been replaced with six #168 black Soundsphere loudspeakers which are deftly hidden between the eggshell light shades. The manager and staff state that the background music is even and “delightful.”

Steven M. Rosstad of United States Communications, New York City, is impressed by the sound quality and cost-saving installation. Steven looks forward to using Soundspheres as a “problem solver” in future challenging situations.

Write or call direct for further information.

**SOUNDSPHERE** A PRODUCT OF  
**SONIC SYSTEMS, INC.**

737 Canal Street • Bldg 23B • Stamford, CT 06902 • USA • Tel (203) 356-1136

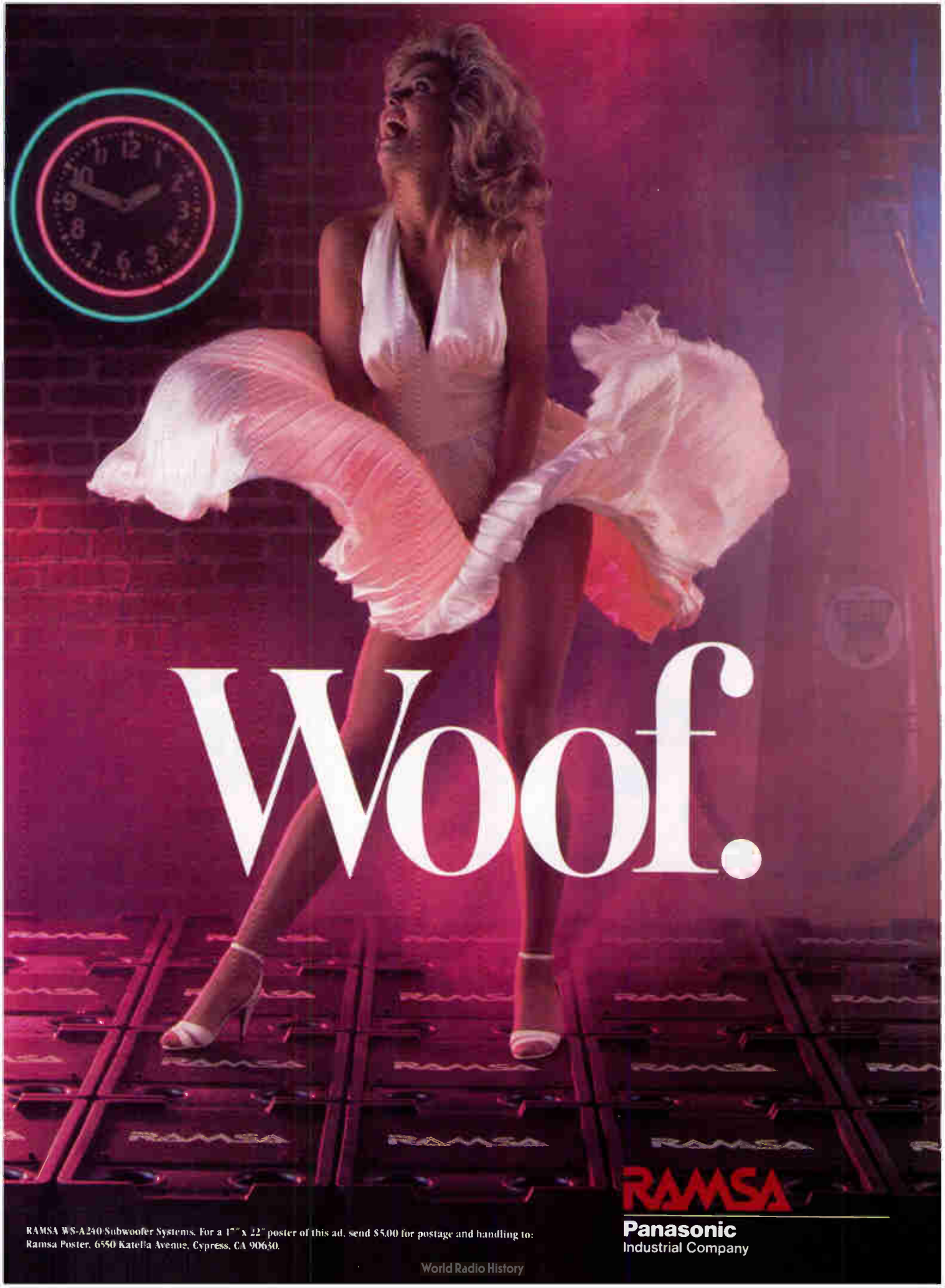

# woof.

**RAMSA**

**Panasonic**  
Industrial Company

RAMSA WS-A240 Subwoofer Systems. For a 17" x 22" poster of this ad, send \$5.00 for postage and handling to:  
Ramsa Poster, 6550 KatePa Avenue, Cypress, CA 90630.

Pres.: Bob Rice  
 V.P.: Pat Peterson  
 V.P.: Marc Hall  
 Mkt'g: Mark Dodge

## DUKANE CORPORATION

2900 Dukane Dr.  
 St. Charles, IL 60174  
 (312) 584-2300, FAX# 312-584-2370  
 Pres.: J. McWilliams Stone, Jr.  
 Group V.P.: William P. Finnegan  
 Division General Mgr.: Steve Deppe  
 Mkt'g Mgr.: Derek Podobas  
 Nat'l Sales Mgr.: Warren Anderson  
 Service Mgr.: Cliff Carlson  
 Doug Fellabaum, Sycamore, IL, 800-445-0152(#2301)  
 Don Mouritzen, Beecher, IL, 800-445-0152(2303#)  
 Art Strilli, Edison, NJ, 800-445-0152(#2302)  
 Pete Kendall, Jacksonville, FL, 904-262-6025(#2306)  
 Jack Brown, Dallas, TX, 214-943-7528(#2305)  
 Ed Nuhring, Portland, OR, 800-445-0152(#2307)

Wally Smutts, Toronto, Ontario, Canada, 312-584-2300  
 Ken Lind, Wellesley Hills, MA, 617-235-6817

Products: ceiling, columns, components, environment protected, flush-mount, full-range, high-frequency drivers, horns, low-frequency drivers, music system speakers, omni-directional, outdoor, PA horns, paging horns, paging, portable, voice communications

## Eastern Acoustics Works, Inc.

One Main St.  
 Whitinsville, MA 01588  
 (617) 234-6158, FAX# 800-234-0086  
 Pres.: Kenneth Berger  
 Mkt'g Director: Frank Loyko  
 Sales Mgr.: Sandy Macdonald  
 Engineering Director: Kenton Forsythe  
 Customer Support: Steve Davis

## Eden Electronics, Inc.

PO Box 338  
 1st St.  
 Montrose, MN 55363

(612) 675-3650

Pres.: David D. Nordschow

## Edge Distribution, Inc./Turbosound

611 Broadway, #841  
 New York, NY 10012  
 (212) 460-9940, FAX# 212-460-9947  
 Pres.: Alan Wick

V. P. Sales/Mkt'g: Dan Abelson  
 V. P. Electronic Prod.: Dave Talbot  
 Applications Engineer: Tim Kalliches  
 Western Audio Sales, Glendale, CA, 818-246-3806

Applied Audio Marketing, Asheville, NC, 704-252-9313

Michael Chafee Assoc., Sarasota, FL, 813-921-4294

Tenicki and Assoc., Houston, TX, 713-528-2005

Audio Assoc., Baltimore, MD, 301-854-6122

Northmar, Seattle, WA, 206-524-5170  
 Steffey Marketing, Northbrook, IL, 312-480-3575

Jamm Distributing, Matteson, IL, 312-747-6363

AMH Sales, Denver, CO, 303-429-2203

# Thindy II

## Model 2301 Wall/Ceiling Flush Mount Loudspeakers



Spring-loaded bracket.

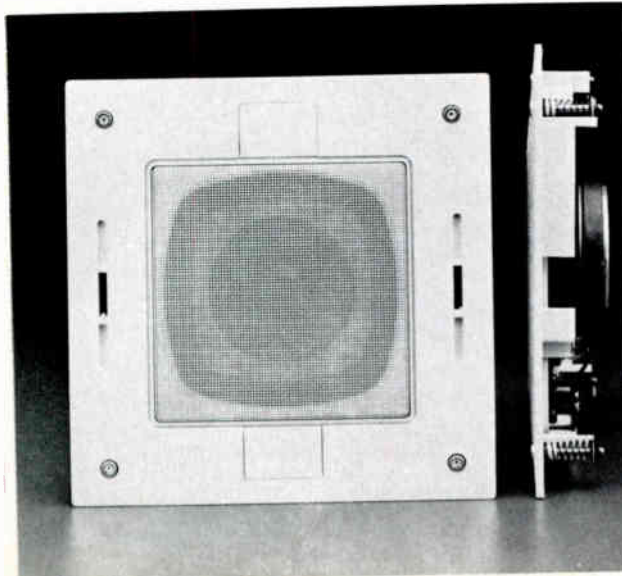

## The Second Generation.

**The thinness of 1 3/4" produces full range sound for wall or ceiling mount.**

The THINDY II is a specialized honeycomb-ring speaker (patent pending). The thinness of 1 3/4" and the size of 9" x 9" square has excellent specifications. Frequency response is 65 Hz to 20,000 Hz; power handling capacity is 30 watt RMS and 60 watt max.; sensitivity is 90 db 1W/1M; impedance is 6 ohms; and is available in colors BLACK or IVORY. The NEW patent spring loaded brackets make wall or ceiling installation faster and easier.

# OWI

**OWI Incorporated**

1160 Mahalo Place  
 Compton, CA 90220  
 213.638.4732  
 FAX: 213.638.8347  
 1.800.638.1694

# HARRIS P-TEC LITES



- 70 Volt with Volume Control
- No Ceiling Tile Cutting or Damage
- The Ideal Voice Paging Speaker
- Also P-Tec/5 Piezzo Technology Available

Authorized Harris Distributor

**PORTLAND INSTRUMENT**

ORDER TOLL FREE

**800-621-5640**

(At Tone Dial 778563)



# FANE

*Towards Perfection*

## **SOUND TECHNOLOGY SUPREME**

*Precision engineered, state-of-the-art professional high power loudspeakers performing to a standard of excellence which fulfils every demand of the world's most discriminating sound consultants and musicians.*

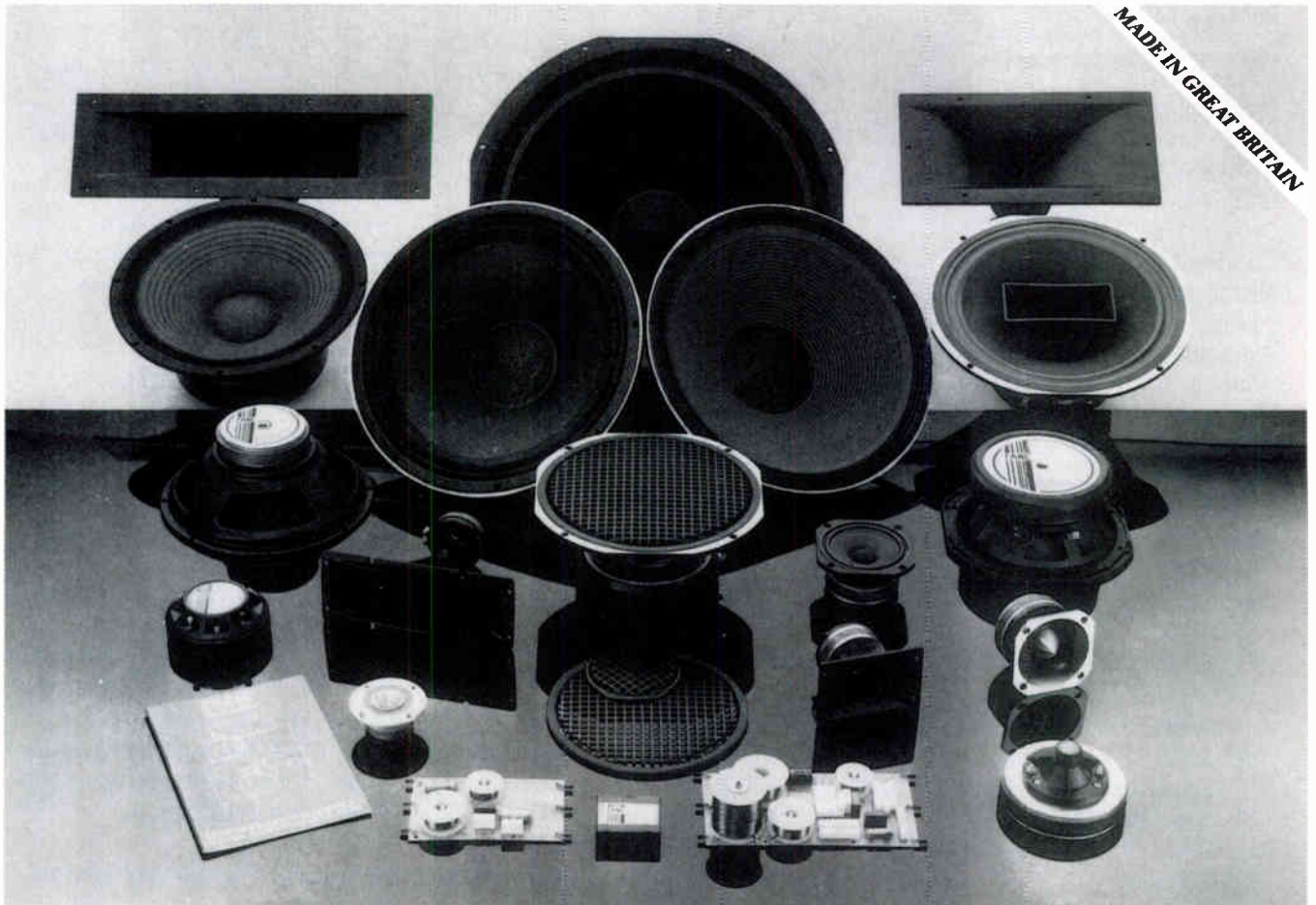

### **USA AVAILABILITY**

*Information, supplies and service are available NOW from:*

## **Fane Acoustics Inc.**

872 Thomas Dr., Bensenville, IL 60106  
Tel. (312) 766-7020 FAX (312) 766-7397

### **Fane Acoustics Limited**

286 Bradford Road, Batley, West Yorkshire, WF17 5PW, England. Tel: (0924) 476431 Fax (0924) 471799 Telex 556498 AUDIO.G

Products: full-range , multi-way/high-powered, portable, stage monitors, sub-woofer, systems

Electronic Systems Group, Inc.  
4405 Vineland Rd., St. C-8  
Orlando, FL 32811  
(305) 423-2363

Electro-Voice, Inc.  
600 Cecil Street  
Buchanan, MI 49107  
(616) 695-6831, 800-527-6701, FAX#  
616-695-1304

Pres.: Robert D. Pabst  
V.P. Sales & Mkt'g: Paul McGuire  
Director of Mkt'g: Jim Long  
Chief Engineer: Earl Harris

George M. Conneen Co., Inc.,  
Springfield, PA, 215-544-5884

Metropolis Audio Marketing, Inc.,  
Edison, NJ, 201-225-0085

R.J. Marketing Ltd., Rockville, MD,  
301-251-0330

The Smith Company, Hartford, CT,  
203-523-0512

Ron Tunks Sales, Inc., Tamarac, FL,  
305-722-2803

Wilson Audio Sales, Nashville, TN, 615-  
646-4477

Audio Resources, Westmont, IL, 312-  
655-1180

B.C. Electronic Sales, Inc., Mission,  
KS, 913-262-1720

Jones Audio Sales, Plano, TX, 214-  
867-0202

C.L. Pugh & Assoc., Inc., Columbus,  
OH, 614-486-9678

Riley & Petchell Sales, Inc., Detroit, MI,  
313-937-300

Lopnow & Assoc., Redmond, WA,  
206-883-3205

Radon & Assoc., Sacramento, CA,  
916-923-2524

Silver Peak Marketing Ltd., Wheat  
Ridge, CO, 303-467-9042

Western Audio Sales, Glendale, CA,  
818-246-3806 x

Products: ceiling, columns, compact, components, environment protected, explosion-proof, flush-mount, foreground, full-range , high-frequency drivers, high-power, horns, low-frequency drivers, mid-bass, multi-way/high-powered, music system speakers, outdoor, PA horns, paging horns, paging, portable,

processor controlled, stage monitors, studio/reference monitors, sub-woofer, surface-mount, systems, tweeters

Emilar  
4570 East Eisenhower Circle  
Anaheim, CA 92807  
(714) 779-8394

Environmental Sound  
31220 La Baya Dr. Boulevard, Ste 110  
Westlake Village, CA 91362  
(818) 706-0228, FAX# 818-889-5605  
Pres.: Pascal Delbuck  
Mkt'g Director: Ron Glathoffer  
Advertising Mgr.: Dean McEntyre  
Chief Engineer: Pascal Delbuck  
Plant Mgr.: Bill Ward  
DB Marketing, East Rockway, NY, 516-  
596-1244  
Factory Rep., Westlake Village, CA,  
818-706-0228  
Products: ceiling, decorative, flush-mount, foreground, full-range , music system speakers

Fane  
1316 East Lancaster St.  
Fort Worth, TX 76102  
(817) 336-5114

Fanon Courier  
14281 Chambers Road  
Tustin, CA 92680  
(714) 669-9890, 800-345-1354, FAX#  
714-669-1081  
Pres.: Frank Blaha

Director Sales/Mkt'g: Murray Trotiner  
Director of Engineering: Miguel Santana  
Products: PA horns, paging horns, paging

Fender Musical Instrument Corp.  
1130 Columbia Street  
Brea, CA 92621  
(714) 990-0909, FAX# 714-990-3986  
Mgr. Pro Audio: Cal Perkins

Len Finkler Company  
80 Alexdon Road  
Downsview, Ontario M3J2B4  
(416) 630-9103

Formula Audio  
Route 5, Box 440-3  
Zebulon, NC 27597  
(919) 269-6441

Foster  
15000 Calvert St.  
Van Nuys, CA 91411  
(213) 994-0686

Fostex Corp. of America  
15431 Blackburn Ave.  
Norwalk, CA 90650  
(213) 921-1112, FAX# 213-802-1964  
Pres.: Y. Abe  
Exec. V.P./General Mgr.: Fred Huang  
V.P. Sales/Mkt'g: Mark Cohen  
Products: columns, compact, components, full-range , high-frequency drivers, low-frequency drivers, music system speakers, outdoor, portable, powered, studio/reference monitors, sub-woofer, systems, tweeters

Fourjay Industries, Inc.  
3400 Stop Eight Road  
Dayton, OH 45414-0617  
(513) 890-6444, FAX# 513-890-1692  
Pres.: J.M. Fulkerson II  
Director of Sales: M.W. (Bud) Frawley  
Products: ceiling, components, environment protected, flush-mount, foreground, full-range , horns, music system speakers, noise masking, omni-directional, outdoor, PA horns, paging horns, paging, surface-mount, voice communications

Frazier/Division of Sound-Craft Systems, Inc.  
PO Box 319  
Petit Jean Mountain, Route 3  
Morrilton, AR 72110-9532  
(501) 727-5543, 800-643-8747  
V.P. : James Truelsen  
Products: ceiling, columns, compact, components, custom, decorative, environment protected, flush-mount, foreground, full-range , high-frequency drivers, high-power, horns, low-frequency drivers, multi-way/high-powered, music system speakers, omni-directional, stage monitors, studio/reference monitors, sub-woofer, surface-mount, systems, tweeters, voice communications

# THE BRITISH ARE COMING! THE BRITISH ARE COMING!

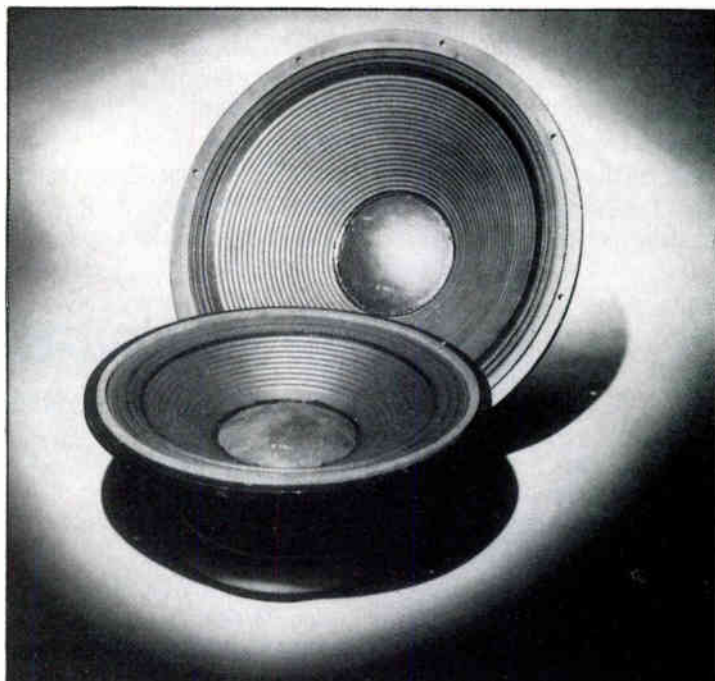

Studio 7 15-inch & 18-inch sizes rated at 500 watts

- PRIZE WINNING QUALITY PROVEN IN BRITAIN AND EUROPE.
- AVAILABLE EXCLUSIVELY FROM WALDOM IN NORTH AMERICA.
- TWO SERIES AND 40 MODELS TO CHOOSE FROM.
- TOPS FOR MI AMPS AND SOUND REINFORCEMENT/ PRO SOUND.
- TOPS FOR CLUB, AUDITORIUM, PA INSTALLATIONS.

## WALDOM INTRODUCES MCKENZIE THE SOUNDLY BRITISH LOUDSPEAKERS

### MC KENZIE STUDIO 7 SERIES— POWER AND QUALITY TO SPARE!

- 20 MODELS RATED FROM 100 TO 500 WATTS.
- 10-INCH, 12-INCH, 15-INCH AND 18-INCH SIZES.
- 15-INCH AND 18-INCH MODELS RATED AT 500 WATTS.
- RUGGED CAST ALUMINUM BASKETS PLUS HIGH TEMP COILS.

### MC KENZIE PRO SERIES— AFFORDABLE SOUND WITHOUT COMPROMISE.

- 20 MODELS RATED AT 50 TO 200 WATTS.
- 10-INCH, 12-INCH AND 15-INCH SIZES.
- 15-INCH SIZE EVEN HAS CAST ALUMINUM BASKET.
- HIGH TEMP COILS AND PARTS.

**waldom**

ELECTRONICS, INC  
A KATY INDUSTRIES COMPANY

*... the Sound Source*

4301 West 69th Street/Chicago, Illinois 60629  
Telephone: (312) 585-1212/Telex: 244810/FAX: (312) 585-7847

**NOTE SOME  
DEALERSHIPS AND  
REP TERRITORIES  
STILL AVAILABLE.**



GLI/Integrated Sound Systems  
1227 Walt Whitman Road  
Melville, NY 11747  
(516) 351-2100

Galaxy Audio  
625 East Pawnee Ave.  
Wichita, KS 67211  
(316) 263-2852  
Chief Engineer: Brock Jabara, P.E.  
Engineer: Monte Ballard  
Sales Mgr.: Jim Pearce  
Products: stage monitors

Gemco Electronics, Inc.  
PO Box 993  
550 Airport Rd.  
Gallatin, TN 37066  
(615) 452-5960  
Pres.: Jerry A. Graves  
Sales Mgr.: Byron Graves  
Chief Engineer: Todd Adams  
Office Mgr.: Mrs. Tiny Brown

Gollehon Industries, Inc.  
3105 Madison Ave. SE  
Grand Rapids, MI 49508  
(616) 247-8231

Gotham Audio Corp.  
1790 Broadway, 8th floor  
New York, NY 10019-1412  
(212) 765-3410  
Pres.: Russ O. Hamm  
Eastern Sales Mgr.: Jerry Graham  
Western Sales Mgr.: Juergen Wahl  
Sales Engineer: Peter Engel



**HARRIS CORPORATION, DRACON DIVISION**  
809 Calle Plano  
Camarillo, CA 93010  
(805) 987-9511, 800-437-2266, FAX# 805-987-2547  
V.P./General Mgr.: John R. Mason  
V.P. Sales & Mkt'g.: Jack McGuigan

Director of Sales: Tom Erdmann  
Paging Prod. Mgr.: Tom Johnson  
Metals/Racks/Tools Prod. Mgr.: Terry Smith  
Test Sets Prod. Mgr.: John Akins  
Don Bivens, Lake Elsinore, CA, 714-672-2168  
Gary Foster, Columbia, MD, 314-442-2288  
Rob Lincoln, Melbourne, FL, 407-259-0991  
Mark Skilowitz, Newfield, NJ, 609-697-4580  
Jim Fetterer, Seattle, WA, 206-243-7762  
Bill Boone, Libertyville, IL, 312-816-1080  
Dave Whelan, W. Springfield, MA, 413-731-9552  
Products: ceiling, explosion-proof, full-range, horns, music system speakers, omni-directional, PA horns, paging horns, paging, powered, surface-mount, systems, talkback, underwater, voice communications

Hi Lo Fabrication and Manufacturing  
PO Box 509  
CR 1105  
Rio Vista, TX 76093  
(817) 373-2247  
Pres.: Cecil Caro  
Production Engineer: Cecil Caro  
Sales/Secretary: Bridget Caro  
Products: columns, compact, components, custom, decorative, horns, monitor panels, outdoor, PA horns, paging horns, stage monitors, studio/reference monitors, systems, voice communications

Hirschmann of America  
PO Box 229  
Industrial Row  
Riverdale, NJ 07457  
(201) 835-5002, 800-225-0524  
Sales Mgr.: Andy Swenson

International Music Co. (I. M. C.)  
PO Box 2344  
1316 E. Lancaster  
Ft. Worth, TX 76113-2344  
(817) 336-5114, 800-433-5627, FAX# 817-870-1271  
Chairman of the Bd./CEO: Tommy Moore  
Pres.: Jerry Freed

## The world's first simulated stone outdoor speaker system Completely water and weather proof Designed for Audio Sonic Accuracy

Frequency response 58 Hz-18.5 kHz.  
Power handling 100 watts continuous

Whether your applications are:

- industrial
- architectural
- landscaping
- indoor gardens
- amusement parks
- shopping centers
- office buildings
- or for your own back yard



you won't believe the sound of the **ROCKUSTICS** loudspeaker systems.

*Enhance* the looks and sound of your next installation.

# ROCKUSTICS INC.

41 East Main Street, Bayshore, NY 11706 (516) 665-6497



**FROM A PORTABLE,  
SELF-CONTAINED VOCAL PA TO  
LARGE CUSTOM SYSTEMS,  
FOSTEX PRODUCTS AND  
COMPONENTS DELIVER.**

- MICROPHONES • SPEAKER SYSTEMS • LOUDSPEAKER COMPONENTS
- HEADPHONES • AMPLIFIERS • MIXERS • RECORDERS • SYNCHRONIZERS



FOSTEX RP TECHNOLOGY

If you work with sound, you owe it to yourself and your clients to audition these remarkable transducers. To date, they have received over twenty international patents.

**Fostex**

Pro Sound Division

15431 Blackburn Ave.  
Norwalk, CA 90650  
(213) 921-1112

V.P. Sales: C.H. Murray  
 Dir. of Akai EMI: Mike McRoberts  
 Akai Prod. Specialist: Kevin Kennedy

**Intersonics, Inc.**

3453 Commercial Ave.  
 Northbrook, IL 60062-1818  
 (312) 272-1772, FAX# 312-272-9324  
 Sales Mgr.: Tom Melzer  
 Director: Thomas Danley  
 Production Mgr.: John Halliburton

**JBL PROFESSIONAL**

8500 Balboa Blvd  
 Northridge, CA 91329  
 (818) 893-8411, FAX# 818-893-3639  
 Pres.: Ron Means  
 V.P. Sales: Ken Lopez  
 V.P. Mkt'g: Mark Gander  
 Applications Engineer: Drew Daniels  
 Mkt'g Mgr./Sound Contracting: Steve Romeo  
 Video Sales: Don Wilson  
 Neil Conly, Bedford, TX, 817-540-3066  
 Bill Hamilton, Folsom, PA, 215-543-4677  
 Steve Armstrong, Northridge, CA, 818-707-2529  
 Tom Walter, Barrington, IL, 312-382-4925  
 Products: ceiling, columns, components, foreground, full-range, high-frequency drivers, high-power, horns, low-frequency drivers, mid-bass, multi-way/high-powered, music system speakers, portable, powered, processor controlled, stage monitors, studio/reference monitors, sub-woofer, surface-mount, systems, tweeters

**KDM Electronics, Inc.**

705 Progress Ave., Unit #59  
 Scarborough, Ontario, Canada M7H 2X1  
 (416) 439-7158  
 Pres.: Ron Bull  
 Products: full-range, high-power, multi-way/high-powered, music system speakers, omni-directional, underwater

**Klipsch & Associates, Inc.**

PO Box 688  
 Route 4, Oakhaven Rd.  
 Hope, AR 71801  
 (501) 777-6751, FAX# 501-777-6753  
 Pres.: Paul W. Klipsch

V.P.: Raymond Booles  
 V.P.: E. Jerome Werner  
 Nat'l Sales Mgr.: P. Woody Jackson  
 Int'l Sales Mgr.: Jack Fountain  
 Products: full-range, high-frequency drivers, horns, low-frequency drivers, mid-bass, multi-way/high-powered, music system speakers, portable, stage monitors, sub-woofer, systems, tweeters

**LAR Sound**

718 Ninth St.  
 Niagara Falls, NY 14301  
 (716) 242-2442  
 Pres.: Larry Kutner  
 Wood & Co., Buffalo, NY, 716-886-0019  
 Products: full-range, high-power, mid-bass, music system speakers, outdoor, stage monitors, studio/reference monitors, voice communications

**Lowell Manufacturing Co.**

3030 Laclede Sta. Road  
 St. Louis, MO 63143  
 (314) 781-9058, 800-325-9660  
 Chairman: Ben W. Lowell  
 Pres.: Dorothy H. Lowell  
 Sales Mgr.: John J. Lowell  
 Sales: Wilhelm R. Lowell  
 Engineering: Karl R. Schneider

**M.B. America (Master Blaster America)**

215 Tremont St.  
 Rochester, NY 14608  
 (716) 436-2720

**MG Electronics**

32 Ranick Rd.  
 Hauppauge, NY 11788  
 (516) 582-3400, FAX# 516-582-3229  
 Pres.: Louis Maltz  
 V.P.: Elliott Maltz  
 Sales Mgr.: Stan Grey  
 Miller Assoc., Stamford, CT, 203-869-7793  
 Forti Assoc., Kensington, MD, 301-949-1706  
 Cavendish & Winchester, Atlanta, GA, 404-449-5104

Raymar Associates, Duncanville, TX, 214-296-9833

Products: ceiling, columns, compact, components, environment protected, flush-mount, foreground, full-range, high-frequency drivers, high-power,

horns, music system speakers, outdoor, PA horns, paging horns, systems, tweeters, voice communications

**MTX Loudspeakers - The Mitek Group**

One Mitek Plaza  
 Winslow, IL 61089  
 (815) 367-3000  
 Pres./CEO: Loyd Ivey  
 V.P. Mkt'g: Rod Boyer  
 Reg. Sales: Rob Landsberg  
 Int'l Sales: Dave Armon  
 Director PR: James Terhark

**MacPherson Speakers**

3750 Wood Road  
 Lansing, MI 48906  
 (517) 371-4148  
 Pres.: Dave MacPherson  
 Production: Mike Cosgrove  
 Sales: Dave Arnold

**Mark IV Cinema Systems**

600 Cecil Street  
 Buchanan, MI 49107  
 (616) 695-6831

**Dean Markley Strings & Electronics, Inc.**

3350 Scott Blvd., Suite 45  
 Santa Clara, CA 95054  
 (408) 988-2456, 800-538-8330, FAX# 988-0441  
 Pres.: Dean Markley  
 Exec. V. P.: Bari Wilson  
 Nat'l Sales Mgr.: Tom Dreibelbis

**Martin America**

PO Box 3248  
 Chatsworth, CA 91313  
 (818) 718-1031, FAX# 818-718-1032  
 Pres.: Ted Telesky  
 V.P.: Dave Martin  
 Sales Mgr.: Linda Frank

**McCauley Sound, Inc.**

13608 94th Ave. E.  
 Puyallup, WA 98373  
 (206) 848-0363  
 Pres./Sales Mgr.: Tom McCauley  
 V.P./Production: Pete McCauley

**Meyer Sound Laboratories, Inc.**

2832 San Pablo Ave.  
 Berkeley, CA 94702  
 (415) 486-1166, FAX# 415-486-8356  
 Pres.: John Meyer



# EXTENDED FAMILY

Toa has greatly expanded its selection of professional audio products with the addition of 21 exciting new high-definition speaker systems. You can now choose Toa speakers for every conceivable sound contracting application, from a small SM Series personal monitor to a thundering SE system with an 18-inch woofer.

There's the SL Series of integrated speaker and stage monitoring systems and the rugged SD Series monitor/speaker systems. Style, durability, quality and price make them perfect for nightclub and auditorium installations.

Exceedingly clean and powerful, the premier 380SE and 480SE systems are spe-

cifically designed for critical applications. Incorporating Toa's latest breakthroughs in high power, wide dispersion speaker technology, these systems offer the wide dynamic range and extended frequency response required to reproduce the subtleties of digitally recorded or created music.

And to reinforce the ultra-low frequencies with outstanding realism, you have the SEB, SDB and SLB subwoofer systems.

Personal monitoring systems include the RS-20—tough, portable, easy to set up—and the SM Series of bracket-mountable on-stage monitors, ideal for both portable use and permanent installations in

churches, schools and concert halls. For superior near-field monitoring in recording studios and broadcast control rooms, Toa brings you the ME Series of studio monitors, shielded for use in A/V installations.

For more information on Toa's extended family of professional speaker systems, talk to your local Toa representative today, or call us at (800) 843-4750, in California (800) 632-2157.

Toa Electronics, Inc., Professional Audio Group, 601 Gateway Blvd., Suite 300, South San Francisco, California 94080. Telephone (415) 588-2538, Telex 331332, FAX (415) 588-3349.



TOA

V.P.: Helen Meyer  
Mkt'g/Sales Mgr.: Gary Hudson

Misco/Minneapolis Speaker Co.  
3806 Grand Ave.  
Minneapolis, MN 55409  
(612) 825-1010  
Pres.: Cliff Digre  
Sales Mgr.: Don Ringham  
Chief Engineer: Cliff Digre  
General Mgr.: Dan Digre

Modular Sound Systems - The Mitek Group  
One Mitek Plaza  
Winslow, IL 61089  
(815) 367-3000  
Pres./CEO: Loyd Ivey  
V.P. Mkt'g: Rod Boyer  
Reg. Sales: Rob Landsberg  
Int'l Sales: Dave Armon  
Director PR: James Terhark

Motorola, Inc./Ceramic Products  
4800 Alameda Blvd. N.E.  
Albuquerque, MN 87113  
(505) 822-8801

Int'l Sales Mgr: Bob Munn  
W. Reg. Sales Mgr.: Al Lowenstein  
C. Reg. Sales Mgr.: Roger Milewski  
E. Reg. Sales Mgr.: Don Bacso  
Programs Cdr.: Cheryl Iverson

The Music People, Inc.  
PO Box 648  
West Hartford, CT 06107  
(203) 521-2248, 800-289-8889, FAX#  
203-521-2428  
Pres.: James R. Hennessey  
Director of Sales: Earl "Buzz" Goodwin  
Comptroller: John Gutowski  
Purchasing Mgr.: Robert Murray  
Publicity/Promotion: Lisa Radefeld

Music Supply Co., Inc.  
809 N. Madison  
Dallas, TX 75208  
(214) 946-8450, 800-527-1522, FAX#  
214-946-9155  
Pres.: W. E. Brown  
Sales: Betty Brown

Numark Electronics  
503 Newfield Ave.  
Edison, NJ 08837  
(201) 225-3222, FAX# 201-287-2155  
Pres.: Harry Kotovsky  
V.P.: Robert Kotovsky  
Numark/PPD, Simi Valley, CA, 805-  
522-3550

**OWI, INC.**  
1160 Mahalo Pl.  
Compton, CA 90220  
(213) 638-4732, 800-638-10WI, FAX#  
213-638-8347  
V.P. Engineer: Hiroaki Okayama  
Director of Mkt'g: Ned Morioka  
Office Mgr.: June Morioka  
Credit Mgr.: Linda Matsumoto  
Products: ceiling, compact, custom,  
decorative, environment protected,  
flush-mount, foreground, full-range,  
high-power, mid-bass, multi-  
way/high-powered, music system  
speakers, omni-directional, outdoor,  
studio/reference monitors, surface-  
mount, systems, voice  
communications

IN STOCK

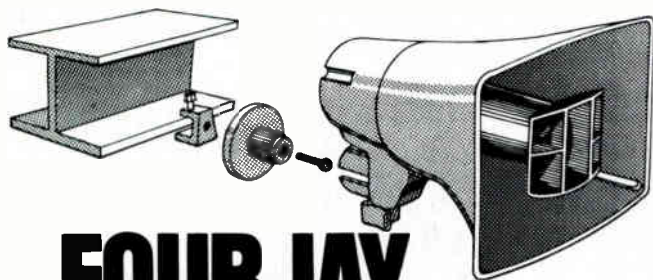

## FOURJAY Cuts Installation Costs

You'll save time and money when you choose a Fourjay Paging Speaker. It practically installs itself. And you can depend on it for quality...

- Nearly unbreakable mounting base made of Lexan®
- Long hook-up cable for hard wiring assures weatherability.
- Unique speaker design disperses high frequencies equally.
- Enclosed transformer with selectable taps.

Each Fourjay Paging Speaker is tested for optimum talk-back sensitivity to assure performance in intercom applications. With a Fourjay Speaker, you'll improve quality and cut installation costs dramatically.

LEXAN® is a GE trademark



**FOURJAY INDUSTRIES, INC.**  
3400 Stop Eight Road, Dayton, Ohio 45414  
Phone (513) 890-6444 • FAX (513) 890-1692

IMMEDIATE DELIVERY

World Radio History



CWY ELECTRONICS IS YOUR IN-STOCK SOURCE FOR QUALITY UNIVERSITY SOUND PRODUCTS. CWY ELECTRONICS IS THE MASTER DISTRIBUTOR FOR INDIANA AND KENTUCKY, SERVING YOUR NEEDS FOR OVER 30 YEARS.

**CWY**  
electronics

CALL RANDY JESSUP AT  
INDIANA 1-800-382-7526  
KENTUCKY 1-800-428-7596  
405 NORTH EARL AVENUE  
LAFAYETTE, INDIANA 47903



In compression drivers, less distortion equals more accurate sound. Theoretically, transducer sound outputs are an exact copy of their electrical inputs. In real-world compression drivers, distortion must be minimized to satisfy the critical listener. Careful design of the magnetic circuit, voice coil and suspension components helps to reduce non-linearities which cause production of upper harmonics, multiples of the fundamental frequency. Manufacturers' data sheets typically show the level of second and third harmonic components relative to the fundamental.

However, other types of distortions can have greater significance in speech and especially in music. Subharmonic distortion components at one half, one third, etc., of the fundamental frequency are of particular concern in the output of a compression driver. Although the second and third harmonics of the frequency range may be outside the audible spectrum, the second or third *subharmonics* are in the middle of the passband where the ear is most sensitive.

No compression driver diaphragm behaves as an ideal simple piston at all frequencies; some types of "break up" produce subharmonic distortion. At Altec Lansing we solved this problem in the 288 series of compression drivers. This knowledge was applied in making the careful choices of diaphragm size and material for the Pascalite™ diaphragm assembly in the new model 299 compression driver.

The resulting engineering achievement makes the 299

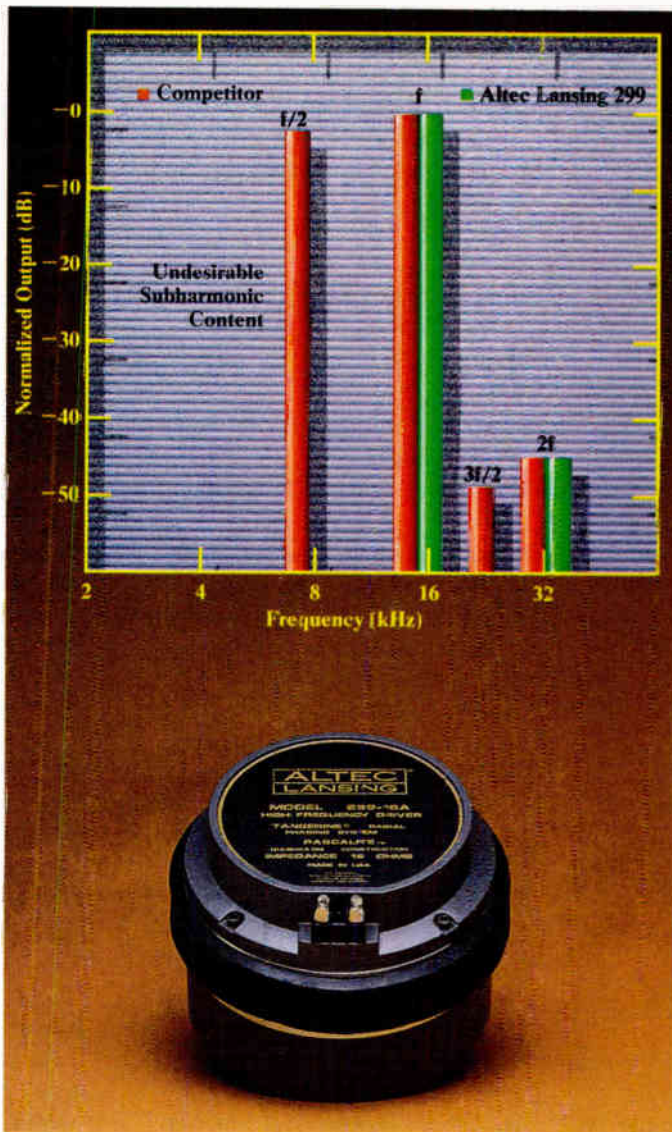

equal in acoustic output to large format compression drivers using titanium diaphragms, while minimizing the problem of subharmonic distortion.

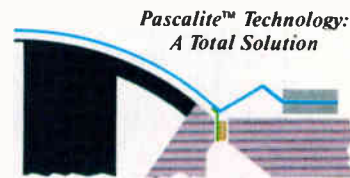

■ High Strength Aluminum Alloy  
■ Aramid Fiber Voice Coil Support

2.8" Diameter Voice Coil and Diaphragm Assembled with State-Of-The-Art Adhesive in Cutaway One-Half View Mounted in Driver

This graph, based on extensive Altec Lansing research with TEF® analysis, shows the output of a competitor's compression driver with a four-inch diameter titanium diaphragm when driven at 15.5 kHz with a modest input power level of one watt. It also shows the output of the Altec Lansing 299 Pascalite™ diaphragm driver at the same power level. The horizontal axis is frequency, while the vertical axis shows the relative amplitude of the output. At one half the fundamental frequency, the output of the competitor's driver is louder than any of its upper harmonics. This kind of spurious midband tone makes "S" sound like "SHH" and blurs musical definition. *The graph shows the subharmonic content of the Altec Lansing model 299 driver to be virtually unmeasurable.*

The benefit of lower total distortion in a compression driver is more accurate sound, and more satisfied customers and audiences.

# Fact.

## In Compression Drivers, Less Distortion = More Accurate Sound



P.O. Box 26105 · Oklahoma City, Oklahoma 73126-0105 USA · 405-324-5311 · Telex 160-369  
© 1987 Altec Lansing Corporation



Oaktron Industries, Inc.  
1000 30th St.  
Monroe, WI 53566  
(800) 257-4538  
Pres./CEO: Jerry Disch  
Executive V. P.: Bob Taller  
V. P. Sales: Jim Hendrickson

Olson Acoustics  
920 Grayson St.  
Berkeley, CA 94710  
(415) 644-2500

Onboard Monitor Corp  
7001 West 29th Ave.  
Hialeah, FL 33014  
(305) 823-4835  
Mkt'g: Bob Waterstripe  
Products: custom

Orevox Corp.  
PO Box 1046  
512 35th St. NE  
Auburn, WA 98002  
(206) 735-0220, 800-237-0700, FAX#  
206-251-9142  
CEO: Daniel Wu  
Sales Mgr.: Russ Stanford  
Products: components, custom,  
foreground, full-range, high-  
frequency drivers, high-power, horns,  
low-frequency drivers, mid-bass,  
music system speakers, outdoor, PA  
horns, paging horns, paging, sub-  
woofer, talkback, tweeters

PA Concepts  
450 Taft Drive  
South Holland, IL 60473  
(312) 339-8014

#### **PAS PROFESSIONAL AUDIO SYSTEMS**

1224 West 252nd St.  
Harbor City, CA 90710  
(213) 534-3570, FAX# 213-530-2384  
Pres.: Larry Doran  
Product Mgr.: John Kirkland  
Innovative Audio Sales, Pontiac, MI,  
313-673-2280  
Clearview Marketing, Forest Hills, NY,  
718-592-0710  
Professional Audio Assoc., Burlington,  
MA, 617-229-6050  
MBT, Pittsburgh, PA, 412-344-1360  
Applied Audio, Ashville, NC, 704-252-  
9313

Music Sales Unlimited, Orlando, FL,  
305-898-6645  
Stan Sliz Assoc., Broomfield, CO, 800-  
525-2670  
Tenicki Assoc., Houston, TX, 713-528-  
2005  
Innovative Sales & Marketing, Fountain  
Valley, CA, 714-549-7770  
Future Sales, Redmond, WA, 206-868-  
5577  
Charlie Winkler & Assoc., Uniontown,  
OH, 216-699-9511  
Wayne Fuday, Fairfax, CA, 415-459-  
6880

Products: full-range, low-frequency  
drivers, mid-bass, multi-way/high-  
powered, processor controlled, stage  
monitors, studio/reference monitors,  
sub-woofer, systems

Panasonic Industrial Company/Ramsa  
6550 Katella Ave  
Cypress, CA 90630  
(714) 895-7278, FAX# 714-895-7242  
Nat'l Sales/Mkt'g: Steve Wooley  
Eastern Sales Mgr.: D.J. Bierut  
Central Sales Mgr.: Greg Braithwaite  
Western Sales Mgr.: James Murray  
Pusecker Sales, Upper Montclair, NJ,  
201-744-1834

Professional Audio Associates,  
Burlington, MA, 617-229-6050  
David Prinzi, Webster, NY, 716-671-  
9266  
World Wide Electronics, Pembroke  
Pines, FL, 305-584-7024  
World Wide Electronics, Jacksonville,  
FL  
Evans Sales & Mkt'g, Nashville, TN,  
615-297-7997

A/V Mkt'g, Carmel, IN, 317-846-1034  
Key Mkt'g, Plymouth, MI, 313-459-  
6040

New Horizons Elec. Mkt'g,  
Bannockburn, IL, 312-234-5911  
J.B. Parent Co., Dublin, OH, 614-764-  
0064

Music Interventions & Assoc., Kansas  
City, MO, 816-453-4448

Tenicki & Assoc., Houston, TX, 713-  
528-2005

New West Audio, Burbank, CA, 818-  
955-9706

Brian Trankle Assoc., Belmont, CA,  
415-595-4004

Brian Trankle Assoc., Sacramento, CA,  
916-369-7030

Northmar, Seattle, WA, 206-524-5170  
Pearson & Pearson, Denver, CO, 303-  
722-6996

Products: compact, foreground, full-  
range, high-power, music system  
speakers, portable, stage monitors,  
studio/reference monitors, sub-  
woofer, systems

Paramount Sound Systems  
5555 Melrose Ave.  
Los Angeles, CA 90038  
(213) 468-4601

Paso Sound Products  
14 First St.  
Pelham, NY 10803-1495  
(914) 738-4800, FAX# 914-738-3954  
Executive V.P.: Paul Mastrangelo

Sales Mgr.: David Moore  
Product Mgr.: Ken Obrien  
Credit Mgr.: Marilyn Beckerson  
Operations Mgr.: Anthony Sgueglia  
All West Electronics, Camarillo, CA,  
805-388-1789

Anderson Sales, Braintree, MA, 617-  
848-9194

Pace Sales, Charlotte, NC, 704-365-  
3216

De Witt Austin Co., Alpharetta, GA,  
404-442-1326

Dowell Assoc., St. Louis, MO, 314-  
849-4234

Mountain Representatives, Denver, CO,  
303-623-0972

J.Y.S. Comm. Co., Dallas, TX, 214-  
349-1650

Lienau Assoc., Inc., Columbia, MD,  
301-621-4113

Lienau Assoc., Inc., New Town, PA,  
215-860-2100

SLK Tech Rep, San Francisco, CA,  
415-822-4884

Miguel Lopez, Hialeah, FL, 305-822-  
6853

Marketline, Snellville, GA, 404-972-  
9048

Messnick Sales, Liverpool, NY, 315-  
622-3211

Miller Assoc., Ltd., Greenwich, CT,  
212-840-2866

Robert Milsk Co., Inc., Southfield, MI,  
313-354-3310

Robert Milsk Co., Indianapolis, IN, 317-  
842-3400

Weller Electronic Sales, Worthington,  
OH, 614-885-7819



Bruce Burns:

“Finally... I found a speaker system that delivers real power with a smooth, natural high end.”

Burns Audio won the 1987 ProSound News “Sound Reinforcement Award, Festival Category,” for Liberty Island ceremonies. Other credits include: “We the People...” the Barbra Streisand HBO Special, Happy Birthday Hollywood and the Emmies.

“**W**ith other processor based systems, I can hear the processor. And high power meant harsh high end. But not with Apogee.”

Bruce Burns discovered that, individually, the Apogee AE-5 speakers give him both high power and high fidelity. Adding additional trapezoidal cabinets produces a dramatic array.

The Apogee two channel electronically coupled system has a fixed crossover point and sonically transparent limiters. Apogee is the only manufacturer who offers a compact, road version processor with input and output connectors on the front panel of the unit for quick installation and removal.

Steel flying hardware is built into the speaker cabinets and complete rigging gear is available. Rugged. And you can fit more power into smaller spaces... in the room... on the stage... and in the truck.

Bruce puts it all together, “... I’m telling you, the good design, great sound and ease of hanging are unbelievable. Apogee solves my problems.”

“Call us today to arrange a demonstration or for information on the complete family of loudspeaker systems from Apogee Sound.”

**APOGEE**

**SOUND INC.**

Worldwide distribution:

CANADA: AKG Acoustics (416) 292-5161  
FRANCE: Simplex Electronique 42 71 53 30  
HONG KONG: Tom Lee Music 3-7221098  
MEXICO: Selectro Especta (905) 544-1345

NORWAY: Siv.ing. Benum (02) 14 54 60  
SPAIN: Sony Espana (93) 330 65 51  
SWEDEN: Englund Musik AB 08/970920

1150 Industrial Ave., Suite C  
Petaluma, CA 94952  
707-778-8887  
fax # 707-778-6923

Frank Lintern Assoc., Naperville, IL,  
312-983-0935  
Products: ceiling, columns, compact, components, decorative, environment protected, flush-mount, foreground, full-range, high-frequency drivers, high-power, horns, monitor panels, music system speakers, noise masking, omni-directional, outdoor, PA horns, paging horns, paging, portable, surface-mount, talkback, voice communications

Peavey Architectural Acoustics Division  
PO Box 2898  
711 A Street  
Meridian, MS 39301  
(601) 483-5376, FAX# 601-484-4278  
Prod Mgr.: Ken Valentine  
Products: compact, full-range, music system speakers, surface-mount

Peavey Electronics Corp.  
PO Box 2898  
711 A Street  
Meridian, MS 39301  
(601) 483-5365, FAX# 601-484-4278

Prod Mgr.: Ken Valentine  
Products: columns, compact, high-frequency drivers, mid-bass, multi-way/high-powered, music system speakers, portable, processor controlled, stage monitors, sub-woofer

Poly-Planar, Inc.  
50 Graphic Place  
Moonachie, NJ 07074  
(201) 641-2206, FAX# 215-794-0263  
Pres.: Norm Lange

Projected Sound, Inc.  
PO Box 112  
469 Avon Ave.  
Plainfield, IN 46168  
(317) 839-4111, FAX# 317-839-2476  
Pres.: Thomas F. Hilligoss, Sr.  
V. P.: Forrest O. Hilligoss  
Sec./Treasurer: J. Mark Hilligoss  
Products: ceiling, music system speakers, outdoor, paging

Pyle Industries, Inc.  
501 Center St.  
Huntington, IN 46750  
(219) 356-1200, FAX# 210-356-2830

Quam-Nichols Co.  
234 E. Marquette Rd.  
Chicago, IL 60637  
(312) 488-5800, FAX# 312-488-6944  
Pres.: W.G. Little  
Distributor Sales Mgr.: G.L. Johns  
Chief Engineer: Oswald Rohrbacher  
Vector Inc., Seattle, WA  
Given-Flanagan Assoc., W. Boylston, MA  
R.E. Breuer Co., Pt. Washington, NY  
Cartwright & Bean of Georgia, Atlanta, GA  
The Lewis & Dunnigan Co., Inc., Syracuse, NY  
Mandabach-Lehner Co., Columbus, OH  
McBride Loudspeaker Source, Inc., Waterloo, Ont., CD  
Foster Technical Sales Co., Edina, MN  
Robert Milsk Co., Southfield, MI  
Brian Trankle & Assoc., Belmont, CA  
Bidwell Sales Assoc., Gardena, CA  
J.Y. Schoonmaker Co., Inc., Dallas, TX  
Ken Levy & Assoc., Chicago, IL  
Lowery Assoc., Broomall, PA  
R.W. Kunz & Assoc., Prairie Village, KS

ROR  
55 Sloane Ave.  
Staten Island, NY 10306  
(212) 979-5396  
Dir. R&D/V.P.: Ted Rothstein

**PAGING/TALKBACK HORN SPEAKERS**  
With Built-in Transformers For Indoor/Outdoor Use  
Rugged Beige ABS Housings—Top Quality  
Super Competitive Prices For Volume Users



**MODEL #HS-12T**  
11" x 6-5/8" x 10-1/4" Depth  
Input: 25/70 Volt Transformer  
& 8 OHMS Direct  
Power Handling: 32 Watts  
Frequency Response: 300-14,000 HZ  
Sound Level: 125 DB/32W/4FT.  
Impedance Taps: 2500/1250/625/312/  
156/83/42 OHMS  
Wattage Taps: 70V 2/4/8/16/32 Watts  
25V 1/2/4/8/16 Watts  
Dispersion Angle:  
120 Degrees (Horizontal)  
90 Degrees (Vertical)

**MODEL #HS-17T**  
7-5/8" Bell Diameter x 9" Depth  
Input: 25/70 Volt Transformer &  
8 OHMS Direct  
Power Handling: 16 Watts  
Frequency Response: 350-14,000 Hz  
Sound Level: 120 DB/16W/4FT.  
Impedance Taps: 5000/1250/625/312.156  
83 OHMS  
Wattage Taps: 70V 1/2/4/8/16 Watts  
25V 0.5/1/2/4/8 Watts  
Dispersion Angle: 130 Degrees



**ELECTRONICS**  
Quality Loudspeaker Products

32 Ranick Rd.  
Hauppauge, NY 11788

**516-582-3400**

Fax: 516-582-3229

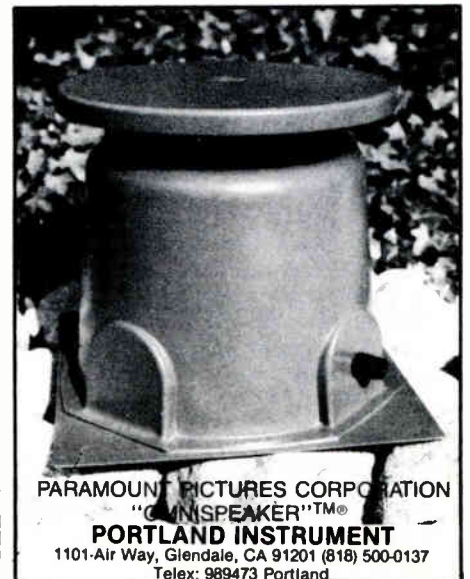

PARAMOUNT PICTURES CORPORATION  
"GAIN SPEAKER"™  
**PORTLAND INSTRUMENT**  
1101-Air Way, Glendale, CA 91201 (818) 500-0137  
Telex: 989473 Portland

800-621-5640, AT TONE 778563



# McCAULEY

. . . Pure  
Performance



The quality of McCauley loudspeaker systems goes far beyond cabinetry and exterior decor. Inside every McCauley system is what our company is all about, the driving force behind every system—its components. Not just a collection of pieces and parts that you find in so many other companies' boxes, but a precisely matched set of transducers that have been designed, engineered, and manufactured at McCauley and by



McCauley to deliver a signature of pure professional performance to the term "State of the Art."

To experience McCauley speaker enough for some; claim puts you in a performance." Tame the Series 800 system at an authorized McCauley dealer. Call or write the factory for detailed product specifications.



the sheer power of a system is reward but to lay your world of "Pure Performance."

**McCauley Sound, Inc.**

13608 94th Ave. E., Puyallup, Washington, USA 98373 (206) 848-0363

Ross Systems/IMC  
PO Box 2344  
Ft. Worth, TX 76113  
(817) 336-5114, FAX# 817-870-1271

St. Louis Music  
1400 Ferguson Ave.  
St. Louis, MO 63133  
(314) 727-4512, 800-325-8148, FAX#  
314-727-8929  
Sales Training Dir.: Tony Moscal  
Product Mgr.: Gary Byers  
Dir. of Operations: John Karpowicz  
Pres.: Gene Kornblum

Sanctuary Sound Systems  
113 Newport Drive  
Oak Ridge, TN 37830  
(615) 482-9242  
Mkt'g: Barry Boseman  
Products: custom

Sanming Sound Company  
5282 Research Ave.  
Huntington Beach, CA 92649  
(714) 891-2252, FAX# 714-891-7813  
Sales/Mkt'g: Leon C. Hsieh  
Pres./General Mgr.: Hugh C. Hsieh  
Chief Engineer: S.W. Hsu  
Chuck Olson Assoc., Renton, WA, 206-  
271-5416  
Repworks, Inc., Chicoppe, MA, 413-  
533-0845  
Forti Assoc., Kensington, MD, 301-  
949-1706  
Rohr Wanger Roberts Inc., Rock Hill,  
SC, 803-324-5111  
Roy Colen Sales, Mill Valley, CA, 415-  
383-8700  
George Pettitt Co., Berkeley, IL, 312-  
261-0342  
Design Factors, Hacienda Heights, CA,  
213-697-7576  
Cavendish & Winchester Inc.,  
Hollywood, FL, 305-927-3870  
Weller Sales, Worthington, OH, 614-  
885-7819  
Robert Milsco Co., Inc., Southfield, MI,  
313-354-3310

Sonic, Inc.  
3383 E. Layton Ave.  
Cudahy, WI 53110  
(414) 483-5091  
Pres.: Gary Hahlbeck  
V.P./Marketing: Dave Schneck

## SOUNDSPHERE

Sonic Systems, Inc.  
737 Canal St., Bldg. 23B  
Stamford, CT 06902  
(203) 356-1136, FAX# 203-324-0893  
Pres.: Peter Hamilton  
V. P. : John J. Karamon

Sony Professional Audio  
1600 Queen Anne Road  
Teaneck, NJ 07666  
(201) 833-5200  
Pres.: William G. Connolly  
V.P.: Jerry Smith  
Products: studio/reference monitors

Sound Development Industries  
428 Ft. Denaud Rd.  
La Belle, FL 33935  
(813) 675-0100, 800-675-3656  
Owner: Uolevi L. Lahti  
Chief Engineer: David Friday

Soundscape Speakers, Inc.  
4405 Vineland Rd., Ste. C-8  
Orlando, FL 32811  
(305) 423-2363  
Pres.: Martin Collins  
Project Engineer: Robb Resler

Soundtech  
230 Lexington Dr.  
Buffalo Grove, IL 60089  
(312) 541-3520, 800-323-4173, FAX#  
312-541-3616  
Pres.: Rudy Schlacher  
Sales Mgr.: Keith Brawley  
Sales Director: Len Brawling  
Products: full-range , high-frequency  
drivers, horns, low-frequency drivers,  
mid-bass, monitor panels, multi-  
way/high-powered, music system  
speakers

SpeakerCraft  
3615 Presley Avenue  
Riverside, CA 92507  
(714) 787-0543, FAX# 714-787-8747  
Director of Mkt'g: Randy Peede  
Products: ceiling, decorative,  
environment protected, foreground,  
full-range , outdoor, surface-mount

Speco Div., Components Specialties, Inc.  
PO Box 624  
1172 Rt. 109  
Lindenhurst, NY 11757  
(516) 957-8700, 800-645-5516, FAX#  
516-956-9142  
V.P./Sales: Mel Hulkower  
V.P./General Mgr.: Jim Ganci  
Sales Mgr.: Eric Forman  
Products: ceiling, columns, compact,  
components, custom, decorative,  
flush-mount, foreground, full-range ,  
high-frequency drivers, high-power,  
horns, low-frequency drivers, music  
system speakers, outdoor, PA horns,  
paging horns, paging, sub-woofer

Spectra Sonics  
3750 Airport Rd.  
Ogden, UT 84405  
(801) 392-7531  
Pres./Owner: William G. Dilley  
Engineer/Sales: Gregory D. Dilley  
William Watkins, Merrick, NY, 516-  
546-5374

Sunn Musical Equipment Corporation  
1130 Columbia Street  
Brea, CA 92621  
(714) 990-0909, 800-854-6230, FAX#  
714-990-3986  
Pres.: Bill Schultz  
Director of Mkt'g: Joe Green  
Products: full-range , high-frequency  
drivers, horns, low-frequency drivers,  
music system speakers, outdoor, PA  
horns, portable, stage monitors

### TOA ELECTRONICS, ENGINEERED SOUND & COMMUNICATIONS DIVISION

PO Box 2047  
601 Gateway Boulevard  
South San Francisco, CA 94080  
(415) 588-2538, 800-843-4750, in CA  
800-632-2157, FAX# 415-588-3349  
Pres.: Yoshiro Ishida  
Director of Mkt'g: Fred Fredericks  
Nat'l Sales Mgr.: Richard Krochmal  
Nat'l Sales Mgr./Engineered Intercom &  
Security Div.: Al Burns  
Products: ceiling, compact,  
components, foreground, full-range ,  
high-frequency drivers, high-power,  
horns, low-frequency drivers, multi-  
way/high-powered, PA horns, paging  
horns, stage monitors,  
studio/reference monitors, subwoofer

---

**TANNOY**<sup>®</sup>  
The Name for Loudspeakers

TANNOY NORTH AMERICA INC.  
300 Gage Ave., Unit 1  
Kitchener, Ont., Canada N2M 2C8  
519/745-1158  
Telex 069-55328  
Fax #519-745-2364

The message needs to be clear. Whether it is delivered by the singers in the choir, the gentle voices of the flutes in the orchestra, the crisp, clean notes of the piano or the spoken word. And the message must be just as clear in the back row of the balcony as it is in the front, without being loud, harsh or irritating. Tannoy loudspeakers possess a significant advantage. Their unique, world-renowned Dual Concentric drive units deliver sound which is smooth, pleasant and musical. Great sound makes all the difference in the world. And Tannoy is making that difference for the people at World Harvest Church, Bethany World Prayer Centers, Jimmy Swaggert Ministries and countless others worldwide. For natural, transparent sound reinforcement, from a whisper to a joyful noise — Tannoy.

FAITH COMES BY  
HEARING



# Get Loud & Low Without Getting Big & Nasty

## Celestion SR System

Until we introduced the SR sound reinforcement system, "professional" meant loudspeakers that delivered more reinforcement than sound. Phase distortion, coloration and uneven dispersion were accepted as unpleasant but unavoidable facts of life.

SR changed all that. Celestion engineers have achieved breakthroughs in driver design, system protection and cabinet materials. The result is an unprecedented combination: Ruggedness, reliability, room-filling power—and transparently natural, thoroughly lifelike reproduction. It's a difference that's immediately apparent to knowledgeable ears.

SR components combine in fully integrated systems that can handle almost any application, easily, unobtrusively and *muscially*.

---

Imagine stage monitoring, disco and restaurant systems that combine earth-shaking power with *audiophile* reproduction. Now audition the SR system—and discover that reality can surpass your imagination.

---

The SRC-1 System Controller provides complete thermal, electrical and mechanical speaker protection along with crossover functions and active equalization.



Celestion SR. Some call it hi-fi, only louder. Whatever you call it, it's what sound reinforcement should be. Contact your Celestion dealer for full information and specifications.

# CELESTION

89 Doug Brown Way, Holliston, MA 01746 (617) 429-6706



The compact SR-1 approaches the theoretical ideal of point source reproduction, with a single cone/dome driver that covers the full frequency range from 50 Hz–20 kHz. Uniform dispersion at all frequencies makes full coverage easy at any volume level. Power handling conservatively rated at 500 watts/side. Compact SR cabinets are built of a virtually indestructible, ultrarigid high density polymer and designed for hanging, stacking, stand mounting or floor use.

The optional SR-2 subwoofer with 18" driver delivers maximum LF impact, with power handling of 1000 watts/side and a 3 dB down point of 40 Hz. The unique cabinet design is rugged, rigid, compact and unobtrusive.

**TANNOY**

Tannoy North America, Inc.  
 300 Gage Ave, Unit 1  
 Kitchener, Ontario, Canada N2M 2C8  
 (519) 745-1158, FAX# 519-745-2364  
 Managing Director: Wib Heuckroth  
 Sales/Mkt'g Mgr.: Bill Calma  
 Credit Mgr.: Kathy Kent  
 Sales: Rob Hofkamp  
 Parts/Svce Mgr.: Ivan Frivarski  
 Audio Assoc., Glenwood, MD, 301-854-6122  
 Hot House Productions, Highland, NY, 914-691-6077  
 Disc Mastering, Nashville, TN, 615-254-8825  
 Technical Marketing, Atlanta, GA, 404-457-0988  
 The TK Group, Loveland, CO, 801-298-8902  
 World Wide Electronics, Pembroke Pines, FL, 305-966-6622

Protech Marketing, Newport Beach, CA, 714-723-0498  
 Powerlines Marketing, Evanston, IL, 312-864-1147  
 Blackhawk Marketing, Pacific Palisades, CA, 213-454-8196  
 JMS Marketing, Austin, TX, 512-266-1113  
 Bob White & Assoc., Solon, OH, 216-248-1317  
 Pro Musica Sales, Keene, NH, 603-352-4831  
 Products: ceiling, components, custom, decorative, environment protected, flush-mount, foreground, full-range, portable, stage monitors, studio/reference monitors, sub-woofer, systems

Technical Audio Devices (TAD) Pioneer Electronics (USA), Inc.  
 2265 E. 220th St.  
 Long Beach, CA 90810  
 (213) 835-6177  
 V.P. Mkt'g: Mike Fidler

Sr. Mgr. Product Planning: Mark Makabe  
 Market Planner: Deanna Lee

**3M SOUND PRODUCTS**

223-5S-09, 3M Center  
 St. Paul, MI 55144-1000  
 (612) 733-9214, FAX# 612-736-9433  
 Mkt'g Mgr.: Richard G. Barker  
 Sales Mgr.: Don Sluder  
 Products: ceiling, decorative, foreground, full-range, music system speakers, outdoor, PA horns, paging horns

**Turbosound, Inc.**

611 Broadway, #841  
 New York, NY 10012  
 (212) 460-9940, FAX# 212-460-9947  
 Pres.: Alan Wick  
 V. P. Sales/Mkt'g: Dan Abelson  
 V. P. Electronic Prod.: Dave Talbot  
 Applications Engineer: Tim Kalliches  
 Western Audio Sales, Glendale, CA, 818-246-3806  
 Applied Audio Marketing, Asheville, NC, 704-252-9313

**"I CAN UNDERSTAND WHAT'S BEING SAID!"**

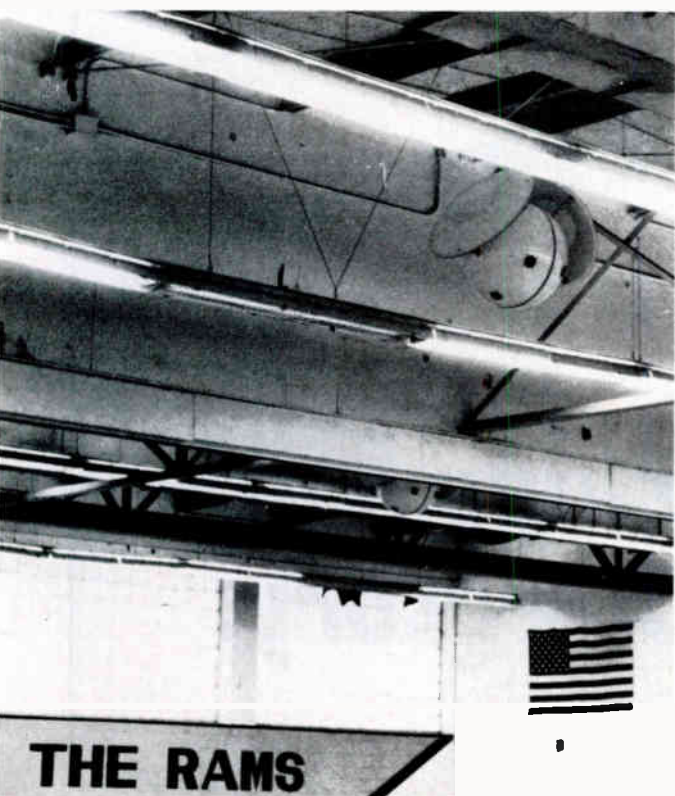

After the installation at Taylor Center High School Gym of a new sound system with two #2715 Soundsphere speakers and various electronics, Dave Hill, of Comcast in Warren, MI, received the comment, which speaks for itself "Great full sound!" Robert Haarala, Principal has told Tina Merwin, President of the Class of '85 that the system, partially paid for by the class, is "fantastic!"

Dave Hill also comments, "Recently, I received a call from another high school sports booster club asking Comcast to visit their school and tell them how their gym could be made to sound as good as the one at Taylor Center." Dave continues, "It's always a pleasure to receive compliments, but better yet to get referrals from customers."

Write or call direct for further information.  
**SOUNDSPHERE** A PRODUCT OF SONIC SYSTEMS, INC.  
 737 Canal Street • Bldg 23B • Stamford, CT 06902 • USA • Tel (203) 356-1136

Looking for a wireless microphone, or wondering who's the best person to talk to about a company's podium microphones?



**You'll find the answers in the**

**1988-  
1989**

***Sound &  
Communications  
Blue Book Directory.***

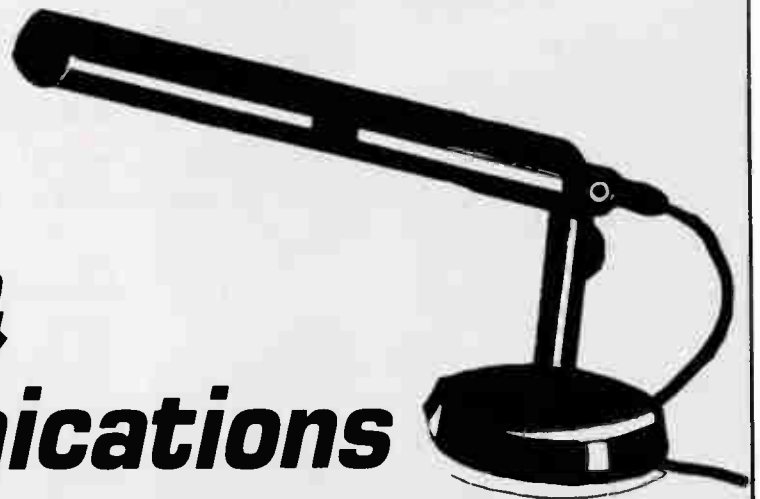



Michael Chafee Assoc., Sarasota, FL,  
813-921-4294  
Tenicki and Assoc., Houston, TX, 713-  
528-2005  
Audio Assoc., Baltimore, MD, 301-854-  
6122  
Northmar, Seattle, WA, 206-524-5170  
Steffey Marketing, Northbrook, IL, 312-  
480-3575  
Jamm Distributing, Matteson, IL, 312-  
747-6363  
AMH Sales, Denver, CO, 303-429-2203  
Products: full-range, multi-way/high-  
powered, portable, stage monitors,  
sub-woofer, systems

**UNIVERSITY SOUND, ELECTRO VOICE,  
INC.**

600 Cecil St  
Buchanan, MI 49107  
(616) 695-6831  
Pres.: Robert D. Pabst  
V.P. Sales and Mkt'g: Paul McGuire  
Chief Engineer: Alan Watson  
Mkt'g Mgr./Comm. Products: W.  
Douglas Wilkens

George M. Conneen Co., Inc.,  
Springfield, PA, 215-544-5884  
Metropolis Audio Marketing, Inc.,  
Edison, NJ, 201-225-0085  
R.J. Marketing Ltd., Rockville, MD,  
301-251-0330  
The Smith Company, Hartford, CT,  
203-523-0512  
Ron Tunks Sales, Inc., Tamarac, FL,  
305-722-2803  
Wilson Audio Sales, Nashville, TN, 615-  
646-4477  
Audio Resources, Westmont, IL, 312-  
655-1180  
B.C. Electronic Sales, Inc., Mission,  
KS, 913-262-1720  
Jones Audio Sales, Plano, TX, 214-  
867-0202  
C.L. Pugh & Assoc., Inc., Columbus,  
OH, 614-486-9678  
Riley & Petchell Sales, Inc., Detroit, MI,  
313-937-3000  
Loppnow & Assoc., Redmond, WA,  
206-883-3205  
Radon & Assoc., Sacramento, CA,  
916-923-2524

Silver Peak Marketing Ltd., Wheat  
Ridge, CO, 303-467-9042  
Western Audio Sales, Glendale, CA,  
818-246-3806  
Products: ceiling, columns, compact,  
components, environment protected,

**UREI**

8500 Balboa Blvd.  
Northridge, CA 91329  
(818) 893-8411, FAX# 818-893-3639  
Pres.: Ron Means  
V.P. Sales: Ken Lopez  
V.P. Mkt'g: Mark Gander  
Applications Engineer: Drew Daniels  
Mkt'g Mgr. Sound Contracting: Steve  
Romeo  
Neil Conly, Bedford, TX, 817-540-3066  
Bill Hamilton, Folsom, PA, 215-543-  
4677  
Steve Armstrong, Northridge, CA, 818-  
707-2529  
Tom Walter, Barrington, IL, 312-382-  
4925  
Products: studio/reference monitors

**A · E · S · T · H · E · T · I · C · S**

The new CSV Series speaker systems by Community complements the decor of the most discriminating contemporary commercial environment. CSV sound systems and floor monitors' built-in dynamic protection circuitry assures high reliability. Our simplified brackets guarantee ease of installation and offer the system designer a wide choice of mounting options. Also available are visually identical, specification-equivalent, optimally vented low frequency enclosures.

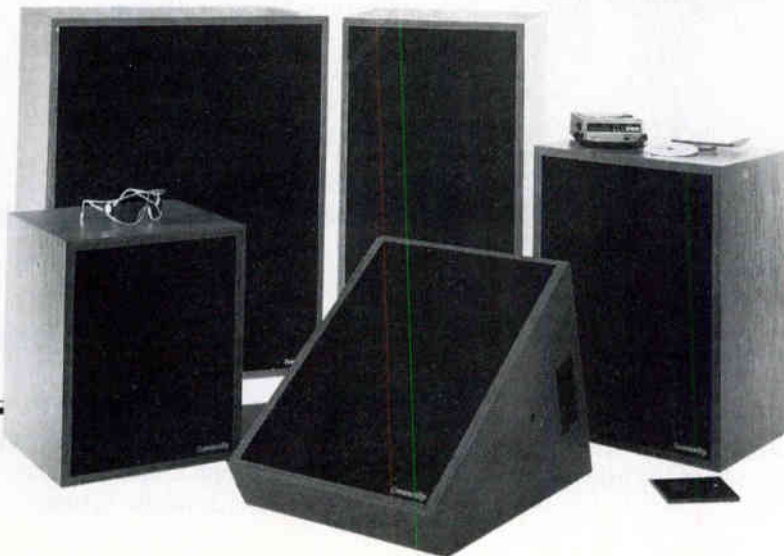

**Community Light & Sound, Inc.**  
333 East 5th Street  
Chester, PA 19013  
(215) 876-3400  
tlx 834649 PhillyPA Cher

explosion-proof, flush-mount, full-range, high-frequency drivers, high-power, horns, low-frequency drivers, mid-bass, music system speakers, outdoor, PA horns, paging horns, paging, portable, sub-woofer, surface-mount, systems, tweeters, underwater, voice communications

Valcom, Inc.  
1111 Industry Ave.  
Roanoke, VA 24013  
(703) 982-3900  
Mkt'g: Donald Buck

Products: talkback, voice communications

Waldom Electronics, Inc.  
4301 West 69th Street  
Chicago, IL 60629  
(312) 585-1212, FAX# 312-585-7847  
Pres.: Mario C. Vescovi  
Product Mgr.: Mark A. Baumann  
Promotion Mgr.: Andrew J. Placco  
Products: components, full-range, high-frequency drivers, horns, low-frequency drivers, mid-bass, music system speakers, tweeters

Westlake Audio, Inc./Professional Products MFG Group  
2696 Lavery Court, #18  
Newbury Park, CA 91320  
(805) 499-3686, FAX# 805-498-2571

David Wexler & Co.  
3553 W. Peterson Ave.  
Chicago, IL 60659  
(312) 478-9800, FAX# 312-478-9095  
Pres.: B.R. Wexler  
V.P.: David Wexler  
Mkt'g: Joan Morris  
Products: ceiling, columns, compact, custom, environment protected, explosion-proof, flush-mount, full-range, high-frequency drivers, high-power, horns, low-frequency drivers, mid-bass, multi-way/high-powered, music system speakers, outdoor, PA horns, paging horns, paging, portable, powered, stage monitors, studio/reference monitors, sub-woofer, surface-mount, systems, talkback, tweeters, underwater, voice communications

Wheelock, Inc.  
273 Branchport Ave.  
Long Branch, NJ 07740  
(201) 222-6880, FAX# 201-222-8707  
Pres.: P. W. Tarlton  
V.P. Mkt'g/Sales: W.L. Goldstein  
Mkt'g Mgr./Telephone-Paging: Art Arlow  
Tech. Support Engineer: W. Best  
Products: ceiling, columns, music system speakers, omni-directional, outdoor, paging, talkback, voice communications

Workman Electronic Products  
PO Box 3828  
75 Packinghouse Rd.  
Sarasota, FL 33578  
(813) 371-4242

**PROFESSIONAL AUDIO DIVISION,  
YAMAHA MUSIC CORPORATION, USA**  
PO Box 6600  
6600 Orangethorpe Ave.  
Buena Park, CA 90622  
(714) 522-9011, FAX# 714-739-2680  
Products: compact, decorative, full-range, multi-way/high-powered, music system speakers, powered, stage monitors, studio/reference monitors, sub-woofer, systems



Sonic builds a wide ranging line of speaker systems for sound reinforcement, guitar, bass, keyboard, and DJ applications. Featured are components from EV, Celestion, and RCF in addition to our own Nitro cast frame speakers and proprietary horns. A generous extra discount program combines with low cost UPS freight on more than half of our line to help you generate additional profit dollars. Write or call for your free dealer information kit today.

## SONIC INC.

3383 E. Layton Avenue Cudahy, WI 53110 (414) 483-5091



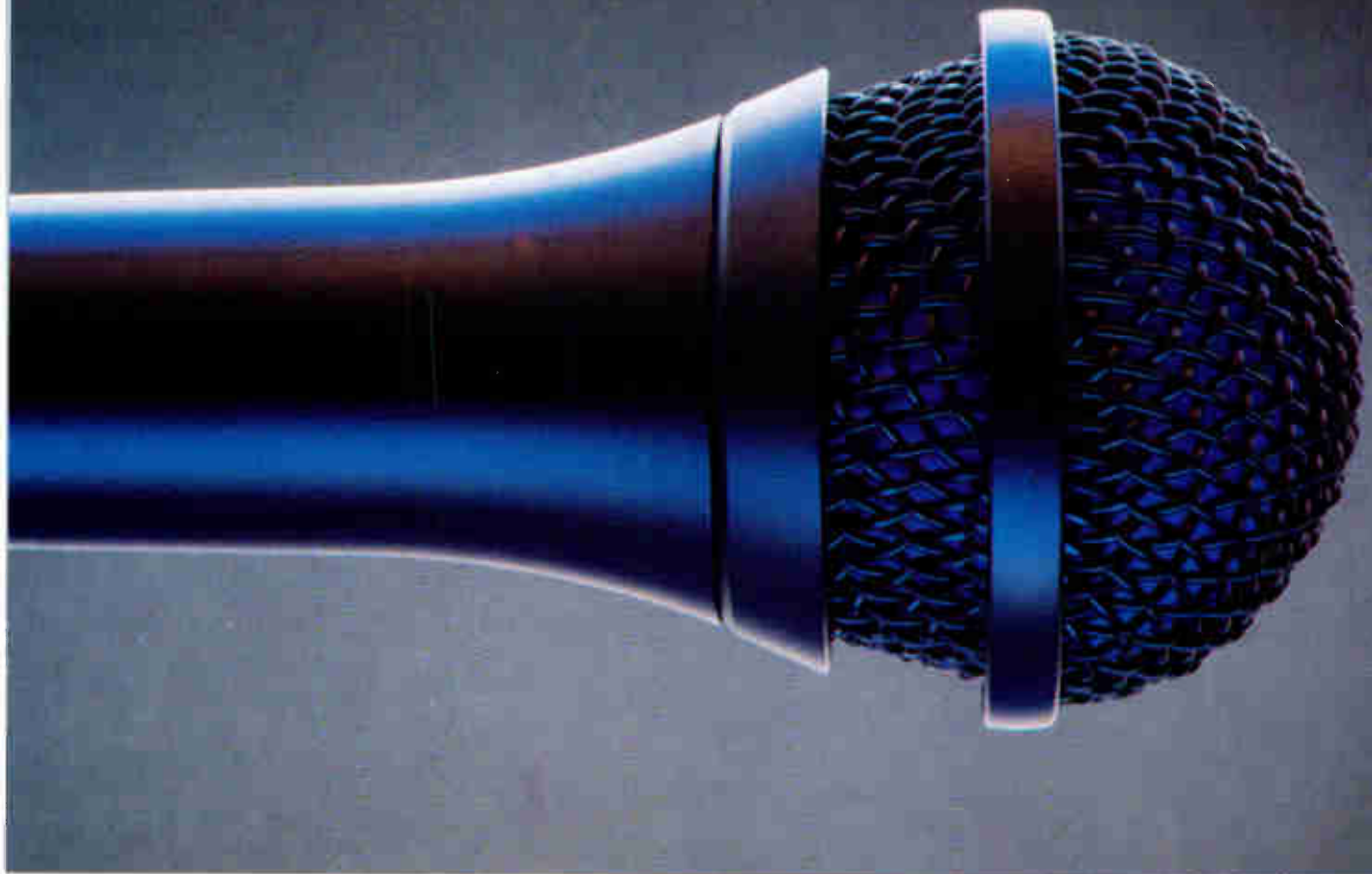

Crown CM-300 Differoid®

# Wondering what kind of shape microphone technology is in?

The **CM-300 Differoid®** hand held microphone sets a new standard for Gain-Before-Feedback. Absolutely.

Bringing vocals out of extensive background noise has been one of the most difficult and often nearly impossible tasks in the sound reinforcement business. The **CM-300** solves this problem — as well as others, with the kind of reliability you've come to expect from Crown.

Excellent Gain-Before-Feedback and impressive distant sound rejection for greater microphone isolation — better control of the mix, even under extremely high monitor levels.

To fully appreciate the unique capabilities of the **CM-300** visit your Crown dealer for a demonstration.



The **CM-200 Cardioid**. Smooth and articulate sound - versatile in application. For vocals or instruments it's a rugged performer with capabilities unique to the CM Series line. The bottom line: the **CM-200** just sounds great.



The **CM-100 Omnidirectional**. As a close-up microphone, this hand held **PZM®** maintains a natural sound with extreme clarity and no bass boost. Ideal for vocals and instruments and as reliable as the Crown name itself.

CM Series microphones are designed for studio or field use. Each has pop filtering to suppress breath noises, the ability to handle incredibly high SPLs without distortion and a balanced, low impedance output - allowing long cable runs without hum or high frequency signal loss.

Equally important to how well they work is how long they work; built to withstand hard use and backed by the best warranty in the industry.

Taking innovation one step further Crown introduces the **CM SELECT Series** — combining all the performance characteristics of the CM Series with the special feel and elegance of a solid wood handle. Red Oak, Claro Walnut, Ziricote, Russian Birch, Coco Bola.

It's obvious microphone technology is in great shape at Crown.



**CROWN**

INTERNATIONAL, INC.

1718 WEST MISHAWAKA ROAD, ELKHART, INDIANA 46517



# MICROPHONES

## MICROPHONES

ACO Pacific, Inc.  
2604 Read Ave.  
Belmont, CA 94002  
(415) 595-8588, FAX# 415-591-2891  
Pres.: Noland L. Lewis

AKG Acoustics, Inc.  
77 Selleck St  
Stamford, CT 06902  
(203) 348-2121, 800-243-7885, FAX#  
203-324-1947  
Pres.: S. Richard Ravich  
V.P./Operations: Derek Pilkington  
V.P./Finance: Robert Netter  
Tech Sls Coordinator: Timothy  
Derwallis  
Products: boundary, communications,  
condenser, contact pickups,  
dynamic, electret condenser,  
goosenecks, hand-held, headset  
boom, miniature, podium, push-to-  
talk, shotgun, specialty, stands,  
stereo

AMS/Calrec (AMS Industries, Inc.)  
PO Box 31864  
3827 Stone Way N.  
Seattle, WA 98103  
(206) 633-1956, FAX# 206-547-6890  
Mkt'g Director: Nigel Branwell  
Service Mgr.: Graham Murray  
Credit Mgr.: Kathleen Mallory  
Products: condenser, instrumentation,  
specialty, stereo

Accusonics Systems Corp.  
2101 Jericho Turnpike  
New Hyde Park, NY 11040  
(516) 328-3300  
General Mgr.: Dennis Goodman  
Products: communications

Astatic/CTI  
Harbor & Jackson  
Conneaut, OH 44030  
(216) 593-1111, 800-421-3161, FAX#  
216-593-5395  
Pres.: Larry Phillips  
Nat'l Sales Mgr.: Jim Edwards

Director of Mkt'g: Jim Edwards  
OEM Sales Mgr.: Ronald L. Ebersole  
Products: communications, condenser,  
dynamic, electret condenser,  
goosenecks, hand-held, headset  
boom, miniature, podium, push-to-  
talk, specialty, stands

Audio Engineering Associates  
1029 N. Allen Ave.  
Pasadena, CA 91104  
(213) 684-4461, FAX# 818-798-2378

Audio-Technica U.S., Inc.  
1221 Commerce Drive  
Stow, OH 44224  
(216) 686-2600, FAX# 216-688-3752  
Pres.: Jon R. Kelly  
Nat'l Sales Mgr.: Mike Wuellner  
Mkt'g Mgr./Pro Products: Greg Silsby  
Sr. Transducer Engineer: Bob Herrold  
Products: boundary, condenser,  
dynamic, electret condenser,  
goosenecks, hand-held, headset  
boom, miniature, podium, shotgun,  
specialty

Auditel Systems, Ltd.  
396 Porter Ave.  
Buffalo, NY 14201  
(716) 886-0019, FAX# 716-886-1615  
Pres.: David Langtry  
Prod. Mgr.: Tony Roberson  
Mkt'g Director: Jim Wood  
Products: condenser, dynamic, electret  
condenser, goosenecks, hand-held,  
headset boom, podium, specialty

Audix  
5635 W. Las Positas  
Pleasanton, CA 94566  
(415) 463-1112, 800-888-9992, FAX#  
415-463-2149  
V.P. Sales: Cliff Castle  
Nat'l Sales Mgr.: Michael Liebener  
Products: condenser, dynamic, electret  
condenser, goosenecks, hand-held,  
instrumentation, miniature, podium,  
shotgun, specialty, stereo

Barcus-Berry, Inc.  
5381 Production Drive  
Huntington Beach, CA 92649  
(714) 898-9211, 800-854-6481, FAX#  
714-898-7962  
Pres.: L.M. Barcus  
Exec. V.P.: John Berry  
John B. Anthony Co., Stamford, CT,  
203-322-9202  
McFadden Sales & Marketing,  
Columbus, OH, 614-761-3177  
New Horizons Electronics,  
Bannockburn, IL, 312-234-5911  
MetroRep Sales, Freehold, NJ, 201-  
462-1221  
Ron Tunk Sales, Tamarac, FL, 305-  
722-2803  
Products: condenser, contact pickups

Beyer Dynamic, Inc.  
5-05 Burns Ave  
Hicksville, NY 11801  
(516) 935-8000, FAX# 516-935-8018  
V.P./General Mgr.: Paul Murphy  
Mkt'g Mgr.: Mike Solomon  
Products: boundary, communications,  
condenser, dynamic, electret  
condenser, goosenecks, hand-held,  
headset boom, instrumentation,  
miniature, podium, push-to-talk,  
ribbon, shotgun, specialty, stands

Bogen Communications, Inc.  
PO Box 575  
50 Spring St.  
Ramsey, NJ 07446  
(201) 934-8500, FAX# 201-934-9832  
Pres.: John H. Ochtera  
V.P. Sales/Sound Prod.: David A.  
Chambers  
V.P. Sales/Telecomm. Prod.: Charles  
Ferreri  
Bruce Barrett, Garland, TX, 214-530-  
0467  
Kingston Sales Corp., Indianapolis, IN,  
317-876-2545  
Kevin Koehler, Batavia, IL, 312-879-6871  
Tim McDonnell, Willoughby Hills, OH,  
216-942-2429

**We have many competitors. But no competition.**



© 1997 Sennheiser Electronic Corporation (N.Y.)

Sennheiser Electronic Corporation, 6 Vists Drive, P.O. Box 987, Old Lyme, CT. 06371 (203) 434-9190 Manufacturing Plant: D-3002 Wedemark, West Germany  
**PROFESSIONAL MICROPHONES • HEADPHONES • WIRELESS MICROPHONES • INFRA-RED SYSTEMS**

Steve McGrew, Kennesaw, GA, 404-422-4608

Meyer Mkt'g, Inc., Deerfield Beach, FL, 305-481-9250

W.B. Pray Sales, Inc., Northboro, MA, 617-393-3434

Jay Sample, Sandy, UT, 801-942-1059  
Scott Sampson, Encino, CA, 818-996-5484

Mike Schneider, Baltimore, MD, 301-563-5390

Walt Spencer, Ramsey, NJ, 201-934-8500

White Radio Ltd., Burlington, ONT, Canada, 416-632-6894

Roburn Agencies, Inc., Yonkers, NY, 914-968-1016

Products: dynamic, push-to-talk

Bruel & Kjaer Instruments, Inc.  
185 Forest St.

Marlborough, MA 01752  
(617) 481-7000, FAX# 508-485-0519  
Studio Mics/Mgr.: Adrian Weidman  
Bruel & Kjaer, Livonia, MI, 313-522-8600

Bruel & Kjaer, Hoffman Estates, IL, 312-358-7582

Bruel & Kjaer, Anaheim, CA, 714-978-8066

Bruel & Kjaer, Marietta, GA, 404-422-5200

Bruel & Kjaer, West Caldwell, NJ, 201-227-6100

Products: condenser

C-T Audio Marketing, Inc.

South Tech Industrial Plaza, 3050 SW 14th Place, Suite 3  
Boynton Beach, FL 33426  
(407) 738-0622, 800-CT-AUDIO  
Pres.: Andre Walton  
Products: contact pickups

Clarity, A Division of Valcom, Inc.

1111 Industry Ave. SW  
Roanoke, VA 24013  
(703) 982-7003, 800-962-6009, FAX# 703-982-7032  
Products: electret condenser, goosenecks, hand-held, push-to-talk

Coherent Communications, Inc.

13756 Glenoaks Blvd.  
Sylmar, CA 91342  
(818) 362-9393, FAX# 818-362-7045  
Products: electret condenser

Countryman Associates, Inc.

417 Stanford Ave.  
Redwood City, CA 94063  
(415) 364-9988, FAX# 415-364-2794

Crown International, Inc.

1718 W. Mishawaka Road  
Elkhart, IN 46517  
(219) 294-8000, FAX# 219-294-8329  
Pres./CEO: Mr. Clyde Moore  
Mgr. Mkt'g Svcs: Dave McLaughlin  
Director of P.R./Adv.: Margo Sousley  
Sales Mgr.: Jim Beattie  
Microphone Prod. Dir.: Bill Raventos  
Amplifier Prod. Dir.: Verne Searer  
Products: boundary, communications, condenser, contact pickups, electret condenser, goosenecks, hand-held, headset boom, instrumentation, miniature, podium, specialty

J. W. DAVIS & CO.

PO Box 26177  
3030 Canton Street  
Dallas, TX 75226

## Half-Rack Mic Preamp Marvel

The Stewart Electronics MP-2 gives you more features and greater performance than other units costing twice as much. Bar none. And, it does it in a space saving half-rack design.

The MP-2 features: 3-band active EQ with sweepable mid; +48v phantom power; switchable output levels (-10, +4, +8); clip indicator; phase inversion switch; switchable low cut filter; EQ defeat switch; and a summing input which allows the signal from other equipment to be combined with the MP-2's balanced and unbalanced outputs.

The specs are as impressive as the features: 10Hz to 70kHz frequency response; -128dB S/N at max output; distortion .009%; max output +24dB; max gain +78dB.

Like all Stewart Electronics products, the MP-2 is reliable. This is simply the highest quality, best priced microphone preamplifier you can use for direct to tape, or any other professional application.

# Stewart

ELECTRONICS

11460 Sunrise Gold Circle  
Rancho Cordova, CA 95742  
(916) 635-3011



Designed and manufactured in the U.S.A.  
© 1988 Stewart Electronics.



# Introducing the New Generation of Wireless Microphones from HME.



## All New RF Link. All New Switching Diversity. All New Packaging. And Unbeatable Sound.

HME's new Series 50 is so advanced that anything else is a compromise.

Here's just a few highlights:

A completely new RF link greatly improves the capture ratio for dropout-free performance under the most demanding conditions. Our new state-of-the-art noise-free switching diversity system has broken the price/performance barrier.

There's a new, rugged ABS body on the hand-held models, along with an advanced internal antenna with superb radiation characteristics. The new dual-frequency body pacs give you top

performance under physical as well as electrical abuse.

HME's new NRX II™ noise reduction system has to be heard to be believed. It's the only noise reduction system designed *expressly* for wireless microphones. And it's available only in HME's New Generation Series 50, both hand-held and body pac.

See your HME dealer for the final shock:

You'll find HME's Series 50 price *below* every other professional system. That's because we're sure every thinking professional will standardize on it.

And why not. There's nothing even close.



**HM ELECTRONICS, INC.**

6675 Mesa Ridge Road  
San Diego, CA 92121, USA  
Phone: (619) 535-6060  
FAX: 619-452-7207

**HME's New Series 50 Wireless Microphone—with NRX II™**

## No Equal. Nothing Close.

HME Products are distributed internationally  
IN CANADA—GERRAUDIO Distribution Inc. • PH (416) 868 0528 FAX 416-866-6419  
IN CENTRAL AND SOUTH AMERICA—Servicios Electronicos Especializados • PH (905) 544 1345 FAX 905-545 6509  
All other Countries—Gexco International • PH (201) 688-0100 FAX 201-688-2336

(214) 651-7341, 800-527-5705, in TX  
800-442-1564, FAX# 214-939-0328  
Pres.: Charles Griffith  
V.P. Sales: Jack W. Tucker  
Chief Engineer: Mike Lamm  
Products: dynamic, hand-held

Electro-Voice, Inc.  
600 Cecil Street  
Buchanan, MI 49107  
(616) 695-6831, 800-527-6701, FAX#  
616-695-1304  
Pres.: Robert D. Pabst  
V.P. Sales & Mkt'g: Paul McGuire  
Director of Mkt'g: Jim Long  
Chief Engineer: Earl Harris  
George M. Conneen Co., Inc.,  
Springfield, PA, 215-544-5884  
Metropolis Audio Marketing, Inc.,  
Edison, NJ, 201-225-0085  
R.J. Marketing Ltd., Rockville, MD,  
301-251-0330  
The Smith Company, Hartford, CT,  
203-523-0512  
Ron Tunks Sales, Inc., Tamarac, FL,  
305-722-2803

Wilson Audio Sales, Nashville, TN, 615-  
646-4477  
Audio Resources, Westmont, IL, 312-  
655-1180  
B.C. Electronic Sales, Inc., Mission,  
KS, 913-262-1720  
Jones Audio Sales, Plano, TX, 214-  
867-0202  
C.L. Pugh & Assoc., Inc., Columbus,  
OH, 614-486-9678  
Riley & Petchell Sales, Inc., Detroit, MI,  
313-937-300  
Loppnow & Assoc., Redmond, WA,  
206-883-3205  
Radon & Assoc., Sacramento, CA,  
916-923-2524  
Silver Peak Marketing Ltd., Wheat  
Ridge, CO, 303-467-9042  
Western Audio Sales, Glendale, CA,  
818-246-3806 x  
Products: carbon, communications,  
condenser, dynamic, electret  
condenser, goosenecks, hand-held,  
headset boom, podium, push-to-talk,  
shotgun, stands

**ELENEX, INC. (EAST)**  
7 Wayland St.  
N. Cohocton, NY 14868  
(716) 534-5280, 800-356-8433, FAX#  
716-534-5950  
Pres.: Sten Persson  
Product Mgr.: Dave Arseneau  
Sales: Geoffrey Spencer  
Products: communications, push-to-  
talk, specialty

Fostex Corp. of America  
15431 Blackburn Ave.  
Norwalk, CA 90650  
(213) 921-1112, FAX# 213-802-1964  
Pres.: Y. Abe  
Exec. V.P./General Mgr.: Fred Huang  
V.P. Sales/Mkt'g: Mark Cohen  
Products: dynamic, electret condenser,  
stereo

Gotham Audio Corp.  
1790 Broadway, 8th floor  
New York, NY 10019-1412  
(212) 765-3410  
Pres.: Russ O. Hamm  
Eastern Sales Mgr.: Jerry Graham

## DON'T STAND FOR ANYTHING LESS.

For years podium microphones have suffered from a number of problems inherent to their design. The old goosenecks became one of two things; too stiff — accompanied by an unnerving racket, faithfully amplified during each



Sophisticated high performance element design

adjustment, or too limp — they just wouldn't stay where you put them.

Crown engineers have long been frustrated with the same problems on podiums in their own town halls, school boards, places of worship, etc. They decided to address today's podium mike problems and created the new **LM-200 Series** microphone.



The **LM-200** features a unique ball-and-socket joint allowing infinite adjustment and smooth, quiet movement. Its rugged steel construction is typical of Crown quality and durability.

A sophisticated element design offers natural sound and excellent gain-before-feedback.

Unique ball-and-socket joint

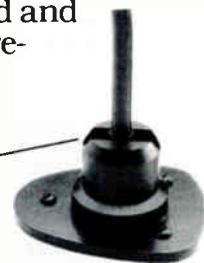

Elegant appearance, superior mechanical operation and high quality performance make the **LM-200** the obvious choice.

 **CROWN** INTERNATIONAL, INC.

1718 W. MISHAWAKA ROAD, ELKHART, INDIANA 46517

# How to make your best church sound systems disappear from sight!

Actual Size  
Model AT853 Unidirectional  
Condenser Choir Microphone

## Install Audio-Technica UniPoint® miniature studio-quality microphones

Every congregation deserves the best possible sound, whether at the service or listening to broadcasts or tape. Now you can install superior sound without bulky microphones and awkward microphone stands that intrude on the services.

### New Directional Choir Microphone

Audio-Technica engineers have broken new ground with our UniPoint design that delivers studio-quality sound from tiny, inconspicuous *directional* microphones. Our new choir microphone is so small and light that it can be suspended by its own slim cable, making it virtually invisible. Yet it offers controlled pickup of only the choir, sharply reducing room noise and reverberation.

### Directional models for altar, lectern, pulpit, plus lavaliers

Four other UniPoint models for use at the lectern or pulpit offer the same clarity, full range, and directional pickup control. Our comprehensive approach to church sound also includes a surface-mounted directional microphone that lies flat on altar, table, or floor. We round out the selection with directional lavalier microphones that solve acoustic problems other lavaliers can't handle. The entire line provides



Model AT871  
UniPlate Boundary Cardioid



Model AT857AM  
Podium Cardioid

full freedom of movement to the participants, yet the microphone is almost unseen.

### Better sound is now smaller, lighter, less visible

Whether your customer's sound system is solely for sound reinforcement, or is also used for radio/TV or tape recording of the service, UniPoint microphones improve the sound quality while remaining almost invisible.

### Our experts are ready to help

If you ever need help with specific installations – whether large or small – our Audio-Technica church sound experts are ready with answers to your most difficult problems. To watch your toughest church sound installation problems disappear, call or write us today.

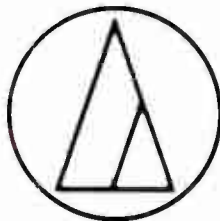

## audio-technica.

1221 Commerce Drive, Stow, OH 44224  
(216) 686-2600



Western Sales Mgr.: Juergen Wahl  
Sales Engineer: Peter Engel

(HME) HM Electronics, Inc.  
PO Box 261669  
6675 Mesa Ridge Rd.  
San Diego, CA 92121  
(619) 535-6060, FAX# 619-452-7207  
Pres.: Harry Y. Miyahira  
V.P.: Donald Kutz  
Director of Mkt'g: J. Michael Hughes  
Nat'l Sales Mgr.: Randy Opela  
Mkt'g Coordinator: Tonnia B. Sills

IQS, Inc.  
12812-J Garden Grove Blvd.  
Garden Grove, CA 92643  
(714) 539-7842, FAX# 714-556-8325  
Pres.: William Elder  
V. P.: Douglas Evered  
Products: instrumentation

International Music Co. (I. M. C.)  
PO Box 2344  
1316 E. Lancaster  
Ft. Worth, TX 76113-2344

(817) 336-5114, 800-433-5627, FAX#  
817-870-1271

Chairman of the Bd./CEO: Tommy Moore  
Pres.: Jerry Freed  
V.P. Sales: C.H. Murray  
Dir. of Akai EMI: Mike McRoberts  
Akai Prod. Specialist: Kevin Kennedy

Knowles Electronics, Inc.  
3100 N. Mannheim Rd.  
Franklin Park, IL 60131  
(312) 455-3600

Milab/ Exp  
11288 Ventura Boulevard, Suite 304  
Studio City, CA 91604  
(818) 843-1830  
Nat'l Sales Mgr.: Colin Waters  
Mkt'g: Susan Tesh  
Product Mgr.: Kurt Wolfgang

Milliphonics  
Salina Star Route, Logan Mill Road  
Boulder, CO 80302  
(303) 444-3167

The Music People, Inc.  
PO Box 648  
West Hartford, CT 06107  
(203) 521-2248, 800-289-8889, FAX#  
203-521-2428  
Pres.: James R. Hennessey  
Director of Sales: Earl "Buzz" Goodwin  
Comptroller: John Gutowski  
Purchasing Mgr.: Robert Murray  
Publicity/Promotion: Lisa Radefeld

Numark Electronics  
503 Newfield Ave.  
Edison, NJ 08837  
(201) 225-3222, FAX# 201-287-2155  
Pres.: Harry Kotovsky  
V.P.: Robert Kotovsky  
Numark/PPD, Simi Valley, CA, 805-  
522-3550

Panasonic Industrial Company/Ramsa  
6550 Katella Ave  
Cypress, CA 90630  
(714) 895-7278, FAX# 714-895-7242  
Nat'l Sales/Mkt'g: Steve Wooley  
Eastern Sales Mgr.: D.J. Bierut  
Central Sales Mgr.: Greg Braithwaite  
Western Sales Mgr.: James Murray  
Pusecker Sales, Upper Montclair, NJ,  
201-744-1834

Professional Audio Associates,  
Burlington, MA, 617-229-6050  
David Prinzi, Webster, NY, 716-671-  
9266

World Wide Electronics, Pembroke  
Pines, FL, 305-584-7024  
World Wide Electronics, Jacksonville,  
FL

Evans Sales & Mkt'g, Nashville, TN,  
615-297-7997  
A/V Mkt'g, Carmel, IN, 317-846-1034  
Key Mkt'g, Plymouth, MI, 313-459-  
6040

New Horizons Elec. Mkt'g,  
Bannockburn, IL, 312-234-5911  
J.B. Parent Co., Dublin, OH, 614-764-  
0064

Music Interventions & Assoc., Kansas  
City, MO, 816-453-4448  
Tenicki & Assoc., Houston, TX, 713-  
528-2005

New West Audio, Burbank, CA, 818-  
955-9706

Brian Trankle Assoc., Belmont, CA,  
415-595-4004

Brian Trankle Assoc., Sacramento, CA,  
916-369-7030

## Performance impressive enough to change a sound pro's old habits.

# SURPRISING!

**Telex TE10 and TD13** sound reinforcement mics are making believers out of sound pros who have been automatically specifying the same microphone for years. These new low mass design condensers (TE10) and high output dynamics (TD13) are meeting the demands of even the toughest pros while at the same time providing unexpected savings. Surprise yourself. For detailed information write Telex Communications, Inc.,

9600 Aldrich Avenue So.,  
Minneapolis, MN 55420.



Controlled frequency response  
on TD13 dynamic enhances vocals

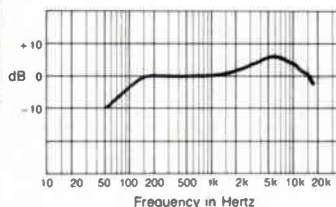

Wide, flat, studio quality  
frequency response for TE10 condenser

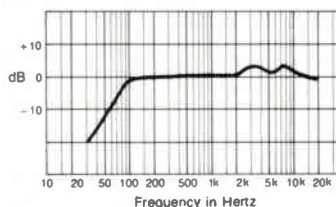

**TELEX**  
TELEX COMMUNICATIONS, INC.

# The wireless mic you asked for.



## True-diversity systems with the professional quality you expect from Cetec Vega, at unusually attractive prices.

**PRO 2 Series** Cetec Vega's PRO 2 dual-receiver true-diversity wireless-microphone systems are far superior to phase-diversity and all other diversity systems for eliminating dropouts caused by multipath (reflected-signal) conditions. Configured around the technically advanced Model R-32 true-diversity wireless receiver, the systems are extremely reliable and provide crisp, clean, clear, solid audio.

The ruggedly constructed R-32 diversity receiver features Cetec Vega's advanced DYNEX II audio-processing system for superior signal-to-noise ratio and widest dynamic range.

A PRO 2 true-diversity wireless system, built with typical Cetec Vega professional quality, normally would be expected to cost more than other systems. However, through innovative

design and advanced manufacturing techniques, the systems are available at unusually attractive prices.

Contact your Cetec Vega dealer (or factory representative) for more information.

All Cetec Vega products are made with pride in the USA

### PRO 1 Series . . .



... for applications not requiring diversity. Configured around the Model R-31B receiver.

 **Cetec Vega**

Division of Cetec Corporation

9900 Baldwin Place  
El Monte, California 91731-2204  
Telephone: (818) 442-0782  
Toll-free: 800-877-1771  
Telex #: 910-587-3539  
FAX: (818) 444-1342

- Northmar, Seattle, WA, 206-524-5170  
 Pearson & Pearson, Denver, CO, 303-722-6996  
 Products: electret condenser, headset boom, miniature, specialty
- Paso Sound Products  
 14 First St.  
 Pelham, NY 10803-1495  
 (914) 738-4800, FAX# 914-738-3954  
 Executive V.P.: Paul Mastrangelo  
 Sales Mgr.: David Moore  
 Product Mgr.: Ken Obrien  
 Credit Mgr.: Marilyn Beckerson  
 Operations Mgr.: Anthony Sgueglia  
 All West Electronics, Camarillo, CA, 805-388-1789  
 Anderson Sales, Braintree, MA, 617-848-9194  
 Pace Sales, Charlotte, NC, 704-365-3216  
 De Witt Austin Co., Alpharetta, GA, 404-442-1326  
 Dowell Assoc., St. Louis, MO, 314-849-4234  
 Mountain Representatives, Denver, CO, 303-623-0972  
 J.Y.S. Comm. Co., Dallas, TX, 214-349-1650  
 Lienau Assoc., Inc., Columbia, MD, 301-621-4113  
 Lienau Assoc., Inc., New Town, PA, 215-860-2100  
 SLK Tech Rep, San Francisco, CA, 415-822-4884  
 Miguel Lopez, Hialeah, FL, 305-822-6853  
 Marketline, Snellville, GA, 404-972-9048  
 Messnick Sales, Liverpool, NY, 315-622-3211  
 Miller Assoc., Ltd., Greenwich, CT, 212-840-2866  
 Robert Milsk Co., Inc., Southfield, MI, 313-354-3310  
 Robert Milsk Co., Indianapolis, IN, 317-842-3400  
 Weller Electronic Sales, Worthington, OH, 614-885-7819  
 Frank Lintern Assoc., Naperville, IL, 312-983-0935  
 Products: communications, condenser, dynamic, electret condenser, goosenecks, hand-held, podium, push-to-talk, stands
- Peavey Architectural Acoustics Division  
 PO Box 2898  
 711 A Street  
 Meridian, MS 39301  
 (601) 483-5376, FAX# 601-484-4278  
 Prod Mgr.: Ken Valentine  
 Products: dynamic
- Peavey Electronics Corp.  
 PO Box 2898  
 711 A Street  
 Meridian, MS 39301  
 (601) 483-5365, FAX# 601-484-4278  
 Prod Mgr.: Ken Valentine  
 Products: electret condenser
- Penn Fabrication (USA), Inc.  
 PO Box 506  
 29B Ethel Ave.  
 Hawthorne, NJ 07506  
 (201) 423-4404  
 Sales Director: Mike Panasuk  
 General Mgr.: Richard Stratford  
 General Mgr.: Gavin Naismith  
 Products: stands
- Philips Microphones  
 77 Selleck St.  
 Stamford, CT 06902  
 (203) 348-2121
- Posthorn Recording  
 142 West 26th St.  
 New York, NY 10001  
 (212) 242-3737  
 Owner/Pres.: Jerry Bruck  
 Studio Mgr.: Michael P. Hesse  
 Personnel/PR: Louise A. Bloomfield  
 Products: boundary, condenser, electret condenser, goosenecks, hand-held, miniature, podium, shotgun, specialty, stands, stereo
- Roanwell Corporation  
 180 Varick St.  
 New York, NY 10014  
 (212) 989-1090
- Sennheiser Electronic Corp. (CT)  
 PO Box 987  
 6 Vista Drive  
 Old Lyme, NY 06371  
 (203) 434-9190, FAX# 203-434-1759  
 Pres.: Andrew Brakhan  
 V.P. Mkt'g: Tony Tudisco  
 Products: boundary, condenser, dynamic, electret condenser, goosenecks, hand-held, headset boom, instrumentation, miniature, podium, shotgun, specialty
- Shure Brothers, Inc.  
 222 Hartrey Ave  
 Evanston, IL 60202-3696  
 (312) 866-2553, FAX# 312-866-2279  
 Pres.: James Kogen  
 V.P. Sales: Lottie Morgan  
 Director of Sales: Al Hershner  
 Mkt'g Mgr./Sound Reinforcement: Sandy Schroeder  
 Mkt'g Mgr./Professional Prod.: John Phelan  
 Mgr. Mkt'g Comm.: Lee Habich  
 Peter E. Schmitt, Co., Leonia, NJ, 201-944-2806  
 Steffey Marketing, Northbrook, IL, 312-480-3575  
 Berman-Gravley Co., Costa Mesa, CA, 714-549-2122  
 Rep \* Tech, Terrell, TX, 214-222-2131  
 S.K. Macdonald, Lisbon, MD, 301-982-1088
- Sony Professional Audio  
 1600 Queen Anne Road  
 Teaneck, NJ 07666  
 (201) 833-5200  
 Pres.: William G. Connolly  
 V.P.: Jerry Smith  
 Products: condenser, electret condenser, stereo
- Speco Div., Components Specialties, Inc.  
 PO Box 624  
 1172 Rt. 109  
 Lindenhurst, NY 11757  
 (516) 957-8700, 800-645-5516, FAX# 516-956-9142  
 V.P./Sales: Mel Hulkower  
 V.P./General Mgr.: Jim Ganci  
 Sales Mgr.: Eric Forman  
 Products: carbon, communications, goosenecks, hand-held, push-to-talk
- TOA ELECTRONICS, ENGINEERED SOUND & COMMUNICATIONS DIVISION**  
 PO Box 2047  
 601 Gateway Boulevard  
 South San Francisco, CA 94080  
 (415) 588-2538, 800-843-4750, in CA 800-632-2157, FAX# 415-588-3349  
 Pres.: Yoshiro Ishida  
 Director of Mkt'g: Fred Fredericks  
 Nat'l Sales Mgr.: Richard Krochmal



# AKG's C 562. The Mic That's Out of Sight.

Take its size. Just over 6 inches wide, and only  $\frac{1}{4}$  inch thin, this pre-polarized, condenser, boundary layer mic looks nothing like a mic. So it tends to disappear into the background. On the floor at the stage apron, on a wall, on a ceiling at a conference— or wherever you don't want a mic showing, you need a C 562.

How does it sound? Amazingly natural...high SPL capability, low rumble and wind noise and no disturbing comb filter effects. It's hemispherical polar pattern is designed to pick up sound with incredible presence for a mic that's practically invisible.

And its ultra-widefrequency response doesn't miss a nuance. When all you need to "see" is the sound— all you need to use is the C 562.



**Focusing on new technology.**  
77 Selleck St. Stamford, CT 06902  
(203) 348-2121

© AKG 1988 • Akustische und Kino-Geräte GmbH, Austria

Nat'l Sales Mgr./Engineered Intercom & Security Div.: Al Burns  
 Products: condenser, dynamic, electret condenser, hand-held, push-to-talk

Tascam (TEAC Professional Division)  
 7733 Telegraph Road  
 Montebello, CA 90640  
 (213) 726-0303, FAX# 213-725-1994  
 Mkt'g Mgr: Bill Mohrhoff  
 Nat'l Sales Mgr.: Gregg Hildebrandt  
 W. Reg. Mgr.: Fred Allard  
 S. Reg. Mgr.: Bill Stevens  
 E. Reg. Mgr.: Chuck Prada  
 Products: condenser, dynamic, electret condenser, goosenecks

Telex Communications, Inc., Pro Audio Dept.  
 9600 Aldrich Ave. S.  
 Minneapolis, MN 55420  
 (612) 884-4051, FAX# 612-884-0043  
 Chairman of the Board: Ansel Kleiman  
 Exec. V.P.: Jeffrey Wetherell  
 V.P. Mkt'g: James Arrington  
 Director of Mkt'g: Donald Mereen  
 Director of Advertising: Ronald Taylor

Wes-Tech Marketing, Culver City, CA, 213-870-9286

Bencsik Assoc., Ocala, FL, 904-732-9775

Monfort Electronic Marketing, Indianapolis, IN, 317-872-8877

Mountain Representatives, Inc., Denver, CO, 303-623-0972

Murphy & Cota, Inc., Atlanta, GA, 404-875-2525

Northland Assoc., Moorhead, MN, 218-233-4616

White Radio Ltd., Burlington, Ontario, Canada, 416-632-6894

Rancilio Assoc., Inc., St. Louis, MO, 314-631-3326

SAGA, Oswego, NY, 315-343-5739

Sigmat Corporation, Valley Forge, PA, 215-783-6666

J.Y. Schoonmaker Co., Dallas, TX, 214-349-1650

Weller Electronic Sales, Worthington, OH, 614-885-7819

Ziskind Assoc., Rolling Meadows, IL, 312-577-1624

Burcaw Company & Assoc., Warren, MI, 313-573-4605

S&F Northwest, Seattle, WA, 206-622-6036

Lichtenauer & Associates, Antioch, CA, 415-757-1200

Products: communications, condenser, dynamic, electret condenser, goosenecks, hand-held, headset boom, instrumentation, miniature, podium, push-to-talk

### 3M SOUND PRODUCTS

223-5S-09, 3M Center  
 St. Paul, MI 55144-1000  
 (612) 733-9214, FAX# 612-736-9433  
 Mkt'g Mgr.: Richard G. Barker  
 Sales Mgr.: Don Sluder  
 Products: goosenecks, hand-held

### UNIVERSITY SOUND, ELECTRO VOICE, INC.

600 Cecil St  
 Buchanan, MI 49107  
 (616) 695-6831  
 Pres.: Robert D. Pabst  
 V.P. Sales and Mkt'g: Paul McGuire  
 Chief Engineer: Alan Watson



CWY ELECTRONICS IS YOUR IN-STOCK SOURCE FOR QUALITY NADY 101 VHF AND 201 VHF WIRELESS SYSTEMS. SAME DAY SHIPMENT AND CENTRAL LOCATION SAVE YOU DAYS OF WAITING AND DOLLARS OF AIR FREIGHT



CALL RANDY JESSUP AT INDIANA 1-800-382-7526  
 OUT OF STATE 1-800-428-7596  
 405 NORTH EARL AVENUE  
 LAFAYETTE, INDIANA 47903

Are you  
**moving?**

Don't miss a single issue.

PLACE MAILING LABEL HERE

Name \_\_\_\_\_  
 Address \_\_\_\_\_  
 City \_\_\_\_\_  
 State \_\_\_\_\_ Zip \_\_\_\_\_

Return to:  
 Deborah Droge  
 Sound & Communications  
 25 Willowdale Avenue  
 Port Washington, NY 11050

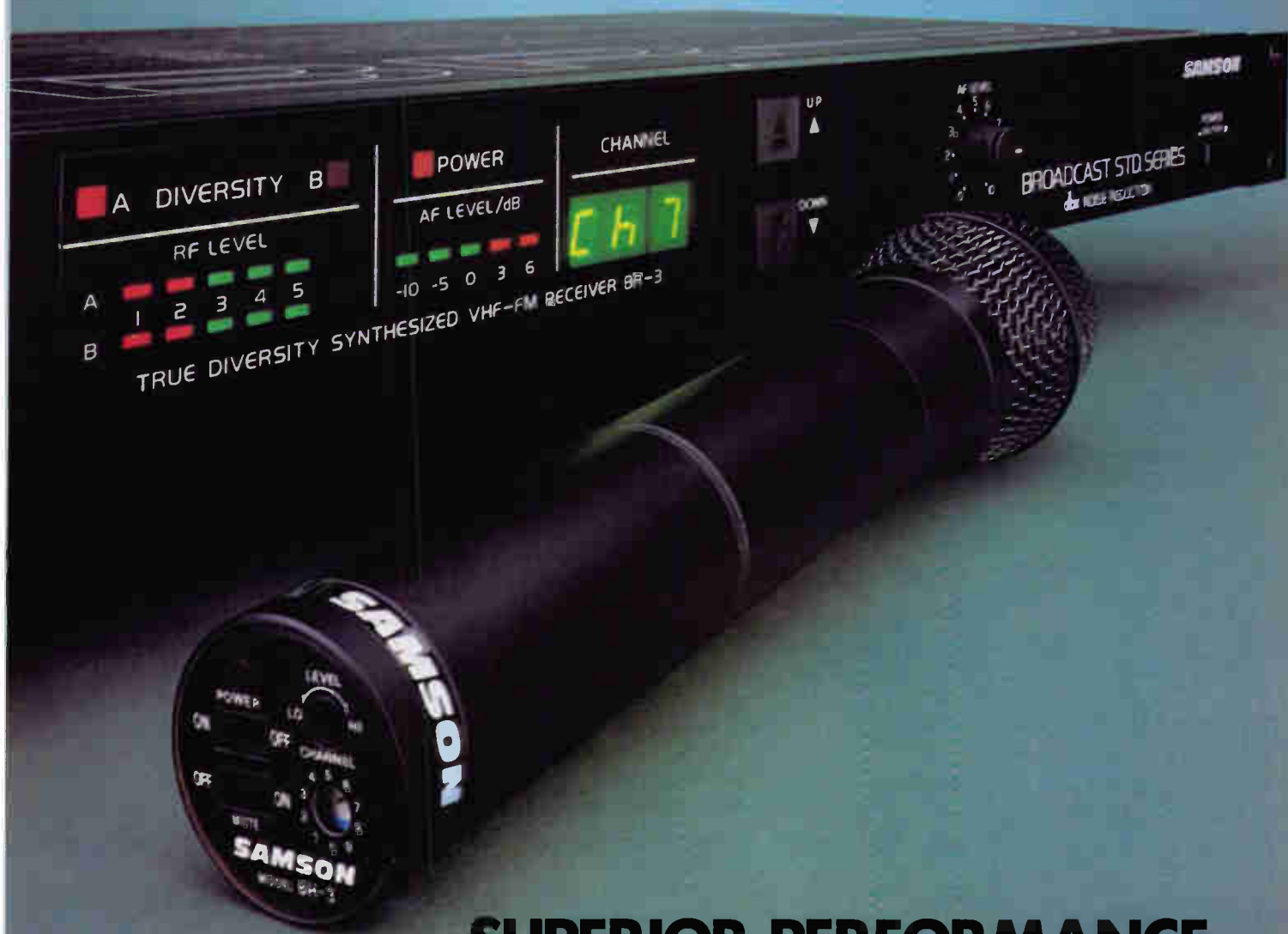

## SUPERIOR PERFORMANCE ANYWHERE, ANYPLACE, EVERY TIME.

No matter how much you spend on a wireless system without selectable channels in the receiver and transmitter, you'll always be vulnerable to potentially damaging interference.

That's why the Samson Broadcast STD wireless system offers ten selectable channels in *both*. Simply dial up the ideal channel in the receiver, then select the identical channel in the transmitter

for optimal transmission quality.

We also included an exclusive Samson feature to let you see the RF level on each available frequency before you use the system. The receiver's visual "window", two five-segment L.E.D. level ladders, scans each channel for instant confirmation of the clearest frequency.

But the real benefit of Broadcast STD truly becomes apparent once

you hear the system. Samson's sophisticated "new generation" RF circuitry with dbx\* noise reduction provides more dynamic headroom and the purest, most transparent audio quality available in wireless today.

The Broadcast STD Series combines these leading edge features so you *know* you're getting matchless performance. Anywhere, anyplace and every time.

Broadcast STD Series available in Hand-Held, Lavalier & Instrument Systems.

Samson Technologies Corp. 485-19 South Broadway, Hicksville, NY 11801 (516) 932-3810  
TLX 284696 SAM UR FAX (516) 932-3815  
In Canada: Omnimedia Corporation Ltd., 9653 Cote De Liesse, Dorval, Quebec H9P 1A3  
514-636-9971

\* dbx is a registered trademark of BSR North America Ltd.  
© 1987 Samson Technologies Corp.

**SAMSON**<sup>®</sup>  
WE TOOK THE WORRY OUT OF WIRELESS<sup>®</sup>

Circle 209 on Reader Response Card



Mkt'g Mgr./Comm. Products: W.  
Douglas Wilkens

George M. Conneen Co., Inc.,  
Springfield, PA, 215-544-5884

Metropolis Audio Marketing, Inc.,  
Edison, NJ, 201-225-0085

R.J. Marketing Ltd., Rockville, MD,  
301-251-0330

The Smith Company, Hartford, CT,  
203-523-0512

Ron Tunks Sales, Inc., Tamarac, FL,  
305-722-2803

Wilson Audio Sales, Nashville, TN, 615-  
646-4477

Audio Resources, Westmont, IL, 312-  
655-1180

B.C. Electronic Sales, Inc., Mission,  
KS, 913-262-1720

Jones Audio Sales, Plano, TX, 214-  
867-0202

C.L. Pugh & Assoc., Inc., Columbus,  
OH, 614-486-9678

Riley & Petchell Sales, Inc., Detroit, MI,  
313-937-3000

Loppnow & Assoc., Redmond, WA,  
206-883-3205

Radon & Assoc., Sacramento, CA,  
916-923-2524

Silver Peak Marketing Ltd., Wheat  
Ridge, CO, 303-467-9042

Western Audio Sales, Glendale, CA,  
818-246-3806

Products: carbon, communications,  
condenser, dynamic, goosenecks,  
hand-held, podium

Wright Microphones  
2093 Faulkner Rd. N.E.  
Atlanta, GA 30324  
(404) 321-3886

Pres.: Tom Wright  
Products: condenser, dynamic, electret  
condenser, specialty

**PROFESSIONAL AUDIO DIVISION,  
YAMAHA MUSIC CORPORATION, USA**

PO Box 6600  
6600 Orangethorpe Ave.  
Buena Park, CA 90622  
(714) 522-9011, FAX# 714-739-2680  
Products: dynamic, electret condenser,  
headset boom, specialty

## MICROPHONES (WIRELESS)

AKG Acoustics, Inc.  
77 Selleck St  
Stamford, CT 06902  
(203) 348-2121, 800-243-7885, FAX#

203-324-1947  
Pres.: S. Richard Ravich  
V.P./Operations: Derek Pilkington  
V.P./Finance: Robert Netter

Tech Sls Coordinator: Timothy  
Derwallis  
Products: hand-held,

**Q** ● Wondering who makes an 1800-watt  
● amplifier? And where you can find  
● a rack to put it in?

**A** ● You'll find the answers in the  
● 1988/89 *Sound & Communications*  
● Blue Book Directory.

**Cetec Vega**  
 9900 Baldwin Pl.  
 El Monte, CA 91734-2204  
 (818) 442-0782, 800-877-1771, FAX#  
 818-444-1342  
 Pres.: Gary J. Stanfill  
 Director of Mkt'g: Kenneth M. Bourne  
 Nat'l Sales Mgr.: Paul Baughman  
 Customer Svce Engineer: Joe Watts  
 Products: body packs, hand-held,

**Coherent Communications, Inc.**  
 13756 Glenoaks Blvd.  
 Sylmar, CA 91342  
 (818) 362-9393, FAX# 818-362-7045  
 Products: body packs, hand-held,

**COMTEK**<sup>®</sup>  
 COMMUNICATIONS TECHNOLOGY, INC.

**Comtek, Inc.**  
 357 W. 2700 St. South  
 Salt Lake City, UT 84115  
 (801) 466-3463, FAX# 801-484-6906  
 Pres.: Ralph Belgique  
 Application Engineer: Steve Kartchner  
 In-House Sales: Stacy Hayes-Garcia  
 Products: body packs, hand-held,

**Eddor**  
 1948 East Pomona  
 Santa Ana, CA 92705  
 (714) 648-0292, 800-854-0259, FAX#  
 714-648-0117  
 Pres.: Larry Weston  
 Office Mgr.: Phyllis Weston  
 Sales Mgr.: Deanna Weston  
 Products: body packs, hand-held,

**(HME) HM Electronics, Inc.**  
 PO Box 261669  
 6675 Mesa Ridge Rd.  
 San Diego, CA 92121  
 (619) 535-6060, FAX# 619-452-7207  
 Pres.: Harry Y. Miyahira  
 V.P.: Donald Kutz  
 Director of Mkt'g: J. Michael Hughes  
 Nat'l Sales Mgr.: Randy Opela  
 Mkt'g Coordinator: Tonnia B. Sills  
 Products: body packs, hand-held,

**LECTROSONICS, INC.**  
 581 Laser Road NE  
 Rio Rancho, NM 87124  
 (505) 892-4501, 800-821-1121, FAX#



**Nady 101/201 Wireless Systems:** The ultimate price/performance breakthrough in VHF Wireless Systems, 120 dB Dynamic Range, 250 foot operation. True Diversity and single-channel; Lavalier, Hand-Held, and Instrument Transmitters available. Receivers rack mount. List prices start at \$279.

# The Systems Approach. Nady Wireless. Nady Infrared.

Maybe the problem is a small facility with an even smaller budget - but you need wireless microphones.

Your requirements may be for a very complicated multi-channel wireless installation. It has to sound great and work flawlessly.

Or your plans call for a Large-Area Infrared installation. Complete coverage, user-friendly receivers - the works. And you don't want to break the bank.

Only one resource provides a total, integrated solution: The Nady Professional Audio Line.

We give you choices - systems solutions - that no one else can. Our 101/201 VHF Wireless Systems start at \$279 list for a Nady 101 LT lavalier system. Wireless doesn't get more affordable than that.

And the Nady 1200 Series Wireless sets the industry standard for full-feature, top-end wireless performance.

Wireless manufacturers make many confusing claims regarding system specifications. Take our suggestion: listen to a Nady 101/201 or a Nady 1200 side-by-side with any other wireless on the market - regardless of the claimed specs - and you'll be impressed with the extra 15 dB dynamic range you get with Nady Wireless.

The Nady IR-300 is a Large-Area Infrared system with a unique modular design for easy, efficient installation in any size facility. You don't have to run AC to power the emitters. And you can add to the system as needed in the future. Best of all, you can have a Nady IR-300 infrared package for one-third to one-half less than the competition gets for the same area coverage.

So, the next time you need wireless or infrared, try the systems approach. The Nady Systems Professional Audio Line.

Nady Systems, Inc., 1145 65th St.,  
 Oakland, CA. Phone 415/652-2411



**Nady 1200 Wireless System.** The newest generation of top-end Nady Wireless Systems, with the best specs in the business. Full output features for total flexibility. Sophisticated front-end circuitry for maximum multi-channel capability, and True Diversity for drop-out free performance. Features a completely redesigned Hand-Held Transmitter with user-switchable elements. Receiver rack-mounts. List price from \$1,599.



**Nady IR-300 Large-Area Infrared Systems.** Unique modular design for easy, efficient installation in any size facility. You don't have to run AC to power the emitters. And you can add to the system as needed in the future. Choice of user-friendly receivers. Best of all, you can have a Nady IR-300 infrared package for one-third to one-half less than the competition gets for the same area coverage.

.505-892-6243  
Pres.: John Arasim  
V.P. Engineering: Larry Fisher  
Mkt'g Mgr.: Bruce Jones  
Svce Mgr.: Alan Gembola  
Factory Sales: Shari McKay  
Gary Castelluccio & Assoc., Clifton, NJ,  
201-772-3333  
Products: body packs, hand-held,

Nady Systems, Inc.  
1145 65th St.  
Oakland, CA 94641  
(415) 652-2411, FAX# 415-652-5075  
Adv. Director: Royce Krilanovich  
Mkt'g Director: Howard Zimmerman  
Mkt'g Ass.: Sharon Banke  
Products: body packs, hand-held,

Paso Sound Products  
14 First St.  
Pelham, NY 10803-1495  
(914) 738-4800, FAX# 914-738-3954  
Executive V.P.: Paul Mastrangelo  
Sales Mgr.: David Moore  
Product Mgr.: Ken Obrien  
Credit Mgr.: Marilyn Beckerson  
Operations Mgr.: Anthony Sgueglia

All West Electronics, Camarillo, CA,  
805-388-1789  
Anderson Sales, Braintree, MA, 617-  
848-9194  
Pace Sales, Charlotte, NC, 704-365-  
3216  
De Witt Austin Co., Alpharetta, GA,  
404-442-1326  
Dowell Assoc., St. Louis, MO, 314-  
849-4234  
Mountain Representatives, Denver, CO,  
303-623-0972  
J.Y.S. Comm. Co., Dallas, TX, 214-  
349-1650  
Lienau Assoc., Inc., Columbia, MD,  
301-621-4113  
Lienau Assoc., Inc., New Town, PA,  
215-860-2100  
SLK Tech Rep, San Francisco, CA,  
415-822-4884  
Miguel Lopez, Hialeah, FL, 305-822-  
6853  
Marketline, Snellville, GA, 404-972-  
9048  
Messnick Sales, Liverpool, NY, 315-  
622-3211  
Miller Assoc., Ltd., Greenwich, CT,  
212-840-2866

Robert Milsk Co., Inc., Southfield, MI,  
313-354-3310  
Robert Milsk Co., Indianapolis, IN, 317-  
842-3400  
Weller Electronic Sales, Worthington,  
OH, 614-885-7819  
Frank Lintern Assoc., Naperville, IL,  
312-983-0935  
Products: body packs, hand-held,

Peavey Architectural Acoustics Division  
PO Box 2898  
711 A Street  
Meridian, MS 39301  
(601) 483-5376, FAX# 601-484-4278  
Prod Mgr.: Ken Valentine  
Products: hand-held,

Samson Technologies Corp.  
485-19 South Broadway  
Hicksville, NY 11801  
(516) 932-3810, FAX# 516-932-3815  
V.P./Mkt'g & Sales: Scott Goodman  
V.P. Engineering: Doug Bryant  
Export Mgr.: Kevin Moran  
Sales: Mike Hennesey  
Sales: Dave Olivier  
Sales: Mike Vallerella

Sennheiser Electronic Corp. (CT)  
PO Box 987  
6 Vista Drive  
Old Lyme, NY 06371  
(203) 434-9190, FAX# 203-434-1759  
Pres.: Andrew Brakhan  
V.P. Mkt'g: Tony Tudisco  
Products: body packs, hand-held,

Sony Professional Audio  
1600 Queen Anne Road  
Teaneck, NJ 07666  
(201) 833-5200  
Pres.: William G. Connolly  
V.P.: Jerry Smith  
Products: body packs, hand-held,

Swintek Enterprises, Inc.  
587 Division St.  
Campbell, CA 95008  
(408) 378-8091, FAX# 408-378-6980  
Pres.: William P. Swintek  
Cinequip, Inc., Toronto, Ont., CD, 416-  
920-5424  
Maga Techtronics, Artarmon, NSW,  
Australia, 02-438-3377  
Commercial Electronics, Vancouver  
B.C., CD, 604-669-5525

**ONE  
IS  
NOT  
ENOUGH**

Additional copies of  
the 1988/1989 Blue  
Book are available  
at \$12 each. Please  
send your check or  
money order to:  
Deborah Droge  
Circulation Director  
25 Willowdale Ave.  
Port Washington,  
NY 11050



# Imagine, **TELEX** **QUALITY** At Offshore Prices



## The Best of Both Worlds

It's now available with the new FMR-25 Wireless Microphone Systems made in the USA. For a list of important features that exceed

the competition and a price that doesn't, call or write Telex Communication, Inc., 9600 Aldrich Av. So. Minneapolis, MN 55420

**TELEX**<sup>®</sup>

Call Toll Free 1-800-328-3771

# The AES Heyser Scholarship Fund



The Richard C. Heyser Scholarship Loan Fund has been set up to honor Dick Heyser, a highly gifted, loved and respected engineer, with a lasting memorial. The scholarship loan will financially assist promising graduate engineering students in the field who, otherwise, could not continue with their studies.

In March of 1987 Dick died, just a few months before he would have assumed the office of AES President. He not only was active in AES but he contributed greatly to the audio field through his Time Delay Spectrometry discoveries. He gave of himself on a personal level as well. Carolyn Davis, Co-Founder of Synergetic Audio Concepts, said of the fund, "Dick, himself, gave so much to all those with whom he came in contact, especially those just starting out; we feel Dick would have been pleased to know he is being remembered in this way."

In conjunction with this memorial, a major update of The PHD Program<sup>†</sup> will be dedicated to Dick Heyser and all the proceeds will go to the Richard C. Heyser Scholarship Loan Fund.

You may obtain a program for a donation of \$300.00 or more; prior owners may upgrade for a donation of \$50.00 or more. Make your check payable to the Richard C. Heyser Scholarship Loan Fund. Send to the Richard C. Heyser Scholarship Loan Fund, c/o *Sound and Communications*, 25 Willowdale Avenue, Port Washington, NY 11050.

<sup>†</sup>Trademark of Ambassador College.

## TOA ELECTRONICS, ENGINEERED SOUND & COMMUNICATIONS DIVISION

PO Box 2047  
601 Gateway Boulevard  
South San Francisco, CA 94080  
(415) 588-2538, 800-843-4750, in CA  
800-632-2157, FAX# 415-588-3349  
Pres.: Yoshiro Ishida  
Director of Mkt'g: Fred Fredericks  
Nat'l Sales Mgr.: Richard Krochmal  
Nat'l Sales Mgr./Engineered Intercom &  
Security Div.: Al Burns  
Products: body packs, hand-held,

Telex Communications, Inc., Pro Audio  
Dept.

9600 Aldrich Ave. S.  
Minneapolis, MN 55420  
(612) 884-4051, FAX# 612-884-0043  
Chairman of the Board: Ansel Kleiman  
Exec. V.P.: Jeffrey Wetherell  
V.P. Mkt'g: James Arrington  
Director of Mkt'g: Donald Merein  
Director of Advertising: Ronald Taylor  
Wes-Tech Marketing, Culver City, CA,  
213-870-9286

Bencsik Assoc., Ocala, FL, 904-732-  
9775

Monfort Electronic Marketing,  
Indianapolis, IN, 317-872-8877

Mountain Representatives, Inc.,  
Denver, CO, 303-623-0972

Murphy & Cota, Inc., Atlanta, GA, 404-  
875-2525

Northland Assoc., Moorhead, MN, 218-  
233-4616

White Radio Ltd., Burlington, Ontario,  
Canada, 416-632-6894

Rancilio Assoc., Inc., St. Louis, MO,  
314-631-3326

SAGA, Oswego, NY, 315-343-5739

Sigmat Corporation, Valley Forge, PA,  
215-783-6666

J.Y. Schoonmaker Co., Dallas, TX,  
214-349-1650

Weller Electronic Sales, Worthington,  
OH, 614-885-7819

Ziskind Assoc., Rolling Meadows, IL,  
312-577-1624

Burcaw Company & Assoc., Warren,  
MI, 313-573-4605

S&F Northwest, Seattle, WA, 206-622-  
6036

Lichtenauer & Associates, Antioch, CA,  
415-757-1200

Products: body packs, hand-held,



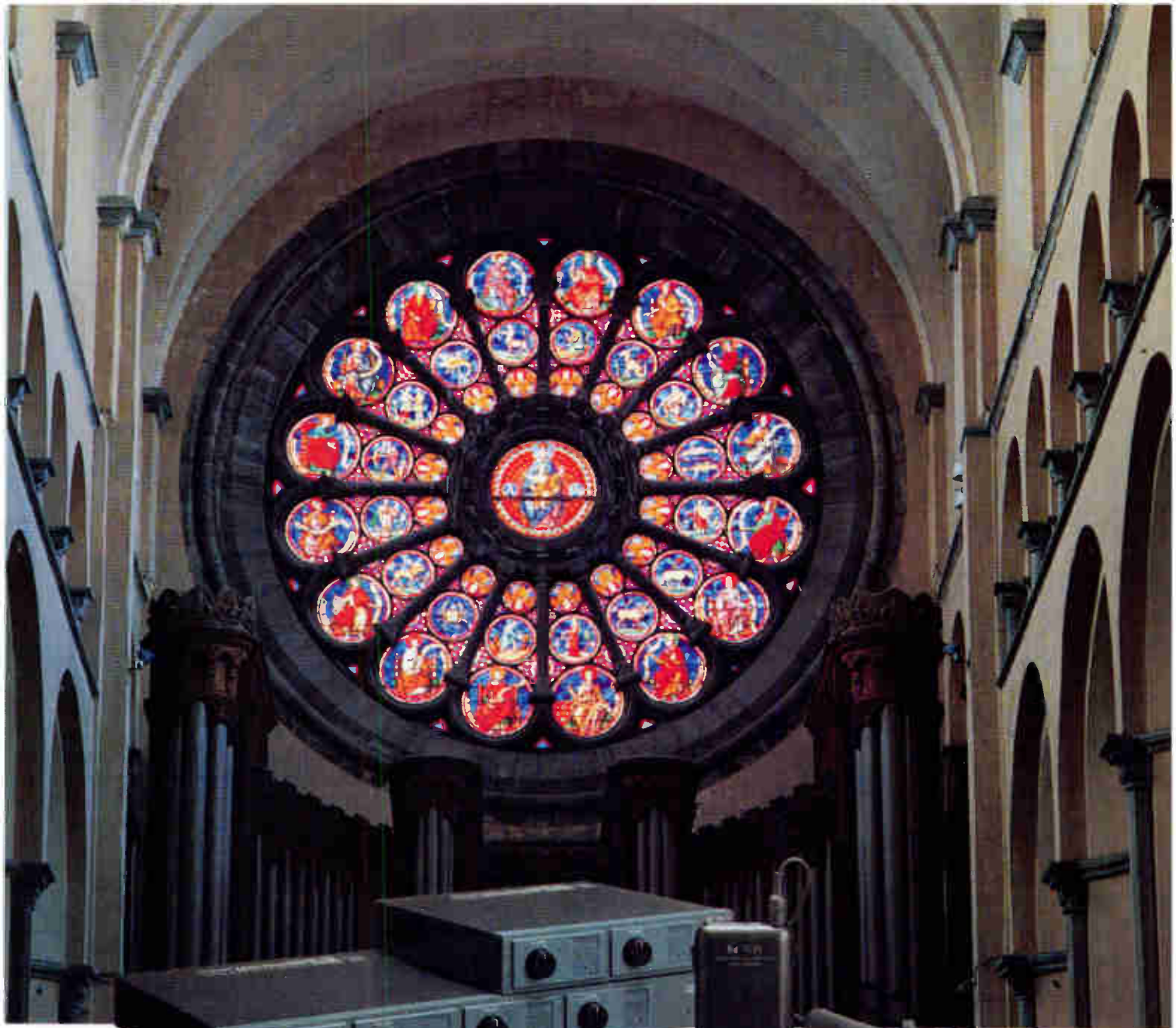

## Toa's New Family of Wireless Microphones Created to Reinforce the Spoken Word

With the introduction of our new vhf hi-band wireless microphones, Toa has redefined the concept of outstanding wireless performance at an affordable price.

You asked for wireless microphone technology that delivers substantially longer battery life. Toa responded by incorporating the latest advancements in miniaturized surface mount components into our new wireless microphones. Battery life has been extended to over thirty hours during continuous use, utilizing one AA battery.

You needed extended dynamic range and superior signal-to-noise ratios. Toa responded by designing a unique new compander circuit that achieves wide dynamic range against a background of vanishing low noise.

You wanted a wireless system completely free from external

interference. Toa responded by introducing our fabulous new tone-key circuit design. This technological breakthrough virtually dispenses with the possibility of external interference.

Toa's new modular wireless systems are available in diversity and non diversity configurations.

### Wireless Microphones from Toa Created to Reinforce the Spoken Word

#### Toa Electronics, Inc.

#### Commercial Products Group

601 Gateway Blvd., South San Francisco, CA 94080  
Tel (415) 588 2538 Telex 331332 Fax 588 3349

Toa Canada (403) 489 5511 Edmonton,  
(416) 624 2317 Toronto or (514) 931-5888 Montreal—  
Toa UK (0277) 233882 Essex — Toa Europe  
(040) 2506091 Hamburg — Toa Japan (0797) 71 2222



World Radio History



# MIXERS/MIXING CONSOLES

## MIXERS, MIXING CONSOLES

ADM Technology, Inc.  
1626 E. Big Beaver Rd.  
Troy, MI 48084  
(313) 524-2100

AMS/Calrec (AMS Industries, Inc.)  
PO Box 31864  
3827 Stone Way N.  
Seattle, WA 98103  
(206) 633-1956, FAX# 206-547-6890  
Mkt'g Director: Nigel Branwell  
Service Mgr.: Graham Murray  
Credit Mgr.: Kathleen Mallory  
Products: broadcast, custom, digital,  
ENG, modular, portable, powered,  
production, rack-mount, recording,  
theatrical, VCA

API Audio Products, Inc.  
7951 Twist Lane  
Springfield, VA 22153  
(703) 455-8188, FAX# 703-455-4240

Akai Professional-IMC  
PO Box 2344  
1316 Lancaster St.  
Fort Worth, TX 76113-2344  
(817) 336-5114, FAX# 817-870-1271  
Products: automatic

Allen and Heath  
5 Connair Rd.  
Orange, CT 06477  
(203) 795-3594, FAX# 203-795-6814  
V.P./Sales Mgr.: Charles Augustowski  
Pres.: John Ball  
General Mgr.: Jean Rathgeber  
Engineer/R&D: John Petrucelli  
Engineer: Joseph Boerst  
GMI/New England, Avon, MA, 617-588-8043  
Sherwood Assoc., Endicott, NY, 607-785-1590  
Metropolis Marketing, Edison, NJ, 201-225-0085  
Audio Assoc., Glenwood, MD, 301-854-6122  
Ron Tunks Sales, Tamarac, FL, 305-722-2803

Cambridge Marketing, S. Euclid, OH,  
614-890-7788  
Jamm Dist., Flossnor, IL, 312-747-6363  
Centurian Marketing, Ballwin, MO, 314-227-7229  
JMS Marketing, Austin, TX, 512-266-1113  
Loppnow & Assoc., Redmond, WA,  
206-883-3205  
AMH Sales, Palos Verdes Estates, CA,  
213-373-2034  
Products: broadcast, microprocessor,  
MIDI, modular, monitor, portable,  
production, rack-mount, recording,  
theatrical

Amek/TAC US Operations  
10815 Burbank Blvd.  
N. Hollywood, CA 91601  
(818) 508-9788, FAX# 818-508-8619  
Operations Mgr.: Sue Jones  
AMEK Nat'l Sales Mgr.: Tim Wilson  
TAC Nat'l Sales Mgr.: Arnold Toshner  
Nat'l Svce Mgr.: Ray Dilfield  
Products: automatic, broadcast,  
computer controlled, custom, MIDI,  
monitor, portable, production, rack-  
mount, recording, theatrical, VCA

Audioarts Engineering  
Five Collins Road  
Bethany, CT 06525  
(203) 393-0887

Audio Logic  
5639 S. Riley Lane  
Salt Lake City, UT 84107  
(801) 268-8400, 800-453-7484, FAX#  
801-262-4966  
Pres.: John Johnson  
V.P.: David O. DiFrancesco  
Finances: Jay Fuller  
Int'l East: Wayne Morris  
Western Sales: Scott Grow  
Communications: Dean Stubbs  
Products: broadcast, combo,  
production, rack-mount, recording,  
theatrical

Audio Systems Company  
PO Box 1174  
1815 Michigan Ave.  
Bismarck, ND 58502  
(701) 223-3800, 800-852-6522  
Pres.: Lynn Mader  
V.P.: Lyle Mader  
Sales Mgr.: Mark Schmidt  
Products: automatic,  
compressor/leveler, computer  
controlled, rack-mount

Audio-Technica U.S., Inc.  
1221 Commerce Drive  
Stow, OH 44224  
(216) 686-2600, FAX# 216-688-3752  
Pres.: Jon R. Kelly  
Nat'l Sales Mgr.: Mike Wuellner  
Mkt'g Mgr./Pro Products: Greg Silsby  
Sr. Transducer Engineer: Bob Herrold  
Products: ENG, portable

Auditel Systems, Ltd.  
396 Porter Ave.  
Buffalo, NY 14201  
(716) 886-0019, FAX# 716-886-1615  
Pres.: David Langtry  
Prod. Mgr.: Tony Roberson  
Mkt'g Director: Jim Wood  
Products: automatic, computer  
controlled, gated, modular, rack-  
mount, VCA

Autogram Corp.  
PO Box 456  
1500 Capital Ave.  
Plano, TX 75074  
(214) 424-8585, 800-327-6901  
Pres.: Ernest T. Andele Jr.

Biamp Systems  
PO Box 1260  
14270 NW Science Park Drive  
Portland, OR 97229  
(503) 641-7287, 800-826-1457, FAX#  
503-626-0281  
Pres.: Ralph Lockhart  
Sales Mgr.: Ron Camden  
V.P. Engineering: Bob Doty

**Bogen Communications, Inc.**

PO Box 575  
50 Spring St.  
Ramsey, NJ 07446  
(201) 934-8500, FAX# 201-934-9832  
Pres.: John H. Ochtera  
V.P. Sales/Sound Prod.: David A.

Chambers  
V.P. Sales/Telecomm. Prod.: Charles Ferreri  
Bruce Barrett, Garland, TX, 214-530-0467

Kingston Sales Corp., Indianapolis, IN, 317-876-2545

Kevin Koehler, Batavia, IL, 312-879-6871  
Tim McDonnell, Willoughby Hills, OH, 216-942-2429

Steve McGrew, Kennesaw, GA, 404-422-4608

Meyer Mkt'g, Inc., Deerfield Beach, FL, 305-481-9250

W.B. Pray Sales, Inc., Northboro, MA, 617-393-3434

Jay Sample, Sandy, UT, 801-942-1059

Scott Sampson, Encino, CA, 818-996-5484

Mike Schneider, Baltimore, MD, 301-563-5390

Walt Spencer, Ramsey, NJ, 201-934-8500

White Radio Ltd., Burlington, ONT, Canada, 416-632-6894

Roburn Agencies, Inc., Yonkers, NY, 914-968-1016

Products: modular, paging

**Bozak, Inc.**

326 South St  
New Britain, CT 06051-3721  
(203) 225-0555  
Pres.: Donald D. Bowers  
Dir. of Mkt'g: William J. Kieltyka  
Chief Engineer: Sheldon Glick

**Broadcast Audio Corp**

11306 Sunco Dr.  
Rancho Cordova, CA 95670  
(916) 635-1048  
Pres.: John Fernandez  
CEO: David Evans

**Broadcast Electronics, Inc.**

PO Box 3606  
4100 N. 24th St.  
Quincy, IL 62305  
(217) 224-9600, FAX# 217-224-9607  
Pres.: Larry Cervon

V.P. Mkt'g: Curtis Kring  
V.P. Engineering: Geoff Mendenhall  
V.P. Treasurer: Bob Weaver  
V.P. Operations: Tom Ash  
V.P. Prod. Mgmt: John Burtle  
Products: broadcast, modular

**Carvin Corp.**

1155 Industrial Ave.  
Escondido, CA 92025  
(619) 747-1710

**Cetec Ivie**

1366 West Center St.  
Orem, UT 84057  
(801) 224-1800, FAX# 801-224-7526

Pres.: Craig Berry  
V.P.: Joel Zabriskie  
Mkt'g Mgr.: Glen Meyer  
Product Engineering Mgr.: Larry Driskill  
Production Mgr.: Bob Greene  
Products: automatic, gated, modular, paging, rack-mount, VCA

**Creative Audio Design & Development**

1875 Rue Panama, Suite D  
Brossard, Que., CD J4W2S8  
(514) 672-8862, FAX# 514-672-3399  
Pres.: Pierre Pare  
V.P. Engineering: Shane Morris  
Engineering R&D: Denis Lambert

**DAX Audio Group, Inc.**

1231 S.E. Gideon St.  
Portland, OR 97202  
(503) 232-4445  
Pres.: Rich Stevenson  
Engineering Mgr.: Bob Herb

**DDA-Division of Klark Teknik**

30B Banfi Plaza N  
Farmingdale, NY 11735  
(516) 249-3660  
Pres.: Jack Kelly  
Nat'l Sales Mgr.: Sam Spennacchio  
Field Sales Mgr.: Keith Worsley  
Products: modular, monitor, portable, production, recording, theatrical, VCA

**DOD Electronics Corp.**

5639 South Riley La.  
Salt Lake City, UT 84107  
(801) 268-8400, 800-453-7484, FAX# 801-262-4966  
Pres.: John Johnson  
V. P.: David DiFrancesco  
Finances: Jay Fuller

Int'l: Wayne Morris  
Western Sales: Scott Grow  
Communications: Dean Stubbs  
Products: disco, ENG, production, rack-mount, recording, theatrical

**D & R, USA**

1720 Chip N Dale Drive  
Arlington, TX 76012  
(817) 548-1677, FAX# 817-277-6066  
Nat'l Sales Director: Paul Westbrook

**Design Direct Sound**

6850 35th N.E., Suite 1  
Seattle, WA 98115  
(206) 527-4371  
Pres.: Bob Rice  
V.P.: Pat Peterson  
V.P.: Marc Hall  
Mkt'g: Mark Dodge

**Eddor**

1948 East Pomona  
Santa Ana, CA 92705  
(714) 648-0292, 800-854-0259, FAX# 714-648-0117  
Pres.: Larry Weston  
Office Mgr.: Phyllis Weston  
Sales Mgr.: Deanna Weston  
Products: automatic, compressor/leveler, gated, modular, monitor, paging, rack-mount, VCA

**Electro-Voice, Inc.**

600 Cecil Street  
Buchanan, MI 49107  
(616) 695-6831, 800-527-6701, FAX# 616-695-1304

Pres.: Robert D. Pabst

V.P. Sales & Mkt'g: Paul McGuire  
Director of Mkt'g: Jim Long  
Chief Engineer: Earl Harris  
George M. Conneen Co., Inc.,  
Springfield, PA, 215-544-5884

Metropolis Audio Marketing, Inc.,  
Edison, NJ, 201-225-0085

R.J. Marketing Ltd., Rockville, MD,  
301-251-0330

The Smith Company, Hartford, CT,  
203-523-0512

Ron Tunks Sales, Inc., Tamarac, FL,  
305-722-2803

Wilson Audio Sales, Nashville, TN, 615-646-4477

Audio Resources, Westmont, IL, 312-655-1180



# The PM1800 works. C

The location for a fixed installation can range anywhere from devils to dolphins. And so you need a mixing console that can handle the demands of any kind of environment. No matter what they are.

That's right where the Yamaha PM1800 Professional Audio Mixing Console fits in. For reliability. Durability. And mixing finesse.

First of all, the PM1800 is remarkably reliable. Performance

after performance. With system after system. Through brimstone and brine.

Of course, we made it durable because it's worth keeping around. In fact, the PM1800 inherited most of its features and capabilities from the legendary PM3000.

The design, just like its predecessor the M1500, is familiar in all the right aspects and improved in the others. Such as a unique





# Some hell or high water.

transformer option, so it can work with or without them. Plus wide use of internal jumpers so the signal flow can be changed just about any way that's needed.

And if you've mixed on a Yamaha console before, rest assured that the PM1800 will be just as easy to use. Because it's as friendly and familiar as our other models.

We suggest that you check into the PM1800 Audio Mixing Console

at your nearest Yamaha Professional Audio dealer. Someday, it just may keep you out of hot water.

Yamaha Music Corporation,  
Professional Audio Division, P.O.  
Box 6600, Buena Park, CA 90622.  
In Canada, Yamaha Canada Music  
Ltd., 135 Milner Avenue,  
Scarborough, Ontario M1S 3R1.

**YAMAHA**<sup>®</sup>  
Engineering Imagination™

- B.C. Electronic Sales, Inc., Mission, KS, 913-262-1720  
 Jones Audio Sales, Plano, TX, 214-867-0202  
 C.L. Pugh & Assoc., Inc., Columbus, OH, 614-486-9678  
 Riley & Petchell Sales, Inc., Detroit, MI, 313-937-300  
 Loppnow & Assoc., Redmond, WA, 206-883-3205  
 Radon & Assoc., Sacramento, CA, 916-923-2524  
 Silver Peak Marketing Ltd., Wheat Ridge, CO, 303-467-9042  
 Western Audio Sales, Glendale, CA, 818-246-3806 x  
 Products: portable, powered
- Europa Technology, Inc.  
 1638 West Washington Blvd  
 Venice, CA 90291  
 (213) 392-4985
- Fender Musical Instrument Corp.  
 1130 Columbia Street  
 Brea, CA 92621  
 (714) 990-0909, FAX# 714-990-3986  
 Mgr. Pro Audio: Cal Perkins
- Fostex Corp. of America  
 15431 Blackburn Ave.  
 Norwalk, CA 90650  
 (213) 921-1112, FAX# 213-802-1964  
 Pres.: Y. Abe  
 Exec. V.P./General Mgr.: Fred Huang  
 V.P. Sales/Mkt'g: Mark Cohen  
 Products: portable, powered, production, recording
- Gaines Audio  
 PO Box 17888  
 1237 E. Main Street  
 Rochester, Ny 14609  
 (716) 266-0780  
 Owner: Jon Gaines  
 Products: rack-mount
- Hill Audio, Inc.  
 5002B N. Royal Atlanta Dr.  
 Tucker, GA 30084  
 (404) 934-1851, FAX# 404-934-1840  
 Sales Mgr.: Bob Allen  
 Svce Mgr.: Rick Rogers  
 Innovative Sales and Marketing, Irvine, CA, 714-549-7770  
 Ouzunoff and Assoc., Yorktown Heights, NY, 914-245-6452
- Products: modular, monitor, rack-mount, recording
- Howe Technologies Corp.  
 2300 Central Ave., Suite E  
 Boulder, CO 80301  
 (303) 444-4693
- IED Innovative Electronic Designs, Inc.  
 9701 Taylorsville Rd  
 Louisville, KY 40299  
 (502) 267-7436, FAX# 502-267-9070  
 V.P. Mkt'g & Sales: Tom Roseberry  
 Mkt'g Assistant: Wanda R. Martin  
 Pres.: Hardy Martin  
 Sec./Treas.: Ray Allen  
 V.P. R & D: Robert Ponto  
 Derek Allen Assoc., Toluca Lake, CA, 818-840-8327  
 Bensik Assoc., Ocala, FL, 904-732-9775  
 Plus 4 Marketing, Pleasant Hill, CA, 415-937-0650  
 Yore Company, White Bear Lake, MN, 612-770-9760  
 Products: automatic, computer controlled, custom, digital, microprocessor, modular, rack-mount, VCA
- ITT/DES, Inc.  
 20 Mayfield Ave.  
 Edison, NJ 07607  
 (201) 225-6121, 800-524-1646  
 V.P.: Donald Duthaler  
 Chief Engineer: Jeffrey Stellman
- Johnson Electronics, Inc.  
 4301 Metric Drive  
 Winter Park, FL 32792  
 (407) 677-4030, FAX# 407-679-1288  
 Pres./CEO: A.J. Schell  
 V.P. Mkt'g: Robert W. Peters  
 V. P./Engineering: Ken St. John  
 Products: modular, paging, rack-mount
- KDM Electronics, Inc.  
 705 Progress Ave., Unit #59  
 Scarborough, Ontario, Canada M7H 2X1  
 (416) 439-7158  
 Pres.: Ron Bull  
 Products: modular, portable
- Klark-Teknik Electronics, Inc.  
 30 B Banfi Plaza N  
 Farmingdale, NY 11735  
 (516) 249-3660, FAX# 516-420-1863  
 Pres.: Jack Kelly  
 Nat'l Sales Mgr.: Sam Spennacchio  
 Field Sales Mgr.: Keith Worsley  
 Products: modular, production, recording, theatrical
- Korg U.S.A., Inc.  
 89 Frost St.  
 Westbury, NY 11590  
 (516) 333-9100, 800-645-3188, FAX# 516-333-9108  
 Sr. V.P.: Michael Kovins  
 Products: MIDI
- LPB, Inc.  
 28 Bacton Hill Rd.  
 Frazer, PA 19355  
 (215) 644-1123  
 Pres.: Richard H. Crompton  
 Sales Mgr.: John P. Tiedeck  
 Burden Assoc., Canoga Park, CA, 818-340-4590  
 Products: broadcast
- LVW Electronics  
 2400 Naegle Road  
 Colorado Springs, CO 80904  
 (303) 471-8430
- Logitek  
 3320 Bering Dr.  
 Houston, TX 77057  
 (713) 782-4592, 800-231-5870, FAX# 713-782-7597  
 Pres.: Tag Borland  
 Products: broadcast, custom, ENG, portable, rack-mount, VCA
- Midas Audio Systems Ltd.  
 54-56 Stanhope St.  
 London, UK NW1 3EX  
 (01) 388-7060  
 Managing Director: John Grumbridge  
 Sales Mgr.: Peter Cornell  
 Products: monitor, portable, production, theatrical
- Neotek Corporation  
 1154 West Belmont Avenue  
 Chicago, IL 60657  
 (312) 929-6699, FAX# 312-975-1700  
 Sales Rep: Laura Chase  
 Martin Audio, New York, NY, 212-541-5900

Audio Engineering Assoc., Pasadena, CA, 818-798-9127  
 Pyramid Audio, South Holland, IL, 312-339-8014  
 Pro Media, San Francisco, CA, 415-957-1383  
 Sonotechnique, Montreal, CN, 514-739-3368  
 Products: custom, MIDI, modular, production, recording, theatrical, VCA

Brian Trankle Assoc., Belmont, CA, 415-595-4004  
 Brian Trankle Assoc., Sacramento, CA, 916-369-7030  
 Northmar, Seattle, WA, 206-524-5170  
 Pearson & Pearson, Denver, CO, 303-722-6996  
 Products: broadcast, combo, disco, modular, monitor, portable, production, rack-mount, recording, theatrical

Products: paging, portable, powered, rack-mount

Peavey Electronics Corp.  
 PO Box 2898  
 711 A Street  
 Meridian, MS 39301  
 (601) 483-5365, FAX# 601-484-4278  
 Prod Mgr.: Ken Valentine  
 Products: MIDI, portable, powered, rack-mount, recording

## Neve

Berkshire Industrial Park  
 Bethel, CT 06801  
 (203) 744-6230, FAX# 203-792-7863  
 Pres.: Barry J. Roche  
 V.P. Sales: Anthony H. Langley  
 Eastern Reg Sales Mgr.: Phil Wagner  
 SE Reg Sales Mgr.: Tom Semmes  
 Western Reg Mgr.: Rick Plushner  
 Mgr. of Engineering: Geoffrey M. Langdon

Paso Sound Products  
 14 First St.  
 Pelham, NY 10803-1495  
 (914) 738-4800, FAX# 914-738-3954  
 Executive V.P.: Paul Mastrangelo  
 Sales Mgr.: David Moore  
 Product Mgr.: Ken Obrien  
 Credit Mgr.: Marilyn Beckerson  
 Operations Mgr.: Anthony Sgueglia  
 All West Electronics, Camarillo, CA, 805-388-1789

Professional Sound Corporation  
 5707 Cahuenga Blvd.  
 N. Hollywood, CA 91601  
 (818) 760-6544  
 Pres.: Al Krist  
 Chief Engineer: Ron Meyer

Panasonic Industrial Company/Ramsa  
 6550 Katella Ave  
 Cypress, CA 90630  
 (714) 895-7278, FAX# 714-895-7242  
 Nat'l Sales/Mkt'g: Steve Wooley  
 Eastern Sales Mgr.: D.J. Bierut  
 Central Sales Mgr.: Greg Braithwaite  
 Western Sales Mgr.: James Murray  
 Pusecker Sales, Upper Montclair, NJ, 201-744-1834

Anderson Sales, Braintree, MA, 617-848-9194  
 Pace Sales, Charlotte, NC, 704-365-3216

QSC Audio Products, Inc.  
 1926 Placentia Ave  
 Costa Mesa, CA 92627  
 (714) 645-2540, 800-854-4079, FAX# 714-645-7927

Director of Mkt'g: Greg McVeigh  
 Nat'l Sales Mgr.: Peter Kalmen  
 Sales Engineer: Andy Murray  
 Products: paging, rack-mount

Professional Audio Associates,  
 Burlington, MA, 617-229-6050  
 David Prinzi, Webster, NY, 716-671-9266

De Witt Austin Co., Alpharetta, GA, 404-442-1326  
 Dowell Assoc., St. Louis, MO, 314-849-4234  
 Mountain Representatives, Denver, CO, 303-623-0972

Quantam Audio Labs  
 2752 Walnut Ave.  
 Tustin, CA 92680  
 (714) 838-8833, FAX# 714-838-9619  
 Sales Engineer: David Rollins  
 Products: broadcast

World Wide Electronics, Pembroke Pines, FL, 305-584-7024  
 World Wide Electronics, Jacksonville, FL  
 Evans Sales & Mkt'g, Nashville, TN, 615-297-7997  
 A/V Mkt'g, Carmel, IN, 317-846-1034  
 Key Mkt'g, Plymouth, MI, 313-459-6040

J.Y.S. Comm. Co., Dallas, TX, 214-349-1650  
 Lienau Assoc., Inc., Columbia, MD, 301-621-4113

## RANE CORP.

10802 49th Ave. W.  
 Everett, WA 98204-3400  
 (206) 355-6000, FAX# 206-347-7757  
 V.P. Mkt'g: Larry Winter  
 Dir. Tech. Mkt'g: Terry Pennington  
 Sales Coordinator: Debbie Cooksey  
 Products: disco, modular

New Horizons Elec. Mkt'g,  
 Bannockburn, IL, 312-234-5911  
 J.B. Parent Co., Dublin, OH, 614-764-0064

Lienau Assoc., Inc., New Town, PA, 215-860-2100  
 SLK Tech Rep, San Francisco, CA, 415-822-4884

Recordex Corp.  
 1935 Delk Industrial Blvd.  
 Marietta, GA 30067  
 (404)

Music Interventions & Assoc., Kansas City, MO, 816-453-4448

Miguel Lopez, Hialeah, FL, 305-822-6853  
 Marketline, Snellville, GA, 404-972-9048

Roland Corp., US  
 7200 Dominion Circle  
 Los Angeles, CA 90040  
 (213) 685-5141  
 Pres.: Tom Beckman  
 Dir. Of Communications: Nancy Kewin  
 Communications: Barbi Clark

Tenick & Assoc., Houston, TX, 713-528-2005

Messnick Sales, Liverpool, NY, 315-622-3211  
 Miller Assoc., Ltd., Greenwich, CT, 212-840-2866

New West Audio, Burbank, CA, 818-955-9706

Robert Milsk Co., Inc., Southfield, MI, 313-354-3310  
 Robert Milsk Co., Indianapolis, IN, 317-842-3400

Weller Electronic Sales, Worthington, OH, 614-885-7819  
 Frank Lintern Assoc., Naperville, IL, 312-983-0935



# FAMILY CONNECTIONS

Designing a commercial sound system with just the right combination of features is a constant challenge for audio professionals. The solution must provide sound quality, reliability and value for your customer. But just as important is flexibility. You need a fully compatible solution that's easily customized for any application.

That's why more professionals than ever choose the Toa 900 Series. This integrated family of mixers, power amplifiers, graphic equalizers and accessories has proved itself in thousands of installations worldwide. Designed to fulfill Toa's 'install and forget'



philosophy, it sets the standard for ruggedness and functionality.

Now the product family is even more versatile. We just upgraded and expanded our line of 900 Series plug-in modules. These 36 interchangeable units let you

adapt the core system to meet virtually any requirements. And later, as your client's needs change, it's a simple task to add new capabilities.

With over half a century of expertise and innovation built in, Toa's modular 900 Series delivers performance to make you proud. For more information, talk to your local Toa representative today, or call us at (800) 843-4750, in California (800) 632-2157.

Toa Electronics, Inc., Commercial Group, 601 Gateway Blvd., Suite 300, South San Francisco, California 94080. Telephone (415) 588-2538, Telex 331332, FAX (415) 588-3349.

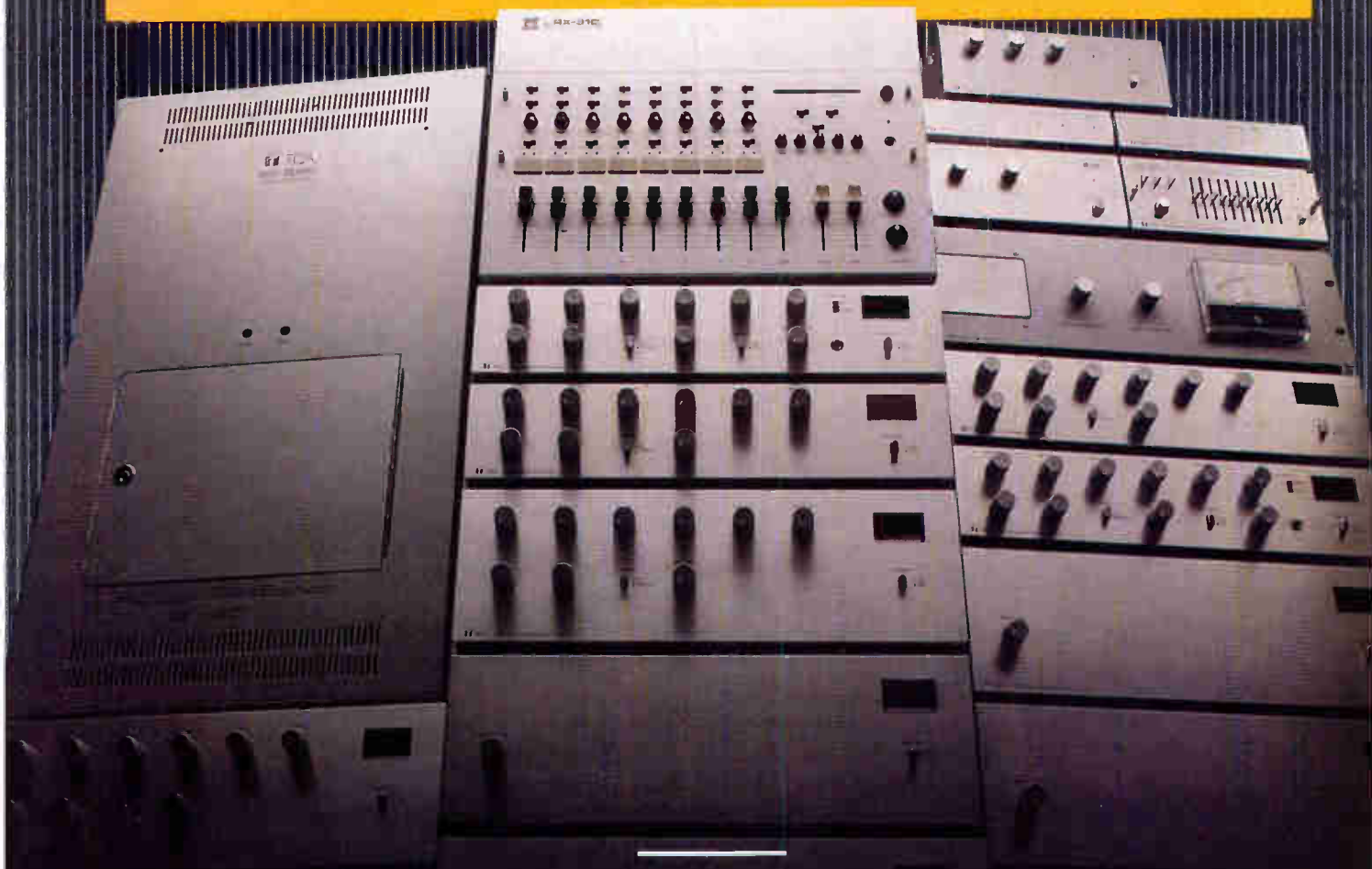

TOA

Rupert Neve, Inc.  
 Berkshire Industrial Park  
 Bethel, CT 06801  
 (203) 744-6230, FAX# 203-792-7863  
 Pres.: Barry J. Roche  
 V. P. of Sales: Anthony H. Langley  
 E. Reg. Sales Mgr.: Phil Wagner  
 S. E. Reg. Sales Mgr.: Tom Semmes  
 W. Reg. Sales Mgr.: Rick Plushner

St. Louis Music  
 1400 Ferguson Ave.  
 St. Louis, MO 63133  
 (314) 727-4512, 800-325-8148, FAX#  
 314-727-8929  
 Sales Training Dir.: Tony Moscal  
 Product Mgr.: Gary Byers  
 Dir. of Operations: John Karpowicz  
 Pres.: Gene Kornblum

Sanctuary Sound Systems  
 113 Newport Drive  
 Oak Ridge, TN 37830  
 (615) 482-9242  
 Mkt'g: Barry Boseman

Sescom, Inc.  
 2100 Ward Dr.  
 Henderson, NV 89015  
 (702) 565-3400, FAX# 702-565-4828  
 Products: compressor/leveler, portable,  
 production

Sontec Electronics, Inc.  
 Audio Dr.  
 Goldbond, VA 24094  
 (703) 626-7256  
 Sales Mgr.: Burgess Macneal  
 Products: broadcast, custom, portable,  
 recording

## Soundcraft

**SOUNDCRAFT**  
 PO Box 2200  
 8500 Balboa Blvd.  
 Northridge, CA 91329  
 (818) 893-4351, FAX# 818-893-3639  
 Pres.: Ron Means  
 V.P. Sales: Ken Lopez  
 V.P. Mkt'g: Mark Gander  
 Nat'l Sales Mgr.: David Kimm  
 Tech. Applications: Gordon Cochran  
 Neil Conly, Bedford, TX, 817-540-3066

Bill Hamilton, Folsom, PA, 215-543-  
 4677  
 Steve Armstrong, Northridge, CA, 818-  
 707-2529  
 Tom Walter, Barrington, IL, 312-382-  
 4925  
 Products: broadcast, MIDI, modular,  
 monitor, portable, production, rack-  
 mount, recording, theatrical

Soundtech  
 230 Lexington Dr.  
 Buffalo Grove, IL 60089  
 (312) 541-3520, 800-323-4173, FAX#  
 312-541-3616  
 Pres.: Rudy Schlacher  
 Sales Mgr.: Keith Brawley  
 Sales Director: Len Brawnling  
 Products: powered

Soundtracs, A Division of Samson  
 Technologies Corp.  
 485-19 South Broadway  
 Hicksville, NY 11801  
 (516) 932-3810  
 V.P. Mkt'g/Sales: Scott Goodman  
 V.P. Engineering: Doug Bryant  
 Export Mgr.: Kevin Moran  
 Sales: Mike Hennesey  
 Sales: Dave Olivier  
 Sales: Mike Vallerella  
 Products: production, recording,  
 theatrical

**SOUND WORKSHOP PROFESSIONAL  
 AUDIO PRODUCTS, INC.**  
 50 Werman Ct.  
 Plainview, NY 11803  
 (516) 756-0140, FAX# 516-756-9622  
 Pres.: Michael Tapes  
 Sales Mgr.: Lee Pomerantz  
 Products: computer controlled,  
 custom, modular, production,  
 recording, theatrical, VCA

Sphere Electronics, Inc.  
 20201 A Praire  
 Chatsworth, CA 91311  
 (213) 349-4747

Stewart Electronics Corp.  
 11460 Sunrise Gold Circle, Suite B  
 Rancho Cordova, CA 95742  
 (916) 635-3011, FAX# 916-635-1787  
 Nat'l Sales/Mkt'g Mgr.: James M.  
 Ruse

Applied Audio, Asheville, NC, 704-252-  
 9313  
 Cambridge Pro Sales, Westerville, OH,  
 614-890-8144  
 GMC, Springfield, PA, 215-544-5884  
 Pacific Audio Group, Torrance, CA,  
 213-375-2611  
 Future Sales, Redmond, WA, 206-868-  
 5577  
 JAMM Dist., Flossmoor, IL, 312-799-  
 0550  
 McManus Music Sales, MN, 612-432-  
 5321  
 On the Road Mrkt., Upper Montclair,  
 NJ, 201-746-0501  
 Pro Sound & Light, Lakewood, CO,  
 303-986-5999  
 RPM Sales, Carrollton, TX, 214-446-  
 3010  
 B. Trankle & Assoc., Belmonti, CA,  
 415-595-4004  
 Pro Sound Assoc., Jacksonville, FL,  
 904-744-1170  
 Products: rack-mount, recording

Studer Revox America, Inc.  
 1425 Elm Hill Pike  
 Nashville, TN 37210  
 (615) 254-5651, FAX# 615-256-7619  
 Dir./Prof. Dealer Prod.: David C.  
 Bowman  
 Mgr. Studer Direct Sales: Chris Ware  
 New York, NY, 212-255-4462  
 Dallas, TX, 214-943-2239  
 Los Angeles, CA, 818-780-4234  
 San Francisco, CA, 415-930-9866  
 Pro Audio LTD, Chicago, IL, 312-526-  
 1660  
 Products: broadcast, portable,  
 recording

Studiomaster  
 1340-G Dynamics St.  
 Anaheim, CA 92806  
 (714) 524-2227, FAX# 714-524-5096  
 Mkt'g: Jim Giordano  
 Products: microprocessor, modular,  
 rack-mount

Sunn Musical Equipment Corporation  
 1130 Columbia Street  
 Brea, CA 92621  
 (714) 990-0909, 800-854-6230, FAX#  
 714-990-3986  
 Pres.: Bill Schultz  
 Director of Mkt'g: Joe Green

Products: combo, portable, powered, theatrical

TAC/Amek Consoles, Inc.  
10815 Burbank Blvd.  
N. Hollywood, CA 91601  
(818) 508-9788

Tascam (TEAC Professional Division)  
7733 Telegraph Road  
Montebello, CA 90640  
(213) 726-0303, FAX# 213-725-1994  
Mkt'g Mgr.: Bill Mohrhoff  
Nat'l Sales Mgr.: Gregg Hildebrandt  
W. Reg. Mgr.: Fred Allard  
S. Reg. Mgr.: Bill Stevens  
E. Reg. Mgr.: Chuck Prada  
Products: combo, portable, production, recording

Television Technology Corp.  
PO Box 1385 Broomfield, CO  
80020-8385  
(303) 665-8000, FAX# 303-673-9900  
Pres.: William J. Kitchen  
Exec. V.P.: Michael Lehrman  
V.P. Mkt'g: Dirk Freeman  
Low Power Sls Mgr.: Marvin Berdemeier  
Radio Sls Mgr.: Gordon Allison  
Sales Admin.: Alex De Lay  
Products: broadcast

Trident Audio USA  
2720 Monterey St., Ste. 403  
Torrence, CA 90503  
(213) 533-8900  
Pres.: Wayne D. Freeman  
Sales Mgr.: Lon LeMaster

## UREI

8500 Balboa Blvd.  
Northridge, CA 91329  
(818) 893-8411, FAX# 818-893-3639  
Pres.: Ron Means  
V.P. Sales: Ken Lopez  
V.P. Mkt'g: Mark Gander  
Applications Engineer: Drew Daniels  
Mkt'g Mgr. Sound Contracting: Steve Romeo

Neil Conly, Bedford, TX, 817-540-3066  
Bill Hamilton, Folsom, PA, 215-543-4677  
Steve Armstrong, Northridge, CA, 818-707-2529  
Tom Walter, Barrington, IL, 312-382-4925  
Products: broadcast

## UNIVERSITY SOUND, ELECTRO VOICE, INC.

600 Cecil St  
Buchanan, MI 49107  
(616) 695-6831  
Pres.: Robert D. Pabst  
V.P. Sales and Mkt'g: Paul McGuire  
Chief Engineer: Alan Watson  
Mkt'g Mgr./Comm. Products: W. Douglas Wilkens  
George M. Conneen Co., Inc.,  
Springfield, PA, 215-544-5884  
Metropolis Audio Marketing, Inc.,  
Edison, NJ, 201-225-0085  
R.J. Marketing Ltd., Rockville, MD,  
301-251-0330  
The Smith Company, Hartford, CT,  
203-523-0512  
Ron Tunks Sales, Inc., Tamarac, FL,  
305-722-2803  
Wilson Audio Sales, Nashville, TN, 615-646-4477  
Audio Resources, Westmont, IL, 312-655-1180  
B.C. Electronic Sales, Inc., Mission, KS, 913-262-1720  
Jones Audio Sales, Plano, TX, 214-867-0202  
C.L. Pugh & Assoc., Inc., Columbus, OH, 614-486-9678  
Riley & Petchell Sales, Inc., Detroit, MI, 313-937-3000  
Loppnow & Assoc., Redmond, WA, 206-883-3205  
Radon & Assoc., Sacramento, CA, 916-923-2524  
Silver Peak Marketing Ltd., Wheat Ridge, CO, 303-467-9042  
Western Audio Sales, Glendale, CA, 818-246-3806  
Products: combo, monitor, portable

Vidicraft, Inc.  
0704 SW Bancroft Street  
Portland, OR 97201  
(503) 223-4884, 800-547-1491, FAX# 503-243-1995  
General Mgr.: Steve Johnson  
Nat'l Sales Mgr.: Dave Landis  
Product Mgr.: Glenn Olson  
Products: recording

Ward-Beck Systems Ltd.  
841 Progress Ave.  
Scarborough, Ontario, Canada M1H 2X4  
(416) 438-6550, FAX# 416-438-3865  
Pres.: Ronald W. Ward  
V.P.: Rodger K. Beck  
Dir. of Engineering: Arthur A. Schubert, Jr., P. Eng.  
Canadian Sales Mgr., Eugene L. Johnson  
Sales Cdr.: Sylvia Fantin-Napper

Wheatstone Corporation  
6720 VIP Parkway  
Syracuse, NY 13211  
(315) 455-7740, FAX# 315-454-8104  
Pres.: Gary Snow  
V. P.: Andrew Calvanese  
Engineer: Michael Shane  
Salesman: Tim Guhl  
Mkt'g Coordinator: Pattye Bagshaw  
Products: automatic, broadcast, custom, modular, monitor, production, recording

## PROFESSIONAL AUDIO DIVISION, YAMAHA MUSIC CORPORATION, USA

PO Box 6600  
6600 Orangethorpe Ave.  
Buena Park, CA 90622  
(714) 522-9011, FAX# 714-739-2680  
Products: automatic, broadcast, combo, compressor/leveler, computer controlled, digital, disco, MIDI, modular, monitor, powered, rack-mount, recording, theatrical



# SIGNAL PROCESSING

## AUDIO SIGNAL PROCESSORS

ADA Signal Processors, Inc.  
7303 Unit D Edgewater Dr.  
Oakland, CA 94621-3095  
(415) 632-1323, 800-241-8888, FAX#  
415-632-9358

V.P.: Lorry Marcus  
Sales Mgr.: Dave Gonden  
Sales Rep: Eric Schultheis  
Products: automatic equalizers,  
preamps, digital effects, digital  
delays, digital signal processors,  
equalizers, graphic equalizers, octave  
equalizers

AKG Acoustics, Inc.  
77 Selleck St  
Stamford, CT 06902  
(203) 348-2121, 800-243-7885, FAX#  
203-324-1947

Pres.: S. Richard Ravich  
V.P./Operations: Derek Pilkington  
V.P./Finance: Robert Netter  
Tech Sls Coordinator: Timothy  
Derwallis  
Products: digital effects, digital reverbs,  
digital delays, digital signal  
processors

AMS/Calrec (AMS Industries, Inc.)  
PO Box 31864  
3827 Stone Way N.  
Seattle, WA 98103  
(206) 633-1956, FAX# 206-547-6890  
Mkt'g Director: Nigel Branwell  
Service Mgr.: Graham Murray  
Credit Mgr.: Kathleen Mallory  
Products: audio/video synchronizers,  
digital effects, digital reverbs, digital  
delays, digital signal processors

ART—Applied Research and Technology,  
Inc.  
215 Tremont St  
Rochester, NY 14808  
(716) 436-2720, FAX# 716-436-3942  
Pres.: Philip Betette  
V.P. Sales & Mkt'g: Peter Beverage  
V.P. Manuf.: John Langlois

V.P. Engineering: Tony Gambacurta  
V.P. Engineering: Richard Neatrou  
Products: 1/3 octave equalizers,  
automatic equalizers, preamps, digital  
effects, digital reverbs, digital delays,  
equalizers, graphic equalizers

Advanced Music Systems  
Billington Rd.  
Burnley, Lancashire, UK BB11 5ES  
(0282) 57011  
Managing Director: Mark Crabtree  
Sales/Mkt'g Mgr.: Stuart Nevison  
Sales Mgr.: John Gluck

Akai Professional-IMC  
PO Box 2344  
1316 Lancaster St.  
Fort Worth, TX 76113-2344  
(817) 336-5114, FAX# 817-870-1271  
Products: automatic equalizers,  
preamps

Alesis Corporation  
3630 Holdrege Ave.  
Los Angeles, CA 90016  
(213) 467-8000, FAX# 213-836-9192  
Pres.: Keith Barr  
Exec. V.P./COO: Russell Palmer  
V.P. Mkt'g: Allen Wald  
Nat'l Sales Mgr.: Ralph Goldheim  
Reg. Sales Mgr.: Ted Keffalo  
Products: 1/3 octave equalizers, digital  
effects, digital reverbs, digital signal  
processors, equalizers, noise gates,  
signal enhancers

Altec Lansing Corp.  
PO Box 26105  
Oklahoma City, OK 73126-0105  
(405) 324-5311, FAX# 405-324-8981  
Pres.: Dave Merrey  
Dir. Mkt'g Dev.: Ted Uzzle  
Nat'l Sales Mgr.: Jerry Spriggs  
Mgr., Export Mkt'g: John Sexton  
Nat'l Accts Mgr.: Tim Smith  
Technical Svces Mgr.: Gary Jones  
Products: 1/3 octave equalizers,

ambient noise controlled level  
controllers, crossovers, equalizers,  
compressors, graphic equalizers,  
limiters

Aphex Systems Ltd.  
13340 Saticoy St. N.  
N.Hollywood, CA 91605  
(818) 765-2212, 800-762-7349, FAX#  
818-765-3912  
Pres.: Marvin Caesar  
V.P. Engineering: Donn Werrbach  
Director of Mkt'g: Paula Lintz  
Sales: Julie Molnar

Apogee Electronics Corp.  
1517 20th ST  
Santa Monica, CA 90404  
(213) 828-1930, FAX# 213-828-9720  
Mkt'g Director: Grace N. Gehman  
Products: digital signal processors

# ASHLY

**ASHLY AUDIO, INC.**  
100 Fernwood Ave.  
Rochester, NY 14621  
(716) 544-5191, 800-828-6308, FAX#  
716-266-4589  
Pres.: William Thompson  
Senior V.P.: Bob French  
V.P.: David Malloy  
Office Mgr.: Ellen Price  
Products: 1/3 octave equalizers,  
crossovers, de-essers, equalizers,  
compressors, graphic equalizers,  
limiters, noise gates, notch filters,  
parametric equalizers

Audio Digital, Inc.  
1000 South Bertelsen Rd., Suite #4  
Eugene, OR 97402  
(503) 687-8412, 800-423-1082, FAX#  
503-687-0632

Pres./Dir. of Engineering: Gary Hardesty  
Office Mgr.: Kathleen Gallagher  
Products: ambient noise controlled level controllers, audio/video synchronizers, digital encoding, digital delays, digital signal processors, limiters

Audio Logic  
5639 S. Riley Lane  
Salt Lake City, UT 84107  
(801) 268-8400, 800-453-7484, FAX# 801-262-4966  
Pres.: John Johnson  
V.P.: David O. DiFrancesco  
Finances: Jay Fuller  
Int'l East: Wayne Morris  
Western Sales: Scott Grow  
Communications: Dean Stubbs  
Products: 1/3 octave equalizers, crossovers, de-essers, digital effects, digital delays, equalizers, compressors, graphic equalizers, limiters, noise gates, signal enhancers

Audio Systems Company  
PO Box 1174  
1815 Michigan Ave.  
Bismarck, ND 58502  
(701) 223-3800, 800-852-6522  
Pres.: Lynn Mader  
V.P.: Lyle Mader  
Sales Mgr.: Mark Schmidt  
Products: ambient noise controlled level controllers, automatic equalizers, preamps, VCAs

Azden Corporation  
147 New Hyde Park Road  
Franklin Square, NY 11010  
(516) 328-7500  
Mkt'g: Den Bush

BBE Sound, Inc.  
5500 Bolsa Avenue, Suite 245  
Huntington Beach, CA 92649  
(714) 897-6766, 800-233-8346, FAX# 714-895-6728  
CEO: John C. McLaren  
CFO.: Scott Anderson  
Nat'l Sales: Jim Lucas  
Operations Mgr.: Jennifer Drescher

Director of Engineering: Robert Crooks  
Tech Svces Sup.: Ryan Coutts  
Products: signal enhancers

B.S.S. Audio  
611 Broadway  
New York, NY 10012  
(212) 460-9940, FAX# 212-460-9947  
Mkt'g: Dan Abelson  
V.P.: Dave Talbot  
Products: compressors, limiters, noise gates

Brooks Electronic System Technology  
4061 E. La Palma Ave., Suite B  
Anaheim, CA 92807  
(714) 630-2383, 800-323-1188, in CA 800-523-8486

CADD Creative Audio Design & Development, Inc.  
1875-D Panama St.  
Brossard, Que., Canada J4W 2S8  
(514) 466-1691, FAX# 514-672-3399  
Pres.: Pierre Pare  
Engineering Sales: Shane Morris  
Engineering Sales: Denis Lambert

## WE INTERRUPT THIS MAGAZINE...



Security cover available.

**...For the world's first fully-reliable, easy-to-install automatic ambient sensing level controller.**

# Symetrix

From sedate hotel lobbies to noisy factory floors, the problem's the same: Announcements and music are either too loud or too soft (and some unauthorized person is always reaching for the gain control). Previous attempts to solve the problem were either a pain to calibrate or ran away on their own at the worst possible moment.

The new Symetrix 571 SPL Computer installs in minutes without test gear. And then uses internal microprocessor software to monitor ambient sound level like a sharp on-site operator: It instantaneously and accurately differentiates between ambient noise and music/paging signals. And then makes smooth, automatic, *error-free* gain adjustments.

The 571 includes a full-function paging controller with balanced mic and line level paging inputs, music input and page-over music capability. Even variable averaging times and noise-to-gain ratio.

Call Doug Schauer for a detailed Symetrix 571 brochure today.

Unless you specialize in mortuary installations.

We now return you to this magazine.

(206) 282-2555  
4211 24th Avenue West  
Seattle, Washington 98199  
TELEX 703282 SYMETRIX UD

Distributed in Canada by S.F. Marketing (514) 733-5344.

Signal processing at its best

# SUPERNATURAL CONTROL



ature doesn't recognize the ISO centers on graphic equalizers. But with the GE 30 Interpolating Constant-Q Equalizer you maintain proven constant-Q filter performance between ISO centers when two sliders are activated simultaneously. Interaction and unwanted side-effects are minimized.

You'll never have to bother making decisions about boost/cut or cut-only, direct or transformer coupled outputs, terminal strips or three-pin connectors. The GE 30 gives you all these options with the push of a button. Even a steel security cover is standard.

The power of two conventional equalizers in one. Meet your acoustical challenges with the super-natural control of the Rane GE 30.

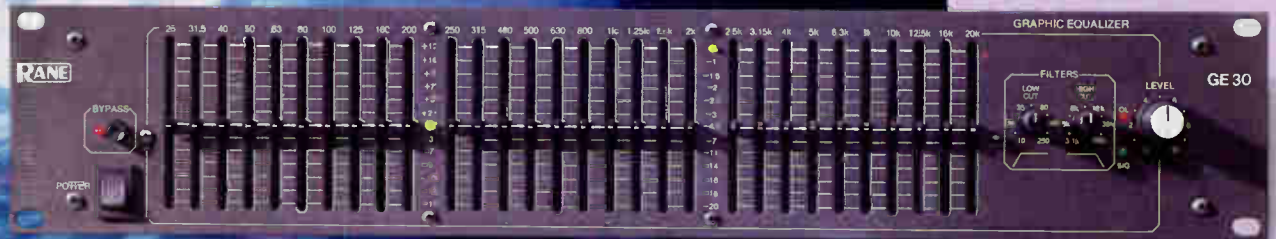

## RANE

Rane Corporation  
10802-47th Ave. W.,  
Everett, WA 98204.  
(206)355-6000.



Products: de-essers, digital signal processors

## Carvin Corp.

1155 Industrial Ave.  
Escondido, CA 92025  
(619) 747-1710

## Cetec Ivie

1366 West Center St.  
Orem, UT 84057  
(801) 224-1800, FAX# 801-224-7526  
Pres.: Craig Berry  
V.P.: Joel Zabriskie  
Mkt'g Mgr.: Glen Meyer  
Product Engineering Mgr.: Larry Driskill  
Production Mgr.: Bob Greene  
Products: 1/3 octave equalizers, crossovers, equalizers, compressors, graphic equalizers, limiters, notch filters, octave equalizers, VCAs

## Chandler Industries, Inc.

590 19th St.  
San Francisco, CA 94107  
(415) 626-1742, FAX# 415-626-0671  
CEO: Paul Chandler  
V.P.: Adrian Chandler  
Credit Mgr.: Leisa Mock  
East Coast Rep: Michael Rain  
West Coast Rep: Ross Wright  
Customer Service: Chris Chandler  
Products: automatic equalizers, preamps, signal enhancers

## Circuit Research Labs, Inc.

2522 W. Geneva Dr.  
Tempe, AZ 85282  
(800) 535-7648  
Mkt'g Director: Ray Updike  
Sales Mgr.: Bob Richards

## Clarity

Nelson Lane  
Garrison, NY 10524  
(914) 424-4071, FAX# 914-424-3467  
Pres.: Gregory Kramer  
Mkt'g & Sales Mgr.: Colleen Donnelly  
Mkt'g Mgr.: Terry Tegarden  
Products: interface units

## Clarity, A Division of Valcom, Inc.

1111 Industry Ave. SW  
Roanoke, VA 24013  
(703) 982-7003, 800-962-6009, FAX# 703-982-7032  
Products: equalizers

## Creative Audio Design & Development

1875 Rue Panama, Suite D  
Brossard, Que., CD J4W2S8  
(514) 672-8862, FAX# 514-672-3399  
Pres.: Pierre Pare  
V.P. Engineering: Shane Morris  
Engineering R&D: Denis Lambert

## DAX Audio Group, Inc.

1231 S.E. Gideon St.  
Portland, OR 97202  
(503) 232-4445  
Pres.: Rich Stevenson  
Engineering Mgr.: Bob Herb  
dbx, Div. of BSR North America, Ltd.  
PO Box 100C  
71 Chapel St.  
Newton, MA 02195  
(617) 964-3210, FAX# 617-527-5288  
Nat'l Sales Mgr.(Pro): Scott Berdell  
Int'l Sales Mgr.: Ilisa Aronow  
OEM Sales Engineer: Ken Nevard  
V.P. Mkt'g: John Stiernberg  
Sr. Product Specialist: Bob Accettullo  
Pres.: Mike Kelly  
Products: 1/3 octave equalizers, automatic equalizers, preamps, de-essers, digital signal processors, equalizers, compressors, graphic equalizers, limiters, noise gates, notch filters, parametric equalizers, octave equalizers, signal enhancers, VCAs

## DOD Electronics Corp.

5639 South Riley La.  
Salt Lake City, UT 84107  
(801) 268-8400, 800-453-7484, FAX# 801-262-4966  
Pres.: John Johnson  
V. P.: David DiFrancesco  
Finances: Jay Fuller  
Int'l: Wayne Morris

Western Sales: Scott Grow  
Communications: Dean Stubbs  
Products: 1/3 octave equalizers, crossovers, digital delays, equalizers, compressors, graphic equalizers, limiters, signal metering

## Digitech

5639 South Riley Lane  
Salt Lake City, UT 84107  
(801) 268-8400, 800-453-7484, FAX# 801-262-4966  
Pres.: John Johnson  
V.P. Engineering: David O. DiFrancesco  
V.P. Finance: Jay Fuller

## Int'l Mkt'g: Wayne Morris

Western Sales: Scott Grow  
Corp. Communications: Dean Stubbs  
Products: digital effects, digital reverbs, digital delays, digital signal processors

## Dolby Laboratories, Inc.

100 Potero Ave.  
San Francisco, CA 94103  
(415) 558-0200  
Chairman: Ray Dolby  
Pres.: Bill Jasper  
V.P.: Ioan Allen  
V.P. Sales & Mkt'g.: Ed Schummer  
US Sales Mgr.: George Douglas

## Dorrough Electronics

5221 Collier Place  
Woodland Hills, CA 91364  
(818) 999-1132, FAX# 818-379-1292  
Pres.: Mike Dorrough  
Mkt'g Mgr.: Susan Bauch  
Sales Mgr.: John Churchill  
Products: compressors, limiters, signal metering

## Eddcor

1948 East Pomona  
Santa Ana, CA 92705  
(714) 648-0292, 800-854-0259, FAX# 714-648-0117  
Pres.: Larry Weston  
Office Mgr.: Phyllis Weston  
Sales Mgr.: Deanna Weston  
Products: 1/3 octave equalizers, ambient noise controlled level controllers, equalizers, compressors, noise gates, octave equalizers, VCAs

## Edge Distribution, Inc./Turbosound

611 Broadway, #841  
New York, NY 10012  
(212) 460-9940, FAX# 212-460-9947  
Pres.: Alan Wick  
V. P. Sales/Mkt'g: Dan Abelson  
V. P. Electronic Prod.: Dave Talbot  
Applications Engineer: Tim Kalliches  
Western Audio Sales, Glendale, CA, 818-246-3806  
Applied Audio Marketing, Asheville, NC, 704-252-9313  
Michael Chafee Assoc., Sarasota, FL, 813-921-4294  
Tenicki and Assoc., Houston, TX, 713-528-2005

Audio Assoc., Baltimore, MD, 301-854-6122

Northmar, Seattle, WA, 206-524-5170  
Steffey Marketing, Northbrook, IL, 312-480-3575

Jamm Distributing, Matteson, IL, 312-747-6363

AMH Sales, Denver, CO, 303-429-2203

Editron USA, Inc.  
748 N. Seward St.  
Hollywood, CA 90038  
(213) 464-8723

Electro-Voice, Inc.  
600 Cecil Street  
Buchanan, MI 49107  
(616) 695-6831, 800-527-6701, FAX# 616-695-1304

Pres.: Robert D. Pabst  
V.P. Sales & Mkt'g: Paul McGuire  
Director of Mkt'g: Jim Long  
Chief Engineer: Earl Harris

George M. Conneen Co., Inc.,  
Springfield, PA, 215-544-5884

Metropolis Audio Marketing, Inc.,  
Edison, NJ, 201-225-0085

R.J. Marketing Ltd., Rockville, MD,  
301-251-0330

The Smith Company, Hartford, CT,  
203-523-0512

Ron Tunks Sales, Inc., Tamarac, FL,  
305-722-2803

Wilson Audio Sales, Nashville, TN, 615-646-4477

Audio Resources, Westmont, IL, 312-655-1180

B.C. Electronic Sales, Inc., Mission,  
KS, 913-262-1720

Jones Audio Sales, Plano, TX, 214-867-0202

C.L. Pugh & Assoc., Inc., Columbus,  
OH, 614-486-9678

Riley & Petchell Sales, Inc., Detroit, MI,  
313-937-300

Loppnow & Assoc., Redmond, WA,  
206-883-3205

Radon & Assoc., Sacramento, CA,  
916-923-2524

Silver Peak Marketing Ltd., Wheat  
Ridge, CO, 303-467-9042

Western Audio Sales, Glendale, CA,  
818-246-3806

Products: crossovers, graphic  
equalizers

## ELTREX INTERNATIONAL

2 Columbia Dr.  
Amherst, NH 03031  
(603) 886-3500, 800-432-7631, FAX#  
603-886-3508

Sales Mgr.: Bill Ryan  
Products: digital delays, VCAs

Eventide, Inc.  
One Alsan Way  
Little Ferry, NJ 07643  
(201) 641-1200, FAX# 201-641-1640  
Sales Mgr.: Gil Griffith  
Pres.: Richard Factor

Products: digital effects, digital reverbs,  
digital delays, digital signal  
processors, compressors, limiters,  
noise gates, signal enhancers

Fostex Corp. of America  
15431 Blackburn Ave.  
Norwalk, CA 90650  
(213) 921-1112, FAX# 213-802-1964  
Pres.: Y. Abe  
Exec. V.P./General Mgr.: Fred Huang  
V.P. Sales/Mkt'g: Mark Cohen  
Products: audio/video synchronizers,  
crossovers, graphic equalizers

## Phantom Flexibility

**S**tewart Electronics Phantom Power Supplies deliver a true +48 volts to mics, direct boxes or any other devices requiring phantom power. And they operate balanced or unbalanced. You can get a Stewart Phantom Power Supply for one to six outputs. Each channel features short circuit protection, isolated outputs, individual regulation of each channel, very low noise and crosstalk. Best of all, the system is expandable so you can operate up to 12 channels using one 24v power supply.

Like all Stewart Electronics products, the Phantom Power Supplies are reliable. Less than 0.2% of Stewart products have ever required servicing. These are the highest quality, best priced supplies on the market to give your jobs a little extra margin as well as flexibility.

## Stewart

ELECTRONICS

11460 Sunrise Gold Circle  
Rancho Cordova, CA 95742  
(916) 635-3011



Designed and manufactured in the U.S.A.  
© 1988 Stewart Electronics.

# The difference between hearing most of the music and all of it.



It's a vital difference. Especially if you're an engineer, musician, vocalist, composer, producer or broadcaster.

## **BBE Makes The Difference**

And the difference is heard around the world. In leading recording studios, at major live concerts, and by audiences of top-rated radio stations.

## **What's The BBE Difference?**

We make an exclusive line of audio processors. For all audio uses. Professional. Personal. Industrial. Wherever sound is involved, so are we.

Our technology restores the proper harmonic structure of sound by compensating for amplitude and phase distortion.

## **What's The Result?**

You won't believe it. You literally will hear nothing like it. That's because instead of hearing most of the music, you'll hear all of it.

## **How Is It Done?**

Well, we began 10 years and 42 patent claim awards ago. But simply, the BBE SYSTEM:

- Divides the audio spectrum into three bandwidths
- Applies specific phase corrections to each band
- Makes dynamic high-frequency amplitude compensations as required

## **What Do The Experts Say About BBE?**

"The most hearable advance in audio technology since high fidelity itself."— *Music Connection Magazine*

"The effect is shattering!"— *Music Technology Magazine*

"I can't imagine working on another album without BBE."— *Steve Levine, producer of The Beach Boys, Culture Club, Denice Williams, and BPI Producer of the Year*

"The difference in (BBE) processed audio and non-processed audio is like the difference between high-fidelity speakers with and without pillows placed in front of them."— *Radio World Magazine*

"For my own personal system, it was the answer to problems I had been trying to solve with a graphic equalizer. The system has never sounded so good."— *Mix Magazine*

"You're in aural heaven."— *Music & Sound Output Magazine*

## **Full Warranty**

All BBE products are backed by a full year's warranty on all parts and labor.

## **Where Can You Hear The BBE Difference?**

For the name of the BBE professional sound dealer nearest you call toll free 1-800-233-8346. In California 1-800-558-3963.

Then stop by. You'll love what you hear. All of it.

**BBE**  
**Sound Inc.**

5500 Bolsa Avenue  
Suite 245  
Huntington Beach, CA 92649  
(714) 897-6766



# The Ultimate in Analyzers and Equalizers Designed for the Audio Professional



## MODEL 4400 - ONE-THIRD OCTAVE L-C ACTIVE EQUALIZER

*Our flagship, and quite possibly, the finest one-third octave equalizer in the world.*

28 one-third octave, single-tuned, L-C active filters on I.S.O. centers from 31.5 Hz through 16 kHz. Boost or cut 10dB via continuously variable, calibrated, rotary potentiometers. High-

pass and low-pass filters continuously variable, 12 dB/octave. Active balanced input. 3 single-ended outputs. Optional plug-in BI-AMP or TRI-AMP crossover networks, noise generators and isolation transformers. 3 front panel level trimmers.

Specifications: unity gain; noise -92 dBv (20 kHz bandwidth); distortion less than 0.2% THD (worst case); frequency center tolerance  $\pm 3\%$ ; 115/230 vac 50/60 Hz operation; barrier strip connectors; black brushed finish with white nomenclature; matching metal security cover furnished.

*Specify Excellence*

*Specify White*

## MODEL 4650 - ONE-THIRD OCTAVE R-C ACTIVE EQUALIZER

Features linear controls. 28 one-third octave, single-tuned, R-C active filters on I.S.O. centers from 31.5 Hz through 16 kHz. Boost or cut 12dB via continuously variable, calibrated, 60mm, linear potentiometers with center detents.

Fixed 12 dB/octave roll-off filters at 16 Hz and 35 kHz. EQ in/out switch. Single bi-color LED metering indicates power, headroom and clipping. Optional input and output isolation transformers.



Specifications: unity to 10dB gain, adjustable; noise -82 dBv (20 kHz bandwidth); distortion less than 0.05% THD (worst case); frequency center tolerance  $\pm 5\%$ ; XLR and TRS connectors; 115/230 vac 50/60 Hz operation; black brushed finish with white nomenclature; matching metal or clear security cover optional.

## MODEL 4660 - ONE-THIRD OCTAVE R-C ACTIVE EQUALIZER

Same features and specifications as Model 4650. Also includes continuously variable, 12dB/octave high and low-pass filters.



## MODEL 4675 - TWO-THIRDS OCTAVE TWO CHANNEL, R-C ACTIVE EQUALIZER

Linear Controls. Each channel features: 14 filters on I.S.O. two-thirds octave centers from 40 Hz through 16 kHz; Boost or Cut 12dB via continuously variable, calibrated, 60mm, linear potentiometers with center detents.

EQ in/out switch; 12dB/octave, continuously variable high-pass filter; LED clip indicator; servo-balanced input and output may be unbalanced without termination. High current output stage to drive long lines.

*Specify Excellence*

Specifications: unity to 10dB gain; noise -82 dBv (20 kHz bandwidth); distortion less than 0.05% THD (worst case); frequency center tolerance  $\pm 5\%$ ; XLR connectors; 115/230 vac 50/60 Hz operation; black brushed finish with white nomenclature; matching metal or clear security cover optional.

## MODEL 4700 - DIGITALLY CONTROLLED ONE-THIRD OCTAVE, ACTIVE EQUALIZER

*Available by January 1989*

Plan now to specify this remarkable new product, which will feature the quality and performance you expect from White Instruments.

WHITE INSTRUMENTS • Equalizers, Analyzers, Crossovers & Filters, for Audio Professionals

Specify White



**MODEL 4500 - ONE-THIRD OCTAVE R-C ACTIVE EQUALIZER**

28 one-third octave, single-tuned, R-C active filters on I.S.O. centers from 31.5 Hz through 16 kHz. Boost or cut 10dB via continuously variable, calibrated, rotary potentiometers with center detents.

High-pass and low-pass filters are continuously variable, 12 dB/octave. Single bi-color LED metering indicates power, headroom and clipping. Single-ended input and 3 buffered outputs. Optional plug-in BI-AMP or TRI-AMP crossover networks, noise generators and isolation transformers. 3 level trimmers. Specifications: unity gain; noise -82 dBV (20 kHz bandwidth); distortion less than 0.05% THD (worst case); frequency center tolerance  $\pm 3\%$ ; barrier strip connectors; remote 115 vac power supply included; black brushed finish with white nomenclature; matching metal security cover furnished.



**MODEL 4200A - ONE-THIRD OCTAVE L-C ACTIVE, CUT-ONLY EQUALIZER**

*Cut-only sister to the world famous Model 4400.*

Identical features and specifications with only two exceptions: Filter range is cut-only to -15dB; Up to 10dB gain is continuously adjustable.



**MODEL 4240A - ONE-SIXTH OCTAVE "VOICE RANGE", L-C ACTIVE EQUALIZER**

28 single-tuned, L-C active filters on I.S.O. centers including 19 one-sixth octave filters between 250 and 2000 Hz and 9 broader, *end shaping* filters.

Design optimizes equalization of systems where *SPEECH* is the prime program material.

Boost or cut 10dB via continuously variable, calibrated, rotary potentiometers. High-pass and low-pass filters continuously variable, 12 dB/octave. Active balanced input. 3 buffered outputs. Optional plug-in BI-AMP or TRI-AMP crossover networks, noise generators and isolation transformers. 3 front panel level trimmers. Specifications: unity gain; noise -92 dBV (20 kHz bandwidth); distortion less than 0.2% THD (worst case); frequency center tolerance  $\pm 3\%$ ; 115/230 vac 50/60 Hz operation; barrier strip connectors; black brushed finish with white nomenclature; matching metal security cover furnished.



**MODEL 4301A - ONE-SIXTH OCTAVE "SMALL ROOM" L-C ACTIVE EQUALIZER**

42 single-tuned, L-C active filters on I.S.O. centers including 28 one-sixth octave filters between 40 and 900 Hz and 14 one-third octave filters at 31.5 Hz and 1 kHz through 16 kHz.

Design optimizes equalization of systems where greater *LOW* frequency resolution is required.

Boost or cut 10dB via continuously variable, calibrated, rotary potentiometers. High-pass and low-pass filters continuously variable, 12 dB/octave. Active balanced input. 3 buffered outputs. Optional, plug-in BI-AMP or TRI-AMP crossover

networks, noise generators and isolation transformers. 3 front panel level trimmers. Specifications: unity gain; noise -92 dBV (20 kHz bandwidth); distortion less than 0.2% THD (worst case); frequency center tolerance  $\pm 3\%$ ; 115/230 vac 50/60 Hz operation; barrier strip connectors; black brushed finish with white nomenclature; matching metal security cover furnished.

**MODEL 4310A - ONE-SIXTH OCTAVE "LARGE ROOM" L-C ACTIVE EQUALIZER**

42 single-tuned, L-C active filters on I.S.O. centers including 29 one-sixth octave filters between 180 Hz and 4.5 kHz and 11 one-third octave filters from 31.5 Hz through 160 Hz and 5 through 10 kHz plus 2 two-thirds octave filters centered at 12.5 and 16 kHz.

Design optimizes equalization of systems where greater *MID* frequency resolution is required.

Other features, functions and specifications are identical to Model 4301A.



### MODEL 4100A - TWO CHANNEL OCTAVE BAND, L-C ACTIVE EQUALIZER

Two separate channels sharing only the power supply. 10 octave band, single-tuned, L-C active filters on I.S.O. centers from 31.5 Hz through 16 kHz. Boost or cut 10 dB via continuously variable, calibrated, rotary potentiometers. High-pass filters continuously variable from 20 Hz through 160 Hz at 12 dB/octave. Continuously variable input level controls attenuate the signal up to 20 dB after the balanced input amplifiers for stereo balancing. Peak signal detectors for each channel light LED indicators 2 dB from maximum rated output. EQ in/out switches. 2 outputs (each channel) for BI-AMP



operation (with installation of optional crossover). 2 accessory sockets for optional input/output transformers and crossover networks. Specifications: unity gain; noise -92 dBv (20 kHz bandwidth); distortion less than 0.2% THD (worst case); frequency center tolerance  $\pm 6\%$ ; 115/230 vac 50/60 Hz operation; barrier strip connectors; black brushed finish with white nomenclature; matching metal security cover furnished.

### MODEL 4320 - ONE-THIRD OCTAVE PASSIVE EQUALIZER, 0/10k OHM

No matching loss when driven by 0 ohms and terminated by 10,000 ohms. 27 one-third octave, single-tuned, L-C filters on I.S.O. centers from 40 Hz through 16 kHz. Cut to -10dB via continuously variable, calibrated, rotary potentiometers. Accessory socket for optional low-level crossover networks. 2 outputs for BI-AMP operation. EQ in/out switch. Barrier strip connectors. Black brushed finish with white nomenclature. Matching metal security cover furnished.



### MODEL 4520 - ONE-THIRD OCTAVE PASSIVE EQUALIZER, 600/600 OHM

Same as Model 4320 except that this unit requires a 600 ohm input and output matching link.

### MODEL 4220 - OCTAVE BAND PASSIVE EQUALIZER, 0/10k OHM

No matching loss when driven by 0 ohms and terminated by 10,000 ohms. 9 octave band, single-tuned, L-C filters on I.S.O. centers from 63 Hz through 16 kHz. Cut to -10dB via continuously variable, calibrated, rotary potentiometers. Accessory socket for optional low-level crossover networks. 2 outputs for BI-AMP operation. EQ in/out switch. Barrier strip connectors. Black brushed finish with white nomenclature. Matching security cover furnished.



### MODEL 4420 - OCTAVE BAND PASSIVE EQUALIZER 600/600 OHM

Same as Model 4220 except that this unit requires a 600 ohm input and output matching link.

### SYSTEM 200 SIGNAL ANALYZER

Microprocessor controlled. Software dependent features and functions. Interchangeable filter sets. Processes 45dB dynamic range in peak and average modes simultaneously. 3 smoothing time constants. 2 multi-function, 7-segment, LED displays. 15 by 30 LED filter matrix plus separate overrange, broadband level and dBm/dB-spl readouts. 1, 2, and 3dB per light scales. 8 nonvolatile memories store real time snapshots or accumulations. Built-in pink noise generator. Oscilloscope and X-Y plotter outputs. 15 volt microphone powering. T<sub>60</sub> function



produces 3 different reverb time extrapolations and averages up to 16 successive measurements. Optional 5-function signal generator, RS-232 port and extended memory capability plug-in cards. 115/230 vac 50/60 Hz operation.

*Specify Excellence*

### MODEL 140 - ONE-THIRD OCTAVE SOUND ANALYZER

27 double-tuned, one-third octave filters on I.S.O. centers from 40 Hz through 16 kHz. 27 by 10 LED filter display plus separate broadband and overrange displays. 1 and 2dB per light resolution. Built-in pink noise generator. Microphone and line level inputs. Display position vernier. Sync and log amplifier outputs for remote oscilloscope display. Rugged, ATA road case



included. Meets A.N.S.I. S1.11-1971 Class II Specifications. 115/230 vac 50/60 Hz operation. 14 year worldwide track record for reliability.



**MODEL 141A - MICROPHONE MULTIPLEXER**

Time shares the outputs of three dynamic or self-powered microphones spaced across a room and presents a single line level input to a real time analyzer. The result is an average spectral display of the three signals. This saves a great deal of time which would be spent *walking the room* with a sound level meter or real time analyzer. Battery powered by 1 nine volt battery. Three microphone inputs via XLR connectors. Level adjustments aided by LED meter. Battery condition button. Multiplex or single microphone operation modes. Line level, low impedance output via XLR and parallel binding posts.



**LOW-LEVEL CROSSOVER NETWORKS and FILTERS FOR AUDIO APPLICATIONS**

Standard products include BI-AMP and TRI-AMP, low-level crossover networks with 12, 18 or 24dB/octave responses. We also have crossover networks optimized for use with constant directivity horns. These crossovers may be used as plug-in accessories for our equalizers or in stand-alone applications. 4-way and 5-way crossover networks may be special ordered for stand-alone use.

We have hundreds of high-pass, low-pass, band-pass and notch filter designs. Most of these filters are made to order. Please write or phone to discuss your particular application or to order our bulletin, *Filters for Audio Applications*.

**SYSTEM 3900 - NARROW BAND NOTCH FILTERS PASSIVE 600/600 OHMS**

202 fixed frequency filters from 50 Hz through 2400 Hz constitute the master System 3900 test-set. Filters are left on the job in the 3900-1 manifold and replaced in the master set later. Sound system feedback and room ring modes are attenuated using notch filters having extremely narrow bandwidths. Thus, very little program material is affected. Being passive, the filters do not add random noise to the audio signal as do tunable, active notch filters. The filters are designed to operate in a 600/600 Ohm impedance link. System 3900 may be rented from White Instruments. Please write or call for additional information.



**MODEL 151 - PORTABLE PINK NOISE GENERATOR**

Digitally generated pink noise, 20 Hz through 20 kHz. Word Length 268,000,000 bits. Clock Rate 100 kHz. Battery operated: 30 hours with 1 nine volt battery. LED battery condition indicator. Microphone level output 10 mVrms into 600 ohms. Line level output 0.39 Vrms into 600 ohms. RCA connectors. Size 2.25" by 3.75" by 1.375".

**MODELS 4262A, 4464A and 4533A**

Designed to plug into most of our active equalizers and turn them into masking noise generators for use in *SPEECH PRIVACY* systems. Model 4464A is the most commonly used pink noise generator. Model 4262A includes a variable low-pass filter. Model 4533A can be switched between pink and white noise.



P.O. BOX 698, AUSTIN, TEXAS 78767  
 TELEX: 776409 WHITE INST AUS • (512) 892-0752  
 FAX: (512) 892-0855

Furman Sound, Inc.  
 30 Rich St.  
 Greenbrae, CA 94904  
 (415) 927-1225, FAX# 415-927-4548  
 Pres.: Jim Furman  
 V.P.: Susan Furman  
 Nat'l Sales Mgr.: Joseph Desmond  
 Chief Engineer: Jim Murphy  
 Operations Mgr.: Ed Specht  
 Products: crossovers, equalizers,  
 compressors, noise gates, parametric  
 equalizers

(203) 938-2588, FAX# 203-938-8740  
 Pres.: Martin E. Miller  
 V.P. Mkt'g: Marj Miller

Heil Ltd.  
 2 Heil Drive  
 Marissa, IL 62257  
 (618) 295-3000

IED Innovative Electronic Designs, Inc.  
 9701 Taylorsville Rd  
 Louisville, KY 40299  
 (502) 267-7436, FAX# 502-267-9070  
 V.P. Mkt'g & Sales: Tom Roseberry  
 Mkt'g Assistant: Wanda R. Martin  
 Pres.: Hardy Martin  
 Sec./Treas.: Ray Allen  
 V.P. R & D: Robert Ponto  
 Derek Allen Assoc., Toluca Lake, CA,  
 818-840-8327  
 Bensik Assoc., Ocala, FL, 904-732-  
 9775  
 Plus 4 Marketing, Pleasant Hill, CA,  
 415-937-0650

Yore Company, White Bear Lake, MN,  
 612-770-9760

Products: ambient noise controlled  
 level controllers, digital signal  
 processors, compressors, interface  
 units, noise gates, signal metering,  
 VCAs

ITT/DES, Inc.  
 20 Mayfield Ave.  
 Edison, NJ 07607  
 (201) 225-6121, 800-524-1646  
 V.P.: Donald Duthaler  
 Chief Engineer: Jeffrey Stellman

Gaines Audio  
 PO Box 17888  
 1237 E. Main Street  
 Rochester, Ny 14609  
 (716) 266-0780  
 Owner: Jon Gaines  
 Products: interface units

Industrial Research Products, Inc.  
 321 Bond St.  
 Elk Grove Village, IL 60007  
 (312) 439-3600, 800-255-6993, FAX#  
 312-640-9607  
 Pres.: Robert G. Roth  
 General Mgr.: Mahlon Burkhard  
 Mkt'g Mgr.: Roger Carroll  
 Chief Engineer: Richard Peters  
 Piper Assoc., Inc., Needham, MA, 617-  
 449-1144

Gold Line  
 PO Box 115  
 W. Redding, CT 06896

# WHEN THE TIME COMES FOR PERFECT SOUND, THERE'S ONLY ONE DELAY YOU SHOULD PUT UP WITH.

## ADD-2 ADD-3

Audio Digital sets the world's standards for precise synchronization in the most demanding acoustical environments.

The Audio Digital ADD-2, with two delay outputs, and ADD-3, with three delay outputs, bring sound perfection within easy reach.

- Microprocessor controlled and programmable from front panel in 15 microsecond increments.
- Easy to use...with the industry's only alpha-numeric display for precise settings and diagnostics.
- Rich, transparent sound quality. Low distortion and wide dynamic range.
- Competitively priced for utmost affordability.
- Reliable. UL listed. Unique security mode.

Audio Digital Inc., 1000 S. Bertelsen, Suite 4  
 Eugene, Oregon 97402 (503) 687-8412

**1-800-423-1082**

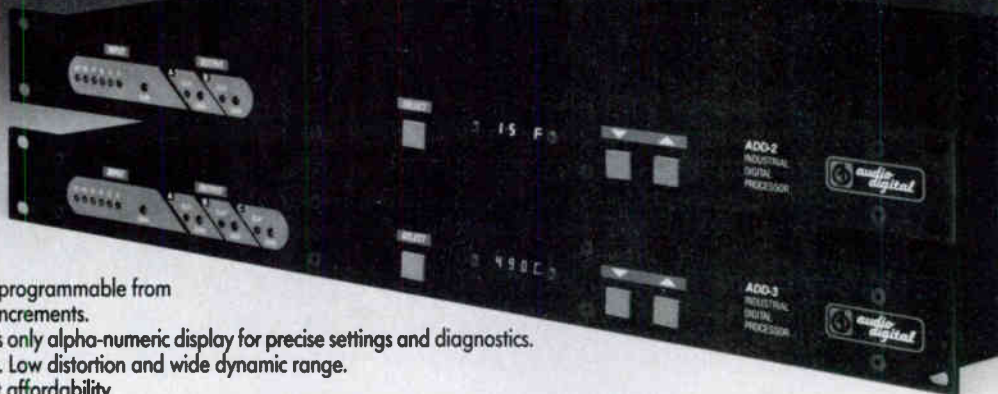



# THE IEQ WITH Smartcurve™

Not Just Another  
Programmable Equalizer  
With MIDI™

**T**he IEQ with Smartcurve™ is a programmable, high performance graphic equalizer that includes a video output. For those who wish to enjoy the video output of the IEQ, ART makes the IEQ Video Monitor.\* Smartcurve™, proprietary software developed by ART gives you instant actual frequency response as easy as the push of a button.

The IEQ Family consists of both the 2/3 octave and the 1/3 octave graphic equalizers. Both types come in two varieties, Controllers and Satellites. A Controller is a self-contained programmable intelligent graphic equalizer capable of controlling 15 satellites at once. IEQ Satellites are exactly the same unit except the front panel controls are eliminated.\*

#### IEQ Model Specifications:

##### Controller & Satellite

- 128 battery backed presets
- MIDI
- Frequency Response  
20Hz-20kHz  $\pm$  0.5dB
- THD -  $\leq$  .009% @ 1kHz, 0dBm typical
- Dynamic Range -  $\geq$  100dB typical
- Balanced inputs and outputs

##### \*IEQ Video Monitor Features

- 19" rack mountable
- NTSC compatible monochrome monitor
- 4 Selectable inputs
- Standard RCA jacks for easy connections

It Has To Be A Work Of . . .

# ART

Applied Research & Technology

215 Tremont Street  
Rochester, NY 14608  
(716) 436-2720  
TELEX: 4949793 ARTROC  
FAX: (716) 436-3942

For more information see your local dealer.

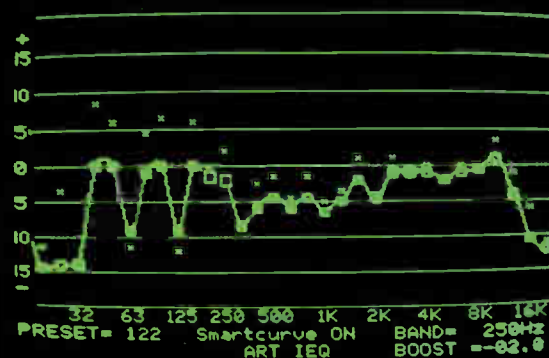
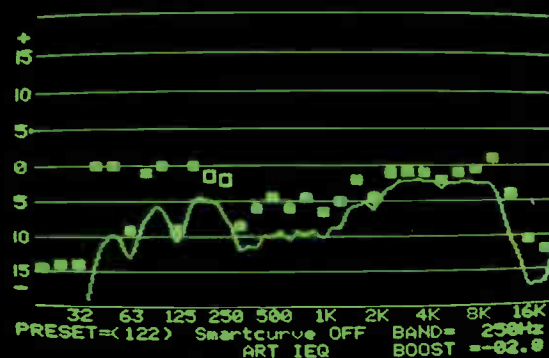
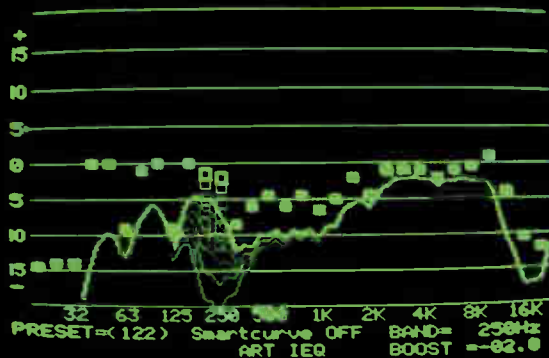

## 1 See the Sound

This is a video output of the IEQ as the unit is being adjusted. The sliders can be moved  $\pm$  15dB in 1/2dB steps to get the exact response you need. With the simple push of a button, complex equalization can be done in seconds with incredible accuracy.

## 2 Hear the Sound

The power of the IEQ readily becomes apparent as the video display plots the frequency response due to the slider setting. The IEQ offers high quality constant "Q" equalization. The video graphic display shows the correlation between the sliders and the frequency response.

## 3 Perfect Sound

Turn Smartcurve™ on and perfect equalization is at your fingertips. Note the difference between second frame, (Smartcurve™ OFF) and this frame. The position of the sliders represent the actual frequency response of the EQ. Interaction between bands is virtually eliminated. Incredible! Just think, now when you adjust the EQ you get exactly what you need. The "perfect" EQ? Let your eyes and ears decide.



World Radio History



Inovonics, Inc.  
 1305 Fair Ave.  
 Santa Cruz, CA 95060  
 (408) 458-0552  
 Pres.: James B. Wood  
 Operations Mgr.: Ann Pelz

International Music Co. (I. M. C.)  
 PO Box 2344  
 1316 E. Lancaster  
 Ft. Worth, TX 76113-2344  
 (817) 336-5114, 800-433-5627, FAX#  
 817-870-1271  
 Chairman of the Bd./CEO: Tommy  
 Moore  
 Pres.: Jerry Freed  
 V.P. Sales: C.H. Murray  
 Dir. of Akai EMI: Mike McRoberts  
 Akai Prod. Specialist: Kevin Kennedy

## JBL PROFESSIONAL

8500 Balboa Blvd  
 Northridge, CA 91329  
 (818) 893-8411, FAX# 818-893-3639  
 Pres.: Ron Means  
 V.P. Sales: Ken Lopez  
 V.P. Mkt'g: Mark Gander

Applications Engineer: Drew Daniels  
 Mkt'g Mgr./Sound Contracting: Steve  
 Romeo  
 Video Sales: Don Wilson  
 Neil Conly, Bedford, TX, 817-540-3066  
 Bill Hamilton, Folsom, PA, 215-543-  
 4677  
 Steve Armstrong, Northridge, CA, 818-  
 707-2529  
 Tom Walter, Barrington, IL, 312-382-  
 4925

Products: 1/3 octave equalizers,  
 ambient noise controlled level  
 controllers, crossovers,  
 compressors, interface units,  
 levelers, limiters, notch filters,  
 parametric equalizers, octave  
 equalizers, transcription preamps

## KDM Electronics, Inc.

705 Progress Ave., Unit #59  
 Scarborough, Ontario, Canada M7H  
 2X1  
 (416) 439-7158  
 Pres.: Ron Bull  
 Products: digital delays

Klark-Teknik Electronics, Inc.  
 30 B Banfi Plaza N  
 Farmingdale, NY 11735  
 (516) 249-3660, FAX# 516-420-1863  
 Pres.: Jack Kelly  
 Nat'l Sales Mgr.: Sam Spennacchio  
 Field Sales Mgr.: Keith Worsley  
 Products: 1/3 octave equalizers, digital  
 reverbs, digital delays, graphic  
 equalizers, parametric equalizers

## Lexicon, Inc.

100 Beaver ST.  
 Waltham, MA 02154  
 (617) 891-6790, FAX# 617-891-0340  
 Pres.: Ronald Noonan  
 Dir. of Sales: Joel Silverman  
 Advanced Prod. Sales Mgr.: Brian  
 Zolner  
 B'cast. Sales Mgr.: Lawrence Rich

## Lyntec/Technical Visuals

7030 Grandview  
 Merriam, KS 66204  
 (913) 722-4047  
 Pres.: Lynn J. Potter  
 Products: ambient noise controlled  
 level controllers



## The Patented Look of 21st Century Equalization

The tamper-proof 1/3 octave equalizer POD from MicroAudio. The  
 equalization system of the 21st century is available today



4438 S.W. Hewett  
 Portland, OR, USA 97221  
 (503) 292-8896  
 TELEX 4997744 INTR  
 800-445-1248

the "B" series combining EQ.

Marcom/The Scotts Valley Group, Inc.  
PO Box 66507  
Scotts Valley, CA 95066  
(408) 438-4273

Meyer Sound Laboratories, Inc.  
2832 San Pablo Ave.  
Berkeley, CA 94702  
(415) 486-1166, FAX# 415-486-8356  
Pres.: John Meyer  
V.P.: Helen Meyer  
Mkt'g/Sales Mgr.: Gary Hudson

Micro Audio, Inc.  
4438 S.W. Hewett  
Portland, OR 97221  
(503) 292-8896, 800-445-1248  
Pres.: Eugene B. Rimkeit  
Dir. of Engineering: Richard Schomburg  
V.P. Manufacturing: David Elsbernd  
Sales Mgr.: H.C. Garrison  
Professional Sound & Light, Lakewood, CO, 303-  
Western Audio Sales, Glendale, CA,  
Signal Marketing,  
Powerlines Marketing,  
McFadden Sales,  
Products: 1/3 octave equalizers

Numark Electronics  
503 Newfield Ave.  
Edison, NJ 08837  
(201) 225-3222, FAX# 201-287-2155  
Pres.: Harry Kotovsky  
V.P.: Robert Kotovsky  
Numark/PPD, Simi Valley, CA, 805-  
522-3550  
Products: digital effects, digital delays,  
equalizers

Orban Associates, Inc.  
645 Bryant St.  
San Francisco, CA 94107  
(415) 957-1067  
Mkt'g Mgr.: Sid Goldstein  
Products: automatic equalizers,  
preamps, de-essers, equalizers,  
compressors, graphic equalizers,  
levelers, limiters, noise gates, notch  
filters, parametric equalizers, signal  
enhancers

## **OXMOOR CORPORATION**

237 Oxmoor Circle  
Birmingham, AL 35209  
(205) 942-6779, FAX# 205-942-9633  
Pres.: Lynn A. McCroskey

Production Mgr.: Jim Watson  
Nat'l Sales Mgr.: Richard Mitchell  
Allwest Electronics, Camarillo, CA,  
805-388-1789  
Dimension IX Marketing, Dallas, TX,  
214-348-9657  
Loppnow & Assoc., Redmond, WA,  
206-883-3205  
Yore Company, White Bear Lake, MN,  
612-770-9760  
Repworks, Chicopee, MA, 413-533-  
0845  
Products: 1/3 octave equalizers,  
automatic equalizers, preamps,  
equalizers, graphic equalizers,  
levelers, octave equalizers

Panasonic Industrial Company/Ramsa  
6550 Katella Ave  
Cypress, CA 90630  
(714) 895-7278, FAX# 714-895-7242  
Nat'l Sales/Mkt'g: Steve Wooley  
Eastern Sales Mgr.: D.J. Bierut  
Central Sales Mgr.: Greg Braithwaite  
Western Sales Mgr.: James Murray  
Pusecker Sales, Upper Montclair, NJ,  
201-744-1834  
Professional Audio Associates,  
Burlington, MA, 617-229-6050  
David Prinzi, Webster, NY, 716-671-  
9266  
World Wide Electronics, Pembroke  
Pines, FL, 305-584-7024  
World Wide Electronics, Jacksonville,  
FL  
Evans Sales & Mkt'g, Nashville, TN,  
615-297-7997  
A/V Mkt'g, Carmel, IN, 317-846-1034  
Key Mkt'g, Plymouth, MI, 313-459-  
6040  
New Horizons Elec. Mkt'g,  
Bannockburn, IL, 312-234-5911  
J.B. Parent Co., Dublin, OH, 614-764-  
0064  
Music Interventions & Assoc., Kansas  
City, MO, 816-453-4448  
Tenick & Assoc., Houston, TX, 713-  
528-2005  
New West Audio, Burbank, CA, 818-  
955-9706  
Brian Trankle Assoc., Belmont, CA,  
415-595-4004  
Brian Trankle Assoc., Sacramento, CA,  
916-369-7030  
Northmar, Seattle, WA, 206-524-5170  
Pearson & Pearson, Denver, CO, 303-  
722-6996  
Products: crossovers, digital delays

Paso Sound Products  
14 First St.  
Pelham, NY 10803-1495  
(914) 738-4800, FAX# 914-738-3954  
Executive V.P.: Paul Mastrangelo  
Sales Mgr.: David Moore  
Product Mgr.: Ken Obrien  
Credit Mgr.: Marilyn Beckerson  
Operations Mgr.: Anthony Sguelgia  
All West Electronics, Camarillo, CA,  
805-388-1789  
Anderson Sales, Braintree, MA, 617-  
848-9194  
Pace Sales, Charlotte, NC, 704-365-  
3216  
De Witt Austin Co., Alpharetta, GA,  
404-442-1326  
Dowell Assoc., St. Louis, MO, 314-  
849-4234  
Mountain Representatives, Denver, CO,  
303-623-0972  
J.Y.S. Comm. Co., Dallas, TX, 214-  
349-1650  
Lienau Assoc., Inc., Columbia, MD,  
301-621-4113  
Lienau Assoc., Inc., New Town, PA,  
215-860-2100  
SLK Tech Rep, San Francisco, CA,  
415-822-4884  
Miguel Lopez, Hialeah, FL, 305-822-  
6853  
Marketline, Snellville, GA, 404-972-  
9048  
Messnick Sales, Liverpool, NY, 315-  
622-3211  
Miller Assoc., Ltd., Greenwich, CT,  
212-840-2866  
Robert Milsk Co., Inc., Southfield, MI,  
313-354-3310  
Robert Milsk Co., Indianapolis, IN, 317-  
842-3400  
Weller Electronic Sales, Worthington,  
OH, 614-885-7819  
Frank Lintern Assoc., Naperville, IL,  
312-983-0935  
Products: 1/3 octave equalizers,  
equalizers, compressors, graphic  
equalizers, octave equalizers

Peavey Electronics Corp.  
PO Box 2898  
711 A Street  
Meridian, MS 39301  
(601) 483-5365, FAX# 601-484-4278  
Prod Mgr.: Ken Valentine  
Products: 1/3 octave equalizers,  
crossovers, digital effects, digital

reverbs, digital delays, digital signal processors, equalizers, graphic equalizers

**PROTECH AUDIO CORP.**

Flowerfield, Bldg. #1  
St. James, NY 11780  
(516) 584-5855  
Sales Mgr.: Bill Murphy  
Sales Engineering: Joe Giambone  
Peregrine Rep's, Houston, TX, 713-772-6765

**QSC Audio Products, Inc.**

1926 Placentia Ave  
Costa Mesa, CA 92627  
(714) 645-2540, 800-854-4079, FAX# 714-645-7927  
Director of Mkt'g: Greg McVeigh  
Nat'l Sales Mgr.: Peter Kalmen  
Sales Engineer: Andy Murray  
Products: crossovers, equalizers, compressors, limiters, notch filters

**RSP Technologies**

1633 Star Batt Drive  
Rochester, MI 48309  
(313) 853-3055, FAX# 313-853-5937

**RANE CORP.**

10802 49th Ave. W.  
Everett, WA 98204-3400  
(206) 355-6000, FAX# 206-347-7757  
V.P. Mkt'g: Larry Winter  
Dir. Tech. Mkt'g: Terry Pennington  
Sales Coordinator: Debbie Cooksey  
Products: 1/3 octave equalizers, automatic equalizers, preamps, crossovers, digital delays, equalizers, compressors, graphic equalizers, limiters, noise gates, parametric equalizers

**Richmond Sound Design, Ltd.**

1234 West 6th Ave.  
Vancouver, Canada V6H 1A5  
(604) 734-1217, FAX# 604-734-3901  
Systems/Sales Mgr.: Damon Wootten  
Accounts Mgr.: Marilyn Williams  
Project Coordinator: Linda Pearson  
Full Compass Systems, Madison, WI,  
Products: 1/3 octave equalizers, automatic equalizers, preamps, crossovers, digital signal processors, equalizers, compressors, interface units, limiters, octave equalizers, VCAs

**Rocktron Corp./RSP Tech.**

1633 Star Batt Drive  
Rochester, MI 48309  
(313) 853-3055  
Mkt'g: Jim Chowning

**Roland Corp., US**

7200 Dominion Circle  
Los Angeles, CA 90040  
(213) 685-5141  
Pres.: Tom Beckman  
Dir. Of Communications: Nancy Kewin  
Communications: Barbi Clark

**SCV, Inc.**

1101-A Air Way  
Glendale, CA 91201  
(818) 500-0137

**Scantek Inc.**

51 Monroe St, #1606  
Rockville, MD 20850  
(301) 279-9308, FAX# 301-279-9309  
Pres.: Richard J. Peppin, P.E.  
Service Mgr.: Gary Fraiman  
Products: 1/3 octave equalizers



# HOW TO LEVEL A HOTEL FOR UNDER \$350.

DOD graphic equalizers are veritable workhorses for improving public address sound quality in airports, shopping malls, hotels and public buildings.

That's because DOD makes more configurations of quality graphic EQs for more professional applications, than any other company in the world. For a lot less than you'd expect.

For a demonstration, see your professional audio dealer or sound contractor.

He'll recommend DOD with no reservations.



©1988 DOD Electronics Corporation. 5639 So. Riley Lane, Salt Lake City, Utah 84107. (801) 268-8400.



R-431 Graphic Equalizer (top) R-830 Graphic Equalizer (bottom)



## Sescom, Inc.

2100 Ward Dr.  
Henderson, NV 89015  
(702) 565-3400, FAX# 702-565-4828  
Products: crossovers, compressors,  
graphic equalizers, interface units,  
levelers, limiters, noise gates,  
parametric equalizers, VCAs

## Sonic Research Assoc.

PO Box 13744  
Arlington, TX 76094-0744  
(817) 792-2061  
Pres./Mkt'g: Kyle A. Holbrook  
V.P. Technology: Michael J. Yacavone  
Operations Mgr.: Olvy L. Johnson

## Sontec Electronics, Inc.

Audio Dr.  
Goldbond, VA 24094  
(703) 626-7256  
Sales Mgr.: Burgess Macneal  
Products: equalizers, compressors,  
interface units, limiters, parametric  
equalizers, transcription preamps

## Soundtech

230 Lexington Dr.  
Buffalo Grove, IL 60089  
(312) 541-3520, 800-323-4173, FAX#  
312-541-3616  
Pres.: Rudy Schlacher  
Sales Mgr.: Keith Brawley  
Sales Director: Len Brawnling  
Products: equalizers, compressors,  
graphic equalizers, limiters

## Spectra Sonics

3750 Airport Rd.  
Ogden, UT 84405  
(801) 392-7531  
Pres./Owner: William G. Dilley  
Engineer/Sales: Gregory D. Dilley  
William Watkins, Merrick, NY, 516-  
546-5374

## Stewart Electronics Corp.

11460 Sunrise Gold Circle, Suite B  
Rancho Cordova, CA 95742  
(916) 635-3011, FAX# 916-635-1787  
Nat'l Sales/Mkt'g Mgr.: James M.  
Ruse

Applied Audio, Asheville, NC, 704-252-  
9313

Cambridge Pro Sales, Westerville, OH,  
614-890-8144

GMC, Springfield, PA, 215-544-5884

Pacific Audio Group, Torrance, CA,  
213-375-2611

Future Sales, Redmond, WA, 206-868-  
5577

JAMM Dist., Flossmoor, IL, 312-799-  
0550

McManus Music Sales, MN, 612-432-  
5321

On the Road Mrkt., Upper Montclair,  
NJ, 201-746-0501

Pro Sound & Light, Lakewood, CO,  
303-986-5999

RPM Sales, Carrollton, TX, 214-446-  
3010

B. Trankle & Assoc., Belmonti, CA,  
415-595-4004

Pro Sound Assoc., Jacksonville, FL,  
904-744-1170

Products: interface units, transcription  
preamps

## Aphex Can Solve Your Problems of Dynamics Control and Clarity . . . Automatically.



Security cover available

The **Aphex Compellor/Aural Exciter** (Model 303) is a single, one rack height package combining two of your favorite tools. A monaural Compellor for completely automatic gain control, and the circuitry of the Aural Exciter to produce dramatically improved clarity, dimension and detail.

Once the Compellor/Aural Exciter is installed and set up in a PA or other sound system, no user adjustments are needed. The Compellor section makes your system "idiot proof" . . . levels

will remain consistent regardless of the source material or who is operating the system. The Aural Exciter increases intelligibility and penetration . . . even at reduced power levels, or in highly reverberant rooms, or under high ambient noise conditions. The 303 is an indispensable flexible tool for every new or existing system . . . from basic paging systems to complex touring sound systems.

For additional information, contact us today.

**APHEX SYSTEMS LTD.** 13340 Satlicoy St. North Hollywood, CA 91605 (818) 765-2212

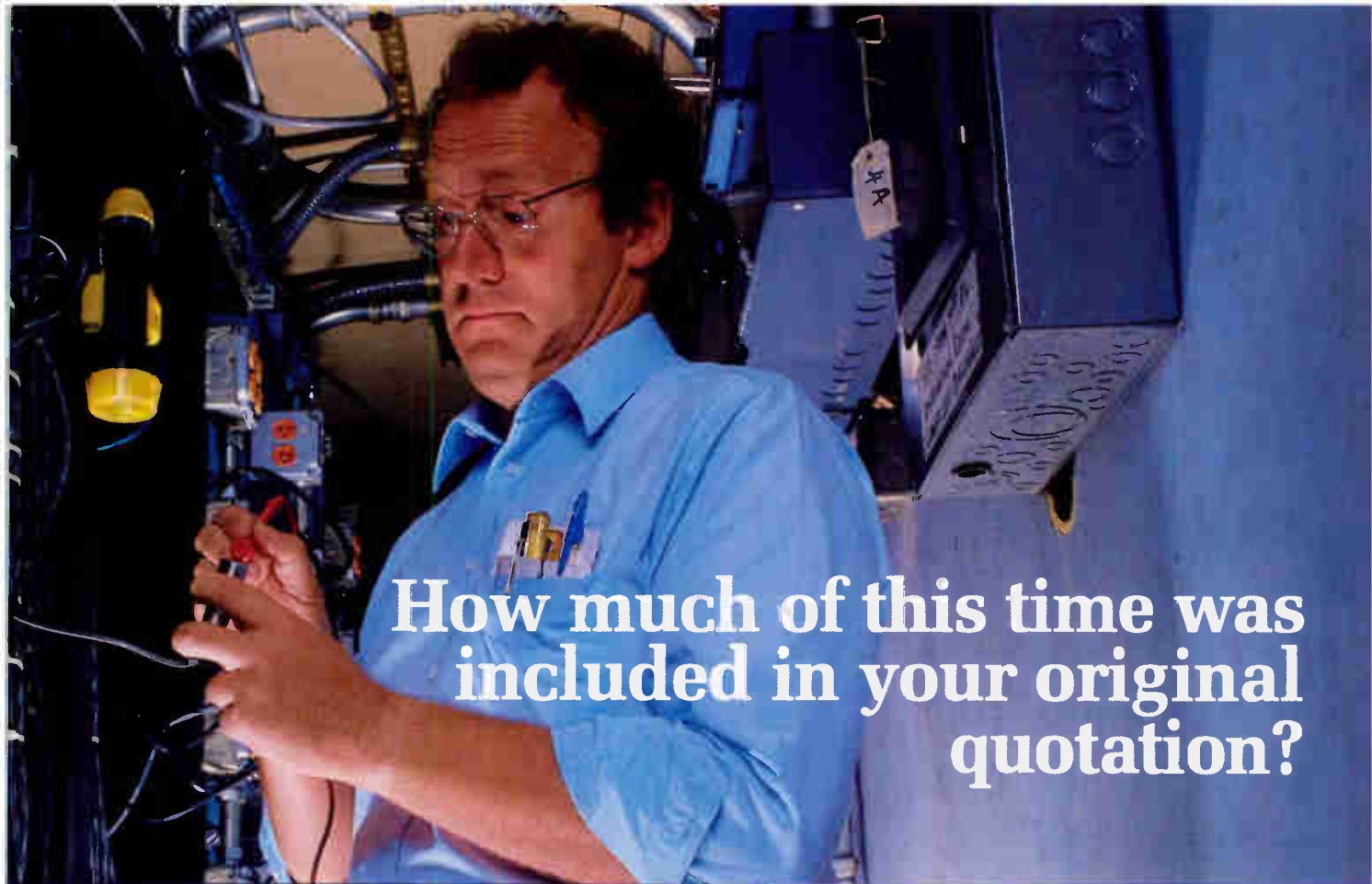

# How much of this time was included in your original quotation?



## **Klark-Teknik reliability means lower total lifetime cost**

Unplanned service calls will consume your profit margin on an installation faster than you can say "I'll take care of it." That's the best reason we know of to specify and install equipment on the basis of its total lifetime cost, not just the initial purchase price.

## **Klark-Teknik standards deliver operational security**

Our standards are so demanding because operating conditions can be so severe. We use only the highest grade components: oil-damped metal shaft faders, sturdy rack mount chassis, toroidal power supply transformers.

Years ago, our equalizers pioneered the use of thick film micro-electronic circuits. This technology reduces equivalent solder connections by more than 50%: its proven reliability is one reason we back Series 300 Graphic Equalizers with a five year limited warranty.

The other reason is the 100 hours of testing every Klark-Teknik product undergoes before being shipped. Our standard procedures include stereo dynascope board inspections, full performance verification and a cycled burn-in followed by a complete re-check.

Lower standards of design, construction and testing could make our equalizers less expensive to purchase. But it would make them more costly to own. There are no short cuts to true "set and forget" operation.

## **Klark-Teknik products for a full range of applications**

Perhaps you'd like to spend less time patching things up: if so, you owe it to yourself to investigate Klark-Teknik graphic or parametric equalizers and digital delay lines. For full information on their design, construction and applications, write to Klark-Teknik or your distributor at the address below.

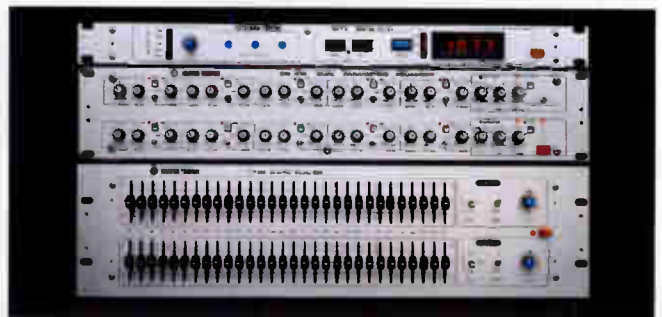

Each one of Klark-Teknik's Series 300 Graphic Equalizers, Series 400 Parametric Equalizers and Series 700 Digital Delay Lines is optimized for specific applications.

Klark-Teknik Electronics Inc.,  
30B Banfi Plaza North,  
Farmingdale, NY 11735 (516) 249-3660  
Klark-Teknik Plc., Klark Industrial Park, Walter Nash Rd.,  
Kidderminster, Worcs., U.K. DY11 7HJ (0562) 741515  
Distributed in Canada by: Omnimedia Corp., 9653 Côte de Liesse,  
Dorval, Quebec H9P 1A3 (514) 636-9971





Studio Master  
PO Box 2344  
229 Sunny Isles Blvd.-PO Drawer P  
Ft. Worth, FL 76113  
(817) 336-5114  
Dale Peterson

Sunn Musical Equipment Corporation  
1130 Columbia Street  
Brea, CA 92621  
(714) 990-0909, 800-854-6230, FAX#  
714-990-3986  
Pres.: Bill Schultz  
Director of Mkt'g: Joe Green  
Products: 1/3 octave equalizers,  
crossovers, graphic equalizers,  
octave equalizers

Symetrix, Inc.  
4211 24th Ave. West  
Seattle, WA 98199  
(206) 282-2555, 800-288-8855, FAX#  
206-282-5504  
Pres.: Dane Butcher  
Mkt'g Director: Doug Schauer  
Mkt'g/Sales Admin: Lavina Speer  
Products: ambient noise controlled  
level controllers, de-essers, interface

units, levelers, limiters, noise gates,  
notch filters, parametric equalizers

T.C. Electronic  
1 Serpentine Road  
Tenafly, NJ 07670  
(201) 568-1820, FAX# 201-871-0455

TDM Design, Inc.  
PO Box 573  
Route 1  
Hillsboro, OR 97124  
(503) 647-5957  
Pres.: Tim Miller

### TOA ELECTRONICS, ENGINEERED SOUND & COMMUNICATIONS DIVISION

PO Box 2047  
601 Gateway Boulevard  
South San Francisco, CA 94080  
(415) 588-2538, 800-843-4750, in CA  
800-632-2157, FAX# 415-588-3349  
Pres.: Yoshiro Ishida  
Director of Mkt'g: Fred Fredericks  
Nat'l Sales Mgr.: Richard Krochmal  
Nat'l Sales Mgr./Engineered Intercom &  
Security Div.: Al Burns  
Products: crossovers, digital delays,

equalizers, graphic equalizers,  
limiters, parametric equalizers,  
octave equalizers



**UREI  
ELECTRONIC  
PRODUCTS**

### UREI

8500 Balboa Blvd.  
Northridge, CA 91329  
(818) 893-8411, FAX# 818-893-3639  
Pres.: Ron Means  
V.P. Sales: Ken Lopez  
V.P. Mkt'g: Mark Gander  
Applications Engineer: Drew Daniels  
Mkt'g Mgr. Sound Contracting: Steve  
Romeo  
Neil Conly, Bedford, TX, 817-540-3066  
Bill Hamilton, Folsom, PA, 215-543-  
4677  
Steve Armstrong, Northridge, CA, 818-  
707-2529  
Tom Walter, Barrington, IL, 312-382-  
4925  
Products: crossovers, digital signal  
processors, equalizers, levelers,  
noise gates, transcription preamps

Valley International, Inc.  
PO Box 40306  
2817 Erica Pl.  
Nashville, TN 37204  
(615) 383-4737, FAX# 615-269-5441  
Pres.: Norman Baker  
Sales Mgr.: Tom Irby  
CE Michael Morgan

Wheatstone Corporation  
6720 VIP Parkway  
Syracuse, NY 13211  
(315) 455-7740, FAX# 315-454-8104  
Pres.: Gary Snow  
V. P.: Andrew Calvanese  
Engineer: Michael Shane  
Salesman: Tim Guhl  
Mkt'g Coordinator: Pattye Bagshaw  
Products: 1/3 octave equalizers,  
equalizers, compressors, graphic  
equalizers, limiters, notch filters,  
parametric equalizers, octave  
equalizers

THE TRUE THOROUGHbred...



**MODEL 4400  
L-C ACTIVE  
ONE THIRD OCTAVE  
EQUALIZER**



Don't be misled by pseudo-technical hype, proprietary snake oil and outlandish claims, slickly rendered in four colors. Compare, for yourself, the White Instruments 4400 with any other one-third octave graphic in the world. When peak performance counts you will find the White to be the true thoroughbred! Thousands of world class recording studios, performing venues, sports arenas, touring systems and open plan offices chose White equalizers because they were simply the best.

**White  
instruments**  
Division of C VAN R Inc

P. O. Box 698, Austin, Texas 78767  
TELEX 776409 WHITE INST AUS  
512/892-0752  
FAX (512) 892-0855

For detailed information  
write or call:





**WHITE INSTRUMENTS**

PO Box 698  
 5408 US Highway 290W  
 Austin, TX 78767  
 (512) 892-0752, FAX# 512-892-0855  
 Pres.: Carl Van Ryswyk  
 V.P.: Shirley Van Ryswyk  
 Mkt'g Mgr.: Emory Straus  
 Chief Engineer: Richard Bocoock  
 Audio Mkt'g Assoc., Brecksville, OH,  
 216-526-2426  
 Avwest, Inc., Fountain Hills, AZ, 602-  
 946-1811  
 Bensik Assoc., Inc., Ocala, FL, 904-  
 732-9775  
 Design Factors, La Habra Heights, CA,  
 213-697-7576  
 Gemini Electronic Mkt'g, Edmonds,

WA, 206-776-3121  
 L.S.M., Phelps, NY, 315-548-4891  
 Sigmet, Freehold, NJ, 201-462-1221  
 Monfort Electronics Mkt'g,  
 Indianapolis, IN, 317-872-8877  
 New Resources, Inc., Norwell, MA,  
 617-659-1463  
 Rancilio Assoc., St. Louis, MO, 314-  
 631-3326  
 Rep Tech, Inc., Terrell, TX, 214-222-  
 2131  
 Richard S. Pass Assoc., Inc.,  
 Langhorne, PA, 215-757-6100  
 Shalco, Inc., Ferndale, MI, 313-547-  
 4771  
 Warren Associated Sales Reps, Santa  
 Clara, CA, 408-988-7762  
 Wilson Audio Sales, Nashville, TN, 615  
 646-4477  
 Ziskind Assoc., Inc., Rolling Meadows,  
 IL, 312-577-1624  
 CB Electronics Mkt'g, Arvada, CO, 303-  
 422-0561  
 Ziskind Associates, Inc., Rolling

Meadows, IL, 312-577-1624  
 Products: 1/3 octave equalizers,  
 crossovers, equalizers, graphic  
 equalizers, notch filters, octave  
 equalizers

**PROFESSIONAL AUDIO DIVISION,  
YAMAHA MUSIC CORPORATION, USA**

PO Box 6600  
 6600 Orangethorpe Ave.  
 Buena Park, CA 90622  
 (714) 522-9011, FAX# 714-739-2680  
 Products: 1/3 octave equalizers,  
 automatic equalizers, preamps,  
 crossovers, de-essers, digital effects,  
 digital reverbs, digital delays, digital  
 signal processors, equalizers,  
 compressors, graphic equalizers,  
 interface units, levelers, limiters,  
 noise gates, notch filters, parametric  
 equalizers, octave equalizers

Zonic Corp.  
 2000 Ford Circle  
 Milford, OH 45150  
 (513) 248-1911, FAX# 513-248-1589

**MIDI**

ADA Signal Processors, Inc.  
 7303 Unit D Edgewater Dr.  
 Oakland, CA 94621-3095  
 (415) 632-1323, 800-241-8888, FAX#  
 415-632-9358  
 V.P.: Lorry Marcus  
 Sales Mgr.: Dave Gonden  
 Sales Rep: Eric Schultheis

AKG Acoustics, Inc.  
 77 Selleck St  
 Stamford, CT 06902  
 (203) 348-2121, 800-243-7885, FAX#  
 203-324-1947  
 Pres.: S. Richard Ravich  
 V.P./Operations: Derek Pilkington  
 V.P./Finance: Robert Netter  
 Tech Sls Coordinator: Timothy  
 Derwallis  
 Products: signal processing

Alesis Corporation  
 3630 Holdrege Ave.  
 Los Angeles, CA 90016  
 (213) 467-8000, FAX# 213-836-9192  
 Pres.: Keith Barr  
 Exec. V.P./COO: Russell Palmer  
 V.P. Mkt'g: Allen Wald

Nat'l Sales Mgr.: Ralph Goldheim  
 Reg. Sales Mgr.: Ted Keffalo  
 Products: signal processing, system  
 controllers, hardware

Alexander Publishing  
 3537 Old Conejo Road, #101  
 Newbury Park, CA 91320  
 (805) 499-6200, FAX# 805-498-8744  
 CEO/Publisher: Peter Alexander  
 Products: software

Allen and Heath  
 5 Connair Rd.  
 Orange, CT 06477  
 (203) 795-3594, FAX# 203-795-6814  
 V.P./Sales Mgr.: Charles Augustowski  
 Pres.: John Ball  
 General Mgr.: Jean Rathgeber  
 Engineer/R&D: John Petrucelli  
 Engineer: Joseph Boerst  
 GMI/New England, Avon, MA, 617-588-  
 8043

Sherwood Assoc., Endicott, NY, 607-  
 785-1590  
 Metropolis Marketing, Edison, NJ, 201-  
 225-0085

Audio Assoc., Glenwood, MD, 301-  
 854-6122  
 Ron Tunks Sales, Tamarac, FL, 305-  
 722-2803  
 Cambridge Marketing, S. Euclid, OH,  
 614-890-7788  
 Jamm Dist., Flossnor, IL, 312-747-  
 6363  
 Centurian Marketing, Ballwin, MO, 314-  
 227-7229  
 JMS Marketing, Austin, TX, 512-266-  
 1113  
 Loppnow & Assoc., Redmond, WA  
 ,206-883-3205  
 AMH Sales, Palos Verdes Estates, CA,  
 213-373-2034  
 Products: hardware

Apple Computer, Inc.  
 20525 Mariani Ave.  
 Cupertino, CA 95014  
 (408) 996-1010

Bacchus Software Systems  
 2210 Wilshire Blvd. #330  
 Santa Monica, CA 90403  
 (213) 820-9145  
 Eric Bloom

- Darwin Foye  
Products: software
- Clarity  
Nelson Lane  
Garrison, NY 10524  
(914) 424-4071, FAX# 914-424-3467  
Pres.: Gregory Kramer  
Mkt'g & Sales Mgr.: Colleen Donnelly  
Mkt'g Mgr.: Terry Tegarden  
Products: signal processing
- Digidesign, Inc.  
1360 Willow Road, Suite 101  
Menlo Park, CA 94025  
(415) 327-8811, FAX# 415-327-0777  
Products: software, hardware
- Digital Music Corp.  
5312-J Derry Ave.  
Agoura Hills, CA 91301  
(818) 991-3881, FAX# 818-991-4185  
Sales Mgr.: Gene Barkin  
Products: hardware
- Digitech  
5639 South Riley Lane  
Salt Lake City, UT 84107  
(801) 268-8400, 800-453-7484, FAX# 801-262-4966  
Pres.: John Johnson  
V.P. Engineering: David O. DiFrancesco  
V.P. Finance: Jay Fuller  
Int'l Mkt'g: Wayne Morris  
Western Sales: Scott Grow  
Corp. Communications: Dean Stubbs  
Products: signal processing, system controllers, hardware
- Dr. T's Music Software, Inc.  
220 Boylston St., #206  
Chestnut Hill, MA 02167  
(617) 244-6954, FAX# 617-244-5243  
Pres.: Emile S. Tobenfeld  
CEO: A.L. Hospers  
V.P. Operations: Ann O'Donnell  
Director Nat'l Sales: Oz Barron  
Director Int'l Sales: Jeff Pucci  
Products: software
- Dynaware Corporation  
1163 Chess Drive, Ste J  
Foster City, CA 94404  
(415) 349-5700, FAX# 415-249-5879  
Pres.: Nabuyuki Fujii  
General Mgr.: Yasunori Tanaka
- Product Mgr.(Japan): Kazuya Hashimoto  
Product Mgr.(Japan): Tatsushi Fujisawa  
Product Mgr.(USA): Jane L. Smith  
Products: software
- Electronic Arts  
1810 Gateway Drive  
San Mateo, CA 94404  
(415) 571-7995
- Eventide, Inc.  
One Alsan Way  
Little Ferry, NJ 07643  
(201) 641-1200, FAX# 201-641-1640  
Sales Mgr.: Gil Griffith  
Pres.: Richard Factor  
Products: signal processing
- Forte Music, Inc.  
PO Box 6322  
San Jose, CA 95150  
(415) 965-8880  
Pres.: Steve Salani
- Hybrid Arts, Inc.  
11920 W. Olympic Blvd.  
Los Angeles, CA 90064  
(213) 826-3777, FAX# 207-6666
- Imagine Computers & Software  
751 South Kellogg, Suite A  
Goleta, CA 93117  
(805) 683-1183, FAX# 805-683-7749
- Intelligent Music  
PO Box 8748  
116 North Lake Ave.  
Albany, NY 12206  
(518) 434-4110, FAX# 518-434-0308  
Pres.: Joel Chadabe  
Mkt'g: Laurie Anderson Bishop  
Customer Svce: Peter Swank  
Tech Support: Antony Widoff  
Products: software
- Korg U.S.A., Inc.  
89 Frost St.  
Westbury, NY 11590  
(516) 333-9100, 800-645-3188, FAX# 516-333-9108  
Sr. V.P.: Michael Kovins  
Products: signal processing
- Lake Butler Sound Co., Inc.  
5331 W. Lake Butler Road  
Windermere, FL 32786  
(407) 656-5515  
Pres.: Emmett Bradford  
NY Reps, Nesconset, NY, 516-724-5485  
West Coast Mkt'g, Anaheim, CA, 714-998-4969  
Products: system controllers, hardware
- Lync Systems, Inc.  
14 Walker Way  
Albany, NY 12205  
(518) 452-0891, FAX# 518-462-9637
- Oberheim-ECC  
2015 Davie Ave.  
Commerce, CA 90040-1704  
(213) 725-7870, FAX# 213-888-2874  
Executive V.P.: Robert Selan  
V.P. Sales: Mike Papa  
V.P. Engineering: Jim Letts  
Production Mgr.: Faye Fitzgerald  
Mkt'g & Promotions: Beth Letts  
Customer Svce Mgr.: Tom Dunn  
Products: system controllers, hardware
- Peavey Electronics Corp.  
PO Box 2898  
711 A Street  
Meridian, MS 39301  
(601) 483-5365, FAX# 601-484-4278  
Prod Mgr.: Ken Valentine  
Products: signal processing, system controllers
- Quiet Lion  
PO Box 219  
7335 Craner Ave.  
Sun Valley, CA 91353  
(818) 765-6224, FAX# 818-767-6821  
Pres.: John Fitzpatrick  
V.P.: Susan Fitzpatrick  
Tele-MIDI, Pasadena, CA, 800-888-MIDI  
Products: software
- RANE CORP.**  
10802 49th Ave. W.  
Everett, WA 98204-3400  
(206) 355-6000, FAX# 206-347-7757  
V.P. Mkt'g: Larry Winter  
Dir. Tech. Mkt'g: Terry Pennington  
Sales Coordinator: Debbie Cooksey  
Products: signal processing

Roland Corp., US  
7200 Dominion Circle  
Los Angeles, CA 90040  
(213) 685-5141  
Pres.: Tom Beckman  
Dir. Of Communications: Nancy Kewin  
Communications: Barbi Clark

Swanson Analysis, Inc.  
PO Box 65  
Johnson Road  
Houston, PA 15342  
(412) 746-3304, FAX# 412-746-9494

Systems Design Associates, Inc.  
5068 Plano Parkway, Suite 121  
Plano, TX 75093

(817) 497-6185  
Pres.: Dan Cody  
Product Specialist: Gary Knudson  
Products: software  
360 Systems  
18740 Oxnard St.  
Tarzana, CA 91356  
(818) 342-3127, FAX# 818-342-4372  
Director of Sales: Don Bird  
Products: system controllers

Voyetra Technologies  
333 Fifth Ave.  
Pelham, NY 10803  
(914) 738-4500, FAX# 914-738-6946  
Pres.: Carmine Bananno  
V.P.: Frederick Romano

Chief Software Design: Bruce Frazer  
Products: software

**PROFESSIONAL AUDIO DIVISION,  
YAMAHA MUSIC CORPORATION, USA**  
PO Box 6600  
6600 Orangethorpe Ave.  
Buena Park, CA 90622  
(714) 522-9011, FAX# 714-739-2680  
Products: signal processing, system controllers

Zeta Music Systems, Inc.  
2823 Ninth St.  
Berkeley, CA 94710  
(415) 849-9648, 800-622-MIDI, FAX# 415-843-8026

## PATCH BAYS & ROUTING SWITCHERS

ADC Telecommunications  
4900 W. 78th St.  
Minneapolis, MN 55435  
(612) 835-6800, FAX# 612-893-3138

Akai Professional-IMC  
PO Box 2344  
1316 Lancaster St.  
Fort Worth, TX 76113-2344  
(817) 336-5114, FAX# 817-870-1271  
Products: digital, matrix

Audio Accessories, Inc.  
Mill St.  
Marlow, NH 03456  
(603) 446-3335, FAX# 603-446-7185  
Pres.: M.B. Hall  
General Mgr.: David Hall  
PM T.J. Symonds

Audio Systems Company  
PO Box 1174  
1815 Michigan Ave.  
Bismarck, ND 58502  
(701) 223-3800, 800-852-6522  
Pres.: Lynn Mader  
V.P.: Lyle Mader  
Sales Mgr.: Mark Schmidt  
Products: matrix, microprocessor, remote controllable

Audio Visual Systems  
725 Lorraine Blvd.  
Los Angeles, CA 90005  
(213) 934-3006

Auditel Systems, Ltd.  
396 Porter Ave.  
Buffalo, NY 14201  
(716) 886-0019, FAX# 716-886-1615  
Pres.: David Langtry  
Prod. Mgr.: Tony Roberson  
Mkt'g Director: Jim Wood  
Products: microprocessor, pre-wired, remote controllable

Autopatch A/V Systems  
PO Box 3002  
Spokane, WA 99202  
(509) 747-1246  
V.P. Mkt'g: Dick Myers  
V.P. Engineering: Jay Turkovsky  
Products: audio/video

BSM Systems, Inc.  
PO Box 19007  
W. 7106 Will D. Alton Lane, Suite 106  
Spokane, WA 99219  
(509) 838-0110, FAX# 509-328-0510  
Sales Mgr.: Marceen Zappone  
Pres.: Bruce Morse  
Products: audio/video, digital, matrix, microprocessor, remote controllable

Benchmark Media Systems, Inc.  
3817 Brewerton Rd.  
N. Syracuse, NY 13212  
(315) 452-0400  
Pres.: Allen H. Burdick

Cal Switch  
13717 S. Normandie Ave  
Gardenia, CA 90249  
(213) 770-2330, 800-CAL-S-W-C-H,  
FAX# 213-327-2741  
Pres.: Irwin Perlman  
V.P.: Bob Andrade  
V.P.: Herb Poncher

Conex Electro-Systems, Inc.  
PO Box 1342  
1602 Carolina St.  
Bellingham, WA 98227  
(206) 734-4323  
Eng. Director: Bill Hamelin  
Gen. Mgr.: John Plattner  
Service Mgr.: Jerry Huddle

Conquest Electronic Wire & Cable  
PO Box 757  
7319 Duvan Dr.  
Tinley Park, IL 60477  
(312) 429-1770, 800-323-7671, in IL  
800-344-2667, FAX# 312-429-4688  
Pres.: Robert Jares, Jr.  
V.P.: Larry Spalla  
Sales Engineer: Ron Wirth  
Sales Engineer: Ken Bernd  
Sales Engineer: Mike Sanfilippo  
Credit Mgr.: Norm Corsi  
Products: audio/video



### CONQUEST SOUND, INC.

PO Box 757  
7319 Duvan Dr.  
Tinley Park, IL 60477  
(312) 429-1770, 800-323-7671, FAX#  
312-429-4688  
Pres.: Robert Jares, Jr.  
V.P.: Larry Spalla  
Sales Engineer: Ron Wirth  
Sales Engineer: Ken Bernd  
Sales Engineer: Mike Sanfilippo  
Credit Mgr.: Norm Corsi  
Products: audio/video

### EECO, Inc.

1601 E. Chestnut Ave.  
Santa Ana, CA 92702  
(714) 835-6000

### Gaines Audio

PO Box 17888  
1237 E. Main Street  
Rochester, Ny 14609  
(716) 266-0780  
Owner: Jon Gaines  
Products: audio/video

### Grass Valley Group

PO Box 1114  
Grass Valley, CA 95945  
(916) 478-3000, FAX# 916-478-3187  
Executive V. P.: Dave Mayfield  
V. P. Mkt'g: Bob Cobler  
V.P. Sales: Randy Hood  
Grass Valley Group, Paramus, NJ, 201-  
845-7988  
Grass Valley Group, Elkhart, IN, 219-  
264-0931  
Grass Valley Group, Woodland Hills,  
CA, 818-999-2303  
Grass Valley Group, Arlington, TX, 817-  
483-7447  
Products: components

### Hedco

PO Box 1985  
12520 Loma Rica Dr.  
Grass Valley, CA 95945  
(916) 273-9524, 800-433-2648, FAX#  
916-273-6948  
Pres.: John Hayes  
V.P./General Mgr.: Bill Fink  
Sales Mgr.: Ross Shelton  
Production Mgr.: Steve Miller

SE Reg Sales Mgr.: Eric King  
Midwest Reg Sales Mgr.: Tom Harmon  
SW Reg Sales Mgr.: Eloy Chairez  
Dan Antonellis, Metuchen, NJ, 201-  
494-1019  
Lyle Bailey, Canoga Park, CA, 818-704-  
5601  
Tom Harmon, North Royalton, OH,  
216-237-9642  
Eric S. King, Lynchburg, VA, 804-384-  
7001

### Vidicraft, Inc.

0704 SW Bancroft Street  
Portland, OR 97201  
(503) 223-4884, 800-547-1491, FAX#  
503-243-1995  
General Mgr.: Steve Johnson  
Nat'l Sales Mgr.: Dave Landis  
Product Mgr.: Glenn Olson  
Products: audio/video, matrix

### PROFESSIONAL AUDIO DIVISION, YAMAHA MUSIC CORPORATION, USA

PO Box 6600  
6600 Orangethorpe Ave.  
Buena Park, CA 90622  
(714) 522-9011, FAX# 714-739-2680  
Products: matrix, remote controllable

### Hughes Electronic Devices Corp.

PO Box 1985  
Grass Valley, CA 95945  
(916) 273-9524, 800-HEDCO GV

### IED Innovative Electronic Designs, Inc.

9701 Taylorsville Rd  
Louisville, KY 40299  
(502) 267-7436, FAX# 502-267-9070  
V.P. Mkt'g & Sales: Tom Roseberry  
Mkt'g Assistant: Wanda R. Martin  
Pres.: Hardy Martin  
Sec./Treas.: Ray Allen  
V.P. R & D: Robert Ponto  
Derek Allen Assoc., Toluca Lake, CA,  
818-840-8327  
Bensik Assoc., Ocala, FL, 904-732-  
9775  
Plus 4 Marketing, Pleasant Hill, CA,  
415-937-0650  
Yore Company, White Bear Lake, MN,  
612-770-9760

### Industry West Electronics

270 N. Geneva Rd.  
Orem, UT 84057  
(801) 226-1000  
Products: mult boxes



**We want to hear  
about your  
latest  
installation!**

**Tell us about it so we  
can tell everyone else in  
Contracting Close-Up.**

Write to:  
*Sound & Communications*  
25 Willowdale Avenue  
Port Washington, NY 11050  
or call: (516) 767-2500

International Music Co. (I. M. C.)  
 PO Box 2344  
 1316 E. Lancaster  
 Ft. Worth, TX 76113-2344  
 (817) 336-5114, 800-433-5627, FAX#  
 817-870-1271  
 Chairman of the Bd./CEO: Tommy  
 Moore  
 Pres.: Jerry Freed  
 V.P. Sales: C.H. Murray  
 Dir. of Akai EMI: Mike McRoberts  
 Akai Prod. Specialist: Kevin Kennedy

Lyntec/Technical Visuals  
 7030 Grandview  
 Merriam, KS 66204  
 (913) 722-4047  
 Pres.: Lynn J. Potter  
 Products: matrix

Patch Bay Designation Co.  
 4742 San Fernando Road  
 Glendale, CA 91204  
 (818) 241-5585, FAX# 818-507-5050  
 Pres.: Scott Lookholder  
 Operations Mgr.: Charlie Schufer  
 Shop Foreman: Kevin Duhart  
 Artist: Rosie Gloria  
 Art Coordinator: Joaquin Serrano

**PRO CO SOUND, INC.**  
 135 E. Kalamazoo Ave.  
 Kalamazoo, MI 49007  
 (616) 388-9675, 800-253-7360, FAX#  
 616-388-9681  
 Pres.: Charlie Wicks  
 V.P. Comm. Div.: Jeff Garstick  
 V.P. Pro. Div.: Jerry Smelker  
 V.P. Operations: Tish Weber  
 Chief Engineer: Scott Burnham

Radical Electronics  
 2872 Hartland Road  
 Falls Church, VA 22043  
 (703) 573-6910

Sescom, Inc.  
 2100 Ward Dr.  
 Henderson, NV 89015  
 (702) 565-3400, FAX# 702-565-4828  
 Products: mic splitters, mult boxes

Target Technology  
 PO Box 609  
 Penn Valley, CA 95946  
 (916) 639-2102

Tascam (TEAC Professional Division)  
 7733 Telegraph Road  
 Montebello, CA 90640  
 (213) 726-0303, FAX# 213-725-1994  
 Mkt'g Mgr: Bill Mohrhoff  
 Nat'l Sales Mgr.: Gregg Hildebrandt  
 W. Reg. Mgr.: Fred Allard  
 S. Reg. Mgr.: Bill Stevens  
 E. Reg. Mgr.: Chuck Prada  
 Products: audio/video

Trimm, Inc.  
 PO Box 489  
 400 W. Lake Street

Libertyville, IL 60048  
 (312) 362-3700, FAX# 312-680-3888  
 Pres.: Wallace Newton  
 Engineering: Aurel Seiceanu  
 Customer Svce: Nancy Calkins

Utah Scientific, Inc.  
 1685 W. 2200 S.  
 Salt Lake City, UT 84119  
 (801) 973-6840, 800-453-8782, FAX#  
 801-973-0255  
 Director of Sales: Gary La Munyan  
 Director of Prod. Mgmt: Scott Bosen  
 NE Reg Sales Mgr.: Dan Antonellis

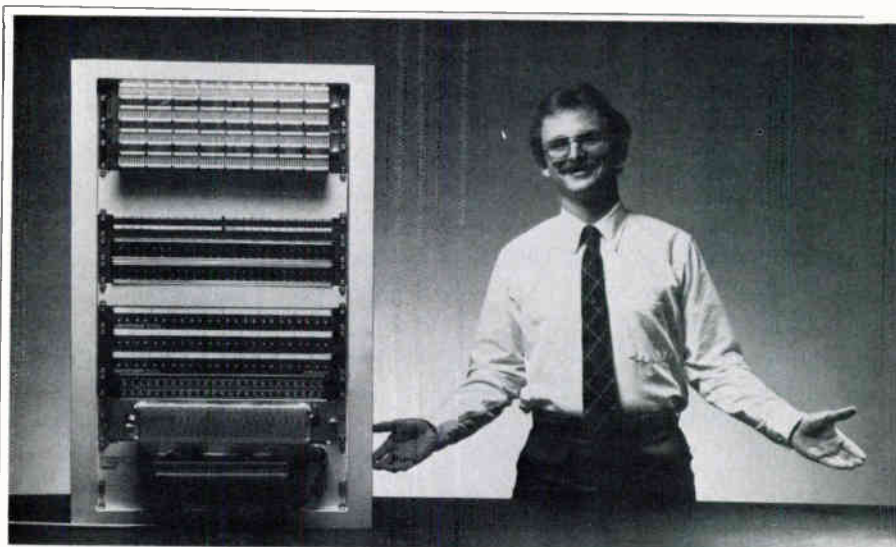

If you're one of the unfortunate folks who's ordered off-the-shelf patch panels only to be confronted with substandard performance, back orders, or both, this ad's for you.

Gentner has over 200 standard patch panel combinations to choose from. But, you configure your patch panel to your specifications. You select the bay front, jack and termination configuration that exactly meets your need. No compromises. Your patch panels will be constructed of the highest quality components, performance tested and delivered on schedule.

And, that goes for super custom requests, too.

What you want is what you get. Within budget and on time, every time.

## **Gentner Prewired Patch Panels and the Closest Competition.**

For complete product information and specifications, give us a call today. You'll find out just how easy it is to plug-in to the number one patch panel supplier.

**GENTNER**  
 ELECTRONICS  
 CORPORATION

540 West 3560 South, Salt Lake City, UT 84115 • (801) 268-1117 • FAX (801) 265-1394

# SOUND MASKING PRODUCTS

## ASHLY

### ASHLY AUDIO, INC.

100 Fernwood Ave.  
Rochester, NY 14621  
(716) 544-5191, 800-828-6308, FAX#  
716-266-4589

Pres.: William Thompson  
Senior V.P.: Bob French  
V.P.: David Malloy  
Office Mgr.: Ellen Price  
Products: graphic equalizers,  
processors

### Atlas/Soundolier

1859 Intertech Dr.  
Fenton, MO 63026  
(314) 349-3110, FAX# 314-349-1251  
V.P. Sales: Tom Erickson  
E. Region/Sales: Andy Musci  
W. Region/Sales: Bud Waters  
V.P./Mkt'g Consultant: Herbert Jaffe  
Products: loudspeakers, noise  
generators, self-contained

### DUKANE CORPORATION

2900 Dukane Dr.  
St. Charles, IL 60174  
(312) 584-2300, FAX# 312-584-2370  
Pres.: J. McWilliams Stone, Jr.  
Group V.P.: William P. Finnegan  
Division General Mgr.: Steve Deppe  
Mkt'g Mgr.: Derek Podobas  
Nat'l Sales Mgr.: Warren Anderson  
Service Mgr.: Cliff Carlson  
Doug Fellabaum, Sycamore, IL, 800-  
445-0152(#2301)  
Don Mouritzen, Beecher, IL, 800-445-  
0152(2303#)  
Art Sbrilli, Edison, NJ, 800-445-  
0152(#2302)  
Pete Kendall, Jacksonville, FL, 904-  
262-6025(#2306)  
Jack Brown, Dallas, TX, 214-943-  
7528(#2305)  
Ed Nuhring, Portland, OR, 800-445-  
0152(#2307)  
Wally Smutts, Toronto, Ontario,  
Canada, 312-584-2300

Ken Lind, Wellesley Hills, MA, 617-  
235-6817

Products: central, graphic equalizers,  
loudspeakers, noise generators,  
programmable, zoned

### Dyna-Systems

5371 Tennyson St., Unit 1  
Denver, CO 80212  
(303) 455-5400  
Pres.: Robert C. Chanaud, Ph.D.  
Mgr. of Operations: Vince Pietraban  
Mkt'g. Director: Thomas A. Koenig

### Eddor

1948 East Pomona  
Santa Ana, CA 92705  
(714) 648-0292, 800-854-0259, FAX#  
714-648-0117  
Pres.: Larry Weston  
Office Mgr.: Phyllis Weston  
Sales Mgr.: Deanna Weston  
Products: graphic equalizers, noise  
generators

### Eventide, Inc.

One Alsan Way  
Little Ferry, NJ 07643  
(201) 641-1200, FAX# 201-641-1640  
Sales Mgr.: Gil Griffith  
Pres.: Richard Factor  
Products: processors

### Insul-Art Acoustics Corp.

107 Allen Blvd.  
Farmingdale, NY 11735  
(516) 694-0002, 800-526-0908  
Pres.: Jack D. Leonard  
V.P.: Harold Goldstein  
Tech Sales Mgr.: Johnathan Leonard  
Int'l Sales Mgr.: Marge Lohr  
Sales Coordinator: Elaine Sak  
Installation Mgr.: Brian Leonard  
Products: central, graphic equalizers,  
loudspeakers, noise generators, self-  
contained, zoned

### Interior Acoustics

PO Box 839  
Belle Meade, NJ 08502  
(201) 874-4155, 800-221-0580

Klark-Teknik Electronics, Inc.  
30 B Banfi Plaza N

Farmingdale, NY 11735  
(516) 249-3660, FAX# 516-420-1863  
Pres.: Jack Kelly  
Nat'l Sales Mgr.: Sam Spennacchio  
Field Sales Mgr.: Keith Worsley

### Lyntec/Technical Visuals

7030 Grandview  
Merriam, KS 66204  
(913) 722-4047  
Pres.: Lynn J. Potter  
Products: noise generators,  
programmable

### OFFICE TECHNOLOGIES

4551 Bloomington Ave., S.  
Minneapolis, MN 55407  
(612) 721-2457  
Pres.: Steven J. Orfield  
V.P./Sales: Marianne Seitz  
Raleigh C. Ferry & Assoc., Inc., Buford,  
GA, 404-945-3142  
Worldwide Electronics, Pembroke  
Pines, FL, 305-584-7024  
Products: central, loudspeakers, zoned

### Powertronix

10623 Lawson River Ave.  
Fountain Valley, CA 92708  
(714) 963-5411  
Pres.: Robert Gehlke  
Sales Mgr.: Bill Organ

### RANE CORP.

10802 49th Ave. W.  
Everett, WA 98204-3400  
(206) 355-6000, FAX# 206-347-7757  
V.P. Mkt'g: Larry Winter  
Dir. Tech. Mkt'g: Terry Pennington  
Sales Coordinator: Debbie Cooksey  
Products: graphic equalizers, noise  
generators

### SonoMask Systems, Inc.

1130 Route 22 West  
Mountainside, NJ 07092  
(201) 232-7000

### PROFESSIONAL AUDIO DIVISION, YAMAHA MUSIC CORPORATION, USA

PO Box 6600  
6600 Orangethorpe Ave.  
Buena Park, CA 90622  
(714) 522-9011, FAX# 714-739-2680  
Products: graphic equalizers



# SOUND SYSTEM PRODUCTS

## DISCO COMPONENTS & SYSTEMS

### Aris/Eta

1710 Enterprise Parkway  
Twinsburg, OH 44087  
(216) 425-3388, FAX# 216-425-9700  
Mkt'g: Bob Harris  
Products: lighting controls & effects

### BBE Sound, Inc.

5500 Bolsa Avenue, Suite 245  
Huntington Beach, CA 92649  
(714) 897-6766, 800-233-8346, FAX#  
714-895-6728  
CEO: John C. McLaren  
CFO.: Scott Anderson  
Nat'l Sales: Jim Lucas  
Operations Mgr.: Jennifer Drescher  
Director of Engineering: Robert Crooks  
Tech Svces Sup.: Ryan Coutts  
Products: processors

### Bozak, Inc.

326 South St  
New Britain, CT 06051-3721  
(203) 225-0555  
Pres.: Donald D. Bowers  
Dir. of Mkt'g: William J. Kieltyka  
Chief Engineer: Sheldon Glick

### Dyna-Might Sound & Lighting, Inc.

3119-A S. Scenic  
Springfield, MO 65807  
(417) 883-4549

### Fairlight Instruments, Inc.

2945 Westwood Blvd.  
Los Angeles, CA 90064  
(213) 470-6280

### GLI/Integrated Sound Systems

1227 Walt Whitman Road  
Melville, NY 11747  
(516) 351-2100  
Products: DJ mixers, headphones

### JBL PROFESSIONAL

8500 Balboa Blvd  
Northridge, CA 91329  
(818) 893-8411, FAX# 818-893-3639  
Pres.: Ron Means

V.P. Sales: Ken Lopez

V.P. Mkt'g: Mark Gander

Applications Engineer: Drew Daniels  
Mkt'g Mgr./Sound Contracting: Steve  
Romeo

Video Sales: Don Wilson

Neil Conly, Bedford, TX, 817-540-3066

Bill Hamilton, Folsom, PA, 215-543-  
4677

Steve Armstrong, Northridge, CA, 818-  
707-2529

Tom Walter, Barrington, IL, 312-382-  
4925

Products: DJ mixers, processors, sub-  
woofers, turntable cartridges, and  
accessories

### Lighting and Electronics

Market Street Industrial Park  
Wappingers Falls, NY 12590  
(914) 297-1244, FAX# 914-297-9270

### Numark Electronics

503 Newfield Ave.  
Edison, NJ 08837  
(201) 225-3222, FAX# 201-287-2155  
Pres.: Harry Kotovsky  
V.P.: Robert Kotovsky

Numark/PPD, Simi Valley, CA, 805-  
522-3550

Products: DJ mixers, headphones,  
turntable cartridges, and accessories,  
turntables

### Panasonic Industrial Company/Ramsa

6550 Katella Ave  
Cypress, CA 90630  
(714) 895-7278, FAX# 714-895-7242  
Nat'l Sales/Mkt'g: Steve Wooley  
Eastern Sales Mgr.: D.J. Bierut  
Central Sales Mgr.: Greg Braithwaite  
Western Sales Mgr.: James Murray  
Pusecker Sales, Upper Montclair, NJ,  
201-744-1834

Professional Audio Associates,  
Burlington, MA, 617-229-6050

David Prinzi, Webster, NY, 716-671-  
9266

World Wide Electronics, Pembroke  
Pines, FL, 305-584-7024

World Wide Electronics, Jacksonville,  
FL

Evans Sales & Mkt'g, Nashville, TN,  
615-297-7997

A/V Mkt'g, Carmel, IN, 317-846-1034

Key Mkt'g, Plymouth, MI, 313-459-  
6040

New Horizons Elec. Mkt'g,  
Bannockburn, IL, 312-234-5911

J.B. Parent Co., Dublin, OH, 614-764-  
0064

Music Interventions & Assoc., Kansas  
City, MO, 816-453-4448

Tenicki & Assoc., Houston, TX, 713-  
528-2005

New West Audio, Burbank, CA, 818-  
955-9706

Brian Trankle Assoc., Belmont, CA,  
415-595-4004

Brian Trankle Assoc., Sacramento, CA,  
916-369-7030

Northmar, Seattle, WA, 206-524-5170

Pearson & Pearson, Denver, CO, 303-  
722-6996

Products: DJ mixers, sub-woofers

### Paso Sound Products

14 First St.  
Pelham, NY 10803-1495  
(914) 738-4800, FAX# 914-738-3954

Executive V.P.: Paul Mastrangelo  
Sales Mgr.: David Moore

Product Mgr.: Ken Obrien

Credit Mgr.: Marilyn Beckerson

Operations Mgr.: Anthony Sgueglia  
All West Electronics, Camarillo, CA,  
805-388-1789

Anderson Sales, Braintree, MA, 617-  
848-9194

Pace Sales, Charlotte, NC, 704-365-  
3216

De Witt Austin Co., Alpharetta, GA,  
404-442-1326

Dowell Assoc., St. Louis, MO, 314-  
849-4234

Mountain Representatives, Denver, CO,  
303-623-0972

## 210 MESSAGE REPEATERS, STORECASTERS

White Radio Ltd., Burlington, Ontario,  
Canada, 416-632-6894  
Rancilio Assoc., Inc., St. Louis, MO,  
314-631-3326  
SAGA, Oswego, NY, 315-343-5739  
Sigmet Corporation, Valley Forge, PA,  
215-783-6666  
J.Y. Schoonmaker Co., Dallas, TX,  
214-349-1650  
Weller Electronic Sales, Worthington,  
OH, 614-885-7819  
Ziskind Assoc., Rolling Meadows, IL,  
312-577-1624  
Burcaw Company & Assoc., Warren,  
MI, 313-573-4605  
S&F Northwest, Seattle, WA, 206-622-  
6036  
Lichtenauer & Associates, Antioch, CA,  
415-757-1200  
Products: headphones

**URE**  
8500 Balboa Blvd.  
Northridge, CA 91329  
(818) 893-8411, FAX# 818-893-3639  
Pres.: Ron Means  
V.P. Sales: Ken Lopez  
V.P. Mkt'g: Mark Gander  
Applications Engineer: Drew Daniels  
Mkt'g Mgr. Sound Contracting: Steve  
Romeo  
Neil Conly, Bedford, TX, 817-540-3066  
Bill Hamilton, Folsom, PA, 215-543-  
4677  
Steve Armstrong, Northridge, CA, 818-  
707-2529  
Tom Walter, Barrington, IL, 312-382-  
4925  
Products: DJ mixers, processors,  
turntable cartridges, and accessories

**VIBRATION TECHNOLOGY, LTD.**  
1950 Ellesmere Road, Unit #12  
Scarborough, ONT, Canada M1H 2V8  
(416) 438-9320, FAX# 416-439-1937  
Pres.: Adrian Ball  
V.P.: Harry Gandhi  
Products: DJ mixers, sub-woofers,  
turntable cartridges, and accessories,  
turntables

**PROFESSIONAL AUDIO DIVISION,  
YAMAHA MUSIC CORPORATION, USA**  
PO Box 6600  
6600 Orangethorpe Ave.  
Buena Park, CA 90622  
(714) 522-9011, FAX# 714-739-2680  
Products: DJ mixers, headphones,  
processors, sub-woofers

## MESSAGE REPEATERS, STORECASTERS

Adaptive Micro Systems, Inc.  
7840 N. 86th St.

Milwaukee, WI 53224  
(414) 357-2020, 800-558-7022, FAX#

414-357-2029  
Products: sign systems

**ONE  
IS  
NOT  
ENOUGH**

Additional copies of  
the 1988/1989 Blue  
Book are available  
at \$12 each. Please  
send your check or  
money order to:  
Deborah Droge  
Circulation Director  
25 Willowdale Ave.  
Port Washington,  
NY 11050

Atis, Ltd.  
6025 Atlantic Blvd., Suite D  
Norcross, GA 30071  
(404) 446-7234, FAX# 404-446-7237  
V.P. Tech Svcs: Peter Lorenz  
Nat'l Sales Mgr.: Tony Vespoli  
Products: digital systems, message  
units, digital voice recording

Audi-Cord Corp.  
1845 W. Hovey Ave.  
Normal, IL 61761  
(309) 452-9461

Audiocom, Inc.  
8100 Oak La., Penthouse 401  
Miami Lakes, FL 33016  
(305) 825-4653, 800-272-0555

Automation Devices, Inc.  
PO Box AD  
Automation Park  
Fairview, VA 16415-0904  
(814) 474-5561



**CHIPS WITH LIPS, INC.**

20 South Santa Cruz Ave.  
PO Box 459  
Los Gatos, CA 95031-0459  
(408) 395-3336 FAX #408-395-3436  
V.P./Sales: Andrew Osterman  
V.P./Marketing: Steven Landry  
Nat'l Sales Mgr.: Marjorie Hamlin  
Credit Mgr.: Mary Samuel

**Clever Devices Ltd.**

PO Box 2002  
Port Washington, NY 11050  
(516) 767-0682  
Pres.: William Long  
Director/Engineering: Jim Prince  
Director/Programming: Neil Perone

**CompuSonics Video**

2345 Yale Street  
Palo Alto, CA 94306

(415) 494-1208, FAX# 415-494-3040  
Pres.: John P. Stautner

**ELTREX INTERNATIONAL**

2 Columbia Dr.  
Amherst, NH 03031  
(603) 886-3500, 800-432-7631, FAX#  
603-886-3508

Sales Mgr.: Bill Ryan  
Products: digital systems, message  
units, digital voice recording

**Heliotrope General**

3733 Kenora Drive  
Spring Valley, CA 92077  
(619) 460-3930, 800-854-2674, FAX#  
619-460-9211

V.P.: Barry W. Brunye  
Office Mgr.: Barbara Smith  
Sales: Mark Albert  
Products: digital systems, message  
units, digital voice recording

**La Belle**

510 W. Worthington  
Oconomowoc, WI 53066  
(414) 567-9101

**MACKENZIE LABORATORIES, INC.**

PO Box 3029  
5507 Peck Rd.  
Arcadia, CA 91006  
(818) 579-0440, 800-423-4147, FAX#  
818-448-7131

Pres.: Addison R. Taylor  
V.P./Chief Engineer: Nagy Khattar  
Sales & Sys.: Joe Vitale  
Products: digital systems, cart  
machines, message units, digital  
voice recording

**Multiplex Technology, Inc.**

251 Imperial Hwy  
Fullerton, CA 92635  
(714) 680-5848, 800-423-0584  
Nat'l Sales Mgr.: Frank White  
Products: sign systems

**NEL-TECH LABS, INC.**

PO Box 1030  
Londonderry, NH 03053  
(603) 434-8234, FAX# 603-434-1265  
Pres.: Gary Stapleford  
Exec. V.P.: Ken Ritter  
Products: digital systems, cart

# Digital Record/Play Message Repeater



*Shown: DigiMac Model DM-A digital record/play message repeater. DigiMac audio quality is excellent and completely natural, just like a tape recording.*

- Up to eight minutes of message time
- Make recordings on the spot
- No moving parts, no maintenance, no downtime
- Natural voice, just like a tape recording
- Fully warranted for two years

MacKenzie's new DigiMac is a record/play, natural-voice message repeater that plays pre-recorded messages over public address and paging systems. Typical applications include public service messages, parking warnings, safety announcements and security messages. DigiMac is also ideal for museums, exhibits, displays and trade shows.

DigiMac is easy to use. Just plug a reel-to-reel or cassette player into the unit and transfer your pre-recorded program directly into DigiMac's memory. You can play your program immediately—over and over on command or continuously.

All DigiMac models come with built-in battery backup to protect memory. Models are available with sound/sync and microphone input for live recording.

For more information about the versatile new DigiMac, call MacKenzie Laboratories toll-free: **800-423-4147**

**MACKENZIE** MacKenzie Laboratories, Inc.  
5507 Peck Rd., Arcadia, CA 91006 USA, 818/579-0440, Fax: 818/448-7131



machines, message units, digital voice recording, sign systems

### Portac, Inc.

108 Aero Camino  
Santa Barbara, CA 93117  
(805) 685-2960

### Sierra Video Systems

PO Box 2462  
Grass Valley, CA 95945  
(916) 273-9331

### TOA ELECTRONICS, ENGINEERED SOUND & COMMUNICATIONS DIVISION

PO Box 2047  
601 Gateway Boulevard  
South San Francisco, CA 94080  
(415) 588-2538, 800-843-4750, in CA  
800-632-2157, FAX# 415-588-3349  
Pres.: Yoshiro Ishida  
Director of Mkt'g: Fred Fredericks  
Nat'l Sales Mgr.: Richard Krochmal  
Nat'l Sales Mgr./Engineered Intercom & Security Div.: Al Burns  
Products: cart machines

### Tape-Athon Corp.

13633 Crenshaw Blvd.  
Hawthorne, CA 90250  
(213) 676-6752

Pres.: Leon E. "Lee" Tate  
General Mgr.: Robert Haller  
Director Engineering: Bernard Sayers  
Director Mkt'g: John Bagley  
Sales Coordinator: Bob Mayfield  
Sales Mgr.: Rick Bottom  
Chuck Olson Assoc., Renton, WA, 206-271-5416

Warren Assoc., Santa Clara, CA, 408-988-7762

Greg Dzubay & Assoc., Peoria, AZ, 602-979-2358

Spivey-Leboeuf Assoc., Richardson, TX, 214-231-3190

Central Marketing Group, Kansas City, MO, 816-741-7460

John E. M. Anderson, Minneapolis, MN, 612-823-6459

Gustafson System Sales, Palatine, IL, 312-358-2505

Avcom, Inc., N. Olmsted, OH, 216-777-2060

Elmarcon, Inc., Indianapolis, IN, 317-846-0221

Saga, Oswego, NY, 315-343-5739

Pinz Sales Corp., Rockville Centre, NY, 516-678-6887

ASR Enterprises, LTD., Fallston, MD, 301-893-0001

Murphy & Cota, Atlanta, GA, 404-875-2525

Bencsik Assoc., Ocala, FL, 904-732-9775

Design Factors, La Habra Heights, CA, 213-697-7576

Products: message units

### 3M SOUND PRODUCTS

223-5S-09, 3M Center  
St. Paul, MI 55144-1000  
(612) 733-9214, FAX# 612-736-9433  
Mkt'g Mgr.: Richard G. Barker  
Sales Mgr.: Don Sluder  
Products: cart machines, message units, digital voice recording

### Vicon Industries

525 Broad Hollow Rd.  
Melville, NY 11747  
(516) 293-2200, 800-645-9116  
Pres.: Donald N. Horn  
Executive V.P.: Arthur Wallace  
V.P. Finance: Kenneth Darby  
V.P. Mkt'g/Sales: Ronald J. Teixeira  
Vicon Industries, Norcross, GA, 404-449-0499

Vicon Industries, Brea, CA, 714-990-3858

Vicon Industries, Washington, D.C., 703-553-7580

Products: digital systems, cart machines, message units, digital voice recording, sign systems

## MAGNETIC TAPE SYSTEMS & SUPPLIES

### AGFA-Gevaert, Inc., Magnetic Tape Div.

100 Challenger Rd.  
Ridgefield Park, NJ 07660  
(201) 440-2500  
V.P. General Mgr.: Maria A. Curry  
Nat'l. Sales Mgr.: Andrew Da Puzzo  
Audio Prod. Mgr.: Joe Tibensky  
Video Prod. Mgr.: Chris Emery  
Mkt'g. Comm. Mgr.: Teri Sosa

### AVSC

1880 Embarcadero Rd.  
Palo Alto, CA 94303  
(415) 493-3814  
Pres.: Richard Wilson  
General Mgr.: Veldon Leverich  
Office Mgr.: Diane Leverich

### Accurate Sound Corp.

3515 Edison Way

Menlo Park, CA 94025

(415) 365-2843  
Pres.: Ronald M. Newdoll

Products: cassette players & changers, cassette recorders, high-speed duplicators

### Akai Professional-IMC

PO Box 2344  
1316 Lancaster St.  
Fort Worth, TX 76113-2344  
(817) 336-5114, FAX# 817-870-1271  
Products: cassette recorders

### American Recorder Technologies, Inc.

PO Box 3592  
4505-2H Industrial St.  
Simi Valley, CA 93063  
(805) 527-9580, 800-782-6911, FAX#

805-527-1433

Pres.: Alan Adelstein

### Ampex Corp., MTD

401 Broadway, M/S 22-02  
Redwood City, CA 94063  
(415) 367-3888, FAX# 415-367-4132

### R.B. Annis Co., Inc.

1101 N. Delaware St.  
Indianapolis, IN 46202  
(317) 637-9282

### Apex Machine Co.

3000 N.E. 12th Terrace  
Ft. Lauderdale, FL 33334  
(305) 566-1572  
Sales Exec.: Alfred Coningsby III  
Sales Exec.: Todd Coningsby

Atis, Ltd.  
6025 Atlantic Blvd., Suite D  
Norcross, GA 30071  
(404) 446-7234, FAX# 404-446-7237  
V.P. Tech Svcs: Peter Lorenz  
Nat'l Sales Mgr.: Tony Vespoli  
Products: cassette recorders, reel-to-reel recorders & players, transcription systems

Bedford, MA 01730-1471  
(617) 271-6642

Benjamin International, Inc.  
1460 Old Country Road  
Plainview, NY 11803  
(516) 753-0700, 800-572-8989, FAX# 516-753-0839  
Pres.: Joseph N. Benjamin  
V.P.: Charles Tanner  
Products: degaussers, demagnetizers, tape splicers

Capitol Magnetic Products  
6902 Sunset Blvd.  
Hollywood, CA 90028  
(213) 461-2701  
Pres.: Edward C. Khoury  
Senior V. P./Sales: H. J. "Bud" Jackson  
V. P. Int'l Sales: Larry Krutsinger  
Managing Dir./U. K.: Steve Castle  
Dir./Technical Mkt'g: Joseph Kempler

Audico, Inc.  
219 Crossen Ave.  
Elk Grove, IL 60007  
(312) 640-1030  
Pres.: Bill Hinkle  
V.P.: Norm Deletzke

Bonneville Media Communications  
130 Social Hall Ave.  
Salt Lake City, UT 84111  
(801) 237-2400  
Products: cassette tape

Cetec Gauss  
9130 Glenoaks Blvd.  
Sun Valley, CA 91352  
(213) 875-1900, FAX# 818-767-4479  
Pres.: Jim Williams  
Products: high-speed duplicators

Audiolab Electronics, Inc.  
3725 Esperanza Dr.  
Sacramento, CA 95864  
(916) 348-0200  
Pres.: Robert E. Stofan  
Mkt'g/Sales Mgr.: Ronald A. Stofan  
Production Engineer: Marc A. Moore

Burlington Audio/Video Tapes, Inc.  
106 Mott St.  
Oceanside, NY 11572  
(516) 678-4414, 800-331-3191  
Pres.: Ruth Schwartz  
V.P.: Rudy Schwartz  
Jr. V.P.: Jan Schwartz  
Sales Mgr.: Ray Colon

Chemtronics, Inc.  
681 Old Willets Path  
Hauppauge, NY 11788  
(516) 582-3322

BASF Corporation, Information Systems  
19 Crosby Drive

Electronic Specialists, Inc.  
PO Box 389  
171 S. Main St.

*New from MacKenzie Laboratories, the leader in digital message repeaters*

# Random Access Digital Audio

MacKenzie's Random Access Digital Audio (RADA) is an audio message repeater system with multiple-message capability. It is designed to serve as the voice playback section of alarm systems in applications such as:

- Life-safety announcements
- Fire evacuation
- "Code Blue" messages
- Security warnings

Messages are digitized, stored in removable EPROM memory chips and controlled by the system's built-in microprocessors. The voice is entirely natural, just like a tape recording.

RADA provides the various levels of supervision required in life-safety systems, as well as continuous digital self-check and voice-check. Message prioritization and FIFO are standard features. Power interruptions won't affect the system's memory. The highly reliable, all-solid-state RADA system has *no moving parts*, so it requires *no maintenance*.

RADA is furnished in standard 19-inch equipment rack configuration. The basic unit provides up to 80 messages. Building-block expansion via sub-chassis



*RADA unit shown with front cover removed.*

provides capacities of more than 500 messages. Message lengths can be as short as 7.5 seconds or as long as 30 seconds. For more information about the versatile new RADA system, call MacKenzie Laboratories toll-free:

**800-423-4147**

**MACKENZIE** MacKenzie Laboratories, Inc.

5507 Peck Road □ Arcadia, California 91006 USA □ (818) 579-0440

Natick, MA 01760  
(617) 655-1532

Fidelipac Corp.  
PO Box 808  
Moorestown, NJ 08057  
(609 ) 235-3900, 800-468-8273  
Sales Director: Jack Ducart  
V.P. Mkt'g: Arthur Constantine

Fostex Corp. of America  
15431 Blackburn Ave.  
Norwalk, CA 90650  
(213) 921-1112, FAX# 213-802-1964  
Pres.: Y. Abe  
Exec. V.P./General Mgr.: Fred Huang  
V.P. Sales/Mkt'g: Mark Cohen  
Products: cassette recorders, cassette  
tape, cleaners, degaussers,  
demagnetizers, multi-tracks, reel-to-  
reel recorders & players

Geneva Group of Companies, Inc.  
7255 Flying Cloud Dr.  
Eden Prarie, MN 55344  
(612) 829-1724  
Pres.: Edward E. Griffin  
Sales Mgr.: Bruce A. Bowen

Infonics, Inc.  
2302 E. Michigan Blvd.  
Michigan City, IN 46360  
(219) 879-3381  
Pres.: Carol Lant  
V.P.: David Smith

International Electro-Magnetics, Inc.  
350 North Eric Drive  
Palatine, IL 60067  
(312) 358-4622

International Music Co. (I. M. C.)  
PO Box 2344  
1316 E. Lancaster  
Ft. Worth, TX 76113-2344  
(817) 336-5114, 800-433-5627, FAX#  
817-870-1271  
Chairman of the Bd./CEO: Tommy  
Moore  
Pres.: Jerry Freed  
V.P. Sales: C.H. Murray  
Dir. of Akai EMI: Mike McRoberts  
Akai Prod. Specialist: Kevin Kennedy

International Tapetronics/3M  
PO Box 241  
2425 S. Main St.

Bloomington, IL 61702-0241  
(309) 828-1381, 800-447-0414, FAX#  
309-828-1386  
Sales Rep. Tom Becker  
Sales Rep.: John Schaab  
Sales Rep.: Jim Woodworth  
Product Specialist: Chuck Kelly  
Products: cart recorders/players, carts

#### **JBL PROFESSIONAL**

8500 Balboa Blvd  
Northridge, CA 91329  
(818) 893-8411, FAX# 818-893-3639  
Pres.: Ron Means  
V.P. Sales: Ken Lopez  
V.P. Mkt'g: Mark Gander  
Applications Engineer: Drew Daniels  
Mkt'g Mgr./Sound Contracting: Steve  
Romeo  
Video Sales: Don Wilson  
Neil Conly, Bedford, TX, 817-540-3066  
Bill Hamilton, Folsom, PA, 215-543-  
4677  
Steve Armstrong, Northridge, CA, 818-  
707-2529  
Tom Walter, Barrington, IL, 312-382-  
4925  
Products: cart recorders/players

JRF Magnetic Sciences, Inc.  
101 Landing Road  
Landing, NJ 07850  
(201) 398-7426

#### **MACKENZIE LABORATORIES, INC.**

PO Box 3029  
5507 Peck Rd.  
Arcadia, CA 91006  
(818) 579-0440, 800-423-4147, FAX#  
818-448-7131  
Pres.: Addison R. Taylor  
V.P./Chief Engineer: Nagy Khattar  
Sales & Sys.: Joe Vitale  
Products: cart recorders/players, carts

Magnifax International, Inc.  
Route 1 Box 764  
Rogers, AR 72756  
(501) 925-1818, FAX# 501-925-1841  
Products: high-speed duplicators

Magnetic Reference Lab (MRL)  
229 Polaris Ave.  
Mountain View, CA 94043  
(415) 965-8187, FAX# 415-965-8187  
Pres.: John G. McKnight  
Products: test tapes

Microtran  
PO Box 236  
145 East Mineola Ave.  
Valley Stream, NY 11582-0236  
(516) 561-6050, FAX# 516-561-1117  
Pres.: Albert J. Eisenberg  
V.P. Sales: Walter Benschler  
Chief Engineer: Vulf Ozechov  
Purchasing Agent: Belle Moskowitz  
Production Mgr.: Charles Meyer  
Advertising Mgr.: Lou Anne O'Conner  
Products: degaussers, demagnetizers

Nakamichi America, Corp.  
19701 South Vermont Ave.  
Torrance, CA 90502  
(213) 538-8150, 800-421-2313, FAX#  
213-324-7614  
Pres.: Yas Yamazaki  
Exec. V.P./General Mgr.: Dean Miller  
V.P. Sales: Jett Logan  
V.P. Operations: Ray Privette  
Mkt'g Mgr.: Jun Sakamoto  
Professional Audio Assoc., Burlington,  
MA, 617-229-6050  
Rancilio Assoc., St. Louis, MO, 314-  
631-3326  
Applied Audio Marketing, Asheville,  
NC, 704-252-9313  
Tenick & Assoc., Houston, TX, 713-  
528-2005  
Western Audio Sales, Glendale, CA,  
818-246-3806  
Audio Assoc. Corp., Verona, NJ, 201-  
239-3727  
Audio Resources, Inc., Westmont, IL,  
312-655-1180  
Bencsik Assoc., Inc., Ocala, FL, 904-  
732-9775  
C.M. Sales, Farmington Hills, MI, 313-  
553-8070  
JB Parent Co., Dublin, OH, 614-764-  
0064  
Keiser & Assoc., Bountiful, UT, 801-  
298-8902  
L.P. Marketing, Inc., Oakland, CA, 415-  
532-5600  
Northshore Marketing, Seattle, WA,  
206-284-9699  
Sigmet Corp., Valley Forge, PA, 215-  
783-6666  
Products: cassette recorders, cassette  
tape, demagnetizers

Nortronics Co., Inc.  
8101 Tenth Ave. North  
Minneapolis, MN 55427



(612) 545-0401, FAX# 612-540-8678  
 Pres.: John A. Yngve  
 Mkt'g Oper. Mgr.: Karen Nickolauson  
 Engineering Mgr.: Mike Drees  
 Products: heads

**Otari Corp.**

378 Vintage Park Drive  
 Foster City, CA 94404  
 (415) 341-5900, FAX# 415-341-7200  
 Pres.: Jack Soma  
 Mkt'g Mgr.: John Carey  
 Nat'l Sales Mgr.: David Roudebush  
 Product Specialist: Tom Burrows  
 Products: cart recorders/players,  
 heads, high-speed duplicators, multi-  
 tracks

**PHI Technologies, Inc.**

4605 North Stiles  
 Oklahoma City, OK 73105-3328  
 (405) 521-9000  
 Pres.: Gary Zebrowski  
 Director of Operations: Bill Seaman  
 Sales Mgr., Consumer: Dan Reynolds  
 Sales Mgr., Sys./OEM: Michael Morgan

**Paso Sound Products**

14 First St.  
 Pelham, NY 10803-1495  
 (914) 738-4800, FAX# 914-738-3954  
 Executive V.P.: Paul Mastrangelo  
 Sales Mgr.: David Moore  
 Product Mgr.: Ken O'Brien  
 Credit Mgr.: Marilyn Beckerson  
 Operations Mgr.: Anthony Sgueglia  
 All West Electronics, Camarillo, CA,  
 805-388-1789  
 Anderson Sales, Braintree, MA, 617-  
 848-9194  
 Pace Sales, Charlotte, NC, 704-365-  
 3216  
 De Witt Austin Co., Alpharetta, GA,  
 404-442-1326  
 Dowell Assoc., St. Louis, MO, 314-  
 849-4234  
 Mountain Representatives, Denver, CO,  
 303-623-0972  
 J.Y.S. Comm. Co., Dallas, TX, 214-  
 349-1650  
 Lienau Assoc., Inc., Columbia, MD,  
 301-621-4113  
 Lienau Assoc., Inc., New Town, PA,  
 215-860-2100  
 SLK Tech Rep, San Francisco, CA,  
 415-822-4884

Miguel Lopez, Hialeah, FL, 305-822-  
 6853

Marketline, Snellville, GA, 404-972-  
 9048

Messnick Sales, Liverpool, NY, 315-  
 622-3211

Miller Assoc., Ltd., Greenwich, CT,  
 212-840-2866

Robert Milsk Co., Inc., Southfield, MI,  
 313-354-3310

Robert Milsk Co., Indianapolis, IN, 317-  
 842-3400

Weller Electronic Sales, Worthington,  
 OH, 614-885-7819

Frank Lintern Assoc., Naperville, IL,  
 312-983-0935

Products: cassette players & changers,  
 cleaners, demagnetizers

**Projector Recorder Belt Corp.**

PO Box 176  
 Whitewater, WI 53115  
 (414) 473-2151

**Quantam Audio Labs**

2752 Walnut Ave.  
 Tustin, CA 92680  
 (714) 838-8833, FAX# 714-838-9619  
 Sales Engineer: David Rollins  
 Products: degaussers

**Recortec, Inc.**

275 Santa Ana Court  
 Sunnyvale, CA 94086  
 (408) 737-8441  
 Pres.: Lester H. Lee  
 V.P.: Eldon A. Corl  
 Mkt'g Director: Ronald Truxell

**Saki Magnetics, Inc.**

26600 Agoura Road  
 Calabasas, CA 91302  
 (818) 880-4054, FAX# 818-880-6242  
 Pres.: Eugene Sakasegawa  
 Dir./Sales & Mkt'g: Trevor Boyer  
 Auteri Assoc., Inc., Miller Place, NY,  
 516-331-5022  
 Coast Recording Equip., Hollywood,  
 CA, 213-462-6058  
 JRF/Magnetic Sciences, Inc.,  
 Greendell, NJ, 201-579-5773  
 Nortec West, Vancouver, Canada, 403-  
 252-8141  
 Teletek Electronics, Ltd., Ontario,  
 Canada, 416-499-3242

**Sony Professional Audio**

1600 Queen Anne Road  
 Teaneck, NJ 07666  
 (201) 833-5200  
 Pres.: William G. Connolly  
 V.P.: Jerry Smith  
 Products: multi-tracks, reel-to-reel  
 recorders & players

**SOUNDCRAFT**

PO Box 2200  
 8500 Balboa Blvd.  
 Northridge, CA 91329  
 (818) 893-4351, FAX# 818-893-3639  
 Pres.: Ron Means  
 V.P. Sales: Ken Lopez  
 V.P. Mkt'g: Mark Gander  
 Nat'l Sales Mgr.: David Kimm  
 Tech. Applications: Gordon Cochran  
 Neil Conly, Bedford, TX, 817-540-3066  
 Bill Hamilton, Folsom, PA, 215-543-  
 4677  
 Steve Armstrong, Northridge, CA, 818-  
 707-2529  
 Tom Walter, Barrington, IL, 312-382-  
 4925  
 Products: multi-tracks, reel-to-reel  
 recorders & players

**Standard Tape Laboratory, Inc.**

26120 Eden Landing Rd., Suite 5  
 Hayward, CA 94545  
 (415) 786-3546  
 Pres.: Frank G. Lennert

**Studer Revox America, Inc.**

1425 Elm Hill Pike  
 Nashville, TN 37210  
 (615) 254-5651, FAX# 615-256-7619  
 Dir./Prof. Dealer Prod.: David C.  
 Bowman  
 Mgr. Studer Direct Sales: Chris Ware  
 New York, NY, 212-255-4462  
 Dallas, TX, 214-943-2239  
 Los Angeles, CA, 818-780-4234  
 San Francisco, CA, 415-930-9866  
 Pro Audio LTD, Chicago, IL, 312-526-  
 1660  
 Products: cassette recorders, multi-  
 tracks, reel-to-reel recorders &  
 players

**Sunkyong International, Audio Division**

17106 S. Avalon Blvd.  
 Carson City, CA 90746  
 (213) 327-5010, 800-237-8372, FAX#

# Introducing Panasonic Professional Digital Audio.

## The difference between a purchase and an investment.

Digital technology is here now. And without a committed investment in the necessary digital hardware, audio professionals won't be able to cut it in the competitive world of audio production.

Panasonic is a service-oriented organization that's committed to a substantial, long-term investment in the future of digital production.

Our first offering is a quartet of digital audio tape and compact disc products that answer the specific demands of professional environments. Rugged, reliable, hard working designs incorporating the essential features and high quality you need to make your investment pay off.

New from Panasonic are a pair of professional DAT machines. The portable SV-250 for field and location recording, and the rack-mount SV-3500 for studio and permanent applications.

The SV-250 Portable DAT: 3.5 pounds  internal battery  mic/line inputs  high-precision metering  dual MASH A-to-D 64-times

oversampling digital filters  headphone monitoring.

The SV-3500 Studio DAT: high-speed search  full programming functions  multiple-repeat mode  wired remote  XLR ins/outs  CD/DAT digital interface.



SV-3500 Studio DAT.



SV-250 Portable DAT.



For demanding industrial

CD applications, the rackmount SL-4300 Single-CD and SV-4700 Magazine Compact Disc players feature heavy duty transports, four-times oversampling and dual DACs for ultra-linear replay quality.

The SL-4300 CD Player: direct access

to any track in under a second  playback sequencing with up to 20 selections  automated series play mode. The SL-4700 CD Player: a removable magazine holds six CDs  36-event random access to any CD track on any disc  full-feature remote control unit.

SL-4300 CD Player.



SL-4700 CD Player.

If you're considering the purchase of a studio quality DAT recorder or CD player, spend a few minutes talking to a Panasonic dealer. The investment could pay off for the rest of your career.

For the name of your nearest dealer, call 714-895-7278 now, or write to us at Panasonic AVSG, 6550 Katella Ave., Cypress, CA 90630.

**Panasonic**  
Professional Audio Systems



213-327-0276  
Mkt'g: Tony Kim

## Tape-Athon Corp.

13633 Crenshaw Blvd.  
Hawthorne, CA 90250  
(213) 676-6752  
Pres.: Leon E. "Lee" Tate  
General Mgr.: Robert Haller  
Director Engineering: Bernard Sayers  
Director Mkt'g: John Bagley  
Sales Coordinator: Bob Mayfield  
Sales Mgr.: Rick Bottom  
Chuck Olson Assoc., Renton, WA, 206-271-5416  
Warren Assoc., Santa Clara, CA, 408-988-7762  
Greg Dzubay & Assoc., Peoria, AZ, 602-979-2358  
Spivey-Leboeuf Assoc., Richardson, TX, 214-231-3190  
Central Marketing Group, Kansas City, MO, 816-741-7460  
John E. M. Anderson, Minneapolis, MN, 612-823-6459  
Gustafson System Sales, Palatine, IL, 312-358-2505  
Avcom, Inc., N. Olmsted, OH, 216-777-2060  
Elmarcon, Inc., Indianapolis, IN, 317-846-0221  
Saga, Oswego, NY, 315-343-5739

Pinz Sales Corp., Rockville Centre, NY, 516-678-6887  
ASR Enterprises, LTD., Fallston, MD, 301-893-0001  
Murphy & Cota, Atlanta, GA, 404-875-2525  
Bencsik Assoc., Ocala, FL, 904-732-9775  
Design Factors, La Habra Heights, CA, 213-697-7576  
Products: cassette players & changers, multi-tracks, reel tape, reel-to-reel recorders & players

## Tascam (TEAC Professional Division)

7733 Telegraph Road  
Montebello, CA 90640  
(213) 726-0303, FAX# 213-725-1994  
Mkt'g Mgr.: Bill Mohrhoff  
Nat'l Sales Mgr.: Gregg Hildebrandt  
W. Reg. Mgr.: Fred Allard  
S. Reg. Mgr.: Bill Stevens  
E. Reg. Mgr.: Chuck Prada  
Products: cassette recorders, cleaners, demagnetizers, high-speed duplicators, multi-tracks, reel tape, reel-to-reel recorders & players, test tapes

Technics Professional  
One Panasonic Way  
Secaucus, NJ 07094

(201) 348-7000  
Products: reel-to-reel recorders & players

## Uher of America

7067 Vineland Ave.  
N. Hollywood, CA 91605  
(818) 764-1120  
Pres.: John Belgiorno  
Executive V.P./Mkt'g: George A. Rose

## VIF International

PO Box 1555  
Mountain View, CA 94042  
(408) 739-9740  
Pres.: Nancy Mackechnie  
Advisor/Int'l Op.: Gordon Mackechnie

## Versadyne International, Inc.

504-D Vandell Way  
Campbell, CA 95008  
(408) 379-0900, FAX# 408-379-0902  
Pres.: Robert W. Kratt  
Products: high-speed duplicators

## PROFESSIONAL AUDIO DIVISION, YAMAHA MUSIC CORPORATION, USA

PO Box 6600  
6600 Orangethorpe Ave.  
Buena Park, CA 90622  
(714) 522-9011, FAX# 714-739-2680  
Products: cassette recorders, multitracks

# PA SYSTEMS

## AIPHONE INTERCOM SYSTEMS

PO Box 90075  
1700 130th Ave. N.E.  
Bellevue, WA 98005  
(206) 455-0510, FAX# 206-455-0071  
Pres.: Hiko Shinoda  
Nat'l Sales: Jim Morrison  
Products: mixer/amplifier, telephone

## Allen and Heath

5 Connair Rd.  
Orange, CT 06477  
(203) 795-3594, FAX# 203-795-6814  
V.P./Sales Mgr.: Charles Augustowski  
Pres.: John Ball  
General Mgr.: Jean Rathgeber  
Engineer/R&D: John Petrucelli  
Engineer: Joseph Boerst  
GMI/New England, Avon, MA, 617-588-8043

Sherwood Assoc., Endicott, NY, 607-785-1590  
Metropolis Marketing, Edison, NJ, 201-225-0085  
Audio Assoc., Glenwood, MD, 301-854-6122  
Ron Tunks Sales, Tamarac, FL, 305-722-2803  
Cambridge Marketing, S. Euclid, OH, 614-890-7788  
Jamm Dist., Flossnor, IL, 312-747-6363  
Centurian Marketing, Ballwin, MO, 314-227-7229  
JMS Marketing, Austin, TX, 512-266-1113  
Loppnow & Assoc., Redmond, WA, 206-883-3205  
AMH Sales, Palos Verdes Estates, CA, 213-373-2034

Products: mixer/preamps, modular

## Amplivox Communication

Products/Security Intercom, Inc.  
1833 N. 105th  
Seattle, WA 98133  
(206) 523-6170  
Pres.: Gerard H. Mooyman  
Director of Sales: Jeffrey L. Groth  
Sales Mgr.: Claudio Mazzola  
Nat'l Advertising: John Bernard  
Products: music distribution

# ASHLY

**ASHLY AUDIO, INC.**  
100 Fernwood Ave.

# Need telephone system paging enhancements that are:

- Low Cost • Easy to Install • Easy to Sell

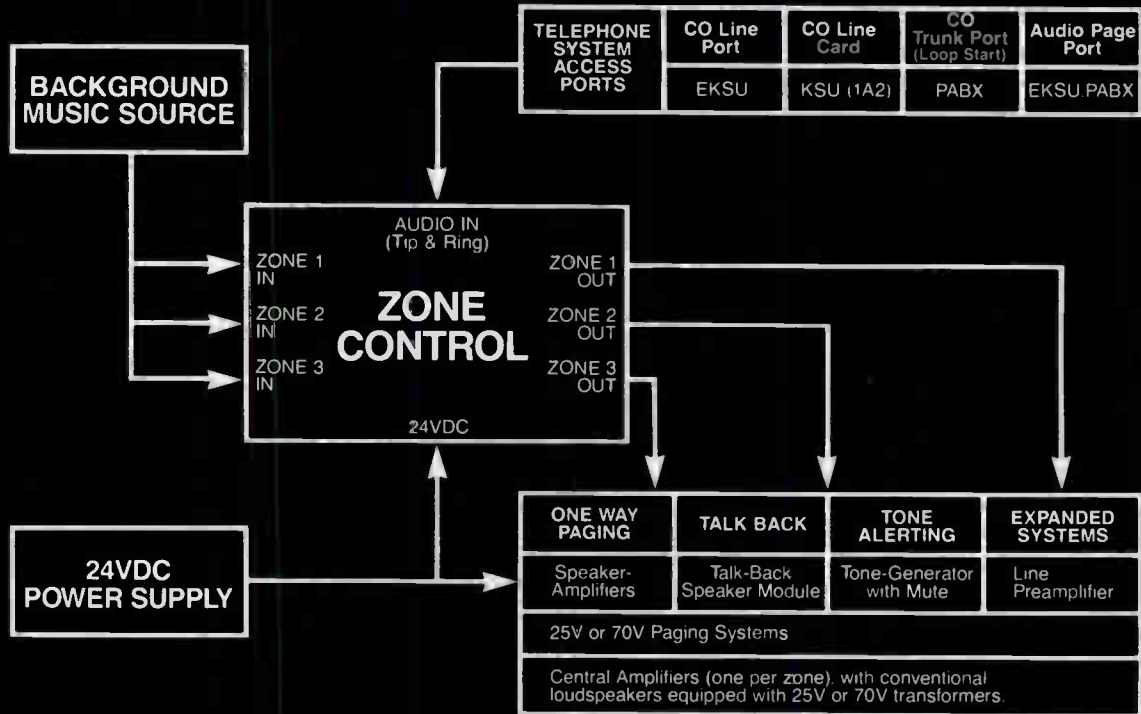

## Wheelock has the answers

Take a close look at Wheelock's telephone system compatible paging systems. You'll find a truly low-cost three zone control with all-call and background music mute ... a self-contained talk back speaker module providing unmatched talk back pick up direction and intelligibility ... a full line of 4" speaker-amplifiers. Plus many other features just right for your customers' expanding communications needs.

Selling and installing Wheelock telephone system peripherals gives you a strong competitive edge.

You can help your customers meet their requirements while increasing your sales and profits. And you'll have another edge, too ... Wheelock know-how and experience going back 55 years as a supplier to Western Electric.

For a free demonstration or more information on the growing line of Wheelock telephone peripherals, contact the Customer Service Manager, Wheelock, Inc., 273 Branchport Avenue, Long Branch, New Jersey 07740, (800) 631-2148; in New Jersey (201) 222-6880.

**wheelock**  
THE SIGNAL SOURCE<sup>SM</sup>

World Radio History

Rochester, NY 14621  
(716) 544-5191, 800-828-6308, FAX#  
716-266-4589

Pres.: William Thompson  
Senior V.P.: Bob French  
V.P.: David Malloy  
Office Mgr.: Ellen Price  
Products: mixer/preamps, processors,  
signalling

Audio Systems Company  
PO Box 1174  
1815 Michigan Ave.  
Bismarck, ND 58502  
(701) 223-3800, 800-852-6522  
Pres.: Lynn Mader  
V.P.: Lyle Mader  
Sales Mgr.: Mark Schmidt  
Products: mixer/amplifier,  
mixer/preamps, modular, zoned

Auditel Systems, Ltd.  
396 Porter Ave.  
Buffalo, NY 14201  
(716) 886-0019, FAX# 716-886-1615  
Pres.: David Langtry  
Prod. Mgr.: Tony Roberson

Mkt'g Director: Jim Wood  
Products: mixer/preamps, modular

BBE Sound, Inc.  
5500 Bolsa Avenue, Suite 245  
Huntington Beach, CA 92649  
(714) 897-6766, 800-233-8346, FAX#  
714-895-6728  
CEO: John C. McLaren  
CFO.: Scott Anderson  
Nat'l Sales: Jim Lucas  
Operations Mgr.: Jennifer Drescher  
Director of Engineering: Robert Crooks  
Tech Svces Sup.: Ryan Coutts  
Products: processors

BCE/Edcom, Division of CCS, Inc.  
1585A Britannia RD. E., #7  
Mississauga, Ontario, Canada L4W  
2M4  
(416) 678-0801, FAX# 416-678-0480  
Pres.: Peter Jova  
Sales Mgr.: Keith Moore  
Products: music distribution, signalling,  
zoned

Bogen Communications, Inc.  
PO Box 575  
50 Spring St.  
Ramsey, NJ 07446  
(201) 934-8500, FAX# 201-934-9832  
Pres.: John H. Ochtera  
V.P. Sales/Sound Prod.: David A.  
Chambers  
V.P. Sales/Telecomm. Prod.: Charles  
Ferreri  
Bruce Barrett, Garland, TX, 214-530-  
0467  
Kingston Sales Corp., Indianapolis, IN,  
317-876-2545  
Kevin Koehler, Batvia, IL, 312-879-6871  
Tim McDonnell, Willoughby Hills, OH,  
216-942-2429  
Steve McGrew, Kennesaw, GA, 404-  
422-4608  
Meyer Mkt'g, Inc., Deerfield Beach, FL,  
305-481-9250  
W.B. Pray Sales, Inc., Northboro, MA,  
617-393-3434  
Jay Sample, Sandy, UT, 801-942-1059  
Scott Sampson, Encino, CA, 818-996-  
5484  
Mike Schneider, Baltimore, MD, 301-

## SPECO A Totally Sound Company Quality PA Systems, priced to let you win the bid!

- FULL LINE of AMPLIFIERS - with FM/AM TUNER - with AUTO REVERSE CASSETTE •
- 8" SPEAKERS - SPEAKER ASSEMBLIES with GRILLES •
- TRANSFORMERS - SOUND COLUMNS •
- WALL BAFFLES - INTERCOMS •
- LINE TRANSFORMERS - ATTENUATORS •
- CEILING GRILLES - L-PADS •
- PA HORNS - PA AMPLIFIERS •
- ALL WEATHER POLYPROPYLENE SPEAKERS •
- SECURITY PRODUCTS •
- ENCLOSED WEATHERPROOF POLYPROPYLENE MINI-SPEAKERS WITH BUILT-IN 70V & 25V LINE TRANSFORMERS •



G810CPP  
POLYPROPYLENE  
SPEAKER

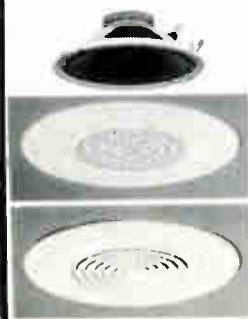

WB8-10F-70



GSE-8P  
SOUND  
ENHANCER



DMS-3TS  
MINI 3-WAY  
SPEAKER  
WEATHERPROOF



MHL-1  
MICROPHONE

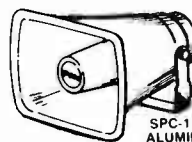

SPC-15RT  
ALUMINUM  
PA SPEAKER

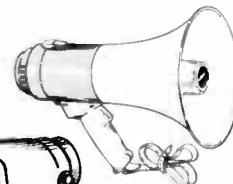

ER-370  
MEGAPHONE



G1260APP  
150 WATTS  
RMS



PAFM-45  
COMPLETE MUSIC &  
PAGE SYSTEM



PAFM-60C  
60 WATTS



PAT-60  
60 WATTS



PAT-120  
120 WATTS



PAT-20  
MOBILE PA  
AMPLIFIER

**CALL US FOR OUR NEW  
BACKGROUND SOUND WALL POSTER**

TOLL FREE  
800-645-5516

SPECO DIVISION  
COMPONENTS SPECIALTIES, INC.  
1172 ROUTE 109, P.O. BOX 624  
LINDENHURST, N.Y. 11757

IN NEW YORK  
516-957-8700



563-5390  
Walt Spencer, Ramsey, NJ, 201-934-8500  
White Radio Ltd., Burlington, ONT, Canada, 416-632-6894  
Roburn Agencies, Inc., Yonkers, NY, 914-968-1016  
Products: mixer/amplifier, mixer/preamps, modular, music distribution, zoned

**CETEC RAYMER**

13278 Ralston Ave.  
Sylmar, CA 91342  
(818) 362-9516, FAX# 818-367-5292  
Pres.: Hugh T. Wilcox  
Sales Support Rep: Michelle Price  
Sales Coordinator: Jean Hurst  
Products: mixer/amplifier, mixer/preamps, modular, music distribution, signalling, telephone, zoned

**J. W. DAVIS & CO.**

PO Box 26177  
3030 Canton Street  
Dallas, TX 75226  
(214) 651-7341, 800-527-5705, in TX 800-442-1564, FAX# 214-939-0328  
Pres.: Charles Griffith  
V.P. Sales: Jack W. Tucker  
Chief Engineer: Mike Lamm  
Products: mixer/amplifier, telephone

**DUKANE CORPORATION**

2900 Dukane Dr.  
St. Charles, IL 60174  
(312) 584-2300, FAX# 312-584-2370  
Pres.: J. McWilliams Stone, Jr.  
Group V.P.: William P. Finnegan  
Division General Mgr.: Steve Deppe  
Mkt'g Mgr.: Derek Podobas  
Nat'l Sales Mgr.: Warren Anderson  
Service Mgr.: Cliff Carlson  
Doug Fellabaum, Sycamore, IL, 800-445-0152(#2301)  
Don Mouritzen, Beecher, IL, 800-445-0152(2303#)  
Art Sbrilli, Edison, NJ, 800-445-0152(#2302)  
Pete Kendall, Jacksonville, FL, 904-262-6025(#2306)

Jack Brown, Dallas, TX, 214-943-7528(#2305)  
Ed Nuhring, Portland, OR, 800-445-0152(#2307)  
Wally Smutts, Toronto, Ontario, Canada, 312-584-2300  
Ken Lind, Wellesley Hills, MA, 617-235-6817  
Products: mixer/amplifier, mixer/preamps, modular, music distribution

**Edecor**

1948 East Pomona  
Santa Ana, CA 92705  
(714) 648-0292, 800-854-0259, FAX# 714-648-0117  
Pres.: Larry Weston  
Office Mgr.: Phyllis Weston  
Sales Mgr.: Deanna Weston  
Products: mixer/amplifier, mixer/preamps, modular, music distribution, telephone, zoned

**Electro-Voice, Inc.**

600 Cecil Street  
Buchanan, MI 49107  
(616) 695-6831, 800-527-6701, FAX# 616-695-1304  
Pres.: Robert D. Pabst  
V.P. Sales & Mkt'g: Paul McGuire  
Director of Mkt'g: Jim Long  
Chief Engineer: Earl Harris  
George M. Conneen Co., Inc.,  
Springfield, PA, 215-544-5884  
Metropolis Audio Marketing, Inc.,  
Edison, NJ, 201-225-0085  
R.J. Marketing Ltd., Rockville, MD,  
301-251-0330  
The Smith Company, Hartford, CT,  
203-523-0512  
Ron Tunks Sales, Inc., Tamarac, FL,  
305-722-2803  
Wilson Audio Sales, Nashville, TN, 615-646-4477  
Audio Resources, Westmont, IL, 312-655-1180  
B.C. Electronic Sales, Inc., Mission,  
KS, 913-262-1720  
Jones Audio Sales, Plano, TX, 214-867-0202  
C.L. Pugh & Assoc., Inc., Columbus,  
OH, 614-486-9678  
Riley & Petchell Sales, Inc., Detroit, MI,  
313-937-300  
Loppnow & Assoc., Redmond, WA,  
206-883-3205

Radon & Assoc., Sacramento, CA,  
916-923-2524  
Silver Peak Marketing Ltd., Wheat  
Ridge, CO, 303-467-9042  
Western Audio Sales, Glendale, CA,  
818-246-3806 x  
Products: mixer/amplifier,  
mixer/preamps

**Fostex Corp. of America**

15431 Blackburn Ave.  
Norwalk, CA 90650  
(213) 921-1112, FAX# 213-802-1964  
Pres.: Y. Abe  
Exec. V.P./General Mgr.: Fred Huang  
V.P. Sales/Mkt'g: Mark Cohen  
Products: mixer/amplifier

**HARRIS CORPORATION, DRACON DIVISION**

809 Calle Plano  
Camarillo, CA 93010  
(805) 987-9511, 800-437-2266, FAX# 805-987-2547  
V.P./General Mgr.: John R. Mason  
V.P. Sales & Mkt'g.: Jack McGuigan  
Director of Sales: Tom Erdmann  
Paging Prod. Mgr.: Tom Johnson  
Metals/Racks/Tools Prod. Mgr.: Terry Smith  
Test Sets Prod. Mgr.: John Akins  
Don Bivens, Lake Elsinore, CA, 714-672-2168  
Gary Foster, Columbia, MD, 314-442-2288  
Rob Lincoln, Melbourne, FL, 407-259-0991  
Mark Skilowitz, Newfield, NJ, 609-697-4580  
Jim Fetterer, Seattle, WA, 206-243-7762  
Bill Boone, Libertyville, IL, 312-816-1080  
Dave Whelan, W. Springfield, MA, 413-731-9552  
Products: telephone, zoned

Hill Audio, Inc.  
5002B N. Royal Atlanta Dr.  
Tucker, GA 30084  
(404) 934-1851, FAX# 404-934-1840  
Sales Mgr.: Bob Allen

- Svce Mgr.: Rick Rogers  
Innovative Sales and Marketing, Irvine,  
CA, 714-549-7770  
Ouzunoff and Assoc., Yorktown  
Heights, NY, 914-245-6452  
Products: mixer/amplifier
- IED Innovative Electronic Designs, Inc.  
9701 Taylorsville Rd  
Louisville, KY 40299  
(502) 267-7436, FAX# 502-267-9070  
V.P. Mkt'g & Sales: Tom Roseberry  
Mkt'g Assistant: Wanda R. Martin  
Pres.: Hardy Martin  
Sec./Treas.: Ray Allen  
V.P. R & D: Robert Ponto  
Derek Allen Assoc., Toluca Lake, CA,  
818-840-8327  
Bensik Assoc., Ocala, FL, 904-732-  
9775  
Plus 4 Marketing, Pleasant Hill, CA,  
415-937-0650  
Yore Company, White Bear Lake, MN,  
612-770-9760  
Products: mixer/preamps, modular,  
processors, signalling, zoned
- KDM Electronics, Inc.  
705 Progress Ave., Unit #59  
Scarborough, Ontario, Canada M7H  
2X1  
(416) 439-7158  
Pres.: Ron Bull  
Products: mixer/preamps, modular,  
music distribution, zoned
- Magna-Sound  
5501 108th St.  
Corona, NY 11368  
(718) 271-5200  
Pres.: Ben Frankenstein  
Sales Mgr.: J. Miner  
Secretary: D. Shupack  
Products: mixer/amplifier
- Multi-Vox Ltd.  
9967 St. Michel Blvd.  
Montreal- Nord, Quebec, Canada H1H  
5G7  
(514) 321-3131  
Pres.: Jean Lajoire  
Engineer: Dominique Malenfant  
Operations Mgr.: Georges Morissette  
Sales/Technical Cdr.: Antoine Krelio
- NEL-TECH LABS, INC.**  
PO Box 1030
- Londonderry, NH 03053  
(603) 434-8234, FAX# 603-434-1265  
Pres.: Gary Stapleford  
Exec. V.P.: Ken Ritter  
Products: signalling
- Panasonic Industrial Company/Ramsa  
6550 Katella Ave  
Cypress, CA 90630  
(714) 895-7278, FAX# 714-895-7242  
Nat'l Sales/Mkt'g: Steve Wooley  
Eastern Sales Mgr.: D.J. Bierut  
Central Sales Mgr.: Greg Braithwaite  
Western Sales Mgr.: James Murray  
Pusecker Sales, Upper Montclair, NJ,  
201-744-1834  
Professional Audio Associates,  
Burlington, MA, 617-229-6050  
David Prinzi, Webster, NY, 716-671-  
9266  
World Wide Electronics, Pembroke  
Pines, FL, 305-584-7024  
World Wide Electronics, Jacksonville,  
FL  
Evans Sales & Mkt'g, Nashville, TN,  
615-297-7997  
A/V Mkt'g, Carmel, IN, 317-846-1034  
Key Mkt'g, Plymouth, MI, 313-459-  
6040  
New Horizons Elec. Mkt'g,  
Bannockburn, IL, 312-234-5911  
J.B. Parent Co., Dublin, OH, 614-764-  
0064  
Music Interventions & Assoc., Kansas  
City, MO, 816-453-4448  
Tenicki & Assoc., Houston, TX, 713-  
528-2005  
New West Audio, Burbank, CA, 818-  
955-9706  
Brian Trankle Assoc., Belmont, CA,  
415-595-4004  
Brian Trankle Assoc., Sacramento, CA,  
916-369-7030  
Northmar, Seattle, WA, 206-524-5170  
Pearson & Pearson, Denver, CO, 303-  
722-6996  
Products: mixer/preamps, modular
- Paso Sound Products  
14 First St.  
Pelham, NY 10803-1495  
(914) 738-4800, FAX# 914-738-3954  
Executive V.P.: Paul Mastrangelo  
Sales Mgr.: David Moore  
Product Mgr.: Ken Obrien  
Credit Mgr.: Marilyn Beckerson  
Operations Mgr.: Anthony Sgueglia
- All West Electronics, Camarillo, CA,  
805-388-1789  
Anderson Sales, Braintree, MA, 617-  
848-9194  
Pace Sales, Charlotte, NC, 704-365-  
3216  
De Witt Austin Co., Alpharetta, GA,  
404-442-1326  
Dowell Assoc., St. Louis, MO, 314-  
849-4234  
Mountain Representatives, Denver, CO,  
303-623-0972  
J.Y.S. Comm. Co., Dallas, TX, 214-  
349-1650  
Lienau Assoc., Inc., Columbia, MD,  
301-621-4113  
Lienau Assoc., Inc., New Town, PA,  
215-860-2100  
SLK Tech Rep, San Francisco, CA,  
415-822-4884  
Miguel Lopez, Hialeah, FL, 305-822-  
6853  
Marketline, Snellville, GA, 404-972-  
9048  
Messnick Sales, Liverpool, NY, 315-  
622-3211  
Miller Assoc., Ltd., Greenwich, CT,  
212-840-2866  
Robert Milsk Co., Inc., Southfield, MI,  
313-354-3310  
Robert Milsk Co., Indianapolis, IN, 317-  
842-3400  
Weller Electronic Sales, Worthington,  
OH, 614-885-7819  
Frank Lintern Assoc., Naperville, IL,  
312-983-0935  
Products: mixer/amplifier,  
mixer/preamps, modular, music  
distribution, processors, telephone
- Peavey Electronics Corp.  
PO Box 2898  
711 A Street  
Meridian, MS 39301  
(601) 483-5365, FAX# 601-484-4278  
Prod Mgr.: Ken Valentine  
Products: mixer/amplifier
- PRECISION ELECTRONICS, INC.**  
9101 King St.  
Franklin Park, IL 60131  
(312) 678-5350  
Pres.: William S. Grommes  
CE A.A. Hart  
Sales Mgr.: William Stow  
General Mgr.: G. Hussain  
Products: mixer/amplifier,

mixer/preamps, telephone

**PROTECH AUDIO CORP.**

Flowerfield, Bldg. #1  
St. James, NY 11780  
(516) 584-5855  
Sales Mgr.: Bill Murphy  
Sales Engineering: Joe Giambone  
Peregrine Rep's, Houston, TX, 713-772-6765

QSC Audio Products, Inc.  
1926 Placentia Ave  
Costa Mesa, CA 92627  
(714) 645-2540, 800-854-4079, FAX# 714-645-7927  
Director of Mkt'g: Greg McVeigh  
Nat'l Sales Mgr.: Peter Kalmen  
Sales Engineer: Andy Murray

**SMC INTERNATIONAL, INC.**

2505 N. 24th St.  
Omaha, NE 68110  
(402) 453-0332, 800-456-9107, FAX# 402-451-2876  
Chief Op. Officer: Jay B. McMartin  
Sales Mgr.: Larry Y. Wiedman  
Dir. of Engineering: Richard L. Diercks  
Miller & Associates, Richardson, TX, 214-437-5733  
Central Mkt'g Group, Kansas City, MO, 816-741-7460  
Products: mixer/amplifier,  
mixer/preamps, modular, telephone, zoned

Senior Audio, Inc.  
13431 Purnice  
Norwalk, CA 90650  
(213) 802-9942  
Mkt'g: Steve Kim  
Products: mixer/amplifier

Soundtech  
230 Lexington Dr.  
Buffalo Grove, IL 60089  
(312) 541-3520, 800-323-4173, FAX# 312-541-3616  
Pres.: Rudy Schlacher  
Sales Mgr.: Keith Brawley  
Sales Director: Len Brawling  
Products: mixer/amplifier

Speco Div., Components Specialties, Inc.  
PO Box 624  
1172 Rt. 109  
Lindenhurst, NY 11757

(516) 957-8700, 800-645-5516, FAX# 516-956-9142  
V.P./Sales: Mel Hulkower  
V.P./General Mgr.: Jim Ganci  
Sales Mgr.: Eric Forman  
Products: telephone

Stewart Electronics Corp.  
11460 Sunrise Gold Circle, Suite B  
Rancho Cordova, CA 95742  
(916) 635-3011, FAX# 916-635-1787  
Nat'l Sales/Mkt'g Mgr.: James M. Ruse  
Applied Audio, Asheville, NC, 704-252-9313  
Cambridge Pro Sales, Westerville, OH, 614-890-8144  
GMC, Springfield, PA, 215-544-5884  
Pacific Audio Group, Torrance, CA, 213-375-2611  
Future Sales, Redmond, WA, 206-868-5577  
JAMM Dist., Flossmoor, IL, 312-799-0550  
McManus Music Sales, MN, 612-432-5321  
On the Road Mrkt., Upper Montclair,

NJ, 201-746-0501  
Pro Sound & Light, Lakewood, CO, 303-986-5999  
RPM Sales, Carrollton, TX, 214-446-3010  
B. Trankle & Assoc., Belmonti, CA, 415-595-4004  
Pro Sound Assoc., Jacksonville, FL, 904-744-1170  
Products: mixer/preamps

Sunn Musical Equipment Corporation  
1130 Columbia Street  
Brea, CA 92621  
(714) 990-0909, 800-854-6230, FAX# 714-990-3986  
Pres.: Bill Schultz  
Director of Mkt'g: Joe Green  
Products: mixer/amplifier

**TOA ELECTRONICS, ENGINEERED SOUND & COMMUNICATIONS DIVISION**

PO Box 2047  
601 Gateway Boulevard  
South San Francisco, CA 94080  
(415) 588-2538, 800-843-4750, in CA 800-632-2157, FAX# 415-588-3349

**think ambicon™**  
for a sound PA paging system



in factories,  
shopping malls, airports, lounges,  
mass transit systems, racetracks,  
you name it, you profit.

The Ambicon listens to ambient noise and automatically adjusts PA levels to compensate for variations. Ambicon, preferred in sound reinforcement by leading professionals. Increase profits and reliability. Call or write today for the complete story.

**ProTech™** (516) 584-5855  
**Audio**

Flowerfield Bldg #1  
St. James, N.Y. 11780



Pres.: Yoshiro Ishida  
 Director of Mkt'g: Fred Fredericks  
 Nat'l Sales Mgr.: Richard Krochmal  
 Nat'l Sales Mgr./Engineered Intercom &  
 Security Div.: Al Burns  
 Products: mixer/amplifier,  
 mixer/preamps, modular, music  
 distribution, processors, signalling,  
 telephone

Tascam (TEAC Professional Division)  
 7733 Telegraph Road  
 Montebello, CA 90640  
 (213) 726-0303, FAX# 213-725-1994  
 Mkt'g Mgr.: Bill Mohrhoff  
 Nat'l Sales Mgr.: Gregg Hildebrandt  
 W. Reg. Mgr.: Fred Allard  
 S. Reg. Mgr.: Bill Stevens  
 E. Reg. Mgr.: Chuck Prada  
 Products: mixer/preamps

**3M SOUND PRODUCTS**  
 223-5S-09, 3M Center  
 St. Paul, MI 55144-1000  
 (612) 733-9214, FAX# 612-736-9433  
 Mkt'g Mgr.: Richard G. Barker  
 Sales Mgr.: Don Sluder  
 Products: mixer/amplifier, music  
 distribution

Vicon Industries  
 525 Broad Hollow Rd.  
 Melville, NY 11747  
 (516) 293-2200, 800-645-9116  
 Pres.: Donald N. Horn  
 Executive V.P.: Arthur Wallace  
 V.P. Finance: Kenneth Darby  
 V.P. Mkt'g/Sales: Ronald J. Teixeira  
 Vicon Industries, Norcross, GA, 404-  
 449-0499  
 Vicon Industries, Brea, CA, 714-990-  
 3858  
 Vicon Industries, Washington, D.C.,  
 703-553-7580

Products: signalling

Wheelock, Inc.  
 273 Branchport Ave.  
 Long Branch, NJ 07740  
 (201) 222-6880, FAX# 201-222-8707  
 Pres.: P. W. Tarlton  
 V.P. Mkt'g/Sales: W.L. Goldstein  
 Mkt'g Mgr./Telephone-Paging: Art  
 Arlow  
 Tech. Support Engineer: W. Best  
 Products: modular, signalling,  
 telephone, zoned

**PROFESSIONAL AUDIO DIVISION,  
 YAMAHA MUSIC CORPORATION, USA**  
 PO Box 6600  
 6600 Orangethorpe Ave.  
 Buena Park, CA 90622  
 (714) 522-9011, FAX# 714-739-2680  
 Products: mixer/amplifier,  
 mixer/preamps, music distribution

## PORTABLE SOUND SYSTEMS

Allen and Heath  
 5 Connair Rd.  
 Orange, CT 06477  
 (203) 795-3594, FAX# 203-795-6814  
 V.P./Sales Mgr.: Charles Augustowski  
 Pres.: John Ball  
 General Mgr.: Jean Rathgeber  
 Engineer/R&D: John Petrucelli  
 Engineer: Joseph Boerst  
 GMI/New England, Avon, MA, 617-588-  
 8043  
 Sherwood Assoc., Endicott, NY, 607-  
 785-1590  
 Metropolis Marketing, Edison, NJ, 201-  
 225-0085  
 Audio Assoc., Glenwood, MD, 301-  
 854-6122  
 Ron Tunks Sales, Tamarac, FL, 305-  
 722-2803  
 Cambridge Marketing, S. Euclid, OH,  
 614-890-7788  
 Jamm Dist., Flossnor, IL, 312-747-  
 6363  
 Centurian Marketing, Ballwin, MO, 314-  
 227-7229  
 JMS Marketing, Austin, TX, 512-266-  
 1113  
 Loppsnow & Assoc., Redmond, WA  
 ,206-883-3205

AMH Sales, Palos Verdes Estates, CA,  
 213-373-2034  
 Products: mixers

Anchor Audio, Inc.  
 913 West 223rd St  
 Torrance, CA 90502  
 (213) 533-5984, 800-262-4671, FAX#  
 213-533-6050  
 Pres.: Jim Van Waay  
 Nat'l Sales Mgr.: Jon Peirson  
 Sales Admin: Maggie Keleher  
 Products: amplifiers, columns, DC  
 battery powered, lecturns, mixer  
 amplifiers, powered lecturns,  
 powered speakers, speakers, wireless

**ARGOS PRODUCTS CO.**  
 600 S. Sycamore St.  
 Genoa, IL 60135  
 (815) 784-5118  
 Pres.: Donald C. MacLaughlin  
 Sales/V.P.: Ron Evers  
 Credit Mgr.: Rosella Johnson  
 Chief Engineer: Loren Schrader  
 Purchasing Agent: Ray Melton  
 Ted Firaneck Sales, Pontiac, MI, 313-  
 373-9595  
 Nevco, Inc., Kansas City, MO, 816-

421-1751  
 W.A. Hendrickson Co., N. Scituate,  
 MA, 617-545-0652  
 Maish Sales, Mulberry, IN, 317-296-  
 2322  
 TMC Sales, Ft. Lee, NJ, 201-944-8340  
 Shamrock Sales, Dayton, OH, 513-258-  
 1227  
 Pacnor Marketing, Lynwood, WA, 206-  
 771-6016  
 Murphy & Cota, Atlanta, GA, 404-875-  
 2525  
 Mel Foster Tech. Sales, Edina, MN,  
 612-941-9800  
 Bensik Assoc., Ocala, FL, 904-732-  
 9775  
 Stinson Assoc, Havertown, PA, 215-  
 446-8585  
 Lewis & Dunnigan, Syracuse, NY, 315-  
 446-5522  
 G. MCL Cole Co., Parkridge, IL, 312-  
 692-6040  
 Wes Tech. Marketing, Culver City, CA,  
 213-837-1398  
 Products: columns, DC battery  
 powered, lecturns, powered lecturns,  
 speakers

# ASHLY

**ASHLY AUDIO, INC.**

100 Fernwood Ave.  
Rochester, NY 14621  
(716) 544-5191, 800-828-6308, FAX#  
716-266-4589

Pres.: William Thompson  
Senior V.P.: Bob French  
V.P.: David Malloy  
Office Mgr.: Ellen Price  
Products: amplifiers, processors

**BBE Sound, Inc.**

5500 Bolsa Avenue, Suite 245  
Huntington Beach, CA 92649  
(714) 897-6766, 800-233-8346, FAX#  
714-895-6728

CEO: John C. McLaren  
CFO.: Scott Anderson  
Nat'l Sales: Jim Lucas  
Operations Mgr.: Jennifer Drescher  
Director of Engineering: Robert Crooks  
Tech Svces Sup.: Ryan Couatts  
Products: processors

**Celestion Industries, Inc.**

89 Doug Brown Way  
Holliston, MA 01746  
(617) 429-6706, FAX# 508-429-2926  
V.P./Gen. Mgr.: Peter Wellikoff  
Mkt'g Mgr.: Barry Fox  
Nat'l Sales Mgr.: David Deranian  
Credit Mgr.: Kathy Maguire  
Customer Svce Mgr.: Kip Starrett  
Products: amplifiers, powered  
speakers, processors, speakers,  
weatherproof speakers

**Comtek, Inc.**

357 W. 2700 St. South  
Salt Lake City, UT 84115  
(801) 466-3463, FAX# 801-484-6906  
Pres.: Ralph Belgique  
Application Engineer: Steve Kartchner  
In-House Sales: Stacy Hayes-Garcia  
Products: wireless

**LEE DAN COMMUNICATIONS**

155 Adams Ave.  
Hauppauge, NY 11788-3699  
(516) 231-1414, 800-533-3261, FAX#  
516-231-1498

Pres.: Leon Goldberg  
V.P. Operations: Lawrence J. Goldberg

V.P. Finance/Admin.: David H. Goldberg

Sr. Technician: Sandy Hoffman  
Customer Svce: Linda E. Scaturro  
Production Sup.: Gabriel Figueroa  
Products: amplifiers, columns, DC  
battery powered, lecturns,  
megaphones, powered lecturns,  
speakers, weatherproof speakers

**J. W. DAVIS & CO.**

PO Box 26177  
3030 Canton Street  
Dallas, TX 75226

(214) 651-7341, 800-527-5705, in TX  
800-442-1564, FAX# 214-939-0328

Pres.: Charles Griffith  
V.P. Sales: Jack W. Tucker  
Chief Engineer: Mike Lamm  
Products: amplifiers, columns,  
megaphones, mixer amplifiers,  
speakers, weatherproof speakers

**DUKANE CORPORATION**

2900 Dukane Dr.  
St. Charles, IL 60174  
(312) 584-2300, FAX# 312-584-2370  
Pres.: J. McWilliams Stone, Jr.

# STANDOUT

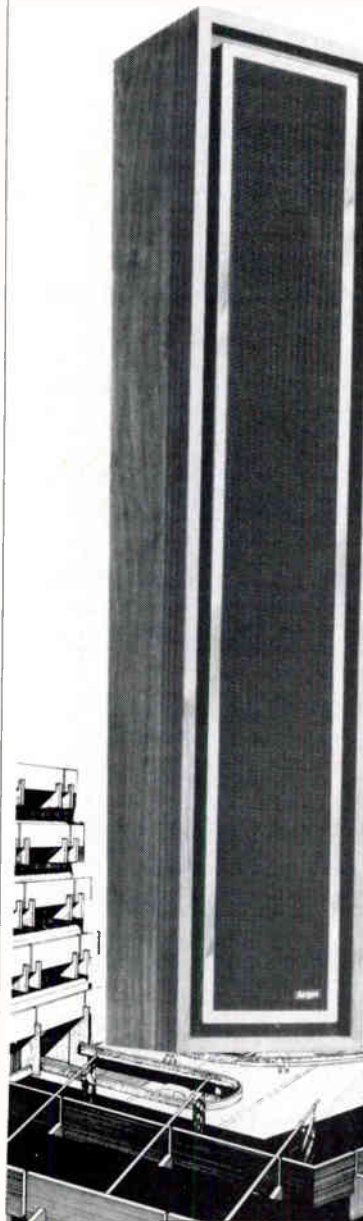

In many difficult sound reinforcement situations, a properly designed and engineered sound column is the speaker system that offers the best solution. The Adjustacoustic® (shown here) with its built-in adjustable equalization filter allowing each column to be tuned to match individual room acoustics, is such a system.

Argos with 16 different models to choose from, has been designing and building sound columns for over 30 years. If you would like to know more about how sound columns solve sound problems, write:



A Division of Argos Products Company  
600 So. Sycamore St., Genoa, Illinois 60135

- Group V.P.: William P. Finnegan  
 Division General Mgr.: Steve Deppe  
 Mkt'g Mgr.: Derek Podobas  
 Nat'l Sales Mgr.: Warren Anderson  
 Service Mgr.: Cliff Carlson  
 Doug Fellabaum, Sycamore, IL, 800-445-0152(#2301)  
 Don Mouritzen, Beecher, IL, 800-445-0152(2303#)  
 Art Sbrilli, Edison, NJ, 800-445-0152(#2302)  
 Pete Kendall, Jacksonville, FL, 904-262-6025(#2306)  
 Jack Brown, Dallas, TX, 214-943-7528(#2305)  
 Ed Nuhring, Portland, OR, 800-445-0152(#2307)  
 Wally Smutts, Toronto, Ontario, Canada, 312-584-2300  
 Ken Lind, Wellesley Hills, MA, 617-235-6817  
 Products: amplifiers, columns, DC battery powered, mixer amplifiers, mixers, powered speakers, speakers, weatherproof speakers
- Fanon Courier  
 14281 Chambers Road  
 Tustin, CA 92680  
 (714) 669-9890, 800-345-1354, FAX# 714-669-1081  
 Pres.: Frank Blaha  
 Director Sales/Mkt'g: Murray Trotiner  
 Director of Engineering: Miguel Santana  
 Products: megaphones
- Fostex Corp. of America  
 15431 Blackburn Ave.  
 Norwalk, CA 90650  
 (213) 921-1112, FAX# 213-802-1964  
 Pres.: Y. Abe  
 Exec. V.P./General Mgr.: Fred Huang  
 V.P. Sales/Mkt'g: Mark Cohen  
 Products: powered speakers, speakers
- Galaxy Audio  
 625 East Pawnee Ave.  
 Wichita, KS 67211  
 (316) 263-2852  
 Chief Engineer: Brock Jabara, P.E.  
 Engineer: Monte Ballard  
 Sales Mgr.: Jim Pearce  
 Products: powered speakers
- Joe's Sound and Salami Co.  
 303 Clymer Ave.  
 Morrisville, PA 19067
- (215) 736-0811  
 V.P. Director of Mkt'g: Corrine S. Gately  
 Manufacturer's Rep: Chris Ross  
 Manufacturer's Rep: Eric Schwarts  
 Dir. of Adv./Sls Ass.: Doris Morgenfruh  
 Products: speakers
- KDM Electronics, Inc.  
 705 Progress Ave., Unit #59  
 Scarborough, Ontario, Canada M7H 2X1  
 (416) 439-7158  
 Pres.: Ron Bull  
 Products: lecturns
- LECTROSONICS, INC.**  
 581 Laser Road NE  
 Rio Rancho, NM 87124  
 (505) 892-4501, 800-821-1121, FAX# 505-892-6243  
 Pres.: John Arasim  
 V.P. Engineering: Larry Fisher  
 Mkt'g Mgr.: Bruce Jones  
 Svce Mgr.: Alan Gembola  
 Factory Sales: Shari McKay  
 Gary Castelluccio & Assoc., Clifton, NJ, 201-772-3333  
 Products: DC battery powered, powered lecturns, powered speakers, wireless
- Panasonic Industrial Company/Ramsa  
 6550 Katella Ave  
 Cypress, CA 90630  
 (714) 895-7278, FAX# 714-895-7242  
 Nat'l Sales/Mkt'g: Steve Wooley  
 Eastern Sales Mgr.: D.J. Bierut  
 Central Sales Mgr.: Greg Braithwaite  
 Western Sales Mgr.: James Murray  
 Pusecker Sales, Upper Montclair, NJ, 201-744-1834  
 Professional Audio Associates,  
 Burlington, MA, 617-229-6050  
 David Prinzi, Webster, NY, 716-671-9266  
 World Wide Electronics, Pembroke Pines, FL, 305-584-7024  
 World Wide Electronics, Jacksonville, FL  
 Evans Sales & Mkt'g, Nashville, TN, 615-297-7997  
 A/V Mkt'g, Carmel, IN, 317-846-1034  
 Key Mkt'g, Plymouth, MI, 313-459-6040  
 New Horizons Elec. Mkt'g,  
 Bannockburn, IL, 312-234-5911
- J.B. Parent Co., Dublin, OH, 614-764-0064  
 Music Interventions & Assoc., Kansas City, MO, 816-453-4448  
 Tenicki & Assoc., Houston, TX, 713-528-2005  
 New West Audio, Burbank, CA, 818-955-9706  
 Brian Trankle Assoc., Belmont, CA, 415-595-4004  
 Brian Trankle Assoc., Sacramento, CA, 916-369-7030  
 Northmar, Seattle, WA, 206-524-5170  
 Pearson & Pearson, Denver, CO, 303-722-6996  
 Products: amplifiers, mixers, speakers, wireless
- Paso Sound Products  
 14 First St.  
 Pelham, NY 10803-1495  
 (914) 738-4800, FAX# 914-738-3954  
 Executive V.P.: Paul Mastrangelo  
 Sales Mgr.: David Moore  
 Product Mgr.: Ken O'Brien  
 Credit Mgr.: Marilyn Beckerson  
 Operations Mgr.: Anthony Sgueglia  
 All West Electronics, Camarillo, CA, 805-388-1789  
 Anderson Sales, Braintree, MA, 617-848-9194  
 Pace Sales, Charlotte, NC, 704-365-3216  
 De Witt Austin Co., Alpharetta, GA, 404-442-1326  
 Dowell Assoc., St. Louis, MO, 314-849-4234  
 Mountain Representatives, Denver, CO, 303-623-0972  
 J.Y.S. Comm. Co., Dallas, TX, 214-349-1650  
 Lienau Assoc., Inc., Columbia, MD, 301-621-4113  
 Lienau Assoc., Inc., New Town, PA, 215-860-2100  
 SLK Tech Rep, San Francisco, CA, 415-822-4884  
 Miguel Lopez, Hialeah, FL, 305-822-6853  
 Marketline, Snellville, GA, 404-972-9048  
 Messnick Sales, Liverpool, NY, 315-622-3211  
 Miller Assoc., Ltd., Greenwich, CT, 212-840-2866  
 Robert Milsk Co., Inc., Southfield, MI, 313-354-3310



Robert Milsk Co., Indianapolis, IN, 317-842-3400

Weller Electronic Sales, Worthington, OH, 614-885-7819

Frank Lintern Assoc., Naperville, IL, 312-983-0935

Products: amplifiers, columns, DC battery powered, lecturns, megaphones, mixer amplifiers, mixers, powered lecturns, powered speakers, processors, speakers, weatherproof speakers, wireless

Peavey Electronics Corp.

PO Box 2898

711 A Street

Meridian, MS 39301

(601) 483-5365, FAX# 601-484-4278

Prod Mgr.: Ken Valentine

Products: amplifiers, columns, mixer amplifiers, mixers, speakers, wireless

Perma Power Electronics, Inc.

5601 W. Howard Ave.

Chicago, IL 60648

(312) 647-9414, FAX# 312-647-1472

Pres.: Norman A. Ackerman

Mkt'g Mgr.: Jay Goldstein

Sales Mgr.: Mike Shatz

Products: columns, DC battery powered, lecturns, megaphones, weatherproof speakers

**PRECISION ELECTRONICS, INC.**

9101 King St.

Franklin Park, IL 60131

(312) 678-5350

Pres.: William S. Grommes

CE A.A. Hart

Sales Mgr.: William Stow

General Mgr.: G. Hussain

QSC Audio Products, Inc.

1926 Placentia Ave

Costa Mesa, CA 92627

(714) 645-2540, 800-854-4079, FAX#

714-645-7927

Director of Mkt'g: Greg McVeigh

Nat'l Sales Mgr.: Peter Kalmen

Sales Engineer: Andy Murray

Products: amplifiers

Sieler Design Products

PO Box 2128

1308 W. 130th St.

Gardenia, CA 90247

(213) 324-9663

Pres.: Patrice Sieler

Chief Engineer: George Sieler

Sunrise Sales, Romeoville, IL, 815-886-2300

Alan Sarfaty & Assoc., Great Neck, NY, 516-466-6770

TorTech Mkt'g, Toronto, CN, 416-536-1441

Products: DC battery powered, lecturns, megaphones, powered lecturns

Sound Craft Systems, Inc.

PO Box 319

Rt. 3

Morrilton, AR 72110-9532

(501) 727-5476

Pres.: Earle Love

V.P.: Hugh McDonnell

Sec./Treas.: Katherine Foust

Sales Mgr.: Hank Shaw

Soundtech

230 Lexington Dr.

Buffalo Grove, IL 60089

(312) 541-3520, 800-323-4173, FAX#

312-541-3616

Pres.: Rudy Schlacher

Sales Mgr.: Keith Brawley

Sales Director: Len Brawnling

Products: mixer amplifiers, mixers

Speco Div., Components Specialties, Inc.

PO Box 624

1172 Rt. 109

Lindenhurst, NY 11757

(516) 957-8700, 800-645-5516, FAX#

516-956-9142

V.P./Sales: Mel Hulkower

V.P./General Mgr.: Jim Ganci

Sales Mgr.: Eric Forman

Products: amplifiers, megaphones

Sunn Musical Equipment Corporation

1130 Columbia Street

Brea, CA 92621

(714) 990-0909, 800-854-6230, FAX#

714-990-3986

Pres.: Bill Schultz

Director of Mkt'g: Joe Green

Products: amplifiers, mixer amplifiers, mixers, speakers

**MINI-VOX  
THE PINT SIZE PA SYSTEM  
THAT ROARS**



**Lightweight - Only 5 lbs.**

**Powerful 15 watt amplifier**

**Durable and water resistant**

**Available in Black, Yellow, Red**

**Ideal for guided tours, athletic events, auctions, crowd control, disaster preparedness**



**ANCHOR AUDIO, INC.**

**1-800/ANCHOR-1**

**In Ca: 213/533-5984**

## TOA ELECTRONICS, ENGINEERED SOUND & COMMUNICATIONS DIVISION

PO Box 2047  
601 Gateway Boulevard  
South San Francisco, CA 94080  
(415) 588-2538, 800-843-4750, in CA  
800-632-2157, FAX# 415-588-3349  
Pres.: Yoshiro Ishida  
Director of Mkt'g: Fred Fredericks  
Nat'l Sales Mgr.: Richard Krochmal  
Nat'l Sales Mgr./Engineered Intercom &  
Security Div.: Al Burns  
Products: amplifiers, DC battery  
powered, megaphones

## UNIVERSITY SOUND, ELECTRO VOICE, INC.

600 Cecil St  
Buchanan, MI 49107

(616) 695-6831  
Pres.: Robert D. Pabst  
V.P. Sales and Mkt'g: Paul McGuire  
Chief Engineer: Alan Watson  
Mkt'g Mgr./Comm. Products: W.  
Douglas Wilkens  
George M. Conneen Co., Inc.,  
Springfield, PA, 215-544-5884  
Metropolis Audio Marketing, Inc.,  
Edison, NJ, 201-225-0085  
R.J. Marketing Ltd., Rockville, MD,  
301-251-0330  
The Smith Company, Hartford, CT,  
203-523-0512  
Ron Tunks Sales, Inc., Tamarac, FL,  
305-722-2803  
Wilson Audio Sales, Nashville, TN, 615-  
646-4477  
Audio Resources, Westmont, IL, 312-

655-1180  
B.C. Electronic Sales, Inc., Mission,  
KS, 913-262-1720  
Jones Audio Sales, Plano, TX, 214-  
867-0202  
C.L. Pugh & Assoc., Inc., Columbus,  
OH, 614-486-9678  
Riley & Petchell Sales, Inc., Detroit, MI,  
313-937-3000  
Loppnow & Assoc., Redmond, WA,  
206-883-3205  
Radon & Assoc., Sacramento, CA,  
916-923-2524  
Silver Peak Marketing Ltd., Wheat  
Ridge, CO, 303-467-9042  
Western Audio Sales, Glendale, CA,  
818-246-3806  
Products: speakers, weatherproof  
speakers

# PRO-AUDIO SOUND SYSTEMS & PRODUCTS

Audio Systems Company  
PO Box 1174  
1815 Michigan Ave.

Bismarck, ND 58502  
(701) 223-3800, 800-852-6522  
Pres.: Lynn Mader

V.P.: Lyle Mader  
Sales Mgr.: Mark Schmidt  
Products: audio processors,  
distribution systems

## M.A.P. AUDIO A COMPLETE LINE OF FIELD-PROVEN AUDIO COMPONENTS

### IMPAC SERIES FRAME 4900 FOR:

- Preamps ● VCA's
- Dist. Amps ● Switchers
- Line Amps ● Phono/Tape Preamps ● And More!

### DISTRIBUTION AMPLIFIER SYSTEM 7821-33

- Single or Dual
- With Compressor ● With Mic Pre

### NEWS ROOM SWITCHER 7301

- 10 Source Taping Fax ● Mic Pre for Intro

### STEREO COMPRESSOR 7102

- For Master Control or TX Facilities

### CONSOLE MODULES

- Oscillators ● Equalizers ● Compressor/Limiters
- Power Supplies - AND MORE!

SEND FOR DATA



**MODULAR  
AUDIO PRODUCTS**

Brookhaven R&D Park • One Roned Road  
Shirley, NY 11967 • (516) 345-3100 • 1-800-333-7697



Auditel Systems, Ltd.  
396 Porter Ave.  
Buffalo, NY 14201  
(716) 886-0019, FAX# 716-886-1615  
Pres.: David Langtry  
Prod. Mgr.: Tony Roberson  
Mkt'g Director: Jim Wood  
Products: distribution systems

BBE Sound, Inc.  
5500 Bolsa Avenue, Suite 245  
Huntington Beach, CA 92649  
(714) 897-6766, 800-233-8346, FAX#  
714-895-6728  
CEO: John C. McLaren  
CFO.: Scott Anderson  
Nat'l Sales: Jim Lucas  
Operations Mgr.: Jennifer Drescher  
Director of Engineering: Robert Crooks  
Tech Svces Sup.: Ryan Coutts  
Products: audio processors

Celestion Industries, Inc.  
89 Doug Brown Way  
Holliston, MA 01746  
(617) 429-6706, FAX# 508-429-2926  
V.P./Gen. Mgr.: Peter Wellikoff  
Mkt'g Mgr.: Barry Fox

Nat'l Sales Mgr.: David Deranian  
 Credit Mgr.: Kathy Maguire  
 Customer Svce Mgr.: Kip Starrett  
 Products: audio processors, auxiliary accessories, interface devices

**CONQUEST SOUND, INC.**

PO Box 757  
 7319 Duvan Dr.  
 Tinley Park, IL 60477  
 (312) 429-1770, 800-323-7671, FAX# 312-429-4688  
 Pres.: Robert Jares, Jr.  
 V.P.: Larry Spalla  
 Sales Engineer: Ron Wirth  
 Sales Engineer: Ken Bernd  
 Sales Engineer: Mike Sanfilippo  
 Credit Mgr.: Norm Corsi  
 Products: interface devices

**E and E Instruments International, Inc.**

PO Box 1313  
 920 Gleneyre St., Suite Z  
 Laguna Beach, CA 92651  
 (714) 494-0231, FAX# 714-494-2594  
 V.P.: Ursula (Uschi) Eastman  
 Export Mgr.: Tom Brady

Eventide, Inc.  
 One Alsan Way  
 Little Ferry, NJ 07643  
 (201) 641-1200, FAX# 201-641-1640  
 Sales Mgr.: Gil Griffith  
 Pres.: Richard Factor  
 Products: audio processors

IED Innovative Electronic Designs, Inc.  
 9701 Taylorsville Rd  
 Louisville, KY 40299  
 (502) 267-7436, FAX# 502-267-9070  
 V.P. Mkt'g & Sales: Tom Roseberry  
 Mkt'g Assistant: Wanda R. Martin  
 Pres.: Hardy Martin  
 Sec./Treas.: Ray Allen  
 V.P. R & D: Robert Ponto  
 Derek Allen Assoc., Toluca Lake, CA, 818-840-8327  
 Bensik Assoc., Ocala, FL, 904-732-9775  
 Plus 4 Marketing, Pleasant Hill, CA, 415-937-0650  
 Yore Company, White Bear Lake, MN, 612-770-9760  
 Products: audio processors, auxiliary accessories, distribution systems,

interface devices

Korg U.S.A., Inc.  
 89 Frost St.  
 Westbury, NY 11590  
 (516) 333-9100, 800-645-3188, FAX# 516-333-9108  
 Sr. V.P.: Michael Kovins  
 Products: audio processors

Modular Audio Products  
 PO Box 488  
 Barrington, IL 60011  
 (312) 382-4550  
 Pres.: Jim Wischmeyer  
 Products: audio processors, auxiliary accessories, distribution systems, interface devices

**OXMOOR CORPORATION**

237 Oxmoor Circle  
 Birmingham, AL 35209  
 (205) 942-6779, FAX# 205-942-9633  
 Pres.: Lynn A. McCroskey  
 Production Mgr.: Jim Watson  
 Nat'l Sales Mgr.: Richard Mitchell  
 Allwest Electronics, Camaville, CA,

**AUDIO PRODUCTS**



**ES 212 — HYBRID TELEPHONE INTERFACE \$995.**



**70 SERIES CONSOLE MOUNT CLOCKS AND TIMERS \$174-\$570.**

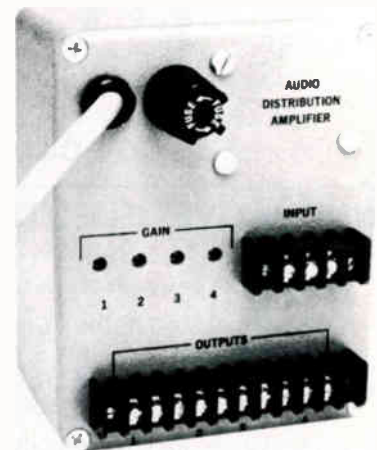

**ES 217 AUDIO DISTRIBUTION AMPLIFIER \$129.**

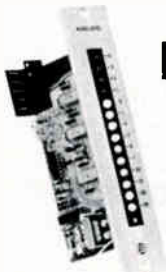

**ES 214 \$ 131**

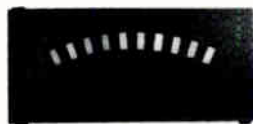

**ES 216 \$63.**

**AUDIO LEVEL INDICATORS**

142 SIERRA ST. EL SEGUNDO, CALIFORNIA 90245  
 (213) 322-2136





805-388-1789  
Dimension IX Marketing, Dallas, TX,  
214-348-9657  
Loppnow & Assoc., Redmond, WA,  
206-883-3205  
Yore Company, White Bear Lake, MN,  
612-770-9760  
Repworks, Chicopee, MA, 413-533-  
0845  
Products: audio processors, auxiliary  
accessories, distribution systems,  
interface devices

Pacific Recorders & Engineering Corp.  
2070 Las Palmas Dr.  
Carlsbad, CA 92009  
(619) 438-3911  
Pres.: Jack K. Williams  
Sales Mgr.: Anders Madsen  
Reg. Sales Mgr.: Sandy Berenics  
Reg. Sales Mgr.: Michael Uhl  
Reg. Sales Mgr.: Vince Basse  
Products: audio processors,  
distribution systems, interface  
devices

Panasonic Industrial Company/Ramsa  
6550 Katella Ave  
Cypress, CA 90630  
(714) 895-7278, FAX# 714-895-7242  
Nat'l Sales/Mkt'g: Steve Wooley  
Eastern Sales Mgr.: D.J. Bierut  
Central Sales Mgr.: Greg Braithwaite  
Western Sales Mgr.: James Murray  
Pusecker Sales, Upper Montclair, NJ,  
201-744-1834  
Professional Audio Associates,  
Burlington, MA, 617-229-6050  
David Prinzi, Webster, NY, 716-671-  
9266  
World Wide Electronics, Pembroke  
Pines, FL, 305-584-7024  
World Wide Electronics, Jacksonville,  
FL  
Evans Sales & Mkt'g, Nashville, TN,  
615-297-7997  
A/V Mkt'g, Carmel, IN, 317-846-1034  
Key Mkt'g, Plymouth, MI, 313-459-  
6040  
New Horizons Elec. Mkt'g,  
Bannockburn, IL, 312-234-5911  
J.B. Parent Co., Dublin, OH, 614-764-  
0064  
Music Interventions & Assoc., Kansas  
City, MO, 816-453-4448  
Tenick & Assoc., Houston, TX, 713-  
528-2005  
New West Audio, Burbank, CA, 818-  
955-9706  
Brian Trankle Assoc., Belmont, CA,  
415-595-4004  
Brian Trankle Assoc., Sacramento, CA,  
916-369-7030  
Northmar, Seattle, WA, 206-524-5170  
Pearson & Pearson, Denver, CO, 303-  
722-6996

## The One Source Company

Brighten your future with IED's reliable, state-of-the-art  
total systems that can save you time and earn you money.

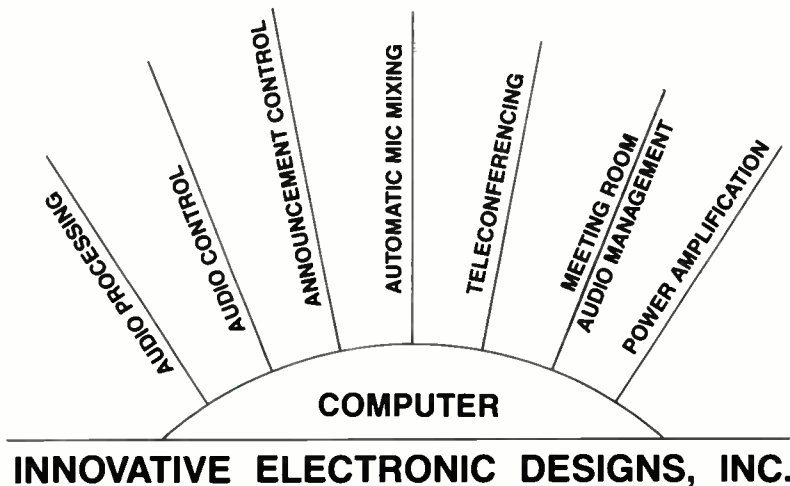

Building block structure allows custom designs for:

AIRPORTS, RACETRACKS, CONVENTION CENTERS, MEETING  
ROOMS, EXHIBITION HALLS, STADIUMS, ARENAS, COURT-  
ROOMS, LEGISLATIVE ASSEMBLIES, BOARDROOMS,  
THEATERS, SCHOOLS, CHURCHES, HOSPITALS . . .

IED Model 500 Audio Control System  
IED Model 500ACS Announcement Control System  
IED Model 4000 Automatic Mixer System  
IED Model 5000 Audio Processing System  
IED Model 6000 Power Amplifier System  
IED Meeting Room Audio Management System

**EARN MORE TODAY WITH THE TECHNOLOGY  
OF TOMORROW - IED**

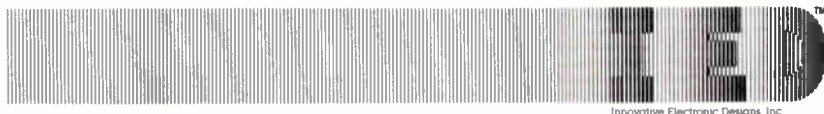

9701 Taylorsville Road  
Louisville, Kentucky 40299

For more information contact Tom Roseberry  
(502) 267-7436 Fax (502) 267-9070

**See us at NSCA booth 1101**

Circle 242 on Reader Response Card

Portasound, Inc.-Div. of Soundcraft  
Systems, Inc.  
PO Box 319  
Route 3  
Morrilton, AR 72110-9532  
(501) 727-5543, 800-643-8747

### PROTECH AUDIO CORP.

Flowerfield, Bldg. #1  
St. James, NY 11780  
(516) 584-5855  
Sales Mgr.: Bill Murphy  
Sales Engineering: Joe Giambone  
Peregrine Rep's, Houston, TX, 713-  
772-6765

**QSC Audio Products, Inc.**  
 1926 Placentia Ave  
 Costa Mesa, CA 92627  
 (714) 645-2540, 800-854-4079, FAX#  
 714-645-7927  
 Director of Mkt'g: Greg McVeigh  
 Nat'l Sales Mgr.: Peter Kalmen  
 Sales Engineer: Andy Murray  
 Products: distribution systems

**RANE CORP.**

10802 49th Ave. W.  
 Everett, WA 98204-3400  
 (206) 355-6000, FAX# 206-347-7757  
 V.P. Mkt'g: Larry Winter  
 Dir. Tech. Mkt'g: Terry Pennington  
 Sales Coordinator: Debbie Cooksey  
 Products: audio processors



**Rauland-Borg Corp.**  
 3535 W. Addison St.  
 Chicago, IL 60618  
 (312) 267-1300, FAX# 312-267-1127  
 Pres.: William Krucks  
 Sr. V.P./Sales & Mkt'g: Kenneth T.  
 James  
 Chief Engineer: Lawrence Gleason  
 Nat'l Sales Mgr.: Rick Blunt  
 Harry B. Hahn, Olathe, KN, 913-829-  
 9427  
 William C. Zophy, Ft. Myers, FL, 813-  
 433-4766  
 Harold De Vaney, Dickinson, TX, 713-  
 337-1040  
 Hank Plaisier, El Toro, CA, 714-837-  
 2626  
 Vince Ward, Vashon Island, WA, 206-  
 463-5582  
 Joseph A. Ciotti, Claymont, DE, 302-  
 798-6558  
 William Lewis, Louisville, KY, 502-491-  
 4273  
 Raymond Bailey, Granville, IL, 815-339-  
 6789  
**Rauland-Borg Inc., Mississauga, ONT.,**  
**CD, 416-821-2225**  
**Jim Welch, Scarborough, ONT., CD,**  
**416-438-4756**  
 Products: audio processors, auxiliary  
 accessories, distribution systems,  
 interface devices

**Spectra Sonics**  
 3750 Airport Rd.  
 Ogden, UT 84405  
 (801) 392-7531  
 Pres./Owner: William G. Dilley  
 Engineer/Sales: Gregory D. Dilley  
 William Watkins, Merrick, NY, 516-  
 546-5374

**Stewart Electronics Corp.**  
 11460 Sunrise Gold Circle, Suite B  
 Rancho Cordova, CA 95742  
 (916) 635-3011, FAX# 916-635-1787  
 Nat'l Sales/Mkt'g Mgr.: James M.  
 Ruse  
 Applied Audio, Asheville, NC, 704-252-  
 9313  
 Cambridge Pro Sales, Westerville, OH,  
 614-890-8144  
 GMC, Springfield, PA, 215-544-5884  
 Pacific Audio Group, Torrance, CA,  
 213-375-2611  
 Future Sales, Redmond, WA, 206-868-  
 5577  
 JAMM Dist., Flossmoor, IL, 312-799-  
 0550  
 McManus Music Sales, MN, 612-432-  
 5321  
 On the Road Mrkt., Upper Montclair,  
 NJ, 201-746-0501  
 Pro Sound & Light, Lakewood, CO,  
 303-986-5999  
 RPM Sales, Carrollton, TX, 214-446-  
 3010  
 B. Trankle & Assoc., Belmonti, CA,  
 415-595-4004  
 Pro Sound Assoc., Jacksonville, FL,  
 904-744-1170  
 Products: audio processors, interface  
 devices

**Studio Technologies, Inc.**  
 5520 West Touhy Ave.  
 Skokie, IL 60077  
 (312) 676-9177, FAX# 312-982-0747  
 Pres.: Gordon K. Kapes  
 Director of Mkt'g: Carolyn Cashel

**Sunn Musical Equipment Corporation**  
 1130 Columbia Street  
 Brea, CA 92621  
 (714) 990-0909, 800-854-6230, FAX#  
 714-990-3986  
 Pres.: Bill Schultz  
 Director of Mkt'g: Joe Green

**Switchcraft, Inc.**  
 5555 N. Elston Ave.  
 Chicago, IL 60630  
 (312) 792-2700, FAX# 312-792-2129  
 Director of Mkt'g: Terry Leen  
 Mkt'g Prod. Mgr./Audio: William Kysiak  
 Mkt'g Prod. Mgr./Telecomm.: R. Neidl  
 Products: auxiliary accessories,  
 interface devices

**TOA ELECTRONICS, ENGINEERED SOUND  
 & COMMUNICATIONS DIVISION**

PO Box 2047  
 601 Gateway Boulevard  
 South San Francisco, CA 94080  
 (415) 588-2538, 800-843-4750, in CA  
 800-632-2157, FAX# 415-588-3349  
 Pres.: Yoshiro Ishida  
 Director of Mkt'g: Fred Fredericks  
 Nat'l Sales Mgr.: Richard Krochmal  
 Nat'l Sales Mgr./Engineered Intercom &  
 Security Div.: Al Burns  
 Products: audio processors

**TECHNICAL PROJECTS, INC.**

PO Box 1449  
 449 Princeton Ave.  
 Barrington, IL 60011  
 (312) 381-5350, 800-562-5872, FAX#  
 312-381-4360  
 Pres.: Glenn Mullis  
 Sec./Treas.: Sibbelina Mullis  
 Professional Audio Mkt'g, New York,  
 NY, 516-367-8620  
 Sound Sales, Lanham, MD, 301-731-  
 6355  
 Audio Marketing Assoc., Brecksville,  
 OH, 216-526-2426  
 Wm. M. Linz & Assoc., Deerfield, IL,  
 312-945-9600  
 Design Factors, Hacienda Heights, CA,  
 213-697-7576  
 Products: interface devices

**PROFESSIONAL AUDIO DIVISION,  
 YAMAHA MUSIC CORPORATION, USA**

PO Box 6600  
 6600 Orangethorpe Ave.  
 Buena Park, CA 90622  
 (714) 522-9011, FAX# 714-739-2680  
 Products: audio processors, interface  
 devices

**TUNERS, CD PLAYERS**

**AIPHONE INTERCOM SYSTEMS**

PO Box 90075  
1700 130th Ave. N.E.  
Bellevue, WA 98005  
(206) 455-0510, FAX# 206-455-0071  
Pres.: Hiko Shinoda  
Nat'l Sales: Jim Morrison  
Products: AM, FM

**Audio Access**

363-A Vintage Park Drive  
Foster City, CA 94404  
(415) 341-9620, FAX# 415-341-0168  
Mkt'g: Chris Stevens  
Products: changers

**Bogen Communications, Inc.**

PO Box 575  
50 Spring St.  
Ramsey, NJ 07446  
(201) 934-8500, FAX# 201-934-9832  
Pres.: John H. Ochtera  
V.P. Sales/Sound Prod.: David A. Chambers

V.P. Sales/Telecomm. Prod.: Charles Ferreri

Bruce Barrett, Garland, TX, 214-530-0467

Kingston Sales Corp., Indianapolis, IN, 317-876-2545

Kevin Koehler, Batavia, IL, 312-879-6871

Tim McDonnell, Willoughby Hills, OH, 216-942-2429

Steve McGrew, Kennesaw, GA, 404-422-4608

Meyer Mkt'g, Inc., Deerfield Beach, FL, 305-481-9250

W.B. Pray Sales, Inc., Northboro, MA, 617-393-3434

Jay Sample, Sandy, UT, 801-942-1059

Scott Sampson, Encino, CA, 818-996-5484

Mike Schneider, Baltimore, MD, 301-563-5390

Walt Spencer, Ramsey, NJ, 201-934-8500

White Radio Ltd., Burlington, ONT, Canada, 416-632-6894

Roburn Agencies, Inc., Yonkers, NY, 914-968-1016

Products: AM, FM, tuner-amplifiers

Sylmar, CA 91342  
(818) 362-9516, FAX# 818-367-5292  
Pres.: Hugh T. Wilcox  
Sales Support Rep: Michelle Price  
Sales Coordinator: Jean Hurst  
Products: AM, FM, tuner-amplifiers

**Clarity, A Division of Valcom, Inc.**

1111 Industry Ave. SW  
Roanoke, VA 24013  
(703) 982-7003, 800-962-6009, FAX# 703-982-7032  
Products: FM

**Eddcor**

1948 East Pomona  
Santa Ana, CA 92705  
(714) 648-0292, 800-854-0259, FAX# 714-648-0117  
Pres.: Larry Weston  
Office Mgr.: Phyllis Weston  
Sales Mgr.: Deanna Weston

**Fanon Courier**

14281 Chambers Road  
Tustin, CA 92680  
(714) 669-9890, 800-345-1354, FAX# 714-669-1081  
Pres.: Frank Blaha  
Director Sales/Mkt'g: Murray Trotiner  
Director of Engineering: Miguel Santana  
Products: tuner-amplifiers

**Johnson Electronics, Inc.**

4301 Metric Drive  
Winter Park, FL 32792  
(407) 677-4030, FAX# 407-679-1288  
Pres./CEO: A.J. Schell  
V.P. Mkt'g: Robert W. Peters  
V. P./Engineering: Ken St. John  
Products: FM, tuner-amplifiers

**Panasonic Industrial Company/Ramsa**

6550 Katella Ave  
Cypress, CA 90630  
(714) 895-7278, FAX# 714-895-7242  
Nat'l Sales/Mkt'g: Steve Wooley  
Eastern Sales Mgr.: D.J. Bierut  
Central Sales Mgr.: Greg Braithwaite  
Western Sales Mgr.: James Murray  
Pusecker Sales, Upper Montclair, NJ, 201-744-1834  
Professional Audio Associates,  
Burlington, MA, 617-229-6050

David Prinzi, Webster, NY, 716-671-9266

World Wide Electronics, Pembroke Pines, FL, 305-584-7024

World Wide Electronics, Jacksonville, FL

Evans Sales & Mkt'g, Nashville, TN, 615-297-7997

A/V Mkt'g, Carmel, IN, 317-846-1034

Key Mkt'g, Plymouth, MI, 313-459-6040

New Horizons Elec. Mkt'g, Bannockburn, IL, 312-234-5911

J.B. Parent Co., Dublin, OH, 614-764-0064

Music Interventions & Assoc., Kansas City, MO, 816-453-4448

Tenick & Assoc., Houston, TX, 713-528-2005

New West Audio, Burbank, CA, 818-955-9706

Brian Trankle Assoc., Belmont, CA, 415-595-4004

Brian Trankle Assoc., Sacramento, CA, 916-369-7030

Northmar, Seattle, WA, 206-524-5170

Pearson & Pearson, Denver, CO, 303-722-6996

Products: changers

**Paso Sound Products**

14 First St.  
Pelham, NY 10803-1495  
(914) 738-4800, FAX# 914-738-3954  
Executive V.P.: Paul Mastrangelo  
Sales Mgr.: David Moore  
Product Mgr.: Ken Obrien  
Credit Mgr.: Marilyn Beckerson  
Operations Mgr.: Anthony Sgueglia

**PRECISION ELECTRONICS, INC.**

9101 King St.  
Franklin Park, IL 60131  
(312) 678-5350  
Pres.: William S. Grommes  
CE A.A. Hart  
Sales Mgr.: William Stow  
General Mgr.: G. Hussain

**Sony Professional Audio**

1600 Queen Anne Road  
Teaneck, NJ 07666  
(201) 833-5200  
Pres.: William G. Connolly

**CETEC RAYMER**

13278 Ralston Ave.



V.P.: Jerry Smith

Speco Div., Components Specialties, Inc.  
PO Box 624  
1172 Rt. 109  
Lindenhurst, NY 11757  
(516) 957-8700, 800-645-5516, FAX#  
516-956-9142

V.P./Sales: Mel Hulkower  
V.P./General Mgr.: Jim Ganci  
Sales Mgr.: Eric Forman  
Products: tuner-amplifiers

Studer Revox America, Inc.  
1425 Elm Hill Pike  
Nashville, TN 37210  
(615) 254-5651, FAX# 615-256-7619  
Dir./Prof. Dealer Prod.: David C.  
Bowman

Mgr. Studer Direct Sales: Chris Ware  
New York, NY, 212-255-4462  
Dallas, TX, 214-943-2239  
Los Angeles, CA, 818-780-4234  
San Francisco, CA, 415-930-9866  
Pro Audio LTD, Chicago, IL, 312-526-  
1660  
Products: FM

**TOA ELECTRONICS, ENGINEERED SOUND  
& COMMUNICATIONS DIVISION**

PO Box 2047  
601 Gateway Boulevard  
South San Francisco, CA 94080  
(415) 588-2538, 800-843-4750, in CA  
800-632-2157, FAX# 415-588-3349  
Pres.: Yoshiro Ishida  
Director of Mkt'g: Fred Fredericks

Nat'l Sales Mgr.: Richard Krochmal  
Nat'l Sales Mgr./Engineered Intercom &  
Security Div.: Al Burns  
Products: AM, changers

Tascam (TEAC Professional Division)  
7733 Telegraph Road  
Montebello, CA 90640  
(213) 726-0303, FAX# 213-725-1994  
Mkt'g Mgr.: Bill Mohrhoff  
Nat'l Sales Mgr.: Gregg Hildebrandt  
W. Reg. Mgr.: Fred Allard  
S. Reg. Mgr.: Bill Stevens  
E. Reg. Mgr.: Chuck Prada

Technics Professional  
One Panasonic Way  
Secaucus, NJ 07094  
(201) 348-7000

**HEARING ASSISTANCE SYSTEMS**

Auditel Systems, Ltd.  
396 Porter Ave.  
Buffalo, NY 14201  
(716) 886-0019, FAX# 716-886-1615  
Pres.: David Langtry  
Prod. Mgr.: Tony Roberson  
Mkt'g Director: Jim Wood  
Products: closed loops inductive,  
infrared systems, multi-  
channel, processors

Coherent Communications, Inc.  
13756 Glenoaks Blvd.  
Sylmar, CA 91342  
(818) 362-9393, FAX# 818-362-7045  
Products: closed loops inductive

**COMTEK**<sup>®</sup>  
COMMUNICATIONS TECHNOLOGY, INC.

Comtek, Inc.  
357 W. 2700 St. South  
Salt Lake City, UT 84115  
(801) 466-3463, FAX# 801-484-6906  
Pres.: Ralph Belgique  
Application Engineer: Steve Kartchner  
In-House Sales: Stacy Hayes-Garcia  
Products: wireless systems AM/FM

LPB, Inc.  
28 Bacton Hill Rd.  
Frazer, PA 19355  
(215) 644-1123  
Pres.: Richard H. Crompton  
Sales Mgr.: John P. Tiedeck  
Burden Assoc., Canoga Park, CA, 818-  
340-4590  
Products: wireless systems AM/FM

**LECTROSONICS, INC.**  
581 Laser Road NE  
Rio Rancho, NM 87124  
(505) 892-4501, 800-821-1121, FAX#  
505-892-6243  
Pres.: John Arasim  
V.P. Engineering: Larry Fisher  
Mkt'g Mgr.: Bruce Jones  
Svce Mgr.: Alan Gembola  
Factory Sales: Shari McKay  
Gary Castelluccio & Assoc., Clifton, NJ,  
201-772-3333  
Products: wireless systems AM/FM

Nady Systems, Inc.  
1145 65th St.  
Oakland, CA 94641  
(415) 652-2411, FAX# 415-652-5075  
Adv. Director: Royce Krilanovich  
Mkt'g Director: Howard Zimmerman  
Mkt'g Ass.: Sharon Banke  
Products: infrared systems

**OVAL WINDOW AUDIO**  
78 Main St.  
Yarmouth, ME 04096  
(207) 846-6250  
Mkt'g Director: Robert Gilmore  
Products: closed loops inductive

Phonic Ear, Inc.  
250 Camino Alto  
Mill Valley, CA 94941  
(415) 383-4000, 800-227-0735, FAX#  
415-332-3085  
Pres.: James C. Mulford  
V.P.: Richard G. Pimentel

Siemens Hearing Instruments, Inc.  
10 Corporate Place S  
Piscataway, NJ 08854  
(201) 562-6600, 800-345-0183, FAX#  
201-562-6696  
Mkt'g: Ann Wallace

Stewart Electronics Corp.  
11460 Sunrise Gold Circle, Suite B  
Rancho Cordova, CA 95742  
(916) 635-3011, FAX# 916-635-1787  
Nat'l Sales/Mkt'g Mgr.: James M.  
Ruse  
Applied Audio, Asheville, NC, 704-252-  
9313  
Cambridge Pro Sales, Westerville, OH,  
614-890-8144  
GMC, Springfield, PA, 215-544-5884

Pacific Audio Group, Torrance, CA,  
213-375-2611  
Future Sales, Redmond, WA, 206-868-  
5577  
JAMM Dist., Flossmoor, IL, 312-799-  
0550  
McManus Music Sales, MN, 612-432-  
5321  
On the Road Mkt., Upper Montclair,  
NJ, 201-746-0501  
Pro Sound & Light, Lakewood, CO,  
303-986-5999  
RPM Sales, Carrollton, TX, 214-446-  
3010

B. Trankle & Assoc., Belmonti, CA,  
415-595-4004  
Pro Sound Assoc., Jacksonville, FL,  
904-744-1170  
Products: multi-channel, processors  
Telex Communications, Inc., Pro Audio  
Dept.  
9600 Aldrich Ave. S.  
Minneapolis, MN 55420  
(612) 884-4051, FAX# 612-884-0043  
Chairman of the Board: Ansel Kleiman  
Exec. V.P.: Jeffrey Wetherell  
V.P. Mkt'g: James Arrington

Director of Mkt'g: Donald Merein  
Director of Advertising: Ronald Taylor  
Wes-Tech Marketing, Culver City, CA,  
213-870-9286  
Bencsik Assoc., Ocala, FL, 904-732-  
9775  
Monfort Electronic Marketing,  
Indianapolis, IN, 317-872-8877  
Mountain Representatives, Inc.,  
Denver, CO, 303-623-0972  
Murphy & Cota, Inc., Atlanta, GA, 404-  
875-2525  
Northland Assoc., Moorhead, MN, 218-  
233-4616  
White Radio Ltd., Burlington, Ontario,  
Canada, 416-632-6894  
Rancilio Assoc., Inc., St. Louis, MO,  
314-631-3326  
SAGA, Oswego, NY, 315-343-5739  
Sigmet Corporation, Valley Forge, PA,  
215-783-6666  
J.Y. Schoonmaker Co., Dallas, TX,  
214-349-1650  
Weller Electronic Sales, Worthington,  
OH, 614-885-7819  
Ziskind Assoc., Rolling Meadows, IL,  
312-577-1624  
Burcaw Company & Assoc., Warren,  
MI, 313-573-4605  
S&F Northwest, Seattle, WA, 206-622-  
6036  
Lichtenauer & Associates, Antioch, CA,  
415-757-1200  
Products: wireless systems AM/FM

## UNEX, A DYNATECH COMPANY

PO Box 574  
3 Lyberty Way  
Westford, MA 01886  
(508) 692-9505, FAX# 508-692-9409  
Pres.: John D. Ela  
Nat'l Sales Mgr.: Robert L. Birch  
Customer Svce Mgr.: Catherine M.  
Koch  
Products: infrared systems

Williams Sound Corp.  
5929 Baker Rd.  
Minnetonka, MN 55345-5997  
(612) 931-0291, 800-328-6190  
Pres.: James M. Broz  
V.P. Mkt'g: Paul Ingebritsen  
V.P. Engineering: J. Kershaw  
Customer Svce Mgr.: Terry Roushar  
Products: closed loops inductive, multi-  
channel, processors, programmable,  
wireless systems AM/FM

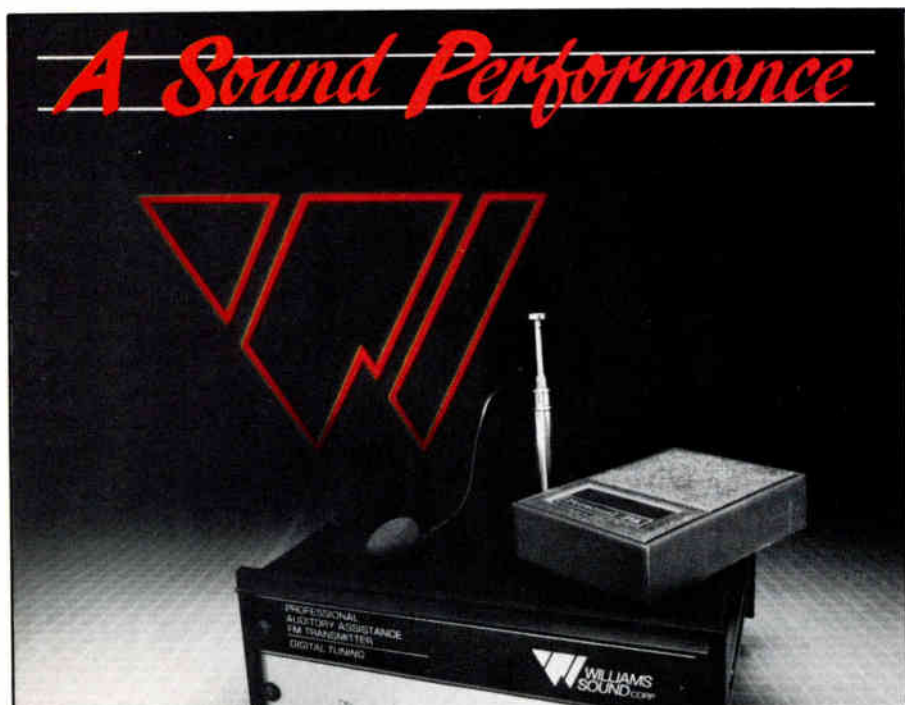

**With  
No  
Strings  
Attached** The Williams Sound Personal  
PA hearing assistance system has set the standard  
for performance, efficiency and affordability.  
Over 12,000 installations in houses of worship,  
theatres, and auditoriums attest to its popularity.

Only Williams Sound supports its products with  
a three-year warranty ... with no strings attached.

For high quality, durable hearing assistance  
systems, turn to the leader — Williams Sound.

For complete information,  
call 1-800-328-6190.  
(In MN: 612/931-0291.)  
In Canada: Call Thorvin  
Electronics - 416/276-7271.



**WILLIAMS SOUND CORP.**  
5929 Baker Road  
Minnetonka, MN 55345-5997

(Made in USA)  
World Radio History



# TEST EQUIPMENT

## TEST EQUIPMENT & TOOLS

A&D Engineering, Inc.  
1555 McCandless Dr.  
Milpitas, CA 95035  
(408) 263-5333

AVNC/Instrument Division  
250 Shagbark Dr., RD #1  
Cheswick, PA 15024  
(412) 265-4444

Acoustilog  
19 Mercer St.  
New York, NY 10013  
(212) 925-1365

Aegis  
2115 Pico Blvd.  
Santa Monica, CA 90405  
(213) 392-9972, 800-345-9871, FAX#  
213-392-6445  
Products: PC systems, software

All Electronics Corp.  
PO Box 567  
6228 Sepulveda Blvd.  
Van Nuys, CA 91408  
(818) 904-0524, 800-826-5432, FAX#  
818-781-2653  
Mgr. Sales: Harold Oliver  
Products: electronic tools

Altair Electronics, Inc.  
1694 Calle Zocalo  
Thousand Oaks, CA 91360  
(805) 529-2496

Amber Electro Design, Inc.  
3391 Griffith St.  
St. Laurent, Q.C., Canada H4T 1W5  
(514) 735-4105, 800-361-3697, FAX#  
514-340-1468  
Pres.: Wayne Jones  
Products: audio tape diagnostics,  
bench-top instrumentation, distortion  
analyzers, hand-held instruments,  
noise & vibration analyzers, PC  
systems, software, sound intensity  
measurement equipment &  
microphones

American Reliance, Inc.  
9241 E. Valley Blvd.  
Rosemead, CA 91770  
(818) 287-8400

Anatrol Corp.  
10895 Indeco Dr.  
Cincinnati, OH 45241  
(513) 793-8844, FAX# 513-793-0075

Apogee Electronics Corp.  
1517 20th ST  
Santa Monica, CA 90404  
(213) 828-1930, FAX# 213-828-9720  
Mkt'g Director: Grace N. Gehman

Ariel Corp.  
110 Greene St., Suite 404  
New York, NY 10012  
(212) 925-4155

Asaca/Shibasokui  
12509 Beatrice St.  
Los Angeles, CA 90066  
(213) 827-7144, 800-423-6347

Audio Control Industrial  
22313 70th Ave. W.  
Mountlake Terrace, WA 98043  
(206) 775-8461, FAX# 206-778-3166  
Pres.: Thomas E. Walker

Audio Precision, Inc.  
PO Box 2209  
Beaverton, OR 97075  
(503) 627-0832, 800-231-7350, FAX#  
503-641-8906  
Pres.: Bob Metzler  
Products: audio tape diagnostics,  
bench-top instrumentation, distortion  
analyzers, DSP hardware, DSP  
software, FFT-spectrum analyzers,  
FM stereo testing, frequency-domain  
acquisition/analysis, MTS test  
equipment, PC systems, software,  
realtime analyzers

BBC-Metrawatt/Goerz  
2150 W. 6th Ave.

Broomfield, CO 80020  
(303) 469-5231, 800-821-6327  
General Mgr.: Daric Jarvis  
Mkt'g Mgr.: Brad Seavoy  
Sales Mgr.: Erik Pfanku

Banner  
PO Box 1803  
Shelby, NC 28150  
(704) 487-7012

Barcus-Berry, Inc.  
5381 Production Drive  
Huntington Beach, CA 92649  
(714) 898-9211, 800-854-6481, FAX#  
714-898-7962

Pres.: L.M. Barcus  
Exec. V.P.: John Berry  
John B. Anthony Co., Stamford, CT,  
203-322-9202

McFadden Sales & Marketing,  
Columbus, OH, 614-761-3177  
New Horizons Electronics,  
Bannockburn, IL, 312-234-5911  
MetroRep Sales, Freehold, NJ, 201-  
462-1221  
Ron Tunk Sales, Tamarac, FL, 305-  
722-2803  
Products: transducers

Beckman Ind., Instrumentation Div.  
3883 Ruffin Road  
San Diego, CA 92123  
(619) 495-3200, FAX# 619-268-0172

Boonton Electronics Corp.  
791 Rt. 10  
Randolph, NJ 07869  
(201) 584-1077, FAX# 201-584-3037

Bruel & Kjaer Instruments, Inc.  
185 Forest St.  
Marlborough, MA 01752  
(617) 481-7000, FAX# 508-485-0519  
Pres.: G. Perry  
V. P. Sales: G. Michel  
Bruel & Kjaer, Livonia, MI, 313-522-  
8600



Bruel & Kjaer, Hoffman Estates, IL,  
312-358-7582  
Bruel & Kjaer, Anaheim, CA, 714-978-  
8066  
Bruel & Kjaer, Marietta, GA, 404-422-  
5200  
Bruel & Kjaer, West Caldwell, NJ, 201-  
227-6100

Cabletronix  
PO Box 3003  
366 Washington St.  
Newburgh, NY 12550  
(914) 565-7570, 800-431-9473, in NY  
800-942-WIRE, FAX# 914-564-5332  
Pres.: Stephen L. Roth  
V. P.: Leonard Ellentuch  
Sales Mgr.: Tom Martirano  
Products: linemen's test sets

Celestial Software, Inc.  
125 University Ave.  
Berkeley, CA 94710  
(415) 420-0300

Cetec Ivie  
1366 West Center St.

Orem, UT 84057  
(801) 224-1800, FAX# 801-224-7526  
Pres.: Craig Berry  
V.P.: Joel Zabriskie  
Mkt'g Mgr.: Glen Meyer  
Product Engineering Mgr.: Larry Driski  
Production Mgr.: Bob Greene  
Products: data acquisition, function  
generators, hand-held instruments,  
microprocessor systems, noise &  
vibration analyzers, realtime  
analyzers, RT60 meters, sound  
intensity measurement equipment &  
microphones, SPL meters

Chadwick Helmut  
4601 N. Arden Dr.  
El Monte, CA 91731  
(818) 575-6161

**COMMUNICATIONS CO., INC.**  
3490 Noell St.  
San Diego, CA 92110  
(619) 297-3261, FAX# 619-297-3279  
Pres.: Peter Jordan  
V.P.: Michael Jordan  
Chief Engineer: David Johnson

Products: RT60 meters, sound intensity  
measurement equipment &  
microphones

Computational Systems, Inc.  
835 Innovation Drive, Suite 110  
Knoxville, TN 37922  
(615) 675-2110  
Pres.: Ronald G. Canada  
V.P. R & D: Kenneth R. Piety  
Director of Mkt'g: M.B. "Mel"  
Nathanson  
Sales Mgr.: E. Forrest Pardue  
Adv. Mgr.: Don Sidlowski  
Purchasing Buyer: Pam Hubbard

Contact East, Inc.  
PO Box 786  
335 Willow St. South  
N. Andover, MA 01845  
(508) 682-2000, 800-225-5370, FAX#  
508-688-7829  
Products: analog multimeters, bench-  
top instrumentation, cable testers,  
digital multimeters, digital storage  
oscilloscopes, electronic tools,

## Introducing The PC-40 Computer Controlled Spectrum Analysis System from Ivie

Portable — Battery Operated  
20 Nonvolatile Memories  
Screen Dump to Optional Printer  
RS232, Serial and Paralleled Outputs  
Precision Preamp and Air Condenser Microphone  
Class III Filter Selectivity  
dBm, dBV, and AC Volts Measurement  
Built-in BASIC  
A Growing List of Software Options

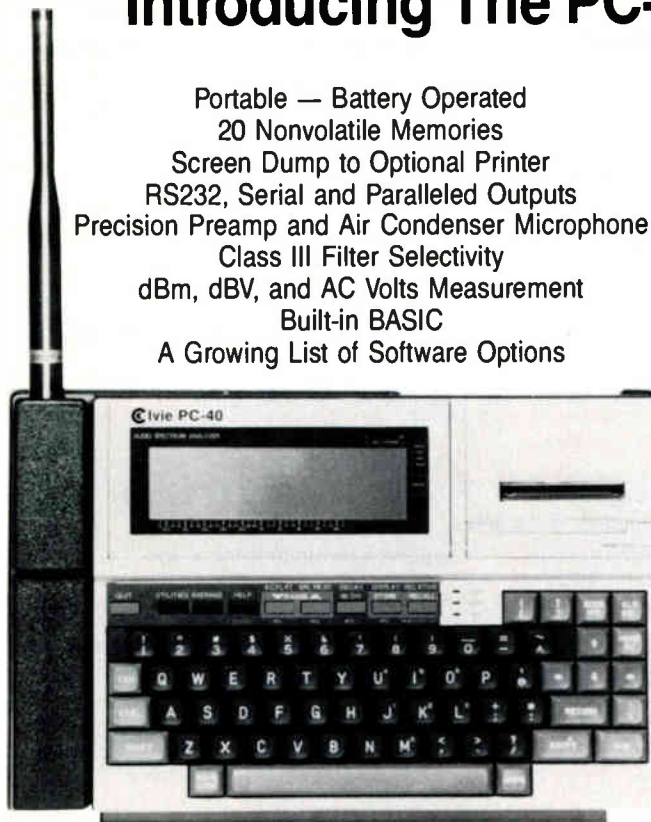

The PC-40 computer controlled spectrum analysis system from Ivie represents a solid advancement in instrumentation flexibility. In addition to its standard features, available software options allow for the measurement of RT<sub>60</sub> and for PC to PC transfer of data files for manipulation and documentation.

For the whole story, contact the Ivie factory for complete information.

 **Cetec Ivie**

1366 West Center Street  
Orem, Utah 84057  
Telephone 801-224-1800  
TELEX or TWX 910-971-5884  
FAX 801-224-7526

function generators, hand-held instruments, linemen's test sets, oscilloscopes

John Fluke Mfg. Co., Inc.  
PO Box 9090  
Everett, WA 98206  
(206) 347-6100, 800-426-0361

Gary Foster, Columbia, MD, 314-442-2288  
Rob Lincoln, Melbourne, FL, 407-259-0991  
Mark Skilowitz, Newfield, NJ, 609-697-4580  
Jim Fetterer, Seattle, WA, 206-243-7762  
Bill Boone, Libertyville, IL, 312-816-1080  
Dave Whelan, W. Springfield, MA, 413-731-9552  
Products: analog multimeters, linemen's test sets

Cyborg Corp.  
94 Bridge St.  
Newton, MA 02158  
(617) 964-9020, FAX# 617-332-8819

GHI Systems, Inc.  
916 N. Western Ave., 201  
San Pedro, CA 90732  
(213) 548-6544

DSP Development Corp.  
One Kendall Square  
Cambridge, MA 02139  
(617) 577-1133, FAX# 617-494-1394

Gaines Audio  
PO Box 17888  
1237 E. Main Street  
Rochester, Ny 14609  
(716) 266-0780  
Owner: Jon Gaines  
Products: function generators

Dallas Instruments, Inc.  
10205 Plano Rd.  
Dallas, TX 75238  
(214) 349-1180, 800-527-7071,  
FAX# 214-348-7044

GenRad, Inc.  
300 Baker Ave.  
Concord, MA 01742  
(617) 369-4400

Data Check Corp.  
9918 Via Pasar  
San Diego, CA 92126  
(619) 578-0101, FAX# 619-566-2014

Gold Line  
PO Box 115  
W. Redding, CT 06896  
(203) 938-2588, FAX# 203-938-8740  
Pres.: Martin E. Miller  
V.P. Mkt'g: Marj Miller

Data Physics Corp.  
1210 S. Bascom Ave., Suite 224  
San Jose, CA 95128  
(408) 977-0800, FAX# 408-977-0801

Gulton Industries/Servonic Div.  
1644 Whittier Ave.  
Costa Mesa, CA 92627  
(714) 642-2400

Data Precision, Div. Analogic  
8 Centennial Dir  
Peabody, MA 01961  
(617) 246-1600



Davis Instruments Mfg. Co., Inc.  
513 E. 36th St.  
Baltimore, MD 21218  
(301) 243-4301, 800-368-2516, FAX#  
301-889-3442

Dunegan Div., Physical Acoustics Corp.  
19-B Thomas St.  
Irvine, CA 92718  
(714) 380-1544, FAX# 714-951-1269

Dynamic Software Systems  
6272 Guyson Ct.  
Pleasanton, CA 94566  
(415) 484-1111

Endevco  
30700 Rancho Viejo Rd.  
San Juan Capistrano, CA 92675  
(714) 493-8181, FAX# 714-661-7231

**HARRIS CORPORATION, DRACON DIVISION**

809 Calle Plano  
Camarillo, CA 93010  
(805) 987-9511, 800-437-2266, FAX#  
805-987-2547

V.P./General Mgr.: John R. Mason  
V.P. Sales & Mkt'g.: Jack McGuigan  
Director of Sales: Tom Erdmann  
Paging Prod. Mgr.: Tom Johnson  
Metals/Racks/Tools Prod. Mgr.: Terry  
Smith

Test Sets Prod. Mgr.: John Akins  
Don Bivens, Lake Elsinore, CA, 714-  
672-2168

Harrison Systems, Inc.  
PO Box 22964  
Nashville, TN 37202  
(615) 834-1184, FAX# 615-834-1365  
V. P. Sales/Mkt'g: Claude Hill  
V. P. Mkt'g Comm.: Brad Harrison  
V. P. Broadcast Sales: Dave Purple  
Broadcast Prod. Mgr: Martin Burns  
Eric Johnson

Heath Co.  
Hilltop Road  
St. Joseph, MI 49085  
(616) 982-3315, 800-253-0570

Hewlett-Packard Co.  
3000 Hanover St.  
Palo Alto, CA 94304  
(415) 857-1501, FAX# 415-857-5518

Hitachi Denshi America Ltd.  
175 Crossway Park West  
Woodbury, NY 11797  
(516) 921-7200, 800-824-9751, FAX#  
516-921-0993

Hoffend & Sons, Inc.  
34 E. Main St.  
Honeoye, NY 14471  
(716) 229-5998, FAX# 716-229-2746

Honeywell Test Instruments Div.  
PO Box 5227  
Denver, CO 80217  
(303) 773-4700, 800-231-8202, FAX#  
303-773-4762

IQS, Inc.  
12812-J Garden Grove Blvd.  
Garden Grove, CA 92643  
(714) 539-7842, FAX# 714-556-8325  
Pres.: William Elder

- V. P.: Douglas Evered  
Products: data acquisition, DSP hardware, DSP software, FFT-spectrum analyzers, PC systems, software
- Iwatsu America, Inc.  
430 Commerce Blvd.  
Carlstadt, NJ 07072  
(201) 935-8580
- Kay Elemetrics Corp.  
12 Maple Ave.  
Pine Brook, NJ 07058  
(201) 227-2000, FAX# 201-227-7760  
Pres.: John M. Crump  
Sales Mgr.: Stephen Crump  
Dir. Engineering: Bill Harbeson  
Purchasing Agent: Marsden Shaw  
Dir. of Advertising: Cathy Ditzig  
Products: speech transmission analysis
- Keithley Instruments Div.  
28775 Aurora Rd.  
Cleveland, OH 44139  
(216) 248-0400, 800-552-1115
- Kinometrics/TrueTime  
3243 Santa Rosa Ave.  
Santa Rosa, CA 95407  
(707) 528-1230  
V.P./General Mgr.: John vanGroos  
Sales Mgr.: Rick Dielman  
Engineering Mgr.: Ed Petroka  
Production Mgr.: Gerry Wilson  
Purchasing Agent: Chuck Hundley
- Klark-Teknik Electronics, Inc.  
30 B Banfi Plaza N  
Farmingdale, NY 11735  
(516) 249-3660, FAX# 516-420-1863  
Pres.: Jack Kelly  
Nat'l Sales Mgr.: Sam Spennacchio  
Field Sales Mgr.: Keith Worsley  
Products: FFT-spectrum analyzers
- Krohn-Hite Corp.  
255 Bodwell St.  
Avon, MA 02322  
(617) 580-1660, 800-582-1660, FAX# 508-583-8989
- LEQ Measurements, Ltd.  
175 Advance Blvd.  
Brampton, Ontario, Canada L6T 4J1  
(416) 791-3440
- Larson-Davis Laboratories  
1681 W. 820 North  
Provo, UT 84601  
(801) 375-0177, FAX# 801-375-0182
- Leader Instruments Corp.  
380 Oser Ave.  
Hauppauge, NY 11788  
(516) 231-6900
- Leasametric Instrument Rental Division  
1164 Triton Dr.  
Foster City, CA 94404  
(800) 553-2255, 800-553-2255  
General Mgr.: Rick Warp  
Product Mgr.: Mike Nelson
- MG Electronics  
32 Ranick Rd.  
Hauppauge, NY 11788  
(516) 582-3400, FAX# 516-582-3229  
Pres.: Louis Maltz  
V.P.: Elliott Maltz  
Sales Mgr.: Stan Grey  
Miller Assoc., Stamford, CT, 203-869-7793  
Forti Assoc., Kensington, MD, 301-949-1706  
Cavendish & Winchester, Atlanta, GA, 404-449-5104  
Raymar Associates, Duncanville, TX, 214-296-9833  
Products: transducers
- MetraByte Corp.  
440 Myles Standish Blvd.  
Taunton, MA 02780  
(508) 880-3000, FAX# 508-880-0179  
Pres.: John Powderly  
Chairman: Berry W. Phillips  
V.P. Mkt'g: Bob Judd  
V.P. Sales: Bendrix Bailey  
V.P. Engineering: Richard Robbins
- Metrosonics, Inc.  
PO Box 23075  
Rochester, NY 14692  
(716) 334-7300
- Meyer Sound Laboratories, Inc.  
2832 San Pablo Ave.  
Berkeley, CA 94702  
(415) 486-1166, FAX# 415-486-8356  
Pres.: John Meyer  
V.P.: Helen Meyer  
Mkt'g/Sales Mgr.: Gary Hudson
- Micro Audio, Inc.  
4438 S.W. Hewett  
Portland, OR 97221  
(503) 292-8896, 800-445-1248  
Pres.: Eugene B. Rimkeit  
Dir. of Engineering: Richard Schomburg  
V.P. Manufacturing: David Elsbernd  
Sales Mgr.: H.C. Garrison  
Professional Sound & Light, Lakewood, CO, 303-  
Western Audio Sales, Glendale, CA,  
Signal Marketing,  
Powerlines Marketing,  
McFadden Sales,  
Products: realtime analyzers
- Micro-Trak Corp.  
620 Race St.  
Holyoke, MA 01040  
(413) 594-8501
- Multigon Industries, Inc.  
559 Gramatan Ave.  
Mt. Vernon, NY 10522  
(914) 664-7300  
V. P. : William Stern  
Norman Fayne  
Robert Frumm  
Fishel Botnick  
Bernard Miller
- Music Supply Co., Inc.  
809 N. Madison  
Dallas, TX 75208  
(214) 946-8450, 800-527-1522, FAX# 214-946-9155  
Pres.: W. E. Brown  
Sales: Betty Brown
- Nicolet, Test Equipment  
PO Box 4288  
5225 Verona Rd.  
Madison, WI 53711-0288  
(608) 273-5008, 800-356-3090, FAX# 608-273-5061
- Non-Linear Systems/Div. of Kaypro Corp.  
533 Stevens Avenue  
Solana Beach, CA 92075  
(619) 481-4300, FAX# 619-755-6029  
General Mgr.: Ben Fisher  
Sales Mgr.: Jeanne Simmons  
Products: bench-top instrumentation, digital multimeters, hand-held instruments, metering systems, oscilloscopes



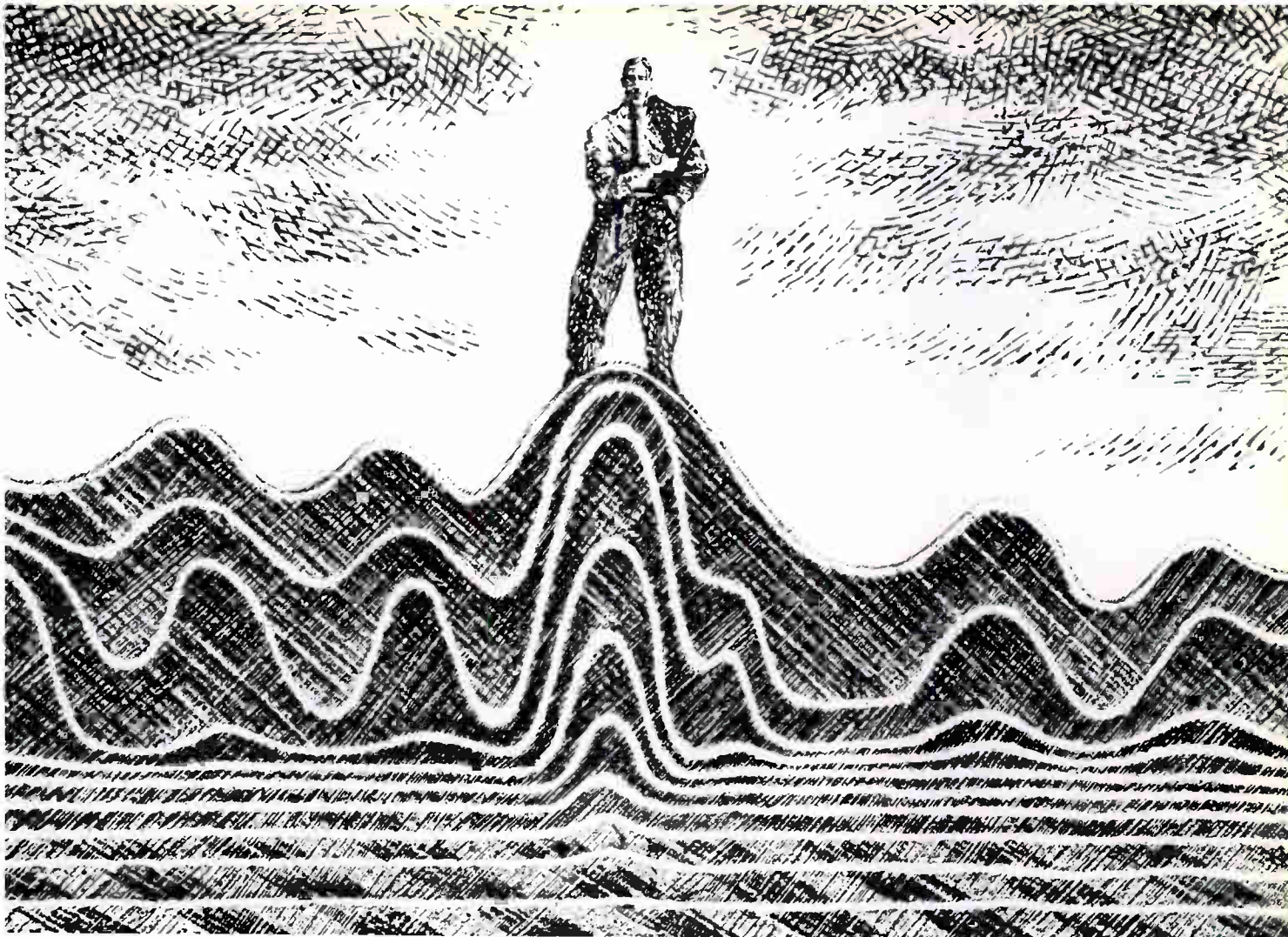

# See how it sounds at the top.

Perhaps you want to check the performance specs of a new speaker system/design. Or solve intelligibility problems in a large auditorium. If your job involves acoustic analysis, the new TEF<sup>®</sup> 12 *Plus* will put you on top.

The TEF 12 *Plus* is a comprehensive system for looking at sound. One machine, portable and software driven, replaces analyzers that cost more but do less. It's equally at home in the speaker lab, on the assembly line, or in the field. And with new software and operating speeds over twice as fast as its predecessor, the TEF 12 *Plus* does the work of a multitude of specialized instruments.

For speaker designers and manufacturers, TEF provides the functions of an anechoic chamber,

gives accurate phase measurements, and permits time alignment and cabinet reflection measurements.

If you're a sound consultant or contractor, TEF helps you align and EQ speaker clusters, set delay lines, and measure phase and impedance. And, you get quick, accurate RT60, STI, rapid STI, and ALCON measurements.

See where the new TEF 12 *Plus* can take you. Circle the reader service card number for more information. Or, to set up a demonstration, call Techron today.

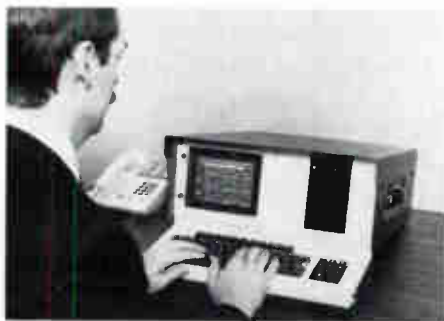

**TECHRON**

1718 W. Mishawaka Road, Elkhart, Indiana 46517 • (219) 294-8300





### 1/3 OCTAVE AUDIO ANALYZER

- **THE STUDIO;** to check room response and monitor the mix.
- **LIVE SOUND;** to eliminate feedback and easily set room EQ.
- **SOUND CONTRACTING;** to analyze rooms, set EQ and SPL levels, eliminate feedback, verify system performance.

**FEATURES INCLUDE:** built-in rechargeable batteries; built-in microphone, aux line input, SPL in A or C weight, Decay settings.

**FILTERS:** 30 bands on ISO centers to ANSI Class II double tuned specifications.

**SUGGESTED RETAIL \$599.95**

## GOLD LINE LOFT

P.O. Box 115 • West Redding,  
CT. 06896 • (203) 938-2588  
Fax-(203) 938-8740



### GL60-REVERB TIME METER

The GL60 is a professional instrument to measure the reverberation time of a room. Readings indicating the time it takes for a signal to decay by 60dB are displayed from .1 to 10 seconds.

**IDEAL FOR:**

- Equalizing Reverb Times in Recording Studios
- Installing Sound Systems
- Selecting Speaker Locations
- Microphone Placement

**SUGGESTED RETAIL \$399.95**

**CONTRACTOR PRICES**

Norland Corp.  
Norland Dr.  
Fort Atkinson, WI 53538  
(414) 563-8456, 800-333-8456, FAX#  
414-563-8456 ext. 339

North America Soar Corp.  
1126 Cornell Ave.  
Cherry Hill, NJ 08002  
(609) 488-1060

Panasonic Ind. Co./Instrumentation Dept.  
Two Panasonic Way  
Secaucus, NJ 07094  
(201) 392-4050, FAX# 201-392-4436  
Gen. Mgr.: Milton A. Landau  
Nat'l Sales Mgr.: Joseph O. Goetz  
Tech Support Mgr.: Robert Klein

Princeton Applied Research  
PO Box 2565  
Princeton, NJ 08540  
(609) 452-2111

Progressive Electronics, Inc.  
325 S. El Dorado  
Mesa, AZ 85202  
(602) 966-2931, 800-528-8224, FAX#  
602-967-8602  
Sales Mgr.: Scott Anderson  
Mkt'g/Sales: Lisa M. Rudy  
Distribution Mgr.: Michael J. Horn  
Sales Rep.: RJ Anderson  
Pres./CEO: Richard L. Anderson

Quest Electronics  
510 S. Worthington St.  
Oconomowoc, WI 53066  
(414) 567-9157, 800-558-9526, FAX#  
414-567-4047  
V.P./General Mgr.: Robert J. Wurm  
Nat'l Sales Mgr.: Paul James  
Assistant Mgr.: Rita Suechting  
Products: noise & vibration analyzers

RC Electronics, Inc.  
5386 Hollister Ave.  
Santa Barbara, CA 93111  
(805) 964-6708

RE Instruments  
31029 Center Ridge Rd.  
Westlake, OH 44145  
(216) 871-7617  
Pres.: Joergen Voldby  
AE Steve Watts  
Advertising Mgr.: T. Zavesky

Rapid Systems  
433 N. 34th St.  
Seattle, WA 98103  
(206) 547-8311  
Pres.: John Overbeck  
Chief Engineer: Mark Casebolt  
V.P. Mkt'g: Bo Ray  
Applications Engineer: Mark Olsen

Rion Instrument Div., Mott Assoc., Inc.  
PO Box 42546  
Houston, TX 77042  
(713) 777-5509, FAX# 713-777-3126

Rockland Scientific Corp.  
10 Volvo Dr.  
Rockleigh, NJ 07647  
(201) 767-7900, FAX# 201-767-1890

Rohde & Schwarz-Polarad, Inc.  
5 Delaware Dr.  
Lake Success, NY 11042  
(516) 328-1100

SPM Instrument, Inc.  
359 N. Main St.  
Marlborough, CT 06447  
(203) 295-8241, FAX# 203-295-0182

Scantek Inc.  
51 Monroe St, #1606  
Rockville, MD 20850  
(301) 279-9308, FAX# 301-279-9309  
Pres.: Richard J. Peppin, P.E.  
Service Mgr.: Gary Fraiman  
Products: realtime analyzers, sound  
intensity measurement equipment &  
microphones, SPL meters

Schlumberger Instruments  
20 North Ave  
Burlington, MA 01803  
(617) 229-4825, 800-225-5765, FAX#  
617-229-4885  
V.P. General Mgr.: Kent Morgan  
E. Instruments Sales Mgr.: John  
Jansen  
W. Instruments Sales Mgr.: Floyd  
Grissler  
Nat'l Sales Mgr.: Dick Hamel

Scientific-Atlanta, Spectral Dynamics Div.  
PO Box 23575  
San Diego, CA 92123  
(619) 268-7100, 800-231-6753, FAX#  
619-268-7047

Products: dual-channel spectrum analyzers, FFT-spectrum analyzers

linemen's test sets, MTS test equipment, RF signal generators

equipment & microphones, SPL meters, video test signal generators

Scott Instrument Lab., Division of Lindley Co.  
40 Roselle St  
Mineola, NY 11501  
(516) 746-6505, FAX# 516-746-6510

SiGnology  
1750 Silacci Dr.  
Campbell, CA 95008  
(408) 374-6464  
Pres.: Bill Huber  
Sales Mgr.: Dick Benson

Soltec Corp.  
Sol Vista Park  
San Fernando, CA 91340  
(818) 365-0800  
Pres.: Marvin Solomon  
V.P. Sales E. Region: Byron McIntire  
V.P. Sales W. Region: Gary Paiser

Sencore  
3200 Sencore Dr.  
Souix Falls, SD 57107  
(605) 339-0100, 800-843-3338, FAX# 605-335-6379  
Pres.: Al Bowden  
Exec. V.P./Sales & Mkt'g: Doug Bowden  
Merchandising Mgr.: Rob Barden  
Telemkt'g Mgr.: Garrett Carter  
Products: bench-top instrumentation, cable testers, digital multimeters, FM stereo testing, function generators, hand-held instruments, MTS test equipment, oscilloscopes, RF signal generators, sound intensity measurement equipment & microphones, video test signal generators

Simpson Electric Co.  
853 Dundee Ave.  
Elgin, IL 60120  
(312) 697-2260, FAX# 312-697-2272  
President: H. B. Washburn  
Sec./Treas.: D. S. Anderson  
Director of Mkt'g: M. J. Scala  
Director of Engineering: J. C. Reich  
Simpson Electric Co., Riverside, CA, 714-683-0121  
Seacom Sales Co., Lauderdale Lakes, FL, 305-486-0260  
Products: analog multimeters, bench-top instrumentation, digital multimeters, function generators, hand-held instruments, linemen's test sets, sound intensity measurement

Sound Technology  
1400 Dell Ave  
Camp, CA 95008  
(408) 378-6540, FAX# 408-378-6847  
Pres.: Robert A. Anderson  
V.P. Mkt'g: Kent McGuire

Speco Div., Components Specialties, Inc.  
PO Box 624  
1172 Rt. 109  
Lindenhurst, NY 11757  
(516) 957-8700, 800-645-5516, FAX# 516-956-9142  
V.P./Sales: Mel Hulkower  
V.P./General Mgr.: Jim Ganci  
Sales Mgr.: Eric Forman

Sescom, Inc.  
2100 Ward Dr.  
Henderson, NV 89015  
(702) 565-3400, FAX# 702-565-4828  
Products: bench-top instrumentation

Sharp Electronics Corp., Instrumentation Div.  
PO Box 588  
10 Keystone Pl.  
Paramus, NJ 07652  
(201) 529-8200

Shigma, Inc./Ono Soki C. Ltd.  
80 Martin Ln.  
Elk Grove Village, IL 60007  
(312) 640-8640, 800-323-0315, FAX# 312-640-1276

Siedle Intercom  
780 Parkway  
Broomall, PA 19008  
(215) 353-9595, 800-874-3353, FAX# 215-353-9716  
Pres.: Earl Zausmer  
Products: cable testers, electronic tools, hand-held instruments,

## Affordable, 1/3 Octave, Real Time Analyzer With Memories & SPL Display Under \$1000.

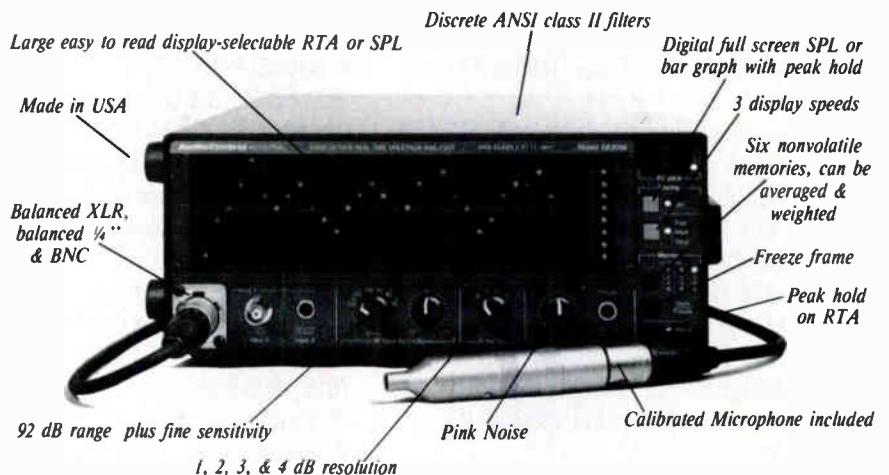

Options: • Printer (parallel) interface • Internal, rechargeable battery pack  
• Rack mount • Carry case

The SA-3050A from Audio Control Industrial  
Call today for more information!

**Audio Control Industrial™**

22313 70th Ave. West Mountlake Terrace, WA 98043 (206) 775-8461

See us at NSCA booth 224

World Radio History  
Circle 265 on Reader Response Card



Products: analog multimeters, digital multimeters, digital storage oscilloscopes

**A.W. Sperry Instruments, Inc.**  
245 Marcus Blvd.

Hauppauge, NY 11788

(516) 231-7050

Pres.: Fred Malawista

V. P. Sales/Mkt'g: Dennis W. Carroll

Controller: Rebecca Bellinato

Engineering Mgr.: Ed Grenzit

Assistant to V. P.: Roseann Bedell

**Structural/Kinematics Corp.**

950 Mapelawn

Troy, MI 48084

(313) 643-4622

**Techron, div. of Crown International, Inc.**

1718 W. Mishawaka Rd.

Elkhart, IN 46517

(219) 294-8300, FAX# 219-294-8329

TEF Product Specialist: Larry J. Shank

Techron Sales Mgr.: Bill Landow

Aim Marketing Group, Mishawaka, IN,

219-256-2025

Audio Marketing Assoc., Brecksville,

OH, 216-526-2426

Audio Resources, Westmont, IL, 312-

655-1180

Bensik Assoc., Inc., Ocala, FL, 904-

732-9775

Darmstedter Assoc., Baldwinsville, NY,

315-638-1261

Dobbs-Stanford Corp., Dallas, TX, 214-

358-0800

GMI/New England, Avon, MA, 617-588-

8043

Kodo Assoc., Minneapolis, MN, 612-

881-1255

Lichtenauer & Assoc., Antioch, CA,

415-757-1200

Marshank Sales Co., Culver City, CA,

213-559-2591

Metrorep, Freehold, NJ, 201-462-1221

Northshore Marketing, Seattle, WA,

206-284-9699

Pro Tech Marketing, Salt Lake City, UT,

801-943-8331

Secom Systems, Atlanta, GA, 404-455-

0672

R.J. Throckmorton, Ballwin, MO, 314-

227-7222

**Tektronix, Inc.**

PO Box 500

Beaverton, OR 97077

(503) 627-711800-, 800-547-1512,

FAX# 503-627-5139

**Tektronix, Signal Analysis Unit**

1350 Dell Ave., Unit 104

Campbell, CA 95008

(408) 374-6464, FAX# 408-374-6467

Mkt'g Mgr.: Rick Wills

Applications Eng. Mgr.: Loren

Enochson

General Mgr.: Bill Huber

Tektronix, Inc., Irvine, CA, 714-660-

8080

Tektronix, Inc., Rolling Meadows, IL,

312-259-7580

Tektronix, Inc., Irving, TX, 214-550-

0525

Tektronix, Inc., Lexington, MA, 617-

861-6800

Tom Villano, Gaithersburg, MD, 301-

948-7151

Products: FFT-spectrum analyzers

**TeleMatic (division of UXL Corp.)**

108-02 Otis Ave.

Corona, NY 11368

(718) 271-5200

Pres.: Ben Frankenstein

Sales Mgr.: Neil Howard

CE Salverio Guardi

Office Mgr.: Dorothy Davis

**3M SOUND PRODUCTS**

223-5S-09, 3M Center

St. Paul, MI 55144-1000

(612) 733-9214, FAX# 612-736-9433

Mkt'g Mgr.: Richard G. Barker

Sales Mgr.: Don Sluder

**Vertigo Recording Products**

12115 Magnolia Blvd., #116

N. Hollywood, CA 91607

(818) 907-5161

Chf/Engineer: Charles Bolois

Assistant Sales: Kevin Kaiser

Products: tool kits

**Westpark Communications, Inc.**

2408 Superior Dr.

Arlington, TX 76013

(817) 469-1144

Pres.: Jim Burke

V. P. Mkt'g: Sam Smith

V. P. Engineering: Larry Norris



**WHITE INSTRUMENTS**

PO Box 698

5408 US Highway 290W

Austin, TX 78767

(512) 892-0752, FAX# 512-892-0855

Pres.: Carl Van Ryswyk

V.P.: Shirley Van Ryswyk

Mkt'g Mgr.: Emory Straus

Chief Engineer: Richard Bocock

Audio Mkt'g Assoc., Brecksville, OH,

216-526-2426

Avwest, Inc., Fountain Hills, AZ, 602-

946-1811

Bensik Assoc., Inc., Ocala, FL, 904-

732-9775

Design Factors, La Habra Heights, CA,

213-697-7576

Gemini Electronic Mkt'g, Edmonds,

WA, 206-776-3121

L.S.M., Phelps, NY, 315-548-4891

Sigmat, Freehold, NJ, 201-462-1221

Monfort Electronics Mkt'g,

Indianapolis, IN, 317-872-8877

New Resources, Inc., Norwell, MA,

617-659-1463

Rancilio Assoc., St. Louis, MO, 314-

631-3326

Rep Tech, Inc., Terrell, TX, 214-222-

2131

Richard S. Pass Assoc., Inc.,

Langhorne, PA, 215-757-6100

Shalco, Inc., Ferndale, MI, 313-547-

4771

Warren Associated Sales Reps, Santa

Clara, CA, 408-988-7762

Wilson Audio Sales, Nashville, TN, 615-

646-4477

Ziskind Assoc., Inc., Rolling Meadows,

IL, 312-577-1624

CB Electronics Mkt'g, Arvada, CO, 303-

422-0561

Products: data acquisition, filter sets,

frequency-domain

acquisition/analysis, function

generators, microprocessor systems,

noise & vibration analyzers, PC

systems, software, realtime

analyzers, RT60 meters, SPL meters

# USED/REBUILT/RENTAL EQUIPMENT

## USED, REBUILT EQUIPMENT & BROKERS

Communication Equipment Brokers, Inc.  
1500 W. Carroll Ave.  
Chicago, IL 60607  
(312) 829-8810, 800-621-4397  
Pres.: Mark Hastings  
Director: John Presti

Datacraft, Inc.  
13714 S. Normandie

Gardena, CA 90249  
(213) 321-2320, 800-421-2289, FAX#  
213-532-9521

Electro Rent Corp.  
4209 Vanowen Pl.  
Burbank, CA 91505  
(818) 843-1221

CEO: Dan Greenberg  
Pres.: William Weitzman

Eventide, Inc.  
One Alsan Way  
Little Ferry, NJ 07643  
(201) 641-1200, FAX# 201-641-1640  
Sales Mgr.: Gil Griffith  
Pres.: Richard Factor

**What's new?** Each month, *Sound & Communications* Products Department showcases many of the new products being introduced by both large and small manufacturers. And noted technical writer and consultant Gary Davis focuses on one new product each month in his commentary, *A Closer Look*.

**Don't be left out!**

Send all your product news (with photos) to:

Bill Intemann  
Managing Editor  
*Sound & Communications*  
25 Willowdale Avenue  
Port Washington, NY 11050

# WIRE & CABLE

## WIRE/CABLE COMPONENTS

AMP Netcon  
PO Box 1776  
Southeastern, PA 19482  
(215) 647-1000

Alarm Accessory Ltd.  
PO Box 212  
Claymont, DE 19703  
(302) 792-3620, 800-441-7082, FAX#  
302-792-7713  
Pres.: William J. Holt

Operations Supervisor: Angela M. Bopp  
Products: accessories, alarm, conduits,  
connectors, raceways, security,  
switches

All Electronics Corp.  
PO Box 567  
6228 Sepulveda Blvd.  
Van Nuys, CA 91408  
(818) 904-0524, 800-826-5432, FAX#  
818-781-2653  
Mgr. Sales: Harold Oliver  
Products: accessories, adapters,  
computer cable & peripherals,  
connectors, plugs, pre-wired  
systems, terminals, XLR connectors

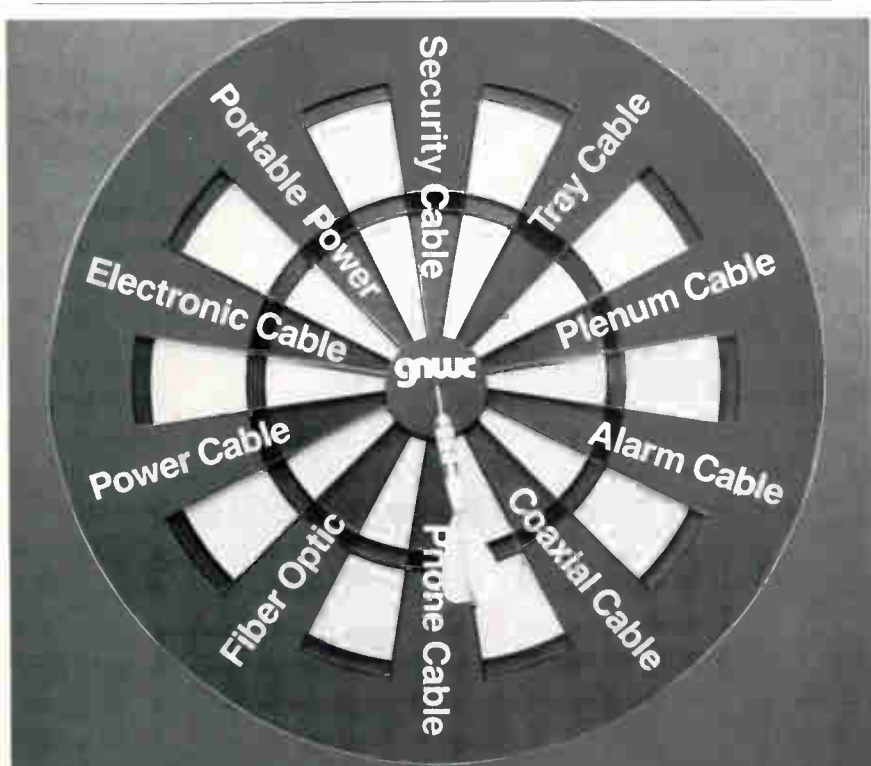

## Your best shot for in-stock wire & cable

Trying to find the right wire and cable to meet your needs can sometimes become a game in itself. If you're tired of playing games and losing, it's time to give it your best shot—Great Northern Wire & Cable. We've got all the right products at the right price, in-stock and ready-to-go in most cases.

Great Northern Wire & Cable . . . always on target for your wire and cable needs.

**SEND ME "SUPER STOCKER"**  
Every 60 days we publish a complete list of all in-stock products. If you would like to receive our "Super Stocker" list, please write your name and address on your company letterhead and send it to GNWC Attn: "Super Stocker".

**gnwc**  
great northern wire and cable, inc.  
1401 Brook Drive, Downers Grove, IL 60515  
312/627-1777  
Illinois Toll Free 1-800-826-2962  
Outside Illinois Toll Free 1-800-468-2121  
Fax No. 1-312-932-4342

## FLUSH MOUNT 75 OHM BNC CONNECTORS

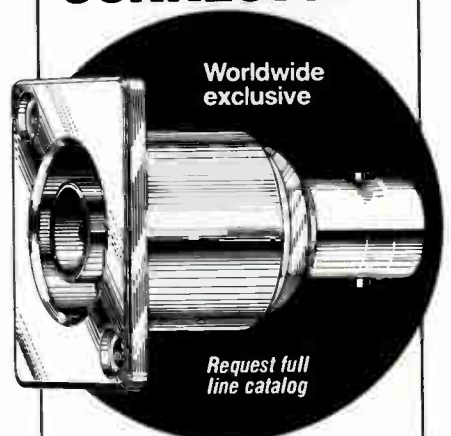

- Recessed panelmount less prone to damage.
- Fully isolated. Compatible with all other manufacturers BNC connectors.
- Beryllium copper external contact with gold coated center contact pin.
- VSWR characteristic (<1.1) up to 2 GHz.

**CANARE**

CANARE CABLE INC.  
555 5TH ST., NO. 1G • SAN FERNANDO, CA 91340  
(818) 840-0993 • FAX (818) 842-7548



Alpha Wire  
 711 Lidgerwood Ave.  
 Elizabeth, NJ 07207  
 (201) 925-8000, 800-52A-LPHA, FAX#  
 201-925-7429

Amphenol Products  
 4300 Commerce Court  
 Lisle, IL 60532  
 (312) 983-3500

Atlas Wire & Cable Corp.  
 133 S. Van Norman Road  
 Montebello, CA 90640  
 (213) 723-2401  
 Mkt'g: Tom Coubayre

Audio Quest, Inc.  
 PO Box 940  
 N. Chicago, IL 60064  
 (312) 473-1200, 800-457-4579  
 Pres.: Matt Coleman  
 Mkt'g Mgr.: Kimberly Heeres

Belden Wire & Cable  
 PO Box 1980  
 Richmond, IN 47375  
 (317) 983-5200, FAX# 317-983-5294  
 Pres.: Roger Cornett  
 V.P./OEM Sales: Ed Stull  
 Mkt'g Communications Mgr.: Bill  
 Hayes

Berk-Tek, Inc.  
 132 White Oak Road  
 New Holland, PA 17557  
 (717) 354-6200, 800-237-5835, FAX#  
 717-354-7944  
 Pres.: Joseph L. Boscov  
 Treasurer: Steven Bright  
 V. P. Operations: Harold Styer  
 V. P. Sales/Mkt'g: Sue Stefar  
 Nat'l Sales Mgr.: Brad Hubinek  
 Purchasing Director: Allan Schoonover

Bi-Tronics, Inc.  
 PO Box 125  
 76 Main Street  
 Tuckahoe, NY 10707  
 (914) 793-3221, 800-522-7377, FAX#  
 914-961-4244  
 Pres.: J. Schwartz  
 Sales Mgr.: Ron Huppert  
 Products: accessories, adapters,  
 alarm, audio, computer cable &  
 peripherals, connectors, control,  
 data, fiber optics, jacks, low-

# FIBERVISION'S GOT IT ALL FOR YOU

Everything in  
 fiber optic video — including  
 full *Technical Support*

All the advantages of Fiber Optic Technology configured in simplified  
 easy-to-install, ready-to-operate systems.

Fiber vision systems are in use everywhere that clear, reliable,  
 interference-free reception is vital.

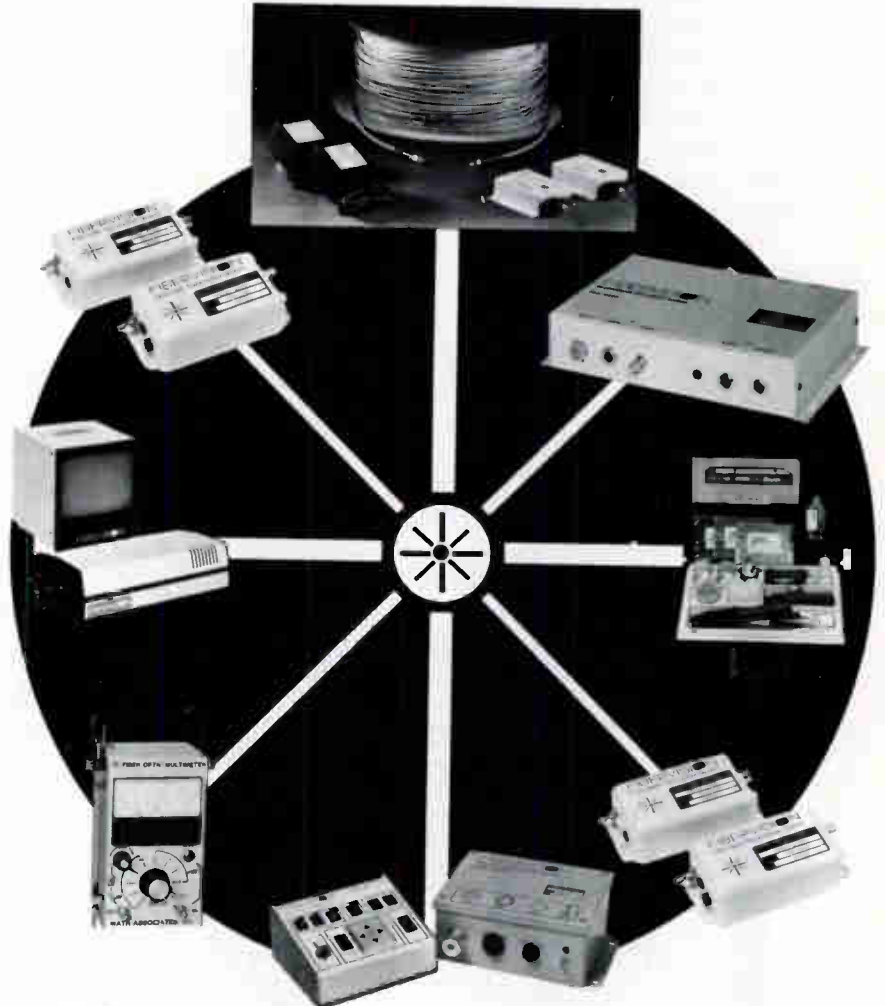

## Ready-to-operate systems

**8600**  
 • designed to replace  
 coax up to 1500 feet  
 distance  
 • transmitter/receiver  
 modules, ac  
 adapters, cable  
 w/connectors  
 • no adjustments or  
 special tools required

**FBX/FBR-3000**  
 • compatible with most  
 CCTV cameras and  
 monitors  
 • interfaces with 600-  
 ohm intercoms and  
 paging amplifiers  
 • transmits either TTL,  
 RS-232, RS-422 or  
 Manchester pan-tilt  
 zoom signal

**FX-FR-1000**  
 • 8 MHz bandwidth, up  
 to 3 mile distance w/o  
 amplifier  
 • transmitter/receiver  
 modules  
 • can be operated from  
 ac, dc, or batteries

2200 Shames Drive, Westbury, NY 11590 • 516-334-6800.

# MATH ASSOCIATES, INC.

10 YEARS OF FIBER OPTIC VIDEO LEADERSHIP ✨

capacitance, panels, plenum cable, plugs, security, shielded, sleeving, solid, specials, stranded, telecommunications, terminals, transformers, tubing, video, XLR connectors

**Brim Electronics, Inc.**  
120 S. Home Place  
Lodi, NJ 07644  
(201) 796-2886, FAX# 201-778-2792  
Pres.: B. Danziger  
GH Assoc., Stow, MA, 617-897-1741  
Products: accessories, adapters, alarm, audio, computer cable & peripherals, conduits, control, data, hardware, jacks, low-capacitance, markers, plenum cable, plugs, shielded, sleeving, specials, stranded, tubing

**CZ Labs, Inc.**  
55 Railroad Ave.  
Garnerville, NY 10923  
(914) 268-5056

**Cabletronix**  
PO Box 3003  
366 Washington St.  
Newburgh, NY 12550  
(914) 565-7570, 800-431-9473, in NY  
800-942-WIRE, FAX# 914-564-5332

Pres.: Stephen L. Roth  
V. P.: Leonard Ellentuch  
Sales Mgr.: Tom Martirano  
Products: accessories, adapters, alarm, audio, computer cable & peripherals, connectors, control, data, fiber optics, hardware, jacks, low-capacitance, markers, plenum cable, plugs, pre-wired systems, security, shielded, sleeving, solid, specials, stranded, telecommunications, terminals, tubing, video

**Calrad Engineered Electronic Products**  
819 No. Highland Ave.  
Los Angeles, CA 90038  
(213) 465-2131

**Cal Switch**  
13717 S. Normandie Ave

Gardenia, CA 90249  
(213) 770-2330, 800-CAL-S-W-C-H,  
FAX# 213-327-2741  
Pres.: Irwin Perlman  
V.P.: Bob Andrade  
V.P.: Herb Poncher

**Canare Cable, Inc.**  
555 Fifth St.  
San Fernando, CA 91340  
(818) 840-0993, FAX# 818-842-7548  
General Mgr.: Barry Brenner

**Champlain Cable Corp.**  
PO Box 7  
Winooski, VT 05404  
(802) 655-2121, 800-451-5162, FAX#  
802-655-2025  
Mkt'g Mgr.: Clayton Vaughn  
Products: alarm, computer cable & peripherals, control, data, low-capacitance, plenum cable, security, shielded, solid, stranded, telecommunications

**Connectronics Corporation**  
652 Glenbrook Road



**COMPLETE SUPPLIES  
FOR  
SOUND INSTALLERS**  
BULK WIRE - CONNECTORS -  
SHRINK TUBING -  
WALL MOUNTING PLATES -  
AUDIO ACCESSORIES

FOR MORE INFORMATION CALL:  
**1-800-325-0266**  
IN MISSOURI: 1-800-331-1223

**QUALITY  
SERVICE  
PRICE**

**FREE!**

- **Audio**
- **Video**
- **Data**
- **RF**
- **Communi-  
cations**

**NEW  
1988  
INSTALLER  
CATALOG  
FULL LINE...**

Connectors and Adaptors in stock plus exclusive Connector Locator Service\*  
 Hi quality bulk cable featuring Mogami Superflexible and Ultraminature  Tools and Accessories  Hundreds of new items.

For professional installers of Electronics Systems of every kind.

Ask about our 5% discount for your first catalog order...celebrating our 21st Year.

**CALL TODAY! 800-522-7377;**

in NY 914-793-3221 for catalog, price list, engineering assistance and quotes. ALL FREE without obligation:



**Bi-Tronics Is The Answer.**

**BI-TRONICS, INC.**  
Box 125, Tuckahoe, NY 10707

Stamford, CT 06906  
(203) 324-2889, 800-322-2537  
Exec. V.P.: Richard Chilvers

**Conquest Electronic Wire & Cable**  
PO Box 757  
7319 Duvan Dr.  
Tinley Park, IL 60477  
(312) 429-1770, 800-323-7671, in IL  
800-344-2667, FAX# 312-429-4688  
Pres.: Robert Jares, Jr.  
V.P.: Larry Spalla  
Sales Engineer: Ron Wirth  
Sales Engineer: Ken Bernd  
Sales Engineer: Mike Sanfilippo  
Credit Mgr.: Norm Corsi



**CONQUEST SOUND, INC.**

PO Box 757  
7319 Duvan Dr.  
Tinley Park, IL 60477

(312) 429-1770, 800-323-7671, FAX#  
312-429-4688  
Pres.: Robert Jares, Jr.  
V.P.: Larry Spalla  
Sales Engineer: Ron Wirth  
Sales Engineer: Ken Bernd  
Sales Engineer: Mike Sanfilippo  
Credit Mgr.: Norm Corsi  
Products: accessories, adapters,  
alarm, audio, computer cable &  
peripherals, connectors, fiber optics,  
jacks, low-capacitance, panels,  
plenum cable, plugs, pre-wired  
systems, raceways, security,  
shielded, solid, stranded, switches,  
transformers, XLR connectors

Franklin Park, IL 60131-1412  
(312) 455-8830, 800-621-4278, FAX#  
312-455-8837  
Pres.: T. Mann  
V.P.: K. Rankin  
Sales Operations: S. Boynton  
Customer Svce: M. Braden  
V.P. Mkt'g: M. Abramson  
Products: alarm, audio, computer cable  
& peripherals, control, data, low-  
capacitance, plenum cable, shielded,  
sleeving, tubing, video

**Current Cable Co., Inc.**  
2610 W. Chicago Ave.  
Chicago, IL 60622  
(312) 486-7100, 800-821-2432  
Pres.: Arthur Shaiman  
Sales Mgr.: Bernard Lewis  
Chief Engineer: John Rudd



**Consolidated Electronic Wire & Cable Corp.**  
11044 King St.

**Daburn Electronics and Cable Corp.**  
70 Oak St.  
Norwood, NJ 07648

When You Need It  
We've Got It

**Switchcraft®**  
A Raytheon Company

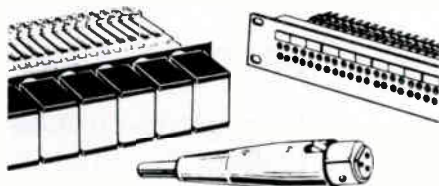

- JACK PANELS
- AUDIO CONNECTORS
- PLUGS AND PATCH CORDS
- MULTI-SWITCH® SWITCHES



We Stock The Entire  
Switchcraft Inventory

**CALL  
(800) CAL-SWCH**

13717 S. Normandie Avenue  
Gardena, California 90249

**EASTMAN  
WIRE & CABLE CO.**

MANUFACTURERS OF UL LISTED  
WIRE & CABLE FOR THE  
SECURITY, FIRE, ELECTRONICS  
& SOUND INDUSTRY

P.O. BOX 139  
PINEY HOLLOW ROAD  
WINSLOW, NJ 08095

THE ULTIMATE IN:  
QUALITY WIRE  
FAST COURTEOUS SERVICE  
CONVENIENT PACKAGING  
REEL E-Z BOXES  
STOCK SHIPMENTS  
COMPETITIVE PRICES

NOW AVAILABLE - PLENUM CABLE  
ARTICLE 725, 760 & 800  
SMALL & LARGE ORDERS  
SOLID & STRANDED  
SHIELDED & UNSHIELDED  
CONSTRUCTION AVAILABLE

GET THE WIRE YOU WANT -  
TALK TO THE WIRE EXPERTS!

Try the New EASTMAN/UL Approved  
WIRE & CABLE  
CL2, CL2P, FPL, FPLP  
Meeting 1987 National Electric Code  
Specifications  
For Your Current Needs

If you would like a new Catalog,  
Please Call or Write.

CALL TOLL FREE  
1-800-257-7940  
N.J. 609-567-1252  
FAX 609-567-7993



(201) 768-5400, FAX# 201-768-9642  
 Pres.: Howard Danziger  
 Nat'l Sales Mgr.: Randy Hibshman

Customer Svce: Linda E. Scaturro  
 Production Sup.: Gabriel Figueroa  
 Products: audio, shielded, solid,  
 specials, stranded, transformers,  
 video

### LEE DAN COMMUNICATIONS

155 Adams Ave.  
 Hauppauge, NY 11788-3699  
 (516) 231-1414, 800-533-3261, FAX#  
 516-231-1498  
 Pres.: Leon Goldberg  
 V.P. Operations: Lawrence J. Goldberg  
 V.P. Finance/Admin.: David H.  
 Goldberg  
 Sr. Technician: Sandy Hoffman

Delta Wire & Cable  
 PO Box 833  
 N. Chicago, IL 60064  
 (312) 473-4990  
 Pres.: Matt Coleman  
 Sales Mgr.: Perry Stein

Fluorocarbon Co., Samuel Moore Group  
 1199 S. Chillicothe Road  
 Aurora, OH 44202  
 (216) 562-9111, 800-342-6630, in OH  
 800-562-5151, FAX# 216-562-8480  
 Mkt'g: Gary Ward

Georgia Cable and Wire  
 463 Commerce Park Drive  
 Marietta, GA 30060  
 (404) 423-0705, 800-421-9473, FAX#  
 404-423-1980  
 General Mgr.: William Kelly  
 Sales Mgr.: Robert W. Delano  
 Products: audio, computer cable &  
 peripherals, control, data, low-  
 capacitance, security, shielded, solid,  
 specials, stranded

Great Northern Wire & Cable, Inc.  
 1401 Brook Dr.  
 Downers Grove, IL 60515  
 (312) 627-1777, FAX# 312-932-4342  
 Mkt'g: Bob Swanson

HOSA Technology, Inc.  
 13042 Moore St.

## YOU CAN'T INSTALL WHAT YOU DON'T HAVE



Don't let electronic cable shortages keep you from completing a job on time, or shipping an order need at competitive prices.

Consolidated has over 12,000 wire and cable constructions available off-the-shelf. We can fill your requirements exactly and ship within 24 hours. For almost 70 years, we've built our business on competitive pricing, customer service and most importantly, quality products.

Consolidated's product line meets the latest (UL), (CSA), NEC, IEEE, OSHA and MIL-SPEC standards. We can now supply cable conforming to the revised 1987 National Electrical Code. UL approved cables available for immediate delivery include:

CL2	CL2P
CL3	CL3P
FPL	FPLP

You don't have to wait for the latest in cable design, Consolidated has it. Call Consolidated today for a quick quote, sample, or catalog. We've got what you need!

**1-800-621-4278**

 **Consolidated**  
 electronic wire & cable

11044 King Street • Franklin Park, IL 60131 • 312-455-8830  
 Cable Address: CONWIRE • TWX: 910 227 1705 • FAX: 1-312-455-8837

### "Hear the Difference"

### OXYGEN-FREE SPEAKER CABLES by SOUND RUNNER

- OFC QUAD 13-Awg**  
4x16 Awg/105-Strands
- 10-Awg/238-Strands**
- 12-Awg/168-Strands**
- 16-Awg/67-Strands**
- PLENUM OR PVC**

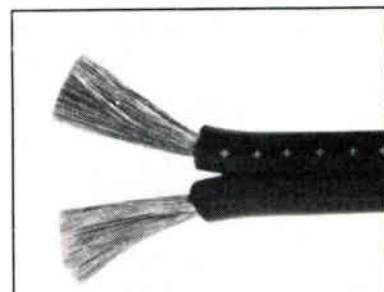

Sound Runner Div.  
**MARSHALL ELECTRONICS  
 INC.**

P.O. Box 2027  
 Culver City, CA 90230

**Phone 213/390-6608  
 24-Hr. Fax 213/391-8926**

Cerritos, CA 90701  
(213) 926-0808, 800-255-7527, FAX#  
213-404-3487  
Pres.: Sho Sato

Westbury, CA 11590  
(213) 390-6608, FAX# 213-391-8926  
Pres.: Henry Schultz  
V.P. & General Mgr.: Leonard Marshall  
Mgr. Cust Svce/Mkt'g: Leroy  
Ellingworth

Noramco Wire & Cable Co., Ltd.  
4185 Dawson St.  
Vancouver, B.C., Canada V5C 4B3  
(604) 298-2133, 800-663-8434, FAX#  
604-298-9115  
Mkt'g: Russ Good

ITT Pomona Electronics/Div. ITT Corp.  
PO Box 2767  
1500 E. Ninth St.  
Pomona, CA 91766  
(714) 623-3463

**MATH ASSOCIATES, INC.**  
2200 Shames Dr.  
Westbury, NY 11590  
(516) 334-6800, FAX# 516-334-6473  
Pres.: Ellen Math  
V.P. Sales/Mkt'g: Edmund Henckel  
Director R & D: Irwin Math  
Products: fiber optics

Numark Electronics  
503 Newfield Ave.  
Edison, NJ 08837  
(201) 225-3222, FAX# 201-287-2155  
Pres.: Harry Kotovsky  
V.P.: Robert Kotovsky  
Numark/PPD, Simi Valley, CA, 805-  
522-3550

Ideal Wire Products, Inc.  
Lorum St.  
Tewksbury, MA 01876  
(617) 851-4541, 800-762-7668  
Pres.: Robert T. Leahy  
Products: audio, control, data,  
security, shielded, solid, stranded,  
telecommunications

Microtran Co., Inc.  
PO Box 236  
145 E. Mineola Ave.  
Valley Stream, NY 11582-0236  
(516) 561-6050  
Pres.: Albert J. Eisenberg  
V.P. Sales: Walter Benschler  
Chief Engineer: Vulf Ozechov

Penn Fabrication (USA), Inc.  
PO Box 506  
29B Ethel Ave.  
Hawthorne, NJ 07506  
(201) 423-4404  
Sales Director: Mike Panasuk  
General Mgr.: Richard Stratford  
General Mgr.: Gavin Naismith  
Products: accessories, connectors,  
fuses and holders, jacks, video

International Wire & Cable  
520 Business Center Dr  
Mt Prospect, IL 60056  
(312) 299-0021, 800-323-0210, FAX#  
312-298-8433

The Music People, Inc.  
PO Box 648  
West Hartford, CT 06107  
(203) 521-2248, 800-289-8889, FAX#  
203-521-2428  
Pres.: James R. Hennessey  
Director of Sales: Earl "Buzz" Goodwin  
Comptroller: John Gutowski  
Purchasing Mgr.: Robert Murray  
Publicity/Promotion: Lisa Radefeld

Penny & Giles, Inc.  
2716 Ocean Park Blvd., Suite 1005  
Santa Monica, CA 90405  
(213) 452-4995  
Pres.: Bob Rose  
V.P.: David McLein  
Sales Person: C.J. Melechin  
Products: accessories, adapters, audio,  
conduits, connectors, control, jacks,  
pre-wired systems, transformers,  
video

King Wire & Cable Corp.  
179-45 110th Ave.  
Jamaica, NY 11433  
(718) 657-4422  
Pres.: Lester Dorfman  
Treas./Sec.: Henry Zelinger  
V.P.: Robert Dorfman  
V.P.: Marty Newman

Music Supply Co., Inc.  
809 N. Madison  
Dallas, TX 75208  
(214) 946-8450, 800-527-1522, FAX#  
214-946-9155  
Pres.: W. E. Brown  
Sales: Betty Brown

RMS Electronics, Inc.  
50 Antin Place  
Bronx, NY 10462  
(212) 892-6700, 800-223-8312  
Chairman: Joseph F. Bradway Jr.  
Pres.: Roger Nejes  
Nat'l Sales Mgr.: Lee R. Heller

Kulka-Smith, Inc.  
1913 Atlantic Ave.  
Manasquan, NJ 08736  
(201) 223-9400, FAX# 201-223-8788

National Electric Cable  
1730 Elmhurst Rd.  
Elk Grove Village, IL 60007  
(312) 593-8100

R-Columbia Products Co., Inc.  
2808 St. Johns Ave.  
Highland Park, IL 60035  
(312) 432-7915

Lemo USA, Inc.  
335 Tesconi Circle  
Santa Rosa, CA 95401  
(707) 578-8811  
General Mgr.: Samuel M. Sokolik  
Nat'l Sales Mgr.: David Battaglia  
Sr. Applications Engineer: Bill Lee, P.E.  
Materials Control Mgr.: John Connolly  
Controller: Cheryl Powers

Nemal Electronics, Inc.  
12240 N.E. 14th Ave.  
N. Miami, FL 33161  
(305) 893-3924, 800-327-5999, FAX#  
305-895-8178  
Pres: Benjamin Nemser  
Sales Admin.: Hilda Manten

Remeo Products Corp.  
41 Bridge St.  
Florida, NY 10921  
(914) 651-4431, 800-431-3864, FAX#  
914-651-4160

Marietta Wire & Cable  
463 Commerce Park Drive  
Marietta, GA 30067  
(404) 422-5708, 800-692-9473

Marshall  
89 Frost Street

# WEST PENN WIRE...

## A Company With All The Right Connections

If your business is involved with sound, communications, video, background music, intercoms, data installations, security, fire alarms etc., then you should be doing business with WEST PENN WIRE—a company with all the right connections. Some of them include:

- Fire Protective Cable, Plenum & Non Plenum
- Data Grade Communication Cable
- Coaxial Cable, Plenum & Non Plenum
- Shielded Pair & Loop Cable
- Power Limited Circuit & Remote Control Signalling Cable
- Twinaxial Cable, Plenum & Non Plenum
- Local Area Network Cable
- Inside Telephone Cable
- Audio Cable, Plenum & Non Plenum
- RS 449 (RS 442 & RS 423)
- Special Composite Cable (Consult Factory)
- RS 232, Plenum & Non Plenum
- RS 232 Extended Distance Cable
- Multiple Pair Computer Cable
- Computer Cable Plenum Dual 59
- Control Cable, Plenum & Non Plenum
- IBM Type 1 & IBM Type 2, Plenum & Non Plenum

Excellent prices, great service and a company that cares about its customers... that's **West Penn Wire**.

Send for our free catalog, then call the experts at

**1-800-245-4964.**

or, in PA, 800-222-8883

**WPW**  
WEST PENN WIRE

2833 West Chestnut St.  
Washington, PA 15301  
FAX 412/222-6420

See West Penn Wire at the NSCA Exposition in booth #101.



Pres.: Al Muhlrud  
 V.P. Sales: Ken Pimental  
 Nat'l Sales (Remfo): Mary Galbraith  
 Products: alarm, audio, computer cable & peripherals, connectors, data, fiber optics, low-capacitance, plenum cable, plugs

Products: low-capacitance, plenum cable, security, shielded, solid, telecommunications

Nat'l Sales Mgr.: Louis Valente  
 Exec. V.P.: Donald Hastings  
 Reg Sales Mgr.: Richard Tovornik  
 Reg Sales Mgr.: Dan Hastings  
 Reg Sales Mgr.: Robert Bruno  
 Products: alarm, audio, computer cable & peripherals, data, low-capacitance, plenum cable, security, shielded, solid, specials, stranded, telecommunications, video



Resco, Inc.  
 PO Box 2244  
 366 Washington St.  
 Newburgh, NY 12550  
 (914) 565-7570, 800-942-WIRE, FAX# 914-564-5332  
 Pres.: Stephen L. Roth  
 V.P.: Leonard Ellentuch

**WEST PENN WIRE CORP.**  
 2833 West Chestnut St.  
 Washington, PA 15301  
 (412) 222-7060, 800-245-4964, FAX# 412-222-6420

Whirlwind  
 100 Boxart St.  
 Rochester, NY 14612

Saxton Wire & Cable Products, Inc.  
 215 N. Rt. 303  
 Congers, NY 10920  
 (914) 268-6846

Sescom, Inc.  
 2100 Ward Dr.  
 Henderson, NV 89015  
 (702) 565-3400, FAX# 702-565-4828  
 Products: transformers

Signal Cable Co.  
 2500 Commonwealth Ave.  
 North Chicago, IL 60064  
 (312) 689-9090, 800-323-9355  
 Sales Mgr.: Don Prochilo  
 V.P. Sales: Kerry Glicken

Stancor  
 131 Godfrey St.  
 Logansport, IN 46947  
 (219) 722-2244, FAX# 219-722-5189  
 Mkt'g/Sales Mgr.: Terry Smith  
 Product Mgr.: Rich Noel  
 Products: transformers

TEI Electronics, Inc.  
 570 W. 18th St.  
 Hialeah, FL 33010  
 (305) 888-3980, 800-327-8811

Tappan Wire & Cable, Inc.  
 256 Oak Tree Rd.  
 Tappan, NY 10983  
 (914) 359-9300, 800-247-9099, FAX# 914-359-9369  
 Pres.: Sidney Grant  
 V.P.: Michael Ressa  
 Sales Mgr.: Leslie Brady



## TAPPAN WIRE & CABLE

# HOME OF THE WIREMAN

# 800-247-9099

**MANUFACTURERS OF UL CABLE FOR:**

- INTERCONNECT
- INTERCOM
- PAGING
- SOUND
- FIRE ALARM
- BURGLAR ALARM
- SECURITY
- COMMUNICATIONS

**INTERCOM & AUDIO SHIELDED & UNSHIELDED**

**BELDEN EQUALS**

## TAPPAN WIRE & CABLE INC.

**256 OAK TREE ROAD, TAPPAN, NY 10983**  
 914-359-9300      800-247-9099      FAX 914-359-9369

(716) 663-8820, 800-772-9997, FAX# 716-865-8930  
Pres.: Michael Laiacona  
V.P./General Mgr.: Bonnie Gardner  
Sales Mgr.: Ray Bellizia  
Design Engineering: Carl Cornell  
Electrical Engineering: Jim Kelsey  
Products: accessories, adapters, audio, computer cable & peripherals, connectors, jacks, plugs, pre-wired systems, raceways, terminals, transformers, video, XLR connectors

**ZIPPERTUBING CO.**  
13000 S. Broadway  
Los Angeles, CA 90061  
(213) 321-3901  
Pres.: Terry Plummer  
Executive V.P.: Bruce Hoffine  
Director of Mkt'g: Michael Sullivan  
Ziptape Sales Mgr.: Ed Hackett  
Southwest Sales Mgr.: Don Ernewein  
Ziptape Identification Systems,  
Tempe, AZ, 602-967-8888

Tom Maguire & Assoc., Norwood, MA,  
617-551-0500  
Eastern Sales Office, Wayne, NJ, 201-256-4980  
Southwest Sales Office, Dallas, TX,  
214-931-7060  
Components Specialty Co., Cleveland, OH, 216-734-0655

## WIRE/CABLE SYSTEMS

All Electronics Corp.  
PO Box 567  
6228 Sepulveda Blvd.  
Van Nuys, CA 91408  
(818) 904-0524, 800-826-5432, FAX# 818-781-2653  
Mgr. Sales: Harold Oliver  
Products: audio, cable reels

Products: audio, custom, data, instrument, microphone cable, snakes, multi-pair, speaker, video

Products: audio, custom, data, fiber optics, instrument, multi-pair, speaker, video

B & B Systems, Inc.  
28111 N. Avenue Stanford  
Valencia, CA 91355  
(805) 257-4853  
V. P. Sales/Mkt'g: Michael Shore  
District Mgr.: Mike Ward  
OEM Mgr.: William McKinley

**Cabletronix**  
PO Box 3003  
366 Washington St.  
Newburgh, NY 12550  
(914) 565-7570, 800-431-9473, in NY 800-942-WIRE, FAX# 914-564-5332  
Pres.: Stephen L. Roth  
V. P.: Leonard Ellentuch  
Sales Mgr.: Tom Martirano  
Products: audio, custom, data, fiber optics, instrument, microphone cable, snakes, multi-pair, speaker, video



**CONQUEST SOUND, INC.**  
PO Box 757  
7319 Duvan Dr.  
Tinley Park, IL 60477  
(312) 429-1770, 800-323-7671, FAX# 312-429-4688  
Pres.: Robert Jares, Jr.  
V.P.: Larry Spalla  
Sales Engineer: Ron Wirth  
Sales Engineer: Ken Bernd  
Sales Engineer: Mike Sanfilippo  
Credit Mgr.: Norm Corsi  
Products: audio, custom, data, fiber optics, instrument, microphone cable, snakes, MIDI, multi-pair, multi-pin disconnect, panels, speaker, splitting, stageboxes, video

Bi-Tronics, Inc.  
PO Box 125  
76 Main Street  
Tuckahoe, NY 10707  
(914) 793-3221, 800-522-7377, FAX# 914-961-4244  
Pres.: J. Schwartz  
Sales Mgr.: Ron Huppert  
Products: audio, cable reels, custom, data, fiber optics, instrument, microphone cable, snakes, MIDI, multi-pair, multi-pin disconnect, panels, speaker, splitting, stageboxes, video

Chester Cable/Division of Alcatel, NA  
15 Oakland Ave.  
Chester, NY 10918  
(914) 469-2141, FAX# 914-469-9935  
Pres.: Frank B. Leibold  
Director of Sales: Peter P. Deschner  
V.P. Mkt'g/Bus. Development: Yves Bonnamour  
Sales Engineer: Nancy L. Werner  
Engineer: Steve Luciana  
Account Rep: Kim Beissel

Brim Electronics, Inc.  
120 S. Home Place  
Lodi, NJ 07644  
(201) 796-2886, FAX# 201-778-2792  
Pres.: B. Danziger  
GH Assoc., Stow, MA, 617-897-1741

Clifford of Vermont, Inc.  
PO Box 51  
83 Main St.  
Bethel, VT 05032  
(802) 234-9921, 800-451-4381, FAX# 802-234-5006  
Advertising Mgr.: Clifford Cyphers

Consolidated Electronic Wire & Cable Corp.  
11044 King St.  
Franklin Park, IL 60131-1412  
(312) 455-8830, 800-621-4278, FAX# 312-455-8837  
Pres.: T. Mann  
V.P.: K. Rankin  
Sales Operations: S. Boynton  
Customer Svce: M. Braden  
V.P. Mkt'g: M. Abramson

Products: audio, data, fiber optics, microphone cable, snakes, MIDI, multi-pair, multi-pin disconnect, speaker, video

**LEE DAN COMMUNICATIONS**

155 Adams Ave.  
Hauppauge, NY 11788-3699  
(516) 231-1414, 800-533-3261, FAX# 516-231-1498

Pres.: Leon Goldberg  
V.P. Operations: Lawrence J. Goldberg  
V.P. Finance/Admin.: David H. Goldberg

Sr. Technician: Sandy Hoffman  
Customer Svce: Linda E. Scaturro  
Production Sup.: Gabriel Figueroa  
Products: audio, cable reels, microphone cable, snakes, multi-pair, speaker, video

**Hi Lo Fabrication and Manufacturing**

PO Box 509  
CR 1105  
Rio Vista, TX 76093  
(817) 373-2247

Pres.: Cecil Caro  
Production Engineer: Cecil Caro  
Sales/Secretary: Bridget Caro  
Products: audio, custom, microphone cable, snakes, panels, speaker, splitting, stageboxes, video

**L and L Sales Co., Inc.**

PO Box 238  
441 E. Old Hickory Blvd.  
Madison, TN 37116  
(615) 868-6976

**MATH ASSOCIATES, INC.**

2200 Shames Dr.  
Westbury, NY 11590  
(516) 334-6800, FAX# 516-334-6473  
Pres.: Ellen Math  
V.P. Sales/Mkt'g: Edmund Henckel  
Director R & D: Irwin Math  
Products: fiber optics

**Monster Cable Products, Inc.**

101 Townsend St.  
San Francisco, CA 94107  
(415) 777-1355, FAX# 415-896-1745  
Director Special Projects: Gary Reber  
Pres.: Noel Lee  
Mkt'g Mgr.: Rita Geary

**Portland Instrument**

1101A Air Way  
Glendale, CA 91201  
(818) 500-0137, 800-621-5640, FAX# 818-240-1828

Pres.: Ronald A. Fuller  
Prod Mgr/In-Outdoor Sys.: Jack Simpson  
Prod Mgr./Wire & Cable: Judy Gill  
Production Mgr.: Patrick T. Gratner  
Tech Svces: Chris Norton  
Controller: Ken Thiele  
Products: audio, custom, microphone cable, snakes, multi-pair, multi-pin disconnect, panels, splitting, stageboxes, video

**PRO CO SOUND, INC.**

135 E. Kalamazoo Ave.  
Kalamazoo, MI 49007  
(616) 388-9675, 800-253-7360, FAX# 616-388-9681

Pres.: Charlie Wicks  
V.P. Comm. Div.: Jeff Garstick  
V.P. Pro. Div.: Jerry Smelker  
V.P. Operations: Tish Weber  
Chief Engineer: Scott Burnham

**Quabbin Wire & Cable Co., Inc.**

10 Maple St.  
Ware, MA 01082  
(413) 967-6281, 800-368-3311, FAX# 413-967-7564

Pres.: Paul D. Engel  
Executive V. P.: Deborah M. Engel  
Mgr. of Sales/Mkt'g: Thomas R. Russell

Nat'l Sales Mgr.: Marjorie R. Bacis  
Operations Mgr.: George W. Melnik  
Controller: Daniel G. Griswold  
Southern States Wire, Atlanta, GA, 404-455-4075  
McCoy Assoc., Inc., Richardson, TX, 214-864-1838

R.F.C. Sales, Brea, CA, 714-990-9695  
Rouzer Sales Co., Minneapolis, MN, 612-544-3145  
R.F. Mayo Associates, Denver, CO, 303-442-2155

**Rapco Cable & Lighting**

PO Box 50  
Route 1  
Jackson, MO 63755  
(314) 243-1433, 800-325-0266, FAX# 314-243-1384  
Pres.: R.T. Lorenz

V.P.: Phyllis Lorenz  
Sales Mgr.: James LaFerney  
Chief Engineer: Mike Torbet  
Plant Mgr.: John Walter

**Trompeter Electronics, Inc.**

PO Box 5069  
31186 La Baya Drive  
Westlake Village, CA 91359-5069  
(818) 707-2020, FAX# 818-706-1040  
Pres.: E. Trompeter  
General Mgr.: J.T. Roling  
Sales/Mkt'g Mgr.: Hap Gladish  
Adv./Mkt'g: G. Thalberg  
Currie, Peak & Frazier, Orlando, FL  
Knight Company, Los Angeles, CA  
L & M Associates, Elmwood Park, NJ  
Berndt Associates, Arlington Heights, IL  
Milestek, Argyle, TX  
Products: audio, data, instrument, panels, splitting, video,

**Whirlwind**

100 Boxart St.  
Rochester, NY 14612  
(716) 663-8820, 800-772-9997, FAX# 716-865-8930

Pres.: Michael Laiacona  
V.P./General Mgr.: Bonnie Gardner  
Sales Mgr.: Ray Bellizia  
Design Engineering: Carl Cornell  
Electrical Engineering: Jim Kelsey  
Products: audio, cable reels, custom, data, microphone cable, snakes, MIDI, multi-pair, multi-pin disconnect, panels, speaker, splitting, stageboxes, video

**Wilco Communications, Inc.**

PO Box 60579  
Sunnyvale, CA 90061  
(408) 746-3993  
Pres.: Charles Wirll

**Wireworks Corp.**

PO Box 3600  
380 Hillside Ave.  
Hillside, NJ 07205  
(201) 686-7400, 800-624-0061, FAX# 201-686-0483

Pres.: Gerald Krulewicz  
V. P.: Larry Williams  
Customer Svce Mgr.: Angela DiCicco  
Products: audio, custom, data, microphone cable, snakes, multi-pair, multi-pin disconnect, panels, splitting, stageboxes, video



# INDEX OF MANUFACTURERS' REPRESENTATIVES

## ALABAMA

Lee Assoc. Mid-South  
Huntsville, 205-533-5896  
REMC0  
Huntsville, 205-533-3763

## ARIZONA

Avwest, Inc.  
Fountain Hills, 617-545-0652  
Bidwell Sales Assoc. of AZ  
Mesa, 602-265-2029  
Greg Dzuby & Assoc.  
Peoria, 602-979-2358  
JR Morgan Agency, Inc.  
Phoenix, 602-268-3464  
Jeff Steen  
Phoenix, 602-431-1206  
Yocum Marketing, Inc.  
Mesa, 602-265-5056

## ARKANSAS

Skip Hill  
Lonoke, 501-843-7310

## CALIFORNIA

AMH Sales  
Palos Verdes Estates, 213-373-2034  
Advanced Communications Mkt'g  
Laguna Niguel, 714-582-5167  
Adventure Communications, Inc.  
San Diego, 619-753-4634  
Derek Allen Assoc.  
Toluca Lake, 818-840-8327  
Allwest Electronics  
Camaville, 805-388-1789  
Asoteric Mkt'g  
Pasadena, 714-964-4433  
Audio Services  
Los Angeles, 818-980-9891  
Audio/Video  
San Diego, 619-565-1101  
Tom Aye  
San Jose, 408-993-9428  
B and E Assoc.  
San Leandro, 415-351-1550  
Lyle Bailey  
Canoga Park, 818-704-5601  
Balzer-Wolf Assoc.  
Irvine, 714-261-6877  
Ray Baragary  
Lakewood, 213-633-5820  
Berman-Gravley Co.  
Costa Mesa, 714-549-2122  
Bidwell-Schwartz Associates, Inc.  
Gardena, 213-770-0300  
Don Bivens  
Lake Elsinore, 714-672-2168  
Blackhawk Marketing  
Pacific Palisades, 213-454-8196  
Neil Buckley  
San Jose, 408-978-5649  
Burden Assoc.  
Canoga Park, 818-340-4590  
Carlson & Assoc.  
Campbell, 408-370-1284  
Dan Castro  
Irvine, 714-261-6304  
Gabriella Chambers  
Westminster, 714-839-8835  
Coast Recording Equip.  
Hollywood, 213-482-6058  
Roy Colen Sales  
Mill Valley, 415-383-8700  
Bob Connelly  
Woodland Hills, 818-999-4854  
Design Factors  
LaHebra Heights, 213-697-7576  
Esco Systems  
Los Angeles, 818-242-8823  
Esoteric Mkt'g  
Pasadena, 714-964-4433  
Don Forth Assoc.  
West Covina, 818-919-2322

Don Forth Assoc.  
City of Industry, 818-333-8009  
Wayne Fuday  
Fairfax, 415-459-6880  
Funke & Assoc.  
Campbell, 408-866-0648  
Futura  
Lomita, 213-539-1710  
Future Sales  
Fairfax, 415-459-6880  
Steve Gleason  
Burbank, 818-848-7512  
Gravley & Assoc.  
Irvine, 714-852-9994  
HMC, Inc.  
Arcadia, 818-447-0958  
Ken Hyer  
Burbank, 818-841-8711  
Image Mkt'g  
Costa Mesa, 714-650-7718  
Innovative Sales and Marketing  
Irvine, 714-549-7770  
Innovative Sales and Mkt'g  
San Francisco, 415-952-0943  
Interconnect Sales Group  
Santa Clara, 408-980-1166  
Jacobson & Assoc.  
Newark, 415-791-2336  
E. B. King & Assoc.  
Saratoga, 408-867-2111  
Klaveness & Assoc.  
Fair Oaks, 916-966-1227  
Kristi LeBlanche  
Cardiss By the Sea, 619-463-2662  
Gary Kuntz  
Cupertino, 415-326-0280  
L. P. Marketing, Inc.  
Oakland, 415-532-5600  
Lakeside Assoc.  
Irvine, 714-730-1333  
LaVigne-Muliffe, Inc.  
Santa Fe Springs, 213-692-9074  
Lessing Assoc.  
Newhall, 805-254-0274  
Lessing & Assoc.  
Valencia, 805-295-0225  
Lichtenauer & Assoc.  
Antioch, 415-757-1200  
Rich Lomax  
N. Hollywood, 818-763-9587  
Loomis & Assoc. Inc.  
Alameda, 415-865-2200  
Dan Lopez  
213-327-0001  
Mark V  
Mountainview, 415-964-6275  
Marshank Sales Co.  
Culver City, 213-559-2591  
McKinley Sales  
San Diego, 619-271-7221  
Meyer & Ross  
Burlingame, 415-348-6800  
Moulthrop  
Pleasanton, 415-463-0450  
New West Agency  
San Diego, 619-299-3269  
New West Audio  
Burbank, 818-955-9706  
John Dehler  
Maraga, 415-283-5244  
Pacific Audio Group  
Torrance, 213-375-2611  
Pass Assoc.  
Sunnyvale, 408-735-9040  
Hank Plaisier  
El Toro, 714-837-2626  
Plus 4 Marketing  
Pleasant Hill, 415-937-0650  
Pro Tech Marketing  
Newport Beach, 714-650-5633  
Prorpeco  
Foster City, 415-570-5055  
Protech Marketing  
Newport Beach, 714-723-0498

R.F.C. Sales  
Brea, 714-990-9695  
Radon & Assoc.  
Sacramento, 916-923-2524  
Ruppert Sales & Eng.  
San Jose, 408-998-8717  
SLK Tech Rep  
San Francisco, 415-822-4884  
SLK/Tech Rep.  
Hayward, 415-785-4531  
Scott Sampson  
Encino, 818-996-5484  
Jerry Smith  
Los Angeles, 818-763-2349  
Summer Spector  
Laguna Hills, 714-768-8585  
Scott Sylvester  
San Diego, 619-267-4143  
T.C. Marketing  
Woodland Hills, 818-710-9580  
Tele-MIDI  
Pasadena, 800-888-MIDI  
Television Equipment Assoc.  
Los Angeles, 213-271-9570  
Teqni Rep Assoc.  
Sun Valley, 818-768-4223  
B. Trankle & Assoc.  
Belmont, 415-595-4004  
Vision Video  
Los Gatos, 408-356-1286  
Wagners S.P.D.  
Anaheim, 714-630-6671  
Warren Assoc.  
Santa Clara, 408-988-7762  
West Coast Mkt'g  
Anaheim, 714-998-4969  
Westech  
Fountain Valley, 714-962-2545  
Western Audio Sales  
Glendale, 818-248-3806  
WestTech Marketing  
Culver City, 213-870-9286

## COLORADO

AMH Sales  
Denver, 303-429-2203  
CB Electronics Mkt'g  
Arvada, 303-422-0561  
Rod Cur  
Denver, 303-322-3646  
R. F. Mayo Associates  
Denver, 303-442-2155  
Mountain Representatives  
Denver, 303-623-0972  
John Paonessa  
Denver, 303-986-3600  
Pearson & Pearson  
Denver, 303-722-6996  
Pro Sound & Light  
Lakewood, 303-986-5999  
Prof. Sound Products  
Lakewood, 303-986-5999  
Professional Sound & Lighting  
Lakewood, 303-986-5999  
Silver Peak Marketing Ltd.  
Wheat Ridge, 303-467-9042  
Stan Sliz Assoc.  
Broomfield, 800-525-2670  
Chuck Stieff & Assoc.  
Plattsville, 303-587-2500  
The TK Group  
Loveland, 801-298-8902  
Technical Products Corp.  
Denver, 303-333-1141  
Torbert & Assoc.  
Loveland, 303-532-3313  
Larry Wilson  
Englewood, 303-779-8686

## CONNECTICUT

Abbott Allison Company  
Branford, 203-481-0405  
John B. Anthony Co.  
Stamford, 203-322-9202  
Miller Assoc.  
Stamford, 203-869-7793

Miller Assoc., Ltd.  
Greenwich, 212-840-2866  
Chris Pelzar  
N. Canton, 203-693-1501  
The Smith Company  
Hartford, 203-523-0512  
Videoplay Industries  
Tolland, 203-872-9195

## WASHINGTON, DC

Forti Assoc., Inc.  
301-949-1706  
Al Gary  
202-479-2242

## DELAWARE

Joseph A. Ciotti  
Claymont, 302-798-6558  
Mike McMahon  
312-843-8800

## FLORIDA

American General Dist. Corp.  
Miami, 305-649-5408  
Bencsik Assoc.  
Ocala, 904-732-9775  
Brennan Assoc.  
Clearwater, 216-439-3265  
Cartwright & Bean, Inc.  
Orlando, 407-422-4531  
Cavendish & Winchester Inc.  
Hollywood, 305-927-3870  
Cell Communications  
Miami, 305-584-8331  
Michael Chafee Assoc.  
Sarasota, 813-921-4294  
Alvan C. Chaney & Assoc.  
Hialeah, 305-558-3933  
Coaxial Systems Assoc., Inc.  
Tequesta, 305-746-6626  
Col-Ins-Co.  
Orlando, 305-423-7615  
Hustling Enterprises  
Redington Beach, 813-393-8982  
Pete Kendall  
Jacksonville, 904-262-6025(#2306)  
Klump Sales  
Jacksonville, 904-287-5205  
Rob Lincoln  
Melbourne, 407-259-0991  
Miguel Lopez  
Hialeah, 305-822-6853  
Meyer Marketing  
Boca Raton, 305-481-9250  
Music Sales Unlimited  
Orlando, 305-898-6645  
Pro Sound Assoc.  
Jacksonville, 904-744-1170  
Row & Sons  
Fort Myers, 813-481-2949  
Lynn Sandefur  
Tampa, 813-391-1231  
Seacom Sales Co.  
Lauderdale Lakes, 305-486-0260  
Jerry Sehi  
Ft. Lauderdale, 305-525-0872  
Bob Seidman  
Ft. Lauderdale, 305-581-5666  
Ron Tunks Sales, Inc.  
Tamarac, 305-722-2803  
World Wide Electronics  
Miramar, 305-966-6622  
Worldwide Electronics  
Pembroke Pines, 305-584-7024  
William C. Zophy  
Ft. Myers, 813-433-4766

## GEORGIA

De Witt Austin Co.  
Alpharetta, 404-442-1326  
Cartwright & Bean  
Atlanta, 404-233-2939  
Cavendish & Winchester  
Atlanta, 404-449-5104

Creative Audio Marketing  
Marietta, 404-642-7827  
Jim Darrah  
Atlanta, 404-395-6611  
Dyna-Systems  
Atlanta, 404-429-1570  
Etrep  
Atlanta, 404-938-7108  
Raleigh C. Ferry & Assoc., Inc.  
Buford, 404-945-3142  
E. A. Garreau Assoc.  
Atlanta, 404-458-8030  
Hollingsworth & Still  
Norcross, 800-241-5712  
Frank Malloy  
404-394-8813  
Marketline  
Snellville, 404-972-9048  
Steve McGrew  
Kennesaw, 404-422-4608  
Millar Electronics  
Atlanta, 404-634-3350  
Murphy & Cota, Inc.  
Atlanta, 404-875-2525  
Henry Phillips  
Atlanta, 404-992-3070  
Bill Ray Assoc.  
Atlanta, 404-351-6367  
Bill Roberts  
Norcross, 404-263-9349  
Secom Systems  
Atlanta, 404-455-0672  
Jim Sims  
Cumming, 404-889-9300  
Southern States Wire  
Atlanta, 404-455-4075  
Technical Marketing  
Atlanta, 404-457-0988  
Ed Wolf  
Atlanta, 404-455-0672

## HAWAII

J. C. Electronics  
Honolulu, 808-943-8514  
Pacific West Marketing  
Honolulu, 808-261-7558  
Prorpe Hawaii  
Honolulu, 808-847-4038

## IOWA

Beams Company  
Des Moines, 515-255-1148

## ILLINOIS

Audio Resources  
Westmont, 312-655-1180  
Raymond Bailey  
Granville, 815-339-6789  
Bill Boone  
Libertyville, 312-816-1080  
Brainard-Wiwon Mkt'g  
Arlington Hts., 312-437-2700  
Bob Burns & Assoc.  
Park Ridge, 312-823-9360  
Cambridge Co.  
Niles, 312-647-8100  
Denning Electronics  
Hinsdale, 312-920-1488  
Gordy Duval  
Chicago, 312-774-5115  
Thom Fehrman  
Winslow, 815-367-3000  
Doug Fellabaum  
Sycamore, 800-445-0152(#2301)  
Gustafson System Sales  
Palatine, 312-358-2505  
Norm Hagemann  
Batavia, 312-584-2300  
F.F.Hill-Gray, Inc.  
Elmhurst, 312-832-4101  
JAMM Dist.  
Flossmoor, 312-799-0550  
Jamm Distributing  
Matteson, 312-747-6363  
Dick Kemar  
McHenry, 312-699-8656

Kevin Koehler  
Batvia, 312-879-6671  
Monte Lamb  
Hinsdale, 312-323-0530  
Frank Lintern Assoc.  
Naperville, 312-983-0935  
William M. Linz Assoc.  
Deerfield, 312-945-9600  
Sam Lynn  
Chicago, 312-657-7787  
G. MCL Cole Co.  
Parkridge, 312-692-6040  
Majestic Sales  
Chicago, 312-582-4300  
Joseph McCaffrey  
312-790-2898  
Don Mouritzen  
Beecher, 800-445-0152(2303#)  
Garreth Nelson  
Chicago, 312-773-6001  
New Horizons Electronics  
Bannockburn, 312-234-5911  
Parcom  
Elk Grove, 312-228-6360  
Keith Parker & Assoc.  
Northbrook, 312-498-0353  
Vern Pearson  
800-255-2255 ext 8874  
George Pettit Co.  
Berkeley, 312-261-0342  
Powerlines Mkt'g  
Evanston, 312-864-1147  
Pro Audio LTD  
Chicago, 312-526-1660  
Pyramid Audio  
South Holland, 312-339-8014  
Raines & Assoc.  
Northbrook, 312-498-0890  
Doug Randle  
Carpentersville, 800-445-0152(2301#)  
Sound Marketing  
Palos Heights, 312-448-6715  
Steffey Marketing  
Northbrook, 312-480-3575  
Stiffler Marketing  
Chicago, 312-480-3575  
Sunrise Sales Company  
Romeoville, 815-886-6034  
Ward Marketing  
Chicago, 312-409-3635  
William Warnock  
Barrington, 312-382-4550  
David Zaabel  
Schaumburg, 312-980-8805  
Ziskind & Assoc.  
Rolling Meadow, 312-577-1624

## INDIANA

AV Marketing  
Carmel, 317-846-1034  
Aim Marketing Group  
Mishawaka, 219-256-2025  
Jim Church Marketing  
Bloomington, 812-334-0383  
Electronic Representatives  
Indianapolis, 317-894-1414  
Elmarcon, Inc.  
Indianapolis, 317-846-0221  
Kingston Sales Corp.  
Indianapolis, 317-876-2545  
Maish Sales  
Mulberry, 317-296-2322  
Bill McDaniel  
Indianapolis, 317-823-4206  
Robert Miisk Co.  
Indianapolis, 317-842-3400  
Monfort Electronics  
Indianapolis, 317-872-8877  
Pat Norman Sales  
Indianapolis, 317-842-5811  
Pro-Marketing Systems  
Indianapolis, 317-846-9591  
R.C.S., LTD.  
Zionsville, 317-873-4740  
Dennis Ramer  
Walton, 219-626-3115  
SEA, Inc.  
Carmel, 317-846-2591  
Kevin Talmant Assoc.  
Madison, 812-866-5533

## KANSAS

B.C. Electronic Sales, Inc.  
Mission, 913-262-1720

Thomas L. Dowell & Assoc.  
Overland Park, 913-648-7373  
Harry B. Hahn  
Olathe, 913-829-9427  
R.W. Kunz & Assoc.  
Prairie Village, 913-648-8427  
Midtec Assoc.  
Lenexa, 913-541-0505  
Nead & Assoc.  
Shawnee Mission, 913-268-8763  
Cliff Uttley  
Lenexa, 913-888-7940

## KENTUCKY

William Lewis  
Louisville, 502-491-4273  
G. Thelen & Assoc.  
Ft. Mitchell, 606-341-8181

## LOUISIANA

Wm. B. Allen Supply Co.  
New Orleans, 504-525-8222  
Corrigan Agency  
Covington, 504-893-7455  
Tim Lawson  
Baton Rouge, 504-291-0371  
Metro Joe's Marketing  
Metairie, 504-887-1885

## MASSACHUSETTS

Dana Aherm  
Quincy, 617-770-9914  
Anderson Sales  
Braintree, 617-648-9194  
Gary Angell  
Wellesley, 617-235-1110  
Crawford Assoc.  
Andover, 617-470-2122  
Double Edge Audio  
Haverhill, 617-372-5526  
Frank Assoc.  
Sudbury, 617-443-5131  
GMI/New England  
Avon, 617-588-8043  
Givan Associates  
West Boylston, 617-835-3161  
Hanoud & Assoc.  
Rehobath, 617-252-3735  
Arnold Harris  
Clinton, 617-365-6364  
W.A. Hendricks Co.  
N. Scituate, 617-545-0652  
Gerald Horne Assoc.  
Stow, 617-897-1741  
Instrument Dynamics  
Boston, 617-245-5100  
Intersell  
Burlington, 617-273-3844  
Ken Lind  
Wellesley Hills, 617-235-6817  
MBK  
Boston, 617-269-0629  
Tom Maguire & Assoc.  
Norwood, 617-551-0500  
George Markunas Industries  
Avon, 617-588-8043  
William F. McFadden  
Danvers, 617-777-7228  
New Resource  
Norwell, 617-659-1463  
Piper Assoc.  
Needham, 617-449-1144  
W.B. Pray Sales, Inc.  
Northboro, 617-393-3434  
Pro Audio Associates  
Burlington, 617-229-6050  
Professional Audio Assoc.  
Burlington, 617-229-6050  
R.G. Associates  
Stow, 617-897-7146  
Repworks  
Chicopee, 413-533-0845  
Dave Whelan  
W. Springfield, 413-731-9552  
Zieco, Inc.  
Boston, 617-861-8300

## MARYLAND

ASR Enterprises, LTD.  
Fallston, 301-893-0001  
Audio Assoc.  
Baltimore, 301-854-6122  
Boggs & Assoc.  
Ft. Washington, 301-292-2047

David H. Brothers  
Baltimore, 301-764-7189  
David L. Brothers  
Finksburg, 301-833-0920  
Craig Davidson  
Gaithersburg, 301-670-0022  
EIL Instruments  
Sparks, 301-771-4800  
Gary Foster  
Columbia, 314-442-2288  
Imagitron Sales  
Upperco, 301-374-5600  
Judkins, Assoc.  
Baltimore, 301-234-0010  
Lienau Assoc.  
Columbia, 301-621-4113  
S.K. Macdonald  
Lisbon, 301-982-1088  
Marketline Ltd.  
Baltimore, 301-944-2111  
Mechtronics Sales, Inc.  
Rockville, 301-340-2130  
Music America  
Columbia, 301-995-1578  
R.J. Marketing Ltd.  
Rockville, 301-251-0330  
Mike Schneider  
Baltimore, 301-563-5390  
Frank Smith  
Huntingtown, 301-855-1258  
Sound Sales  
Lanham, 301-731-6355  
Sturgill Assoc.  
Columbia, 301-995-1578  
Taub Sales  
Silver Springs, 301-622-9100  
Tom Villano  
Gaithersburg, 301-948-7151  
WD Marketing  
Silver Spring, 301-585-5311  
Frank White  
Severna Park, 301-647-0995

## MAINE

Harry Starbird  
Portland, 207-774-8448

## MICHIGAN

ASI Assoc.  
Ann Arbor, 313-663-3733  
Burcaw Company & Assoc.  
Warren, 313-573-4605  
C.M. Sales  
Farmington Hills, 313-553-8070  
CRM  
Sterling Heights, 313-826-8980  
Andy Combs  
Pontiac, 313-673-2280  
Ted Firaneck Sales  
Pontiac, 313-373-9595  
Innovative Audio Sales  
Pontiac, 313-673-2280  
H. Y. James  
Farmington Hills, 313-471-0027  
Key Mkt'g  
Plymouth, 313-459-6040  
Chuck Mick  
Southfield, 313-354-3310  
Robert Miisk Co., Inc.  
Southfield, 313-354-3310  
Riley & Petchell Sales, Inc.  
Detroit, 313-937-3000  
Rittner Products  
Rochester, 313-651-1333  
Jack M. Thorpe  
East Detroit, 313-779-6363

## MINNESOTA

Alarmtronics  
Burnsville, 612-890-0309  
John E. M. Anderson  
Minneapolis, 612-823-6459  
Cinequipt  
St. Paul, 612-646-1780  
Mel Foster Tech. Sales  
Edina, 612-941-9800  
Gustafson Sales  
Red Wing, 612-388-4277  
Hanna-Lind  
Edina, 612-925-5700  
Kodo Associates, Inc.  
Minneapolis, 612-881-1255  
McManus Music Sales  
612-432-5321  
Northland Assoc.  
Moorhead, 218-233-4616

Presentation Sales  
Minneapolis, 612-925-2691  
R.W. Sales, Inc.  
St. Paul, 612-646-2710  
Rouzer Sales Co.  
Minneapolis, 612-544-3145  
Universal Agents & Assoc.  
Bloomington, 612-894-3660  
Yore Company  
White Bear Lake, 612-770-9760

## MISSOURI

Broadway  
Kansas City, 816-474-1771  
Cadon Technical Sales  
St. Louis, 314-645-8670  
Central Mkt'g Group  
Kansas City, 816-741-7460  
Centurian Marketing  
Ballwin, 314-227-7229  
Dowell Assoc.  
St. Louis, 314-849-4234  
ESC  
St. Louis, 314-725-0933  
KKB Assoc.  
St. Louis, 314-647-2400  
Pete Kallaos  
Creve Coeur, 314-878-3365  
Lowall-Kangas  
St. Louis, 314-821-4050  
MJA, Inc.  
St. Charles, 314-723-0400  
Music Interventions & Assoc.  
Kansas City, 816-453-4448  
Nevco, Inc.  
Kansas City, 816-421-1751  
Chuck Rancilio Assoc., Inc.  
St. Louis, 314-631-3326  
R.J. Throckmorton Sales  
Ballwin, 314-227-7222  
RJ Throckmorton  
Glencoe, 314-227-7222

## N. CAROLINA

Adams & Assoc.  
Greensboro, 919-272-6838  
Applied Audio Marketing  
Asheville, 704-252-9313  
Atlantic Marketing Services  
Matthews, 704-542-3380  
Crest Electronics, Inc.  
Greensboro, 919-288-2787  
Bob Edsall  
Asheville, 704-252-9313  
Pace Sales  
Charlotte, 704-365-3216

## NEW HAMPSHIRE

Associated Systems  
Manchester, 603-473-2297  
Bell Controls, Inc.  
Nashua, 603-882-6984  
CompRep Systems  
Nashua, 603-883-1212  
Pro Musica Sales  
Keene, 603-352-4831

## NEW JERSEY

Dan Antonellis  
Metuchen, 201-494-1019  
Audio Assoc. Corp.  
Verona, 201-239-3727  
Austin Assoc.  
Willingboro, 609-871-9290  
Bob Bernstein  
201-882-8010  
Bi-State Marketers  
Ridgefield, 201-943-5888  
Gary Castelluccio & Assoc.  
Clifton, 201-772-3333  
John Chez  
Ringos, 201-788-5151  
Component Marketers  
Leonia, 201-947-9300  
Dolan Assoc.  
Watchung, 201-753-2671  
East Coast Lighting & Sound  
Wyckoff, 201-652-7641  
Freedman & Assoc.  
Cherry Hill, 609-751-0157  
Harold Gray Assoc.  
Englewood, 201-894-0894  
Dennis C. Hansen  
Piscataway, 201-463-3827  
Hartmann Assoc.  
Union, 201-850-3750

John Hoover  
Cherry Hill, 609-667-1297  
Metropolis Marketing  
Edison, 201-225-0085  
On the Road Mkt.  
Upper Montclair, 201-746-0501  
Pusecker Sales  
Upper Montclair, 201-744-1834  
Quality Video Supply  
Hackensack, 201-488-8336  
Gary Rosen  
Paramus, 201-368-5185  
Art Sbrilli  
Edison, 800-445-0152(#2302)  
M. Schlarman  
Wanaque, 201-839-2243  
Jim Schlott  
Ramsey, 201-934-7574  
Peter E. Schmitt, Co.  
Leonia, 201-944-2806  
Sesco-Mid Atlantic  
Toms River, 201-929-1705  
Sigmet Corp.  
Freehold, 201-462-1221  
Mark Skilowitz  
Newfield, 609-697-4580  
Walt Spencer  
Ramsey, 201-934-8500  
Sprung-Nussbaum  
Englewood, 201-569-5666  
TMC Sales  
Ft. Lee, 201-944-8340  
Triad Marketing  
Wayne, 201-696-8625

## NEW MEXICO

Trembly Assoc.  
Albuquerque, 505-266-8616

## NEW YORK

ABS Technologies  
Islip, 516-277-7101  
ALI  
NYC, 212-620-3086  
Audio Services  
New York, 212-977-5150  
Auteri Assoc., Inc.  
Miller Place, 516-331-5022  
Ray Benck  
Binghamton, 607-775-4437  
Bob Brennan  
Hempstead, 516-565-2323  
Irv Brown Company  
Brooklyn, 718-493-1379  
Jack Brown Electronics  
Whitestone, 718-767-1977  
Canavan-Scanlon Assoc.  
Syracuse, 315-437-1271  
Jody Carver  
Somers, 914-248-5806  
Cascade Control  
Oyster Bay, 516-922-0071  
Clearview Marketing  
Forest Hills, 718-592-0710  
Alby Currant Sales  
Pittsford, 716-586-1100  
DB Marketing  
East Rockway, 516-596-1244  
Darmsedtler Assoc.  
Baldwinsville, 315-638-1261  
Sheldon A. Goodman Assoc.  
Oswego, 315-343-5739  
Hot House Productions  
Highland, 914-691-6077  
Hudson Marketing  
Bayside, 718-352-7365  
Jayso Elect. Corp.  
Bronx, 212-798-1050  
L.C.A. Sales  
Tuckahoe, 212-402-6600  
L.S.M.  
Phelps, 315-548-4891  
Lewis & Dunning  
Syracuse, 315-446-5522  
Liebel & Merle Sales  
Rochester, 716-385-3961  
Light America  
New York, 212-260-7860  
Robert McAll  
516-966-8000  
Jack Mesnick Sales  
Liverpool, 315-622-3211  
Ozunoff and Assoc.  
Yorktown Heights, 914-245-8452



Paston-Hunter  
Syracuse, 315-437-2992  
Pinz Sales Corp.  
Rockville Centre, 516-678-6887  
David Prinzi  
Webster, 716-671-9266  
ProAudio Marketing  
Melville, 516-367-8620  
Professional Audio Mkt'g  
New York, 516-367-8620  
Professional Electric  
Yonkers, 914-779-6118  
R.C.S., LTD.  
Yorhtown Heights, 914-245-2866  
Roburn Agencies, Inc.  
Yonkers, 914-968-1016

SAGA  
Oswego, 315-343-5739  
Alan Sarfata & Assoc.  
Great Neck, 516-466-6770  
Schmitt Industrial Mkt'g  
W. Hempstead, 516-486-3510  
Schmitt Mkt'g  
Islandia, 516-582-5888  
Sherwood Assoc.  
Endicott, 607-785-1590  
James F. Somers  
Geneva, 315-789-7938  
William Stern  
Mt. Vernon, 914-664-7300  
Upstate Marketing  
Burnt Hills, 518-399-6311  
William Watkins  
Merrick, 516-546-5374  
Wood & Co.  
Buffalo, 716-886-0019

## OHIO

A M A  
Brecksville, 216-526-2426  
Audio Mkt'g Assoc.  
Brecksville, 216-526-2426  
Awcom, Inc.  
N. Olmsted, 216-777-2060  
Cambridge Marketing  
S. Euclid, 614-890-7788  
Cambridge Pro Sales  
Westerville, 614-890-8144  
Components Specialty Co.  
Cleveland, 216-734-0655  
Dardon & Assoc.  
Olmsted, 216-234-4555  
Tom Harmon  
N. Royalton, 216-237-9642  
K/T Depco  
Cleveland, 216-442-6200  
J.W. Lehner Co.  
Stow, 216-686-1965  
Tim McDonnell  
Willoughby Hills, 216-942-2429  
McFadden Sales & Marketing  
Columbus, 614-761-3177  
J.B. Parent Co.  
Dublin, 614-764-0064

C.L. Pugh & Assoc., Inc.  
Columbus, 614-486-9678  
Walter D. Radner  
Westfield Center, 216-887-5646  
Shamrock Sales  
Dayton, 513-258-1227  
Teplitz Assoc.  
Cleveland, 216-439-3265  
Weller Electronic Sales  
Worthington, 614-885-7819  
Bob White & Assoc.  
Solon, 216-248-1317  
John S. Wilkin & Assoc.  
Hillboro, 513-393-1137  
Charlie Winkler & Assoc.  
Uniontown, 216-699-9511

## OREGON

Jack Charles  
Portland, 503-284-0216  
Earl & Brown Co.  
Portland, 503-245-2283  
Ed Nuhring  
Portland, 800-445-0152(#2307)

## PENNSYLVANIA

George M. Conneen Co., Inc.  
Springfield, 215-544-5884  
FMA Assoc.  
K. of Prussia, 215-337-9211  
Franklin Communications  
N. Whales, 215-643-3031  
GMC  
Springfield, 215-544-5884  
Jacobson Assoc.  
Horsham, 215-674-2937  
KBZ Communications  
Furlong, 215-348-9481  
Richard Lewis Sales  
Glenside, 215-886-1555  
Lienau Assoc., Inc.  
New Town, 215-860-2100  
Lowery Assoc.  
Broomall, 215-356-5300  
MBT  
Pittsburgh, 412-344-1360  
Milanese Assoc.  
Phila., 215-763-2138  
C. H. Newton & Assoc.  
Fourtown, 215-233-0333  
North Coast Mkt'g  
Erie, 814-456-6435  
PMC Packaging Co.  
Warrington, 215-628-0560  
Richard S. Pass Assoc., Inc.  
Langhorne, 215-757-6100  
Sigmet Corporation  
Valley Forge, 215-783-6666  
Susan Stamm  
Pittsburg, 412-344-1360  
Stinson Assoc.  
Havertown, 215-446-8585  
Arthur E. Tilley, Jr.  
Fayetteville, 717-352-8432  
Martin Weinberg  
Glenside, 215-885-4244

## S. CAROLINA

Rohr Wanger & Roberts  
Rock Hill, 803-324-5111

## TENNESSEE

Evans Sales & Mkt'g  
Nashville, 615-297-7997  
Exec. Sec. Inc.  
Nashville, 615-331-6700  
Graeme Goodall  
Nashville, 615-883-8140  
Glen Hadley  
Germantown, 901-757-2524  
James McFarren  
Nashville, 615-227-5027  
Rob Payne  
Knoxville, 615-966-3786  
Wilson Audio Sales  
Nashville, 615-646-4477

## TEXAS

A/V Mkt'g  
Ft. Worth, 817-246-7166  
Admiral Sales Co.  
Richardson, 214-357-9212  
Audio Visual Marketing  
Ft. Worth, 817-246-7166  
Bruce Barrett  
Garland, 214-530-0467  
Dick Bellew Sales, Inc.  
Dallas, 214-644-7881  
Jack Brown  
Dallas, 214-943-7528(#2305)  
Bob Bryan & Assoc.  
Ft. Worth, 817-237-5603  
Crockett/Petty  
Dallas, 214-350-3377  
Designed Performance  
Dallas, 214-458-1655  
Harold De Vaney  
Dickinson, 713-337-1040  
Dimension IX Marketing  
Dallas, 214-348-9657  
Dobbs-Stanford Corp.  
Dallas, 214-358-0800  
Graham/Davis, Inc.  
Dallas, 214-231-3034  
Hite Electronics  
Mansfield, 817-483-7077  
Jim Hughes Co.  
Dallas, 214-221-1536  
J.M.S. Marketing  
Austin, 512-266-1443  
J.Y.S. Comm. Co.  
Dallas, 214-349-1650  
Jones Audio Sales  
Piano, 214-867-0202  
Peter Koehler  
214-350-1232  
Lex Lawson & Assoc.  
Garland, 214-272-8482

Charles Lucas Sales Company  
Dallas, 214-330-8181  
Marketing Concepts  
Irving, 214-869-0669  
McCoy Assoc., Inc.  
Richardson, 214-864-1838  
Glenn McDaniel  
Dallas, 214-385-3322  
Duke McLane  
Dallas, 214-247-5999  
Miller & Associates  
Richardson, 214-437-5733  
P.A.S.  
Ft. Worth, 817-483-7474  
Peregrine Southwest  
Houston, 713-589-8481  
Jerry Petty  
Dallas, 214-386-3809  
Ed Proctor  
Ft. Worth, 817-535-2771  
RPM Sales  
Carrollton, 214-446-3010  
Raymar Associates  
Duncanville, 214-296-9833  
Reproca  
Dallas, 214-363-0977  
Rep Tech  
Terrell, 214-222-2131  
Sandra Sheppard  
Carrollton, 214-394-8472  
Spectra Sales Corp.  
Richardson, 214-234-3600  
Spivey-Leboeuf Assoc.  
Richardson, 214-231-3190  
Summit Sales  
Houston, 713-890-5333  
Summit Sales  
Wylie, 214-442-6052  
Tenick & Assoc.  
Houston, 713-528-2005  
Texas Pro Reps  
Ft. Worth, 817-847-0625  
Zonk & Assoc.  
Richardson, 214-238-7651

## UTAH

General Communications, Inc.  
Murray, 801-266-5731  
Keiser & Assoc.  
Bountiful, 801-298-8902  
Pro Tech Marketing  
Salt Lake City, 801-943-8331  
Jay Sample  
Sandy, 801-942-1059

## VIRGINIA

Bill H. Bailey  
Hopewell, 804-748-4149  
Eric S. King  
Lynchburg, 804-384-7001  
Pantech, Inc.  
Springfield, 703-451-5700  
SAC Communications  
Vienna, 703-281-2558  
Richard Smith  
Herndon, 703-834-3600

## WASHINGTON

Carlidan Alarm & Comm.  
S. Federal, 206-839-8433  
Jim Fetterer  
Seattle, 206-243-7762  
Future Sales  
Redmond, 206-866-5577  
Gemini Electronic Mkt'g  
Edmonds, 206-776-3121  
Loppnow & Assoc.  
Redmond, 206-883-3205  
Northmar  
Seattle, 206-524-5170  
Northshore Marketing  
Seattle, 206-284-9699  
Northwest Sales Firm  
Tacoma, 206-759-9995  
Chuck Olson Assoc.  
Renton, 206-226-2112  
Pancor Marketing  
Lynnwood, 206-771-6010  
Roger Ponto Assoc.  
Kirkland, 206-821-2996  
RIK Assoc., Inc.  
Tacoma, 206-759-0833  
S & F Northwest Inc.  
Seattle, 206-525-5203  
Terminal Sales  
Seattle, 206-441-9610  
Vector Corp.  
Seattle, 206-322-4343  
Vince Ward  
Redmond, 206-643-1074  
Vince Ward  
Vashon Island, 206-463-5582

## WISCONSIN

Ludwig Marketing  
Kenosha, 414-697-9355  
Mid America  
Milwaukee, 414-742-2211

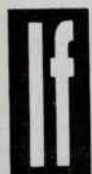

**you need to find out who makes paging systems, or who is the one person at an intercom company you really need to talk to. . .you'll find all the answers in the 1988/1989 Sound & Communications Blue Book.**



# INDEX OF MANUFACTURERS

A-1 Business Supplies, Inc.	24	Alpha Wire	245	Audiocom, Inc.	210
AB International Electronics, Inc.	53	Alphametrix Controls Corp.	33	Audio Design Associates	53
ACO Pacific, Inc.	156	Altair Electronics, Inc.	235	Audiolab Electronics, Inc.	213
ACS Communications	26	Altec Lansing Corp.	53, 112, 183	Audio Logic	174, 184
A&D Engineering, Inc.	235	Alternative Telecommunications Corp.	87	Audio Precision, Inc.	235
ADA Signal Processors, Inc.	53, 183, 201	Altronic Co., Ltd.	81	Audio Quest, Inc.	245
ADC Telecommunications	203	Amber Electro Design, Inc.	235	Audiosears Corp.	26
ADM Technology, Inc.	174	Ambeti Corp.	33	Audio Systems Company	50, 53, 71, 174 184, 203, 220, 228
AEI Music Network, Inc.	75	Amco Engineering Co.	17	Audiotech	126
AES Corp.	33	Amek/TAC US Operations	174	Audio-Technica U.S., Inc.	26, 126, 156, 174
AGFA-Gevaert, Inc., Magnetic Tape Div.	212	American Acoustic Products	15	Audio Video Supply, Inc.	42
AKG Acoustics, Inc.	26, 156, 168, 183, 201	American Acoustics, The Mitek Group	112	Audio Visual Systems	203
AMP Netcon	244	American Fibertek, Inc.	42	Audisar	11, 42, 67, 108, 126
AMS/Calrec (AMS Industries, Inc.)	156, 174, 183	American Laser Systems, Inc.	42	Auditel Systems, Ltd.	26, 67, 71, 73, 156 174, 203, 220, 228, 233
AMSECO	33	American Recorder Technologies, Inc.	212	Audix	156
AMX	71	American Reliance, Inc.	235	Audra International	126
API Audio Products, Inc.	174	Ampex Corp., MTD	212	Auernheimer Labs and Co.	126
ART—Applied Research and Technology, Inc.	183	Amphenol Products	245	Auratone Corp.	126
A & S Case Company	17	Amplified Music Products Corp.	53	Auth Company	33
ASC Acoustic Sciences Corp.	15	Amplivox Communication Products/ Security Intercom, Inc.	75, 218	Autogram Corp.	174
ATC Supply Corp.	87	AmPro Corporation	42	Automation Devices, Inc.	210
ATI - Audio Technologies, Inc.	53	Amtel Security Systems, Inc.	33	Autopatch A/V Systems	203
AVA Electronics Corp.	24	Anatrol Corp.	235	Avtec Industries, Inc.	73
AVL Systems, Inc.	15	Anchor Audio, Inc.	224	Azden Corporation	184
AVNC/Instrument Division	235	Anixter Brothers, Inc.	26	BAL Corporation	17
AVSC	212	R.B. Annis Co., Inc.	212	BASF Corporation, Information Systems	213
Aarmor Case Co.	17	Ansett Technologies, Inc.	73	B & B Systems, Inc.	252
Accurate Sound Corp.	212	Antennacraft	42	BBC-Metrawatt/Goerz	235
Accusonics Systems Corp.	26, 112, 156	Antenna Specialist Co.	42	BBE Sound, Inc.	11, 99, 184, 207, 220 225, 228
Acoustiflex Corp.	15	Anvil Cases, Inc.	17	BCE/Edcom, Division of CCS, Inc.	33, 52 53, 81, 97, 100, 103, 106, 220
Acoustilog	235	Apex Machine Co.	212	B.E.S.T. Int'l Corp.	126
Acoustone Grille Cloth	15, 108	Aphex Systems Ltd.	183	BGM International	75
Adams-Smith	42	Apogee Electronics Corp.	183, 235	BGW Systems, Inc.	53
Adaptive Micro Systems, Inc.	90, 106, 210	Apogee Sound, Inc.	112	BLI Corp.	15
Adpro Pty. Ltd.	33	Apple Computer, Inc.	201	BSM Systems, Inc.	203
Advanced Music Systems	183	Argos Products Co.	67, 112, 224	B.S.S. Audio	184
Aegis	235	Ariel Corp.	235	Bacchus Software Systems	201
Aerocooustic Corp.	15	Aris/Eta	11, 17, 31, 207	Banner	235
Aiphone Intercom Systems	33, 42, 53, 67 81, 87, 90, 95, 97, 102, 108, 112, 218, 232	Armstrong Cork Co.	15	Barcus-Berry, Inc.	156, 235
Akai Professional-IMC	174, 183, 203, 212	Asaca/Shibasokui	235	Beckman Ind., Instrumentation Div.	235
Alarm Accessory Ltd.	24, 33, 244	Ashly Audio, Inc.	53, 183, 206, 218, 225	Belden Wire & Cable	245
Alarm Controls Corp.	33	Astatic/CTI	156	Floyd Bell, Inc.	33
Alarmco	33	Atis, Ltd.	51, 210, 213	Benchmark Media Systems, Inc.	203
Alesis Corporation	53, 183, 201	Atlas/Soundolier	11, 17, 24, 33, 42, 50 51, 67, 91, 95, 102, 106, 108, 112, 206	Benjamin International, Inc.	213
Alexander Publishing	201	Atlas Wire & Cable Corp.	245	Berk-Tek, Inc.	245
All Electronics Corp.	24, 33, 235, 244, 252	Audico, Inc.	213	Beyer Dynamic, Inc.	26, 156
Allen and Heath	174, 201, 218, 224	Audi-Cord Corp.	210	Biamp Systems	174
Allsafe Co.	33	Audio Accessories, Inc.	203	Doug Biron Assoc., Inc.	15
Alpha Audio	15	Audio Control Industrial	235	Bi-Tronics, Inc.	11, 24, 245, 252
Alpha Communications	81, 87, 91 97, 99, 106	Audio Digital, Inc.	183	Blonder-Tongue Laboratories, Inc.	42
Alpha Omega Case Company	17	Audio Engineering Associates	156	Bobadilla Cases, Inc.	17
		Audio Access	71, 232		
		Audioarts Engineering	174		

## 258 INDEX OF MANUFACTURERS

- Bogen Communications, Inc. . . . 33, 54, 95  
 97, 103, 108, 126, 156, 175, 220, 232
- Bonneville Media Communications . . . 213
- Boonton Electronics Corp. . . . 235
- Bose Corporation-Professional  
 Products . . . . . 126
- Bostick . . . . . 15
- Boston Acoustics . . . . . 126
- Boulder Amplifiers . . . . . 54
- Bourns, Inc./Trimpot Div. . . . . 11
- Bozak, Inc. . . . . 73, 126, 175, 207
- Bretford Mfg. Co., Inc. . . . . 67
- Brim Electronics, Inc. . . . . 24, 246, 252
- Broadcast Audio Corp . . . . . 175
- Broadcast Electronics, Inc. . . . . 175
- Broadcast Tech. of Colorado . . . . . 44
- Brooks Electronic System Technology . . . 184
- Bruel & Kjaer Instruments, Inc. . . . 158, 235
- BrystonVermont Ltd. . . . . 54
- Bud Industries, Inc. . . . . 17
- Burle Industries, Inc. . . . . 44
- Burlington Audio/Video Tapes, Inc. . . . 213
- C-Audio . . . . . 54
- C&K Systems, Inc. . . . . 34
- CADD Creative Audio Design  
 & Development, Inc. . . . . 184
- CCTV Corporation . . . . . 44
- CMX Communications . . . . . 73
- C-T Audio Marketing, Inc. . . . . 158
- CZ Labs, Inc. . . . . 246
- Cabletronix . . . . . 24, 31, 236, 246, 252
- Cabtron Systems, Inc. . . . . 17
- Calibration Standard Instruments . . . . 126
- Califone International, Inc. . . . . 67
- Calrad Engineered Electronic Products . . 246
- Cal Switch . . . . . 203, 246
- Calzone Case Company . . . . . 17
- Cambridge Electronics Laboratories . . . 34, 81
- Canare Cable, Inc. . . . . 246
- Capaul Corp. . . . . 15
- Capitol Lighting Products . . . . . 11
- Capitol Magnetic Products . . . . . 213
- Carver Corp. . . . . 54
- Carvin Corp. . . . . 54, 126, 175, 186
- Casco/MTN Sound . . . . . 75
- Case Component Network . . . . . 17
- Cases, Inc. . . . . 17
- Catel Telecommunications, Inc. . . . . 44
- Celestial Software, Inc. . . . . 236
- Celestion Industries, Inc. . . . 128, 225, 228
- Celotex Corp. . . . . 15
- Centro Corp. . . . . 44
- Cepco . . . . . 34
- Cerwin-Vega . . . . . 128
- Cetec Gauss . . . . . 128, 213
- Cetec Ivie . . . . . 54, 175, 186, 236
- Cetec Raymer . . . . . 54, 221, 232
- Cetec Vega . . . . . 169
- Chadwick Helmuth . . . . . 236
- Champlain Cable Corp. . . . . 246
- Chandler Industries, Inc. . . . . 186
- Channel Master, Div. of Avnet, Inc. . . . . 44
- Channelmatic, Inc. . . . . 44
- Chemtronics, Inc. . . . . 213
- Chester Cable/Division of Alcatel, NA . . 252
- Chips with Lips . . . . . 211
- Circuit Research Labs, Inc. . . . . 186
- Clarity . . . . . 186, 202
- Clarity, A Division of Valcom, Inc. . . . 54, 128  
 158, 186, 232
- David Clark Co., Inc. . . . . 26, 81, 87, 95, 100
- Clarostat Mfg. Co., Inc. . . . . 11
- Clear-Com Intercom Systems . . . . 26, 87, 95  
 97, 100, 103
- Clever Devices Ltd. . . . . 211
- Clifford of Vermont, Inc. . . . . 252
- Closed Circuit Systems . . . . . 44
- Coherent Communications, Inc. . . . 34, 158  
 169, 233
- Cohu, Inc., Electronics Div. . . . . 34, 44
- Colorado Video . . . . . 73
- Columbia Scientific, Inc. . . . . 87
- Communication Equipment Brokers, Inc. . 243
- Communications Co., Inc. . . . . 11, 95, 236
- Communications Equipment Co., Inc. . . 91  
 97, 103
- Communications Products, Inc. . . . . 34
- Community Light & Sound, Inc. . . . . 128
- Compact Monitor Systems Corp. . . . . 130
- Compression Labs, Inc. . . . . 44, 73
- CompuSonics Video . . . . . 211
- Computational Systems, Inc. . . . . 236
- Computer Application Systems, Inc. . . . 34
- Com-Tec, Inc. . . . . 34, 91, 97
- Comtek, Inc. . . . . 87, 100, 169, 225, 233
- Comutronic . . . . . 52, 54
- Conex Electro-Systems, Inc. . . . . 203
- Connectronics Corporation . . . . . 246
- Conquest Electronic Wire & Cable . . . 203, 247
- Conquest Sound, Inc. . . . . 11, 204, 229  
 247, 252
- Consolidated Electronic  
 Wire & Cable Corp. . . . . 247, 252
- Contact East, Inc. . . . . 17, 24, 31, 236
- Controlled Acoustics Corp. . . . . 15
- JL Cooper Electronics . . . . . 54
- Cornell Electronics Products, Inc. . . . 34, 50  
 91, 97, 106
- Countryman Associates, Inc. . . . . 158
- Creative Audio Design  
 & Development . . . . . 175, 186
- Crest Audio . . . . . 54
- Crest Electronics, Inc. . . . . 44, 91
- Crestron Electronics, Inc. . . . . 68, 71
- Crown International, Inc. . . . . 54, 158
- Current Cable Co., Inc. . . . . 247
- Cyborg Corp. . . . . 237
- DAX Audio Group, Inc. . . . . 55, 175, 186
- dbx, Div. of BSR North America, Ltd. . . 186
- DCL Company . . . . . 130
- DCS Audio Products, Inc. . . . . 55
- DDA-Division of Klark Teknik . . . . . 175
- DIA General, Inc. . . . . 34
- DIS-USA . . . . . 73
- D. J. Associates, Inc. . . . . 24
- D.O. Industries . . . . . 68
- DOD Electronics Corp. . . . . 11, 175, 187
- D & R, USA . . . . . 175
- DSP Development Corp. . . . . 237
- Daburn Electronics and Cable Corp. . . . 247
- Da-Lite Screen Co., Inc. . . . . 68
- Dallas Instruments, Inc. . . . . 237
- Lee Dan Communications . . . . 17, 34, 44, 51  
 68, 82, 87, 91, 97, 103, 107  
 108, 130, 225, 248, 253
- Danavox Inc./Telecommunications Div. . . 26
- Data Check Corp. . . . . 237
- Datacraft, Inc. . . . . 243
- Data Physics Corp. . . . . 237
- Data Precision, Div. Analogic . . . . . 237
- Davis Instruments Mfg. Co., Inc. . . . . 237
- J. W. Davis & Co. . . . . 11, 17, 24, 55, 68  
 108, 130, 158, 221, 225
- Dayton Industrial Corp. . . . . 75
- Delta Magnetics . . . . . 55
- Delta Wire & Cable . . . . . 248
- Design Direct Sound . . . . . 130, 175
- De-Tech Systems, Inc. . . . . 36
- Detection Systems, Inc. . . . . 36
- Diamond Electronics, Inc. . . . . 44
- Digidesign, Inc. . . . . 202
- Digital Music Corp. . . . . 202
- Digitech . . . . . 187, 202
- Diversatronics . . . . . 91
- Diversified Case Co. . . . . 17
- Dolby Laboratories, Inc. . . . . 187
- Door Alarm Devices Corporation . . . . . 36
- Doorking . . . . . 36
- Dorado Systems Corp. . . . . 36
- Dorrrough Electronics . . . . . 187
- Dr. T's Music Software, Inc. . . . . 202
- Dukane Corporation . . . . . 18, 52, 55, 87, 91  
 98, 132, 206, 221, 225
- Dunegan Div., Physical Acoustics Corp. . 237
- Duracote Corp. . . . . 15
- Durcom, Inc. . . . . 87
- Dyma Engineering . . . . . 55
- Dynair Electronics, Inc. . . . . 44
- Dynamic Software Systems . . . . . 237
- Dyna-Might Sound & Lighting, Inc. . . . 207
- Dynamote Corp. . . . . 31
- Dyna-Systems . . . . . 206
- Dynaware Corporation . . . . . 202
- E and E Instruments International, Inc. . 229
- EAR/Caraway Audio . . . . . 18
- EECO, Inc. . . . . 204
- ELMA Electronic, Inc. . . . . 18
- EMCOR Products/Crenlo, Inc. . . . . 18
- EMI, Inc. (Electro-Mechanical  
 Imagineering, Inc.) . . . . . 44

EMS/Music	75	Flight Form Cases, Inc.	19	Hewlett-Packard Co.	237
E.R.L. Electronic Products, Inc.	82	Florence Corp.	37, 68, 82, 92	Hi Lo Fabrication	
E.S.E.	47	John Fluke Mfg. Co., Inc.	237	and Manufacturing	21, 109, 136, 253
East Coast Lighting and Sound Corp.	18	Fluorocarbon Co.,		Hill Audio, Inc.	58, 178, 221
Eastboard Consoles	19	Samuel Moore Group	248	Hirschmann of America	47, 136
Eastern Acoustics Works, Inc.	132	Formula Audio	134	Hitachi Denshi America Ltd.	237
Eby Co.	73	Forte Music, Inc.	202	Hoffend & Sons, Inc.	237
Eckel Industries, Inc.-Acoustic Div.	15	Foster	134	Holophonics	58
Eddor	11, 52, 55, 68, 73, 75, 108, 169	Fostex Corp. of America	56, 68, 134	Home Safeguard Industries, Inc.	37
	175, 187, 206, 221, 232		160, 178, 193, 214, 221, 226	Honeywell Test Instruments Div.	237
Eden Electronics, Inc.	132	Four Designs Co.	19	HOSA Technology, Inc.	248
Edge Distribution, Inc./Turbosound	132, 187	Fourjay Industries, Inc.	109, 134	House of Metal Enclosures, Inc.	21
Editron USA, Inc.	193	Franklin Instrument Co., Inc.	37	Housing Devices, Inc.	37
EI Mar Plastics, Inc.	19	Frazier/Division of		Howe Technologies Corp.	178
Elbex America	47	Sound-Craft Systems, Inc.	134	Hudson Photographic Industries	68
Elbex America, Inc.	36	Furman Sound, Inc.	193	Hughes Electronic Devices Corp.	204
Electro Force Corp.	56	GBE Group	68	Hybrid Arts, Inc.	202
Electrohome Ltd.	47	GHI Systems, Inc.	237	Hybrid Cases	21
Electronic Arts	202	GLI/Integrated Sound Systems	136, 207	IED Innovative Electronic Designs, Inc.	58
Electronic Specialists, Inc.	213	Gaines Audio	12, 19, 178, 193, 204, 237		178, 193, 204, 222, 229
Electronic Systems Group, Inc.	134	Galaxy Audio	136, 226	IGM Communications, Inc.	52
Electrorack Products Co.	19	Gallien-Krueger	56	IQS, Inc.	162, 237
Electro Rent Corp.	243	Gemco Electronics, Inc.	109, 136	ISS Engineering, Inc.	47
Electro Space Fabricators	19	Gemini, Inc.	19	ITT/DES, Inc.	88, 178, 193
Electro-Voice, Inc.	11, 56, 108, 134, 160	General Devices Co., Inc.	19	ITT Pomona Electronics/Div. ITT Corp.	249
	175, 193, 221	General Design Group	15	Ibanez/Hoshino (USA), Inc.	58
Electro-Vox Industries, Inc.		Geneva Group of Companies, Inc.	214	Ideal Wire Products, Inc.	249
(Santel Group)	36	GenRad, Inc.	237	Ikegami Electronics (USA), Inc.	47
Elenex, Inc. (East)	36, 95, 100, 103, 160	Gentex Corp.	37	Imagine Computers & Software	202
Elenex, Inc. (West)	19, 36, 56, 95, 103, 107	Gentner Electronics Corporation	73	Impact Industries, Inc.	21
Eltrex International	36, 52, 193, 211	Gentner RF Products	72	Impart, Inc.	21
Emergency Products Corp.	36	Georgia Cable and Wire	248	Industrial Acoustics Company	15
Emilar	134	Gold Line	193, 237	Industrial Research	
Encom Products Co., Inc.	95	Gollehon Industries, Inc.	136	Products, Inc.	58, 75, 193
Endevco	237	Good Foundations, Inc.	19	Industry West Electronics	58, 204
Engineered Electronics, Inc.	92	Gotham Audio Corp.	136, 160	Infonics, Inc.	214
Environmental Sound	134	Grass Valley Group	204	Inovonics, Inc.	195
Equipto Electronics Corp.	19	Great American Market, The	19	Insul-Art Acoustics Corp.	15, 206
Ethereal Concepts	12, 31, 71	Great Northern Wire & Cable, Inc.	248	Intec Video Systems	47
Europa Technology, Inc.	178	Grozier Technical Systems, Inc.	19	Intelligent Controls, Inc.	37
Eventide, Inc.	193, 202, 206, 229, 243	Gulton Industries/Servonic Div	237	Intelligent Music	202
FM Acoustics Limited (USA)	56	Gyyr Products, div. of Odetics, Inc.	37, 47	Interior Acoustics	206
FM Tubecraft	15	(HME) HM Electronics, Inc.	56, 102	International Electro-Magnetics, Inc.	214
FSR, Inc.	12, 47, 68, 71, 73		162, 169	International Music Co.	
Fairlight Instruments, Inc.	207	H.O.M.E., Inc.	47, 109	(I. M. C.)	136, 162, 195, 205, 214
Fane	134	HSA Heather Sound	19	International Satellite Systems	75
Fanon Courier	56, 95, 104, 134, 226, 232	Hacoustic USA, Inc.	56	International Tapetronics/3M	214
Faraday, Inc.	36	David Hafler Company,		International Wire & Cable	249
Federal Signal Corp.,		Div. of Rockford Corp.	56	Intersonics, Inc.	138
Commercial Products Group	36	Adam Hall Supplies, Ltd.	19	Iwatsu America, Inc.	238
Fender Musical		Hammond Manufacturing Co., Inc.	19	JBL Professional	47, 58, 68, 109
Instrument Corp.	56, 134, 178	Harris Corporation,			138, 195, 207, 214
Fidelipac Corp.	214	Dracon Division	19, 24, 56, 75, 109	JRF Magnetic Sciences, Inc.	214
Len Finkler Company	56, 134		136, 221, 237	JVC Co. of America	47
Fire Burglary Instruments, Inc.	36	Harrison Systems, Inc.	237	Jan-AI Cases	21
Firecom/Auth Co.	36	Heath Co.	237	Javelin Electronics	47
Fire-Lite/Notifier	37	Hedco	204	Jaydik Communications Co.	48
Fisher-Berkeley Corp.—Ektacom	51, 82	Heil Ltd.	193	Jensen Transformers, Inc.	12
	87, 92, 95, 104	Heliotrope General	211	Jensen Tools, Inc.	24
Flight Case Co.	19	Henry Engineering Co.	12	Jensen Video Sonics	37



Jeron Electronic Systems, Inc. ....	51, 82	Maas-Rowe Carillons .....	81	Nakamichi America, Corp. ....	26, 214
	92, 98, 104	MacKenzie Laboratories, Inc. ...	52, 211, 214	Napco Security System .....	37
Joe's Sound and Salami Co. ....	21, 226	MacPherson Speakers .....	138	National Electric Cable .....	249
Johnson Electronics, Inc. ....	58, 75, 88	Magna-Sound .....	58, 222	Navco Security Systems .....	37
	178, 232	Magnifax International, Inc. ....	214	Nel-Tech Labs, Inc. ....	38, 52, 81, 107, 211, 222
Juice Goose, A Division of		Magnetic Reference Lab (MRL) ..	214	Nemal Electronics, Inc. ....	249
Whitenton Industries, Inc. ....	31	Magne-Tronics, Inc. ....	75	Neotek Corporation .....	178
KDM Electronics, Inc. ....	58, 138, 178	Mallory Capacitor Co. ....	107	Neutrik USA, Inc. ....	25
	195, 222, 226	Marcom/The Scotts Valley Group, Inc.	196	Neve .....	179
Kalamazoo Technical Furniture, Inc.	21	Marietta Wire & Cable .....	249	Nicolet, Test Equipment .....	238
Kay Elemetrics Corp. ....	238	Mark IV Cinema Systems .....	138	Niles Audio Corporation .....	68
Keithley Instruments Div. ....	238	Dean Markley Strings &		Non-Linear Systems/Div. of Kaypro Corp.	238
Kinemetrix/TrueTime .....	238	Electronics, Inc. ....	138	Noramco Wire & Cable Co., Ltd.	249
King Wire & Cable Corp. ....	249	Marlee Electronics Corp. ....	37	Norland Corp. ....	240
Klark-Teknik Electronics, Inc. ....	178, 195	Marsh Products, Inc. ....	104	North America Soar Corp. ....	240
	206, 238	Marshall .....	249	Northern Information Technology	48
Klipsch & Associates, Inc. ....	138	Martin America .....	138	Northern Sound .....	16
Knowles Electronics, Inc. ....	162	Mason Industries, Inc. ....	15	Nortronics Co., Inc. ....	214
Korfund Dynamics Corp. ....	15	Math Associates, Inc. ....	37, 48, 249, 253	Numark Electronics .....	21, 29, 48, 60, 140
Korg U.S.A., Inc. ....	178, 202, 229	McCauley Sound, Inc. ....	110, 138		162, 196, 207, 249
Koss Corporation .....	26	McGohan Electronics, Inc. ....	58	OWI, Inc. ....	140
Koyo International, Inc. of America	48	McMartin International, Inc. ....	60	Oaktron Industries, Inc. ....	110, 142
Krohn-Hite Corp. ....	238	Med-Tek .....	92	Oberheim-ECC .....	202
Kulka-Smith, Inc. ....	249	Mellotone .....	16	O'Brien Partition Co. ....	16
L and L Sales Co., Inc. ....	253	MetraByte Corp. ....	238	Office Technologies .....	206
LAR Sound .....	138	Metragen Ltd. ....	26	Olson Acoustics .....	142
LEQ Measurements, Ltd. ....	238	Metrosonics, Inc. ....	238	Omni Q, Inc. ....	32, 68
LM Engineering .....	21	Meyer Sound Laboratories, Inc. ....	60, 138	Omnimount Systems .....	110
LPB, Inc. ....	178, 233		196, 238	Onboard Monitor Corp .....	142
LVW Electronics .....	58, 178	Micro Audio, Inc. ....	196, 238	Opamp Labs, Inc. ....	68
La Belle .....	211	Micro-Trak Corp. ....	238	Orban Associates, Inc. ....	196
Labor Saving Devices .....	24	Microtran .....	12, 214, 249	Orevox Corp. ....	38, 142
Lake Butler Sound Co., Inc. ....	202	Microvoice Corporation .....	73	Otari Corp. ....	215
Larson-Davis Laboratories .....	238	Midas Audio Systems Ltd. ....	178	Oval Window Audio .....	233
Latham Time Recorder Co. ....	107	Middle Atlantic Products .....	21, 25, 110	Owens-Corning Fiberglas, Corp.,	
Leader Instruments Corp. ....	238	Mikrolab Video, Inc. ....	48	Acoustic Products Div. ....	16
Leasametric Instrument Rental Division	238	Milab/Exp .....	162	Oxmoor Corporation .....	72, 196, 229
Lectrosonics, Inc. ....	169, 226, 233	Millbank Electronics Group Ltd. ....	60	PA Concepts .....	142
LeFebure .....	37	Miller-Stephenson Chemical Co., Inc.	25	PAR Products, Inc. ....	21
Leitch Video Limited .....	58	Milliphonics .....	162	PAS Professional Audio Systems	142
Lemo USA, Inc. ....	249	Mirtone Communication &		P/H Electronics, Inc. ....	69
Lenco, Inc. ....	21	Security, Inc. ....	37, 82	PHI Technologies, Inc. ....	215
Lexicon, Inc. ....	195	Misco/Minneapolis Speaker Co. ....	140	Pacific Recorders & Engineering Corp.	230
Lighting and Electronics .....	207	Mitsubishi Electric Sales America, Inc.	48	Paladin Corp. ....	25
Lightronics .....	12	Modular Audio Products .....	229	Panasonic Ind. ....	48, 60
Lightwave Communications, Inc. ....	48	Modular Sound Systems -		Panasonic Ind. Co./	
Linear & Digital Systems, Inc. ....	31	The Mitek Group .....	140	Instrumentation Dept. ....	240
Littlite Gooseneck Lamps/CAE .....	24	Monroe Electronics, Inc. ....	72	Panasonic Industrial Company/Ramsa	60
Logitek .....	178	Monster Cable Products, Inc. ....	253		69, 110, 142, 162, 179, 196
Louroe Electronics .....	37	Motorola, Inc./Ceramic Products	140		207, 222, 226, 230, 232
Lowell Manufacturing Co. ....	110, 138	Multigon Industries, Inc. ....	238	Panduit Corp. ....	25
Lumitrol Corp. ....	32	Multiplex Technology, Inc. ....	211	Paramount Sound Systems .....	142
Lync Systems, Inc. ....	202	Multi-Vox Ltd. ....	82, 92, 98, 222	Parasound Products, Inc. ....	60
Lyntec/Technical Visuals .....	195, 205, 206	The Music People, Inc. ....	140, 162, 249	Parsons Mfg. Corp. ....	21
M.B. America (Master Blaster America)	138	Music Programming, Inc. ....	75	Paso Sound Products .....	12, 38, 60, 69, 76
MFJ Enterprises, Inc. ....	48	Music Supply Co., Inc. ....	25, 140, 238, 249		83, 98, 110, 142, 164, 170, 179
MG Electronics .....	12, 37, 107, 110, 138, 238	Musically Intelligent Devices	72		196, 207, 215, 222, 226, 232
MPO Videotronics .....	48	Muzak .....	75	Patch Bay Designation Co. ....	205
M & S Systems, Inc. ....	82	NEC America, Inc. ....	48	Peavey Architectural Acoustics Division	14
MTX Loudspeakers - The Mitek Group	138	Nady Systems, Inc. ....	26, 170, 233		62, 164, 170

Peavey Electronics Corp. .... 14, 62, 164 179, 196, 202, 222, 227	Radical Electronics ..... 205	Scientific-Atlanta, Spectral Dynamics Div. .... 240
Peerless Sales Co. .... 21, 48, 110	Radio Design Labs ..... 111	Scott Instrument Lab., Division of Lindley Co. .... 241
Pelco Sales ..... 48	Radionics, Inc. .... 51	Seal-O-Matic Co. .... 25
Penn Fabrication (USA), Inc. .... 14, 16, 21 25, 110, 164, 249	Ramko Research, Inc. .... 62	Securitron Magnalock Corporation .... 38
Penny & Giles, Inc. .... 249	Ramsdell Audio ..... 146	Security Intercom, Inc. .... 38
Pentagon Industries, Inc. .... 76	Randall Corporation ..... 62	Security Resources ..... 38
Perma Power Electronics, Inc. .... 32, 227	Rane Corp. 62, 179, 197, 202, 206, 208, 231	Seeburg Corp. .... 77
Perreaux/GMI Distributors ..... 62	Rapco Cable & Lighting ..... 253	Seeburg Music Satellite Network ..... 77
Philips Microphones ..... 164	Rapid Systems ..... 240	Selco Products Co. .... 25
Phonic Ear, Inc. .... 233	Rauland-Borg Corp. .... 52, 74, 88, 94, 95 99, 231	Select Engineered Systems ..... 38
Pinkerton Controls System Corp. .... 38	R-Columbia Products Co., Inc. .... 249	Sencore ..... 241
Pittsburgh Corning Corp. .... 16	Recordex Corp. .... 179	Senior Audio, Inc. .... 223
Plantronics, Inc. .... 29	Recortec, Inc. .... 215	Sennheiser Electronic Corp. (CT) ..... 29, 164, 170
Platt Luggage ..... 21	Red Acoustics (USA), Ltd. .... 146	Sensor Engineering Co. .... 38
Poetker Communications, Ltd. .... 98	Reliable Security Systems, Inc. .... 38	Sentex Systems, Inc. .... 86
Polyphaser Corporation ..... 32	Remeo Products Corp. .... 249	Sescom, Inc. .... 14, 63, 70, 181, 198 205, 241, 251
Portac, Inc. .... 212	Renkus-Heinz, Inc. .... 146	J.H. Sessions & Son ..... 25
Portasound, Inc.-Div. of Soundcraft Systems, Inc. .... 230	Resco, Inc. .... 251	Setcom Corp. .... 29
Portland Instrument ..... 38, 94, 98, 253	Research Technology International ..... 22 48, 69	Seven Systems, Inc. .... 77
Posthorn Recording ..... 164	Revere Industries ..... 77	Shallco, Inc. .... 14
Powermark, Inc. .... 32	Richmond Sound Design, Ltd. .... 14, 63, 88 99, 197	Shape Magnetronics, Inc. .... 32
Power Solutions, Inc. .... 62	Ring Group, Inc. .... 83, 88, 94, 99, 146	Sharp Electronics Corp., Instrumentation Div. .... 241
Powertronix ..... 38, 52, 62, 206	Rion Instrument Div., Mott Assoc., Inc. 240	Sharp Electronics Corp./ Professional Products Division ..... 70
Precision Electronics, Inc. .... 62, 222, 227	Roadrunner Cases, Inc. .... 22	Shigma, Inc./Ono Soki C. Ltd. .... 241
Precision Fabrication Technologies, Inc. .... 21, 232	Roanwell Corporation ..... 164	Shure Brothers, Inc. .... 164
Premier Metal Products Co ..... 22	Robot Research, Inc. .... 38, 48	Siedle Intercom ..... 40, 48, 86, 94, 99 104, 241
Princeton Applied Research ..... 240	Rockland Scientific Corp. .... 240	Sieler Design Products ..... 227
Pro Co Sound, Inc. .... 205, 253	Rocktron Corp./RSP Tech. .... 197	Siemens Hearing Instruments, Inc. .... 233
Professional Sound Corporation ..... 179	Rockustics, Inc. .... 146	Sierra Video Systems ..... 212
Progressive Electronics, Inc. .... 240	Rocronics Lighting, Lasergraphics & Special Effects, Inc. .... 208	Sight & Sound Entertainment, Inc. .... 77
Projector Recorder Belt Corp. .... 215	Rofu International Corp. .... 38	Signal Cable Co. .... 251
Protech Audio Corp. .... 62, 72, 107, 197 223, 230	Rohde & Schwarz-Polarad, Inc. .... 240	SIGnology ..... 241
Proudfoot Co., Inc. .... 16	Roland Corp., US ..... 179, 197, 203	Silent Watchman ..... 40
Pulnix America, Inc. .... 38	Ross Systems/IMC ..... 148	Simpson Electric Co. .... 241
Pyrok, Inc. .... 16	Rowe International, Inc. .... 77	Sims Vibration Dynamics ..... 16
Pyrotronics ..... 38	Rupert Neve, Inc. .... 181	Skydyne ..... 22
QSC Audio Products, Inc. .... 14, 62, 69, 76 179, 197, 208, 223, 227, 231	Ruslang Corp. .... 22	Skytronics Electrical Inc. .... 208
Q-Line Corp. .... 111	SCA Data Systems ..... 77	Sola, A Unit of General Signal ..... 32
Quabbin Wire & Cable Co., Inc. .... 253	SCS/Sound Code Systems ..... 63	Solid Support Industries ..... 22
Quam-Nichols Co. .... 76	SCV, Inc. .... 197	Soltec Corp. .... 241
Quantam Audio Labs ..... 179, 215	SMC International, Inc. .... 63, 77, 223	Sonic Research Assoc. .... 198
Quest Electronics ..... 240	SPM Instrument, Inc. .... 240	Sonic, Inc. .... 148
Quickset International, Inc. .... 22	SWR Engineering, Inc. .... 63	Sonic Systems, Inc. .... 148
Quiet Lion ..... 202	St. Louis Music ..... 63, 148, 181	Sonitrol Corp. .... 40
RC Electronics, Inc. .... 240	Saki Magnetics, Inc. .... 215	SonoMask Systems, Inc. .... 206
RE Instruments ..... 240	Sammi Sound Technology ..... 16	Sontec Electronics, Inc. .... 64, 72, 181, 198
RMS Electronics, Inc. .... 249	Samson Technologies Corp. .... 170	Sony Professional Audio ..... 29, 148, 164 170, 215, 232
ROH ..... 88	Sanctuary Sound Systems ..... 148, 181	Sony Security ..... 40
RPG Diffusor Systems, Inc. .... 16	Sanming Sound Company ..... 148	Sound Absorbent Materials Company, Inc. .... 16
RSP Technologies ..... 197	Sanyo Fisher, Inc. .... 48	Soundcoat Co., Inc. .... 16
RTE Deltec Corp. .... 32	Saxton Wire & Cable Products, Inc. .... 251	Sound Control Technologies, Inc. .... 74
RTS Systems, Inc. .... 62, 88, 95, 98, 102, 104	Scantek Inc. .... 197, 240	
Racon, Inc. .... 48	Schlumberger Instruments ..... 240	
Racware, Inc. (Rackmounted Computers) 22	Schroff, Inc. .... 22	
	Schulmerich Carillons, Inc. .... 81	
	Scientific Atlanta/OPTIMA Div. .... 22	





# INDEX OF BRAND NAMES

- A—E**  
**Adam Hall Hardware** (Tektrak)  
**Adam Hall Supplies Ltd.** (East Coast Lighting and Sound Corp.)  
**Advanced Technology Design (ATD)** (AB International Electronics, Inc.)  
**Akai** (Intl Music Co. (I. M. C.))  
**Anacom** (Med-Tek)  
**ASS Fiberglass Horns** (Tektrak)  
**Atlas Sound** (Atlas/Soundolier)  
**Audio Centron** (St. Louis Music)  
**Audio Developments** (Gotham Audio Corp.)  
**Audio Logic** (Audio Logic)  
**Audioarts Engineering** (Wheatstone Corporation)  
**Audiologix** (Professional Sound Corporation)  
**Audiomaster** (Shure Brothers, Inc.)  
**Audsco** (Audio Systems Company)  
**Blackjack** (Dean Markley Strings & Electronics, Inc.)  
**Boss** (Roland Corp., US)  
**BSS Audio** (Edge Distribution, Inc./Turbosound)  
**C-ducer** (C-T Audio Marketing, Inc.)  
**ClearVoice** (Shure Brothers, Inc.)  
**Communitel** (Bogen Communications, Inc.)  
**DDA** (Klark-Teknik Electronics, Inc.)  
**doorGuard** (Reliable Security Systems, Inc.)  
**doorMag** (Reliable Security Systems, Inc.)  
**Drum Wizard** (C-T Audio Marketing, Inc.)  
**Dyad** (Soundcoat Co., Inc.)  
**Dynafex** (Circuit Research Labs, Inc.)  
**Dynamite** (Valley International, Inc.)  
**Ektacom** (Fisher-Berkeley Corp.—Ektacom)  
**Electrocolor** (Blonder-Tongue Laboratories, Inc.)  
**EMT** (Gotham Audio Corp.)  
**Ericsson** (Alternative Telecommunications Corp.)  
**Ericsson** (ATC Supply Corp.)  
**Excalibur Cases** (Great American Market)  
**F—K**  
**F.O.S.** (Faraday, Inc.)  
**Forsythe** (Eastern Acoustics Works, Inc.)  
**Gatex** (Valley International, Inc.)  
**GBC** (CCTV Corporation)  
**Guardsmen** (Blonder-Tongue Laboratories, Inc.)  
**Hafler** (David Hafler Company, Div. of Rockford Corp.)  
**HMA** (Gotham Audio Corp.)  
**ITC** (International Tapetronics/3M)  
**JVS** (Jensen Video Sonics)  
**K & H** (Gotham Audio Corp.)  
**L—R**  
**Link Dynamic Crossovers** (Tektrak)  
**Littlelite** (Littlite Gooseneck Lamps/CAE)  
**Loft** (Gold Line)  
**Lucasey Manufacturing** (Impart, Inc.)  
**Martin Audio Products** (Martin America)  
**Masterline** (Blonder-Tongue Laboratories, Inc.)  
**McKenzie Speakers** (Waldom Electronics, Inc.)  
**Micropass** (Racon, Inc.)  
**MMC** (Fisher-Berkeley Corp.—Ektacom)  
**Moduline Modular Enclosures** (Precision Fabrication Technologies, Inc.)  
**Mogami** (Marshall)  
**MRL** (Magnetic Reference Lab (MRL))  
**Neumann** (Gotham Audio Corp.)  
**Nikko** (Paso Sound Products)  
**Norwegian Electronics.** (Scantek Inc.)  
**NTP** (Gotham Audio Corp.)  
**Omni Craft** (C-T Audio Marketing, Inc.)  
**P.A.S.** (Professional Audio Systems)  
**Paramount Speaker** (Portland Instrument)  
**Petcom** (Poetker Communications, Ltd.)  
**Powertronix** (Comutronix)  
**PPD** (Numark Electronics)  
**Prologue** (Shure Brothers, Inc.)  
**Ramsa** (Panasonic Industrial Company/Ramsa)  
**Raymer** (Cetec Raymer)  
**RCF** (Eastern Acoustics Works, Inc.)  
**Rembrandt** (Compression Labs, Inc.)  
**Ross** (International Music Co. (I. M. C.))  
**S—Z**  
**S.H. Couch** (Faraday, Inc.)  
**S.T.R.** (Alpha Communications)  
**Schoeps** (Posthorn Recording)  
**SCV** (Portland Instrument)  
**Seck** (Connectronics Corporation)  
**Sentinel** (American Zettler Corp.)  
**Servodrive** (Intersonics, Inc.)  
**Shipboard Audio** (Comutronix)  
**Silent Page** (Quest Electronics)  
**Smart Systems** (Renkus-Heinz, Inc.)  
**Sonalert** (Mallory Capacitor Co.)  
**Sonex** (Alpha Audio)  
**Sonosax** (Professional Sound Corporation)  
**Sonotrim** (Posthorn Recording)  
**Sound Runner** (Marshall)  
**Soundfoam** (Soundcoat Co., Inc.)  
**Soundfoil** (Soundcoat Co., Inc.)  
**Soundmat** (Soundcoat Co., Inc.)  
**Soundolier** (Atlas/Soundolier)  
**Standard Electric Time** (Faraday, Inc.)  
**Starforce USA** (Skytronics Electrical Inc.)  
**STL** (Standard Tape Laboratory, Inc.)  
**TAD** (Technical Audio Devices Pioneer Elect's (USA), Inc.)  
**TEAC** (Tascam Pro Div.)  
**Tect** (Audix)  
**Teletalk** (Faraday, Inc.)  
**3rd Generation Pro-Audio** (Tektrak)  
**TMW Tajimi** (Marshall)  
**Toki Tape Light Systems** (Capitol Lighting Products)  
**Transwave** (Schell Electronics, Inc.)  
**Tube Driver Preamps** (Chandler Industries, Inc.)  
**Turbosound** (Edge Distribution, Inc.)  
**US Audio** (Whirlwind)  
**Vega** (Cetec Vega)  
**Video-Com** (Mirtone Communication & Security, Inc.)  
**Visonik** (Hirschmann of America)  
**VT Amplifiers** (Vibration Technology, Ltd.)  
**Walker Consoles** (Design Direct Sound)  
**Zetcom** (American Zettler Corp.)

# INDEX OF ADVERTISERS

Page	Company	Telephone	Page	Company	Telephone
60	AB Systems	(916) 783-7800	92	Jeron Electronic Systems, Inc.	(800) 621-1903
84,85,105	Aiphone Intercom Systems	(206) 455-0510	199	Klark-Teknik Electronics, Inc.	(516) 249-3660
165	AKG Acoustics	(203) 348-2121	86	Lee Dan	(800) LEE-DAN1
35	Alarm Accessories	(302) 792-3620	211,213	MacKenzie Laboratories, Inc.	(800) 423-4147
141	Altec Lansing	(405) 324-5311	248	Marshall Electronics	(213) 390-6608
227	Anchor Audio	(213) 533-5984	245	Math Associates	(516) 334-6800
198	Aphex Systems Ltd.	(818) 765-2212	145	McCauley Sound, Inc.	(206) 848-0363
143	Apogee Sound Inc.	(707) 778-8887	135	McKenzie Loudspeakers	(312) 585-1212
194	Applied Research & Technology	(716) 436-2720	144	MG Electronics	(516) 582-3400
225	Argos Sound	(815) 784-5118	195	Micro-Audio	(803) 292-8896
32	Aris/ETA	(216) 425-3388	18	Middle Atlantic Sudio Products	(201) 839-1011
23,146	Atlas/Soundolier	(314) 349-3110	228	Modular Audio Products	(516) 567-9620
241	Audio Control	(206) 775-8461	169	Nady Systems Inc.	(415) 652-2411
193	Audio Digital	(800) 423-1082	209	Nel-Tech Labs	(603) 434-8234
49	Audio Systems	(701) 223-3800	208	Numark Electronics Corp.	(201) 225-3222
161	Audio-Technica	(214) 686-2600	132	OWI	(213) 638-4732
188	BBE Sound Inc.	(800) 233-8346	67	Oxmoor	(205) 942-6779
57	BGW Systems	(213) 973-8090	4,131,216-217	Panasonic/Ramsa	(714) 895-7278
246	Bi-Tronics	(800) 522-7377	41	Panasonic Industrial/CCTV	(201) 392-4050
147	Bose Corp.	(617) 879-7330	78	Pentagon Industries	(312) 271-8300
43	Burle Industries	(717) 295-6123	144	Portland Instrument	(818) 500-0137
247	Cal Switch	(800) CAL-SWCH	113-124	Professional Audio Systems	(213) 534-3570
244	Canare Cable Inc.	(818) 840-0993	223	Pro-Tech Audio	(516) 584-5855
63	Carver	(206) 775-1202	65	QSC Audio Products	(714) 645-2540
150	Celestion Industries	(617) 429-6706	185	Rane Corporation	(206) 774-7309
127	Cetec Gauss	(213) 875-1900	246	Rapco Cable and Lighting	(800) 325-0266
236	Cetec Ivie	(801) 224-1800	100	Rauland-Borg Corp.	(312) 267-1300
59	Cetec Raymer	(213) 875-0423	101	Ring Group of North America	(800) 645-9690
163	Cetec Vega	(818) 442-0782	136	Rockustics	(516) 665-6497
153	Community Light & Sound	(215) 874-3400	167	Samson Technologies Corp.	(516) 489-2203
248	Consolidated Electronic Wire & Cable	(800) 621-4278	157	Sennheiser Electronic Corp.	(203) 434-9190
155,160	Crown	(219) 294-8000	154	Sonic, Inc.	(414) 483-5091
82,112,140,166	CWY Electronics	(317) 448-1611	130,151	Sonic Systems, Inc.	(203) 356-1136
30	David Clark Company	(617) 756-6216	220	SPECO/Div. Component Specialties, Inc.	(800) 645-5516
102	Delta Communications	(206) 582-2201	89	Stentofon Communications Inc.	(816) 231-7200
93	Diversatronics Inc.	(800) 345-1244	158,187	Stewart Electronics	(916) 929-4431
197	DOD Electronics	(801) 268-8400	69	Stewart Filmscreen	(213) 326-1422
247	Eastman Wire and Cable	(800) 257-7940	88	Swintek Telecommunications	(408) 378-8091
Cover 2	Electro-Voice	(616) 695-6031	184	Symetrix	(206) 282-2555
229	ESE	(213) 322-2136	149	Tannoy North America, Inc.	(419) 745-1158
133	Fane Acoustics Ltd.	(817) 336-5114	251	Tappan Wire & Cable	(800) 247-9099
55	Fanon Courier	(714) 669-9890	103,104	Technical Projects	(800) 562-5872
36	Faraday	(517) 423-2111	239	Techron Industrial Products	(219) 294-8300
137	Fostex Pro Sound Division	(213) 921-1112	82	Tektone	(305) 844-2383
109,140	Fourjay Industries, Inc.	(513) 890-6444	162,171	Telex Communications, Inc.	(800) 328-3771
128	Frazier	(800) 643-8747	39,139,173,180	TOA Electronics, Inc.	(800) 843-4753
72	FSR Inc.	(201) 239-0988	129	Turbosound, Inc.	(212) 460-9940
205	Gentner	(801) 268-1117	61	U.S. Audio	(716) 663-8820
240	Gold Line Connector, Inc.	(203) 938-2588	135	Waldom	(312) 585-1212
244	Great Northern Wire & Cable	(800) 468-2121	250	West Penn Wire	(800) 245-4964
132	Harris—Division of Dracon	(800) 621-5640	219	Wheelock, Inc.	(800) 631-2148
159	HM Electronics, Inc.	(619) 578-8300	61	Whirlwind	(716) 663-8820
76	IBMA	(216) 833-4164	189-192,200	White Instruments	(512) 892-0752
Cover 3	Industrial Research Products, Inc.	(312) 439-3600	234	Williams Sound	(800) 328-6190
230	Innovative Electronic Design, Inc.	(502) 267-7436	3,176-177	Yamaha	(714) 522-9011
Cover 4	JBL Professional	(213) 893-8311	74	York Controls	(800) 234-2126
13	Jensen Transformers, Inc.	(213) 876-0059			

“Total system integration and flexibility with greatly reduced fabricating and installation time . . . that’s what I get from System 41”

*Robert F. Ancha  
Ancha Electronics, Inc.*



First System 41 installed at Willow Creek Church, Barrington, Ill.

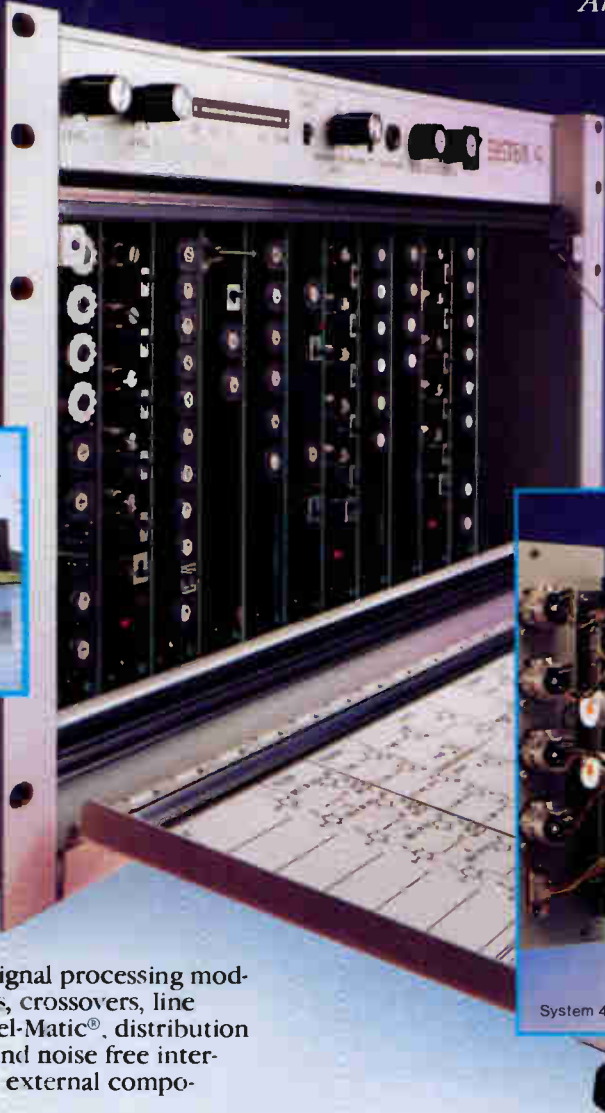

System 41 includes a wide range of signal processing modules - mixers, equalizers, notch filters, crossovers, line drivers, remote control, limiters, Level-Matic®, distribution amplifiers - with totally compatible and noise free interconnection within the system and to external components and monitors.

- Contractors will like the economy of assembly, fast installation, and easy service.
- System developers will like the aids for fast design and specification with components from one source.
- The owner will appreciate the neat professional appearance, system security and reliability of IRP products.

System 41 is designed and manufactured by a company dedicated to solving problems in sound with state of the art innovations and technology.

Call, FAX or write for System 41 information.



System 41 signal processing modules.

**INDUSTRIAL  
RESEARCH  
PRODUCTS,  
INC.**

A Knowles COMPANY

321 Bond Street • Elk Grove Village, IL 60007  
In IL: 1-312-439-3600  
TOLL FREE: 1-800-255-6993  
TELEX: 701845 • FAX: 1-312-640-9607



# It Takes More Than A Little Neodymium To Change The Face Of Driver Technology.



Hailed as the catalyst for a new generation of high performance compression drivers, the rare earth compound neodymium showed up in our R&D lab shortly after it was first formulated. But its extremely high cost and sensitivity to heat had to be overcome before neodymium could live up to its full potential.

The availability of this highly magnetic, extremely lightweight material coincided perfectly with our development of the Coherent Wave™ phasing plug.

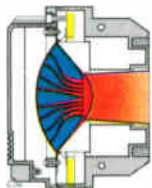

*JBL's 2450J Neodymium Compression Driver with Coherent Wave™ phasing plug provides in-phase combining of sound waves for extended high frequency performance. JBL's patented diamond surround titanium diaphragm with new embossed dome greatly reduces distortion and damage at high SPL.*

This new design, a phasing plug with annular apertures of constant path length, uniformly directs sound through to the throat providing in-phase combining of sound waves for extended high frequency performance. This new technology is combined with our patented diamond surround titanium diaphragm, incorporating a new embossed dome, to reduce the possibility of distortion or damage at high SPL.



2450J

The 2450's smaller size translates to tighter spacing of horn arc arrays, more even and precise coverage and greatly reduced requirements for delay. Plus, the 2450 nets out at a mere 4.8 kg (10.5 lb). The benefits of this dramatic weight reduction include lower shipping costs to the site or on the road and significantly less load bearing requirements for both structures and rigging. With built-in mounting points, the 2450 will take much less time to install.

Yes, it took more than a little neodymium to change the face of driver technology. But we're confident you will find the breakthrough results were certainly well worth the wait and the effort.



JBL Professional  
8500 Balboa Boulevard, Northridge, CA 91329  
© 1988 - JBL Incorporated A Harman International Company