

PRO AUDIO REVIEW



The Industry's Equipment Authority

August 2002

TWO-TRACK



RECORDERS

MAILING LABEL: DIGIT 337 344/1329, PRODUCTION, 8/10/02, FOR MILLER, ASST. CE, KITH, 29033 S. AUGUSTA, PL., TUCSON, AZ 85710-7905

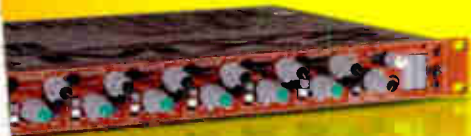

the Rack:

mixer



Inexpensive Digital Tracks:
Alesis HD24 Recorder

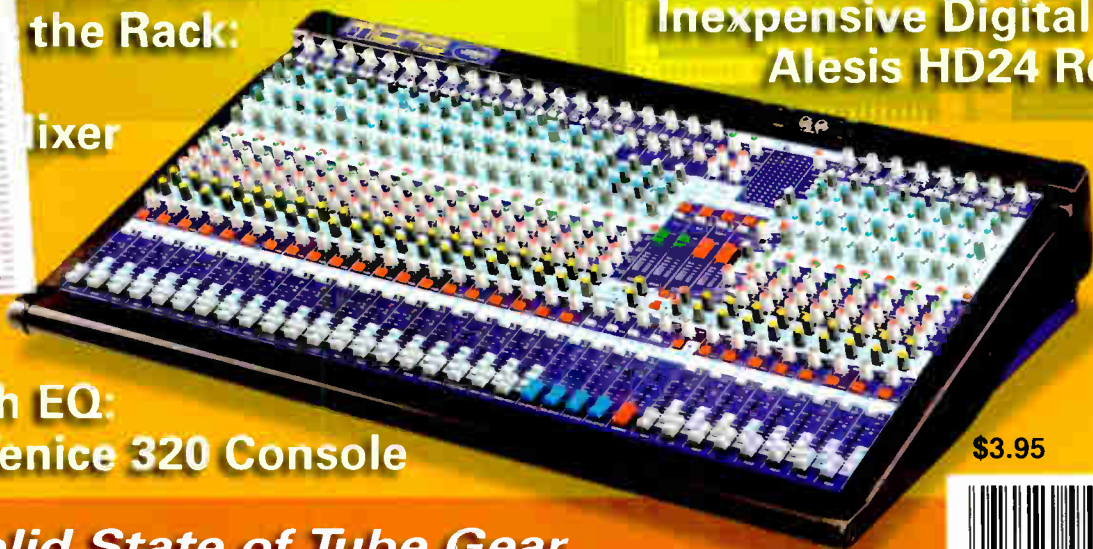

Top-notch EQ:
MIDAS Venice 320 Console

\$3.95

- *The Solid State of Tube Gear*
- *A Vocal Essential: TC Helicon VoicePrism*
- *Bel Canto's Amazing Digital eVo Amplifier*



www.proaudioreview.com

PROFESSIONAL RECORDING EQUIPMENT

MANLEY

Langevin



COMPANY PROFILE: Manley Laboratories, Inc. in recent years has expanded and thrived under EveAnna Manley's leadership. Our 11,000 sq. ft. building houses our own machine-shop, printed circuit board manufacture, audio transformer winding, engraving, and silk-screening facilities. All custom design, R&D, assembly, testing, and quality control processes are performed with precision and pride at the Manley factory, located just 35 miles east of Los Angeles.

**NEO-CLASSIC:
MANLEY ALL-TUBE GEAR**
We take a purist approach to everything we build; refining, executing, and expanding upon Manley's legacy of vacuum tube design philosophies proven over years of real-world experience, using high quality modern components, many of which are fabricated in-house. This attention to detail delivers the rich, present, and natural sound our vacuum tube designs are renowned for. Never small, sterile, or boring.

Beyond this, Manley means reliability, real technical support, and a company attitude that professionals depend on.

BIG BANG FOR THE BUCK: LANGEVIN
LANGEVIN is a legendary marque of premium electronics whose lineage goes back to World War II. **MANLEY** acquired the **LANGEVIN** brand name several years ago. With these products we offer you the different sonic flavor that **ALL-DISCRETE CLASS A CIRCUITRY** brings using fresh, original designs built alongside and to the same exacting standards as the Manley equipment.

We believe that good music and those who create it deserve the finest gear.

The choice is yours.

MANLEY LABORATORIES, INC.
13880 MAGNOLIA AVE.
CHINO, CA. 91710 USA
TEL: (909) 627-4256
FAX: (909) 628-2482

email: emanley@manleylabs.com

<http://www.manleylabs.com>

READER SERVICE NUMBER 2

Halls of Fame

REVERB6000 IS MASSIVE IN REVERB AND DELAY



"The 6000 allows me to move my sound effects from small caves to exterior wide expanses with startling realism"



CHRISTOPHER BOYES
RECORDING MIXER, SOUND DESIGNER

"Having experimented with the latest algorithms, I feel the 6000 has what it takes to become the industry standard for 5.1 reverberation"



JOHN KURLANDER
SCORING MIXER



"Since I've integrated the 6000 into my studio, I find I use other reverbs/processors less and less. Not only does it emulate other reverbs convincingly, on it's own it opens up a world of new possibilities. The reverbs are more detailed and subtle. The 5.1 reverbs are dramatic and are already completely indispensable"



GEORGE MASSENBURG
ENGINEER, PRODUCER

NEW FORMATS

Reverb for 6.1 Format
16 Mono Reverbs in One Frame

OLD CLASSICS

Desirable Reverbs from the Past
Nonlinear Effects and Beyond

WILD REFLECTIONS

Ultimate Delays and
Reflection Design

Read about the new Reverb6000 on
www.tcelectronic.com



Reverb6000 contains great new algorithms and
presets from the best in our industry

READER SERVICE NUMBER 3

TC ELECTRONIC INC. USA • ☎ (805) 373 1828 • [FAX] (805) 379 2648

WWW.TCELECTRONIC.COM

World Radio History

t.c. electronic
ULTIMATE SOUND MACHINE

Evaluating audio products for professionals in commercial recording, broadcast production, audio for video/film, project studios, live sound, contracting and multimedia.

EQUIPMENT REVIEWS

- 10** Alesis HD24 Multitrack Hard Disk Recorder
On the Bench p. 14
By David Christopher
- 20** Midas Venice 320 Console
By David Rittenhouse
- 23** Whirlwind PCDI and Direct2 DI Boxes
By Will James
- 24** ATI 8MX2 Rackmount Preamp/Mixer
By Tom Young
- 26** HHB CDR830 BurnIt PLUS CD Recorder
By Andrew Roberts
- 28** TC Helicon VoicePrism Processor
By Stephen Murphy
- 35** Crane Song Spider Rackmount Mixer
By Loren Alldrin
- 39** Universal Audio Teletronix LA-2A Leveling Amplifier
By Ted Spencer
- 47** AKG C 900 Microphone
By Roger Williams III

Crane Song
Spider Rackmount
Mixer
Page 35

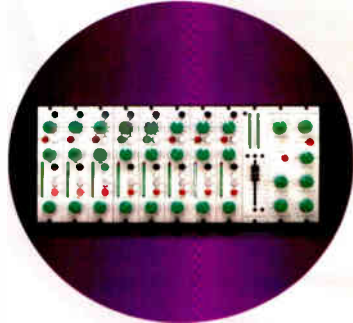

Universal Audio
LA-2A Compressor
Page 39



TC Helicon
VoicePrism Processor
Page 28

FEATURES

- 16** Book Review: "Producing in the Home Studio with Pro Tools" by David Franz
By J. Arif Verner
- 42** The Solid State of Tube Gear
By Nick Bailly

DEPARTMENTS

- 6** Publisher's Page
- 8** Out of the Box
- 18** Single Slice
Puddle of Mudd's "Drift & Die"
- 32** PAR Files
Lincoln Theater
- 38** The High End
Bel Canto's eVolutionary Amplifier
- 49** Two-Track Recorders Buyers Guide
- 58** MicroViews



MUSICIAN'S FRIEND

Apply Today!
Musicians Friend Platinum Member
Make Your Purchase
INTEREST FREE FOR 6 MONTHS!
(On Purchases Over \$499)
FOR 3 MONTHS!
(On Purchases Over \$199)

NEW LOWER PRICE!

SAVE \$100



MACKIE®
Powered Plug-Ins, DSP Card Bundle UAD-1
PABH-700255 List \$999.00 ~~\$799.99~~ **\$699.99**



AKAI
professional

DPS24 24-Track Digital Personal Studio
PABH-242041 List \$5,499.00

CALL FOR SALE PRICE

Includes FREE Shockmount
\$100 Value!



C2000B Mic with FREE \$100 Shockmount
PABH-271165 ~~List \$482.00~~ **\$179.99**

PreSonus
Audio Electronics



ACP88 Eight-Channel Compressor/Gate
PABH-184109 List \$1,100.00 **\$899.99**

t.c. electronic
ULTIMATE SOUND MACHINES



Voice Prism Plus Voice Processor
PABH-183121 List \$1,898.00

CALL FOR SALE PRICE

SAVE \$50



Hafler
TA1600 Power Amp
PABH-480932 ~~List \$399.00~~ ~~\$299.99~~ **\$249.99**

FREE CATALOG!
One-Year Subscription!

OPEN
24 HOURS A DAY
7 DAYS A WEEK

WEEKLY WEB GIVEAWAY!
Win Up To \$1000 In FREE GEAR!

888.310.2959

musiciansfriend.com

READER SERVICE NUMBER 5

4 EASY WAYS TO ORDER!

- 1 Call: 888.310.2959
- 2 Click: www.musiciansfriend.com
- 3 Fax: 541.776.1370
- 4 Write: P.O. Box 4520
Medford, OR 97501

45-DAY DOUBLE GUARANTEE!

- Best Price Guarantee
- Money-Back Satisfaction Guarantee

SPEEDY DELIVERY!

- Most orders are shipped on the same day!
- Most items delivered in just 2 or 3 business days.

Limited to stock on hand; prices subject to change; standard catalog shipping rates apply. \$Additional delivery charges for 2-day service. *On orders received by 5pm Eastern Time, Monday through Friday.

To get your **FREE** Catalog subscription, fill out this handy coupon and mail to: Musicians Friend, Dept. CR, P.O. Box 4520, Medford, OR 97501

Name _____

Address _____

City _____ State _____ Zip Code _____

E-mail address _____

Area(s) of interest:

Studio (recording) Guitar Bass Keyboard Drums

Stage (PA, lights, etc.) DJ

SOURCE CODE: PABH



Tubes Glow in a Summer Swelter

Welcome to the dog days. As I write this column, there is a heat wave raging out-

side, so I will be quick about it.

We have a roundup of great reviews, including two buck-banging recorders, the \$1,999 Alesis HD24 multitrack hard disk recorder and HHB's BurnIt Plus CDR with more features than the old BurnIt — at a lower price. Also, Tom Jung dives into the Bel Canto Designs eVo digital amplifier with his High End column.

An interesting feature contained in this issue is Nick Bailly's report on the continued fascination with vintage and new tube audio gear. Sixty years later and pro tube gear is still going strong. It seems that today's audio engineers see tube equipment (microphones, compressors, preamps, etc.) as a perfect complement for the modicum of digital products out there, including consoles, recorders, workstations and software. Some digital software even seeks to emulate the "tube" sound.

THAT TUBE MAGIC

Companies such as Manley Labs, Groove Tubes, and D.W. Fearn carry on the vintage tube torch, steadfastly convinced that nothing sounds better when tube gear is designed correctly. The well-worn, but appropriate, terms are always used: "live," "real sounding," "three-dimensional," and, of course, "warm."

My favorite tube/digital pairing is taking a tube mic and or mic pre straight into the digital recorder. With acoustic guitars, the result is always a live-like character with a tinge of warmth that all-digital rigs cannot match.

The hi-fi tube aficionados are so passionate there is even a magazine dedicated to the "valve" art: Vacuum Tube Valley (www.vaccumtube.com). The quarterly magazine recounts tube history, reviews new products, and my favorite feature is the comparisons of old tubes vs. new tubes. Occasionally, there

are professional tube gear articles as well.

CDRS GALORE

Changing the subjects from tubes to tracks, if you take a look the two-track (or stereo) recorder Buyers Guide, you will spot the new trend: the low-cost proliferation of CDRs. Yeah, there are still analog cassettes and DATs around, but the CD burner is becoming king. I will bet that in a few years new DAT decks will be extremely hard to find.

Speaking of hard to find: Believe it or not folks, there are only two 1/4-inch, half-track recorders still made. Otari still offers its venerable MX-5050 10-inch reel deck. With its up to 15 ips record speed, dbx noise reduction, good sonics and beefy transport, the deck was a favorite of U.S. radio broadcasters. You can still get one for about, gulp, \$4,452! That is \$2,226 per track.

TASCAM is the only other company manufacturing a half-track, R-R — the BR20. Like the Otari, it is a 10-inch, 15 ips deck. It will set you back about \$3,400.

In my opinion, half-track R-Rs at 15 ips make great acoustic guitar and clean electric guitar recordings. I still keep my Technics 1520 in tip-top shape for just such recordings, though pinch rollers and spare parts are said to be hard to find

PRODUCT WATCH

In this column, I will occasionally mention products that have not yet been officially reviewed in PAR, but I have had a chance to check out. Since I am a Mac guy, my pick this month is Bias Peak 3.0.

Since version 1.5, I have always loved this intuitive, Macintosh-friendly recorder/editor/processor. The new one has the same feel, plus some cool new features, including a built-in mastering EQ and advanced VST routing matrix. The full review is scheduled in an upcoming issue near you.

John Gatski is publisher/executive editor of Pro Audio Review. And though encouraged to get a new audio computer, he steadfastly refuses to abandon his vintage 1996 Macintosh 7600.

PRO AUDIO REVIEW

Vol. 8 Issue 8 • August 2002

Evaluating audio products for professionals in commercial recording, broadcast production, audio for video/film, project studios, live sound, contracting and multimedia.

Publisher, Executive Editor: John Gatski ext. 119
e-mail: jgatski@aol.com
Associate Group Publisher: Nick Humbert
e-mail: n.humbert@audiomedia.com
Managing Editor: Brett Moss ext. 143
e-mail: bmoss@imaspub.com
Technical Editor: Edward J. Foster
Studio Editor: Steve Murphy
e-mail: smurph@smurphco.com
Technical Consultant: Tom Jung

Contributors: Bruce Bartlett, Dr. Frederick Bashour, Nick Bailly, Edd Forke, Edward J. Foster, Carlos Garza, Will James, Bob Katz, Bascom H. King, Daniel Kumin, Carl Lindemann, Russ Long, Glen O'Hara, Alan R. Peterson, Rich Rarey, Andrew Roberts, Alan Silverman, Mark Ulano, J. Arif Verner, Roger Williams, Tom Young

Production Director: Lisa McIntosh
Production Manager: Annette Linn
Ad Traffic Manager: Kathy Jackson
Publication Manager: Carolina Schierholz
Product Showcase:
Classified Coordinator: Angela Washington
Graphic Designer: Joaquin Araya

President/CEO: Stevan B. Dana
VP: Carmel King
COO/Editorial Director: Marlene Lane
Sales Director: Eric Trabb
National Sales Manager: Alan Carter ext. 111
West Coast Sales: Paul DaCruz 707-789-0263
Ad Coordinator: Joanne Munroe ext. 152
Dir. of Marketing and Circ.: Sheryl Unangst ext. 164
Senior Circulation:
Fulfillment Mgr.: David Fisher ext. 167
Corporate Marketing Mgr.: Amy Gutowski ext.123

Extensions refer to office number 703-998-7600



PRO AUDIO REVIEW (ISSN 1083-6241) is published monthly by IMAS Publishing Group, 5827 Columbia Pike, First Floor, Falls Church, Va. 22041.

Phone: 703-998-7600 Fax: 703-998-2966

Periodicals postage paid at Falls Church, VA 22046 and additional mailing offices. POSTMASTER: Send address changes to Pro Audio Review, P.O. Box 1214, Falls Church, Va. 22041.

©2002 by JRS Publishing, Inc. All rights reserved.

REPRINTS: Reprints of all articles in this issue are available. Contact the author and Joanne Munroe (ext. 152) at Pro Audio Review.

Printed In The U.S.A.



TASCAM DM-24: The Affordable Luxury Console Is Here



Luxury usually comes with a hefty price tag. Not so with the new TASCAM DM-24 32-Channel 8-Bus Digital Mixing Console.

The DM-24's features are usually reserved for super high-end mixers. With 24-bit/up to 96kHz digital audio, the DM-24 blows away the standards in sonic quality for affordable consoles. With its internal automation, you'll get more power at your fingertips than you would from those huge consoles in commercial facilities. With some of the finest spatial and modeling processing from TC Works™ and Antares™, you can create fully polished productions without ever going to the

rack. With incredibly flexible routing, fully parametric EQ, machine control capabilities, touch-sensitive motorized faders, and lots of audio interfaces, you can integrate the DM-24 into any studio environment.

Whether you're working with standalone hard disk recorders, DAW systems, MDMs or analog tape, the DM-24 is optimized to be the very best choice in consoles designed for 24-track recording. Ready to get everything you ever wanted (and more) in a digital console? Get the DM-24 today at your authorized TASCAM dealer.

DM-24 DIGITAL MIXING CONSOLE

NEW! Version 1.6 Software Update!

- 16 more channels at mixdown (total of 48)
- New MIDI Machine Control capabilities, including compatibility with Mackie™ hard disk recorders
- New routing features, including eight more post-fader aux sends, 24-track simultaneous recording, and stereo bus signal routing to the multitrack I/O
- Enhanced user interface
- "Keep" and "Touch" automation features now available

And there's more! Visit www.tascam.com to get all the info on v1.6, download the file and update the DM-24 via MIDI.

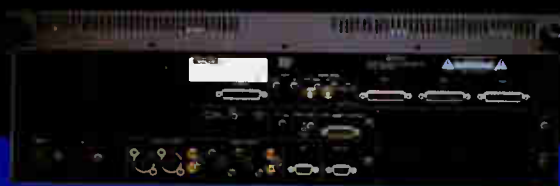

The DM-24's rear panel includes AES/EBU digital I/O, S/PDIF digital I/O, MIDI In, Out and Thru jacks, ADAT Optical input and output, external footswitch connector, time code input, GPI port, word sync in, out/thru, DTRS remote port, RS-422 9-pin control port, 24-channel TDIF I/O and more. Shown here with standard interfaces. Not luxurious enough? Customize your DM-24 with two expansion ports for extra analog, TDIF, ADAT or AES/EBU modules.

All trademarks are the property of their respective holders
www.tascam.com

TASCAM

a whole world of recording

Sterling Modular Swivel Wing Console

The latest addition to Sterling Modular's studio furniture line is the Swivel Wing Console. The Swivel Wing is designed for audio and video workstation use. Materials include heavy duty birch and maple plywood cabinetry and steel frames. Features include tiltable keyboard shelf, movable wings (motorizing the wings is an option), cable raceways, two 13RU rack boxes and articulating arms for speakers and video monitors. Options include a bridge, wing extensions, additional rack boxes, acoustically-damped rack box with glass door and additional monitor arms. Price starts at \$7,995.

Contact: Sterling Modular at 610-369-5802, www.sterlingmodular.com; or circle [Reader Service 61](#).



Tannoy V Series Sound Reinforcement Speakers

Tannoy's V Series is a family of mid-sized sound reinforcement speakers. Units range from an 8-inch all the way to an 18-inch model. The V8 (8-inch woofer) and V12 (12-inch woofer) both use Tannoy's Dual Concentric driver unit while the 15-inch V15 uses the new Power Dual driver. All three can also be used horizontally as stage monitors. The V18 is an 18-inch single driver subwoofer. The V300 is a dual 12-inch unit using the twin Super Dual drivers. All but the sub accommodate most installation and flying hardware. All units offer pole mounts, handles and are made of birch plywood with steel grilles. Prices: V8 - \$699; V12 - \$1,199; V15 - \$2,150; V300 - \$2,525; V18 - TBA.

Contact: Tannoy at 800-565-5253, www.tannoy.com; or circle [Reader Service 62](#).

M Audio Tampa Preamp

In a change from its traditional computer-oriented boxes and PCI cards, M Audio's Tampa preamp is a new direction. The Tampa is a Class A operator with the usual accoutrement of preamp features - 20 dB pads (input and output), low-cut filter, phase reverse, mic/DI switch and VU meter. To get that "tube" sound M Audio's engineers utilize what they call Temporal Harmonic Alignment processing. Extra goodies include variable impedance, an opto-compressor and, in a nod to the modern world, AES/EBU and S/PDIF digital outs (44.1 kHz, 48 kHz, 88.2 kHz and 96 kHz sample). Price: \$699.

Contact: M Audio at 626-445-2842, www.m-audio.com; or circle [Reader Service 63](#).



Groove Tubes GT6L6GE Pentode Tube

What's old is new again at Groove Tubes! The GT6L6GE is a recreation of the original 6L6 from General Electric. But it is more than a recreation! The GT6L6GE is actually built using many of the same machines used to create the original along with surviving supplies of the same original materials. The tube is compatible with any application where a 6L6/KT66/5881 tube would work. Prices: \$90 for a matched pair and \$180 for a quartet.

Contact: Groove Tubes at 818-361-4500, www.groovetubes.com; or circle [Reader Service 64](#).

Galaxy Audio Check Mate CM100 SPL Meter

An SPL meter is one of those tools everyone talks about but few have. Solve that dilemma with Galaxy Audio's new Check Mate CM100 SPL Meter. The CM100 is battery-powered and utilizes an electret microphone. It measures sound levels with a variety of criteria including A-weighted and C-weighted. Frequency range is from 31.5 Hz - 8 kHz while resolution is within 0.1 dB. Price: \$149.

Contact: Galaxy Audio at 316-263-2852, www.galaxyaudio.com; or circle [Reader Service 65](#).



MORE GUTS, MORE GLORY!

EMX

From cool-running, high-wattage power amps to premium SPX™ digital effects, Yamaha's six new EMX powered mixers are all about making your performances memorable. Building on our long track record of successful mixer designs, we've jam-packed these newest models with great practical features like a power amp mode selector; a standby switch; plenty of Low-Z, Hi-Z and Super Hi-Z inputs... even optional rackmount capability.* Yet, amazingly, they range in price from just \$499 to \$1299 (MSRP), a small price to pay for glory. Once again, Yamaha gives you more for less.

YAMAHA

CREATING 'KANDO' TOGETHER



BOX-STYLE EMX

EMX62M

- Single 200W amp†
- 4 XLR inputs
- 7-Band EQ
- 3 Digital effects
- \$499.00

EMX66M

- Dual 300W amps
- 6 XLR inputs
- Two 7-Band EQs
- 8 Digital effects
- \$649.00

EMX68S

- Dual 400W amps
- 6 XLR inputs
- Two 7-Band EQs
- 16 SPX digital effects
- \$799.00

EMX88S

- Dual 400W amps
- 8 XLR inputs
- Two 7-Band EQs
- 16 SPX digital effects
- \$899.00

Visit yamaha.com/proaudio for complete specifications.

©2002 Yamaha Corporation of America, Pro Audio, P.O. Box 9901, Davis Park, CA 95618. www.yamaha.com/proaudio. For information, call (877) OMA894. Yamaha is a registered trademark of Yamaha Corporation. All rights reserved.

†EMX62M is not equal mountable. All prices listed in dollars & cents.



CONSOLE-STYLE EMX

EMX5000-12

- Dual 500W amps
- 12 inputs
- 9-Band EQ
- 32 SPX digital effects
- LF crossover for subs
- \$999.00

EMX5000-20

- Dual 500W amps
- 20 inputs
- 9-Band EQ
- 32 SPX digital effects
- LF crossover for subs
- \$1,299.00



Club Series Speakers

YSP (Yamaha Speaker Processing) circuitry built into every new EMX model, enhances the performance of Club Series speakers, Yamaha's renowned sound reinforcement workhorses.

Alesis HD24 Hard Disk Recorder

On the Bench Page 14

BY DAVID CHRISTOPHER

It has been quite awhile since Alesis introduced the ADAT multitrack tape cassette recorder, changing the project studio landscape overnight by offering a relatively inexpensive way to enter the multitrack digital realm.

But, times change and the world of audio-tape is slowly fading into oblivion, its popularity usurped by the ever more affordable hard disk.

Realizing it must adapt to the changing audio landscape, Alesis has developed and brought to market the HD24 (\$2,499), a 24-track digital hard disk recorder with some interesting new ideas and features not found on its most direct competitors.

FEATURES

The HD24 is a three RU, rackmountable unit weighing in at a relatively modest 21 pounds. As its name implies, the HD24 is a 24-track digital recorder that records at 24-bit on standard IDE hard drives, even drives running at 5400 RPM. This allows for a cost per track that beats the previous ADAT tape format. Recording at 48 kHz, a 10 GB hard drive will give you 45 minutes of 24-track recording time. The test machine came with a 20.5 GB drive, giving me roughly 90 minutes to play with right out of the box.

It's the way it writes data that makes the HD24 unique. Alesis developed a new method for storing data on hard drives, which it calls ADAT FST.

Traditional computers store information in fragments, taking your guitar solo, breaking it up into little pieces and storing it here and there so that the drive can fit as much information as possible. While this is fine for the traditional computer application, recording music in this fashion causes the drive to "trash" around looking to reassemble all



those scattered files into a music stream.

The HD24 writes in a more linear fashion, storing all the tracks of a song together. While this may lower the actual amount of data a drive can store, it makes life easier for the drive while allowing for quicker retrieval of data.

The hard drive is mounted in a removable caddy. This makes for simple drive swapping when you are trying to separate projects or if you find yourself filling them up at a rapid pace. Two caddies come as standard equipment so you will be able to keep both bays occupied should you find a need.

The machine is targeted at 44.1 kHz and 48 kHz sample rates. You can record at 88.2 and 96 kHz, but you are limited to 12 tracks and must use the digital inputs. There is an optional board available, the EC-2, which allows higher resolution recording through the analog inputs but the track limitation still exists. Consider this a fair tradeoff for the \$1,999 price.

The specs include a signal-to-noise ratio of 103 dB (A-weighted) and a THD+N of less than 0.003 per cent with a frequency response of 22 Hz to 22 kHz.

The front panel does a good job of keeping you informed without overwhelming you, a worthy feat when considering the amount of information being conveyed here. It includes buttons for transport control, locate, editing, clock source, sample rate selection and the utilities menu, as well as a host of other functions. You will also find 24 10-segment, peak

Fast Facts

Applications:
Studio

Key Features:
24-track, 24-bit digital recording; 44.1 kHz, 48 kHz, 88.2 kHz and 96 kHz sample rates; analog and digital I/O

Price:
\$2,499

Contact:
Alesis at 310-821-5000,
www.alesis.com; or circle
Reader Service 10.

reading meters and an arming button for each track located below them. All settings you have chosen, as well as time, song and hard drive information, are shown on the alphanumeric display.

The rear panel features 48 1/4-inch TRS jacks (24 input, 24 output) as well as three sets of ADAT lightpipe digital I/O, each handling eight channels. If you are building from the ground up and plan on using an analog console, be sure to consider the cost of cables in your budget. Also included is the ADAT sync in for connection to the Alesis BRC, and sync out for connecting multiple HD24s

continued on page 12 ►

A Killer Track Record.

The 7 Series. Professional cassette recorders from Denon.

Since 1953, when Denon first developed a professional-use tape recorder for broadcast, Denon has armed professionals with state-of-the-art cassette recorders. The 7 Series is no exception. With sound quality as our number one goal, we also work to develop user-friendly features. To manufacture rugged dependability. And to offer the kind of functional variety your industry demands. Since 1910, audio professionals have relied on Denon. The 7 Series is proof that you can, too.



DENON

Imagine what we'll do next

Number
One
番

www.denon.com • Denon Electronics, 19 Chapin Rd., Pine Brook, NJ 07058 (973) 396-0810

Denon Canada, Inc. 5505 Apple Creek Blvd. Markham, Ontario L3R 1B5 (905) 475-4085

World Radio History
READER SERVICE NUMBER 11

► *Alesis from page 10*

together, MIDI in and out, word clock in for external clocking and plugs for the included LRC remote control, and a punch switch for those who like to go it alone.

The last and perhaps most interesting feature on the back is the Ethernet connection. This allows the transfer of sound files to your computer for complex editing as well as transfer via the Internet if you are working on a project with someone in another part of the world.

And if using FTP is too slow for your tastes, Alesis is working on a quicker way to move files to your PC. The manufacturer is currently beta testing new PC software and an external drive bay that would allow drive swapping. When it is time to transfer, just pull your drive from the HD24 and plug it into your PC. It needs to be pointed out that the HD24 drive being placed into a PC will not be the main system drive but a supplemental drive.

Software upgrades can be done via MIDI or through the Ethernet port if you would like to get it done a little faster.

Also included is the LRC (Little Remote Control), which contains the basic transport controls as well as buttons for loop and locate functions. If you desire to keep the HD24 in another room or just want more function at your fingertips, the optional BRC (Big Remote Control) is available.

IN USE

My first experiment involved a simple transfer of some final mixes from my computer into the HD24. With my original setup, using a Mackie 24 x 8 mixer, use of the analog inputs was required and I fully anticipated some loss of quality during the process. But any degradation was minimal and would have been hard to discern in all but the most critical listening environments.

While I found the HD24 and Mackie to be a good combination, I really wanted the chance to record at 96 kHz to get a full appreciation of the machine. Fortunately, a solution appeared at the last minute when a friend purchased a TASCAM DM-24 digital mixing board and was gracious enough to allow me to experiment with it for a couple of days.

I later got a chance to revisit this test using the DM-24, which allowed for a digital transfer using the ADAT optical inputs. Comparisons between the original and this

new version revealed some subtle differences, yet choosing a favorite was more difficult than expected. Chalk this up to the quality of the Alesis converters, a thought that revisited my mind many times during the sessions.

Preparing for some multitrack recording gave me a chance to get familiar with the interface and find some interesting facets of the HD24s functionality.

One example is the track setup feature. In a bid to save hard disk space, you choose how many tracks you are going to use before you start. The options are 24, 16, 8, 4 and 2 tracks when recording at 44.1 kHz or 48 kHz (12, 8, 6 and 2 tracks when using higher resolutions). I like the idea but would like the ability to add tracks in the middle of a project should the need arise.

And it quickly became apparent how important the locate feature is. If you do not use it, getting to different parts of a song becomes a bit tedious. Alesis chose not to adopt the same functionality in the rewind and fast forward buttons that most computer systems use. Instead, they work in three ways. Push once and the track rewinds (or advances) five seconds, hold it down and it will scroll, hold with the stop button and it will scrub. Let go and it will stop. Want to rewind back to the beginning? You will find life much easier programming locate zero rather than pushing the rewind button for a few minutes.

My next bit of fun involved the editing feature. I recorded some individual parts and imported some others, and then I spliced them together into a finished song using the copy and paste functions much like a computer. While performing the same task on a computer would be much more efficient, the HD24 proved useful as an editor.

Finally, I recorded pieces using all 24 tracks to see if it would groan or creak or give me the odd error message. I also paid close attention to the quality of the individual tracks to see if any of my hard work during the recording process was getting lost upon playback. The recordings were excellent, a big improvement on the original ADAT system and on par with systems I have often dreamed I could afford. The beauty is, this time I could. And try as I might, I just could not get it to do anything foul that was not my own fault.

Testing the second drive bay meant finding an additional hard drive. After some digging, one was secured and mounted. This made backups a simple, painless process. A welcome feature indeed.

SUMMARY

Alesis is working hard to ensure the success of the HD24. Software upgrades have been quick in coming and the new EC-2 board option makes it even more competitive. Its user interface was a pleasure to deal with, leaving little time wasted on problem solving and more time making music. Sound quality was top notch, even at the lower sample rates that most people will be using. Add a MasterLink CD recorder and you have a quick, efficient way to steer your project from tracking to mixdown. Though it has taken Alesis awhile to come to the table, at least it showed up with a good hand.

David Christopher is a songwriter and producer. He has worked with artists including Eva Cassidy and Yvonne Charbonneau.

REVIEW SETUP

Shure KSM 44, SM-57, Oktava MC-012 microphones; Mackie 24 x 8 mixer; TASCAM DM-24 digital; Event PS-6 monitors; AKG K 240 headphones; Monster and BLUE cables; TC Electronics M3000 digital processor, FMR RNC compressor.

Product Points

ALESIS HD 24 HARD DISK RECORDER

Plus

- Works flawlessly
- Fully ADAT-compatible provides many features and functions in one box

Minus

- Some features still in beta

The Score

A worthy successor to Alesis's ADAT lineage.

TRUST YOUR MIX TO MIDAS

“Frankly, there is nothing that compares to the Venice in sound quality and size! And believe me, I’ve tried everything...”

Marvin Sutton, FOH engineer, Morgan Sound
Faith Hill/Tim McGraw



“I can honestly say that this is the sweetest sounding board I have tested.”

Jamie Rio, Technical Reviewer, Gig Magazine
Blue Barrel Jazz and Blues Festival

“We auditioned the Venice 240 at AES this year and were blown away!”

Marty Wentz, FOH Engineer
9-piece showband, “Which Doctor”

“I’ve dreamed of something like this, and now Midas has come through with its Venice series.”

Etienne Lemery, Technical Reviewer, SONO Mag World Edition

“This is an outstanding console! We’ve had it jammed to the max and it performs wonderfully! Truly a MIDAS!”

Jack Haffamier, Manager, Nelson Sound
Pasadena Pops/Wayne Newton/Jay Leno at Bally’s Events Center

“Keeping the show within budget. Saving the sound. Truly fantastic!”

Robbie McGrath
Peter Dinklage/Weezer US Tour

“This is the money! I had every single hole at the back of the Venice 320 filled with all the toys like Summits, Focusrite® and Drawmers®. I was running three sends back to stage for monitors, two for effects and the last for subs. DI outs to Pro Tools®. I was maxxed out, and it seemed to like it. I did too!”

Cristiano Avigni, FOH Engineer
Athena

To get your own Midas, call 1-800-392-3497 or visit us at www.midasconsoles.com

DESIGNED FOR A PURE PERFORMANCE

VENICE

ALESIS HD24 HARD DISK RECORDER



The Alesis HD24 is equipped with 24 channels of balanced analog input & output connectors. Digital I/O is in the form of the Alesis ADAT optical connectors. Since I did not have a way to convert ADAT to the AES/EBU format of my Audio Precision, Alesis agreed to loan me a prototype ADAT A14 so I could look at the digital I/O characteristics of the HD24.

Unlike some of the other recent tape and hard disk recorders that I have measured in my lab and have had somewhat of a difficult time figuring out how to make work, the HD24 rewarded me with immediate and intuitive functionality. As received, the HD24 was limited to a 48 kHz sampling frequency for analog I/O. In the digital I/O mode, the sampling frequency maximum is 96 kHz.

Since it is likely that the HD24 would be mostly used in the analog I/O mode, the following measurements were made in this mode. Frequency response for the sampling frequencies of 44.1 and 48 kHz are shown plotted in Figure 1. The frequency range is down to 10 kHz and is linear to best show the high frequency

rolloff shape. Square wave response was indicative of FIR digital filtering having symmetrical mirror image ringing at the beginning and end of each half cycle. Total harmonic distortion plus noise (THD+N) in a 22 kHz measuring bandwidth as a function of signal frequency and sampling frequency is shown in Figure 2. Figure 3 shows the reduction in distortion with input level for a 1 kHz tone for Channels 1, 2, 23, & 24 at a sampling frequency of 48 kHz. Checking other channels showed similar results, revealing good channel to channel similarity in the HD24. Both the A/D and D/A converters contribute to the increase in distortion as input level approaches full scale. Input/output linearity was quite good down to -110 dBFS. This is illustrated in Figure 4. Shown in the figure are the results for Channels 1 & 2 at a sampling frequency of 48 kHz. Channel separation varied with how far the channels are separated.

Not surprisingly, things really shine in the D/D mode with the HD24. Essentially, every measurement is just about at the threshold of my Audio Precision System Two Cascade measuring system. For example, the frequency response is ruler flat over the whole audio range. The distortion plus noise is close to the 24-bit limit and is plotted as a function of frequency in Figure 6.

— Bascom H. King

Bench Measurement



Figure 1: Frequency response at 44.1 kHz and 48 kHz.



Figure 2: THD+N as a function of signal frequency at 44.1 kHz and 48 kHz.

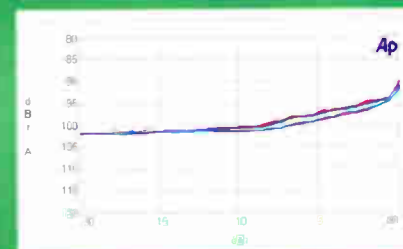

Figure 3: THD+N vs. input level for a 1 kHz tone at 48 kHz for Channels 1, 2, 23 and 24.

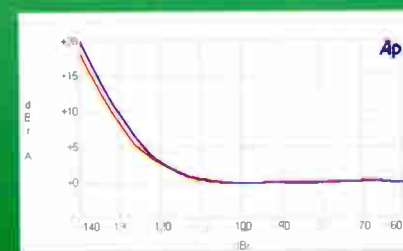

Figure 4: Deviation from linearity of a 1 kHz test signal for Channels 1 and 2 at 48 kHz.



Figure 5: Digital I/O THD vs. frequency at 96 kHz and at digital full scale.

[ANALOG/ANALOG I/O]	
OUTPUT LEVEL	6.69V, 18.7 dBu
18.7 dBu in, 44.1/48 kHz	
INPUT IMPEDANCE	20.0 kilohm
44.1/48 kHz	
OUTPUT IMPEDANCE	440 ohm
44.1/48 kHz	
FREQUENCY RESPONSE	+0.0, -0.25 dB 20 Hz - 20.0 kHz
44.1 kHz	-3.0 dB @ 21.0 kHz
48 kHz	+0.0, -0.25 dB 20 Hz - 20.0 kHz
	-3.0 dB @ 22.7 kHz
TOTAL HARMONIC DISTORTION	< 0.003% 20 Hz - 17.0 kHz
44.1 kHz	< 0.015% @ 20.0 kHz
48 kHz	< 0.003% 20 Hz - 19.0 kHz
	< 0.15% @ 22.0 kHz
LINEARITY ERROR	+/- 0.5 dB 0 to -110 dBFS
44.1/48 kHz	< +10.0 dB @ -130 dBFS

continued on page 16 >



Ready?

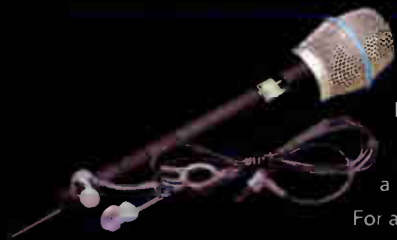

Of course. When you rely on wireless touring gear with a truly legendary reputation, you're always ready. Night after night, the unbeatable combination of Shure UHF Series Wireless Microphones and PSM 700 Personal Monitors delivers the sound that meets your high standards. New ultra-wide frequency bands for our UHF Wireless Series give you more simultaneous systems than ever, and the exclusive frequency locator feature built into every PSM 700 receiver lets you find a clear channel, fast. Total reliability, minimum hassle. All the audience hears is performance.

For additional detailed information on any of our professional touring sound products, visit www.shure.com.

SHURE
It's Your Sound

READER SERVICE NUMBER 15

World Radio History

Producing in the Home Studio with Pro Tools

Newcomers looking to get their feet wet in the world of Pro Tools LE have come to the right place. *Producing in the Home Studio with Pro Tools* by David Franz (\$34.95, published by Berklee Press) is the perfect introduction to Digidesign's ubiquitous software.

The book offers a kind of "quick start" for both PC and Mac users. Fortunately, it's not a rehash of the manual but rather it walks you through a typical session. The first part, "Getting Started," covers all the basics information. Franz discusses how a studio is connected, setting up a listening environment, and establishing proper signal levels.

The next section, "Preproduction," delves further into planning and budgeting projects, songwriting and arranging concepts, scheduling sessions and rehearsals. Moving on to "Production," the author

talks about improving system performance. This is helpful information since Pro Tools LE and Pro Tools Free are host-based applications.

The last section, "Postproduction," deals with issues of mixing and mastering. As to be expected, effects and dynamics are covered along with Pro Tools automation.

The book comes with an accompanying CD-ROM. The disc includes a copy of Pro Tools Free along with plug-in demos and product literature.

Producing in the Home Studio with Pro Tools is easy to read and all the basic topics are covered. Professional engineers, however, looking for information on HD or Mix systems, TDM architecture or advanced applications will need to look elsewhere.

— J. Arif Verner

Contact: Berklee Press at 617-747-2146, www.berkleepress.com; or circle **Reader Service 16**.

ALESIS HD24 Hard Disk Recorder

► Bench Table from page 14

SIGNAL TO NOISE RATIO	
44.1 kHz	
Wideband	72.0 dB
A weighted	102.0 dB
48 kHz	
Wideband	72.0 dB
A weighted	103.0 dB
DYNAMIC RANGE	
THD+N of a 1 kHz	
-60 dBFS signal in	
a 22 kHz + A wtd	
Measurement Bandwidth	
44.1/48 kHz	101.0 dB
QUANTIZATION NOISE	
THD+N of a 20 Hz	
tone at 0 dBFS in	
a 400 Hz to 22 kHz	
Measurement Bandwidth	
44.1 kHz	-100.5 dBFS
48 kHz	-100.7 dBFS
CHANNEL SEPARATION	
Adjacent channels	
44.1/48 kHz	> 80 dB 20 Hz - 2.0 kHz
	> 60 dB @ 20.0 kHz
Separated by one channel	
44.1/48 kHz	> 100 dB 20 Hz - 20.0 kHz
Channels 1 & 8	
44.1/48 kHz	> 110 dB 20 Hz - 12.0 kHz
	> 107 dB @ 20.0 kHz
[DIGITAL/DIGITAL I/O]	
FREQUENCY RESPONSE	
44.1 kHz	< +/- 0.025 dB 10 Hz - 20.7 kHz
48 kHz	< +/- 0.025 dB 10 Hz - 22.5 kHz
96 kHz	< +/- 0.025 dB 10 Hz - 45.0 kHz
TOTAL HARMONIC DISTORTION + NOISE	
44.1 kHz	< 139 dBFS 10 Hz - 20.7 kHz
48 kHz	< 139 dBFS 10 Hz - 22.5 kHz
96 kHz	< 139 dBFS 10 Hz - 45.0 kHz
CHANNEL SEPARATION	
Adjacent channel,	
Ch 1 > 2 & 2 > 1	
44.1 kHz	> 155 dB 10 Hz - 20.7 kHz
48 kHz	> 155 dB 10 Hz - 22.5 kHz
96 kHz	> 155 dB 10 Hz - 45.0 kHz

Note: Unless otherwise noted, all measurements are for channels 1 & 2. Digital I/O measurements made with Alesis ADAT A14 Beta ADAT-AES/EBU converter. Word length of digital audio test signal was 24 bit.

Go wherever the music takes you.



ProComm™ Professional Wireless
Microphone Systems by Peavey



When the show's rolling, everybody's moving, including you. You want to work the stage, touch the whole crowd. And the only thing stopping you is the cord that's got you tethered like a dog on a leash. Peavey's ProComm wireless microphone systems will set you free. Need a hand-held, headset or lavalier mic – even a guitar set-up? We've got you covered. All of our systems come in three configurations to suit any need: VHF and UHF single-channel true diversity or 30-channel UHF. And our transmitters are designed with muting circuits to reduce RF noise and lengthen battery life. Want to *really* touch your audience? Get a ProComm wireless microphone from Peavey.



See the ProComm online at www.peavey.com and click "Dealer Locator" to find a dealer near you.

LISTEN TO THIS™



Single Slice

BY CHUCK TAYLOR

Puddle of Mudd's "Drift & Die"



SINGLE: "Drift & Die"

ALBUM: *Come Clean* (Flawless/Geffen/Interscope Records)

DATE RECORDED: March 2001

ENGINEER: John Kurzweg

PREVIOUS PROJECTS: Creed, Eagle-Eye Cherry, Social Burn

SINGLE SONGWRITERS: Wesley Scantlin, Jimmy Stewart

SINGLE PRODUCER: John Kurzweg

MASTERING ENGINEER: Vlado Meller

STUDIO: Third Stone Recording, Los Angeles; except for drums, which were tracked at NRG Studios, Los Angeles

INSTRUMENTS: Electric and acoustic guitars, drum kit, bass, cello sample

CONSOLE: Customized Neve

RECORDER: Studer two-inch tape deck for drums, otherwise 24-bit Digidesign Pro Tools

MONITORS: Hafler TRM-8s

MICROPHONES: Shure SM7 for vocals, Shure SM57 on snare and most guitars, Shure Beta 52, Sennheiser 421, AKG C 12, Neumann 84

MICROPHONE PREAMPS: guitars and most drums on Neve 1066, API 512 for snare drum

PROCESSORS: Tube Tech CL1B compressor, GML stereo compressor, Empirical Labs EL8 Distressor compressor

Engineer's Diary

When producer/engineer John Kurzweg was asked to get his hands dirty with Puddle Of Mudd, it took him one listen to the Los Angeles band's demo to know they were onto something — in particular with the raw version of "Drift & Die." "It had a huge vibe of the things that were good about late '60s and early '70s rock, with a touch of new rock," Kurzweg says. "That really appealed to me."

It turns out that appeal was universal: the song reached the top 5 on Billboard's Mainstream Rock and Modern Rock Tracks charts and helped propel Puddle of Mudd's debut *Come Clean*, to double-platinum status. But like many hit songs, "Drift & Die" went through a mighty metamorphosis before the public got a first listen. When it was first tracked, lead singer Wes Scantlin made sure there were plenty of extra elements for Kurzweg to play with to build the song. "It literally existed in several forms for a few days," he explains. "The first thing I did was sneak the drums in sooner, and make parts of the backing band a little less repetitive. Then we added a lot of vocal overdubs throughout; there were a lot of things in Pro Tools to fool around with."

Kurzweg also added a sampled cello and, to boost the center guitar solo, ran it through any number of effects, including a "wah-wah," to make it more unique. Unlike many behind the board, Kurzweg has enjoyed the rare advantage of producing most of the projects he engineers, including rock giant Creed, with whom he has worked since the band's first album in 1996. "The people that I learned from when I was first banging around were like that," he says. "A lot of it was budgetary, so I learned the business wearing two hats at once."



Photo: CeCe Kern Kurzweg

John Kurzweg

Chuck Taylor, a regular contributor to *Pro Audio Review*, is senior editor at *Billboard* magazine in New York.

BRYSTON



www.bryston.ca

14B ST

BRYSTON

Bryston Limited P.O. Box 2170, 677 Neal Drive, Peterborough, Ontario Canada K9J 7Y4
1-800-632-8217 www.bryston.ca

TAKING POWER TO THE NEXT LEVEL.

READER SERVICE NUMBER 190

Midas Venice 320 Console

BY DAVID RITTENHOUSE

Midas, a name that has been synonymous with large, high-end touring consoles, now offers a line of small frame mixers, the Venice series. The three variants of Venice (160, 240, and 320) differ only in their numbers of mono inputs, 8, 16, and 24 respectively. The 320 (\$5,325), the big brother of the three is the one reviewed here.

FEATURES

The Venice 320 has 24 mono mic and line inputs, four stereo input channels that feature the same mic pre as the mono channel including a high-pass filter. In addition there are four stereo line inputs (two line-level inputs to accept stereo signals) it also has six auxes - two pre, two post, and two switchable. There are four subgroups, master stereo, and master "b" output which is switchable mono/stereo, pre or post fader, and an extra 10dB of gain on the output, plus direct outs from all 24 mono mic inputs. Back panel connections are as follows: subgroups have four impedance balanced 1/4-inch jacks; the two pre-fader mono send have two balanced XLR jacks; the two post-fader aux has two 1/4-inch balanced jacks, the two independently switchable pre/post aux sends, stereo master, and master "b" out, are all on balanced XLRs. Inserts are available for all 24 mono inputs, subgroups and master stereo out via single point 1/4-inch jacks. There are also two stereo 1/4-inch headphone jacks switchable PFL/AFL.

Input gain for a mic is continuously variable from 0 dB to +60 dB, as with line input in a mono channel from -20 dB to +40 dB. Phantom power (48V) is switchable individually per channel and controlled from a switch on the rear connector panel with a 48V status LED on the top

panel for each channel. Input line level (0 dB) into a stereo channel is continuously variable from -10 to +20 dB.

The most important and impressive feature is the quality of the mic preamps. All of the Venice series consoles have been equipped with the same XL4 preamps from their larger cousin. The XL4s can handle a maximum input level of +22 dB from 15 Hz to 100 kHz. Cross talk at 1 kHz was rated at <-80 dB channel to channel.

The EQ has incredible sound and versatility. The EQ on the mono channels starts off with a 2nd order Butterworth high-pass filter at 80 Hz. Treble is ± 15 dB at 12 kHz (shelving). High-mid and low-mid are both ± 15 dB, with continuously variable frequency selection. High-mid at 400 Hz to 8 kHz (one octave bandwidth) and low-mid at 100 Hz to 2 kHz (one octave bandwidth). Bass is ± 15 dB at 80 Hz (shelving). The EQ on the stereo channels is as follows: treble at ± 15 dB at 12 kHz (shelving), high-mid at ± 15 dB at 3 kHz (one-four octaves BW), low-mid at ± 15 dB at 300 Hz (one-four octaves BW), and bass at ± 15 dB at 80 Hz (shelving). There is an individual EQ "on" switch for each input strip.

Each input is fitted with its own pan knob, mute and solo switch. Group assign-

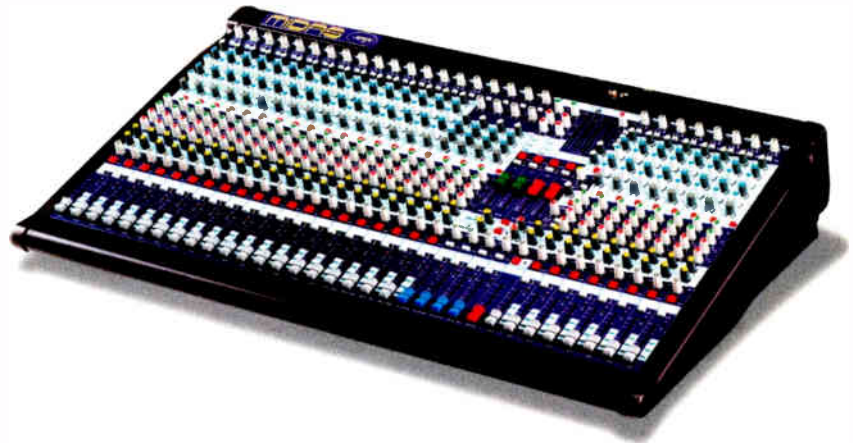

Fast Facts

Applications:

Live audio, front of house, monitor, or both, and sidecar to a larger console; small venue installation, corporate and touring audio.

Key Features:

24 mono, four stereo inputs, four group, two stereo, six aux outputs, XL4 preamps., XL3/XL4 four-band state variable EQ, talkback section

Price:

Venice 160 - \$3,158, 240 - \$4,325, 320 - \$5,325

Contact:

Midas at 800-392-3497 ext 4482, www.midasconsoles.com; or circle Reader Service 20.

ments are switched as 1-2, 3-4 and/or master. It is possible to choose the solo signal to be PFL or AFL at the master headphone out. Incoming signal to both mono and stereo channels is displayed with two LED's. Green for signal preset and red for peak signal. The Venice is also outfitted with long-life "super-slide" *continued on page 22* ►

A complete 1000 watt system!

Whether it's for your band, church or school, Carvin's PA800/PA1200 package systems allow you to run the whole group in stereo while powering your monitors! The lightweight mixer pumps out 1000w RMS from three amps delivering 333w each. You also get two built-in 24-Bit digital multi-effects processors with over 256 effects each!

There has never been a system so easy to use with so much clarity, power and flexibility! Discover the complete line of Carvin sound packages for "matched system" performance.

PA SERIES 8 and 12 CHANNEL MIXERS:

- Three high current power amps – R-L/Monitor
- 1000w RMS – 333w per amp at 4Ω
- Two 24-Bit stereo effects processors
- Assign any channel to effects 1 or 2
- Assignable 9-Band EQ's – mains or main/monitor
- Super quiet, high-headroom mic/line pre-amps
- Three Band channel EQ @ 80Hz, 750Hz and 11.5k Hz
- Balanced XLR line outputs, RCA In/Out connectors
- Easy to use and carry. These compact mixers weigh only 28 lb.
- Engineered with double sided copper FR-4 military spec cards and SMT construction for rock-solid reliability and interference free performance.
- Continuous full RMS power is assured from the 6063-T5 aluminum heat sink cooled by a quiet dual-speed fan.

832 15" SPEAKERS and 722 12" MONITORS:

- Deep bass punch with crystal clear highs for exceptional clarity
- High power handling 832: 400 watts, 722: 300 watts
- Strong, lightweight plywood construction, covered with Duratuff II™ and protected with steel corners and grills • Stand-mount inserts

CARVIN

CARVIN

832 Speakers



optional SS20 stands

optional MS13 stands

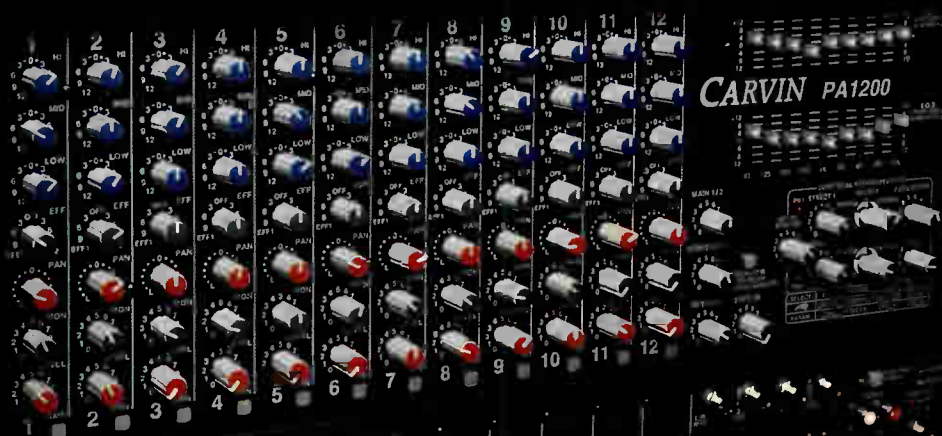

CARVIN

722 Monitors

8 CH Mixer PA800 \$669⁹⁹ 12 CH Mixer PA1200 \$769⁹⁹

Package System including monitors 1200P-832-722 \$1659⁹⁹

- 1000W PA1200 mixer • Two 832 400W speakers
- Two 722 300W monitors • Two CM50 mics • Two 20ft XLR mic cables • Four PH50 speaker cables



CARVIN
800.854.2235

To ORDER, SPECS or for a FREE catalog carvin.com/pro_sound
WORLD'S #1 FACTORY DIRECT MUSIC STORE
Enter carvin.com's weekly FREE GEAR giveaway!

► *Midas from page 20*
faders from ALPS.

The comprehensive master section on Venice features four high-resolution LED bargraphs. These meter monitor 1 and 2 as well as master left and right. The monitor bargraph is automatically switched to solo (PFL or AFL) if any channel solo button is

I was truly impressed with the Midas' overall sonic performance.

engaged. The four subgroups can be routed to the stereo master or used as independent outputs from the rear connector panel. An XLR talk back input is also provided on the front surface and controlled with a rotary pot for gain. The talkback may be routed via a series of nonlatching switches to monitors, aux groups, and masters. Dimensions for this small wonder are only 35.7 inches wide x 22.4 inches deep x 7.6 inches tall, and the 320 weighs only 57 pounds.

IN USE

The Midas console was used on a variety of shows over two months. The Venice is beautifully versatile; covering the gamut of corporate audio, satellite linked teleconferences, to the straightforward rock-n-roll gig. The aux setup allows the Venice to perform as either front of house, monitor, or both.

It performed flawlessly at a corporate awards show, using multiple lavalier mics, lectern and standard CD playback. I have always been a huge fan of the clarity and accuracy of the Midas EQs. This smaller Venice console was no exception. I liked the control and performance of a larger console in a compact form. This way I do not have to lug around an XL3 (or other same-sized console) to a show where I know I will only have 20 inputs; yet I keep all the qualities of that larger version.

I was able to group the lavaliers and lectern mics separately and insert a parametric EQ over each group. I was truly impressed with the over all sonic performance. There was nothing lacking and the mic preamps held up to the "Midas sound."

I also used it with a wedding/cover band. The Venice met all my needs for this show. It was both the front of house and four-mix monitor console - driving BSS compressors and EQs to QSC PowerLight 3.4 and 4.0 amps and six EAW KF 300 speakers as the main system. I wanted to hear how a drum kit sounded with the Venice. Well, in a word... Perfect! The sonic perfection really shows through on a properly gated kick drum. The EQ is transparent in its colorization and the clarity of the XL4 pres was amazing. Just that slight 3 - 4 dB bump at 6 kHz was accurate and appropriate to brighten up the vocals over top the searing bass lines of the 70s funk medley.

Monitor functionally was easy. I ran four mixes (prefader) into BSS FDS-355 Omnidrive processor, BGW GT amps, and then into EAW SM500 speakers (biamped). I still had two auxes left to run signal to Yamaha SPX 990 and Lexicon PCM 80 effects units. Everything needed in a small frame console without sacrificing the sound quality. The band was happy and so was I.

Finally, on a large, multiple room conference all inputs and outputs were fully loaded and I fed a Drawmer DA6 distribution amp from the stereo master "b" for extra outputs. The Venice held its purity of audio quality - even when connected to multiple sources. The feeds to and from video and the satellite link were not jeopardized due to an inferior console. It is in these situations that you enjoy the sound of silence from the Venice; when you know silence is all that is supposed to be heard.

The only down side to the Venice 320 was the fact that the console is without a matrix. The stereo master "b" is a great functioning extra output that can be use to feed a distribution amp or the Midas XL88 (outboard matrix), but it still does not act as a multisource matrix itself. I also found that the 48V phantom power switch (per channel) is located on the rear connector panel and not on the front console surface where it would be more accessi-

ble. Those negatives aside, the Venice 320 was a trooper and took everything I could throw at it.

SUMMARY

Overall, in the large market of small consoles, Midas has made the Venice series with a welcome quality the others do not have. Midas's motto of "pure performance" holds true with the Venice 160, 240, and 320. The versatility, sonic superiority and logical layout should make the Venice a want of any club, small sound company or sidecar to the touring professional. If the price tag looks a little high (\$5,325 list) it is; but it is also well worth it.

David Rittenhouse is the chief engineer at RCI Sound Systems and a regular contributor to Pro Audio Review.

REVIEW SETUP

BSS FDS-355 Omnidrive Compact processor, FCS-966 graphic EQ, DPR-402 compressor; Yamaha SPX 990, Lexicon PCM 80 digital effects processors; QSC PowerLight 1.4, 3.4, 4.0, BGW GTC amplifiers; EAW SM500, KF 300 and RCI 390 speakers; Countryman Isomax IV, Shure Beta 58, Beta 85, SM57, SM58, SM85, Sony ECM-77, beyerdynamic M 88, M 160, Sennheiser MD421, ME 40 and AKG C 391 microphones; Countryman Type 85 DI box.

Product Points

MIDAS VENICE 320

Plus

- Excellent microphone preamps
- Brilliant EQ
- Versatility in a small footprint

Minus

- No matrix
- Phantom power switch placement

The Score

With a full palette of features and connections, the Midas Venice 320 is a great addition to the Midas console legacy.

Whirlwind PCDI and Direct2 DI Boxes



BY WILL JAMES

Whirlwind is widely known as an audio interface and snake purveyor of high-end quality. They now introduce two new items to their line, the PCDI and the Direct2.

FEATURES

The PCDI (\$199) and the Direct2 (\$199) are both housed in a very stout aluminum enclosure approximately 5 and 1/2 inches long by 3 inches wide and 1 and 1/2 inches tall. The PCDI is a gold-colored unit, featuring two XLR style recessed outputs, that are color coded as channel one being white and channel two being red. Located directly between the two XLR connectors are two similarly color-coded, recessed signal ground lift rocker switches. On the opposing side of the computer interface, are located the input connectors, which offer a single stereo (TRS)

A 1/8-inch connector serves as input for computer or CD player. Directly next to the 1/8-inch connector reside two stereo sets of RCA connectors, one set being input and the other set being a signal link, or pass through.

continued on page 30 ►

Applications:

PCDI for computer and CD player interface; Direct2 for stereo keyboards, stereo guitar rigs.

Key Features:

PCDI has 1/8-inch and RCA inputs; Direct2 has dual XLR connectors, color-coded I/O.

Price:

PCDI - \$199, Direct2 - \$199.

Contact:

Whirlwind at (716) 663-8820, www.whirlwindusa.com; or circle Reader Service 47.

Fast Facts

Still compromising
with a 'standard' Cardioid?

DPA
MICROPHONES

TYPE 4011 CARDIOID MICROPHONE

- ◆ Award winning technical performance
- ◆ Highest SPL handling
- ◆ Widest frequency range

and much, much more...

Never compromise on quality.
Visit dpamicrophones.com

DPA Microphones
335 Gage Ave., Suite #1 Kitchener, ON Canada N2M 5E1
Tel: (519)745-1158 Fax: (519)745-2364 Toll Free Dealer Faxline: (800)525-7081
e-mail: inquiries@tgina.com Literature requests: litplease@tgina.com

READER SERVICE NUMBER 23

ATI 8MX2 Preamp/Mixer

BY TOM YOUNG

ATI (Audio Toys, Inc.), manufacturer of the Paragon mixing console, has developed a rack-mountable, portable mixer/pre-amplifier using the same preamp design found in their high-end analog consoles. At a price of \$2,995 the ATI 8MX2 provides high performance in a compact package for use with hard disk or tape-based digital multitrack recorders for live music or location based sound recording. The ATI 8MX2 can be used as a stand alone eight-channel mixer. This device complements the sonic characteristics of a microphone and is a good choice for recording situations where natural sound is desired. The 8MX2, coupled with an analog or digital storage device, provides a fully featured integrated studio or location recording system.



FEATURES

The ATI 8MX2 is a very compact 1RU (11 inches deep). It weighs a mere seven pounds. The front panel has eight separate input control areas and a master section. Each input area has a switch for cue, phase reverse, return and mix. There are two dual concentric knobs controlling input gain (inner) with limiter threshold (outer) and mix level (inner) with mix pan (outer). All switches used on the 8MX2 are gold plated, self-cleaning and self-wiping. The potentiometers are rated for more than 10,000 cycles, making all controls of very high quality.

The master section front panel has a switch to determine monitoring of the mix output or the two-track return, with two more switches to select the signal to be metered and monitored. One switch selects channel return in monitor when cued and one for pre or post limiter cue select. There is one dual concentric rotary that controls mix level (inner) and mix pan (outer). A 1/4-inch stereo headphone jack with a level control pot is also included.

All signal levels are displayed on a 10-segment LED bargraph meter. An AC power switch toggle with an 'on' LED completes the master section.

The input gain is adjustable from +0 dB to +65 dB on a 41-position detented pot. This provides smooth control to easily repeat settings for various microphones. Also, with individual limiters on each channel and line level multitrack returns, it is clear that the 8MX2 is a very flexible well thought out device.

On the rear panel, each channel section has individual ground lift switches and a switch for 48V phantom power above the eight XLR connectors. Two nine-pin D-sub connectors are provided for linking additional units together. The channel outputs and channel return signals are carried via two 25-pin D-sub connectors. There are six TRS jacks on the back for monitor L/R, mix out L/R, and "2 TRK Ret" L/R. AC input is selectable between 118VAC or 240VAC with an operating range from -15 percent to +10 percent of nominal.

IN USE

I used the ATI 8MX2 while doing a rehearsal session for an upcoming Tony Bennett and kd Lang recording in New York. I recorded the tracks for a reference rehearsal tape.

Microphones that I am very familiar with sonically were plugged into the ATI 8MX2 preamps — Neumann KMS 105 on vocals,

LEARN the ART of RECORDING



RECORDING WORKSHOP

- The Original, founded 1971
- Effective, Hands-On Approach
- 2 Months, 300+ hrs Training
- 3 to 6 Students per Class
- 8 Studio Facility, Latest Gear
- Affordable Tuition
- Job Placement Assistance
- On-Campus Housing



RECORDING WORKSHOP
School of Audio & Music Production

Contact us for a Free Brochure

800-848-9900

www.recordingworkshop.com

email: info@recordingworkshop.com

Outside USA: 740-663-2544 Fax: 740-663-2427

455-P Massieville Road, Chillicothe OH 45601

Ohio State Board of Proprietary School Registration #80-07-0696T

READER SERVICE NUMBER 24

Fast Facts

Applications:

Live sound/location recording, studio

Key Features:

Eight channels, 48V phantom power, phase reverse, eight-channel multichannel output and return for recorders and workstations via 25-pin D-sub

Price:

\$2,995

Contact:

ATI at 301-776-7879, www.audiotoys.com, www.8mx2.com; or circle Reader Service 75.

Sennheiser MKH80 for piano, Sennheiser MKH800 on bass and snare Neumann KM184 for snare drum. The 8MX2 was then connected via a 25-pin D-sub to TRS cable to a Yamaha AW4416 digital audio workstation.

Upon initial listening to the microphones with headphones connected to the 8MX2, I was immediately impressed with the quietness of the unit. I then set nominal levels on the preamps and adjusted the microphone placements to achieve an attractive sound for each instrument. Even without using the EQ on the AW4416, the vocals and all the instruments had a very pleasant natural sound that complemented each instrument. The limiter was adjusted for the bass and snare microphones and provided a nice tight sound without diminishing the dynamics of the playing.

With 20 dB of headroom in the mic preamps, you really should not need the limiter in most cases. However, it is still nice to have the feature when recording to digital to prevent peaking - since distortion is very audible when digital signals are recorded too hot.

On another day of rehearsal, a film crew from ABC's 20/20 came to shoot for an upcoming segment. I gave them the mix out L/R from the 8MX2 and panned the vocals to left and the instruments to right for the audio feed sent to the video tape recorders. The 20/20 audio crew was knocked out with the quality of the sound they were getting. They

said that they could not believe the studio quality of the compact 8MX2, which would make the ATI unit an excellent choice for a remote mixer.

SUMMARY

The ATI 8MX2 rackmount, eight-channel preamp/mixer is a nice addition to any recording application. With true audio quality and flexibility, the 8MX2 contains an exceptional number of routing and mixing features for a single rack-space device. When recording, it presents integrity in the sound as

REVIEW SETUP

Yamaha AW4416 digital audio workstation; Neumann KMS 105, KM184, Sennheiser MKH80, MKH800 microphones; Sony MDR-7506 headphones.

natural as the original audio source — ideal in any recording situation, home studio or touring application.

Tom Young, a regular contributor to Pro Audio Review, is currently the live sound engineer for Tony Bennett.

SEE WHAT SUROUNDS YOU

LF		CNTR		RT		LS		RS		SUB	
20	20	20	20	20	20	20	20	20	20	20	20
18	18	18	18	18	18	18	18	18	18	18	18
16	16	16	16	16	16	16	16	16	16	16	16
14	14	14	14	14	14	14	14	14	14	14	14
12	12	12	12	12	12	12	12	12	12	12	12
10	10	10	10	10	10	10	10	10	10	10	10
8	8	8	8	8	8	8	8	8	8	8	8
6	6	6	6	6	6	6	6	6	6	6	6
4	4	4	4	4	4	4	4	4	4	4	4
2	2	2	2	2	2	2	2	2	2	2	2
0	0	0	0	0	0	0	0	0	0	0	0
-2	-2	-2	-2	-2	-2	-2	-2	-2	-2	-2	-2
-4	-4	-4	-4	-4	-4	-4	-4	-4	-4	-4	-4
-6	-6	-6	-6	-6	-6	-6	-6	-6	-6	-6	-6
-8	-8	-8	-8	-8	-8	-8	-8	-8	-8	-8	-8
-10	-10	-10	-10	-10	-10	-10	-10	-10	-10	-10	-10
-12	-12	-12	-12	-12	-12	-12	-12	-12	-12	-12	-12
-14	-14	-14	-14	-14	-14	-14	-14	-14	-14	-14	-14
-16	-16	-16	-16	-16	-16	-16	-16	-16	-16	-16	-16
-18	-18	-18	-18	-18	-18	-18	-18	-18	-18	-18	-18
-20	-20	-20	-20	-20	-20	-20	-20	-20	-20	-20	-20
-24	-24	-24	-24	-24	-24	-24	-24	-24	-24	-24	-24
-28	-28	-28	-28	-28	-28	-28	-28	-28	-28	-28	-28
-30	-30	-30	-30	-30	-30	-30	-30	-30	-30	-30	-30
-40	-40	-40	-40	-40	-40	-40	-40	-40	-40	-40	-40
-50	-50	-50	-50	-50	-50	-50	-50	-50	-50	-50	-50

- ◆ 5.1 Format Models
- ◆ 7.1 Format Models
- ◆ Medium Precision Models
- ◆ High Precision Models
- ◆ Console Top
- ◆ Vertical Displays
- ◆ IEC Standard Ballistics

Logitek

Call 800-231-5870 for more information or visit our website - www.logitekaudio.com

READER SERVICE NUMBER 25

HHB CDR830 BurnIT PLUS CD Recorder

BY ANDREW ROBERTS

When the HHB CDR830 BurnIT CD recorder was introduced two years ago, many users were disappointed that the original BurnIT (*PAR* 7/01) did not have the I/O and synchronization options needed for professional use. The latest version, the BurnIT PLUS (\$649), has added those features with substantial improvements over the BurnIT for \$50 less!

FEATURES

The CDR830 BurnIT PLUS has an extensive feature list, many of which are shared with its predecessor. For those of you not already familiar with the CDR830 family, I will briefly run through some of their shared capabilities and then talk about changes made to the PLUS. According to HHB, the BurnIT PLUS has many of the basics that the BurnIT had: two-rack-space chassis, a single drive, CD/CD-R/CD-RW capability, a full function remote, a substantial display window, and unbalanced analog and digital I/O. The unit has all kinds of handy features like text info capability, one track and all-track sync record, digital level adjustment, balance control, random track playback, fade in/out, skipping tracks, SCMS ignore/use, auto & manual track ID, blank space record, and the ability to check material at the end of an unfinalized CDR.

The front panel of the BurnIT PLUS contains a group of traditional transport controls, digital and analog level controls, a headphone jack and corresponding level control, scroll, display (elapsed track time/remaining track time/total disc playing time/etc.), title/mode (disc title/artist name/track title/case size), monitor (input source), erase (CD-RW), synchro, finalize, auto/manual (track ID) and input selector controls.

When it comes to I/O, the new BurnIT PLUS has all the bases covered. Passed on

from the BI are unbalanced analog RCA ins and outs and digital I/O via coaxial and optical S/PDIF connections. The BurnIT PLUS features balanced digital I/O (XLR), balanced analog I/O (XLR, mic/line adjustable), a word clock input (BNC) and a parallel remote port. A switch selects between S/PDIF and AES/EBU input.

IN USE

In the studio, the BurnIT PLUS proved very useful. I used it to make a CD from material in my computer. I simply patched the coax digital out of my MOTU 2408 to the HHB's coax input and selected the coax digital input using the input selector button. In this scenario, I was not able to utilize the HHB's synchro mode. Therefore, I resorted to manual operation. But the synchro function can be very handy. I used it while transferring a previously recorded live performance from DAT. Since my DAT tape already had track numbering and I wanted to transfer the entire performance, I chose

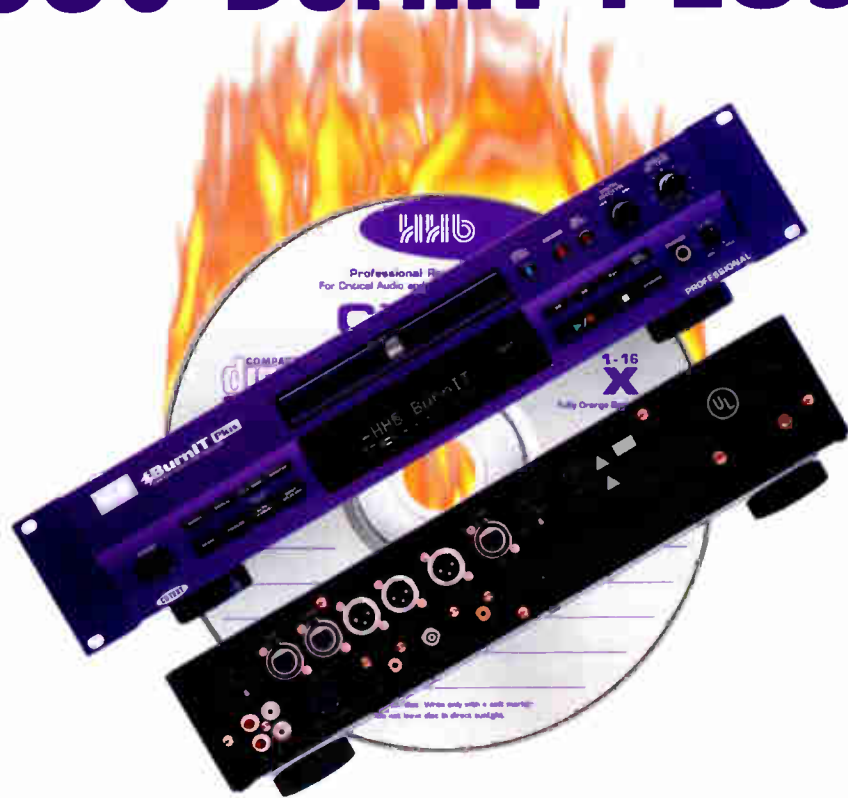

Fast Facts

Applications:
Studio, broadcast, live sound

Key Features:
CD-R/CD-RW formats, word clock, onboard sample rate converter, 24-bit A/D-D/A, defeatable SCMS, wide range of I/O options

Price:
\$649

Contact:
HHB at 805-579-6490,
www.hhbusa.com; or circle
Reader Service 26.

Sync-Final using the synchro button. As soon as the HHB detected input signal via the coax digital input, it went into record-play and began labeling the track IDs at the same time. When the tape was finished, the BurnIT PLUS finalized the disc automatically.

The BurnIT PLUS has a couple of features that make it very easy to create compilations. By using the Sync-1 setting, you can transfer audio and track ID, but the BurnIT PLUS will stop after only one track. Also, with a digital level control, you can compensate for discs that are much louder than others.

I also used the BurnIT PLUS at an all day music festival to make CDs of each performer's set. I patched the FOH console's mix output to the HHB's analog inputs and used the record manual mode. While this worked well, I had trouble with auto ID as the HHB was putting several songs under one track number. Adjusting the auto track ID threshold was very easy and remedied the problem.

My only real problem with the HHB was with the headphone amp. At a mix position 70 feet out from the speakers, with isolating phones and at very reasonable SPLs, I had a hard time hearing the program material — even with the headphone level control all the way up. Compared to the headphone amp in my console, the BurnIT PLUS's output was anemic.

SUMMARY

The HHB BurnIT PLUS is a truly professional CD player/recorder. With the additional I/O connections and word clock in, you can confidently bring it into nearly any professional recording situation. Hats off to HHB for making these additions to the original BurnIT. The new BurnIT PLUS is a reasonably priced unit that is easy to use and creates

high quality recordings. Recording studios, radio stations, sound companies, learning institutions and worship houses will find this unit to be an exceptional value.

Andrew Roberts, a regular contributor to Pro Audio Review, is a sound reinforcement and recording engineer.

REVIEW SETUP

Pentium III computer; Sonic Foundry CD Architect software, SoundForge 4.5 DAW software; MOTU 2408 interface; TASCAM DAP1 DAT recorder; Mackie SR24-4, Spirit 328 mixers; Mackie HR824 monitors; Audio-Technica ATH-M40 headphones.

Analog Perfection



P2 ANALOG **NEW!**

2-CHANNEL MICROPHONE PREAMPLIFIER

Discover how great your microphones and instruments really sound with preamps from True Systems. The new 2-channel P2 Analog features the same world-class mic and DI inputs, along with super-precision construction from the now-famous Precision 8, with the addition of several important advancements including stereo-phase correlation metering.

PRECISION 8

8-CHANNEL MICROPHONE PREAMPLIFIER



Need more inputs? The Precision 8 conserves studio space by offering eight channels in a single rack unit. The combination of MS decoding, DI inputs, advanced metering and unparalleled sound make this unit unique in the vast world of mic preamps. Either way, True Systems preamps give you the best possible sound with your mic collection.

TRUE
systems

Distributed by NeumannUSA • One Enterprise Drive • Old Lyme, CT 06371
Phone: 860-434-5220 • Fax: 860-434-3148 • Canada: Tel: 514-426-3013 • Fax: 514-426-3953
e-mail: info@neumannusa.com • www.neumannusa.com

READER SERVICE NUMBER 27

Product Points

HHB CDR830 BURNIT PLUS CD RECORDER

Plus

- Very versatile
- Affordable
- Easy to use

Minus

- Weak headphone amp

The Score

A very competent free-standing CD burner at a reasonable price.

TC Helicon VoicePrism Plus Vocal Processor

BY STEPHEN MURPHY

TC Helicon is a collaboration between TC Electronic of Denmark and IVL Technologies of Canada. TC Electronic's expertise in DSP wizardry is known worldwide; lesser-known IVL pioneered vocal pitch processing with Digitech's near-vintage Vocalist range. The VoicePrism Plus vocal channel, intelligent four-part harmony generator and dual effects processor is the prodigal child of this successful pairing.

FEATURES

VoicePrism Plus (\$1,898) is the updated version of the ground-breaking VoicePrism processor; the "Plus" indicates the addition of the Voicecraft card. The Voicecraft card is available separately (\$599) to update the earlier VoicePrism model.

The VoicePrism Plus' two-rack-space case has an angled front panel featuring a large LCD display, a data wheel for scrolling through presets and five dedicated buttons for browsing settings categories (shift, scale, manual, chord and effects). Four soft knobs below the display adjust various on-screen parameters. Additional edit buttons are used to access the individual sections of the processor (vocals, effects, comp/EQ, mix and Step). Input meters and a large numerical preset display are incorporated on the left side of the LCD screen.

Also on the front panel is a section for levels and utility functions which includes individual knobs for input, lead voice, harmony voices and effects levels. Additional buttons in this section control effect bypass, utility options, phantom power, help menus and preset management functions. An XLR for microphone input and a 1/4-inch stereo jack and level knob for headphones complete the front panel.

Connections on the rear panel include a single TRS 1/4-inch line in jack, a TRS 1/4-



inch aux in jack (for input to the effects section only), and two TRS 1/4-inch line outputs. The new Voicecraft card adds digital I/O on XLRs for AES and phono jacks for S/PDIF (full 24-bit) and changes the function of original S/PDIF output-only jack to provide access to the unprocessed mic/line (left) and aux (right) inputs — a nice touch. The unit operates at 44.1 kHz or 48 kHz internally, syncs to incoming digital audio and can dither its 24-bit output to 20, 16 or 8 bits.

A +4dBu/-10dBV input level switch, standard fuse-loaded IEC A/C jack, MIDI in/out/thru and a 1/4-inch footswitch jack for stepping through presets complete the back panel.

IN USE

The first item displayed upon powering up the VoicePrism Plus is the Preset screen. This general display shows the most important information about the preset in use, including key, harmony mode, scale type and number and type of harmony parts. Occasionally hilarious human head icons represent the gender and type of formant shifting for each the harmony parts (up to four) in the chosen preset. Other amusing head icons are available at the TC Helicon website (www.tc-helicon.com). The preset screen also displays the basics of the compressor, equalizer and dual effects sections.

The functions of the four soft knobs change depending on the preset selected and usually

Fast Facts

Applications:
Studio, live sound

Key Features:
44.1 kHz, 48 kHz sample rates,
48V phantom powered mic pre-amp, numerous voice manipulation effects, onboard digital processor effects, compressor

Price:
\$1,898

Contact:
TC Helicon at 805-373-1828,
www.tc-helicon.com; or circle
Reader Service 28.

represent the most frequently needed functions. Pushing in on the soft knob conveniently opens up a drop-down list of other functions that can be assigned to the soft knobs.

The aforementioned edit buttons access a set of layered parameter screens for fine-tuning the selected function. The first edit button, for example, is for adjusting Vocals and then navigating to the Harmony tab brings up four faces illustrating the gender of the backing parts. Using the soft knobs, it's possible to change the level, pan, gender and voicing of each part, and, as the gender value is changed, the little face icon morphs through its repertoire of facial types.

continued on page 30 ►

Over 10,000
channels installed

Millennia
Music & Media Systems

Telarc (50+ ch)
Barbra Streisand
Celine Dion
Sarah McLachlan
Shania Twain
Andrea Bocelli (32 ch)
Pavarotti
The Three Tenors
Academy Awards (72 ch)
Grammy Awards
MTV Music Awards
Jimmy Douglass
Los Angeles Philharmonic
San Francisco Symphony
Cleveland Orchestra
Baltimore Symphony
Seattle Symphony (24 ch)
Houston Grand Opera
Berlin Philharmonic
Czech Philharmonic (32 ch)
Dallas Symphony
New World Symphony
La Scalla Opera House
San Francisco Opera
L.A. Opera
Hollywood Bowl (54 ch)
Kennedy Center (24 ch)
Paramount Pictures
Skywalker Ranch
20th Century Fox
Sony Pictures
The White House
Bruce Swedien
Bob Clearmountain
Walter AfanasiEFF
Frank Serafine
Marc Anthony
Les Paul
NPR (80+ ch)
Keith Jarrett
Clair Brothers
Hans Zimmer
Walter Becker
Harmonia Mundi
George Benson
Koch Intl
Tom Jung DMP Records
BMG Studios NYC
Muscle Shoales Recording
Record Plant
Effanel Remote (24+ ch)
Dave Hewitt Remote (40 ch)
Sony Classical (16 ch)
Bose Lab. R & D (32 ch)
Dolby Labs R & D
B.L.U.E.
Josephson Mics
Royer Labs

HV-3D

Setting a standard
in critical
acoustic music recording
worldwide.

Renowned for effortless dynamics and extraordinary musical realism, the HV-3D offers four and eight channels of Millennia's sonically invisible HV-3 microphone preamplifiers newly packaged in a road hardened 26 pound steel chassis.

With over 10,000 channels now installed, the HV-3D is a first choice of the world's great symphony orchestras, major film scoring stages, and a who's who in discriminating acoustic recording.



Optional DPA (B&K) +130V mic inputs
Entirely shielded internal power supply
32 dBu output headroom — high current
23 dBu input headroom — no pads required
Optional "DC Inputs" — ideal for ribbon mics
Vintage-grade build quality and component selection
High resolution mil-spec gold gain switching (36 steps)



530.647.0750
Fax 647.9921

www.mil-media.com

Millennia Media, Inc.
Pleasant Valley, CA

► *TC Helicon from page 28*

The new Voicecraft board adds vocal modeling based on studies and samples of many different voice types. The subject of voice modeling and the technology implemented here could fill this whole magazine; fascinating stuff, but it'll have to wait for the *PAR* "Vocal Formant Synthesis and Glottal Analysis Issue." In brief, the near real time (surprisingly little delay) process maps formants and glottal sounds of the chosen voice type to those of the inputted voice. Additional adjustments for initial pitch-ins and vibrato modulation are based on the complex characteristics of actual voices.

On to the important bit: how does it sound? Let me start off by saying the TC reverbs and choruses within the dual effects processors are almost worth the street price on their own. Add in the vocal channel provisions (quality mic pre, compressor and EQ) and, of course, the powerful capabilities that define the main purpose of the box — vocal modeling and harmonies — and this versatile production tool is a bargain.

I found, like most audio processors and effects units, the VoicePrism Plus has the potential to be used for good or evil. In the wrong hands, over- or improper use of any processor can result in aural atrocities; the potential increases with the Grail-like nature of the VoicePrism Plus.

So let me start by bursting some bubbles: no, you can't input Bob Dylan's "voice like sand and glue" (to quote "Song for Dylan" by David Bowie) and output Vince Gill... thank God. But with realistic expectations and some finesse, this box can create tasteful

effects, fatten up lead vocals and add depth and life to layered harmonies.

I successfully used the VoicePrism Plus to do all of the above, and was impressed with the results. The trick is to start with decent tracks and know the limitations of what can and cannot be accomplished with this powerful tool.

I found that one of the best applications of the VoicePrism Plus was to use its harmony and vocal emulation capabilities to improve the otherwise "incestuous" sound that results when one person performs all the parts of a layered harmony (think Enya's "Sail Away"). As a recording artist as well as a recording engineer/producer, I often find myself in that exact situation, simply for the lack of proximate warm bodies who can sing. I mean, where are all the singers at four A.M. when you need them most?

The ability to fold in qualities of other male and/or female voices along with my own — complete with subtle timing, pitch and vibrato variations — quickly transformed a track I was working on from that "hey, look at me...I sang all the parts" sound to one that sounds very ensemble-like.

Again, it took some restraint and experimentation to reach the level of understanding necessary to produce results that sit imperceptibly in the mix.

Thankfully, TC includes lots of great presets with which to get started. These range from simple lead vocal thickening programs to full ensemble harmonies to truly bizarre effects. Experimenting with the presets and their respective settings for a few hours shortened the learning curve considerably. TC also includes an online context-sensitive help sys-

tem, accessible via a dedicated button on the front panel — definitely a nice touch.

My one wish for the VoicePrism Plus is that its XLR microphone input be located or duplicated on the back panel. Though not a major complaint, it is a bit inconvenient (and unattractive) for typical studio installations where existing mic runs terminate at the back of the rack; I cannot imagine the frontal location is that much more useful in live applications either.

SUMMARY

After spending some quality time experimenting, you can't help but learn the ways of VoicePrism Plus. Use that knowledge for good, not evil; the VoicePrism Plus will reward you with many voices of experience (and their relative harmonies).

The bottom line? When provided with decent source vocals and used with care, it is easy to see the VoicePrism Plus becoming an essential tool for many recording engineers and producers.

Stephen Murphy, contributing studio editor for PAR, has hundreds of vinyl and CD releases, including a Grammy Award-winning and a Platinum-selling album. Steve can be reached at smurph@smurphco.com.

REVIEW SETUP

Westlake 8.1, Mackie HR824 and TripleP Pyramid studio monitors; Hafler H3000 power amplifiers; Digidesign Pro Tools MixPlus workstation; Zaolla Silverline analog and digital cables

► *Whirlwind from page 23*

The Direct2 is a black box of identical material and size, but has matching black XLR style connectors and a handy silkscreened legend to define the signal ground lift switches. The opposing side of the Direct2 offers two pairs of 1/4-inch connectors, also allowing for signal input and pass through on two channels, with a 20 dB pad on each input.

IN USE

I used the PCDI on numerous occasions as a CD player, cassette deck and computer

interface to my Soundcraft Series Five FOH console (which has only XLR in). All the connectors were of excellent quality and made positive contact each time. I connected the Direct2 to several stereo keyboard rigs on quite a few shows, and again, found the connections to be solid and clean.

SUMMARY

The two devices from Whirlwind are very reliable, solid units. They are constructed with the highest quality parts and the housing is virtually indestructible. They are both well made, well-thought-out inter-

face devices, and both earn my highest recommendation.

Will James, owner and chief engineer of Atlantis Audio and Lighting, is a regular contributor to Pro Audio Review.

REVIEW SETUP

Soundcraft Series Five 48-channel FOH console; Korg 01W keyboard; Sony portable CD player; Macintosh G4 Powerbook computer; Rapco RoadHog mic and 1/4-inch patch cables.



...AND IT'S JUST AS GOOD AS BELDEN

Is it?

You just might get bitten if you are using anything other than Belden cable. Ask your cable manufacturer to prove the performance. Ask whether they have an extensive design for manufacturability process that eliminates problems before the first cable is made. Ask about their sigma goals and how they are achieving customer satisfaction. Ask whether they can demonstrate that the performance they certify on the spool is the performance you will get when the cable is installed.

Because one cable manufacturer is dedicated to making sure the installed performance of your cable matches your expectations, every time, without exceptions. That manufacturer is Belden. Use anything else, and you just might get bitten.

To find out more about how we can help you, contact Belden at [1-800-BELDEN-4](tel:1-800-BELDEN-4), or visit us at www.belden.com.



1-800-BELDEN-4
www.belden.com

Performance Delivers The Future™

PARfiles

35 Millimeter Music At the Historic Lincoln Theatre

BY STEPHEN MURPHY

EVENT: *35 Millimeter Music: An Orchestral Road Trip*, a benefit for The D.C. Youth Orchestra.

FACILITY: Lincoln Theatre, Washington, D.C., 1,250 seats

COMPOSER/CONDUCTOR: Television and film composer Charlie Barnett

AUDIO REQUIREMENTS: Audiophile live sound and 32-track recording of 60-piece orchestra

PRODUCTION: Greg Lukens (Audio Director); E.L. Copeland (Theater Coordinator); Bill Wolf (Production)

ENGINEERS: David Morse (front-of-house); Bill Krantz (recording)

CONSOLES: Sony DMX-100 digital console (FOH); Yamaha 02R digital console (reference mix)

THEATER SPEAKERS: Meyer Sound MTS-4A and UPA-1P powered speakers

ROOM SETUP/PROCESSING: BSS FDS-366 OMNIDRIVE, EAW SMAART software, Earthworks M30 mics

MICROPHONE PREAMP CHANNELS: 10 x API (API 212), 6 x Millennia Media (HV-3D), 16 x True Systems (2 x Precision 8)

RECORDERS: Four TASCAM DA-78 DTRS digital recorders

MICROPHONES: Neumann KM 143 x 2 (oboes, clarinets), KM 140 x 2 (violins), KM 86 x 2 (basses), TLM 170 (solo bass), U 89 (harp), SKM 140 set (solo violin), KMS 150 (solo voice), KM 184 x 2 (rear ambience); Sennheiser MKH 800 x 3 (main array, violas), MKH 20 x 4 (flanked array, house ambience), MKH 40 x 3 (cellos, trumpets, trombones), MKH 50 (tuba), MKH 60 (solo bass), EW 345 (wireless vocal); AKG 414 x 3 (percussion); MBHO MBC-603 x 2 (Fr. Horn, flutes), MBC-608 (bassoon).



Photo by Stephen Murphy

In the 1920's, the "U Street Corridor" was Washington D.C.'s cultural center for the black academic and entertainment communities. Today, only the beautifully restored Lincoln Theatre, original home base of D.C. natives Duke Ellington and Pearl Bailey, stands as a reminder of what was once called "The Black Broadway."

On June 22, 2002, "35 Millimeter Music: An Orchestral Road Trip," was presented at the Lincoln Theatre. Sponsored by The Foundation for New American Symphonic Music, it featured the music of film composer and Washington D.C. native Charlie Barnett. The show was held to benefit the D.C. Youth Orchestra. The concert, produced with the generous support of Sennheiser USA, Washington Professional Systems and many of the area's top audio engineers and performers, was a unique aural experience and a critical success. I spoke with the event's Audio Director, Greg Lukens, about producing and recording the concert in the historic theater:

With so many great theaters in D.C. — Ford's, Warner, National, Kennedy Center — how was The Lincoln chosen for this event?

The Lincoln Theatre was the obvious choice because it was built as both a live performance hall and first-run movie theater. Its long history in both fit perfectly with the title and subject of the event: "35 Millimeter Music." Charlie Barnett's evocative compositions, such as "The Blue Chevrolet," set in motion ragged *still* pictures from his childhood. Our goal for the audio was to produce a live theater experience that takes the best aural imagery found in movies one step farther by encouraging the audience to feel, imagine and visualize their own "movies."

I imagine having some of the best pro audio gear available contributed to the overall success of the concert.

Absolutely. We had 32 great mics going into 32 great preamps and then split to feed the live theater mix and the recording to 32 tracks. But the fact that the sound engaged and involved the audience wouldn't have been possible without the intense collaboration of the many talented people who contributed to the benefit. I'm very much looking forward to exploring the multitrack recording and multi-camera video footage of the event for upcoming CD and DVD releases.

For more information on Charlie Barnett, his foundation, The Foundation for New American Symphonic Music, and the Lincoln Theatre, visit www.charliebarnett.com and www.thelincolntheatre.org.

Optimized Aperture™ Horns

VGC™
(Vented Gap Cooling)

100 Hour Power Test

13-ply Birch Cabinets

Advanced Technology
Dividing Networks



UNRIVALED PERFORMANCE!

SR-X series

Unrivaled Product Selection.

No other professional speaker series offers you as many choices. With 18 unique speaker designs, there's an SR-X system that's just right for your musical and personal style.

Unrivaled Build Quality.

Their 13-ply baltic birch cabinets, virtually indestructible DuraFlex™ finish and tongue and groove construction are just a few of the reasons your SR-X system will gracefully shrug off the effects of life on the road.

Unrivaled Testing Ensures Unrivaled Satisfaction.

No other comparable system is tested like an SR-X. While most manufacturers test their speakers for only a few minutes, each SR-X design is tested for 100 hours at rated power output. This subjects SR-X to more strain and stress than they would typically experience in years of actual use! It's a JBL commitment that assures you unparalleled confidence and satisfaction.

Unrivaled Reliability.

With the highest sensitivity and lowest power compression in their class, all SR-X Series speakers play louder longer.

Unrivaled JBL Technical Superiority.

Pure Titanium Diaphragm Compression Drivers in all two-way and three-way models assures you of superior power handling and reliability. VGC™ Vented Gap Cooling means transducers that control heat build-up. The result: increased power handling and decreased power compression. Dual Mode Crossovers provide total system flexibility. Optimized Aperture™ Horns feature driver exit and throat flare that integrate seamlessly. As a result, SR-X Series speakers minimize throat distortion and provide smooth frequency response, even at the highest SPLs.

Add it all up, and you'll know why 9 out of 10 speaker systems travelling with today's top touring artists feature:

JBL'S CONCERT PROVEN COMPONENTS



A Harman International Company

www.jblpro.com/sr13

RECEIVED SERVICE NUMBER 33

World Radio History

Professional

THE AUDIX D-SERIES

D-1 - Slight mid-range enhancement. Excellent for snare, bongos, high-hat, flute

D-2 - The ultimate 'tom' mic! Captures lower mids with pin-point accuracy. Toms, congas, sax, percussion.

D-3 - You can mic a jet engine with the D3. Flat, accurate response. Ideal for guitar cabs, timbales, trumpet.

D-4 - Wide dynamic range with extended lows. Floor toms, kick drum, baritone sax, trombone, bass cabs.



Drumkit



Guitar Cabs



Percussion



Brass

The Fantastic Four

FANTASTIC 4 YOUR STUDIO

Great recordings always start with great mics.

And with the D-series dynamic instrument microphones, you have four of the most versatile instrument microphones ever made. Compact, lightweight, and easy to place, the D-series microphones will record very high sound pressure levels accurately and without distortion. Audix VLM capsule technology insures that you will capture a realistic and uncolored image with pin-point accuracy.

Look for these superheroes in the pro audio department of your favorite retailer. And don't be surprised when you find out how affordable they are!

FOR A DEALER NEAR YOU CALL: 800-966-8261
TEL: 503-882-6933 FAX: 503-682-7114 www.audixusa.com

Audix Corporation PO Box 4010, Wilsonville, OR 97070
Canada, Cabletek Electronics LTD, 604-942-1001 fax 604-942-101D

AUDIX
PERFORMANCE IS EVERYTHING

© Audix Corporation 2002. All rights reserved. Audix and the Audix logo are trademarks of Audix Corporation.

World Radio History
READER SERVICE NUMBER 34

Crane Song Spider Mixer

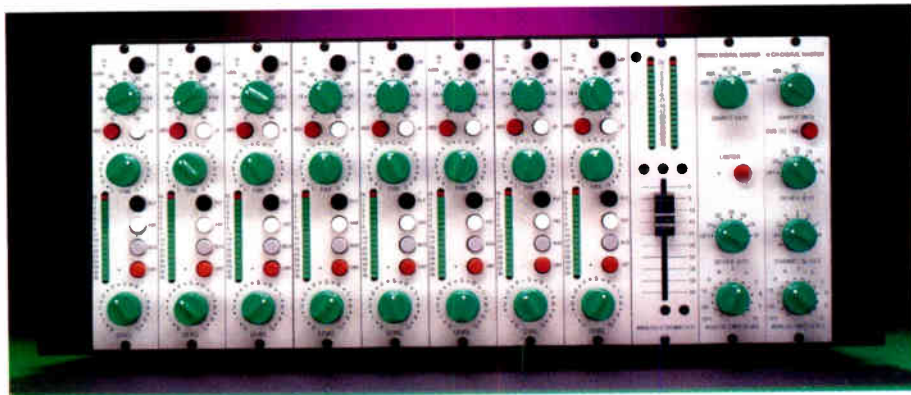

BY DR. FRED BASHOUR

For the past thirty years, I have used a highly-tweaked and severely modified Suburban Sound SS-III 8x2 mixer for most of my analog mixing tasks, but have been looking for a modern replacement for quite some time. I first encountered a prototype of the Crane Song Spider mixer at the 1999 AES convention. I thought it was the coolest-looking product there, and it promised the sound quality and flexibility I needed for my classical remote recording sessions.

I eventually received one of the first Spiders manufactured — in July, 2001 — and pressed it into service the very next day on a three-day recording session at Studio Dufay. I have subsequently used it daily, as well as on several commercial classical CD projects during the fall and winter. I eventually exchanged it for a currently-manufactured unit (incorporating my suggestions for increased flexibility with the analog direct outputs) in mid-April, 2002. I type this review, having just returned from using my “new improved Spider” at a week-long recording session at the “Great American Brass Band Festival” in Danville, KY.

FEATURES

The Spider (\$7,500) mixer’s unique combination of analog and digital circuitry begins with eight discrete Class A preamps similar to those used in its “Flamingo” mic preamp —

Fast Facts

Applications:

Location recording, analog mixing, vacuum tube and tape emulation via analog and digital signal processing, front end for DAWs.

Key Features:

8x2 mic or line mixer with simultaneous analog and digital direct and stereo outputs, several digital effects

Price:

\$7,500

Contact:

Crane Song at 715-398-3627, www.cranesong.com; or circle Reader Service 76.

gain blocks which were designed to exhibit warm sound and excellent transient response. Each Spider input channel also incorporates a switchable “fat” amplifier stage, in order to supply tube-like color upon demand. This analog circuit is modeled after the one used in Crane Song’s HEDD-192, its popular digital high-end mastering processor. The mixer can be switched to eight channels of line input (on 1/4-inch phone jacks) as well.

The Spider also has ten channels of built in A/D converters which feature Crystal Semiconductor’s latest technology 24 bit, 96

continued on page 36 ▶

8MX2

Rack Mount Preamp/Mixer

“The 8MX2 provides eight great sounding mic preamps in one of the most practical packages I’ve ever seen. For computer based recording systems, it’s AMAZING. I never leave home without my 8MX2!”

Sam Berkow
SIA Acoustics

Features

- 8/2/8 Mixer
- 8 Line Level Multi-Track Returns
- 8 into 2 Mix Bus with Pan
- 10 Segment input/mix LED meter
- 10 Segment gain reduction meter
- Headphone and speaker monitor out
- 8 channels in 1u rack space
- Link multiple units

Each Channel Includes:

- 48v Hi-voltage Mic Pre
- Threshold Limiter
- Direct Out
- Selectable 48v Phantom Power

Perfect for:

- Remote Recording
- Live Broadcast Feeds
- Studio “sidecar” inputs
- All critical Digital recording formats



The AT1 Group
301/776-7879
301/776-8117 fax
www.8MX2.com



► *Crane Song from page 35*

kHz chips, and provide extremely wide dynamic range. In addition, Spider's digital section also contains 300 MIPS of digital signal processing dedicated to analog tape emulation. This effect — based on the sonic characteristics of Ampex 456 tape — is adjustable over a very wide range on each channel and was also taken from the HEDD-192's design.

Each of the Spider mixer's ADCs is preceded by a switchable peak limiter stage, which prevents the converters from being overdriven. Spider's ten analog outputs appear in two places. First, they can be accessed as the "ring" on its standard TRS insert connectors, enabling the user to send each channel to an external effects box, and then return it to the mixer before A/D conversion. Alternatively, by using easy-to-make cables, those jacks be used simply as direct outs. Spiders built since March, 2002 also feature a separate rear panel nine-pin D-sub connector, which also contains the eight direct outputs. Eight rear panel pre/post pushbuttons determine the source of these direct outputs, relative to the "fat" and peak limiter circuits, and the front panel level controls.

Spider's stereo digital output is fed from the internal stereo bus and appears simultaneously in three formats on three connectors, which can be accessed in parallel: AES/EBU, S/PDIF, and TOSLink. It can also be routed — at the flip of a front panel switch — to channels 7 and 8 of the multichannel digital outputs. The eight-channel digital direct outputs can be interfaced through a choice of three different option boards: AES/EBU, ADAT optical, or TDIF; one is installed within each Spider.

The stereo outputs and the eight channel outputs can be used simultaneously—and at different sample rates and bit depths as well. This means, among other things, that a recordist can feed an eight-channel MDM recorder or DAW and a stereo DAT machine or CD recorder at the same time. Output dither is variably selectable from 24 bits down to 15 bits, and is generated through a proprietary analog process.

One the rear panel, the Spider's digital section also features work clock input and output BNC connectors, providing the use the flexibility of making the mixer either

master or slave when recording, for example, to DTRS cassette machines.

Very tightly packed with high-end parts, the Spider itself is only four rack-spaces high but, since it generates considerable heat, is best installed with at least 3/4 or an inch of free space above and below. Its rack ears are so punched that I was able to install it in my (unfortunately no longer available) shallow five rack-space SKB carrying case. The power supply is sold with a full rack-size front panel, so it can be installed in any standard 3.5-inch rack location.

IN USE

I have received considerably more than my usual share of "great sound, Dr. Fred" comments on every project I have tracked through the Spider. In my opinion, its mic/line preamps are the first solid state circuits I have really been able to live with, day in and day out. They are not fussy about mic output level or impedance, and simply make each of my mics sound great. On occasion, when I want the additional different personalities imparted by my vacuum tube Fearn, Manley, or Millennia Media preamps, I do use them, patched into the Spider's line inputs. But make no mistake, the Spider sounds so good that I now bring along my separate mic preamps only on big-budget projects during which I'm allowed the necessary extra setup time. Usually they stay home at Studio Dufay!

The second use I have found for the Spider is perhaps even more exciting and revolutionary — especially for an engineer who has long tried to "keep everything digital." I mix-down through it! That is to say, once I have made my multichannel digital recordings (stored and edited inside my MOTU or Merging Technologies Pyramix DAWs), I frequently leave the digital domain (in order to add Crane Song, Manley, or Amek analog processing) and do my final mix through analog! This way, I can record at 96 kHz (via MOTU) or at 192 kHz or DSD (via the Pyramix) for the highest quality masters. Eventually, I will route the DAWs respective analog outputs through the Spider, add appropriate analog processing, and finally output a nice 44.1 kHz, 24-bit file suitable for dithering down to 16-bit while making CD master files.

But here is the coolest part: Even though there is no automation in the Spider, I set up my DAWs virtual mixers with all the mix moves I need, and then simply "go through" the Spider at a nominal unity gain which makes sense for the final stereo level. I enjoy all the wonderfulness of being in the analog domain with the Spider's I/O flexibility, coupled with the precise automation control my MOTU and Pyramix DAWs give me. If this is not the "best of both worlds," I don't know what is!

SUMMARY

The Crane Song Spider is the first 8x2 location recording mixer I have purchased since 1972. At that rate, it should be at least 2032 before I consider replacing it!

Dr. Fred Bashour is a jazz pianist, church organist, classical music producer/engineer, intermittent college professor, consultant to university music libraries on the digital storage of course listening materials and a contributor to Pro Audio Review.

REVIEW SETUP

Neumann/Stephen Paul SM 69, M 50, M 249, Royer SF-12, 12A, R-121A, Manley Labs/AGK C 24 mics; DW Fearn VT-2, Millennia Media M-2b mic preamps; TASCAM DA-78HR DTRS, Sony PCM-R100 DAT recorders; Merging Technologies Pyramix, MOTU 1296 DAWs; Manley/Tannoy monitors.

Product Points

CRANE SONG SPIDER

Plus

- Superior analog and digital sound quality
- Flexible I/O and routing

Minus

- None

The Score

The Spider joins the two other high-end analog mixers — Manley 16 x 2 and Millennia Media's Mixing Suite — at the top of the heap, and ups the ante by including high quality multichannel digital conversion and several unique effects.

Finally,
24 bit/96 kHz recording
for the rest of us.



Introducing the D2424LV

24-TRACK HARD DISK RECORDER/EDITOR

• 24 Analog and Digital I/O • Second Drive Bay • \$1799 MAP

FOSTEX
www.fostex.com

Fostex America, 15431 Blackburn Avenue, Norwalk, CA 90650, Tel: 562-921-1112 Fax: 562-802-1964

World Radio History
READER SERVICE NUMBER 37

Bel Canto's eVolutionary Amplifier



THE
HIGH END

BY TOM JUNG

Just about when I think I have heard every type of power amplifier topology made, someone comes along with something new and changes my outlook on how we drive loudspeakers. Bel Canto Design is not a new name to me, being somewhat familiar with its

single-ended triode vacuum tube designs (which incidentally is the sonic starting point for all of their newer digital designs). John Stronczer, president and chief designer of Bel Canto, told me that he worked for almost three years looking for a topology that had the musicality of the single-ended triode vacuum tubes and feels that they nailed it with the eVo.

FAST-SWITCHING AMP

At the heart of the eVo amplifier is a modified Tripath DPP (Digital Power Processing) module which is fundamentally a very sophisticated delta-sigma A/D converter, not unlike the converters used for DSD (Direct Stream Digital). The amplifiers output uses two N-channel MOS-FET switches between the power supply rails that turn on and off within 30 billionth of a second! There seem to be many advantages to this type of topography not the least of which is pristine sound. Slew rate is rated at over 6,000 volts per microsecond which is more than 10 times that of any analog power amplifier. Efficiency is greater 90 per cent which make the eVo one of the coolest running high power quality amplifiers ever, and that's just a start.

The eVo line of amplifiers are available in two, four or six-channel models - all with a versatile bridging capability. This bridging function makes for an accommodating platform in all types of installations, especially where multichannel is concerned. All models provide for both balanced XLR and unbalanced RCA inputs and five-way binding posts for the outputs. Bridging is as simple as it gets with a push of a button and a speaker terminal change.

THE EVO6

The eVo6, tested here (\$4,900), contains six amplifiers, each rated at 120 watts into eight ohms and 200 watts into four ohm, which seems like plenty of power for most applications. Each pair of amplifiers share a circuit board and become totally differential when the bridging mode is selected increasing the output power to

360 watts into eight ohms and 500 watts into four ohms. Any combination of single or bridged setups from six-channel to three-channel can be configured. A pushbutton power switch and a nice blue LED are located on the front panel.

Because no external heat sinks are necessary all eVo amplifiers are fairly compact measuring just 17.5 inches x 18.5 inches x 4.5 inches. Sorry, no rackmount available just yet.

I auditioned the amp using a multichannel SACD, of a Philips 10-PE SACD player digitally connected to an EMM Labs DAC8 Mk IV multichannel D/A converter (PAR 12/01) feeding an EMM Labs Switchman Mk II (PAR 4/01). The six balanced outputs of the Switchman then fed the eVo 200.6 driving six SLS S8R ribbon monitors. On several of my own projects I have been using a center surround channel instead of an LFE channel hence the sixth speaker.

AUDITIONING WITH SACD

I listened to several SACDs, many of which were projects that I recorded and was almost too familiar with. My first impression was the tight control of the bottom end, this amplifier has what I call "good hands" meaning it controls the woofer in such a way that it almost makes the ported enclosure of the S8Rs sound like a sealed box. The midrange has the inner detail found in some high-end solid state amplifiers - but without any harshness typically associated all that detail. The upper frequencies are very open with lots of air, again, without being edgy or harsh sounding.

I did notice that when I pushed the amplifier harder, say over 90 dB SPL the openness started to close in and the holographic effect of the SACDs became more flat. Because this phenomena seemed to be level related I reconnected the front three speakers with the eVo in the bridged mode and connected the Sunfire Cinema Grand multichannel amplifier (PAR 9/01) in rear.

EXCELLENT SOUND QUALITY

I was amazed at how much difference bridging made, the bottom was even more controlled while the depth perception was defiantly more holographic. Now the eVo maintained all of these niceties even when the level was increased way beyond where I wanted to listen. In order to absolutely evaluate the eVo in the bridged mode I asked Michael McCormick of Bel Canto to send me an additional eVo6 so I could have bridged eVos on all six speakers, two three-channel amplifiers - one for the front and one for the rear.

continued on page 47 ➤



Universal Audio Teletronix LA-2A Leveling Amplifier

BY TED SPENCER

Considering the mystique and the high prices being paid for certain vintage professional audio products (Pultec equalizers, Neumann U47 microphones and numerous others) it's no wonder that manufacturers are "recreating" many of them at a breakneck pace. Whether it is an "accurate" or an "in the style of" approach to these replicas, however, almost none of them are true reproductions. It seems the designers (usually for good reasons) cannot resist improving on the originals, so most of these pieces are known to be "not exactly" the same and thus to some would-be buyers, rightly or wrongly, "not exactly" as good.

Enter Universal Audio and the Putnam



brothers, Bill and Jim. They are sons of the late Bill Putnam Sr., legendary recording engineer, studio owner and designer of many notable pro audio devices. Unlike virtually all other replica products, the Universal Audio LA-2A is an almost identical part-for-part copy of the original. This undeniably purist approach results in all the greatness and all the flaws of the originals.

FEATURES

In the world of compressors, it just does not get much simpler than the Universal Audio LA-2A (\$2,995). In fact, next to some low-end, one-slider dbx units (like the 163X) that were made some years back, there is no compressor I know of with fewer controls.

continued on page 40 ►

Hear What The Hype Is All About

"The C-3 is THE HIP new guitar mic. It gives your Marshalls that phat-gut-punch we all crave. I'll never cut another record without one."

Scott Rouse - Producer, Grammy Nominee, Nashville, Tennessee

I have a microphone "wish list". You have allowed me to check off both the U87 with the C1 and the C12 with the T3.

Ted Perlman - Producer/Arranger/Composer
Bob Dylan, Chicago, Kaci, 2gether, Young MC

One of the best vocal mics in the world is the \$300 Studio Projects C1. You can spend way more for "one of those" mics from Germany if your ego demands it, but the C1 is certainly the sonic equivalent.

Pete Leoni - Producer Engineer, Tech writer and reviewer



C1

Single-pattern
Cardioid
List \$299

C3

Multi-pattern
Cardioid, Pad, Filter
List \$599

T3

Variable-pattern
Tube
List \$1099

All models include shockmount and case

StudioProjects™



P M I
AUDIO GROUP

PMI Audio Group
23773 Madison St., Torrance, CA 90505 USA
toll-free 877 563 6335 fax 310 373 4714
Visit Us Online at www.studioprojectsusa.com

READER SERVICE NUMBER 39



VT-1

Tube Mic Pre, Discreet Class A/B switching,
with variable Tube Drive. List \$299

Introducing the R-122 Phantom Powered Ribbon Microphone!

ROYER RIBBONS

Here it is, the first phantom powered ribbon microphone ever, with as much output as a condenser mic. Plug it in and go!

Based on Royer's ground breaking R-121, the award-winning R-122 gives you 100% of the warm, sweet, natural tone that people expect from a Royer ribbon, but with 15 dB more sensitivity. And with Royer's integrated circuitry, the ribbon element always sees a perfect load, eliminating any mic-pre matching problems - you get all of the tone, all of the time.

Let a Royer ribbon warm up your digital recordings today.

To hear the Royer Demonstration CD, order at www.royerlabs.com

The future of ribbon microphones - brought to you today by Royer Labs.

www.royerlabs.com
818.760.8472

READER SERVICE NUMBER 40

► Universal Audio from page 39

On the Universal Audio Teletronix LA-2A, controls consist of a limit/compress toggle switch, an output gain control, a combination threshold/gain reduction control, a +4 or +10 output/gain reduction meter display switch and a power switch. There is also a front panel trim pot for calibrating the meter's "0" indication when showing gain reduction.

On the back is a sidechain pre-emphasis control that increases the compressor's sensitivity to high frequencies (originally intended for radio broadcast purposes). Most users will never touch this pot though, leaving it at its default wideband setting. The entire front panel, true to the original, is thoroughly vintage looking: large black plastic knobs, big stainless steel toggle switches, a big ol' retro-looking meter and a gray painted faceplate.

The faceplate is hinged to allow access to the innards without removing the unit from a rack. Removing the two screws and lowering the panel buys you a trip on the way-back machine to the pro audio days of yore. Inside this beauty is an obviously handmade feast of point-to-point wiring and discrete components. No chips, no printed circuit boards, just something that will gladden the hearts of those who, like me, still remember the days of their youth spent building hi-fi systems from kits. It is a treat just to open this thing up and look. The tubes, transformers (three of them; input, output and power) and optical attenuator module all protrude directly off the back of the unit.

The design of the LA-2A is simple, but in its day it was quite advanced. It uses an electro-luminescent panel (similar to a certain type of night light, of all things) and a photoelectric cell to control compression. As the audio input signal increases in level, the electro-luminescent panel glows brighter and the photoelectric cell "looking" at it decreases in resistance.

The innate characteristics of the panel and cell contribute to the unique compression behavior of the unit. Compared to other incandescent light-based devices in its time, the electro-luminescent panel design of the LA-2A was a step forward because it has an inherently faster attack time.

Release time-wise, the cadmium-sulfide

Fast Facts

Applications:
Studio

Key Features:
Single-channel, optical compression, VU meter. Near perfect re-creation of original Teletronix LA-2A design.

Price:
\$2,995

Contact:
Universal Audio at 831-466-3737; www.uaudio.com; or circle Reader Service 77.

photocell reacts in a two-stage manner, initially releasing halfway in about 60 milliseconds. The remainder of the release time varies depending on how long and how far into compression the unit has been driven. Simply put, the longer the time and/or the further the extent into compression the unit is driven, the slower the release will be. This makes a significant contribution to the LA-2A's characteristic sound.

The choice of "compression" or "limiting" available with the toggle switch is described in the manual as being largely a matter of ratio. It is my impression that even in limit mode, the unit is not what would normally be referred to as a brick wall-type limiter - just a fairly high-ratio compressor. Specific ratios are not given, but my guess is that "compress" might be about 3:1 and "limit" might be more like 10:1 (The manufacturer says that in Limit mode the compression ratio is maintained up to a certain point wherein the ratio will increase until it becomes a 'brick wall.' Pushed beyond that point compression will disengage.). Interestingly, the nominal output level is +10 dBm, not +4 as is the more modern convention. Stereo linking to a second LA-2A is available though barrier strip connectors on the back panel.

IN USE

The LA-2A in the modern era has been generally known as something of a specialty device, not a "compressor for all occasions," if you will. It most decidedly has a sound, and if you are looking for transparent compression that otherwise leaves the signal as pristine as possible, this is not the box for you.

The Solid State of Vintage Tube Gear

BY NICK BAILY

In this burgeoning digital age, the casual observer might think the venerable vacuum tube to be an anachronism - long obsolete. In fact, as a quick trip to any pro sound retailer will tell you, there are probably more pieces of pro tube gear in production and available now than ever before, all the way from the consumer level to the most exacting (and expensive) pro audio applications.

In addition, many classic designs - both tube and solid state - fetch a premium on the resale market and have prompted new products that range from dead-on reproductions to original implementations of vintage design techniques. To shed some light on this phenomenon, *Pro Audio Review* surveyed leading designers and manufacturers in this active segment of the industry.

NO SUBSTITUTES

Anthony Demaria, head and namesake of **Anthony Demaria Labs**, known for high-end classic designs, explains as follows: "If you talk to top engineers, they have every option available to them; most are using the latest version of Pro Tools. So you might ask, 'Is this the end of [outboard] solid state and tube gear?' But they will tell you that there really is no substitute for tube gear, sonically. You can take a snapshot and work on it, but you have to start out with a decent image; the old fashioned gear can do that."



Pendulum Audio 6386 limiter

ADL recently introduced the ADL 670, a reproduction of the highly sought Fairchild 670 tube compressor, which lists for \$25,000. "The design of these opto-compressors is stone age, relatively speaking," Demaria said, "but you just can't get that soft knee sound

D. W. Fearn VT-4 equalizer

from a transistor."

Another manufacturer making major inroads with reproductions is **Universal Audio**. The company was founded by Bill Putnum, son of M.T. "Bill" Putnam, the original engineer of many the famed UREI (see 1176LN review, *PAR* 3/01) and Teletronix (see LA-2A review this issue, p.39) solid state processors. Universal's versions have been produced from the original blueprints. Universal's first tube piece, the 2610 preamp (*PAR* 1/02), was also a throwback to an earlier Putnam gem, the preamp section from the 610 modular console. Most recently UA introduced the solid state 2108, a preamp based on the input stage of the 1176LN.

TRIED AND TRUE FORMULA

In the early 1990's, **Manley Labs**'s first few products were inspired by vintage pieces. The Manley Pultec-based EQP1-A and MID equalizers as well as the Manley and Langevin ELOP limiters were loosely based on classic designs but executed with modern design enhancements and components.

However, after 1996 when Craig 'Hutch' Hutchison took over as design chief, Manley's products started to take an original direction. Fresh analog designs such as the Massive Passive (*PAR* 10/99), 16x2 Mixer (*PAR* 8/01) and the new SLAM! Stereo

Limiter And Mic preamp came straight out of the design lab with little reference to any historic gear at all beyond a heavily retro look and extensive use of tubes.

Groove Tubes founder Aspen Pittman has been extolling the benefits of tube architecture for decades, and explains that if anything, digital audio has made tube designs even more relevant.

MORE DYNAMIC RANGE

"Digital audio's biggest contribution is really to expand dynamic range," Pittman said. "Frequency response and distortion really haven't changed all that much. We have started listening with 'bigger ears' because there's now better dynamic range. I think it's a misconception to say that tubes are coming back just because they warm up recordings. It's not that tubes distort, it's that they have huge dynamic range, and now it's easier to appreciate them."

"Since we now have better measurements, we actually see that tubes have less distortion than transistors," he explained. "Things sound or feel truer because in fact they are truer. Most people think of tubes as warm, by which I'm assuming they mean second order distortion. There's a place for that, sure. But that's just one subset of what tubes are useful for."

Pittman's Groove Tubes has broken from the pack of retro-influenced designs by taking a different approach to tube design on several recent products. The VIPRE mic preamp (*PAR* 4/01) is the first all tube mic preamp with a fully differential circuit path, carrying the principles of balanced audio all the way though the unit. Requiring twice as

continued on page 45 ►

THE ULTIMATE MULTIZONE AMP. 8 CHANNELS. 2 RACK SPACES. INCOMPARABLE.

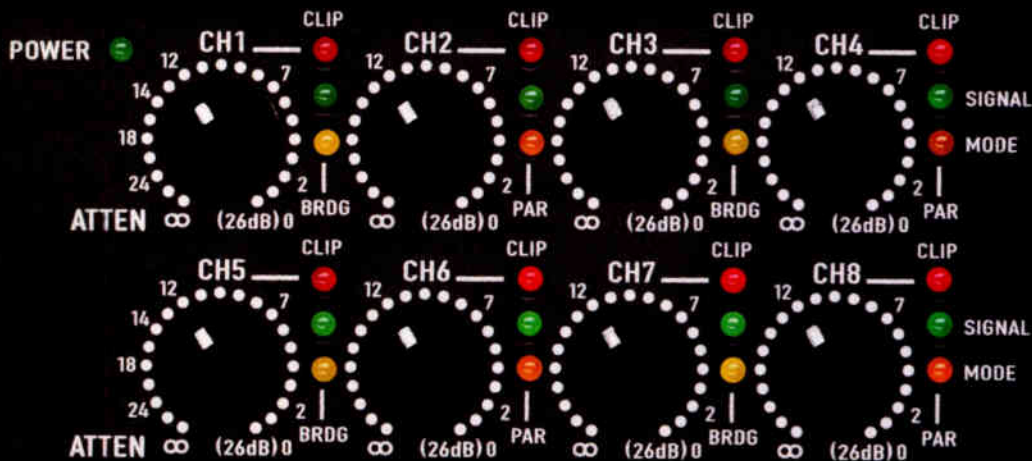

INTRODUCING QSC'S NEW 8-CHANNEL CX168.

With eight channels (130 watts@ 4 ohms, all channels driven), the new CX168 combines QSC's legendary sound quality with unmatched versatility. All in a compact 2RU design. Featuring **POWERWAVE™** QSC's exclusive PowerWave™ technology for enhanced performance and lighter weight, the CX168 has the features contractors need. DataPorts for remote management and DSP. The ability to bridge channel pairs. Recessed and detented gain controls plus a custom security cover for tamper-proof installations. The incomparable CX168. The world's only 8-channel, 2RU amp. Available only from QSC—the industry leader for more than 30 years. For information on how the CX168 can benefit your next install,

visit www.qscaudio.com/cx/8chsc.htm or contact your QSC representative now. Toll free: (800) 854-4079.

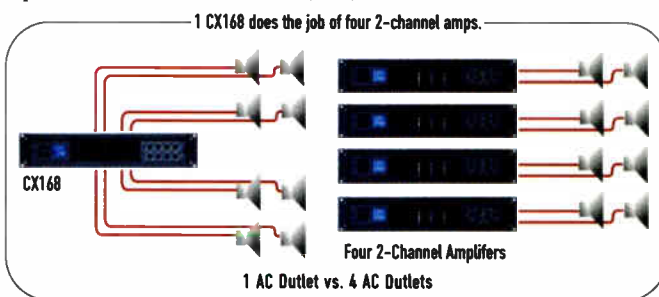

8Ω: 6x90W 4Ω†: 6x130W
20 Hz–20 kHz, .05% THD, All Ch. Driven †20 Hz–20 kHz, 0.1% THD, All Ch. Driven



Rear View of the CX168

QSC
AUDIO

*QSC® and the QSC logo are registered with the U.S. Patent and Trademark Office. QSC Audio Products, Inc., 1675 MacArthur Blvd., Costa Mesa, CA 92626 USA

► **Vintage Gear from page 42**

many tubes and components, the design yields very high specs, such as 70 dB of gain. The VIPRE employs eight input transformers, allowing five different ways to load the microphone, and it can emulate old consoles with the ability to vary ballistics (slew rate).

Groove Tubes recently introduced the Solo Single recording amplifier (\$899 head/\$999 combo) designed as a flexible device for recording guitar in the studio. The Solo Single allows changes in sound by changing tubes, with over a dozen different options.

Pendulum Audio's Greg Gualtieri, echoing some of Pittman's comments, divides tube/retro gear into two basic categories. "There are vintage [original] pieces and recreations of classic pieces. I think the used market has suffered in that what's out there in good shape has already been snapped up. The average studio is not able or not interested in dealing with the maintenance problems, hence the reissue market."

Gualtieri also noted a product class which he calls the "effect device, with tubes used to color the sound." He adds, "In some cases it's almost a sales thing only, with tubes not having an appreciable effect on the sound, and in some cases there's a sound that people find desirable, often called warmth, although that term is so vague I'm hesitant to try to define it. There's second order harmonic distortion, sure, but tubes are not limited to just that. Many of us who build hi-res tube circuits are not averse to tube distortion. But when you don't want it, you don't have to have it."

TUBES ARE MORE 3-D

Gualtieri sees tubes are more three dimensional. "An all tube signal path gives you a greater level of detail and clarity than digital and hybrid gear," he explained. "The stuff I'm interested in has a well-designed tube circuit with better detail - a three dimensionality that you just can't get from solid state gear. It was present in the best gear of the 1940s and 50s. It's not based on harmonic distortion, it's based on clarity of signal path. Some of us are working on refining these successes with modern packaging and power supplies and reliability, and I think this changes the impression of what a 'tube' sounds like."

Gualtieri said he implemented these refinements in his latest design, the Quartet, an all in one box, containing a preamp, opto-com-

pressor, de-esser and three-band tube EQ, all of which are independently patchable. The Quartet joins Pendulum's MDP-1 Vacuum Tube Mic/DI Preamp (PAR 5/99), OCL-2 Electro-Optical Tube Compressor/Limiter and ES-8 and 6386 Variable Mu Tube Limiters (PAR 3/00).

While the largest interest in tube gear is in the area of tube-based preamps and processor boxes, the retro craze has not passed over microphones.

Seemingly from day one thousands of mics (mostly but not always tube) from Neumann, AKG, beyer, Shure, et al, along with the output of vintage companies, such as Telefunken, have been kept in daily working order. These mics never really went out of style, but recently a retro craze has swept the mic industry. While Neumann has not (yet) reissued the U 47 (though it did develop a close cousin, the M 147), within the last five years tube mics,

continued on page 46 ►



Groove Tubes Vipre
Variable Impedance Preamp

WHAT MICROPHONES DREAM ABOUT.

VARIABLE IMPEDANCE INPUT
Custom-wound transformers load mics at 300, 600, 1200 or 2400 ohms, multiplying the performance potential of every microphone. Additional transformerless balanced bridged, line and instrument inputs.

VARIABLE RISE TIME
Select between five amplification styles - ranging from Smooth-and-Classic (Slow) to Bright-and-Modern (Fast). These two features alone provide 25 unique tone-shaping combinations from any single microphone!

ALL TUBE, BALANCED CLASS A DESIGN
Eight Groove Tubes in a fully differential signal path dramatically lowers noise and distortion - while expanding bandwidth (7Hz to over 100kHz).

PRECISION GAIN
Custom-built ceramic deck attenuators control 75dB of gain in 5dB and 1dB stepped increments.

AUTHENTIC VU METERING
With five switchable viewing ranges.

Stop dreaming.

Only Vipre does what no other preamp can.

Visit our website at www.groovetubes.com or call us at **818 361 4500** for complete specs and a list of Groove Tube Vipre dealerships.

GROOVE TUBES CUSTOM SHOP PRODUCTS™

©2002 Groove Tubes, Inc. All rights reserved. Groove Tubes, the GT logo and Vipre are registered trademarks of Groove Tubes, Inc. Product names and other trademarks are the property of their respective owners.

READER SERVICE NUMBER 45

► *Vintage Gear from page 45*

nominally the indication of an expensive and classy recording studio, have proliferated. One would be hard pressed to name a mic manufacturer that has not released at least a tube mic and a number of smaller and new companies selling rock-bottomed-priced "tube" mics.



Manley Labs Massive Passive equalizer

Other tube microphones on the market include: AKG's SOLID-TUBE (PAR 1/98), Audio-Technica's AT-4060 (PAR 9/98), Studio Projects' T3 and several models for Groove Tubes and Manley Labs.

And then there are the "reissues." Two years ago Telefunken ELAM 251 copies from Lawson and Soundelux simultaneously appeared.

JOIN THE CROWD

A surprisingly large number of well-known manufacturers have developed one or more tube-oriented products, while many companies have carved out a niche with high-end tube based signal processors.

Doug Fearn's D. W. Fearn has been toiling away for years with his highly sought-after handcrafted tube-based preamps and processors

Anyone who has heard it knows ...

Dual Channel

VT-2
Vacuum Tube
Microphone Preamplifier

D. W. FEARN

(610) 793-2526
P.O. Box 57 • Pocopson, PA • 19366 • Fax (610) 793-1479
www.dwfearn.com

READER SERVICE NUMBER 46

such as the VT-2 (PAR 7/96) and VT-4 (PAR 3/01).

Demeter Amplification has been steadily adding to an extensive line of tube processors and amplifiers. Recent introductions include the HXM-1 Stereo Tube Microphone Preamp and HXC-1 Tube Optical Compressor.

Mercury Recording followed the Pultec EQ (and Fairchild limiter) reissue call. Its EQ-H, EQ-P (Pultecs) and 66 (Fairchild) have stunningly retro looks along with consciously imitated 1950s/60s construction.

Hayne Davis's **Davisound** is another purveyor of tube processors and preamps as is **Requisite Audio**.

Tube Tech's CL 2A dual compressor, SMC 2A (PAR 10/00) compressor and MEC 1A tube mic pre/EQ/compressor (PAR 10/98) have become go-to tools for many engineers, as has the UK-based **TL Audio's** 5021 Two-Channel Valve Compressor. The VP-1 is a high-end tube-based "voice processor." TL Audio recently debuted a variety of new processors, notably the Ivory 2 series, which brings in TL valve designs at a somewhat lower price point. TL Audio is now distributed in the US by HHB.

HHB has also joined the tube club with, at one time, several lines (Classic [PAR 6/99, 10/99] and Radius) of tube preamps and processors (matching similar products from TL Audio). Now with TL Audio onboard, HHB's main tube offerings are the Fatman processors (PAR 10/00).

Joemeek has long walked the line between retro gear and modern design. The SC2 Stereo Compressor is the latest incarnation of its popular stereo compressor. Its VC-2 Tube Channel (PAR 11/97) is just one of a slew of tube-based products.

Summit Audio, manufacturer of the TLA-100A Tube Limiting Amplifier, recently debuted the TD-100 Instrument Preamp and Tube Direct Box (PAR 6/02) and TLA-50 Tube Leveling Amplifier, both half-rack units based on a single 12AX7A tube.

Other manufacturers known for a wide line of non-tube pro audio devices have introduced tube-based designs, some of very recent vintage. **Drawmer** recently debuted the Tube Station and Tube Station 2 mic preamps and compressors. Both feature digital outputs designed to integrate directly into DAWs and digital recorders. These join Drawmer's long and studio-tested line of "1960s" tube-based processors and preamps.

Manufacturer **dbx** employs a lone 12AX7 in its new compact single-channel tube mic preamp, the Mini Pre and its Silver Series of tube-based preamps and multiprocessors reviewed well (PAR 10/98, 10/00, 10/01).

Aphex and **PreSonus** are two long-time manufacturers who have made both solid state and the occasional tube piece, mostly preamps. Aphex's Model 1100 (PAR 7/00) is a particularly strong performer.

In the opposite direction, at times it seems that **ART** (Applied Research and Technology) has thrown a tube into almost everything it makes - from preamps (PAR 7/96, 3/97) to processors (PAR 10/98) - including an A/D-D/A converter, the DIO (PAR 9/01).

Meanwhile, **Millennia Media's** NSEQ-2 EQ and TCL-2 Twincom comp/lim (PAR 6/99) and the more recent Origin STT-1 Recording Channel (PAR 10/00) all utilize solid state and tube stages.

And **M Audio** recently joined the tube crowd with the Tampa tube mic preamp/processor. Why the sudden jump into a seemingly crowded pool? Could it have anything to do with M Audio's new consultant, Aspen Pittman?

Nick Baily is a live sound and studio engineer in New York City.

AKG C 900 Microphone

BY ROGER WILLIAMS III

The Austrian-based, Harman-owned company, AKG, which has more than 50 years' experience creating mostly recording studio and instrument microphones (I have used and abused the C 414 and D 12, respectively), has introduced a new line of performance handheld vocal mics under the Emotion series banner. The flagship of this new line is the C 900, a cardioid pattern condenser mic claimed by the manufacturer to give recording studio performance at the price of a music store standard.

FEATURES

A 24-carat gold-sputtered transducer along with a "Doubleflex" transducer shock-mount and "Frequency-Independent" cardioid response pattern are put together to help the vocalist cut through a mix with less handling noise and better gain before feedback. The unit comes with a rugged mic clip/stand adapter, carrying bag and PB 1000 presence boost attachment, which clips directly onto the C 900 capsule to produce a hi-mid boost of 5 dB between 5 kHz and 9 kHz for and increased speech intelligibility. The C 900 needs from 9 to 52V phantom power to run, and an inline battery power supply (the B15) is an optional accessory. The mic has a post-echo frequency response of 20 Hz to 20 kHz. A low impedance of 200 ohms is well matched with most console input impedances.

The C 900 impressed me initially with its fit and finish. A tough black, wire-mesh grille and cast enameled handle give it a well-balanced, solid feel. The gold-colored trim ring sets it apart from the Shure wannabe crowd, and the clip itself looks Euro-tech enough to garner attention.

IN USE

I decided to try a pair of the AKGs in place of the Shure Beta 58s that were normally used by a local vocal-heavy rock outfit. The small stage and crowded performance

area in this honky-tonk usually presents a bit of a challenge for setup. Lack of depth forces the band to set up floor monitors at a 90-degree angle to the two up-front microphones, in other words directly facing the sides of the mics. For most mics this usually means a bit of monitor EQ adjustment.

I was able to get a good sound quickly through a Yorkville mixer and Pulse speaker combination. The EQ needed minimal adjustment. With the PB 1000 accessory attached, the high-mid bump gave the vocalists the punch they liked. The band was able to flow from blues rock to acoustic material without major mic pre EQ adjustments. The bass player remarked how smooth the response was, and I had to agree.

Low-frequency rolloff from about 80 Hz down was very natural and from 100 Hz through 2 kHz the C 900 was extremely flat — neutral yet powerful. Clear, even-tempered highs gave an overall impression of a well-balanced signal reproducer, especially during the acoustic repertoire. Moving around the mics while adjusting boom stands for the acoustic interlude showed that the shock-mount system was doing a good job of minimizing handling noise.

SUMMARY

I give the AKG C 900 high marks for its sonic qualities, handling noise abatement and off-axis rejection capability. And while I have not been a big fan of AKG handheld vocal microphones in the past, I believe they are certainly onto something here.

Roger Williams III, a systems designer for MAS Audio, longtime NSCA, ICIA member and Syn-Aud-Con grad, is a regular contributor to Pro Audio Review.



► *High End from page 38*

WOW! I never thought changing the rear amplifiers could make such a difference. The holographic qualities became so pronounced that the speakers seemed to disappear, something I rarely experience.

At \$4,900 for an amplifier of this quality the Bel Canto eVo6 represents good value. I believe that these digital amps are the future of audio amplification.

Tom Jung, founder of DMP Records, is Pro Audio Review's technical consultant and a regular contributor.

Contact: Bel Canto Design at 612-317-4550, www.belcantodesign.com; or circle Reader Service 38.

EVO'S UNIQUE CLASS

The term Class T was coined by Tripath Technology Inc. makers of the module which is the centerpiece of the eVo line of digital amplifiers. Bel Canto actually opens up each module to make individual "secret" modifications before they become a part of the eVo products.

The fundamental frequency of the Tripath is somewhere in the 700 kHz range with a 30 MHz, governing clock, while the effective switching frequency is changed over a 200 kHz to 1.5 MHz range. This spreads the digital energy created by the amplifier over a wide bandwidth, similar to spread spectrum technology greatly reducing the energy at any one frequency. This permits using a simple 80 kHz LC filter to attenuate the digital energy while maintaining good phase response.

The audio information is actually carried in the complex modulation of dithered switching edges. The digital processor controls the modulation of the output switches. Feedback around the output switches is taken from the common node of the output switches before the LC filter and fed back to the digital power processor. This feedback is used to insure that any variation in the switching speed of each output device is compensated for optimizing the linearity of the output stage.

Both THD and IMD are rated below 0.01% across the audio band at all power levels while crossover distortion is all but eliminated with this design.

- Tom Jung



WHIRLWIND DIRECT BOXES

YOUR CONNECTION TO THE HARDEST WORKING NAME IN THE BUSINESS.

For the past 25 years Whirlwind Direct Boxes have been hard at work around the globe. In fact, they're so tough that they've become the most widely used in the business. Built with heavy-duty metal construction and premium components for extreme durability, these industrious

little boxes also boast all the features you asked for. Most important, there's an entire work force to choose from, so you'll never have to sacrifice legendary Whirlwind quality to fit the budget. Whirlwind Direct Boxes. We know where you're coming from and we know where you need to go.

whirlwind®

www.whirlwindusa.com
READER SERVICE NUMBER 48

888.733.4396

Two Track Recorders

TASCAM 322 Dual-Well Cassette Recorder

Features: Analog cassette format; dual-well; pitch control ($\pm 10\%$); Dolby B, C, HX Pro; auto reverse; headphone controls; optical leader sensor; 2x duplication; RS232 port for remote control. Price: \$799.

Contact: TASCAM at 323-726-0303; or circle **Reader Service 66**.



Denon DN-780R Dual-Well Cassette Recorder

Features: Analog cassette format; pitch control ($\pm 12\%$); record level control; Dolby B, C, HX Pro; MPX filter; auto tape type selector/calibration; 2x duplication; linkable/cascade remote control mode. Price: \$699.

Contact: Denon Electronics at 973-396-0810; or circle **Reader Service 67**.

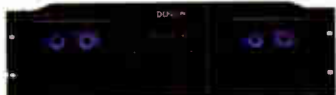

Sony TC-WR565RM Dual-Well Cassette Recorder

Features: Analog cassette format dual-well; Dolby B, C, HX Pro; pitch control; automatic calibration; play and edit functions. Price: \$320.

Contact: Sony at 800-686-7669; or circle **Reader Service 68**.



Marantz PMD430 Cassette Recorder

Features: Analog cassette format; three heads; Dolby B; dbx noise reduction; MPX filter; confidence monitoring; 15 dB, 30 dB pad; limiter; pitch control ($\pm 6\%$); bias adjustment; VU meters. Price: \$699.

Contact: Marantz/Superscope at 630-820-4800; or circle **Reader Service 69**.



Sony PCM RS00 DAT Recorder

Features: DAT format; four-motor direct drive transport; Super Bit Mapping; auto-head cleaning; headphone controls; -10/+4 dB operation; variable speed cue/shuttle dial; defeatable SCMS; remote control. Price: \$1,550.

Contact: Sony at 800-686-7669; or circle **Reader Service 70**.



TASCAM DA-45HR DAT Recorder

Features: DAT format; high resolution, standard recording modes; 24, 16-bit; 44.1, 48 kHz sampling rates; defeatable SCMS; jog/shuttle dial; AES/EBU, S/PDIF, word clock I/O. Price: \$2,249.

Contact: TASCAM at 323-726-0303; or circle **Reader Service 71**.



Fostex D-15 DAT Recorder

Features: DAT format; four motors; 18-bit A/D, 20-bit D/A; 44.1, 48 kHz sample rates; no SCMS; Avid video reference; jog/shuttle dial; optional timecode function. Price: \$3,295.

Contact: Fostex at 562-921-1112; or circle **Reader Service 72**.



Sony MDS-E10 MiniDisc Recorder

Features: MiniDisc format; 24-bit A/D-D/A; hot start; pitch control; basic edit functions; Long Play; keyboard port; remote control. Price: \$600.

Contact: Sony at 800-686-7669; or circle **Reader Service 73**.



Denon DN-M991RM MiniDisc Recorder

Features: MiniDisc format; cart machine style controls; basic editing functions; auto-cue; hot start; pitch control ($\pm 8\%$); programmable playlist/operation; record lockout; defeatable SCMS; RS-232C, RS-422A, 25-pin D-sub. Price: \$2,499.

Contact: Denon Electronics at 973-396-0810; or circle **Reader Service 74**.



TASCAM MD-801R mkII MiniDisc Recorder

Features: MiniDisc format; autocue; track autoready; pitch control ($\pm 10\%$); editing functions; word clock; timer; 20-bit A/D-D/A; ATRAC 4-5; keyboard port; headphone control; remote control. Price: \$2,699.

Contact: TASCAM at 323-726-0303; or circle **Reader Service 81**.



continued on page 53 ➤



LIVE / STAGE

Roland VS-2480 24-Track Digital Studio Workstation

24-track/24-bit digital recording hard disk tabletop recording workstation with user-selectable sampling rates up to 96kHz. Integrated 64-channel digital mixer with 17 motorized faders. Up to 8 onboard stereo effects processors. Features include Mouse, ASCII keyboard inputs (PS/2 mouse included) and an external VGA monitor output provide access to software-style editing and control.



- 24-bit digital recording with user-selectable sampling rates up to 96kHz and 56-bit processing
- 24-track playback (12-tracks @ 96kHz) and a total of 384 virtual tracks (16 per track)
- Up to 16 tracks can be recorded simultaneously
- 1000 markers, 100 locators and 999 levels of Undo
- 24-voice Sample Phrase Pads for triggering and arranging samples directly from disk
- Includes 30GB IDE internal hard drive • Audio CDs and data can be backed-up quickly and easily using the optional VS-CDRII CD Recording System
- 320 x 240 dot backlit LCD

- Mouse and ASCII Keyboard Inputs for software-style editing and control • VGA output connection.
- **17 Motorized Faders** to control inputs, tracks, auxes and effects returns as well as MIDI info.
- 16 rotary encoders • 100 mixer scenes • Onboard dynamics and 4-banc EQ per channel
- **Up to 8 Onboard Stereo Effects Processors**
- **Total of 36 Inputs and 32 Outputs**
- Coaxial and optical digital I/O
- SCSI connection to the optional VS-CDRII or external hard drives
- MIDI In & Out/Thru
- Also available **VS-2480CD** with Built-in CD burner

Antares AVP Antares Vocal Producer



- Combines Auto-Tune Pitch Correction and Microphone Modeling Along With a Full Complement of Vocal Processing Functions • Analog Tube Modeling • Variable Knee Compressor • Downward Expander/Gate
- Variable Frequency De-Esser • Two band Parametric EQ
- Automatic Mono or Stereo Double Tracking • Fully Programmable
- Factory Presets for a Wide Variety of Vocal Styles • Full MIDI Automation
- Virtually every major function is only a button press away

t.c. electronic M-One XL Dual Effects Processor



- 25 Incredible TC effects: XL Reverbs, Chorus, Tremolo, Pitch, Delay, Dynamics and more • XLR connectors - Dual I/O
- Analog-style User Interface • Presets: 200 Factory/100 User
- Dual-Engine design • 24 bit A/D-D/A converters
- S/PDIF digital I/O, 44.1-48kHz • 24 bit internal processing
- Enhanced Early Reflections & Reverb Tails
- Improved Reverb Density
- Small Rooms - NEW!!!

Focusrite Platinum 5 Penta Stereo Compressor and Class A Mic Pre



- **High Impedance Instrument Input** • Works as a mono compressor when recording or as a stereo compressor, without the mic pre when recording or mixing. • Image width enhancer • 16 preset compression settings that can be freely adjusted for individual needs • Side chain inserts for each channel • Balanced 1/4" ins and outs (accepts unbalanced connectors) • Front panel balanced XLR mic and high impedance 1/4" instrument inputs • Optional 44.1, 48, 88.2 or 96 kHz 24-bit S/PDIF digital output with BNC word clock input

PreSonus Digimax 8-Channel Mic Pre with Digital Duts



- 8 Dual Servo Mic Preamps with UltraWide dynamic range and very low noise operating levels • Dual Domain limiter on every channel
- EQ enhance, pad and phantom power on every channel
- 1/4" Instrument inputs on channels 1 and 2
- Phase reverse on channels 1 and 2 • Eight 24 bit ADC converters
- 24-bit Light Pipe and S/PDIF digital outputs • AES/EBU digital outputs are available as an option • External clock sync input and Master clock output • 1/4" milled aluminum panel with blue anodized knobs

SHURE KSM-44SL Multi-Pattern Condenser Microphone

Premium vocal microphone for studio recording

- Dual 1-inch, gold-layered, Mylar diaphragms
- Class A, discrete, transformerless preamplifier
- Cardioid, omni and bi-directional polar patterns
- Subsonic filter eliminates rumble below 17 Hz
- Integrated 3-stage pop grille and shock mount
- 15 dB pad and 3-position low-frequency filter
- Includes ShureLock elastic-suspension shock mount, swivel mount, protective pouch and locking aluminum carrying case
- 20 Hz - 20 kHz frequency response



TLM-103 Cardioid Condenser Microphone

The TLM 103 utilizes the tried and true transformerless circuit found in numerous Neumann microphones along with a large cardioid diaphragm capsule to provide an acoustically well-balanced mic with low self-noise and high sound pressure level transmission.

- Large cardioid capsule derived from the U 87
- Pressure gradient transducer
- Available in satin nickel and matte black
- Includes an SG 103 swivel mount and a wooden jeweler's box • Optional EA-1 suspension mount
- Frequency range 20 Hz-20 kHz



AKG 414 TL II Vintage TL

Free AKG K240M Headphones w/ purchase!

- Combines the best of old and new. legendary C12 acoustics and the latest generation of C414 transformerless FET electronics. Although similar in design and shape to the C414BULS, the TLII features a capsule that is a faithful sonic recreation of the one used in the classic C12 tube mic combined with computer-aided manufacturing techniques that assure greater uniformity in response from mic to mic.
- Cardioid, hypercardioid, omnidirectional and figure 8 polar patterns • Warm, smooth microphone that is suitable for high-quality digital recording. • INCLUDES SHOCKMOUNT
- Frequency response 10Hz to 20kHz



TASCAM CC-222 Combination Cassette & CD Recorder

- CD Recorder and Cassette Deck in 3-U rack mount • RIAA phono input for direct connection of turntables • Independent RCA analog inputs and outputs for CD recorder and cassette deck
- Decks can be used independently • Headphone output w/ level control • Sync one and sync all CD record modes • Auto ID sensitivity level • Inc. RC-222 remote
- **CD Recorder / Player Features**— Compatible with standard & consumer (audio only) CD-R and CD-RW discs • S/PDIF Coax and Optical Digital I/O • TEAC computer CD-RW drive mechanism • Timer play • Shuffle & program modes
- **Cassette Features**— Bi-Directional cassette mechanism • Record mute function
- Dolby B Noise Reduction • ±12% Pitch Control on Cassette Deck • RTZ (Return To Zero)



HHB CDR-830/CDR-830 Plus CD-RW CD Recorders



- Unbalanced RCA analog as well as coaxial & optical S/PDIF digital I/O
- 1 track, all tracks, and all tracks with finalize synchro recording • 24-bit
- Standard & audio only CD-RW compatible • SCMS-free digital input • Digital input gain & balance controls • CD Text • 2x CD finalize • Infra-red remote
- **CDR-830 Plus Adds**— Balanced XLR analog I/O & AES/EBU (XLR) digital input
- SCMS management— create discs that cannot be copied, copied once or not copy protected • 8-pin parallel control interface • All functions on front panel
- 32 to 48 kHz sample rate converter • Word clock on BNC Connector

KRK V-Series Bi-Amplified Reference Monitors

These bi-amplified near field reference monitors are able to satisfy the most critical listening requirements. The separate built-in power amplifiers for each woofer and tweeter and true electronic crossover that tailors the power and frequency response specifically for each transducer combine to deliver the dynamic range and performance required for everything from digital production to 5.1 surround sound.



- **V-Series Feature**— Magnetically shielded • Variable Gain +6dB to -30dB
- XLR - 1/4" TRS Combo plug inputs accommodate balanced and unbalanced line level signals
- **V4 Features**— 1" Fabric Dome tweeter, 4" Woven Kevlar woofer • 15 Watt HF & 30 Watts LF amplification • 65Hz - 20kHz frequency response ±2dB • Maximum SPL @ 1m: 101dB Music 104dB Peak
- **V6 Features**— 1" Silk Dome tweeter and 6-inch Polyvinyl woofer • Max SPL at 1m rated at 102dB Music, 105dB Peak • 30 Watt HF and 60 Watt LF amplification • 58Hz - 22kHz frequency response ±2dB
- **V8 Features**— 1-inch Silk Dome tweeter & 8-inch Woven Kevlar woofer • 60 Watt HF and 120 Watt LF amplification • HF adjust (+1dB, Flat, -1dB) LF adjust -3dB @ 45, 50 & 65 Hz • 47Hz - 23kHz frequency response: ±2dB • Max SPL at 1m is rated at 110dB Music, 116dB Peak



marantz PMD 680/690 Compact Flash Recorders

- The PMD680 (monaural) and PMD690 (stereo) audio recorders capture high-quality digital audio files directly to PC Cards, Compact flash or to an IBM Microdrive
- Audio data can be transferred to a computer for editing, or uploading to the Internet. • File formats include compressed MP2 and uncompressed .wav file. • Mark tracks recording for easy search during playback • 2-Second Pre-Record Buffer • RCA Analog In/Out • Coaxial Digital Output • Built-in Microphone, Speaker and headphone output
- Includes an XLR and 1/4" Mic input with -15/-30 dB attenuator. **PMD680** has a telephone jack and the **PMD690** a +48V phantom power for condenser mics



HHB MDP-500 PortaDisc Professional Portable MiniDisc Recorder

- Balanced XLR mic / line inputs
- Switchable phantom power and limiting
- 6-second pre-record memory buffer
- **USB interface** allows real-time transfer of files to computer editing systems
- Coaxial and optical S/PDIF digital I/O
- Built-in monitor speaker and back-up microphone
- Includes 8 x AA NiMH batteries, AC Adapter/ 100V-240V charger, soft case, carrying strap, and HHB MD80 MiniDisc.



STUDIO / RECORDING

MACKIE CFX Series

Sound Reinforcement Mixer with Effects

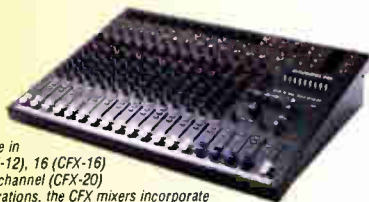

Available in 12 (CFX-12), 16 (CFX-16) and 20-channel (CFX-20) configurations, the CFX mixers incorporate digital effects and a 9-band graphic EQ to offer all-in-one compact mixing solutions. Based on developments made for the Mackie Digital 8-Bus Mixer the 32-bit EMAC (Extended Multiplication and Accumulation) effects processor found in the CFX Series sounds clean and realistic rivaling many outboard processors.

All Input Channels Feature: Pan, Mute, PFL solo, 2 Aux Sends with balanced 1/4" outs (switchable pre/post), external and internal EFX Send Input Channels; Mic/Line inputs feature low-noise, high-headroom mic preamps, 3-band EQ with 100Hz 18 dB/octave low-cut filters • Stereo Line Inputs 4-band EQ on stereo line channels • Inserts

Subgroups: 4 Subgroup buses with 1/4" TRS outs and L/R assign

Effects: 32-bit internal EMAC digital effects with 9 reverbs, 4 delays, phaser, chorus, flange; 2 parameter controls and an EFX wide spatial expander and bypass switch

Master Section: 9-band stereo low noise, low distortion, phase-coherent graphic EQ • Unbalanced RCA tape/CD I/O • Two stereo effects returns with balanced 1/4" inputs • 12-segment tri-colored LED meters

Outputs: Balanced XLR & 1/4" TRS main outs with inserts • Balanced XLR subwoofer output with built-in 18dB/oct. 75Hz crossover • Headphone out w/ level control • Extra 1/4" TRS stereo outputs with level control

TASCAM DM-24

Digital Mixing Console

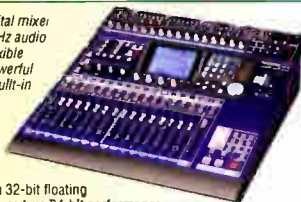

32-channel/8-bus digital mixer combines 24-bit, 96kHz audio quality with highly flexible routing, extremely powerful built-in automation, built-in professional-quality effects, dynamics processing and parametric EQ.

- Fully 24-bit, 96kHz compatible – Custom 32-bit floating point processor ensures true 24-bit performance throughout the digital signal path
- Flexible 32-channel/8-bus console with 6 aux sends
- High-quality, configurable Compressor and four band, parametric EQ on each channel – Channels 1-16 also feature a high quality Gate/Expander
- 16 mic pres, 16 balanced mic/line inputs on XLR & TRS jacks and 16 inserts • Digital I/O included as standard: 24 channels of TDIF, 8 channels of ADAT, (2) two channel AES/EBU and (2) two channel S/PDIF
- Two option slots are also provided for additional AES/EBU, TDIF, ADAT & Analog interface modules or a Cascade module for linking two DM-24s together • Powerful built-in automation (no computer required)
- (2) built-in, fully editable effects processors with reverb, spatial effects and mic/speaker modeling effects developed by TC Works, Antares and TASCAM
- Comprehensive user interface, featuring large LCD screen and LED ring encoder • (17) 100mm touch-sensitive moving faders
- Optional MU-24 meter bridge
- 4 assignable senders and returns also configurable as inserts for tape return path • Phantom power switchable in groups of four
- The perfect companion mixer for the MX-2424

BEHRINGER MX-1604A

12x2x2 Desktop Rack Mixer

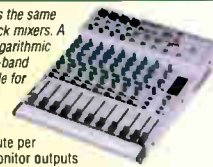

Behringer's smallest mixer yet maintains the same high standards as the rest of the Eurock mixers. A total of 12 input channels with 60mm logarithmic faders, even on the ALT 3-4 bus outs, 3-band EQ and balanced I/O throughout. Suitable for live sound, desktop music workstations, non-linear video, fixed installations.

- 12 inputs- 4 mic/line and 4 stereo
- 2 aux sends, 3-band EQ and Solo/mute per channel • 1/4" balanced Master & Monitor outputs
- 1/4" balanced Mute 3/4 Bus Outs (accessed by mixing input channels) • Stereo RCA tape inputs & outputs
- 1/4" Headphone out with level control • 2x stereo aux returns

SHURE FP33

Portable 3-Channel Stereo Mixer



- Used the world over for remote audio recording, ENG/EFP applications and location film production • 3 XLR-balanced mic/line inputs with 48V/12V phantom and 12V T (A-B) power
- Light enough, small enough and rugged enough to take anywhere
- Two outputs • Center detented pan pots for each input channel
- Built-in oscillator • Two headphone jacks • Tape out jack, and a monitor input for the headphone circuit • Exceptionally low noise design and wide dynamic range — ideal for digital transmission links or digital video/audio media, including DAT and recordable CD.

MACKIE FR Series

High Current Power Amplifiers



The FR Series Fast Recovery power amps from Mackie use traditional designs such as massive toroid transformers, huge storage capacitors, state-of-the-art output devices and cooling systems.

All FR Series Power Amps Feature—

- High continuous current output
- Fast Recovery design • Built-in variable low-cut filters
- Switchable limiters • XLR and TRS input with XLR signal pass-through
- 5-way binding posts and 1/4" or Speakon outputs • T-Design cooling with front inlet and side outlets • Detented gain controls • Selectable stereo, mono and bridged amp modes • Massive toroid transformers

QSC RMX Series

Power Amplifiers



Model	8Ω	4Ω	2Ω
850	200	300	430
1450	280	450	700
2450	500	750	1200

- Up to 2400 watts in 2 rack spaces
- 3-year warranty plus optional 3-year extended service contract
- High-current toroidal transformers • Independent user-defeatable clip limiters, DC and thermal overload protection on each channel
- Selectable low-frequency filters @ 300r 50 Hz • Balanced 1/4", XLR and barrier strip inputs • Binding post and Neutrik Speakon outputs
- Front mounted gain controls • Signal and Clip LED indicators

CROWN CE1000/2000

Power Amplifiers



Model	Power	Impedance
CE 1000	560W @ 2 ohms	450W @ 4 ohms
CE 2000	975W @ 2 ohms	660W @ 4 ohms

- 1/4" T.R.S., XLR and barrier strip inputs
- Neutrik Speakon output connectors
- Proportional fan-assisted cooling
- SST module allows customized features such as stereo crossover capabilities
- Short circuit protection
- 3-Year, No-Fault Warranty

MACKIE SRM-450

Bi-Amplified Sound Reinforcement Monitor



- FR-Series 300W low frequency and 150W high frequency amplifiers
- 24dB/Octave Linkwitz-Riley electronic crossover
- 45Hz to 20kHz frequency response
- 300mm long-throw low frequency transducer
- High-output precision titanium compression driver
- Studio-quality maximum dispersion horn
- XLR balanced mic/line input and thru
- Level control w/ signal present and peak LEDs
- 75Hz low cut and +3dB 100Hz and 12kHz contour switches • Electronic time correction, phase alignment and equalization • Timed power down • 51lbs.

audio-technica U100 Series

UHF Wireless System



- 100 Phase Lock Looped channels in the 728 - 725 - 740.500 MHz UHF frequency band avoids interference from DTV frequency bands
- 300' operating range typical
- True Diversity operation • Balanced XLR output with level control • 5-7 hour life using a single 9 volt battery (7-9 hrs for transmitters)
- Headphone jack with volume control
- ATW-1101 Body-pack Transmitter - Available with AT831 cardioid or MT830 Omnidirectional Lav mics
- ATW-1102 Plug-on Transmitter - 3-pin XLR input for use with all dynamic and most self powered mics

SENNHEISER e-Pack 855

evolution Mic kit

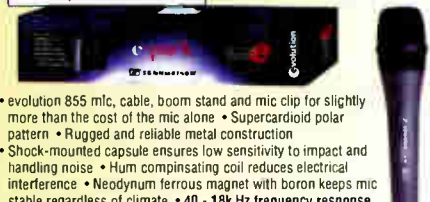

Includes the PM200 mic stand, mic clip and 21' mic cable

- evolution 855 mic, cable, boom stand and mic clip for slightly more than the cost of the mic alone • Supercardioid polar pattern • Rugged and reliable metal construction
- Shock-mounted capsule ensures low sensitivity to impact and handling noise • Hum compensating coil reduces electrical interference • Neodymium ferrous magnet with boron keeps mic stable regardless of climate • 40 - 18k Hz frequency response

JBL EON Power 15 G2

15-Inch Full-Range Bi-Amplified Speaker



- 300 watt LF and 100 watt HF amplifiers
- 15" neodymium Differential Drive LF driver and a 1.75" ferro-fluid cooled compression driver with a titanium diaphragm
- The Loop/Mix output allows you to daisy-chain any number of EON speakers or send a mixed signal directly to a main PA.
- Two 1/4" line inputs with independent level control for keyboards, pre-amped guitars, basses, CD players or an input from a mixer.
- Hi and Low frequency EQ controls
- 42 Hz - 17 kHz frequency response ±3 dB
- Accepts 110 - 230 VAC, 50 - 60 Hz

SENNHEISER evolution 100

UHF Wireless System



Includes Mountable UHF Receiver, Bodypack Transmitter with Lavalier Microphone & Plug-On Transmitter

- UHF wireless system operates in the 630-662 MHz frequency range • PLL Synthesized • HDX noise reduction
- Total of 1280 available frequencies
- 60 - 18k Hz frequency response
- EK100- Camera mountable UHF receiver with 4 - preset memory locations, Mute switch, 1/8" output
- SK100- Body pack transmitter available with an ME-2 omnidirectional electret lav mic; > 8hrs with alkaline 9V
- SKP100- Plug-on transmitter with XLR input for dynamic and self powered mics, > 8hrs with alkaline 9V

SHURE BETA 57A & 58A

Dynamic Mics



In the tradition of the SM57 and SM58, these two microphones are of the same basic shape, but feature a higher output, better gain-before-feedback and a wider frequency response. The Beta57A is tailored towards instrument applications while the Beta58A is best suited for live vocals.

They Both Feature—

- Supercardioid polar pattern
- High output neodymium element
- Pneumatic shock mount reduces handling noise
- Hardened steel mesh grille resists wear
- 50Hz to 16kHz frequency response

Radio **Promotes.** Radio **Provides.**



Radio has **Power.**

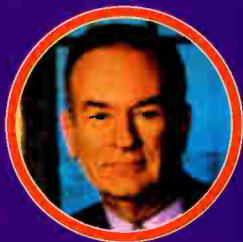

Friday, September 13
The NAB Radio Show Keynote

Sponsored by:



Bill O'Reilly
Host, The Radio Factor with Bill O'Reilly



September 12–14, 2002 • Seattle, WA
Washington State Convention and Trade Center

The power of new ideas. The power of cutting-edge sales strategies. The power of making the right contacts at exactly the right time. This is the degree of power that we've harnessed for you this September at The NAB Radio Show.

See You in Seattle!

Special 2-for-1 NAB Member Registration Offer!
Find out more by visiting www.nab.org/conventions/radioshow



Saturday, September 14
Radio Luncheon

Sponsored by:



NAB National Radio Award Recipient
Dick Ferguson
Vice President/Co-CEO, Cox Radio, Inc.

THE NAB
RADIO
SHOW®

Exhibiting Information: Tracy Mulligan, 202.429.5336
Sponsorship Information: Brad Williams, 202.775.3514

www.nab.org/conventions/radioshow

► Two-Track Recorders from page 49

HHB Portadisc MiniDisc Recorder

Features: MiniDisc format; phantom power; basic editing functions; mono function; six-second buffer memory; ATRAC 4.5 compression; USB port; battery operable. Price: \$1,545.
Contact: HHB Communications USA at 310-319-1111; or circle **Reader Service 82**.

**Marantz PMD650 Portable MiniDisc Recorder**

Features: MiniDisc format; onboard sample rate converter; standard (74 minutes), long play (148 minutes) recording modes; 48V phantom power; mic pad; limiter; shock buffer; basic edit functions; onboard mic, speaker; LCD. Price: \$1,249.

Contact: Marantz/Superscope at 630-820-4800; or circle **Reader Service 83**.

**Otari MX5050 BIII Reel-to-Reel recorder**

Features: 1/4" reel-to-reel format, 3.75/7.5/15 IPS; pitch control ($\pm 20\%$); dbx noise reduction; calibration controls; test tone generator; onboard splicing block; VU meters. Price: \$4,452.
Contact: Otari at 800-877-0577; or circle **Reader Service 84**.

**TASCAM BR-20 Reel-to-Reel Recorder**

Features: 1/4" reel-to-reel format, 7.5/15 IPS; three-head design; pitch control ($\pm 12\%$); +4/-10 dB operation; fader/event start; onboard speaker; onboard splicing block; calibration controls. Price: \$3,699.
Contact: TASCAM at 323-726-0303; or circle **Reader Service 85**.

**Sony CDR-W66 Compact Disc Recorder**

Features: CD R/CD RW format; onboard sample rate converter; 24-bit A/D-D/A;

onboard DSP functions; Super Bit Mapping; PC control; remote control. Price: \$1,125.

Contact: Sony at 800-686-7669; or circle **Reader Service 86**.

Denon DN-C550R Dual-Well CD Recorder

Features: CD-R/CD-RW format; 24-bit A/D-D/A; onboard sample rate converter; 32 - 48 kHz sample rates; 44.1 kHz master sample rate; 2X dubbing; defeatable SCMS; CD Text; multisession. Price: \$899.

Contact: Denon at 973-396-0810; or circle **Reader Service 87**.

**HHB CDR830 BurnIT PLUS CD Recorder**

Features: CD-R/CD-RW format; onboard sample rate converter; 44.1 kHz master sample rate; defeatable SCMS; stable platter mechanism; headphone control; remote control. Price: \$649.

Contact: HHB Communications USA at 805-579-6490; or circle **Reader Service 88**.



continued on page 54 ►

Acoustics First®

Materials To Control Sound And Eliminate Noise

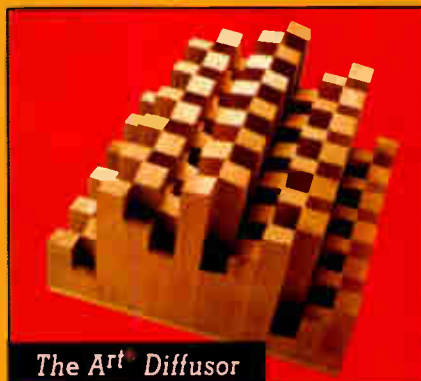

The Art Diffusor

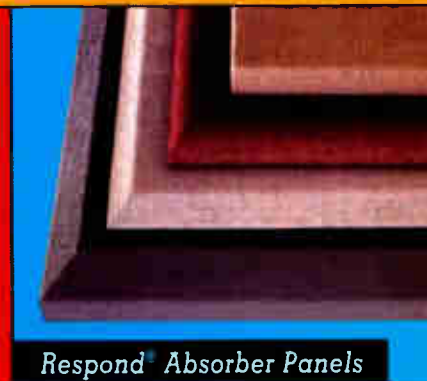

Respond Absorber Panels

Sound Absorbers

Noise Barriers

Sound Diffusers

Noise Isolators

Toll Free

1-888-765-2900

Web: <http://www.acousticsfirst.com>

READER SERVICE NUMBER 99

► Two-Track Recorders from page 53

Sonifex Courier Portable Hard Disk Recorder

Features: PCMCIA card format; scrub wheel editing functions; supports MPEG Layer 2, WAV files; USB port; phantom power; high-pass filter; limiter; onboard speaker; headphone controls; battery operable. Price: \$2,800.

Contact: Sonifex/Independent Audio at 207-773-2424; or circle **Reader Service 89**.



TASCAM CD-RW2000 CD Recorder

Features: CD R/CD RW format; 24 bit A/D-D/A; onboard sample rate converter; 32 - 48 kHz sample rate; input level controls; output level trim control; buffer memory; word clock; defeatable SCMS. Price: \$1,125.

Contact: TASCAM at 323-726-0303; or circle **Reader Service 90**.



Superscope PSD300 CD-R/CD-RW Recording System

Features: CD R/CD RW format; dual drive; onboard EQ; key change; temp controls; 2x duplication; onboard mic, speaker; portable/tabletop design. Price: \$1,099.

Contact: Superscope at 630-820-4800; or circle **Reader Service 91**.



Nagra V

Features: Removable hard disk drive (Orb); 2.2 GB; 44.1, 48 kHz sample rates; 24-bit A/D-D/A; BWF files; onboard four-channel mixer; mic sensitivity; 20-second buffer; 48V, T power; M/S; optional SMPTE timecode, 88.2/96 kHz packages. Price: \$5,650.

Contact: Nagra USA at 800-813-1663; or circle **Reader Service 92**.



PRODUCTS & SERVICES

You consider a microphone to be a fine musical instrument so does the MP-2



A Designs presents the pure tube-in/tube-out stereo microphone preamplifier the MP-2

Built with Jensen input transformers. Paired with custom output transformers. You get unimpeded dynamics delivered at the lowest noise level

Capture the warmth and richness of analog. Yet maintain the crystal clear spectrum of sound perfect for digital recording.

MP-2 by A Designs... True pro-audio stereo mic-pre. Built in the USA. Impressively affordable.

Ask for a demo at your favorite retailer.



A DESIGNS West Hills CA 91304
Voice 818 716 4153 Visit us at www.adesignsaudio.com

Reader Service 98

PRO AUDIO REVIEW

The Industry's Equipment Authority

Reprints are highly effective when you use them to:

- Develop direct-mail campaigns
- Provide product/service literature
- Create trade show materials
- Present information at conferences and seminars
- Train and educate key personnel, new employees
- Enhance media kits

Custom REPRINTS

Joanne Munroe
Phone: 703-998-7600 ext. 152
Fax: 703-671-7409
Email: jmunroe@imaspub.com

PRODUCTS & SERVICES

Got a problem? We Build Solutions...

Since 1982, Henry Engineering's "blue boxes" have been solving your problems!

- Audio Interface
- Audio Mixing
- Audio Distribution
- Telephone Information
- Digital Audio Storage
- Control Interface

**Over 60,000 units
in use worldwide**
**How can we
help you?**



www.henryeng.com
Tel: 626.355.3656
Fax: 626.355.0077



Blueboxes, Inc

Reader Service 95

SRC-1 Digital Audio Sample Rate Converter



The Phase 3 SRC-1 allows any digital audio signal format to be converted to professional AES3 (XLR) or AES3-ID (BNC) formats, up to 96 kHz.

Input signals may be S/PDIF (coaxial or optical), AES3, or AES3-ID, at 32, 44.1, 48, or 96 kHz.

The SRC-1 will lock to the internal clock, the separate AES3 sync input, or to a composite video input (BNC). Dither on the converted outputs may be set to 16, 20 or 24 bits, or disabled completely.

Conversion may also be bypassed completely.

VIDEOQUIP
RESEARCH LIMITED
www.videoquip.com

Phone: 416-293-1042
Fax: 416-297-4757
Toronto, Canada
TOLL FREE 1-888-293-1071

Reader Service 96

NANOAMP SERIES™ Problem Solvers DM200 - DIGITAL MONITOR

D/A • METER • HEADPHONE • LINE OUT
FIELD OR STUDIO • COMPACT • DESK OR RACK MOUNT



DM200

- UL & CE 24VDC remote power supply



**AUDIO
TECHNOLOGIES
INCORPORATED**

- AES/EBU Input Signals
- Sample Rates 27 to 96kHz
- XLR, RCA and BNC Inputs
- Loop-thru Inputs with switchable terminations
- Transformer Isolated Inputs
- 24 Bit D/A Converter
- Headphone, Meter and Stereo Balanced Line Outputs

Free Brochure Available Upon Request
<http://www.atiguys.com>

328 W. Maple Avenue • Horsham, PA 19044
800-959-0307 • 215-443-0330 • Fax: 215-443-0394

Reader Service 97

Audio Equipment Exchange

ACOUSTICS

AcousticsFirst™
 Toll-Free Number: **888-765-2900**
 Full product line for sound control and noise elimination.
 Web: <http://www.acousticsfirst.com>

Auralex acoustics
 www.auralex.com
 Expert Advice
FREE Consultation!
 Your Studio.
 Your Sound.
 Our Passion.
NEW!
D36 Roominator-DST
 TOTAL SOUND CONTROL™ • www.auralex.com

WhisperRoom INC.
 SOUND ISOLATION ENCLOSURES
 Vocal Booths
 Broadcast Booths
 etc...
 PH: 423-585-5827
 FAX: 423-585-5831
 E-MAIL: whisper@ics.net
 WEB SITE: www.whisperroom.com
 116 S. Sugar Hollow Road
 Mornstow, Tennessee 37813

CONSOLES

Sales@SoundBroker.com

(310) 333-1960

SoundBroker.com

Linking Buyers & Sellers Together

We Buy & Sell For You
New & Used

Consoles - Speakers - Amps
 Meyer, Crown, Crest, QSC
 Satisfaction Guaranteed

proaudioreview.com
 the professional's
 choice for
 product reviews
 To advertise call
703-998-7600, ext. 154.

CONTROL PANELS

CUSTOM PANELS & METALWORK

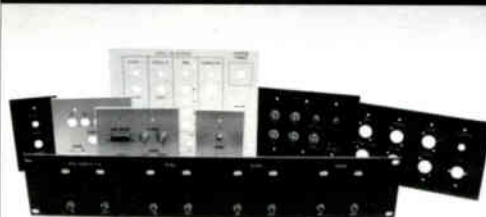

Custom panels in Aluminum, Steel, Stainless & Brass. Wide choice of finishes. Silk screened or engraved graphics. Custom wood mounting systems & desktop consoles.



PANELAUTHORITY INC.

PHONE 815.838.0488 | FAX 815.838.7852 | www.panelauthority.com

EQUIPMENT

ALAN SMART COMPRESSORS



C-1, C-2 & Multi-channel versions
 available in the U.S. & exclusively distributed by:
Sunset Sound, Hollywood (323) 469-1186
www.sunsetsound.com

SPEAKERS

-- TRI-STATE LOUDSPEAKER RE-CONING --
 FREE WHOLESALE PRICE LIST
 (724) 375-9203

SOUND/LIGHTING

Sound Productions
 Selling All The Major Brands Since 1973
800-203-5611
CHECK OUT OUR NEW WEBSITE
WWW.SOUNDPRO.COM
 NEW, USED, DEMO & CLEARANCE ITEMS UPDATED DAILY

WANT TO SELL

Calrec Q2 Audio Console

Great sonic quality with incredible flexibility. 48 large faders with stereo mic/line inputs; 4 large faders for 4 more stereo line inputs; 8 large faders for 8 stereo groups and 60 smaller faders for another 60 stereo inputs. Four stereo main outputs; 32 multi-track outputs, 8 mono & two stereo aux sends. Eight stereo tally-follow circuits, lots of metering. Used only in NBC's Olympics Broadcast Center. \$100,000 savings.

If interested please contact:
Mike Shaughnessy - 203-964-8627
Michael.Shaughnessy@nbc.com

GET RESULTS WITH YOUR CLASSIFIED AD!

For more information, rates and deadlines, call Simone Fewell at **703-998-7600, ext. 154** or e-mail: sfewell@imaspub.com.

SOUND & LIGHTING SYSTEMS

ST. LOUIS, MO SINCE 1988
 "LOWEST OVERHEAD MEANS LOWEST PRICES"
 A&H, Alesis, Ashly, BSS, Crown, Drawmer, DBX, DHS, EAW, Eminence, Flamingo, Furman, JBL, Horizon, Mackie, Marantz, Pre-Sonus, Pre-Co, RCF, Renkus - Heinz, Soundcraft, Whirlwind, All Lighting, Recording, Microphones, and DJ



Web site: www.slsdoc.com
 Toll Free (888) 819-7445



Lease & Finance Terms
 Fax: (314) 371-2121

Email: solisys@prodigy.net
 P.O. Box 78325. St. Louis, MO 63178



AD INDEX

This listing is provided for the convenience of our readers.
Pro Audio Review assumes no liability for inaccuracy.

Page No.	Advertiser	Website	Reader Service #
53	.Acoustics First	www.acousticsfirst.com	99
54	.A-Designs	www.adesignsaudio.com	98
43	.ADK	www.adkmic.com	43
55	.ATI	www.atiguys.com	97
35	.Audio Toys, Inc.	www.8mx2.com	35
34	.Audix	www.audixusa.com	34
50	.B&H Photo-Video	www.bhphotovideo.com	50
51	.B&H Photo-Video	www.bhphotovideo.com	51
31	.Belden Wire & Cable	www.belden.com	31
19	.Bryston Ltd.	www.bryston.ca	190
21	.Carvin	www.carvin.com	21
46	.D.W. Fearn	www.dwfearn.com	46
11	.Denon Electronics (USA) Inc.	www.denon.com	11
23	.DPA Microphones/TGI North America	www.dpamicrophones.com	23
13	.EVI Audio	www.electrovoice.com	13
37	.Fostex Corporation	www.fostex.com	37
45	.Groove Tubes, LLC	www.groovetubes.com	45
55	.Henry Engineering	www.henryeng.com	95
33	.JBL Professional	www.jblpro.com/sr13	33
59	.Kurzweil	www.kurzweilmusicsystems.com	59
25	.Logitek	www.logitekaudio.com	25
2	.Manley Labs	www.manleylabs.com	2
60	.Midi-Man	www.m-audio.com	60
29	.Millennia Media	www.mil-media.com	29
5	.Musician's Friend	www.musiciansfriend.com	5
17	.Peavey	www.peavey.com	17
41	.Presonus	www.presonus.com	41
44	.Q5C Audio Products	www.q5caudio.com/cx/8chsc.htm	44
24	.Recording Workshop	www.recordingworkshop.com	24
40	.Royer Labs	www.royerlabs.com	40
27	.Sennheiser Electronic Instruments	www.neumannusa.com	27
15	.Shure Brothers, Inc.	www.shure.com	15
39	.Studio Projects	www.studioprojectsusa.com	39
3	.TC Electronic	www.tcelectronic.com	3
7	.TEAC America, Inc.	www.tascam.com	7
55	.Videoquip	www.videoquip.com	96
48	.Whirlwind	www.whirlwindusa.com	48
9	.Yamaha Commercial Audio	www.yamaha.com/proaudio	9

Pro Audio Review DISTRIBUTOR DIRECTORY

The Case Specialists



Medium to Heavy Duty
Cases for Keyboards,
Mixers, Guitars, Rack
Mount Equipment & More!

Call for pricing on standard
or custom designed cases!

DISCOUNT DISTRIBUTORS
800-346-4638 (in NY) 631-563-8326
www.discount-distributors.com

ARE YOU
A DISTRIBUTOR?
LET OUR READERS KNOW...

ADVERTISE!!!.....

PRO AUDIO REVIEW'S DISTRIBUTOR DIRECTORY

is an efficient, effective and
affordable advertising option!
For more information about
rates and deadlines
call Simone at
1-800-336-3045 ext.154.

Advertising Sales Representatives

East Coast/Midwest Sales

Alan Carter 703-998-7600 ext. 111
Fax: 703-671-7409

West Coast Region Sales

Paul DaCruz 707-789-0263
Fax: 707-789-0251

UK & Ireland, Benelux, Scandinavia, Africa, Middle East

Derek Gregory 44(0)1761-420123
Fax: 44(0)1761-42123

Japan

Eiji Yoshikawa 81-3-3327-2688
Fax: 81-3-3327-3010

Classifieds

Simone Fewell 703-998-7600 ext. 154
Fax: 703-671-7409

Product Showcases

Tina Tharp 773-472-2495
Fax: 773-472-2496

2002 Classified Advertising Rates

	(1x)	(3x)	(6x)	(12x)
1-9 column inch	\$90	\$85	\$80	\$75
Distributor Directory	\$140	\$130	\$125	\$120
Professional Card	\$95	\$90	\$85	\$80

Mac Tools and AKG K 240 Studio Headphones

MICRO
VIEWS

BY FRANK BEACHAM

There are many excellent products to process and control audio entering the USB port of your Macintosh computer. These range from portable input devices such as the USBPre Audio Interface from Sound Devices to digital audio workstation controllers from TASCAM and others. Yet...

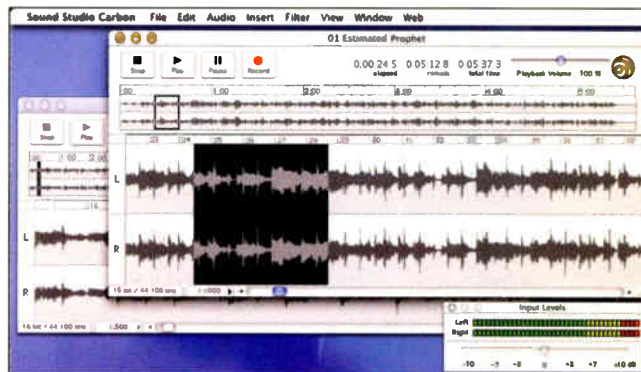

Felt Tip Sound Studio screenshot

professional-quality audio tools to the masses.

Griffin iMic USB Audio Adapter (\$35): For convenience, portability, utility and low cost, it's hard to beat the iMic USB Audio Interface from Griffin Technology of Nashville. Priced at an affordable \$35 and weighing a feather-like two ounces, the iMic is a universal USB audio recording and playback adapter that supports virtually any microphone or line level input signals.

In addition to a switchable mic/line level input via a 3.5mm mini jack, the iMic supports a stereo audio output that provides greater power output than what is found on most computers. This extra kick offers a welcome level boost for headphones users. The iMic is plug-and-play with all USB Macs, including those running on the new OS X operating system. No drivers are needed.

I have used the iMic with an OS X-powered Apple iBook to grab sound from an array of sources, including professional mixers, consumer stereo systems and microphones. It has worked flawlessly each time. It also sounds good. Sampling internally at 24 bits, the iMic boasts an excellent S/N ratio, wide dynamic range and good high-end frequency response. A lot of audio bang for the buck!

Felt Tip Sound Studio (\$49.99): A good, inexpensive companion for the iMic is the versatile Sound Studio digital audio editing and recording application written by Lucius Kwok of Felt Tip Software in Philadelphia.

Of course there are far more elaborate and expensive sound editing applications for the Macintosh, but Sound Studio (which works with both OS 9 and OS X) offers tremendous capability and simplicity for under \$50. It takes full advantage of the Mac's built-in sound recording and playback capabilities.

Sound Studio, which comes with a 14-day free trial, allows users to record live CD-quality audio, to digitize collections of vinyl and tapes, to edit new and pre-existing digital audio with a waveform display, and to save audio in several industry-standard file formats.

It comes with a good selection of effects filters, including chorus, flanger, reverb, EQ, compressor, expander and noise gate. Clicks and pops can be repaired with the interpolate filter. There's capability to remove DC offset and fix inverted signals. Tone and noise generators along with a sample rate converter are included. The slick, well-designed, intuitive Sound Studio brings affordable

AKG K 240 Studio Headphones (\$179): The latest iteration of AKG's K 240 Studio Headphones introduce Varimotion XXL diaphragm technology, a new 1.2-inch low impedance transducer design with improved dynamic range and resolution. The updated transducer is also more sensitive, offering significantly higher decibel levels than the original K 240M at the same gain settings.

Based on the classic 20-year-old studio workhorse AKG K 240 headphone design, the semi-open, circumaural K 240 Studio Headphones, weighing 8.5 ounces, offer a frequency response of 15 Hz – 25 kHz. The headset includes a single 10-foot oxygen-free copper cable and self-adjusting headband that conforms to about any head size.

Not only did I find the sound of these new headphones pleasant and extremely accurate, but I appreciated the elevated volume levels enabled by the 55 ohm impedance. This extra efficiency gives the K240 Studio headphones real flexibility, allowing their use with the lame underpowered headphone amps often found on portable CD players, laptop computers and keyboards.

I also liked the robust gold-plated 3.5mm mini plug and screw-on adapter for standard 1/4-inch phone jacks. Not only could I be confident these phones would work with just about any device, but the premium-quality cable/connector configuration is rock solid, appearing to be extremely secure for professional working environments.

For more information contact:

Griffin Technology at 615-399-7000, www.griffintechology.com; or circle **Reader Service 78**.

Felt Tip Sound Studio at www.felttip.com; or circle **Reader Service 79**.

AKG at 615-620-3800, www.akgusa.com; or circle **Reader Service 80**.

SOUND...
PERFORMANCE...
& CONTROL

PC2



The award-winning PC2 Series from Kurzweil offers more options and power than ever before. Following on the design of our award-winning PC88, the PC2 features outstanding sound and impressive master controller capabilities.



Available in three models:
PC2— 76-note, semi-weighted performance keyboard
PC2X— 88-note, fully weighted performance keyboard
PC2R— 11 rack-mountable sound modules

The PC2 Series also includes 24-bit digital outs and KB3™ Tone Wheel Organ Modeling. Options include a 128-voice polyphony expansion, two 16Mb Sound ROM expansion slots, and a ribbon controller. Sounds include a Triple Strike Stereo Grand Piano, Stereo Strings, Take 6 Vocals and hundreds of others.

*Now featuring the **Orchestral ROM expansion card** - included in all new units or as an option for customers who own a PC2. The **Orchestral ROM card** provides 16 MB of sounds, including 128 new programs, 32 new setups, and **General MIDI**. Sounds include **String Sections, Solo Strings, Woodwinds, Orchestral Brass, Jazz Brass, Orchestral Ensembles, Choir, Organ, Harp, Nylon String Guitar, Orchestral Percussion, Ethnic Percussion, plus more.***

For complete specifications and MP3 demos, visit the Kurzweil web site at www.kurzweilmusicsystems.com.

KURZWEIL
Music Systems

Kurzweil Music Systems
9501 Lakewood Drive, S.W., Suite D
Lakewood, Washington 98499
253-589-3200
Fax: 253-588-6809
www.kurzweilmusicsystems.com

Canadian Division
365C Victoria Park Avenue, Suite 105
Toronto, Ontario M2H 3P7
416-492-9899
Fax: 416-492-9299

Put your whole
sound in the
sweet spot.



TAMPA - The Professional Mic Preamplifier and Compressor with Temporal Harmonic Alignment™

TAMPA is a professional microphone/instrument preamp unlike any other. That's because our design team set out to discover just why expensive tube technology sounds so good, and devise a way to land that sound at affordable solid state prices. The result is far beyond tube modeling. It's a whole new technology called Temporal Harmonic Alignment™.

TAMPA even comes with direct digital output and world-class dual optical servo compressor built-in.

- >> Class A circuitry throughout
- >> Built-in dual optical servo compressor/limiter
- >> Variable impedance optimizes vintage mic performance
- >> Available 66dB system gain
- >> S/PDIF and AES/EBU output to digital recording gear

Unlike most solid state electronics, tube-based devices strike the ear as having such a "warm" sound because the added mid-range harmonics have the same temporal relationship as natural mechanisms like strings, drumheads and vocal chords. This results in a sweet spot that makes vocals, guitars and other midrange-rich content sound especially pleasing. TAMPA's revolutionary new Temporal Harmonic Alignment technology produces that same phase relationship found in both tubes and nature. And unlike tubes, TAMPA's sweet spot spans the full spectrum of your sound from bass to cymbal.

M-AUDIO
Redefining the Studio™

See the M-AUDIO dealer near you or visit us online: www.m-audio.com

READER SERVICE NUMBER 80
World Radio History