

TEC Award-Winners · Willie Nelson · Producer Jerry Harrison

U.S. \$4.95 CANADA \$5.95 NOVEMBER 1992

MIX

**Customized Recording Consoles:
Coming Full Circle**

**Small Consoles
for Post-Production**

PROFESSIONAL RECORDING · SOUND AND MUSIC PRODUCTION

**Directories: North Central
and Canadian Studios**

SOUND
FOR
K.D. LANG



-9
-12
-15
-18
-22
-27
-32
-38
-44
-51
-60

8 Tracks

RECORD
INPUT

1 2 3 4 5 6 7 8

POWER

1 2 3 4 5 6 7 8

Demos to masters. Creativity to tape. Dreams to reality. Magic phrases for those who want to make music that sounds as good as it feels.

The inspiration for these thoughts is the **Alesis ADAT Professional Digital Audio Recorder**, a technological revolution that tears down the walls to your creativity while delivering world class master recordings. Too good to be true?

Here's the concept. ADAT fuses a supersonic Alesis-designed very large scale integrated chip set with the proven reliability of an industrial grade S-VHS* tape transport and a logical, sensible user interface. The result is a digital tape recording system that exceeds the most demanding requirements of professional audio and that can be used by literally anybody. Hard to believe?

Here's some specs. Bandwidth 20Hz to 20kHz ± 0.5 dB. Total Harmonic Distortion plus Noise 0.009%. Wow and flutter unmeasurable. ADAT uses the professional standard 48kHz sample rate and delivers better than 92dB dynamic range.

Here's some features. ADAT uses the familiar tape recorder controls that you already know how to use so

recording is fast, intuitive, effortless. Connections are provided for balanced +4dBu levels on a single 56 pin ELCO** connector and unbalanced -10dBV signals on 1/4" jacks. And ADAT uses S-VHS tape because it's a proven, robust recording medium with wide 1/2" tape to solidly support ADAT's 8 recording tracks while delivering 40 minutes of recording time.

The best part. ADAT's Proprietary Synchronization Interface (Patent Pending) locks multiple ADATs, independent of the audio tracks, to single sample accuracy $\pm 5\%$ of 1/48,000th of a second! In other sciences this is referred to as 'air tight'. So multiple ADATs function in perfect mechanical and electronic unison: up to 16 ADATs without an external controller. That's 128 tracks!

More best part. ADAT's Proprietary MultiChannel Optical Digital interface (Patent Pending) simultaneously sends all 8 tracks of recorded information out the Digital I/O for perfect safety tapes and perfect track bounces.

Even more best part. The optional BRC Master Remote Control opens a whole other door to the ADAT miracle. With it you can control up to 16 ADATs (128 simultaneous tracks) with full transport functions, track offsets, machine offsets,

8 Tracks to Megatracks, Megatrack and ADAT Worldwide Network are trademarks of Alesis Corporation
*VHS is a registered trademark of JVC **ELCO is a registered trademark of Elro Corporation-a Kyneca Group Company
Also available: The AI-1 ADAT to AES EBU and S-PPDF Digital Interface with sample rate converter.
RMB 32 Channel Remote Meter Bridge.
Call 1-800-5-ALESIS for information about the ADAT Worldwide Network.



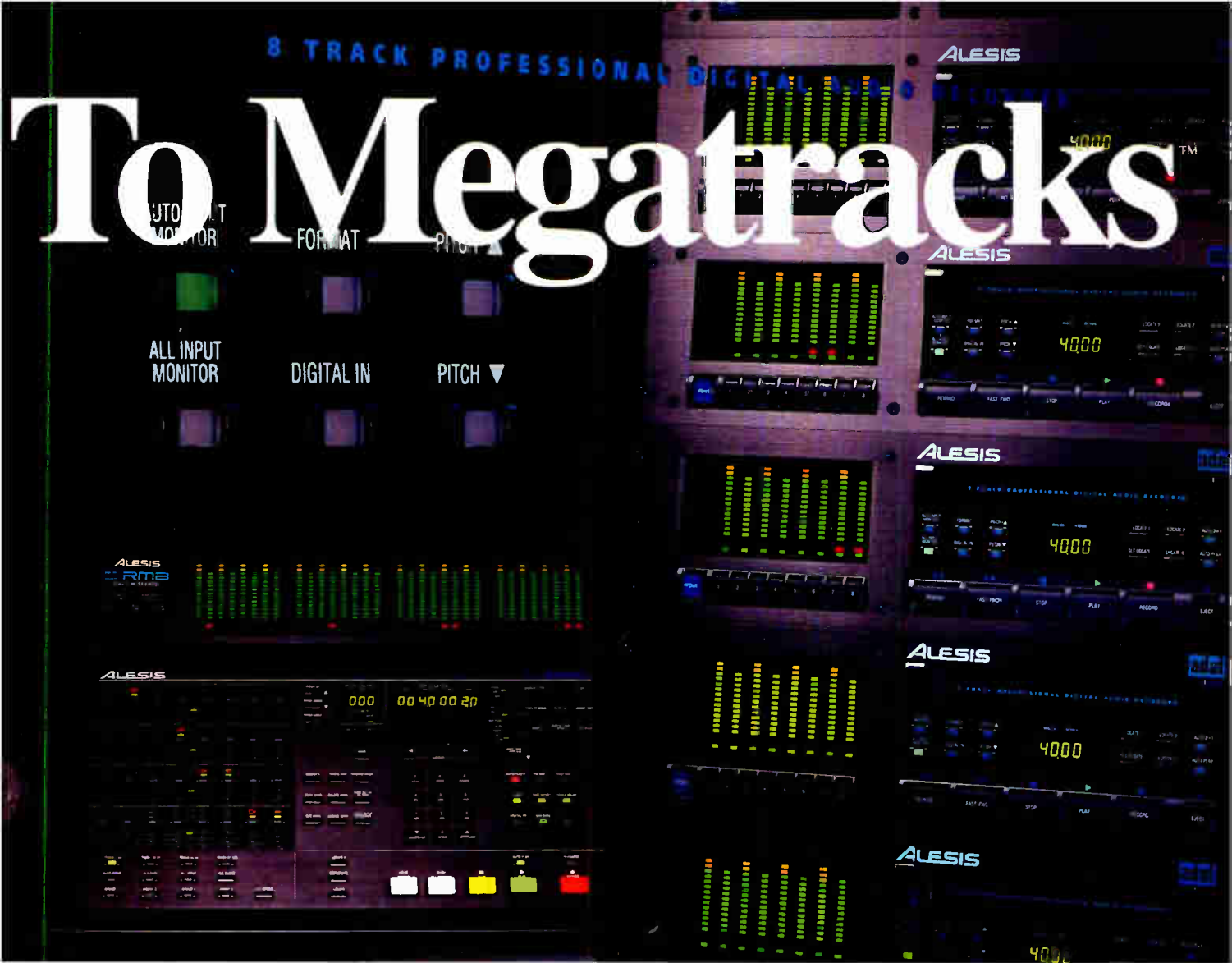

To Megatracks

digital assembly editing via the Digital I/O, SMPTE and MIDI Time Code, Video Sync and more.

What does all this mean? Here's just a few benefits.

It's commonly known that many hours are wasted during expensive album projects while the artist, producer and engineer work in vain to reproduce the rhythmic feel and tonal nuance of demos. Demos that couldn't be used because they suffered from noise, limited bandwidth and overall sonic feebleness. Those days are over forever.

ADAT's Sync and Digital I/O perpetually link your demos to your masters making them all part of the same creative process. Every track you record on ADAT is a master track that can be flown into any other ADAT recording, at any time. The best part is that ADAT can be there at any time to catch you at your best, flawlessly stored in the digital domain...forever.

Need more tracks? ADAT studios can be expanded at any time. The cost of a single ADAT is remarkably inexpensive and new ADATs can be added as budgets permit. Add the BRC at any time for more control and advanced editing. Producers please note: with ADAT, Megatrack™ recording is a reality.

Your favorite sax player lives in Idaho? No problem. Send 'Supersax' a formatted tape with a guide track of your song. You'll get back 7 tracks of burning solos you can fly back into your production. All in perfect sync, all in the digital domain. All dripping with soul. Want more tracks? Just send more tapes.

ADAT is not only a new recording medium, it is the new recording standard. Imagine a network of ADAT users from bands, composers and project studios to professional studios, video editing suites and broadcast production studios. All recording master quality tracks with full compatibility and no barriers between their creative disciplines. In fact, we're launching the ADAT Worldwide Network™ multitrack recording group to facilitate communication between ADAT studios.

In time we'll all start taking these little miracles for granted. Before that inevitable event, unpack your first ADAT and track a minute of single notes and chords on your favorite instrument. Play loud, play soft. Play it back and listen really close. It's always a good feeling to have your mind completely blown.

See your Alesis ADAT Dealer today and start Megatracking on ADAT.

Alesis Corporation 3630 Holdrege Avenue Los Angeles CA 90016



USE READER SERVICE CARD FOR MORE INFO

Bottoms Up



In recent years, the popularity of nearfield monitoring has become the mainstay of engineers throughout the industry. From midi rooms and home studios to major recording facilities, small-reference monitors are precariously perched atop consoles everywhere.

This current trend, however, presents its own unique problems, in terms of inadequate bass performance, particularly in the critical 40-100 Hz. region.

With this dilemma in mind, Tannoy now offers a compact and affordable solution in the PS-88.

The PS-88 is a purpose built nearfield sub woofer designed for under console placement, and represents considerably more thought and design than the average amplified bass loudspeaker.

The PS-88 utilizes a proprietary amplifier which takes advantage of a performance region not normally used in a loudspeaker system, the area below box resonance. The amplifier provides a correcting signal to overcome the natural 12dB per octave

rolloff of a woofer in a sealed box.

The result is a flat response from the point where the dynamic limiter takes over up to the system resonance of the speaker and a 18 dB per octave rolloff above system resonance. The amp eliminates the need for a passive crossover, which often performs poorly at high power levels.

The dynamic limiter constantly monitors the input signal and dramatically adjusts the correcting signal to give the deepest bass possible at that signal level, given the finite power and excursion limits of the system.

When utilized in reference mixing applications, a very useful and revealing picture of low frequency information comes into focus, offering well balanced, subsonic reinforcement, knitting seamlessly with the majority of todays small reference monitors.

Tannoy / TGI North America Inc. • c/o Bill Calma • 300 Gage Ave., Unit 1,
Kitchener, Ontario, Canada N2M 2C8 • (519) 745-1158 • Fax (519) 745-2364



TRY & TAKE IT TO THE LIMIT

STUDER A827-24

When you've got a major recording project, you need the professional power and reliability of Studer Multi-tracks. Why? So you can devote your full, undivided attention to the music and sound of each track. With the fastest transports in the industry, superior electronics, and most importantly the legendary sound quality that withstands the test of time, your imagination can take it to the limit. Call the professionals at Studer—providing quality audio for over 40 years.

STUDER

Studer Revox America, Inc. • 1425 Elm Hill Pike • Nashville, TN 37210 • Tel: 615/254-5651 • Fax: 615/256-7619
New York 212/626-6734 • Los Angeles 818/780-4234
Studer Revox Canada Ltd., Toronto 416/510-1347

USE READER SERVICE CARD FOR MORE INFO

MIX

PROFESSIONAL RECORDING • SOUND AND MUSIC PRODUCTION

NOVEMBER 1992, VOLUME 16, NUMBER 11

AUDIO

- 20 **Insider Audio:** Mini Disc Technology, Part 1—
Signal Format *by Ken Poblmann*
- 30 **Customized Recording Consoles:**
Coming Full Circle *by George Petersen*
- 30 **Big Advantages in Very Small Consoles**
by Gail Cork
- 42 **The Byte Beat:** Audio Telecommunications
by Paul Potyen
- 71 **1992 TEC Award Winners**
- 108 **The Operator:** Leasing—Is It For You?
by Chris Stone
- 110 **International Update:** Focus on Canada
by Terri Stone, Lynda Ashley and Tom Harrison
- 121 **Producer's Desk:** Talking Head Jerry Harrison
by Jeff Forlenza

PAGE 121

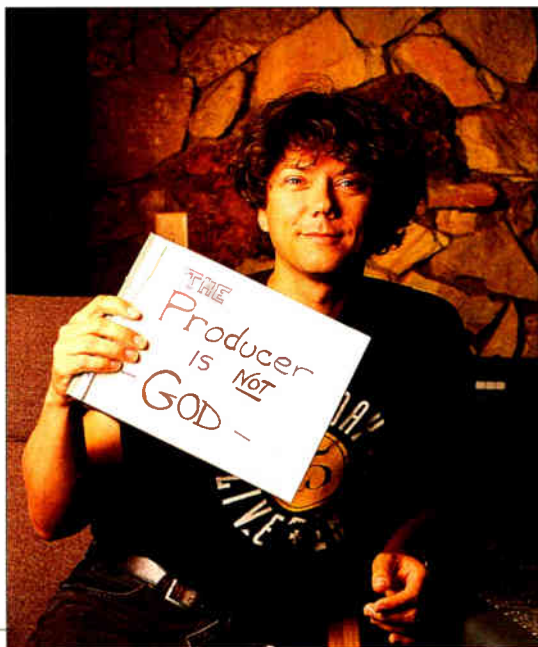

PRODUCTS

- 72 **Preview/Hot Off the Shelf**
- 77 **Auditions:** Dolby Spectral Processor;
The Hollywood Edge "Cartoon Trax";
"Macworld Music & Sound Bible"
by George Petersen and Paul Potyen
- 87 **Field Test:** More A/D Converters
by Bob Hodas and Paul Stubblebine

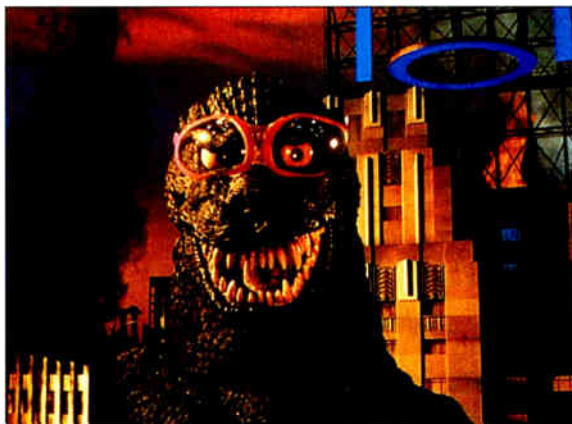

PAGE 48

POST-PRODUCTION

- 48 **Post-Script:** Sound for "Parker Lewis"; Small
Consoles for Post-Production; The Weird World
of "Wild Palms"; Charles Barkley vs. Godzilla in
3-D; Facility Profile—Ron Rose Productions
by Tom Kenny, Blair Jackson and Dan Daley
- 66 **Studio View:** So You Want to Be In Pictures
by Dan Daley

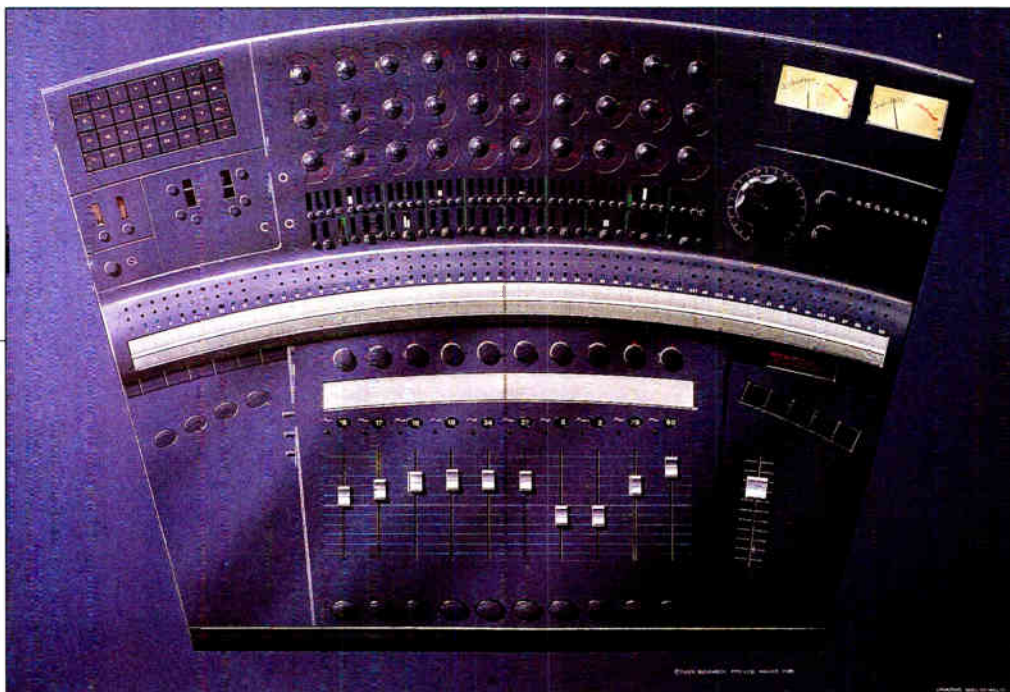

LIVE SOUND

- 92 **SoundCheck/News Flashes:** k.d. lang, George Strait *by David (Rudy) Trubitt*
- 102 **Milwaukee Summerfest** *by Nort Johnson*
- 107 **New Sound Reinforcement Products**

MUSIC

- 26 **The Fast Lane:** The Sea, A Minor Effigy *by Stephen St. Croix*
- 127 **Lunching with Bonzai:** Willie Nelson *by Mr. Bonzai*

TAPE & DISC

- 130 **Survey Reveals 1630 Dominates as Mastering Standard** *by Dr. Toby Mountain*
- 133 **Tape & Disc News/Splices** *by Philip De Lancie*

DEPARTMENTS

- 8 **From the Editor**
- 12 **Current**
- 16 **Industry Notes**
- 136 **Coast to Coast**
(Including Sessions, Studio News, NY Metro Report, L.A. Grapevine, Chicago Loop, In Session with Dylan)
- 158 **Feedback**
- 160 **Ad Index**
- 161 **Classifieds**

Cover: Established in 1973, Chicago's Acme Recording offers a full line of recording, CD mastering and real-time cassette duplication services. The control room features an automated 36-input Amek M3000 console, Studer 24-track recorder and Tannoy FSMU monitors. The spacious 20x40-foot studio has natural light and floating walls/floors. **Photo:** Custom Medical Stock Photo. **Inset Photo:** Steve Jennings.

DIRECTORIES

- 117 **Canadian Recording Studios**
- 143 **North Central U.S. Recording Studios**

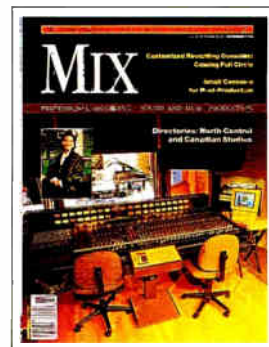

D R E A M M A C

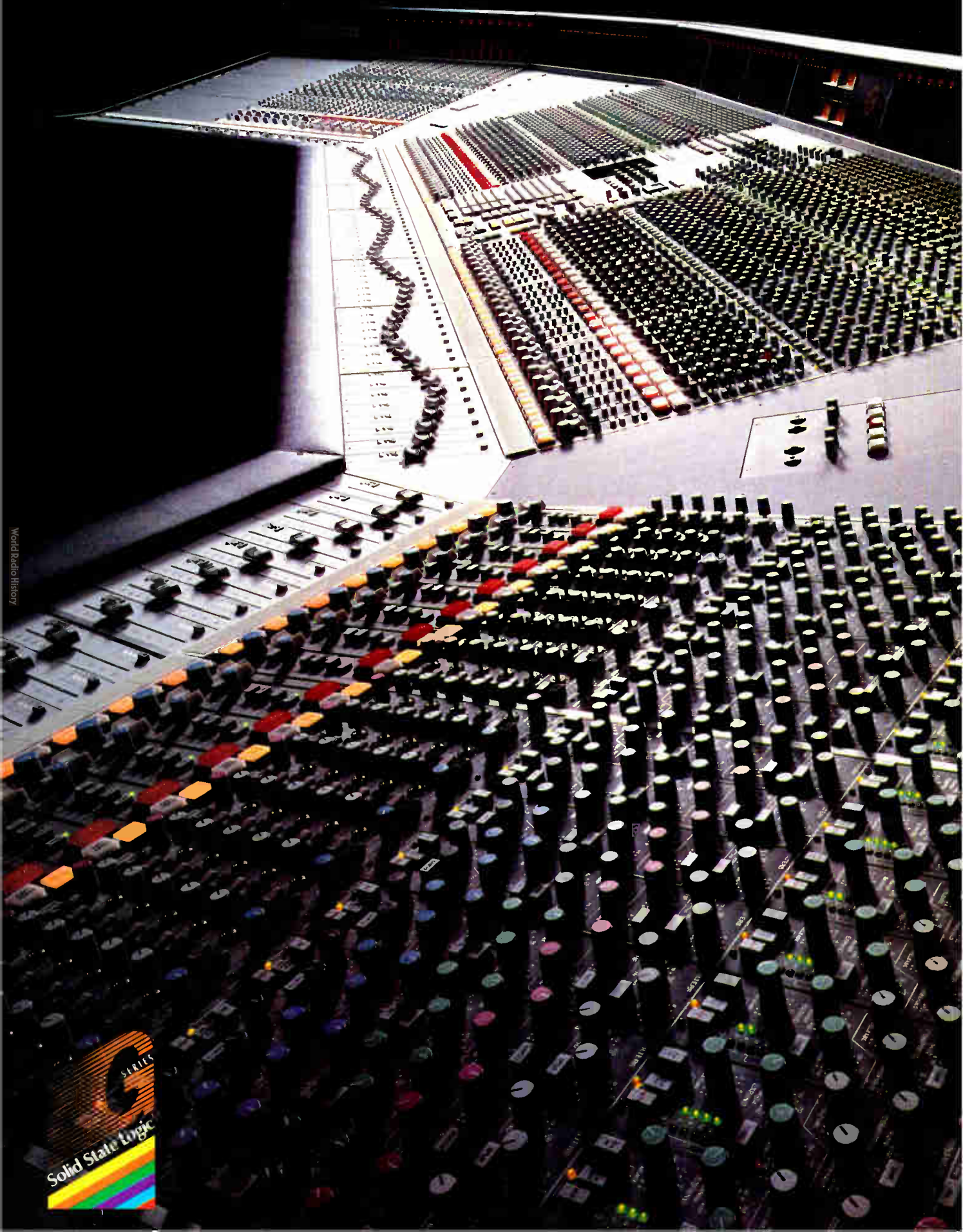

World Radio History



H I N E

SL 4000 G SERIES Master Studio System

■
'L' or 'U' shaped console wings

■
Mono or stereo modules

■
Advanced G Series circuitry and sonic performance

■
Two styles of equalisation

■
Compressor/limiter, expander/gate in every channel

■
G Series Studio Computer provides the world's most advanced
session management software

■
Ultimation™ dual automation system
(moving fader or VCA operation)

■
Total Recall™ of all I/O module settings

■
Tape autolocation under computer control

■
Synchroniser system for master and slave and multi-slave
autolocation and synchronisation of audio, video or film transports
to all timecode formats and bi-phase or tach pulses

■
Events Controller for non-synchronous devices

■
Programmable equalisation and panning system

■
Worldwide standard in music production

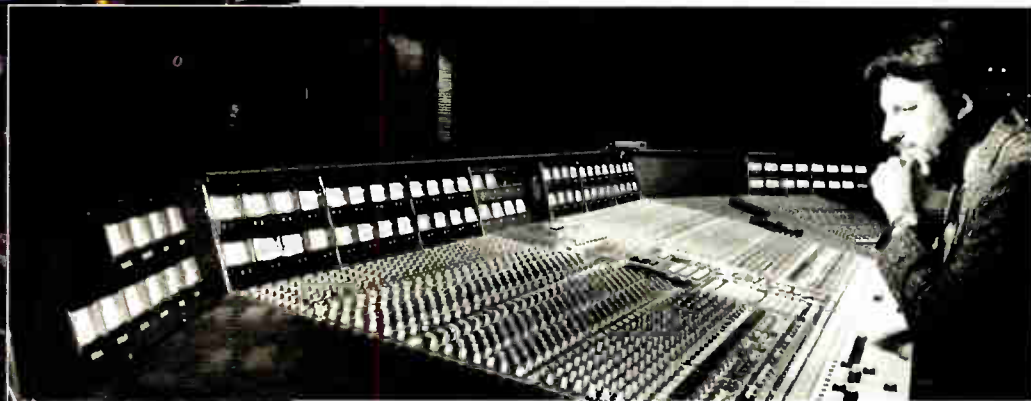

Solid State Logic

International Headquarters:

Begbroke, Oxford, England OX5 1RU · Tel: (0865) 842300

Paris (1) 34 60 46 66 · Milan (2) 612 17 20 · Tokyo (3) 54 74 11 44

New York (212) 315 1111 · Los Angeles (213) 463 4444 · Toronto (416) 363 0101

US Toll Free: 800-343 0101

World Radio History

FROM THE EDITOR

This month we take another look at the central nervous system of the recording studio, the mixing console. As George Petersen points out in his survey of custom console designs, not too many years ago *all* consoles were custom designed. In some ways, we have returned to a time when the demands for unique features put the onus on manufacturers to tailor their products to the specific needs of the users. With increasingly varied applications for mixing systems come increasingly novel approaches to customization.

An especially noteworthy signal control manufacturer named DISQ made its first appearance at last month's AES convention. Far from the humble origins more typical in this business, DISQ's launching pad was built by Gotham Audio, George Massenburg Labs, and—are you sitting down?—AT&T. AT&T's Bell Labs has churned out advanced audio technology in experimental situations for many years. The company's first commercial venture in the pro audio market originated from an idea of Gotham Audio's Russ Hamm, who saw the potential in combining AT&T's research work with GML's development potential.

DISQ's first product is a bit out of the ordinary, as one might expect from its esoteric parentage. "It's not really much to see. It's just a cube—a high-power, parallel-processing box that AT&T basically developed for the military. It's capable of doing gigaflops of processing," explains senior editor Mel Lambert, who got an early view of the device and will be reporting on it in greater depth in the near future.

To give this product its pro audio application, GML wrote an interface translator from its plug-in automation system that piggybacks onto an existing Neve VR console, or a G or E Series SSL equipped with a GML Moving Fader automation package. The DISQ system grabs the scanned information from the console and pulls it out via Ethernet to the processing cube; it then implements the movements from the console's control surface into the digital domain, essentially turning the analog console into a virtual digital mixer.

At a price of about \$350,000, this cube isn't for everyone. But it represents an intriguing new brain trust at work to supply improved approaches to mixing applications.



Keep reading,

David Schwartz
Editor-in-Chief

 **BPA** Circulation independently audited and verified by
Business Publications Audit of Circulation since 1985.

Mix magazine is published at 6400 Hollis St. #12, Emeryville, CA 94608 and is ©1992 by Act III Publishing. Mix (ISSN 0164-9957) is published monthly. Subscriptions are available for \$46.00 per year. Single copy price is \$4.95; back issues \$6.00. Missed issues within the U.S. must be claimed within 45 days of publication date and abroad, within 90 days. Send subscription applications, subscription inquiries and changes of address to Mix magazine, PO Box 41525, Nashville, TN 37204 or call (800) 888-5139. Outside U.S., call (615) 377-3322. POSTMASTER: Send address changes to Mix magazine, PO Box 41525, Nashville, TN 37204. Address all other correspondence to Mix magazine, 6400 Hollis St. #12, Emeryville, CA 94608; (510) 653-3307, Fax: (510) 653-5142. Second class postage paid at Oakland, CA, and additional mailing offices. Editeur Responsable (Belgique), Christian Desmet, Vuurgatstraat 92, 3090 Overse, Belgium. This publication may not be reproduced or quoted in whole or in part by printed or electronic means without written permission of the publishers.

STAFF

EDITOR-IN-CHIEF David M. Schwartz

PUBLISHER Hillel Resner

MANAGING EDITOR Blair Jackson
PRODUCT EDITOR George Petersen
ASSOCIATE EDITORS

Paul Polyen Tom Kenny
ASSISTANT EDITORS

Jeffrey Forlenza Terri Stone
SOUND REINFORCEMENT EDITOR

David (Rudy) Trubitt
TAPE & DISC EDITOR Philip De Lancie
SENIOR EDITOR Mel Lambert

TECHNICAL EDITOR Ken Pahlmann
CONSULTING EDITOR Stephen St. Croix

EDITOR-AT-LARGE Mr. Bonzai

TEC AWARDS EDITOR Karen Margroff Dunn
EAST COAST EDITOR Dan Daley
LOS ANGELES EDITOR Amy Ziffer

CONTRIBUTING EDITORS
Bob Hodas Linda Jacobson
Larry Oppenheimer Bruce Pilato

ART DIRECTOR Tim Gleason
ASSISTANT ART DIRECTOR Patricia Law
GRAPHIC DESIGNER Linda Gough

ASSOCIATE PUBLISHER Jeffrey Turner
SOUTHERN CALIFORNIA/SOUTHWEST AD MGR.
Sue Horwitz

EASTERN ADVERTISING MANAGER
Michele Kanatous

NORTHWEST/MIDWEST AD MGR. John Pledger
SALES ADMINISTRATOR Joanne Zola

SALES ASSISTANTS Tina Spinelli
Christine Cali Ann Spears

CLASSIFIEDS AD MANAGER Robin Boyce
CLASSIFIEDS ASSISTANTS
Elizabeth Hildreth Jill Stauffer

DIRECTORIES ADVERTISING MANAGER Lauri Newman
DIRECTORIES ASSISTANT Melissa McMillion
DATABASE COORDINATOR Cyndi Lukk

MARKETING MANAGER Elise Malmberg
ART DIRECTOR, SPECIAL PROJECTS

Michael Zipkin
ASSISTANT TO THE PUBLISHER/
EVENT COORDINATOR Jane Byer

DIRECTOR OF
OPERATIONS AND MANUFACTURING
Anne Letsch

PRODUCTION DIRECTOR Georgia George
COLLATERAL PRODUCTION MANAGER Ellen Richman
ADVERTISING TRAFFIC MANAGER

Donna Price
PRODUCTION ASSISTANT Chris Ferrell

CIRCULATION MANAGER Steve Willard
CIRCULATION ASSOCIATE Karen Stackpole

CONTROLLER David Rothenberg
SENIOR ACCOUNTANT Benjamin A. Pittman
ACCOUNTS RECEIVABLE MANAGER

Lea Lewis
ACCOUNTING

Bettye Gardner Therese Wellington
WAREHOUSE MANAGER Charles Nielsen
WAREHOUSE ASSISTANT Anne Eickelberg

RECEPTIONISTS
Rebecca Bogart Barbara Schultz

AN ACT III PUBLICATION
ALSO PUBLISHERS OF:
ELECTRONIC MUSICIAN
MIX BOOKSHELF

GROUP PUBLISHER
Hillel Resner
DIRECTOR OF CORPORATE DEVELOPMENT
David Schwartz

NATIONAL EDITORIAL, ADVERTISING and BUSINESS OFFICES, 6400 Hollis St. #12, Emeryville, CA 94608. (510) 653-3307, IMC 736, FAX: (510) 653-5142. **SOUTHERN CALIFORNIA ADVERTISING OFFICES**, 1999 Avenue of the Stars, Suite 500, Los Angeles, CA 90067. (310) 551-4035, FAX: (310) 556-3855. **EAST COAST ADVERTISING OFFICES**, 235 W. 48th St. #35B, New York, NY 10036. (212) 315-1800, FAX: (212) 315-1848. **DIRECTORIES ADVERTISING**, (800) 344-LIST. **CLASSIFIEDS ADVERTISING**, (800) 747-3703. **MIX BOOKSHELF**, (800) 233-9604. **CIRCULATION INQUIRIES**, PO Box 41525, Nashville, TN 37204. (800) 888-5139, (615) 370-5643.

Founded in 1977 by
David Schwartz and Penny Riker Jacob

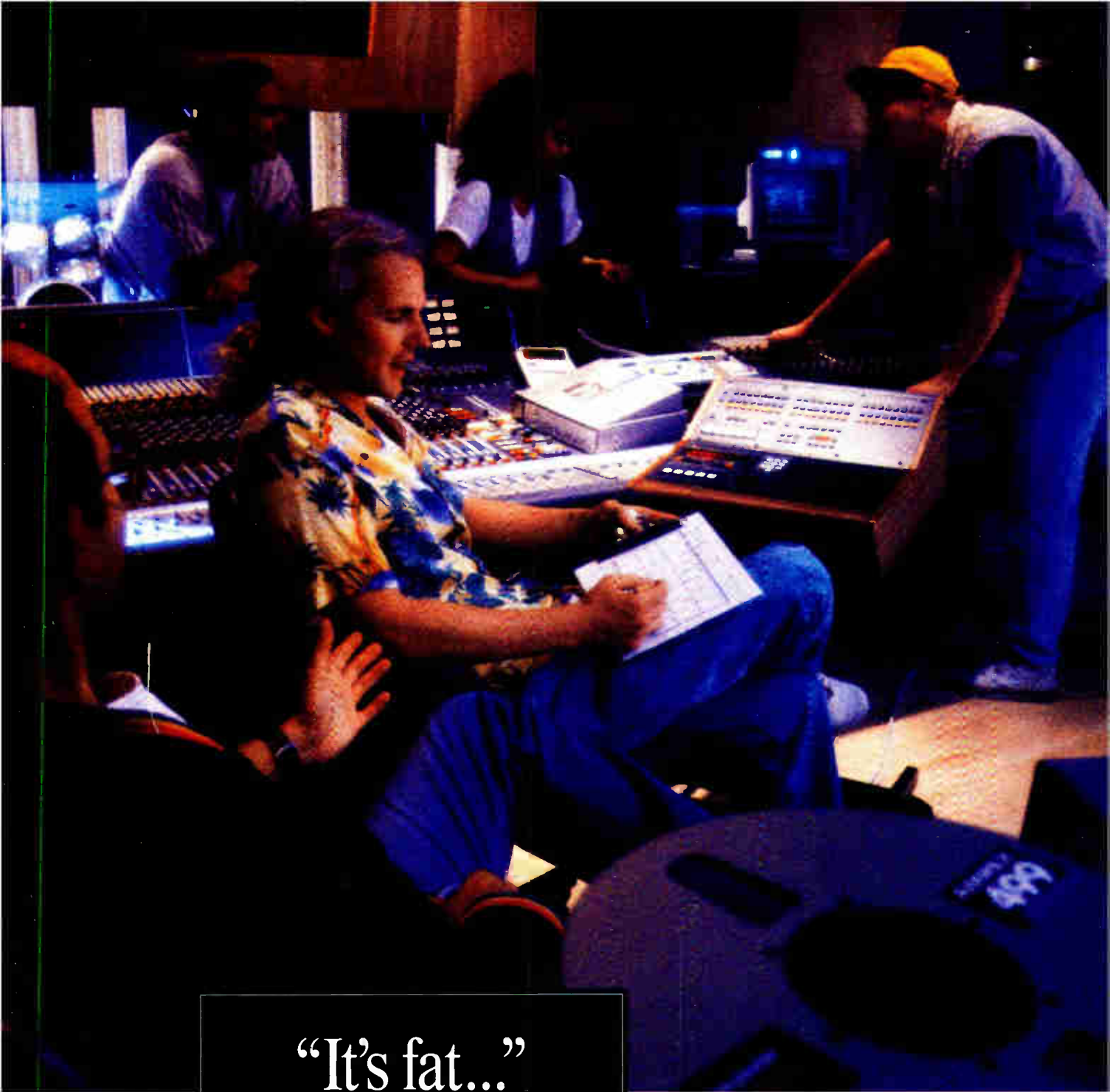

Andor Studios, Hollywood

“It’s fat...”

We’re printing at 9 over 250 and it still doesn’t sog up.
I know, the harder you hit it, the better it gets.
Listen to that high hat.
It’s stiff.
Yeah, and it’s not squashed.
No, it’s not compressing at all.
That’s pretty amazing.

What’s amazing is the noise floor.
What noise floor? I don’t hear any noise.
Right!
Hey, this sound’s got everything I need.
It’s got depth all right. You can hear everything—way back in there.
Clarity, punch, depth—that’s it.

You heard it. Ampex 499.
I’d say it was audibly superior.
I’d say it just *sounds* better.



Ampex 499.
It just *sounds* better.

AMPEX

VERY WARM...

All microphones capture sound. Sony's new C-800 and C-800G capture subtlety. These vacuum tube microphones are the product of five years of intensive research and critical evaluation. The result: some of the world's most respected musicians and engineers now demand the extraordinarily warm, rich and natural sound these microphones deliver.

Designed especially for musical instrument recording, the C-800 incorporates a large diaphragm capsule capable of a maximum input sound pressure level of 150 dB SPL. Its extremely wide dynamic range gives you the flexibility to use diverse microphone techniques on a variety of instruments.



C-800



SONY

SONY

AND VERY COOL.

The C-800G is engineered to excel in vocal recording applications and employs an innovative thermo-electric cooling system, which significantly reduces inherent noise and distortion. A newly developed dual diaphragm capsule provides superior off-axis frequency response.

All of which means this: for sound that's very warm and very cool, one name is very clear. Sony.

For more information, call 1-800-635-SONY, ext. TUBE.

C-800G

CURRENT

AES: REPORT FROM THE FLOOR

Over 15,000 audio professionals and 300 manufacturers convened at San Francisco's Moscone Convention Center October 1-4 for the 93rd Convention of the Audio Engineering Society. This was the first time AES was held in San Francisco, but the record attendance and amiable location proved so successful that AES is considering a return to the City by the Bay for the 1994 show.

AES provided a "New Ideas Room," offering free space to deserving local cottage companies who otherwise couldn't afford to exhibit. This generous gesture of support for struggling cottage industries should become a tradition for future shows.

A group of digital equipment manufacturers met and formed the Digital Manufacturers Association to find solutions to the problems stemming from improper or incomplete implementation of the various forms of the AES/EBU and S/PDIF digital interface standards. While no major accords were reached, the formation of the DMA and the recognition of the dilemma of digital incompatibility is an important step toward an industry-wide solution.

Of course, products and new technologies are the central focus of any AES convention. Tascam started things off with the unveiling of its much-awaited DA88 (\$4,499), a rack-mount digital 8-track recorder that can hold up to 100 minutes on a Hi-8mm tape. A modular system, the DA88 can be expanded by connecting additional units for up to 128 tracks. The front panel features a jog/shuttle wheel, switchable 44.1/48kHz sampling rates, $\pm 6\%$ varispeed, two locate points and auto punch-in/out, MIDI machine control and a plug-in SMPTE card



PHOTO: GEORGE PETERSEN

for chase-lock to video or other time code sources are optional. Deliveries of the DA88 should begin next month.

Meanwhile, things were heating up in the Alesis ADAT camp as the company demonstrated digital assembly editing techniques using multiple ADATs and the BRC controller. Perhaps more significantly, Fostex entered the modular digital multitrack market by announcing plans to manufacture digital recorders and establish a licensing agreement with Alesis. According to Fostex VP David Oren, the ADAT-compatible Fostex recorders should debut in the first quarter of 1993.

In the high-end, there was considerable buzz about AT&T's entry into the pro audio market with the DISQ Digital Mixer Core system, developed in conjunction with George Massenburg Labs and Gotham Audio. More on this next month, along with our expanded coverage from AES.

—George Petersen

SPARS RESHUFFLES BOARD

Changes announced at the SPARS meeting at the October AES convention included the move of Triad Productions' Richard Trump from president to chairman of the board, with Dwight Cook of Sound Works assuming the presidency. Howard Schwartz is now vice president. Paul Christensen of Omega Productions returns as secretary and Steve Lawson of Bad Animals returns as treasurer. Buddy Brundo of Conway Recording and Stewart Sloke of Waves were added as new board members.

OTARI DEMO FACILITY

Otari Corp. opened an audio post-production demonstration facility in conjunction with its Los Angeles products sales rep, FMT Audio. Potential clients may now do hands-on testing of products such as the new DE-24 editing system and the ProDisk-464 digital audio workstation.

—CONTINUED ON PAGE 16

A.R.T. SHATTERS THE PRICE OF PROFESSIONAL MIXING TECHNOLOGY!!!

THE PHANTOM PROFESSIONAL SERIES CONSOLE

Every once in a while a product comes to market that offers a brilliancy in design that seems beyond human engineering. The Phantom Series consoles offer the performance and features of mixing boards costing thousands of dollars more. They are rugged enough to take the pounding of steady live use. They are also so transparent and utterly free of noise that they are the first choice for precision multitrack recording! From a four track home studio to 32 channel digital, the Phantom consoles offer a level of performance that is inspiring. A.F.T. has taken the fidelity of world class recording mixers and made the technology available in a professional console that is as silent as its' name implies. Production unit will vary slightly from photo.



- 16/24/32 CHANNEL VERSIONS
- ULTRA LOW NOISE LINE AND XLR BALANCED MIC INPUTS
- 8 AUXES
- 8 DIRECT OUTPUTS
- 16 PATCH POINTS
- 4 SUBGROUPS
- OVER 20 MIX OUTPUTS
- COMPREHENSIVE 4-BAND EQUALIZATION
- PHANTOM POWER
- MAIN-SUB SELECTOR SWITCHES
- 8 CHANNEL DEDICATED TAPE RETURN SECTION
- BOTH PRE AND POST-FADE MONITOR AND AUX SENDS
- CLIPPING INDICATOR LIGHTS EACH CHANNEL
- FULL CHANNEL SOLOING
- FULL CHANNEL MUTING
- LONG TRAVEL SHIELDED FADERS
- SWITCHABLE OUTPUT METERING
- SWITCHABLE MONITOR METERING
- ISOLATED 2 TRACK MONITOR TAPE RETURN
- SEPARATE STEREO CONTROL ROOM OUTPUT
- ASSIGNABLE TALKBACK-MAIN, MONITOR, AUX.
- INDEPENDANT SOLO LEVEL
- SEPARATE HIGH POWERED HEADPHONE OUTPUT
- RUGGED ALL STEEL HEAVY DUTY CHASSIS

- SLEEK, WOOD END PANELS (OPTIONAL)
- LINEAR CAPACITIVE ULTRA LOW NOISE CIRCUITRY
- HIGH-HEADROOM INPUT PROCESSING
- ADVANCED INPUT/OUTPUT COMPARATIVE DESIGN PROVIDES EXTREMELY WIDE DYNAMIC RANGE
- SEALED BODY LOW NOISE POTS
- 100% R.F. SHIELDING VIA METAL ENCLOSURE
- HEAVY DUTY HARDCONTACT SWITCHES THROUGHOUT
- COMPUTER CONTROLLED PRECISION SOLDERING
- PRECISION AUTOMATED ASSEMBLY INSURES CONSISTENCY
- MIL-SPEC GLASS EPOXY CIRCUIT BOARDS
- HIGH FIDELITY EQUALIZATION CIRCUITS
- NEW DESIGN AND ASSEMBLY TECHNIQUES PROVIDE THE TRANSPARENCY OF CONSOLES COSTING THOUSANDS OF DOLLARS MORE.
- AUTOMATED ASSEMBLY AND COMPUTERIZED TESTING MAKE THE PRICE UNBELIEVABLY LOW.

A.R.T.

THE SOUND OF PERFECTION

APPLIED RESEARCH AND TECHNOLOGY 215 TREMONT ST. ROCHESTER N.Y. 14608 • 715-436-2720 • FAX 716-436-3942

USE READER SERVICE CARD FOR MORE INFO

World Radio History

INDUSTRY NOTES

Solid State Logic of Los Angeles appointed **Phil Wagner** as vice president of Western operations. Wagner will oversee sales, technical support and administration of SSL's expanding Western regional sales office...**Lynn Martin** was named U.S. sales and product manager for **Allen & Heath** (Salt Lake City, UT). Martin will continue as Eastern sales manager for all **DOD Electronics** products...**TOA Electronics' Communication Systems Division** appointed **Bill Ghan** to represent TOA-CSD in the newly created Northwest sales region comprising Alaska, Idaho, Oregon, Montana, Washington and Wyoming. New regional manager **Mike Corcoran** supervises sales and marketing in Colorado, Illinois, Indiana, Iowa, Kansas, Kentucky, Michigan, Minnesota, Missouri, Nebraska, North Dakota, Ohio, South Dakota, West Virginia and Wisconsin. In other TOA news, the company opened a new office, directed by **Jonathan Parker**, to provide full support and ordering services for all TOA products; it also includes its own demo room. Joining Parker are customer service supervisor and applications coordinator **Ken Jorgenson**, communications systems Eastern regional sales manager **Bob Hager** and **Kazuo Musa**, assistant to the president, marketing. The new office is at Spalding Woods Office Park, 3850 Holcomb Bridge Rd., Ste. 145, Norcross, GA 30092, phone (800) 733-7088. At TOA's corporate headquarters in South San Francisco, **Bill Ford** was appointed marketing manager, digital mixing systems...**Pat Maloney** was promoted to director of operations for **Apogee Sound Inc.**, Petaluma, CA, and **Nick McGeachin** was appointed director of export sales... **Scott Bushman** was promoted to VP of finance and operations at the **Record Plant**, Hollywood, CA...**Meyer Sound** of Berke-

ley, CA, appointed **Jamie Anderson** to the newly created position of SIM[®] operations manager... **Christopher Moore** formed **Seven Woods Audio Inc.** to provide consulting services to manufacturers of professional audio, consumer audio, broadcast, telecommunications and computer equipment. Those seeking help in the creation of products can contact the company at 44 Oak Ave., Belmont, MA 02178, phone (617) 489-6292...**Minnie Warren** was named human resources manager at **Electro-Voice Inc.**, Buchanan, MI...**Aphex Systems** (Sun Valley, CA) appointed **Chrissie McDaniel** sales coordinator...**Nvision Inc.**, Nevada City, CA, established a regional sales office in Sherman Oaks, CA. The office, which is for sales and technical support, is managed by Nvision's field sales engineer, **Lon Neumann**...**Ensoniq Corp.** (Malvern, PA) made two appointments: **Cosmo Watts** is the new Southwest district sales manager for the musical instruments division and **C-LAB** software. He will cover Southern California, Nevada and Arizona. **David Netting** is marketing specialist for the musical instrument division...**Los Angeles-based Motown** records announced the formation of its new **MoJazz** label...The fifth annual **National Conference of College Broadcasters** will be held November 19-22 at the Omni Biltmore Hotel in Providence, RI. Highlights include an unveiling of the National Association of College Broadcaster's Five Year Plan, the ASCAP music showcase, the second annual National College Radio Awards and the National College TV Programming Awards. For more information, contact the NACB at (401) 863-2225...We are sad to report the passing of longtime industry veteran **Clay Hutchinson**, former owner of **Kingdom Sound**, **Cove City Sound** and **Second City Sound Studios**. ■

—FROM PAGE 12, CURRENT

For more information, call Otari at (415) 341-5900, or speak to Craig Bell of FMT Audio at (818) 972-3687.

FIVE-YEAR SUIT SETTLED

Audio manufacturer **Behringer** was found guilty of infringement on the German patent covering the **Aphex Aural Exciter**. The Frankfurt Provincial Court determined that all past and current versions of the Behringer "exciters" infringe on the Aphex patent. The Sun Valley, Calif.-based company filed the suit back in 1987.

DIGITAL MAGNETICS ACQUIRED

Pacific Ocean Post (Santa Monica, Calif.) acquired **Digital Magnetics** and annexed 10,000 square feet of adjacent space to house five custom digital audio rooms. **Bruce Botnick**, whose digital credits date back to 1979 and the first *Star Trek* movie, will head the audio department and assume a partnership in POP. The facility will be designed to handle projects ranging from commercial and television mixing to feature film soundtrack recording.

CONVENTION NEWS

The 134th **SMPTE Technical Conference and Equipment Exhibit** takes place November 10-13 in Toronto at the Metro Toronto Convention Centre. Advance registration is no longer possible, but participants can register at the Centre throughout the conference or on November 8 from 1 p.m. to 6 p.m. and November 9 from 7:30 a.m. to 6 p.m.

Synergetic Audio Concepts and **PSN** will co-sponsor the **1993 Live Sound Reinforcement Workshop** at Chapman University Campus in Orange, Calif., on January 12-14, preceding the winter NAMM show. Registration fee for the workshop is \$650 per person and includes materials and meals. The emphasis this year will be on concert sound as well as high-quality sound systems for theme parks, houses of worship and special events. ■

Soundcraft

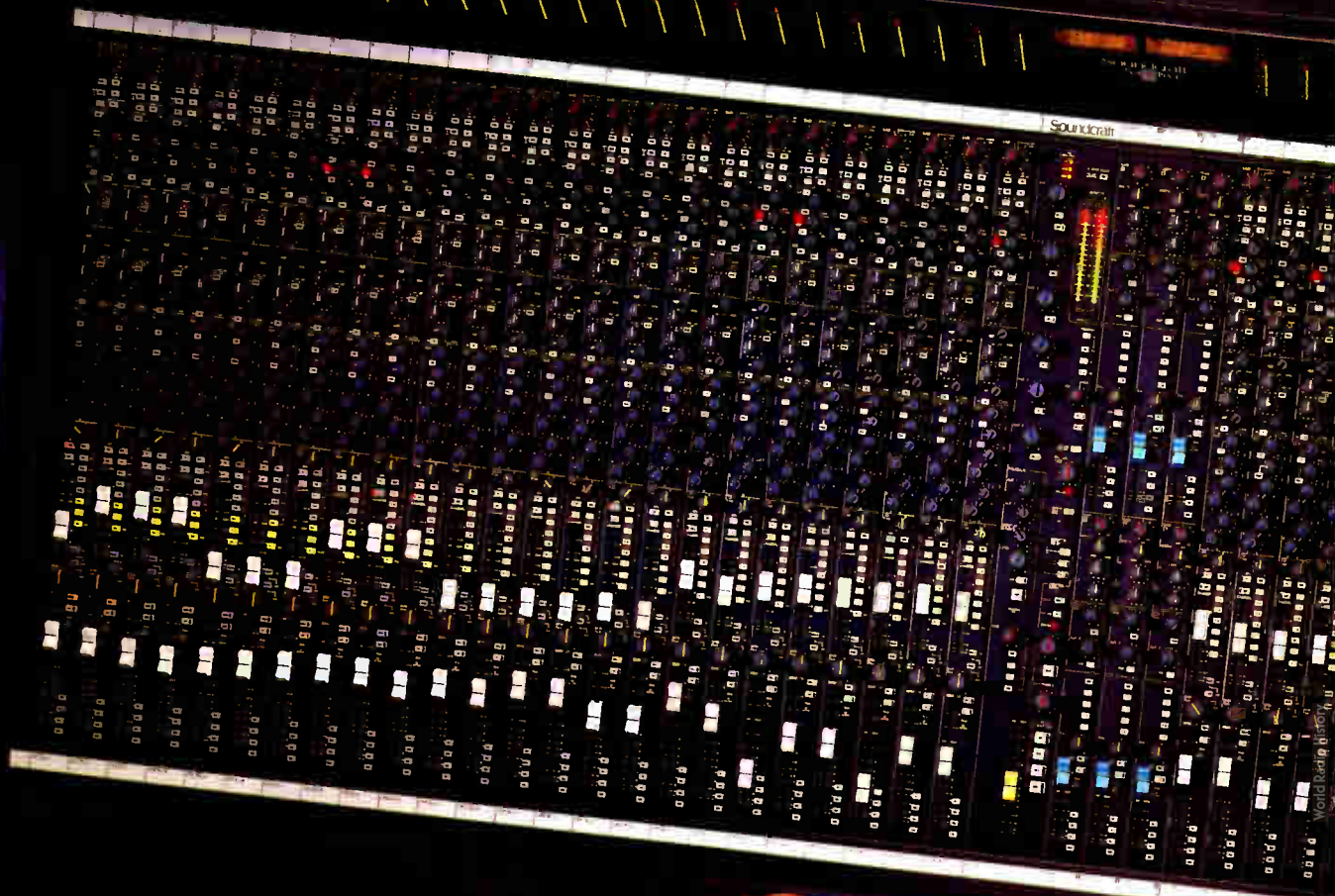

THE PERFECT PARTNERSHIP

It's late. You've both been working hard into the night, putting the finishing touches to a complex soundtrack. But you've done it, in time and on budget, thanks to your expertise—and thanks to SAPPHYRE.

SAPPHYRE is ideal for the post-production environment: dependable in tight corners, fast when you're working against the clock. Featuring advanced, patented Soundcraft technology. Ingenious routing offering all the benefits of an in-line design—without the hassles. A powerful noise gate—on every channel—making it easy to clean up rough audio tracks. Unique features that keep SAPPHYRE in a class of its own. Now there's an optional patchbay—for even easier access to practically everything.

And above all, Soundcraft quality, flexibility and performance. They're designed into every SAPPHYRE we make. Audio quality that's a match for any digital audio or stereo transmission system, from our famous padless mic preamp to the equally unique active panpot. Standard, dual line and stereo input modules for ultimate flexibility. And performance that has to be heard to be truly appreciated. With features like these, you know you'll get along fine: it's a brilliant way to work.

SAPPHYRE. It's everything you need in a production partner.



Soundcraft
Sapphyre

by Ken C. Pohlmann

MINI DISC TECHNOLOGY

SIGNAL FORMAT

P

ART 1

The Mini Disc, developed by Sony Corp., is designed to be the first recordable, erasable optical disc audio format for consumer applications. It incorporates many aspects of CD technology as well as existing optical media technology used in computer applications and introduces numerous other innovations to create a highly sophisticated and original format. This disc format provides random access to data; its small size and shock memory promote portability; and its data reduction system preserves high sound quality. When the Mini Disc is introduced later in 1992, on the tenth anniversary of the CD, Sony will again transform the consumer audio market and dramatically affect the professional audio industry that services it.

This article will provide an overview of this new technology

and explain the signal format used to code data on the Mini Disc. In the months to come, subsequent articles will delve into subjects such as optical pickup design, data writing and reading, magnetic field modulation, ATRAC (Adaptive Transform Acoustic Coding) data reduction, disc construction, and disc mastering and manufacturing. The series will conclude with a hands-on listening test of an MD recorder.

The Mini Disc employs a 64mm-diameter optical disc permanently housed in a rigid, plastic cartridge. Two types of discs are available: prerecorded and recordable. Prerecorded discs are quite similar to CDs in design, using impressed pits against a reflective layer with a single shutter on one side of the cartridge to permit access by the reading optical pickup. Prerecorded discs are playback-only, hence accidental erasure is im-

possible. Recordable discs employ magneto-optical technology, and the cartridge has two shutters, one on each side of the cartridge, for the optical reading pickup and the magnetic recording head. The magnetic head physically touches the disc surface during recording, but head and disc wear are said to be quite low.

In either type, discs contain 74 minutes of stereo audio program along with subdata information



**Due for release
this month is
Sony's MZ-1, a
Mini Disc play-
er/recorder
priced at
\$749.95.**

The Most Widely Used Studio Microphones.



Take a look around the next time you're in the studio. Ask the most demanding musicians and recording engineers what microphone they use to produce the brightest and clearest sound. You'll find that most of them prefer AKG 414's for recording their music's

incredible dynamic range, subtle nuance and emotion.

It's no wonder that the 1990 and 1991 *Billboard* surveys found that AKG microphones are the "#1 Most Widely Used Studio Microphones."

For years the 414 series and its AKG signature sound have been a part of recording the best music in the business. That's why the 414 is a studio classic.



AKG Acoustics, Inc.
1525 Alvarado Street
San Leandro, California 94577 USA
Tel: (1) 510/351-3500
Fax: (1) 510/351-0500

©1991 AKG Acoustics, Inc. AKG is a registered trademark of Akustische U. Kino-Geräte Ges.m.b.H. Austria

USE READER SERVICE CARD FOR MORE INFO

Classic.



The 414 is available in two models, the C414 B-ULS and the C414 B-TL.



1. Should you ask a lot of demanding questions before buying a 16-bit sampler?

2. Does it have 20-bit D/A conversion to insure 16-bit fidelity?
3. Does it have multi-mode filters with resonance?
4. Are there multiple Performance locations with “snapshots” of parameters?
5. Is there Truncate Fade-in and Fade-out for “clickless” start and end points?
6. Does it have positional (horizontal) crossfading between Patches?
7. Does it have Time Stretching, and if so, can you see the pitch alteration?
8. Does it have realtime audio digital stereo output versus standard digital I/O only for backup?
9. Does it have Note Number Exclusives for cutting off one sample with another?
10. Does it have an RGB or composite monitor output?
11. Can you combine the velocity-switching, mixing and crossfading of up to four samples on one key?
12. Can you expand the memory with standard Macintosh SIMMs?
13. Does it have an “Undo” or “Recover” function?
14. Is there a mouse port for fast and easy programming and editing?
15. Does it have realtime “Scrubbing” for locating edit points easily?
16. Does it have four-stage rate and level envelopes?
17. Does it have Templates for setting up TVA and TVF envelopes quickly?
18. Is there a comprehensive, world-class sample library available from the manufacturer?
19. Does it have Normalizing?
20. Does it have a Digital Filter with +/- emphasis for permanently “EQing” samples?
21. Is there Auto-looping?
22. Is there realtime aural feedback when looping, and is it easy to do?
23. Are there multiple LFO parameters and waveforms?
24. Is there an Alternating Loop mode?
25. Can you load or save Performances (multi-timbral setups)?
26. Is there matrix modulation in the Patch Control page for flexible control routing?
27. Does it have Analog Feel to make certain Patches sound less “sterile?”
28. Does it have accurate Phase Lock or will it lose stereo imaging when active?
29. Does it have digital Compression and Expansion?
30. Does it have Wave Draw allowing you to actually redraw the waveform?
31. Does it have an Insert function for splicing data into the middle of other data?
32. Does it have an Area Erase function for erasing data but leaving the space (time)?
33. Does it have a sample Mix function with a delay parameter?
34. Does it receive Polyphonic aftertouch?
35. Are there different Velocity Curves available?
36. Is there an Index and Jump function for accessing any page in the sampler easily?
37. Are there “Select” windows for finding and assigning samples, patches, etc. quickly?
38. Is there a Volume ID with view field or similar cataloging system?
39. Does it have a 48kHz sampling rate through the digital and analog ins?
40. Is there an “Auto-patch” feature which automatically makes full-blown patches from your samples in a matter of seconds?
41. Does it have resampling, including the ability to resample an entire Performance?
42. Does it have a pre-trigger parameter so as not to lose the attack of your samples?



Yes.

Roland®

Roland Corporation US, Dept. S-770, 7200 Dominion Circle, Los Angeles, CA 90040-3647, 213 685-5141, ext. 315.

Call or write us for a free S-770/S-750 demo CD.

USE READER SERVICE CARD FOR MORE INFO

World Radio History

(serving much the same function as the CD's subcode). Pre-recorded discs contain about four times more subdata than recordable discs, permitting value-added features such as stored text information. Future incarnations of MD could store multimedia data in addition to audio data.

A block diagram of a Mini Disc recorder/player is shown in Fig. 1. The servo, control and user interface systems are similar to those found in CD players. The optical pickup also functions similarly when reading pre-recorded discs, but when writing data the laser's power is increased to heat the data surface, momentarily changing the magnetic properties of the data layer. The magnetic head is used to bathe the disc in a flux field, and, in conjunction with the heating laser, it writes data to the disc. In addition, the process of reading magnetically stored data from a recordable disc differs significantly from optically reading pits on a pre-recorded disc. As in the CD, the MD uses Eight to Fourteen Modulation and Cross Interleave Reed Solomon Code during encoding and decod-

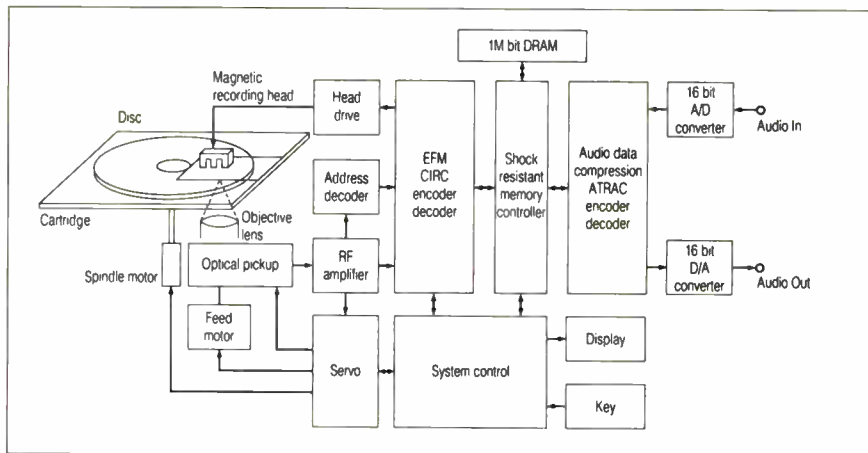

Figure 1: Mini Disc block diagram.

ing. A large memory buffer, holding 1 MB, gives the player great immunity over physical shock: Even if the input flow is disrupted, data may leave the buffer without interruption. The ATRAC data reduction method uses psychoacoustic principles of masking and a Modified Discrete Cosine Transform to diminish data throughput to about 20% of its original volume, with minimal audio degradation. Traditional A/D and D/A converters are used to input and output analog audio signals, in addition to 44.1kHz SPDIF (with SCMS) I/O.

The recordable Mini Disc signal

format, shown in Fig. 2, is similar to that employed in the CID-ROM Mode 2 recording format. In the Mode 2 format, 98 CID frames compose one sector, which is equivalent to 13.3 milliseconds of playing time. During recording, following ATRAC, EFM and CIRC, data is grouped into blocks. CIRC interleave length is 108 frames, or 14.5 milliseconds. To use CIRC, three sectors must be used as linking sectors, and their area is called a link area. A link area greater than 108 frames (one sector) must be filled before writing begins (and after data ends) to perform proper interleaving. To use disc area effi-

The Ultra Effect Affect:

midi
programmable

20/20

studio effects



play global store exec
edit add/del comp bypass

91st
AUDIO
ENGINEERING
SOCIETY
CONVENTION
BEST
IN
SHOW

The SDR™ 20/20 Digital Effects Processor

is your catalyst for creativity in both the performing and recording environment. There are 21 basic effects such as EQ, Reverb, Chorus, Delay, Distortion, etc., which are totally independent of each other and may be combined in any order. These effects represent the sound cornerstones of the SDR 20/20's amazing possibilities. The innovative capabilities of this processor call for visualization more than explanation. For example, up to eight effects can be strung together in an "effect block" and each may be independently mixed and its level separately adjusted, with the final mix assignable to the preset of your choice. 128 permanent factory presets and 128 duplicate presets which may be altered, changed completely, or saved, give you endless possibilities in creating your own custom sound effects.

In addition to these numerous effects possibilities, the SDR 20/20 offers the ability to focus all processing power to a single "Ultra" effect. An example of this Ultra

ciently, data can be written piecemeal across a disc; however, a random scattering would require many link areas on the disc, thus reducing capacity. To overcome this, data is written only after being grouped into substantial recording units called clusters, each containing 36 sectors. Rewriting is also performed in integer multiples of one cluster. Pending writing to disc in a cluster, data is temporarily saved in RAM—the same memory that serves as a shock buffer during playback.

The first three sectors of a 36-sector cluster serve as link sectors during recording; the fourth sector is reserved for subdata. ATRAC-recorded audio data is stored in the remaining 32 sectors. After the last cluster sector is written, error correction data is written in the first link sector and half of the second sector in the following cluster.

The data on master discs of playback-only MDs is recorded continuously along the data spiral, thus the three sectors are not needed in a link area. As a result, all of the first four sectors can be used for subdata, holding text or other information. In addition, clearly, it is impossible to

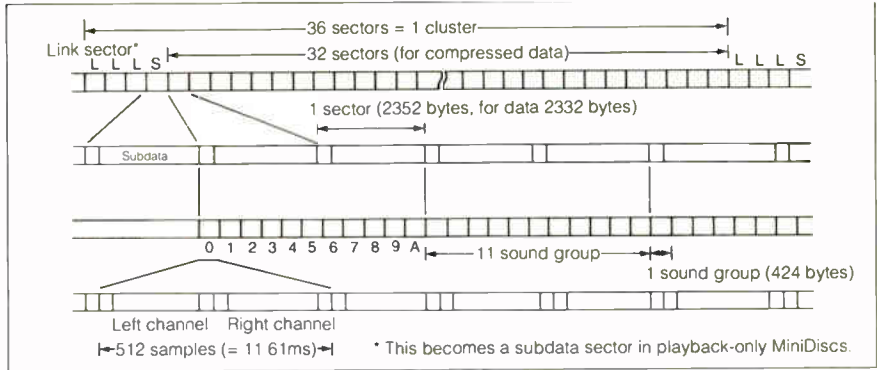

Figure 2: Mini Disc data format configuration.

record the entire subdata contents of the prerecorded MD onto a recordable MD.

During ATRAC encoding, following reduction, audio data is grouped into 424-byte units called sound groups, with 212 bytes each for the left and right audio channels. Eleven sound groups are distributed into two sectors with left and right channels of five sound groups in the first sector, along with the left channel of a sixth sound group. The second sector contains the right channel of the sixth group and the left and right channels of another five sound groups. In other words, each of the two sectors contains $424 \times 5 + 212 \times 1 = 2,332$ bytes of compressed audio data. In this way, 11

sound groups are written per two sectors in each 32-sector cluster. During playback, this data is decompressed for both channels with a playing time of 11.6 milliseconds. Although perceptual coding is used by the ATRAC system to reduce the data volume, the signal recording format itself is quite flexible. As in the CD-ROM format, a variety of data types with suitable data reduction methods could be placed on a Mini Disc. For example, one possible future use for the format could be video storage. ■

Ken Poblmann is professor of music at the University of Miami and director of the Music Engineering programs there.

Imagination Powered by Innovation



MADE IN U.S.A.



Data

PEAVEY
AUDIO MEDIA RESEARCH

effect is the "Ultra Reverb" currently included in the palette of selectable effects. With software upgradeability the SDR 20/20 can be customized to meet future studio requirements.

Balanced ins and outs with selectable inputs and a 64x oversampling 16-bit Delta-Sigma A to D converter make the SDR 20/20 studio ready and ensure low noise and better sound quality. *So, go ahead and power up your imagination through the innovations of Peavey with the SDR 20/20 Digital Effects Processor.*



Made in the U.S.A.

FEATURES

- High quality Reverb and Ultra Reverb
- Multi-effects formed from individual effects
- Independent mix and level control where applicable
- Dynamic effect parameter control via MIDI
- Remote programming capabilities via MIDI
- Balanced ins and outs
- +4 dB to -10 dB selectable and programmable
- Four types of EQ
- Software upgradeable

PEAVEY

AUDIO MEDIA RESEARCH™

by Stephen St.Croix

THE SEA, A MINOR EFFIGY

EARTH
When I was a kid, I never had the luxury of going back to the same school two years in a row. I never spent an entire year in the same state, never had friends for more than several months. I spent my initial formative musical years on the road (in the sand, as it were), on or around Air Force bases in the deserts of Nevada, New Mexico and Arizona.

AIR

This situation did in fact have some totally absurd advantages. Due to the extremely faulty judgment of a certain alcoholic test-pilot, by the time I was ten I had enjoyed the illegal perk of accumulating several hours (and almost an hour of actual stick time) in the fastest jet fighters of the era. Though this unofficial activity was certainly thrilling, I eventually came to feel that something might be missing in my life. One day as I surveyed my world from a fighter cockpit during a "mail run" at 1,500 feet, I realized what it was—water.

WATER, WATER, EVERYWHERE...JUST NOT HERE

The entire time I lived in the desert the Beach Boys, Jan and Dean, the Surfaris and the Ventures called to me; to me personally, to move out west and live with them on the beach. They called to me through my ugly little GE AM portable radio whenever I had the money to buy batteries.

I even figured that Dion, the Everly Brothers and the others who didn't focus on the sea were singing about lives and loves just a couple of blocks inland.

Well, I was definitely more than a couple of blocks inland. I was in fact an "Arizona Surfer" (an inland desert kid who lives, breathes and dreams about the ocean and about surfing in particular), having never even *seen* the Pacific coast, except through surf music.

My case of Arizona Surfosity was almost classic. I had surf pictures on my walls, in my wallet, under the seat of my scooter and my motorcycle, and all over my school supplies. I wore surfer clothes and walked the surfer walk (as well as I could, having only seen it on TV a couple of times). I even studied and learned how to make my own surf board. But I was way inland, way hot and way dry. A true Arizona Surfer.

Then one fine 115 degree day, I finally made the move out to the beautiful Southern California coastline, and I took my little Arizona surfboard (and the radio) with me.

What got me out there? The music, of course. Maybe it was the C, A minor, F, and G (*now* you understand the title!) magic of "Lover's Concerto," "Santa Catalina" and a thousand other Teen Surf Ballads. Or maybe it was the silly spring-reverberated, three chord "Wipeout." Fender to Fender, string to string;

*Music has never lied to me
on any of the occasions it has beckoned with
pictures of paradise.*

The Alesis 3630...

a compressor that sounds great,
does everything and is affordable



When we blueprinted the new **Alesis 3630 Compressor Limiter** we had a hard time cutting out features. So we left them all in.

Threshold, attack and release controls.



Hard knee or soft knee, and peak or RMS compression. All the options you need to custom configure the 3630 for any recording application... especially necessary for digital recording.

A great metering system tells you exactly what's happening to the signal, with separate meters for gain reduction and input or output. The 3630 uses the industry standard VCA for low noise and great sound. There's a side chain for keying and ducking, adjustable noise gate, -10 or +4 dB operation. All this for a price that's like getting one channel free.

Retail price of the 3630 is \$299.*
Read the headline again. Then go hear the 3630 at your Alesis dealer today.

**Slightly higher in Canada*

Alesis Corporation 3630 Holdrege Avenue Los Angeles CA 90016

USE READER SERVICE CARD FOR MORE INFO

World Radio History



pictures of paradise.

Surf music, Caribbean tourist tunes or the real Caribbean folk music, Jamaican-British ska or the real Rastafarian religious chants, King's Hawaiian-American or the original twenty-minute drum solos that they had before King: They all tell their own truths. Each celebrates that magic strip of sand that mates our little land world with the vast beauty of the sea. These island or beach cultures produce a unique flavor of music that I became hopelessly attracted to the very first time I ever heard it, well before I had ever even *seen* the sun set in the ocean.

BUT WAIT

Being a Boomer, I am a bit spoiled when it comes to music. Generally, America and I have always drifted along together (except for the '70s—I have never even *been* in a disco). We have rockers in their 40s today because *we* are in our 40s. This was never allowed before, because *we* weren't allowing it. Now that we are older, we have changed the rules so that we could keep our Boomer-Rockers.

But surf has gone underground. I couldn't have been the only one in America who liked this stuff; these albums *sold*. The only surf music I can find today is from the Mermen (a Seattle export), or from Dennis Dragon and his sporadically existing Surf Punks. I know there are a couple of others, but I don't know where. Almost the only widely released "island" music I have heard recently was the *Beetlejuice* soundtrack.

There is of course one major exception: reggae. This is the *only* type of island music that we air now, and like the others of the past, you can identify it from miles away, almost before you can really even *hear* it: The original dance bar sound of Bunny or the modern commercial synthoid bump of Ziggy. Ska. I like almost all of it, but it's not enough.

I need new stuff to go along with the old *American* standards like "Surfin' U.S.A.," "Lonely Sea," "Surfer Girl," or even "Little Deuce Coupe." Or maybe "Green Onions," "Apache," "Pipeline," or "Walk, Don't Run."

Am I the *only* one? Now that I think about it, I guess I could be. ■

Mr. St. Croix feels that every now and then you gotta write for the few. He has gone off to catch a wave now.

this was truly an American Music.

When I got there, I found that these tunes had not lied, they had not let me down. Everything was exactly as the songs had painted, only bigger and better. My little board worked great, and I learned to surf. I underwent the metamorphosis that every Arizona Surfer dreams of: I became a *California* surfer.

ANOTHER TIME, ANOTHER PLACE

This wasn't the only time that music has called to me and made promises of Paradise undiscovered. Years later, steel drums took me to the Caribbean. They didn't lie either. I've been back over 30 times. (I lived in St. Croix and played the most outrageous bar in the Virgin Islands—great times, low survival rate.)

Then my radio (a different one now) showed me a third place: Hawaii.

Sometime around 1917, Charles E. King took the chants of the Hawaiian Islands and adapted them to the ukulele. He got a serious handle on the style and went on to write the bulk of what we now consider to be traditional Hawaiian music.

Their Queen, Liliuokalani, apparently took King's music, ukulele and all, and adopted it as Hawaii's very own. She also wrote what must be the best-known Hawaiian song of all time ("Aloha Oe") in 1923, and King grabbed the copyright. Sounds like a typical King and Queen deal, if you ask me.

Anyway, it took quite some time for me to answer this radio call, but I did. The Hawaii that I discovered was exactly what the music that invited me promised, except that it rained a little more than I had expected.

Then came Rio. It was just like the music promised. Then Nice, Cannes, Australia, North Africa, Mexico, the Netherlands Antilles, Bonaire, San Salvador, Haiti, the Dominican Republic, Eluthra and even the shores of Italy. I answered the musical calls from all these places. I swam in their oceans and surfed their waves (when they had them). I fell asleep in the setting sun on each of their beaches, listening to the very same music that invited me there. I drank alcohol and fell over (I was a kid).

Music has never lied to me on any of the occasions it has beckoned with

Hear The Warmth . . . Summit Tube Processing

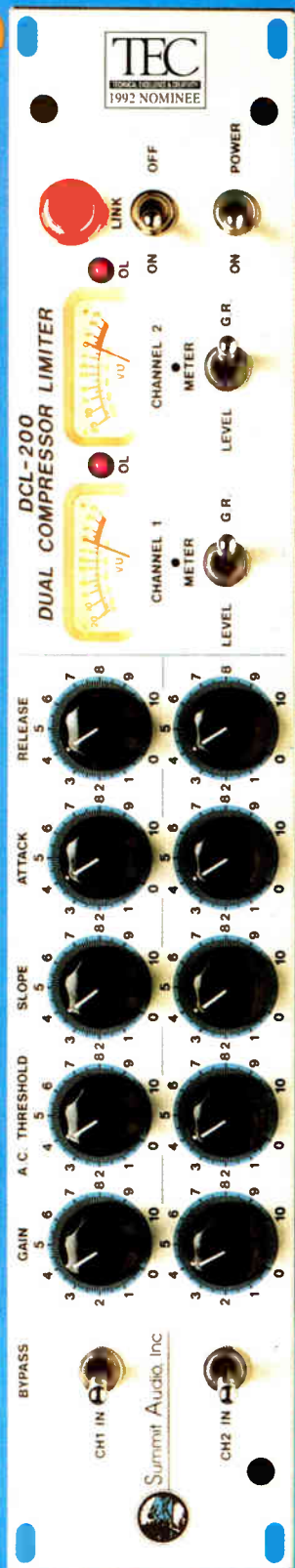

Summit Audio Inc.

P.O. Box 1678, Los Gatos
California 95031 U.S.A.
408-395-2448
Fax: 408-395-1403

USE READER SERVICE CARD FOR MORE INFO

HENDRIX

FROM THE MAKERS OF MOZART

LEVELS

One Meter per input channel with Stereo VUs give comprehensive, at-a-glance indication of the state of your mix.

CLASSIC SOUND

AMEK's 4-band fully-parametric equalizer with swept pass filters. This is the equalizer which established AMEK's envied reputation for audio performance through hundreds of hit records over the last decade. Why settle for anything less?

PROVEN

AMEK/Steinberg SUPERTRUE automation - Faders, Mutes and 7 Channel Switches automated in real time or off-line with full SMP1 and MIDI interface. Compatible either way with AMEK MOZART mix information, generated from any MOZART installation worldwide. Can you afford not to join the fastest-growing console automation user group?

OPTION

Computer-controlled SUPERTRUE Digital Dynamics on every channel. Compressors, Gates, Limiter and other Dynamics devices controlled from the computer and stored with the mix. A new first in automation.

PRICE

All of this comes for a ridiculously reasonable price. Buy your ticket to audio perfection and bring reality a little bit closer.

VERSATILITY

Two panning and monitoring modes. Low HENDRIX to be used for Recording (two channel stereo) and Film (3-channel stereo with Surround).

INTERFACING

Balanced inputs, outputs and busses are all carefully designed to give HENDRIX clean, quiet, crosstalk-free interconnections.

AUXILIARIES

12 balanced auxiliary busses give you the flexibility to address a wide range of Effects devices. All the control you need in today's complex, heavily-processed mixing environment.

INPUTS

Each channel has two discrete paths; Eq can be split between them, giving 80 Equalized inputs. In addition we give you 4 complete stereo inputs with 4-band Eq and sends, and 4 stereo Effects Returns. Enough inputs to cover most recording and mixing situations, in a console under 2 metres wide - including the jackfield!



Head Office, Factory and Sales: AMEK Systems and Controls Ltd., New Islington Mill, Regent Trading Estate, Oldfield Road, Salford M5 4SX, England. Telephone: 061-834 6747. Telex: 668127. Fax: 061-834 0593.

AMEK/TAC US Operations: 10815 Burbank Blvd, North Hollywood, CA 91601. Telephone: 818/508 9788. Fax: 818/508 8619.

World Radio History

AMEK SYSTEMS & CONTROLS LTD. UNIT 11 AMEK TOWER, BURBANK, CA 91601

CUSTOMIZED RECORDING CONSOLES

COMING FULL CIRCLE
BY GEORGE PETERSEN

Everybody in the audio business dreams about having a custom console—an audio tool designed expressly to exacting specifications and needs. Yet once upon a time, not so very long ago, all consoles were custom. Even as recently as the mid-1960s the concept of a large selection of standard models in recording studio mixer designs was pure fantasy. In fact, more often than not, the recording console of that era was typically the home-brewed product created to fill the needs of that particular facility and built either by the studio engineering staff or by a designer of custom electronics.

Besides the disappearance of huge rotary level controls and the appearance of espresso machines in the control room, things have changed dramatically. Today, studio owners are faced with myriad options when selecting a new console. There are currently dozens of companies offering mixers in every conceivable configuration, and the permutations offered can be staggering. The industry has come full circle—from custom consoles to standard designs and now to standard models that can be customized to meet almost any requirement or application.

If your needs are modest—say, a



Artist rendering of Flux VSC console design.

Big Advantages in Very Small Consoles

by Gail Cork

While the trends in other areas of electronics head toward compact technology, recording consoles have grown significantly in size over the past decades.

With the exception of a few products, such as the Euphonix Crescendo, Yamaha DMR8 and the AMS Logic 2, the possibility

—CONTINUED ON PAGE 38

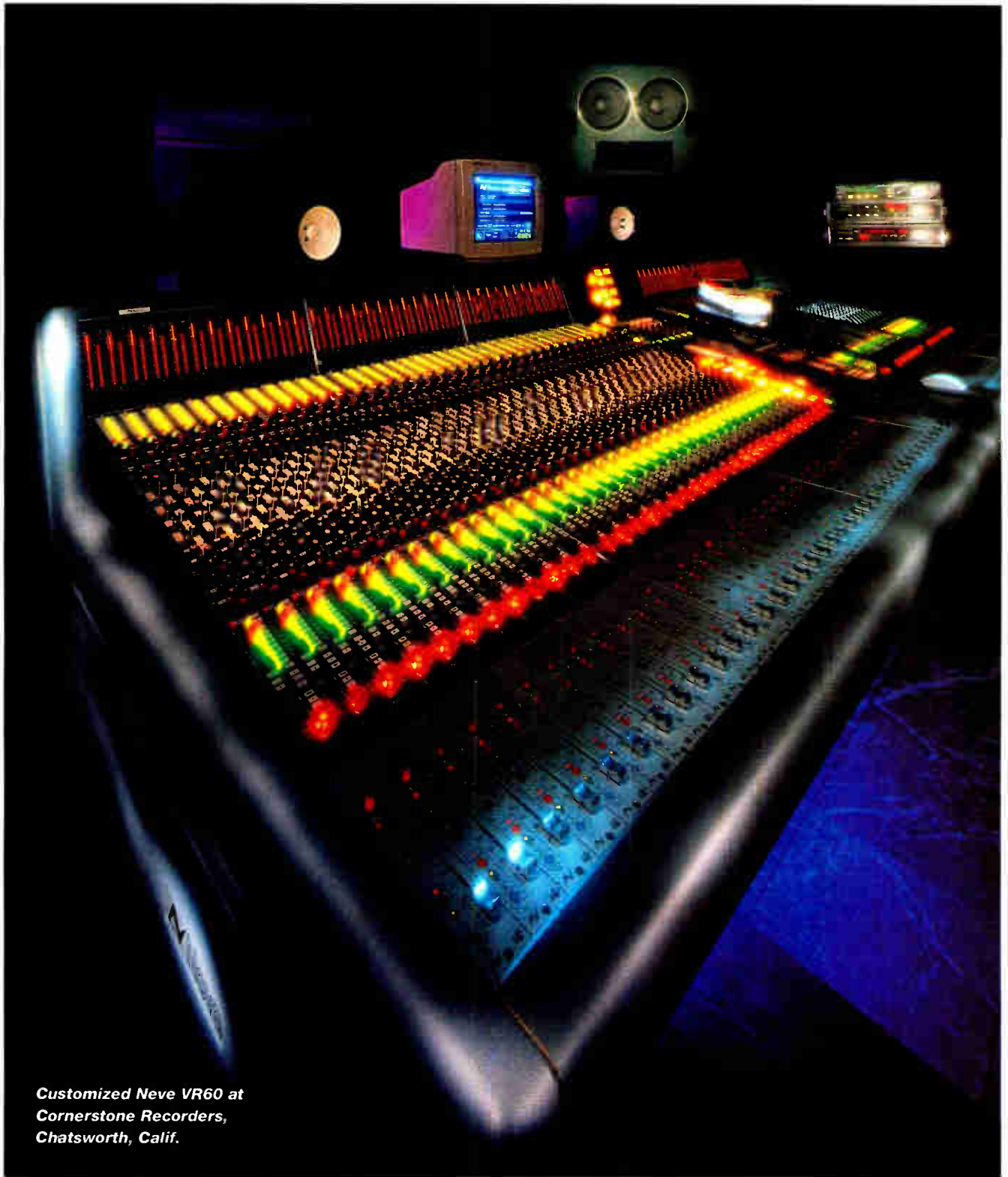

*Customized Neve VR60 at
Cornerstone Recorders,
Chatsworth, Calif.*

simple, non-modular board at the lower end of the price spectrum—buying decisions come a lot easier. But as soon as you get into that \$20,000-and-up price range, things start to get interesting.

Decisions, Decisions

Perhaps the most important factor to consider is the console mainframe it-

self. One feature that's become more commonplace—at least among certain mega-input installations—is the addition of side “wings” that improve the ergonomics of the ultra-long frame situation by creating a U-shaped console.

Shortloading (ordering a frame that's slightly larger than your present needs dictate) makes a lot of

sense and certainly provides for future expansion, but physical limitations of the console-to-room dimension ratio can become the deciding issue. Shortloading does offer the advantage of reducing a console's original purchase price (particularly for a facility that's starting out), but keep an eye on the future availability of modules, especially if you hear

level *The Castle Recording Studio*

SuperDupe Creations *Advantage*

R.O. Studios *American Zoetrope*

Independent Sound *National B*

leo Produ

op Dis

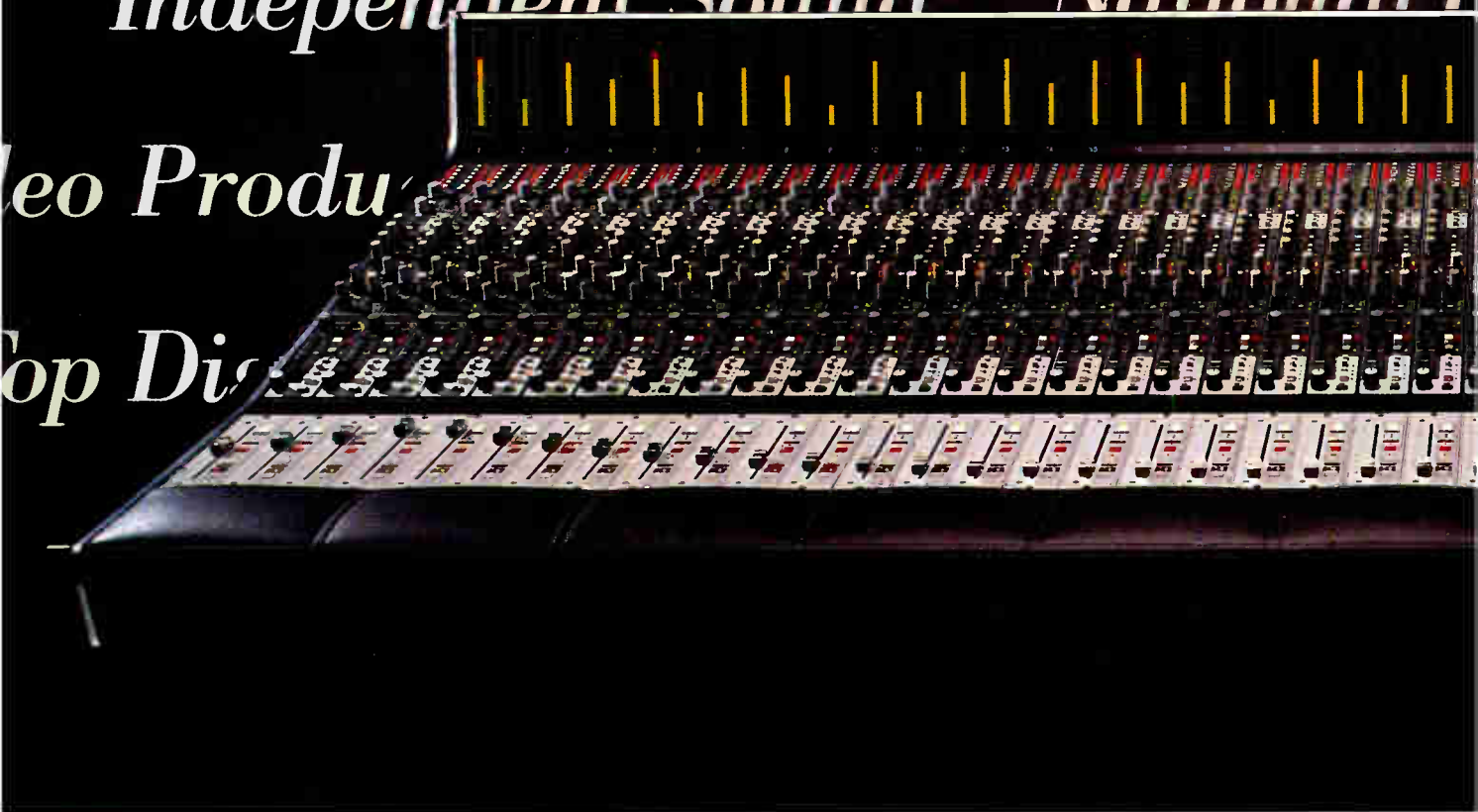

These studios demand an audio console that sounds as good or better than any in the world. And they'll break tradition to get it.

These professionals have a tendency to "go for it" — to put all other considerations aside except the quality and originality of their work. They care little about "the way it's usually done," and even

less about who has, or has not, done it before. As a result, they show up a lot at the top of the charts, and on Emmy night, or Oscar night...

Otari Corporation
U.S.A.
(415) 341-5900
Fax (415) 341-7200

World Radio History

Otari Inc.
Japan
(0424) 81-8626
Fax (0424) 81-8633

Music Productions *Renown Sou*
Audio *Delta Studio* *Sonic Image*
Serafine Studios *Studio Avalon*
Recording Studios *Flossing & Flessi*
ation D
Studio

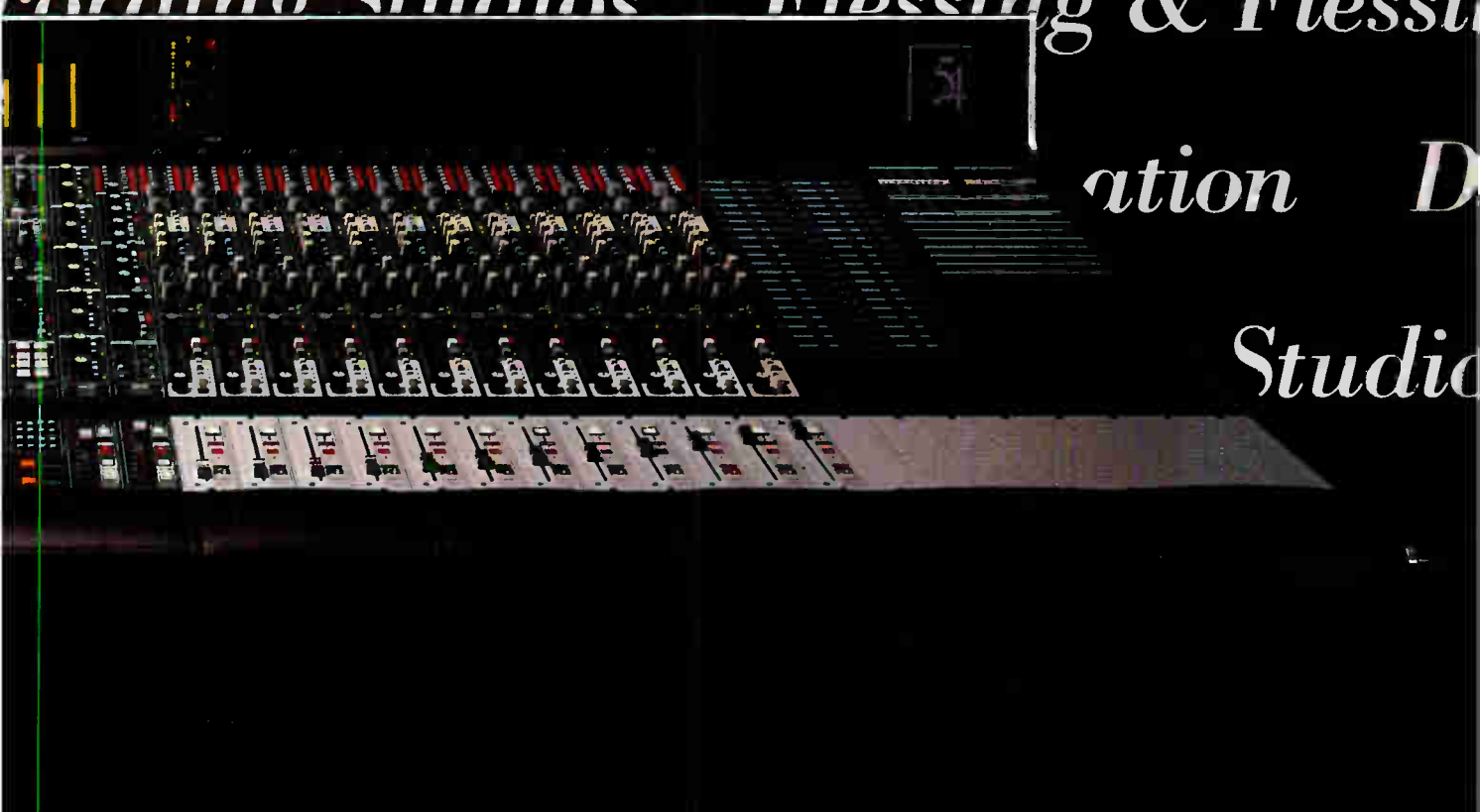

They recognize that in the audio console business, terms like "vintage" and "traditional" are often ad-speak for *old*.

And not only do they demand a console that sounds as good or better than any console in the world, regardless of price, they're also business-smart enough not to mortgage their entire facility to get it.

They buy Otari's Series 54 for music recording, and the Series 54-P for post.

While Otari's name is new to the *console* business, three decades in the *audio* business have taught us that most audio professionals reject the practice by manufacturers of selling new names on old technology, year after year. Instead, they expect

fresh, rigorous designs that work, and the best customer support in the business.

They get it from Otari.

If you don't own an Otari console by now, it's time to figure out why.

Call Otari. (415) 341-5900.

OTARI

Otari Corporation
378 Vintage Park Drive
Foster City, CA 94404
U.S.A.

USE READER SERVICE CARD FOR MORE INFO

Otari
(UK) Ltd.
United Kingdom
(0753) 580777
Fax: (0753) 42600

Otari
Deutschland GmbH
Germany
02159 50861-3
Fax: 02159 1778 **World Radio History**

Otari Singapore
Pte., Ltd.
Singapore
(65) 743-7711
Fax: (65) 743-6430

The Right Connections

Sam Ash
New York, NY
(212) 719-2640

Manny's Music
New York, NY
(212) 819-0578

Gand Music
Chicago, IL
(708) 446-4263

Goodman Music
N. Hollywood, CA
(213) 845-1145

Direction Sound
Los Angeles, CA
(310) 276-2063

Westlake Audio
Los Angeles, CA
(213) 851-9800

West L.A. Music
Los Angeles, CA
(213) 477-1945

Ace Music Center
N. Miami, FL
(305) 891-6201

YRS MIDI Systems
Fern Park, FL
(407) 331-6333

Richard Audio
Montreal, PQ
(514) 733-5131

Adcom Electronics
Toronto, ON
(416) 251-3355

Saved By Technology
Toronto, ON
(416) 928-6434

Steve's Music
Toronto, ON
(416) 593-8888

Annex High Tech
Vancouver, BC
(604) 682-6639

Sound Technology
Letchworth, UK
(0462) 480-000

Soundware
Aarhus, Denmark
(086) 11 89 12

Creative Software
Oslo, Norway
(02) 64 14 30

Ceritec
Utrecht, Holland
(030) 316 353

And Music
Wiesbaden, Germany
(0611) 928 050

M. Casale Bauer
Bologna, Italy
(051) 76 66 48

SCV Audio
Paris, France
(0148) 63 22 11

Giant Electronics
Bienne, Switzerland
(032) 22 52 78

SSL



ATARI
MUSIC CENTRE

Macintosh

AKAI
professional



Roland

Hybrid Arts, Inc.

E-MU

ensoniq

digidesign

SPECTRAL

IBM

KURZWEIL

 **DYNATEK**
STRUCTURED FOR STORAGE

DynaTek Automation Systems Inc.,
15 Tangiers Road,
Toronto, Ontario, Canada
M3J 2B1
Tel.: (416) 636-3000 Fax: (416) 636-3011

USE READER SERVICE CARD FOR MORE INFO
World Radio History

Right: Detail of a customized Solid State Logic SL-5000 Series three-operator film mixing console, fitted with dynamics modules, multi-joystick LCRS panning, dual computer entry keyboards, centralized routing controls and space for installing custom transport and synchronization controllers.

any rumors about the manufacturer discontinuing the model you bought.

However, even without the need for increasing inputs, the availability of some additional space near the master section may be just the ticket if you plan to build in some custom accessories at a later date. One that comes to mind is TimeLine's Console Control Unit keypad for fingertip transport control of the Lynx synchronization system.

Modules are another source of console diversity, offering a selection of stereo or mono inputs and equalization. Regarding the latter, Sony's MXP-3000 Series board may be the

winner in this category. Five preamp and five equalization modules are available for the 3000, or the console can be ordered without preamps or EQ modules, ready for plug-in third-

party modules from suppliers such as API or the John Hardy Company.

Virtually unknown just ten years ago, effects return modules can pack a lot of line-level inputs in a small

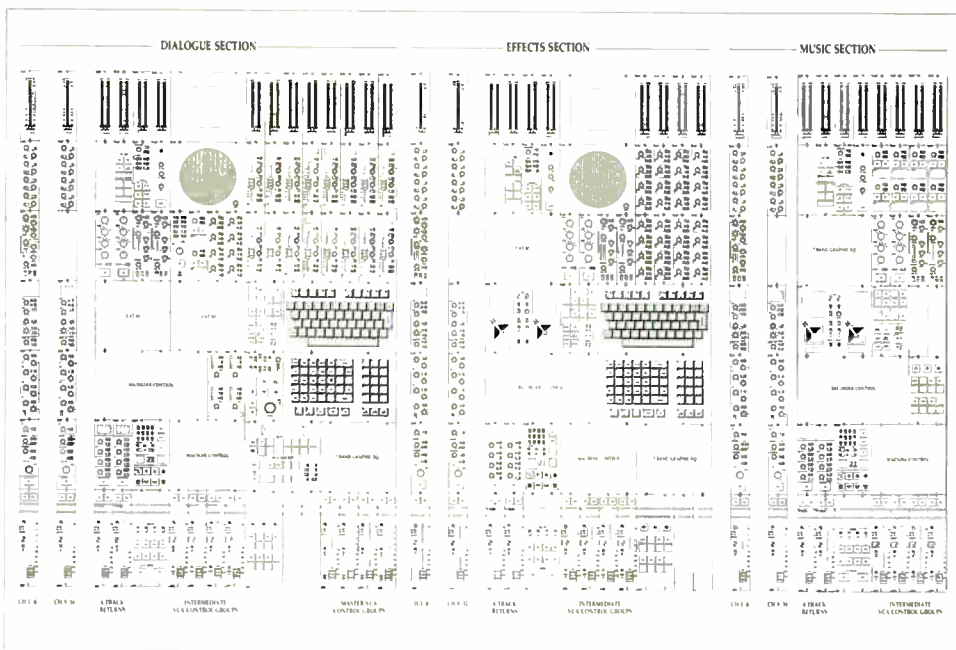

UPGRADE YOUR CONSOLE

INSTALL UPTOWN'S

MOTOR FADER AUTOMATION SYSTEM

WE DID.....

Warner Bros, Hollywood
 SIS Paris
 Magmasters, London
 Berwick Street Studios, London
 Battery Studios, London
 The Cutting Rooms, Manchester
 Boogie Park Studios, Hamburg
 MG Sound Vienna
 Studio 20, Brussels
 Scanax Studios, Oslo
 Hyped Right, Los Angeles
 Digital Music Studios, Toronto
 Bermuda Recorders
 Sound Associates, New York
 Crystal Clear Recorders, Dallas
 Colorado Sound, Denver....



AUDIONATION SYSTEMS

UK Office Tel (0)207 282880 Fax (0)207 232023
 USA Office Tel (508) 443 8053 Fax (508) 443 4844

USE READER SERVICE CARD FOR MORE INFO

amount of space (typically four or eight inputs per module). While these effects returns offer a hefty serving of input power, they are frequently limited in terms of equalization, sends and mute/solo capabilities. However, they are a godsend when you need lots of inputs in a hurry. Stereo input modules are also gaining in popularity, taking the place of a single mono input strip and proving ideal for feeding any 2-channel sources into the mix.

Engineers can be fussy about metering preferences, and many consoles can be ordered with a combination of VU, LED or plasma meters

to suit particular—or peculiar—monitoring tastes. Of course, if you don't like the output meters on your present board, a number of companies manufacture high-quality, stand-alone units that can sit on the console top or, with a touch of metalwork, be fitted into an existing meter bridge. Recently, onboard phase metering has become a popular (and highly useful) option offered on many high-end mixers.

Patch bays offer more food for thought in the console decision-making process. These can be either right- or left-side mounted and integrated into the console or located

elsewhere. Once the norm, console patch bays with 1/4-inch TRS jacks now compete with units fitted with the more compact TT (Tiny Telephone) jacks.

Ordering an in-console patch bay is one method of providing space for later expansion. If space is at a premium and you really want to squeeze more modules into the console at some future date, the on-board patch bay could be removed from the console and remoted to an outboard rack or sidecar. This isn't necessarily a fun job, but if you absolutely need more console space, it's worth considering.

A variety of choices exist in the realm of faders, especially with mid-priced mixers that offer premium-quality faders as an option. Another possibility to consider is purchasing an automation-ready console that integrates VCA faders in anticipation of the day when the board could be quickly and easily upgraded with an automation system.

Automation systems have evolved over the years with a complexity to match—or even surpass—changes in console design. Once the exclusive domain of the recording elite, moving fader systems have steadily come down in price, while a combination of faster servo motors and increased microprocessor control has greatly improved system speed and accuracy.

Meanwhile, VCA systems have taken advantage of available PC-based hardware to offer flexible user-friendliness in a cost-efficient package. Console buyers can now select from either proprietary systems provided by the mixer manufacturer or from a number of third-party suppliers. For more information, see the May 1992 issue of *Mix* for information on companies offering automation systems for the retrofit market.

Obviously, by picking and choosing from available options, a customized console can be assembled from off-the-shelf components, with anticipated delivery in a reasonable (as dictated by the manufacturer) amount of time. However, there are specialized applications where an off-the-shelf approach to console design doesn't apply. For example, the typical music recording console is not particularly well-suited to the needs of the film or video mixing/scoring/post-production market.

M-1

MICROPHONE PREAMPLIFIER

"No comparison!" "Whoa!" "Even the producer could tell the difference!"
A few typical comments! The M-1 is clearly superior. Here's why:

The JENSEN JT-16-B INPUT TRANSFORMER, IMPROVED!
The world's best mic-input transformer, now even better!

THE 990 DISCRETE OP-AMP. The 990A-24V is far superior to the monolithic op-amps found in other equipment.

DC SERVO and INPUT BIAS CURRENT COMPENSATION
eliminate all coupling capacitors and degradation they cause.

Standard equipment: illuminated push-buttons, shielded toroidal power transformer with 6-position voltage selector switch, silver plated XLRs, ground-lift switches, phantom power, polarity reverse and gain controls. Options include the Jensen JT-11-BM output transformer, VU-1 meter (shown), PK-1 meter, gold plated XLRs.

THE JOHN HARDY COMPANY

P.O. Box AA631
Evanston, IL 60204

Phone: (708) 864-8060 Fax: (708) 864-8076

USE READER SERVICE CARD FOR MORE INFO

YOUR NEXT CONSOLE PURCHASE MAY HAVE A
PROFOUND IMPACT UPON YOUR ART AND BUSINESS.
SO LISTEN CAREFULLY, CHOOSE WISELY, AND BE SURE
THE CONSOLE'S BUILDERS ARE PASSIONATELY COMMITTED.

POPULAR MYTH HAS IT THAT success in the music and recording business is a matter of luck, a happy spin of Fortuna's wheel. Sure.

Fact is, if you've enjoyed any luck, an unwavering dedication to your work likely made it happen.

When it's time for a new console, however, lots of people will court you for your money, but few will share or understand the nature of your passion. Does that matter?

It should. For just like you, we at D&R are serious — passionately serious — about what we do. It shows in the way we design and handcraft our entire console range.

Mere words, we know. So we invite you to listen critically to any console from any of our worthy competitors. Regardless of the price. Then apply your ears to one of our consoles. You'll hear what thousands of D&R owners know.

Our zealous devotion to quality goes beyond sonic subtleties. It also manifests itself in



This crustacean understands grounding better than some manufacturers — so don't be suckered. At D&R, we employ a unique star-ground system. On each circuit. On each module. On every console.

highly tangible ways.

For instance, we phase-correlate every audio stage. Our star-grounded circuit and module designs eat noise for lunch. And we surround the complete signal path with a custom-welded, fully shielded steel chassis.

These are just a few of the make-sense reasons why all D&R boards sound so quiet and so accurate. (Ordinary designs in an aluminum chassis can't touch this — and you can hear the difference.)

Naturally, being rather fervent in our passion, we have come up with some inspired features. Such as floating subgroups (which we pioneered, by the way). Full-band, "high-def" equalizers. Extensive sourcing. User-configurable aux send, monitor, channel, and EQ signal paths.

All of which will inspire you to work faster, more flexibly, and ultimately, more profitably.

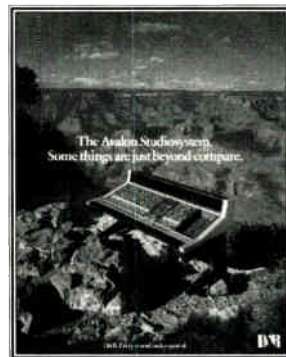

Remember this ad? We sure do. Instead of airbrushing this stunt, we carefully balanced a half-ton D&R Acalon on the edge of the Grand Canyon. Like we said, committed.

Oh yes — this brings us to another matter. Our North American prices are factory-direct. So with D&R, your money buys far more.

Far more committed support. Far more performance. Far more features. To get to the point, far more console.

Now, if this sounds intriguingly

rational, let's get to know each other. After all, our passionate commitment to handcrafting the finest consoles may have a profound impact. Upon you.

D&R

D&R WEST: (818) 291-5855
D&R NASHVILLE: (615) 661-4892
D&R SOUTHWEST: (409) 756-3737
D&R USA: (409) 588-3411

D&R ELECTRONICA B.V.
Rijnkade 15B, 1382GS Weesp,
The Netherlands tel (+) 31 2940-18014

D&R handcrafts consoles for recording, live sound, theatre, post-production and broadcast. Factory-direct North American prices range from over \$100,000 to under \$11,000 US\$, plus freight.

where onboard transport controls, specialized monitoring, LCRS (left-center-right-surround) outputs and multi-operator mixing might be the norm.

Companies such as Harrison, Neotek, Neve, Otari, SSL and others all provide specialized modules to adapt their designs to requirements of the large film mix board. However, due to the finite number of facilities requiring large film consoles, it is unlikely that any mixer manufacturer keeps its warehouse stocked with such devices. And as the physical layout and working methodology of any two post houses varies

widely, it is unlikely that identical consoles would work equally well in different studios. So the large film mixer remains the last bastion of the *truly* custom console.

However, with the evolution of new music formats (surround sound, Dolby stereo, HDTV, stereo TV, etc.), features that were once exclusively defined for the film and post markets—such as LCRS joystick pan-pots—have trickled down into recording studio console designs. After Solid State Logic received numerous requests for customized consoles that combined advantages of its SL-5000 broadcast mixer with its

SL-4000 Series music consoles, the result was the SL-8000, a hybrid design that offered the best of both. And at last month's AES show in San Francisco, Neve unveiled the V-SP, a new version of its VR music console that incorporates specialized functions for scoring and post work (hence the "SP" designation in the name).

As to the future of console designs, it's a safe bet that we should expect more of this same trend, where the prospective purchaser will have an ever-increasing number of options to choose from. And while it's not the same situation as the 1962 studio owner sitting down with the engineering staff to map out the exact locations of those eight Bakelite knobs and where to place those dual 6-inch VU meters, the 1992 scenario is a lot more fun. You'd better believe it. ■

When not writing for Mix, George Petersen operates a Third World-class recording facility in the San Francisco Bay Area that still has a vintage RCA mixer with Bakelite knobs.

—FROM PAGE 30, BIG ADVANTAGES

of reducing the physical size of the mixing console surface has been previously dismissed for a number of reasons, not the least of which is psychological resistance. There is something intrinsically satisfying about working a beautiful, long console, a satisfaction nurtured by the pervasive myth that bigger is better.

Once the psychological barrier is removed, the theoretical benefits of a smaller work surface become obvious. Provided this can be achieved without sacrificing speed and clarity, a small desk interferes less with room acoustics and allows the engineer to remain in the center of the stereo image. Improvements in ergonomic efficiency include reductions in eye movements (which have a direct bearing on fatigue levels) and the distance arms have to travel. Remember that 60% of the knobs on long consoles are out of reach.

Of course, a compact surface could only compete in speed of operation with a traditional console if keystroke entries from computer keyboards, trackballs and touchscreens were reduced or virtually eliminated.

Could a virtual surface be quicker

TURN HEAR.



CS-10 Control Station



JL Cooper Electronics • 12500 Beatrice Street • Los Angeles, CA 90066 • 310-306-4131 • FAX 310-822-2252

USE READER SERVICE CARD FOR MORE INFO

THESE CONSOLES SO MANY FEATURES COULDN'T FIT THE ALL ON THIS PAGE



SOLO. A new breed of console packed with more features per square inch than anything in its class. And the pure, transparent sound that has made Soundtracs so popular in studios and on stages around the world. At prices that make sense for today's cost-conscious professionals.

SOLO LIVE. Available in 16, 24 and 32 input frame sizes. Four independent sub-groups, right/left master and mono sum output. Four band EQ with two swept mids. Six auxiliary sends. Balanced inputs and outputs. Four stereo effect returns. 48V phantom powering for all mic inputs. Raised meter bridge.

SOLO MIDI RECORDING. Available in 16, 24 and 32 input frame sizes. Automated MIDI Muting on all channel inputs, monitor inputs, group outputs, stereo effect returns and auxiliary masters. Four band EQ with two swept Mids, assignable to monitor inputs. Six auxiliary sends—four assignable to monitor inputs. Four stereo effect returns with two band EQ, balance and level controls. Raised meter bridge.

We wanted to list *all* of the features on SOLO consoles but we ran out of space. If you want to find out more about ev



SOUNDTRACS

Exclusively distributed in the U.S. by Samson Technologies Corp.

P.O. Box 9068, Hicksville, NY 11802-9068 Tel (516) 932-3810 Fax (516) 932-3815

© 1992 Samson

USE READER SERVICE CARD FOR MORE INFO

World Radio History

to operate? Could a simpler, more efficient system of channel interrogation be developed? Could a miniature console with only ten assignable faders be as functional as having all 60 faders physically before you?

The answer to all these questions is yes, according to Michael Stavrou, principal of Flux Research Pty Ltd., Sydney, Australia, and one of Air Studio's longtime senior mixing engineers. A patent is pending for his new console design, incorporating a radically different approach to channel assignment, interrogation and overview. Although less than one-sixth the size of a conventional 60-

channel console, in many ways the system provides more information and control to the engineer.

Like all good design, the basic concept is compelling in its simplicity. The photo on p. 30 shows what appears to be a small 10-channel desk with one curious addition: Across the middle is a 60-segment bar or strip that relates to the 60 channels of sound to be controlled. If this were a full-sized 60-channel desk, it would stretch perhaps 15 feet in length. Wherever you position your chair, there would be faders in front of you.

But rather than moving your

chair, touch the bar and those faders now appear in front of you as the ten faders and instantly reassign themselves to those channels.

The large scribble script above these faders would show, in your own handwriting, the instruments you are now controlling. Channel numbers appear within the mute button directly above each fader. Your own handwriting also appears along the 60-channel scribble script: The engineer need only touch the elongated selector strip for an instant overview of all channels.

The selector strip acts as the central input device for channel selection and provides an overview of priority conditions such as channel overload, signal present and fader movement indicators. But the most important function of the horizontal strip is its capacity to randomly access channels. Instead of sliding the chair from end to end of a long console, your fingertip can "pick off" desired channels in any order, simply by touching the strip. If you were to touch the bass, kick, snare, then slide your finger along four guitar tracks, you would have selected seven channels for fader control, with only four actions—an increase in ergonomic efficiency over existing assignable consoles of between 300% and 800%.

Pointing to a track on the selector strip prepares the engineer for the decision to assign, interrogate, solo or mute that track. The buttons to activate any of these choices are within five degrees of the user's focal point at this time, so the next button to hit is already at the user's fingertips. To make sure a signal present in that channel is not overloading requires only raising the line of vision by three degrees. This degree of instrument/user integration enables the engineer to stay one step ahead of the next decision. Despite the concentration of display information around a greatly reduced area, the control surface remains uncluttered, with ample room for hands to operate knobs comfortably.

Though Stavrou has no intention of becoming a console manufacturer after three years of development, he is interested in speaking with others who share his vision of the future. ■

Gail Cork is a freelance writer and former editor of Music Business magazine, Sydney, Australia.

Sound Solutions

ASHLY has been building world-class equalizers for well over 20 years. Our new GQX-Series models take advantage of this experience with some true advances in the technology. Precision Wein-Bridge filters, and newly designed summing amplifiers, provide extremely accurate response, low noise, negligible distortion, and excellent immunity to magnetic fields. All filters exhibit true constant "Q" response, with absolute minimum ripple. The full-throw faders are a custom-manufactured metal-shaft type, with the center detented position being utilized as an "on/off" switch for that filter (to minimize any possible degradation in signal noise levels.) Combine these features with our full Five Year Worry-Free Warranty. It's obvious why ASHLY equalizers are the best solution to your equalization situation.

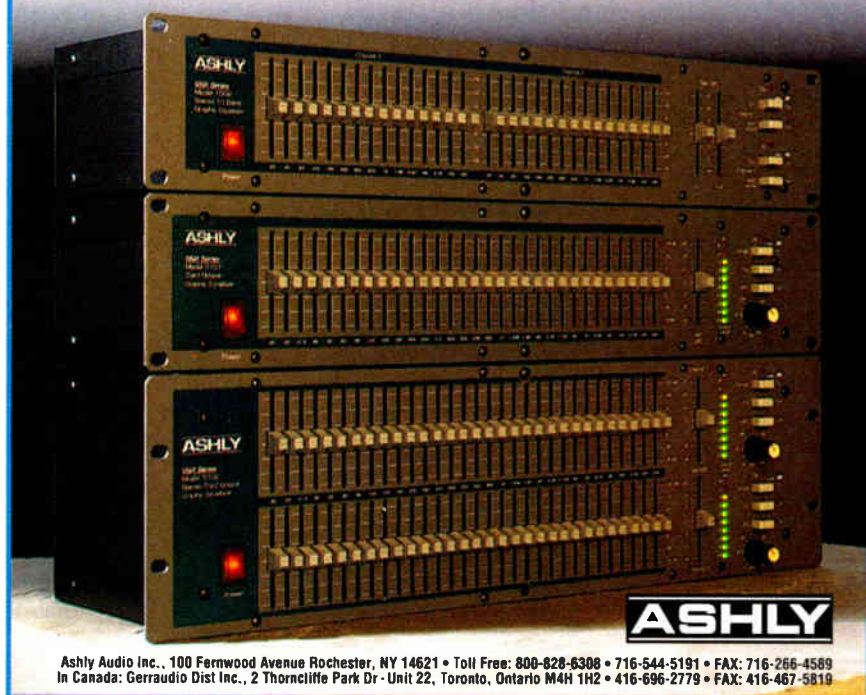

Ashly Audio Inc., 100 Fernwood Avenue Rochester, NY 14621 • Toll Free: 800-828-8308 • 716-544-5191 • FAX: 716-266-4589
In Canada: Gerraudio Dist Inc., 2 Thorncliffe Park Dr - Unit 22, Toronto, Ontario M4H 1H2 • 416-696-2779 • FAX: 416-467-5819

USE READER SERVICE CARD FOR MORE INFO

WHY



IS

EVERYONE

TALKING

ABOUT

Today's market is demanding more complex productions and higher audio quality on shorter schedules and with tighter budgets. Studios and engineers need a console that works as fast as they can create. Old analog boards have charm, but they are too big and take too long to reset. The new all digital desks are underdeveloped, complicated and far too expensive. After four years of continuous development, one company is delivering the product that makes sense today. Euphonix has the speed, power and flexibility of Total Digital Control with the simplicity and natural sound of analog signal processing. It's no wonder industry leaders have made the move to the CSII. And when Euphonix introduces the new additions to their product line, you'll realize the last four years were just a warm-up.

Sales and Service
10647 Riverside Drive
N. Hollywood, CA 91602
Ph: (818) 766-1666
Fax: (818) 766-3401

Corporate HQ
220 Portage Avenue
Palo Alto, CA 94301
Ph: (415) 855-0300
Fax: (415) 855-0430



Euphonix

USE READER SERVICE CARD FOR MORE INFO

World Radio History

by Paul Potyen

GETTING WIRED

AUDIO AND TELECOMMUNICATIONS

A virtual world exists today for anyone equipped with a computer, modem and telephone line. While it's not yet as glamorous as the virtual reality demonstrations you may have seen at multimedia conferences or on *Entertainment Tonight*, this world gives you the immediacy and convenience of a telephone, the "store-and-forward" flexibility of a phone machine or interoffice e-mail, and the ability to transmit and receive any kind of data—including faxes—from computer to computer.

What's in it for you, the pro audio engineer, producer, musician or developer? Why might you want to participate in this global communications game? On a basic level you can communicate with others in your profession via direct modem, much the same as you do with a telephone, with the added benefit of file and fax transfer. But far more powerful are the online services that cater to the needs of audio professionals. But before I talk about that, I'd like to go over a few basics.

A modem converts the digital signal from a computer into an analog signal that can be sent over a telephone line. Modems (an acronym for MODulator/DEModulator) are designed to transfer data at one or more standard speeds, mea-

sured in bits per second. That number is sometimes referred to as its baud rate. Standard baud rates range from 300 to 57,600 bps and beyond, although the most common rates for personal computer-based users are 2,400 or 9,600 bps. As you might expect, faster is better, but it's also more expensive.

Your modem connects to any serial port on your computer. Internal card modems are popular for IBM compatibles, and some of the newer Macintoshes incorporate internal modems as an option. A wide variety of modem software is available, ranging from no-frills shareware such as

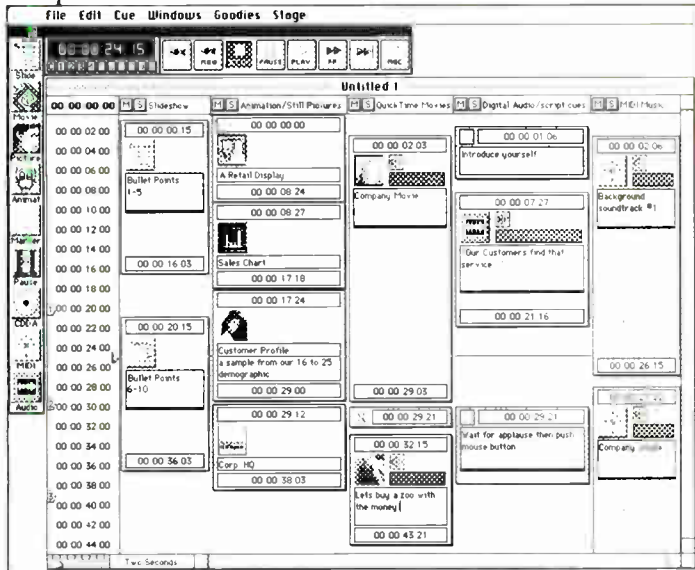

ILLUSTRATION PATSY LAW BACKGROUND DESIGN NANCY TERZIAN

Chip Shots

PASSPORT PRODUCER

Passport Designs Inc. has introduced Passport Producer, a Macintosh software package for in-



tegration and synchronization of digital media such as video, audio, MIDI and graphics into cohesive presentations.

Producer presents users with a timeline for integrating media elements, called "cues." It uses SMPTE time code for frame-accurate alignment of the different elements, and an element can be modified by "double-clicking" on a cue that is linked to its original application. Producer can be used for multitrack recording, soundtrack production and for combining MIDI music with live instruments and vocals. It is scheduled for a fall release at a suggested retail price of \$395.

Circle #201 on Reader Service Card.

STEINBERG/JONES TIMEBANDIT

TimeBandit, a Macintosh application for offline time correction, time compression, expansion, pitch shift and harmonization of digital audio, is now available

from Steinberg/Jones. A proprietary algorithm is used to process any mono or stereo audio files stored in Sound Designer 1 and 2 formats. (Audio IFF format will be supported in a future update.) Retail price is \$495.

Circle #202 on Reader Service Card.

MUSICATOR GS

Musicator GS for Windows is

a notation-based sequencer for the Windows environment. It supports Windows Multimedia Extensions, General MIDI and Roland's GS standard. The program produces transcription without the need for conversion from MIDI-based software to notation software. Capable of 16-track MIDI playback, Musicator GS also comes with its own music fonts and can use any Windows fonts. List price is \$299.

Circle #203 on Reader Service Card.

DR. T'S COPYIST PRO-DTP

Dr. T's Version 2.5 of Copyist Professional-DTP for the IBM PC features real-time MIDI input with scrolling playback, tran-

scription and input of shifting time signatures, step time MIDI input and more. Playback is also supported for all popular interface cards. Copyist 2.5 sells for \$450, with upgrades offered to registered users.

Circle #204 on Reader Service Card.

RADIUS VIDEOVISION

Now shipping from Radius is VideoVision, which consists of a digital interface card for the Mac with built-in video in/out at 24-bit



resolution, an external connector panel for video and audio connections, and comprehensive software controls. The package allows users to combine computer graphics, text, sound, and analog and digital video on a Mac II Series or Quadra computer. Flicker-free NTSC, PAL or SECAM output to videotape is possible. VideoVision is priced at \$2,399.

Circle #205 on Reader Service Card.

FreeTerm for the Mac to comprehensive packages such as FreeSoft's White Knight II for the Mac and ProComm for MS-DOS. Additionally, many manufacturers supply software along with the modem. The software is used to configure your modem to your specific system and to set communications protocols, dial numbers, and connect and transfer files using those protocols.

An arcane discussion on the technical aspects of data communications standards and protocols could easi-

ly take up the remaining space of this column, so instead I'll refer the curious reader to *MacWorld*, August 1992, for a more comprehensive treatment of that subject. For our purposes, it's good to know that progress has been made in standardization; the vast majority of modem manufacturers' products are designed using compatible standards. These standards address transfer speed as well as error correction issues. The latter are important because static on a phone line can cause corruption of data—a much

more serious problem than the annoying static you may encounter during voice transmission.

It's a good idea to buy the fastest modem you can reasonably afford, since your modem's baud rate directly affects the time it takes to receive (download) or send (upload) files. Typically, a 30KB file transfer takes about two minutes to complete at 2,400 bps—that's four times longer than at 9,600 bps.

One advantage of modem communication is that it allows Macintosh,

Atari, MS-DOS and Amiga users to communicate with a minimum of difficulty, and in many cases it's the best

reads standard MIDI files, it can be opened and played. For computer keyboard-based "conversations" and transfer of text files without error correction, ASCII text transmission is

chinese. Similarly, when your computer receives a fax, you can read it directly from the screen, and, if necessary, you can then convert the image and print it out. (As all of you

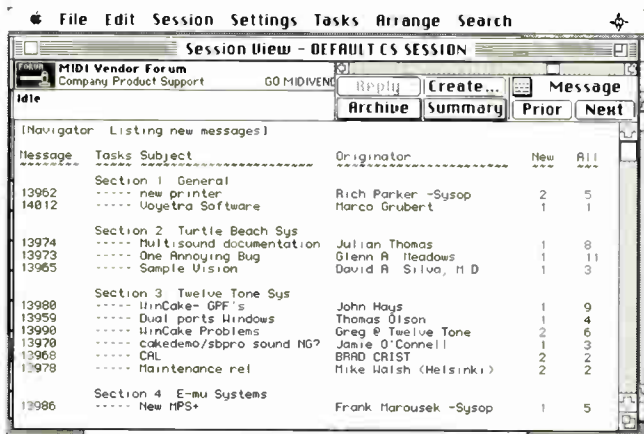

Figure 1: CompuServe's MIDI Vendor forum as displayed via Navigator software.

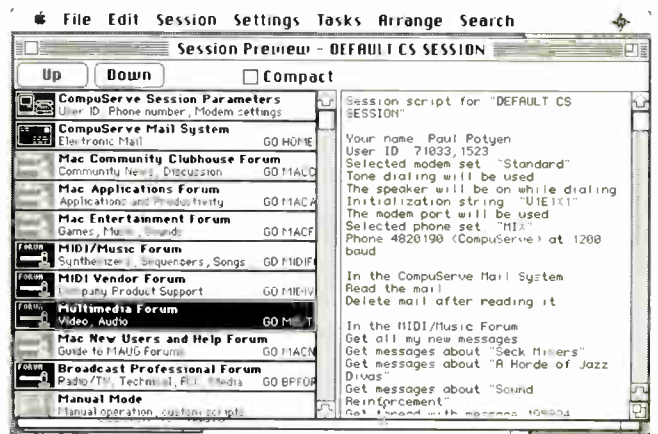

Figure 2: Session preview window for CompuServe's Navigator.

way to transfer files. Common file transfer protocols include Xmodem, Ymodem, Zmodem and Kermit. For example, a standard MIDI file can be sent from an IBM-compatible computer to a Mac using the Xmodem protocol. The resulting file will show up as an icon on the Mac, and if you have a MIDI sequencer that

commonly used.

Recently, fax modems have appeared on the market at reasonable prices. Even if you already have a fax machine, you might want to look into a fax modem. You can send documents directly from your desktop without having to print them out and feed them into a conventional fax ma-

environmentally aware readers know, we've already got plenty of paper.) Fax modems normally come with separate fax software.

But the best reason to get wired is the treasure chest of information and data available through electronic bulletin boards and commercial online information services. Bulletin



The Performing Artists' Network

Established in 1981, The Performing Artists' Network is the oldest and largest music network serving professionals in all aspects of the music business. More than 3,000 users log on from more than 40 countries. Well known PAN users include Herbie Hancock, Branford Marsalis, Pete Townshend, Jan Hammer, Jeff Lorber, J.M. Jarre, Wally Badarou (Level 42), Will Lee (*Late Night With Letterman*) and Tommy Mandel (Bryan Adams). Engineers who are on PAN include Bruce Swedien, John Snell and Bruce Nazarian.

Manufacturers are represented online not just by marketing reps but by engineers and programmers. Examples include Chris Meyer, co-author of MIDI and main designer of the Roland DM-80 workstation, and Doug Wyatt,

author of the Opcode MIDI System. Manufacturers have set up special interest groups as well. For example, Studer maintains a discussion forum for Dyaxis users as a means of technical support. Users can trade hints among themselves and communicate with tech support personnel and hardware engineers who log on from the Studer Editech office.

More than 225 manufacturers offer hotline services. When you submit your suggestion, question or complaint, PAN automatically faxes your message to the tech support office of the appropriate company.

In fact, PAN has been most innovative in the area of remote fax services. These services are specially geared toward the needs of the music industry and are not offered by general-purpose commercial networks. PAN offers incoming and outgoing fax services that incorporate optical character recognition and fax forwarding. You can have your e-mail and forum messages automatically faxed to your office or studio. Acts

like Billy Joel and The Who used PAN as a fax-central during their tours, with the Network forwarding faxes to each new city as the bands arrived. For members who are too busy to use their modems to log on, PAN offers the PanScan service, where floppy disks are sent to users each month with their electronic mail and all new forum messages and database updates. Periodicals such as *Pollstar* and *A&R Reporter* are available electronically online. Others, like *Electronic Musician* and *Keyboard*, maintain online cumulative indices and forums. An area called Gigbank is a database where users can upload their resumes and availability. Entertainment law consulting is also available online. The best part of PAN, however, is the interaction among performers, engineers and programmers in the forums. Recent discussions have included thorough treatments of genlock, sync and time code issues.

—Ataru Tanaka (Internet address: ataru@ccrma.stanford.edu)

GIVE IT ALL YOU'VE GOT. WE DID.

Listen. You don't compromise when it comes to making your music. Neither did we when we built the ultimate 8-track cassette for you to record it with.

The TASCAM 238 Syncaset is one lean, mean, roadable machine. It's got the kind of sound quality and headroom that'll continue to impress you and your band gig after gig.

For about half of what you'd expect to plunk down for a bulkier open-reel deck, you get a

heavy-duty 8-track cassette jammed with pro features like automated punch in/out. Autolocate. Auto rehearse. Tape jog/shuttle control. Switchable dbx noise reduction. And optional full-function remote.

The synchronizable 238 also lets you lock up to your videos later on.

We put a lot into the 238 so, on stage or in the studio, you can give it all you've got.

See the very uncompromising 238 Syncaset for yourself today at your nearest TASCAM dealer.



TASCAM

© 1991 TEAC America, Inc., 7733 Telegraph Road, Montebello, CA 90640, 213/726-0303.
dbx is a registered trademark of AKG Acoustics, Inc.

USE READER SERVICE CARD FOR MORE INFO
World Radio History

board services (BBSs) are operated by individuals, businesses, nonprofit organizations and government agencies for the purpose of sharing information. One such example is the BMUG BBS, which offers information and discussions on a variety of Macintosh-related subjects, including MIDI, digital audio and multimedia. In many cases, the service is provided free of charge as a form of technical support. In the audio industry, it's more common to find online manufacturer technical support from commercial online information services such as America Online, the WELL, CompuServe, GENie and PAN (Performing Artists' Network).

In the case of commercial services, technical support is available from participating manufacturers and interested individuals. In fact, one of the most engaging aspects of such services is the lively discussion that takes place among the participants. Ask a question or state an opinion and you're likely to get an abundance of feedback, and the thread can often careen off into any number of unpredictable directions.

Each online service has its own dis-

tinct personality—from the free-for-all spirit of the WELL to the more professional demeanor of CompuServe—as well as its own system of online navigation. While you can use one of the telecommunications software applications previously mentioned to navigate the labyrinths of a service, many commercial services offer their own easy-to-use custom apps. And they are well worth the expense. For example, CompuServe's Navigator package (\$50) allows you to set up your session *before* you go online, with features such as creating e-mail messages to others, replying to messages previously sent to you and searching databases for keywords or specific files. This minimizes your online time and expense.

Another advantage offered by commercial online services is the ability to communicate with people on the other side of the planet as easily as the other side of town. This low-cost communication is made possible through the use of packet switching networks such as Sprintnet (previously known as Telenet) and Tymnet, which allow you to use a local phone number to access the dedicated high-speed transmission lines that connect to remote network mainframes. Most

online services allow you to take advantage of this technology. To find out what your local Tymnet access number is, call (800) 336-0149. For Sprintnet, the number is (800) 877-5045.

You can send e-mail messages to members of online services to which you don't subscribe thanks to a worldwide mega-network of connected computer networks and conferencing systems. The largest of these is Internet, which consists of more than 2,000 networks. Subsidized by the U.S. government, Internet provides access to supercomputers in international academic and scientific communities in more than 40 countries.

Two commercial online services of particular relevance to our industry are CompuServe and PAN. At more than half a million members, CompuServe is the world's largest personal information and communication service. More than 1,500 services are offered to its members, including Associated Press Online, Grolier's Encyclopedia, current stock quotes and forums ranging from gardening to artificial intelligence. CompuServe's Broadcast/Professional for-

—CONTINUED ON PAGE 159

BETTER AUDIO FOR ANY DIGITAL RECORDER



THE LEXICON 20/20 AD ANALOG-TO-DIGITAL CONVERTER

Whether you are 16- or 20-bit capable, the new 20/20 AD sets a higher standard in digital conversion. Most significantly, if your recorder can only process 16 bits, the 20/20 AD can *digitally* compress the signal from 20 bits to 16 bits, ensuring that you get the maximum performance out of your digital recorder.

- 2 Channel 20-Bit Audio, 112 dB Dynamic Range
- 4 Channel 18-Bit Audio, 100 dB Dynamic Range
- Digital Compressor/Limiter
- Choice Of Dither Spectra

The 20/20 AD offers the finest analog-to-digital conversion available today. Which, coming from Lexicon, should be no surprise. After all, Lexicon has consistently led the way towards improved digital audio. Visit your Lexicon dealer to hear how you can improve the audio going into your 16-bit digital recorder.

1971

Delta-T 101 Delay Line
World's First Digital Audio
Product

1987

480L Digital Effects System
World's First Widely
Accepted 18-bit Processor

1992

20/20 AD Analog-to-Digital
Converter—20-bit A—D
112dB Dynamic Range

Lexicon

HEARD IN ALL THE RIGHT PLACES

100 BEAVER STREET, WALTHAM, MA 02154
TEL (617) 736-0300, FAX (617) 891-0340

USE READER SERVICE CARD FOR MORE INFO

AKAI
DIGITAL

Magneto Optical Disk Editing Just Made a Quantum Leap!

Introducing . . . The AKAI DD1000i Version 2.3

An impressive array of new features

- Timestretch 50% - 200%
- RS422 Master
- RS422 Slave
- Archive to DAT
- Digital gain change in Record
- Record start by threshold or MIDI
- Auto Take name increment
- Auto Q-List play
- Make 50 cuts on the fly
 - in Record Mode
 - in Edit Mode
- Many Others

DD1000i
V 2.3

- Removable Sony MO media
- 1BIT Sigma-Delta conversion
- 2 in 4 out
- Digital I/O
- Printer Port
- Use up to 6 external MO drives
- SMPTE • MIDI • VITC option
- Two SCSI busses, MIDI, RS422
- House sync to NTSC or PAL
- Jog/scrub audio
- Waveform display
- Q-List mode (SMPTE based EDL)
- Song mode (fast assembly)
- Playsheet mode (cart mode)
- Completely self contained unit
- Optional remote controllers
- Optional Mac/Atari software
- Sample rate conversion 48, 44.1, 32KHZ
- 30 min/side stereo @44.1KHZ
- 80 min/side mono @32KHZ
- DL1000 remote controls 7 DD's at once!

New DD-QMAC V2.0

- Multiple Q-Lists open at same time
- Multiple Cut windows at same time
- Scrub audio from Cutting window
- Scrub cues from Q-List
- Color support
- Up to 4 times faster than V1.0
- Floating transport window
- Full undo capability
- Nudge cues in time by any amount

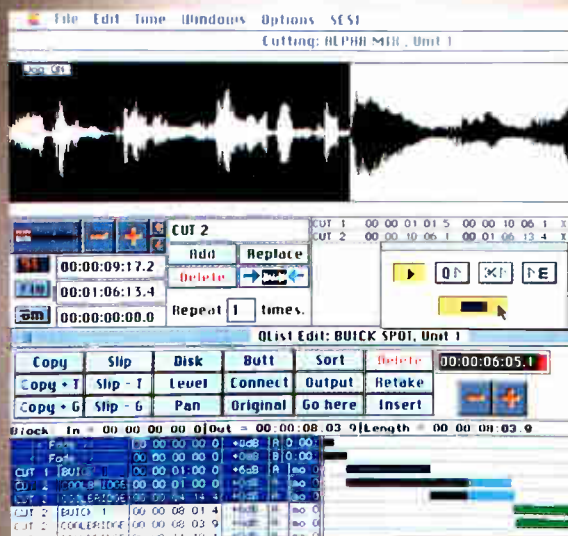

Aka Digital • P.O. Box 2344 Ft. Worth, TX 76113-2344 • Phone (817) 336-5114 • FAX (817) 870-1271

USE READER SERVICE CARD FOR MORE INFO

World Radio History

FACILITY SPOTLIGHT

Ron Rose Productions Blooms in Detroit

by Blair Jackson

What do you think of when someone mentions Detroit? The Big Three automakers? Motown and Mitch Ryder? Baseball great Ty Cobb? Well, Ron Rose Productions, one of metro Detroit's top audio complexes, has ties to all three. Founder Ron Rose was a popular disc jockey in town during the '60s and '70s; he started a recording business in



1976 in his home, which had once been owned by Ty Cobb; and today Rose's highly successful operation draws much of its production and post work from Ford, GM and

Chrysler.

From a humble start with a pair of 4-track rooms, Ron Rose Productions, located just a few miles outside of Detroit in

—CONTINUED ON PAGE 52

"Wild Palms": Sound for a World Turned Weird

by Blair Jackson

Oliver Stone's greatly anticipated foray into the television miniseries arena hits the small screen this fall with the six-hour *Wild Palms*, a futuristic story about a United States senator who heads a bizarre religious cult that tries to take over



John Ross of Digital Sound & Picture at the Euphonix CSII. Note the DAWN workstations.

Below: Oliver Stone and James Belushi on the set of "Wild Palms."



CREDIT: AEC-TV

the minds of its victims. The program incorporates holograms, virtual reality and a computer chip that may lead to immortality; in other words, it's a sci-fi world far removed from Stone's usual directorial or production terrain.

Sound supervision for the show was handled by John Ross, who, with his wife Nancy, runs the up-and-coming post house Digital Sound & Picture in Culver City (L.A.), Calif. The two-year-old facility's

—CONTINUED ON PAGE 52

Godzilla vs. Barkley in 3-D Sound

Not often do 30-second commercial television spots have the production

Jeff Roth, Focused Audio, in front of the Barnaby 2000 Sonic Imaging System.

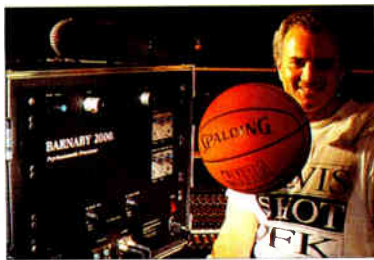

PHOTO: IRISAN HEALY

and marketing budgets of a small-scale feature film, complete with teasers announcing it as a coming attraction. But then it's not often that Godzilla meets basketball superstar Charles Barkley on the streets of Tokyo.

Nike's new shoe campaign debuted on the MTV Music Awards broadcast on September 9. Before that, however, there were posters, T-shirts, full-page ads in *Rolling Stone*, teasers—everything short of a McDonald's soft drink cup. No expenses were spared in production, from the

stunning visuals produced by Industrial Light & Magic, to the big bucks for Charles Barkley, to the rights for Godzilla. (Yes, somebody owns the rights to Godzilla.) By the time the spot hit audio post at San Francisco's Focused Audio, there was consider-

—CONTINUED ON PAGE 58



PHOTOS COURTESY OF INDUSTRIALLIGHT & MAGIC

Sound for "Parker Lewis": See a Dog, Hear a Cat

Even if you don't have a teenager at home, you might want to give Fox's *Parker Lewis* a chance. Aimed at an audience raised on MTV, the half-



PHOTO: RANDY TEPFER

Bob Redpath, sound editor, on the dubbing stage at Sony Studios.

hour show makes full use of quick cuts, odd p.o.v.'s, swishes, pans, close-ups, pull-backs, you name it. And the sound dances in step, standing

Corin Nemec (l) stars as Parker Lewis and Jennifer Guthrie as his girlfriend, Annie.

on its own without distracting the viewer. Which is what sound is supposed to do, only this isn't an ordinary soundtrack.

"I think pre-production, production and picture editing allow us these moments for sound so that it doesn't distract—it's necessary," says Bob Redpath, on staff at Sony Pictures Studios and supervising sound editor on *Parker Lewis* for the

—CONTINUED ON

PAGE 62



PHOTO: GENE ARIAS

Communism falls. The dream team dominates. EIIIIXP ships.

“ 16 gigabyte
library ”

“ 32 mono voices;
16 stereo voices ”

“ 8 MB RAM standard-
upgradable to 32 MB ”

“ AES/EBU digital
Input/Output ”

The World is a Better Place.

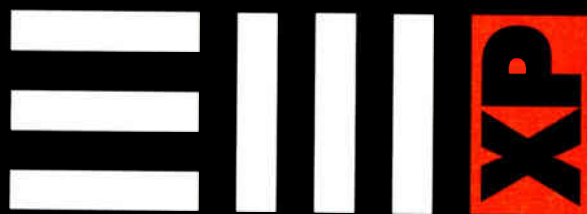

E M U L A T O R
Digital Sample Playback System

\$3,995

(Suggested retail price)

Call 408-438-1921 for your nearest EIIIIXP dealer.



E-mu Systems, Inc.

P.O. Box 660015, Scotts Valley, California 95067-0015

U.K. E-mu Systems, Ltd., Suite 6, Adam Ferguson House, Eskmills Industrial Park, Musselburgh, EH21 7PQ

All trademarks are property of their respective companies.

USE READER SERVICE CARD FOR MORE INFO

Made in the USA

Small Consoles For Post-Production

by Dan Daley

With post-production growing so fast, it's inevitable that some of the glitz of the top end—the digital audio workstations, the mega-consoles, the DSP, etc.—give way to the more prosaic aspects of the job. While the more glamorous toys tend to get the ink (and, for the most part, rightfully so), their very hugeness creates spaces between their functions that are being filled by less seductive, but extremely utilitarian, bits of equipment.

The small console is a perfect example. A growing number of audio post-production facilities are finding advantages in smaller boards that, when dedicated to off-line audio functions such as ADR and Foley, free up the more costly consoles and their expensively outfitted rooms for other work. Even in increasingly digital environments, simple, non-automated workhorse analog consoles are more and more used to feed the audio-for-picture chain.

The project studio phenomenon has been one of the prime motivators of this trend, though not necessarily intentionally. The project stu-

—CONTINUED ON PAGE 56

Product Spotlight: Friend-Chip TCR-1

Distributed by Euro-Stuff (Torrance, Calif.) is the TCR-1 time code refresher from Friend-Chip of Berlin, Germany. Housed in a single-rackspace chassis, the TCR-1 outputs constant level, symmetrical-waveform SMPTE time code from incoming code that may be distorted from multiple-generation copying or other problems. With a sensitivity adjustable to -30 dB, the unit is said to read weak time code tracks, and all time code formats are recognized automatically. The TCR-1 retails at \$149.

—George Petersen

Meet the family. The only power conditioning family specially designed for the unique needs of audio.



Here's Grandpa. The **PL-8 Power Conditioner and Light Module** is the original — it's the most popular rack accessory ever! It gives you clean power and handy rack illumination. Cousin **PL-PLUS**, shown in the photo, adds super RFI filtering, a line voltage meter, an extra long AC cord, and a 15 amp rating.



The **AR-117 and AR-230 AC Line Voltage Regulators** not only clean your power but actually correct the voltage if it's too high or too low. Worry no more about sags, brownouts, or overloaded generators. For those really heavy loads, big brother **AR-PRO** handles a whopping 30 amps. It can accept any line voltage from 88 to 264 volts and return a stable 120 — enough to power an entire stage or studio, anywhere in the world.

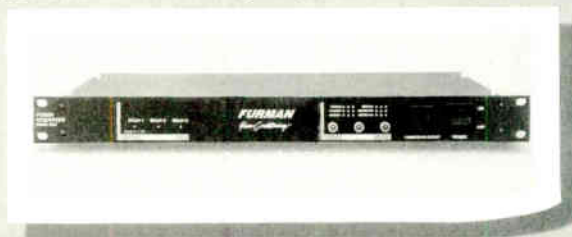

The new kid in the family is the **PS-3 Power Sequencer**, a conditioner that powers your equipment up and down in a 3-step delayed sequence, avoiding loud pops that can blow speakers and large inrush currents that can trip breakers. Available options allow operation from a remote location using a wired switch or a switched outlet.

FURMAN

Power Conditioning

Furman Sound, Inc.
30 Rich St.
Greenbrae, CA 94904 USA

Phone: (415) 927-1225
Fax: (415) 927-4548

USE READER SERVICE CARD FOR MORE INFO

NOVEMBER 1992 MIX 51



Discover The Secret Of The Pyramids.

We've discovered a new acoustical foam that outperforms any we've ever seen (or ever sold).

ALPHA Acoustical Foam.

The secret is in its unique pyramid design.

Performance. ALPHA Pyramids have a superior ability to absorb low-end ambient noise. No other product can compare.

Pattern. ALPHA Pyramids' uniform pattern means easy matching for an attractive installation. Other products require random matching.

Packaging. All ALPHA Pyramids are UPS shippable.

Alpha Acoustics has discovered the secret of the pyramids. And we're impressed. That's why we now offer ALPHA Acoustical Foams to our customers. Call us. We'll gladly send you a brochure and a free sample.

Call 1-800-782-5742.

Acoustical Solutions, Inc.

Richmond, Virginia

Licensee **Alpha Audio Acoustics**



USE READER SERVICE CARD FOR MORE INFO



For those who take it seriously...

Now providing advanced training in conjunction with **Solid State Logic**

It's not enough to study the "art" of recording. You simply must learn the *technology* of recording. That's the only way to insure your career for today *and* tomorrow!

"IAR grads are the most highly motivated and best trained of anyone entering the engineering field. I give IAR my highest endorsement."

Dan Healy, Chief Engineer
The Grateful Dead

800-544-2501

NY, NJ, CT 212-777-8550

Lic. by NYS Ed Dept / HS Diploma or GED Required
App for Veterans Training / Financial Aid if Eligible



Institute of Audio Research

64 University Place, Greenwich Village, New York, New York 10003

take, all that kind of information, into a relational database.

"The show gets edited and it comes to us," Ross continues. "We have our telecines done with feet and frame, SMPTE time code, and we take the editor's work track, put it up on a bench, and someone goes through, gets the edge code numbers, and tracks through the code book which scene and takes are used in which particular location. This information is also edited into a relational database. The common denominator in the relational database is the scene and take information.

"The dialog editors then go through the telecines and basically rebuild the whole show from the DAT output," Ross explains. "And this is where the DAWN comes into play. The DAWN takes an AES/EBU feed from the DAT machine, and we use the editor's work track as a sync reference, so we basically flange or phase the track the whole way through and rebuild it. It also gives us the opportunity, instead of just using the takes the editors use, to have this whole bank of information pertaining to the show—which is what the DATs are—and go through and find interesting production effects or go through and find some fills from non-printed takes that may be very useful."

Although the show is set in L.A. in some undefined future, sonically it was a relatively straightforward show for Ross and his three sound designers. Still, it required a considerable amount of creative thinking. For example, in one sequence, where some characters go back in time and meet in a holographic world, "one of the effects the director wanted was the sound of their voices before they speak—sort of reverse reverb concept. So what we did was—and this is where it was very useful having workstations on the actual dubbing stage—we duplicated all the dialog elements and then pasted them onto open tracks on the dialog system, advanced them by ten frames and just fed that input into the reverb, and then had a reverse reverb setup on the Lexicon 480 itself. It's an interesting sound and fairly easy to do in this environment."

In contrast to regular series television, Ross says that he and his crew have a "reasonable length of time" to work on the sound for *Wild Palms*,

Quality You Can Count On Today...and Tomorrow

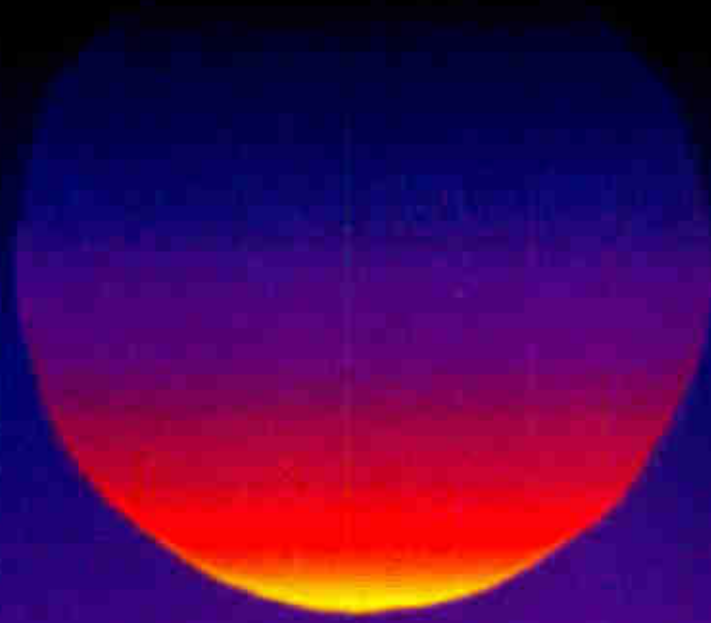

Professional Audio Duplicating Tape

UCR Chrome MCX Cobalt Type II MCX Ferric Cobalt
SKX Premium Ferric SH Standard Ferric

SUNKYONG
Professional Products

Sunkyong Magnetic, America, Inc., 4041 Via Oro Avenue, Long Beach, CA 90810 1-800-337-5729 Outside CA 1-800-237-8372

THE QUALITY YOU CAN COUNT ON FOR MORE THAN
World Radio History

and the quality of the show has made the experience quite rewarding. "It's an interesting concept, very unusual, which is very attractive," Ross says of the show. "It should be fun." ■

—FROM PAGE 51, SMALL CONSOLES FOR POST
dio requires a solid, functional console that can handle anywhere from eight to 24 inputs, provide at least two—preferably four or more—mono and stereo aux sends, a serviceable routing matrix, monitoring capability (either in-line or jukebox) and line/mic capability. That's exactly what some manufacturers responded to, and in doing so they filled a new and growing need in post-production, as well.

Not all the small consoles being used in post-production are of that recent generation, but some of them underscore the needs. At Streeterville Recording in Chicago, studio president Jimmy Dolan acknowledges that had such a choice of small boards been available three years ago when he brought in a 15-year-old, 12-input Neve console for

Foley and ADR work, he might have considered other consoles. As it is, he's quite satisfied with the vintage Neve, which interfaces perfectly with live and Synclavier Foley work done at Streeterville, he says.

Reflecting the sentiments echoed by other post facility operators, Dolan says, "We needed a place to do killer dialog and other voice tracks, a place that could feed the bigger consoles. And one that could offline and provide a certain level of quality, which could go directly to the main mixing rooms but at the same time keep those rooms free for larger projects. It fits right in with the idea of a facility concept. From a time-management perspective, a small console for ADR and Foley and other offline work lets you break down the post-production process into a series of smart rooms that feeds the signal chain and doesn't take up any more room than the project calls for."

Additionally, Dolan explains, this modular approach, which the small console room reflects, helps studios outside Hollywood work on limited aspects of films and charge compet-

itive prices without tying up primary rooms.

Not that Hollywood hasn't gotten the idea as well. At Sound Trax in Burbank, where the main console is an Aries 24, ADR and Foley mixer Kris Campbell works off several small Tascam boards for those applications. Sound Trax's Tascam M208 and M224 consoles are used in an interesting configuration. For Foley, the former is used for mic input and the latter for monitoring; a Tascam M216 handles the monitoring role for ADR. While one larger console (or even the 24-input M224 alone) could handle the job, Campbell says the configuration is useful because he gets better monitoring audio than he might from a console monitor section, and because the dedicated input board allows him to leave all the mics plugged in and simply move them about as needed.

"It's a matter of versatility, which is what those consoles give me for ADR and Foley," Campbell explains, "and of cost-effectiveness, which they also give me, considering we already had them in the studio be-

—CONTINUED ON PAGE 58

HOW TO GET FROM HERE...

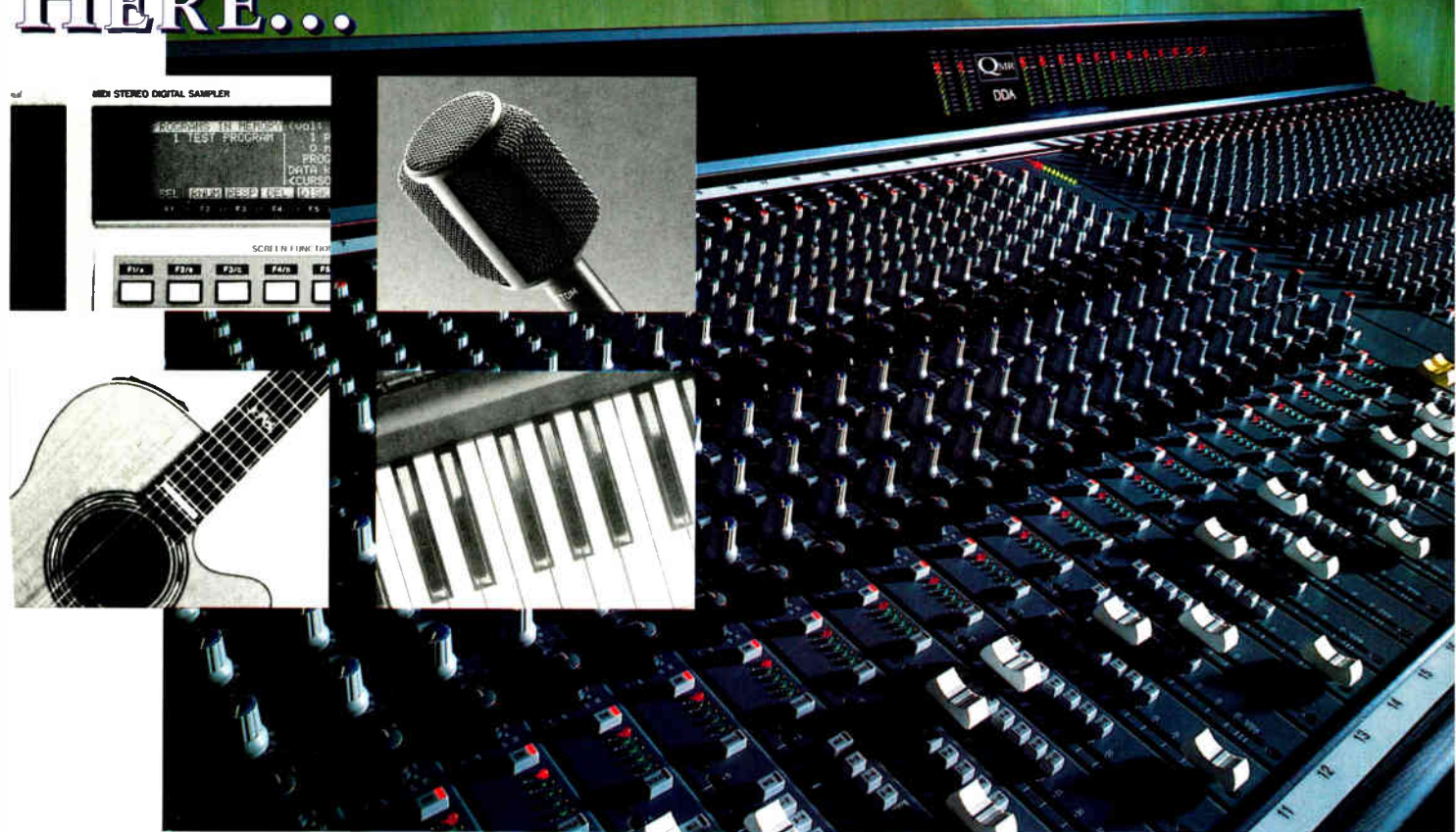



OCTOPUS AT MUSICAL INFINITIES

Musical Infinities (San Francisco), a recording studio/production house owned by James Harrington, recently brought in John Scott to run the "Octopus" service department. Octopus, pictured here, is a Mac-based workstation running Pro Tools, SampleCell, Studio Vision and Sound Tools—enclosed in ATS flight cases. Clients use the 24-track main studio to record straight to the hard drive, then take the Octopus system home or to their project studio for the creative assembly and edit tasks. Then the project can be brought back to the studio for mixdown and layback to all video formats. Scott and Musical Infinities further offer creative/technical on-call service. ■

...TO HERE

QMR

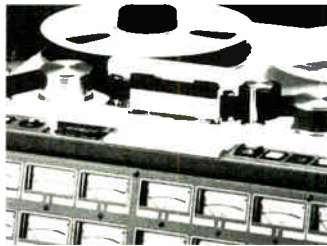

QMR is a new, competitively-priced and highly professional mixing console from DDA. Its flexibility and outstandingly clean signal path ensures that, no matter what your signal source or your recording format, you can be sure of an accurate recording.

With QMR, nothing is added to, or taken away from, the original performance. Its signal transparency will leave you thinking that there is, literally, nothing in between the perfect performance and the perfect recording.

WITHOUT LOSING, OR ADDING, A THING IN BETWEEN

 **DDA**
a MARK IV company

Pinnacle Audio, 200 Sea Lane, Farmingdale, Long Island, New York, NY 11735 • Tel: (516) 249 3660 • Fax: (516) 420 1863

USE READER SERVICE CARD FOR MORE INFO
World Radio History

—FROM PAGE 56, SMALL CONSOLES FOR POST
 fore we used them for these applications. They also fit into the smaller rooms very nicely.”

In this case, they provide an additional benefit—instant modifications. “If it comes up that we have an impedance mismatch or a difference in balanced or unbalanced lines, it’s a simple matter for one of our in-house technicians to come in and do a fast modification,” he says. “Simple console, simple modifications.”

Less simple to modify would be the Euphonix Crescendo CSII that National Sound in Manhattan recently

installed for ADR and Foley work. Not that modifications are all that necessary, according to creative director Peter Fish, who points to the Crescendo’s all-stereo 24 inputs, digital handling of analog signal, computerized EQ and automation features. From the point of view of features and price, it’s a night-and-day situation compared to the preceding one, but it highlights the fact that the small console can be anything you want—or can afford—in post-production.

Fish says that in addition to the whiz-bang features, the size of the Crescendo had much to do with its

purchase for ADR and Foley applications, reflecting the desire of facility operators to use space effectively, while freeing up the larger rooms for mixing and layback projects. “In New York, where space is very limited and very expensive, that’s a very real consideration at any price point,” explains Fish.

The Euphonix console is applied to ADR and Foley situations in fairly conventional ways. But the board’s more advanced features are diligently applied in speeding up those processes. For instance, the Crescendo can print two discrete mixes simultaneously and can recall stereo and M&E mixes at the touch of a button. “It’s a small console in a small room, but those kinds of features give me a world-class small room,” Fish says.

Small consoles, big benefits. The needs of lower budgets, tighter schedules and the continuing demand for better audio-for-picture are going to push this trend along even further in the future. ■

—FROM PAGE 49, GODZILLA VS. BARKLEY

able, albeit unspoken, pressure to deliver a soundtrack as big as the 150-foot main characters.

“The imagery is really like a 30-second movie,” says Focused Audio owner Jeff Roth, “and you can’t let that kind of image go by without the sound treatment of a feature film. The layers have to be there. Every sound you take, whether it’s explosions or screams or footsteps, needs to be pitched because these guys are 150 feet tall. Even if you Foley a footstep with some gravel under it, it’ll sound ludicrous to picture without the shifts.”

All the pitch-shifting was accomplished in Pro Tools (“You can do really large shifts with no anomalies,” says Roth), with editing mainly taking place on the 16-track AMS AudioFile Plus. The mix went through a 40-channel Sony/MCI JH-636 with DiskMix II+ automation, which came in handy when recalling for a PAL version and a mono film mix. The monitors in Focused are JBL 4435s.

So what kinds of sounds are we talking about? Fire, steam, explosions, building demolition, Godzilla growls, Barkley growls, fires, low rumbles, screams. All of the ambient effects and music—basically any-

for your ears only



■ The VITALIZER is a new powerful and creative psycho-acoustic equalizer, specifically designed to be compatible with the way the human ear perceives sound.



- "I found the Vitalizer virtually indispensable for fine-tuning my mixes". **AUDIO MEDIA.**
- "Equalizes sounds in a way none of my existing equalizers comes close to matching". **SOUND ON SOUND.**
- "The best such device I have had the pleasure of using". **HOME STUDIO AND RECORDING.**



THE VITALIZER

a truly virtuoso performer

spl

SASCOM
MARKETING
GROUP



FOR DETAILS OF YOUR U.S.A. DEALER, CONTACT SASCOM: (416) 420-3946

MANUFACTURED BY SPL (49) 2163 8761 FAX (49) 2163 83028 - INTERNATIONAL MARKETING: THE HOME SERVICE: TEL (81) 943 4949 FAX (81) 943 5155

USE READER SERVICE CARD FOR MORE INFO

Proven Success

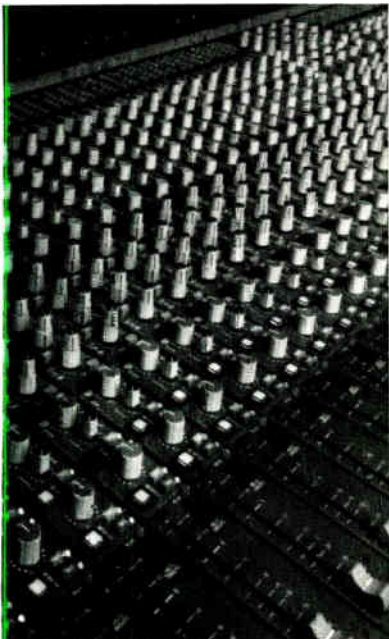

▲ TAC MAGNUM

- * 24-Buss In-line console/32 track monitor option
- * 4 Band EQ
- * 8 Aux sends
- * 2 mute groups
- * Automation ready
- * On-board patchbay

SOUTHERN CALIFORNIA'S EXCLUSIVE DEALER



▲ SOUNDTRACS IL4832

48x32 In-Line Console with 48-track monitoring.
Just ask Walter Becker!

SOUNDTRACS IL3632 (pictured) also available.

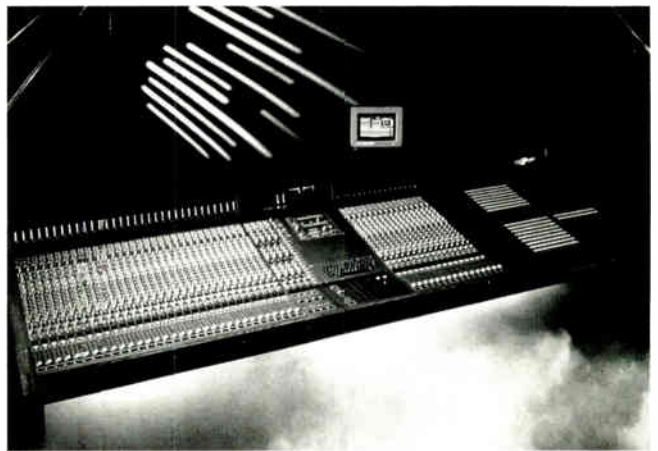

▲ **AMEK MOZART RN80x32** In-Line Console with Supertrue Automation and real-time dynamics. Rupert Neves' newest creation featuring his improved EQ and mic preamps!



▲ **LEXICON 300** Digital Effects – best sounding 'verb we've heard under 10K!

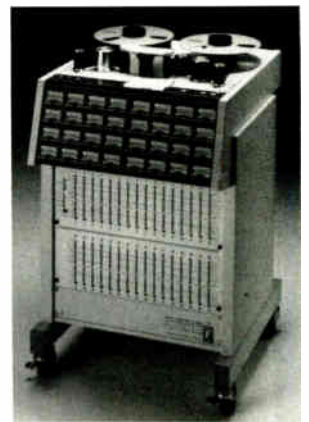

▲ OTARI MX-80 2" RECORDER

- * Full-Function Remote
- * Interface to SMPTE/EBU Time-Code
- * Now with locator/stand



▲ TC ELECTRONIC TC-2290

Digital Multi-Effects/100K Sampler – dynamic range 100dB.

PROFESSIONAL AUDIO SERVICES AND SUPPLY CO.

619 SO. GLENWOOD PLACE, BURBANK, CA 91506. ☎ 818/843-6320. FAX: 818/843-5754



OTARI

Eventide

TANNOY

NOIŽ MONITOR

lexicon
The Art and Science of Sound

AS WELL AS ALL MAJOR LINES

USE READER SERVICE CARD FOR MORE INFO



Magnetics

Your #1 Source for Magnetic Media

AMPEX

TAPE DISTRIBUTORS

Audio-Video & Computer Tape

AMPEX-456 as low as . . .

1/4" plastic hub (pancake)	\$9.61 ea
1/2" metal reel	\$31.03 ea
1" metal reel	\$53.73 ea
2" metal reel	\$116.36 ea

Call for more bargain value prices on cassettes and DAT tapes.

(Orders shipped same day received)

FAX us your order!
713-783-1203
24hrs. a day · 7 days a week

GLO Magnetics

713-783-1449 · 800-460-1449

3945 Braxton · Houston, Texas 77063

USE READER SERVICE CARD FOR MORE INFO

RECORDING EQUIPMENT

—All Major Brands—



FOR STUDIOS/HOMES CHURCHES/CLUBS

- Reel to Reel Decks (2-4-8-16-24 Track)
- Cassette Decks • Mixing Boards
- Mikes • Studio Monitor Speakers
- Special Effects Units Accessories

TASCAM
TEAC Production Products



- VOLUME DEALER
- NEW & USED
- E-Z TERMS
- ALL MAJOR CREDIT CARDS
- PROFESSIONAL ADVICE

Call for pricing information.

RHYTHM CITY

1485 NE Expressway
Atlanta, Georgia, 30329

1-404-237-9552 • 1-404-237-8526

Special Pricing for Package Systems.

thing that wasn't a hard effect and didn't require frame accuracy—were placed on the Sony JH-24 24-track machine with Dolby SR. As Roth says, it's a long shot that the client will want to move the fire sound by one frame.

The voices, explosions and basketball, however, were placed in the AudioFile for accurate lock-to-picture. Godzilla's voice comes from four different sources. Some was pulled directly from the laserdisc of a 1985 remake. Some came from the Hanna-Barbera library, which Roth believes is what they used on the original 1956 film (an elephant trumpet, followed by an elephant roar, pitched down several octaves). Some came from lion growls off a new Network library ("a friendlier, more talkative type of voice," used near the end of the spot). And some came from mix engineer Jay Shilliday growling into a mic. Barkley's voice was delivered on 1/4-inch.

But the basketball sound is what grabs you, first appearing from off-camera, stage right. It's a big ball, and the sound had to stand out, which is why Roth and company recorded binaurally with the custom Barnaby 2000 Sonic Imaging System, developed by Jeff Gold.

"One of the reasons we chose to do the ball in 3-D," Roth explains, "is that I like to work in stereo on everything, and that builds up lots of layers of tracks. On this spot we had 40 tracks going, but typically in the mix you have all these elements fighting with each other and you end up playing with equalization. What Jeff Gold has done with Barnaby 2000 is develop an EQ that helps the spatial information be mono-compatible so that nothing disappears when it folds into mono. The EQ adds no equipment-induced phasing, and it highlights the directional information—up/down, left/right, front/back—so that you get a 3-D experience through speakers.

"When you have 40 elements happening and you have one that's very important and it's been recorded in the 3-D process, it stands out without monkeying with the board EQ, or adding effects, or trying to add more level," Roth continues. "It stands out from the other elements spatially."

The basketball's importance goes beyond mere bounce sounds. It is tied to the rhythm of the music tracks. In fact, three music mixes were delivered



**OUT OF OUR
MINDS**

and into

YOURS

FOR THIRTEEN YEARS, Full Sail has been one of the nation's leading EDUCATION FACILITIES for AUDIO, VIDEO and FILM CAREERS • 3-time WINNER of MIX's

TEC (TECHNICAL EXCELLENCE and CREATIVITY) AWARD for OUTSTANDING INSTITUTIONAL ACHIEVEMENT, RECORDING SCHOOL or PROGRAM •



we take
your
DREAMS
seriously

**FULL SAIL CENTER FOR
THE RECORDING ARTS**
3300 UNIVERSITY BLVD • WINTER PARK (ORLANDO) FLORIDA • 32792

1-800-CAN-ROCK



on DAT for the final, composed by Big Trax's Dan Obst with a 76-piece orchestra on the MGM lot in Hollywood. The first mix was basketball only; the second was full music with basketball; and the third was full music minus basketball, which is what was eventually used.

Roth and Gold then recorded their own basketball sounds, bouncing a ball in seven incremental steps toward Barnaby 2000—Gold's man-quin "Barnaby" with two microphones placed in its ears to simulate human psychoacoustic recognition.

There are really two sounds involved: the bounce as it hits the floor, and the "ping" as it rises in the air. It's the ping that provides the most directional information, as it has much higher frequency information. Then, in the same seven incremental locations, Roth slapped the ball to provide the hand-meets-ball sound. Essentially, Barnaby 2000 serves as a stereo mic, with left and right signals stored on separate channels of the DAT.

Everything then went into the AudioFile, with the absolute time from

the DAT providing enough accuracy to establish sync. Shilliday added in a few explosions to augment the bounces, and presto! 3-D from your TV. Final mix was to DAT at 48 kHz, laid back to a D-1 master. Actually, Wieden and Kennedy producer John Adams called for two video edits, resulting in two D-1 masters—one for NTSC, one for PAL. The AudioFile's time expansion capabilities were used to quickly adjust the length of the spot 4% for the PAL DAT. The film mix followed a few weeks later for distribution in Europe and Asia. ■

—FROM PAGE 49, SOUND FOR "PARKER LEWIS"

past three years. "If you see a character being pulled along by his feet, in *Parker Lewis* you expect to hear the tennis shoes squeaking or a car tire skid. Or a rubber-pull as he stretches his collar. We'll specifically cue spots for bigger-than-life slaps or some sort of party-maker noise when somebody turns their head. I was raised on cartoons and the Three Stooges and that sort of thing, so I guess that's where I look for some of

the ideas."

Cartoon, as we know, is something of a no-no word in Hollywood. Let's try "animated sound." Or "hyper-real sound." Whatever you call it, this type of sound is central to *Parker Lewis*, and the concept doesn't begin with Redpath or the Three Stooges or Saturday-morning fare. It begins with the script.

"One of the most unusual aspects of this show is the amount of consideration given to picture and sound

post from the earliest stages of writing," Redpath says. "I think that's unusual in TV. We've even had writers call and ask for the name of an effect used in such-and-such a show, then write that into the next script. The swish-pan to a face close-up is something where we might add a sound, though it's really just a camera move. We know that, but on *Parker Lewis* we get to hear it."

All of the audio post is handled in-house at Sony, where the show is

EXPERIENCED EQ SEEKS WORK

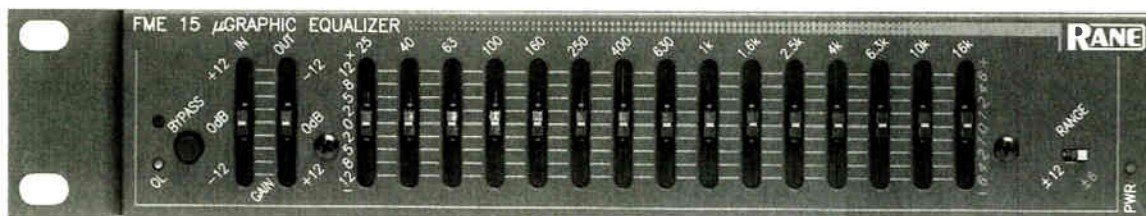

High-performance $\frac{2}{3}$ -octave graphic equalizer available to start work immediately. Honorably discharged from highly-respected manufacturer. Works well with any other equipment. Recording/broadcast qualifications. Interpolates well. Proven track record. Small but very capable. Will work standing up or laying down. Call (206) 355-6000 for references. Ask for the FME 15 Constant-Q $\frac{2}{3}$ -Octave micro-Graphic Equalizer.

RANE CORPORATION 10802 - 47th Ave. W., Mukilteo, WA 98275. (206) 355-6000



USE READER SERVICE CARD FOR MORE INFO

John Arrias and DIC//DAT...

achieving the Ultimate in Sound!

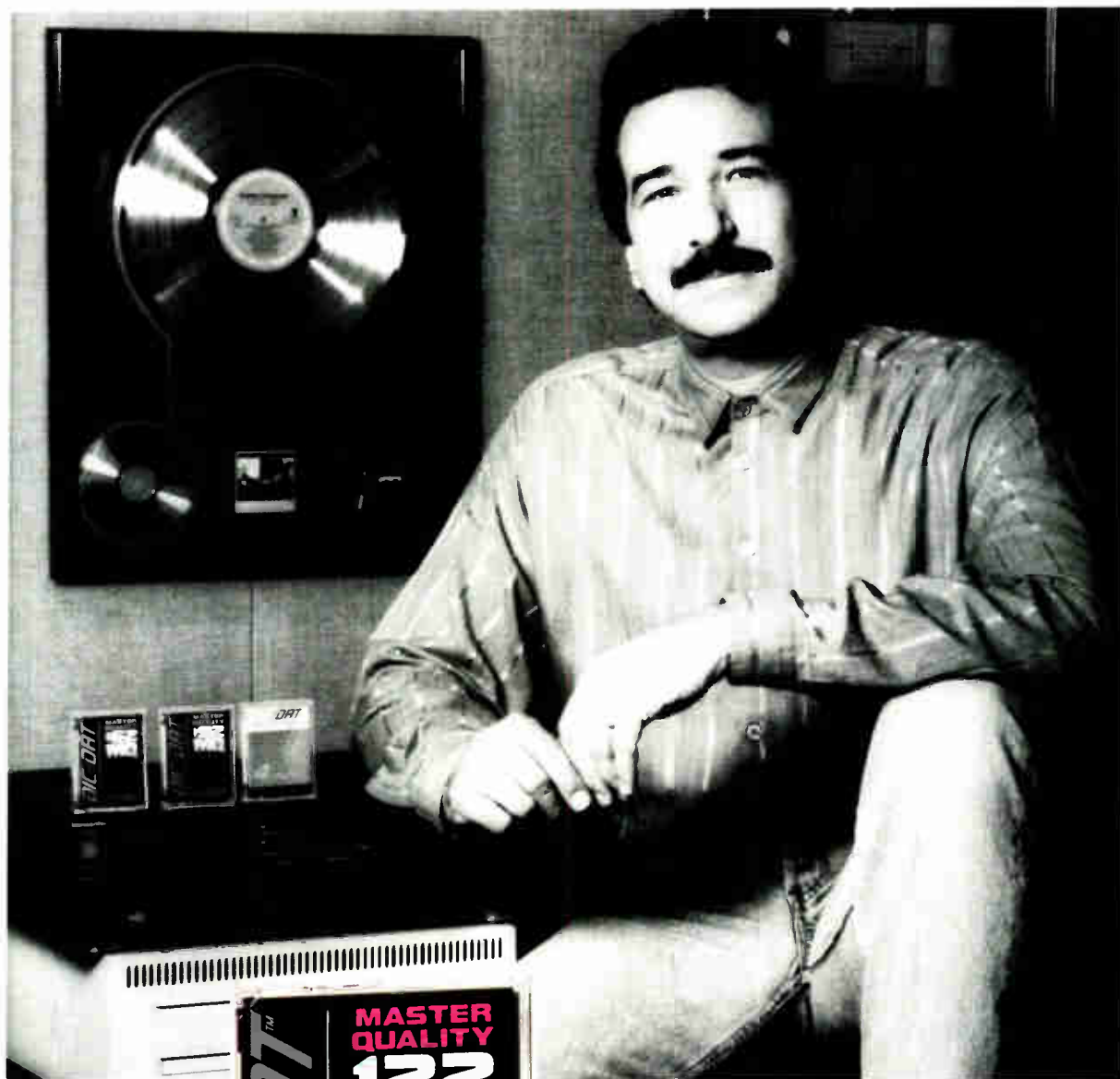

Technology in its highest form. That's the John Arrias trademark witnessed on albums he engineered for Barbra Streisand, Bob Seger and countless other artists who demand his distinctive sound of perfection.

John developed his own audio preservation system which transforms older analog recordings into crisp, clear digital sounds. And to back up these and new recordings, he uses four digital audio tape computer drive units. Whether mixing down or backing up, John relies on DIC Digital's MQ series DAT and 4 mm data grade metal particle tape products.

The only cassette made in the U.S.A., the MQ shell has increased stability and structural integrity so it can stand up to rigorous studio use inflicted by the most astute engineers.

MQ's proprietary metal particle technology is enhanced with a formulation finish that reduces friction in the tape to head interface. Combined with its dust-busting design, the MQ cassette virtually eliminates environmental contamination that leads to recording errors and tape jamming.

For impeccable recordings, today's engineers use DIC Digital's DAT tape products for the ultimate digital sound.



DIC//DAT™

The Ultimate in Sound

222 Bridge Plaza South, Fort Lee, NJ 07024
201-224-9344 • 800-328-1342 • Fax: 201-224-9363

READER SERVICE CARD FOR MORE INFO © DIC DIGITAL SUPPLY CORPORATION 1992

World Radio History



*The Star
is
born!*

Professional sound recordists
have dreamed about owning a
digital NAGRA.

Now it's available.

4 channel digital recorder
reliable open reel 1/4" tape
extra headroom with full 24 bits
per sample

NAGRA-D.

From the company which has
always set the industry standard
in audio recording. And which
made the name **NAGRA** original
and famous.

NAGRA

Solid State Logic

The Portable Dream

New York Rental Company's
Flight-Cased SL 4000

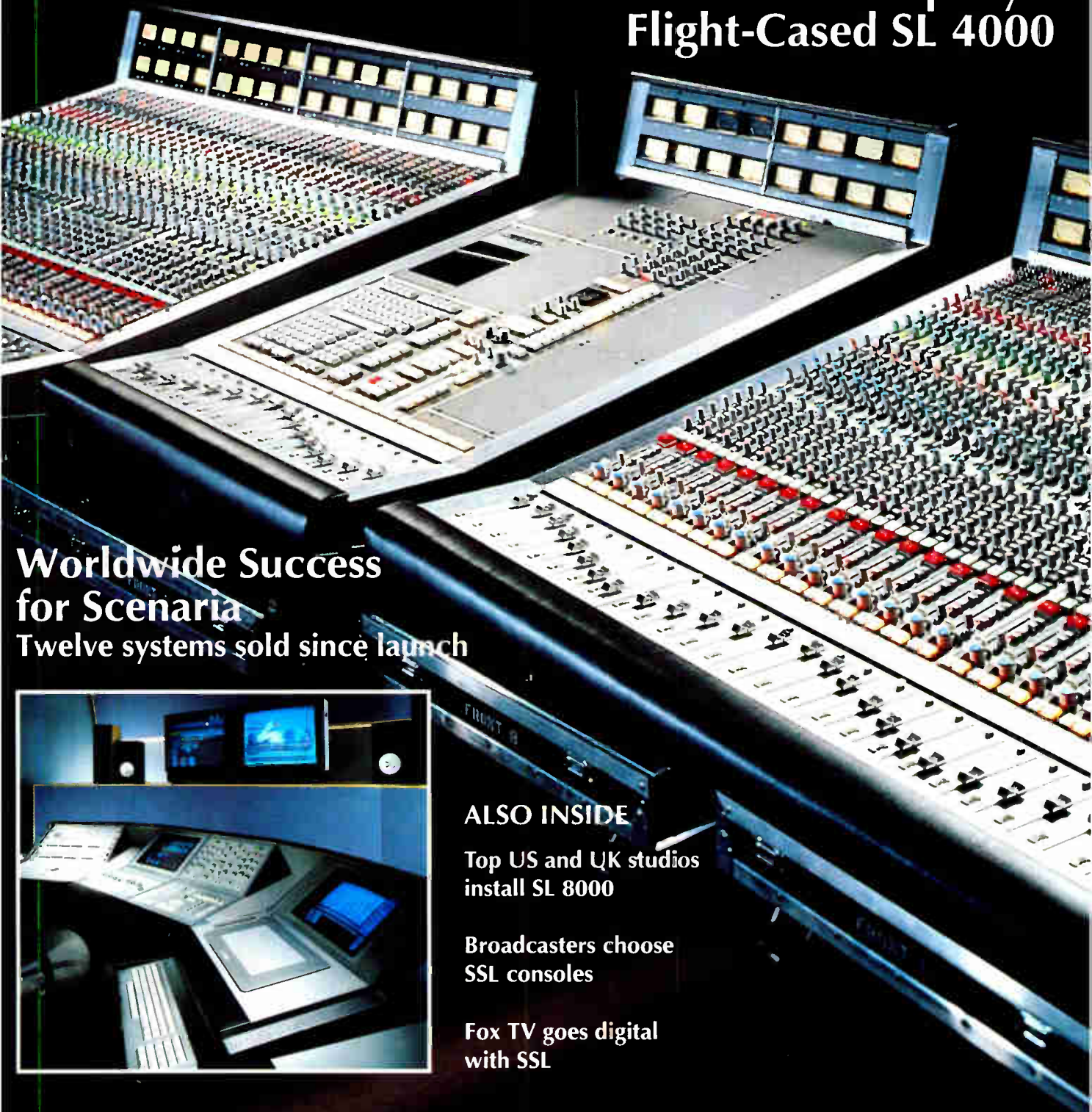

**Worldwide Success
for Scenaria**
Twelve systems sold since launch

ALSO INSIDE

Top US and UK studios
install SL 8000

Broadcasters choose
SSL consoles

Fox TV goes digital
with SSL

The Portable Dream Machine!

Now you can take your studio with you

These days it can take a year or more for a top artist to record and mix a new album. With so much time devoted to the creation of a new work, the traditional solution has often been to build a professional studio in your home. To avoid being tied to one location for a year or more, the perfect answer would be a complete studio, neatly packaged into flight cases, which can be taken anywhere, and set up in less than two hours.

The SSL Portable Studio provides solutions to all of these problems, and is the brainchild of Steerpike, an enterprising New York-based rental company. The company's dream of a transportable studio package was brought to life this summer by designers and production staff at Solid State Logic's Oxford headquarters. The result is a 64-channel SL 4000 G Series console, with the Ultimation™ moving fader system and Total Recall™, which breaks into three sections and folds up on its flight case bases. Other flight cases contain the patchbay, G Series computer, power supply, outboard equipment and a Sony 3348 digital multitrack. All of the units are linked by multipin connectors to allow rapid assembly and packing.

Steerpike's first client for the Portable Studio is Sting, who recently began work

on a follow-up album to *The Soul Cages* at his home in rural Wiltshire. Sting has spent time developing tracks at home with producer Hugh Padgham and other musicians, but has the capability to pack up and relocate whenever he wants.

"The great thing is that everything is fully connectorised," says Hugh. "Once the flight cases arrive, the system just plugs together, and you're ready to roll."

Sections of the console pivot onto their backs on the flight case bases, before the tops are fitted ▶

The complete Portable Studio, showing the console completely assembled and all outboard equipment, power supplies and G Series computer fitted in flight cases ▼



Dreams Built To Order

The last twelve months have seen an increasing demand from broadcasters, music studios and artists for G Series consoles, large and small, built to meet their precise specifications.

The recent Portable Studio package is only one example of a trend amongst clients to specify something unique and individual, either as a focus for their recording facility, or to meet specific practical needs.

Here is a summary of the many G Series options that clients are able to choose from:

- Frame sizes from 32 to 96 channels
- L or U shaped console wings
- 45, 55 or 95 degree frame angles - or user specifiable
- Mono or stereo I/O modules
- Two styles of equalisation (E or G Series)
- Oxygen-free cable
- VU, PPM or Plasma Bargraph metering
- Patchbay on left, right, or remote from console
- VCA automation or Ultimation™ moving fader system
- Total Recall™ computer system
- Master Transport Selector
- Synchroniser Interface
- Events Controller
- Programmable Equaliser
- Programmable Joystick Pan Controls (SL 8000)
- Additional Tape Transport Controls (SL 8000)

◀ *A winged SL 4000 G Series console - the Dream Machine*

Scenaria - A Major Success Worldwide

Twelve systems ordered since launch

Scenaria, the world's only Digital Audio/Video Production System, has been warmly welcomed by post-production facilities around the world. In the few months since its introduction at NAB, Solid State Logic has received orders for twelve Scenaria systems from major facilities, from Tokyo to Detroit.

These include:

Avenue Edit, Chicago
Mouri, Japan
Omnibus, Japan
Post Perfect, New York (3 Scenaria systems)
Producer's Color, Detroit

Saunders & Gordon, London
Tape Gallery, London
Video Post & Transfer, Dallas
Video Sunmall, Japan
Voss & Partners, Dusseldorf

Facilities around the world have been quick to realise the advantages of combining random access audio and video. With Scenaria they have a 38-channel, fully automated digital mixing console with a 24-track random access recorder/editor and random access video storage. For the first time, editing, signal processing and mixing can be carried out to picture, entirely in the digital domain.

The Scenaria demonstration suite at SSL's Oxford headquarters, which has been booked solidly since the launch

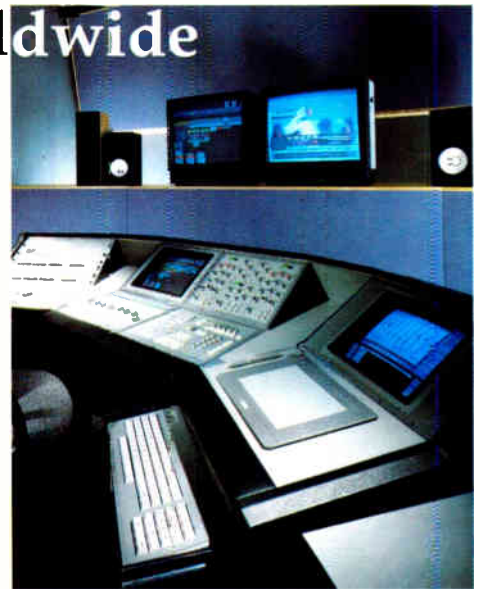

ScreenSound and SoundNet Updates

A major software revision is now available for ScreenSound which extends its range of operational possibilities to make it the most powerful and comprehensive audio post-production editor available.

Amongst this latest package of operational features are:

- **Multiple input recording - with unlimited drop-ins/outs**
- **Audio clip Hold - for fast re-editing**
- **Selective back-up/restore to MO disc**
- **MO working discs**
- **Serial VTR emulation**
- **Full Scenaria compatibility**

To coincide with the latest enhancements to ScreenSound a number of important new SoundNet features have also been added:

- **Print a Directory**
Includes all Sound Files and Desk Files
- **Expanded Off-line Directory**
Directories of up to 32 off-line MO discs can be stored in the SoundNet database
- **Selective Back-up/Restore**
Back-up and restore of individual Desk Files, Desk Files with audio sources, or the entire working disk
- **Full Scenaria compatibility**

There are also a number of new hardware options available for both ScreenSound and SoundNet:

- **SSL's PatchBay audio/control routing matrix**
- **High Speed MO drive**
- **Faster Exabyte tape streamer which offers 5 times realtime back-up and restore rates.**

London Studios Install Scenaria



▲ (l-r) Robin Saunders and Ken Gordon with SSL's Stuart Grant

Top post companies order systems

Two of London's top post-production companies, Saunders & Gordon and The Tape Gallery, ordered Scenaria systems within weeks of the official launch.

Saunders & Gordon

Saunders & Gordon Studios, owned and managed by Robin Saunders and Ken Gordon, became the first UK facility to install a Scenaria in September.

Most of the studio's work is post-production for television commercials, although it is also involved in broadcast television dubbing, corporate and audio-visual work, radio commercials and even

talking books.

The Scenaria, which is to be used on a wide variety of projects, brings Saunders & Gordon's total of digital suites to three. With five other recording rooms and comprehensive audio and video transfer facilities, Scenaria was chosen as the ideal addition to the studio's capabilities.

Says Robin Saunders: "We had been looking for a system that combined 24-track digital random access recording with a totally automated digital

console, but until Scenaria came along, the only solution was to mix and match one manufacturer's console with another manufacturer's recording system - with all the compromises of performance that entailed. With Scenaria we have a dream system that not only fulfils all our requirements for an integrated production tool, but also looks like the cat's pyjamas!"

The Tape Gallery

The Tape Gallery was founded in 1981 and has five recording studios specialising in sound for television, cinema and radio. The first London studio to record and edit digitally, The Tape Gallery plans to use its Scenaria for a variety of projects, but primarily for commercial 35mm film dubbing and video post-production.

Solid State Logic

"How I Use My Network..."

SoundNet users talk

Craig O'Donnelly, Aspect Ratio

"SoundNet has truly enhanced the flexibility of our ScreenSounds, because we can go from one job to another, grab something from the hard disk, copy it and keep right on working."

Mike Levesque, Nutmeg Recording

"Before we added SoundNet, if a client booked an hours worth of time, I used to have to waste an hour of time for back-up and restore - SoundNet has given me back that hour of downtime and I'm using it to work with clients."

Jay Scott, General Television Network

"SoundNet allows us to work from a central database, giving us rapid access to a huge number of sound files. Since many of our jobs involve revisions, SoundNet's off-line back-up and restore capabilities are essential for efficient servicing of our clients."

Jeff Buikema, Image Express

"SoundNet has helped us to expand our audio capacity. When we are working with a job that requires more than eight channels, SoundNet allows us to set up more channels by slaving several ScreenSounds together."

Craig Maniglia, Musifex

"We can have four drives on-line via SoundNet - that's twelve hours of audio. We could have two drives with two different programs on them; we can have one drive with music, one with sound effects, while the optical drive is also filled with sound effects. The possibilities with SoundNet are just mind-boggling."

ScreenSound in Japan



Sapporo Eizo Productions, in the northern Japanese city of Sapporo, is one of the increasing number of post-production facilities in the country where ScreenSound is being installed. As in the rest of the world, Japanese studios are realising the creative benefits of SSL's digital technology

They Keep Coming Back!

Studios place repeat orders for ScreenSound

Such is the popularity of ScreenSound that first time users quickly realise the creative and financial benefits to be gained from the system.

After having purchased a ScreenSound and used it for a short while, many customers have been back to place repeat orders, some for multiple ScreenSound systems and SoundNet digital audio networks.



▲ Buddy King (right) and Tom Maydeck of Soundcastle/Post Modern, Los Angeles, working on a new Batman cartoon series with ScreenSound

Among those repeat customers are Soundtrack (4 ScreenSounds + SoundNet), COPRA (2 ScreenSounds + SoundNet), Howard Schwartz (2 ScreenSounds + SoundNet), Clack (3 ScreenSounds + SoundNet), Pomann (2 ScreenSounds + SoundNet), Soundcastle/Post Modern (3 ScreenSounds + SoundNet), Sound Interchange (3 ScreenSounds + SoundNet), and Nutmeg (3 ScreenSounds + SoundNet)

ScreenSound in Virginia

Phoenix Recording, Arlington, Virginia has recently installed a ScreenSound. Pictured is Grant Rutledge (right), Chief Engineer, with client David Powers of Harrison Powers Transmission

SSL Digital for TV Documentary

Audio to picture editing on ScreenSound

Peter Gabriel's continuing involvement with WOMAD (World of Music, Arts and Dance) has led to a series of projects being undertaken over the past year at Real World Studios, in Wiltshire, culminating in a TV Special screened in July of this year. The audio to picture work was undertaken on a ScreenSound digital audio editor.

Real World Records, owned by Peter Gabriel and WOMAD, is dedicated to giving world musicians the opportunity to work with technical equipment otherwise unavailable in their own countries. Since last August, Real World Records has produced five individual albums from bands as far away as Tanzania and Russia, and three collaborative albums involving a number of well-known artists such as Sinead O'Connor and Karl Wallinger from World Party. Four SSL consoles were involved in the project, under the supervision of producers which included Rupert Hine, Phil Ramone and Tony Berg.



▲ Editing the WOMAD TV Special at Real World Studios, Wiltshire, England

Filming for the TV Special took place throughout recording. All post-production work was subsequently carried out at the studio on ScreenSound. The programme was broadcast in the UK, Germany and Australia.

The final editing of the TV documentary was completed at M2 Video in London, where the music, which was re-mixed onto ScreenSound, was integrated with all the various behind-the-scene noises and commentary - again using ScreenSound.

Top UK Studios Confirm Commitment to SSL

London's Abbey Road and Air Studios Install SL 8000s

Two of the world's leading recording studios are among the latest to re-equip with the SL 8000 Multi-Format Production System.

Abbey Road Studios

Abbey Road has installed a 72-channel SL 8000 G Series console complete with Ultimotion™ dual automation system in the refurbished Studio 3

Ken Townsend, Director of Operations at Abbey Road, explains the reasoning behind the studio's new console purchase: "Studio 3 is a first-class room, and we have updated it with the latest and best equipment. The flexibility of the SL 8000 will enable us to carry out a wide variety of projects in there, from pop music recording, to film and video work. Abbey Road has always attracted top-class producers and engineers from around the world, and the SL 8000 will bring in more of the better quality rock album work. At the same time, of course, the SL 8000's ability to work in all formats gives us the 'future-proofed' capability to handle practically any audio recording project."

In the short time that the console has been installed, Kate Bush, Morrissey and Julia McKenzie have recorded in Studio 3, and Henry Mancini has used the console for film soundtrack mixing.

Studio 3 at London's Abbey Road Studios, where one of the world's first SL 8000 Multi-Format Production Systems is installed



Air Studios

London's renowned Air Studios is also amongst the first to order an SL 8000 G Series Multi-Format Production System. The console, which is an 80-channel frame with 72 modules fitted, also has Ultimotion™. It is being installed in Air's magnificent new Lyndhurst Hall facility in North London.

Malcolm Atkin, Studio Manager at Air Studios, says: "In planning ahead we

needed to cover all the bases, and the SL 8000 is the best and most versatile console for use in many different applications. Although the room will be used primarily for Rock and Roll mixdown, we also plan to be doing a lot of audio-to-picture work with the desk. In fact, we already have a two month booking for the room for just such an application. When the client heard that we can also do LCRS mixing with the SL 8000, he immediately began to think of extending the booking!"

ScreenSound for Satellite Broadcaster

Leading Asian Broadcaster Installs digital editor

Hong Kong is home to one of the most sophisticated satellite broadcasting installations in Asia. STAR (Satellite Television Asia Region) TV broadcasts 5 television channels - including the BBC-World Service and MTV - via the AsiaSat 1 satellite.

ScreenSound was chosen for the station's new audio post-production facility because of its flexibility, ease-of-use and proven upgrade path. Adam Pinch, Sound Supervisor, explains: "We looked at other hard-disk editing systems, but felt that ScreenSound met our needs far better. After having used it operationally now for six months or so, I can say that we made

the right decision."

With five different channels and transmission in two standards, STAR TV has chosen an all-digital system of internal signal coding to take full advantage of the digital processing of its signal converters. This also allows a clean signal path for digital graphics and provides for support of future formats, such as HDTV. ScreenSound fits perfectly into this environment. "At STAR TV, the Broadcast Operations and Engineering departments have to serve the needs of five channels, all of which have different requirements and ways of working," says Phil Braden, Vice President Broadcast



▲ Adam Pinch, Sound Supervisor, using ScreenSound in the new audio post-production facility at STAR TV, Hong Kong

Operations and Engineering. "The bottom line is that the channel producers prefer working in our in-house audio suite rather than going to any of the outside Hong Kong sound facilities. That says it all."

Solid State Logic

Enterprise Beams Aboard SL 8000s

Two Multi-Format Production Systems keep studio "Ahead of the curve"

The Enterprise Recording Studios, Burbank, has become the first facility in the USA to feature the world's only mixing console designed for all music, television, video and motion picture formats.

The installation of the 96-channel and 80-channel SL 8000 G Series consoles, both with Ultimation™, marks the eighth and ninth SSL consoles at this Emmy Award-winning studio complex. Last year, The Enterprise became the first studio in the world to install SSL's Ultimation™, moving fader/VCA automation system.

Enterprise CEO, Craig Huxley explains: "Our mission is to keep our clients ahead of the curve and to offer them an interbreeding of the finest in music technology with the farthest advances in multi-dimensional film sound technology."

"The SL 8000 offers Enterprise the music capabilities of the acclaimed SL 4000

console as a platform, and adds to that vast additional capabilities to work in a variety of formats traditionally used for television and film. The crew on The Enterprise chose the SL 8000 because it offers music producers and engineers the chance to get creative with tomorrow's formats today!"

With the SL 8000, Enterprise engineers can now mix for Dolby™ Surround, Dolby SR-D, Kodak™ CDS, HDTV and even new '3-D' music recording processes.

The console features SSL's powerful Ultimation™ moving fader/VCA automation, and the new Automated Joystick Pan controls.

The system also provides Left, Centre, Right and Surround panning on every channel.

The Enterprise,

conceived and constructed after Huxley composed and designed music for the popular *Star Trek* films, has always taken an innovative "new frontiers" approach to audio. High ceilings, geometrically shaped furniture and huge video projection screens in the control rooms of the Kandinsky-like ('Memphis' style) studios add to the facility's vibrant feel of the future.

Craig Huxley, CEO of The Enterprise, with one of the studio's two SL 8000 G Series Multi-Format Production Systems

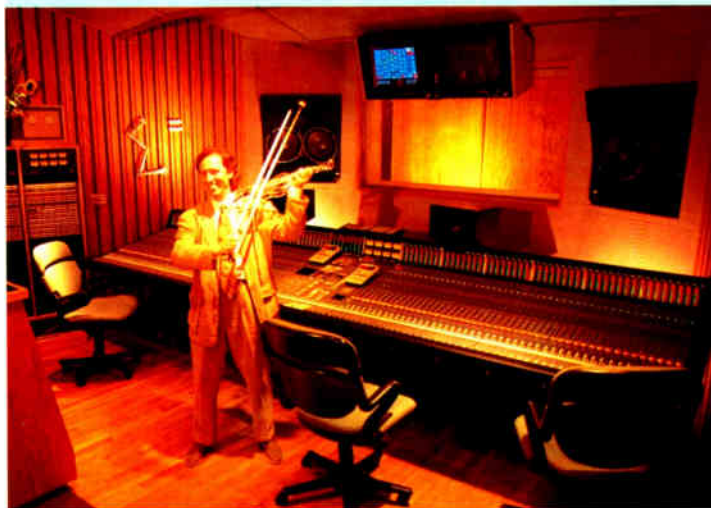

Fox TV Goes Digital with SSL



Members of the team at Fox Tape working with ScreenSound include Russell Brasher, Judy Frenkel, Steve Jamerson, Jon Schroeder, Kent Tunks, Gary Singleman, Chris Homer, Paul Robie, Andy Harper and Carol Woodford

ScreenSound and SoundNet assist creativity in editing

Fox Tape Division, the Hollywood-based audio/video post-production facility that handles most on-air

promotions for Fox Broadcasting Company, recently added two ScreenSound systems and a SoundNet network to its post-production facilities.

Currently, Fox Tape produces 300 to 350 promos per week for the network. With this heavy schedule, a key issue for Fox, according

to VP of Operations, Tony Ciesniewski, is the ability to work with people and equipment that can make rapid changes.

"Fox has been fortunate in terms of viewer popularity, and our operations are growing at a tremendous rate," says Ciesniewski. "It is our philosophy that engineering should be transparent, and

technology should facilitate creativity rather than stand in its way. ScreenSound and SoundNet have given our mixers more flexibility in the way they work; now we spend our time on the creative aspects of the overall project, rather than worrying about which patch cords to put together."

Fox currently has five off-line rooms, two on-line rooms and two sweetening rooms. ScreenSound is currently being used in both sweetening rooms for editorial work, for recording, effects, time compression and expansion, and for retrieving information instantly.

"Before we added ScreenSound, we used to do razor blade editing on 4-track, and we used many carts, a lot of mixdowns, and we would have to edit pieces on a separate machine on analogue tape," explains Chris Homer, Manager of Post Production for Fox Tape Division. "Now we're using ScreenSound to pre-edit and we've really increased the output capabilities of the rooms. Now we can edit portions of a job on ScreenSound at the same time as we're mixing other portions on the console."

Adds Ciesniewski: "At Fox we are always looking for better, faster ways to accomplish our projects. ScreenSound is definitely one of those better and faster ways."

European Broadcasters Choose SSL



◀ BBC Radio 2 Presenter John Dunn, on-air with the latest of four SL 5000 M Series consoles to be installed in Broadcasting House, London

production facility has been built at LWT's South Bank studios, and an SL 5000 M Series console with Instant Reset™ has been installed for on-air use.

The console's unique flexibility, and the ability to configure it to match LNN's exact operating requirements, were major factors in LNN's decision.

AB Productions - Paris

AB Productions, an independent broadcast production company specialising in children's programmes and cartoons, has recently installed an SL 4048 G Series. The SL 4048 was chosen because its versatility will enable it to be used for a variety of projects.

Swedish Television - Axjo

Swedish Television, responsible for national broadcasting of both radio and television, has recently purchased its 11th SSL console, an SL 6040 G Series, which will be used for on-air work in the south of the country. Swedish Television chose SSL because of its reliability and flexibility for live broadcasting.

Antenne 2 - Paris

The second State television channel in France, Antenne 2 has specified an SL 4048 G Series console, the first to be sold to a broadcaster in France. The console is to be installed in Reje 40, the company's largest shooting stage, which is currently being refurbished to provide a full digital production capability, including digital video. The SL 4048 has been modified to suit all the applications required.

VTM - Brussels

VTM, the only commercial television station in Belgium, has purchased three SL 5000 M Series consoles to be installed in a new facility in Brussels.

Variety of consoles used in Radio and TV

Across Europe, radio and television broadcasters are increasingly specifying Solid State Logic audio consoles for a wide range of applications, from recording and on-air use, to in-house training. Amongst the latest to have specified SSL are:

BBC - London

BBC Radio 2 has ordered a fourth SL 5000 M Series console for its new transmission suite complex at Broadcasting House. This

latest console has identical features to the previous three, including remote facilities that allow a measure of self-operation by the presenter.

Teletota - Paris

Teletota is one of France's largest production companies. The studio also has the contract for adapting productions to Dolby consumer video cassette format. Teletota has installed an SL 4040 G Series with modifications which will enable it to meet the requirements of the Dolby contract.

LNN - London

London News Network is a news service shared by the two commercial television stations for the London area. A news

ScreenSound for Film Dubbing

"The obvious choice" for digital editing

Studiosound, part of Mercury Theatres, the London-based film dubbing studios, has chosen Solid State Logic's ScreenSound audio-for-video editing system to take them to the forefront of digital sound editing.

Henry Dobson, Head of Sound, explains why they installed the SSL ScreenSound. "It was essential that we chose a system that was not only a complete recording device in itself, but could also be used in combination with our existing dubbing operations to achieve greater flexibility. ScreenSound is the only system that has been sympathetic in its design and operation with film editors and mixers."

Studiosound attracts a wide range of clients from television, film and video and it was felt essential for the continuing success of the studio to install ScreenSound. As Henry Dobson says: "SSL's reputation and commitment made ScreenSound the obvious choice."

▼ Henry Dobson, Head of Sound at Studiosound, dubbing to picture with the studio's ScreenSound



Effanel Music, the first US independent mobile recording facility to feature a Solid State Logic console, has installed a new 52-channel SL 4000 G Series console with Ultimition™ in its newly-expanded recording vehicle.

Effanel thus becomes the first mobile recording facility in the world to offer its customers Ultimition, SSL's new Moving Fader/VCA console automation system.

"Though we're a mobile facility, having the new SSL with Ultimition makes us equal to any of the top five recording studios in New York," says Effanel owner Randy Ezratty (rear) pictured with engineer/producer John Harris

From the Desk of...

Hugh Padgham



Hugh Padgham enjoys the highest reputation for his work as both engineer and producer. He has created many of the most memorable recordings of recent years, including albums for Phil Collins, Genesis, David Bowie and Police. He is currently working on a new album with Sting, using the special Portable Studio package developed by SSL (see page 2).

"I love the excitement of everyone playing ensemble when we're recording the basic tracks," Hugh says. "And with the Portable Studio set-up at Sting's home there's the additional thrill of having all the musicians actually performing in the same room as the console, without the divisions you normally get in a studio. The whole process has been much more relaxed. I know that Sting is absolutely delighted with it."

In his role as producer, Hugh has to keep sight of the final result through the whole track-laying process. "I have the mix in

mind all of the time that I'm working on the recording, from the first performance, through experiments with overdubbing to the mix itself," he says. "In contrast, the two or three mixing projects that I do every year take a different kind of skill. There you largely have to make the most out of what is already on tape."

And the main advantages of taking the studio into the home? "SSL has done a brilliant job putting the Portable Studio together. We are working in fresh air and daylight - and we don't have to send out for pizzas!"



▲ Hugh Padgham with the SSL Portable Studio in Sting's Wiltshire home, where they are working on the follow-up to the Soul Cages album

Product Training

Continuing SSL's worldwide support for its system users, a Maintenance Training course for SL 4000 and SL 6000 console systems was recently held in SSL's Los Angeles office.

The office demonstration room provided an intimate classroom atmosphere, with a complete G Series console and computer system forming the centrepiece for demonstration and hands-on experience.

Conducted by David Grinstead, SSL's Training Manager and Graham Caddy, Product Support Manager, the course was attended by engineers from Seattle, Dallas and Phoenix as well as Los Angeles.

For further information on SSL Training Courses, contact your nearest SSL office, or David Grinstead at Begbroke



▲ Engineers at the SL 4000 and SL 6000 Maintenance Training Course recently held at SSL's Los Angeles office

SSL Sales Boom in France

Paris Office Meets Demand of French Studios

Throughout France, studios are increasingly choosing Solid State Logic consoles and digital systems for a variety of applications.

"We have seen a number of major console and ScreenSound orders over recent months," says Alain David, Sales Manager of SSL France. "These include consoles for internationally renowned music recording facilities like Studio Guillaume Tell, and orders from leading post-production houses and broadcasters like Antenne 2."

Apart from the sales to AB Productions, Antenne 2 and Teletota (detailed on the previous page) the following French studios have also purchased SSL:

COPRA Film has opened a new department dedicated to audio editing using ScreenSound. The studio has also recently ordered a second ScreenSound and SoundNet to give the disk-switching and off-line back-up needed for a new



▲ Yves Fougeray, Head of Audio Operations at Antenne 2 (seated), and Alain David, Sales Manager, SSL France, seen with the French broadcaster's SL 4000 G Series console during acceptance testing at SSL's Oxford headquarters

feature film which they are working on. Studio Guillaume Tell is one of France's most prestigious recording studios. Regularly used by artists such as Elton John, the studio has ordered its third SSL console. The SL 4080 G Series Master Studio System has 64 channels fitted, and features Total Recall™ and the unique Ultimotion™ system which combines moving fader and VCA automation.

SSL Worldwide

International Headquarters

Solid State Logic
Begbroke, Oxford, OX5 1RU, England
Tel: (0865) 842300 • Fax: (0865) 842118

France

1 rue Michael Faraday
78180 Montigny le Bretonneux
Tel: (1) 3460 4666
Fax: (1) 3460 9522

Japan

3-55-14 Sendagaya
Shibuya-Ku
Tokyo 151
Tel: (03) 5474 1144
Fax: (03) 5474 1147

Germany

Röntgenstrasse 104
6100 Darmstadt 12
Tel: (6151) 938640
Fax: (6151) 938645

USA (Headquarters)

320 West 46th Street
New York
NY 10036
Tel: (212) 315 1111
Fax: (212) 315 0251

Italy

Via Pirandello 17
20099 Sesto San Giovanni
Milan
Tel: (2) 262 24956
Fax: (2) 262 24938

USA (Western Region)

6255 Sunset Boulevard
Los Angeles
CA 90028
Tel: (213) 463 4444
Fax: (213) 463 6568

also shot on the lot. Typically, a show is spotted on a Thursday, with the actual reels and all the picture delivered the next morning. By the following Friday, the team is in Dub Stage 15, mixing for two days on the automated, two-position Otari Premiere. Elements are delivered to the dub stage on four 24-track machines.

But we're getting ahead of ourselves. Foley, which involves as many as 100 cues per show, takes up one day. ADR is usually recorded over a three-day period, though the show is only about 5% to 10% looped, according to Redpath. The sole dialog editor, working from 1/4-inch that's been dumped into a WaveFrame 400, gets five days, as do the two effects editors. Effects are cut on the WaveFrame 1000.

"With a show like this, the workstations are great," Redpath says. "We can store any effects we've come up with from the previous seasons, keep them on the hard drive, recall them, enhance them, play them forward, backward—whatever we want. Within the hard drive, or backed up on 8mm, we keep all the effects we've ever recorded or done on the Foley stage or pulled from other libraries. In essence, we have our own *Parker Lewis* library. And we also rely heavily on the Sound Ideas library, as well as the Hollywood Edge Premiere Edition, going back to the Hanna-Barbera library."

While the effects give the show body and pizzazz, and the music (composed by Dennis McCarthy) gives it a modern-day video feel, it's the voice-over, often accompanied by re-creations or flashbacks, that provides the structure. The story moves along from inside the title character's head. Sometimes the voice-over is recorded in the temp dub, sometimes on the set, sometimes on an ADR stage, sometimes in a dressing room. The producers, who are also writers, will often change a line or two while on the dub stage.

"We EQ the voice or go to voice-over, so that we obviously know we are in his head," Redpath says. "That's how we get away with some of the comical sounds. We're in somebody's head, and when you're in somebody's head you can hear or think or do anything you want. It's not reality." ■

IMPERIAL TAPE Company, Inc.

1928 14th St. Santa Monica, Ca. 90404-4605

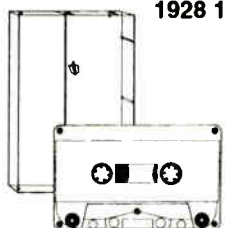

**AUDIO AND VIDEO
DUPLICATION**

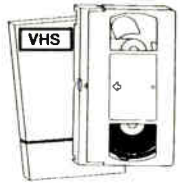

**CUSTOM LENGTH
BLANK AUDIO
VIDEO CASSETTES**

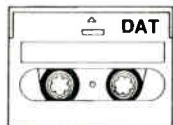

**NATION'S FINEST DIRECT PAD PRINTING
ON BLANK AND DUPLICATED CASSETTES**



**AMPEX 3M BASF
MAXELL TDK**

TO ORDER
310 • 396 • 2008 (LOCAL)
800 • 736 • 8273 (NATION)
FAX ORDER
310 • 396 • 8894

RAZOR BLADES
LEADER/SPlicing TAPE

AUDIO SWABS
HEAD/RUBBER CLEANER

USE READER SERVICE CARD FOR MORE INFO

CAN YOU RESIST THE PRESSURE OF OVER 250 ATMOSPHERES?

THE ELEMENTS TRAFFIC SKYLINES & CITY SOUNDS
 QUIET ROOMS & OTHER WORLDS TRAVEL & TRANSPORT
 INDUSTRY & COMMERCE BIRDS, ANIMALS & INSECTS
 EXTERIORS WITH PEOPLE INTERIORS WITH PEOPLE

Designed and created by dedicated and experienced sound engineers, File Effects is the new digitally recorded sound effects library available on CD, specialising in high-quality atmospheres. Each disc contains around 75 minutes of material - with most tracks a full 3 minutes in duration - providing the perfect background for the creation of effective sound tracks.

'A Sound Designer's dream - irresistible!'

FRANK SERAFINE

CALL OR FAX FOR FREE FILE EFFECTS DEMO CD

CONTACT YOUR LOCAL DISTRIBUTOR:

AUDIO ACTION

Burbank, Ca.
 Tel: (800) 533 1293
 Fax: (818) 845 8039

GEFEN SYSTEMS

Woodland Hills, Ca.
 Tel: (800) 545 6900
 Fax: (818) 884 3108

PROMUSIC INC.

Ft Lauderdale, Fla.
 Tel: (800) 322 7879
 Fax: (305) 776 2074



Josef Weinberger Ltd
 12--14 Mortimer Street,
 London W1N 7RD England
 Tel: (071) 255 1829 Fax: (071) 436 9616

by Dan Daley

SO YOU WANT TO BE IN PICTURES

Post-production is the fastest-growing component of audio today. Between scads of new cable channels, better audio for films and the proliferation of special interest videos, marrying audio to picture is a boom field—and one where project studios are making their mark.

The equipment is there. Inexpensive synchronizers and improved MIDI-to-SMPTE tracking have put audio-for-video well within reach of the project studio, and the slow but steady trend away from flatbed film audio is going to make cinematic audio a ripe area in the relatively

cable, project studios already have a lot of the gear and expertise to handle audio post. But network-style commercials and long-form programming still require more of what traditional post houses can offer in terms of equipment, technology and expertise.

That may be changing, though: just as project studios have approached—and at times exceeded—the abilities of big-time audio recording studios, so will project studios ultimately give traditional post houses a run for their money. Whether the project studio that finally meets that standard will look more like the traditional post house it aimed to replace is another matter. We've already seen project studios grow to the point where they take on many of the characteristics—and overhead—of traditional studios.

Project rooms are now in a position to interact with traditional facilities in a far better and considerably less rancorous manner than they did less than five years ago.

Project studio owners are interacting with post houses on a more mature plane at this point because they've had time to build up their expertise in audio. Plus, they now have an even wider and still growing array of technological tools available at price points they can afford.

And just as project studios are meeting traditional post houses at a somewhat different level technologically, the post houses realize, for the most part, that they cannot do everything audio. The project rooms and traditional audio post studios have a level of interface available now that can benefit both.

Inexpensive synchronizers and improved MIDI-to-SMPTE tracking have put audio-for-video well within reach of the project studio, and the slow but steady trend away from flatbed film audio is going to make cinematic audio a ripe area in the relatively near future as well.

near future as well.

The fact that the ability is there, however, doesn't necessarily mean that project studios will compete with traditional audio post houses immediately or in the near future. Certainly in television, especially

BIG EASY.



The M700 is a 32-buss production console series that combines sonic purity and a familiar, flexible architecture in standard configurations up to 128 input channels. Designed using a minimal number of active components, the M700's signal path is clean and efficient, which results in a natural sounding mix that's open, robust and transparent.

The ease and flexibility of the M700 Series can be extended by means of TASCAM's new Moving Fader Automation (MFA) package, a full-featured, stand-alone automation system which can be enhanced with a computer as a display terminal. The very responsive MFA package includes TASCAM-designed motorized faders with 12-bit resolution, along with capabilities for sub-grouping faders, mutes and solos.

If you haven't yet seen the remarkable M700/MFA production console in action, you can easily do so by calling (213) 726-0303. Or by writing TASCAM, 7733 Telegraph Road, Montebello, CA 90640.

TASCAM II

© 1991 TEAC America, Inc.

USE READER SERVICE CARD FOR MORE INFO

World Radio History



Jack Renner
and the ATM35 on

**Bass,
Brass,**

and all that jazz!

Jack Renner needs little introduction. As co-founder, Chairman, and Chief Engineer of Telarc International he has been nominated 11 times and won 5 Grammys just for classical engineering alone. Jack Renner and the Telarc team pioneered digital orchestral recording and the minimalist microphone technique that is now the standard for premium-quality classical CDs.

But when Jack recently decided to create a series of jazz CDs to complement the superb Telarc classical library, he knew – from his years of location recording – that he would need a new approach to solve the difficult acoustic and performance problems posed by live recording in jazz night clubs.

After an intensive search, he has found exactly the string bass sound he needs... with the Audio-Technica ATM35. This small cardioid condenser microphone can be clipped directly to the instrument. Its unique mount is readily positioned for best balance and consistent level all night long.

The cardioid capsule can also be easily replaced with an omni element when needed. Its low noise is impressive and the smooth extended response is both realistic and musical. Everyone loves the results: the musicians, the technicians, the record buyers, and Jack. But he also found the ATM35 has another role to play.

When Jack Renner clips the ATM35 to a trumpet or trombone he finds it equally musical, even with very intense playing. He gets very low distortion and noise, and consistent high quality no matter how much the musicians move around. Jack's goal of recording brass exactly as it is heard in live performance has been met simply and precisely.

He notes that while the microphone is actually quite close to the instrument it sounds farther away, with acoustic "air" that provides an amazingly natural perspective. And the ATM35 offers almost no restriction to the freedom of movement and expression that is so important to live jazz.

Location photos Frank Micciotta

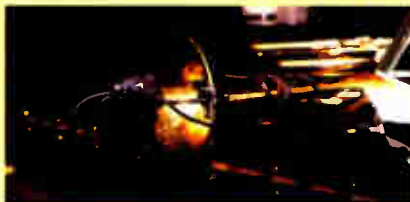

You can hear the superb performance of the ATM35 for yourself. Just listen to this sampling of recent Telarc CDs that have gained critical acclaim:

To Diz With Love (Live at the Blue Note) *Dizzy Gillespie*, trumpet, *Peter Washington*, bass

Lionel Hampton (Live at the Blue Note) *Milt Hinton*, bass

Bobby Short (Late Night at the Cafe Carlyle) *Beverly Peer*, bass

Manhattan Mambo sax, horns, vocals

The Count Basie Orchestra (Live at El Morocco) brass solos...and more

releases in this live jazz series are due shortly.

Put the mighty little ATM35 to work today.

Whether used for quality sound reinforcement or the most critical recording, this versatile microphone is outstanding. Just ask Jack Renner and Telarc! Write, phone, or fax for more details or see your Audio-Technica sound specialist today.



audio-technica®

INNOVATION □ PRECISION □ INTEGRITY

Available in the U.S. and Canada from Audio-Technica U.S., Inc.

1221 Commerce Drive, Stow, OH 44224

(216) 686-2600 • Fax (216) 686-0719

**Model ATM35
Cardioid Condenser
Microphone**

USE READER SERVICE CARD FOR MORE INFO

ONE STORY

A perfect example of this is found in the occasional relationship between Videomix, a Manhattan audio post facility, and Steve Horelick's Oasis project studio. Twice now Horelick has been commissioned to do the theme and incidental music for the HBO/Black Canyon Productions special "When It Was a Game," a paean to baseball the way it used to be. A sequel ran on the cable network this past summer.

The responsibilities for each were clear: Horelick did the music, Videomix did the sound effects, sweetening and layback. Could either have also done the other's job? A qualified yes, with acknowledgments to the fact that each would have had to go out-of-house to get certain technologies. Videomix would have needed musicians and musical equipment, Horelick would have needed more sophisticated post technologies. At the very least he would have needed more time, and that would have detracted from what Horelick does best: music.

"That's the real dividing line between how project studios and post houses can interact," says Horelick. "I know my equipment, and I'm good with it, but my main concern is the music and getting the technology to support that, not the technology itself. And that's where the post house comes in. They have the technology and know how to use it."

Technologically, Horelick cites the improvements in MIDI-to-SMPTE tracking as the prime reason for increased interfacing. Time code DAT is another feature that puts both types of facilities on a more level playing field. (Horelick uses a Fairlight III for music composition and sequencing.) Steve Dwork, president of Videomix, has considered adding some musical equipment, not for music creation but to facilitate the work of project studio composers who would then have to bring only data disks instead of sound generators, too. "It's under consideration here," he says, "so that the musician can work offline at his own studio and then come online here."

Aside from the practical considerations, Dwork sees this type of inter-

—CONTINUED ON PAGE 155

Bruce Swedien

DEMANDS

DOLBY SR

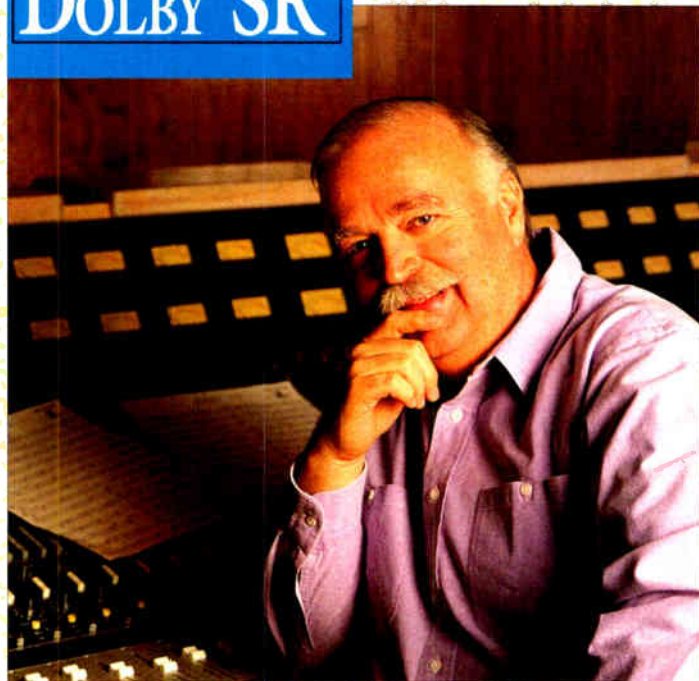

Alan Siller

"A little voice inside tells me not to give up my analog machines. There is a refinement and character with analog not available with other mediums."

Occupation

Producer, engineer, songwriter.

Recent credits

Co-produced 5 and engineered 11 songs on Michael Jackson's "Dangerous." Currently working with Michael Jackson, Sergio Mendes and Rene Moore.

Career credits

At age 19 recorded Tommy Dorsey, and hasn't stopped yet: Quincy Jones, The Chicago Symphony, Duke Ellington, Count Basie, Stan Kenton, Oscar Peterson, Sarah Vaughn, Natalie Cole, Barbra Streisand, Dizzy Gillespie, Diana Ross, Nat 'King' Cole. Awards: 3 Grammy's (8 nominations); TEC Hall of Fame.

Career direction

"I want to do more co-producing and song writing along with engineering."

On his technique

"Lately I have returned to recording directly to analog recorders, later transferring the final elements to digital for editing and storage."

On Dolby SR

"Dolby SR allows the inherent beauty of analog recording to come through without annoying hiss, hum, or print-through. I use Dolby SR on all my projects."

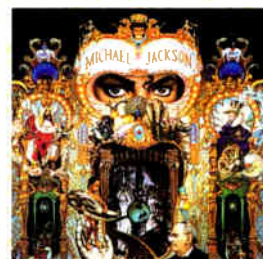

Michael Jackson's "Dangerous" (Epic)
5 songs co-produced, 11 engineered
by Bruce Swedien

Dolby SR; now over 61,000 tracks worldwide.

WHEN IT CAME TO BEHRINGER WE LET THE EXPERTS MAKE THE NOISE.

Leading experts in recording, film post-production and live sound are discovering the many advantages of the Behringer 2-channel and 8-channel DeNoisers. They know Behringer takes the noise out of the dirtiest signal path without altering the audio quality. Their reactions show why Behringer is now the most talked about name in professional audio circles.

"Simply lovely. Smiles all around. Room agreement was unanimous: We want this thing on all our tracks." **Mike Joseph—Editor REP, March 1992**

"I have used similar 'single-ended' devices on the mixes of 'Ghost' and 'Godfather III' and found the Behringer Mark III to be superior in every category—from ease of operation to final result.

"Consequently, I am—without hesitation—recommending to LucasArts/Skywalker Sound that they buy at least four channels of Behringer Mark III DeNoising for each mixing console here and in Los Angeles; a total of twelve mixing rooms."

Walter Murch—Film Editor and Music Mixer, LucasArts/Skywalker Sound

"If the phrase *noise floor* is in your vocabulary and you would prefer that it was not, get a Behringer single ended noise reduction unit to the top of your *got to have one* list." **Robert Scovill—Sound Engineer/Mixer, Rush/Def Leppard**

The experts know why Behringer DeNoisers let them take the noise out and leave the audio quality in. Isn't it time you discovered all the good things Behringer can do for your audio?

THE PERFECT EAR.



Exclusively distributed in the US. by Samson Technologies Corp., P.O. Box 9068, Hicksville, NY 11802-9068 Tel (516) 932-3810 Fax (516) 932-3815

© Samson 1992

USE READER SERVICE CARD FOR MORE INFO

world radio history

THE 1992 TEC AWARDS



WINNERS

Beginning with the mayor's office declaring Friday, October 2, 1992, as TEC Awards Day in San Francisco, the 1992 Technical Excellence & Creativity Awards was the scene of many heartfelt acceptance speeches and surprise winners. The event was emceed by the fabulous Bud E. Luv, and the presenters, including Fred Catero, Anne Robinson, Hal Blaine, Steve Douglas, Tom Scott, Robin Winter, Chad Smith, Jim Keltner, Roger Nichols, Chris Stone, Jeff Baxter, Tom Lord-Alge, Bruce Swedien, Bob Ludwig, Mark Mothersbaugh and David Schwartz, handed out 23 TEC Awards, the Hall of Fame Awards and the Les Paul Award before more than 700 audio industry professionals. For a complete wrap-up of the evening's events, see the December issue of *Mix*.

HALL OF FAME

Bob Moog
Phil Ramone
Bill Porter

LES PAUL AWARD

Bob Clearmountain

O U T S T A N D I N G

TECHNICAL ACHIEVEMENT

- Recording Devices**
Alesis ADAT Digital Multitrack
- Transducer Technology/
Microphones**
Electro-Voice N/DYM Series III
- Transducer Technology/
Loudspeakers**
JBL 4200 Series Studio Monitors
- Computer Software/Peripherals**
Mark of the Unicorn Digital Performer Sequencer
- Signal Processing Technology**
Digitech VHM5 Vocalist
- Ancillary Equipment Technology**
Apogee AD-500 Analog-to-Digital Converter
- Console Technology**
Solid State Logic SL 8000
- Musical Instrument
Technology**
Alesis D-4 Drum Module
- Sound Reinforcement
Product of the Year**
Future Sonics Ear Monitors
- Recording Product
of the Year**
Alesis ADAT Digital Multitrack

CREATIVE ACHIEVEMENT

- Audio Post-Production
Engineer**
Gary Rydstrom
- Remote/Broadcast Recording
Engineer**
David Hewitt
- Sound Reinforcement Engineer**
Robert Scovill
- Mastering Engineer**
Bernie Grundman
- Record Producer**
Don Was
- Recording Engineer**
George Massenburg

INSTITUTIONAL ACHIEVEMENT

- Acoustics/Facility Design Company**
Russ Berger Design Group, Inc., Dallas, TX
- Sound Reinforcement Company**
Showco Inc., Dallas, TX
- Recording School/Program**
Berklee College of Music, Boston, MA
- Mastering Facility**
Bernie Grundman Mastering, Hollywood, CA
- Audio Post-Production Facility**
Skywalker Sound North, San Rafael, CA
- Remote Recording Facility**
Westwood One Mobile Recording Division, Culver City, CA
- Recording Studio**
Ocean Way Recording, Hollywood, CA

Left to right:
Roger Nichols,
Bob Ludwig,
Bob Clearmountain,
and Phil Ramone.



Alex Berliner

NEW PRODUCTS

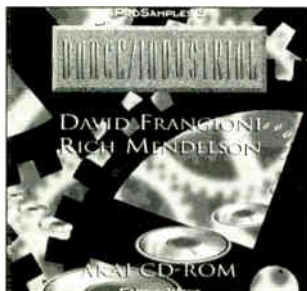

PROSAMPLES 5

Designed for the dance producer/musician/programmer is ProSamples 5 from East-West Communications (Del Mar, CA). A CD-ROM in the Akai S1100 format, ProSamples 5 has 139 original (no copyright problems) loops by David Frangioni and Rich Mendelson. Optional MIDI file sequence disks in Macintosh and Atari ST formats allow producers to replace individual sounds or create custom loops that can be edited using the flexibility of an outboard sequencer.

Circle #228 on Reader Service Card

ROLAND SP-700

The SP-700 16-bit sample playback module from Roland (Los Angeles) brings the pro quality of Roland's S-770/750 samplers at an affordable \$2,895 price. The unit features 8 MB of RAM waveform memory (expandable to 32 MB via standard SIMMs), along with digital EQ and panning, Time Variant Filters, eight audio outputs, large LCD and a load-while-play function.

Circle #226 on Reader Service Card

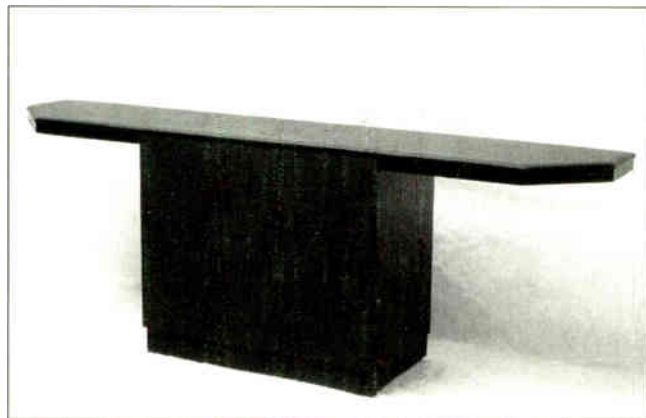

CLEARVIEW MONITOR LIFT

Vision Audio (Hunt Valley, MD) offers the Clearview Monitor Lift, a system that, with a touch of a button, automatically raises or lowers near-field reference speakers or video monitors, providing an unobstructed path between the main monitors and the engineer—and a clear sight line into the studio. The system also accommodates monitors up to 200 pounds, which may be too large for a fragile meter bridge.

Circle #231 on Reader Service Card

ZOOM 9200 ADVANCED REVERBERATION PROCESSOR

From Zoom (South San Francisco) comes the 9200 Advanced Reverberation Processor, configurable as one, two, three or four independent processors (in serial or parallel modes) with 16-bit, 20kHz bandwidth performance. The single-space processor also features RAM/ROM card storage, +4dBm balanced XLR inputs/outputs and full MIDI implementation. List is \$2,995.

Circle #230 on Reader Service Card



TROISI DIGITAL COMPANION SERIES

Available through Northeastern Digital Recording (Southborough, MA) is the Troisi Digital Companion Series with a portable D/A Converter, portable A/D Converter and rack-mount Digital Preamplifier. The 16-bit units are designed to be retrofittable to improved 18-bit and 20-bit converter chips as the technology becomes available.

Circle #227 on Reader Service Card

OTARI DTR-90N DAT

Now shipping from Otari (Foster City, CA) is the DTR-90N studio DAT recorder (\$8,495), a 4-head design with a removable front panel that doubles as a full-function remote. Options include the CB149 assembly editor for controlling two decks, a quick-start, instantaneous-play card, and a time code reader/generator/synchronizer/video sync card.

Circle #229 on Reader Service Card





NAGRA T-AUDIO RETURNS

Phi Technologies (Oklahoma City, OK) has reintroduced the Nagra T-Audio time code 2-track at nearly half its original price. The center-track analog recorder can sync to any reference (SMPTE/EBU time code, house sync, pilot tone, bi-phase, etc.), with bidirectional chase in real time or FF/rewind. Video edit and telecine protocols are also supported. In related news, the Nagra-D 4-channel, 24-bit digital audio portable sync recorder is now shipping.

Circle #235 on Reader Service Card



MICROTECH GEFELL TUBE MIC

Available through Gotham Audio of New York City is the UM 92S, a microphone combining the same classic M7 capsule used in the company's popular UM 70S but incorporating three-pattern switching and triode-based tube electronics.

Circle #237 on Reader Service Card

APHEX AURAL EXCITER C2

Aphex Systems, of Sun Valley, CA, debuts the Type-C², a unit combining both Aural Exciter™ and Big Bottom processing. The latter is said to improve bass in the same way that an Aural Exciter enhances the high end.

The 2-channel, single-rackspace C² uses a psychoacoustic process to increase the perception of bass without vastly increasing amplitude or generating subharmonics that can burn out speakers or oversaturate tape. The C² retails at \$349.

Circle #232 on Reader Service Card



SPATIAL SOUND SSP-200

The SSP-200 from Spatial Sound (Fairfax, CA) is an automatable, multichannel sound panner for professional surround sound applications. Two joystick controllers allow the engineer to position sounds from any of the unit's balanced +4dBu inputs and eight outputs. Manipulations can be stored in onboard sequences or controlled externally via MIDI or FSK; the SSP-200 is compatible with all 4-, 5- and 6-channel surround formats. Applications include film/video surround mixing and theater/special venue shows.

Circle #233 on Reader Service Card

CARVER CD RECORDER

The PDR-10 from Carver (Lynnwood, WA) is a stand-alone professional CD recorder with a preliminary net user price of \$8,500. Features include AES/EBU and S/PDIF digital I/O, and RCA and balanced XLR analog inputs/outputs with isolation transformers on the balanced outs. The unit creates a temporary table of contents during recording, allowing start/stop operation and the ability to mark false starts or unwanted tracks for deletion. Both serial (RS-422) and parallel control ports are provided.

Circle #234 on Reader Service Card



HUGHES RETRIEVER

Hughes Audio (Rancho Margarita, CA) has introduced Retriever, a lower-priced version of its popular AK-100 3-D sound processor. The new unit retails at \$179 and lacks the AK-100's three-way LED display, but uses the same patented SRS (Sound Retrieval System) circuitry to process sound signals, making them appear to emanate from outside the locations of the playback speakers.

Circle #236 on Reader Service Card

TANNOY SYSTEM 6 NFM

TGI North America (Kitchener, ON, Canada) announces the Tannoy System 6 NFM (\$795/pair), a compact (16x9x9.5-inch) studio monitor design using a 6.5-inch, dual-concentric driver. The System 6 NFM features a new HF waveguide and molded cone surround, providing true point-source, phase-coherent performance with constant directivity and symmetrical off-axis dispersion.

Circle #238 on Reader Service Card

A-DAM PRICE CUT

Akai Professional (Ft. Worth, TX) has announced a major price reduction (now \$14,995) in its Akai Digital Audio Multitrack, a 12-track modular recording system that can be expanded to 24 or 36 tracks. The rack-mounted, 8mm video-tape-based system features +4dB analog inputs/outputs and a 37-pin digital port that connects to optional AES/EBU, Sony, Mitsubishi and Yamaha digital format converters.

Circle #239 on Reader Service Card

CAIG DEOXIT

DeoxIT, from Caig Laboratories (Rancho Bernardo, CA), is a fast-acting solution that cleans, preserves, lubricates and improves conductivity on contact and interconnect surfaces such as plugs, jacks, switches, relays, PCB edge connectors, batteries and pots. Available in spray, liquid wipes and pen applicators, the new formula also prevents dissolved oxides and contaminants from reattaching to metal surfaces.

Circle #240 on Reader Service Card

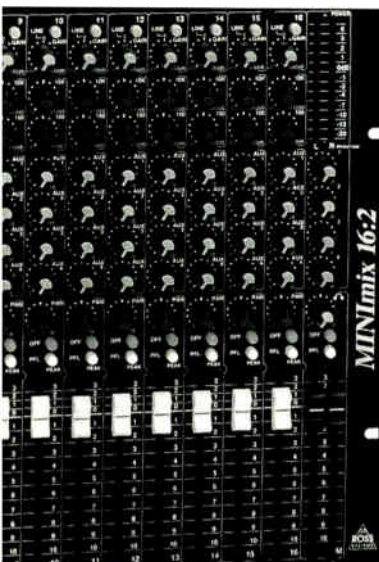

ROSS MINIMIX

Minimix from Ross Systems (distributed by International Music Co., Ft. Worth, TX) is a rack-mountable mixer with 16 mic/line inputs, 2-band EQ, four aux sends, balanced XLR mic preamps with 48VDC phantom power, LED metering and 100mm long-throw faders. Retail is \$995.

Circle #241 on Reader Service Card

HOT OFF THE SHELF

The Producers Toolkit, Vol. 1, is a CD collection of 200 (home, work, outdoor and environmental) sound effects, along with 150 special effects (lasers, swooshes, stingers and rhythmic connectors). Call GMI at (206) 656-8414...**The Millennia HV-2** (\$795) is a high-quality, rack-mount (130VDC) power supply and line driver for B&K 4000 Series mics. Call (916) 363-1096...**The AirCRAFT Music Library** has released its 50th CD of production music. Call (800) 343-2514...New from SAMS publishing, **Project Studio Blueprint** (\$24.95) is a text focusing on creating the personal studio. At technical bookstores or call Mix Bookshelf: (800) 233-9604; (510) 653-3307...**How To Be Successful in the Mobile DJ Business** is a video/ book course with tech and business tips for the aspiring DJ. Call (800) STAR-DJS for info...**Manhattan Production Music** added two new vol-

umes ("Nostalgic Rock" and "Country, Bluegrass & Blues") to its CD library. Call (800) 227-1954 or (212) 333-5766...**Summertone's Timecode Monitor** for detecting and logging time code errors is now available in a rack-mount version with built-in printer. Call A. Z. Associates at (800) 441-3179 or (617) 444-0191...**Otari ProDisk PD-464's** new 4.0 software simplifies operation and offers a choice of working in a standard EDL format or from a high-resolution, color, graphic-editing display. Call (415) 341-5900.

FREE STUFF:

The 1992 Amplifier Products Cross Reference Guide from Analog Devices, manufacturer of high-performance linear and mixed-signal ICs, is a must for the designer or manufacturer. Call (617) 329-4700 for a copy...**The MCM Catalog** has 17,000 electronic components—semiconductors, TV and VCR parts, speak-

ers, tools, chemicals and more. Call (800) 543-4330 for a free copy...**The Lemo Shortform Connector Catalog** lists dozens of self-latching, circular connectors for manufacturers and other connector specifiers. Call (800) 444-5366...**The SoundStation Product Guide**, a booklet on DAR's 4- to 16-track workstations, is available from your local dealer or from Digital Audio Research, Chessington, UK; FAX: (011) 44 372-743532...**Computer-Aided Classification of Sound Effects Taking into Account the Psychoacoustic Characteristics of Human Hearing** is a 51-page report that summarizes the required calculations used to generate quantitative data about psychoacoustic parameters of sounds. For a free copy of the report (written by HEAD Acoustics, a manufacturer of binaural recording gear), send a request on letterhead to Sonic Perceptions, 28 Knight Street, Norwalk, CT 06851. ★

A fast, reliable DAW with extraordinary sound for post and music.

For around \$7000, Roland's DM-80 digital audio workstation combines round-the-clock reliability,

WITH EVERY NEW TECHNOLOGY, THERE COMES A DAY WHEN PRICES DROP AND PERFORMANCE JUMPS. TODAY IS THAT DAY.

editing speed, and superb sound. Features like 100 layers per track, SMPTE capture, easy back timing, full automation, MIDI tempo mapping and MIDI sync,

plus copying, pasting and looping make the DM-80

indispensable for music production, and sound for video or film.

Skeptical? Listen to this. One customer who had budgeted for a conventional DAW took this opportunity to buy *three* DM-80s. Now he can accomplish at three stations *simultaneously* what he was planning to do at one!

The DM-80 is easily upgraded from



Roland's custom VLSI chips give the DM-80 amazing power at a price that will astound you!

4 to 32 tracks, and you can add SCSI-compatible drives as you need more recording time—up to 12 hours per 4 tracks. And because it all comes from Roland, you'll get great service, too!

Call (213) 685-5141, ext. 337 for a brochure, or to schedule a demo.

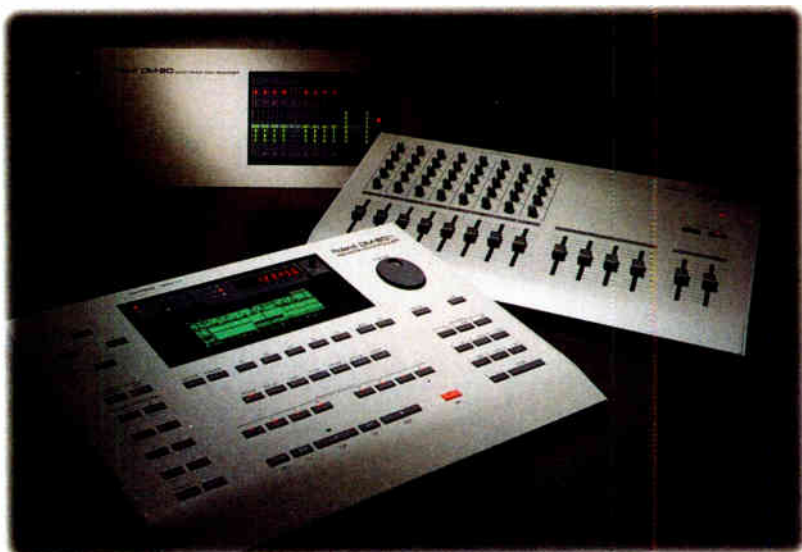

Roland

Pro Audio Video

Roland Corporation US, 7200 Dominion Circle, Los Angeles, CA 90040-3696

©Roland Corporation US 1992

USE READER SERVICE CARD FOR MORE INFO

World Radio History

NO AUDIO TAPE HAS EVER RATED SUCH INCREDIBLE RESPONSE.

"I love the extra headroom it gives you. Different types of music call for you to hit the tape differently. I've hit it light and I've hit it hard, and the 3M 996 will definitely take the level." —Ed Cherney, independent producer

"You can hit it 3 dB hotter without any distortion or bottom-end modulation. It's a mirror image of the source material." —Tom Tucker, Paisley Park Studios

"A lot of engineers and producers want to really be able to slam levels to achieve a certain sound. 3M 996 gives them more options and opens more doors, sonically speaking." —Barry Bongiovi, Power Station

Clear. Dynamic. Musical. Exciting. That's the response recording engineers are giving 3M 996 Audio Mastering Tape. Because 3M 996 audio tape is giving them the performance they've always wanted: The ability to record as hot as you want (level +9) with virtually no distortion. A signal-to-noise ratio of 79.5 dB. Print-through level of -56.5 dB. And maximum output level of +14 dB (at 1 kHz.). So 3M 996 audio tape returns every note, every nuance, every thrill exactly as you put it down. Call 1-800-245-8332 for full information. **We won't be satisfied until you are.**

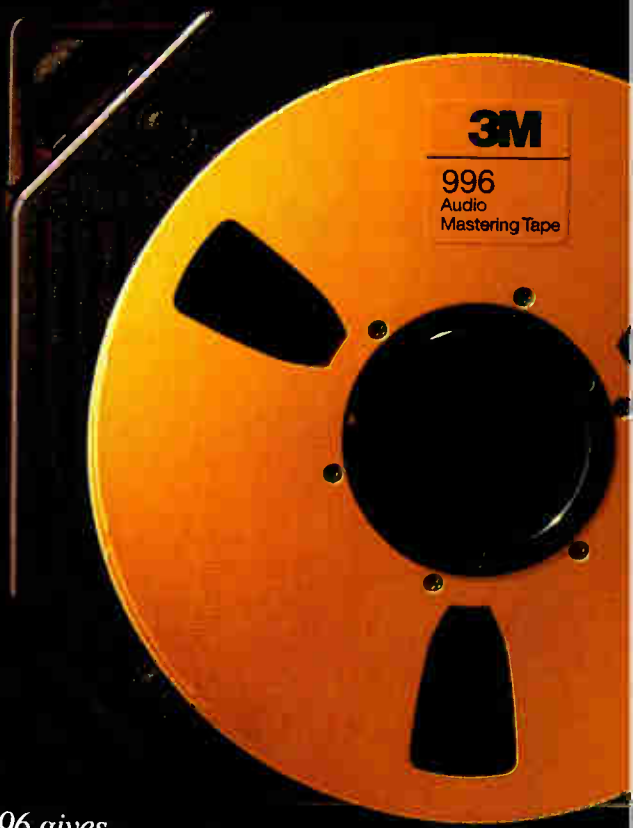

by George Petersen

PRODUCT

CRITIQUES AND COMMENTS

D

DOLBY SPECTRAL PROCESSOR

The Dolby name is hardly a stranger to millions of audio consumers and theater-goers worldwide, not to mention the company's presence with a least a zillion tracks of Dolby A-type and SR-equipped recorders in pro studios everywhere. But when you think of companies that manufacture signal processing gear for studio outboard racks, Dolby is not one of those names that instantly comes to mind. That could change with the Dolby Spectral Processor, which was unveiled at last month's AES show in San Francisco.

with a sidechain that boosts (compresses) all low-level information without attenuating high-level signals. This occurs via a sophisticated system of eight processors (both sliding- and fixed-band) that partition the signal in terms of frequency and level. This boosted audio is routed to a 3-band EQ section that is summed with the original signal. As noise may also be boosted along with the processed audio, the unit has single-ended noise reduction sections on each channel, which are sliding band filters (similar to Dolby B-type processing) that reduce noise



List priced at \$1,760 and housed in a single-rack chassis, the Spectral Processor is a stereo/dual mono dynamic equalizer offering the ability to raise the level of low-level signals in three frequency bands without affecting high-level signals. Unlike conventional equalizers—which alter the selected parts of the audio spectrum without regard to level—the Spectral Processor fully boosts those portions of an audio signal that fall below a user-defined threshold. Above the threshold, the amount of boost is gradually reduced, until at high levels, the unit is at unity gain.

The Spectral Processor operates

by up to -12 dB.

Inputs and outputs are floating, electronically balanced XLR-types with switching for +4dB or -6dB input signals. Each channel on the front panel has a threshold control (with LED level display), the equalization controls with in/out bypass switches, single-knob NR control and output level adjust. When activated, the stereo link switch permits either threshold control—whichever is set higher—to control the dynamics action (but not EQ) of both channels.

One of the Spectral Processor's unique features is the design of the

Leading Edge Today... Leading Edge Tomorrow!



Frequency Response: 10-22KHz, +0,-0.5 dB, Fs=48KHz; THD: < 0.06% 1kHz, 0 dBm; Dynamic Range: >95 dB; Digital Conversion: Linear 18bit 64x in, 20bit 8x out, Max. Level: +22 dBm

Imagine a new signal processor with state-of-the-art presets and unequalled performance. The M5000 is the machine of the future and designed to stay that way. Other units may be obsolete before you make the last lease payment, but the M5000 Digital Audio Mainframe is here to break that cycle! It's the first user upgradeable digital effects processor, a 24 bit system for today and tomorrow.



The 60 Sec. Upgrade - All system files and standard factory presets are written directly to Flash ROM via the 3.5 inch disk drive, eliminating costly and time consuming EPROM changes. And because the disk drive is DOS compatible you can back up vital data on your PC as well as receive updates by mail or modem and burn them directly into the unit's non-volatile memory without removing the M5000 from your rack! Use the floppy drive or JEIDA/PCMCIA memory card slot to save your sounds and you can have thousands of presets archived and available for use without an external computer.

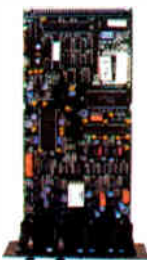

Protecting Your Investment - The 18 bit resolution 64x oversampled A to D and 20 bit resolution 8x oversampled D to A module provides superior phase and group delay linearity. (Translation = It sounds great!) Should you want to upgrade in the future, we have modularized our AD-DA and DSP sections so you can keep up with advancing technology without having to purchase a whole new piece of equipment. Using analog I/O you can expand your system to two stereo processors for half the cost of an additional unit!



Sounds that Astound - And more to come! High dynamic range and wide-band frequency response are hallmarks of all t.c. products and the M5000 is no exception. One listen to the true stereo algorithms will tell you this is no ordinary reverb. Imaging is wide and all rooms decay smoothly into total silence. The Pitch Shifter is equally impressive and is optimized for noise-free, lightning-fast transpositions. Chorus programs are rich and delay programs are clean and precise. MIDI control of various program parameters and SMPTE time code patch change is standard. World class DSP developers are continuously working on additional algorithms to be available on disk or memory card.



The Heart of "Darcness" - The DSP module uses t.c.'s exclusive Digital Audio Reverb Co-processor technology. DARC boosts the M5000's digital processor well beyond the normal level of performance. How far? For critical early reflections DARC can deliver an astounding 600 early reflections per second, almost 3 times that of competitive units. Each DSP module has its own AES/EBU, SPDIF and Optical ins and outs. All digital studio? Expand your system to a maximum of four stereo processors using Digital I/O.

OF DENMARK

t.c. electronic®

Technology for today and tomorrow.

International Head Office DENMARK: Phone:(+45) 86 26 28 00 Fax:(+45) 86 26 29 28

AUSTRALIA: (03) 428 9797 AUSTRIA: (222) 601 17 BELGIUM: (0) 11 28 1458 CANADA: (514) 738 3000 CHILE: (2) 231 2356
ENGLAND: 0691 658 550 FINLAND: (9) 0-592 055 FRANCE: (1) 48 47 45 26 GERMANY: 052 313 2972 GREECE: (0) 1 883 6377
HOLLAND: (0)30 414500 HONG KONG: 3 620202 5 ISRAEL: (0) 3 544 1113 ITALY: (02) 50 841 - JAPAN: (0) 3 332 3211
KOREA: (02) 741-0831 NORWAY: (2) 710710 PORTUGAL: (1) 4754348 SINGAPORE: 748 9333 - SPAIN: (93) 796 31 00
SWEDEN: (+45) 86 26 28 00 SWITZERLAND: 93 87 26 56 TAIWAN: 2 716 8896 U.S.A.: (805) 373-1828 Fax: (805) 379-2648

USE READER SERVICE CARD FOR MORE INFO

World Radio History

equalization controls, which combines three 0-20dB boost controls (LF/MF/HF) with two pots that adjust the crossover points between the three bands. While this is obviously different from any other EQ on the market, the Spectral Processor concept becomes simple if you think of it as working in the same manner as a crossover in a three-way loudspeaker system. With that in mind, operation is far more intuitive.

The sidechain switch is a useful addition that routes the result of the sidechain processing to the output, so the engineer can hear only the portion that's being added to the original signal. This simplifies the whole process of tweaking sounds. Also, when set in this sidechain mode, the unit's outputs can be returned as console inputs to provide additional flexibility when mixing live or multitrack sessions. Of course, the Spectral Processor can also be used as an in-line device to treat program material.

Switchable lowpass and highpass

filters (to prevent unwanted signals from reaching the low-level processing stage) are also provided, although the physical placement of the filters on the front panel (near the output knob) might give the user the impression that the filtering occurs at the end—rather than toward the beginning—of the chain. But aside from the location of the HPF/LPF switches, the unit's layout is straightforward.

Over a period of weeks, I used the Spectral Processor on a variety of sessions ranging from album sessions to broadcast production mixing. The equalization is smooth, and with +20 dB available in each band, it's easy to overdo the effect. As it turns out, I rarely needed to turn the controls up past the +10dB mark, although having the extra flexibility is nice when you need it.

Combined with some judicious setting of the threshold knob, the Spectral Processing effect can range from sledgehammer to extremely subtle. For example, vocals can be brightened without overemphasizing sibilants, or a take where a vocalist turns slightly away from the mic can

be fixed without having to overly compress the entire performance.

Making A/B comparisons between processing in/out settings requires two hands; a single sidechain in/out switch that would change both channels simultaneously would be preferable. Also, the EQ in/out switch is fairly close to the noise reduction control, and, on more than one occasion, I accidentally changed switch settings while turning the EQ knob.

The single-ended noise reduction works extremely well, effectively knocking out hiss and noise that can result from boosting noise in otherwise quiet passages. Dolby should consider making a unit with two or four channels of this noise reduction circuitry in a rack package.

More often than not, I found myself using the Spectral Processor in a stereo configuration, where I had to set up both channels identically. A stereo-only version of the Spectral Processor (with one set of knobs controlling both channels) would be useful, as the Spectral Processor is ideally suited for enhancing and improving the clarity of stereo program

AUTOMATION FOR THE MASSES

The best in MIDI Automation, the Niche Audio Control Module (ACM) is a versatile device designed to maintain the absolute clarity of your audio signal, using an innovative non-VCA technology to eliminate coloration. The ACM can be controlled by any sequencer giving you the power of Total Recall of all your dynamic and snapshot levels and mutes. Eight individual inputs/outputs and stereo mix out for **\$479** retail. Check it out at your local dealer and start mixing with eight arms.

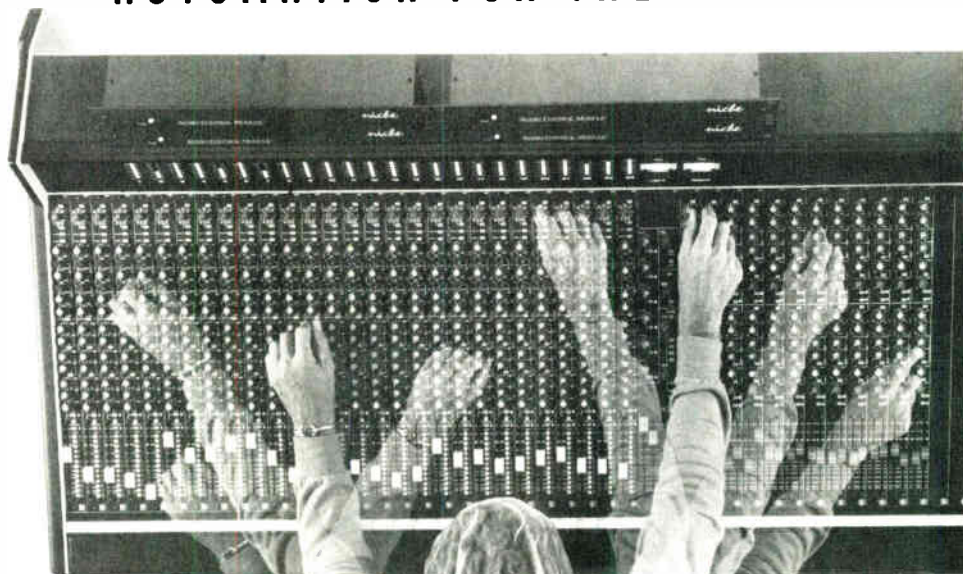

niche / **THE
RUSS JONES
MARKETING
GROUP**

17700 Raymer St., #1001
Northridge, CA 91325
818-993-4091
FAX: 818-701-7452

TEC
1991
NOMINEE

USE READER SERVICE CARD FOR MORE INFO

THE CONSOLE COMPANY

EAR- Experience The Industry's WIDEST SELECTION

Why waste time and money
convassing the country when one
call to EAR will do it all? Whether
you need consoles, multitracks,
digital processors, workstations,
or complete systems, you can
count on EAR for:

- Most Extensive
Selection in the U.S.
- Leasing, Buy/Sell/Trade
- New and Used,
Buy/Sell/Trade



*Call On The Voice
OF Experience!*

EAR PROFESSIONAL AUDIO/VIDEO 2641 E. McDowell Phoenix, AZ 85008 602.267.0600

USE READER SERVICE CARD FOR MORE INFO

Memorize This Number!

1-800-966-9686

This free call is your musical connection!

- Knowledgeable Sales Staff
- Courteous Service
- Fast Delivery
- Major Brands
- Leasing and Financing available
- Specializing in Keyboards, Multitrack,
Software, and Signal Processing
- Fax us your wish list

Get ready for the 21st Century!

Call Century Music Systems Now!



**CENTURY
MUSIC
SYSTEMS**

AUDITIONS

material in mastering, tape duplication, film/video post and broadcast production applications.

Combining superb audio quality and flexibility into a studio tool that takes a new and different approach in an area crowded with a lot of me-too products, the Spectral Processor makes a most impressive debut. It will be interesting to see what other products may follow from Dolby in the years to come.

Dolby Laboratories, 100 Potrero Ave., San Francisco, CA 94103; (415) 558-0200.

THE HOLLYWOOD EDGE "CARTOON TRAX"

Over the years, CD sound effects libraries have gotten more and more specialized, and *Cartoon Trax*, the latest release from The Hollywood Edge, is no exception to this trend. A five-CD set with 99 tracks on each disc, *Cartoon Trax* is packed with—you guessed it—an incredibly wide variety of splits, spots, boings and booms, taken from the vaults of classic *cartoonmeisters* that you probably admired as a kid. But this diverse smorgasbord doesn't stop there, as the library includes a dose of newer, synth-based sounds to round out the collection.

However, the fun in *Cartoon Trax* is not limited to a mere 495 cuts, as a majority of the tracks contain multiple versions of each entry. This brings the number of effects in the set well into the thousands, especially with tracks such as "Raspberry Buzz" (12 versions), "Short Metallic Debris Falls" (offering ten versions, this track is one of 41 in the "Impacts" category) and a personal favorite of mine, "Various Gloppy Mud Pots," with 21 versions offered on a single track.

Besides the usual (unusual?) collection of squeaks, drips, drops, bangs and pops/stretches, the library includes a large assortment of human, animal and mechanical sounds. Over 60 tracks with musical snips are also provided, ideal for creating all sorts of tags, stingers and music beds.

Anyone who's ever used sound effects will testify that the usual stuff can get old pretty quick, and *Cartoon Trax* provides a perfect addition to spice up any standard SFX li-

IF YOU THINK POWER AMPLIFIERS GET OLD, YOU DON'T OWN A BRYSTON.



How long do you expect a professional power amplifier to last? Three years? Six? Brystons are expected to perform flawlessly for at least 20 years—the term of our warranty on all professional products. Within that period, if your Bryston develops any problem not caused by improper operation, we will provide the solution.



20 years

of unlimited

service. The only people

who aren't amazed at this kind of support are

Bryston owners. They know how rarely it's needed. In fact, many of them have gone fifteen years without a single problem.



Perhaps that's because Bryston engineers don't think age is a reason for an amplifier to malfunction.

That means paying strict attention to every component, then spending an entire day building each Bryston power amplifier, crossover or preamplifier. After assembly, every Bryston product must endure a 100 hour burn-in period before it's complete.

before it's complete.



Is all this attention excessive?

Hardly, considering the length of time your Bryston will last. Besides, we don't

think an amplifier's performance and reliability should be compromised because its manufacturer was willing to make compromises. Even if they were made 20 years ago.



BRYSTON

Bryston Marketing Ltd.
Tel: (416) 746-0300 Fax: (416) 746-0308
U.S. Distribution: Brystonvermont Ltd.
Tel: (800) 673-7899 Fax: (215) 628-2970

brary. Yet the collection is designed for more than mere "cartoon" applications, as the exaggerated effects

presented here are often exactly what's needed when you want a sound effect to be noticed, especially in a short commercial spot where you don't have hours to get a point

across. As an added plus, the effects on *Cartoon Trax* offer excellent starting points for the sound designer—a bit of looping, pitch shifting or other manipulations can go a long way toward creating some interesting new sounds. But either way, this one will definitely put some "springggg" into your productions. *Cartoon Trax* is \$495 (or through Christmas 1992 at a special introductory direct price of \$395), and a CD demo is available

free to interested professionals.

The Hollywood Edge, 7060 Hollywood Blvd., Hollywood, CA 90028; (800) 292-3755 or (213) 466-6723.

MACWORLD MUSIC & SOUND BIBLE by Paul Potyen

Weighing in at more than four pounds and comprising almost 1,400 pages of text, diagrams and charts, the *Macworld Music & Sound Bible* is the most ambitious and up-to-date reference available for anyone interested in audio and music on the Mac. Written by Christopher Yavelow and published by IDG Books Inc., the book is divided into nine parts: Basics; Sound; Composition; Notation; Performance; Post-production; Film, Video, and Synchronization; Multimedia; and Education.

This is not a book that you'll necessarily curl up with next to the fireplace; it's designed to be read in chunks. An abbreviated table of contents, a complete table of contents and a comprehensive index make it easy to navigate its pages. In addition, each chapter begins with a short set of phrases that describe what you will find, ending with a

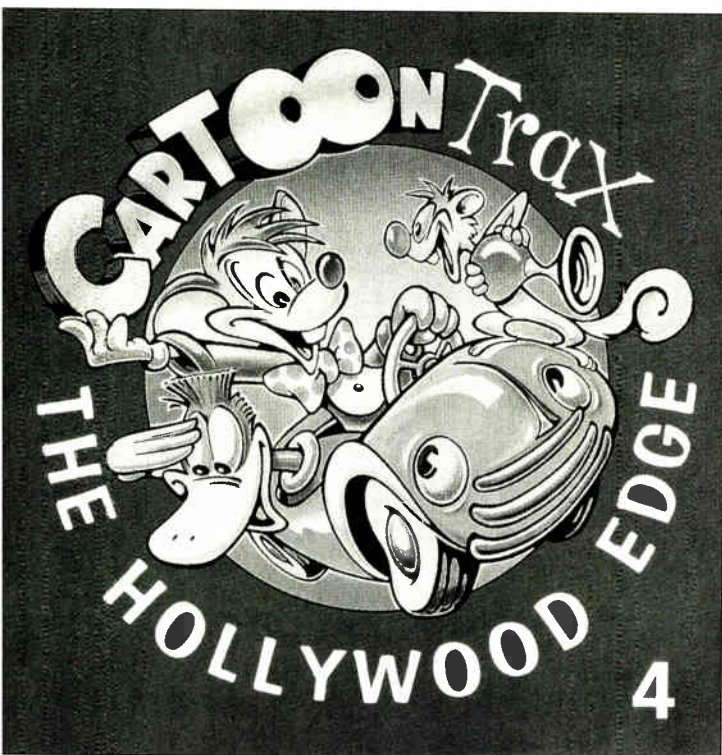

Neutrik SpeakOn™ Connectors... safe for sound

A speaker/amplifier interconnect that is virtually indestructible and ensures safe conditions for audio equipment and operators.

Now with U.L. and
C.S.A. recognition.

Another
Neutrik
innovation

Neutrik USA, Inc. • 195-53 Lehigh Ave. • Lakewood, NJ 08701-4527
TEL: 908-901-9488 • FAX 908-901-9608

NEUTRIK
USA, INC.
CONNECTORS
AUDIO TEST SYSTEMS
INFOMATIC SYSTEMS



USE READER SERVICE CARD FOR MORE INFO

Until every facility and touring system gets one, you'll want to keep your SuperGate™ nearby. That's

“NOBODY TAKES MY SUPERGATE.”

because dbx's real engineering advances mean your 172 will pull sparkling, clean output from material other gates can't touch. You won't want to let go of your SuperGate because it sounds better, sets up faster and does more for you than those other gates can.

You'll be more selective with Voltage Controlled Filters.

The SuperGate uses sophisticated VCF's to produce steep slopes that are TWICE as selective—dramatically reducing false triggering. They're also faster to set up because the PARAMETRIC design lets you zoom in on exactly the instrument or part of the attack you want to catch.

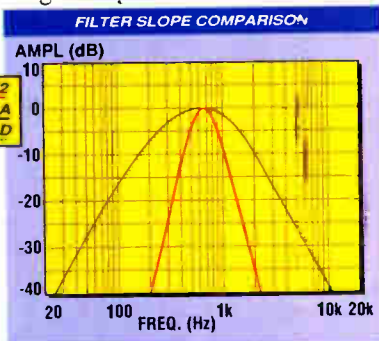

You'll stop time with Transient Capture Mode.

You can see and hear the difference TCM™ makes compared to other gates. With real-world filter and threshold settings, it attacks so quickly you'll actually catch those critical transient wavefronts that give percussive signals their life and definition.

You'll control time with One-Shot™ mode.

In One-Shot mode, the 172 gives muscle tone to that drummer

with the not-so-steady hand or foot, so you get solid, even output from erratic input. There's more—we'll fax you the whole story. But with all of the people who want to get their hands on a SuperGate, it may be awhile before you can test one for yourself. When you do get yours, you may find yourself going to extremes to hang onto it.

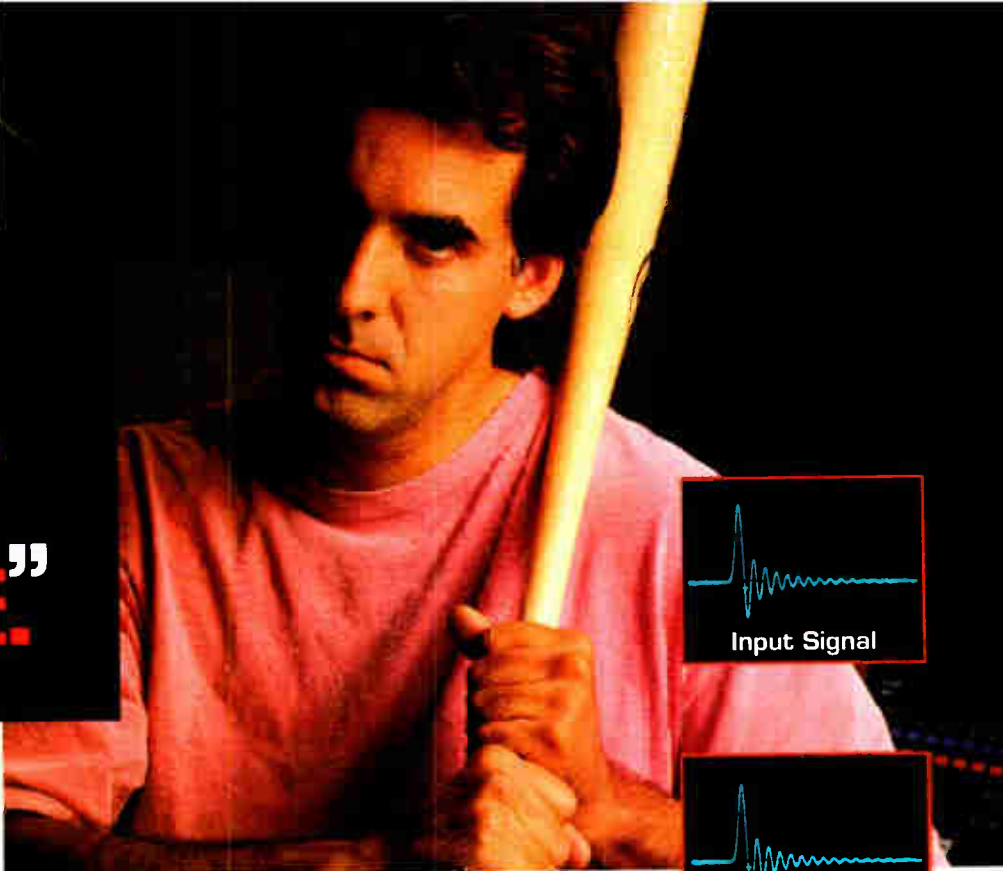
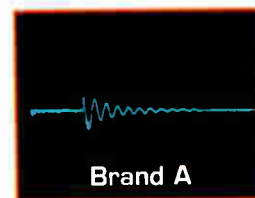
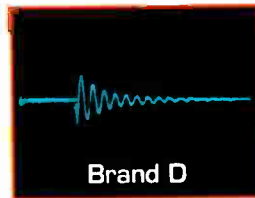
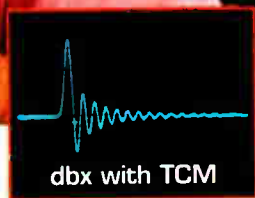
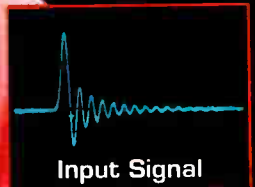

172 SUPERGATE

FOR AN INSTANT 172 DATASHEET AND WHITE PAPER, CALL THE dbx FAX HOTLINE AT 415-694-3991

A DIVISION OF AKG ACOUSTICS, INC. • 1525 ALVARADO STREET • SAN LEANDRO, CA 94577 • TEL: 510.351.3500 • FAX: 510.351.0500

SuperGate, Transient Capture Mode (TCM) and One Shot are trademarks of Akg Acoustics, Inc. dbx is a registered trademark of Cullison Electronics Corporation © 1992 Akg Acoustics, Inc.



USE READER SERVICE CARD FOR MORE INFO

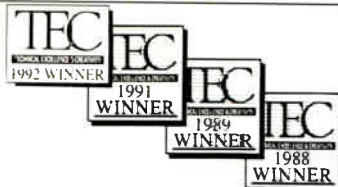

**RUSS
BERGER
DESIGN
GROUP
INC**

4004
BELTLINE
SUITE 110
DALLAS
TEXAS
75244
214/661-5222
FAX
214/934-3935

INDEPENDENT CONSULTANTS SPECIALIZING IN:

- RECORDING AND BROADCAST FACILITY DESIGN AND PLANNING
- ARCHITECTURAL ACOUSTICS
- NOISE AND VIBRATION CONTROL
- TECHNICAL SYSTEMS DESIGN

USE READER SERVICE CARD FOR MORE INFO

AUDITIONS

summary. The language is clear and accurate. In addition, graphic elements are placed in the margins to help you find "tips," "special features," "alerts" and "technical info."

For example, the section on post-production is divided into two chapters: "Direct-to-Hard Disk Recording" and "MIDI Mixing and Studio Automation." It includes a foreword by Evan Brooks, vice president of engineering at Digidesign, and the 80 pages that follow include coverage of basic concepts of random access audio, analog and digital I/O, and

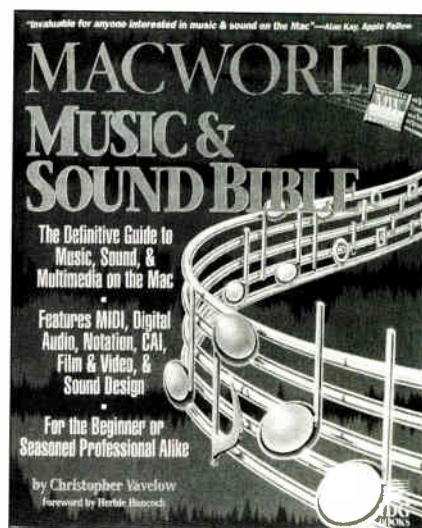

synchronization; a description of all the latest available systems with a chart comparing the features of each; an overview of MIDI-based mixing; and a rundown of hardware and software tools for mixing from JL Cooper, Lexicon, Niche, Mark of the Unicorn, Opcode, Yamaha and others.

Priced at \$37.95, *Macworld Music & Sound Bible* is remarkable in its coverage of the many disparate areas of music and sound production for the Macintosh. It would make an excellent reference for anyone involved in pro audio production, as well as a good text for a college course on the subject of audio and computers. My only caveat is that this area of audio is advancing so rapidly that much of what is contained within its covers could well be out of date in six months. But that's why they have second editions. It's available at technical bookstores or through the Mix Bookshelf, (510) 653-3307 or (800) 233-9604. ■

The Ultimate Demo Tape.



Now, the ultimate demo tape is a CD. An optical format that's digital in quality and virtually indestructible. In this competitive industry it pays to be absolutely sure the music you promote will not only sound great but will guarantee an audience. For more information, call Frank Kramer at 1-800-TDK-TAPE (Ext: 200).

TDK
As Serious As You Can Get.

POWER USERS PREFER SONIC



Whether they work in a small studio, a major record company, or a large post-production house, our customers have lots of reasons to make Sonic the digital audio workstation of choice.

It's powerful – Our systems feature background loading to the hard disks, real-time playback of edits and mixes, 24-bit editing, and simultaneous playback of 8 to 12 channels from a single hard disk. You can undo, redo, and change edits in an instant and satisfy even the most fickle producer.

It's expandable – As you grow, your system can grow with additional hardware/software modules for CD PreMastering, Multitrack Editing and Recording, Sound for Picture, CD Printer, NoNOISE, SonicNet, and more.

It's affordable – You can think big, but start small. The SonicStation, our basic platform, is highly affordable (\$4,995 plus Mac and hard disks) yet it's packed with power.

It's the latest – Sonic Solutions has always been on the cutting edge of digital audio development. We were the first to offer double-speed CD recording and the PreMaster CD for direct glass mastering, now supported by CD plants and mastering studios. And we are the first to offer a true digital audio network. With our new SonicNet, a high-speed FDDI network, Sonic systems can work together and share files and processing resources transparently! SonicNet delivers a big boost in productivity to any multi-system studio.

No other system matches our performance and productivity—that's why power users prefer Sonic! Call us for more information.

Telephone 415 485-4800 Fax 415 485-4877
1891 East Francisco Blvd. San Rafael, California 94901



SONIC SOLUTIONS

USE READER SERVICE CARD FOR MORE INFO

World Radio History



CONCEPTUAL IMAGING

S P A T I A L I Z E R[®]

360° Real-Time Virtual Imaging System

Contact Audio Intervisual Design

213 845 1155

Spatializer is a registered trademark of Desper Products Inc.

Patents pending

© DPI 1992



USE READER SERVICE CARD FOR MORE INFO

World Radio History

by Bob Hodas and Paul Stubblebine

ANALOG TO DIGITAL CONVERTERS

PART III

Once again we find ourselves at Rocket Labs Mastering Studio in San Francisco. The three new converters we tested were the Neve HRC-1 at 20 bits dithered, the Sony DAD-A2000 at 16 bits, and the Wadia WA4000 at 20 bits. We also listened to the Apogee AD-500 with the current modifications.

We hope you are all familiar with the drill by now. If not, please refer to *Mix*, May 1991 and March 1992, for a complete description of the procedures used in the recording and double-blind listening tests.

APOGEE

A full description of the \$1,995 AD-500 can be found in our March '92 article. Recent modifications to the unit claim extended deep bass and tighter bass in general. Imaging also is said to be improved. Apogee Electronics: (310) 915-1000.

NEVE

The HRC-1 is a two-rackspace unit that houses both A/D and D/A converters. Neve offers numerous internal routing options as well as bit rates of 16, 18 and 20 bits. The converters employ Neve's proprietary design. The HRC-1 only converts the AES/EBU format; SDIF-2 and S/PDIF are not available. Internal switching for 110 or 230 VAC operation is standard. Input and output levels are also internally selectable using jumpers. Neve claims pin 2 hot for this unit, but we found that it was actually pin 3 hot on the A/D side and pin 2 hot on the D/A side.

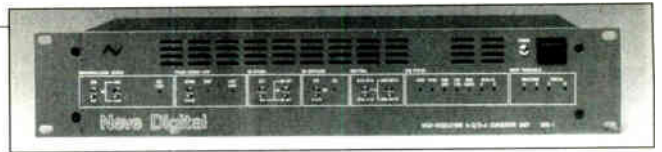

This is an obvious error that should have been noticed in quality control.

The front panel is logically laid out in seven sections. The Synchronization panel contains two switches and an LED. A three-posi-

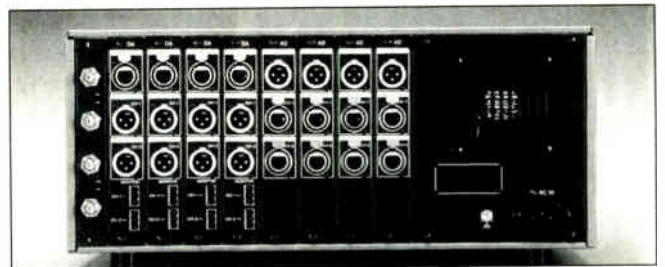

tion sync source switch selects the digital audio XLR, the digital sync XLR or the internal clock as the master clock. The sample frequency se-



lection switch selects either 44.1 kHz or 48 kHz. Automatic sampling selection occurs when in the digital audio XLR mode. A reference lock LED indicates lock to the digital



"The best sound effects library is The Hollywood Edge — without a doubt!"

Oliver Stone, Director

(J.F.K., Born on the Fourth of July, Platoon)

"Excellent!"

Martin Scorsese, Director

(Cape Fear, GoodFella's, Raging Bull, Taxi Driver)

"Nothing else even comes close!"

Shadoe Stevens

(American Top Forty)

**Hot off the press!!!
Ask us about CARTOON TRAX.**

Listen for yourself-

If you buy sound effects for your company, call us for a

FREE DEMO DISC!

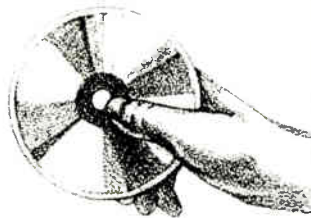

Call Toll Free
800-292-3755

In CA Call
213-466-6723

The
HOLLYWOOD
Edge

7060 Hollywood Blvd. • Hollywood, CA 90028

USE READER SERVICE CARD FOR MORE INFO

sync XLR.

The Phase Lock Loop section houses a switch for selecting chase or normal modes. The chase mode is used for high-jitter clock sources, while the normal mode works with low-jitter sources. If the switch is in normal but there is too much jitter to lock, the unit automatically selects chase. The unit-locked LED indicates when the PLL has locked to its source.

The analog outputs always have 20-bit dither applied, but dither for the digital output is selectable in the Re-Dither section. Dither on/off is selected via a two-position switch. A second switch selects whether you want 16-, 18- or 20-bit dither. This means that you can dither in the digital domain, a feature unique among A/D converters.

The De-Emphasis switch and LED select de-emphasis on the digital input audio.

Two routing switches select internal signal routing. You may choose: "1" Analog In to Digital Out, Digital In to Analog Out; "2" Analog In to Analog Out, Digital In to Digital Out; "3" Analog In to Analog and Digital Out; and "4" Digital In to Analog and Digital Out.

Seven Digital Input Status LEDs indicate the following: Lock indicates lock to a digital input source clock. Sync shows that the digital is synchronized to the PLL clock within $\pm 25\%$ of the sample period. PAR ERR indicates parity error. CRC ERR indicates correctable digital errors. Non-Audio indicates that the non-audio bit mode is set, thus muting the analog out fed from the digital input. Invalid A indicates an invalid AES "validity" flag for channel A. Invalid B indicates the same for channel B.

Input threshold LEDs warn of signals -1.16 dBFS for both the analog and digital inputs.

The rear panel contains all XLR connectors for analog in and out, digital in and out, and digital sync in. Fan noise is very quiet.

The HRC-1 retails for \$9,785. Neve/Siemens Audio: (203) 744-6230.

SONY

The DAD-A2000/A2000R consists of a mainframe and an assortment of

cards. The DAF-2000 frame is a two-rackspace unit with power supply, video clock board, clock board and room for four cards. Cards available are a DABK 2001 A/D converter and a DABK-2002 D/A converter. The A/D operates at 16 bits, using I-bit sigma-delta technology; the D/A uses a digital filter of 16-bit input and 18-bit output with 8-times oversampling. Cards may be mixed and matched, allowing for up to eight channels of audio. This unit may be connected to a digital audio tape recorder or a digital VTR. It converts only to the AES/EBU format.

The front panel is a hinged door that swings open to reveal the various cards. It has a smoked plastic window that allows one to see significant LEDs and an indicator that shows power on or various problems analyzed by a self-diagnostic logic.

We cannot say that any one box fills all the bills.

Inside the front panel door is the power switch and a headphone jack with volume pot. This jack receives the same signal as the back panel monitor outs. The CK board has two functions. The Sync Clock button selects for LEDs indicating internal clock, external video sync, external digital sync and word sync. Sampling frequency is selectable to 48, 44.1 or 44.056 kHz. If external clock is supplied, then the unit will follow 44.1 kHz ($\pm 12.5\%$) and 48 kHz ($+4/-12.5\%$). The D/A can operate from 38 kHz to 54 kHz. The VCK board has four LEDs indicating frame frequency of an external video input. The D/A board contains a pre-emphasis switch, five-segment LED stereo input level meters with trim pots, and an input monitor selector that routes the analog signal to the headphone jack or rear panel monitor outs. The A/D board has LED in-

dicators for de-emphasis, mono signal detection and AES/EBU format error detection. The output level meter is a five-segment LED stereo display with analog output level trim pots.

The rear panel has space for four converter back panels. Permanent residents include the AC receptacle and a noisy fan. The XLR monitor outputs can be used to monitor signals from the A/D or D/A cards. The user may select pin 2 or pin 3 as hot with a jumper cable. Two BNC connectors and a 75-ohm termination switch are provided for a reference video input and loop-through. Two more BNCs and a switch are for word sync input and configured the same as above.

Retail price for a DAF-2000 frame is \$5,000. The A/D card is \$2,000; a D/A card is \$1,500. Sony Business & Professional Products: (201) 930-1000.

WADIA

The Wadia WA4000 is a single-rack-space unit using the Ultra Analog ADC20048A 20-bit converter chip. Once solely a consumer audio company, Wadia seeks to bring "audiophile" engineering into the pro world. They claim proprietary designs for ROM upgradability and enclosure detuning. They also claim an extremely accurate crystal clock at 2 PPM. Formats supported are AES/EBU, SDIF-2 and S/PDIF.

The front panel is simple and elegant. A momentary button selects a 44.1 or 48kHz sampling rate, with LED for each. A Mode button selects four bit-rates and polarity. These modes are 20 bits, 20 bits polarity inverted, 16 bits dithered, and 16 bits dithered, polarity inverted. Inverted polarity is shown with an LED, and 16-bit status lights the two -20dB level indicators. Another button selects between internal and external sync. LED indicators designate which is active, and a third LED shows lock. There are seven level LEDs for each channel as well as an overload LED.

The rear panel houses the AC receptacle and fuse along with a variety of digital connector options. There is a true 75-ohm BNC co-ax connector for S/PDIF and two independent XLR AES/EBU outputs. There is also an XLR AES/EBU external sync input. SDIF-2 connectors

Boynton Studio introduces FOSTEX PD-2 portable timecode DAT

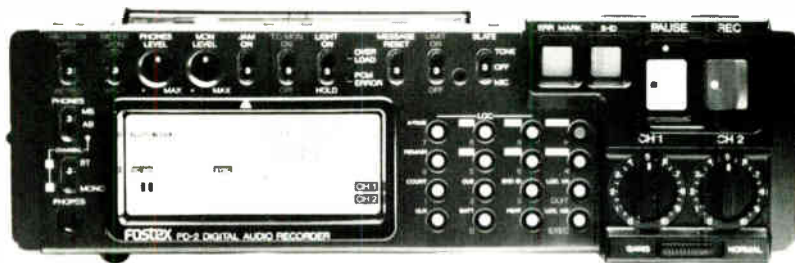

Now in stock at **Boynton Studio**
your full service pro audio dealer

Melody Pines Farm • Morris, NY 13808

Phone (607) 263-5695

Fax (607) 263-2373



Hear Yesterday, Today and Tomorrow

US* READER SERVICE CARD FOR MORE INFO

MAKERS • DISC MAKERS • DISC

Complete Cassettes in 7 Days!

WITH BLACK & WHITE INSERTS

- Includes FREE Graphic Design
- Dolby HX PRO Duplication
- HI-TECH Clear Shell
- Major Label Quality

Club Series:

300 C-12
Cassettes
\$499

Complete with design, typesetting,
film and printing, Dolby HXPro
duplication, clear shell and box,
and cellophane wrap

Some happy
clients who
got their
cassettes
FAST:

Syrice D. Adams,
Cleveland, OH
"Thanks for the
great design!"



Chuck Block,
Washington, DC
"More affordable
than I thought."



Greg Disotell,
New Orleans, LA
"Your excellent service
is much appreciated."



Also Available: Complete
CD and LP Manufacturing

Call Today For Our FREE Full
Color Catalog 1-800-468-9353



1328 N. 4th Street, Philadelphia, PA 19122, TEL: 215-232-4140, FAX: 215-236-7763

Now
DAT's at
an incredible
price!



When you
want the
BEST DAT
Recorder
for the
BEST
PRICE,

there's one magic
number to call:
1-800-356-5844



Casio • Marantz • Otari
Panasonic • Paramount
Sony • Tascam • Technics
Prices too low to advertise!

FULL COMPASS

1-800-356-5844
Consultation 608-271-1100
5618 Odana Rd, Madison WI 53719

are BNC for word clock in and out and Channel 1 and 2. Finally, the glass fiber optical output is not compatible with the current plastic fiber optic interface. Glass is capable of longer runs, but at this time we know of no pro manufacturers supporting this interface. The two analog inputs also have recessed level control pots. These are not even full turn pots. For 0.1dB accuracy, multi-turn pots would do a better job.

Retail price of the WA4000 is \$4,500. Wadia Digital Corp.: (715) 386-8100.

LISTENING TESTS

The first piece was "Waiting Song," a current folk-pop release by Barbara Highbie. Instrumentation was piano, vocal, electric bass, drums, congas, acoustic guitar and percussion.

Apogee: Bass has good punch and the track a good deal of life. High-frequency air is good, but sibilance seems a bit exaggerated and hard. Image is good. Moving harmonics on held piano chords in the intro provided a good test of low-level resolution. The Apogee resolution was good, but some warmth was missing. Vocal a bit darker. The pulse or rhythmic drive of the track was well-preserved.

Neve: Life or presence is missing. Loss of warmth and deep bass. Lower harmonics on piano not strong. Image is good. Vocal dark. Sibilants ragged.

Sony: Very good image. Deep bass present but some punch is gone. Reverb and low-level resolution is good. Instruments a little smudged together. Slight air loss. Sibilants have a little extra but were not harsh. Good passing harmonics on piano. Good life. Vocal loses a little bit of body.

Wadia: Lively. Image good. Pulse is good but deep bass and warmth are lacking. Passing harmonics all right. Upper air gone and sibilants a bit gritty. Vocal gets a slight megaphone quality. Bass and midrange seem disconnected.

The second listening piece was a mono narrator reading copy from a magazine. Half of this selection included some background room noise that added dimension and demonstrated low-level resolution quite well.

Apogee: Tonal balance lightened. Close, but no low bass. Good low-level resolution.

Neve: One step removed, just that little bit of presence missing. Low-level information discernible but less resolved. Tonal change.

Sony: Closest. Vocal loses some definition. Good low-level resolution. Good reproduction of vocal pops.

Wadia: Once again, a slight megaphone quality. Good background noise. Pops good.

The next test was the Slavyanka Chorus, a choir of 25 male voices, recorded with a Blumlein miking technique in the chapel of Saint Vincent's School, San Rafael, Calif.

Apogee: Good blend. Good life. Tonal balance a little lighter. Acoustic depth remains. Slightly strained on loudest passage.

Neve: Flat, gray. Life gone, no depth and reverb less. Warmth lost.

Sony: Mix clearer but hall sound is reduced, depth lost. Some harshness on loud passages.

Wadia: Good dynamics. Good sense of hall at low levels but fades out as music gets loud. No strain on peaks.

So, do we have a clear winner? As you see, we cannot say that any one box fills all the bills. It is hard to give a concrete score, but here is a general roundup of our impressions. On Barbara Highbie, the Apogee and Sony seemed to best represent the music. The spoken word found the Wadia on top, with Sony and Apogee in the second ranking. With the chorus, the Apogee felt closest, with Wadia and Sony close behind. We can say that the Neve was generally disappointing in all categories.

We are still searching for the near perfect representation of life. We can't say we're satisfied yet. The industry still has a way to go, and new boxes are in the works. We will continue listening, so look for Part IV in the months to come. Among the new entries will be the Lexicon 20-bit system unveiled at last month's AES, Sony's new 20-bit card and a few other surprises. ■

Bob Hodas is a recording engineer based in the San Francisco Bay Area. Paul Stubblebine is the chief mastering engineer at Rocket Labs in San Francisco.



THE EXCITEMENT IS ONLY BEGINNING.

The ENSONIQ DP/4: Four 24-bit effects processors with effects that will add punctuation to anybody's music!

When we announced that we were entering the multi-effects arena, musicians were curious. When we introduced the DP/4 digital processor, they were interested. But now that the DP/4's been put through its paces, they're impressed!

From top studio engineers to professional reviewers, musicians have had exciting things to say about the DP/4. First, they're impressed that it's the first "parallel multi-effects processor that can replace a whole rack of equipment" - a designation made possible by the DP/4's four custom 24-bit processing

"The DP/4 is capable of so many sound permutations that it's almost like a new instrument."
NICK BATZDORF,
Home & Studio Recording

chips, each of which remains 100% dedicated to delivering top-quality sound.

Some have noted that "ENSONIQ has been able to cram every signal processing function known to man (and then some) into one box." About the 400 preset effects algorithms: "it's clear that a lot of thought went into their development" and that they're competitive in quality to those in single-effect units costing twice as much. Plus, they're "instantly usable and eminently programmable."

Musicians and engineers everywhere are

"ENSONIQ sets a new standard for versatility with the DP/4."
JIM AIKIN,
Keyboard Magazine

learning to enjoy the signal routing flexibility of the DP/4's digital patch bay and the fact that its

digital sub-mixing allows them to start mixing at the output stage - freeing up channels for their final mix.

The ENSONIQ DP/4. Great sound, unapproached flexibility, and incredible value. Get in on the excitement at your local Authorized ENSONIQ Dealer. Call 1-800-553-5151 for the one nearest you.

"You'll love the DP/4. Simply, it has more sound variation potential than any other signal processor on the planet."
BRENT HURTIG,
Musician

ensoniq®

THE TECHNOLOGY THAT PERFORMS

Please send me more information on the ENSONIQ DP/4 Also, please send me information on ENSONIQ Synthesizer Workstations ENSONIQ Sampling Workstations

Name _____ Address _____
City _____ State _____ Zip _____ Phone (____) _____

Mail to: ENSONIQ, Department X-32 155 Great Valley Parkway, Malvern, PA 19355



SQ-1 PLUS 32 Voice Personal Music Studio



SD-1 32 Voice Music Production Synthesizer



KS-32 Weighted Action MIDI Studio



SQ-R PLUS 32 Voice Synthesizer Module

USE READER SERVICE CARD FOR MORE INFO

World Radio History

by David (Rudy) Trubitt

SOUND CHECK

K.D. LANG'S THEATER TORCH TOUR

"It's not rock, it's not country—it's a bunch of things put together," says k.d. lang's house mixer and production manager Grant McAree, who has been with lang for the last seven years. lang and her band are playing smaller (2,000-seat) venues across the U.S., Canada and Europe. "She doesn't want to play really big places," McAree continues. "She

feels she can reach everybody at this level. This particular material is moody and dark, and she wants that kind of focus. I have no complaints—I'm quite happy working in theaters."

Sound equipment for the tour is provided by Kian (Richmond, British Columbia). The system centers around a Gamble EX Series console, BSS drive gear and flown Meyer MSL-3 loudspeakers with 650 subs on deck. Meyer

UPAs and UPA-1s are used both as stage monitors and balcony fill, depending on the specifics of the venue at hand. The tour's 12 monitor mixes are handled by Rob Hadfield, who has been with the organization for three tours.

"Before the tour started," McAree says, "we did some rehearsals in a small hall and then a week in a theater. This year everybody showed up with as much signal processing as I have up front. They have MIDI controllers to run it, so most of the processing is done by the band."

McAree describes some specifics regarding individual instruments: "If it's an acoustic guitar, most times it's a Takamine. You can have the most beautiful Gibson or Martin, but you'll spend months trying to get a pickup system that sounds as good as an off-the-block Takamine. It offers a lot of control for the monitor mixer and the

—CONTINUED ON PAGE 97

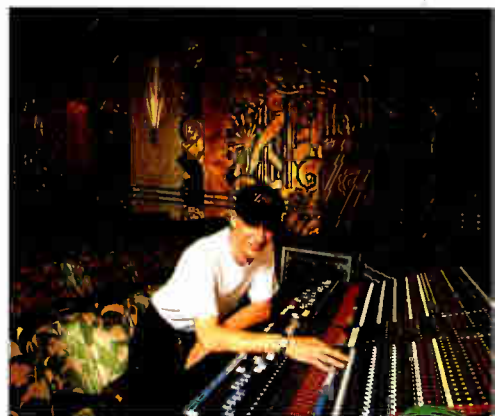

k.d. lang and her soundman/production manager Grant McAree at Oakland's Paramount Theater.

PHOTOS: STEVE JENNINGS

Tour Profile



George Strait

"I've basically got three jobs," Paul Rogers says. "Production manager, sound engineer and systems tech/crew chief. That happens in country music. It's not like rock 'n' roll acts where they can have one person do each job. But the good part is when the show is over every night and I talk to George. Any complaints about anything—lights, sound—is all my responsibility. It takes a lot of pressure off the crew, and it gives George

one guy to deal with for everything. It works great."

Rogers began his relationship with George Strait through the sound company Dallas Backup, which Strait worked with in the Texas Five States region. In 1981, Rogers left his chief engineer position with Dallas Backup and went full-time to the Strait Organization. In '86, Dallas Backup began touring nationally with Strait.

Rogers describes a normal



Above: Paul Rogers is behind the Yamaha PM3000 at San Carlos' Circle Star Theater.

day: "We come in at 10 in the morning, and by 3, with an hour break, we're ready for sound-check. That's hanging all the stuff, pink noising and checking everything. We've got EAW, which I love to death." The tour carries 30 EAW KF850s (24 flown, eight on deck) and eight EAW subs and processors. "We're very limited in what we can carry," Rogers explains. "We've got one semi and a bobtail for all the sound, lighting and band gear. There are some rooms we get into, like the Arco arena in Sacramento, where it's almost not enough. But the system's good enough that you can get it all the way up to red-line, and it'll get you through the night."

"I use an analyzer to set the house EQ up," Rogers continues. "I won't even pink noise if we're on the third or fourth night in a row—I'll just 'ear-ball' it. But on the first night, I'll analyze it immediately to make sure everything's working. Then I'll find

BEFORE you buy any brand of 16-channel mixer, consider why the CR-1604's become the rack-mount mixer of choice for top pros (request our literature packet and we'll include an astonishing list of touring and session players, studio producers, engineers, songwriters, sound track composers and late-night talk show bands who rely on Mackie).

EXCLUSIVE design features. One reason we specialize in mixing boards is so we can be maniacally meticulous about details others overlook. Some details help make the CR-1604 rugged and roadable. Others contribute to the mixer's excellent sound quality. And some, like our unique gain architecture and mix amp topology aren't really details at all, but rather represent a fundamentally better way to mix music.

FANATICAL engineering means phenomenal sound. Compare our specs and features with anyone. But remember that the bottom line is what your ears tell you. Put a CR-1604 through a hands-on work-out and you'll understand why several major-label CD releases have been recorded and mixed solely on Mackie mixers.

OUTPUT-O-RAMA: Main stereo outputs with enough oomph to drive any balanced or unbalanced input. In fact, all outputs have sufficient level to drive any input. All outputs/inputs are fully protected.

TRIM matches any signal from instrument levels to -10dBm semi-pro to $+4\text{dBu}$ pro gear.

7 SENDS via 4 knobs with plenty of gain above unity for special effects and center detent at unity gain, **4 STEREO AUX RETURNS** with super-high headroom, low noise and enough gain to work with all levels.

MUSICALLY-USEFUL EQ. We're amazed at how many users tell us that our 80Hz, 2.5kHz & 12.5kHz EQ points and circuit design not only sounds sweet but in some cases have replaced outboard equalization!

COLD-ROLLED STEEL CASE
BUS 3&4 ASSIGN

STEREO IN-PLACE
SOLO maintains stereo perspective for all soloed channels & returns.

UNITY PLUS faders with 0dB gain at center detent minimize noise, boost headroom, provide 20dB more gain above unity to reduce constant trim re-adjustment as input levels change.

BETTER-THAN-DIGITAL. -90dB S/N ratio with 108dB dynamic range (vs. digital with -90dB S/N and 90dB dynamic range). Incidentally, when comparing specs, make sure they reflect real world conditions as ours do. Compare closely and you'll appreciate the fanatical engineering that went into the CR-1604's specs. And why we differ so vastly from mixers that merely masquerade as Mackies.

STUDIO-GRADE MIC PREAMPS. Only the CR-1604 incorporates discrete, large-emitter geometry transistor preamplifiers instead of just simple ICs. That's why only our mic preamps deliver -129dBm E.I.N., 0.005% THD yet can handle $+14\text{dBu}$ max inputs without need for a pad. You'll get all the punch and delicacy of expensive studio board preamps.

LARGE INTERNAL POWER SUPPLY provides power for $+48\text{V}$ phantom mic power, 12V BNC lamp socket, and bi-polar power for main circuitry, hi-output headphone amp & sophisticated enhancements such as our XLR10 mic preamp expander & internal full-fader/muting MIDI automation board. Our supply not only eliminates inconvenient "wall warts & line lumps" but gets rid of their hum-inducing magnetic fields, too.

They're typically driven into non-linearity (15kiloGauss or more) causing stray 25-35 μV magnetic fields that are easily picked up by shielded audio cables. Our oversized, instrumentation-grade transformer loafs at 10kiloGauss, reducing stray fields to under $1\mu\text{V}$.

GNARLY CIRCUIT BOARDS. Unlike brittle phenolic, our horizontally-mounted, double-sided, through-hole plated fiberglass boards and rigid, multi-point suspension prevent damage from external impact.

MIX AMPS WITH TWICE THE HEADROOM. Signals from all inputs simultaneously converge here. Conventional mix amps can overload and distort when you start pouring on the channels. Our gain structure solves the problem for audibly better sound. Cram the CR-1604 with 16 hot signals and it still has more headroom than other mixers running 8 inputs. No wonder ours is the mixer of choice among top percussionists like Chester Thompson (Genesis), Bashiri Johnson (Whitney Houston) & Babe Pace (C+C Music Factory)

ULTRA-DENSE CIRCUIT TOPOLOGY. Unlike budget mixers which cut corners with passive circuitry, we added input and output buffers so the CR-1604 is compatible with a much wider range of devices.

Silky smooth SEALED ROTARY POTENTIOMETERS prevent contamination from dust, smoke, liquids & are CO-MOLDED without the use of easily-shattered phenolic mechanical parts (a major reliability problem in many conventional mixer designs). Plus, our exclusive **ENERGY-ABSORBING KNOB DESIGN** transfers vertical impact away from pots and main circuit board, greatly reducing possible damage.

MACKIE.

MACKIE DESIGNS INC • 12230 WOODINVILLE DR • WOODINVILLE, WA 98072
1-800-258-6883 • FAX 206/487-4337 • COMPUSERVE: GO MACKIE

USE READER SERVICE CARD FOR MORE INFO

Word Radio History

WIN MACKIE'S NEW 8-BUS CONSOLE!
SEE PAGE 128

LIVE SOUND

three or four points that are a problem and fix them. I don't necessarily go for a flat [spectrum]. With the EAWs, the first thing I notice is a 200-250Hz bump. I really have to dig on those frequencies. There's also a little 400 and 500, and for my own ear, 2 and 2.5 kHz. I don't care *what* system it is—if I want to be loud and punchy, I've got to get rid of those frequencies. Then I can pump it up, and it's not going to hurt your ears."

Crest 8001s are the amps of choice. "We've been using Crest a long time," Rogers says. "When the PSA-2 came out, we sat down with a Crest and a Crown and listened to them naked, and we really liked the sound of the Crest better. That was back when they had the 4001 and 5001. The only thing I don't like is that they come up with something new every year—next thing you know, you have a bunch of stuff that doesn't match up exactly.

"George's vocal mic is a Beyer," Rogers explains. "It's great as far as monitor rejection. The one thing I don't like is that as soon as he walks away from the mic it picks up all kinds of high-end stuff from the stage. I don't even hook his guitar up to the P.A. system—it's more of a prop than anything. If he walks away from the mic and really gets into playing, his guitar goes flying through the vocal mic—I just turn it off. I'm using your standard array of mics on drums—an EV RE-20 and a ddrums kick trigger, Shure SM57 on the snare, SM81 on the hi-hat, Sennheiser 421 on the toms and SM81 on the overheads. I use 57s on a couple of guitar amps, but everything else is direct: the steel, the fiddle, the piano and acoustic guitars."

When the show starts, Rogers has a golden opportunity to nail the details. "George doesn't hit the stage until the third song," he ex-



FREE TEE-SHIRT
MOST PURCHASES

ROCK well
CHRISTMAS

THOROUGHbred 1(800) 800-4654
MUSIC In Florida Dial: 1 (813) 237-5597

All year long it's *RUSH, RUSH, RUSH*; and then, this time of year, we really get busy. So let's slow it down long enough to be thankful for **Traditional Values: PRODUCT KNOWLEDGE, SERVICE AFTER THE SALE, ATTENTION TO DETAIL, AND THE SPIRIT OF GIVING.**

ROCK WELL in 1993 from your music department store.

Electronics, Percussion, Guitars, Amps, Keyboards, and Accessories.



2204 East Hillsborough Avenue, Tampa, FL 33610 Fax Your Order: (813) 238-5443

USE READER SERVICE CARD FOR MORE INFO



STUDIO

beyerdynamic

TG-X 580

Microphones · Headphones · Wireless Systems

56 Central Ave., Farmingdale N.Y. 11735
Tel. (516) 293-3200 / Fax (516) 293-3208

plains. "The band does two songs. They have lead breaks in both songs that go right down my [Yamaha PM3000] console. It goes steel, fiddle, guitar, guitar and piano. Then they do it again! After those two songs, I'm where I should be.

"I mix the way I want to mix. I don't have anybody over my shoulder, and I haven't in the eight years I've been with him. I've learned to see who the crowd consists of. On the East

Coast we saw nothing but people 55 and older. They're very pleasant and quiet, and luckily those rooms let you achieve a good, quiet mix—you won't get a big, punchy mix with these little P.A. systems, anyway. I don't want anybody up here bitching about [levels].

"When we do our normal situation in an arena, the crowd is 25 and under and screaming at the top of their lungs. It needs a punchy mix. I start with the kick drum. Once that sounds good, I

know everything else is going to fall into place. Some people would probably say I'm a little heavy-handed on drums, but it works in situations where we've got our regular crowd. We do a big stereo mix."

Dale Trout, another Strait/Dallas Backup veteran, handles nine stage monitor mixes from a Yamaha PM2800 monitor console. "I try to pay equal attention to everyone in the band," Trout says. "I would almost say I spend the least time with George."

If the opening act has no monitor or house engineer, Trout and Rogers will fill in. But a very relaxed, hands-off approach prevails if the support act does have engineers. "Everybody knows that an engineer can hear someone's mix and say, 'If only I could fix that one thing, it would be a great mix,'" Rogers says. "That's why I leave opening acts' mixers alone. That's their domain. If I feel there's something damaging happening, I'll say something. But a lot of these opening act engineers are surprised at how easy-going I am. Any knob you want to twist, twist it."

Rogers is now comfortable juggling his three jobs, although his situation is a recent development. "Until the first of this year, I had a system tech—Allen Miller. This guy was the best tech I ever had. I used to walk in [to sound check] and say, 'Sounds good, Allen,' and that was it. He and I would reach for knobs at the same time—literally reach for the same knob at the same time and sit there and laugh at each other. Now he's doing my job—production manager and mix engineer for Allen Jackson. When I lost him, I knew I'd never find anyone to do it the way I wanted, so I decided to do it myself. I called up Charles and said, 'How 'bout I go back to work for you?' It's been great to be back in touch with my system again." ▲

Sound reinforcement editor David "Rudy" Trubitt urges you to vote.

C:MAX Wearable Monitor Systems



- Choose between wireless and hardwired versions
- Control your own listening volume and stereo environment
- Protect your hearing
- Universal ear pieces — no special custom molding required
- Lowers stage volumes and *eliminates feedback*
- No more heavy amp racks and speakers — reduces truck space
- Our wireless systems are FCC licensed

CMCI Systems are designed by RF experts, live mixing professionals, and leading audiologists, and use the patent pending C:MAX™ psychoacoustic stereo environment.

Leading the Way in Monitoring Technology

CMCI

Circuits Maximus Company, Inc.



214 N. Park Drive
Arlington, VA 22203
703-276-0125

© CMCI 1992 CMCI, C:MAX and CMCI are service marks of Circuits Maximus Company, Inc.

USE READER SERVICE CARD FOR MORE INFO

—FROM PAGE 92, K.D. LANG

house. The piano's got Helpenstill in it with a Schubert preamp. When you want to hear it, you just turn it up. You don't have to fight with it. The vibes have an Ayott pickup system in them for the same reason."

Lang's performance is filled with precise mic-handling technique. "She takes care of a lot of [the level control]," McAree acknowledges. "She's singing through an AKG 535. She does have some limiting on her [a dbx 900 rack]. Not much effects on her vocal—just a little reverb and the odd in-time delay. The records sometimes have more processing, but it seems like more is less with k.d. People come to the show to hear her sing, so you can't get too zealous trying to hear every instrument because you'll find the reason people came is buried. It's a bit of a trick. But if it's being played, it should be heard."



PHOTO: NEIL ADAMSON

MorganSound's Neil Atkinson runs a Soundcraft Europa console at Mt. Hood.

MT. HOOD JAZZ FESTIVAL

Located just outside Gresham, Ore., the 1992 Mt. Hood Jazz Festival played host to jazz and blues artists David Benoit, Earl Klugh, Freddie Hubbard, Take Six and Ray Charles. The following weekend, the Mt. Hood International Blues Festival featured B.B. King,

AKG • APEX • BEYER • CROWN • DBX • FOSTEX • JBL

• 360 SYSTEMS (DIGICART) • TOA ELECTRONICS • TRAM •

NY's Best Kept Secret!

For over 35 years, the largest, sharpest Broadcasters, Production Houses and Contractors have remained our clients.

The Secret.

ALL MAJORS BRANDS IN STOCK
THE FASTEST DELIVERY
THE BEST PRICES

What are you waiting for?

Get in on NY's best kept secret
OUTSIDE NY CALL: 1-800-345-DALE (3253)
IN NY CALL: 1-212-475-1124

DALE ELECTRONICS

THE PRO-AUDIO SUPER STORE

7 EAST 20th STREET, NEW YORK, NY 10003

RADIO DESIGN LABS • SHURE • SONY • TELEX • SAMSON

• ELECTRO-VOICE • GENTNER • RTS SYSTEMS • SENNHEISER •

USE READER SERVICE CARD FOR MORE INFO

TOUR

beyerdynamic

TG-X 480

56 Central Ave., Farmingdale N.Y. 11735
Tel. (516) 293-3200, Fax (516) 293-3288

beyerdynamic
Microphones • Headphones • Wireless Systems

AFTER YEARS OF BUILDING A REPUTATION, TAD IS NOW BUILDING PERFORMANCE SPEAKER SYSTEMS.

For years, TAD® components have been used by major speaker manufacturers and touring sound companies. Three years ago, TAD engineers focused on creating a high performance speaker system of their own. The result is the new TAD TCM Series. Made in the U.S.A., TCM speakers feature entirely new technology for the industry.

FEATURING TD-4002



Transducer Technology

OPAXIAL™
(Opposite Axis)
Transducer Orientation

Dramatically reduces – by more than 20dB – 2nd harmonic distortion in the 50Hz to 100Hz range.

TAD Technical Audio Devices
Pioneer Professional Products Division

For more information on TAD by Pioneer and the TAD TCM Series, call (310) 816-0415 or FAX (310) 816-5941.

APAXIAL™
(Asymmetrical Pattern, Axis and Level)

Permits precise level and pattern control, virtually eliminating comb filtering and lobing in an array.

PPC™
(Phase Plug Couple) Technology

Eliminates the compression driver's "throat" and "couples" the horn directly to the phase plug, thereby reducing throat compression and distortion.

AFAST™
(Aconstical-Filter Assisted System Tuning)

Improves phase, frequency and transient response through the application of a secondary vent to the LF port and HF dispersion horn.

CGR™
(Capacitor Gap Reduction) Passive Network

Improves overall tonal characteristics by dissipating the capacitance which occurs in the magnetic gap of a loudspeaker.

ENCLOSURE CONSTRUCTION

Features CNC fabrication of 14-ply Finland birch, mil-spec aluminum flying track and rated stainless steel fasteners. Engineered to convenient "truck-pack" dimensions.

Buddy Guy and Etta James. Sound for both events was provided by Seattle-area's MorganSound (Lynwood, Wash.). MorganSound supplied a 70kW JBL sound system that included 26 Array Series, 44 Concert Series and four SR 4700 cabinets. Five delay towers were used. Driving it all were seven of JBL's new ES-52000 digital controllers, JBL/UREI power amplifiers and two linked Soundcraft Europa consoles. Additional crew support was provided by members of JBL's staff, who came for a real-world test of their gear.

MorganSound is a longtime user of JBL cabinets with an inventory that includes about 60 JBL 4852s. The festival gave them a chance to hear familiar enclosures with the new digital controller. "The ES-52000 made the P.A. sound twice as big," MorganSound's Charlie Morgan says. "First, it does the proper voicing for the selected speaker enclosure. That means you require very little EQ as long as the speakers are aimed correctly. Second, you get the time delays right in the high packs. Third, it does the bi-radial EQ that's required—we use the 60-degree horns. It also tightens up the bass because of the zero phase-shift crossovers."

"It opens up the system," agrees MorganSound's tour division manager, Neil Atkinson. "It helps you define your mixes. No matter where you position anything in the mix, it's there—it really adds clarity. It has much better depth of field, and it's warmer, too."

"I've been asked if I hear digital quantization noise," Morgan adds, "but the clock rates are so high that I don't perceive it. There is a group delay of about eight to ten milliseconds in the system, but that didn't appear to be a problem. It tends to put the sound system more in phase with the stage anyway." Although working with some of



**The Zoom 9200
Advanced Reverberation
Processor**

It is about passion. It is about the joy of sound. It will make your music and audio tracks sound better. It will make you stay up late. Free of gimmicks, it is honestly the most refined spacial simulator ever built, at any price. Simply, the Zoom 9200 is pure sonic ecstasy.

Zoom

Zoom Corporation Of America
385 Oyster Point Boulevard, Suite 7, South San Francisco, California 94080
Tel: (415) 873-5885 Fax: (415) 873-5887

USE READER SERVICE CARD FOR MORE INFO



LEARN THE ART OF RECORDING

THE RECORDING WORKSHOP IS THE WORLD'S LEADING SCHOOL FOR "HANDS-ON" TRAINING IN MUSIC RECORDING TECHNOLOGY. IN OUR INTENSIVE, 5-WEEK PROGRAM, YOU'LL LEARN THE CREATIVE OPERATION OF PROFESSIONAL RECORDING EQUIPMENT. WE'LL TEACH YOU THE JOB SKILLS NEEDED TO SUCCESSFULLY START YOUR CAREER AS A RECORDING ENGINEER, PRODUCER OF STUDIO MUSICIAN

- ▶ 6 STUDIOS FILLED WITH THE LATEST EQUIPMENT: DIGITAL RECORDING TO HARD DISK, DAT MASTERING, AUTOMATED MIXING, MIDI AND MUCH MORE
- ▶ INTENSIVE, 5-WEEK PROGRAM GIVES YOU MORE QUALITY, IN-STUDIO EXPERIENCE THAN MOST LONG TERM SCHOOLS
- ▶ SMALL CLASSES, PERSONAL ATTENTION
- ▶ JOB/INTERNSHIP PLACEMENT ASSISTANCE
- ▶ FINANCIAL AID AVAILABLE
- ▶ NO PREVIOUS EXPERIENCE REQUIRED
- ▶ LOW-COST, ON-CAMPUS HOUSING

FOR FREE BROCHURE, PLEASE CALL OR WRITE TODAY

THE RECORDING WORKSHOP
1-800-348-9900 1-614-663-2510
455-X MASSIEVILLE ROAD, CHILLICOTHE, OHIO 45601

OHIO STATE BOARD OF SCHOOL AND COLLEGE REGISTRATION #80-07-0696T

1989 THE RECORDING WORKSHOP



the musical acts proved a bit difficult, MorganSound singled out two band engineers for commendation—David Benoit's Tim Aller and Earl Klugh's Dave Palmer. "We were very appreciative of them—they did a great job," Morgan says.

In addition to festivals and tours in the Pacific Northwest, MorganSound keeps busy with a number of related activities. "We can break [our touring system] down into many small systems

for industrials," Morgan says. "We also have a retail store and an electronics and loudspeaker repair center with full-time techs. We do design and install work as well. Our customers are a lot of nightclubs, nursing homes, churches. We do everything from a small church up to what we call 'production churches' with full sound and lights.

"Our business has its hot and cold moments. The overhead is high, but when all our divisions are working well, we make

money. We've been in business for 23 years, so we must be doing something right!"

PM4000S ENTER THE FIELD

A-1 Audio (Hollywood, Calif.) took delivery of its first Yamaha PM4000 mixing board. The board is being used on a tour of the Broadway musical *The Music of Andrew Lloyd Webber*, featuring a 60-piece orchestra and 12 vocalists. "The PM4000 cleaned up the sound of the show so much," engineer David Shoemaker says. "The EQ is great. The vocals in particular come out so much cleaner now."

A-1 also installed a PM4000 in the Circus Maximus showroom at Caesar's Palace, Las Vegas. "The console is superbly designed for the major live-performance venues we service," A-1's president Albert Siniscal says. "It offers numerous inputs to handle large orchestras, has an excellent equalizer section and provides the monitor and matrix outputs needed to dispense sound to different locations in a variety of venues."

NEWS FLASHES

Two Cadac J-type consoles are involved in Toronto theater productions—*Kiss of the Spider Woman* and *Joseph and the Amazing Technicolor Dreamcoat*. Sound design on both shows is by Martin Levan. The desk on *Kiss* has 60 inputs with 12 sub groups, 24 matrix outputs and 5 programmable routing modules. The *Joseph* console has 72 inputs with 12 sub groups, 24 matrices and two programmable routers...On the subject of Canadian theaters, Adamson was selected to provide loudspeakers for three theaters in the North York Performing Arts Center, also in Toronto. Other Canadian theaters doing the same are the Stratford Festival's Avon Theater and the Yukon Place Performing Arts Centre in Whitehorse... Sound Force (Dayton, OH) installed a house system at the newly constructed Frazee Pavilion, a 4,600-seat outdoor venue

1200 WATTS BUILT IN

16 BIT DIGITAL EFFECTS BUILT IN!

SPEAKER PROCESSOR BUILT IN!

1200 W STEREO AMP BUILT IN!

16 CHANNELS BUILT IN!



CANADA & USA

YORKVILLE SOUND LTD.
80 Midwest Road,
Scarborough, Ontario M1P 4R2

YORKVILLE SOUND INC.
4600 Witmer Industrial Estate, Unit #1
Niagara Falls, New York 14305

The Yorkville Audiopro 1216 may look like any other compact, quality 16 channel board but inside there's a powerful 1200 W stereo amp using the same circuitry you'll find in our Audiopro 1200 amp; a 16 bit Alesis Digital Effects Processor to give you

16 of the best time delay and reverb presets available in the industry; Speaker Processor circuitry to tailor the frequency response of your cabinets and Yorkville's proprietary Self-Correcting Hum Reduction circuitry that makes all outputs compatible with balanced or unbalanced lines. All this in a package only 29" x 16" x 5" backed by Yorkville's 2 year Unlimited Warranty! See it. Hear it. Believe it. You're going to want it.

*Also available in 12 channel version



located in Kettering, OH. QSC MX Series amplifiers and JBL loudspeakers were used. "We've been using the MX amps for years with great success," Jeff Smith, owner of Sound Force, says. "We like the new MXa Series—the redesign of the rear panel is a big improvement." On a related note, QSC EX 4000 and EX 2500 amplifiers have received CSA certification, the Canadian equivalent of UL...Wanderlust Light and Sound (Elk Rapids, MI) geared up for expanding work in the North Central region, including a mix of festival and college, club and industrial gigs. The company is adding a fourth P.A. system as well as additional lights and trucking gear...TAD and production company Roadworx Productions joined forces to engineer the first public demonstration of TAD's TCM1821 sound reinforcement loudspeaker. Thirty-six of the two-way, passively crossed-over boxes were used at a show featuring Tommy James and Chubby Checker at Fulton, GA's county stadium with a crowd of over 50,000. The array required only 16 Crown 3600 amplifiers...Speaking of Crown, 39 customized Crown PCC-160 surface-mount microphones were installed in a committee room of the Florida state Capitol in Tallahassee. The work was performed by All Pro Sound of Pensacola, FL...Bag End TA-15 full-range and ELF-1 and D18E-R subwoofers will be used at the International Computer Music Conference in San Jose, CA...Speeda Sound (Fresno, CA) used MIDI-programmable graphic EQ on the California fairground circuit. The company owns 60 Digitech MEQ-28s, which are used for monitor EQ...AAA Services, the contracting division of Orth Audio Inc. (Garden Grove, CA) was busy installing Renkus-Heinz loudspeakers in Southern California churches. ☺

The Top Touring Acts of Today Are Using The Sonic Technology of The Future!



Phil Collins and Ear Monitors™...
"We Can't Dance" Tour '92.

THE ULTIMATE IN SOUND TECHNOLOGY! EAR MONITORS™

- Custom fitted
- Studio monitor quality anywhere on stage
- Reduces vocal and hearing fatigue
- Wireless and hard-wired systems
- Cosmetically appealing
- Increased sound quality to both performer and audience
- Eliminates feedback problems
- Lower stage volumes

F U T U R E
S O N I C S INC

EAR MONITORS™ HEAR WHAT YOU'VE BEEN MISSING

655 DANBURY COURT, NEWTOWN, PA 18940
TEL. (215) 579 4414 FAX (215) 579 0769

© Future Sonics Inc. 1992



USE READER SERVICE CARD FOR MORE INFO

by Nort Johnson

MILWAUKEE SUMMERFEST



designs and equipment, says Terry Linnemann, who has worked the festival as dB Sound's site supervisor for several years and is president of Linnemann Sound. "Depending on who was there, it was usually 9 a.m. until 1 or 2 o'clock in the morning," Linnemann says. "So we have to pace ourselves, because with almost two weeks of those kinds of conditions, you can get tired real fast."

The Summerfest grounds cover 90 acres along 3,500 feet of Lake Michigan frontage. The sound crews had to cope with the 24,000-seat Marcus Amphitheater on the south, plus four smaller outdoor stages.

The Old Style, which generally draws between 8,000 and 15,000, is a permanent brick structure (as are the Pabst stage and Miller Oasis) with excellent loading facilities, backstage area, dressing rooms and production offices. This year, the stage hosted such acts as the Indigo Girls, Sass Jordan, the Arc Angels, the Marshall Tucker Band and the Allman Brothers, who drew a crowd of 15,000.

The Pabst Showcase stage also has excellent production facilities. Shows here included Peter Frampton, the Four Tops, Jefferson Starship and The Temptations.

Next, heading north up the midway, is the Miller Oasis, which was built three years ago. A short list of acts that performed there this year includes Kenny Loggins, the Neville Brothers, Reggae Sunsplash bands and South Side Johnny & the Asbury Jukes.

Last but not least, on the far north end of the grounds, is the

**Charlie Sexton
of the Arc
Angels. See
more photos
on page 106.**

PHOTO: RUDY APAS

It's billed as the "world's greatest" music festival, and that might not be stretching things too far. For the 25th consecutive year, Milwaukee's Summerfest played host to some of the biggest names in show business for 11 days in late June and July.

Chicago's dB Sound supplied the sound for Summerfest's main stages, as it has since 1979, in addition to their regular touring work (this summer dB supported

Metallica, Skid Row, Hammer and the Allman Brothers). With record attendance and Milwaukee's crazy summer weather, just pulling it off this year would be any sound contractor's goal. dB went one step further and handled the music on five stages—from noon to 11 p.m. each day—without a hitch. That's quite a feat.

And success was the result of long hours as well as the right

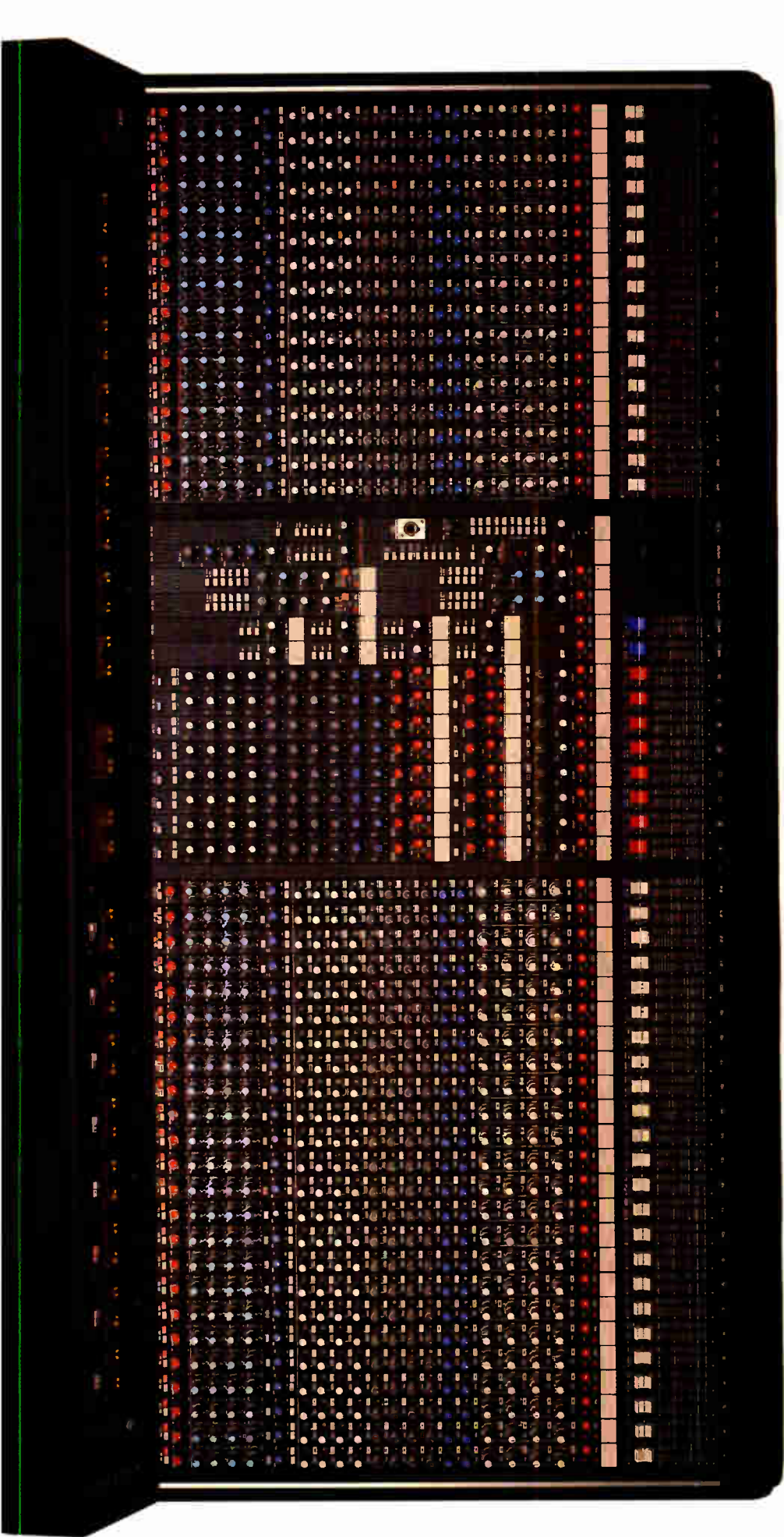

RAMSA WRS-840 Monitor Console. Just ask these sound companies: A1 - Audio (Frank Sinatra, Liza Minelli, The Temptations, Tony Bennett, K.T. Oslin, Gladys Knight). **Burns Audio** (Academy Awards, Grammy Awards, Golden Globe Awards, Academy of Country Music Awards, Kennedy Center Honors, San Diego Civic Auditorium (Summer Season), San Diego Starlight Bowl (Summer Season), Soul Train Music Awards, Las Vegas Spring Mountain Ranch (Summer Concert Series), Warner Brothers Re-dedication Ceremonies). **dB Sound, Chicago** (Aerosmith, Stryper, New Order, P!nk, Sugarcubes, Prince). **Eighth Day Sound** (Erasure, Bad English, Alice Cooper, Lisa Stansfield, Jethro Tull, The Escape Club, The Tom-Tom Club/Deborah Harry/Ramones/Jerry Harrison Tour, Tom Jones, Kool & The Gang). **Maryland Sound** (David Bowie, Neil Diamond, Debbie Gibson, Anita Baker, Kenny G, Luther Vandross, Hall & Oates, Miami Sound Machine, Neil Young, David Lee Roth, Belinda Carlisle, Melissa Manchester, Patti LaBelle, Paul Simon, George Benson, Steve Miller, Pink Floyd, Roberta Flack, Dolly Parton, Ann Murray, Joe Jackson, Boy George, Stevie Wonder, Earth, Wind and Fire, The Cure, Whitney Houston). **Naked Zoo** (Wayne Newton, The Commodores, Roger Whitaker). **Pro Media** (Luciano Pavarotti). **See Factor** (Lou Reed, Smokey Robinson, David Byrne). **Sound Image** (Barbara Mandrell, Jackson Browne, John Denver, Jimmy Buffett, The Robert Gray Band). **Sun Sound Audio** (Joe Cocker, Harry Belafonte, TheCult). For information, contact: Ramsa, 6550 Katella Ave., Cypress, CA 90632, 714-373-7278.

RAMSA

Panasonic

Broadcast & Television Systems Company

Miller Mainstream Rock stage. It sits apart like an orphan, facing the lake. House of Lords, Charlatans UK, Shot Gun Messiah, King's X and The Storm were on this year's bill.

"We have the festival split up into three parts," explains Todd Johnson, production coordinator at dB. "The Marcus Amphitheater is a part, the rock stage is another part and then the three brewery stages are another. We have a crew manager, Jimmy Iturrieta, on the rock stage, and if he has any problems or requests he deals directly with our production office. Terry Linnemann deals with the three brewery stages and he deals directly with us too, as does the crew at Marcus. It's three different things and we treat them separately."

THE MILLER ROCK STAGE

Because its lineup leans heavily toward hard rock and heavy metal acts, the Miller rock stage faces the lake on the far north

end of the grounds. It is the only stage that is not permanent—it's built of steel scaffolding with steel and wooden bleachers.

To attack this stage, dB used six blocks of EV MT-4 cabinets, three blocks per side (each block consisted of two MTH-4 three-way cabinets and two MTL-4 bass cabinets). For the FOH position, they brought in a Yamaha PM3000 and dB drive rack with normal band limiting along with a typical assortment of delays, reverbs, gates and limiters. Power was handled by racks of Crest 8001 amplifiers. The monitor desk was a Midas Pro 40 36x16 console, also using Crest power and EV wedge monitors.

"It's worked really well," says crew chief Iturrieta, who is a veteran of shows with Hammer, Skid Row and AC/DC. "We brought in six blocks of MT. I wasn't really sure if that was going to be enough to cover it, but it's been working pretty well so far. I haven't had any com-

plaints about the headroom. It covers the area well, sometimes a little too well. That's part of the reason they have this stage facing the lake—so it doesn't bother any of the other stages or any of the other areas."

A veteran crew was another reason for the rock stage's success this year. Bill Kurtz (Aerosmith, Skid Row, Hammer) and Don Dome (Skid Row, AC/DC) had a handle on the stage and monitor chores; they were able to tackle any problems that arose.

THE BREWERY STAGES

The next stage south on the grounds is the Miller Lite Oasis. It's the newest of the three permanent "brewery" stages. Since it's right off the main midway, directly across from a lot of vendors and other small entertainment areas, the proper sound system is the key to its success.

dB decided to bring in a Meyer system. They flew 16 MSL-3 cabinets, eight per side, from permanent towers on each side

- Dedicated controller with "hard" buttons for all edit commands
- Integrated machine control with Audio Freeze Frame
- Keystroke Macros for automating complex tasks
- Editing across multiple tracks
- EDL Conform with list optimisation
- High resolution low-stress graphics
- Scrolling waveform display on all visible tracks
- Instantaneous Zoom from 8 hours down to 6 frames across the screen
- True object oriented editing with crossfades and level control
- 24 tracks with individual outputs
- 16 track continuous playback from one hard drive
- Up to 20 hours of hard disk storage
- 8 track continuous playback from magneto-optical drives
- Optional MIDI sampling and sequencing package

US Sales: Ph (213) 460 4884, Fax (213) 460 6120

FASTER

FRIENDLIER

FAIRLIGHT



WORLD'S FASTEST AUDIO EDITOR

USE READER SERVICE CARD FOR MORE INFO

of the stage, along with four Meyer 650 sub cabinets on each side. A Yamaha PM3000 40x8x2 house console handled the FOH position with a typical dB drive rack. A Ramsa WR-S840 40x16 monitor desk was used for monitors. Meyer amp racks powered the house and Crests were used for the monitors.

Sound for this stage was excellent. To avoid disturbing the neighbors, the Meyer cabinets were directed down and into the crowd. This seemed to work quite well. Jeff Swartz of Capitol Sound, Virginia, was brought in to babysit the stage for the duration of the fest.

The Pabst stage, 300 feet to the south, had similar conditions. Again, a Meyer system was used with the same number of Meyer MSL 3 cabinets and 650 subs. The difference here was the FOH position: dB used a TAC SR 6000 super console 40x8x2 with the same drive rack as the Miller stage and a Midas Pro 4 36x10 monitor console. Again, the area used Meyer power in the house and Crest for monitors. Paul Holzer of dB Sound watched over the revelry for all 11 days.

Four hundred feet to the south lies the Old Style stage, which drew more mainstream talent. Of all the brewery stages, this is probably the most flexible, due to its position right off the south gate on a public street, which allowed acts to pull tour buses and trucks right into the backstage area.

But it can be tricky, according to Linnemann, who is in charge of the Old Style stage and is coordinating production on the other stages. "The stage itself is a permanent structure that was built under a four-lane highway that runs about 300 feet above the grounds," he explains. "Any engineer knows that when you're dealing with concrete and steel you'll have reverberant problems. That stage has a natural reverb sound that

some engineers like and some don't. The union FOH engineer who has been there for a few years is Bill Schmitt, and he works with the bands' engineers. Because of his experience there weren't any problems."

This stage received unique reinforcement. They brought in dB-designed HD 3 JBL-loaded mid-high cabinets, eight HDB low-end cabinets and Crown MA 2400 amps for the mains: a Yamaha PM3000 40x8x2 for the house, and a normal dB drive rack. A

Ramsa WR-S840 40x16 monitor desk was used with a mixture of Crown PSA 2s, Crest 8001s and MA 2400s for the monitors.

THE MARCUS AMPHITHEATER

The Marcus Amphitheater on the far south end of the Summerfest grounds is a fairly new shed, completed in 1988. Although most of the acts coming to play here carried their own sound, dB was asked to supply a system in case it was needed. Co-owner of dB Sound Bruce Gordon says

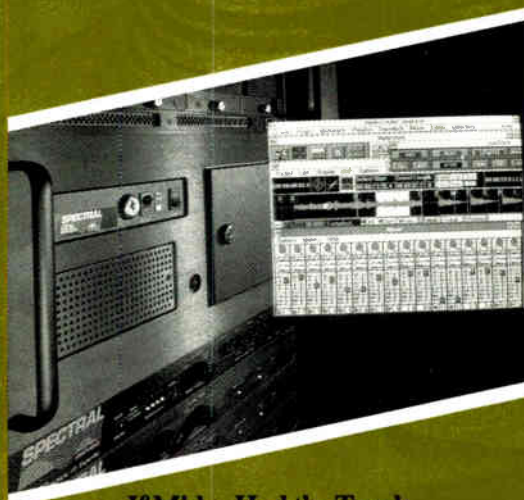

If Midas Had the Touch But Didn't Want to Part With the Cold Cash...

He'd get his hands on a Spectral Synthesis *Digital Studio*™. Or, if he had really itchy fingers, he'd go for Spectral's fully configured *AudioEngine*™.

After all, any of our hundreds of customers worldwide would agree that a Spectral Digital Audio Workstation is as good as gold to the audio/video pro. Spectral's state-of-the-art technology provides the utmost in speed, flexibility and power at a fraction of the cost of other systems.

Where else can you get a truly integrated real-time digital studio—16 tracks (with 256 virtual tracks!), up to 16 channels of I/O, 16-bit sampling, editing, digital signal processing and mixing, all controllable through MIDI and completely digital—without having to cough up the big bucks.

You don't have to be a King Midas to have the very best in digital recording and editing right at your fingertips and still keep your cash flow flowing.

With Spectral, everything you touch turns to gold.



19501 144th Ave NE, Woodinville WA 98072
TEL. (206) 487-2931 · FAX (206) 487-3431

MASTERING THE DIGITAL DOMAIN

USE READER SERVICE CARD FOR MORE INFO

that at first a system wasn't needed for the amphitheater. "As artists were added to the schedule and some dropped out, they called us at the end of May and told us they needed a system for the Marcus. So we brought a system up and left it in a truck. On the 26th, we used it for Clint Black and on the 27th we used it for Steve Miller. A few days went by and we brought it back in for The BoDeans on the second. We had a day off and brought it in for the rap package [Jodeci Mint Condition] on the fourth."

The system incorporated a Gamble EX 56 house console, a Ramsa WR-S840 monitor console, ten blocks of EV MT-4 with EV wedges for monitors, MT for sidefills,



Top: The Marcus Amphitheater stage. Bottom: Old Style stage monitor position.

and Crest 8001 amps for power all around. That's nothing to sneeze at for a shed this size.

I was able to catch three of the four shows at the Marcus, and the system was more than adequate. Gordon was pleased, too. "It went real well," he sums up. "All I can say is, we got some great reports." 🎧

Nort Johnson is assistant to the editor at Chicago Music Magazine and is a veteran of the concert, festival and touring scene. He is also a weekly guest speaker at the Concert Production program at Chicago's Columbia College.

Microphobia

(mī·krə·fō·bē·ə) n. The fear of feedback.

Awarded to FBX-M

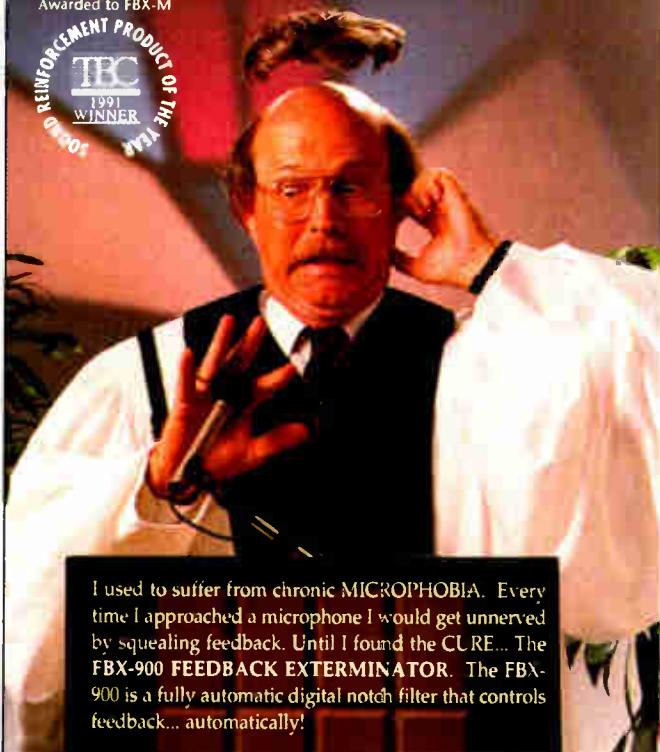

I used to suffer from chronic MICROPHOBIA. Every time I approached a microphone I would get unnerved by squealing feedback. Until I found the CURE... The FBX-900 FEEDBACK EXTERMINATOR. The FBX-900 is a fully automatic digital notch filter that controls feedback... automatically!



THE FBX-900 CURES FEEDBACK!

"Recently, we installed a sound system into the aerobics instruction area of a new health club facility. Normally, feedback occurs when a microphone moves in front of the speaker system, but here, we installed the FBX and it cured the feedback! Now the aerobics instructors can move freely around the entire room with their wireless."

Dean Sims - Intelligo Inc, Winona, MN

"I have used the FBX on a number of different venues and I knew that it worked. I didn't know just how good it worked until I faced a three day conference with changing humidity, temperatures and over 50 open mics... WITH NO FEEDBACK!"

Peter Archambault, PMA Industries, Johnson, RI

The FBX-900 Feedback Exterminator continuously monitors the sound program, detects resonating frequencies and places narrow 1/10 octave digital notch filters, automatically terminating feedback!

Call Sabine at 904/371-3829 for more information.



Sabine™

Musical Manufacturing Company, Inc.

4637 M.W. 6th Street • Gainesville, Florida 32609 • (904)371-3829 • FAX - (904)371-7441

*The names FBX-900 and FBX Feedback Exterminator are registered trademarks of Sabine Musical Mfg. Co., Inc.

MADE IN U.S.A.

USE READER SERVICE CARD FOR MORE INFO

SOUND REINFORCEMENT NEW PRODUCTS



FURMAN PS-8 POWER SEQUENCER

Furman Sound (Greenbrae, CA) offers the PS-8, a rack-mount power conditioner that not only absorbs harmful spikes, surges and RFI but also powers up a rack of equipment in a three-step delayed sequence. The sequence is automatically reversed on power-down. A multicolor display on the front panel indicates faults in the AC mains wiring. A model that allows remote operation (PS-8R) is also available.

Circle #212 on Reader Service Card

AVX AMPLIFIED HEARING PRODUCTS

Distributed by Group One Ltd. (Farmingdale, NY) is the AVX line of induction loop systems for hearing-impaired audiences or special audio programs such as museum tours. The system uses a single wire loop around the perimeter of the listening area (up to 5,000 square feet); once inside the loop, a standard hearing aid set to the "T" position (or the RXti beltpack and conventional headphone) receives audio in that area.

Circle #213 on Reader Service Card

ADAMSON AW18 WOOFER

Originally designed to be used in Adamson's (Pickering, ON, Canada) B218 and S218 enclosures, the AW18 woofer is now available. This 18-inch LF driver features a Kevlar cone, which the manufacturer says offers better transient response and extended low-frequency performance, while eliminating fatigue and modal breakups in the operating band.

Circle #214 on Reader Service Card

DOD SERIES II

The Series II line from DOD (Salt Lake City) includes two active crossovers (three-way stereo, four-way mono or two-way stereo/three-way mono), 31-band real-time analyzer with internal pink noise generator, and calibrated mic with 40-foot cable, quad noise gate, stereo gated compressor/limiter and five graphic equalizers (15- and 31-band versions in mono and stereo packages, with switchable low-cut filters). The dual 31-band Model 231 shown here has a frequency response of 20-20k Hz (± 0.5 dB) and 1/4-inch balanced/unbalanced inputs; balanced XLR inputs are optional.

Circle #215 on Reader Service Card



D&R AXION CONSOLE

Designed for high-end installations and touring applications is the Axion from D&R Electronics (Montgomery, TX). Priced from \$60,000, Axion provides features common to studio consoles but in a rugged package. Standard amenities include 12 aux sends, 4-band fully parametric EQ, 8 discrete buses, 8 VCAs, high-resolution meters, and an extensive microprocessor-based muting system under MIDI or SMPTE control.

Circle #216 on Reader Service Card



by Chris Stone

EQUIPMENT LEASING

IS IT FOR YOU?

The AES show is over, and you are presumably pondering which of the exciting new products you absolutely “must have” and how you are going to pay for them. Now is the time to consider equipment leasing as an alternative to direct purchase. There are many arguments for and against leasing vs. buying. Your decision should be based on your asset base; how good your credit is; your current retained earnings picture; and the amount of additional monthly payments, taxes and insurance that you can afford (in your opinion *and* in the leasing company’s opinion). Also consider how much cash flow you can reasonably expect to generate with your purchase, and your own desire to lease or buy.

The basics of lease vs. buy are fairly simple. If you buy something, you either write a check or borrow the money from someone, such as your bank or your mother-in-law, for which you negotiate terms of repayment. You may, in addition, negotiate extended terms with the manufacturer/dealer/owner of the desired equipment to pay them cash with no interest over a short period of time—usually between one and six months. This is an additional way to preserve your capital, and it allows you to retain your cash or stretch out your borrowing over a longer period of time. You take title to the equipment after you pay for it, enter it into your asset accounts and hopefully start to make money immediately with the new/used gear.

Most people are familiar with the process of buying. The ins and outs of leasing are not always as well known. Leasing does have many positives: First, leasing major items such

as consoles makes sense because it simplifies the task of determining what you need to pay each month (along with rent, telephone and payroll) to stay in business or to open that new room. Second, it preserves your credit line with your bank, which is usually based on 75% of the liquidation value of the assets you own. These new assets you are leasing will not be part of your owned asset base. This is financial leverage; getting the

OPERATOR’S TIP OF THE MONTH:

If you want to be positive about the details of your leasing deal, ask your lessor for an amortization schedule for your lease. This will be a little more work for the lessor, but it will show you any front-loaded interest (rule of 78s) and also let you know what your buy-out will be at any time you want to consider it. Very few people know this is available.

“most bang for your buck” in its simplest form. Third, your recording studio friends and industry associations such as SPARS can tell you who the good leasing brokers are and how much over bank prime rate they are charging for their leases.

A leasing broker can do all the paperwork on your lease and then place it with a bank. The bank will

—CONTINUED ON PAGE 168

Mix Directories

Have a New Look!



Don't miss your listing in the new **Mix Directories**! With over 15 years of directories experience, *Mix* is the leading resource for current, accurate listings of audio businesses throughout the U.S. and worldwide.

Mix's redesigned monthly directories provide the ideal format for promoting your facility, products or services to the professional audio industry. Here are a few **new features** included with your monthly listings:

New Photo/Logo Size

Larger Company Name in Bold Type

Icons to Represent Services Offered

Equipment Redesign

Call Lauri Newman **toll-free** at **(800) 344-LIST** (5478) for more information on how the new **Mix Directories** can increase your company's sales and visibility.

MIX

6400 Hollis Street #12
 Emeryville, CA 94608
 TEL (510) 653-3307
 FAX (510) 653-8171 or (510) 653-5142



RECORDING STUDIO
 Los Angeles, CA

Los Angeles, CA 90048; (213) 852-1505. **Manager:** Bill Dooley, Scott Stillman, Scott Studio: 30'x27', control room 10'x10'. **Equipment:** Neve 8078. **Audio:** 1) MklII, Ampex ATR-102 1/2" 4-track 1/2". (2) Panasonic 1/2" ES. **Monitors:** (2) Control used w/TAD components, (2) KRK "D00". **Other Major:** A-2A, (2) Fairchild 660, (2) QH2, GML 8220 parametric eq, mi-1 preamp, (2) UREI rawmer DS-201 dual gate, 300, EMT 140 tube reverb DMX-16, Yamaha REV-1, Lexicon 224, Lexicon 3000, (2) dbx 160, Sony 9R-32 video monitor, (2) re 32264 limiter, (2) 67, Neumann U47, (2) (5) AKG 451, Neumann (8) Siure SM57, (8) 409, (?) AKG D-12, (2) **ization & Credits:** Our o recordings possible, of a rather unique mix ar as well as many of ort has been made to uality while maintain- sphere, at an afford- de producers Tom fman, artists John



SCOTTSDALE CONFERENCE RESORT
 Scottsdale, AZ

SCOTTSDALE CONFERENCE RESORT

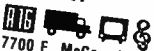

7700 E. McCormick Pkwy., Scottsdale, AZ 85258; (602) 596-7690; FAX: (602) 596-7420. **Owner:** Scottsdale Conference Resort. **Manager:** Brian Court, Dempsey, Terry Baker, John Haro, Mike Floor, Martin control room 20'x18'. **Dimensions:** Studio 21'x26', 24'x16', TAC Scorpion 16x8, Soundcraft 600 16x8, Tascam M4 8x4. **Audio Recorders:** Otari MX-70 16-track, Otari MTR-12 2-track w/center track time code, Otari 5050 MklII 2-track, Otari 5050B 4-track, (2) TEAC 3440 4-track, (2) Tascam 122, Nakamichi MR-1, Tascam 234 4-track, Tascam 133 3-track, **Monitors:** (2) JBL 4430, (2) Tannoy SRM-12B, (8) JBL 4401, (2) Auratone SC. **Other Major Equipment:** (8) dbx 150X Type I, (2) Adams-Smith 2600 synch, Adams-Smith LTC writer, Adams-Smith reader, Lexicon PCM42, Yamaha REV7, Eventide H949, (3) Yamaha SPX90, Lexicon 200, (3) Gatex noise gate, (3) dbx 166 comp/limiter, Symetrix 522, Scamp rack, Aphex II Aural Exciter, Studio Technologies AN-Z stereo simula- tor, (20) dbx 903 comp/limiter, (3) Klark-Teknik DN360 graphic EQ, (4) dbx 904 parametric EQ, dbx 902 de- esser, (3) Rane 10-band EQ, (6) Crest 3000, (2) Steinway 6'6" grand piano, Grass Valley 16001L switcher, Grass Valley DPM-100 digital effects proces- sor, Grass Valley model 100 switcher, Convergence 204 editor, Sony BVU-950 recorder, Sony BVU-920 DT recorder, (3) JVC CR-850U recorder, (3) Sony 5850 OAL camera, Ikegami ITC-730 camera, (2) M7 camera, (2)

by Terri Stone

FOCUS ON CANADA

W

HEN RECORDING IS A REAL CIRCUS

For someone who has never seen Cirque du Soleil, the avant-garde circus that is the pride of Canada, the first indication of the troupe's mad-cap sensibility is the language in which their latest CD, *Saltimbanco*,

the title, and that's a derivative of an old Italian word that means someone who does acrobatics in public."

Delaney is a freelance engineer based out of Studio Victor in Montreal, where *Saltimbanco* was mostly recorded. He has been at the board for the last two Cirque du Soleil CDs,



is recorded. Some tracks sound Slavic; maybe Polish, maybe Russian. Others have a distinctly African flavor. One might be Italian. None of them makes sense.

Engineer Michael Delaney reveals the secret. "It's totally fictitious. It was invented by Rene Dupere [one of the two men who arranged, programmed and produced the CD] and a few others. The only real word is

The process he describes of recording the latest project sounds as exhilarating as the show itself.

"These tracks are primarily used for the live shows," he says, "and that makes for a very concentrated gig. First, Rene goes to Cirque rehearsals to get ideas for music to accompany each act. Then he and Luc Gilbert [the main producer and a co-

—CONTINUED ON PAGE 112

PHOTO: AL SEIB

Vancouver Scene

by Tom Harrison

Will Bryan Adams' soon-to-be-opened studio change the course of the recording business in Vancouver?

As surely as Adams has been Vancouver's best known rock 'n' roll star for the past decade, the city's studios have been split into three identifiable camps since the mid-1980s.

The first group is centered around the high-profile recordings produced at Little Mountain Sound and Vancouver Studios by staunch hometowners Bruce Fairbairn (Bon Jovi, Aerosmith, AC/DC), Bob Rock (Metallica, Motley Crüe, Cher) and Mike Fraser (Jimmy Page, AC/DC).

The second group owes its existence to the sizable amount of film, TV and animation production being done here, which took off five years ago when Stephen J. Cannell (*MacGyver*, *Wise Guy*) began his move from L.A. to "Hollywood North," as Vancouver media like to refer to the city. The local industry got another hefty boost when Aaron Spelling (*Beverly Hills 90210*) likewise set up shop here this year, providing further incentive for such custom post-

production services as those offered by Dick and Roger's, which opened two years ago and is doing steady business, especially in the field of animation.

The last is the business-as-usual group, a plethora of established and new studios that cater to specialized areas of domestic record production (blues for Blue Wave, gospel/Christian for White Water, country for Bullfrog, to use three examples), jingles, demos or technical schools.

It's essentially a situation in which the best-known studios or most experienced people in the industry have created their own identities and enhanced the identity of Vancouver's recording profile as a whole. But, as Bob Rock warns, that situation could deteriorate quickly if those involved can't keep up.

"The facilities need to be updated," Rock says. "As good as Little Mountain or Vancouver Studios are, with the kind of recording I or Fairbairn or Fraser are involved in, we need a lot more than they are able to provide."

Rock's point is made by his decision to mix the next Bon Jovi album at A&M in L.A. Both he and Fair-

—CONTINUED ON PAGE 114

Toronto Scene

by Lynda Ashley and Terri Stone

"There is an amazing amount of American work being shot here. Toronto is booming for TV post-production," says Peter Mann, general manager of the one of the city's largest studios, Sounds Interchange. The reason for the healthy post market is predictable—the Canadian dollar. With its value hovering around 83 cents, Yanks get a great deal when they bring productions north.

About 60% of Sounds Interchange's business is commercial production, 30% is post-production work for television and movies, and about 10% is album work. Recent projects include new records by Jeff Healy and Anne Murray and *Panic in the City*, a CBS movie-of-the-week. "We are about double where we were a year ago," Mann says. "We didn't expect things to go this well, but they have. And we think business will be up another 25% next year." Sounds Interchange expanded its facilities—again—in October, adding to the \$25 million in

—CONTINUED ON PAGE 115

Studio Spotlight

Imuson Recording Studios of Montreal, designed by Pilchner Associates, recently opened with the local French-speaking market in mind: "Im" from *image*, "mus" from *musique* and "son" being the French word for sound. As its name indicates, the studio is equipped for music recording and audio-for-video post-production.

The studio is on the top floor of the turn-of-the-century Trebas Institute building in Old Montreal. Windows in the control room, MIDI room and recording studios provide natural light and views.

Imuson is designed for both educational and commercial clients. Trebas, an educational institution providing training in audio engineering, music production and music business, uses the studio for student productions. In addition, Trebas hopes to mine Montreal's business of French-language versions of North American videos and TV shows.



Equipment includes a DDA DMR-12 32-input console, an Otari MX-80B 24-track recorder and two Studer Editech Dyaxis digital audio workstations.

—FROM PAGE 110, CIRQUE DU SOLEIL

programmer and arranger] go to their home setup and sequence themselves to death. They also have to adapt the music for the album so it can stand on its own. After they've got it to a certain point, they come into the studio with their setup. They mostly use C-Lab's Notator for MIDI sequencing.

"Some of the tunes started as 24-track Dolby SR, and we'd fill up almost all 24 of the tracks," Delaney continues. "Not all of the pieces make the final cut for the show, so there was hesitation to do really elaborate work on anything initially. But the gun was on the studio crew because they wanted the CD available by the time the Cirque toured. Bill Szawlowski was mixing some tracks while I was cutting vocals for others. It's fun because you stay focused, but at the end of the project, we had a lot of crazy people bumping into walls.

"I made full use of Studio Victor's live room. It was built in the '30s and is quite large, so it permits me to use distant-miking techniques. On the strings and choir [a 12-voice choir appears on most songs] I use M-S distant-miking techniques, and on the drum kits I use close-miking for fullness with distant miking for the 'pow' factor.

"I used a lot of multiple miking on the kick and snare. For the snare it was a Shure SM57 and a [Sennheiser] 451; for kick drum it was a 421 and a Neumann TLM-170. I also used the AKG C-24 stereo tube."

With the prevalence of electronic reverb, a live room might seem unnecessary. "The advantage with a live room is that you automatically have a balance of direct sound and reflected sound," Delaney says. "Especially with such structured arrangements, we had a good idea of where everything would end up in the final mix when we went to put the instruments on.

"With an ambient mic, right away you have reflected sound, which the ear will interpret as being farther away. When you come to do the final placement, the thing will automatically sound farther away, so you don't have to goose up all this electronic reverb to pull the image farther away from you. That lets you

have something else in the foreground, [thereby creating] some depth of field."

Most of *Saltimbanco* was recorded in Studio A, which has an Amek Mozart board. Delaney calls the board "unusual" because "it uses bits and pieces, like a Prism input, a couple of Focusrite inputs, some old Neve compressors, and bits and pieces of an SSL, as well. That's one way to have the thick sound without having the entire board; the cost of a console like that would force you to have rates that are very high. We have to be competitive. In Quebec, you have 6 million people to target for French music. Automatically, your revenue's less, so your budgets are less as well. If your sales go over a couple hundred thousand, you're really cookin'."

Saltimbanco promises to reach a wider audience than the French-speaking Quebecois can offer. The Cirque recently struck a deal with BMG Records to release the CD internationally. Despite the fact that this is the first of the Cirque du Soleil soundtracks to get major release (previous soundtracks have been available at the shows), Delaney remains modest: "Billy did a great job in mixing, and a lot of credit has to go to the writers. The tunes lend themselves to a certain sound. Other than that, in all fairness I have to credit the musicians. For example, the drummers sound great, and for me it's only a question of 'put the microphone here, he probably won't hit it.' I just got the stuff off the floor and onto the storage medium."

BITS AND PIECES

Comfort Sound of Toronto had a busy summer. Among many other gigs, the studio's mobile truck covered the Ontario segment of Muchmusic's Canada Day broadcast. Comfort's senior music engineer Andrew St. George flew to Vancouver to mix the West Coast show, and Comfort alumni David Hillier did the St. John's, Newfoundland, segment of the 12-hour extravaganza. Spinal Tap appeared at all three locations, playing St. John's at 10 a.m., Toronto at 5 p.m. and Vancouver at 11 that night. Only the Tap could tour the country in one day... Vancouver Studios, which took over the operation of Little Mountain Sound late last year, pushed its boundaries further

with the start-up of two production companies. Queens Cross, a joint venture with Hollywood Production Co., produces and posts low-budget feature films. London Smith Discs, another Vancouver Studios venture also mentioned in the regional roundup, signed a label distribution deal with A&M Canada and should have its first two albums out by the time you read this... Tim Archer was promoted to chief engineer at Master's Workshop (Toronto)... Artists who recorded albums at Vancouver's Mushroom Studios in recent months include Numb (*Death On the Installment Plan*), Hanna Tiferel Siegel (*The Healing Circle*) and Mystery Machine (untitled at press time). Goldrush Recording Co. was in with the Robert Minden Ensemble to record a score for the National Film Board (*To Canada With Love and Some Misgivings*). In addition, Mushroom bade goodbye to longtime manager Linda (Nicol) Rosenbaum in September... Nick Blagona is a fairly recent addition to the staff of McClear Pathe Recording and Post-Production Studios in Toronto. Also at McClear, Mike Jones finished engineering the new Nylons album a few months ago... Sound Link Audio Services (Toronto) was made a new dealer for WaveFrame products... Recently in at Fluid Sound, located in Vancouver's historic Gastown district: Gary Comeau and Backseat Driver, Peter Honeychurch and the Zealots, the Sacred Hearts, Tippy a Go-Go, Barrie Balshaw (produced by Paul Hyde), Custer's Last Band Stand, The Ladybugs and CBC-TV, working on *The Jellybean Odyssey* with Michael Conway Baker... Toronto's BCB Productions was named the exclusive distributor of Clair Bros. products for Ontario... The Canadian Broadcasting Corporation bought three Neve audio consoles for use in the CBC television studios... Audio-Technica added several new rep firms to its roster. Distribution of the Artist Series, Uni-Point, 40 Series, wireless and teleconferencing products will be covered by Merchant Marketing for Ontario (excluding the Ottawa metropolitan area) and Fairwest Sales for all of western Canada. Yorkville Sound Ltd. will be exclusive distributor of the A-T Pro Series in Canada... The International Teleproduction Society elected new members to

Introducing the Alesis RA-100 Reference Amplifier



Every link in your studio is critical to good mixes. Studio monitors, your board... even your amplifier.

Why not improve your mixes and step up to the **Alesis RA-100 Reference Amplifier**. An amp designed for the critical demands of production audio. With the RA-100 and your monitor speakers, the mix you hear in your studio is the mix you'll hear everywhere else.

The RA-100 is accurate, dead quiet, and at 100 Watts a side*, has the power to do the job. It's like a straight line between your mixer and your monitors.

On stage the RA-100's cool operation and unique protection circuitry make it ideal for PA and sound reinforcement, with the punch and clarity your performances deserve.

Plus, through ingenious circuit design the RA-100 handles peaks and overloads intelligently, so it plays louder without audible distortion.

At \$349** the RA-100 is the unbeatable value in reference amplification. Kick your old hi-fi amp out of your studio and get an RA-100 at your Alesis dealer today. You'll hear exactly what you should be hearing.

**Into 4 Ohms, 75 Watts into 8 Ohms*

***Suggested Retail Price. Slightly higher in Canada*

Alesis Corporation 3630 Holdrege Avenue Los Angeles CA 90016



USE READER SERVICE CARD FOR MORE INFO

its board of directors, among them Phil Keeling of Magnetic Enterprises (Toronto)...SMPTE is holding its 134th Technical Conference and Equipment Exhibit in Toronto from November 10-13. The theme is "Images in Motion—The Second Century." Two all-day tutorials, "Multimedia World" and "The Post Experience," will be held concurrently on November 9.

Didn't see your facility or company name here? Send press releases and photos for inclusion in "International Update" to *Mix*, 6400 Hollis St., Ste. 12, Emeryville, CA 94608 U.S., attention Terri Stone. ■

—FROM PAGE 111, VANCOUVER SCENE

bairn are notorious stay-at-homes when it comes to working on projects. For this reason alone, he looks forward to the opening of Bryan Adams' studio.

"Vancouver's always been a good music town. Things like Adams' studio and what Roger is doing in animation are continuing that, so it's

pretty healthy. Adams is going to have a world-class studio."

Like his *Waking Up the Neighbors* album, which seemed to take an eternity to complete, Adams' studio has been anticipated since he purchased the best of the Neve consoles and a boarded-up heritage building in Vancouver's Gastown district four years ago.

Situated at 104 Powell Street, only blocks away from the office of his manager, Bruce Allen, the facility will house the revamped 56-channel Neve for tracking and a 72-channel SSL for mixing. A third room is being discussed for 1993 when the studio opens.

When it does open, it will be the ideal combination of Adams' fondness for vintage recording gear and his publicized efforts to preserve some of the city's architecture. It also will have a rival of sorts in the shape of a 48-track SSL facility being built for Adams' former writing partner, Jim Vallance.

These studios are the latest developments in a creative relationship that launched itself at Little Mountain Sound in the late 1970s. Designed to

accommodate jingle production, Little Mountain also provided a creative environment not only for Adams and Vallance, but for the engineers and producers who have worked there.

As Fairbairn's star rose with his work on LPs by Loverboy, Blue Oyster Cult and then Bon Jovi's *Slippery When Wet*, he brought along Bob Rock, who brought along Mike Fraser. Their successes prompted Bruce Allen to set up a corporate management division to handle the careers of Fairbairn, Rock, Ken Lomas (Little Angels, Thunder, Aerosmith) and Randy Staub (engineer on the last Motley Crüe and Metallica albums).

Their success also saved Little Mountain Sound, which endured several years of financial fiascos until Bruce Levens, operator of the competing Vancouver Studios (Bonnie Raitt, k.d. lang, London Quireboys), took it over late last year and overnight gave himself access to seven of the best-known rooms in Vancouver. Levens, young, aggressive and close to the rhythms of the city's teeming original music scene, has taken Little Mountain into yet another arena with the establishment of London

This is not a toy!



Reverb by DYNACORD

Audio Quality

When Dynacord set out to build a new reverb/multi-effects processor, the goal was superb audio quality and an abundance of high quality reverb programs and effects structures, all in an extremely user friendly configuration. The finished product is the DRP-15. A powerful creative tool — not a toy.

Advanced Technology

With 24 bit internal processing utilizing a custom chip developed by Dynacord engineers, the DRP-15 is fast, clean & rich with a smooth tail. Add an S/N ratio of >104dB, and you have a reverb with superb audio quality as well as computing power and flexibility to spare.

Unlimited Options

The DRP-15 has 100 factory pre-set programs and 128 programmable user memories. In addition there are (10) effect structures which allow manipulation of EQ, reverb, modulation, pitch shift, delay, and dynamic parameters. Of course the DRP-15 is fully MIDI compatible.

Dynacord: Hirschberger Ring 45, D-8440, Straubing, Germany, Tel: 09421-7060
Pinnacle Audio: Exclusive USA Distributors, 200 Sea Lane, Farmingdale, NY 11735. Tel: (516) 249-3660

USE READER SERVICE CARD FOR MORE INFO

Smith Discs (LSD), an indie label that has inked a distribution deal with A&M.

Around the corner from Levens is Dick and Roger's, 1,000 square feet of comfortable working space designed by two more alumni of Little Mountain, Dick Abbott and Roger Monk.

"Little Mountain specialized," says Monk, "but the key to our success is that we diversified. We can do a cartoon series such as *The Adventures of T Rex* and also digitally edit a recording project such as Rock-head."

From his vantage point, Monk sees how his business reflects a shift that began when Pinewood, one of the first of the city's 24-track facilities, moved exclusively into the area of film and TV work a decade ago. As "Hollywood North" has grown and the jingle business and local record production has been swatted around by the economy, Pinewood has been followed by Post Modern (formerly the Spot Shop, owned by David Hall and Mark Scott), Wave Productions and others.

"The people who are doing well have been here a long time," Monk observes. "We've all found our own niches."

Tom Harrison is a music critic for the Vancouver Sun.

—FROM PAGE 111, TORONTO SCENE

upgrades the facility completed a little over a year ago.

Not everyone is as positive as Mann. Kevin Evans is general manager of Manta Eastern Sound, the product of a merger of two of Toronto's oldest studios. He says bluntly that mid-summer was a disaster, particularly in albums, but adds that his firm has been doing a lot of commercial work lately (mostly jingles) and is bidding on a few TV shows.

"The recession brought on a lot of competitiveness," Evans says, "and now anybody with a digital audio workstation can call themselves a production house. The studios here have to be very diversified to compete effectively: do commercial work, albums, everything. It looks like we'll be busy in the fall, but we are cautious. We'll have two really busy days, and then the next

MICRO SOUND

Digital Audio Workstations

38 Stereo-Tracks

When even 24 tracks are not enough...

Use hundreds of stereo segments to build hour+ Mixes with up to 38 playing at the same time! Create and move audio segments as easily as MIDI sequencing.

Sample precision graphic wave editing allows instant, seamless changes to be done/undone/redone at any time, while zone mixing further increases speed.

Record master files direct to disk using simultaneous record/play overdub and sync optionally to MTC, SMPTE or Video for sample precision synchronization.

Ready to run 486-33/50MHz Workstations starting at \$7,795 with 96 track-minutes @ 44.1KHz. Add to your computer - \$3,690.

Ask today for a free 24 page brochure to discover how MicroSound will improve your professional productivity.

Special limited edition price \$117



(919) 870-0344
Fax: (919) 870-7163



Micro Technology Unlimited
156 Wind Chime Court
Raleigh, NC, USA 27615

USE READER SERVICE CARD FOR MORE INFO

THE NEWEST IN DIGITAL AUDIO TECHNOLOGY

only at
THE DAT STORE

NEW IN STOCK: CD RECORDERS

DIRECTLY RECORDS AUDIO FROM ANY SOURCE • HI-FI RECORDING DISC COMPATIBLE W/ CONVENTIONAL CDS

NEW IN STOCK: MICRO DAT RECORDERS

ULTRA SMALL 3/4" SIZE CASSETTE • LONG BATTERY LIFE WITH SINGLE "AAA" BATTERY • DIGITAL STEREO RECORDING

COMING IN OCTOBER: DCC

DIGITAL RECORD/PLAYBACK W/ OUTSTANDING SOUND QUALITY • PLAYBACK COMPATIBILITY • QUICK TRACK ACCESS W/ ADDRESS DATA • TEXT INFORMATION DISPLAY

COMING IN NOVEMBER: MINIDISC

QUICKRANGE SEARCH • TOTAL DURABILITY • SHOCK & VIBRATION RESISTANT COMPATIBILITY • 74 MINUTE RECORDABLE DISCS • SUPERB COMPACTNESS W/ EXCELLENT SOUND

IN STOCK SINCE 1988: DAT RECORDERS

COVER 30 MAKES 41 MODELS SALES • RENTALS • REPAIRS • DUPLICATIONS • DAT TO DAT • DAT TO CD • CD TO CD • AAA BATTERIES & BULK MEDIA FOR ALL RECORDERS • ACCESSORIES & BULK MEDIA FOR ALL RECORDERS

CALL TODAY!

THE DAT STORE

2624 WILSHIRE BOULEVARD SANTA MONICA, CALIFORNIA 90403

WEEKDAYS 9-6 SATURDAYS 1-4 CLOSED SUNDAYS

• FAX 310-828-8757

310-828-6487

—FROM PAGE 115, TORONTO SCENE

day you could shoot a cannon down the hall and not hit anybody. It's been a tough year to track."

Bob Predovich is vice president and general manager of Master's Workshop, an award-winning audio post-production facility that is celebrating its 20th anniversary this year. He says that the Toronto market has been slow for the last few years but that "business is starting to pick up. We've seen a dramatic upturn in the industry in general since about May."

Predovich attributes the resurgence to several factors. "The Canadian dollar dropped relative to the U.S. currency; we have co-production treaties with a number of countries around the world; and the Canadian industry has matured tremendously in the last few years. The quality now is such that our shows sell internationally, including in the U.S. market."

Predovich does not feel that the current boomlet will match the one that swept the city in the last decade,

however. "The Toronto scene has an oversupply of audio post facilities right now. Companies with ties to production groups are doing well, but there are other companies experiencing layoffs. The industry's at a point where it has to restructure and deal with a new reality that's very different from the '80s."

Still, Predovich remains optimistic. "More people will realize that you have to exploit your existing equipment and technologies in a more efficient way. We'll see a lot of indigenous production that will be looked upon favorably in the European and American markets. We are going to see a big upturn in this town over the next few years."

Metalworks Recording Studios, in suburban Mississauga, has only experienced the recession in a marginal way, according to studio manager Alex Andronache. "We're always busy, but our clients' budgets may be bare-bones. In the old days, producers would fax a shopping list of additional equipment and be very brand-specific. Now they'll work with what we have."

Andronache believes that Metal-

works is one of the few studios left in the Toronto area that focuses almost solely on album work. "But domestic music alone wouldn't keep us alive. About 40% of what we do comes from the United States or Europe, especially within the last year or so," he says. Gun N' Roses did some clandestine vocal overdubbing there last year for *Use Your Illusion II*, and Butch Vig recently flew in for lunch to check out the scene. Andronache says that Vig was impressed by Metalworks' "vibe."

Andronache attributes much of the studio's success to that vibe, a quality he can't define exactly but that has something to do with the treatment the talent receives. He also stresses the importance of the high number of repeat clients. Metalworks' continued growth in music, while other studios are turning to industrials and jingles to stay alive, has Andronache understandably upbeat: "Music is alive and healthy up here!"

Toronto writer Lynda Ashley covers audio and video production. Terri Stone is an assistant editor of Mix.

Studio Automation!



CM AUTOMation's MX-816 Pro Mixing Automation System empowers studio engineers, producers and musicians with programmable fader movement, fader recall, snapshots, scenes, mutes, crescendos, decrescendos and timed audio fades. Mix, mute or fade effects in and out. Silence blazing guitars, automate fading footsteps and the delicate mix within a string quartet. Combine vocal parts from multiple tracks into the best performance composite track or send it directly to the master. The MX-816 takes audio dynamics management to new plateaus. No matter what kind of media you're working with: film, video, records, live performance or any multi-media production, the MX-816 opens up new dimensions and directions for audio and signal processing creativity. Control the MX-816 from your MIDI sequencer, MIDI keyboard or MIDI faders. Now you really can fix it in the mix!

Special Features

- * Groups of 8 channels are summed out to produce mix/send out
- * Mute and Max buttons for easy manual control
- * MIDI controlled audio muting (gated or toggle types) using note events
- * Programmable note numbers for channel mute
- * Master mute to mute all channels with one key
- * Supports CM AUTOMation PRO MIX-net for up to 32,000 audio channels
- * 100 patch internal memory to store and recall snapshots and scene fade times
- * Internal patch memory up and down loadable via MIDI system exclusive
- * 28 internal pre-programmed master autofades
- * Separate receive channels for scene recall and channel volume
- * Manual "joystick" scene fade feature
- * Assignable MIDI controller numbers for volume
- * Uses industry standard DX 2150A VCA's and 5532 low noise op amps
- * Ground lift switch to minimize system noise
- * Gold plated audio jacks used thruout

Available in Los Angeles at
West L.A. Music & in New
York at Sam Ash Pro Audio

CM AUTOMation MX-816 Mixing Automation

402 Museum Drive Los Angeles, CA 90065

Sales (800)238-7010, In California (714)488-0024, FAX (818)709-4039

USE READER SERVICE CARD FOR MORE INFO

CANADIAN RECORDING STUDIOS

ALBERTA

AARDVARK RECORDERS 24 TRACK



530-B "S" St. S.; Lethbridge, AB T1J 2B8; (403) 328-4261. Owner: Murray Nelson. Manager: Kevin Wittke & associate.

BETA SOUND RECORDERS LTD.



10534 109 St.; Edmonton, AB T5H 3B2; (403) 424-3063; FAX: (403) 425-2789. Owner: Gary Koliger. Manager: Gary Koliger.

WEST 11TH AUDIO



822 11th Ave. SW Ste. 306; Calgary, AB T2R 0E5; (403) 265-0258; FAX: (403) 266-0890. Owner: Lanny Williamson. Manager: Metro-media Productions. Engineers: Chris McIntosh, Bruce David Leill, Greg Gunhold. Dimensions: Room 1: 14'x12', control 14'x24'. Room 2: control 12'x14'. Room 3: control 14'x14'. Room 4: 24'x18'. Mixing Consoles: Peavey Production Series 32x16x32. Hill Remix 40 input, Tascam 24x4x2, Mackie 1604. Audio Recorders: (6) Alesis ADAT, Studer A80 MN2 16-track 2", (4) Panasonic SV-3700 DAT, TEAC DA-P20, Tascam B12-20T 1/4", Fostex Model 20 1/4", Studer B67 1/4", Scully 280-4, Scully 280-8, Ampex AG440-2. Digital Audio Workstations: Studer Dyaxis. Monitors: Altec 604E custom, (2) Peavey 308, (3) Yamaha NS-10, Auratone, JBL 4311. Other Major Equipment: Adams-Smith Zeta-3B, (3) Sony 7020 3/4" video, (3) Sony SLV-676 1/2" video; NEC & Sony monitors; Drawmer, UREI, Alesis compression; Mac, Atari, IBM computers; Crown power amp; Lexicon, Yamaha, DigiTech, Roland FX processor; Niche automation; Neumann M49, AKG, Beyer, EV microphone; Symetrix phone tap; Korg, Roland, Ensoniq, Peavey keyboards; Cubase, SMPTE track sequencers; 450 sq. ft. video soundstage.

BRITISH COLUMBIA

BASTION CITY MOBILE RECORDING LTD.



3760 Departure Bay Rd.; Nanaimo, BC V9T 1C4; (604) 758-3424. Owner: B.C. Recording. Manager: Scott Littlejohn.

BLUE WAVE PRODUCTIONS LTD.



34 West 8th Ave.; Vancouver, BC V5Y 1M7; (604) 873-3388; FAX: (604) 873-0674. Owner: Tom Lavin. Manager: Diane Delorme.

BULLFROG RECORDING STUDIOS



2475 Dunbar St.; Vancouver, BC V6R 3N2; (604) 734-4617; FAX: (604) 733-0840. Owner: Bullfrog Recording Company Ltd. Manager: Maggie Scherf.

CREATION STUDIOS LTD.



7490 Edmonds St.; Burnaby, BC V3N 1B4; (604) 525-3422; FAX: (604) 980-3805. Owner: Jim Woodyard, Rob Des Cotes. Manager: Jim Woodyard, Rob Des Cotes, John Merritt.

8TH AVENUE SOUND STUDIOS



66 W. 8th Ave.; Vancouver, BC V5Y 1M7; (604) 873-8765; FAX: (604) 873-8765. Owner: T. Wayne Kozak. Manager: Cathy Kumpera.

MUSHROOM STUDIOS



1234 W. 6th Ave.; Vancouver, BC V6H 1A5; (604) 734-1217; FAX: (604) 734-3901. Owner: Charles Richmond. Manager: Valerie Biggin.

PERRY'S RECORDING STUDIO



711 Seymour St.; Kamloops, BC V2C 2H4; (604) 828-8729 (TRAX). Owner: Douglas Perry. Manager: Douglas Perry.

TURTLE MOBILE RECORDING LTD.



1505 W. 2nd Ave., Ste. 202; Vancouver, BC V6H 3Y4; (604) 731-2446; FAX: (604) 732-0922. Owner: Larry Anschell, Dave Trgovcic. Manager: Larry Anschell.

Vancouver Studios

VANCOUVER STUDIOS INC.
Burnaby, BC

VANCOUVER STUDIOS INC.



3955 Graveley Street; Burnaby, BC V5C 3T4; (604) 291-0978; FAX: (604) 291-6909. Manager: Ray Gagliardi. Engineers: Steve Royea, Rod Shupenia, Jason Mauza. Dimensions: Room 1: 44'x27'1", control room 23'6"x24'1". Room 2: 24'1"x17'6", control room 19'10"x17'6". Room 3: 23'8"x11'10", control room 20'11"x10'1". Room 4: 39'6"x38'4". Mixing Consoles: SSL 4056 G Series w/Total Recall and Bar Graphs, Neve 8058, MCI JH-5000 w/automation. Audio Recorders: Studer A800 24-track analog, (3) Otari MTR-100 24-track analog, Otari MX-80 24-track analog, Otari MTR-12 2-track 1/2" analog w/center track time code, Otari MTR-12 2-track 1/4" analog w/center track time code, Otari MX55 2-track 1/4" analog w/center time code, (3) Panasonic SV-3700 DAT, Panasonic SV-3500 DAT, (2) Nakamichi MR-2 cassette, (4) Aiwa ADf810 cassette, Sony PCM3402 2-track digital (DASH). Digital Audio Workstations:

(2) Solid State Logic Screensound Units w/4.0/4.1 software, SoundNet and Diskstore, Avid Media Composer 2000. Monitors: (2) UREI 813C, Tannoy, (2) JBL 4406, (5) Yamaha NS-10, (3) Auratone. Other Major Equipment: (5) TimeLine Lynx synchronizer, (2) TimeLine Lynx KCUC controller, Lexicon 480L, (2) AMS RMX16, (2) Tube-Tech PEQ1 EQ, Korg SDD-1000, (2) TC Electronic 2290/2240 EQ, (2) Eventide H3000 Harmonizer, Yamaha RX17 drum machine, Korg DRV3000 effects processor, selection of 65 current and vintage microphones including: Neumann, Sennheiser, AKG, Calrec Soundfield; Dolby SP24 SR noise reduction 24 channel, (2) Dolby 363 SRIA 2 channel, Yamaha SPX90 effects processor, (2) GML 8200 EQ, (2) Lexicon PCM70 effects processor, (4) BVU800 3/4" video tape recorder, (2) BVU950 3/4" video tape recorder, JBL projection system, BVH2000 1" video tape recorder. Specialization & Credits: Album credits: Queensryche *Empire*, k.d. lang *Ingenua*, *Red, Hot & Blue*, *Absolute Torch and Twang*, Cher, Salt 'n' Pepa, Tom Cochrane, The Odds, London Onireboys, Bob Rock, Skinny Puppy, Barney Bentall, Sara McLaughlin, Sons of Freedom, Annihilator. Film credits: picture and sound editorial, film scoring and ADR/Foley facilities. *A Passion For Murder*—starring Michael Ironside, Michael Nouri. Saban Entertainment: *Boys Will Be Girls*—starring, Corey Haim, *Morning Glory*—starring Christopher Reeves, Steven Stern/Michael Viner Production and *Liar, Liar*—starring Kate Melligan—CBC television movie. TV credits: ADR/Foley/editorial facilities/mix. Various series NHK-TV Japan.

WHITE LINE LOCATION RECORDING LTD.



1052 E. 61st Ave.; Vancouver, BC V5X 2C4; (604) 327-8107; FAX: (604) 327-8107. Owner: David Kellin.

NOVA SCOTIA

REEL TIME RECORDERS LTD.



1489 Hollis St.; Halifax, NS B3J 3M5; (902) 422-8567. Owner: Chuck and Mary O'Hara. Manager: Chuck O'Hara.

ONTARIO

ART-TEC PRODUCTION AND RECORDING



323 Talbot St., 2nd floor; St. Thomas, ON N5P 1B5; (519) 633-9549; FAX: (519) 633-9549. Owner: Kevin & Michelle Taylor. Manager: Michelle Taylor.

EDDY BALTIMORE PRODUCTIONS



439 King St. E. #5; Toronto, ON M5A 1L5; (416) 364-9813. Owner: Edward Hutchison. Manager: Eddy Baltimore.

BROCK SOUND POST AUDIO



576 Manning Ave.; Toronto, ON M6G 2V9; (416) 534-7464; FAX: (416) 538-2563. Owner: Brock Fricker. Manager: Brock Fricker.

CHALET STUDIO



RR #4 Claremont; Toronto, ON L0H 1E0; (416) 649-1360; FAX: (416) 649-2951. Owner: David Chester. Manager: Everett Ravestein.

COMFORT SOUND 24 TRACK MOBILE



26 Soho St., Ste. 390; Toronto, ON M5T 1Z7; (416) 593-7992. Owner: Doug McClement. Manager: Doug McClement. Engineers: Gabe Lee, Andrew St. George. Dimensions: Control room 8'x22'. Mixing Consoles: Neotek Elite 50 input. Audio Recorders: (2) Ampex MM1200 24-track, Tascam DA-30 DAT, Technics RS-1500NS 2-track, Tascam C-3 cassette. Monitors: Tannoy NFM-8, Auratone. Other Major Equipment: (6) dbx 160 compressor, (2) dbx 165 compressor, (4) Drawmer DS-201 noise gate, Lexicon PCM60, Yamaha REV7 digital reverb, Yamaha SPX90, Yamaha 1500 digital delay, QSC

—LISTING CONTINUED ON NEXT PAGE

- Maximum digital tracks
- Maximum analog tracks
- Remote audio recording
- MIDI production
- Tape duplication
- Mix to picture
- Digital editing/CD prep
- In-house music services



—LISTING CONTINUED FROM PREVIOUS PAGE

power amp. (2) Panasonic video monitor, Panasonic color camera, Clear-Com MS-210 Master Station, RCA VHS Hi-Fi recorders, (2) BGW 100 power amp, Amcron D60 power amp, 500' 54-pair transformer isolated mic snake, SDLA 5kVA isolation transformer, Rane graphic EQ, (24) microphone, DI and etc.; (6) AKG K240 headphones, SMPTE time code reader. **Specialization & Credits:** Comfort Sound Mobile has over 900 remote recordings to its credit over the past 15 years. We specialize in music television specials, awards shows, telethons and live albums. Clients include MTV, Sony Music (New York), CBC-TV, Showtime, Nickleodeon, PBS, Muchmusic, Disney and MCA. We've recorded Bryan Adams, Ozzy Osbourne, Glen Campbell, B.B. King, Celine Dion, Super Dave, The Police, k.d. lang, Living Colour, Elvis Costello, Tony Bennet, Spinal Tap, Randy Travis, Martin Short, Motorhead, Raffi, Steve Earle and Oscar Peterson. We can supply digital multitracks if required and our Neotek console is easily configured for 48-track recording and monitoring. We also have a 24-track airpale system which can be flown anywhere in the world. Chief remote engineer Doug McClement has done remotes in Spain, Nigeria, Florida, Michigan, New York, and in every province in Canada. Our motto: "Quality, whether you want it or not!"



db RECORDING STUDIOS
London, ON

db RECORDING STUDIOS



46 Charterhouse Crescent, London, ON N5W 5V5; (519) 659-9529; FAX: (519) 663-8074. Owner: Dan Brodbeck, Rick Brodbeck. **Manager:** Dan Brodbeck. **Engineers:** Dan Brodbeck, Brian Burnes, Geoff Warder, Bill Cox (maintenance). **Dimensions:** Studio 35'x23', control room 20'x19'. **Mixing Consoles:** D&R Dayner 42 36-channel inline. **Audio Recorders:** Sony/MCI JH-24 24-track w/Autolocator III, Tascam MSR-16 16-track, Otari MX-5050B 2-track, Nikko D-60W cassette, Tascam OA-30 DAT. **Digital Audio Workstations:** Digidesign Sound Tools w/Mac IliX 1.2 gig hard drive. **Monitors:** Tannoy System 2.15 DMT, Tannoy PBM-6.5, Yamaha NS-10M. **Other Major Equipment:** Roland R-880 w/GC-8 remote digital reverb, (2) Roland SRV-2000 digital reverb, (2) Yamaha REV7, Alesis Quadraverb, Roland SDF-2500, Roland E-660 digital EQ, (2) Rane RE-27 EQ, Akai PEQ06 EQ, Tascam PE40 EQ, (2) Symetrix 522 gate/comp/exp, (2) Symetrix CL-150 comp, Furman U3A comp, Drawmer OS-404 4 channel gate, Drawmer M-500 dynamic processor, Symetrix 501 comp, Adams-Smith Zeta-3 synchronizer, Akai ME-35T MIDI Trigger, Akai MPC60, Roland RD-1000 digital piano, Sequential Circuits Prophet VS, VOX AC30 (1963) amp, Fender Virulex (1970) amp, Fender Tweed Deluxe (1955) amp, Pearl BLX drum kit, Gretsch vintage drum kit, (2) Roland S-550, Roland MKS-20, Roland MKS-70, Roland MKS-50, E-mu Performance piano mod., Yamaha TG77, Kurzweil K-2000, Korg M-3R, Roland D-70, (2) Roland D-50, Peavey DPM-V3, (25) mics including AKG, Sennheiser, Shure, CAD, EV, etc.

E.M.A.C. RECORDING STUDIOS



432 Rectory St., London, ON N5W 3W4; (519) 667-3622; FAX: (519) 642-7453. **Owner:** Electronic Media Arts Corp. **Manager:** John Farrelly.

EXPERIMENT IV RECORDING STUDIOS



133 Lawson Road, Scarborough, ON M1C 2J3; (416) 284-3794. **Manager:** Edward Agabeg.



INCEPTIONS SOUND STUDIOS
Toronto, ON

INCEPTIONS SOUND STUDIOS



3876 Chesswood Dr., Toronto, ON M3J 2W6; (416) 630-7150; FAX: (416) 630-7157. **Owner:** Chad Irschick, Jeff Wolpert, Harold Kilianski. **Manager:** Harold Kilianski. **Engineers:** Chad Irschick, Jeff Wolpert, Harold Kilianski, Jacques Poirier, Michael Roper. **Dimensions:** Room 1: studio 20'x30', control room 19'x22'. Room 2: studio 18'x26', control room 19'x17'. **Mixing Consoles:** (2) MCI JH-536 w/Diskmix automation and Hardy preamp. **Audio Recorders:** (2) MCI JH-24 24-track w/Oolby SR, MCI JH-110, Ampex ATR-102, Otari MTR-12, Sony 5003, Fostex D20B DAT, Panasonic SV-3700 DAT, Sony OTC 1000 w/Apogee filters, (2) Aiwa HD-X1 DAT. **Digital Audio Workstations:** Sonic Solutions Sonic Station. **Monitors:** (2) State of the Art Electronic CF7 50, (2) Meyer Sound HO-1, (2) Dynaudio Acoustics M1, (4) Yamaha NS-10M, (4) Paradigm 3SE-Mini. **Other Major Equipment:** Adams-Smith 2600 w/controller, Lexicon 480L, (2) AMS RMX16, (2) Klark-Teknik DN780, (2) GML transformerless mic preamp, GML Moog 8200 parametric EQ, GML Dynamic Gain Control Series II, Tube-Tech CL 1A compressor, Tube-Tech PE1B program EQ, Publison IM90, Aphex Systems Compelor, Valley People 610, (2) dbx 160, UREI 1176LN, Drawmer DS-201 dual gate, Publison CL20C, Neumann/Stephen Paul U47 tube, Sanken CU41, AKG The Tube.

MAGNETIC MUSIC



550 Queen St. E., Ste. 205; Toronto, ON M5A 1V2; (416) 367-3600; FAX: (416) 367-4563. **Owner:** Magnetic Enterprises. **Manager:** David Greene.

MANTA EASTERN SOUND



311 Adelaide St. E., Toronto, ON M5A 1N2; (416) 863-9316; FAX: (416) 863-1448. **Manager:** Kevin Evans.

MARGAREE SOUND



225 The Lake Driveway West; Ajax, ON L1S 5A3; (416) 683-5680; FAX: (416) 683-5680. **Owner:** Russell Daigle. **Manager:** Russell Daigle. **Engineers:** Murray Daigle, George Graves, Russell Daigle. **Dimensions:** Room 1: studio 14'x12', control 23'x12'. Room 2: studio 14'x16'. **Mixing Consoles:** Tascam M600 32x24x16x2. **Audio Recorders:** Tascam MSR24 24-track w/dbx, Tascam T52 1/2-track, Tascam DA-30 DAT, Tascam 122 MKII cassette, Nakamichi MR-1 cassette. **Monitors:** RCF 600, NS-10, Klipsch Heresey. **Other Major Equipment:** Bryston 4B amp, Yamaha 215C amps, wide range of outboard gear by Drawmer, Lexicon, Audio Logic, Yamaha, BBE, Alesis, etc. Mics—wide selection by AKG, Neumann, Shure, Electro-Voice, etc. Extensive MIDI setup: DX7 IID, Atan computer, samplers etc. Good selection of musical instruments by Martin, Fender, Ibanez and others. **Specialization & Credits:** Margaree Sound is fast becoming recognized for producing high-quality maritime music. Recordings of John Allan Cameron, Russel Daigle and John Prince continue to keep the Margaree name prominent.

MASTER'S WORKSHOP



306 Rexdale Blvd., Ste. 7; Mississauga, ON M9W 1R6; (416) 741-1312; FAX: (416) 741-1894. **Manager:** Jim Frank.

MASTERTRACK LTD.



35-A Hazelton Ave., Toronto, ON M5R 2E3; (416) 922-4004; FAX: (416) 922-8634. **Owner:** Ken Burgess. **Manager:** Jim McBride.

MCCLEAR PATHE RECORDING & POST



225 Mutual St., Toronto, ON M5B 2B4; (416) 977-9740; FAX: (416) 977-7147. **Owner:** Robert Richards. **Manager:** Jane Rowan.

METALWORKS RECORDING STUDIOS



3611 Mavis Rd., Unit #3; Mississauga, ON L5C 1T7; (416) 279-4008; FAX: (416) 279-4006. **Owner:** Metalworks Studios Inc. **Manager:** Alex Andronache.

MUSIC GALLERY



1087 Queen St. W., Toronto, ON M6J 1H3; (416) 534-6311; FAX: (416) 536-1849. **Manager:** Paul Hodge.



NUMBER 9 SOUND STUDIOS INC.
Toronto, ON

NUMBER 9 SOUND STUDIOS INC.



314 Jarvis St., Ste. 101; Toronto, ON M5B 2C5; (416) 348-8718; FAX: (416) 348-9668. **Owner:** George Rondina, Jim Zolis. **Manager:** George Rondina. **Engineers:** Jim Zolis, George Rondina, Vic Florenca, Gary Fishman. **Dimensions:** Studio 20'x35', control room 20'x25'. **Mixing Consoles:** Amek Angela. **Audio Recorders:** MCI/Sony JH-24, Revox A-810, Revox PR-99, Panasonic SV-3500, Tascam DA-30, Sony PCM-701ES, Aiwa HD-51, (10) Sony TCK-677ES. **Digital Audio Workstations:** Sluder Dyaxis. **Monitors:** Meyer HD-1, Yamaha NS-10 studio, (2) Yamaha NS-10M, Paradigm SE-3 Mini, Tannoy NFM-8, Tannoy PB 6.5, JBL 4311. **Other Major Equipment:** Focusrite 4-channel EQ, Neve 1064 2-channel, Tube-Tech PE-1B 2 channel, Lexicon 480L, (2) Lexicon PCM70, Eventide H3000, (2) Yamaha SPX90 II, (2) Alesis MIDIDiver II, Yamaha O1500 DDL, SSL G384 comp, (2) dbx 160X, dbx 166, UREI LA-4A, (2) Drawmer DL-241, Drawmer OS-201 gate, (3) Ashley SC-33, Telefunken U-87, AKG The Tube, AKG 414, (2) Microtech Gefel GmbH, etc. **Specialization & Credits:** Located in the heart of downtown Toronto, Number Nine Sound Recording Studios is within walking distance of several fine hotels and restaurants. Our philosophy is to deliver high-quality work which has allowed us to remain on the cutting edge of today's high-tech recording industry. Additional services include digital editing and mastering, real time cassette duplication, pro audio equipment rentals and in-house production and programming. Some of our clients include Celine Dion, The Nylons, Candi and the Backbeat, John James, Maestro Fresh Wes, Kish, Glass Tiger, Jane Siberry, Andy Curran, Slick Toxic, Andrew Cash, The Northern Pikes, and The Waltons as well as independent labels and artists. International clients for equipment rentals include Steve Winwood, Pink Floyd, Spinal Tap, ZZ Top, Midnight Oil, En Vogue and others. For rates and information call George Rondina or Jim Zolis at (416) 348-8718 or fax us at (416) 348-9668.

ONE DESTINY ENTERTAINMENT GROUP



PO Box 52; Smiths Falls, ON K7A 4S9; (613) 284-8371; FAX: (613) 283-9850. **Owner:** One Destiny Entertainment. **Manager:** Danielle Gembara.

1:2:1 RECORDING



121 Logan Ave., Toronto, ON M4M 2M9; (416) 406-4121; FAX: (416) 406-0319. **Owner:** Andrew S. Hermant. **Manager:** Melinda Skinner.

THE P.A. DOCTOR



439 King St. E., #5; Toronto, ON M5A 1L5; (416) 364-9813. **Owner:** Edward Hutchison. **Manager:** Patricia Ormsby.

PIAZZUOID RECORDING STUDIO



3615 Weston Rd., Unit 10; Weston, ON M9L 1V8; (416) 748-7440; FAX: (416) 748-6146. **Owner:** Barry Lubotta. **Manager:** Barry Lubotta. **Engineers:** Barry Lubotta, Rob White, Michael Jack, Joey Simoes, Karen Kane. **Dimensions:** Studio 22'x14', control room 22'x16'. **Mixing Consoles:** D&R Avalon 40x32 w/Optifile 3D automation, 20" Sony monitor. **Audio Recorders:** Studer A827 24-track analog, (2) Akai A-DAM synched for 24-track digital recording, Sony PCM-2700 DAT, Panasonic SV-3500 DAT, Fostex E22 1/2", Fostex M20 1/4", Denon D2000 DAT, (3) Denon, Aiwa and JVC cassette decks. **Monitors:** Tannoy DMT15, Genelec 1031A, Hartman 8-25B, KEF O-80. **Other Major Equipment:** Bryston 4B amp, (2) Studer A68 amp, Demeter VTMP 2A tube mic preamp, Demeter stereo tube direct, Klark-Teknik ON-780 digital reverb, Lexicon 300 digital reverb, Lexicon PCM 70, Lexicon PCM 60, Lexicon LXP15, Drawmer M-500 dynamics, Orawmer DL241 comp., Orawmer OS-404 quad noise gate, Summit Audio TL100 compressor, Apogee AD 500 A/D

—SEE LISTING TOP OF NEXT PAGE

—SEE LISTING BOTTOM OF PREVIOUS COLUMN

converter, TimeLine Micro Lynx synchronizer, Yamaha SPX900, Apple Macintosh IIci, Madrigal Proceed digital to analog proc., SPL Vitalizer, extensive MIDI gear w/Opcode Studio, Hammond M-101 organ.

REACTION STUDIOS



48 McGee St., Toronto, ON M4M 2K9; (416) 461-7869. Manager: Ormond Jobin.

ROUND SOUND STUDIOS INC.



60 Pippin Rd., Units 44 & 45; Concord, ON L4K 4M8; (416) 660-5815. Owner: Gina Troiano. Manager: Danny Sustar.

SHAG SOUND STUDIO



P0 Box 518, Postal Station W.; Toronto, ON M6M 5C2; (416) 652-5485. Owner: Dennis Brunet. Manager: Dennis Brunet.

SOUNDFIELD STUDIOS INC.



189 Church St.; Toronto, ON M5B 1Y7; (416) 867-9023; FAX: (416) 363-3907. Manager: Andy Condon.

SOUNDS INTERCHANGE LTD.



49 Ontario St., Toronto, ON M5A 2V1; (416) 364-8512; FAX: (416) 364-1585. Owner: Super Corp. Manager: Tania Smuntochilla.

SOUNDWORKS INC.



500 Newbold St.; London, ON N6E 1K6; (519) 686-5060. Owner: Geoff Keymer. Manager: Geoff Keymer.

WELLESLEY SOUND STUDIOS INC.



106 Ontario St., Toronto, ON M5A 2V4; (416) 364-9533; FAX: (416) 364-7815. Owner: Roger Stemin. Jeff McCulloch. Manager: Dianne Wilding.

WEXFORD STUDIOS LTD.



288 Howden Rd.; Toronto, ON M1R 3E4; (416) 757-8775. Owner: N.W. Corbett. Manager: Tom Atom.

QUEBEC



AMBIANCE (A.R.P. TRACK PRODUCTIONS)
Ste-Anne-des-Lacs, QC

AMBIANCE (A.R.P. TRACK PRODUCTIONS)



34 Chemir des Ormes; Ste-Anne-des-Lacs, QC J0R 1B0; (514) 224-8363; FAX: (514) 224-8363. Owner: Nick K-ica. Manager: Nick Keca.

AUDIOBEC RECORDING



600 Port Royal W.; Montreal, QC H3L 2C5; (514) 384-6667; FAX: (514) 388-1488. Owner: M. Tubie.

CINAR STUDIOS INC.



1207 St. Andre; Montreal, QC H2L 3S8; (514) 843-7070; FAX: (514) 843-7080. Manager: Rene Laroche. Engineers: Francois De-

schamps, Alain Roy, Pierre L'abbe, John Nestorowich. Dimensions: Room 1 studio 25'x15', control room 18'x18'. Room 2: studio 25'x15'. Room 3: control room 15'x15'. Mixing Consoles: Solid State Logic 6056G w/Total Recall, Solid State Logic 4040G, Neotek Essence. Audio Recorders: (4) Studer A820 24-track, Studer A820 8-track, (2) Studer A820 2-track 1/4" & 1/2". (4) Studer A812 2-track. Digital Audio Workstations: (2) Studer Editech Dyaxis. Monitors: TH/Kinoshita Model 5 driven by FM Acoustics. B&W 80B, B&W 801. Other Major Equipment: Dolby SR 127 cards, Studer TLS synchronization system, Soundmaster, Audio Kinetics ES Eclipse (ES bus), (2) Lexicon 480L, Lexicon 300, (6) TC Electronic TC-2290, (2) Aphex Compellor, Aphex Aural Exciter, (3) Drawmer M500, Publison 1M90, (4) Lexicon PCM70, Yamaha SPX150, (2) Yamaha REV5, (2) Yamaha SPX90 II, (6) Alesis MIDiverb II, (8) various processors, (2) Sony BVH-2000 1" video Type C, Sony BVH-2830 1" video Type C w/PCM, Callaway CE150.



IMUSON RECORDING STUDIOS
Montreal, QC

IMUSON RECORDING STUDIOS



451 St. Jean St.; Montreal, QC H2Y 2R5; (514) 845-4142; FAX: (514) 845-2581. Owner: David Leonard. Manager: Mike Matlin. Engineers: Mike Matlin, Jean-Luc Uudin. Dimensions: Room 1: 35'x20' control room 25'x25'. Room 2: 20'x15'. Room 3: 10'x8'. Mixing Consoles: DDA DMR12 32 input, w/full Steinberg automation. Soundcraft 200B 16 input. Audio Recorders: Otari MX-80B

—LISTING CONTINUED ON NEXT PAGE

MINIMIX 16:2



Carefully designed to offer a large number of inputs in a small package, the Ross Systems Minimix provides studio quality mixing capabilities within the price range of almost any musician. Precision engineering has resulted in exceptional sonic and technical performance with careful attention to detail insuring total reliability.

- 16 studio grade mic preamps switchable to line inputs
- 4 Aux sends
- 4 Stereo aux returns
- 100 mm long throw faders
- +48v phantom power
- PFL headphone cue
- Channel muting

Ross Systems is a division of International Music Corp.
P.O. Box 2344 Ft. Worth TX 76113 817-336-5114
Fax 817-870-1271

USE READER SERVICE CARD FOR MORE INFO



CANADIAN RECORDING STUDIOS

—LISTING CONTINUED FROM PREVIOUS PAGE

24-track w/autolocator. Sony 5003V 2-track w/center track time code & sync. Tascam 48 1/2" 8-track w/dbx. Tascam 42 2-track. Tascam 122 MKII cassette. Nakamichi BX-100 cassette. Nikko ND 1000C cassette. **Monitors:** (2) Westlake BBS-M12, (2) JBL 4406, (2) Foxtex near-field, (2) Toa small monitor. **Other Major Equipment:** Sony CDP-310 CD player, Tascam CD301 CD player, JVC 8250U 3/4" U-matic, Adams-Smith Zeta-3 synchronizer, Sony SLV-55UC VHS, (4) Brylston 4B power amp, AKG ADR 68K reverb/sampler, Eventide H3000SE Ultra Harmonizer, Lexicon LXP-1/LPX-5 w/MRC remote, ART SGE Mach II, Aphex Aural Exciter Type C, Aphex Compellor, dbx 166 stereo comp/lim., (2) dbx 160X comp., Drawmer DL-241 dual gate comp/lim., Drawmer DS-201 dual gate, Symatrix 522 stereo comp/lim., Audio Logic MT66 comp/lim., Symetrix SE40 parametric EQ, Roland SRV-2000 reverb, Yamaha SPX90, Tascam PE40 parametric EQ, ADA S1000 delay, Alesis MIDIverb II, Korg SDD-2000 sampling delay, (2) Roland S-330 sampler. **Microphones:** Neumann TLM 170, (2) AKG C-460, (2) AKG C-451, (3) AKG D-535, (2) AKG D-330, AKG D-112, (3) Audio-Technica ATM63, (4) Sennheiser 421, (2) Shure SM57, Shure SM58. **Synths:** (2) PZM, Roland Juno 106 synth, (2) Roland Jupiter 8, Roland JX-8P, (4) Yamaha DX7 & DX7iID, Roland MT-32, (4) Alesis and Roland drum machine, (4) Hybrid Arts SMPTE track, Mastertracks Pro, C-Lab Creator/Notator sequencer.

LE STUDIO MOBILE



PO Box 367, Outremont Station, Montreal, QC H2V 4N3; (514) 273-6861; FAX: (514) 273-4605. **Owner:** Guillaume Bengle.

SONOLAB



1500 Papineau, Montreal, QC H2K 4L9; (514) 527-8671; FAX: (514) 526-1871. **Owner:** Telemetropole. **Manager:** Dov Zimmer.

STARBASE



2121 Hingston Avenue, Montreal, QC H4A 2H9; (514) 486-0876; FAX: (514) 335-6891. **Owner:** Frank Marino. **Manager:** Denyse Bauset.

STUDIO

MORIN HEIGHTS

STUDIO MORIN HEIGHTS
Morin Heights, QC

STUDIO MORIN HEIGHTS



201 Perry St., Morin Heights, QC J0R 1H0; (514) 226-2419; FAX: (514) 226-5409. **Owner:** Studio Audiogramme/Spectel. **Manager:** Mario Rachiele. **Mixing Consoles:** Solid State Logic 4056 G Series w/Total Recall and G Series automation, also on premises, available by special arrangement Neve w/1073 EQ. **Audio Recorders:** Studer A800-24, Ditar MTR-90-24, Studer A80 2-track 1/2". Studer B67 2-track high speed 1/4", Studer B67 2-track low speed 1/4". (2) Studer A710 cassette, Panasonic SV-3500 DAT, Panasonic SV-3700 DAT. **Monitors:** Quedsted 412 MKII, Acoustic Research AR185, Auratone, Yamaha NS-10M, Tannoy 3233 15" Gold monitor. **Other Major Equipment:** (2) Dolby 360 w/A or SR; amps: (2) Quedsted A900E, Macintosh Mc2605, (3) Studer A68, Quedsted DX3000E, Macintosh Mc2300, (4) TimeLine Lynx, Roland SBX80, (2) BGW 750A; (8) Focusrite ISA110 amp/EQ, (4) Advision fixed frequency EQ, Ashley SC66 stereo EQ, (7) LeStudio custom tube EQ, Lexicon 224X, AMS

—LISTING CONTINUED TOP OF NEXT COLUMN

—SEE LISTING BOTTOM OF PREVIOUS COLUMN

RMX-16, (2) Yamaha REV5, Yamaha REV7, Ursula Major Space Station, EMT 140 stereo plate, (2) EMT 140 mono tube plate, AMS DMX 15.80S delay w/harmonizer, (4) LeStudio trigger units, (2) Yamaha SPX90, Lexicon PCM41, (2) DeltaLab Effectron ADM 1024, (2) DeltaLab CompuEffectron CE1700, (2) Loft 440 delays, Drban 245E stereo synthesizer, Amcron VFX2 filter/crossover, Eventide Flanger FL201, BBE 802, RCA BA6A tube limiter, (2) dbx 161 limiter, (2) Neve 2254E compressor, Altec 9473A limiter, Gates M3529B tube limiter, (2) UREI LA-3A limiter, (2) UREI 1176M compressor, Roger Mayer RM58 limiter, Survival Project panner, Drban 516EC Sibilance controller, Syntovox 222 Vocoder, Revox B225 CD player, Alesis MIDIverb II, Yamaha Q2031 stereo graphic EQ, (2) SSL Listen mic preamp/limiter, (2) Stereo SSL E Series quad bus compressor, Aphex Aural Exciter Type B, DBM tube limiter, (3) AKG C-414, (4) AKG D-224E, AKG D-12E, (4) Electro-Voice RE-20, (6) Shure SM58, (2) Shure SM57, Shure SM53, Shure SM81, Sony ECM-33P, (2) Neumann U47, (3) Neumann U87, Neumann KM83i, Studer SKM 5V, (5) Beyer M500, (8) Sennheiser MD-421, (2) Sennheiser MD-441, Sennheiser MD211N, Yamaha 9' concert grand piano, Hammond B-3 w/Leslie. **Specialization & Credits:** Having been in existence since 1974 many major artists have worked here leaving a long legacy of both history and experience. To date they include the following artists many of whom have recorded or mixed a number of albums: The Police, Bryan Adams, Jeff Healey Band, Glass Tiger, Corey Hart, Kim Mitchell, Rush, Keith Richards, Celine Dion, Weir Without Hats, Nazareth, April Wine, Queensryche, David Bowie, Roberta Flack, Rainbow, Cat Stevens, Aldo Nova, Ah-Ha, Sting, Asia, Chicago, Luba.

STUDIO MULTISONS INC.



1208 Beaubien St. E., Rm. 101; Montreal, QC H2S 1T7; (514) 272-7641; FAX: (514) 272-3191. **Owner:** Raymond Du Berger, Jacques Bigras. **Manager:** Raymond Du Berger.

STUDIO PLACE ROYALE INC.



640 St. Paul W., Ste. 600; Montreal, QC H3C 1L9; (514) 866-6074; FAX: (514) 866-6147. **Owner:** S. Brown, N. Rodrigue. **Manager:** S. Brown. **Engineers:** N. Rodrigue, John Smith, J.P. Bissonette, G. Fernandes, S. Brown. **Dimensions:** Room 1: studio 25'x16', control room 20'x15'. Room 2: studio 25'x16', control room 15'x16'. Room 3: control room 16'x20'. **Mixing Consoles:** Amek Angela, Soundcraft TS-12, Allen and Heath Syncon, Allen and Heath 12/2. **Audio Recorders:** Ditar MTR-90, Ditar MX-70, (3) Ditar MTR-12 CTTT, Sony/MCI JH-10 1" layback, Scully 2808 F/T 1/4". **Digital Audio Workstations:** Studer Dyaxis. **Monitors:** (2) Genelec, (2) Tannoy LGM 12", (2) Studer, (2) Tannoy NFM8, (2) Tannoy PBM-6.5. **Other Major Equipment:** (2) Soundmaster synchronizer, (26) Dolby SR, (2) Lexicon PCM70, (2) Neve comp/lim, (2) dbx 166 comp, (2) Harmonizer, Aphex Compellor, (2) Hardy MH1 mic preamp, UREI filter set, (2) Kepex gate, Drban de-esser, Ursula Major Space Station, SPL Vitalizer SX2, JBL video projection 10 ft., Roland S-50, Roland W-30, (4) JVC VCR 1/2" sync, JVC 3/4" sync.



STUDIO SAINT-CHARLES
Longueuil, QC

STUDIO SAINT-CHARLES



85 Grant St., Longueuil, QC J4H 3H4; (514) 674-4927; (514) 526-6043; FAX: (514) 674-6929. **Owner:** Tele Metropole Inc. **Manager:** Lucie Theriault. **Engineers:** Paul Page (chief engineer), Clement Croteau, Martin Lizee. **Dimensions:** Room A: studio 55'x27', control room 15'x27'. Room B: studio 11'x8.5', control room 10'x12'. **Mixing Consoles:** Trident TSM 32x24 modified PSM modules, Soundtracs PC 16x16. **Audio Recorders:** Studer A827 24-track w/remote, Studer A80-8 MkIII 8-track transformerless, Studer A80RC 2-track 1/2" super analog, Studer A80-2 2-track, Studer A820 2-track w/center track time code, Studer A810 2-track w/center track time code, Panasonic SV-3700. **Monitors:** Quedsted 108. **Other Major Equipment:** (2) Triconcept Scimitar CMX S-600 (Cass 4) editor, (6) TimeLine Lynx w/updated chips, (26) Dolby SR and A, Lexicon 480L w/LARC, Lexicon PCM70 version 3.01, (2) Lexicon 224, Lexicon Prime Time 93, (2) Lexicon LXP-5, Lexicon LXP-1, AKG ADR-68K reverb & effects, TC Electronic TC-2290 32-sec sampling, Alesis MIDIverb II, Roland DEP-5, Yamaha SPX90 II, Yamaha SPX1000, Eventide H3000SE, (2) Focusrite EQ ISA 115HD preamp, Vitalizer SX-2, AKG Le Tube, Baldwin SD-10 9' concert grand piano.

STUDIO TEMPO



0707 Charlevoix St., Montreal, QC H9W 6B3; (514) 937-9571; FAX: (514) 937-8201. **Owner:** Yves Lapierre. **Manager:** Carol Alexander. **Engineers:** Ian Terry, Denis Barsalo, Francois Arbour, Denis Cadieux. **Dimensions:** Room 1: studio 40'x22', control room 25'x22". Room 2: studio 32'x20", control room 27'x20". **Mixing Consoles:** Amek G2520 28x24x28x2, DDA AMR-24 44x24x24x2. **Audio Recorders:** Studer A-827 24-track, Studer A-800 MkIII 24-track, Ditar MTR 12 II 4-track, (2) Studer A812-TC-UUK 3-track, Ditar MTR-12 II 2TC 3-track, Ditar MTR-12 II 2 2-track 1/2". (2) Studer B67 mic II 2/2 2-track, Ditar MTR-10 II 2-track and mono, (2) Panasonic SV-3700 DAT. **Monitors:** Quedsted 412, house monitor 2x15" & ribbon tweeter, (2) Studer 2216, Yamaha NS-10M, (2) Auratone. **Other Major Equipment:** EMT 140 stereo reverb plate, Lexicon 480L reverb, Lexicon 224 reverb, (2) Lexicon PCM70 reverb, (3) Lexicon PCM42 DDL, (4) dbx 166 compressor, (4) dbx 160 compressor, (2) UREI 1176LN compressor, Drawmer tube compressor, (2) Yamaha REV7, (2) Yamaha SPX90 reverb, Yamaha REV5, (11) dbx 161 compressor, Dolby SR/A 24x42x2, (16) Dolby A, (2) CMX C280-1 audio editor, (6) Adams-Smith 2600 synchronizer, (2) JVC CR-8250U video 3/4", (60) microphones: Shure, AKG, Neumann, EV, etc.

STUDIO 270



270 Outremont Ave., Montreal, QC H2V 3M1; (514) 270-4918; FAX: (514) 733-4760. **Owner:** 270 Corporation. **Manager:** Robert Langlois. **Engineers:** Robert Langlois, Luciano Arcarese. **Dimensions:** Room 1: studio 20'x12', control room 12'x12". **Mixing Consoles:** Soundcraft 6000 automated 52 inputs. **Audio Recorders:** Ditar MX-80 24-track, Ditar MTR-12 II CT 2-track SMPTE, Tascam MS-16 16-track w/dbx, Panasonic SV-3500 DAT, Panasonic SV-3700 DAT, (2) Nakamichi MR-1, Sony PCM-601. **Monitors:** (2) UREI 809, (2) KRK 703, (2) Tannoy PBM 6.5, (2) Yamaha NS-10, Brylston 4B, Brylston 3B, Brylston 2B. **Other Major Equipment:** Dolby XP-24 NR 24-track SR, Dolby 363 NR 2-track A/SR, TC Electronic 2290, Lexicon PCM70, Lexicon PCM60, Klark-Teknik DN-780, Eventide H3000, Lexicon Prime Time, Lexicon LXP-1, Lexicon LXP-5, Roland DEP-5, Yamaha SPX90, (2) Yamaha REV7, Alesis MIDIverb II, Alexis XTC, Drawmer DL-241B, (3) Drawmer DS-201, (4) dbx 160X, (2) UREI 1176LN, Symetrix 522, (2) Drawmer 1960 tube, Drban 536A, Aphex Type B Aural Exciter, Barcus-Berry 802, (2) Tube-Tech PE-1C, Tube-Tech MP-1B, (2) Drban 642B, (2) Loft 401, (2) Rane GE-30, AKG tube, (3) AKG 414EB, (2) AKG 451, (3) Neumann U87, Neumann TLM-170, Geffel UM-70S, Neumann U89, (40) other microphones, Roland R-8 drum, Foxtex 4030/4035 sync system.

STUDIO VICTOR INC.



1050 Lacasse, Ste. C-214; Montreal, QC H4C 2Z3; (514) 932-9340; FAX: (514) 939-2893. **Owner:** Gaetan Pilon. **Manager:** Louis Pilon.

SASKATCHEWAN

RIGHT TRACKS SOUND STUDIO



2268 Portage Ave., Saskatoon, SK S7H 0Y0; (306) 933-4949; FAX: (306) 934-7441. **Owner:** Right Tracks Productions Ltd. **Manager:** Lyndon Smith.

TOUCHWOOD RECORDING STUDIOS



562 Rink Ave., PO Box 794; Regina, SK S4P 3A8; (306) 775-1929. **Owner:** Grant Hall. **Manager:** Colleen Pukari.

Get Listed

in Mix Directories

Upcoming deadlines:

Recording Schools, Seminars
and Programs:
November 9, 1992

Northwest Recording Studios:
December 8, 1992

Call (800) 344-LIST for a
listing application.

by Jeff Forlenza

JERRY HARRISON

TALKING HEAD BEHIND THE BOARD

Jerry Harrison helped pioneer the influential art/punk sound in the '70s and '80s, first as a member of Jonathan Richman's Modern Lovers and then with Talking Heads. Harrison credits Heads' producer Brian Eno with "demystifying the recording process" for him years ago, and today the keyboardist and Harvard alumnus plys his craft behind the recording console. His production credits include the Violent Femmes' *The Blind Leading the Naked*, Fine Young Cannibals' "Ever Fallen in Love," The BoDeans' *Outside Looking In*, Poi Dog Pondering's *Volo Volo*, Psychefunkapus' *Skin* and Billygoat's *Bush Roaming Mammals*.

Along the way, Harrison, who



Jerry Harrison
in the studio
with Pure.

grew up in Milwaukee and studied filmmaking and painting in college, has kept very busy in a variety of media: He designed the cover for Talking Heads' *Fear of Music* in 1979; he recorded an anti-Reagan rap song, "Five Minutes" (complete with samples of Ronnie's infamous quote, "The bombs start dropping in five minutes") with Bootsy Collins for the 1984 election; he directed his own video single ("Rev It Up") from his band the Casual Gods' *Walk on Water* LP in 1990; he took part in the "Escape from New York" 1990 U.S. tour with the Tom Tom Club, Deborah Harry and The Ramones; and he even found time to go to Moscow to promote *Greenpeace Rainbow Warriors* (a benefit album for Greenpeace that features a Talking Heads song) in 1988.

Known for experimental music making, Harrison is often entrusted

disk & dat



D740 CD Recorder

Effects libraries, commercials, demos, rough mixes, different order of songs, and jingles—Now you can record your own custom CDs with Studer's D740 CD Recorder. Pro features include calibration facility for fixed studio levels, automatic clock changeover to the digital input and much more.

D780 R-DAT

Super fast spooling speeds of up to 400 times play speed. Variable Search Mode with cueing in either direction, Quick Start feature, parallel and serial RS 232/422 interfaces, Auto Cue function—Studer's D780 offers the newest DAT technology.

DYAXIS Digital Workstation

The great sound, full compatibility, and unlimited virtual tracks of Dyaxis make it the perfect choice for the digital studio. Our exclusive MacMix® software has all the professional features you'll ever need such as EQ, DSP, synchronization, time-scaling, sample frequency conversion, mixing, non-destructive editing, plus a new and unique remote controller.

For the ultimate in Hard Disk, DAT and CD professional recording systems, call your Studer representative.



STUDER

Studer Revox America, Inc. • 1425 Elm Hill Pk
Nashville, TN 37210 • Tel: 615/254-5651 • Fax: 615/256-7619
New York 212/626-6734 • Los Angeles 818/780-4234
Studer Revox Canada Ltd., Toronto 416/510-1347

USE READER SERVICE CARD FOR MORE INFO

with gifted young bands whose talents don't conform to the "I-can-hear-a-single" mantras of shortsighted A&R staffs and everyday producers.

We caught up with Harrison as he mixed the Reprise debut from rockers Pure at Little Mountain studios in Vancouver.

Can you tell me a little about the Pure project?

Well, right now we're mixing in Vancouver, which is where they're from. They're a great band, I think that they have a real sense of songwriting. They have really interesting songs that just draw you in.

Was your solo album, The Red and The Black [Sleeping Bag, 1981], your first effort producing?

Before that I had done a single for Nona Hendryx ["Itchin' My Heart"] that came out in France. And then I also co-produced the Escalators' album [*The Escalators with Busta Jones*, 1979].

Do you have a home studio?

I don't have my own. I have kind of an involvement with a studio in Milwaukee called dB Recording, which is where I did the Violent Femmes' *The Blind Leading the Naked*, and most of Casual Gods was done there. I also did a single called "Driving Away From Home" with a group called It's Immaterial that was a hit in England and Canada; it never did much in the U.S. I did a lot of parts of projects: I did a couple of singles—including one for the Fine Young Cannibals—because we were always trying to fit production schedules around Talking Heads tours or solo albums.

What did you study at Harvard?

I studied a course that could have led into either filmmaking or painting. And I also studied filmmaking.

So from Harvard you went to New York with hopes of becoming a filmmaker?

No, from Harvard I joined the Modern Lovers. Then we broke up, and I kind of felt like I'd been involved in inventing a kind of music that no one else in the world was really that interested in. It was kind of like pre-

punk punk music. So it took a few years before other people really appreciated the style that I'd been developing. Anyway, I had to do other jobs: I taught at Harvard a little while, I worked for a computer company. And then I made an album with Elliot Murphy called *Nightlights*. Elliot is a very literate-type songwriter. They used to compare Elliot and Bruce Springsteen as the potential next Bob Dylan, and I guess he didn't win.

How did you first meet up with Jonathan Richman of Modern

Lovers?

He wandered into my apartment with some of the actors who had starred in an Andy Warhol movie. I decided to put him into a movie that I was making and use his music for it. And then I was listening to this music every day trying to figure out how it was going to work in the movie, and he was coming over and hanging out. Then my roommate Ernie Brooks and I just kind of became a part of his band.

How did you wind up with the Talking Heads?

LOUDER BY DEFINITION.

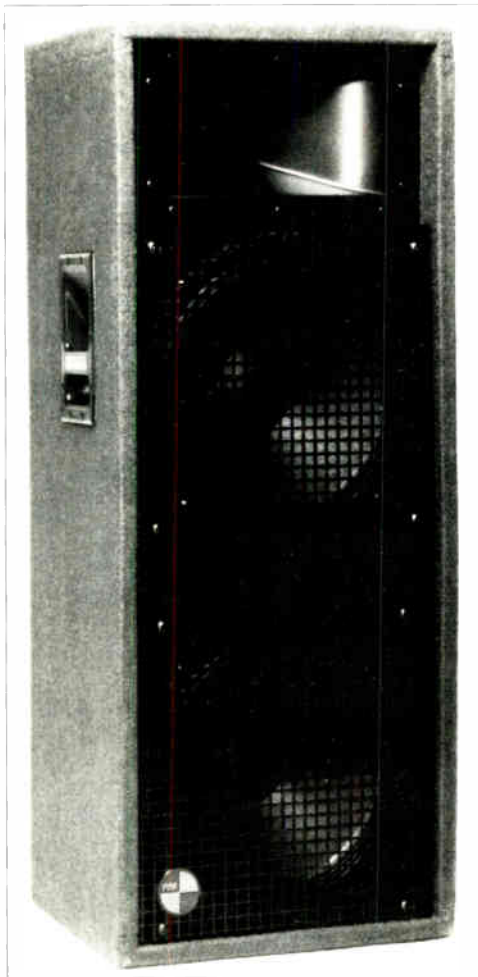

Looking for high level sound reinforcement that lets people hear everything? The best way to get superior vocal and instrumental reproduction with exceptional power handling capability is the Target T1550U two-way portable system.

The T1550U's high power handling is provided by two PAS cast frame 300 watt 15" woofers and a high power 1" compression driver on a constant coverage horn.

A perfect choice for PA companies, clubs and theaters, the T1550U features the finest quality components, construction and finishing to make it a dependable performer for the long haul.

Target T1550U. The new mark for audio quality and power handling in portable sound.



Professional Audio Systems 660 N. Twin Oaks Valley Rd., Suite #101, San Marcos, CA 92069
TEL: 619-591-0360 FAX: 619-591-3602

USE READER SERVICE CARD FOR MORE INFO

**WIN MACKIE'S
NEW 24x8x2
CONSOLE
OR ADD ON
OTTO-1604
MIDI
BOARD**

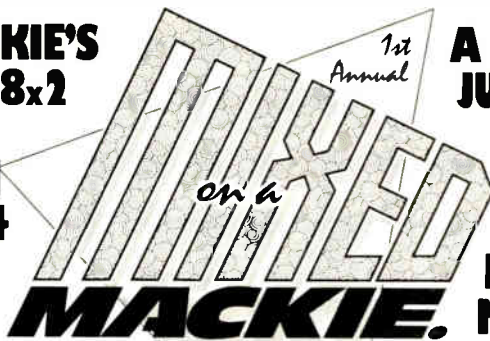

**A CONTEST
JUST FOR
OWNERS
OF
MACKIE
DESIGNS
MIXERS!**

FREE T-SHIRT JUST FOR ENTERING!

It's no secret our mixers are being used to create major label CD productions. But we'd also like to hear what YOU'RE up to! So we're holding the 1st Annual "Mixed On A Mackie" Song Production Contest. Grand Prize is our brand new 24x8x2 console. Four runners up will receive OTTO-1604 add-on MIDI Automation boards for the CR-1604. All five winners will be featured on a Mackie compilation CD. Because sound quality is a major judging criteria, we're asking for DAT tapes only, but they will be returned after the contest...along with a free multi-color "Mixed on a Mackie" t-shirt. Send for your Official Entry Packet today!



*Song
Production
Contest*

If you've done a killer mix on a CR-1604 or MS1202, we'd like to hear it. Send us anything from an original sequencer masterpiece to a live big band recording.

Entries must be: 1) recorded & mixed on a Mackie; 2) 5 minutes or less in length; 3) submitted on a DAT tape (all tapes will be returned). NOTE: You **must** use our Official

Entry Packet. Circle the reader card number below or call our toll-free number for faster response. Entry deadline is **January 31st 1993**. Don't tarry, Harry. Don't wait, Kate. Show us what you can do and maybe win a really BIG Mackie board.



CALL 1-800-258-6883 TOLL-FREE

USE READER SERVICE CARD FOR MORE INFO

"Please pass the Talkback"

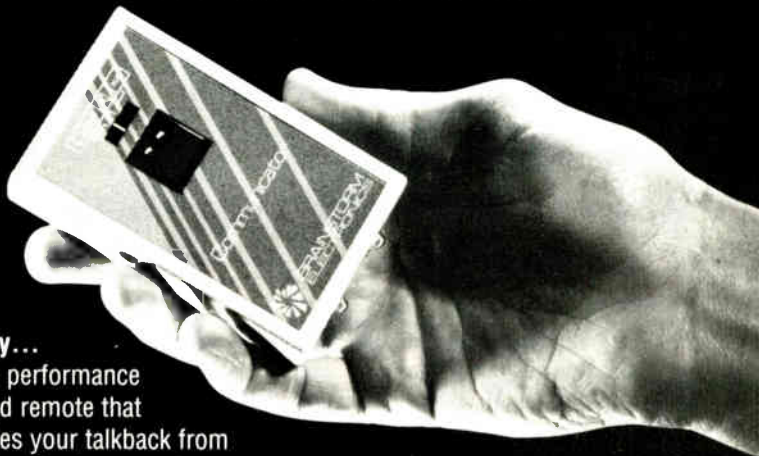

Finally...

A high performance infrared remote that activates your talkback from *anywhere* in the control room.

- No aiming necessary
- Easy installation
- Very affordable

Call for more information.



**BRAINSTORM
ELECTRONICS, INC.**

(213) 475-7570
1515 Manning Ave. #4
Los Angeles, CA 90024

TB-4 Communicator

waste an incredible amount of time moving mics a quarter of an inch, and then if you change the drums it can make so much more of a difference.

Do you like to work on any particular consoles?

Lately, the one I've been liking the most has been the Neve V Series. I loved cutting tracks on the old API console down in Arlyn [in Austin, Texas for the Poi Dog sessions], and I'm perfectly happy working on an SSL for mixing, particularly if someone is really familiar with it. I think there are some real advantages to recording on one console and mixing on another.

When you go to do a mix, what type of listening environment do you like the best: headphones, near-fields, on a car stereo?

Near-fields generally. But it's nice to check things. Actually the best thing I think is to take the mix on a DAT, go sit in another room and play a portable DAT player and just listen with headphones. The most amazing thing that happens with mixing is how sometimes things stick out to you a day later that you just don't even notice when you're doing it. It's like your attention is so amplified when you've listened to a song for eight hours that sometimes the obvious is not obvious anymore. I think this is why some people listen to a mix in their car. Some studios even have radio transmitters so you can listen in your car.

Does your musicality help you much in the recording process?

Sure. Usually I'm able to describe what I think the band should do and help them do it. I might experiment in the future with playing with more of the bands I produce. But these bands I work with have all been so self-contained that I didn't want to step on anyone's toes. Most of these bands have keyboard and guitar players, and I'm really trying to get their performance down. My attitude is that it's their album, and I'm the one who's facilitating making that album. ■

Jeff Forlenza is an assistant editor at Mix.

by Mr. Bonzai

WILLIE NELSON

DEEP IN THE HEART

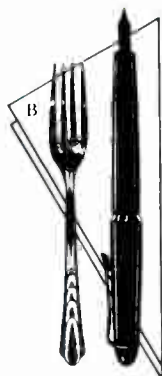

"What I do for a living is get people to feeling good," says Willie Nelson in the introduction to his 1988 autobiography. For decades, Willie has done much more than that—he's brought fresh perspective to rotten old troubles and new life to the beauty that is staring us right in the face.

His own big hits include "On The Road Again" (1980) and "Always On My Mind" (1982). "Crazy" was a major hit for Patsy Cline, and Faron Young scored big with Willie's "Hello Walls." His "Night Life" (he sold the rights for \$150) is one of the most recorded songs in history, with more than 70 artists selling more than 30 million records. As an actor, he made his debut in Robert Redford's *Electric Horseman*, followed by *Honeysuckle Rose* (a starring role as the bandit Barbarosa), and he's made numerous appearances embodying what film critic Pauline Kael describes as "probably the most acceptable noble American in modern movies."

Willie Nelson was born in Abbot, Texas, during the Great Depression. After his parents split up, he was raised by his grandparents, who introduced him to the guitar and taught him music. Following a stint in the Air Force in the early '50s, he worked as a door-to-door salesman and as a radio announcer. Known as Wee Willie Nelson, he signed on with "This is your ol' cotton-pickin', snuff-dippin', tobacco-chewin', stump-jumpin', coffee-pot-dodgin', dumplin'-eatin', frog-giggin' hillbilly from hill country." And through all the tough early years, he wrote his songs and played his gigs in road-houses and honky-tonks. This man

has been exploring his art for a long time in every corner of this crazy country of ours. And he rides a mean guitar.

Willie's recent run-in with the IRS made worldwide news when it was claimed that he owed \$16.7 million in back taxes. Well-known as a man who knows how to enjoy life, it seems he overlooked some bad management decisions made on his

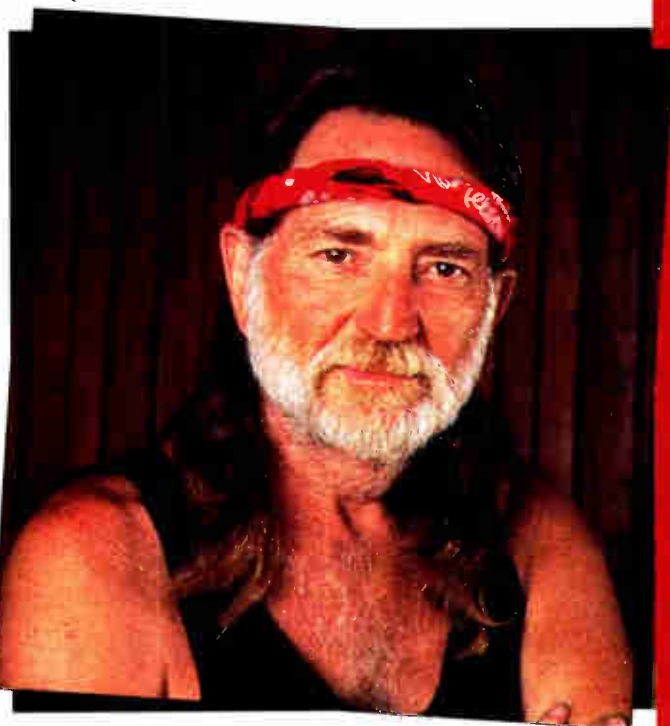

behalf. After losing property, personal belongings and his resort studio complex, the bloodhounds are no longer on his trail—and happily, the studio is back in the family.

The following interview was conducted via Ma Bell at the swank and swinging Pedernales "Cut 'n' Putt" Studio in Spicewood, Texas. Many thanks to owner manager Freddy

SPECIALISTS IN MIDI SYSTEMS
AND HOME RECORDING

Sweetwater Sound

NO HYPE NO HASSLES

For 12 years, Sweetwater Sound has been dedicated to providing the latest technological breakthroughs at affordable prices. Isn't it about time you found out why musicians and engineers around the world have come to depend on Sweetwater Sound for all their equipment needs?

E-mu Systems

Proteus/1, 2 and 3 World
EMAX II, EIII and EIII-X samplers
PROcussion module
Proteus MPS keyboard

TASCAM

Analog & Digital Multi-Track
Recorders, DAT machines
Mixers, Mastering Decks

KORG

01/W, 01/WFD, 01/WPro
01/WProX, 0/3RW, M1
Wavestation EX and A/D

Roland

Synthesizers, Tone Modules
Drum Machines, Samplers
MIDI controllers and Mixers

KURZWEIL

Music Systems

FREE Sweetwater Newsletter

New Sales • Support • Mods • Service • Upgrades

Opcode • Mark of the Unicorn • AKAI • Digidesign • Sony
Ramsa • Passport • TOA • AKG • Panasonic • Digitech
InVision • Nakamichi • JBL Studio Monitors • BBE
Fostex Recording • Lexicon • Coda • Carver • JLCopper
Mackie • Dynatek • Rane • Soundcraft • TAC/Amek
Crown • Anatek • Furman • Oberheim • Tannoy • Juice Goose
KAT • Stewart • Tech 21 • 3M, Ampex & Denon Tape
Macintosh, IBM and Atari MIDI software & interfaces

OTHER MAJOR BRANDS TOO! HUGE IN-STORE INVENTORY!

Our exclusive guarantee:
"If you don't like it, we'll take it
back — with no hassles!"

Confused? What are you waiting for? Pick up the phone
and call us for friendly, FREE advice and great prices!



NO SALES TAX (except IN)
VISA • MasterCard • Discover
AMEX • COD • Trades

Sweetwater SOUND Inc.®

5335 BASS ROAD • FT. WAYNE, IN 46808
(219) 432-8176
FAX (219) 432-1758

USE READER SERVICE CARD FOR MORE INFO

Fletcher, Willie's nephew and some-time drummer (in addition to veteran Paul English). We spoke many times, tracking the Honeysuckle Rose tour bus as it crisscrossed the country, picking up new dates as the band moved along. "Willie's in Colorado now, and we've lost cellular contact," Fletcher would tell me. "He's headed for Cincinnati, but they just picked up a gig in New Orleans." At long last, we caught up with Willie during a brief stop before he was back on the...

Bonzai: Is Don Was going to be working with you?

Nelson: Yes, and as a matter of fact, I hear that he's moving to Austin. Actually, that's a rumor I'd like to start. [Laughs] Yeah, we're doing an album together. He's great—a good musician and a good producer.

Bonzai: Word has it that you've got quite a new technical setup at your Pedernales Studio. Did you build the original studio yourself?

Nelson: Yes, but Chips Moman, the producer/writer and an old friend of mine, came down and oversaw the whole operation and did a fantastic job.

Bonzai: When did you first open up?

Nelson: Back in '81.

Bonzai: Do you like working at your own studio better than other places?

Nelson: Sure. We're not limited to time and you couldn't find a better facility or location.

Bonzai: For those considering recording at your place, what's the big thrill of going to Spicewood, Texas?

Nelson: First of all, we call it the "Cut 'n' Putt" Studio. That means that if you get tired of playing golf you can come in and play music.

Bonzai: In that order?

Nelson: In that order. Never any music until you're through playing golf.

Bonzai: What does the name Pedernales mean?

Nelson: Pedernales is the Indian name for a river down here that runs into the Colorado River. Where they run together is called the Pedernales. It's where things come together.

Bonzai: You used to be in the Air Force—what was your job?

Nelson: I went to military school to study radar, but I got out of there before I had a chance to become famous as a radar mechanic.

Bonzai: You were also a door-to-door salesman—what did you sell?

Nelson: I sold encyclopedias, sewing machines—anything that I felt people needed. When I got in the

Willie Overdubs at Pedernales

Pedernales Recording Studio is about 25 miles west of Austin. The expansive hill-country view makes for a relaxing and peaceful recording environment. Most of Willie's sessions start after golf or "dark-thirty." This is mainly the result of the outdoor activities such as golf, tennis and swimming in the large dog-shaped pool. In the studio Willie has chosen his own personal spot, which looks over Lake Travis and the rolling hills.

A typical Willie session might consist of the usual vocal and guitar overdub. For the vocal a Neumann U87 is used in conjunction with a Summit mic pre, Summit 4-band EQ and a Tube-Tech compressor; this chain is then patched directly into the Tascam DN-800 digital multitrack. Willie's guitar, "Trigger," is normally run through an old Baldwin amp and miked with a Neumann KM84 through a Neve 1099 mic EQ. This is also patched directly to the input of the digital multitrack. Monitoring and headphone mix is accomplished through a Tascam M700 40-input automated console.

—Larry Greenhill, chief engineer, Pedernales

house, if I saw they needed something, I'd sell them one and then go get it.

Bonzai: You also worked as a radio announcer. Was that your inroad to the entertainment world?

Nelson: It was just sort of a way to make a living until I could get back out there playing the guitar.

Bonzai: Did you start playing the

—CONTINUED ON PAGE 156

IN A WORLD OF COMPROMISE, THESE DON'T.



From the DC-300, introduced twenty-five years ago, to the latest Macro-Tech 5000VZ™, Crown amplifiers have earned a reputation for uncompromising performance that is simply unmatched.

Recognized for their sonic accuracy and reliability, our amps are the choice of professionals worldwide—from touring sound companies to recording studios to stadiums everywhere.

And for some very innovative reasons. Like ODEP™, our sophisticated protection circuitry. And P.I.P.* modules, which allow you to plug into the revolutionary IQ System* and future technology as it's developed. Plus, our latest achievement, VZ (Variable Impedance) power supply technology.

Yet beyond all the patented features, Crown is the only manufacturer to offer a 3-Year No-Fault

Warranty that is transferrable, extendable and pays shipping both ways. It's easy to see why our excellence is guaranteed.

For more information or the name of an authorized Crown dealer, call toll-free: 1-800-535-6289.

 **CROWN**
Guaranteed Excellence

Made in U.S.A. Exported as Amcron
P.O. Box 1000 • Elkhart, IN 46515-1000
219/294-8000 • FAX 219/294-8329

USE READER SERVICE CARD FOR MORE INFO

World Radio History

by Toby Mountain

1630 DOMINANT IN MASTERING

SURVEY RESULTS REVEALED

Technology marches on, but standards die hard. So it is with the PCM-1630, the 3/4-inch U-matic standard used for CD mastering. According to our 1992 survey, conducted ten years after the inception of the compact disc (see table), among 12 North American CD plants and 20 mastering facilities, most engineers (63%) believe that the 1630 will still be the mastering standard in two years. Its longevity has been further assured now that Philips and Sony have designated the 1630 as the official mastering format for both DCC and Mini Disc.

ANTIQUATED FORMAT

Even though the 1630 is firmly entrenched, all is not well. Only 35% of the engineers think that the 1630 has been a good format. The strongest complaints are about the reliability issues (mutes, AVG, HOLD errors), cost of U-matic maintenance and tape degradation. In an age of hard drives and optical discs, the 1630 technology seems hopelessly antiquated. A DMR-4000 deck with a multitude of moving parts is used to record a 3/4-inch tape that is sensitive to tension, temperature and humidity. To make things worse, a different deck, with a possibly different alignment, is used at the CD plant to play back the tape. Several mastering engineers at CD plants indicated that between 5% and 10% of all 1630 masters are "problematic" and have to be shipped back to the customer—a terrible waste of time and manpower.

Equally disturbing is the issue of longevity. Mastering engineers have watched their aging 1630 masters degrade slowly while sitting on the shelves. Studies here at Northeastern Digital Recording have shown that CRC error rates will double every

three to five years, and the chance of interpolation errors or mutes will greatly increase.

Most agree that the 1630 should be replaced, but what will it take? Politics aside, it will take a format that offers greater reliability and longevity, as well as many of the 1630's positive features that engineers have come to expect and depend on.

**In an age of
hard drives and optical
discs, the 1630 technology
seems hopelessly
antiquated.**

PMCD—THE DARK HORSE CONTENDER

Along comes a dark horse to replace the 1630 format: the Sonic Solutions PMCD (Pre-Master Compact Disc). The PMCD concept is an ingenious one, derived from the write-once CD (described in "Tape & Disc," February 1992). Ironically, it has been fostered by a unique liaison between Sonic Solutions and Sony. DADC is the first compact disc manufacturer in the world to test and master CDs from PMCD. John Macdonald, head of the pilot program, states, "We've been making glass masters from PMCDs since the beginning of 1992 with good results. Currently we've cut over 200 discs and the success rate has been very good. Only three discs have been rejected during incoming QC, and they were due to incompatibilities between our reader and a client's writer. We've just taken

—CONTINUED ON PAGE 132

Past and Future Formats for CD Mastering: 1630, PMCD and MO

	CD Plant	Mastering Facility	Total
1. Do you think the PCM-1630 has been a good mastering medium for CD?			
YES	6	6	12
NO	1	4	5
SORT OF	5	10	15
2. What are the 1630's three most positive features?			
a high reliability	0	3	3
b SMPTE time code	6	16	22
c re-record/video insert capability	8	15	23
d video as visual aid in mastering	9	9	18
e read-after-write capability	8	15	23
f low cost of blank tape	2	2	4
g good protection of tape in cassette	1	1	2
h other	2	3	5
3. What are the 1630's three most negative features?			
a low reliability (mutes, AVG errors)	8	14	22
b high cost of U-matic maintenance	9	11	20
c slow access in playback	3	13	16
d space requirements for storage	10	2	12
e gradual degradation of medium	5	11	16
f high cost of blank tape	0	4	4
g real-time recording/copying	1	1	2
h other	0	6	6
4. Do you think a PMCD can offer greater reliability than a 1630 master?			
YES	7	12	19
NO	0	0	0
MAYBE	5	9	14
5. Do you think a PMCD system would lower maintenance/labor costs and offer your clients a more attractive/less expensive product?			
YES	4	7	11
NO	1	3	4
MAYBE	7	10	17
6. What are PMCD's three most positive features?			
a high reliability of CD format	8	10	18
b low cost of CD recorder maintenance	8	5	13
c low storage/shipping costs	6	6	12
d low cost of blank media	0	2	2
e conforms to consumer standard	0	11	11
f quick playback access	4	7	11
g eventual 1/2 time record capability	10	12	22
h other	0	2	2
7. What are PMCD's three most negative features?			
a low reliability of CD format	1	0	1
b no SMPTE time code	7	8	15
c no re-record/punch-in capability	7	18	25
d no video as visual aid in mastering	4	5	9
e no read-after-write capability	5	9	14
f high cost of blank media	5	5	10
g poor protection of PMCD master against scratches, fingerprints	2	3	5
h other	1	2	3
8. What format do you think will be the standard in two years?			
1630	7	11	18
PMCD	3	7	10
Some other medium	2	2	4
9. List the features that "some other medium" should have:			
a additional sampling rate options: 48k	0	3	3
b additional quantization options: 16- to 24-bit	2	4	6
c real-time punch-in capability with crossfade	3	3	6
d playable on any standard CD player	3	4	7
e time code readout/synchronization	1	2	3
f read-after-write capability	2	3	5
g continual error correction readout/analysis	4	4	8
h instant (<20 msec) record/playback access	0	1	1
i at least 60-minute storage (44.1k, 16-bit)	2	4	6
j fixed linear recording/playback of program	1	0	1
k non-linear recording/playback controlled	0	0	0
l other	0	0	0

Participants consisted of 12 compact disc facilities and 20 mastering facilities in the United States and Canada.

"AUDIOPHILE
QUALITY"...

EUROPADISK LTD.

**U.S.' MOST
COMPLETE FACILITY!**

SPECIALS - "With This Ad Only"

"Maxi-Single" Cassettes

Complete Packages, 500 - \$715
Everything included - Mastering, Test
Cassette, Graphics Design, 2-Color
0-Card Printing, Label Typesetting/
Printing, & Shrink-Wrap

CD's with Graphics

Complete Packages, 500 - \$1,385
Everything included - All Mastering,
Custom Designed 2-Color Front
Card, Tray Card, Label Film,
Jewel Box & Shrink-Wrap

Call For Our Complete Catalog
with **New, Low Pricing!**

• **Compact Discs**

New, Low-Cost Packages!

• **Cassettes**

Finest European Equipment

• **Dmm® Vinyl**

*Mastering & Pressing
Cleanest, Hottest 12" Vinyl!!*

• **Graphics
Design**

& Printing -
Free Custom Design!

• **Mastering
Studios**

*Neve DTC, Digital Editing
Major Label Work*



EUROPADISK LTD.

75 Varick Street, New York, NY 10013
☎ (212) 226-4401 FAX (212) 966-0456

USE READER SERVICE CARD FOR MORE INFO

NOVEMBER 1992, MIX 131

—FROM PAGE 130, SURVEY REVEALS

delivery on a new Sony double-speed cutting system [modified CD Printer], which we're currently evaluating."

Indeed, the PMCD offers many unique advantages over the 1630. Low storage costs, better longevity because of the "non-contact" medium, and quick random access. But would PMCDs be more reliable than 1630 tapes in a mastering situation? The perception of most engineers in the survey is that it could be.

DATA TESTS

In strict data tests similar to the ones used in my article "The Integrity of Digital Copying" (*Mix*, September 1991) I compared write-once PMCDs with 1630 masters and replicated CDs. For the most part I found the medium delivered perfect results, except under less than ideal conditions: 1) when the disc had several scratches, fingerprints, etc., and 2) when a lower quality CD player was used. Such situations yielded unacceptable interpolation errors. The inherent low reflectivity of the write-once media, also a source of concern, may have exacerbated these problems. So, although the PMCD may be generally more reliable than the 1630, it is certainly not "error-free," which underscores the necessity for an error checking device during mastering from PMCD, just as with a 1630 master!

IS PMCD THE ANSWER?

In return for greater reliability, longevity and convenience, will engineers be willing to sacrifice some of the positive features of the 1630 format—such as SMPTE, re-record and read-after-write capabilities? That seems to depend very much on the facility. For Gary Hollis, manager at TM Century in Dallas, the PMCD provides a great solution for its broadcasting clients since "90 percent of what we create is pretty cut-and-dry and doesn't require a lot of revisions." And, he adds, "We can check the P&Q quickly before the disc goes to the plant."

But for mastering facilities that do album projects for fickle clients, the PMCD's inability to be erased presents somewhat of a dilemma. A request for a minor volume change on one track requires writing a whole

new disc! In the meantime the project may have been removed from the hard drive and archived to tape to make room for newer projects. Reloading the source material and rewriting the PMCD is both time consuming and costly. Clearly, mastering engineers see this as PMCD's greatest liability.

SONY TO THE RESCUE?

If engineers conclude that PMCD does not provide a viable alternative or a significant step forward from the 1630, the search will continue for the next mastering format. Magneto-optical recording, which has made some initial inroads into the computer industry and some audio workstations, seems to be a strong contender.

**The people at
Sony are rumored
to be working on a
proprietary MO format
for CD mastering.**

But as a computer industry standard (3 1/2-inch single-sided and 5-inch double-sided cartridges holding 128 MB and 300 MB per side) with slow seek times, it does not look like a viable mastering format capable of holding 75+ minutes of CD audio.

The people at Sony are rumored to be working on a proprietary MO format for CD mastering. Their expertise in this area has come out of the years of research dedicated to the erasable Mini Disc. With 20-bit recording and "Super Bit-Mapping" soon to become standard options for the mastering engineer, it seems fair to conclude that 16- to 24-bit recording, variable sampling rates (44.1 or 48 kHz), with SMPTE and punch-in/crossfade capabilities could all be standard features. (Participants in our survey created their own "wish list" for such a format as part of question 9.)

Until then, the 1630 will probably remain the "begrudged" standard, with a handful of facilities opting for a piece of the future by using PMCD. ■

Dr. Toby Mountain is the owner of Northeastern Digital Recording, Southborough, Mass.

TOOLS FOR THE RECORDING STUDIO

whirlwind DIRECTOR Direct Box

whirlwind Hot Box Act

OUTPUT 1
30
MUTE MUTE

whirlwind

+10
+5
0
-5

MK-4 LOW Z CABLES
MIDI CABLES
PHSAT HEADPHONE BOX
LINE BALANCER
HOT BOX • IMP 2 • DIRECTOR
CUSTOM PANELS • PATCHBAYS
MEDUSA MULTIWIRED SYSTEMS
COMBINER • SPLITTER • LITTLE IMP
PHASE REVERSE • LIFTER
P-45 AND P-12 POWER AMPS
MIX-5 MIXER

THE BEST PERFORMANCES
ARE BETTER WITH

whirlwind

100 Boxart Street • Rochester, NY 14612
716-663-8820 • FAX: 716-865-8930

USE READER SERVICE CARD FOR MORE INFO

Tape & Disc News

by Philip De Lancie



Tandy VIS

TANDY ENTERS INTERACTIVE TV MARKET WITH VIS

Tandy Corp. has announced its entry into the "interactive TV" market. The company is pushing a new CD-ROM-based player that hooks to a television set and provides interactive entertainment and learning. The Video Information System (VIS) is not compatible with either Philips' CD-I format or Commodore's CDTV, neither of which has really caught fire so far with American consumers.

Like CD-I and CDTV, VIS has been designed for home infotainment rather than the home computing market. The technology is computer-based, but the appearance and marketing come from the consumer electronics field. Set for October launch at a \$700 list price under the Memorex and Zenith brand names, the device is operated with a "Nintendo-like" remote controller. It plays CD-audio discs and offers CD-quality (Red Book standard) audio on the VIS discs as well. Current video capability is 15 frames per second, partial screen, with full motion/full screen to be added later.

Reached at Tandy's Fort Worth, Texas, headquarters, marketing relations director Ed Juge said that what really will set VIS apart from its rivals is the number and variety of disc titles available. So far, 120 games and educational/informational titles are

planned for introduction by the end of the year from more than 60 developers, including Broderbund, Activision, Electronic Arts and Compton's, whose encyclopedia will be bundled with every machine.

According to Juge, the fact that VIS will launch with more available software than CD-I or CDTV results from Tandy's decision to base the device on the IBM PC-compatible world of MS-DOS and Windows, rather than on proprietary systems for which few development tools are available. VIS uses Modular Windows, a subset of Windows 3.1. Since developers can use Windows development tools, porting games and other titles from Windows or DOS into VIS is primarily a

matter of adapting them for input from a controller rather than from a keyboard or mouse. Despite VIS's links to the world of DOS/Windows, no provision has been made for hooking a keyboard or other peripherals to VIS machines to allow them to double as home computers. (CDTV machines may be converted in this manner into Amigas.) But Tandy has left open the possibility of accepting input from cable TV and hooking to a modem as well. VIS also allows two controllers to be used simultaneously for two-person games.

PHILIPS CUTS CD-I PLAYER PRICES

Perhaps anticipating the introduction of VIS, Philips has cut the list price of its CD-I players from \$999 to \$699. According to Philips' John Kasle, the company will also have its long-awaited CD-I video adapter in stores before Christmas. The \$200 cartridge will allow existing players to play CD-I discs containing up to 74 minutes of full motion/full screen "VHS-quality" video. (Current titles offer 15 fps full screen and full motion/quarter screen.) Titles taking advantage of the capability offered by the video adapter, however, are not expected until mid-1993, followed sometime later in the year by players with the video capability built in.

In the meantime, the company will be launching a multimillion dollar ad campaign combining TV, print media and an 800-number informa-

tion line to raise public awareness of CD-I. And as Kodak's CD-I compatible Photo-CD system gets off the ground, it is expected to give a boost to the format as well.

WILL MINI DISC BEAT DCC TO MARKET?

While Philips and Tandy are set for a confrontation in the nascent interactive TV market, Tandy was an early supporter of Philips' DCC. The latest word from Philips Consumer Electronics on the DCC launch, which has been delayed and scaled back more than once (see "Current," October 1992), is that there will be "plenty of supply for the Christmas selling season, probably before Thanksgiving." In addition to the U.S., initial launch markets include the UK, Germany, France and the Netherlands.

As far as the impact of the digital audio recording bill on launch timing, a company spokesman says Philips has not been held up by the fact that the bill, approved by the Senate, has yet to pass in the House. But since record company support for DCC is contingent on enactment of the legislation, Philips may have to revise its U.S. schedule yet again if the bill is not signed into law before launch.

Even if current plans hold, the Thanksgiving timing raises the possibility that Sony, which intends to intro Mini Disc in Japan by November 1 and elsewhere before Christmas, may actually precede Philips into the U.S. market. Meanwhile, Tandy's Ed Juge says his company is set to begin manufacturing DCC machines in Fort Worth. Like Philips, Tandy is starting with home stereo component units, which Juge says are the easiest to engineer because they are not dependent on miniaturization. While Juge says Tandy expects to have DCC out in October, it is not considered likely that the company will launch before Philips.

SPLICES

Gima has developed an enhancement to its Mod 800 CD packaging machine that allows the unit to package not only standard jewel boxes but also the Brilliant double CD box, the Double Slimpack and the Slimline two-piece box. The enhancement is available for field installation on existing units or built into the new Mod 800/MS. The Gima line is

Send Us Your Disk
Send Us Your DAT
We'll Do The Rest
Simple As That.



CASSETTE CD & RECORD MANUFACTURING & PACKAGING
2832 SPRING GROVE AVENUE • CINCINNATI, OH 45225 (513) 681-8400

USE READER SERVICE CARD FOR MORE INFO

TAPE & DISC

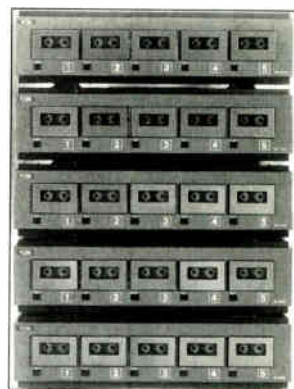

Now! Recording Systems' 5-well
Mothers cassette recorder

sold in the U.S. by E Media of Kennebunkport, ME...Mothers System U.S.A. and MediaAmerica Inc. have formed a joint venture, Now! Recording Systems, to offer real-time duplication services. The New York, NY, company uses the unique 5-well Mothers cassette recorder to record 1 to 10,000 cassettes of live events as they happen, allowing immediate post-event distribution of the program...Audio publisher Brilliance Corporation has purchased two CD 9002 dual pancake loaders from Concept Design for its plant in Grand Haven, MI. The sale, arranged by duplication equipment brokerage, marks the first U.S. installation of the new loader...Versadyne has sold a 1500 Series high-speed duplication system to tape duplicator Hosanna. The system is the second 1500 Series installed at Hosanna's Albuquerque, NM, plant. Hosanna also purchased an Apex CA-80 6-color imprinter...Electro Sound (Sun Valley, CA) has sold high-speed cassette duplication systems to Videolar Da Amazonia in Manaus, Brazil, and Maquilas Musicales in Mexico City...Saki Magnetics of Calabasas, CA, has named company founder Eugene Sakasegawa chairman and chief executive officer, with Richard Drake assuming the posts of president and chief operating officer...BASF has introduced a new standard grade VHS video duplicating tape, VT 19 SG. The tape is backcoated to reduce transient debris and improve handling...Digital House (New York, NY) recently completed work on a CD sampler for *Foundations* magazine. The hard rock and metal trade publication will produce CD samplers quarterly as inserts to the magazine. ■

apex
since 1903

- the inventor and manufacturer of the first production on-audio cassette printer.
- the inventor and manufacturer of the first production on-video cassette printer.
- the largest and finest manufacturer of on-audio and on-video cassette printers in the world.

why settle for less ? ?

apex machine company
3000 n.e. 12th terrace • ft. lauderdale, fl 33334 usa
ph: 305-565-apex • fax: 305-563-2844 • telex: 271601 apex ur

domestic representatives: west coast: master recording supply, Inc.
4000 w. magnolia blvd. ste. j • burbank, ca 91505
ph: 818-841-7500 • fax: 818-841-8134

mid-west: encore marketing company
p.o. box 386 • kenilworth, il 60043
ph: 708-256-6223 • fax: 708-256-8362

When you set out to unearth some strange and startling sounds, start with a tape that's truly out of this world.

That's the philosophy of Mark Mangini who, as the head of Weddington Productions, created the sound effects for major science-fiction thrillers such as *Star Trek*, *Gremlins* and *Poltergeist*, just to name a few.

Mark now relies on Sony Pro DAT

Plus tape for recording and archiving his one-of-a-kind sounds and hauntingly beautiful melodies.

"The low error rate and consistent reliability of Sony Pro DAT Plus is critical in our search to capture and preserve the unusual sounds used in fantasy and horror films," says Mangini.

The new Sony Pro DAT Plus, and unique album case.

People like Mark put Sony's engineers in the right spirit to

continually expand the boundaries of our digital audio tape technology. The proof is found in our new Pro DAT Plus.

Ultra fine metal particles help deliver improved playback output in addition to a superior S/N ratio, while special binders and surface treatments help to achieve error free performance in any natural or supernatural environment.

You'll also discover a heat-resistant shell, anti-static lid and new

two-tape album case to protect your tapes from things that go bump in the night. And an erasure prevention tab to make sure you won't accidentally lose your "voices".

As Mark Mangini knows, a quality tape library is the lifeblood of any post sound company. He also knows that with new Sony Pro DAT Plus, life at Weddington Productions is a lot less scary.

SONY
SONY RECORDING MEDIA

SONY'S NEW
PRO DAT PLUS HAS
EVERYONE HEARING
GHOSTS.



C O A S T

L.A. GRAPEVINE

by Amy Ziffer

As I write this in September, I'm still hearing about the effects of last April's riot. It left its mark on parts of Los Angeles that weren't directly affected at the time. One casualty I only recently learned of was the Dick Grove School of Music and its recording engineering program, although there is a happy ending of sorts: Dick Grove and a number of the staff have created a new teaching facility called the Dick Grove Center for Contemporary Music. But first, the details of the closure...

The Dick Grove School of Music should have been celebrating its 20th anniversary this year, but the Van Nuys institution drew 35% of its students from outside the country, many of whom panicked at the news of the violence. After all, news reports made it look like the entire city was on fire, and someone from Tokyo had no way of knowing that Van Nuys was miles

—CONTINUED ON PAGE 138

IN SESSION: DYLAN AT ACME

by Blair Jackson

In what sounds like one of the more interesting collaborations he's been involved with in recent years, Bob Dylan teamed up with stringed instrument virtuoso-turned-producer David Bromberg for two-and-a-half weeks of intensive recording sessions with Bromberg's band at Acme Recording in Chicago last summer. So far, no release date has been set for Dylan's next album, and there isn't even any assurance that it will consist of material from the Bromberg sessions, but Dylan's sojourn at Acme offers a fascinating glimpse of how the elusive one likes to work.

Dylan's approach on these sessions differed from most of his recent albums because the material he recorded—26 songs, of which 15 were eventually mixed down—consisted entirely of cover material: Some were Bromberg tunes, others were traditional folk and blues songs selected by Dylan and Bromberg.

"Bromberg flew out

to California a couple of weeks before the session to talk to Dylan about what they were going to do," says Acme's Blaise Barton, who engineered the sessions. "Then Bromberg and his musicians came in a couple of days before Dylan got here and ran through a lot of the arrangements, some of which I gather were ones they'd been playing for a number of years already.

"Then the arrangements that Bromberg and his band had worked out in those two days went out the window once Dylan got here," he



continues with a laugh. "He changed the key on some, he added and took out solos, changed instruments around. They were good decisions, too. I was really impressed by Dylan's ability to take a song he'd never played before but maybe heard a few times, and just assimilate it and then play it and sing it his own way."

Dylan has always preferred cutting tracks as live as possible—even putting down the lead vocal as he plays—and these sessions were no exception. With Bromberg producing and playing acoustic or electric guitar, the main studio room was filled with a drummer, bassist, guitarist and pianist on

—CONTINUED ON PAGE 138



Dan Godfrey (left) and Joel Jaffe stand behind the vintage Trident TSM console retrofitted with Neve's Flying Faders custom automation system and ten modules of Neve input at Studio D in Sausalito, CA.

C O A S T

CHICAGO LOOP

by Jeff Forlenza

Long known as the Second City in the shadow of the Big Apple, today's Chicago makes a strong case for first consideration when it comes to audio production. From the blues to alternative rock to hot dance R&B, Chicago has a world-famous sound, and with more major films and TV shows being shot in Chicago than ever before, the Windy City is catching the world's eye as well.

One of Chicago's favorite sons, Murray Allen, has started his own consulting group and has a few reflections on the local scene. "The home studios with workstations are affecting the big rooms," Allen notes. "Video houses are moving into audio recording production: Editel built two audio rooms, one equipped with an Audio-File. Avenue Edits is another video house enlarging its audio facilities with an SSL Scenaria. Two TV series, including *The Untouchables*, are being shot in Chicago, as well as talk shows—the Oprah Winfrey and Jerry Springer shows. And even the advertising sector is adding its own audio facilities."

Allen's consulting group is not only for local hire; rather, they work in different environments around the country depending on what the project requires. Recent projects include ADR for the movie *Backdraft* and audio consulting for TV talk shows. Allen is upbeat about the future of the Chicago recording scene. "Chicago is a leader in digital technology," he notes, "and there's always been a good advertising base willing to pay for the technology advancements that eventually affect

music recording."

Streeterville Studios is an eight-room facility with a 23-year history in downtown Chicago. Streeterville owner and engineer Jimmy Dolan says the scene in Chicago is characterized by "a lot of change, a lot of opportunities," inti-



Jazz giant Yusef Lateef holds his master tapes in front of Sparrow Sound Design (Chicago) after working with engineer Joanie Pallatto on two CDs for his own label YAL.

inating that digital audio workstations are the catalysts. Work at Streeterville comprises a lot of remixes for England; record projects (including "90 percent of Alligator blues projects," according

—CONTINUED ON PAGE 140

N.Y. METRO REPORT

by Dan Daley

If all goes as planned, noted mastering engineer Bob Ludwig, a longtime employee of Manhattan's Masterdisk, will start his own facility in Portland, ME, of all places. Ludwig's family has roots there, and Ludwig says he's looking for a change in lifestyle. The planned studio would have one mastering suite and one editing room and would be named Gateway Mastering Studios. Ludwig's partner in the proposed venture is Dan Crewe, who is the business manager of engineer Bob Clearmountain. Ludwig says that Clearmountain is not involved in the project.

The distance from New York shouldn't be a problem. "I do most of my business by Federal Express anyway," Ludwig explains. "As long as they stay in business and deliver that far north, I'll be all right."

Sony Music is building a huge audio/video complex on the West

—CONTINUED ON PAGE 140

At NYC's The Edison are (L to R) chief engineer Gary Chester, Sinead O'Connor and producer Phil Ramone as they work on the Ensign album *Am I Not Your Girl?*



—FROM PAGE 136, L.A. GRAPEVINE

from the flashpoint. "The day after the riots, they started calling," says Todd Ferguson, vice president of the new school. "Thirty percent of the students scheduled to begin a term in July cancelled." That, combined with a declining enrollment, which Ferguson attributes to the recession, caused the school to close its doors early last summer.

By July 15, however, the new school was operating in Woodland Hills. And recording engineering classes are continuing under the tutelage of Duke Gore, director of Recording Engineering at the old school. "We're trying to

continue what Dick started 20 years ago," says Ferguson, referring to the smaller size of the new operation. Several programs have been scaled back, but he says that only the percussion program had to be eliminated.

Ferguson says the Dick Grove Center for Contemporary Music is crediting all students who paid their tuition in advance to the old school. In an interesting twist that illustrates the frustrations of California's state budget drama, students who attempted to have their tuition refunded by the state's tuition recovery fund are apparently having a hard time. Ferguson says the state claims the fund is empty.

(just another example of why the state motto should be changed to "Gee, where did all the money go?") The Grove Center for Contemporary Music is located at 21050 Erwin St., Woodland Hills, CA 91367; (818) 716-6700.

Happy birthday to Olive St. Digital Post, a month-old facility in Burbank owned by Steven Applebaum. (Applebaum, coincidentally, is the nephew of former Goldstar owner Stan Ross.) Applebaum says he hopes to draw in mostly film work for the ProTools/Trident TSM-based studio.

Both Record Plant and Andora have some new toys to share with their clients. Andora recently added a pair of EMT 140 plate reverbs, a second grand piano, a Hammond B-3 organ with Leslie speakers and a rack of 24 Neve 1073 outboard mic preamps and equalizers. Record Plant signed the papers for a 96-input SSL 8000 G Series console with Ultimotion to go into Studio 4, their new mix room scheduled to open around Thanksgiving.

In the more-to-come department: After unsuccessfully bidding for the former B&B facility in Burbank, Paul Ratajczak, owner of Ground Control Studios in Santa Monica, apparently concluded a deal for Evergreen Recording Studios on or about the first of September. Evergreen is also in Burbank, no more than a mile from B&B, and has two scoring stages, one of which can hold a full studio orchestra. It's unclear at this point what the facility's name will be, whether it will be operated as a separate business entity, or who will staff it.

It is also rumored that the purchase of a large Westside facility is being quietly negotiated; the alleged buyer is the owner of another established L.A. studio complex. Next month, I hope to bring you more information about a major expansion underway at one of L.A.'s largest video post houses, Modern Videofilm, and the construction of a new broadcast and post-production complex for KRCA-TV Channel 62 by Lakeside Associates.

Send L.A. studio news to Amy Ziffer, c/o *Mix* magazine, 1999 Avenue of the Stars, Suite 500, Century City, CA 90067; or call (818) 567-1429. Call for faxing instructions. ■

—FROM PAGE 136, IN SESSION: DYLAN AT ACME most tracks. "At one point we had three horns in there, too," Barton says. "Dylan was in a vocal booth [using a Neumann U47], but he could see out, and I'd say the communication within

If Your Standards Demand the Ultimate in Real Time Quality,

whether you need
10 or 10,000
cassettes a week,

a KABA 4-Track Real Time & 2x
Duplication System is your most

- versatile
- trouble-free
- cost-effective duplicator.

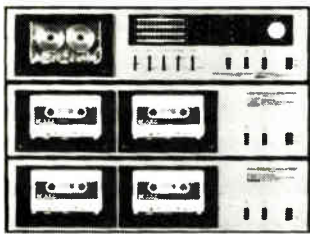

CALL 1-800-231-8273
for free specifications,
prices and a research report
relating system size,
production capacities and
profit potential to system
cost and financing rates.

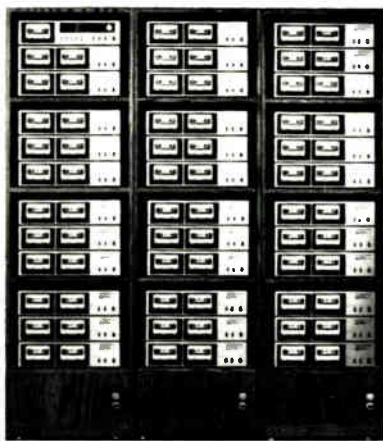

Ask about the KABA CREDIT PLAN. Discover how easy
and profitable it can be to duplicate your own cassettes.



KABA
Research & Development
24 Commercial Blvd., Novato, CA 94949 (415) 883-5041
1-800-231-TAPE Fax (415) 883-5222

USE READER SERVICE CARD FOR MORE INFO

the band was real good.

"A couple of songs also involved a 25-member choir from the South Side of Chicago, and we had to completely change the set-up for them. We used five mics on the choir—a [Neumann] U48 way up high on a boom, two [AKG] C-12s off to the side, and then off to the side and to the rear and sides I used a pair of Audio Technica 801 omnidirectional mics. Because the choir took up so much space in the big room, we moved the drums out into the front reception area along with the bass player, and they cued from headphones. The keyboard and guitar players were in with the choir. It went smooth as silk—Dylan fell right into it. It's funny because a lot of people in the choir had never even heard of Bob Dylan."

The tunes cut with the choir—the gospel standard "I'll Rise Again" and Blind Willie Johnson's "Nobody's Fault But Mine," which Barton described as "eerie and beautiful"—required the most takes (nine on the latter), but most songs were keepers in two or three takes; a few were even one take. "You have to stay on your toes when you work with Dylan," Barton says. "As an engineer, you have no warning when he's going to start. I literally sat there the whole day every day with my finger on 'record,' watching for him to start playing. The first couple of days he'd be in there looking like he wasn't doing anything, so I'd adjust a compressor or something, and then he'd just start playing. I learned my lesson quickly."

Barton says, "The whole thing seemed very casual. He was very relaxed. 'Breezy' is a good way to describe the experience. They'd finish a take, take a break, listen to the playback. Dylan would come in and joke with everyone. It was a nice feeling."

After the sessions were finished, Dylan had to leave town, so Bromberg and Barton supervised the mixing process. Still, "we FedExed mixes to Dylan in New York and got some valuable feedback and constructive criticism on some of the things we were doing," Barton notes. "Some things he liked the first time."

Among the tunes Dylan, Bromberg and his band put to tape (typically using about 23 of 36 inputs) were such venerable numbers as "Lady from Baltimore," which featured just Dylan and Bromberg, the old English folk song "Polly Vaughn," bluesman Furry Lewis' version of "Casey Jones," the ballad

No More Excuses

SigTech
Cambridge Signal Technologies, Inc.

The revolutionary new SigTech AEC-1000 analyzes and graphs the frequency and time domain performance of your monitors and room.

Then the same advanced DSP technology designs and installs a precise corrective filter based entirely on the problems! This filter operates *in time*—so sound begins uncolored and remains so throughout the ear's integration period.

You've never heard anything like it—*it works!* Call SCI for a demonstration and we'll prove it.

AKG, API, Apogee Electronics, Apogee Sound, B&B, Bryston, Canare, Drawmer, Eventide, Gefen Systems, SigTech, Sonic Solutions, Sound Ideas, Soundcraft, Westlake, White Instruments, and other exceptional audio products.

studio consultants, inc.

321 West 44th Street, New York, NY 10036 (212) 586-7376

Equipment, support, and design services for professional audio facilities and broadcasters — since 1971.

USE READER SERVICE CARD FOR MORE INFO

FIRST CALL

Why do world-class producers and studios call us first for digital transfers, digital editing, audio rentals and service?

WE'RE THE DIGITAL SOURCE

DAT, Sony 3348/24, Mitsubishi X-880 and X-86HS (96 kHz) mastering decks—we own 'em all. Equipment breakdown? Call us for a "Special Emergency" low-rate rental replacement.

DIGITAL MASTERING, EDITING, TRANSFERS

All-digital multi-format suite with Harmonia Mundi Format Converter, Sony digital editor w/EQ.

WE'RE DIGITAL EXPERTS

Call anytime for tech support, whether you rent from us or not.

WE'VE GOT WHAT YOUR RACK NEEDS

Lexicon & AMS, Neve EQ... the latest digital and analog gear, plus hard-to-find "classics."

WE NEVER CLOSE

That's right—24 hour service.

WE SHIP WORLDWIDE

You're never too far to go digital.

DIGITAL ASSOCIATES d/b/a

AUDIOFORCE

SOUND RENTAL LOGIC

630 9th Avenue • Room 1012 • New York, NY 10036

For your **FREE** rate card, call **800/847-4123** toll free in USA (212/262-2626 in NY State) or fax us at 212/262-2632.

"Duncan and Brady," and Bromberg's own "Catskills Serenade" and "World of Fools."

"If I had to characterize it," Barton says, "I'd say some of it has a sort of bluegrass sound—mainly acoustic, with some fiddle and mandolin—some of it has a Memphis sound, and of course there's some gospel feeling with the choir. There are some real gems on there. It was exciting for us, and it looked like Dylan had a good time, too." ■

—FROM PAGE 137, *CHICAGO LOOP*

to Dolan); lots of Budweiser and Bud Dry ads; and ADR for *The Wonder Years*. "Daniel Stern will come in to Streeterville, L.A. will fax the script, we'll capture Stern on 3/4-inch and then FedEx the master to L.A.," Dolan explains.

Film work at Streeterville included work with Ron Howard on *Backdraft*, and Penny Marshall and Madonna came in with Richard Marx to do the orchestration work for *A League of Their Own*. "Chicago is a hot place to film," Dolan says, "basically because it's a great backdrop to whatever you want—lakefronts, skylines, suburbs, ethnic blends." Since they bought six AudioFiles in 1988, all of Streeterville's post is done on DAWs. Although Streeterville features two Neve VRs with Flying Faders (Studio 1 and 2) and an SSL 6000 with Total Recall in their Finishing Suite, Dolan is most proud of their workstation setup: "With our DAW network we've been able to create a higher level of performance. The abilities to edit 32nd notes and control tempo allow artists to stretch their creativity because they don't have to worry about tempo and missed notes. [With DAWs] we've improved the quality of records and the efficiency of our work time in the studio."

About eight miles north of the Loop you'll find Seagrape Recording Studios. Chief engineer Mike Konopka reports tough times and a dramatic increase in competition: "In the '80s there were maybe 75 studios in town, now there are maybe 300." Konopka stresses quality people and cooperation with project studios as a buoyant float in turbulent waters. Sessions at "The Grape" have been happening; Larry "Mr. Fingers" Heard tracked and mixed his Number One Billboard dance hit "Closer" off his MCA debut album *Introduction* at Seagrape; R&B act DVS

Boyz worked a project for Profile Records; Certain Distant Suns tracked their debut CDM/Caroline EP entitled *Huge* with Seagrape's own David Trumfio producing and engineering; and Argentina-based trio Spanish Fly worked with Konopka.

And speaking of international flavor, Konopka corroborates Dolan in reporting a big London tie (rather than a New York or L.A. connection) with Chicago. "English people love Chicago blues and R&B," Konopka notes. "And they like to work in the Chicago rooms that have the equipment and sound of those classic albums." One English act recently at Seagrape was Pretty Things/Yardbirds, featuring Jimmy McCarty from the original Yardbirds lineup, as the band worked on a release for St. George Records.

The Chicago Recording Company is one of the biggest facilities in the U.S. It is a 16-studio complex with four multitrack studios and nine audio post-production studios featuring a 72-input Neve VR, SSL, Trident and Neotek boards, two AMS AudioFiles and Mitsubishi digital and Studer analog recorders. Studio manager and engineer Hank Neuberger says they track records at night and do commercial work during the day.

Some recent sessions at CRC: Composer/producer Mike Post came in with orchestra leader Arnie Roth to record the score for the film that opened Michael Jackson's concerts during his European tour. Neuberger tracked the 65-piece orchestra and 20-voice chorus in CRC's Studio D. Hot producer Butch Vig worked with Jersey rockers The Smithereens. Cheap Trick worked with producer Phil Bonanno. Alternative rockers Helmet tracked the title tune from their latest Geffen release with engineer/producer Steve Albini. Jazzman Ramsey Lewis worked with engineer Rich Breen for a GRP release. And Paul McCandless (of Oregon fame) did a solo album for Windham Hill Jazz with producer Steve Rodby.

At Chicago Trax, a multiroom facility featuring an SSL 4040E as well as a Harrison MR4 console, summer sessions were hot: Ministry produced remixes for the Red Hot Chili Peppers and Jesus and Mary Chain. Ice Cube did vocals on Prince Akeem's latest album along with other guest artists Chuck D, and Professor Griff of Public Enemy. Michelle Shocked stopped in at Chicago Trax to record the song "33 RPM Soul" in Studio A. In addition, Four On The Floor, Chicago's a cappella

rock group, recorded nine songs at Trax for an independent release; Jim Casey produced and Blaise Barton (see "In Session with Dylan and Bromberg") co-produced and engineered the sessions that involved no electronic instruments—only human voice. ■

—FROM PAGE 137, *N.Y. METRO*

Side of Manhattan. The center, which is expected to open around the end of the year, will house mastering, mixing and video post-production facilities but no tracking studios. Essentially, existing audio facilities are moving from the old East 52nd Street location, a move likely motivated by high East Side rents. Some video post capability is being added; consoles and other equipment were still being discussed at press time. The studio complex director is reported to be Al Smith.

Interestingly, Sony's new facility is across the street from the new Hit Factory complex on West 54th Street. Hit Factory owner Ed Germano is a longtime friend of Sony Music president Tommy Mottola; however, that had no bearing on their facilities' proximity to each other, according to Germano's publicist. The original Hit Factory, on 237 West 54th Street, will continue to operate after renovations there are completed.

The new site is expected to open in late November, but a couple of shake-down sessions probably will have taken place in October. Hit Factory's satellite studio on West 42nd Street was closed late last summer, and its equipment will likely be divided between the new and old locations.

A new combination project/commercial studio opened over the summer. Studio K, a 1,500-square-foot facility on West 25th Street, has a studio/control room and separate digital editing suite. Studio K, designed by ARcoustics, is notable for how inexpensively it was put together. Construction cost \$15,000, thanks to a do-it-yourself approach in which designers Francis Daniel and Victor Schwartz were used as consultants. Studio K also marks the first implementation of Daniel's patented Modal Mixer, a low-frequency absorption system designed for small rooms.

Across the river in Jersey, Manny's Music sponsored the ninth annual Jimmy Maolan Memorial Golf Tournament, honoring the New York session

drummer who died of the disease, to benefit the Leukemia Foundation during the second week of September. Studio players-cum-duffers, including Paul Shaffer, played at the Alpine Country Club in northern New Jersey, where holes were sponsored by professional audio manufacturers and organizations, including NAMM, Korg and Beyer. Manny's owner, Henry Goldrich, presided over the post-tournament banquet. ■

SESSIONS & STUDIO NEWS

NORTH CENTRAL

George Clinton returned to The Disc Ltd. in East Detroit, MI, to work on his new album for Paisley Park Records. Also at The Disc, Trey Lewd completed their latest Warner Bros. release...Comedian Judy Tenuta recorded vocal tracks and overdubs for her new single at Studio 300 in Chicago. At the controls were Terry Schilling and assistant Ken Sluiter. Candy J. produced the session for Fly Records America...At

Empty Street Productions (Champaign, IL), Pat Ortman produced Sludge Puppies for their single to appear on a dance/rock compilation album...

NORTHEAST

Sinead O'Connor recorded and mixed her new Ensign album, *Am I Not Your Girl?* at The Edison recording studio (a division of National Video Center in NYC) with chief engineer Gary Chester and legendary producer Phil Ramone. Because O'Connor was backed by a 40-piece big band, The Edison's spacious swing-era ballroom came in handy when tracking the 11 songs, which included Sinead's renditions of "I Want to Be Loved By You," and "Don't Cry For Me, Argentina" from the Broadway hit *Evita*...Madonna and producer Shep Pettibone were at Clinton Recording (NYC) doing some orchestral overdubs for her new Maverick/Warner release, *Erotica*. The arranging and conducting of the 45-piece orchestra was handled by Jeremy Lubbock. Michael Farrow engineered the tracks on Clinton's classic Neve 8078 with assistant Troy Halderson...Debbie Harry mixed her new Chrysalis single "Stability" at Giant Recording Studios in

Manhattan. John Luongo produced. Gary Hellman engineered and Charles Lin assisted the sessions...Billy Squier was working on his new Capitol release at The Magic Shop (NYC) with producer Mike Chapman, engineer Kevin Shirley and assistant Joe Warda...

SOUTHERN CALIFORNIA

Virgin Recording artist John Wetton (Roxy Music, King Crimson, Asia) recorded tracks for his solo album at Music Grinder Studios (Hollywood) with producer Bob Marlette and engineer Brian Reeves. Guest musicians on Wetton's solo effort included drummer Simon Phillips (Jeff Beck, The Who's last tour) and master guitarist Robert Fripp. Also at "The Grinder," country superstar Clint Black used L.A. session strongmen Russ Kunkel and Lee Sklar (drums and bass, respectively) to track a song on his upcoming LP with engineer Lynn Peterzell...Miki Coltrane, daughter of legendary jazz saxophonist John Coltrane, was recently at Take One Studios (West Hollywood) recording vocals for her debut project. Coltrane co-produced with Oji Pierce, and Voytek Kochanek engineered...At Urban Street in Inglewood, Kym

B

Burlington Audio / Video Tapes, Inc.

Audio/Video is our middle name!

Call or write for
FREE
Catalog!



Best Prices • Shipped from Stock • Immediate Delivery





106 Mott Street • Oceanside, New York 11572

USA & Canada • **1-800-331-3191**

NYC Area • 516-678-4414 FAX • 516-678-8959

ONLY
ON
SONY
RECORDING MEDIA

USE READER SERVICE CARD FOR MORE INFO

Burlington Audio/Video Tapes, Inc.
is a distributor of the complete line of ...



Professional Audio and Video Products.



BASF 911 MASTERING TAPE

Transparent Sound with a
Solid 10-Year Guarantee!

BASF 911 has outstanding reliability and long term storage stability. Guaranteed 10-year replacement policy. BASF's unique double coated product is the one you can count on for sound transparency...recorded sound with striking source duplication.
Your music is safe with us!



Burlington

Audio/Video Tapes, Inc.
106 MOTT STREET
OCEANSIDE, NY 11572

USA/CANADA 800-331-3191
NYC AREA 516-678-4414



FAX: 516-678-8959

USE READER SERVICE CARD FOR MORE INFO

WhisperRoom^{INC.}

MUSICIAN'S ISOLATION ROOMS

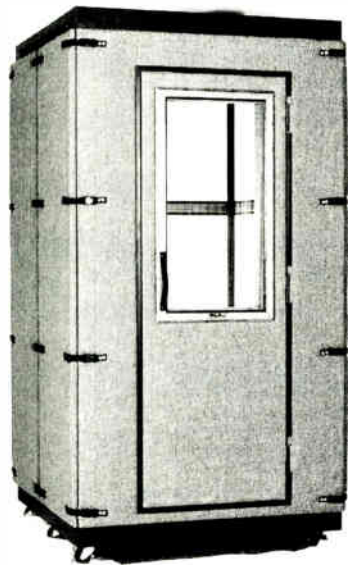

Various Sizes ★ Portable ★ On Wheels
Assemble/Disassemble in Minutes
Quiet Ventilation System
Endorsed By: RCA/BMG Studios, NY
Tel. (615) 585-5827 ★ Fax (615) 585-5813
116 S. Sugar Hollow Rd. ★ Morristown, TN 37813

Armstrong was in doing three songs for a development deal with Almo/Irving. Other projects include rap producer Sir Jinx working with a new artist...

SOUTHWEST

In Carrollton, TX, Luminous Sound Studios reports a hot summer: Vanilla Ice was in finishing his project for SBK Records with Luminous owner Paul Loomis, who co-wrote and co-produced songs for the project; Robert Wechsler engineered and programmed the Synclavier...Over in Dallas, Planet Dallas had Amarillo's The Blue Johnnies in working with producer Patrick Keel and engineer Rick Rooney, and alternative rockers Stranger Than Fiction completed a two-song demo with producer Bobby Romano and engineer Rooney...In Garland, TX, Danny Brown of Sound Logic Recording has been busy. His recent projects include an all-acoustic independent release by Larry Fontenette for Western Music, and on the other side of the spectrum, a project with metalheads Solitude Aeternus for Relativity Records...

NORTHWEST

The Plant (Sausalito, CA) had Hammer back in their facility to mix a new single for Capitol Records in Studio B. Theo Mizuhara produced and Mark Senesac engineered with the assistance of Mark Hensley. John Lee Hooker was in The Plant's Studio A tracking his next release for Charisma with producer Roy Rogers and engineer Sam Lehmer. Guest musicians included Jimmy Vaughn and members of the Robert Cray Band...Speaking of the King Snake: Mitch Woods was at Russian Hill Recording (San Francisco) recording a duet with Hooker for Woods' solo release. Sam Lehmer engineered and Bob Conlon assisted...And speaking of John Lee's legacy: Zakiya Hooker, daughter of the man, recorded her debut for Zamba Records, aptly titled *Another Generation of Blues*, at Music Annex in Menlo Park, CA. Ollan James produced the sessions with engineers Pat Coughlin and Mike Hersh...At Fantasy Studios (Berkeley, CA), Viva Brasil tracked their Latin rhythms with co-producer/engineer Stephen Hart...

SOUTHEAST

Producer Dallas Austin was "jammin'" at Doppler Studios (Atlanta) as he worked on a Bob Marley remix that included new tracks to be mixed with the originals. Engineer Darin Prindle

and assistant Blake Eiseman worked the console...At Sound Stage Studio (Nashville), Glen Campbell was working with producer Jerry Crutchfield and engineer John Guess on a project for Liberty Records...Latin pop sensation Chayanne mixed several live shows at Criteria Recording Studios (Miami) for an upcoming Sony Discos release. The SSL/Studer sessions were engineered by Victor DiPersia and assisted by Keith Rose...

STUDIO NEWS

NRG Recording Services opened a new state-of-the-art recording facility on Weddington Street in North Hollywood, CA. Designed by studio bau:ton and built by Lawrence Construction Co., the 5,000-square-foot facility features a classic 48-input Neve 8068 console with Flying Faders automation, a Studer 827 multitrack and custom TAD monitors...Todd Cashman, president of Bandwest Productions Inc., announced massive additions to his existing rehearsal facility in Anaheim, CA: a digital recording studio featuring the first Sony PCM 332 iS digital recorder on the West Coast, a Soundcraft Sapphire console and Yamaha NS-10M near-fields; a 35x50-foot soundstage with its own console, a Ramsa WR-S424; and several KABA tape duplicators were added to provide real-time tape duplication services...AudioResource Honolulu recently renovated and upgraded their main studio, Studio Mauka. Both the studio and control room received facelifts with new acoustic wall treatments and RPG diffusers, and a Sony PCM 33-i8 digital recorder will now reside in the plush surroundings. Along with the renovations of the main room, a second room was added, Studio Makai, to specialize in audio-for-video and MIDI/commercial production work with its 50-input DDA console...In Sausalito, CA, Studio D Recording retrofitted its vintage Trident TSM console with Neve's new Flying Faders custom automation and ten modules of Neve inputs to give them the best of both worlds: tracking and mixing...Cedar Creek Recording (Austin, TX) upgraded to a 36-input, discrete Neve console (an RCA classical desk designed by Rupert Neve) and also added a Studer 827 24-track to their facility.

Send nationwide sessions, studio news and any pertinent photographs to sessions editor Jeff Forlenza c/o *Mix* magazine, 6400 Hollis St., #12, Emeryville, CA 94608.

NORTH CENTRAL STUDIOS

Information in the following directory section is based on listing applications mailed earlier this year and was supplied by those facilities listed. *Mix* claims no responsibility for the accuracy of this information. Personnel, equipment, locations and rates may change, so please verify critical information with the companies directly.

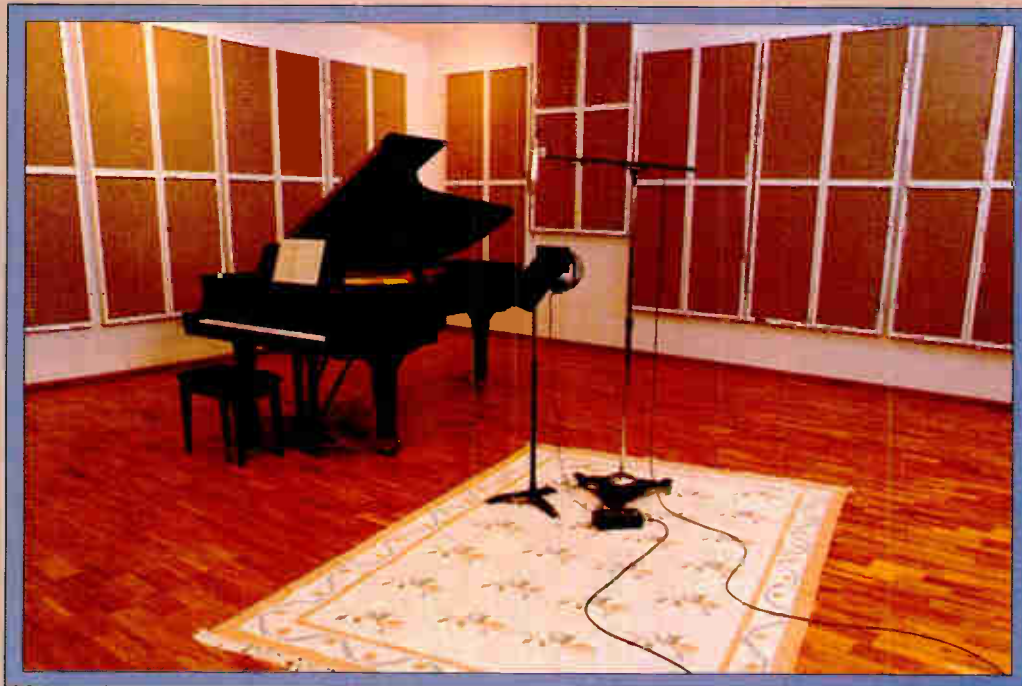

The 30x26 studio with vaulted ceiling, custom-designed baffles and 9-foot concert grand piano in Sweetwater Sound's new recording studio in Fort Wayne, Ind. The facility features an Amek Magnum console with MegaMix automation, Soundcraft Series 760 24-track and Alesis ADAT digital recorder. Sweetwater also has a "MIDI Toy Room" with an array of synthesizers and sound modules. Photo: Dan Nichols.

CONTENTS

145	Illinois	152	Minnesota
148	Indiana	152	Missouri
149	Iowa	153	North Dakota & Ohio
150	Kansas	154	South Dakota
150	Michigan	154	Wisconsin

Upcoming Directory Deadlines:

Recording Schools & Programs: **November 10, 1992**

Northwest Studios: **December 8, 1992**

Video Production & Post-Production Facilities: **January 8, 1993**

Mix listings procedure: Every month, *Mix* mails listing applications to recording studios and/or other vital facilities and services for the recording, sound and video production industries. There is a nominal charge to list a Boldface Listing (name, address, contact and descriptive icons) and an Extended Listing (equipment and services, and photo or logo). If you would like to be listed in a *Mix* Directory, write or call the *Mix* Directories Department, 6400 Hollis St., #12, Emeryville, CA 94608; toll free (800) 344-LIST (344-5478).

Looking For Contacts In the Audio Industry?
Find Them in the

1993 Mix Master Directory

The 1993 Mix Master Directory has the audio contacts you've been looking for. Published by *Mix*, the audio industry's most respected professional magazine, the Master Directory is your primary source for audio information, with **comprehensive listings** of audio manufacturers, suppliers and services throughout the U.S. and Canada. You'll find cross-referenced listings for:

- **Recording & Video Production Facilities**
- **Remote Recording Facilities**
- **Sound Reinforcement Companies**
- **Independent Engineers & Producers**
- **Mastering, Pressing & Duplication Services**
- **Facility Designers & Suppliers**
- **Recording Schools, Programs & Seminars**
- **Equipment Manufacturers**

...and dozens of other audio businesses, from record companies to industry organizations.

If you need audio services, supplies or products, look no further than this essential reference guide! Use the attached form to order your copy of the Mix Master Directory, or call **toll-free** to place your order: (800) 233-9604.

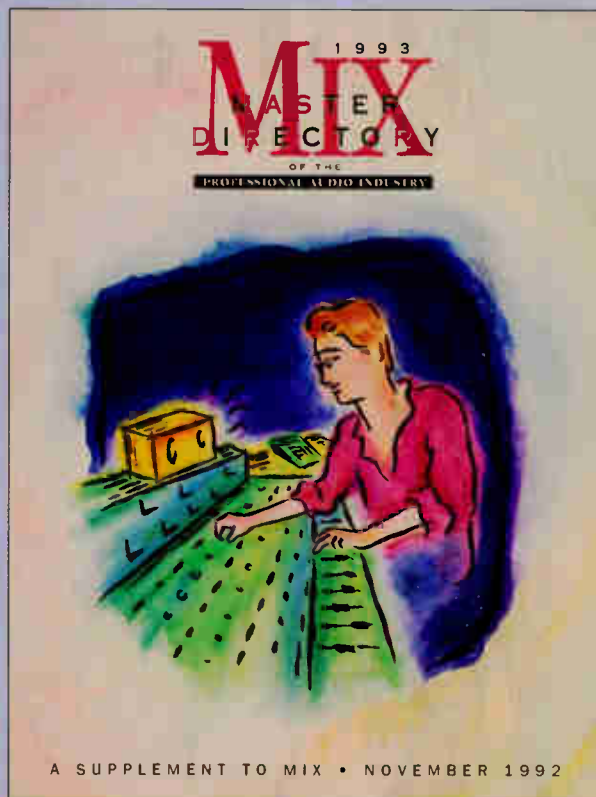

Please send me copies of the 1993 Mix Master Directory at \$24.95 each. (Add \$3.50 shipping and handling. CA, NY & IL residents add appropriate state sales tax.)

Please send me information on being listed in the *Mix* monthly directories.

Name

Company Name

Address

City/State/ZIP

Daytime phone () ext.

Check or Money order enclosed

Check #

Charge to Visa MasterCard Discover Card

American Express Expiration Date

Credit Card #

Cardholder Signature

Shipping times may vary; please allow two to three weeks for delivery. For immediate customer service and rush orders, call (800) 233-9604 or (510) 653-3307. 24 hour fax line (credit card orders only): (510) 653-5142.

Mail completed order form and prepayment to Mix Bookshelf, 6400 Hollis St., Suite 12-G, Emeryville, CA 94608

North Central Studios

ILLINOIS



ACME RECORDING CORP.
Chicago, IL

ACME RECORDING CORP.



1708 W. Belmont; Chicago, IL 60657; (312) 477-7333; FAX: (312) 472-7806. Owner: Jim Rasfeld. Engineers: Paul Smith, Blaise Barton, Al Wittke. Dimensions: Studio: 40'x21'x12', control room 21'x18'x11', mastering room: 15'x11'x12'. **Mixing Consoles:** Vintage Amek M3000 36 input w/automation, Neotek 16x8x4x2, Hill Multimix 16x4x2x1, Roland M-160 16-channel line return mixer, Tascam MM-1 line mixer. **Audio Recorders:** Studer A80VU II 24-track 2", Ampex ATR 102 2-track, Tascam 85-16B 16-track w/dbx, Technics 152 2-track, Sony PCM 2500 R-DAT, Panasonic SV-3500 (44.1), (2) Panasonic SV-3700, Sony PCM-1630/DMR-4000, Technics portable R-DAT, (50) Nakamichi MR-1 cassette decks. **Digital Audio Workstations:** Digidesign Sound Tools on Mac IIci. **Monitors:** Tannoy FSM-U, Radian MM-8, EV Sentry 100, EV Sentry 500, MS 802, Wharfedale Diamond II. **Other Major Equipment:** (2) Lexicon PCM70, Lexicon PCM60, Yamaha RE7, Studio Technologies Ecoplate III, AKG BX-20E, Korg delays, MXR delay, Alesis Microverb, (2) Yamaha SPX90, Klark-Teknik quad compressor, Brooke-Siren quad compressor, Brooke-Siren dual compressor, Teletronics LA-2A, (2) Neumann U47, (2) AKG C-12A, (2) Dolby SR/A. **Specialization & Credits:** Acme provides complete productions services from recording to finished product. We're the only 1630 mastering house in Chicago, with a new dedicated CD mastering room with Sound Tools on the Macintosh. We also provide the largest real-time duplication service in Chicago, with commercial clients like Tullio & Rans, Cliff Colnot, Charles Brown Music, Intuition Music, Steve Sperry and Ken Nordine. We handle custom cassette and CD manufacturing for many musicians and bands and offer full packaging services. Our recent studio clients include Bob Dylan, David Bromberg, Earwig Music, Wolf Records, Delmark Records, Lefty Dizz, John Primer, Kevin Purcell and the Nightburners, The Coctails, Bobby Norfolk, Bill Russo. Our studio is over 800 square feet with natural light and floating walls and floors and we have a comfortable lounge. Other service include blank cassettes in any length in small quantities. Acme was established in 1973.

AIRWAVE RECORDING STUDIOS INC.



2108 W. Roscoe St.; Chicago, IL 60618; (312) 404-0453. Owner: John McCortney, Paul Grigonis, Manager: Lynette McCortney. Engineers: John McCortney, Paul Grigonis, Ehab Haddad, Renee Maltezos. Dimensions: Room 1: studio 55'x25', control room 24'x22'. Room 2: studio 18'x16', control room 20'x16'. Remote van: control 9'x6'. **Mixing Consoles:** TAC Matchless 36x24x8x2 w/Megamix VCA automation, Biamp 2016 20x16x2, Revox C-279 6x2. **Audio Recorders:** Studer A-80 24-track, Otari MX-70 16-track, Studer A-810 2-track w/center time code track, Otari 5050 2-track, Revox A-77 2-track, Revox A-77 1/4-track stereo, Panasonic SV-3700 DAT, Panasonic SV-255 DAT, Sony DTC-1000 DAT, Sony PCM 501 "F1", Technics SV-100 "F1". **Monitors:** (2) Tannoy 215, (4) Norberg BCS-16, (2) Electro-Voice S-100SA, (2) Fostex RM-756, (2) Auratone, (7) AKG D-240 headphones, numerous others. **Other Major Equipment:** (2) custom 14'x12' reverb chambers, (4) Yamaha SPX90, Korg CRV-3000, Korg DRV-1000, ART SGE II, Lexicon PCM42 delay, DeltaLab ADM-1024 delay, (8) Hardy M1 preamp, Symetrix SX-202 2-channel mic preamp, (3) dbx 160X compressor, dbx 166 2-channel compressor, Symetrix 522 2-channel compressor, dbx 263X re-esser, TEAC GR-20 2-channel graphic equalizer, Focusrite 2-channel mic pre EQ, (2) dbx 150X 2-channel noise reduction, Telefunken U-47, (2) Bruel & Kjaer 4006, (2) Schoeps Mk-21, (2) AKG 414, (2) Neumann KM-84, (2) Neumann KM-83, (3) Sennheiser 441, (2) Sennheiser 421, (6) Shure SM81, Electro-Voice RE-20, numerous others, Carver 1.0t amp, Hafler 500 amp.

ARS RECORDING STUDIO



11626 S. Pulaski Rd.; Alsip, IL 60658; (708) 371-8424; FAX: (708) 371-3958. Owner: ARS Enterprises Inc. Manager: Gary A. Cobb.

AUDIO RECORDING UNLIMITED INC.



400 N. Michigan Ave., Ste. 1900; Chicago, IL 60611; (312) 527-7000; FAX: (312) 527-3360. Owner: Mike King.

LEGEND

Maximum digital tracks

Maximum analog tracks

Remote audio recording

MIDI production

Tape duplication

Mix to picture

Digital editing/CD prep

In-house music services

Digital Bin Cassette Tape Duplication

With revolutionary
Duplitronics DHS® Technology
From Your DAT Master

COMPLETE PACKAGE
300 C-12's 300 C-45's
\$395 \$495

Type II Tape, Clear 5-Screw Shell,
Clear Norelco, Direct-on-Cassette
Printing, Black & White Insert, and
all setup charges.

Complete Graphic Services



800-955-7271
804-582-6139
FAX 582-6144
147 Mill Ridge Rd.
Lynchburg, VA
24502

USE READER SERVICE CARD FOR MORE INFO

ANSWERS TO
YOUR SOUND
RECORDING
PROBLEMS!

SHAPING YOUR SOUND

A Fire Videotape Series Filled With Real Life
Solutions to the Recording and Mixing
Problems You Face Everyday.



SHAPING YOUR SOUND WITH MIXERS AND MIXING

SHAPING YOUR SOUND WITH MULTITRACK RECORDING

SHAPING YOUR SOUND WITH EQUALIZERS, COMPRESSORS AND GATES

SHAPING YOUR SOUND WITH REVERB AND DELAY

SHAPING YOUR SOUND WITH MICROPHONES

Dozens of demonstrations, animated sequences and live music examples in hi-fi stereo make each tape a powerful learning and reference tool.

"SHAPING YOUR SOUND can do what no book on the subject has ever been able to accomplish." — MIX MAGAZINE

For information write or call toll free:

First Light Video Publishing
8536 Venice
Los Angeles, CA 90034
(800) 777-1576

GOLD LINE
MANUFACTURED IN U.S.A. SINCE 1961

**NEW: SOUND LEVEL
METER with
DIGITAL NUMERIC
DISPLAY**



Standard: 45 to 120 dB
RANGE OPTION
Preamp: 25 to 120 dB

CONTRACTOR PRICES

Send for free catalog:

Box 500, West Redding, CT 06896
PH (203) 938-2588 FAX (203) 938-8740

USE READER SERVICE CARD FOR MORE INFO

**The very heart
of your
tape
machine**



**Can you
trust it
to just
anyone?**

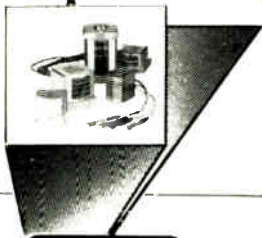

JRF maintains a complete laboratory consisting of state of the art magnetic head refurbishing and optical alignment equipment. In most cases worn, unserviceable magnetic heads for RECORDING STUDIOS, TAPE DUPLICATING, MASTERING, AND BROADCASTING can be restored to original performance specifications for a fraction of the cost of replacement. If our FREE EVALUATION indicates that heads cannot be repaired, we offer premium quality replacement heads as well as heads for custom applications.

JRF/Magnetic Sciences, Inc.
249 Kennedy Road • P.O. Box 121
Greendell, New Jersey 07839

Tel.: (201) 579-5773

Fax: (201) 579-6021



North Central Studios

BARKER RECORDING STUDIO INC.



117 S. Rockford Ave.; Rockford, IL 61104; (815) 399-2929; FAX: (815) 226-0811. Owner: Dwayne and Pam Barker. Manager: Pam Barker.

BARN BURNER RECORDING STUDIO



26380 N. 1500 Ave.; Annawan, IL 61234-9697; (309) 935-6181. Owner: Heath Audio Associates Inc. Manager: Harry Heath.



P.O. Box 27026
Chicago, Illinois 60627

Music & Sound Production

CHICAGO PRODUCTION COOPERATIVE
Dalton, IL

CHICAGO PRODUCTION COOPERATIVE



13808 Lincoln; Dalton, IL 60419; (708) 849-3735; FAX: (708) 849-3874. Owner: Philli Brown. Manager: Philli Brown. Engineers: Curtis Kincaid, Phillip Brown. Dimensions: Studio: 14 x 16'; control room 14 x 25'. **Mixing Consoles:** DDA. **Audio Recorders:** Otari 80 24-track. **Monitors:** (2) Century 500, (2) Tannoy B. **Other Major Equipment:** (8) Omni Craft, (3) dbx compressor, REV7, Lexicon PCM70, ART, Lexicon 42, Roland GP-8, K250, K1000, DX7IIFD, Prophet VS, K3, TD 800, Emax, Matrix C, Roland D50, Alesis D4, Roland 8900, Korg M1, Roland R-8.



CHICAGO RECORDING CO.
Chicago, IL

CHICAGO RECORDING CO.



232 E. Ohio St.; Chicago, IL 60611; (312) 822-9333; FAX: (312) 822-9189. Owner: Alan Kubicka. Manager: Hank Neuberger. Engineers: Phil Bonanno, Chris Sabold, Gus Mossler, Chris Shepard, Hank Neuberger. Dimensions: Room 1: studio 70 x 38', control room 24' x 24'. Room 2: studio 60' x 30', control room 24' x 24'. Room 3: studio 60' x 30', control room 24' x 24'. Room 4: studio 20 x 20 control room 24' x 20'. **Mixing Consoles:** Neve VR72 w/Flying Faders, SSL 600 E/G, Harrison 10. MCI 556 w/Diskmix. **Audio Recorders:** Mitsubishi X850, Studer A827, Studer A800, (4) Sony 7030 Time Code DAT, (6) Panasonic 3700 DAT, Sony center track Time Code, Mitsubishi X-86. **Digital Audio Workstations:** (7) AMS Audiofiles, (3) NED Synclavier, (2) E-mu Emulator 3, (2) Digidesign Sound Tools. **Other Major Equipment:** (3) Eventide H3000, (3) AMS

1580-S, AMS RMX-16, Lexicon 480L, Lexicon 300, (50) Focusrite 115 EQ/premic, (20) Focusrite 130 Dynamics, (3) EMT plates, EMT 251, API EQ, Fairchild limiter, Tube-Tech limiter, (8) Lexicon PCM70, (8) Yamaha REV7, Lexicon 200, (3) Klark-Teknik DN780, Alesis D4, Sony 1" master video recorder, (15) Sony & JVC 3/4" video recorder, (6) TimeLine Lynx, (6) BTX Shadow, (2) Steinway grand piano, Bosendorfer grand piano, (10) Lexicon PCM42. **Specialization & Credits:** 16 studios. Recent clients include: Izzy Stradlin, Smithereens, Enuf Z' Nuff, Cheap Trick, Michael Jackson, R. Kelly & Public Announcement, Ten City, Ramsey Lewis, Helmet, Sting, Winans, Hi-Five, Lonnie Brooks, Butch Vig, Steve Albini, Poster Children, Styx, Dolly Parton, Concrete Blonde, Prong. Post-production clients include: McDonalds, United Airlines, Sears, Budweiser, Coca-Cola, All-Slate, 7up, Sony, Coors, Kellogg's, etc.

CHICAGO TRAX RECORDING



3347 N. Halsted; Chicago, IL 60657; (312) 525-6565; FAX: (312) 525-6942. Owner: Chicago Trax Inc. Manager: Reid Hyams, Debbie Connors. Engineers: Al Ursini, Chuck Kawal, Dave Sears, Keith Auerbach, Jeff Newell, Tim Tisworth. Dimensions: Room 1: studio 35' x 24', control room 24' x 18'. Room 2: studio 16' x 11', control room 14' x 13'. Room 3: control room 8' x 7'. Room 4: control room 11' x 9'. **Mixing Consoles:** SSL 4040E Series w/SSL Studio computer G Series, Harrison MR4 32x24 w/Audio Kinetic Mastermix automation. **Audio Recorders:** Otari MTR-90 II, Otari MX-80, (2) Studer A80 2-track, Studer B67 2-track, Tascam 3340 4-track. **Digital Audio Workstations:** Digidesign Sound Tools, (12) Tascam 122 MkII, Panasonic 3500 DAT, JVC DT90 DAT. **Monitors:** UREI 813B, (4) Yamaha NS-10, (2) Auratone 5C, KRK 9, UREI 811 A, JBL 4313, Tannoy Super Gold LGM. **Other Major Equipment:** TimeLine Lynx synchronizer system, Lexicon 300 digital reverb, Lexicon 200 digital reverb, AMS DMX 15-80S dual delay-sampler/pitch shift, AMS RMX digital reverb, Lexicon PCM42, Lexicon PCM60, Klark-Teknik 780 digital reverb, Ecoplate reverb, Yamaha SPX90, Yamaha REV7, Eventide Ultra Harmonizer, Lexicon Prime Time I & II, Aphex & Drawmer gates, assorted dbx limiter/compressor, GML 8200 EQ, Tube-Tech EQ, Valley People Dyna-Mite, Aphex Studio II Exciter, Sony 5800 3/4" U-Matic. **Specialization & Credits:** Specializing in the production of music and commercials. 32-track and 48-track capabilities: in-house music production company "Music Chicago". Recent clients: Ministry, Sire; Michelle Shocked, Mercury; Die Warzau, Fiction/Atlantic; Ramsey Lewis, Columbia; Ten City, Atlantic; KMFD, WaxTrax; Patrick Moraz; Angela Bofill, Capitol; Skinny Puppy, Capitol; Ronnie Laws, Buddy Miles, Dr. John, Smashing Pumpkins, Skatennis, Prince Akeem w/Chuck D and Flavor Flav of Public Enemy, Chgo Tip Records; Skrew, Latour, PolyGram/Smash. **Remix work:** Duran Duran, Blondie, Lil Louis, Marshall Jefferson, Erasure, Cabaret Voltaire, Ivan Neville, 9' Nails, Red Hot Chili Peppers, Jesus and Mary Chain.

DOMAIN AUDIO SERVICES



289 Main Pl.; Carol Stream, IL 60188; (708) 668-5300; FAX: (708) 668-0158. Owner: Ed Elliott. Manager: Timothy R. Hollinger.

EATIN' RECORDS RECORDING STUDIO



1295C Prairie Ave.; Glendale Heights, IL 60139; (708) 858-5130. Owner: Brian Eaton. Manager: Brian Eaton.

THE HAIR BEAR RECORDING STUDIO



4817 W. 129th St.; Alsip, IL 60658; (708) 389-3373. Owner: Jeffrey A. Islinger. Manager: Jeffrey A. Islinger.

HUBBARD STREET STUDIOS INC.



11 E. Hubbard St.; Chicago, IL 60611; (312) 670-0110.

JDR-DAN INC.



1100 Wheaton Oaks Ct.; Wheaton, IL 60187; (708) 653-1919; FAX: (708) 665-4966. Owner: Corporation. Manager: Kelly Lovett.



METRO MOBILE RECORDING
Glenview, IL

—SEE LISTING TOP OF NEXT COLUMN

METRO MOBILE RECORDING



2097 John's Ct., Glenview, IL 60025; (708) 998-6420; FAX: (708) 998-6421. Owner: Timothy R. Powell. Engineers: Timothy R. Powell, Lawrence Whipple, Dan Glomski. Dimensions: Remote truck 14'x8'. Mixing Consoles: Neotek Elite 50x26, (2) Hill Multi-Mix 16x4 rack mount mixers, Hardy M-1 4x4 microphone preamp. Audio Recorders: (2) Sony JMC1 JH-24 24-track, Ampex ATR-104 4-track 1/2", Panasonic SV-3500 DAT, Sony TCD-10 Pro portable DAT, Sony 300ES DAT, Fostex E-16 1/2" 16-track 15 ips, Tascam 40-4 1/4" 4-track, Scully 280B 1/4" 2-track, (2) Technics 1500 1/4" 2-track, Sony 601 PCM w/Sony SLHF-900 & SLHF-450 Beta, (2) Tascam 112R cassette, (10) Yamaha KG630 cassette. Monitors: UREI 809, Yamaha NS-10, AR Red Box II, Tannoy 6.5 PBM, JBL 4313, Calibration Standards MDM-4, Auratone 5-C. Other Major Equipment: Adams-Smith Zeta-3 transport synchronizer, Eventide H3000SE Ultra Harmonizer w/sampling card, Lexicon PCM60, Lexicon Prime Time digital delay, Yamaha REV7, (2) Yamaha SPX90, (4) Yamaha D1500, Roland SRV-2000, Roland Dimension 'D', (2) Studio Technologies AN-2, Aphex Compeller limiter, Aphex Type C Aural Exciter, (3) Aphex 612 noise gate, (6) dbx 160X limiter, (5) dbx 166 limiter/gate, dbx 165A limiter, (2) dbx 463X noise gate, (2) dbx 263X de-esser, (2) dbx 563X silencers, UREI 117 6N limiter, (2) UREI LA-4 limiter, (2) UREI LA-3A limiter, Burwen DNF-120A dynamic noise filler, Drawmer DS-201 gate, Omni Craft GT-4 gate, Orban 622 EQ, NAD 4300 AM/FM tuner, (160) microphones by Bruel&Kjaer, Schoeps, Sennheiser, Neumann, Sony, AKG, Electro-Voice, Shure, Beyer, Fostex, Milab, RCA, Audio-Technica; Bryston 4NB, Bryston 3B, (2) Crown D-75 power amps; Rane HC-6 headphone amp, (2) Sony CVM-1270 color monitor/receivers, Panasonic WV-F2 CCD color video camera, Toshiba IK-2000 color video camera, Otari EC-201 SMPTE time code reader, 120 amp singlephase power distribution w/350' of cable, 48-channel, 3-way transformer splitter, 36-channel 2-way transformer splitter, 52-channel multipair snake system w/275' of cable, Clearcom intercom system w/5 beltpack/headsets, (8) Missing Link active direct boxes, (2) Stewart active boxes, (8) Pro-Co direct boxes, drum baffle set, Plexiglass drum baffle set. Specialization & Credits: Featuring Chicago's first and only 48-track audio truck. Metro Mobile offers the finest in location audio services for live radio & TV broadcasts, audio-for-video & film production, on-location commercial recording and live album and CD production. Recent clients include David Bowie, The BoDeans, Indigo Girls, John Cougar Mellencamp, the Replacements, Living Colour, Chicago Blues, Jazz and Gospel festivals, Eleventh Dream Day, Poi Dog Pondering, Jesus Jones, Don Dixon, Circus of Power, The Descendants, Ministry, Revolting Cocks, Material Issue, Dream Syndicate, Adrian Belew, Soul Asylum, John Hiatt, KISS, Winger, Robert Cray, Lonnie Brooks, Lonnie Mack, Shriekback, The Nylons, Houses of Love, The Pixies, The Neville Bros., RED Speedwagon, The Church, The Winans, Edwin Hawkins, Santana, WXRT's Sunday Night Concerts, WLUP, WFMT, WBBM-TV, WTTW-TV, WBEZ, HBO, MTV, Showtime, Westwood One, The A&E Network, PBS, National Public Radio, The Disney Channel, A&M, MCA, Alligator, Polygram, CBS, Atlantic, Island, Elektra, Warner Bros., Epic and Geffen Records.

PARAGON RECORDING STUDIOS INC.



9 E. Huron St., Chicago, IL 60611; (312) 266-0075; FAX: (312) 642-6688. Owner: Marty Feldman. Manager: Nancy Feldman. Specialization & Credits: Paragon Recording Studios is celebrating over 25 years as specialists in the international audio recording community with over 40 gold and platinum records in our credits. Our many thanks to our clients, staff and friends who have contributed to our success.

PEGASUS RECORDING



1412 W. Belmont, Chicago, IL 60657; (312) 880-5000 (evening). Owner: Gary Khan. Manager: Ilene Krause.

PRIVATE STUDIOS



705 W. Western Ave., Urbana, IL 61801; (217) 367-3530. Owner: The Private Group. Manager: Jonathan Pines.

R/J RECORDING & SOUND



PO Box 302; 530-C Lark St., Geneva, IL 60134-0302; (708) 232-1932; FAX: (708) 232-1938. Owner: Richard J. Peck. Manager: Richard J. Peck.

RPM STUDIO 8



318 S. Second St., St. Charles, IL 60175; (708) 377-3993. Owner: RPM Productions. Manager: Tom Jancauskas.

SILVER OAKS COMMUNICATIONS



PO Box 8440; Moline, IL 61265; (309) 797-9898; FAX: (309) 797-9653. Manager: Dave Cox.

SOLID SOUND RECORDING STUDIO INC.



2400 W. Hessel Rd., Ste. 430; Hoffman Estates, IL 60195; (708) 882-7446. Owner: Judd Sager. Manager: John Towner, Phil Bonnet.

SONIC TEMPLE



310 E. Chicago; Elgin, IL 60120; (708) 695-0711; FAX: (708) 695-0714. Owner: Graceland Inc. Manager: C. Kalinowski.

SONU/VIDEO IMPRESSIONS



110 River Rd.; Des Plaines, IL 60016; (708) 297-4360; FAX: (708) 297-6870. Owner: Bill Holtane, president. Manager: Paul Sneed.

SPARROW SOUND DESIGN



3501 N. Southport; Chicago, IL 60657; (312) 281-8510. Owner: B. Parker-Sparrow, Joanie Pallatto. Manager: Angel Almeida. Specialization & Credits: Sparrow Sound design is now in its 15th year as a leader in sound recording and music-video production. With one of the largest active collections of rare tube microphones in the world and the Baldwin 9-ft. concert grand, Sparrow Sound Design specializes in jazz, classical and all forms of acoustic and electric music. The entire staff of Sparrow Sound Design are active composers and musicians. The Sparrow facility was designed by Bill Bradley. Its rooms are large and live. The equipment at Sparrow is a blend of vintage and new. Southport records is a division of Sparrow Sound Design with jazz-classical and new music releases for the world market. Clients: Richie Cole, Von Freeman, Redd Holt, George Flynn, Columbia Pictures, Universal Pictures, Yusuf Lateef, Eidee Young, Erwin Helfer, Eden Atwood, Don Bennett, Bobby Lewis, Art Porter, Don Moye, Lester Bowie, Malachi Favors, Joseph Jarman, Paul Wertico, Ed Peterson, Willie Pickens, William Ferris, Carol Moseley Braun.

STAR TRAX RECORDING INC.



4750 W. 137th St.; Crestwood, IL 60445; (708) 489-5242. Owner: Star Trax Inc. Manager: George Luf.



STREETERVILLE..

STREETERVILLE STUDIOS
Chicago, IL

STREETERVILLE STUDIOS



161 E. Grand Ave., Chicago, IL 60611; (312) 644-1666; FAX: (312) 644-8668. Owner: James C. Dolan. Manager: Bob Dolan. Engineers: Fred Breitberg, Bob Kruger, Bob Miller, Mark Zeboski, Tom Miller, David Axelbaum. Dimensions: Room 1: 47'x27', control room 25'x17'. Room 2: 37'x27', control room 24'x18'. The Suite: 14'x15', control room 21'x21. Room 4: 14'x13', control room 21'x20'. Mixing Consoles: Neve VR 48x48x48 w/Flying Faders, Neve VR 48x48x60 w/Flying Faders, SSL 6048, (2) Harrison 4032 32x32x40 w/Autoset I, Neve 2118 6x4x2 w/custom discrete circuitry. Audio Recorders: (3) Otari MTR-90 24-track, (5) MCI JH-24 24-track, (2) Studer A80 4-track, (2) Otari MTR-10 4-track, Otari MTR-12 4-track, (4) Otari MTR-10 2-track, (12) Studer B67 2-track, (2) Studer B77 2-track. Digital Audio Workstations: (6) AMS AudioFile II, Synclavier digital music system. Monitors: (2) UREI 809, (2) UREI 813, (8) Yamaha NS-10, (8) Auratone, (3) Eventide 100, MDM 40, (2) JBL. Other Major Equipment: (3) Lexicon 480L w/LARC, (3) Lexicon 224X w/LARC, (5) Lexicon PCM60, (2) Lexicon Prime Time, (2) Lexicon 92, (3) EMT 140, (2) EMT 240 Gold Foil, (2) MXR digital delay, (2) Eventide 1745, (2) Korg SDD-2000, (3) Yamaha REV7, (3) Yamaha SPX90, (3) TC Electronic 22, (4) AMS SDMX delay/sampler, (2) Yamaha 1500, (2) AMS RMX16, all new & vintage microphones, (4) Sony PCM-2500 R-DAT, (2) Panasonic SV-3500 R-DAT, complete collection of UREI limiters, (12) Kepex/Gain Brains, 48 tracks of Dolby SR, (3) Aphex Expander gate, (12) dbx 463 gates, (5) Drawmer DS-201, (9) dbx 263 de-esser, (3) Focusrite EQ, (3) Pultec EQ, (2) Lang EQ, (2) Industrial Research graphic EQ, (9) Dolby A 24 channel, (8) LXP-1 controller, (4) SPX 90, (9) Lynx synchronizer modules, (4) Aphex Studio Dominators, (2) Aphex Aural Exciter. Specialization & Credits: Streeterville offers AMS AudioFile II systems in all studios for pre-production, in-session manipulation and processing, as well as for mixdown and mastering. Streeterville also offers an optical disc library of 200,000 musical sounds. These sounds can be accessed to originate, replace or enhance "sounds" for your record, film or commercial project. Extensive MIDI interfacing with our Synclavier. Streeterville also offers a writing/programming MIDI room w/Mac Performer ProTeus as well as tying into our larger optical library. Streeterville also

—LISTING CONTINUED ON NEXT PAGE

In Northern California, audio professionals know that Leo's is the one place for all their audio needs—whether a special connector or a top line digital audio workstation. Rentals, too. Pro Audio for Professionals.

we listen so you'll be heard...



PROFESSIONAL AUDIO, INC.
5447 Telegraph Ave.
Oakland, Ca 94609
510.652.1553 or fax: 510.652.6575

USE READER SERVICE CARD FOR MORE INFO

CD-LIKE
QUALITY
ON CASSETTES!!

KLARITY
CASSETTE

REAL-TIME/HIGH-SPEED
CASSETTE DUPLICATION

5 Day Turnaround!!
500 CASSETTES
MUSIC EXPRESS

INCLUDES:
- Free Master Prep
- On-Shell Printing
- Bk & Wh J-Card Inserts
- Packing & Shrinkwrap

High Speed
\$615.00

See Next
Page for
CD SPECIAL

KLARITY CASSETTE, INC.
Waterville, ME 04901
1-800-458-6405
207-873-3911

THE CLASS OF 1991

Meyer
SOUND STUDIOS

Complete 24 Track and
Post Production



3000 SE, Variable Acoustic Main Room, 32 Input Neotek Elite Console, Sony JH-24 UREI 813 Monitors, Reflection Free Zone Control Room. "CLASS OF 1991 - A LOOK AT AMERICA'S HOTTEST NEW ROOMS" MIX MAGAZINE - AUGUST 1991 FEATURE ARTICLE.

For Bookings:
ORA C. ROBINSON
MEYER CREATIVE PRODUCTIONS
208 North 4th Street
Bismarck, ND 58501
701-223-7316
FAX 701-255-4921

USE READER SERVICE CARD FOR MORE INFO

North Central Studios

—LISTING CONTINUED FROM PREVIOUS PAGE

offers stereo digital satellite recording as well as land patch digital recording. Credits include: Robert Cray/Albert Collins/Johnny Copeland (Grammy), Steve Goodman (Grammy), Dave Mason, Ministry, Neil Diamond, Steve Miller Band, Buddy Guy, Johnny Winter (Grammy nominee), Roy Buchanan, Lou Rawls, Lonnie Brooks, Koko Taylor, Katie Webster, James Cotton, Kinsey Report, Kenny Neal, Li'l Charlie & the Nightcats, Delbert McClinton, Madonna *League of Their Own*.

TAKE ONE RECORDING STUDIO



1431 W. Whittaker; Salem, IL 62881; (618) 548-3566; FAX: (618) 548-3585. Owner: C. Keith Bailey. Manager: Don Gessner.

ZONE RECORDING



1316 N. Clybourn; Chicago, IL 60610; (312) 664-5353; FAX: (312) 664-6560. Owner: JP-USA. Manager: Roger Heiss.

UNIVERSAL RECORDING CORP.



32 W. Randolph, Fls. 14 and 15; Chicago, IL 60601; (312) 201-3150; FAX: (312) 201-3140. Owner: David Kalish. Manager: John Scherf. **Specialization & Credits:** Universal Recording houses five production studios, two expansive 32-track music studios, two film/video remix theaters, a THX® approved screening room, a broadcast facility, an audio layback room for video, and an optical transfer suite—all designed by the Universal team. Universal Recording offers full digital audio services, automatic dialog replacement (ADR), music and sound effects library (CD & tape) and Synclavier Sound Design. Recording credits include: Manowar, Steamroller, Metallica, Plácido Domingo, *The Babe*, *Radio Flyer* and *Backdraft*.

VECTOR SOUND DESIGN



PO Box 66692; Chicago, IL 60666; (312) 693-4443. Owner: Doody Dudes. Manager: Lucien Vector.



WAVE DIGITAL
Gurnee, IL

WAVE DIGITAL



4262 Grand Ave.; Gurnee, IL 60031; (708) 336-7702; FAX: (708) 336-8477. Owner: Mike Witte, Alan Pangelinan, Eric Greif. Manager: Brian Griffin. **Specialization & Credits:** Specializing in total digital recording from corporate voice-over to 24-track album production. Other services include digital editing, audio classes and small P.A. rentals. Our staff engineers are also accomplished producers with their work being distributed worldwide. Located between Milwaukee and Chicago, we service a wide range of companies and artists. Project references available upon request.

WOODEN NICKEL SOUND STUDIO



6844 Dickison Cemetery Rd.; Dunlap, IL 61525; (309) 243-7658. Owner: Donald J. Rosser.

WOODSIDE AVE. MUSIC PRODUCTIONS



1618 Orrington Ave., Ste. 203; Evanston, IL 60201; (708) 864-6655; FAX: same-call first. Owner: Steve Rashid. Manager: Mark Levison.

ZEM RECORDING STUDIO



3709 S. 60th Ct.; Cicero, IL 60650; (708) 656-1544. Owner: Ed Zem. Manager: Sue Zajda. Engineers: Ed Zem. **Dimensions:** Studio 20'x22', control room 14'x11'. **Mixing Consoles:** Harrison MR-4 28x24. **Audio Recorders:** Otari MTR-90 MkII 24-track, Ampex ATR-102 2-track, Otari MX-5050 2-track, (2) Akai GX-F91. **Monitors:** B&W 801, B&W DM-12, Yamaha NS-10. **Other Major Equipment:** Dolby SR/A 2 channels, dbx Type 1 2-channel, Lexicon 480L digital effects systems, Lexicon 200, Eventide MOD 3000 Ultra-Harmonizer, Yamaha SPX90, Lexicon Super Prime Time, Eventide 949 Harmonizer, Aphex Compeller compressor/limiter, (2) dbx 165A compressor/limiter, dbx 900 gate/compressor/leveler, (2) Drawmer gates, Dynaflex DX2, Aphex Aural Exciter Type III, EXR Exciter, (8) Neumann, (8) AKG, (8) Shure, (4) Sennheiser, (2) RCA, (8) Electro-Voice, Beyer, (2) Bryston 4B, Crown D-75. **Specialization & Credits:** Zem Recording Studio is a full-service 24-track recording facility. We have over 15 years of experience in all aspects of audio recording. We try to offer maximum service at reasonable rates remembering that customer satisfaction comes first.

ZENITH/DB STUDIOS



676 N. LaSalle Dr.; Chicago, IL 60610; (312) 944-3600; FAX: (312) 944-2843. Owner: Coken & Coken Inc. Manager: Ric Coken.

INDIANA

AIRE BORN INC.



4700 Northwest Plaza, W. Dr.; Zionsville, IN 46077; (317) 876-1556; FAX: (317) 876-1556. Owner: John Bolt, Mike Wilson. Manager: Mike Wilson.

GALT STUDIOS/PRO-VIDEO



139 W. Shore Dr.; Culver, IN 46511; (219) 842-4422. Owner: Brian McCormack. Manager: Jack Johnston. Engineers: Paul Mahern, Brian Galt, Mark Hoffman. **Dimensions:** Room 1: studio 14'x44', control room 13'x25'. **Mixing Consoles:** Neotek Elite 40 Frame, Soundcraft 600 24x8x2. **Audio Recorders:** Otari MTR-90II 24-track, Akai MG140 12-track, Panasonic 3700 DAT, Sony PCM 2300 DAT, Fostex Model 20 1/4". **Monitors:** JBL Control 10, Yamaha NS-10M studio, Yamaha NS-10M. **Other Major Equipment:** Lexicon 300, Eventide H3000S Ultra Harmonizer, (2) Neve 1079 mic preamp and EQ, (2) Neve 2254 limiter/compressor, (10) UREI tube mic preamp, (4) Sontec MPA-1 mic preamp, (2) TEAC 31 tube mic preamp, (2) Hafler T2 tube mic preamp, Drawmer DL-241 dual auto compressor, Drawmer DS-404 quad gate, Symetrix 501 compressor, Lexicon LXP-1, Lexicon LXP-5, Alesis Quadverb, Yamaha SPX900, (2) Neumann U57, (2) Neumann KM-84, (2) AKG 414, (4) Shure SM57, (2) Sennheiser 421, (2) JVC KY20 3 chip cameras, (2) JVC BR-5611U S-VHS VTR, (2) JVC KR-M800U M-II editing VTR, JVC AB Roll editor editing controller, (4) Sony Trinitron monitor, JVC TM-22U monitor, Apple Macintosh Icx 5/170, Truevision NuVistat video board, Truevision video script, Adobe Photoshop, Adobe Illustrator, Yamaha KX88 MIDI Keyboard controller, Kurzweil 1000PX synthesizer, Korg M1 synthesizer, Korg Wavestation synthesizer, Yamaha TX7 synthesizer, Roland R-8 drum machine, Sonus SMX 2000 SYNTE MTC, JVC M3000 special effects gen. **Specialization & Credits:** Galt Studio's with its parent company Pro-Video offers Indiana's most reasonable production costs complemented by some of the newest, quality equipment in the Midwest. Our selections of vintage tube gear, musicians, instruments and technical skills, ensures a high definition recording within a budget. Everything is included in our facility, and day layout rates are priced no differently than nights. Our isolated, woody setting by Indiana's 2nd biggest lake, and included guest house, will help create the special vibe necessary for a great recording.

MARSH RECORDING STUDIOS



3508 Westview Blvd.; Muncie, IN 47304; (317) 284-6100; FAX: (317) 284-1266. Manager: Andrew Marsh.

MIAMI STREET STUDIOS



1619 Miami St.; South Bend, IN 46613; (219) 288-TAPE. Owner: John and Jackie Nuner. Manager: Earl Scott.

NEW LIFE SOUND



506 Colorado St.; Goshen, IN 46526; (219) 533-8793. Owner: Marvin Beachy. Manager: Marvin Beachy.

FOR MORE INFORMATION ABOUT MIX LISTINGS SEE PAGE 143.

professional Audio/Video Supplies immediate shipment

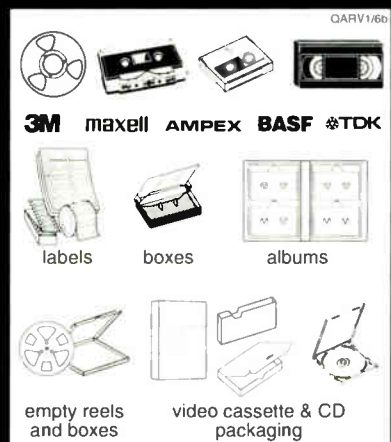

ask for our free PolyQuick catalog

Chicago
(708) 390-7744 Fax: 390-9886
Los Angeles
(818) 969-8555 Fax: 969-2267

PolyQuick

1233 Rand Road, Des Plaines, IL 60016
16018 C. Michaels St., Irwindale, CA 91702



PINEBROOK STUDIOS

PINEBROOK RECORDING STUDIOS INC.
Alexandria, IN

PINEBROOK RECORDING STUDIOS INC.

RA48

PD Box 146, State Rd. 9 S.; Alexandria, IN 46001; (317) 724-7721; FAX: (317) 724-7779. Dimensions: Studio A. 1,500 sq. ft., control room: 14'x20'. Studio B: 18'x15'. control room 15'x12'. Studio C: 2,600 sq. ft., control room: 30'x30'. **Mixing Consoles:** Quad/Eight Coronado (modified) 40x24 tape-based automation, Quad/Eight Coronado 36x24 tape based automation, API all discrete w/Touch Reset & GML automation 56x56x48. **Audio Recorders:** (3) Studer A 827 24-track, (4) Ampex ATR-100 (102, 104, & 1/2' 2-track), MCI JH100 2-track, (2) Panasonic SV-3700 DAT, (2) Revox cassette deck, Fostex E-16 16-track. **Monitors:** UREI 813A, Yamaha NS-10, Tannoy NFM8, Genelec S30NF. **Other Major Equipment:** Hafler, Crown amps, Neumann 87, 84, 86, 47, FET, 67, Microtech-Gefell MIH UM70SZ, AKG, Sony, Sennheiser, B&K, Wahrenbrock, Shure, Lexicon 224XL reverb, Lexicon 200 reverb, EMT 245 digital echo, USAudio GateX, AMS DMX-15-80S, Aphex compellor, (2) Eventide H-3000SE, AMS RMX16 (loaded), Neve 1073 preamp/EQ, (2) Lexicon PCM70, (2) Pultec EOP-1A3, (2) Dolby Cat 280 SR card, Roland Dimension D, Lexicon Prime Time II DDL, Lexicon 480-L/V 1.0 program, AMS RMX16, Valley Rack (KepeX/Gain Brain/Maxi Q), EMT 140 plate reverb, UREI 1176 compressor, Orban 536 de-esser, ITI stereo parametric EQ, Zeta III synchronizer, dbx RM160, dbx FS900/2-902 modules, Neve 1272 line amp (Class A), TC Electronic 2290/22D24, (4) Valley People Kex II, Drawmer DL241 lim/comp, Drawmer DRR DS301 dual gates, Teletronix LA-2A level amplifier, Drawmer DDR DS201B dual gate, Teletronix LA-2A leveling amplifier, Yamaha C7 MIDI-grand piano, DX7, Hammond/Leslie, Prophet V, Prophet 10, Linn drum. **Specialization & Credits:** PineBrook Recording Studios Inc. is located in the PineBrook complex, a large three-studio, full-service, state-of-the-art facility located approximately 45 minutes north of Indianapolis. Serving the music and recording industries since 1973, PineBrook continues to be a one-stop facility for a wide variety of clients, from beginning demo tapes and custom recording projects, to large publishing company and major label projects. All three rooms feature discrete consoles, with PineBrook Studio C serving as the showcase facility for the new generation of API all discrete Series consoles. Private apartments and an 18-hole golf course are adjacent to the complex. Convenient commercial and private plane access. Experience the comfort of working in one of the most extraordinary facilities in America. Quality service in a private environment, giving you the freedom to create at your own pace and with no compromise!



SWEETWATER SOUND INC.
Ft. Wayne, IN

SWEETWATER SOUND INC.

RA24

5335 Bass Rd.; Ft. Wayne, IN 46808; (219) 432-8176; FAX: (219) 432-1758. **Dwner:** Charles J. Surack. **Manager:** Chet Chambers. **Engineers:** Chuck Surack, Jerroll Lehman, Chet Chambers, Bruce Hendrix, Dave Stewart. **Dimensions:** Room 1: studio 26'x26'. control room 17'x28'. Room 2: 6 1/2'x10 1/2'. **Mixing Consoles:** TAC Magnum 72x24 console w/inboard MegaMix automation. **Audio Recorders:** Soundcraft 760 2-inch 24-track, (2) Fostex E-2 1/4" w/center SMPTE track, (2) Panasonic 3700 DAT, Fostex E-16 multitrack remote recording, (4) Alesis ADAT. **Digital Audio Workstations:** Pro Tools 8 channel, (2) Sound Tools. **Monitors:** (2) UREI 813C, (2) Tannoy PBM 6.5, (2) Auratone Cubes, (2) EV Sentry 500. **Other Major Equipment:** KABA cassette duplication system, Kurzweil K250, Kurzweil K2000, (2) Sample Cell cards, Kurzweil

1200 Pro I, Kurzweil 1200 Pro II, Kurzweil 1200 Pro III, (2) Korg EX-8000, Roland D-50, Roland D-550, Roland U-20, E-mu Proteus 1XR, Alesis SR-16. (2) Lexicon reverbs. Opcode Studio Vision sequencer software, MOTU Digital Performer software, Neumann U87, (4) MOTU MIDI Time Piece II, Young Chang 9ft. concert grand piano, (3) Macintosh IIx computers. **Specialization & Credits:** In just under a dozen years, Sweetwater Sound Inc. has grown from being a small 4-track home studio into a state-of-the-art 24-track analog and digital production facility. Our clients include both local musicians and large national corporations such as McDonalds, Central Soya and Lincoln National Life, with custom jingles and music scores, audio-for-video and album production. Our sister retail division offers the latest in music software digital and analog recording equipment and keyboards, and has become an industry leader with knowledgeable tech support, an expert service department and very competitive pricing. A free newsletter is available.

TEMPEL RECORDING STUDIO AND PRODS.

RA24

call for information; Ft. Wayne, IN 46805; (219) 482-3190. **Dwner:** Thomas Tempel.

TRC STUDIOS--THE RECORDING COMPANY

RA24

5761 Park Plaza Ct.; Indianapolis, IN 46220; (317) 845-1980; FAX: (317) 576-1648. **Dwner:** TRC Corp. **Manager:** Gary Schatzlein, Alan Johnson. **Engineers:** Alan Johnson, Steve McQuery, Chris Green. **Dimensions:** Room 1: studio 34'x43'; control room 19'x22'. Room 2: studio 30'x33'; control room 17'x17'. **Mixing Consoles:** Trident 80B 30x24 w/Otari Moving faders. Sound Workshop 34 w/Otari Disk Mix II. **Audio Recorders:** Sony JH-24 w/Dolby SR, (2) Tascam DA-30, Panasonic SV-255, (3) MCI JH-110B 1/2" & 1/4" center track SMPTE w/Dolby SR, MCI JH-110B 1" video layback, (2) Otari 5050B, (2) Tascam 122Mk II, (2) Alesis ADAT, Telex 300 slave open reel duplicator. **Digital Audio Workstations:** Otari PD 464 8-track. **Monitors:** (4) JBL 4435, (10) Yamaha NS-10M studio, (4) Auratone 5C, (2) Tannoy NFM-8, (2) MDM-4. **Other Major Equipment:** Eventide H3000 SE, Lexicon PCM70, Klark-Teknik DN780, Demeter VTP2 tube preamp, API 3124 4-channel preamp, (4) Drawmer DL241 compressor, Summit Audio TPA 200 tube EQ, BBE, TC Electronic 2290 sampler/delay, Adams-Smith 2600, Audio Kinetics Pacer, (4) UREI 1176, (2) Valley Arts PR-10, (2) UREI LA-4, EMT 140 TS plate, (2) Aphex Expressors, Studio Technologies mic preamp, Alesis Quadraverb, (2) Yamaha REV7, Alesis D-4 drum module.

IOWA

AUDIO ART RECORDING STUDIOS INC.

RA24

403 S.W. 8th St.; Des Moines, IA 50309-4615; (515) 282-3223. **Dwner:** Patrick McManus. **Manager:** Keith Brown.

AVATAR PRODUCTIONS

RA16

515 28th St., Ste. 106; Des Moines, IA 50312; (515) 282-9746; FAX: (515) 243-3960. **Dwner:** Michael Meacham/Jeffrey Martin. **Manager:** Michael Meacham.

CATAMOUNT RECORDING

RA24

1005 W. 23rd; Cedar Falls, IA 50613; (319) 235-6517. **Dwner:** Catamount Recording Inc. **Manager:** Tom Tatman. **Engineers:** Tom Tatman, John Thomson, Rick Bisbey (tech), and freelance engineers and producers welcome. **Dimensions:** Studio: 30'x40'. control room 20'x22'. **Mixing Consoles:** Neotek Series IIc automated 32x2. **Audio Recorders:** Otari MX-80 24-track, Otari MTR-10 2-track, Otari MX 5050BII 2-track, Panasonic SV-3500 R-DAT, (6) TEAC V-670 3-head cassette. **Monitors:** Tannoy SRM-15X, Yamaha NS-10M, JBL 4311, Auratone 5C Super Cubes. **Other Major Equipment:** Roland R-880 version 2.0, Eventide H3000S Ultra Harmonizer, TC Electronic 2290 32 sec, Lexicon PCM 70, Lexicon PCM 60, Lexicon LXP-1, Lexicon LXP-5, Lexicon MRC remote, (2) Yamaha SPX-900, Alesis Quadraverb Plus effects, Roland SDE-1000 delay, API 3124 mic pre 4 channels, Summit Audio TLA-100A tube compressor, (2) UREI LA-4 compressor, (2) Drawmer DL-241 stereo compressor, (2) dbx 166 stereo compressor, (2) dbx 160X compressor, Dolby 363 SR noise reduction, Valley GateX gate 4 channel, (2) Omni Craft GT-4 gate 4 channel, Orban 622B stereo parametric EQ, Orban 516 EC de-esser 3 channel, Aphex Aural Exciter, BBE 422A Sonic Maximizer, Neumann M-49, Neumann U87, (2) Neumann KM84i, (2) AKG 414EB, (2) AKG C-501E, AKG D-112, (4) Sennheiser 421, (2) Sennheiser 441, (2) Sennheiser 402U, (6) Shure SM57 tube microphones; Kimball 6 4" grand piano, Yamaha 'Power Tour' drums w/rims, Alesis D-4 digital drums, Fender Deluxe amp (vintage), Tech 21 Sansamp, Fender Stratocaster.

KEONI'S DOWNSTAIRS STUDIO

RA16

1326 Brady St.; Davenport, IA 52803; (319) 323-8631; FAX: (309) 799-7921. **Dwner:** Keoni's/Kil-ir Productions. **Manager:** John Curry.

SEE PAGE 150 FOR AN EXPLANATION OF THE STUDIO SERVICE ICONS. FOR MORE INFO ABOUT MIX LISTINGS SEE PAGE 143.

CATCH THE WAVE...

- DIGITAL 24TRK/2TRK RECORDING
- CD/CASSETTE DUPLICATIONS
- VIDEO DUPLICATIONS
- REEL-TO-REEL TAPE
- EQUIPMENT SALES
- DIGITAL EDITING
- CASSETTE TAPE
- AUDIO CLASSES
- TAPE SUPPLIES
- VIDEO TAPE



REVOLUTIONIZING
THE AUDIO
INDUSTRY

WAVE DIGITAL

4557 GRAND AVE
GURNEE, IL 60031
FAX (708) 336-8477

(708) 336-7702

USE READER SERVICE CARD FOR MORE INFO

NEW

From

KLARITY
CASSETTE

COMPACT DISC
REPLICATION

INTRODUCTORY SPECIAL
1,000 CD's Only \$2.50 each

- Master Set-Up
- Conversion & Plates
- Typesetting
- Proofs
- 2 Color Label Print
- 2 Panel Booklet & Tray Card
- Packaging
- Shrinkwrap

See
Preceding Page
for Other Services

KLARITY CASSETTE, INC.

Waterville, ME 04901

800-458-6405

Coming in Mix:
December 1992

Tape & Disc Special Issue

- **TAPE & DISC**
Premastering Tips for Project Studios
Studio Diversification--Expanding Into Cassette Duplication
Infotainment Delivery in the 21st Century
Launch Update: DCC & Mini Disc
- **DIRECTORIES**
Mastering, Duplication & Replication
- **TECHNICAL FEATURE**
Analog Signal Processing Equipment
- **INDUSTRY UPDATES**
AES Show Report
TEC Awards Results
1992 Audio Production Facilities Survey Report
- **SOUND REINFORCEMENT**
Multimedia Live
Bruce Springsteen In Concert
- **BYTE BEAT**
New Premastering/Noise Reduction Equipment
- **PLUS!**
Recording Notes on T Bone Burnett & Miles Davis' *Doo-Bop*;
Bonzai Lunches with Steve Douglas; Superbitmapping; Mini Disc, part 2.

ATTENTION ADVERTISERS:

Deadline for ad placement is the seventh of the month, two months prior to publication. Call (510) 653-3307 for a 1992 *Mix* Editorial Calendar, space reservations and complete advertising information.

MIX

USE READER SERVICE CARD FOR MORE INFO

North Central Studios

SR AUDIO PRODUCTIONS



1395 Hwy. 65/69; Indianola, IA 50125; (515) 961-3925; FAX: (515) 961-0324. Owner: Michael Lawyer. Manager: Michael Lawyer. Engineers: Michael Lawyer, David Albert, Rick Maly. Dimensions: Room 1: studio 25'x15', control room 16'x16'. Room 2: studio 15'x15'. MIDI studio: 12'x12'. Lounge: 25'x15'. **Mixing Consoles:** Soundcraft Series 600 32x24x8 w/automation, Yamaha RM2408 24x24x8, Fostex 450, Carvin 1604. **Audio Recorders:** Sony JH-24 24-track, (3) Alesis ADAT 8-, 16-, 24-track; Sony 2500 R-DAT, Tascam BR-20T, Studer PR-99, Nakamichi MR-2 cassette, Technics DA-10 R-DAT, Fostex Model 20 2-track, Fostex Model 80 8-track. **Digital Audio Workstations:** Digidesign Pro Tools, Digidesign Sound Designer II, Hybrid Arts ADAP II. **Monitors:** (2) UREI 809, (2) JBL 4313, (2) Yamaha NS-10, (2) Tannoy PBM 6.5, (2) Auratone 5C. **Other Major Equipment:** Sony 5850 3/4" U-matic, Adams-Smith Zeta-3B, Macintosh IIfx, Macintosh SE30; Neumann U67 tube, U87, KM84, AKG 414, 451, D112, Sennheiser 421, 441; Lexicon PCM70, PVM42, LXP-1, Yamaha REV7, SPX90, Alesis MIDiverb II, Quadraverb, Eventide Harmonizer, Valley People Gain Brains, Kepex, Orban compressors & EQs processors; Roland, E-mu, Kurzweil, Yamaha, Alesis, Korg.

TRIAD STUDIOS



1910 Ingersoll Ave.; Oes Moines, IA 50309; (515) 243-2125; FAX: (515) 243-2055. Owner: Richard Trump, Bill Synhorst, Joe Borg. Manager: Richard Trump. Engineers: Rick Condon, Tony Schmitt, Greg Tracy. Dimensions: Room 1: studio 38'x24', control room 22'x21'. Room 2: studio 18'x21', control room 18'x13'. Room 3: studio 5'x10', control room 10'x10'. **Mixing Consoles:** Euphonix CS II w/Total automation, Tascam 520 20x8, Tascam 512 12x8. **Audio Recorders:** AMS Audiophile, Otari MTR-90 MkII 24-track, Tascam ART-60/8 8-track, Tascam 44-OB 4-track, (2) Panasonic SV-3500 R-DAT, (2) Panasonic SV255 R-DAT, Tascam DA-30 R-DAT, Tascam ATR-60-2T 2-track w/center track time code, Otari MX-551M 2-track w/CCTC, Tascam BR-20T 2-track w/CCTC, Otari MXC-55N 2-track, MCI JH-110B 2-track, Nakamichi DMP-100. **Digital Audio Workstations:** Eumig FL1000, Tascam 122 MkII, Nakamichi CR-7A, Magnafax 7801 1/2" bin loop duplicator, Tascam T-2640. **Other Major Equipment:** Adams-Smith Zeta-3, Lexicon 224X1, TC Electronic TC 2290, EMT 240, UREI 927 delay, Yamaha SPX90, (2) Lexicon LXP-5, Lexicon PCM60, (2) Lexicon LXP-1, Alesis Quadraverb, Yamaha 7' grand piano, Rogers drum set.

KANSAS



CORNERSTONE STUDIOS
Wichita, KS

CORNERSTONE STUDIOS



PO Box 4736; Wichita, KS 67204-0736; (800) 392-5539. Owner: Steven D. Falke, Julia D. Prater. Manager: Steven D. Falke. Engineers: Steven Falke, Greg Cox. Dimensions: Room 1: studio 14'x20', control room 25'x14'. Room 2: studio 12'x10'. Room 3: studio 12'x8'. **Mixing Consoles:** Tascam M-3532, Yamaha OMP7, Tascam M-224. **Audio Recorders:** (3) Alesis ADAT w/BRC remote, Fostex G-16, Tascam DA-30, Tascam 38, Tascam 1128, TEAC 3320, TEAC V285CHX. **Monitors:** (2) Altec 604-8G, (4) Yamaha NS-10M. **Other Major Equipment:** Yamaha REV7, Yamaha SPX90, Roland

SRV-2000, (2) Ibanez SDR-1000, Symetrix 525A, Fostex 8330. (2) RCA 44, (2) AKG 414P48, Young Chang 6' grand piano, Fender Twin reverb (vintage), Roland JX-10, Roland MRC-500, (2) Roland D-50, Yamaha TG77, Roland S-50, (2) Oberheim Matrix 6R, Roland MKS-20, Hafler P-500, Tama Imperial Star 5-piece trap set, Yamaha RX5. **Specialization & Credits:** In the control room, an array of carefully selected music production tools, including Alesis ADAT professional audio recorders, are nestled within an acoustic monitoring environment custom-crafted to deliver pinpoint accuracy in stereo imaging, broad-band frequency response and dynamic range. The facilities also include three isolated studios containing a wide range of musical instruments as well as an outstanding grand piano pampered in a humidity-controlled environment. Audio-for-video post-scoring is also available as well as a comprehensive MIDI production system allowing musicians and producers the utmost in creativity and flexibility. Music publishing and other artist development services are offered through Golden Plains Publishing. Located in the Midwest, Cornerstone Studios and Golden Plains Publishing offer luxuries anyone can afford in a relaxed atmosphere, including special hotel and rental car rates. Cornerstone Studios makes even the most challenging productions a reality.

MASTERPIECE PRODUCTIONS & STUDIOS



7002 O'Neil; Wichita, KS 67212; (316) 943-1190; FAX: (316) 943-1190. Owner: Tim Raymond.

WHEELER AUDIO ASSOCIATES INC.



4024 State Line; Kansas City, KS 66103; (913) 362-2500; FAX: (913) 362-2575. Owner: Jim Wheeler. Manager: Jim Wheeler.

MICHIGAN

A & F MUSIC SERVICES



2834 Otsego; Waterford, MI 48328; (313) 682-9025. Owner: Frank Merwin.

ALLIANCE RECORDING CO. INC.



8449 Parshallville Rd.; Fenton, MI 48430; (313) 632-5653; FAX: (313) 632-5653. Owner: Al Hurschman. Manager: Al Hurschman.

THE BROOKWOOD STUDIO INC.



1155 Rosewood, Ste. A; Ann Arbor, MI 48104; (313) 994-4992. Owner: David J. Lau. Manager: Matthew D. Hanson.

BROWN & BROWN RECORDING & MUSIC PROD.



PO Box 224; Portage, MI 49081; (616) 327-8352; FAX: (616) 327-8352. Owner: Kevin and Deborah Brown. Manager: Tim Brown. **Specialization & Credits:** Brown & Brown, located precisely between Detroit and Chicago, specializes in original music for broadcast production, world-class multitrack recording, voice-over and A/V soundtracking. In addition to 2-track digital remote recording, we offer a well-appointed control room using the MCI JH-24 (2" 24/16-track) and Soundcraft 2400B 32x24x24 classic split console. Clients appreciate our large recording room, digital mixdown, well-stocked processing racks and experienced engineers (all are NARAS members with national release credits). Original award-winning Musicimage™ packages are airing in the Midwest and across the U.S. We are always producing demos and album projects for our clients and can help with project presentation and packaging for CD, cassette and vinyl release. Clients include Motown legend Jr. Walker; "TAWC" label Tim Cunningham; gospel artists Zion, The Walkers; comedy/piano great Steve Allen; ACE Records' Dave Caley; "JaMart" artists 2/11; corporate clients: Post Cereals, Kraft, General Foods, Kellogg, Upjohn, Stryker Corp., Western Mich. University and Hope Health Letter. Call for a complete client list.

LEGEND

- Maximum digital tracks
- Maximum analog tracks
- Remote audio recording
- MIDI production
- Tape duplication
- Mix to picture
- Digital editing/CD prep
- In-house music services

CLOUD 10 RECORDING



1450 Coler; Ann Arbor, MI 48104; (313) 663-0222. Owner: Mike Gould. Manager: Mike Gould.

CREATIVE MEDIA PRODUCTIONS LTD.



2165 Carter St.; Mt. Pleasant, MI 48858; (517) 773-0537. Owner: Peter Kehoe.

CRYSTAL CLEAR RECORDING STUDIO



228 Superior Ave.; Crystal Falls, MI 49920; (906) 875-4215. Owner: Charlie Turvey. Manager: Charlie Turvey.

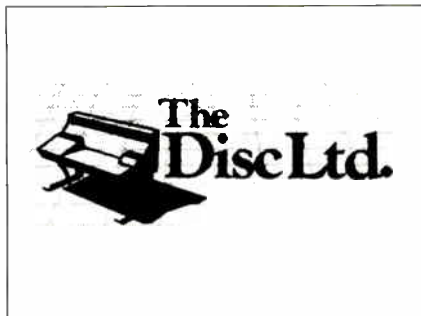

THE DISC LTD.
East Pointe, MI

THE DISC LTD.



14611 E. Nine Mile Rd.; East Pointe, MI 48021; (313) 779-1380; FAX: (313) 772-4320. Owner: Greg Reilly, Bob Dennis. Manager: Greg Reilly. Engineers: Greg Reilly, Scott Sumner, Jim Michewicz, Greg Kutcher. Dimensions: Room 1: studio 20'x40', control room 20'x18'. Room 2: studio 12'x12', control room 12'x12'. Room 3: studio 12'x14', control room 12'x15'. Mixing Consoles: SSL G Series 40x32 w/G Series computer, DDA DMR-12 52 input, API custom 32 input. Audio Recorders: Otari MTR 90 II 24-track analog, Tascam ATR 80 2" 24-track, Ampex ATR 102 2-track, (2) MCI JH-110B 2-track, Mitsubishi 2-track digital, Panasonic 3500 DAT, Tascam DA30 DAT, Ampex MM1000 24-track. Digital Audio Workstations: Digidesign Sound Tools, Emulator 3. Monitors: TOC studio w/Mastering Lab crossovers, UREI 809 w/sub woofers, Yamaha NS-10. Specialization & Credits: We have three 24-track rooms that can handle the smallest or the largest budget. We specialize in providing a friendly, comfortable atmosphere in a professional setting. Studio B includes a full MIDI production facility with the latest sound libraries. We have experienced engineers who pride themselves in working with the producer and artist in a helpful, creative manner. Our client list includes George Clinton (Parliament and Funkadelic), Digital Underground, Roger Troutman, Kiara and many others. With our Sound Tools digital editing system we can premaster tapes for CDs and cassettes. We are licensed by the state of Michigan to teach recording music theory and MIDI production under the Home Recording Institute of Detroit.

FAST TRAX RECORDING STUDIO



2737 Baldwin St.; Janison, MI 49428; (616) 669-3400. Owner: Robert B. Reister. Manager: Colleen M. Horgan.

NEW ACTION PRODUCTIONS



PO Box 2871; Ann Arbor, MI 48106-2871; (313) 484-0176. Owner: Christopher L. Goosman. Manager: Christopher L. Goosman.

NUMARK INC.



51308 Peach Tree Ln.; Shelby Twp., MI 48316; (313) 739-6940. Owner: John Antos, Mark Antos. Manager: Mark Antos.

PEARL SOUND STUDIOS



47360 Ford Rd.; Canton, MI 48187; (313) 455-7606; FAX: (313) 455-4910. Owner: Ben Grosse.

RECORDING INSTITUTE OF DETROIT



(also SideStick Studio); 14611 E. 9 Mile Rd.; East Pointe, MI 48021; (313) 779-1380. Owner: Robert Dennis, Greg Reilly. Manager: Steve Szajna. Specialization & Credits: Established in 1976, The Recording Institute of Detroit offers an extensive 351-436 clock-hour program in recording, MIDI and music technologies (38-45 weeks). The school offers three 24-track studios and classroom facilities. Equipment includes Solid State Logic 4000 G Series, API

and DDA consoles; Lexicon 480L, 224X plus 22 other delay/reverb units, including actual EMT plates; 12 tape machines including 24-track digital and DAT units, 24 synthesizer/sound modules/sampler units including Emulator III; sequencing on Amiga and Macintosh computers and Akai MPC 60; loads of additional outboard gear. Tascam 688 workstations for home recording training and MIDI programming. Students attend a minimum of 9-10 hours per week with an additional 25 hours per week provided for additional help or exposure at no charge. The school publishes its own text and recording/music industry magazine. The end of the program features individual student engineering with instructor feedback on results. Our self-paced music theory classes feature computer-assisted songwriting. Our study-skills training uses Hubbard Study Technology which helps students self-learn equipment from manuals and use new equipment more fully. Internships are included in the program and job placement assistance is available (88% placement rate in 1991-92). Tuition is \$3,349 for entire program or \$799 for first class.

RON ROSE PRODUCTIONS LTD.



29277 Southfield Rd.; Southfield, MI 48076; (313) 424-8400; FAX: (313) 424-8622. Owner: Ron Rose.

SINGLE SOUND ENTERTAINMENT



7555 Ore Lake; Brighton, MI 48116; (313) 231-9345. Owner: Gene Fiero.

SONG SKETCHES PRODUCTIONS



15112 Totten Pl.; Shelby Township, MI 48316; (313) 786-1767. Owner: Robert Payne.

SOUNDSTAGE 1 RECORDING SERVICES



1800 S. 35th St.; Galesburg, MI 49053; (616) 665-7025; FAX: (616) 665-7046. Owner: James R. Cummings. Manager: Kimberly Rasey.

STATION C STUDIOS INC.



941 Wealthy SE; Grand Rapids, MI 49506; (616) 235-3813; FAX: (616) 459-2591. Owner: Thomas Jansen. Manager: Jon Frazer.

STUDIO A RECORDING INC.



5619 N. Beech Oaly; Dearborn Heights, MI 48127; (313) 561-7489; FAX: (313) 561-6736. Owner: Eric and Marilyn Morgeson. Manager: Marilyn Morgeson/Fred Morgeson. Engineers: Eric Morgeson, Randy Poole, Ed Marx. Dimensions: Room 1: studio 40'x30', control room 25'x22' (a John Storyk design). Room 2: MIDI room. Mixing Consoles: SSL 6000E 40x24 w/G Series preamp, SSL automation, Soundcraft 200B 32x4. Audio Recorders: (2) MCI JH-114 24-track, Mitsubishi X-86C 2-track, Sony APR-5003 2-track 1/2" and 1/4", Studer B67 2-track, (2) Tascam 122 Mk II cassette, (3) Sony 730ES cassette, (2) Sony 2500 R-DAT. Monitors: (2) UREI 813, (4) Tannoy NFM-8, (2) Yamaha NS-10M. Other Major Equipment: Klark-Teknik DN70, AMS RMX16, Lexicon 200, Ursa Major 8x32, (5) Yamaha SPX90, (2) Lexicon PCM42, Yamaha REV5, Yamaha REV7, Yamaha SPX900, (4) dbx 160X, (7) Valley People Kepex II, (2) Valley People Maxi-Q, (2) Valley People Dyna-Mite, BBE Sonic Maximizer 822, EXR Exciter, DeltaLab CompuEffectron CE1700, Eventide H910 Harmonizer, Synclavier digital music system, Roland P-330, Korg M-1.

STUDIO DE LUX



5346 Sunnycrest Dr.; West Bloomfield, MI 48323; (313) 855-2942; FAX: (313) 855-3221. Owner: Rick Stawinski. Manager: Rick Stawinski.

TAPE TRACKS RECORDING



2275 Yargerville Rd.; La Salle, MI 48145; (313) 241-6695. Owner: Bill Cuson.

THE TEMPERMILL



2040 Hillton; Ferndale, MI 48220; (313) 399-0550. Owner: David Feeny. Manager: David Feeny.

UNDERGROUND PRODUCTIONS



28407 Gilbert; Warren, MI 48093; (313) 558-4357. Owner: Kevin A. Holevar. Manager: Kevin A. Holevar. Engineer: Kevin A. Holevar. Dimensions: Room 1: studio 12'x8', control room 19'x14'. Room 2: studio 12'x8', control room 12'x8'. Mixing Consoles: Otari Soundworkshop 34C w/Diskmix II 40 ins, Allen and Heath CMC 32, Gemini PMX-15, TOA D-4, TOA D-4E. Audio Recorders: Soundcraft SCM760 24-track, Fostex G16 16-track, Otari MX-5050B II 2-track,

—LISTING CONTINUED ON NEXT PAGE

AUDIO

PACKAGING FOR THE SPOKEN WORD

INJECTION MOLD
BOOK PACKS

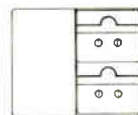

- COMPACT
- DURABLE
- AFFORDABLE

WE ALSO MANUFACTURE
SOFT PACKS • VIDEO SLEEVES

1-800-876-1909
FOR SAMPLES

OR WRITE



LIBRARY
EDITIONS
AUDIO PACKAGING

PO BOX 3704
ALBUQUERQUE, NM 87190

PACKAGING

USE READER SERVICE CARD FOR MORE INFO

DISC MAKERS

CD Replication

- Complete Packages
- Fast Delivery
- Small Quantities
- Full Color

500 CDs &
500 HX Pro
Cassettes
\$2990

Complete Package Price!
Includes design & typesetting.

Call Today For
Complete Details
and Our FREE Full
Color Catalog:



1-800-468-9353

1650 Broadway, Suite 1010,
New York, New York 10019
In NYC call: 212-265-6662 • FAX: 212-2620798

LIVE SOUND & REMOTES

IN THE

JANUARY 1993 MIX

Sound Reinforcement Loudspeakers
MTV Music Awards
Concert Recording
Audio Technologies for Film

DIRECTORY:

Sound Reinforcement and Remote Recording

Featured in the January 1993 issue of *Mix*: applications and equipment for live sound and remote recording, including articles on the making of live albums, loudspeakers for sound reinforcement and sound production for a variety of major touring shows.

Ad Close: November 6, 1992
Materials Due: November 16, 1992

USE READER SERVICE CARD FOR MORE INFO

North Central Studios

—LISTING CONTINUED FROM PREVIOUS PAGE

Panasonic SV-3700 R-DAT, Sony PCM-2500 R-DAT, Casio DA-R100 portable R-DAT, Tascam 122B cassette. **Monitors:** (2) TOA 312-ME. (2) Yamaha NS-10M studio. (2) JBL 4412. (2) TOA 22-ME. **Other Major Equipment:** Aphex Compellor, Lexicon PCM70. (2) Roland SRV-2000, ART DR1, Alesis MIDverb III, Alesis MIDverb II, Alesis 3630 compressor, CDT MC-8 8-channel compressor, (6) Valley People GateX 4-channel noise gate, ART 1500 digital delay, E-mu E III, Ensoniq EPS16+, Roland JX8P, Roland D-50, Moog Source, Korg T-3, Tama Superstar 8-piece drum set, Roland DDR-30 6-piece E. drum set, Roland R-8M, various mics.

VIBES RECORDING STUDIO



18870 Lancashire, Detroit, MI 48223; (313) 836-0936. Owner: Mark A. Jones. Manager: Mark A. Jones.

WHITE ROOM STUDIO



1145 Griswold, 3rd Fl., Detroit, MI 48226; (313) 963-7305; FAX: (313) 962-8135. Manager: Michael Nehra. Engineer: Alan Sutton. **Dimensions:** Room 1: studio 36'x33', control room 16'x14'. Room 2: studio 24'x18'. **Mixing Consoles:** API 2084 32 input w/Jensen transformers, 550A, 550B, 554 EQs. **Audio Recorders:** Ampex ATR-124 24-track, 3M M-79 24-track. (2) Panasonic 3700 DAT **Monitors:** Yamaha NS-10M, KRK, JBL 4311. **Other Major Equipment:** (2) Neve 1073 EQ, Pultec EOPIA tube EQ, Orban 622 EQ, (2) Neve 32264 comp/lim, Teletronix LA-2A comp/lim, (2) API 525 comp/lim, (2) UREI LA-3A comp/lim, RCA BA-6A comp/lim, (2) dbx 160, dbx 162, Valley People 610, Drawmer gate, (2) dbx 902 de-esser, (12) Langevin AM-16 mic pre, Eventide H3000SE sampler, Dynacord DRP-20, Lexicon PCM70, EMT 140 tube mono plate reverb, (2) Fairchild spring reverb units, Roland DDD-1000 delay, (2) Roland 555 chorus echo, Ursa Major Space Station, ADA STD-1 taped delay, Telefunken U47 tube, (2) Neumann U87, AKG C-12 type (tube), (3) Sony C-37 tube, (2) Sony C-37 FET, (2) PML condenser, AKG D-112, Beyer M-380, Beyer M-260 ribbon, (3) Sennheiser 421, (6) Shure SM57 & 58, (2) Vox AC30 top boost guitar amp, (3) Supro guitar amp, (3) Ampeg guitar & bass amp, Magnatone guitar amp, Marshall early 70's 1/2 stack, Hammond B-3 organ w/Leslie.

MINNESOTA

EMC PRODUCTIONS



300 York Ave., Saint Paul, MN 55101; (612) 771-1555; FAX: (612) 771-5629. Owner: EMC Corporation. Manager: Bruce Kennedy.

PAISLEY PARK STUDIOS



7801 Audubon Rd., Chanhassen, MN 55317; (612) 474-8555; FAX: (612) 474-6328. Owner: Prince. Manager: Heidi Hanschu. Engineers: Sal Greco—chief technical engineer, Tom Tucker, Dave Friedlander, Tom Garneau, Brian Poer, Ray Hahnfeldt, Steve Noonan, Steve Durkee, Mitch Mortenson **Dimensions:** Room 1: studio 35'x50', control room 32'x25'. Room 2: studio 35'x35', control room 32'x25'. Room 3: studio 32'x46', control room 14'x16'. **Mixing Consoles:** SSL 6064 64-channel w/G Series automation, API/Demodet 48x24x24 w/Massenburg moving fader automation, Soundcraft TS 24 32x32x24. **Audio Recorders:** (4) Studer A800 24-track, Sony JH-24 24-track, (7) Studer A820 2-track w/center channel time code, Ampex ATR-104 4-track, Studer D820 2-track digital, (2) Sony PCM-2500 DAT w/Apogee filters, (2) Panasonic SV-3700 DAT, digital multitracks available on request, Studer D740 compact disc recorder. **Digital Audio Workstations:** Akai DD1000 digital editor w/MAC interface, Magneto-optical drive, Syquest 44 meg removable hard drive. **Monitors:** Westlake custom 5-way SM-1 w/TAD. **Other Major Equipment:** (6) TimeLine Lynx, (2) Sony BVU-800, (2) Lexicon 480L w/LARC, (2) Lexicon 224XL w/LARC, (4) AMS RMX-16, (4) AMS DMX 15-80S, (3) Quantec ORS, (3) Eventide H3000 w/SE upgrades, (2) Yamaha REV5, (2) Yamaha REV7, (2) Publison Internal machine 90, (3) Lexicon PCM70, (6) Yamaha SPX90II, (2) Lexicon Prime Time II, (4) EMT 140S plate reverb, EMT Gold Foil reverb, (8) Lexicon PCM42, (2) Lexicon PCM41, (2) Eventide SP2016, (3) Dimension D.

SEE PAGE 150 FOR AN EXPLANATION OF THE STUDIO SERVICE ICONS. FOR MORE INFO ABOUT MIX LISTINGS SEE PAGE 143.

PRIME TIME STUDIOS



1317 Clover Or., Bloomington, MN 55420; (612) 884-0778; FAX: (612) 884-1078. Owner: Jim Barker. Manager: Jim Barker. **Dimensions:** Room 1: studio 40'x30', control room 20'x20'. Room 2: studio 20'x20', control room 30'x20'. **Mixing Consoles:** Allen and Heath Saber 36x16x24x2. **Audio Recorders:** Tascam MS-16, (2) Tascam 52, Otari MX-5050, Revox A-77, Sony 2500 R-DAT, Panasonic 3700 R-DAT, Sony TDC R-DAT, Nakamichi MR-1 cassette, (2) Tascam 122 cassette. **Monitors:** (2) JBL 4311, (2) Electro-Voice Sentry III, (2) Auratone, (2) Altec-Lansing VOT. **Other Major Equipment:** Yamaha SPX1000 digital effect, (2) Yamaha SPX90, (4) Alesis MIDverb II, Lexicon digital delay, Orban spring reverb, (2) UREI LA-4 comp/limiter, (2) Alesis 3630 comp/limiter.

SOUND 80



4027 Ids Tower, Minneapolis, MN 55402; (612) 339-9313; FAX: (612) 339-9314. Owner: Jan Erickson. Manager: Bill Lubarsky.



STUDIO M
Saint Paul, MN

STUDIO M



45 E. 7th St., Saint Paul, MN 55101; (612) 290-1453; FAX: (612) 290-1180. Owner: Minnesota Public Radio. Manager: Craig Thorson. Engineers: Tom Mudge, Preston Smith, John Scherf, Paul Baron, Craig Thorson. **Dimensions:** Room 1: studio 45'x36', control room 23'x17'. Room 2: studio 15'x15', control room 22'x15'. **Mixing Consoles:** Neve V Series 36x36x36, Neve 5106 38x8x2. **Audio Recorders:** 3M DMS 32-track digital mastering system, Otari MTR-90II 24-track, Otari MTR-12 w/SMPTe center stripe, (5) Otari MTR-10 2-track, (3) Studer A810 2-track, MCI JH-1108 4-/2-track 1/2", Tascam DA-30, (2) Panasonic SV-3700, Sony DTC-700, (2) Sony PCM-3402 DASH 2-track digital rec/editor, **Monitors:** (2) Genelec 1022A tri-amped near-field, (2) Tannoy PB 6.5, Yamaha NS-1C, (2) Auratone. **Other Major Equipment:** BTX Cipher/Shadow SMPTE interlock synchronizing, Lexicon 480L, Lexicon 224XL, EMT 140 plate, Echoplate I, Echoplate II, (2) Lexicon PCM42, (2) Eventide 969 Harmonizer, Dolby A M-24 24 channel, (4) Dolby 363 A/SR stereo, (8) Dolby A 361, (4) UREI LA-4A compressor/limiter, (6) Aphex 651 expressor compressor/limiter, (4) Neumann U87, (6) Neumann KM84, (4) Neumann KM140, (4) Neumann KM88, Neumann SM69 stereo, AKG C-24 stereo tube, (4) AKG C-414, (6) AKG 452EB, (7) AKG C567 Lavs, (6) Sennheiser MK-2E Lavs, (4) Sennheiser 421, Electro-Voice RE-20, Shure SM57, Shure SM58, (2) Shure SM81, (4) Bruel & Kjaer 4006, (2) Bruel & Kjaer 4011, Steinway Concert D 9 grand piano, Fender Twin reverb guitar amp, Pearl Drums w/Paiste cymbals & toms equipped w/"Rims," other signal processing available. **Specialization & Credits:** We specialize in superb acoustic recording. Spacious studios, a superlative signal chain and staff with knowledge and experience all add up. We know how to listen. Studio M offers a wide range of facilities and services, including digital and analog multitrack recording, synchronized audio post-production for video and DDD capabilities (recording, editing, Xfer and premastering all in digital domain). Studio M is actually three separate facilities which can be reconfigured as needed to fit your project. Our largest acoustic space will comfortably accommodate a 40-piece orchestra. We also have proprietary audio lines to/from the World Theatre (a lovely reconstructed 800+ seat auditorium) for the highest quality live concert recording. Credits include: host location/facility for the Disney Channel's *A Prairie Home Companion* cable series. Ongoing live music broadcasts for Minnesota Public Radio (including the American classical cast Saint Paul Sunday Morning). Classical releases for Virgin Classics (including 1990 Grammy winner recorded by staff engineer Preston Smith). Releases for MCA, Capitol, A&M, EMI London, Columbia and Independent labels.

MISSOURI

ICON RECORDING STUDIO



5089 Waterman Blvd., St. Louis, MO 63108; (314) 367-3121. Owner: Perry Emge. Manager: Perry Emge. Engineers: Mark Beihl, Perry Emge. **Dimensions:** Studio 24'x20'x22'H, control room 27'x25'. **Mixing Consoles:** Soundcraft 6000 24x44 w/automation.

Digidesign, Opcode, Toa, Coda, Passport, Mark of the Unicorn, Ramsa, Roland, Emu, Apple, ART, Anatek, Mackie, Dr.T's, J.L. Cooper, Kawai, Microtech, Panasonic, Chinon, Pacific Coast, Tascam, Rapco, Ultimate Support, Prosonus & much, much more...

1-800-MAC-BEAT
1-505-473-4929

call the experts...
Mac BEAT™

1314 Rufina Cr., Ste. A4 Santa Fe, NM 87501

Audio Recorders: JH-24 24-track 2". Tascam DA 30 DAT, Panasonic SV-3500 DAT, Tascam B42 2-track 1/4", Tascam 34 4-track 1/4".
Technics 555 dual cassette. Digital Audio Workstations: Pro Tools 4-track digital. Studio Vision 2-track digital. **Monitors:** UREI 815, JBL 4408, JBL Control 1. **Other Major Equipment:** Eventide H3000, Eventide 949, Drawmer 1960, Drawmer DS201, Drawmer LX21, (4) dbx 463, (2) dbx 166, dbx 160, Lexicon PCM42, (3) Lexicon LXP1, Lexicon LXP5, (2) Yamaha SPX9011, (2) Alesis 3630, Aphex Expressor, (2) Rane SE15, (5) Electro-Voice 408 N/DYN, AKG 414, (2) Neumann KM84, (2) Audio-Technica AT4033 mic, and much more.

PENGUIN PRODUCTIONS



1026 Carole; St. Louis, MO 63021; (314) 394-0267; FAX: (314) 394-0860. Owner: Richard Byron. Manager: Frank Gagliano.

UNITED RECORDING STUDIOS INC.



3947 State Line; Kansas City, MO 64111; (816) 931-8642; FAX: (816) 753-8765. Owner: Dave McQuitty. Manager: Nate Wetmore.

NORTH DAKOTA

AVI GOBBLER PRODUCTIONS



1825 N. Grandview Ln.; Bismarck, ND 58501; (701) 222-3851. Owner: Bob Newell.

MEYER SOUND STUDIO
Bismarck, ND

MEYER SOUND STUDIO



208 N. 4th St.; Bismarck, ND 58501; (701) 223-7316; FAX: (701) 255-4921. Owner: Meyer Broadcasting Company. Manager: David Swenson.

VIDEO ARTS STUDIOS



1440 4th Ave. N.; Fargo, ND 58102; (701) 232-3393; FAX: (701) 232-9439. Owner: Art Phillips, Mary Ann Phillips. Manager: Steve Germaine.

OHIO

AUDIO RECORDING STUDIOS



35895 Solon Rd.; Cleveland, OH 44022; (216) 498-0911; FAX: (216) 498-0951. Owner: Bruce Gigax. Manager: Heather Copper.

BEACHWOOD STUDIOS



23330 Commerce Park Rd.; Beachwood, OH 44122; (216) 292-7300; FAX: (216) 292-1765. Owner: Pete Vrettas. Manager: Nicki Buyaki.

BEAT BOX MUSIC



2331 Flora St.; Cincinnati, OH 45219; (513) 241-7685. Owner: David Arps/Christopher Fee. Manager: Michael Wright.

DIAMOND MINE RECORDING STUDIO



3115 Bremen Dr.; Columbus, OH 43224; (614) 268-4792. Owner: Bright Moon Productions. Manager: Chris Nye.

HEARTLIGHT STUDIOS



PO Box 294; Westerville, OH 43081; (614) 882-5919. Owner: Randy Kettering. Manager: Kirk Sharrock.

LANDMARK RECORDING STUDIOS



PO Box 179; Chesapeake, OH 45619; (614) 867-5594. Owner: Stephen and Linda Hoffman. Manager: Stephen Hoffman.

MUSICAL INC.



780 Oakland Park Ave.; Columbus, OH 43224; (614) 267-3133. Owner: J.W. Hull. Manager: Warren Hull.

RANMEDIA INC./MIDITRACS



3808 Beecham Ct.; Columbus, OH 43220; (614) 451-7955; FAX: (614) 451-8087. Owner: Ronald Naille. Manager: Brian Naille. Engineers: Brain Naille, Heath Hunt. Dimensions: Room 1: studio 8'x8' (isolation booth), control room 14'x16'. **Mixing Consoles:** Anek/TAC Matchless 36x24x8x2 w/C mix fader automation, CAD Maxcon 16x4x2. **Audio Recorders:** Akai A-DAM 12-track digital, Otari MK-5050 4-track w/dbx, Otari MK-5050 2-track w/dbx, Panasonic SV-3900 DAT w/remote, Panasonic SV-2500 DAT, Panasonic SV-250 portable DAT, Nakamichi 682ZX cassette, Yamaha KX1200V cassette. **Monitors:** B&W Matrix 801 w/Bryston 4B, Tannoy System 8 w/Bryston 3B, Yamaha NS-10M. **Other Major Equipment:** (2) MOTU MIDI Time Piece, Yamaha SPX1000, Alesis Quadraverb, (2) Alesis MIDIverb II, ART DR1, Yamaha SPX90, BBE 822 Sonic Maximizer, Benchmark M1A 4x4 4-channel mic preamp, Calrec Soundfield Mk14 (mic), Neumann SM69 stereo mic, (2) Neumann U87, (2) Neumann KM84, (2) Audio-Technica 4051, Audio-Technica 822 stereo mic, Kurzweil 250 (fully loaded), Roland S-559 w/40 meg HD, Kurzweil 1000, Proteus II, Roland D-50, Yamaha DX7 IIFD, Roland Super Jupiter, Oberheim Matrix 1000, Roland R-8, Bechstein 9' concert grand, Roland MC-500, MOTU Composer/Performer software, Macintosh II computer, Atari 1040ST computer, Canon Almark II hi-fi 8mm camcorder, Sony VO-9600 U-matic SP 3/4" video deck, Sound Ideas CD sfx library. **Specialization & Credits:** Miditracs is a full production 12-track digital MIDI studio located within a media production facility. We offer full 12-track digital (both studio and remote) with SMPTE sync for virtual MIDI tracks. The studio focuses on MIDI production and demos, along with full CD and cassette album project production (from start to finish). Rates are as follows: \$55/hr 12-track studio, \$60/hr 12-track remote, \$40/hr 2-track remote. Project rates and gear rental available. Please call or write with any questions.

455 Massieville rd
chillicothe, oh 45601
1-800-848-9900
1-614-663-2544

THE RECORDING WORKSHOP
Chillicothe, OH

THE RECORDING WORKSHOP



455 Massieville Rd.; Chillicothe, OH 45601; (800) 848-9900; FAX: (614) 663-2427. Owner: Jim Rosebrook, director. Manager: Brian Stritenberger. Engineers: Jeff Ling, Dan Smart, Rob Brumfiel, Rob Gough, Steve Albanese, Greg Jennings, John Hughes, Kurt Zwanzig, Kim Swan, Steve Hancock, Andrew Stines. Dimensions: Room 1: studio 30'x35', control room 30'x27'. Room 2: control room 25'x24', control room 15'x16'. Room 3: studio 30'x40', control room 30'x20'. Room 4: studio 15'x20', control room 15'x17'. **Mixing Consoles:** (2) Sony/MCI 600 Series, (2) Anek/TAC Scorpion, Sound Workshop Logex. **Audio Recorders:** (3) Alesis A0AT, (2) Sony MCI JH-24, (2) Otari MX-70, Fostex E-8, Fostex D-20 DAT, (7) Panasonic 3500 DAT, MCI JH-110, (12) Otari 5050, (2) Nakamichi MR-1. (3) Yamaha C300. **Digital Audio Workstations:** Digidesign/Macintosh Pro Tools, Digidesign/Macintosh Sound Tools. **Monitors:** (2) Custom Steve Durr, (2) UREI 815, (2) UREI 813, (6) Yamaha NS-10, (4) Fostex RM780, (4) JBL 4311, (2) Tannoy NFM-8, (2) Eastern Acoustics. **Other Major Equipment:** Lexicon 224XL, (5) Lexicon PCM70, (2) Lexicon PCM60, Pultec EQH-2, Teletronix LA-2A, (4) Yamaha SPX90, (4) dbx 166, dbx 902, (4) dbx 903, (4) dbx 904, (2) dbx 165A, Alesis Quadraverb, Alesis 3630, Drawmer DL-231, Klark-Teknik DN780, Mark of the Unicorn MIDI Time Piece, Mark of the Unicorn Video Time Piece, Opcode Studio 3, J.L. Cooper CS-10, Fostex 4030/4035. **Specialization & Credits:** The Recording Workshop offers an intensive, 300-hour training program in audio recording. We are the original "hands-on" school for students seeking education in the creative operation of professional recording equipment. Over 200 hours are spent in-studio. This experience includes session setup, mixing technique, recording, mixing, studio etiquette, song production, commercial and audio-for-video production, editing and equipment maintenance. In lec-

—LISTING CONTINUED ON NEXT PAGE

SALE! PLUS FREE ADHESIVE!

MARKERFOAM™ ACOUSTIC FOAM GIANT 54" x 54"

Immediate Shipping

2" Reg. \$29.95 Now \$19.99 • 3" Reg. \$39.95 Now \$29.99! **KILL NOISE QUICK!**

High performance, full-size sheets of super high density Markerfoam. EZ mount. Blue or gray. Super-effective sound absorption for studios. Markerfoam offers best value, looks professional & is proven in studios worldwide. Request Foam-Buyers Guide/Catalog, specs & free samples today. VISA, MC, AMEX, COO, P.O.s, QUANTITY DISCOUNTS

MARKERTEK JUMBO SOUND ABSORB BLANKETS

Heavy-duty 72"x80" padded blankets absorb sound wherever they're hung or draped. Fabulous for stage, studio & field use. Top professional quality at a super saver price! Weight: 6 lbs. Black, \$19.99.

MARKERTEK BLADE TILES™

HIGH PERFORMANCE
LOW, LOW COST!

\$3.49 per tile, 16x16x2" America's best acoustic tile value, only from Markertek! Charcoal. Also available 16x16x3" as shown, \$4.49 each

MARKERSTIK™ foam adhesive. FREE with any Foam purchase in this ad! Limited offer. A \$5.95 per tube value

SONEX
All the colors and sizes plus great prices!

Get our FREE 149-page catalog of over 6,000 exclusive and hard-to-find supplies for audio & video.

800-522-2025 America's most unique catalog for audio & video!
FAX: 514-246-1757

MARKERTEK™
4 High St., Saugerties New York 12477 U.S.A. **VIDEO SUPPLY**

USE READER SERVICE CARD FOR MORE INFO

WHETHER YOU NEED 1 CD...

OR 1,000 CD'S....

MUSIC ANNEX IS THE PLACE TO CALL...

Music Annex Duplication

CALL TOLL FREE 1-800-869-0715

IN SF BAY AREA (510) 226-0800

Valley Sound

Sales & Rental

... is proud to announce the addition of LEXICON and EVENTIDE to our long list of fine audio products...

Which includes: SUMMIT AUDIO, TAD, CREST, DBX, DRAWMER, AKG, TC ELECTRONICS, just to name a few. And of course,

SHEP ASSOCIATES
Neve mic pre-eq replacement modules and 32264A comp/lim modules.

We also have in stock 1073 and other 3-band modules as well as 1081 4-band modules.

We make custom racks and power supplies for any modules.

Please call or fax for pricing on new and used gear.

In Stock:

TAC MAGNUM 6 months old	\$27,000
LEXICON 480L used	\$7,500
OTARI MTR12 1/2"	\$5,150
TRIDENT A range modules	
2 in rack set up w/p.s.	\$2,995
ORBAN 622 B	\$500
3M M79 24 Track	\$8,995
OTARI MX80 32 Track	
update kit; 8 audio cards,	
32 Track headstack new	\$3,750
MCI JH 110 1/4" headstack	
and rollers	\$650

(818) 842-6500
Fax: 842-1860
Burbank, California

USE READER SERVICE CARD FOR MORE INFO

North Central Studios

—LISTING CONTINUED FROM PREVIOUS PAGE

ture, students receive a broader study of audio engineering and music business practices. Our 6-studio recording complex features two automated 24-track studios, two 16-track studios, and 8-track commercial/MIDI production studio, a hard disk digital editing/DAT mastering studio and a conventional editing lab. In-studio class size is three to six students, lecture class size is 48. We have internship and job placement services. We offer low-cost, on-campus housing. Financial aid is available. The Workshop is a TEC Award nominee and is approved by State Board of Proprietary School Registration. Please call for a free brochure.

REFRAZE RECORDING STUDIO



2727 Gaylord Ave., Dayton, OH 45419; (513) 298-2727; FAX: (513) 298-2550. Owner: Mark Fraze, Jane Fraze. Manager: Gary King.

ROME RECORDING CO.



3970 S. High St., Columbus, OH 43207; (614) 497-3970; FAX: (614) 497-1012. Owner: Jack Casey. Manager: Jack Casey.

SCHARREN RECORDING



123 10th St., Toledo, OH 43624; (419) 241-5432; FAX: (419) 242-8400. Owner: Steve Scharren. Manager: Dan Schroeder.

SONIC ARTS DIGITAL AUDIO SERVICES



319 W. Fourth St., Ste. 300, Cincinnati, OH 45202; (513) 352-5890; FAX: (513) 352-5891. Owner: John McDaniel. **Specialization & Credits:** Sonic Arts Digital Audio Services provides original music and audio production services to clients in broadcast, corporate and experimental media. Music/sound design for radio and television spots, full length programs for commercial and public television, and corporate presentation are among John McDaniel's commercial credits. His electronic works for experimental media include large scale outdoor sound environments, modern dance, theatre and computer-animated film. John McDaniel/Sonic Arts actively seeks collaboration with experimental artists in any media in order to find artistic challenges whose meanings transcend "paying the bills." Toys include Pro Tools (8 tracks), SampleCell, and an army of MIDI devices, digital effects, tape machines, lock-to-picture capability and 1" video layback.

SOUND IMAGES



602 Main St., Cincinnati, OH 45202; (513) 241-7475; FAX: (513) 241-4791. Owner: Jack Streitmarter. Manager: Charlaire Martin.

SOUNDSPACE INC.



845 Dayton St., Yellow Springs, OH 45387; (513) 767-7353. Owner: Chris Hertzler.

STORMWATCH PRODUCTIONS



PO Box 751513; Dayton, OH 45475; (513) 293-5280. Owner: G. Allan Clarke. Manager: G. Allan Clarke.

TECHNIMEDIA STUDIOS



124-126 S. Fifth St., Steubenville, OH 43952; (614) 282-5315; FAX: (614) 282-TECH. Owner: Frank DeFede, Mike Pernatozzi. Manager: Jerry Ostrosky.

3001 STUDIOS



580 S. Dayton-Lakeview Rd., New Carlisle, OH 45344; (513) 845-9646; FAX: (513) 845-8153. Owner: Jeff Gastineau. **Specialization & Credits:** At 3001 Studios, we offer the finest in music recording in a secluded, country setting. Our 48-channel, automated, Yamaha digital mixer combined with over 20 MIDI instruments, 64 voice Sample Cell system, and Pro Tools and Roland digital workstations provides complete control over your project. We specialize in all

types of music recording, ranging from heavy metal and rock to gospel and contemporary Christian. The staff at 3001 consists of musicians/songwriters, who can provide custom soundtrack music for your video, film or jingle project and MIDI specialists who are experts at sequencing, programming and Macintosh applications such as (2) Digital Performer, Studio Vision, Sound Designer, Max and Q-Sheet. Located 15 minutes from the Dayton International Airport, we provide the quality you are accustomed to, at a price far below the major cities.

SOUTH DAKOTA

FIOOLE STRING PRODUCTIONS



MCR 89, Box 46; Hermosa, SD 57744; (605) 255-4235. Owner: Stringbean Svenson. Manager: Stringbean Svenson.

WISCONSIN

CONCEPT PRODUCTIONS INC.



7878 Big Sky Dr., Madison, WI 53719; (800) 728-2731; FAX: (608) 833-7893. Owner: Corp. Manager: C. Dan Geocaris.

FAST FORWARD PRODUCTIONS LTD.



6909 Raywood Rd., Madison, WI 53713; (608) 222-5267; FAX: (608) 221-9307. Owner: Mark A. Loeffelholz. Manager: Thomas Kihntopf.

HARVEST PRODUCTIONS



8297 Hillpoint Rd., Cross Plains, WI 53528; (608) 798-2223. Owner: Don Sieb. Manager: Don Sieb.

HG STUDIO



21332 7 Mile Rd., Franksville, WI 53126; (414) 425-3885; FAX: (414) 425-3885. Owner: Don Hunjadi. Manager: Don Hunjadi.

LAUGHING CAT STUDIO



11537 Walnut Ln., Fort Atkinson, WI 53538; (414) 563-9935; FAX: (414) 563-8342. Owner: Al Jewer. Manager: Al Jewer.

RENWOOD RECORDING STUDIO



3510 60th St., Kenosha, WI 53144; (414) 654-3376. Owner: George Renner. Manager: George Renner.

ROYAL RECORDERS



Hwy 50 East, PO Box 1089; Lake Geneva, WI 53147; (414) 248-9100; FAX: (414) 248-9641. Manager: Dan Harjung. **Specialization & Credits:** Royal Recorders offers one of the finest recording environments in the world. Located in Chicago's playground--Lake Geneva, Wisconsin. Royal is only an hour from O'Hare. We include luxury accommodations on the lake as well as the amenities of the Americana Resort Hotel. In addition to the studio's 80-input SSL 4072E console with G Series computer, (2) Mitsubishi 850s and (2) Studer A-800 III, Royal offers a full complement of outboard gear including: (8) Focusrite EQs, (9) API EQs, (4) Neve EQs, (2) GML EQs, (5) LA2A, (8) Pultecs, (2) AMS 1580's, (2) AMS RMX 16, Lexicon 480 and 224XL, and Publison IM-90. We also have one of the largest vintage tube mic collections in the world. Album projects include: Queensryche, Skid Row, Red Hot Chili Peppers, Guns N' Roses, Adrian Belew, Sven Gali, Survivor and more.

SOUND SHOP RECORDING STUDIO



9250 N. Sleepy Hollow Ln., Bayside, WI 53217; (414) 352-2397. Owner: Roger A. Roth. Manager: Roger A. Roth.

Want More Information?

The advertisers in *Mix* are happy to supply readers with additional information about the products and services advertised in this issue.

To receive more information, just circle the appropriate numbers on the Reader Service Card on page 160.

—FROM PAGE 69

relationship between project studio and post house as a healthy one. He doesn't have to do it all, offering music as well as other post aspects, so he can concentrate on what his studio does best. Secondly, at a time of constricted budgets, he says the component approach of composer/project studio on the one hand and post/layback house on the other gives clients a financial break, but only to the extent that both entities can work integrally.

"The beauty of 'When It Was a Game' was the level of interactivity we had," he explains. "Steve was working in his own studio, which he knows well, and that saves him time and the client money. Then he came in here and watched as the picture cuts were made and sound effects and narrations were added. As a result, he had a greater grasp of how the entire picture was shaping up than if a producer hired a composer who had to hire a studio and hire an outside engineer."

BUDGETS

Budgets are something to spend a minute on. They've been going down over the last year or so, mostly thanks to the recession but also due to the increase in market share of cable productions: Though these productions have sparked the post boom, their budgets are, inherently, relatively limited. The project studio, too, is responsible for, if not lowering budgets, at least making lower-budget post-production that much more viable since the project room's overhead and technology investment are considerably lower than that of commercial rooms.

It's precisely that situation that helped precipitate the rancor between audio studios and project studios. But in this instance, since post has more aspects and is more complex (although certainly not more sophisticated) than straight audio recording, a smoother interface is possible. Dwork agrees: "The project studio can be a very specialized feeder to post houses. Post is a broad field, and no one can do it all. I think the response to change can be quicker in this type of arrangement because I'm not waiting for the composer to find an available studio for changes. I think we'll see more

of this happening in the future."

Horelick has seen a range of budgets pass through his studio, from low to high. But they've also been for varying degrees of involvement—some for music only, others for sound effects as well. "I'd like to think it's because people believe that musicians hear sound differently than other [audio professionals]," he muses. "But it may also be because people perceive the project studio as a less expensive alternative to traditional post houses."

On the other hand, of course, the increasingly large and diverse assortment of music and sound libraries now available will give post houses an advantage for clients who don't need—or can be convinced that they don't need—original music.

Even project studios have their own levels of competition from within. "In a bottom-feeding market [project studios] can drive prices down," Horelick says. "I wanted my own studio because, ironically enough, it lets me be less of a studio owner and more of a musician, and that can become my focus instead of money. But if I want \$5,000 and someone working out of their parents' basement will do it for \$500, that has an effect."

The overall effect of project studios interfacing with post houses would seem to be a useful one for all concerned. But downward price pressure—which is affecting every aspect of this industry, from recording rates to duplication costs—could be the stumbling block. Budgets aren't likely to increase in the immediate future, and while the project studio offers a temptingly less pricey alternative to traditional post houses, anyone with a clear understanding of the scope of audio post for complex undertakings knows the limits of what a project studio can realistically be expected to accomplish and accomplish well.

"The post houses have the consoles and related equipment you really need for a mix," says Horelick. "I don't want to have to handle all of that. But I do think the evolution of project studios in terms of post will result in at least the redistribution of post work." ■

Dan Daley is Mix's East Coast editor. As a lifelong New Yorker, he often associates the phrase "post time" with the \$2 window at Aqueduct.

A SINGER'S DREAM!



REMOVES VOCALS FROM RECORDS!

Our VOCAL ELIMINATOR can remove most or virtually all of a lead vocal from a standard stereo record and leave most of the background untouched! Record with your voice or perform live with the backgrounds. Used in Professional Performance yet connects easily to a home component stereo system. Not an equalizer! We can prove it works over the phone. Write or call for a free brochure and demo record.

Listen..



Before You Buy!

- Time Delay
- Reverberation
- Crossovers
- Noise Reduction
- Compressor/Limiters
- Expanders
- Spectrum Analyzers
- Parametric EQ

Don't have regrets about paying too much for a lesser product. In demos and comparisons, we'll show you why we're Better! Our Factory Direct sales allow us to produce a Superior product and offer it to you at a Lower price. Call or write for a free full length Demo Album and 24 page brochure.

LT Sound, Dept. MX-9, 7980 LT Parkway
Lithonia, GA 30058 (404) 482-4724
24 HOURPHONE DEMO LINE: (404)482-2485

USE READER SERVICE CARD FOR MORE INFO

**CASSETTE
INSERTS
IN
7
DAYS**

CS Printing

111 Oak Lawn Ave.
Dallas, Texas 75207
(214) 747-8705
FAX: (214) 748-9922

DAT

AUDIO GALLERY

AMERICA'S BEST PLACE TO BUY DIGITAL AUDIO TAPE RECORDERS

- Best Prices, Service, Warranty
- Newest Models in Stock
- No Commission Sales Staff
- DAT Accessories, Mics, more

NOW AVAILABLE:

SONY DAT WALKMAN

TCD-3!

World-wide model available

LOWEST DAT TAPE PRICES ANYWHERE!

Latest Sony DATs and Mics from Japan here now!

Call us before you buy elsewhere

AUDIO GALLERY

213 • 829 3429

2717 Wilshire Blvd., Santa Monica
CA 90403. FAX: 213 • 829-0304

USE READER SERVICE CARD FOR MORE INFO

LUNCHING WITH BONZAI

—FROM PAGE 128, WILLIE NELSON

guitar as a kid?

Nelson: Yes, that was the first thing I picked up. My grandparents were music teachers, and my older sister knew music real well. She played the piano and I played the guitar, so I learned a lot from just the two of us playing together.

Bonzai: What kind of music did you listen to in your formative years?

Nelson: Well, back in those days I listened to the radio. When you turned the dial you could hear all kinds of music: country music, the Grand Ol Opry, blues coming out of New Orleans, jazz. I heard Frank Sinatra, Roy Acuff and all of 'em about the same time.

Bonzai: You've been compared with Sinatra, even called "The Sinatra of Country." In your mind, why is that?

Nelson: I think it has a lot to do with the phrasing. I always admired his phrasing ability.

Bonzai: About your new studio operation, how has automation changed your recording style? Has it made life easier for you?

Nelson: It's made it easier for the engineer, Larry Greenhill. [Laughs] He was the original engineer here and helped build the studio with Chips Moman.

Bonzai: Freddy Fletcher is the studio manager, but he's also your drummer?

Nelson: Yes, and he owns two studios—this one and another one in downtown Austin called Arlyn Sound, a very popular studio.

Bonzai: I was at the bank yesterday, and the teller asked me who I was interviewing next and I mentioned your name. A guy at the next window leaned over and asked, "Gee, how's it going with Willie and the IRS?" I imagine a lot of people are concerned—what could I say to that guy to convince him that you are surviving well, in spite of the snags along the way?

Nelson: Well, you should tell him that I am now in charge of the IRS, and I get a cut of every dollar that he pays in taxes. In fact, I am using some of his money to pay off my old tax bills. [Laughs] No, really, I'm doing fine. We have reached an agreement, and I think in a month or so I will be able to forget about all

that stuff.

Bonzai: I understand that some of your belongings were auctioned off by the IRS and that the Willie Nelson and Family General Store bought your entire office for its museum and they have it on display for the public.

Nelson: Yes, it's in a museum in Nashville, and also some of it is in Branson, Missouri.

Bonzai: And you can just walk in and conduct business as usual?

Nelson: Oh, sure. Nothing's changed.

Bonzai: Is it true that you once rushed into a burning ranch house in Tennessee to save your favorite guitar, "Trigger"?

Nelson: Actually, I went in there to get my stash that I had left. I think I made up the story about the guitar.

Bonzai: You do a wonderful interpretation of "Georgia On My Mind." As I was listening to it the other night, I wondered if you were singing about a woman or a state.

Nelson: The song originally was written for the state, and it's now the Georgia state song with Ray Charles singing. I'm sure that Hoagy Carmichael was talking about the state, but there are a lot of ladies around named Georgia who take that song as theirs.

Bonzai: What music would you like played at your funeral?

Nelson: Boy, what a question. I wasn't planning on having one.

Bonzai: What animal do you identify with?

Nelson: Horses.

Bonzai: Who is the most amazing artist that you have worked with in your lifetime?

Nelson: Leon Russell.

Bonzai: That's interesting—I was going to ask you about Leon. One of my favorite albums is the one you did with him, *One For the Road*. Beautiful...

Nelson: Well, thank you. I think Leon is the best overall, all-around entertainer. Back in those days, when he was the hot rock 'n' roll king, there was nobody who could touch him as far as electrifying an audience singlehanded. His music ability is fantastic—his style and all that goes along with it is his own. He's a stylist—either you are a real Leon Russell fan, or you're not, and there's a whole lot of us who are. He has a new album out that Bruce Hornsby produced. I would recom-



PERFORMERS SOUGHT

Volunteer Your Talent to Bring Joy to Needy Hearts. Bread & Roses, in its 16th year of bringing live entertainment to institutionalized and disenfranchised people, is seeking performers in or travelling to San Francisco or Marin County.

Call for information
BREAD & ROSES
(415) 381-0320

mend it highly—two geniuses working together.

Bonzai: How was it working with Booker T.?

Nelson: We've worked together a lot. He did the *Stardust* album, which has sold more records than anything I've ever done. All those songs in there were favorite songs of mine. Fortunately, Booker T. was around to produce it. We had become friends, but I didn't think that I was qualified to go into the studio with those songs and produce and record them myself. And I didn't know anybody else who was, until I ran into Booker T. We started talking about it, and I realized pretty quick that this guy had the musical ability to arrange it. We got together, and it's still the best album that I ever made.

Bonzai: Have you ever witnessed a miracle?

Nelson: Every day.

Bonzai: What is the biggest mistake of your life?

Nelson: Oh, I don't know...I really don't know. I hope that I've already made it. [Laughs] I couldn't tell you what it was at the moment, but the list is long.

Bonzai: Do you have a favorite vocal microphone?

Nelson: No, I just leave that up to the guys who listen to the room and my voice that day.

Bonzai: What do you look for in an engineer?

Nelson: Someone who has the ability to really work with the sound and get it the way it is supposed to be. That's not what I do. I just sing and play and work with guys who really know how to put the sound down right. I don't really want to know much about what they do, because the more I get into it, the more confused I get, and then the next year they come out with something different. It's better for me to find a guy like Larry Greenhill who knows all that stuff.

Bonzai: Isn't Stuart Sullivan another engineer you work with?

Nelson: Stuart is a great engineer. He works a lot with Freddy downtown and out here a lot. Eric Paul is another great engineer who has worked a lot out here at Pedernales.

Bonzai: What's wrong with the music industry?

Nelson: Well, honestly, I think it has a lot to do with the fact that musi-

cians aren't running it. It's usually a lawyer or an accountant who has been trained to watch the bottom dollar and doesn't know that much about a good song when he hears it. That's my honest opinion.

Bonzai: What advice would you give to a youngster who wanted to follow in your footsteps?

Nelson: Just play every chance you get for anyone who will listen. Keep doing that until you get done with what you want to get done.

Bonzai: Have you had any lucky breaks in your life?

Nelson: If you believe in luck, I am the luckiest guy alive. I have a saying that I'll take credit for: "Fortunately, we are not in control." That's really the truth. We sit around and think what we would like to happen, but if we have to make it happen—it's impossible. You just have to believe that it is going to happen—fortunately, we are not in control. If you get out of the way and let it happen, most of the time it will. We get in our own way more than anybody else does.

Bonzai: Is it true that you are going to be starring in Kinky Friedman's new movie?

Nelson: Yes, that's true. Kinky and I will play lovers and the film is titled *Cowboys Are Secretly Frequently Fond of Each Other*. [Laughs heartily] That's an old Ned Sublette standard. I don't know if you've heard it, but it will go down in history. I think he wrote the song, anyway. I was doing *Saturday Night Live* some years ago and somebody handed me a tape, and I took it back to my bus and put it on the machine. That's what it was. If you get a chance to hear it, you ought to listen, because it is fantastic.

Bonzai: It's commercially available?

Nelson: Uh—no, you have to know somebody.

Bonzai: How is life on the road these days?

Nelson: I really enjoy it. It's where I am happiest. Of course, coming in second is being here at the studio and the golf course. I couldn't stay here all the time, because it's too good. [Laughs] I would get in *way* too much trouble here on the hill—and have!

Mr. Bonzai was initiated into the mysteries of country music at Kinky Friedman's dude ranch.

Moving?

Let us know!
Call **1-800-888-5139** or write to *Mix* at the address below. Be sure to include your name and both **old and new addresses** (a current mailing label is helpful). Send your subscription related correspondence to:

Mix Magazine
Customer Service
P.O. Box 41094
Nashville, TN 37204-9830

USE READER SERVICE CARD FOR MORE INFO

Professional Audio for the Northwest United States **AUDIO** *Images*

- Audio for Film and Video
- Multi-Track Recording
- Digital Audio Workstations
- Sound Reinforcement
- Computer Music Systems
- Tape and Accessories

70 Oak Grove Street, San Francisco, California 94107
Tel: (415) 957-9131 • Fax: (415) 957-1531

550 Mercer Street, Suite 130 Seattle, Washington 98109
Tel: (206) 285-9680 • Fax: (206) 283-9744

Davis Business Center 4370 N.E. Halsey Street
Portland, Oregon 97213
Tel: (503) 295-5948 • Fax: (503) 386-4062

FEEDBACK

DESIGN CONTROVERSY

I couldn't believe the article "How to Design and Construct a Modern Control Room" [Malcom Chisholm, August '92]. Almost every sentence can be challenged. Almost every classic mistake that people make in control room design was incorporated into the diagram.

While the author will not agree with the above, he should at least admit that the "revolution" involving the LEDE™ ideas was and still is controversial. Your readers should be aware that I and others are not in agreement with the entire LEDE design trademark and philosophy, which in my opinion is an attempt to convince the audio world that there is only one correct way to design a control room. The article implies that the acoustical information is factual; in fact, it is opinion. Actually, the appropriateness of the Haas zone, RPG diffusors, the comb filter effect and other buzzwords used can be shown to be potentially misleading.

I have personally "de-certified" a certified LEDE room that has since become a very successful room on the East Coast, whose engineer called again to thank me yesterday. I have witnessed basic acoustical mistakes, bad ones, in rooms that have, along with their designers, won all the awards but have left people unhappy. My work as an acoustical troubleshooter shows that the more computer printouts designers have, the more likely they are to be bullshitting their clients.

While the author may know "designer/builders" who "guarantee the results," I don't know of any who are leaving a perfect trail of happy customers, because

I get calls after they finish. Your readers should realize that "designer/builders" don't have an independent acoustical consultant looking over their shoulders for mistakes and shortcuts. I know of several "designer/builders" who were carpenters on rooms I designed, and now they go around calling themselves "designer/builders," putting in exactly the same acoustical details that I had them use in other rooms. A shame, when the details of the original room were a compromise due to the special requirements of that customer. I'll give you a guarantee: If the room on page 53 is built, there will be major problems.

I recommend that a prospective studio owner speak to independent consultants with long records of knowing what they're talking about. Get references, and don't be impressed with buzzwords and computers.

*Alan Fierstein
President, Acoustilog Inc.
New York, NY*

THE AUTHOR REPLIES

Mr. Fierstein appears to have written in some haste, with the result that his letter contains very few specific references to the subject at hand, although he is clearly upset with designer/builders, LEDE™ theory, computer printouts and buzzwords. As one of the independent acoustical consultants with whom he appears to be so impressed, I agree with a good deal of what he says. But one reason for the article is that it's a big country, with a very small number of capable designers outside metropolitan centers. That fact leaves the majority of small studio owners to their own devices, as calling in a big-time acoustician from several hundred miles away ain't in the budget. As stated in the preface,

the information in the three-part article is intended to be helpful to those owners. Mr. Fierstein's reference to the acoustical information used in the article as opinion rather than fact is another matter. The LEDE "philosophy" is *theory*, not opinion, and since the difference between the two is *precisely* the difference between magic and science, it deserves comment.

An opinion is a compilation of all the mind's information on a given subject, conscious and unconscious, which is treated in thinking and decision-making as a single item. In computerese, it's an object, and it saves so much time as to be absolutely essential to human thought. It is also worth exactly the value of the untested information that went into it, good and bad, and is unreliable for that reason.

A theory, on the other hand, is a sharp-edged tool that yields predictable results and is not called a theory until it has passed that test.

And that's the point of LEDE. Whether you like the sound of an LEDE or not, whether you believe the theory or not, and whether it looks like an LEDE or not, if you build it to spec it'll sound like an LEDE every time. It's *predictable*.

It can go wrong. If you have a combination of room and monitors you like and you put those monitors in an LEDE, you will hear them as they really sound, and you might not like them anymore. I know of one client (not mine) who unfixed the room when that happened. Oh, yes—the diagram on page 53 has been built. Works good.

Malcolm Chisholm

—FROM PAGE 46

um, Multimedia forum, MIDI Vendor forum (see Fig. 1) and MIDI Music forums are among the most pertinent to *Mix* readers. For more information

Phoning in Your Parts

A recent rush job involving the production of six radio commercials for Chevron was made a little easier through the use of my Mac and my fax modem. After receiving the scripts from the L.A.-based producer by fax modem, I could refer to them on the computer screen during subsequent phone conversations with the producer and later while I was creating MIDI versions of each theme. After the voice-over and sound effects were completed at WAVES in L.A., the 1/4-inch tapes were FedExed north. I converted them into digital audio files and imported them into Studio Vision, where I could then refine the timing of the music to fit the dialog.

After getting approval of the final music versions, I saved the MIDI tracks (which I modified to conform to the General MIDI Spec) as Type 1 MIDI files and modemed them to the copyist. He used Coda's Finale and Passport's Encore to print out parts. Given that translation of performed music to transcribed music remains a complex and inexact science (for example, trills and bent notes don't translate well into notation), the copyist was able to compare the performance (using a Roland Sound Canvas) with the printed parts and make adjustments to the printout. In the case of drum and percussion parts, he chose to write out the parts longhand.

In any event, I was able to get some sleep, rather than having to write out scores for the copyist, and the parts were ready for the musicians at 9 a.m. the next day. Now if only Russian Hill Studios had had a modem connected to a Mac with a LaserWriter...

on CompuServe call (800) 848-8199.

While not nearly as big as CompuServe, PAN is dedicated to addressing the needs of musicians and audio pros. Special interest groups range from business to manufacturers. And PAN is in the process of implementing complete access to Internet. This means that people will be able to gateway to other Internet hosts through PAN, exchanging files from remote systems anywhere in the world. Other services use Internet only as a means of exchanging e-mail, as opposed to files. For more information on PAN, call (215) 584-0300.

A couple of final notes about uploading and downloading files: First, large file sizes and relatively low baud rates have created a market for file compacters—programs that compress data (both applications and files) into a smaller bundle. The advantage of compacters is that they can pass through the low-bandwidth phone lines more quickly, but the downside is that the receiver normally needs to use the program to expand the file. Current popular compacters for the Mac include Compact Pro 1.32, and Salient Software's Disk Doubler 3.7. Most files available

for downloading on commercial BBSs are compacted using one of these methods. The second note is about viruses. Files downloaded from most commercial online services have been checked for viruses. You should do the same when downloading or uploading files. A variety of commercial and shareware virus detection programs are available for this purpose.

As more people discover the advantages of going online, we can expect easier navigation, faster baud rates and increasingly sophisticated versions of this virtual world. By the middle of the decade, Integrated Services Digital Network (ISDN) should be available to a majority of U.S. customers. When that happens, you can replace that modem you just bought with an ISDN connection, which will give you a direct digital connection to your computer at 64,000 bps.

In the near future, look for *Mix* to establish an online presence at one or more electronic watering holes. Stay tuned for further developments. ■

Mix associate editor Paul Potyten can be reached at 710,33,1523@compuserve.com and PAN: Potyten.

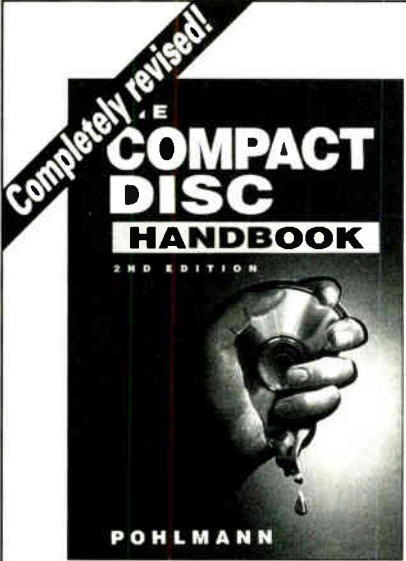

COMPACT DISC HANDBOOK
2ND EDITION
POHLMANN

"Ken Pohlmann elevates the science, physics, and engineering of digital audio into something as fun to read and as fascinating as a top-flight mystery novel."

—Bob Carver, Carver Corporation

New to the 2nd Edition

- in-depth info on recordable CD
- new info on 1-bit conversion
- preview of mini disc technology

The Compact Disc Handbook
2nd Edition Ken C. Pohlmann

Hardcover \$49.95	Paperback \$34.95
Item No. 1475-H	Item No. 1475

A-R Editions, Inc.

Available through MIX BOOKSHELF

To Order: Call toll-free (800) 233-9604, or (510) 653-3307, fax (510) 653-5142 or write to 6400 Hollis St. #12, Emeryville, CA 94608.

We accept VISA, MasterCard, American Express, Discover credit cards, personal checks and money orders.

Add \$3 for shipping. CA and NY residents add state sales tax.

FREE CATALOG AVAILABLE UPON REQUEST

USE READER SERVICE CARD FOR MORE INFO

AD INDEX & READER SERVICE PAGE

PAGE	READER SERVICE NUMBER	ADVERTISER
124	001	Ace Music Center
54	002	Acoustical Solutions
47	003	Akai
21	004	AKG Acoustics
IFC-1	005	Alesis (adat)
27	006	Alesis (3630)
113	007	Alesis (RA-100)
29	-	Amek
9	008	Ampex
134	009	Apex Machine Company
13	010	Applied Research & Technology (ART)
40	-	Ashly Audio
139	011	AudioForce
157	012	Audio Images
86	013	Audio Intervisual Design
35	014	Audiomation Systems
68	015	Audio-Technica
142	016	BASF/Burlington
70	017	Behringer
84	018	Russ Berger Design
95	124	beyerdynamic (TG-X 580)
97	019	beyerdynamic (TG-X 480)
89	020	Boynton Studio
126	021	Brainstorm Electronics
156	022	Bread & Roses
81	023	Bryston
125	024	Burlington Audio/Video Tapes (3M)
141	025	Burlington Audio/Video Tapes (Sony)
155	026	CCS Printing
80	027	Century Music Systems
116	028	CM AUTOMation
96	029	CMCI/Circuits Maximus Company
38	030	JL Cooper Electronics
129	031	Crown
37	032	D & R USA
97	033	Dale Electronics
156	034	D.A.T. - Audio Gallery
115	035	The DAT Store
83	036	dbx Professional Products
56-57	037	DDA
63	038	DIC Digital Supply
14-15	039	Digidesign
IBC	040	DigiTech
89	041	Disc Makers (Cassettes)
151	042	Disc Makers (CDs)

PAGE	READER SERVICE NUMBER	ADVERTISER
69	043	Dolby
114	044	Dynacord
34	045	DynaTek Automation Systems
80	046	EAR Professional Audio/Video
53	047	Electro-Voice (EV)
50	048	E-mu Systems
91	049	Ensoniq
41	050	Euphonix
131	051	Europadisk
104	052	Fairlight
145	053	First Light Video Publishing
90	054	Full Compass
61	055	Full Sail Center for the Recording Arts
51	056	Furman Sound
101	057	Future Sonics
60	058	GLO Magnetics
146	059	Gold Line
36	060	The John Hardy Company
88	061	The Hollywood Edge
65	062	Imperial Tape Company
54	063	Institute of Audio Research
BC	-	JBL Professional
79	064	The Russ Jones Marketing Group
146	065	JRF Magnetic Sciences
138	066	KABA Research & Development
147	067	Klarity Cassette (Cassettes)
149	068	Klarity Cassette (CDs)
147	069	Leo's Professional Audio
17	070	Lexicon (300)
46	071	Lexicon (20/20 AD)
151	072	Library Editions
155	-	LT Sound
152	073	MacBeat
94	074	Mackie Designs (CR-1604)
126	075	Mackie Designs (Contest)
153	076	Markertek Video Supply
124	077	Masterfonics
148	078	Meyer Creative Productions
115	079	Micro Technology Unlimited (MTU)
159	080	Mix Bookshelf
144	-	Mix Master Directory
153	081	Music Annex Duplication
64	082	Nagra/Phi Technology
82	083	Neutrik
32-33	084	Otari

PAGE	READER SERVICE NUMBER	ADVERTISER
24-25	085	Peavey Electronics
148	086	PolyQuick
59	087	Professional Audio Services & Supply
123	088	Professional Audio Systems
134	089	QCA
103	-	Ramsa
62	090	Rane
99	091	The Recording Workshop
60	092	Rhythm City
52	093	Rocket Lab
22-23	094	Roland (S-770)
75	095	Roland (DM-80)
119	096	Ross Systems
106	097	Sabine Musical Manufacturing
58	098	Sascom Marketing Group
145	099	SAS Industries
6-7	-	Solid State Logic (SSL)
85	100	Sonic Solutions
10-11	-	Sony
135	-	Sony Recording Media
18-19	-	Soundcraft
39	101	Soundtracs
105	102	Spectral Synthesis
3	103	Studer Revox (A827-24)
122	104	Studer Revox (D740 & D780)
139	105	Studio Consultants
28	106	Summit Audio
55	107	Sunkyong
128	108	Sweetwater Sound
98	109	TAD/Technical Audio Devices
2	110	Tannoy
44-45	111	Tascam (238)
67	112	Tascam (M700)
78	113	t.c. electronic
84	114	TDK
95	115	Thoroughbred Music
76	116	3M Corporation
154	117	Valley Sound
149	118	Wave Digital
65	119	Josef Weinberger Limited
132	120	Whirlwind Music
142	121	Whisper Room
100	122	Yorkville
99	123	Zoom

CLASSIFIEDS

Business Opportunities

CASH FOR TRACKS

We pay cash for your unsold/unclaimed music tracks. All styles; all lengths. No junk please! Send cassette to: PMW, Box 947, Bryn Mawr, PA 19010, or call Andy at (800) 368-0033.

INVESTMENT OPPORTUNITY

5,000-square-foot recording studio w/2 control rooms, offices, lounge. Good lease. Looking for investor or buyer. Call (212) 255-8911 and ask for Steve.

Investors: New studio/production company seeks funding, equipment. Sophisticated international digital recording. Projects in Russia, U.S., et al. promise great success. Call Matt, (309) 467-3601.

LET THE GOVERNMENT FINANCE your new or existing small business. Grants/loans to \$500,000. Free recorded message: (707) 448-0270. (NL3).

Employment Offered

Immediate Opening for DIGITAL MASTERING ENGINEER Full-time position. Duties include: Premastering of CD projects from analog, DAT and 1630 sources using PCM-1630 and Sonic System. Monitoring, copying and QC of all digital masters. Salary negotiable based upon experience. Please send resume and references to: Dr. Toby Mountain, Northeastern Digital Recording Inc., 2 Hidden Meadow Lane, Southboro, MA 01772, (508) 481-9322.

Employment Wanted

MASTERING ENGINEER

10 years experience with top New York studios. Familiar with current digital/analog equipment. Good with clients. Will relocate.

Please call (914) 591-4161.

Equipment For Sale

STUDER Dyaxis Digital Recorder. 1-hour stereo, 2-hour mono w/system sync. Tape backup AND DSP card (10 band parametric EQ, time compression and expansion). All the latest software. Jess, (602) 948-5743.

Specialists in MIDI systems and home recording.

A knowledgeable, helpful staff...major brands of MIDI-based music and recording equipment...E-mu Systems, Kurzweil, Akai, TOA, JBL, MOTU, Opcode, Digitech, Rane, KAT, Tannoy, 3M, Tech 21, Lexicon, AKG, Carver, Ramsa, Panasonic, Fostex, AMEK/TAC, JL Cooper, Digidesign, all Macintosh and IBM software and interfaces. Huge in-store inventory and in-store service department. Money back guarantee if you are not completely satisfied. Call **Sweetwater Sound Inc.**, 5335 Bass Rd., Ft. Wayne, IN 46808; (219) 432-8176 or fax us at (219) 432-1758.

NEW, USED, DEMO EQUIPMENT HUGE SELECTION OF MULTITRACK RECORDERS, CONSOLES, OUTBOARD GEAR

24-trk recorders, Trident 80C w/ M Faders, Otari 44 and 54 Consoles, Trident 90, Fostex D20, CD Recorders, Digidesign Pro Tools w/Mac II, Audio Media II, Apogee Converters, 8-trk Digital Recorders, Samplers, Cypher 3 Mach System w/ Softouch, Mobile 24-trk Facility, Processors, Roland R880, KRK Monitors, Genelec 1031As, Tannoys, Sony 3324 24-trk, Summit Tube Gear, UREI LA2A, Microtech UM92 Tube Mics. UM70SZ FET.

EQUIPMENT LEASING AND SYSTEMS SPECIALISTS—NEW AND USED COMPONENTS CALL FOR CURRENT FAX LISTING OF EQUIPMENT

EAR PROFESSIONAL AUDIO
(602) 267-0600

WORLDWIDE DELIVERY! KEYBOARDS & RECORDING EQUIPMENT.

GREAT SELECTION - GREAT SERVICE.

OVER 60 YEARS IN BUSINESS.
CARUSO MUSIC

20 BANK ST., NEW LONDON, CT
06320, U.S.A. (203) 442-9600
Fax: (203) 442-0463

TAC Scorpion console 28/12/24/2 w/4 patch bays wired w/Mogami cable in custom desk w/12 single rackspaces equally spaced above meter bridge. Comes w/ten 30-ft. snakes, 24-trk & 2-trk harnesses, MIDI stn. & mic input panel. Call Bob, (805) 251-2599.

EQUIPMENT FINANCING

- ◆ No Down Payment
- ◆ Fixed Rates, Long Terms
- ◆ New or Used Equipment
- ◆ True Lease or \$1.00 Buyout
- ◆ No Financial Statements Required for Transactions Under \$50,000



To apply or request information contact John McMintdes

(713) 680-8822



We Need Your Clean Used 24 Track !!!

Phone (617) 782-4838 Fax (617) 782-4935
List Your For-Sale Items With Us Free!!

SSL parts; G Computer from \$3.8K; E modules from \$2.6K
SSL 6056E TR, \$165K; 4048, \$125K; Neve 24/24, 4 bnd 1081 eq \$50K; 8108, \$45K; BCM 10, \$10K; Trident 80B, \$32K; Neotek Elite, \$30K. API, DDA, Amek call. 2 4 trk Studer A800, \$30K; MCI JH24, \$16K; Otari MX80, \$18K; MX70 16tr, \$9K. Neumann U67, \$2.5K; U47FET \$1.4K; Sony PCM601, \$850; UREI 1176LN, \$650.

New **Apex, Eventide, Tannoy, Adams-Smith, dbx**, call.
Now proudly representing the **Quested** powered monitor !!

OF DENMARK
t.c. electronic
INTEGRATED SYSTEMS (WEST)
Lease or Purchase the TC6032
Moving Fader Remote Eq System
Direct from the Manufacturer
(805) 373-1828

OF DENMARK
t.c. electronic
INTEGRATED SYSTEMS (EAST)
Lease or Purchase the TC6032
Moving Fader Remote Eq System
Direct from the Manufacturer
(800) 451-6032

CONSOLE: Neve 8058 MkII,
better than new! • New Sony APR
24 • Mitsubishi X-86, X-850, 1 1/2
yrs. old, low hours • Call
(804) 464-4924

Tascam DA-800 digital 24-track
DASH recorder. New/Demo \$70k.
Tascam M700 40-input recording
console. New/Demo \$57k. FAX:
Doug (212) 489-4936.

NEOTEK ELITE m2 364 CONSOLE
8 stereo input module subs 48 autom-
ated inputs, Audio Kinetics Master-
mix II automation system. 1000
point patch bay. VERY CLEAN! \$94k.
(313) 349-0115, FAX (313) 349-
9140.

NEOTEK Series II in-line console.
28-input, 24-output, 4 stereo
return, 280 point patch bay, 4-
band parametric Neotek EQ.
ABSOLUTELY NEW CONDITION.
WAS NEVER INSTALLED!
\$18k or Best Offer.
(310) 833-0130.

BEST BUYS!
TAC SCORPION CONSOLE 32x8x2
w/16-track monitoring, extender
card, spare input module. Otari MTR-
12 1/4" 2-track w/center track time
code. MR1 2" 24-track test tape.
Tony (201) 751-9528.

Matching Bruel & Kjaer Series 4000
Professional Microphones and power
supply, \$5k. 12-Track Akai MG1214,
minimum use, \$3k. Mint condition C-
12, \$5k. Few hours, 16-track Mit-
subishi X-400, \$25k. Contact Greg,
(615) 327-0800 or fax (615) 327-
0884.

Harrison MR-4 console, 28-input, 4
stereo mods, 8 subgroup VCA,
\$26,500; Ampex ATR-102 1/4"
tape recorder, \$4k; AMS RMX-16
digital reverb, current updates, \$5k;
Nakamichi MR-1 Cassette Re-
corders (3) @ \$550; Otari MkIII 8-
track 1/2" with dbx and pedestal,
\$2,650. CALL FOR MAJOR LIST.
Tom at (816) 931-3338 or FAX
(816) 931-6841.

New, Used and Vintage Equipment Studio Design & Installation

AES SPECIAL
AKAI A-DAM
1224 & 36 TRACK
DIGITAL
SYSTEMS

Get a portable Dtt
Machine with each
system ordered now
thru Halloween

API
DDA
TRIDENT
SOUNDTRACS
ALLEN & HEATH

ORDER NOW
TC ELECTRONIC
M5000
Modular Digital
Reverb & Effects
Systems
quantities are
limited

800-788-2875

USED EQUIPMENT DEALS - Trident 80B 40x24 w/Moving Fader Auto-\$60K • Arnek angeia 48i
o \$38K • Api 32x16x24 \$48K • Neve 8068 32i/b \$85K • Neve VIII 60 w/Flying Faders-\$290K • SSL
4056e 48i/b \$230K • Neve 8108-56i/b w/FF \$185K • Trident 24 - 36x24 \$23.5K • Soundcraft 600
32x8x16 \$3K • MCI JH-636 36x24 w/auto 19.5K • Soundtracs PC Midi 24 24x16 \$6.5K Demo •
Soundtracs Megs 32x24w/Auto \$ 23K-Demo • Tascam MS-16 Loaded \$6.5k • Tascam 85 16-
loaded \$5K • Tascam MSR 16 \$4K • Fostex G24S \$8500 • Fostex B16 \$2900 • MCI JH-24 \$20K
• Otari MX-80 \$20K • Otari MTR-9011 \$27K • Sony 3324a-400hrs \$46K • Sony APR-24(new) \$29K
• API 550a modules \$795 • Neve 1073 & 1066 \$1.5k • Lex 200 \$1.5K • Saturn 24 Demo • MCI JH-
110B \$2K • TC Electronic 2290 \$1.5K • Akai S1000 \$2450 • AKG C12 \$7K • Eventide H3000-Call
• Neumann U87, U67, U47, KM56, Many others- CALL FOR A FULL LIST OF INVENTORY
CLEARANCE ITEMS - WE BUY QUALITY USED EQUIPMENT - TRY US... YOU'LL LIKE US

Phone 617-426-2875 Fax 617-426-2763
63 MELCHER STREET BOSTON, MA 02210

anything audio
professional audio sales and service

ADAMS-SMITH
AKAI AKAI
DIGITAL AKG
ALLEN AND
HEATH API ART
ASHLY AMS
AUDIO LOGIC
AUDIO-TECHNICA
BBE BSS CASIO-
DAT CREST
CROWN DBX
DDA DEMETER
DIGI-TECH
DRAWMER EAW
EVENTIDE
FOSTEX GML
HAFLER HUGHES
& KETTNER
KLARK-TEKNIK
LEXICON MACKIE
DESIGNS MILAB
MITSUBISHI
MONSTER CABLE
NEVE NUMARK
PS-SYSTEMS
RANE SATURN
SAMSON
WIRELESS
SENNHEISER
SHURE SONY
SOUNDTECH
SOUNDTRACS
STUDIOMASTER
SYMETRIX
TANNOY
T.C.ELECTRONIC
TUBE-TECH
WAVEFRAME



Has
"The Cool Guy Stuff"

a full line dealer for:

OTARI • PRO DISK • AKAI • MEYER
TANNOY • JBL • NEUMANN • AKG
APHEX • API • SUMMIT • KLARK • DBX
DRAWMER • LEXICON • EVENTIDE
SOUNDCRAFT • EV • RAMSA • CREST

financing and much more!

A Full Service Pro Audio Dealer
Serving Chicago & Midwest for 18 yrs.

708-339-8014

Over 100 Pro Audio lines!

For \$7500 you can record
onto your own compact discs!

Kingdom Sound &
Recording Systems

MIDI, Passport, Mark of the Unicorn,
Digidesign, Opcode, JL Cooper,
Tascam, Mics, Decks, R-DAT Re-
corders and Tape, plus much more!
Everything for your project studio!

Call for our Free Catalog

Call 1-800-334-1456

8:30am-5:00pm EST (FAX) 717-662-3875
Request catalog # MX 9-92

American Pro Audio



- Sony/MCI • Trident •
- Tannoy • Eventide •
- Yamaha • Tubetech •
- Fostex • Soundtracs •
- Beyer • Roland • Akai •
- Ramsa • Panasonic •

Mini Lease Program

New or used, trade-ins 24-60
months with buyout option
\$5K-25K no financials
required min. 2 yrs in business.

1-800-333-2172

Mitsubishi X-850
Super Excellent Condition
Original owner. Never moved from
one place. 6,000 hrs used w/
controller. \$65k.
For info call (212) 228-3777
Serious Inquiries Only Please.

Studer A820/24 w/internal Dolby
SR, full remote, 48-ch. stand; Studer-
SSL interface only 1,100 hours,
mint, \$69,500; Neotek Series 1
16x4x2, very clean, \$4,500. (802)
658-0044.

OTARI MX-70 16-trk with dbx type
1 noise reduction, autolocator, re-
mote, stand and all cables. Profes-
sionally maintained, low hours,
PRISTINE CONDITION, \$9.5k.
(310) 450-9795

BERLER

Communications Company
HAVE But really don't need:
•ACES 24-Trk, 2"; \$9k
•AMEK M2000 28-in console;
\$20k.
•AKAI DD1000 Wkstation; \$7.9k
•NEVE 2254 Compressor; \$1.5k
•AKAI A-DAM 12-Trk Digital; \$8.5k
•AMEK M2000 32-in console w/
auto; \$30k.
•Microtech Geffel; \$1k
HAVEN'T GOT But really want:
•Studio Liquidations
•Mid-Priced Rack Gear
•Dolby SR or XP rack 24-ch
(708) 263-6400/Fax: (708) 336-
5776.

MILAM AUDIO

"THE SOURCE"

SINCE 1967

SPECIALIZING IN
ALL TYPES OF RECORDING
EQUIPMENT, SUPPLIES,
DESIGN, INSTALLATION,
AND CONSULTATION

CONSOLES ■ D.A.T. ■ MICS
MULTI-TRACKS
MONITORS ■ AMPS

CALL US TODAY

MILAM AUDIO

1470 Valle Vista Blvd.
Pekin, IL 61554
(309) 346-3161
ORDER HOT LINE:
800-334-8187
FAX 309-346-6431

Mix Classifieds (800) 747-3703

Extremely Quiet Mic Preamps

EIN = -133 dBm 150Ω 20 kHz

\$ 550 / Channel 48 V Phantom
PORTABLE OR RACK MOUNT

AERCO (512) 451-5874

"The Quietest Preamps in the World"
Box 18093 Austin, TX 78760

LFCI Equipment Leasing

- Up to \$75,000 with
credit application only
- Provides:
Off-balance sheet
financing, Tax benefits
- New & used equipment
- Generate capital by
selling & leasing back
equipment
- Nationwide
- Dealers welcome
- Over 10 yrs in the A/V
industry

Apply by phone
(800) 626-LFCI

SOUND WORKSHOP (now OTARI)
series 34c mixing console. 4 years
old, very low hours. 32/24 ARMS
automation ready, great cond.,
\$25k or best offer. Call Jeff (213)
938-9723 or (310) 472-9274.

FAX your Mix Classified
(510) 653-5142

SKB ATA Rack Mounts at an Affordable Price



Meets ATA class 300, Cat.1 Spec. available in 2U - 12U sizes and is
half the weight of conventional wooden racks. Call your local dealer
for a demo or fax for the name of your nearest distributor.

434 West Levers Place, Orange, CA 92667 (817) 847-5400 FAX (817) 847-6319



DATRAX



Originator in DAT Tape Storage Systems.

- DATRAX 60 Solid Oak in Natural or Black Finish
- DAT/DAT Tape Flight Cases
- Nylon DAT Tape Carrying Cases

NEW PLASTIC LINE:

- ▲ DATRAX 40 ▲ Video 8mm Rax, holds 36
- ▲ Cassette Rax, holds 48

For information or to order:

CALL TOLL FREE: 800.9.DATRAX
Tel: 818.783.9133 ▲ Fax: 818.783.9318

BRICO PRODUCTS, 13444 Moorpark St.,
Suite 23, Sherman Oaks, CA 91423



MERCENARY AUDIO

WE HAVE LISTINGS ON
SSLs, APIs, NEVES, etc.
ALSO OTARIS, STUDERS,
AND MOST OTHER HIGH-
QUALITY
PIECES OF PROFESSIONAL
USED EQUIPMENT.
**WE BUY, SELL AND TRADE
VINTAGE EQUIPMENT.**

in stock:

MITSUBISHI X-850 32-TRACK
NEVE 12x2 CONSOLES
API CONSOLES
FAIRCHILD 670, 660, 666
NEUMANN U47s, 67s, SM2
NEUMANN M49, 269, SM69
AKG C-24, C-12, C-28s, 224s
RCA 77-DX, BK5A, BK5B
SONY C-37A, C-500s, 107A
PULTEC: ALL FLAVORS
TELETRONIX LA-2A
UREI LA-4s
NEVE & HELIOS MODULES
AMS RMX-16
STUDER A80VU 2- & 4-TRKS
"this is not a problem"
(508) 543-0069 TEL
(508) 543-9670 FAX

MERCENARY AUDIO
SUPPLEMENTING THE BEST
IN VINTAGE EQUIPMENT WITH
**THE BEST IN NEW
EQUIPMENT**
now representing
FOCUSRITE MODULES
SUMMIT AUDIO
STUDER/REVOX
GML PROCESSING
DEMETER
NEUMANN MICROPHONES
B & K MICROPHONES
ADL COMPRESSORS
"still not a problem"
(508) 543-0069 TEL

Liquidation... Sony MXP-3036 recording console with Sony automation, \$53,900 or B.O.; Fostex E-2230 ips, 1/2" recorder. All excellent cond. (716) 833-8484 for details.

PRO TUBE GEAR!

- **Microphone Preamps**
(nominated for 1992 TEC Award)
- **Mono, Stereo & Quad DI's**
- **Guitar Amps & Preamps**
- **Bass Preamps**

Demeter Amplification has been designing and manufacturing the highest quality, all-tube equipment for over ten years. Isn't it time you experience for yourself the quality that top producers, engineers and recording artists around the world are talking about?

For a free catalog and pricing information call or write us at:

Demeter Amplification
2912 Colorado Ave. #204
Santa Monica, CA 90404

(818) 986-7103 • (310) 829-3755 FAX

We turn our competition upside down!
Perry (212) 279-1416
Coming soon, discrete NEVE mic pre's
vintage guitars and RCA Limiters.
3-band EQs. I also buy recording gear,
8038 frame, Westlake 4-way monitor,
This month's specials:
& frames to fill out or expand your console.
keep them working, as well as modules
compressors, I have the parts and ability to
If you own any 80 Series console, EQ or

SAVE \$300 ON T T
144 POINT PATCH BAYS
brokers of fine and coarse used equipment
audio village 619/320-0728



DISCREET PLUS
Instant Upgrade for your mic collection. The **Discreet Plus** stereo mic preamp by **Inward Connections** smokes the competition. Features all discrete circuitry and the finest components, with line-in, variable HPF/LPF, insert send & return and remote fader-pair. Sold exclusively by **a.d.v.**, call Ross (805) 496-0147; pager 493-6455; fax 379-0676.

STUDIO LIQUIDATION
NEVE 8128 56 inputs w/**Flying Faders** VU meters, rebuilt, mint condition. **Quoted** 312 monitors (UREI retro fit). Call (516) 489-6177.

STUDIOMASTER SERIES II CONSOLE, 32x16x16x2. Great for live or recording. Comes with Anvil Flight case. \$6k. Call (717) 622-6693 or (800) 572-7200 (please leave message).



Audio Video Research is your source for over 100 lines of professional audio & video equipment.

Design * Sales * Service * Installs * Vintage * Used Gear *

AVR has offices in New England and Brasil.

Boston (617) 924-0660
Hartford (203) 289-9475

THE WIDEST SELECTION OF USED GEAR

Amps: Bryston 4B, \$1,100 • Rane HC-6, \$175. **Consoles:** Trident 65 32x16 w/576 pt. PB, beautiful, oak console, \$13.8k • Neotek Series II 36 frame 32x24, w/PB, 2 prod. desk, P & G faders, \$13.5k • Soundworkshop 34C 28x24 w/auto and PB, \$24k. **Digital:** Alpha Audio Disc rec., \$3k • Soundtools w/DAT I/O, AD-in, Mac II w/Macstor 600 meg HD, color monitor, MINT, \$5k • Fostex D-20 DAT w/TC, \$4,900 • Soundtools for Atari w/DAT I/O, \$800 • Teac DAP-20s IN STOCK NOW!! **Effects:** Summit warm Interface, \$900 • Lexicon LXP-15, Mint, \$600 • Korg SDD-2000 Sampling Delay, \$250 • Yamaha SPX-1000, \$825 ea. **Keyboard/Samplers:** Kurzweil MIDI board, \$800 • Kurzweil K100 PX Plus, \$600 • Emulator III w/8 meg, \$3,900 • Roland D-50, \$550 • Roland Octapad II, \$200 • Korg new SG10 Sampling Grand, \$1,600. **Mics:** Neumann U-87 w/shock mt., \$1,600 • EV P1-20, \$300 • (2) Audio Technica ATM-12, \$100 ea. • Neumann U-67, CALL • AT4033 IN STOCK • Neumann U47 Fet, CALL • AKG C12, CALL. **Processors:** Symetrix 528, \$275 • Ashly SG-35E quad gates, \$300 ea. • UREI LA-2A new, \$1,800 • UREI 7110 comp/limiters, \$175 ea. • Aphex Type C, \$150. **Recorders:** Otari MX-80 w/CB-120 + CB-124, \$19.8k • Otari MkIII-8 w/stand and CB-116 w/stand, MINT, \$2,600 • Otari MkIII-2 2-trk w/CTC on rollaround, \$1,500 • Nakamichi MR-2 Mint, \$400 • Tascam MSR-16 w/dbx (demo), \$5,100 • Tascam 234 Rack 4-trk cassette, \$475. **Speakers/Monitors:** Yamaha NS-10m, \$225/pr. Synchronizers: Tascam MTS-1000 MIDiZER (as new), \$1,200.

ALL WARRANTIED AND CALIBRATED TO FACTORY SPECS OR YOUR \$ BACK.

WE BUY, TRADE AND LIST YOUR ITEMS FOR FREE.

MC

VISA

65 MAIN STREET WATERTOWN, MA 02172
TEL (617) 924-0660/FAX (617) 924-0497

THE ULTIMATE WRAPPER



FAST • EASY • TIDY
Velcro Cable Wraps

RIP-TIE
800-348-7600
SABO Tech
P.O. Box 77994 San Francisco, CA 94107

Must Sell Tascam Equipment — like new — 75 hours only: M3700, 32-channel automated mixer w/full meter bridge, \$11.4k. MSR-16S (Dolby S) w/Remote & all cables, \$6.3k. Randy, (212) 662-4848.

(1) pair Neumann TLM-170 microphones, like new, \$2,300. One pair Brüel & Kjaer type 4003 microphones, excellent cond., \$1,900. Sony PCM-601 digital processor, excellent cond., \$450. Jeff Harrison (413) 467-3737.

Home Studio Liquidation

Akai A-DAM 12-track dig, \$12,500; Akai DD-1000 dig. workstation, \$9,200; Yamaha DMP7D, \$2,500; Yamaha AD8X (new), \$2,500; Lexicon 300 (new), \$3,400; Aphex Exciter III, \$550; Aphex Exp/Gate, \$450; (2) JBL/UREI 7110 comp, \$250. (708) 634-2209.

MCI JH-618 Console with Broadcast option. 18 in, 16 out, non-automated with VUs. Very good condition, \$4,750. (702) 736-2303 after 6:00 PM (PST).

Studio Liquidation: API 32-input recording console, \$29k; JL Cooper Magi 2 Automation, six months old, 32 channels internally retrofitted to any console, \$4k; Ampex MM1000 16-track 2-inch machine with new heads, \$4,500. Call Dan (215) 922-0292.

Excellent Multitrack 3M S. 79 2" 24-trk. (Selecteck II autolocator) upgrade it, 95% life on original heads. New UREI 811c. Lexicon 224 digi. rev. (305) 378-4417.

MidiVox® Factory Direct (800) 433-MIDI (6434)

Growl a trumpet—Croon a sax Hum a bass—Scream a guitar Laugh a clarinet—Yell a cello. 2-yr. warranty. \$1,595 30-day money-back guarantee. Visa/Mastercard

35mm MAGNETIC DUBBERS: Magna-Tech Reproducer/Recorders w/ Interlock: MD-235, MD-636, MR-436 for Sale. Call Michael Temmer, (212)206-1475. Fax: (212)929-9082.

TUBE MICS

Neumann, AKG, Telefunken
BOUGHT/SOLD/SERVICED
Power supplies for all tube mics.
Bill Bradley Microphones
(216) 723-6494
Fax (216) 723-6595

Looking for used or new MIDI equipment? We've got tons of super clean Yamaha, Roland, Korg, Ensoniq, Kawai, Akai, Kurzweil and E-mu products in stock. Great prices! Come in or do it all through the mail. Call, write or fax for prices & details. Caruso Music, 20 Bank St., New London, CT 06320, USA; (203) 442-9600. FAX (203) 442-0463.

AMPEX RECORDERS

AG440-8 — 8-track — \$2k.
AG440 — 2-track — \$1k.
Both in good working condition.
Both machines — \$2,700.
(919) 983-5469
(919) 983-2027

MITSUBISHI X-850 with remote and meter bridge. Well-maintained, low hours. \$65k. Serious inquiries please. Ask for Bill, (212) 333-2206.

Auditronics 501 Console 26/16/2 w/ 24- & 2-trk hms, patch bay, \$6,950. Ampex ATR-102 1/4" deck, \$2,900. Nak. MR2s, Orban & Symetrix EQ, 2 chan. dbx NR. Call Barry Dixon, (916) 361-0870 days, fax (916) 361-9879.

CAD Maxcon II console (see Nile Rodgers, *Mix* 5/92). 40-input B-Frame, 6 quad, 2 octal, TypeI output, \$12k. • Akai MG 1212 recorder, extras, \$3k. • Sound Tools w/DAT I/O interface. Vision, Turbosynth, Access MIDI Mapper. Delta Labs DL2. Korg DVP-1. Ober Matrix 1000. Best offers. (408) 438-3096.

MCI JH-636 VU auto console, 32-in, 13 para EQ, \$21k. Otari MTR-10 1/4" 2-trk, \$3k. Emulator III w/ RM45 HD, \$6,800. Sony PCM 701ES Dig Enc., \$600. Echoplate III, \$500. ARP 2600, \$600. Yamaha 816, \$1,300. UREI 6300 power amp, \$650; Delta Lab Compu-effectron, \$400; Aphex Exc. B, \$220; (2) dbx 157 NR 4 channels, \$200 ea. (916) 421-5159.

Digidesign Pro Tools, \$4,500; Dynatek 1.2 Gig Hard Drive, 1.2 Gig DAT back-up and CD-ROM all-in-one, \$4,500; MOTU Video Time Piece, \$800; Tascam CD-401, \$450; PS Systems Dual 80-meg drive, \$550. (516) 351-8446.

For Sale: Sony 3324A digital 24-track with remote-locator, shipping case, low hours and factory warranty from Sept. 1, 1992. \$45k plus shipping. (615) 791-4050.

Trident Series 80 (w/Bud Wyatt Mod), Studer A-80, C-24, AMS RM-16, Neumann U67, U87, (2) KM 54, (2) KM 84, UREI LA-2, (2) LA-4, UREI 813s, EMT 140ST Plate, Call Chuck @ (713) 686-3558, Voice Mail #19.

VINTAGE USED

Consoles: Neve 8128 w/Flying Faders 56-in, \$175k; Neve 8058 28-in, \$75k; (3) Neve sidecars, call; API 32-in, \$48k; Amek 2500 w/ master mix 32-in, \$28k; Soundworkshop 34C 24-in (P&G), \$19.5k; Soundtracs MRX 32-in, \$6.5k; Trident 65 32-in, call; Harrison MR-4 36-in, \$26.5k.
24-track: Studer A-80MkIII, \$19.8k; Otari MTR90-II, call; Otari MX-80, \$17.9k; Ampex MM1200 (16-stack), \$12.5k; Ampex MM1100, call.
16-Track: 3M M79 2" (1"-8 stack), \$7.5k; Otari MX-70 (1"-mint), call; Tascam MS16, \$5.5k; Soundcraft 1"-16 new, \$6.9k; Tascam MSR-16 1/2", \$4.5k; Fostex B-16 & E-16, call.
8-Track: (2) Otari 7800 1" 8-trk, \$4.5k; (2) Otari 5050 MkIII 1/2", \$2.5k.
2-Track: Studer A-820 1/4"; Mitsubishi X-80 DASH (w/Anvil cases); (2) Sony PCM-2500 DATs.
Monitors: Quedest 312s, \$19.5k; Meyer 833s w/brain & phantom susp, \$3.5k; JBL 4435s, \$2.5k; UREI 813-Bs, \$2k; JBL 4313s, \$800.

Reverbs: AMS RMX-16; Lexicon 224XL; (2) EMT140 mono plates, call.
Mics: Neumann U89 (used twice), \$1.5k; (3) Neumann power supplies, 37 yrs old, mint, call; (2) B&K 4006, call; Neumann U67 & U47 tube, call.

Misc: (4) Neve 2074 3-band EQ's, \$3.6k; Neve 1073s, \$1.6k; Lang PEQ-1 tube, \$1.5k; dbx-166 stereo comp. (new), \$350. TELEX 6120M 5-spd cassette duplicator; Akai 1214 12-channel proprietary tape, call; Sony 1" JH 110C-3LB-HP (C-type Video/Audio layback w/ remote), \$9.5k.

Cash paid for Neumann, AKG, Lexicon, Neve & AMS products. List your FOR SALE items FREE. We take trade-ins.

NEW—DEMETER tube mic pre-amps & direct boxes. NEOTEK consoles for music, film & video. HARBOR SOUND AND VIDEO 199 NEWBURY ST. (SUITE 101) DANVERS, MA 01923

Phone: (508) 762-0154
Fax: (508) 762-0497

Wholesale Parts & Accessories.

Buy direct & save! Name brand: wire, cable, connectors, tubes, lamps, racks, cases & hardware, speakers, transistors, I.C.s, custom cables & harnesses, replacement parts for all major brands. Call Mike at (813) 238-6485, ext. 135.

WORLD CLASS MIXING PACKAGE

Just \$1,500 for 24-track, have your 2-inch tape mixed in a world class 48-track SSL-Studer mixing room by top engineers who recently have mixed 11 Top 10 singles and 9 gold or platinum albums.

Call, write or fax today for more information. 48-track package also available.

TEL: (401) 247-0218
FAX: (401) 247-1280

Reliable Musk

WE HAVE THE LATEST DIGITAL RECORDING PRODUCTS

NEW LOW PRICE ON ADAM
AKAI DD-1000 CALL FOR DETAILS

EMU E-3
8 MEG SAMPLER \$7500 NEW

LARGE SELECTION OF USED EQUIPMENT CALL FOR DETAILS

STUDIOS TOUR COMPANIES BANDS

SONY PANASONIC TASCAM DATS IN STOCK

NEW LOW PRICE ON TASCAM DA-30

LOTS MORE RECORDING, PRO SOUND, AND MUSICAL EQUIPMENT

CALL 704 375-8662 EXT. 325

ALL ITEMS SUBJECT TO PRIOR SALE

YOUR BEST BUY is USED RECORDING EQUIPMENT

and
SYE MITCHELL SOUND COMPANY
Delivers the
Best Professional Recording Equipment
(818)348-4977
(818)704-7031 FAX

Newest Name in Tube/Compressor/Limiters Is The ADL 1000

LA-2A Type Design, Quieter With More Frequency Response

Anthony DeMaria Labs
818-340-0228

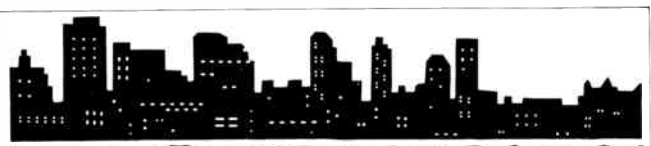

UNDERGROUND SOUND

PRO AUDIO RENTALS

Drum Machines • Monitor Speakers • Amplifiers • Microphones
Noise Reduction • Preamps • Samplers • Synchronizers • Sequencers
Digital Reverbs • Digital Delays • Digital Tape Mach • Analog Tape Mach
Compressors • Mixers • Noise Gates • De-Essers/Exciters
Tube Mics • Equalizers • Custom Racks...We've Got Em

WE CAN BEAT OUR COMPETITOR'S PRICES!!!

Seven Days A Week • 24 Hours A Day
(615)321-4081 (615)664-RENT FAX (615) 327-9285
-7363

CLASSIFIED AD DEADLINES

NOV. 15, '92 closing...JAN. '93 issue
DEC. 15, '92 closing...FEB. '93 issue
(800) 747-3703

Equipment Rentals

db Rents Exotic & Tube Gear !!!

Tubes	Exotica & Other
Neumann U47	API 550 EQ
Neumann U67	1T1/Sontec Para EQ
Pultec Mavec Eq/Pre	A&D Vocal Stressor
Demeter Mic Preamp	Aphex Compellor
Altec 1566A Tube Pre	dbx 165A

Call for Availability
db ENGINEERING Inc.
Tel:(617) 782-0648 Fax:(617) 782-4935

SOUND REINFORCEMENT CONSOLE & FX RENTALS

ATI Paragon	Soundcraft Europa
Midas XL-3	Soundcraft Series 4
TAC SR6000	Soundcraft 800B
Yamaha PM3000	Soundcraft Venue
Gamble EX56	Ramsa WR-S852
Gamble EX48	Ramsa WR-S840
Gamble HC40	TAC Scorpion II
Gamble SC32	TAC Scorpion
Yamaha 2408	TOA RX-7-328

Lexicon • Klark Teknik • t.c. electronic
Eventide • Yamaha • dbx • Panasonic
Roland • Drawmer • Aphex • Symetrix

* FREE travel and shop setup time
* World's largest live console inventory
* 10 yrs of console rental specialization
* Tours - Weekly - Daily - Long Term
* Extremely Competitive Prices!

Hi-Tech Audio
(415) 742-9166



PROFESSIONAL AUDIO RENTALS

310/838-6555
800/441-4415
24-hour Service

Equipment Wanted

EQUIPMENT WANTED
BUY OR TRADE
YOUR USED MULTITRACK
RECORDERS
AND CONSOLES
**EAR PROFESSIONAL
AUDIO/VIDEO**
(602) 267-0600

**MERCENARY AUDIO
WANTS TO BUY YOUR:**

NEVE-SSL-TRIDENT-AMEK
UREI-TELETRONIX-FAIRCHILD
PULTEC-LANG-LEXICON
UNIVERSAL AUDIO-NEUMANN
AKG-TELEFUNKEN-AMS
**ANYTHING THAT IS OF
EXCEPTIONAL AUDIO
QUALITY!**

"this is not a problem"
(508) 543-0069 TEL
(508) 543-9670 FAX

AMS AUDIOFILE WANTED

Basic, 8-channel, 2-hour DAT back up system. Please contact Charlie or Alberto at: (809) 793-8821. Fax (809) 793-8509.

Instruction

MUSIC RECORDING INDUSTRY CERTIFICATE PROGRAM

SF State Univ. Extended Education. Classes taught by Bay Area pros. Expand skills or earn certificate. Engineering, management, songwriting & more!

Call (415) 338-1372.

BOOKS, TAPES, VIDEOS

Get the world's most complete collection of resources for the audio and music professional. Write or call now for your free catalog.

BOOKSHELF

6400 Hollis St. #12, Emeryville, CA 94608
(800) 233-9604 • (510) 653-3307

Maintenance Services & Repair

MAGNETIC RECORDING HEADS

RELAP/REPLACEMENT for Audio, Video, Time Code, Duplication. 30 years of head design experience. IEM, 350 N. Eric Dr., Palatine, IL 60067; tel. (800) 227-4323.

ATR SERVICE COMPANY

Michael Spitz, formerly of Ampex, is now offering REPAIRS * PARTS * MOD KITS for Ampex recorders * All repaired assemblies and refurbished motors for ATR-100/124/800 and MM-1200 are machine-tested prior to shipping * New FLUX MAGNET-ICS mastering heads * Call (415) 574-1165 for details and price list.

FOSTEX • TEAC • SONY • PANASONIC • JVC • AIWA • TASCAM • PIONEER

Pro Digital Inc.

DAT Recorder Service
Fast, expert repairs on all DAT recorder brands & models.
Two Day Turnaround on most Sony and Panasonic machines.
Free Estimates
215.328.6992

Music Products/Software

Funky Drum Loops

48 classic drum beats and 14 great fills on a DAT for \$100. Dump the drum machine and give your productions the "live-drum feel" with these studio session recordings. Motown, Stax, James Brown, and Phil Spector are among the many styles presented. Good Friends Productions. (212) 889-7955.

THE MIRROR IMAGE RECORDING STUDIO CALCULATOR is the engineer/keyboardist/producer's session saver. Figures Akai S1000/S950 timestretch vs. pitch or tempo, tape machine VSO vs. tuning & tempo (including Studer A800 !!). Converts Studer VSO to IPS, figures delay times vs. tempo, song length, and includes a stopwatch. This is the tool you've been waiting for! IBM PC & Compatibles. \$39 from Mirror Image Software. Call for info or to order (516) 424-5650.

StudioPal

The conversion/calculator for Macintosh recording studios.

- SMPTE time code formats
- feet and frames
- bars/beats/ticks & tempos
- delay settings, rhythms
- notes, chords, intervals
- frequencies, wavelengths
- sample rates, megabytes
- tape speed, capstan freq.
- English and Metric
- MIDI reference chart

\$69.95*
+CA tax, MBG

Harmonic Systems, Inc.

Box 488 • Fairfax, CA 94978
(415) 485-5242, MC/Visa

Time to upgrade your equipment?

Look in the Equipment for Sale category or place an ad under Equipment Wanted.
Mix Classifieds work!
Phone (800) 747-3703.

Records, Tapes & CD Services and Supplies

Disc Mastering & Record Prod.
CDs, LPs, 45s, Cassettes
**CD REFS AVAILABLE
THE CUTTING EDGE**
Box 217M
Ferdale, NY 12734
(914) 292-5965

1000 CD'S \$ 2,850.00

QUALITY WORK AT A LOW PRICE

INCLUDES
Pre-master
Glass Master
CD Fabrication
Film Label
Printing
- 4 Color Booklet
- 4 Color Tray Card

TRS
1-(800) 942-DISC (3472)

We'll put your DAT or 1/4" Master in any sequence at no charge

CASSETTE ALBUMS FAST

no minimum
BASF & Maxell Tape
Bin Loop & Real Time Duplication
Color, 8/W Inserts • On-Cassette Printing
Whol Blank Cassettes • Tape & Supplies
Call 904-399-0424 • Fax 904-398-9683

Audio East **THE WAREHOUSE** Studio Sales since 1975
2071-20mx Emerson St. • Jacksonville, FL 32207

Specialized Customer Service for 28 years!

- Custom Loaded Blank & Duplicated Cassettes
- Cassette Duplication
- Quality & Quick Turn-Around
- Complete Packages Personal Service

Jackson Sound Productions
3897 South Jason Street
Englewood, CO 80110
(800) 621-6773

CASSETTE DUPLICATION SERVICES

"ANYTHING THEY CAN DUPE... WE CAN DUPE BETTER!"™

AND CHEAPER TOO!
Real Time duplication package: as low as \$1.05 ea.
- BASF, AGFA or AMPEX CRO 2
- clear SHAPE shell (made in U.S.A.)
direct printing - NORELCO box - shrink wrap

CALL FOR FREE SAMPLE:
1-800-367-1921
CASSETTE DUPLICATION SERVICES **CDS**

EAST PRO AUDIO/VIDEO

REAL TIME DUPLICATION ON NAKAMICHI DECKS
STATE OF THE ART LYREC SYSTEM FOR HI-SPEED DUPLICATION

300 CHROME CASSETTES / FULL COLOR INSERTS \$620

MAJOR LABEL QUALITY PRINTING AND PACKAGING FREE GRAPHIC DESIGN!
1000 CD PACKAGE \$1999
VIDEO DUPLICATION LOWEST PRICES!
BLANK TAPES & ACCESSORIES
FREE CATALOGS 1-800-365-TAPE(8273)

CUSTOM LOADED AUDIO & VIDEO

BLANK CASSETTES
BASF CHROM / CLEAR SHELLS
NORELCO BOX / JEWEL CASE
DUPLICATION
1-800-331-5152
V.S. INT'L, 828 CHESTER STREET
OAKLAND, CA 94607

CD Replication & Cassette Duplication
Real Time & High Speed...
Digital Editing
Graphic Design
Printing
Full Packaging
CD & Cass. Pkgs
ProtoSound
One Mill St.
Burlington, VT 05401

802.864.9020

CALL 1-800-DAT-TAPE OR 1-800-245-6000
AMERICA'S LARGEST DAT TAPE SUPPLIER

SONY PRO	TDK	SANJUE	DAIWA	BASF
1/2" 90	1/2" 90	1/2" 90	1/2" 90	1/2" 90
1/4" 60	1/4" 60	1/4" 60	1/4" 60	1/4" 60
1/4" 30	1/4" 30	1/4" 30	1/4" 30	1/4" 30
1/2" 180	1/2" 180	1/2" 180	1/2" 180	1/2" 180
1/2" 360	1/2" 360	1/2" 360	1/2" 360	1/2" 360
1/2" 720	1/2" 720	1/2" 720	1/2" 720	1/2" 720
1/2" 1440	1/2" 1440	1/2" 1440	1/2" 1440	1/2" 1440

TAPE WORLD

VISA MC NO EXTRA CHARGE WE'LL BEAT ANY PRICE 4.95 SHIPPING ANY SIZE ORDER! WE STOCK OVER 400 DIFFERENT AUDIO & VIDEO TAPES

For Excellence in Sound Make the BEST Choice BEST SERVICES UNLIMITED

RECORD PRESSING
CASSETTE DUPLICATION
CHROME BLANKS
COMPLETE ART DEPARTMENT
FULL COLOR PRINTING
COMPLETE PACKAGING
VIDEO DUPLICATION

7729 Oakport St
Oakland, CA 94621

1 CASSETTE SINGLE \$1.699.00
1 CASSETTE ALBUM \$3,199.00

Prices include pre-mastering, mastering, label printing, full color 1 card 1 card or four panel cd booklet printing, shrink wrap (price does not include comp. time or artwork)

VISA MASTERCARD 1 (800) 627-7365

RECORDING & DUPLICATING SUPPLIES
1-800-272-2591
call for new catalog with lower prices

ARCAL®
2732 Bay Road
Redwood City, CA 94063

Audio Cassette
Labels
Video Cassette

Call for a brochure -
(800) 423-4643

UAL United Ad Label Co.
P.O. Box 2216
Brea, CA 92622-2216

COMPACT DISC MANUFACTURING AND HIGH QUALITY CASSETTE DUPLICATION

Affordable pricing for the independent labels or individuals. Complete services include digital mastering, graphics, color separations, printing, packaging and fulfillment. All work is guaranteed. We will be glad to answer any questions that you may have.

CALL (317) 353-1113 or write to:

WMG, Inc.

(World Media Group)
8472 Brookville Road
Indianapolis, Indiana 46239
Fax (317) 353-0750
Attention: Jeff Mellentine

Mix Classifieds
FAX: (510) 653-5142

CALL TOLL FREE
1-800-527-DISC

A+R RECORD & TAPE MFG.
902 N. Industrial Blvd.
Dallas, TX 75207

214-741-2027

VISA/MASTERCARD ACCEPTED

★ ★ ★
No Hidden
Cost
★ ★ ★

500 CDs • 500 Chrome Cassette Package — \$2890.00
1000 CDs Package — \$2890.00
1000 Chrome Cassette Package (With Camera Ready Art Work) — \$999.00

1000 PACKAGED CASSETTES

- BASF Chrome Plus Tape
- Clear Cassette • Clear Box
- White Imprint • Plastic Wrap
- Full Color Std J Card
- Production Master/Test Copy
- Polymer Imprint Plates

STARTING AT
\$988⁰⁰

Price includes Color Separations and Color Proof

phylco audio/video Est. 1974 **800-348-6194**

AAPEX

ULTIMATE FIDELITY

The world's largest Nakamichi real-time cassette duplication system. Full-service packaging. 50 to 50,000 qty. Outside CA, call toll free (800) 323-AAPX or (415) 492-1300 —Call AAPEX today!

**Orders...
Large or Small,
We Have It All!**

Everything in stock.
Wholesale distributors of:
AMPEX • BASF • 3M • MAXELL • SONY

- Audio video tape
- Assorted reels and boxes
- Splicing/leader tape
- Prepackaged cassettes
- We load bulk cassettes in custom lengths

Call for Quote

(800) 854-1061

TEL (619) 277-2540 • Fax (619) 277-7610

Advance Recording Products

7190 Claremont Mesa Blvd • San Diego, CA 92111
Visa and Mastercard accepted

WHOLESALE DISTR



ESP

TAPES &
CD'S

- CD REPLICATION
- HIGH SPEED CASSETTES
- AUDIOPHILE REAL TIME CASSETTES ON TDK-SA
- DIGITAL MASTERING AND EDITING
- COMPLETE PRINTING AND PACKAGING

EASTERN
STANDARD
PRODUCTIONS, INC.

37 JOHN GLENN DR
BUFFALO NY 14228

TEL 716-691-7631
FAX 716-691-7732
1-800-527-9225

1-800-527-9225
FOR A FREE BROCHURE

COMPACT DISCS REAL-TIME CASSETTES

duplicated on the largest KABA System in the Southwest.

"Quick turnaround, low prices!"

MasterCard and Visa accepted

(214) 630-2957

Crystal Clear Sound

4902 Don Drive, Dallas, Texas 75247

If You Don't Sound Good, We Don't Look Good.

State of the art mastering, replication, and duplication services for the discriminating producer.



TRUTONE INC.

310 Hudson St. Hackensack, NJ 07601 • 201-489-9180 Fax: 201-489-1771

WHEN YOUR READY FOR THE BEST!

State Of The Art Cassette Duplication

HIGHEST QUALITY CASSETTE DUPLICATION • CUSTOM LOADED BLANKS • LOWEST PRICES

1-800-242-2015

CUP OF WATER PRODUCTIONS • 13780 13TH ROAD • PLYMOUTH, IN 46863

SUBSCRIPTION
PROBLEMS?
CALL (800) 888-5139

Multimedia

• 1000 CD's for \$2,295!

- Other great packages available
- Real-time cassette duplication on Nakamichi Decks
- Digital and Analog Bin Loop duplication w/ HiPro
- Video Duplication • Digital mastering and editing
- All major credit cards accepted. • In-House Design
- Free catalogue 1(800) 229-0865
- Baltimore, MD (301) 782-0365

REAL TIME DUPLICATION ON NAKAMICHI DECKS DIRECT FROM DAT

Can you afford to promote your music on anything less?

Complete printing & packaging
All master tape formats accepted
Every tape checked!

For a free brochure:
1-800-456-GLAD (4523)
FAX 716-532-5061

ALL MATERIALS AND WORKMANSHIP GUARANTEED!
MASTERCARD, VISA & AMEX ACCEPTED.

GLAD PRODUCTIONS

13758 Rte. 62 • Collins, N.Y. 14034 • TEL 716-532-5098

DISC MAKERS

Cassette & CD Manufacturing

- FREE Graphic Design •
- Complete Packages •
- Major Label Quality •
- Money Back Guarantee •

500 CDs

with
B&W inserts
in two piece
jewel box

Call Today For Our
FREE Full Color Catalog:
1-800-468-9353

only \$1790

1328 N. 4th St., Phila., PA 19122
215-232-4140 FAX: 215-236-7763

How To Get A RECORD DEAL

Make Your Music LOOK
As Good As It SOUNDS

Full Color CD & Cassette Inserts From \$140

1-800-955-5273 Free Catalog

ASG 0 Cards Too!

TRAXX RECORDING PRODUCTS
325 Long Hill Road
Gillette, NJ 07933

Real-time cassette duplication
From cassette, DAT, Reel to Reel
Custom-loaded cassettes

For Free Catalog call:
(908) 580-9042.

Single Copy CDs made from your recordings from \$99 delivered.
Back-ups \$89. Volume discounts.
CRAIG HOWARD PRODUCTIONS
PO Box 81
Masonville, CO 80541
Call/Fax (303) 223-7769

Custom Loaded Cassette Blanks

utilizing
MAXELL XLII HIGH BIAS TAPE
or your choice of
AMPEX, AGFA, BASF PREMIUM TAPE

Any length up to C-96 rushed to you in
minimum runs of 100 cassettes

TRUTONE INC.
310 Hudson St. Hackensack, NJ 07601
201-489-9180 Fax: 201-489-1771

3M AGFA AMPEX SONY

Audio, video & digital tapes
Sony Professional Pro Audio,
Neumann, Sennheiser, B & K,
Shure & Crown Products.
R & M PRO AUDIO
691 10th Ave., S.F., CA 94118
(415) 386-8400

Sell your used equipment
fast through Mix Classifieds.
Call (800) 747-3703.

Recording Services

SOMETHING EXCITING IS HAPPENING IN NEW YORK. At Electric Kingdom Studios, we're recording some of the TOP recording artists of our time with our TAPELESS STUDIO. Multitudes of digital tracks with the most advanced editing available can be yours for rates only slightly higher than analog 24-track! Our engineers, programmers & producers have charted Top10 for over 15 yrs. Big live room, new Synclavier & NED PostPro disk recorder, Great Outboard. Call for appointment. (212) 431-7755. The future is now...

THE BEST CD MASTERING...

Custom-designed hardware and software by Chief Engineer Bob Katz. 128x Oversampling 20-Bit A to D. Unique Digital Processors. Hard Disk Editing. Tube and Solid State Analog Recorders. CD Mastering is an art. Levels, fades, equalization, spacing—everything is important to you and to us.

CD REPLICATION...

1000 CD's at \$1.55 ea. w/Jewel & Shrink 2500+ at \$1.50 ea. Glass Master Free with 2500+ CD's

CD BOOKLET PRINTING...

1000 4-Panel Booklets at \$23 ea Full-Color Outside, B&W Inside Full-Color Tray Card.
Let our Graphic Artist give your presentation the same attention you give your music.

Digital Domain

Audio for the Golden Ear...
New York, NY (212)369-2932

...COSTS LESS!

AUDIOPHILE QUALITY...
EUROPADISK, LTD.
 US' MOST COMPLETE FACILITY!
 • Cassette Duplication
 • Compact Disc Production
 • DMM Vinyl Pressing • Custom Graphics • Mastering Studios

COMPLETE PACKAGES with state-of-the-art Neve Digital Mastering for CD, Studer & Lyrec HX-Pro Cassette Duplication, DMM Mastering for Vinyl and a complete in-house art department - design, layout, typesetting, color separation. Get THE BEST at no extra cost!

For a Complete Brochure, call or write:
 EUROPADISK, LTD.
 75 Varick Street, New York, NY 10013
 (212) 226-4401 FAX (212) 966-0456



Video Equipment Services & Supplies

Video for Audio Lockup. Rebuilt 3/4" VTRs for sale w/warranty (some w/ address-track time code). JVC: CP5500U, CP555OU, CR6650, CR8200U, CR8250U & CR850U. Some remote control units avail. Sony: VT-5000, VO-5600, VO-5800, VO-5850, BVU-800. (212) 580-9551/(212) 206-1475. Fax: (212) 929-9082. Michael Temmer.

ALL DRUMS
 THE COMPLETE ALL DRUMS CD PRODUCED FOR FILM, TV, RADIO, THEATER, CARTOONS, JINGLES AND MORE COMEDY BA-BA-BOOMS, :29 & :59 BEDS, STYLIZED GROOVES, MULTI BAR LOOPS, HIGH HAT MOVIE CLICHES, FIGHT & CAR CHASE SOLOS, MARCHES & MORE. NO MACHINE CAN DO THIS!
SALES & INFO: 407-260-0079
 MICHAEL WELCH • P.O. BOX 3625 • ORLANDO, FL 32802

NEW PRODUCTS!
EXCITING

GANARE **SONY**
AMPEX **BELDEN**
MOGAMI **whirlwind**
NEUTRIK **3M**
Switchcraft **maxell**

Call now for your **FREE** Necessities
CATALOG UPDATE
518/828-2000

Audio Tape, Cable, Supplies, Equipment

HAVE
 309 POWER AVE, HUDSON, NY 12534

Miscellaneous

COMPLETE CD AND CASSETTE PRODUCTION
DIGITAL HOUSE
 212-333-5950
 MASTERING REPLICATION
 PRINTING TOTAL PACKAGING
 POSTERS GRAPHIC DESIGN STUDIO
 PERSONALIZED EXPERT SERVICE
 330 WEST 58TH ST. NEW YORK, N.Y. 10019
 "FOR THOSE WHO HEAR THE DIFFERENCE"

DB PLUS
DIGITAL SERVICES, INC.

CD MASTERING
 DIGITAL EDITING
 CD PRODUCTION
 DIGITAL TRANSFERS

250 West 57th. St, Suite 725
 New York City, NY. 10019
 212-379-4099 397-2207 (Fax)

The deadline to place your ad in the Mix Classifieds is six weeks prior to the cover date. To place your ad in the next issue of *Mix*, call (800) 747-3703.

Frustrated
 with owner's manuals?
 Get a free copy of our catalog, which features tips and techniques books for equipment by Roland, Alesis, Yamaha, Casio, Korg, Ensoniq, Kawai, Kurzweil and Oberheim.
All titles reviewed and guaranteed!

MIX BOOKSHELF
 6400 Hollis St. #12
 Emeryville, CA 94608
 (800) 233-9604 • (510) 653-3307

How to Place a *Mix* Classified Ad

Please print or type in CAPITAL LETTERS and lowercase. There are 8 lines to the inch and approximately 24 CAPITAL letters or 32 lowercase letters per line. \$80 per inch—1" minimum. Each additional line is \$10. **BOLD TYPE** is \$10 per line; a border is \$10 extra; and a gray screen is \$15 extra. Logos or display advertising up to 4" will be charged at \$100/inch. Logos or display advertising must be camera-ready (width is 1-5/8" or 10 picas). Frequency discount rates are available. Call for information. **Payment by check, money order or charge must accompany ad. DEADLINE is the 15th of the month, 6 weeks prior to publication.** (Classified ads cannot be canceled or refunded after the deadline date.)

Categories Available (check one):

- | | | |
|---|--|--|
| <input type="checkbox"/> Acoustic Consulting | <input type="checkbox"/> Equipment Rentals | <input type="checkbox"/> Records, Tapes & CD Services & Supplies |
| <input type="checkbox"/> Business Opportunities | <input type="checkbox"/> Equipment Wanted | <input type="checkbox"/> Recording Services |
| <input type="checkbox"/> Employment Offered | <input type="checkbox"/> Instruction | <input type="checkbox"/> Studios for Sale |
| <input type="checkbox"/> Employment Wanted | <input type="checkbox"/> Maintenance Services | <input type="checkbox"/> Video Equipment Services & Supplies |
| <input type="checkbox"/> Equipment for Sale | <input type="checkbox"/> Music Products/Software | |
| | <input type="checkbox"/> Miscellaneous | |

Co. Name _____

Name _____

Address _____

Phone _____

I am paying by (check one):

VISA MASTERCARD AMERICAN EXPRESS

Card #: _____ Expiration Date: _____

Signature: _____

Check or Money Order #: _____ Amount Enclosed: \$ _____

MAIL TO: Mix Classifieds, Attn: Robin Boyce, 6400 Hollis St. #12, Emeryville, CA 94608.
 Toll-Free Order Line: **(800) 747-3703** (510) 653-3307 FAX: (510) 653-5142

—FROM PAGE 108, LEASING

pay the seller. Your financial arrangement will be with the bank. You will make your payments to them, and at the end of the lease term, you can purchase the equipment for residual value (usually 10% of the purchase price), or turn over the equipment to the bank.

The rate that you, the lessee, will pay and the quality of the financial institution where the broker places the lease normally depend on your credit-worthiness and on the equipment manufacturer's willingness to guarantee your payment of the lease. The average interest rate paid by the lessee is 7% to 8% over bank prime rate, fixed for the duration of the lease at the time of signing the documents. Some leasing companies charge as much as 12% over prime, depending upon the type of equipment and your financial stability. It is wise to get approval from your leasing broker for the dollar amount and the type of equipment you wish to purchase before signing the purchase order with the seller, as each broker

has his/her own administrative requirements.

Questions that the broker/lessor are certain to ask include your profitability and ability to pay; whether the monthly payment clearly will be generated by additional cash flow from the investment; your reputation in the industry; how long you have been in business; and your payment history. This information will determine whether you have to guarantee the lease with all of your personal assets or whether your studio business is strong enough financially to collateralize the transaction.

My recent, limited survey of current audio equipment leasing options suggests that the average lease is written for five years, with three or four years as a second choice (particularly for consoles, of which an estimated 80% are leased). Most are capitalized leases, which means that you can depreciate the equipment as well as receive other tax deductions because you intend to purchase the equipment at the completion of the lease term. (Check with your accountant for a more detailed explanation of your particular situation.)

You should also be aware that most leases are written under "the rule of 78s," which front-loads the total interest due into the payment structure (again, check with your accountant for more details). You can expect your down payment to average about 15% of the purchase price, with some lessors requesting as much as 25% down. Approximately 10% of studio equipment leases go bad, with the primary reason for non-payment being the studio's refusal to make the payments because the equipment does not contain some feature promised by the manufacturer or does not work the way the studio thought it would.

I've packed a lot of information in this article for you to digest before deciding whether equipment leasing is for you. If you need more information or a better explanation, please write to "The Operator" at *Mix* magazine. Ask about any subject, and I'll do my best to respond promptly. ■

Chris Stone, former studio owner, is president of Filmsonix, a consulting firm serving the professional audio industry.

MIX Reader Service

For more information about products and services advertised in this issue, fill out and return *Mix's* postage-paid reader service card! You'll receive information directly from the advertisers whose products interest you.

sell it. rent it. fix it. teach it.

MIX CLASSIFIEDS

“I have been advertising in *Mix* Classifieds for the last year. This has been a fruitful period for me. When I started, I had no idea *Mix* was so well regarded and widely read. The response I get from your publication is excellent. The very fact that I continually advertise in *Mix* Classifieds gives me credibility in the eyes of *Mix* readers. I am looking forward to many more years of using your fine publication.” —*Michael Temmer, Temmer Video, Inc.*

Think about it. Who *doesn't* read the Classifieds?

For more information or to place your *Mix* Classified Ad, call (800) 747-3703. Deadline: 15th of the month, six weeks prior to cover date.

USE READER SERVICE CARD FOR MORE INFO

The Vocal Harmony Processor THAT DOES IT ALL!

The Vocalist by DigiTech is the only vocal processor that provides natural sounding harmonies with complete editing and programming capability. Offering a multitude of features and functions, the Vocalist accommodates up to five-part harmonies and even compensates for off-key vocals. Full MIDI compatibility combined with 128 factory presets and 128 user-definable programs make the Vocalist the only harmony processor **THAT DOES IT ALL!**

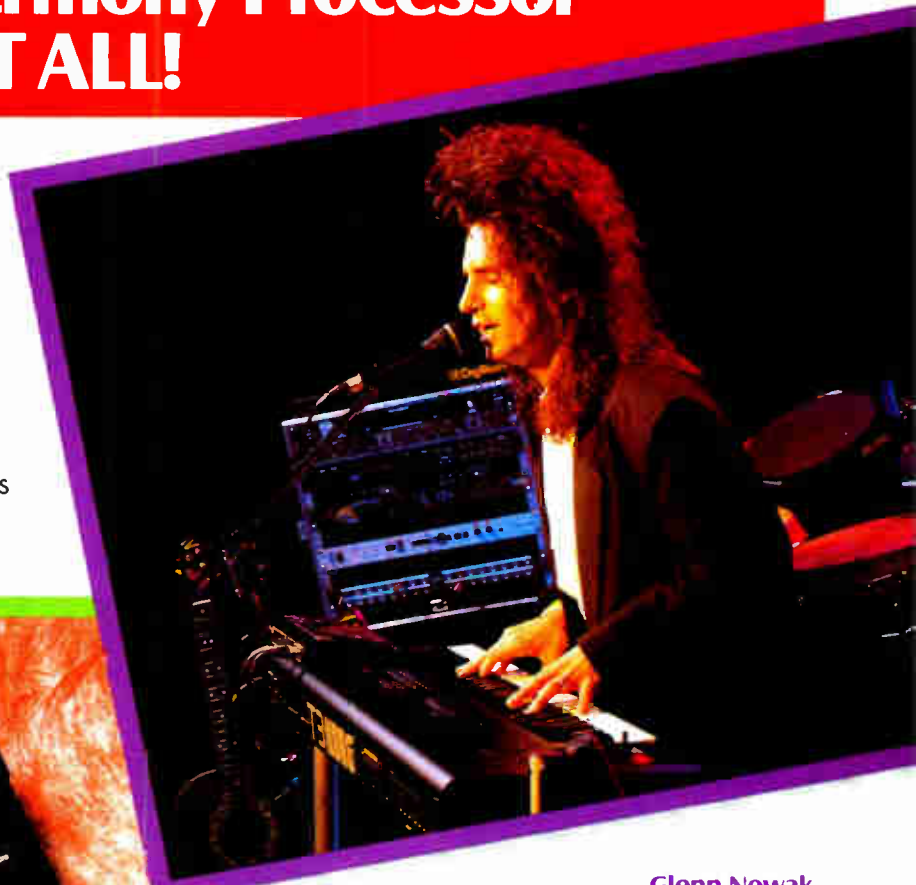

Glenn Nowak-

professional musician, South Bend, Indiana.

"For a guy like me, the Vocalist is like a dream come true. I'm now able to fatten up my vocals with live harmonies. The audience can't believe they're listening to a one-man band. This product is the biggest breakthrough since multi voiced synths hit the market."



Michael Schoenfeld-owner Third Planet From The Sun Studios, Salt Lake City, Utah.

"As one of the area's top production facilities, we handle everything from recording rock bands to church choirs and we also do a ton of radio material. The Vocalist fits the bill in virtually every application. We now can provide our clients with up to five-part harmonies at the touch of a button, and even fix off-key vocals quickly."

DigiTech

A Harman International Company

5639 South Riley Lane
Salt Lake City, Utah 84107
Tel (801) 268-8400 • Fax (801) 262-4966
International Inquiries: (603) 672-4244

USE READER SERVICE CARD FOR MORE INFO



Array Series. Designed To Impress Everyone Who Has Heard It All Before.



The competition to produce the "ultimate" sound reinforcement system is fierce. Each new system design brings claims of having *achieved perfection* or touts *this is the one*. Yet, in time, you can expect the very same manufacturers to introduce new models claiming to have further *perfected perfection* or that their *unorthodox* technology has rewritten the laws of physics. Sound familiar? So how do you impress everyone who has heard it all before? Simple.

JBL engineers have drawn upon proven advancements in loudspeaker design and state-of-the-art digital electronics to create Array Series: a comprehensive sound reinforcement system concept with performance second to none. Developed as dedicated array elements, Array Series systems can be easily configured to fill any venue with seamless coverage from a deceptively small package.

Such performance could only be achieved by designing the exact transducers required for the job. The Array Series is the first professional loudspeaker system to use neodymium magnets. The LF transducer's unique motor structure topology also includes proven Vented Gap Cooling (VGC™) and a deep copper-sleeved gap to significantly reduce distortion and power compression.

The 38 mm (1 1/2 in) exit HF compression driver also uses a neodymium magnet structure, a Coherent Wave™ phasing plug and damped titanium diaphragm. The result is effortless and reliable high frequency output with outstanding accuracy. A 45° Optimized Aperture Flat-Front Bi-Radial™ horn assures proper matching and summing of multiple Array Series systems.

The 13 ply hardwood enclosure has 45° sidewalls to match the horn coverage in arrays, and is reinforced with integral steel attachment hardware, designed to interface with S.A.F.E.™ flying hardware for quick and secure cluster assembly.

System functions, such as crossover filter points, transducer acoustic center alignment, system equalization and protective limiting are achieved totally in the digital domain by the ES52000 Digital Controller. The ES52000 employs Finite Impulse Response (FIR) filters for zero phase shift and requires no amplifier output sensing cables, so you can expand your system by adding Array Series loudspeakers without having to add additional controllers.

The sum of these parts is Array Series: a complete system providing extremely high power handling, very high sound pressure levels with full dynamic range, low distortion and unmatched fidelity. Truly a system capable of impressing *anyone who has heard it all before*.

Call or write for detailed specifications. Or, for more *immediate* response, you can get current product information on Array Series, the ES52000 Digital Controller and all JBL Professional products, *VIA FAX* by calling (818) 895-8190.

JBL

JBL Professional
8500 Balboa Boulevard, Northridge, CA 91329
(818) 895-8411
FAX Information: (818) 895-8190

H A Harman International Company

Pictured above, Array Series installation at the Grand Palace, Branson, Missouri.