

SEPTEMBER 1985  
U.S. \$3.00  
CANADA \$4.00

THE RECORDING INDUSTRY MAGAZINE

# Mix

Interview: David Foster

**Southern California  
Studio Listings**

**Film and TV Sound**

**Frank Zappa**

**Chris Stone**

**Miami Vice's  
Jan Hammer**

**Digital '86  
Supplement**

067682 MXSEP 1299 3 DIR FAE  
JBL INCORPORATED  
MARK R GANDER  
8500 BALBOA BLVD  
NORTHRIDGE CA 91329

## Studer Audio: Production Versatility

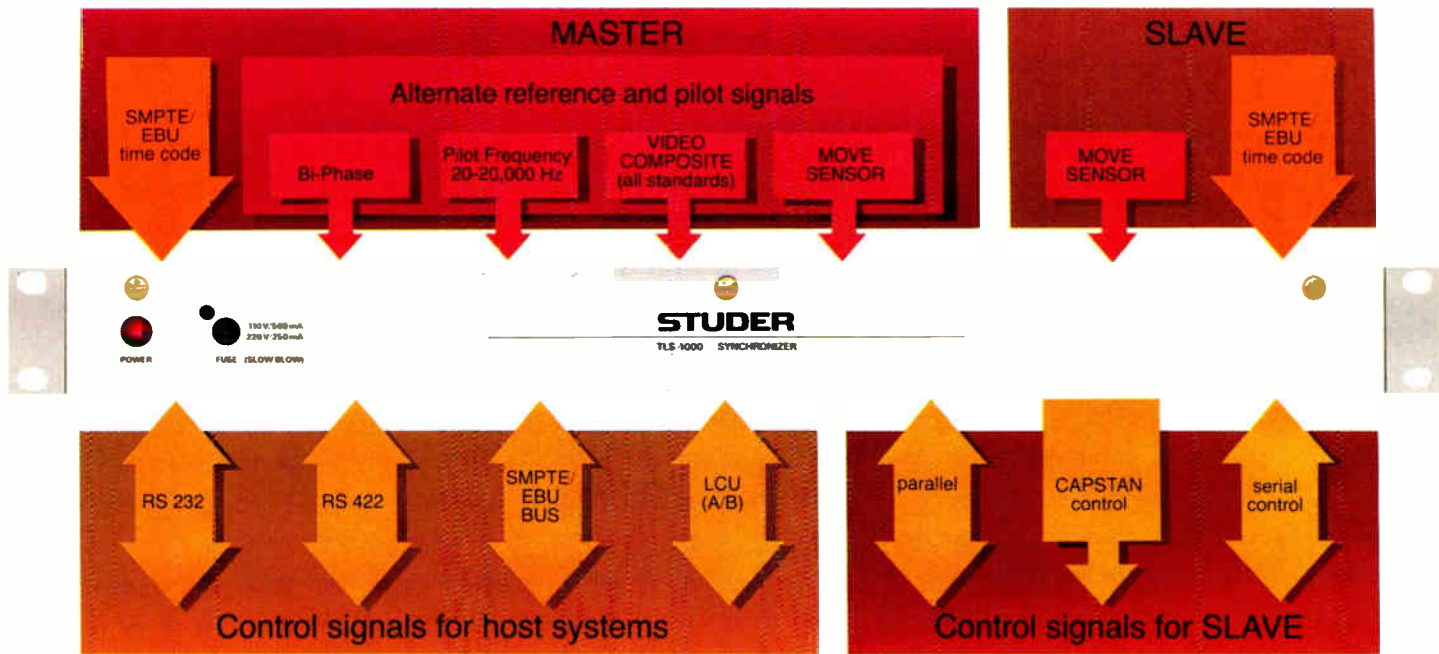

## Studer's flexible approach to synchronization in audio, video and film production.

The new Studer TLS 4000 synchronizer system offers extraordinary flexibility across a broad range of audio/audio, audio/video and audio/film synchronizing applications. And, thanks to its modular design, the TLS 4000 system can expand along with your growing facility.

**Lock in a Box.** The TLS 4000 "black box" unit functions as an extremely accurate chase lock synchronizer for one tape transport. It resolves two SMPTE time codes of any standard, and it will also accept pilot frequencies, video frame pulses, film bi-phase pulses, and move pulses. The RS232/422 serial port links the TLS 4000 synchronizer (in single or multiple units) to centralized controlling and editing systems.

**Local Control Unit (LCU).** A separate Local Control Unit for

the TLS 4000 is available in two different versions: the basic version (type B) for many common applications, and the extended version (type A) which offers enhanced display capabilities as well as WAIT LOCK, SLEW MODE, LOOP, and CUE + GO-TO operating features. The compact Local Control Units fit in standard 19" racks as well as in the extended console overbridge on Studer A810 recorders.

**Suit Yourself.** Modular design lets you tailor a TLS 4000 system to fit your particular needs—present and future. For more information on Studer synchronizing systems, please write or call: Studer Revox America, 1425 Elm Hill Pike, Nashville, TN 37210; (615) 254-5651.

**STUDER REVOX**



Top to bottom Type B LCU, Type A LCU, "black box."

Circle #001 on Reader Service Card



## DEPARTMENTS

- 5 CURRENT
- 6 INDUSTRY NOTES
- 8 SESSIONS
- 10 STUDIO NEWS
- 106 PREVIEW
- 214 CLASSIFIEDS
- 217 AD INDEX
- 218 FEEDBACK

## AUDIO

- 14 LESLIE SCHATZ & THE SOUND FOR "MISHIMA" by Nick Pasquariello
- 32 SEVEN STEPS TO BETTER SYNC by Paul Matthews
- 49 DIGITAL '86: A SPECIAL SUPPLEMENT (See separate contents page)
  - Digital Audio Editing
  - Video Cues in Digital Audio Editing
  - Digital Mixing Consoles
  - Digital Reverb, Part IV
  - News Update
  - Digital Resource Guide
- 110 INTERNATIONAL UPDATE
- 112 SOUND ON STAGE: LIVE AID by George Petersen
- 114 ARTIST STUDIO: JERRY MAROTTA by Dan Daley
- 120 IN SYNC: MIDI SEQUENCERS by Bruce Nazarian
- 150 INTERVIEW: CHRIS STONE OF THE RECORD PLANT by David Goggin
- 159 SOUTHERN CALIFORNIA RECORDING UPDATE by Linda Johnson and Blair Jackson

## MUSIC

- 20 PRODUCER'S DESK: DAVID FOSTER by Iain Blair
- 40 LUNCHING WITH BONZAI: FRANK ZAPPA by Mr. Bonzai
- 124 MI UPDATE by Craig Anderton
- 128 MUSIC NOTES
  - Billy Cobham
  - Wayne Johnson Trio
  - The Flying Pickets
- 134 PLAYBACK: MOBILE FIDELITY'S "WOODSTOCK" by Glenn Lambert
- 146 JAN HAMMER & "MIAMI VICE" by Bruce Pilato

## VIDEO

- 28 BUDDY RICH, LIVE IN S.F. by Elizabeth Rollins
- 138 VIDEO NEWS by Mia Amato
- 140 HOME VIDEO DISTRIBUTION by Neal Weinstock
- 142 MVP: COMPACT VIDEO by Lou CasaBianca
- 144 V66: RADIO WITH PICTURES by Neal Weinstock

## LISTINGS

- 169 SOUTHERN CALIFORNIA RECORDING STUDIOS

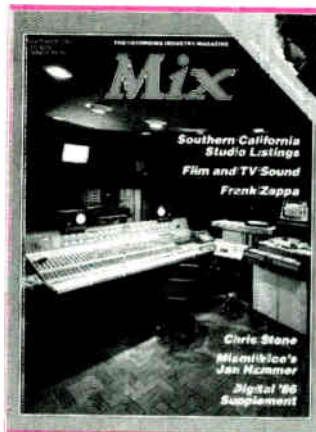

Cover: The pride of West Los Angeles, The Village Recorder's Studio D was originally built for Fleetwood Mac to record their Tusk album. The room comes equipped with Neve 8078 console and Necam automation, and access to the studio's three Sony 3324 digital 24-track recorders and one Mitsubishi X-800 32-track digital. Photo by: Steve Broaddus

In our special supplement on digital recording, beginning on page 46, we offer a broad range of pieces on different aspects of the topic. Ken Pohlmann takes a look at different digital mixing consoles. Part IV of our in-depth examination of digital reverb finds writer Larry Oppenheimer conducting a discussion with experts in the field; and Dr. Toby Mountain writes about "Video Cues in Digital Audio Editing." An added bonus is our "Digital Resource Guide," listing digital recorder manufacturers, studios, mastering houses and rental facilities in the U.S. and around the world.

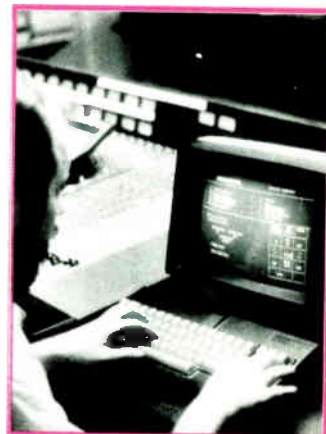

If it's September, then the primary focus of the issue must be Southern California. Besides our extensive listings of 4-, 8-, 16- and 24-track studios (beginning on page 169), *Mix* writer David Goggin conducts an extensive interview with one of the leading lights of Southern California recording, the Record Plant's Chris Stone (page 150); Mr. Bonzai hosts a typically unpredictable lunching with L.A.'s own Mr. Warmth, Frank Zappa (page 40); and in our "Producers Desk" column, Iain Blair chats with David Foster, certainly one of the hottest producers working in Los Angeles (page 20).

*Mix* Magazine is published at 2608 Ninth St., Berkeley, CA 94710 and is ©1985, by Mix Publications, Inc. This is Volume Nine, Number Nine, September, 1985. *Mix* (ISSN 0164-9957) is published monthly. Subscriptions are available for \$24.00 per year. Single or back issue price is \$4.00. Subscriptions outside U.S.A. are \$36.00. Please address all correspondence and changes of address to *Mix* Magazine, 2608 Ninth St., Berkeley, CA 94710. (415) 843-7901. Second Class postage paid at Berkeley, CA and additional mailing offices. *Mix* Magazine is distributed in recording studios, pro-audio stores, music stores and other related businesses. If you have a recording or music related business and would like to distribute *Mix*, please give us a call. Display advertising rates, specs and closing dates are available upon request. This publication may not be reproduced or quoted in whole or in part by mimeograph or any other printed means, without written permission of the publishers.

# AN AUDIO TAPE MACHINE FOR BOTH SIDES OF YOUR MIND

Whether you're an engineer, an artist, or both, Otari's MTR-90 will satisfy your most demanding ideas of what a multi-channel recorder should be.

Once you, the engineer, have put its servo-controlled and pinchroller-less tape guidance system through its paces, no other will do. And when the artist in you experiences the MTR-90's sound, you'll know its superlative electronic specifications will never compromise your recordings. And when the both of you need total session control, the MTR-90 is equipped with a full-function remote, and an optional autolocator.



Post-Production professionals will quickly discover that the MTR-90, when equipped with Otari's new EC-101 chase synchronizer, is absolutely the finest performing tape recorder in the world—nothing else even comes close.

And, of course, you're a businessman, so you'll appreciate that the "90" is also the best bottom-line decision ... because it delivers performance without extravagance. From Otari: The Technology You Can Trust.

Contact your nearest Otari dealer for a demonstration, or call: Otari Corporation, 2 Davis Drive, Belmont, CA 94002, (415) 592-8311  
Telex: 910-376-4890

**OTARI**®

Circle #002 on Reader Service Card

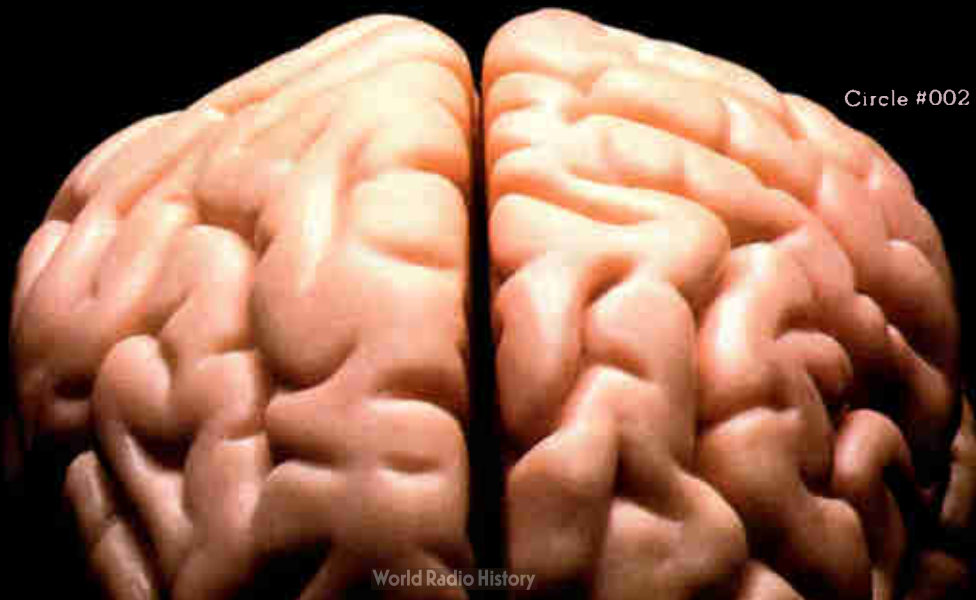

© Otari 1984



# CURRENT

## Home Audio Taping Legislation Introduced

U.S. Representative Carlos Moorhead (R-California), the ranking minority member of the House Judiciary Subcommittee that deals with copyright issues, has introduced a bill into Congress designed to provide a balanced solution to the home audio taping controversy. Dubbed the "Home Audio Recording Act," Moorhead's legislation would exempt consumers from copyright liability for taping music at home for personal use, while providing fair compensation for the creative artists and copyright owners of the music being taped. Under the proposal, the manufacturers and importers of blank audio tape and audio recording equipment would pay a "reasonable" royalty fee to compensate copyright owners.

The president of the Recording Industry Association of America, Stan Gortikov, stated that this legislation "provides a much needed legislative solution to the home audio taping problem, and will help to save America's music by ending the erosion of the music industry's economic base."

Similar legislation to Moorhead's bill is expected to enter the Senate shortly. For further details on this program, the congressman can be contacted at 2442 Rayburn H.O.B., Washington, D.C. 20515.

## Gotham Audio Sold

Gotham Audio Corporation, the New York City-based professional audio equipment dealer and representative, has been sold to a private investment group headed by Russell O. Hamm, longtime vice president of Gotham. In a deal concluded at the end of May, with an effective takeover date retroactive to April 1, 1985, the mostly cash transaction was the result of more than one year's negotiation between the parties.

Gotham, which was founded in 1958 for the purpose of importing the professional equipment manufactured by George Neumann GmbH of Berlin, Germany, will remain at its present address under a lease agreement negotiated at the time of the purchase. The name

Gotham will be retained by the new company, but the logo will be redesigned, according to the new owners.

## Touring Industry Leaders To Meet

The Sixth Annual National Convention and Trade Show for the Professional Live Entertainment Touring Industry, Summit '86, will be held January 23 through 26, 1986, at the Fountainbleau Hotel in Miami. The target audience for these conferences consists of promoters, booking agencies, acts, personal managers, facility directors, concessionaires, merchandisers, production companies, and other touring support personnel, as well as newcomers to those respective fields.

A highlight of this Sixth Annual Summit Conference will be the nationally televised Performance Touring Industry Awards Show. Awards will be presented to the top acts and touring industry entities as voted on by their peers in the touring industry. Panel topics will include the changing roles of promoters and facilities, corporate sponsorship, mega tours, technical services, merchandising, video, artist promotions, and the ever-popular agent/promoter/manager roundtable.

New for Summit '86 will be a special booking agents/buyers gathering. The conference will begin with a golf tournament, and wrap up with a Super Bowl party. For more information, contact Mack Long, Summit '86, 1020 Currie Street, Fort Worth, Texas 76107, phone: (800) 433-5569.

## Chicago Music Expo Set For September

"The music industry is not unlike an octopus without a head, with its arms flailing around in a million different directions," says Paul Kelly of KBA Enterprises. "That's especially true in the Midwest, where there's no person or organization that brings different aspects of the music business together. We're hoping that the Chicago Music Expo will change that a little bit."

Aimed at the professional and semi-professional musician, as well as others not

involved directly in the creative end of music (i.e. business, management, etc.), the Chicago Music Expo offers three intensive days of seminars, manufacturers' exhibits and live performance showcases for a wide spectrum of Chicago-area bands. "Virtually everybody of importance in the Chicago music scene will be involved," Kelly says. "I think it's important we all get together and compare notes and maybe show a little unity."

Some 50 manufacturers of pro-audio equipment will be showing their wares at the Expo; Flanners' Pro Audio is sponsoring this aspect of the show. Kelly says that the seminars will focus on the budding music entrepreneur, with panels on such topics as "International Record Licensing," "How to Structure a Business" and "Plugging Into Organization Networks." There will also be exhibits and seminars aimed at people involved with independent record labels, non-profit music organizations and unions. The music showcase will be, in Kelly's words, "Two-and-a-half days of sampling the many different kinds of bands we have in the area. We'll have almost every style imaginable."

The Chicago Music Expo takes place at Chicago's Hotel Continental, September 20, 21 and 22. For more information, write to the Expo at 110 Schiller, Suite 205, Elmhurst, IL 60126; or call (312) 279-8323.

## Biamp Acquired

Biamp Systems, a Portland, Oregon-based manufacturer of audio sound reinforcement and audio signal processing equipment, has been acquired by the Beaverton, Oregon firm of Leupold and Stevens, a 78-year-old manufacturer of precision equipment. The new organization, called Biamp Systems, Inc., will employ the engineering, production and financial strength of Leupold and Stevens to implement an aggressive marketing program and develop new products, according to its new owners. Don Waggoner, senior vice president corporate ventures and acquisitions, Leupold and Stevens, will serve as president of the new firm. The purchase price was not disclosed.

# INDUSTRY NOTES

The **Gand Music and Sound Expo**, September 14 and 15, noon to 5:30 p.m., in Northfield, IL, features exhibits by 25 music/audio manufacturers as well as demos and workshops. For information, call Joan Gand (312) 446-4263. . . The **Rocky Mountain Film and Video Expo-85**, a project of the **Colorado Film and Video Association** which will feature the latest in film and video equipment by major manufacturers and suppliers, will be held September 13 and 14 at the Regency Hotel in Denver, Colorado. It is being sponsored by **Burst Communications**, **Ceavco Audio-Visual Company**, **Davis Audio-Visual, Film/Video Equipment Service Company** and **Video Teknix**. Call (303) 837-8603 for further details. . . A joint venture between the **National Sound and Communications Association** and the **Electronic Representatives Association** has resulted in a series of nine educational conferences and product exhibits for electronics systems contractors to be presented in nine major US markets, beginning in September. For detailed information, contact ESSC at (313) 781-2010. . . **Audio-Technica's** studio products marketing manager slot has been filled by **Greg Silsby**, formerly the market development manager, professional products for **Electro-Voice, Inc.**, and **Rock Wehrman** has been appointed to the newly-created post of assistant advertising manager. **Charlie Winkler** has moved up to A-T's professional products marketing and sales manager, with **Mark D. Taylor** named the company's national sales manager for music products. . . **Robert Cavanaugh** has joined **Dolby Laboratories** in the San Francisco office as technical marketing consultant, to be responsible for Dolby Professional Product sales in North America with emphasis on product applications, training and dealer relations. . . **Michael Wilke** has been promoted to marketing manager, video tape products at **Ampex Corporation's** Magnetic Tape Division, assuming responsibility

for the development and implementation of all Ampex video tape marketing programs. . . The Professional Video Communications Division of **JVC Company of America** has appointed **Donald G. Thorkelson** sales manager for closed circuit television, responsible for sales, distribution and marketing of CCTV products. . . **George Gilbert** has been appointed service manager for **Solid State Logic** at Stonesfield, Oxford, England, and **David Grinstead** has joined SSL's UK staff as training manager. . . At **Soundcraft Ltd.**, in London, **Barrie Hozier** has become general manager, **John Child** has come on staff as marketing manager, **Claire Finch** has been promoted to marketing coordinator and **Mark Turpin** has been appointed controller of Soundcraft Electronic's two US plants. . . **Howard Mullinack** has been appointed marketing and sales manager at **Orban Associates**, with responsibility for coordinating the Orban Broadcast Dealer network world-wide, and developing the markets for the OPTIMOD-AM, FM and TV products. . . **Roy C. Blankenship** has been appointed national sales manager at **Symetrix, Inc.** with duties to include domestic sales, operations and marketing. . . **World West Productions** has announced plans for **Music Expo '86**, an "open house for the music industry" to be held June 6 through 8, 1986 at the Los Angeles Convention Center. Call (800) 523-9768 for more information. . . At **Electro-sound**, **Jim Donohue** has been appointed general manager for the Long Island duplicating plant, and **Abe Chayet** has been named vice president of sales for the Media Division. . . **Pacific Arts** president **Robert Fead** has announced the appointment of **Stephanie Murray** to the position of general manager where she will be responsible for administration of all office and business affairs, including the supervision of production and manufacturing. . . **Harrison Systems, Inc.** and **Westlake Audio Professional Sales** have re-established their

manufacturer/dealer sales arrangement, including an agreement to install Harrison's new 120 totally automated input Series Ten console in Westlake's new Studio D in Los Angeles. . . **Scott Martin** and **Howard Steele** have formed **CommTech**, an engineering consulting service in El Paso, Texas, to provide planning, design, construction, operation and maintenance services to broadcast properties throughout the Southwest. For inquiries call (915) 532-2860. . . **Movielab Video, Inc.** has added **John Ziemann**, editor, and **Skip Eckel**, colorist, to their post-production team. . . **Al Hospers** has joined the staff of **Dr. T Music Software**, in Watertown, MA, as business manager and design consultant. . . **Bruce Marlin** and **Marcon Marketing** have been appointed by **Pioneer Electronics, USA**, to represent the **TAD** line of professional speakers and studio monitors in Texas, Oklahoma, Louisiana and Arkansas. . . **Mike Klickstein**, of **Western Audio Sales** in Glendale, CA, has been named Representative of the Year by **QSC Audio Products**. . . The **Society for Electroacoustic Music** in the United States has put out a call for electroacoustic tape compositions to be played during the **New Music America Concerts** at the California Institute of the Arts on November 9 and 10. Contact **Dr. Felix Powell**, Music Department, U.M.B.C., Baltimore, MD 21228. . . **Bob Ford** has been named director of production at **Jeff Cooper Architects A.I.A.**, in Calabasas, CA. . . **Donald Rubin** and **Hank Medress** have joined **The Entertainment Music Company** in New York City as creative consultant and director of artist and repertoire, respectively. . . **New York University's Music, Business and Technology** program has formed three music publishing companies, affiliated with ASCAP, BMI and SESAC, respectively, to be staffed by students and designed to find new songs for established artists. For more information, call (212) 598-7792.

M I X		M A G A Z I N E					S T A F F	
PUBLISHER/EDITOR David M. Schwartz		ASSOCIATE PUBLISHER/ADVERTISING DIRECTOR Hillel Reaner					PUBLISHER/GENERAL MANAGER Penny Riker Jacob	
<b>MANAGING EDITOR</b> Blair Jackson <b>ASSISTANT EDITOR</b> George Petersen <b>ASSOCIATE EDITOR</b> Ken Pohlmann <b>MUSIC EDITOR</b> David Gans <b>EDITOR AT LARGE</b> Mr. Bonzal <b>FILM/VIDEO EDITOR</b> Lou CasaBianca <b>CONTRIBUTING EDITORS</b> Iain Blair Larry Oppenheimer Bruce Pilato Elizabeth Rollins Tony Thomas Neal Weinstock		<b>ASSISTANT ADVERTISING DIRECTOR</b> Jeffrey Turner <b>ADVERTISING REPRESENTATIVES:</b> <b>SOUTHERN CALIFORNIA/SOUTHWEST</b> Cecilia Hernandez <b>NORTHWEST/NORTH CENTRAL</b> Harton Firmin <b>DIRECTORIES/CLASSIFIED MANAGER</b> Lauri Newman <b>DIRECTORIES ASSISTANT</b> Athena Craig <b>EDITORIAL ASSISTANT</b> Linda Johnson			<b>ART DIRECTOR</b> Tim Gleason <b>ASSISTANT ART DIRECTOR</b> Bonnie Blair Olshe <b>DESIGN &amp; PRODUCTION</b> Dave Marrs Patsy Messerer <b>TYPESETTING</b> Linda Dierking Lynn McCormick <b>PRODUCTION MANAGER</b> Anne Letsch <b>CIRCULATION MANAGER</b> Mary Holland <b>CIRCULATION ASSISTANT</b> Allison Hershey <b>TRAFFIC MANAGER</b> Neil McKamey		<b>ACCOUNTING DEPARTMENT CONTROLLER/BUSINESS MANAGER</b> Mark Gunther <b>ASSISTANT CONTROLLER</b> Linda Simpson <b>CREDIT/ACCOUNTS PAYABLE</b> Cathy Boyum <b>BOOK DIVISION GENERAL MANAGER</b> Craig Wingate <b>CUSTOMER SERVICE</b> Caryl Sherman <b>OFFICE MANAGER</b> Rachel McBeth <b>RECEPTIONIST</b> Lisa Jensen	

National Editorial, Advertising and Business Offices: 2608 Ninth Street, Berkeley, CA 94710. Telephone: (415) 843-7901  
 Southern California Advertising Office: 4000 MacArthur Blvd., Suite 3000, Newport Beach, CA 92660. Telephone: (714) 851-1706



# DOLBY® NOISE REDUCTION FOR THE 1980'S



SP multi-track unit



360 single-track units



CN 234 for  
Sony BVH 2000



CN 221B for  
Sony BVH  
1000/1100



CN 226 for  
Ampex  
VPR-2

Dolby noise reduction is keeping pace with today's demand for high-quality sound — everywhere. With the introduction of such products as plug-in modules for VTRs and the SP multi-track unit, it is easier than ever before to protect *all* your irreplaceable audio tracks from hiss, hum, and print-through. From broadcasting to music recording, from video sweetening to motion picture dubbing, Dolby A-type NR reliably continues to fulfill its original promise: effective noise reduction combined with complete signal integrity.

Dolby Laboratories Inc., 731 Sansome St., San Francisco, CA 94111,  
Telephone 415-392-0300, Telex 34409, 346 Clapham Road, London SW9,  
Telephone 01-720-1111, Telex 919109. "Dolby" and the double-D symbol  
are trademarks of Dolby Laboratories Licensing Corp. S83/505D

 **Dolby**®

# SESSIONS

## NORTHWEST

At *Triad Studios* in Redmond, WA, former Eagle **Randy Meisner** did game tracking with **Art Ford** producing with **Tom Hall** on the board...**Hi-Tech** has been recording an album for an undisclosed label at **Bear West Studios** in San Francisco...Producer **Bill Jersey** created the score for a one-hour film about the state of Vermont at **The Sound Service** in San Francisco, using a mixture of original music and the facility's Q-Lock synchronizing system and existing library music... Heavy metal madness descended on **Starlight Studio** in Richmond, CA, with EP projects from **Amaranth**, **Valhalla**, **Snyper** and **Divine Right** all shaking the walls. On the slightly milder side, Vallejo's **Pete Escovedo** was in town to produce a demo for singer **Shy-ANN**, and Tazmanian Devils guitarist **Dave Carlson's** new band **The Chills** was in with producer **Norman Kerner** to cut a 45... At **The Banquet Sound Studios** in Santa Rosa, CA, **Ronnie Montrose** produced **Davey Pattison** (former lead singer of Gamma) for his new project. Playing bass was **Glenn Letsch** (also formerly of Gamma). **Mark Lyon** was at the console... Recent activity in Eugene, OR, at **Recording Arts Center Studio** included **Mason Williams** completing mixdown of his new album **Of Time & Rivers Flowing**. Produced and engineered by **Don Ross**, arranged by **Art Mattox**, the album will be released on Williams' own Skookum Records... **Hammers Rule** began work on its newest recording project, a 12-inch EP entitled **After the Bomb**, at **Avalanche Studios** in Denver and produced entirely by the band... **Dr. Gonzo**, The Doc of Comedy Rock, has completed recording his first album at **Outback Studios** in Oakland, CA. The album was produced by **Roger Clark** (formerly with Little Roger and the Goosebumps), engineered by **Wilson Dyer**, with a guest production appearance by **Scott Matthews**... At **Montage Recording Company**, Newark, CA, **Dean Keith** was in completing his EP with a tune written and produced by **Randy Spendlove**; and **Adam Alvarez** and his Christian metal band called **Golgotha** were laying down basic tracks for their new project, engineered by **Mike Hersch**... At **Prairie Sun Recording** in Cotati, CA, **Avatar** was in the studio remixing "Speed Limit" off of their upcoming LP, **12 Inches of Fun** with the production assistance of **Rob Banks**. **Ken Huncovsky** engineered the session, with **Steve Buck** assisting... At **Steve Lawson Productions**, (Seattle, WA) engineer **Terry Date** had his hands full with the popular local pop-rock group **Attachments**, who

completed their ten-song debut album, mixed on 48 tracks... **Westcoast Recording** in Monterey, CA, was chosen by Hollywood producer **Terry Melcher** to record all of the vocal tracks for the soon-to-be-released comeback album by **Doris Day**. Involved in this project with Doris and Terry have been engineers **Bill House** and **Michael David**, and **Bruce Johnston** (Beach Boys keyboard player) doing music tracks...

## NORTH CENTRAL

For the second time in nine months, the black music group **Midnight Star** has been honored with an Ampex Golden Reel Award, the latest celebrating the success of their gold album, **Planetary Invasion**. The presentation was made at Cincinnati's **OCA Studios**, where the album was recorded with engineers **Rick Probst**, **Jim Greene**, **Mark Hillman** and **Jim Bosken**... At **Sound Summit**, Lake Geneva, WI, **Holland** recorded guitar and vocal overdubs for their LP, **Little Monsters**, with **Tom Werman**, producer, **Duane Baron**, engineer, and **Jay Schilliday**, assistant engineer... At **Remington Road Studios**, Schaumburg, IL, activity has included the completion of a new album entitled **Halo**, by **Paul Chastain**, produced by **Michael Freeman**. Freeman also completed tracks for **Eleventh Dream Day**, **Women in Love**, **F-10s**, and **Paint Set**... At **Ryansound Recording Studio**, Detroit, MI, **Bobby Christian** completed mixing of his self-produced single with **Dave Sanders** engineering; and the gospel group, **Chosen** was in cutting tracks for their demo package produced by **Andre Woods**, with **Ray Wimbley** at the console... Recent activity in **Beachwood Studio** included **Dale Peters** engineering five songs for **David Sparkman**, a single for **Samson and Delilah**, and remixing a new single for **Donnie Iris & the Cruisers**... At **Land Recording Studio** in Columbia, MO, engineer **Bob Pruitt** with **Pete Szkolka** assisting, finished a project for **Britt Small & Festival** entitled **Tattered Flags and Broken Promises** on Max Stout Records... Gospel artist **Robert Barry Jr.** completed his latest album project at the **Barn Recording Studio**, Alexandria, IN. **Nina Edwards** produced, **Darrell Powell** engineered, with **David Bentzler** assisting... Recent activity at **Paragon Recording Studios** in Chicago included **Robert Irving III** (synthesizer player, producer and songwriter for Miles Davis's latest album) producing an album project for Expansion Records featuring artist **Tony Ransom**. Paragon's **Marty Feldman** engineered the project; **Bob Kearney** assisted... Producer **Bobby Irving** was in **Chicago Trax**

laying down the title track for Dan Aykroyd's new movie **Wise Guys**; and **Darryl Thompson** produced two new tunes on **The Warmers** for the Passport Jazz label... Some recent action in **The Alliance Recording Company's** new control room included completion of **Scott Frost's** new single with chief engineer **Al Hirschman**; and engineer **Don Pushies** wrapped up mixes for **Johnny Coma & The Snowblind Band**... After a blasting session at **Soto Sound Studio** in Evanston, IL, Chicago heavy metal band **Torment** released one song out of their five song demo on the **Chicago Metalworks** album. The session was engineered by **Jerry Soto**...

## NORTHEAST

**Joey Lynn Turner**, former lead singer of Rainbow, recorded his new album for Elektra Records at **Bearsville Studios**. Veteran producer **Roy Thomas Baker** handled production chores, and the project was engineered by **Jan Taylor** with assistant engineer **Ken Lonas**... At **Greene Street Recording**, N.Y.C. **Joe Piscopo** and **Eddie Murphy** mixed "The Honey-mooners" for CBS, **Hal Wilner** produced, **Rod Hui** engineered and **Dave Harrington** assisted... **Robin Ruddy** and **John Akin** completed mixing their debut album titled **Step-pin' Out** at **Lion & Fox Recording** in Washington, D.C., with chief engineer **Jim Fox** at the board. This folk-oriented album was produced by **Ted Macaluso**... **Pyramid Sound Studios**, Ithaca, NY, had **T.T. Quick** in recording their new LP. **Michael Wagener** produced with **Alex Perialas** engineering and **Peter Bombar** assisting... **Battery Sound** in New York City has been busy with **The Limits**, **David Van Tieghem**, and **Berky/Moschen**, all engineered by **Eric Liljestrand**... E-Street-er **Michael Jonzun** was in **Sheffield Audio-Video Productions** in Phoenix, MD, working on several cuts for **Clarence Clemons**. **Ed Stasium** engineered. Also, **Michael Hedges** was in cutting some new tracks, with **Bill Mueller** engineering... **Rob Freeman** (former producer of the Go-Gos) was in NY's **D&D Recording** working on **Tim Moore's** upcoming release for Elektra Records, with **Danny Caccavo** engineering... At **Celebration Recording**, NYC, artist/producer **Zura King** recorded vocals for a pop album engineered by **Sal Ciampini**, assisted by **Maurice Puerto**... At **Battery Sound Studios** in NYC, film composers **William Mason** and **Tim Reed** recorded the cues to the new Tom Flanagan film entitled **Altar Boy** which is slated for a summer release. **Eric** engineered with **Jessica** assisting... In the works at **Frankford/Wayne**

—PAGE 158



# FROM HAIRPIN TURNS TO STRAIGHTAWAYS, THE SPEED OF SOUND HAS NEVER BEEN SO SMOOTH.



For years, sloppy tape transportation and handling have made the audio engineer's day much harder than it had to be.

This tormenting state has come to an end with the introduction of Sony's APR-5000 2-track analog recorder, available in a center-track time code version.

The APR-5000's precise handling and numerous advanced features make the audio engineer's day run much smoother. For example, the APR-5000's 16-bit microprocessor manages audio alignment with a precision that's humanly impossible. And the additional 8-bit microprocessor opens the way for extremely sophisticated serial communications. In tandem, they reach a truly unique level of intelligence.

Not only does the APR-5000 do its job well; it does it consistently. The die-cast deck plate and Sony's long-standing commitment to quality control maintain that the APR-5000 will hardly need time off.

All of which results in a consistent sonic performance that'll stand even the most critical audio professionals on their ears.

For a demonstration of the recorder that transports analog audio to a new fidelity high, contact your nearest Sony office:

Eastern Region (201) 368-5000;  
Southern Region (615) 366-0333;  
Central Region (312) 773-6000;  
Western Region (213) 537-4300;  
Headquarters (201) 930-6145.

**SONY**  
Professional Audio



© 1985 Sony Corp. of America. Sony is a registered trademark of Sony Corp.

Circle #004 on Reader Service Card

# STUDIO NEWS

**Criteria Recording Studios** in Miami have purchased two Solid State Logic SL6000E 48-input consoles with Total Recall, and a Mitsubishi X-800 32-channel digital multitrack recorder. Studio president and longtime industry pioneer Mack Emerman announced the "New Criteria" at the studio's Thirtieth Anniversary celebration... The new Compact Disc preparation/editing suite at **K Disc Mastering**, Hollywood, CA is now on line, and features a Sony PCM-1610 system with two BVU 800DB video decks and DAE digital editor. The suite was christened with the Little Richard compilation CD for Rhino Records, and other projects since have included four Dan Fogelberg CDs for Columbia, and a new Dazz Band disc for Motown. The facilities third analog cutting room is also now on line... **Alpha Audio** of Richmond, VA (a division of Alpha Recording Corporation) has upgraded their synthesized production equipment with a Kurzweil 250 as well as a Linn 9000... **Preferred Sound** in Woodland Hills, CA has appointed **Bill Thomas** chief engineer/studio manager and acquired AMS reverb and digital delay systems... **UCA Recording** in Utica, NY has completed a year-long renovation and now offers 24-track recording. The equipment inventory now includes a 3M-79 24-track deck with all the update modifications (including the removal of all the transformers) and an Amek "Angela" console, as well as plenty of outboard equipment... With all seven of its editing rooms busy, **Studio C** in San Francisco will be expanding its Mission Street facility over the summer... At **Music Annex** in Menlo Park, CA, recent additions include the ADR/Sony 701-ES 14- and 16-bit digital audio processor, and a Lexicon PCM-60 digital reverb has been added to Studio C as well as a new Amek 2500 console... **MetroGnome, Inc.**, the Nashville-based computer consulting firm that specializes in music industry systems, announced that **Tom Collins Productions** of Nashville has installed MetroGnome's production management system, Tracks Plus... **Steve V. Johnson** has left the position of operations manager at **Tres Virgos Studios** in San Rafael, CA to form a production company, Elegance Productions. Based in Tiburon, Steve will represent acts to record labels as well as produce products for release... New additions to **Goodnight Dallas** include a new Otari MTR-90 24-track deck, and a Lexicon 224-XL digital reverb; also a computer-based Neve 8128 console with Necam 96 automation... **Audio Visual Strategies**, a Southern California-based audiovisual production and services company, has relocated its administrative offices to: 738 North Cahuenga Blvd., Suite C, Hollywood, CA 90038... **Robert Berke Sound** has added veteran **Steve Bravin** to its production engineering staff. Robert Berke Sound has also added a second Otari MTR-90 two-inch

16/24 track tape recorder... **Le Studio, Inc.** has launched a new 24-track studio. The studio, a totally floating construction, features variable acoustics, shock mounted isolation room and percussion stage. The control room, also a floating structure, was built on the LEDE design concept. New equipment includes an MCI/Sony JH636 console with VCA's, Otari MTR-90 recorder, and a full selection of processing equipment... A new offline editing suite has been opened at **CCR Video** of L.A.; this room is a joint venture between CCR and Image Formations. The room is fully-equipped including a CMX 340 controller, a Grass Valley 1600 3c switcher, Sony BVU 800s each with time base correcting and an Ampex ATR 104 4-track with interface for double system stereo editing... **Ocean Audio**, the Los Angeles-based used professional audio dealer, is now offering rentals of a Solid State Logic SSL4000E console which was previously in-service at Ridge Farm Studios in the U.K., and features 40 inputs with mainframe automation... **Sound Genesis**, one of the Northwest's foremost providers of professional audio equipment, has completed two major projects: the complete outfitting of Lucasfilm's newest sound studio, and a substantial upgrading of equipment at Berkeley's **Live Oak Recording Studio**. Lucasfilm's fourth studio was built to accommodate the ever-expanding work load of the company's award-winning staff of sound designers and includes the first Otari MX-70 16-track recorder, a Sound Workshop 34-series console, an Otari 50-50 series 2-track, an Otari MTR-10 with auto locator, and more. For Berkeley-based Live Oak Studios, Sound Genesis provided the automation for their MCI 600 series console, as well as a Sound Workshop DISKMIX II. (Live Oak is the first studio in the country to take delivery of a DISKMIX II)... **Counterpoint Recording Studios**, one of New York's leading commercially-oriented studio operations, has completed a major renovation of their equipment and facilities. The renovation began with the enlargement of Studio B's control room and a variety of cosmetic and acoustical improvements throughout both studios, and finished with the installation of new consoles and tape machines: a Solid State Logic 6000E console with Total Recall for each of the two control rooms, a pair of Otari MTR-90 Mk II 24-track recorders, four Otari MTR-12 two-track and four-track machines, and an assortment of the latest signal processors and digital reverberators from AMS, Eventide, Lexicon, and Marshall. With the exception of the SSLs, all new equipment was supplied by Martin Audio, New York... **MixMasters Audio Production Specialists** is San Diego's newest 24-track studio. Owner **Charles DeFazio** announced the appointment of **Louie Stevens** as general manager/chief engineer and **Alan Harper** as studio man-

ager/engineer. For more information, call (619) 569-7367... A new, full-service 24-track facility in the Atlanta area, **Soundscape Studios**, opened recently. It is primarily hitting the jingle production and master recording markets, but also has the space to accommodate video and soundstage rental as well. Their control room is equipped with audio gear from Neotek, Studer, Lexicon and Valley People, among others, and they are also developing a MIDI system to be installed in studio B. Call (404) 351-1003 for information... In Taylor, MI, a new studio called **Budget-8 Recording Studios**, went on line June 1. They are housed in a 1400 sq. ft. commercial building and are presently doing a lot of video work for local clients. Want to know more about this new 8-track facility? Call (313) 292-1330... A new state-of-the-art audio/visual production facility has been completed at **Turquoise Productions** (St. Louis, MO) according to **Tim Leone**, president. The facility, which features a 24-projector system, will be available for audio/video producers to lease by the hour... **Fish Brook Music** in Boxford, MA, has upgraded to 24 tracks with the purchase of a Sony JH-636 fully automated console and JH-24 multi-track recorder. The control room has been completely redesigned around UREI time-aligned speakers... **Hanf Recording Studios**, Toledo, OH, has changed its name to **Audiocom, Inc.** effective immediately. The name change reflects new corporate goals and objectives including a new audio for video capability, increased capabilities in multi-track audio production, enhancement of volume duplication capabilities and expansion of the firm's services throughout the Midwest... **Pogo Records**, central Illinois' best-established independent recording company, has built **Pogo Records Recording Studio** in Champaign, IL. Intended specifically for independent record production, Pogo Records Recording Studio features a combination of state-of-the-art modern and vintage recording equipment in a 75-year-old historic brick building in the heart of downtown Champaign. The studio features a Studiomaster 24 x 8 mixing console, a 1964 12 x 4 UREI tube mixing console (used by the Shadows of Knight, Turtles, Buckingham, and other '60s groups), a 3M 16-track (2-inch) tape deck, and plenty of outboard gear... **Charles Brown Music** of Cincinnati has opened two new studios: the 8-track SMPTE interlock "Palm Room" and the MIDI-controlled "Synth Room." The Palm Room features an Allen & Heath Syncon B console, Otari MX5050 8-track, and more; the Synth Room boasts a complete Yamaha DX7/QX1/TX816 system with a Roland SBX-80 for SMPTE interlock, etc... **Henry Root**, president of **Hy James**—The Audio Professionals—announced the addition to its expanding staff of **Paul Grzebik** as a broadcast equipment specialist...



*The choice of those  
who can choose.*



Lexicon 224XL  
digital reverberator,  
room simulator  
and effects processor.

Lexicon Inc.  
60 Turner Street  
Waltham, MA 02154  
USA  
(617) 891-6790  
Telex: 923468

*Lexicon International*  
*P.O. Box 122*  
*8105 Regensdorf*  
*Switzerland*  
*(01) 840 0144*  
*Telex: 59222*

**lexicon**

# Create a room

**YAMAHA** REMOTE CONTROL UNIT PCR-1 FOR DIGITAL REVERBERATOR REV-1

REVERB WAVEFORM

DISPLAY  
W.F. F.C. BIT RATIO

E.P.R. REV. P.S. M

LEVEL METER  
IN OUT

PRESET  
1 2 3 4  
5 6 7 8

PANEL  
P EDIT AUTO

MEMORY  
67  
M STR RCL

FUNCTION  
R/T D1 D2 M

400 10K  
200 8K  
100 6K  
50 4K

REPTIVE R/T  
2.6 sec  
MID-LOW

E.P.R. MODE  
1 2 3 4  
5 6 7 8

ROOM SIZE

E.P.R. NUMBER

LIVENESS  
E.P.R. DELAY1 (D1)  
40 ms

REV MODE  
1 2 3 4  
5 6 7 8

HIGH

4K 2K 1K  
MID-HI

500 250 125  
LOW

REV DELAY2 (D2)  
58 ms

AUTO

ON DIRECT

ON EARLY REFLECTION

ON REVERBERATION

ON MASTER



# with a view.

We'd like to open your eyes to the incredible REV-1 digital reverb. Because it gives you unheard-of control over virtually all reverb parameters. And something that has never been seen in any type of reverb: the capability to "look" at the sound as well as hear it.

The remote unit that controls the nineteen-inch rack-mountable unit has a lighted high-resolution LCD display that graphically depicts the results of the adjustments you make.

So getting just the right reverb sound is no longer a question of trial and error.

The logical grouping of the parameter controls on the remote also makes it easy to create any effect you like. Then store it in any of 60 memories for instant recall.

The remote also contains 9 additional RAMs so you can store programs and carry them with you to use anywhere there's an REV-1.

And there are 30 additional ROMs with factory preset sounds. Many of which can be completely edited (as can the user-programmed sounds) by using the LEDs to tell you the set value or indicate in which direction to move the control so you can easily and precisely match the value of the originally programmed sound.

And the sound itself is far superior to any other digital reverb. The REV-1 uses specially developed Yamaha LSIs to create up to 40 early reflections and up to 99.9 seconds of subsequent reverberation. So the effect can be as natural (or unnatural) as you want it to be.

We could go on about the REV-1. Tell you about its 44.1 kHz sampling rate that provides a full 18 kHz bandwidth to prevent the natural frequency content of the input signal from being degraded.

How it has a dynamic range of more than 90 dB for the delay circuitry and more than 85 dB for the reverb circuitry.

But why not take a closer look at the REV-1 at your authorized Yamaha Professional Audio Products dealer. Or for a complete brochure, write: Yamaha International Corporation, Professional Products Division, P.O. Box 6600, Buena Park, CA 90622. In Canada, Yamaha Canada Music Ltd., 135 Milner Ave., Scarborough, Ont. M1S 3R1.



*"EARLY REFLECTION" display mode showing room size and relative level and time of discrete reflections.*



*"REVERB DENSITY" display mode showing level and relative time of subsequent reverberation.*



*"REVERB TIME" display mode showing difference in reverb time in each of four frequency bands.*



*"MEMORY TITLE" display showing the titles of internal ROM memories.*



## YAMAHA



Student revolutionaries meeting before the Temple. Set by Eiko Ishioka.

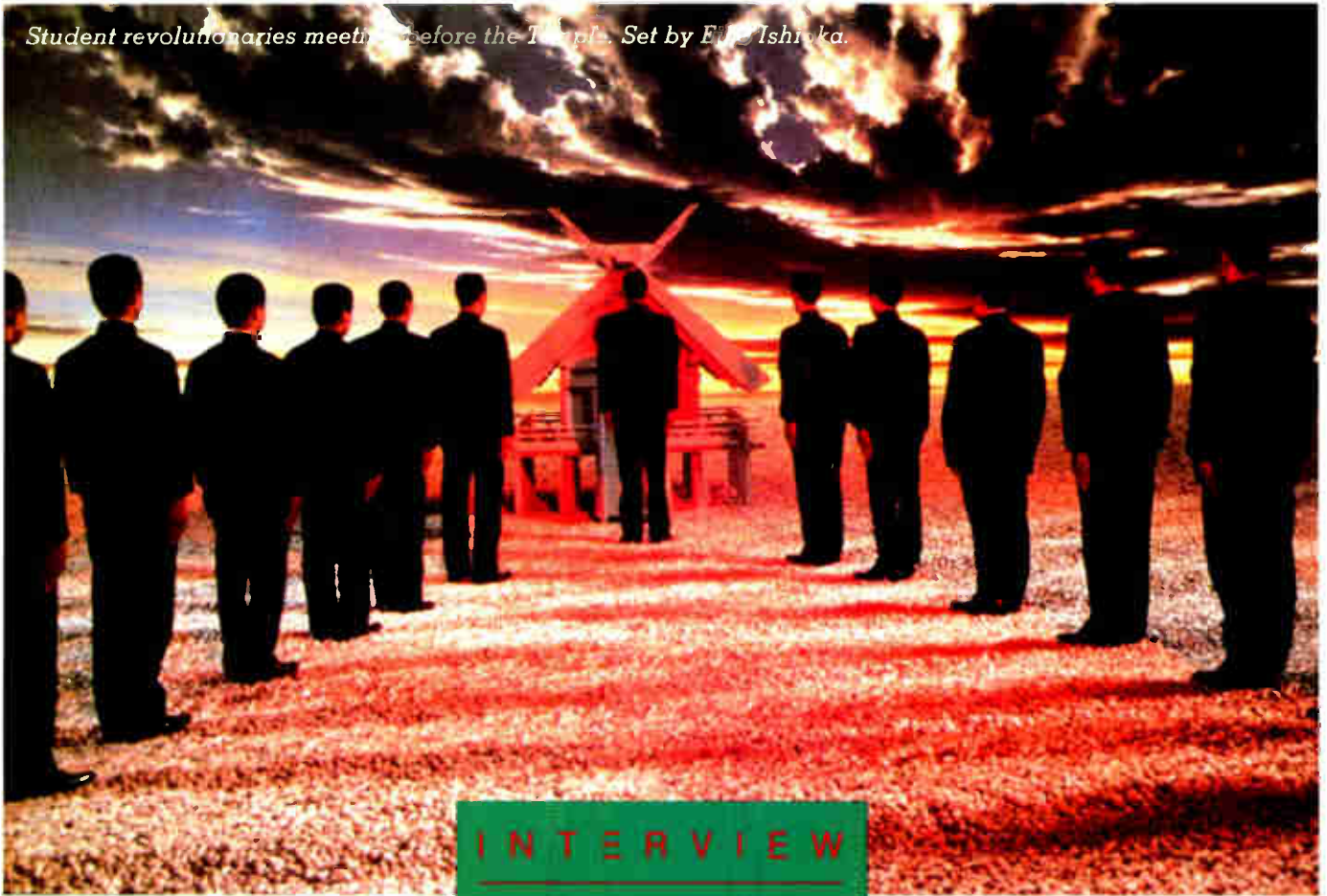

by Nicholas Pasquariello

**H**ow does an American sound designer, who has never been to Japan and does not understand Japanese, go about creating the soundtrack for a Japanese-language feature film about the life and death of that country's foremost post-War cultural hero? Should he travel to Japan to learn something about Japanese culture before embarking on this project; or study the language and customs of this ancient, yet so modern people? And lastly, what would be the best hardware to utilize in creating raw sound for this potentially exotic track?

These were some of the questions Leslie Shatz had to answer after co-producer Tom Luddy hired him to design the soundtrack for the controversial Japanese-American co-production, *Mishima*.

Initially, director Paul Schrader provided Shatz with a complete script of this biographical study of Yukio Mishima—Japan's most acclaimed modern novelist, playwright and author, who committed ritual suicide in 1970 while attempting a military coup at Japan's Department of Defense.

INTERVIEW

LESLIE  
SHATZ

ON

Mishima

REAL & SURREAL  
SOUND

Shatz's work began at the same time as the picture editor's, a rarity for Hollywood films but fairly common for pictures post-produced in the San Francisco area. (Post-production for *Mishima* was done at Lucasfilm and Russian Hill Recording). One of the advantages of such an early entry onto the project was that Shatz was able to screen the partially edited workprint of *Mishima* almost as soon as it was assembled.

In the sections of the film based on Mishima's novels, Shatz discovered extraordinary visuals in the sets of famed Japanese production designer Eiko Ishioka. "Her style is a super realistic one that is surreal. She uses extremely vivid colors and schematic props and archetypes to represent reality and represent ideas and images. It was her work that inspired mine; this was my main preparation for my sound design," said Shatz. (He decided he had all the material he needed for his sound design at hand, and did not need to travel to Japan, after all).

To this ten-year veteran of post-production film sound work, the task ahead was clear: to create a textured, complex sound design analogous to Ishioka's sets.

What hardware would help him create these "archetypes of sound"? On the advice of musician and synthesist



friends, Shatz decided to explore creating sounds on equipment he had never used before—the Yamaha DX7 synthesizer. The DX7 had been recommended for its unusual capability to imitate natural sounds yet create sounds which were disjointed from reality, as Ishioka's sets were disjointed from the reality of Mishima's life in the film.

"So I got the DX7, put it in my editing room and spent two agonizing weeks learning how to program this device. It was really agony. It was like going to school again. I started pushing buttons and for days and days and days got nothing. I got disappointed. I kept playing the cricket sound [which he had successfully experimented with] and thinking: 'We have this. There must be more possibilities.'"

In the following interview Leslie Shatz discusses his solution to this creative block, as well as many aspects of the collaborative filmmaking process on *Mishima*.

(Leslie Shatz's feature film sound credits include: *Apocalypse Now* (1979), *Dragonslayer* (1981), *One from the Heart* (1982), *Rumblefish* (1983), *The Black Stallion Returns* (1983), *Once Upon a Time in America* (1984), *Dune* (1984) and *Mishima* (1985).

*Mix: Give us an example of how you were influenced by Ishioka's sets to do a specific sound effect, sound design or sound sequence on Mishima.*

*Schatz:* The entire concept for the sound for her sequences was derived by the application of the same concept that she used: I wanted to find archetypes of naturalistic sounds and to apply them very specifically and achieve a heightened sense of realism, because that would be the only proper companion to Ishioka's sets.

I managed to program the DX7 to make a nightingale that not only was realistic sounding but one I could perform. I could play it in many different ways. Depending on how hard I pressed the key or which key I pressed, I would get a different nightingale. That was just one effect and at that point things started to open up for me.

*Do you understand why?*

I don't know, I guess it's part of the creative process. All of the days that I felt were spent wasted and just pushing buttons and farting around, I guess on some level I did begin to understand on a deeper level what this machine was doing.

I think if you talk to anybody about the DX7, they'll tell you programming it is a nightmare. There are guys whose specialty is just to do that. At many points I thought: "Oh, God! It's worth it for me to pay my own money to somebody to bail me out of this mess."

But finally I understood how it worked. I started to get wind and wind chimes and different kinds of birds and frogs and ducks and owls and seagulls. These were to be part of the sound design for the section of the film dealing with the first novel, which was *The Temple of the Golden Pavillion*. There was one line that always stood out in my mind: "The beauty of nature is sheer hell." It was a line that this one cynical acolyte said to a young boy as they were walking down this beautiful path.

And so I thought that line was a great banner to keep in my mind as I tried to program these sounds. I was making realistic sounds but when you got them all together it sounded like some kind of prison that these people were in. The beauty was so sweet and treacly and sickening that I felt that it conveyed that concept.

*How much of this was suggested by Schrader?*

Not a single thing. In fact, I hid what I was doing from everybody because I thought they would laugh and say, "Come on, get this stuff out of here. We've got to get down to real work."

One day Schrader came in to the mixing room and was just standing there. He leaned against the synthesizer. He didn't know what it was. And the sound of a car revving up came out of the speaker. Schrader started looking around and asked, "What's going on?"

And then he looked back and I put in the keyboard and he pressed the key and laughed. He realized this was what I'd been doing. And I said, "I've got a bunch of other stuff here, too." He said, "Oh, wow! That's great, fantastic."

I really felt that after all this effort I wanted to sit down and play him every sound and say, "Gee, Paul, this one

took me two weeks. This one took me a week. What do you think of this one?" But he wasn't that kind of guy. He wanted me to get the work done and that was it.

*How long did this preparatory phase last?*

A month and a half, maybe two months. All the while I was trying to lay the groundwork for the rest of the work and we had scratch mixes. Scratch mixes are becoming the bane of the sound designer's existence. First, they [producers and/or directors] want to show the movie in its bare form and then directors get an itch—and rightfully so. They want it to be as good as it possibly can when they project it for themselves and for other people. So, they say, "Do you have the sound of a door opening and closing, a car going by . . .?"

Soon, it becomes more expanded and you start cutting actual sequences of sound and you realize, "Hey, I don't want to do crummy work that's going to be seen by anybody." You can't just say in the screening in the middle of a terribly cut sequence: "Oh, well, this is just for the scratch mix."

So, you start having to lavish large amounts of labor to do it. Then the minute the film is projected the scratch mix is obsolete because they will go back to the cutting room and make changes.

And this was complicated because Philip Glass' music is fairly continuous so you can't cut the scratch mix. So, we would remix the scratch mix and cut all the elements. I was trying to juggle all of that while I was making these sounds with the synthesizer. I wasn't getting a lot of sleep because then I would be remixing the scratch mix at ten at night.

But the big adventure it did have for me was that rather than waiting till the

*Yasosuke Bando as Mizoguchi at the Temple of the Golden Pavillion. Set by Eiko Ishioka.*

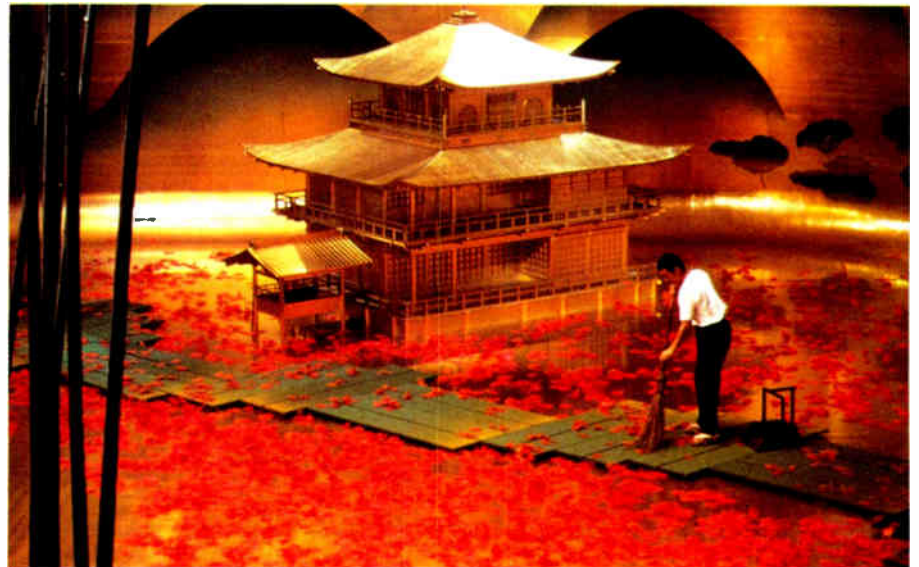

very end to have Paul hear these sounds, I would slip one or two of them in these various scratch mixes, so that people would hear them and become comfortable with them. At first people were very uncomfortable: "Well, what's that? What is that sound? I don't like that."

I guess I was becoming sort of woe-begone because I didn't know if I was on the right track or if what I was pursuing was valid. And finally we had a screening for George Lucas and Francis Coppola [co-executive producers of *Mishima*.] They had several comments about the film and one of them was that they thought these sounds were great and that they wanted more of them.

The sound was one of the elements that was going to differentiate the novel sections from the rest of the film or at least that's the way Tom Luddy related it to me. It made my spirits very buoyant. After that screening Paul came up to me and said, "Do as much of it as you can." Whereas before he was sort of standing on the sidelines, now he was embracing it fully.

*So that was some sort of a consensus?*  
Yes, at that point it was. When Francis and George agree on something it becomes a consensus very quickly.

*How does this compare to previous films you've worked on in terms of the way you went about creating sound and experimenting and researching?*  
Normally, I will sit with a director who will have very specific comments and concepts at various points in the reel: "I want this there and that there." He'll probably want to hear very specific sounds and at that point you go to work in a pretty linear fashion. You gather the sounds you need. You get a crew of people together who can work fast or well. You record Foley and then you go to the mix.

But on this picture [*Mishima*] the director never sat down with me to spot it. He never communicated his vision of the soundtrack of the movie, which I think was evolving all the way along. He wasn't familiar with the mechanical aspects of the soundtrack so I was on my own. Also the budget on the film was low so I had to do things in cost cutting ways wherever I could. For instance, my assistant became the Foley walker and then he became the dialogue editor. I trained him in these various tasks. We normally record Foley on 10 or 12 tracks and it's a big chore to cut it and mix it.

We did the Foley at Russian Hill Recording [San Francisco]. They were very cooperative with us and it was quite an encouraging environment to work in. They recorded to two-inch multitrack tape so we weren't limited

by the number of tracks that we used. We then did Foley in the normal spread-out fashion of up to 12 tracks per reel. We ended up getting the most precise synch on the Foley stage that we could and then we mixed all the tracks down. We mixed 12 tracks down to two tracks; in some cases we have a third track, but not usually. Then the editor just had eight tracks to cut. It was really great because if the synch did become really screwy we could go back to the 24-track and transfer those little bits that were wrong. We didn't have to do that, though.

*Were you given Glass' pre-recorded music track early on?*

He was able to do a temp version of his score for the entire movie within the third week of editing, which is pretty amazing. This wasn't just him playing the piano; it was with bells and strings, all of the instruments that represented what was going to be there in the final performance. And considering that the score runs so continuously throughout the movie, this was such a boon. I don't think the film could have been edited or created in the way that it was without this music on hand so early in that stage of the filmmaking.

I would hope that all composers would be able to move in that direction. So often in a film you work and edit the picture and cut the sound effects and, at the very last minute, they bring in a score that they've spent hundreds of

thousands of dollars on but have only heard once or twice or three times. So there's a mad scramble to try to figure out how it fits with the movie.

We had a complete rendition of the score three weeks into the editing process. Then we cut the score and the picture one against the other. The picture would dictate cuts in the music and the music would dictate certain picture cuts. Then nearing the final cut of the film these notes and cassette of the way the music was applied to the picture were sent back to Mr. Glass. Then he conducted and recorded the real instruments to make the real score onto multitrack.

We brought that back on multitrack to Lucasfilm, where we mixed the music down to the picture, which is a technique that was used exclusively in the old days when music was recorded to three- and four-track and it wasn't a big deal. Now it's not done so much anymore.

Again, in this case I don't see how we could have done it any other way. We used the Q.Lock and locked the film recorder at Lucasfilm and the projector in the big room up to the multitrack downstairs. It was kind of a nightmarish session because the Q.Lock had many problems. But still what we achieved was a tailored mix and a tailored cut of the music because in many cases the music had to be trimmed or expanded.

It was done with the director, composer, the editor, the music producer

---

*(L to R) Samuel Lehmer (RHR) engineer (standing), Marnie Moore (RHR) engineer, and sound designer Leslie Shatz listening to sound cues and foley work created for the film "Mishima."*





# Are YOU Suffering From **THE STEREO NIGHTMARE?**

For years, science has known that many people dream in colour. Recently though, large numbers of television audio engineers are experiencing an entirely different phenomenon: The Stereo Nightmare.

The VTR starts arguing with the synchroniser. The multitracks struggle with the VTR. As the music and efx fight the dialogue, the automation is having yet another brilliant disagreement with itself. The clock looms ominously. The producer is emitting homicidal glares. Maintenance tries to reach the scene, but can't break through the writhing mass of incompatibilities. In the middle of this chaos, a nervous voice comes on the intercom and informs you that the entire management structure has just exploded!

The most frightening thing is that The Stereo Nightmare strikes when its victims are wide awake. The syndrome is all too real. And as it spreads, the industry's loss in man-hours and production costs has become staggering.

Fortunately, there is a cure. Developed by dedicated specialists in a private research laboratory near Oxford, England, it's effectiveness has been proved in case after case, by leading broadcasters and post-production houses throughout the world. We call it the SL 6000 E Series Video System. Our clients call it a dream come true.

If your facility suffers from The Stereo Nightmare, you owe it to yourself and your family to get all the facts. Write for our 40 page colour booklet on the SSL Stereo Video System. Better yet, give our specialists a call. We'll have you working faster and sleeping better — in no time at all.

## **Solid State Logic**

Oxford • New York • Los Angeles • Hong Kong

Stonesfield • Oxford, England OX7 2PQ • (099 389) 8282  
200 West 57th Street • New York, New York 10019 • (212) 515-1111  
5255 Sunset Boulevard • Los Angeles, California 90028 • (213) 463-4444  
22 Austin Avenue, Suite 301 • Simshatsui, Kowloon, Hong Kong • (3) 721-2162

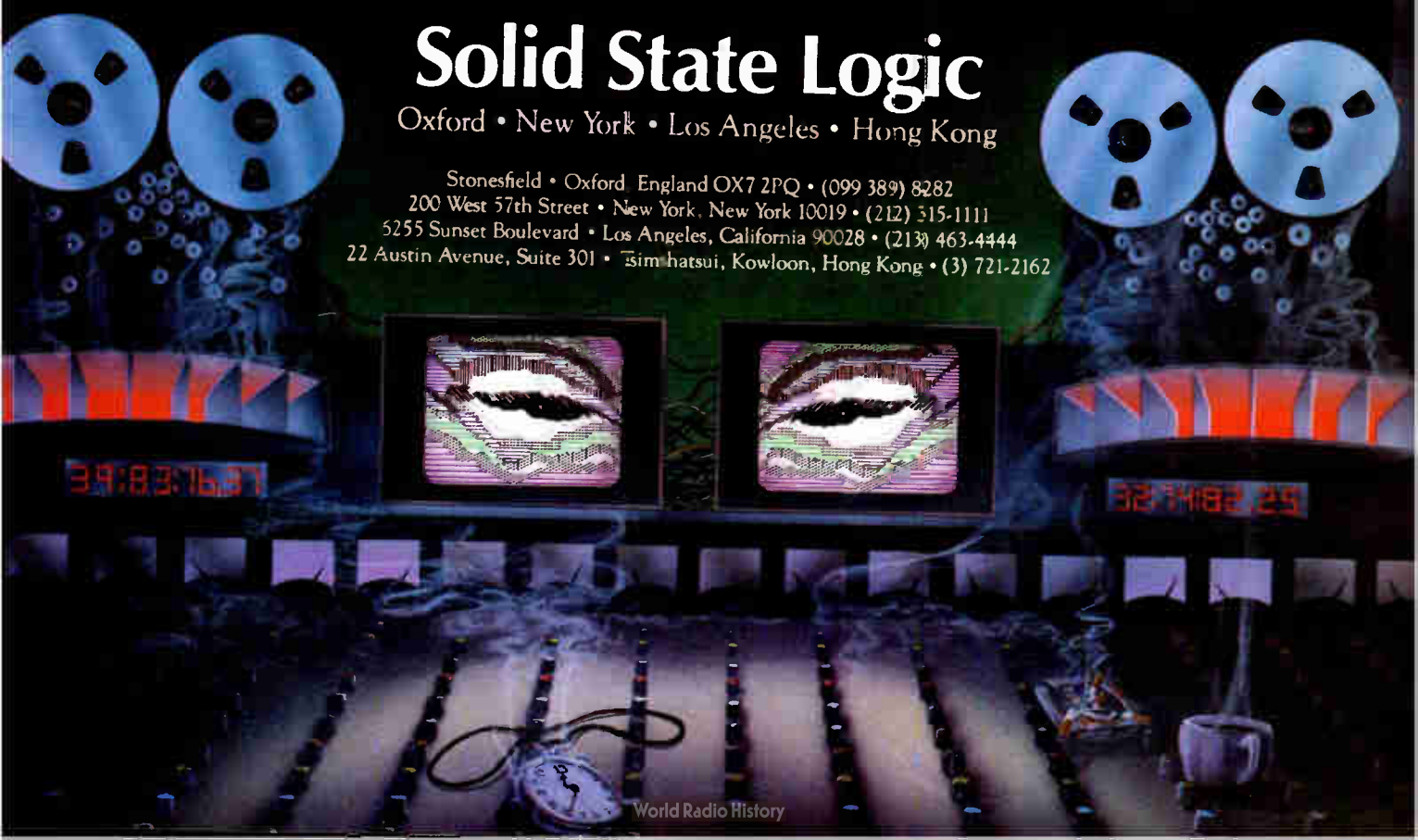

*Ken Ogata as Yukio Mishima posing for a famous photograph.*



a stereo mix regardless of what they said, which is why I prepared my sound effects in stereo.

What we ended up doing was having the parts that dealt with Mishima's final day and of Mishima's biography in mono. We spread the sound image to stereo whenever we entered the world of the novels, which was another way we distinguished the novel sections from the rest of the film.

*Was that your idea?*

Yes, it was, and Paul took to it very well.

*From what I know about the Hollywood film industry, it's hard to imagine that anyone would be given the kind of freedom to research and explore original concepts for sound design like you did on Mishima. Could you imagine working that way down there?*

Every film is different.

*Have you ever worked on a film that way in Hollywood?*

This one [*Natty Gann*] was sort of like that but I snuck it in on them. I never told anybody, "Hey, I'm just going to go off and do sound design and all of this conceptual work..."

*But you snuck it in on Mishima, too.*

Well, yes, it's true, I snuck it in on *Mishima* as far as the director was concerned, but the producer always knew that that's what the film required. That's why he hired me. And it was just a matter of bringing the director up to speed.

Tom Luddy [co-producer of *Mishima*] played a very important role because he got [Michael] Chandler [editor], me, Philip Glass, Eiko Ishioka. He got all of those people around Paul and all of those people had such an incredible contribution. But it's always that way. Filmmaking is collaborative and that's why I find it so exciting. I don't know how well I would do if I was just out on my own, doing my own little compositions and saying, "Here world, here is my stuff." It's so much more exciting to be in the midst of many other people who have great minds and great contributions.

Philip Glass' music inspired me so much. Many of my sounds were tailored to fit within his music. I could control the pitch of the sound on my keyboard to match the key of his music. That worked out very well in certain cases. That was another advantage of having the score so much in advance. I could do stuff that wouldn't be buried by it or try to overpower it. ■

and music conductor and myself there, so there were no surprises.

Nowadays, music is usually delivered on the mixing stage as a three-track—left, center and right—which gives the director no option on how to play it. I think that's a mistake because the mixdown of the music is usually just as critical as the mixdown of the sound effects or the dialogue. There's so much flexibility in the way you mix music in terms of the instruments you choose to feature or, perhaps leave out.

On the movie I'm working on now [*Natty Gann* at Disney Studios] the director likes a particular music cue very well but there's one instrument in it—a marimba—that he hates. The composer gave him a completely mixed-down track so his only option was to drop the cue, which was foolish, so he's going to go back and remix it.

*On Mishima, how many tracks did you deliver to Schrader?*

It varied because certain reels were more complex, but we probably had 50 tracks of sound for any particular reel. There are so many elements involved: dialogue, ADR, Foley. There's a whole set of real sound effects that had to support the real part of the film—the black and white and the biographical section. Then there were the stereo sound effects which were the ones that I was creating.

See, they had never planned mixing the movie in stereo. They had planned mixing it in mono because it was a low budget film and they had the notion that it would be too expensive to mix it in stereo. All the while I felt it was ridiculous to make this movie with a strong element from music and strong element from sound in mono. I was planning on



# If it's worth doing, it's worth doing right.



## We did it right.

It's no surprise that when the key engineers of our PZM<sup>®</sup> microphone technology set their sights on combining the benefits of the boundary effect with unidirectionality, the fruits of their efforts would be nothing less than superior.

After all, Crown has been leading the way in boundary technology longer than anyone in the industry. And, like the PZM project, our commitment to developing the "premiere" unidirectional, surface-mounted microphone rings true.

Introducing the PCC<sup>™</sup>-160 Phase Coherent Cardioid<sup>™</sup> from Crown.

Designed for easy mounting on a boundary surface, the PCC-160 utilizes a subminiature supercardioid mic capsule to create a directional pattern which improves gain-before-feedback, reduces unwanted room noise and rejects sounds from the rear.

For stage reinforcement, podiums, news desks, or for hiding in sets, the PCC-160 offers superior performance.

And because the microphone is mounted on a boundary, direct and reflected sounds arrive at the diaphragm in-phase. The result...wide, smooth frequency response free of tonal coloration or unnatural sound which can occur with conventional microphones.

Self-contained electronics eliminate the need for a sometimes awkward in-line preamp box. The PCC-160 can be powered directly from the console or other remote power source. Or if battery power is convenient, a battery supply unit can be inserted anywhere in the mike line...right up to the console or mixer.

For maximum flexibility, the

PCC-160 features an exclusive three-way "bass tilt" switch which allows you to tailor, up or down, the low-end response for special applications or unusual boundary sizes.

Due to its low profile and "go away gray" finish, the PCC-160 microphone becomes nearly invisible in use, making it ideal for the stage, newsroom or lectern top.

But beneath its cloak of dark gray, the PCC-160 is protected by a heavy-gauge, all-steel body, tough enough to stand up to even the most severe abuse.

The PCC-160. A microphone meeting the needs of today's sound professional with today's most advanced technology.

We did it right.

Call or write for more information and complete specifications.



Crown International, 1718 W. Mishawaka Rd., Elkhart, IN 46517 (219) 294-8000

Circle #007 on Reader Service Card  
World Radio History

by Iain Blair

There's really no need for any lighting in David Foster's spacious den/music room. The sheer number of platinum and gold disks adorning every available inch of wall space dazzle the eye as they reflect each other and the equally impressive number of awards. And a quick glance over them tells quite a story.

## DAVID FOSTER CAN'T SLOW DOWN

There are disks for his album production work with Chicago, Hall & Oates, Alice Cooper, Lee Ritenour, The Tubes, and the cast of *Dreamgirls*. There are trophies for platinum singles like Jennifer Holiday's "And I'm Telling You I'm Not Going," and the Kenny Rogers-Sheena Easton duet, "We've Got Tonight." There are awards for writing and playing on Michael Jackson's "It's the Falling in Love," Boz Scagg's "Breakdown Dead Ahead," Cheryl Lynn's "Got to Be Real" and Earth, Wind & Fire's "After the Love Has Gone." There are arranger/player awards for his work with such artists as Rod Stewart, Paul McCartney, Dolly Parton, Manhat-

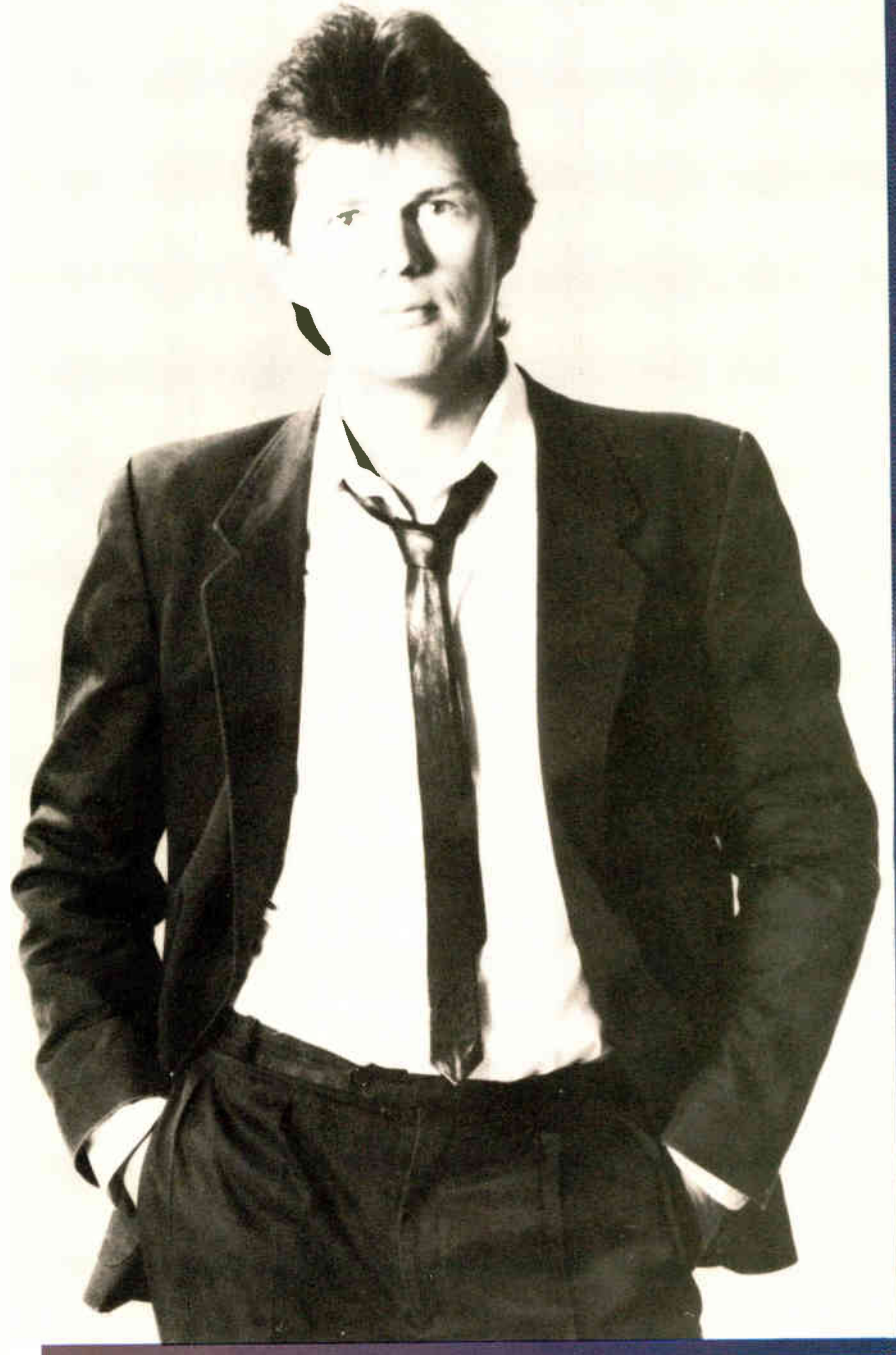

tan Transfer and Neil Diamond. And sitting, almost casually, beside all these riches, is perhaps the most important one of them all—Foster's Producer of the Year Grammy award which he shared this year with Lionel Richie and James Anthony Carmichael.

A few feet away, this multi-talented producer, arranger, songwriter and performer, whose most recent successes earned him a total of six Grammy nominations this year—(that's one more than either Prince, Tina Turner or Cyndi Lauper) is talking animatedly on the phone



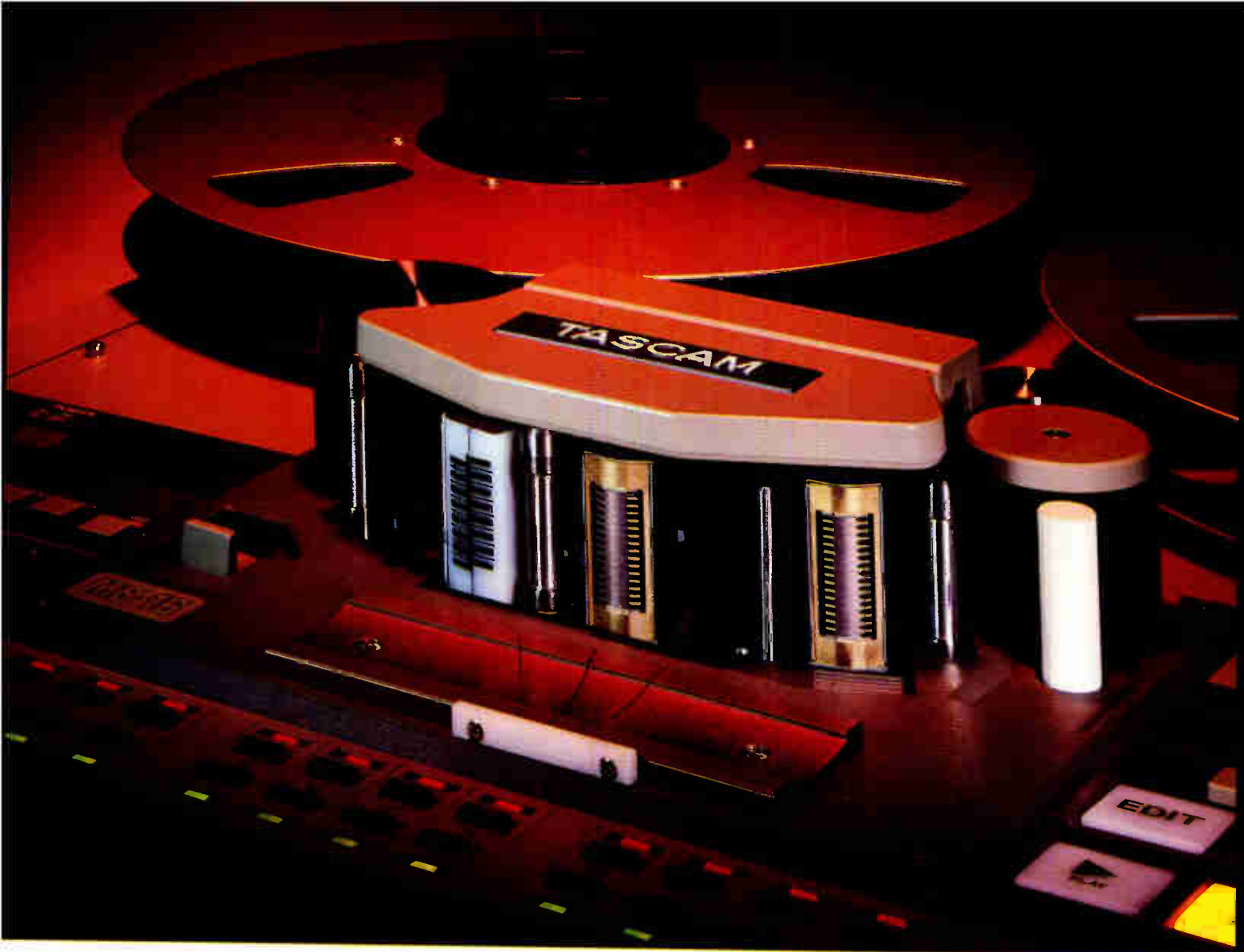

## THE TASCAM MS-16: FOR THOSE WHO'VE HEARD IT ALL BEFORE.

We designed our new 1" 16-track especially for the skeptics. Those who have heard all the other 16 tracks... and all the other claims. Hearing is believing, and the MS-16 delivers enough audio quality to convince the most critical ears. But that's just part of the story. The fact is, the closer you look into the MS-16, the better it gets.

The MS-16's superlative performance begins with our new micro-radii heads. They virtually eliminate "head bumps" and ensure flat frequency response. Put this together with direct-coupled amplifiers throughout, plus ultra-quiet FETs, and you get exceptional transient and low frequency response with extremely low distortion.

Unlike most tape machines, the record/sync and playback heads on the MS-16 are identical in performance, so you can make critical EQ and processing decisions on overdubs or punch-ins without having to

go back and listen a second time. You get what you want sooner and with fewer headaches.

Record/Function switches for each track allow effortless, one-button punch-ins. Input Enable allows instant talkback during rewinds. With the MS-16, you're free to concentrate on the project at hand... rather than on your tape machine.

The MS-16 takes the grief out of locking up with other audio and video machines as well. The 38-pin standard SMPTE/EBU interface affords speedy, single-cable connection with most popular synchronizers and editing systems. And the MS-16's new Omega Drive transport stands up to continual shuttling while handling tape with kid-glove kindness.

Take a closer look at the MS-16. See your TASCAM dealer for a demo, or write us for more information at 7733 Telegraph Road, Montebello, CA 90640.

THE TASCAM MS-16 SIXTEEN TRACK



**TASCAM** THE SCIENCE OF BRINGING ART TO LIFE.

with his long-time associate, engineer Humberto Gatica, about his latest project—building his own home studio.

As he goes over the specs with Gatica, Foster also juggles calls regarding scheduling for the soundtrack he's just completed for *St. Elmo's Fire*, publicity for the Northern Lights African famine relief sessions (which he co-wrote and produced), and the possibility of getting together again with McCartney to finish up some tracks they worked on together last year in Britain.

After the interview, it's a quick photo session, then lunch with some studio executives anxious to pitch another film project, then back in the studios again. "Can't Slow Down" seems like the perfect title for Foster's life right now—but he's not complaining. "This year's just been incredible for me so far, and I'm enjoying every minute of it," he says. "Last year, I went through a period when I began to get really burned out on everything, and I knew I needed to take a break. Now, I'm back on top and things are going really well, and I'm busy planning my own studio which is something I've wanted to do for quite a while—so, no complaints."

• • •

*Mix: How does it feel to be voted Producer of the Year?*

Foster: Great. Wonderful. Really, I'm very honored and proud to get the award, especially considering I was up against guys like Michael Omartian, "Mutt" Lang and The Cars, and of course Prince; so it was quite a thrill.

*Do you consider yourself to be a very technical producer?*

Not really. I'm technical only to a point. Fortunately for me, I have Humberto who's extremely technical and always reaching for something new, so we push each other.

*What are your working methods in the studio nowadays?*

The way we've been making records lately, with very few exceptions, is that I'm playing keyboard bass on most tracks, as well as most of the keyboard parts. In fact, the film soundtrack we've been working on, for *St. Elmo's Fire*, is almost exclusively all me, with the exception of a couple of sax licks and a few tom overdubs. The rest is all me, and the advantage of recording like this is the total control you get.

Anyway, lately we've also been using a lot of machines—drum machines, AMS, and triggering and sampling, such as programming the Emulator II to sample French horns. I've also been using the Kurzweil MIDI'd to the Emu II for low cello sounds, and the Kurzweil itself for the high string sound. It's easily the best I've ever found. It all goes back to when I did the *Dreamweaver* album with Gary Wright and

he showed me a string ensemble and it blew me away. That was the first time I'd heard strings coming out of a box, and I was totally amazed! Now, the Kurzweil has taken that many steps further which is fantastic. You can literally recreate the entire spectrum of the orchestra in the control room now.

*What about drum tracks? Do you still prefer to use a real drum sound, or a machine?*

Well, something we've started doing recently—and it's not a particularly new trick, although it's new to us—is to have real drummers come in the studio and play the song first, and then program what they play. That way, you get the drummers' fills, etc., instead of boring keyboard player's fills, 'cause what do we know about fills? It gives you the best of both worlds. The other thing of course is to have a real drummer trigger loaded AMS bass drum and snare. And now they have a touch-sensitive AMS so you can get the emotion and dynamic range that was lacking before.

*Are you also using more effects these days?*

Yeah, especially echo. We've been getting into a lot of different types of echoes—I mean, I used to just think that echo was echo. I didn't even realize that you could EQ it, or that there were so many different types. So recently we've been using six sends. We've been using two EMT 250s, and the AMS delays, and all sorts of delays, and then when we mix we use six foldbacks of echo. We started working with this setup during the *Chicago 17* sessions, and now we use it all the time.

Now, in one sense, all that sounds like we're doing pretty well. But on the other hand, when I listen to the stuff that's coming out of Britain, it just blows me away. I mean, guys like Trevor Horn are absolutely brilliant, and I think in terms of state-of-the-art production they're simply miles ahead of us. We're just loping along, trying to keep up with them. Just listen to what Horn did with *Frankie Goes to Hollywood*. Whether you like the group or not, there's no denying that his production is just amazing.

*What do you think the main difference is between the "British sound" and the "American sound"?*

(Laughs) Could it be as simple as the Neve board? To me, Britain has always produced great, innovative "sounds." And even though a lot of it is originally copied from the "American" sound, they go off and do their own thing to it, and the results are just incredible. I mean, I don't particularly love Boy George's voice, but his music and the production values are fantastic. And all those British bands, like Tears for Fears,

Wham, and The Thompson Twins all sound amazing and unique.

*I think a lot of people would say that you've also established a fairly identifiable, trademark sound that's essentially very polished and sophisticated.*

Yeah, well I guess Humberto and I have achieved a sound that's recognizable—the "Chicago sound" or whatever—and I don't think we'll ever be able to sway from that too far. On the other hand, the "pursuit of perfection" doesn't interest me as much as it used to. By that I mean that in my twenties, I'd go to any lengths and spend hours and hours getting exactly the sound I wanted. But today, I just don't have as much patience as I used to. I don't know whether it's because I'm getting older, or what. So now the classic line in the studio is, "Will the 14-year-old girl from Illinois think it's out of tune?" "Would she demand that you do one more vocal take for that passage?" and the answer of course is *no!* I used to spend two days on background vocals, but it's simply not practical anymore. It's also prohibitively expensive with today's studio costs. And yet I still love Steely Dan—it's the ultimate in terms of production.

*You're always associated with artists like Lionel Richie, Hall & Oates and Chicago. Have you ever had the urge to get into something totally different, like heavy metal for instance?*

It's funny you should ask, because although I obviously love working on a project like *Can't Slow Down*, at the other end of the spectrum I also love guys like Van Halen, although I suppose they're more hard rock than heavy metal. But yeah, I really like a lot of that stuff. I really think I love heavy metal now because I never paid any attention to it when I was growing up, when most of my friends were into it. I was far too busy being arty-farty. And now, a generation later, I'm really enjoying it. I mean, I love Twisted Sister, believe it or not. Their "We're Not Gonna Take It" is great—it's the Alice Cooper of the '80s!

*What artists would you like to produce that you haven't worked with yet?*

That's tough, because the artists that I love that are out there making great records are doing fine without me. I've always loved Bowie, but what does he need me for? I may do something with Barbra Streisand—we've talked about doing an album of Broadway tunes, and that's to me what she still does the best.

*It seems that you tend to work with already well-established artists.*

I guess that's true, although I just produced this group called The Payolas.



# These people are bananas.



One of these people spent four frantic years on the road with Pablo Cruise; one has a hit rock video in European distribution; another keeps getting stupid song-writing awards for brilliant songs; one has done dozens of national tours with acts like Santana, Bob Dylan, and Blue Öyzer Cult; one is a Canadian, and another has put in so many hours in the control room that his skin is translucent.

#### What's in it for you?

When you're shopping for, looking at, or just wondering about audio equipment, a call or a visit to Bananas gets you a lot more than

just specs and buzzwords. Bananas people are not just sales-wise, they've used the equipment in actual combat, and they know how it feels to be stranded by a lack of honest information and real service. So they'll never leave you in the lurch.

#### What's in it for them?

A great environment, and an opportunity to be creative about solving clients' problems, instead of just moving merchandise—and that's an attitude that starts at the top. Granted, it's an unusual situation, but it's why our customers become our friends.



(The top banana)

#### The Moral of the Story:

Don't let Techno-Trauma drive you crazy . . .



## Get serious, go Bananas.

**Extra:** Could these people put out a newspaper? You bet! And it gets rave reviews for providing information you won't find in the trades. For a one year subscription send \$1.00 to:  
**Bananas At Large** • 802 Fourth Street, San Rafael, CA 94901 / 415-457-7600

Circle #009 on Reader Service Card

# ***YOUR WORLD***



© 1993 3M Co. All rights reserved. Registered trademark of 3M. Photographed at Soundworks Digital Audio/Video Studios, Ltd., NYC.





For you, it's the sixth session of the day. For them, it's the biggest session of the year. So you push yourself and your board one more time. To find the perfect mix between four singers, 14 musicians, and at least as many opinions. To get all the music you heard on to the one thing they'll keep. The tape.

We know that the tape is the one constant you have to be able to count on. So we make mastering tapes of truly world-class quality. Like Scotch 226, a mix of Scotch virtuosity and the versatility to meet your many mastering needs—music, voices, effects. And Scotch 250—with the greatest dynamic range and lowest noise of any tape, it is simply the best music mastering tape in the world.

Both offer a clearer, cleaner sound than any other tape. Getting you closer to your original source. Plus, they're both backed by our own engineers a call away. They are just two of the tapes that make us... number one in the world of the pro.

# OUR TAPE

MASTERS OF CLARITY.

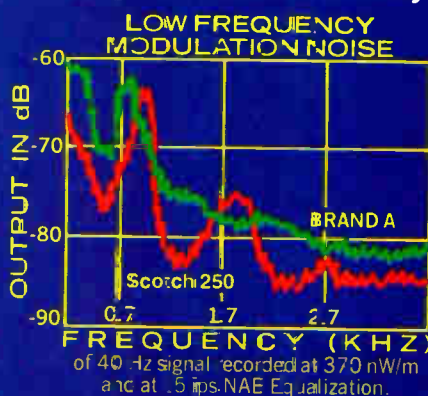

# Scotch®

AUDIO & VIDEO TAPES

NUMBER ONE IN THE WORLD OF THE PRO





*David Foster shares the 1985 Producer of the Year Grammy with Lionel Richie.*

Hopefully the album will do well, and their single just hit the charts, so that may become one of the missing pieces for me—to break a new artist. I think one of the things you're always aware of as a record producer when you work with an established artist like Lionel Richie or Paul McCartney is that there are a lot of people out there who'll buy their latest album regardless of who actually produced it, whereas with a new band the sound of the record is all-important.

*What about the work you did with Paul McCartney? How did that come about?* I think Paul was looking for some fresh input, and he invited me over and we ended up spending ten days or so together last October doing some pre-production work for his next album. Unfortunately, it also came at the tail end of my burnout, when I came off the Fee Waybill album thinking "I've got to take six months off completely, and just get away from all the pressure." I mean, I knew I needed that break, because I'd really had no time off since I'd toured Britain when I was 16 or so. I was so fried that I barely finished Fee's album—in fact, Humberto actually finished it for me.

Anyhow, instead of taking the six months I needed, I ended up taking just five weeks off and then flying over to Britain to meet McCartney. I knew at the time I shouldn't have gone, but I went, and it wasn't right. I just didn't give him my all. I was very preoccupied and feeling sorry for myself, and wishing that I was back on my boat in Vancouver just relaxing. So, it was the

wrong time. But somehow, miraculously, Paul apparently really enjoyed it, so now there's talk of getting back together soon to finish off the tracks we started.

*What was he like to work with?*

Great! The guy is incredible, and we all had a lot of fun together. But I really believe that under different circumstances I could have been good for him. Let's face it, brilliant as he is, everybody needs a little help now and again.

*Speaking of help, what sort of role does Humberto play in your production work?*

Well, for a start we've been working together for seven years now—and we probably see each other far more than we see our wives! In fact, his role is becoming more important every year, to the point where we've co-produced some things—and I actually feel he's a co-producer in every sense of the word, especially when I'm out front doing stuff like keyboard overdubs. It's almost imperative to have someone to bounce ideas off at those times. The other thing is that he's expanding almost beyond belief into new sounds. He realizes even more than I do that to stay competitive in this business you have to really start stretching in the sound department.

*So it's very much a collaborative process?*

Exactly. He's teaching me a lot, and I think I've taught him musicality, meaning that when I met him, I think he was only musical on a surface level, but he now has a lot of depth, and I think he learned it from me. So it's absolutely an even trade-off, because he's given me

the technical side and is there for me to bounce everything off. The old saying about two people thinking like one is absolutely true for us—we don't even have to communicate verbally in the studio to know what the other is thinking, and that's total compatibility.

*Do you always work together as a team?* Pretty much. We've done everything together except for *After the Love is Gone* for Earth, Wind & Fire where they used their own engineer, the Boz Scaggs album and the recent *Here's the World for Ya* Payolas album. So that's nine out of the last 12 albums we've done together. Humberto also works with Quincy Jones—he did the USA for Africa "We Are the World" sessions (see *Mix*, May 1985)—but basically we're very dedicated to each other.

*Were there any times when the collaboration didn't work?*

At one point, early on in the partnership, about six years ago, we were making a lot of records without much success, and there was a time when I said "That's it. If we don't start getting some hits soon, it's obvious that we work much better alone, and have more success apart." But then it all suddenly kicked in, and we got on a roll. And now we seem to be enjoying a lot of success, both together and apart, so it's a great team.

*Since you started producing, studio techniques have changed a lot, what with the increasing sophistication of synthesizers and drum machines, etc.* (Laughs) You're not kidding! The methods have changed so drastically that it's almost like you have to read up on a bunch of technical manuals at night just to keep up with what's going on in the day.

*Which studios do you like to work in?* I love to mix at Lion Share and Sunset Sound, and for overdubs we've been using The Lighthouse a lot recently. It's small, but it's got a great sound and a 32-input Trident board. Generally speaking, I think what's happened over the past few years is that the swankier, state-of-the-art studios have simply become too expensive to use for overdub sessions. You just can't afford to be experimental at \$250 an hour, whereas somewhere like The Lighthouse is very reasonable and if you decide to spend six hours perfecting a guitar part, it's not crippling. And that makes for better records.

*What about your own studio?*

It's still in the planning stages, but it's something we're definitely going to build at my new place down at the beach. I'm looking for a used Trident



board, or API or small Neve board—probably a 32-input, computer-ready setup, though not with the computer, so that I can keep the entire cost of the studio down to around \$300,000. That breaks down to \$100,000 for the board, \$50,000 for the tape deck, another \$100,000 on construction, and the remaining \$50,000 on mikes and outboard gear, etc.

*You and Humberto must have amassed quite a lot of outboard gear over the years.*

Enough to stock a store probably! I've got a lot of keyboards, everything from my nine-foot Yamaha grand to the Emu II; a Mini-Moog for bass; a Jupiter 8 with MIDI; a DX7; a DX1; the Kurzweil; an Oberheim 8 system; a PPG 2.3. And then there's the LinnDrum machine, the EMT 250; the AMS 6½-second memory; the AMS digital reverb, and a stack of Massenberg equalizers and limiters, etc. Like I said, all this new technology looks daunting, but it allows you to be your own group or orchestra which is incredibly effective, especially doing stuff like soundtracks.

*What about scoring the soundtrack for St. Elmo's Fire. Was that a lot different from producing records?*

In some ways, yes. It was my first

motion picture soundtrack, although I've done a couple of songs for films before. The great side was being able to score it entirely by myself with Humberto. I played all the instruments, so it was like doing another solo album. Total control. The part I didn't enjoy too much was working on all the songs with the various different artists involved. It was very schizoid; one day I'd be recording with Billy Squier, and then John Anderson the next, and John Parr the next, and so on. That got pretty crazy. The other problem was that they suddenly upped the deadline by over a month, so that they could rush release it for the summer.

*Despite such problems, would you like to do more soundtracks?*

Definitely, but the conditions would have to be a bit different, meaning being able to score it and do maybe one title song—and not have to deal with putting together a whole album of various songs and artists. Working in films is a whole different ballgame, though, especially in terms of the business—it's brutal! I'll never forget running into Jimmy Iovine once while he was working on *Streets of Fire*, and he looked like a truck had hit him. But then the stakes and the money involved is so much higher. I mean, you can record

an album for under \$100,000 quite easily, but with a movie you're talking a minimum investment of a few million. I mean, the advertising budget alone for *St. Elmo's Fire* is around \$7 million. It's staggering.

*Apart from all your record production, film work and projects like the "Northern Lights" famine relief sessions, you still find time to lecture.*

Yeah, time is always the problem, but I feel it's important, and I consistently do five seminars a year. I also have a song-writing contest up in Canada, and last year I listened to almost 400 tapes, picked the winner and went in the studios and cut a track. This year, there are over 850 entries, and I simply don't have the time to listen to them all, so a panel will narrow them down to 50 for me, and I'll then take the winner in the studios again. I'm really into helping and nurturing young talent. (Laughs) It's probably the *real* reason I even got voted "Producer of the Year." I started getting real cocky about it, until I stopped to think—and then I understood the real reason. I spend a fair amount of time speaking at these seminars and encouraging young songwriters and musicians, etc., and it never occurred to me that they'd all become voting members one day! ■



## It delivers the punch without the bruise.

When you want to increase sonic punch in production, compressor/limiters are indispensable. Orban's 412A (Mono)/414A (Dual Channel/Stereo) Compressor/Limiter is uniquely versatile—it can serve as a gentle "soft-knee" compressor to smooth out level variations, or as a tight peak limiter to protect from overload distortion.

Most importantly, the 412A always delivers its punch with finesse. Instead of the usual pumping and squashing, what you get is amazingly natural sound: the dynamic "feel" of the program material is preserved even when substantial gain reduction occurs. Like a true champion, the 412A works hard but makes it look easy.

Whether the application is DJ mike enhancement, cart transfers or daily production chores, the 412A is a real workhorse. But the best news is that the most flexible and natural-sounding compressor/limiter is also one of the least expensive.

**orban** Orban Associates Inc., 645 Bryant St.  
San Francisco, CA 94107  
(415) 957-1067 Telex: 17-1480

Circle #010 on Reader Service Card



# Buddy Rich Live

## On King Street In San Francisco

by Elizabeth Rollins

For jazz enthusiasts who wince at the thought of Wham being among the first emissaries of modern Western music in China, rest easy in the knowledge that the big band jazz sound is following in their slipstream. Two one-hour videotaped concerts with digitally recorded soundtracks featuring drummer Buddy Rich and his Band originally shown on Bravo Entertainment Network have been sold to the Shanghai Television Network. Steve Michelson, executive producer and president of San Francisco's One Pass Film & Video, negotiated the deal during a four-city tour of the television industry in China which was sponsored by the Northern California chapter of The National Academy of Television Arts & Sciences.

**How producer Gary Reber bucked the major labels and did it his way—all the way to China**

One Pass, which supplied all facilities and holds exclusive worldwide television rights, has also secured a deal with the BBC, and television distribution representative Ken Stutz says he's talking with about ten other overseas television networks. The shows are also being released this month on several consumer formats: VHS HiFi, Super Beta HiFi and Video 8 with digital sound, Pioneer Laser Disc with digital sound, double Compact Disc, double audio cassette and a three record box set on Mobile Fidelity Sound Lab's new record label, Cafe Records. Longtime Buddy Rich fan Johnny Carson has written the liner notes for these releases.

Surely the Chinese TV grabber is the most unusual angle to this story. One imagines scores of Mao jackets assembled on straw mats around The Box in a rural commune meeting hall on the other side of the world. What does Asian logic make of a 68-year-old cool cat beating the skins, wildly propelling a swell of 15 musicians through time and space? The cultural reaction to this uniquely American sound will certainly be interesting to chronicle. But let's bridle our sociological imaginations for a moment—there are several other facets that make these videos unusual from a production and marketing standpoint.

Producer Gary Reber's idea was to show what meticulous planning and synchronous technological and mar-



MR Series now available with 16-track monitoring. See the entire range at AES New York Booth 216/241.



# M SERIES

**NO MORE SLEEPLESS NIGHTS!**

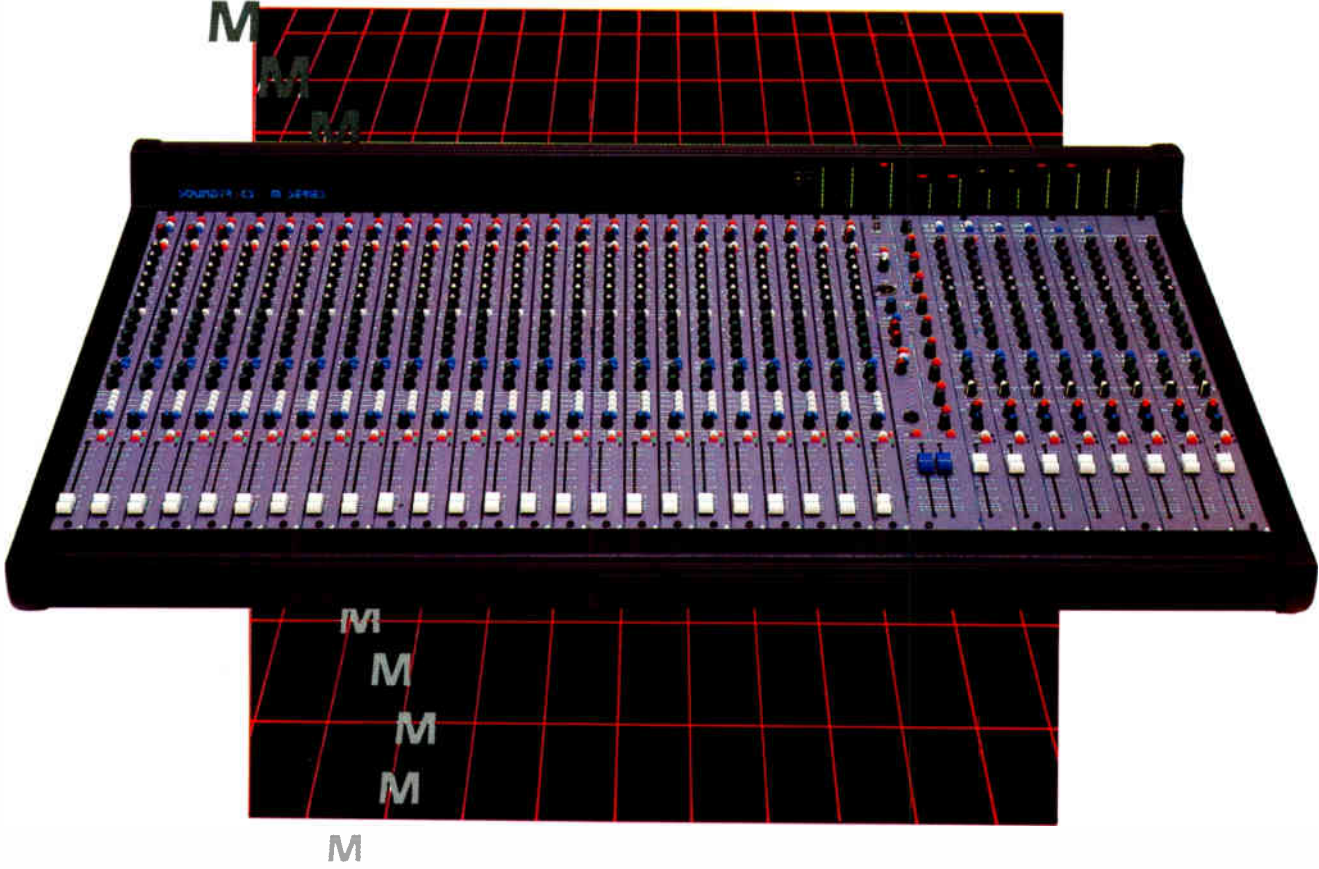

No nonsense eight buss mixing console designed for live sound reinforcement, theatre or eight track recording. Unique facilities such as +30db input headroom, 4 band equalisation, six auxilliary sends, switchable pre or post fade and settable using hand set jumpers to pre or post

equ. By four matrix on each sub group pre or post fade. Stereo return to masters. Fader reverse. Eq on group output, permanent access to all eight busses for effects returns with eq option. Full monitoring of groups. A total solution to an eight buss mixer that will not fail on you; So **NO MORE SLEEPLESS NIGHTS!**

**THE M SERIES BY**



**affordable quality**



COMPUTER AIDED DESIGN

Dealer list and brochure from: Soundtracs Inc. 745 One Hundred and Ninth Street, Arlington, Texas, 76011. Tel: (817) 460 5519  
 MCI Intertec Inc. 745 One Hundred and Ninth Street, Arlington, Texas, 76011. Tel: (817) 469 1600  
 In Canada: OmniMedia Corporation Ltd 9653 Côte de Liesse, Dorval, Québec H9P 1A3 (514) 636 9971

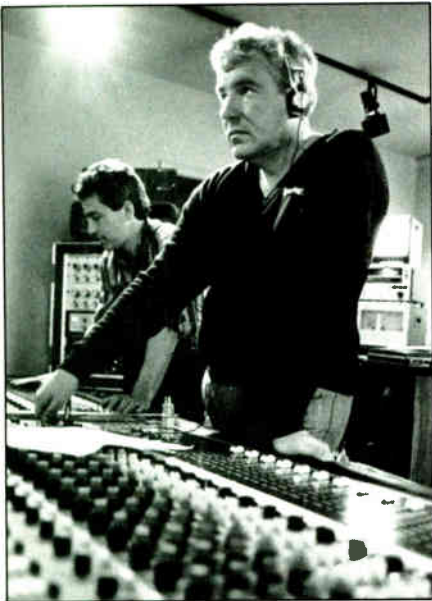

PHOTO: CHRISTI CARTER

*Producer Gary Reber of Bogue-Reber Productions in sound control room at King Street Studios in San Francisco.*

ment, then to arrange a number of consumer distribution deals for both audio and video, while licensing the show to as many non-conflicting television outlets as possible. Manufacturers who loaned equipment would receive tapes of the shows to help promote their products at various trade shows.

When Reber got the agreement from One Pass, a lot of elements fell into place. Not only could they supply the crew, mobile recording truck, post-production facilities, publicity department and distribution network, but their newly opened King Street Studio could provide the ambience of an intimate jazz club, with the features of a full-blown sound stage.

Director and vice president of One Pass Operations, Scott Ross used seven Ikegami cameras, two tulip cranes, and a dolly track to capture the action on the 60x70x20 foot soundstage. Doug Freeman's pink neon, art deco-styled set sat elegantly before a cluster of 30 or 40 cafe tables. The 45-foot Mobile One truck was equipped with a Grass Valley 1680 24-input switcher and Ampex VPR3 one-inch VTRs.

Transforming the spacious but completely empty control room into a top quality recording studio appeared to be the biggest challenge during the shoot. While Reber's main concern was the cleanest, most dynamic and well-balanced mix, engineer Ken Rasek was working with separate pieces of equipment brought in from all over the place, and connected in a room that was not prepared for that purpose.

Another angle that seemed to get practically every major manufacturer into the act was the comparison Reber said he wanted to make between digital and analog characteristics and quality. However the comparison came out, the final soundtrack used for all phases of production and release was recorded with the Sony digital PCM-1610 format. Another digital master was made using the JVC DAS 9000, and for analog: the Studer A810, Nagra T-Audio TC, and the Ultramaster (a custom half-inch 30 ips two-channel system designed by John Curl and Dave Wilson) were used. A Nakamichi ZX-9 cassette recorder and DMP-100 digital processors were used for the producer's reference copy. All of the wiring requirements for the soundtrack production was met by Monster Cable Pro-link interconnect and studio microphone cables.

"Gary has gone way out of his way to get experts in each field—you really have to hand it to him," says Vince Motel of Audio Stuff, who was the Crown PZM miking specialist. In solving the tricky problem of miking a big band, he used the Pressure Zone microphones with plastic boundaries built by Ken Wahrenbrock on the drum kit (the overhead mikes look like futuristic hair dryers in the video) inside the Yamaha piano, on the overheads, and in a large hanging array. "We wanted to get the real effect of a big band," says Motel, "so we went for a *blend* of the 12 member brass section. Gary and I came up with a design for a 200-pound plexiglass array that was basically two three-sided figures that we linked together to catch the blended sound of the entire horn section. We used two PZMs inside, then we hung it out 15

keting efforts can do for a project that probably never would have been undertaken by any of the major record labels. Above all, the 42-year-old Reber strove to capture the most faithful recording of an artist he first became fascinated with when he was nine years old in Dayton, Ohio. "I've always loved Buddy Rich's drumming style. . . Electronics and music have been my hobbies through my whole life. Some guys are into sports or cars, but music, especially jazz, has always been my interest," says Reber, who until 1979 had an established career as an economic development planning consultant, with post-graduate degrees from UC Berkeley and the University of Stockholm.

Eventually, he teamed up with John Bogue in 1984 to form Bogue-Reber Productions, a company that specializes in producing music video using the SQ/Tate matrix encoding system to achieve "surround sound" (an improvement on the SQ matrix quadraphonic, decoder reliant system CBS supported in the mid 1970s). Reber produced digital soundtracks for HBO specials with David Bowie and Dolly Parton using the SQ/Tate system, and with those and other video producer credentials, went on to full-fledged producer status on his own project for Bogue-Reber with One Pass: *Mr. Drums: Buddy Rich and His Band Live on King Street in San Francisco*.

"As an independent producer I can go two ways: I can hire myself out for certain projects, which is fine, but you never own the project; you just get paid for services. Or, I can take on the burden of my own project, which I can work out with the artist and design my own plan for," Reber explains.

The big plan here was to make agreements with a production company and several manufacturers to shoot and cut the show using the best crew and equip-

*The sound control room at King Street Studios was custom built for the Buddy Rich shoot.*



PHOTO: CHRISTI CARTER



feet, and 15 feet up above them," explains Motel. Jean-Pierre Michelou interpreted the design and constructed the array.

AKG tube mikes gave the solos a warm, velvety quality that showed saxophonist Steve Marcus in particular to his best advantage. Countryman Isomax II condenser mikes were clipped to the flutes.

Very little signal processing was used because "This is a big band," Reber says. "It has its own power, and these guys play together night-in and night-out; they've got their sound together." A Lexicon 200 digital reverb was used sparingly, and BBE 202R processing was applied to the rhythm section for transient definition effect.

Chicago engineer Ken Rasek has worked with Reber many times, and has become a specialist at the job of mixing for SQ/Tate projects. To achieve the sensation of sitting in a real sound-field with audio bouncing around on all sides, Rasek used a 16-channel SQ/Tate position encoder console with 360-degree, fixed position pan pots. "With a show like this one you want to get a realistic ambient feel—not some sensational 3-D thing," says Rasek. The "surround sound" quality can only be experienced if an SQ/Tate decoder module is hooked up to a four-channel playback system, but it in no way compromises playback on stereophonic or monophonic equipment.

When it came time to do the logging for post-production, Reber didn't even book off-line time. "We had one program and four iso's on video tape, so with the seven cameras, we knew we had just about every shot. I just listened to my audio (stored on 3/4-inch video tape) through the PCM-1610, and I made my decisions by listening. I'm editing to audio. Sight follows music." After the edit decision list was completed, the master digital soundtrack was transferred digitally to Sony BVH-2000 one-inch video format.

Once the shows were in the can, that marked the start of an entirely separate cycle for the producer. "For a project like this, you can do so much more with a complete marketing strategy. I was able to get Sony, Pioneer and Mobile Fidelity Sound Labs to agree to do cross-promotional co-op advertising for these home video and audio releases," says Reber, the former economic planning and development consultant in him showing. "These people like Buddy Rich have been left behind in the majors' 1985 promotion race. The major labels don't want to spend the time and money to develop the market. But these artists have a great deal to offer. It's really my choosing. What I dig is what I put my time and money into." ■

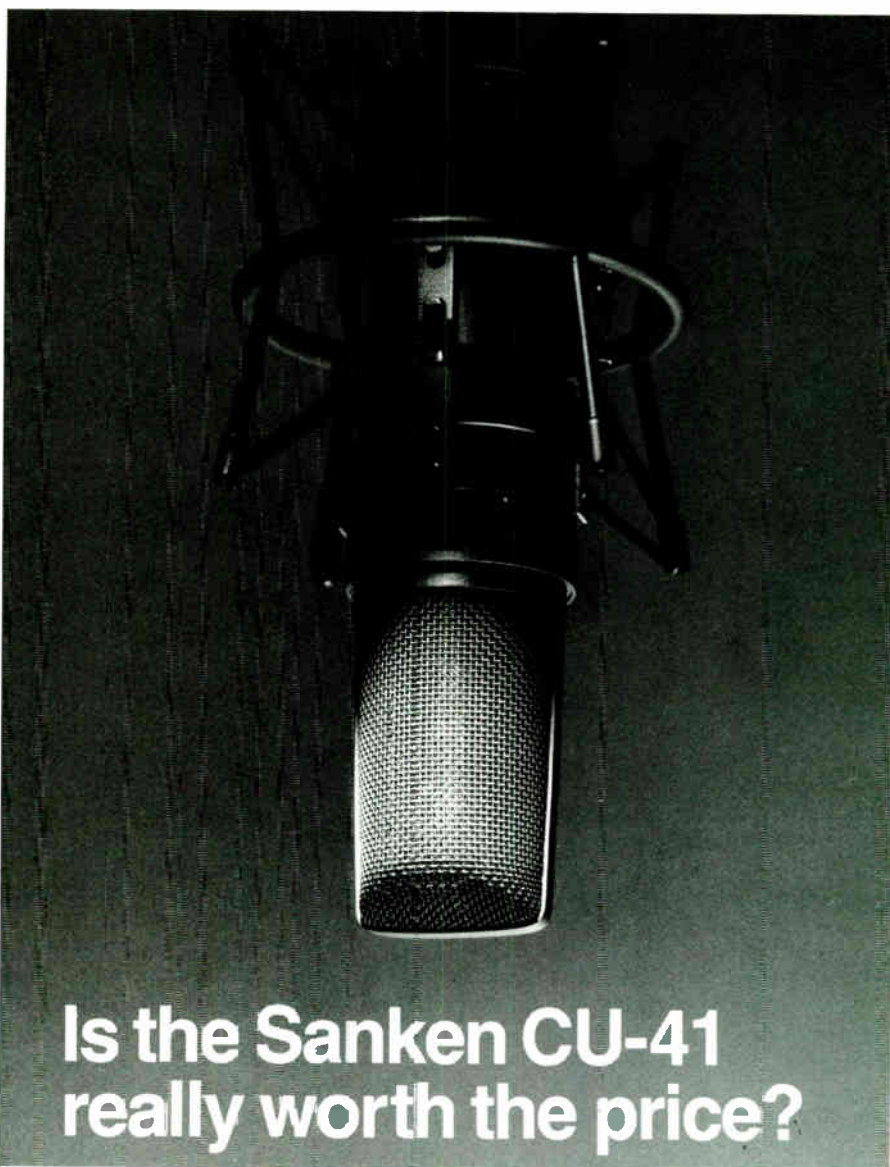

## Is the Sanken CU-41 really worth the price?

**T**he Sanken CU-41 is the most expensive microphone of its kind. Its breakthrough double-condenser design gives you textbook performance: a flat frequency response from 20Hz to 20kHz; an inherent noise level less than 15dB; and a dynamic range of 125dB.

But specs alone aren't reason enough to invest in the CU-41. Neither is the fact that leading sound engineers from LA to London, including Doug Perry, Eric Prestidge, Steve Levine and Tony Faulkner, are using the CU-41 to record the likes of Dolly Parton, Anne Murray, Culture Club, and the London Symphony Orchestra.

To really evaluate and appreciate one of the world's first microphones able to capture the full potential of digital recording, you must try the CU-41 yourself. **Call the Sanken dealer nearest you to arrange a free trial.**

The CU-41 by Sanken.  
Discover the new standard.

**sanken**

Japan's most original microphone maker.

### Exclusive CU-41 Dealers

**Martin Audio Video Corp.**

423 W. 55th St., New York, NY 10019 (212) 541-5900

**Studio Supply Company, Inc.**

1717 Elm Hill Pike Suite B-9, Nashville, Tenn. 37210, (615) 366-1890

Source agent: Par Communications, Inc. 5-72-6 Asakusa, Taito-ku, Tokyo 111 Japan Telex: J27803 HiTech/Phone: 03-871-1370

Circle #012 on Reader Service Card

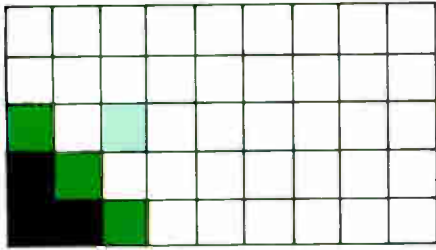

# SEVEN STEPS TO BETTER SYNC

by Paul Matthews

**T**here's no doubt that transport synchronizers have changed the professional sound and video worlds for the better. But sometimes, it seems that getting two (or more) machines in sync long enough to get some useful work done is more difficult than, say, maneuvering the Space Shuttle into an orbit tandem with a tumbling satellite.

There are a number of things you can do to make a synchronizer do its job better and to make it easier to use. While every model is a little different (and you've no doubt learned some tricks to get the most from your particular machine), here are seven techniques to practice that will smooth the sometimes rough path of synchronization.

1. **Use Fresh Code.** Working with time code that was recorded from another tape is inviting disaster. Like all audio, time code quality suffers with each successive generation. Time code is especially vulnerable to the vagaries of magnetic recording, because magnetic recording tape is essentially an analog medium, not a digital one. The recording process tends to round off the edges of the square waves that carry the encoded time code bit values.

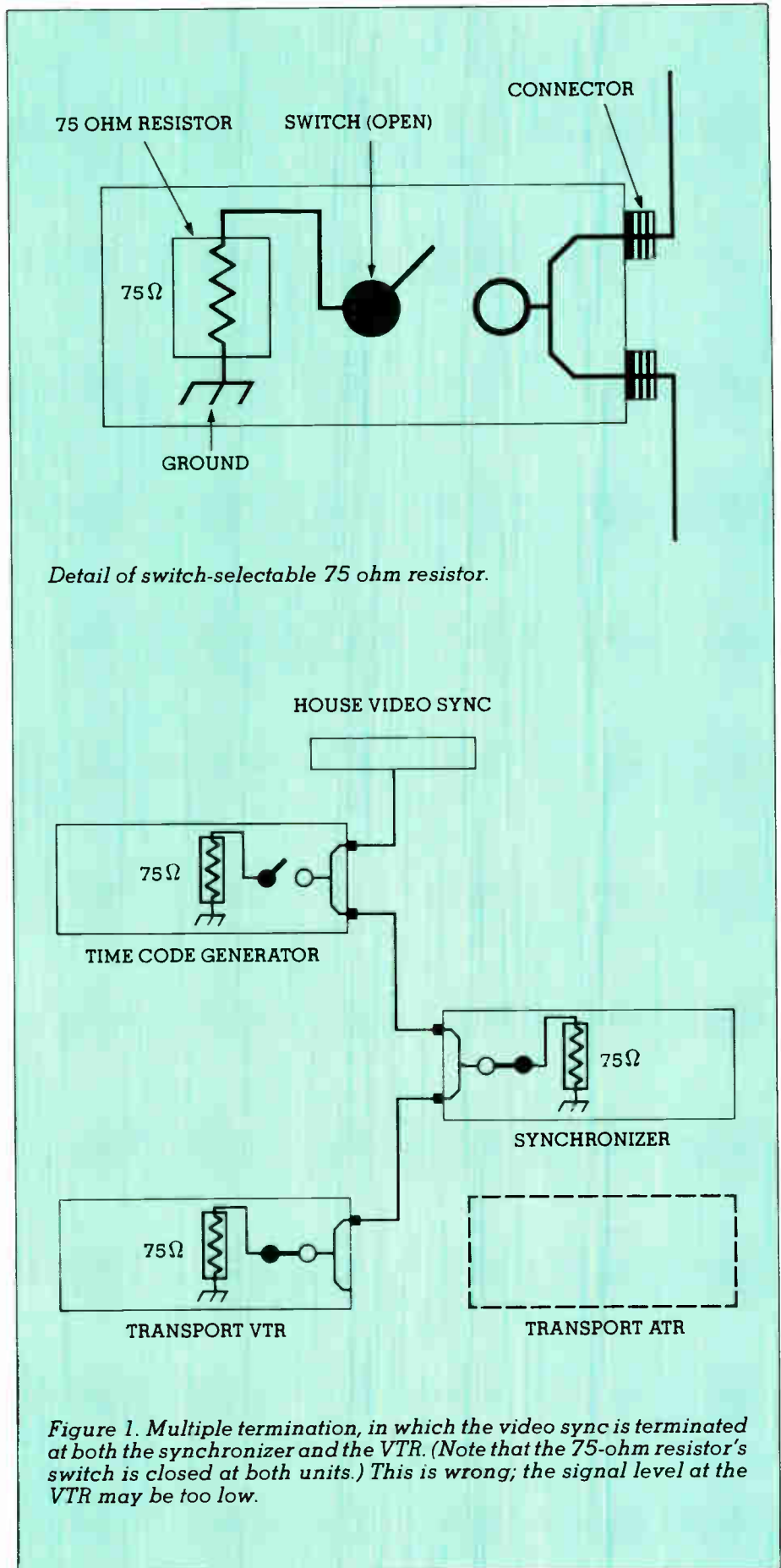



# Before you choose speaker components, listen to Tom Hidley.

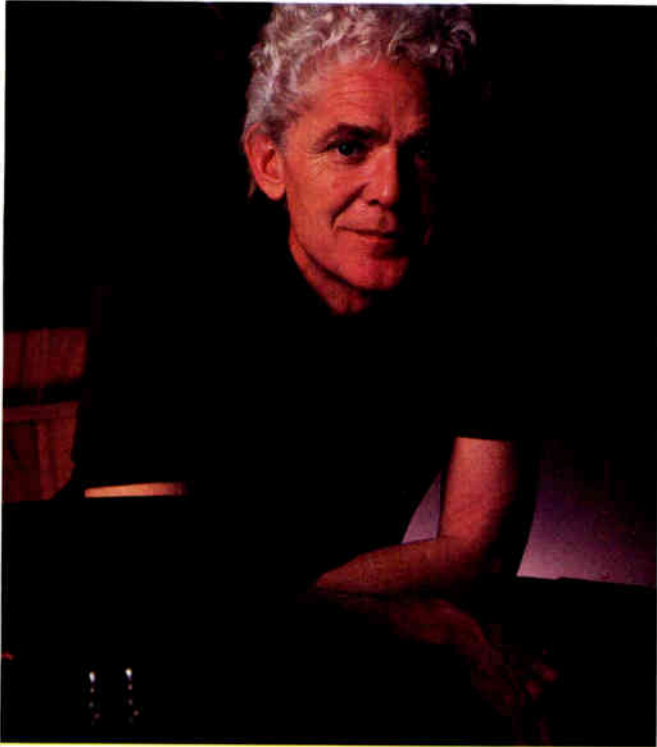

It's a good bet that of all the people reading this ad, 10 out of 10 know the name Tom Hidley.

One engineer we spoke with called him "the best engineer in the world." Another described him, a bit more colorfully, as "pretty damn hot."

But most of you know him as perhaps the foremost studio designer in the world today.

The reason we bring this up is that the speaker components Tom prefers for his clients are the ones we make.

TAD.

---

*"I WILL USE ONLY TAD, UNLESS A CLIENT DEMANDS OTHERWISE."*

---

In fact, he does more than prefer them. Insists Tom, "I will use only TAD, unless a client demands otherwise."

We, of course, are delighted that Tom feels so strongly. But it should also be of more

than passing interest to you, since you want the speaker components you use to be the best.

And on the subject of "best," Tom has some very definite opinions about TAD. "They are the most state-of-the-art, consistent quality products today. Nothing touches their performance, honesty, stability and transient response."

---

*"NOTHING TOUCHES THEIR PERFORMANCE, HONESTY, STABILITY AND TRANSIENT RESPONSE."*

---

There are some sound technological reasons for such enthusiasm. For example, we use only pure beryllium diaphragms in our compression drivers for high speed sound propagation and exceptional efficiency. We also assemble every component by hand, with tolerances as close as a millionth of an inch. And we use exhaustive and esoteric evaluation techniques — such as the Doppler laser and anechoic chamber — every step of the way, from original design right through to manufacturing.

---

*"TAD MAKES THE BEST SOUNDING COMPONENTS I'VE EVER HEARD."*

---

But for Tom, that's all frosting on the cake. "At the end of the day," he says, "it's what comes out of that speaker that determines success or failure. No matter what it measures, it all comes down to what it sounds like. TAD makes the best sounding components I've ever heard."

If you're in the market for professional speaker components, for yourself or a client, we hope you'll seriously consider what Tom Hidley has to say about TAD.

And thanks for listening.

**TAD** Technical Audio Devices

Professional Products Division of Pioneer Electronics (USA) Inc.,  
5000 Airport Plaza Dr., Long Beach, CA 90815. (213) 420-5700.

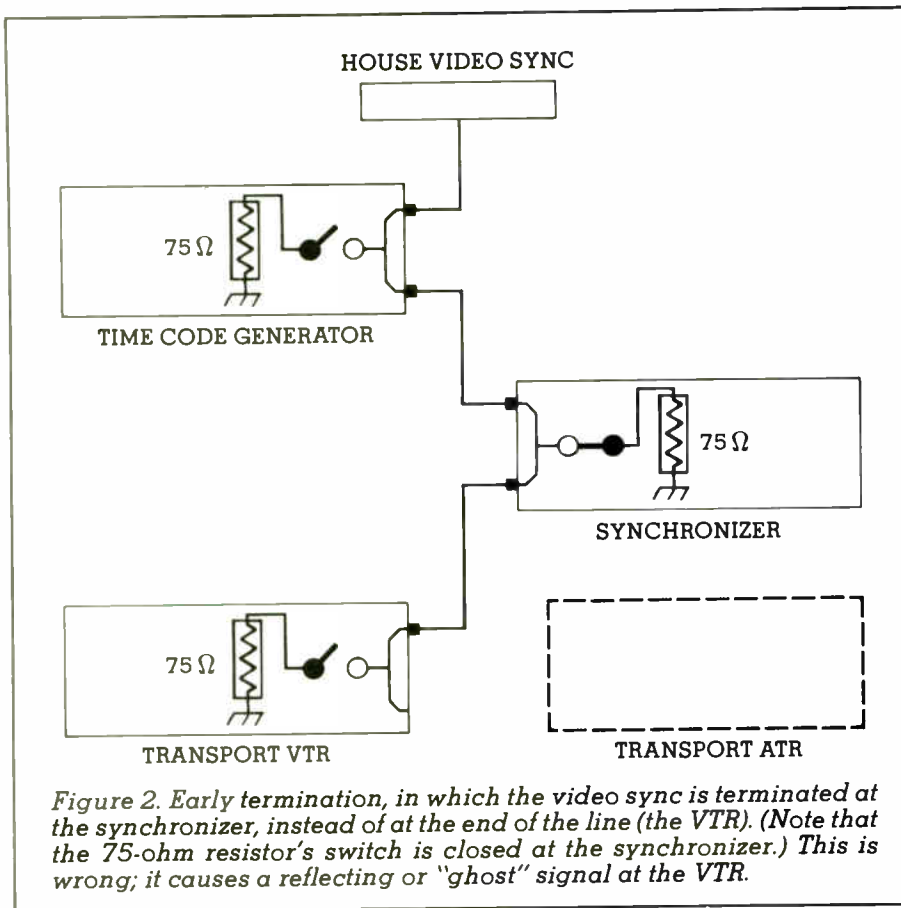

With each generation, it becomes more difficult for the synchronizer to distinguish the rise times. (Signal noise and distortion associated with successive dropouts add to the problem. Small errors occur in reading the code, errors too slight for the operator—but not for the editing system—to notice. You may think you have good time code, but the synchronizer knows you don't.

This rounding is cumulative, worsening with each transfer. While second generation time code may sometimes prove adequate, third generation and older is to be avoided at all cost.

Before using any new reel of tape, stripe it with fresh, first-generation time code created by a time code generator. If for some reason you must transfer time code from one reel to another, route it through a time code generator to reclock and reshape the code before re-recording it.

**2. Stripe the Whole Tape.** It's always a good idea to put fresh time code from beginning to end on a tape. That way you always know that, no matter how long the session or what part of the tape you use, time code will be there.

It's a big mistake to think, "I only need 10 minutes of time code on this tape. I'm only doing one short thing." Two days later, in the thick of production, the synchronizer stops working. You spend 40 minutes trying to track down the cause—including 20 minutes on the phone with the synchronizer manufacturer—only to discover it's because there's no time code on the last take of the session.

Take the time to stripe the whole tape. It'll make life simpler.

**3. Leave Room for Pre-roll.** Laying down time code starting with 00:00:00:00, or starting to record from that point, leaves you no room for pre-rolling.

Synchronizers need to read five to ten seconds of good code before they can "lock" the master and slave machines together. If you don't give them that amount of time for a running start, you'll risk getting distortion caused by fluctuations in tape speed, or missing a record-in point altogether.

Plus, it's a good idea to leave some room in the time code for doing what's known as a "reverse jam." That's where you add time code that increments backwards from a starting point. It's a useful technique when you want to add time code prior to the beginning of take so that it blends right into the code already recorded with the take. (Say, for example, so you can sync some introductory music.)

If, when you layed down the time code, you started the generator at 00:00:00:00, you've got nowhere to go. A reverse jam from that point would be



## Time in your hands

**A**UDIO + DESIGN announces a unique new SMPTE/EBU time code reader. This highly portable unit can be powered by AC or 4 AA batteries; CMOS circuitry and the LCD display allow a battery life of up to 2000 hours. User bits can be displayed at the flip of a switch, plus drop frame and color frame indicators are provided. A rear panel jack supplies regenerated time code at 0 dBv level. Where else can you find all these features in such a compact package (at a very compact price)? Only from Audio + Design.

AUDIO + DESIGN/CALREC, INC.  
P.O. Box 786 • Bremerton, WA 98310 • Phone 206-275-5009, 206-275-5010  
Telex 15-2426

AUDIO + DESIGN RECORDING, LTD.  
Unit 3 Horseshoe Park • Pangbourne, Reading RG8 7JW, England  
Phone (0734) 861088 • UK Telex 848722

**Audio+Design**

FOR THE DIGITAL ERA

©1984 by Audio + Design/Calrec, Inc.

Circle #014 on Reader Service Card



going backwards from 24:00:00:00. If you were anywhere in the older time code section of that tape and instructed the synchronizer to roll the tape to the 24:00:00:00 mark, it would advance the tape right off the reel.

Good time code generators allow you to specify the first time code number when you stripe the tape, so it usually isn't necessary to use 00:00:00:00 at all. Start the generator at 00:01:00:00 instead.

**4. Regulate the Power.** Synchronizers use microprocessors in their work and, like all computers, are adversely affected by fluctuations in the power supply and static on the line.

Changes of any sort in the power can hurt your work. Major drops and surges can cause the unit to "forget" its instructions and cease functioning and, while very annoying, at least such a problem is obvious. More treacherous are minor fluctuations and static that cause insidious errors such as random code errors, misplaced record-ins, etc. Those problems are harder to spot.

Changes in a studio's power are most commonly caused by air conditioners. (Ever notice the room lights dim when one was switched on?) Other culprits include elevators, power company work, other electronic devices or poor earth ground. To avoid problems, regulate the synchronizer's supply of "juice" with either a combination line filter/surge suppressor or a line regulator.

The lower-cost, but restricted, protector is the line filter/surge suppressor. Its filter removes from the AC those frequencies that are higher than 60Hz, while the surge suppressor flattens power spikes. However, it does not guard against power dips or "brown-outs" as does the line regulator.

The line regulator (often called a voltage regulator) keeps the voltage level constant as well as cleans noise from the AC. It is the surer protector against all types of power problems because it "reconstructs" the current to provide a cushion against any power anomalies.

Note that a single line regulator for an entire studio may not be best. While it would filter out power problems that originate outside the studio's walls, it doesn't prevent disruptions caused by equipment on the studio side of the line regulator. It may be beneficial to install a separate unit for the synchronizer's circuit.

**5. Don't Mix Frame Rates.** Synchronizing tapes recorded with different frame rates is just about impossible. Better to plan ahead and avoid the problem. Take for example an attempt to synchronize audio recorded at a drop-frame rate with that recorded at a non-drop frame rate.

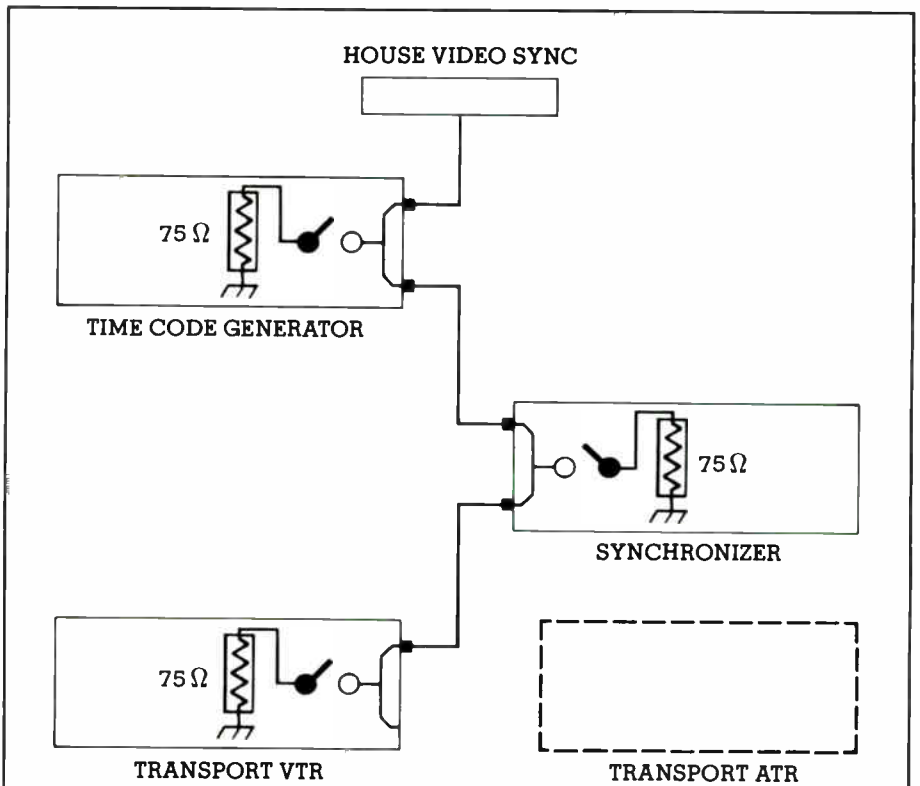

*Figure 3. No termination, in which the video sync is not terminated at all. This is wrong; it also results in reflection.*

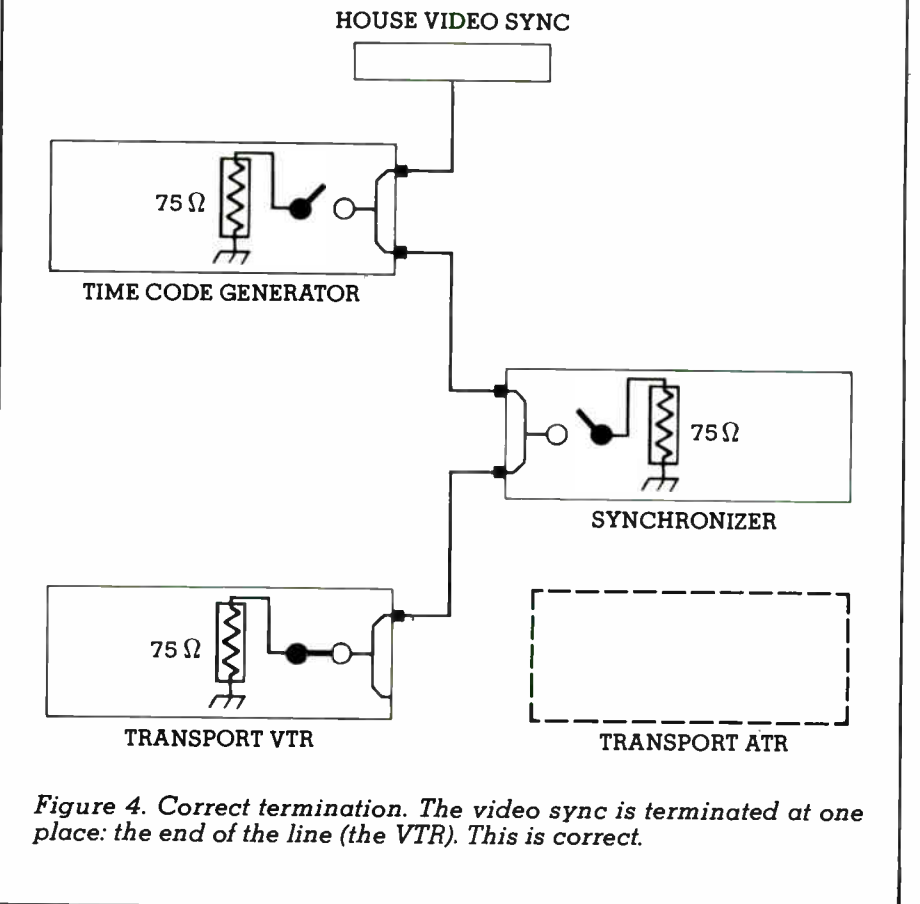

*Figure 4. Correct termination. The video sync is terminated at one place: the end of the line (the VTR). This is correct.*

*You're  
Invited*

The Staff of Professional Audio Services and Supply Company request your presence at our new facility. Formerly a world renowned recording complex, it now features our expanded product line and our acoustically designed demonstration room.

Whether you're buying a whole studio or buying piece by piece, Professional Audio Services will give you master quality recording systems at a competitive price.

.....  
Please R.S.V.P. for more information on all of your audio needs.



Our New Location  
**619 South Glenwood Place**  
**Burbank, CA 91506 (818) 843-6320**

- ACES
- AGFA
- AKG
- Allen & Heath
- AMEK
- Aphex
- Audioarts
- BGW
- dbx
- Electro-Voice
- JBL
- Klark-Teknik
- Lexicon
- Micmix
- Orban
- Otari
- Ramsa
- Scotch
- Sennheiser
- Shure
- Smpl Systems
- Tannoy
- Ursa-Major
- Valley People
- Zetka
- and
- many other
- fine products



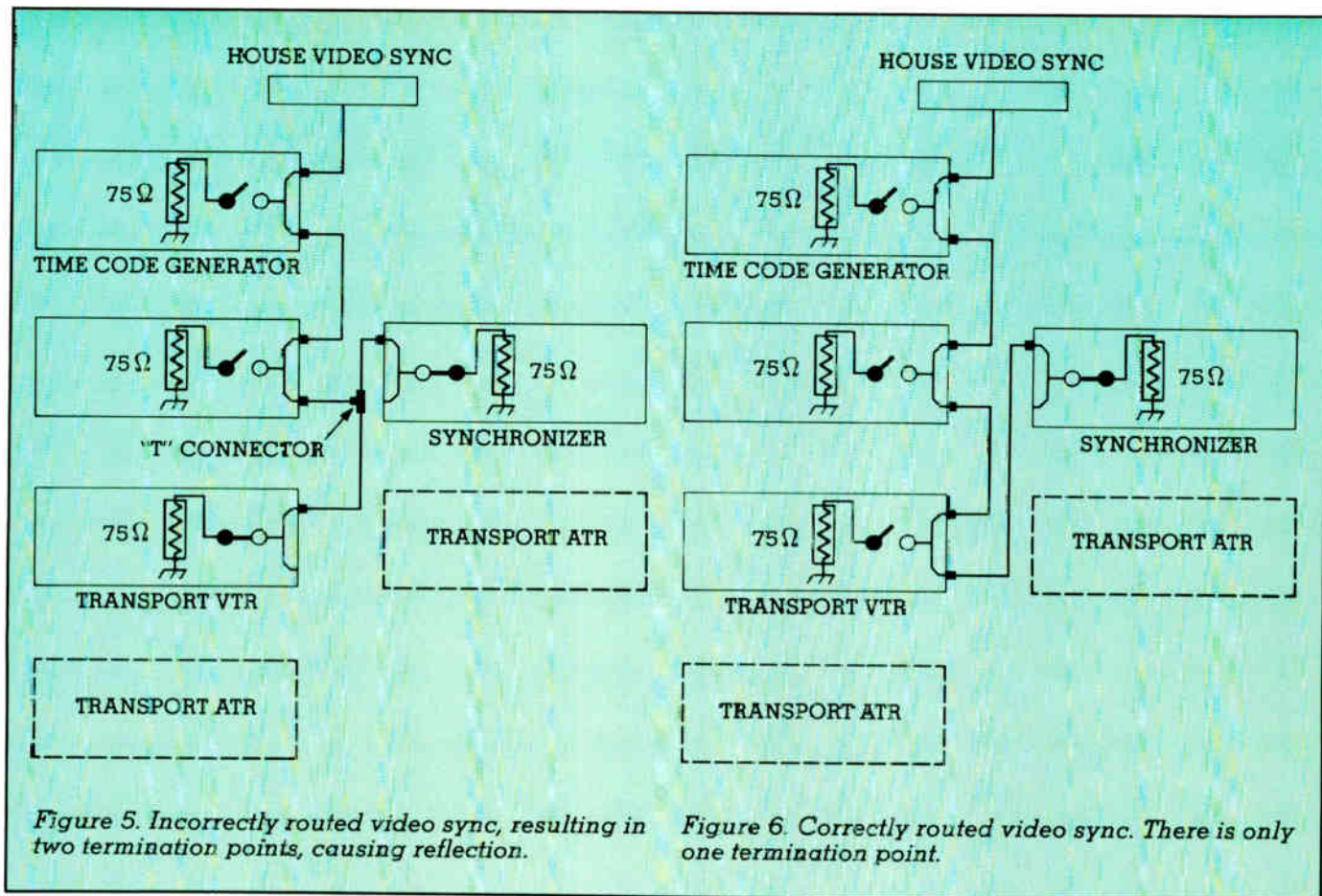

Figure 5. Incorrectly routed video sync, resulting in two termination points, causing reflection.

Figure 6. Correctly routed video sync. There is only one termination point.

"Drop frame rate" derives its name from the method used to adapt the color video frame rate to the frame rate of monochrome (black-and-white) video. The National Television Standards Committee set the color video frame rate at approximately 29.97 frames/second, while monochrome is 30 frames/second. This means that time code generated for a color video program, but clocked at a 30 frames/second rate, would gain 108 frame numbers, or 3.6 seconds of time code, each hour. To make the time code agree with clock time, two frame numbers are dropped every minute except minutes 10, 20, 30, 40 and 50. This is done by dropping the frame numbers :00 and :01 at the change between minutes. For example, 10:42:16.29 skips to 10:42:17:02.

So what happens if you try to synchronize the two different types of time code? Well, if the program material on the tapes was recorded at the same rate (that is, either the color or monochrome sync rate), the program material on the tapes can be locked together but the time code numbers won't go in step. The time code will be virtually useless for editing purposes.

If the material was recorded at two different rates, one program is going to have to be run at the wrong speed. Neither choice is desirable. So plan ahead and avoid the situation entirely.

**6. Avoid Synchronizing Phase-related Material.** The definition here of "phase-related" program material is the content of two audio signals of identical or nearly-identical frequency, carried on separate transports, the phasing of which is critical to the final product. For example, the audio recorded from two microphones miked to the same instrument, or separate recordings of two flutes playing the same passage. In both cases, the quality of the final product rests on matching the incoming sine waves together perfectly.

Unfortunately, no synchronizer has the close tolerance it would take to resolve this precise a phase difference. Synchronizers that advertise a "phase synchronization" capability are being touted for their ability to resolve the phase differences between two time code signals (square waves), not two regular audio tracks (sine waves).

So, if you were to try to synchronize phase-related sounds, the result would inevitably suffer from the peculiar swishing sound known as phasing or flanging. Remember that the term "flanging" itself comes from deliberate attempts to create a distinctive sound by putting a thumb on one transport's feed reel, varying its speed in relation to another transport carrying the same program material.

**7. Correctly Terminate a Video Sync Signal.** This is something you

must do correctly when you use a video sync signal as the reference for the synchronizer. This reference, which includes such waveforms as composite sync, black burst or color bars, is often called "house sync" and piped throughout a facility to act as a central reference for all video applications.

It can affect synchronization not only when the "bad" sync signal is fed directly to the synchronizer, but also by being the source of faulty time code made by a time code generator hooked to the incorrectly-terminated signal.

To be used correctly, the video signal must terminate in a 75 ohm resistor at the last point on the line. That necessity, combined with the ability to loop the video signal through a number of units on the same line, leads to four common video sync problems: multiple termination, early termination, no termination and poor routing.

Most units that accept video sync have a switch that allows you to select termination or non-termination of the line at that unit. In a multiple-termination error, as shown below in Figure 1, such a switch is set to "Terminate" in more than one unit on the same line. That is, the line is terminated not only at the last point on the line, but an intermediate point as well.

This causes the signal level to fall too low; the voltage level is less than it should be. ■

# LOCK AROUND

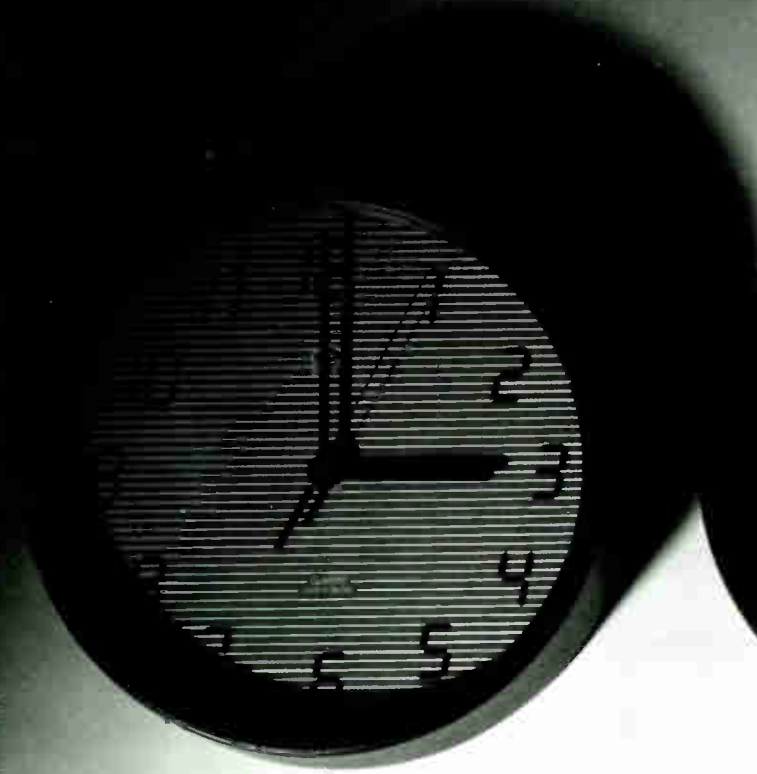

**LONDON**

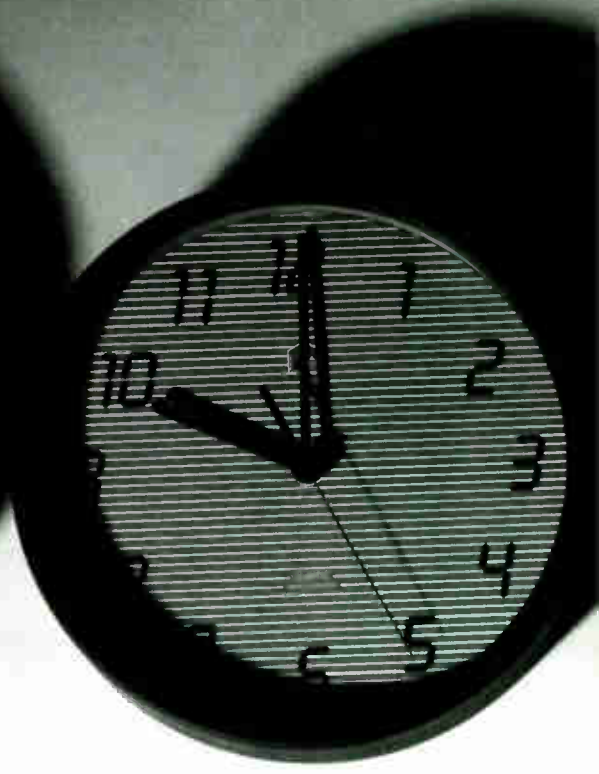

**NEW YORK**



# D THE CLOCK.



**LOS ANGELES**

**TOKYO**

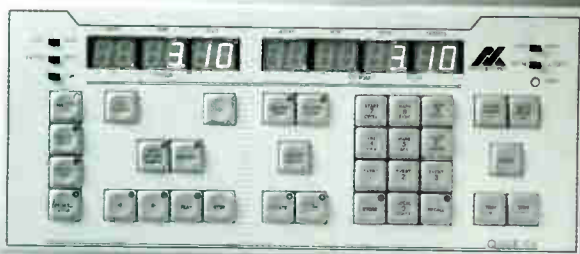

The ability to synchronise video and audio recorders is an increasingly vital facility required in studios all over the world. As much as three-quarters of today's audio recordings involve a visual aspect, and recording is more international than ever before. Basic tracks in New York, string and brass overdubs in London, dubbing in Los Angeles... modern international productions need an international standard for machine synchronisation, and there's really only

one: Q-Lock by Audio Kinetics.

It's the same all over the world. The simple, uncluttered controls. The custom interfaces that suit your machines. The remarkable software capability. The integrated system with built-in expansion possibilities. It all adds up to accuracy and ease of use, and that means speed and creative flexibility. It means Q-Lock. If you're looking for an international standard, you've found it.

Now, more than ever, you need to keep in sync with the times. Lock around the clock - with Q-Lock.

Audio Kinetics Inc.,  
4721 Laurel Canyon Boulevard,  
Suite 209, North Hollywood,  
California 91607, USA  
Tel: (818) 980 5717  
Telex 230 194 781.





PHOTO: LADI VON JANSKY

Frank, at home amidst his lavish recording setup.

# LUNCHING WITH BONZAI

by Mr. Bonzai

## Frank Zappa:

# *Does humor belong in music?*

**I** just left Frank Zappa's house where I finally got to conduct a "lunching" with the maestro himself. Ouch—what a grouch he can be. There I was, well-stocked with a batch of Bonzai questions, whimsical yet pithy, off-the-wall yet down-to-earth. Only hoping that one bozo inquiry wouldn't shoot the whole interview down, I persisted as good-naturedly as possible.

In a world of smelly hypocrites, Zappa is badass and straightforward and hangs loose and does his work—one of those rare characters who doesn't exist for the praise of clowns. Boy, it's refreshing. Even though I was anxious with my desire to really play ball with Frank, at least I could relax with the fact that we both knew he could live without another interview.

When I arrived, he greeted me at the door and



PHOTO LADI VON JANSKY



whisked me into his little video theater: a couple of easy chairs, a large Trinitron and a pair of blastaway speakers. He asked if I would like to watch a few minutes of "Does Humor Belong in Music," his latest audio/visual onslaught. I nodded my reply and settled back to get the real statement of this man—his music, his living theater, his lampoon.

"Doggess," Frank's dog, sauntered over and sniffed my briefcase with an air of airport security. She then sniffed my hand and I offered a friendly pat on the head. Doggess, just like Frank, could take it or leave it. Both of them disappeared into the darkness as the video blasted off—a blaze of fast-cut close-ups and athletic cameraship following musicians in movement on The Pier in New York City last summer. From somewhere I heard Frank shout, "No dissolves, no spin filters, no fog filters." This was video with hard edges, where there is no room for "atmospheric" special effects and visual bandages.

The show is good 'n' BAAAD. He sings his songs and conducts his band with whip-cracking precision. The program, which he produced and directed, is intercut with segments of interviews from various talk shows and press conferences. Through music and conversation, he confronts record companies, disco, Hollywood, Republicans, feminists, gays, and just about every available sore point or tender spot on the soft underbelly of society.

The word is that he feels that our whole scene stinks, that there is little hope for the human race. It's pure, unadulterated Frank Zappa—the enduring professor of punk, and there are yoks galore. It's a food fight for thought.

**Bonzai:** The video is pretty outrageous. You said 'prick,' and everything, right in the first few minutes—who is going to show something like this?

**Zappa:** Have you watched cable television lately? This show is no more outrageous than what they program on Showtime, HBO and The Movie Channel. What's the difference? There is no reason why a double standard should be applied because this is a music show, if you're showing it on a cable system that has explicit sex and R-rated language.

**Bonzai:** Do you feel that television has finally caught up with you after all these years?

**Zappa:** Cable music shows are so slick and blanded-out that they bear no relationship to reality. Why should you expect musicians *not* to have political viewpoints? And why can't they use the same language that characters use in motion pictures? If an artist sings a

song about a character or describes a situation that relates to "real life," he should have access to the same language that a screenwriter uses.

**Bonzai:** Judging from the concert crowds, it's obvious that you have a large following...

**Zappa:** About 20,000 people came to those two shows. There *is* an audience for what I'm doing, but the attitudes of the people who buy shows for television are kind of peculiar. They do not respond well if somebody from the music world says and does the things that I do. Perhaps it embarrasses them—they don't want to deal with it.

**Bonzai:** Where do you think it will be seen?

**Zappa:** I don't know. It was produced in a joint venture with PMI (Picture Music International). They are preparing it for home video release in August or September.

**Bonzai:** Seems to be a natural for home video.

**Zappa:** Yeah, but it still should be broadcast. It's a perfect show for cable. The audio was done on a Sony digital multitrack and mixed down to the PCM-1610. The video shoot used five line cameras and four Sony Betacams. During post-production we took great pains with every shot—image enhancement and color correction—since it was shot live with constantly changing stage lighting, it presented a lot of problems in color balance.

**Bonzai:** Where did you do the post-production?

**Zappa:** Pacific Video—a great place to work. It was just myself, Boeey Cober, the editor, and Rex Ingram, his assistant. Bob Stone supervised the audio here at UMRK (Utility Muffin Research Kitchen). As far as I know, it's the first all-digitally recorded and digitally post-produced music television special.

**Bonzai:** Was it expensive?

**Zappa:** \$150,000 for the shoot and the postproduction, which is not all that outrageous. A lot of work went into it—we shot 40 hours and I reviewed every minute of every camera at least twice before we edited.

**Bonzai:** What is your strongest characteristic as a human being?

**Zappa:** Probably stubbornness.

**Bonzai:** What's the difference between animals and humans?

**Zappa:** Animals are superior.

**Bonzai:** Have you ever witnessed a miracle?

*Our 46th Year*

*Park on the roof*



**RAINBO  
RECORDS**

1738 Berkeley Street  
Santa Monica, California 90404  
(213) 829-0355 (213) 829-3476  
TWX 910-343-6862

**The ONE STOP Center  
For Custom Record  
Pressing and  
Cassette Duplication**

- I** Any Size
- I** Any Shape
- I** Any Picture
- I** Any Color

**In-House  
Mastering • Processing  
Labels • J-Cards**

**Record Jackets  
Picture Sleeves  
Collation • Fulfillment**

**(213) 829-0355**



**No Order Too Large  
No Order Too Small  
10-Day Turn Around**

Circle #017 on Reader Service Card

**Bernie Grundman  
MASTERING**

6054 Sunset Blvd. Hollywood, California

**Complete Disc Cutting Services  
Analog and Digital Sub Masters for:  
Compact Discs  
Cassette Duplication**

**6054 Sunset Blvd., Hollywood, CA 90028 (213) 465-6264**

Circle #174 on Reader Service Card

**EVERYTHING UNDER THE SUN**

**NEW WORLD**

**NEW WORLD AUDIO**  
4877 Mercury Street  
San Diego, CA 92111

Over 100 lines

**Professional Audio Sales**  
1-800-854-2005  
except California (619) 569-1944

Circle #018 on Reader Service Card

**Zappa:** Well, I think I heard my band play this certain bar in my "The Black Page" correctly one time.

**Bonzai:** Do you have any favorite new recording gadgets?

**Zappa:** I like the SSL compressor unit, custom built by Arthur Sloatman. I also like the Synclavier polyphonic sampling system, which I'm using extensively.

**Bonzai:** What's so special about it?

**Zappa:** Well, as you know, sampling is capturing one short segment of a sound which then can be played on the keyboard. Sample one note of a trumpet and you can then play a whole scale of trumpets. With polyphonic sampling, you can now do chords from the sample. We just received a Beta test package of their new "looping" software. It let's you take a short sample and extend it indefinitely. Now a single trumpet "boop" can be played for longer than anyone could hold a breath. It enables you to create new sounds that were impossible before. Yesterday we built what is now labeled as the "Hawaiian Marimba." You take a single marimba note and extend it beyond the normal short marimba duration. And while it's extended you can add vibrato. You can play chords that are obviously marimba, but sustained with a nice vibrato. We took a cowbell, extended it and added a pitchbend. We can do a whole chord of cowbells now that go "clang" and then "doink," up or down.

**Bonzai:** Will you use these sounds in live concerts?

**Zappa:** No, I'm using them for albums and film scoring.

**Bonzai:** If you hadn't become a musician, what would you be doing now?

**Zappa:** I would probably be a chemist, or a physicist.

**Bonzai:** What were your first thoughts when you discovered puberty?

**Zappa:** Discovered puberty? Doesn't it discover you?

**Bonzai:** Who is your best musical friend?

**Zappa:** I don't have any friends in any category—I try to avoid them.

**Bonzai:** Who has musically affected you the most?

**Zappa:** Probably Varese—and also Webern and Stravinsky.

**Bonzai:** Is there anybody special in the world whom you would like to meet?

**Zappa:** No.

**Bonzai:** Are you as successful as you would like to be?

**Zappa:** I would say that the basic char-



acteristic of my life is failure. If there is one thing that I excel at, it's failure—I manage to fail at 100 percent of the things that I do. Since most of the things that I set out to do are theoretically impossible, it's very easy to fail. I've learned to live with it. In terms of machinery and personnel, there never seems to be enough to get things done exactly right.

**Bonzai:** What makes a great music producer?

**Zappa:** I don't know. From the record company point of view, it's someone who makes them billions of dollars. I suppose that's all that matters. That's what a great producer is these days.

**Bonzai:** Is there any quality of human beings that gives you hope for our race?

**Zappa:** None whatsoever—and I mean that sincerely.

**Bonzai:** Who is the Picasso of music, in the sense that he was an innovator who continually shook up the art world?

**Zappa:** Well, I don't know much about the art world, so it's tough for me to comment—but nobody who shakes up the music world lasts. The music world doesn't desire to be shaken up. In the art world they look for the novelty that will create a scandal, but the world of music is not the "world of art"—it's a world of business. Even "classical music" deals with sales figures. No part of the music business deals with the aesthetics of music.

**Bonzai:** Will this ever change?

**Zappa:** No. Whatever aesthetic sense that might have existed in the past seems to be out of phase with contemporary "industrial reality." People don't give a shit.

**Bonzai:** Yet you persist in your career as a musician.

**Zappa:** I persist because it's all I know how to do.

**Bonzai:** How has Moon's popularity affected homelife around here?

**Zappa:** The popularity was in direct proportion to the life cycle of that particular hit single. There was a mysterious fever that surrounded "Valley Girl" that had nothing to do with reality. It complicated matters around here because I have my own schedule for interviews and all the rest of the bullshit that goes with the business and then suddenly she had the same thing, too. I don't drive, she didn't drive at the time, and my wife drives in a carpool. She's a minor and had to be escorted everywhere. It made things real complicated—and last year she had a part in *National Lampoon's European Vacation*, a film shot in Rome. It started out to be an

# JUST THE FACTS ARE NOT ENOUGH. *Experience is required!!*



CHRIS STONE



RICK PLUSHNER



JIM PACE



JEFF EVANS



CANDY MOORE



MIKE NOVITCH

**A**udio Intervisual Design is a third generation equipment sales company focused on systems design. We are staffed with the finest and most experienced professional audio veterans presently assembled in the Los Angeles area.

**I**ntimate hands-on knowledge of new products and new technologies is essential, yet the pace of change leaves you little time. We provide you with the system support and advice to help you move into these new ventures smoothly and profitably.

**D**ecisions require more than just spec sheet facts about a piece of equipment or a system application. When you are in need of experienced consultation on high tech audio equipment and acoustics, call us. You will find that our experience pays off for you.

#### Representing:

- Sony Digital Audio products
- Lynx time code modules
- Meyer studio monitors
- Hidley Acoustic designs
- Harmonia Mundi Acustica
- YNH edit controlled-audio consoles
- AXE digital metronome
- And many more . . .

**(213) 653-0240**



A Record Plant® Affiliate

**AUDIO INTERVISUAL DESIGN**

8456 WEST THIRD STREET • LOS ANGELES, CA 90048

Circle #019 on Reader Service Card

# THE PAYOFF IS PERFORMANCE

Ibanez Professional Products presents five good reasons why you don't have to pay more for professional signal processing.

Each features Ibanez's unique feature-mix and tradition of cost-effectiveness. But the real payoff is best realized when you first plug into an Ibanez.

## DMD2000

The DMD2000 Programmable Digital Delay provides up to 2048 milliseconds of delay at 16 kHz bandwidth, with 8 memory presets and optional remote preset selection.



## GE1502 • GE3101

The GE1502 Dual 2/3 Octave EQ and the GE3101 1/3 Octave EQ are professional graphics in a single-rack package, with boost/cut range switching and 40 Hz, 3-pole high-pass filters.

## MSP1000

The MSP1000 Multi-Signal Processor answers the needs of PA's and monitors with a compressor-limiter section using dbx(tm) VCA IC's, a 2/3 Octave EQ section, and a two-stage notch filter section for feedback suppression.



## HD1500

The HD1500 Harmonics/Delay is a full-function digital delay AND real-time pitch shifter, for all time delay effects and shift intervals within 13 semitones (up and down).



For a full color catalog send \$2.00 to: Ibanez, dept. MXE • P.O. Box 886, Bensalem, PA 19020 • 3221 Producer Way, Pomona, CA 91748 3916 • P.O. Box 2009, Idaho Falls, ID 83403 • In Canada: 6969 Trans Canada Highway, Suite 105, St. Laurent, Quebec, Canada H4T1V5

Circle #020 on Reader Service Card

World Radio History



eight-day shoot, but Gail ended up sitting around with her for about a month. It just makes things a mess, but Moon will be of age pretty soon and she'll be able to go out and do stuff on her own.

**Bonzai:** Why do you choose to live in Los Angeles?

**Zappa:** Because if your musical machinery breaks you can get on the phone and get parts and get somebody to fix it. I dislike Los Angeles and spend a lot of effort to make sure that I never have to go out on the street. I really can't stand to look at the place. What it represents nauseates me. If I had my choice, I definitely wouldn't live here, but I can't think of another place where you can get the service and the equipment.

**Bonzai:** What's the most outrageous thing a fan has done to you?

**Zappa:** I was knocked off the stage by some bimbo in London—broke my leg, a rib, put a hole in the back of my head, broke my nose. I was in a wheelchair for a year.

**Bonzai:** I remember the incident, but I didn't know it was that bad.

**Zappa:** It was pretty bad. I still have back problems as a result of that injury. It wasn't very funny, but he got a year in jail and I imagine a year in an English jail isn't all that terrific either.

**Bonzai:** If you were to star in a film, what would your dream role be?

**Zappa:** I never liked the idea of acting. I have trouble identifying with things that are "make believe," where people pretend...

**Bonzai:** Are you related to the 18th Century composer named Zappa?

**Zappa:** Probably not, but I researched the music and got some scores from the U.C. Berkeley library, the Library of Congress and from a library in Holland. The material was entered into the Synclavier. An album of the material is available—*Francesco Zappa, His First Digital Recording in Over 200 Years*.

**Bonzai:** Are there any new musicians that you appreciate?

**Zappa:** One of the most musical people around today is Alan Holdsworth, a guitar player who has developed a very interesting style. I find him very musical. He did a few albums for Warner Bros., but naturally they dropped him because he wasn't commercial. I also like Chad Wackerman, the drummer who has done a few tours with him, and is also the drummer in our band.

**Bonzai:** You have a reputation for working with fine musicians—who else is in

your band these days?

**Zappa:** Ike Willis on guitar and vocals, Ray White on guitar and vocals, Scott Thunes on bass, Bobby Martin on keyboards, and Alan Zavod on keyboards.

**Bonzai:** Is there any period in history where you would have been more comfortable?

**Zappa:** Not really, because I'm an "electronic kind of guy." An earlier era might have offered more in terms of aesthetics, but so much of what I do involves electronic devices that I don't think I would be happy without them.

**Bonzai:** Do you have any idiosyncrasies?

**Zappa:** I smoke a lot of cigarettes, drink a lot of coffee and do a lot of work.

**Bonzai:** Why do people have pets?

**Zappa:** That varies from person to person. I have pets because I like them better than humans. Some people have pets because they think they're furniture.



PHOTO: LADI VON JANSKY

**Bonzai:** How would you like to be remembered in the distant future?

**Zappa:** I would rather not. I'd rather just skip it. I think that people who build an aspect of remembrance into their work habits—like, "If I don't do this, then how will I be remembered?"—that's really bad. You should just plan for *The Big Blotch*.

**Bonzai:** Do you have any advice for aspiring musicians?

**Zappa:** Go into real estate—or get an Herbalife franchise.

**Bonzai:** Was there anything wrong with this interview?

**Zappa:** No, it was perfect.

\*\*\*

*For those of you interested in getting your hands on the products of Frank Zappa's fertile imagination—records, tapes, videocassettes, T-shirts, sheet music, etc.—just call Barfko-Swill at (818) P-U-M-P-K-I-N.* ■

# Do you hear voices?

If you spend a lot of time thinking about music, you probably have all sorts of sounds running around in your head.

However. What you hear in your mind you just don't hear in your ears. Because your instrument just can't produce it.

Unless, of course, you're playing the Kurzweil 250.™ An instrument engineered to produce any sound anyone can imagine. In all its glory.

**To get great sound, you have to start with great sound.**

Our engineers use Contoured Sound Modeling™ to capture the sounds of real instruments. Contoured Sound Modeling has given the world the famous Kurzweil Grand Piano, Strings and Human Choir.

But if our engineers were merely good engineers, those

voices would sound, well, engineered. Why don't they? Because our engineers are even better musicians.

How did we get the Steinberger™ into our Sound Library? Very carefully.

And as such, they not only use a careful blending of instrument, performer, acoustics, recording techniques and signal processing. They also depend on a tool older than music itself. The human ear.

**Total control at your fingertips.**

If you can press a button, you can call up any of the Kurzweil 250's 45 resident voices and 124 keyboard setups. Instantly. Because they're all in the Kurzweil 250's massive on-board memory. That way, you won't ever have to mess around with disks.

Then play any voice or setup on the Kurzweil 250's velocity sensitive, 88-key wooden keyboard. Which is weighted to feel like a grand piano. So it can be as expressive as a grand piano.

And just as important, the



12 tracks, no waiting.



Kurzweil 250 has a built-in 7900-note 12-track sequencer that lets you compose your own complex arrangements. Edit any note, edit any track, insert notes or change tempos and volumes. And once you're satisfied with what you've got, there's quantization to clean up slight timing errors.

**You get more out of MIDI here.**

MIDI is available on a lot of keyboards. But no keyboard instrument lets you do with MIDI what you can do with the Kurzweil 250.

As either master controller or slave, it gives you access to virtually all of the Kurzweil 250 control functions.

**If you can sample it, you can play it.**

Say "hello" to the Kurzweil 250.

Next thing you know, you'll be hearing "hello" in 4-part harmony. Or 6 part harmony, or 12. How? With our Sound Modeling Program.™

You just plug in a mic (or patch in a line), and off you go. Our Sound Modeling Program will then let you sample your own sounds.

Afterward, do virtually anything with any sound. Comband it, trim it, loop it or play it backwards. Play it like you would any resident voice. Even

layer it onto any resident voice. Imagine Kurzweil Strings that turn into the wind. Or thunder. Or vice versa. Anything you can hear in this universe, you can hear on the Kurzweil 250.

**Stay tuned.**

Today, the Kurzweil 250 is the single best, most expressive instrument you can buy. But it's not alone.

We've introduced the Kurzweil 250 Expander, a portable expander package that you can MIDI to any MIDI keyboard.

We've added the Kurzweil Sound Library, a growing collection of sounds on Macintosh™ disks.

And we will be adding even more in the future.

But whatever we bring to the Kurzweil 250 will always be for the same reason. So the voices you're hearing, everyone can hear.

To find out more about the Kurzweil 250,

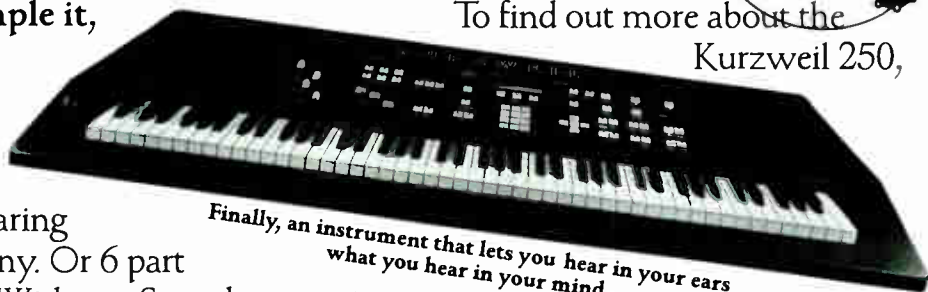

*Finally, an instrument that lets you hear in your ears what you hear in your mind.*

visit your local Kurzweil retailer, or call us at 1-800-447-2245. Or send \$6.95 (Massachusetts residents add 35¢ tax) for a copy of our 50 minute demo cassette, to Kurzweil Demo Cassette, P.O. Box 863, Providence, RI 02901.

Kurzweil Music Systems, Inc.,  
411 Waverley Oaks Road, Waltham, MA  
02154-8464.

Macintosh is a licensed trademark of MacIntosh Laboratories, Inc.

**KURZWEIL™**

Circle #021 on Reader Service Card

Eventide SP2016

Dollars

\$6,895



## NOW IT COSTS MUCH LESS. AND IT DOES EVEN MORE.

**Great News!** Increased production of Eventide's SP2016 now makes it possible for you to get the best sounding, most versatile effects processor/reverb for thousands less. You get the densest, most natural-sounding reverb programs available at any price (just ask anyone who's used an SP). And you get our Generation II software package, with more great effects than any competitive unit. At its new low \$6895 (U.S. list) price, we think you'll find the SP2016 irresistible. Call Eventide at (201) 641-1200 and we'll set up a demo for you.

**More Great News!** Eventide's newest SP2016 Generation II software release includes the hot Reverse and Non-Linear Reverb sounds (just like that British unit—except Eventide gives you TWO independent channels and some additional parameters). Ditto for our stereo Gated Reverb program. Our optional Automatic Panner program has lots of nifty tricks. And wait 'til you hear our exclusive 18-band Channel Vocoder program option. By all means, check out all the latest SP2016 software soon. You'll see... We can do everything the others do, but they can't do what we do!

Circle #022 on Reader Service Card

EVENTIDE, Inc. • ONE ALSAN WAY • LITTLE WORLD RADIO HISTORY, JERSEY 07643 • 201-641-1200 • TWX: 710-991-8715



# DIGITAL 86

A SPECIAL MIX MAGAZINE SUPPLEMENT

## CONTENTS

- 
- 51 Digital Audio Editing ..... by Larry Oppenheimer
- 
- 58 Video Cues in Digital Audio Editing ..... by Dr. Toby Mountain
- 
- 62 Audio Applications: Digital Mixing Consoles ..... by Ken Pohlmann
- 
- 70 Digital Reverb, Part IV ..... by Larry Oppenheimer
- 
- 84 Digital News
- 
- 94 Digital Resource Guide
- 

*The Droid Works' SoundDroid, a hard disk-based, integrated digital recording/mixing/editing/processing system.*



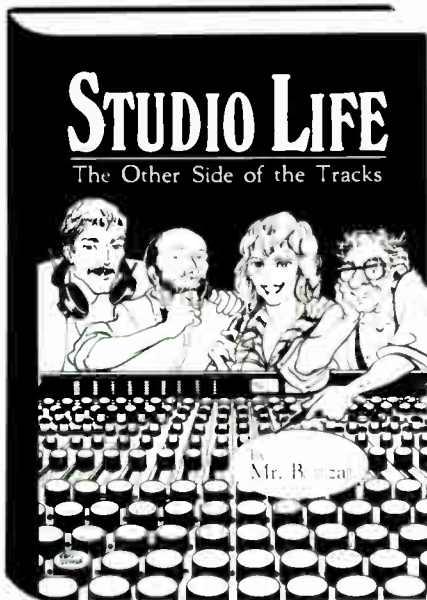

# STUDIO LIFE: The Other Side of the Tracks

by Mr. Bonzai



We finally got the sound we wanted with a Dr. Scholl innersole, a dried sausage and a rabbit's foot, secured to the drum head with a few feet of gaffer's tape.

Homemade electronics are the curse of studios. At my urgent request, Smilin' Deaf Eddie came slumping drowsily into the studio in his customary bathrobe and furry blue slippers, armed with a soldering iron. He went right to work wiring Cannon connectors into Eric's bizarre array of phone plugs, RCA plugs, German U-plugs, and copper deadbolts. While Eric supervised the work and Jon began unloading his horns and wetting his reeds, I returned to the control room to check on Cart.

"We're picking up some radio interference on the monitors when the volume is low," he informed me gravely. "I thought it was just temporary CB, but I can't filter it out."

"It sounds like a ball game through a tin-can telephone," I added. "Where could it be coming from?"

"It's a total mystery. Maybe Eddie can trace it."

"Keep the monitors loud," I suggested. "Maybe they won't hear it..."

As usual, we were barely one step ahead of the game. I used to think that one day the sessions would smooth out, but they never do. A good studio just has less downtime than a crummy one. As Eddie rewired Eric's synthesizer and Cart tried desperately to trace the elusive interference, I tried to scope out what we would need to record Jon Morgana's instruments.

We've all seen the usual clarinets, saxes and flutes ranging from tenor to bass. Jon had some of the rarest and most extreme members of these familiar musical families. The "hairpin piccolo," less than two inches long, was originally designed for a performance of Erik Satie's "Waltz of the Tsetse Fly" and was played with jeweler's tongs. I chose a tiny lavalier mike which we could clip to Jon's moustache to pick up the miniscule sound.

\$7.95 160pp. Quality paperback ISBN 0-918371-00-7 ©1984 Mix Publications

"Incisive satire. I couldn't stop laughing."

—Chris Stone,  
president, Record Plant, L.A.

"It's all here... the inner workings of Tapeland U.S.A."

—Stephen Bishop,  
songwriter/recording artist

"STUDIO LIFE should become the new Bible for all studios."

—Michael Sembello,  
songwriter/recording artist

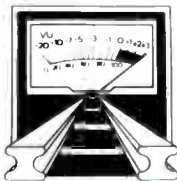

## STUDIO LIFE: The Other Side of the Tracks

by Mr. Bonzai

YES! Please send me \_\_\_\_\_  
copies of STUDIO LIFE.

Enclosed is my payment @\$7.95  
per copy plus \$1.00 postage, or

Bill to:  VISA  Mastercharge

Credit Card Number \_\_\_\_\_

Expiration Date \_\_\_\_\_

Signature \_\_\_\_\_

Name \_\_\_\_\_

Address \_\_\_\_\_

City \_\_\_\_\_

State \_\_\_\_\_ Zip \_\_\_\_\_

**PAYMENT MUST ACCOMPANY ORDER.**  
Quantity Discounts, Inquiries Welcome  
Make checks payable to Mix Publications  
Mail to: Studio Life, c/o Mix Magazine,  
2608 Ninth St., Berkeley, CA 94710  
(415) 843-7901



**Hack & Slash:**

# Digital Audio Editing Is the Cutting Edge

by Larry Oppenheimer

The fact that you are reading this magazine indicates that you are aware of the immense impact that digital technology has had on the production and reproduction of music. The face of the recording industry is changing and, amidst the heat of this upheaval, controversies and breakthroughs abound equally, and usually in tandem. Somebody introduces an idea, a few others come up with their own versions or variations, and the fur flies. Not everyone argues about these things, but there are many, many disagreements. Certainly the acceptance of digital recording has been a long, slow process, as Dr. Thomas Stockham, Jr., a digital recording pioneer and the creator of the Soundstream digital recording and editing systems recalls:

"Soundstream had come along [in the mid '70s] and said, 'Here's the equipment, anybody can have it and use it. Please do, let's all make digital records.' The answer was, 'No, no, go away. No, don't, no! Help!! No!!! No!!! No, and again no!!! Don't you understand? No!!!!' That was the general response."

Even now that digital recording is a fact of life, companies with differing approaches still duke it out regularly in full-page ads and magazine articles that occasionally make one forget that the parties involved are mature professionals. The bottom line is that digital recording is not coming, it is here, and with that question addressed the next act to enter the ring is a predictable one, namely, how does one go about editing this peachy keen digital recording? With only a few exceptions, every recording needs to be edited if only to assemble the cuts into the proper order. As with recorders, the need for digital editing is established but the dust is just starting to get kicked up.

It is very easy when listening to a well-edited recording to not realize that the guitar solo was pieced together from three different takes, that the verses were originally in a different order, that

the live applause was much longer than on the record, or that the sound of the ray guns on the screen is made up of tiny bits of half a dozen sounds, but these are all quite ordinary editing tasks. Digital audio editing not only offers the ability to do these kinds of manipulations, but, with some systems, the genre offers precision and flexibility which is unattainable in the analog domain.

That editing is a very important and commonplace function is attested to by the thousands of hours logged by recording engineers in performing this job. This means that it is of paramount importance that the chosen system(s) be comfortable to use; however, the individuality of editors, their needs and styles, makes this notion difficult to realize. The controversy and factionalism which surround the topic of digital audio editing are not unusual to find with a developing technology which is still

immature. It should be remembered that the introduction of the Soundstream digital recording and editing system was the first time that these services became commercially available. Less than ten years later, a good half dozen systems are either on the market or being readied for introduction. Most of these systems fall into one of three categories, depending on what kind of storage medium is used. A quick look at these categories and their implications — advantages, disadvantages, and what it all means for the users of these systems — will hopefully aid in gaining a perspective on these new tools which are just now in blossom.

A great deal of an editing system's job involves storage and retrieval of information to and from some storage system, consequently editing systems are largely defined by the kind of storage system which they use.

## STATIONARY HEAD TAPE SYSTEMS

Stationary head digital audio tape recorders are mechanically similar to open reel audio and video tape recorders, but electronically they are chock full of digital signal conditioning and processing, analog-to-digital converters (and back again), error correction, and many more mouth-watering morsels. But the lure of stationary head recorders lies largely in the familiar elements of an open reel tape recorder. The reassuring sight of those big reels a-turnin' round puts many an engineer at ease.

More importantly, however, is the ability on machines like Mitsubishi's X-80 two-track and Sony's PCM-3324 multitrack to edit by cutting the tape with a razor blade. Since the invention of magnetic audio tape the most common editing system has been to physically cut the tape and reassemble it into the desired form. Four or five decades and untold miles of tape have forged this technique into a refined art at which any decent engineer should be proficient to some level, just as any child can ride a bicycle or skate.

"Rock and roll" is the common term used to describe the process of locating

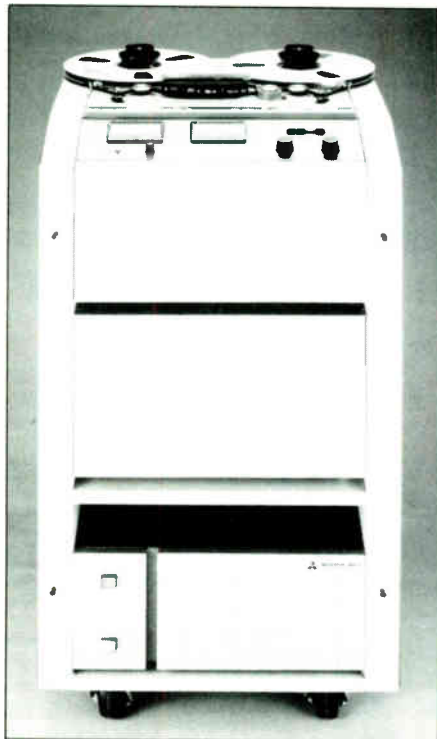

*The Mitsubishi X-80 can be used with either electronic or "razor blade" editing methods.*

the desired edit point. After playing the tape up to the area of the edit, the tape deck is put into an edit mode where the machine is in Play, but the capstan is not engaged to move the tape, thus allowing the engineer to move the reels back and forth manually while listening closely to find the exact spot to mark and cut the tape. This process becomes almost second nature. It is only natural that more engineers will be starting to work with digital recording as it matures, and it is equally natural that they want to be able to use well-honed skills in this new medium.

Frank Zappa is committed to both his style of editing and his Sony PCM-3324; he could be considered a madman with a razor blade in an editing session. "Yeah, I'm pretty good," he concedes. "I've got real good razor cutting abilities because I started off maybe 23 years ago editing dialogue on 3 $\frac{3}{4}$  ips mono tape recordings. That's a pretty unforgiving medium, there's not much slack there. So it's pretty much of a breeze when you're editing something that's going by at 30 ips and has transients that you can locate when you rock the tape. I've never been afraid to put a razor blade to anything. Let me give you an example.

"I think that each roll of the silver foil tape that you use for doing the razor blade edits on the 3324 is 2,000 inches long. The amount of splicing tape that you would use to make one splice would be one inch long. In doing the London Symphony Orchestra album, I

used four rolls of that tape."

The simplicity, immediacy, and overwhelming familiarity of "rock and roll" and "cut and splice" have gone a long way in molding the shape of commercial digital audio editing systems.

But razor blade editing is as difficult and complex to implement on a digital audio recorder as it is simple and straightforward to perform. This is largely due to differences between analog and digital systems in the way information is stored on the tape. In analog systems, the information for one channel of audio is stored longitudinally along one track of the tape, but in digital systems a channel of audio data is mixed with error correction codes and spread across several tracks in an intricate pattern (a process known as "interleaving"). When locating an exact edit point on an analog tape, what you hear is what you'll get if you cut at that point, because the audio for that moment in time is located only at that point on the tape. If the edit point has been properly located, the primary concern is with possible clicks caused by discontinuities in the waveform or record bias at the splice points (assuming that the splice was properly performed with a demagnetized razor). Using an angle cut instead of a perpendicular one solves these problems handily by creating a short crossfade across the complementary cuts of the take-out and take-in points. This is not true with digital, which complicates the situation greatly: the chosen cut point is likely to fall in

the middle of an error correction cycle or across several samples of audio.

The solutions in this case are, in computer jargon, non-trivial. An analog cue track is typically used for the "rock and roll" operation. A high level of sophistication is required in the error correction codes and the error detection and concealment systems to insure that the system responds positively to splices. Mitsubishi recommends that a very small gap be left in the splice to create a completely unambiguous transition to trigger the system.

Crossfades are also more difficult in the digital domain, where signal processing is accomplished through arithmetic operations. To achieve a crossfade, the take-out material must be multiplied by a coefficient which decreases with each multiple from 1 to 0, while the take-in material is scaled by a complementary coefficient increasing from 0 to 1. This is obviously more trouble and expense than simply cutting the tape at an angle.

Another disadvantage of razor blade editing is the need to handle the tape. Anytime that the storage medium has to be touched, the chances of damage to it increase. Zappa elaborates: "People come to you and tell you, 'You can cut it with a razor blade, and some engineer even handled the tape with hamburger juice on his fingers with no problem,' I mean, this is a quote. This is not true. You don't handle the tape with hamburger juice on your fingers. If you do, you've got to be out of your mind. You have to handle a tape very carefully." (Sony literature shows splicing being performed with light gloves on).

In spite of these problems, razor blade editing is still undeniably popular, enough so that some machines are being modified or redesigned to add this capability, like Mitsubishi's X-800 multitrack, which was shipped in its original form (without razor editing) to a number of clients.

Additionally, at the time of this writing, there is no commercially available tape-based multitrack electronic editing system, which makes razor editing on digital multitrack machines the only way to edit a multitrack master with one machine. "The way we do things," illustrates Zappa, "24-track master tapes are razor blade edited right on the 3324, so I make an assembled master. That master is then mixed onto the (Sony PCM) 1610. We lose an analog generation: it comes off of the 24-track, goes into an analog board, gets combined, then gets printed on the two channels of the 1610. That would be the mix of one song, say. When we've done the individual mixes of several songs, we

—PAGE 56



JVC 900 Series digital audio editor.





# If you're reaching for Gold or Platinum, first reach for **AGFA PEM 469**

Because there's never been a mastering tape like it. Agfa PEM 469 captures your sound perfectly in its complete dynamic range. It's everything you've always wanted. Reach...and you'll succeed...with Agfa PEM 469. The only thing standard is the bias.

AGFA-GEVAERT  275 NORTH STREET, TETERBORO, N.J. 07608 (201) 288-4100

Circle #024 on Reader Service Card  
World Radio History

**AGFA**  
**AUDIO**

# Electronic Editing for Digital Multi-track

In recent months, users of Sony's PCM-3324 Digital Multi-track System have been using techniques of electronic assembly that are similar to editing for rotary head digital two-track systems. Sections of 24-track digital audio are transferred from an original master to one or more copies under precise control of the system's microprocessors. This procedure has several advantages over splice editing, analog or digital:

- 1) The original master recording is not altered in any way, yet the edited final product is identical to it in sound quality.
- 2) Edits can be previewed before they are committed to tape. Any number of variations of a splice may be tried out, and changes can be made very precisely.
- 3) "Insert" edits are simple to perform.
- 4) Individual tracks, or groups of tracks may be edited without disturbing the remainder. Final masters may be assembled from numerous takes, and material can be moved freely from one section to another.

5) The technical integrity of the final product is assured since the finished master is all one piece with no splices and continuous digital data from one end of the tape to the other. Unlike two-track electronic editing, the multi-track technique does not require a dedicated editing device. However, it does require a 48-track system consisting of two complete Sony 24-track digital recorders.

The application of this technique is made possible by specific features of the Sony system: The ability to precisely synchronize two machines with a specified offset in tape position; and the ability to program punch-in and punch-out points. Which can be first rehearsed and then executed automatically. The punches themselves are faded in and out at a rate selectable by the operator, emulating angled tape cuts.

Edit points are located in the same manner as for splice editing, but instead of cutting the tape, these points are entered into microprocessor memory as a punch-in time and a precise offset between machines. The edit can then be re-

hearsed. Starting from a few seconds ahead of the edit point, the new master that is being assembled plays. At the edit point, the monitoring output cross-fades to the original master, which is synchronized to enter at the exact desired point. If the resulting splice is not satisfactory, either or both points may be moved about until the desired result is obtained. The punch is then executed exactly as previewed.

That section of material is dubbed until the next desired cut point arrives, and the process is repeated. For insert editing, a punch-out point can also be programmed.

As of this writing, electronic multi-track editing services are offered by facilities in New York, Nashville, Los Angeles and the San Francisco area, experienced users are enthusiastic about the advantages and creative possibilities. Rick McCollister of Nashville's Recording & Music Group states that he doesn't expect to ever cut tape again. At CBS Records, sev-

eral jazz and classical projects have been released to critical acclaim and editor Bud Graham says flatly that the work they have been doing would not have been possible otherwise. "In Mahler's Symphonies, instrument attacks are stretched over long periods of time," says Graham. "Edit points must be exactly determined by experiment if they are to be made inaudible."

At Redwood Digital, John Nowland has gained considerable experience in work with owner Neil Young, who bought some of the first Sonys in the United States. In New York, The Hit Factory's three Sonys have been booked solid. Other facilities equipped to offer this service are the Village Recorder and Record Plant in Los Angeles, Power Station and Atlantic Records in New York. Rapid growth in Sony digital multi-track sales promises even wider availability of full 48-track editing systems in the future.

—Gary Hall

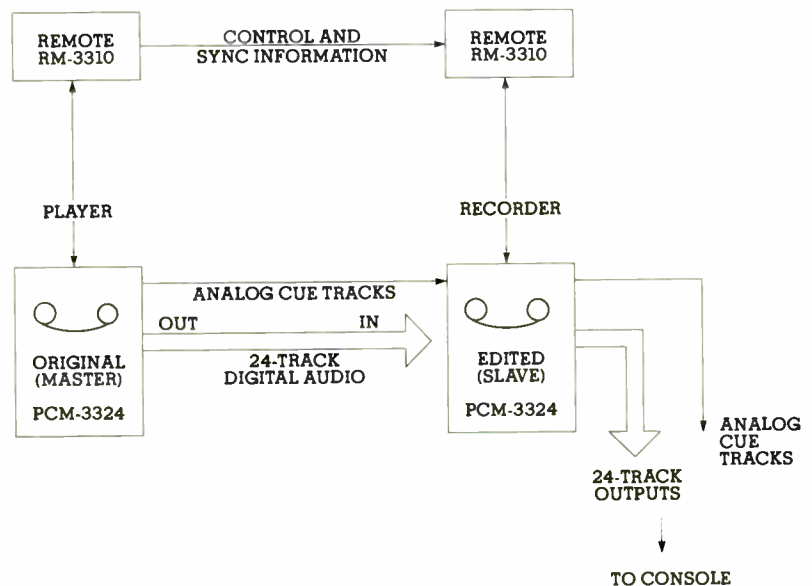

Above: Block diagram indicating flow of both audio and control signals for electronic editing on dual synchronized Sony PCM-3324 digital 24-track recorders. The RM-3310 System Control Units offer full remote control of all recorder functions, up to 100 points of cue memory, autolocation, and edit capability with automatic punch in/out recording.



# dbx

Stand up and be counted.

If you think you can't afford a dbx compressor/limiter, think again.

With the 166 now you can.

Total dynamics control in a brand new product from dbx, the world's number one manufacturer of professional processors



dbx PO Box 1900, 71 Chapel Street,  
World Radio History  
Chicago, IL 60611, USA

**—FROM PAGE 52, DIGITAL EDITING**

go D-to-D (digital format conversion) to two channels of the 24-track. We do another razor blade edit there and make an assembly of the entire album side, then we go D-to-D back to the 1610. That cassette is what goes to Hitsville to get mastered."

**ROTARY HEAD TAPE SYSTEMS (ELECTRONIC EDITORS)**

Stockham's disk-based Soundstream editing system was the first real glimpse that the recording industry got of the power of digital audio. It certainly raised some eyebrows, but skepticism and the very high price of using the system kept it from widespread public acceptance.

Magnetic tape-based systems seemed more cost-effective and, particularly at the time, more practical. This assumption left only two courses of action: adapt current tape systems or design new ones. 3M opted for the latter and became the first on the market with a multitrack, stationary head digital audio recorder; but some of the Japanese companies, like Sony and JVC, were already major manufacturers of video recorders and editors, and this led them to a different conclusion. They realized that stationary head systems and razor blade editing would take considerably longer to develop than a box that could digitize two channels of audio and put them into a video format, which was already capable of the necessary bandwidth to handle digital audio.

The video cassette recorders which are commonly used for storage are rotary head systems, making razor editing impossible. Electronic editing systems

based on SMPTE Time Code were already in use, and some of the ideas and technology from those were adapted to make digital audio editors. The resulting machines, like Sony's DAE-1100 and JVC's AE-900 series, are now into their second or third generations, and their strengths and weaknesses are becoming known. In fact, even the VCRs themselves are being adapted, so that there are several models currently on the market which are optimized for use with digital audio.

These editing systems work on the basis of assembling the edited work by dubbing the selected material from machine to machine, an older method than even the razor blade. In essence, the editing system performs three chores: first, it acts as an intelligent synchronizer/controller, starting the tape machines in the right spots and controlling record and play modes; second, it allows precise searching through the area around the edit point; and third, it allows some level manipulations to be performed on the data.

In practice, the audio is monitored and a button is pressed when an edit point goes by. Several seconds of audio on either side of the button punch are then entered into a block of memory in the editor. This memory can then be searched through or "scrubbed" by turning a rotary dial which moves a pointer in software through the memory, simulating "rock and roll." Once the edit point has been selected, a rehearsal mode allows the engineer to hear how the edit will sound before it is actually performed. This is obviously not possible in razor editing.

Video editors typically only resolve down to one video frame, which, in the U.S., is 33 milliseconds; much too long for an audio editor (aurally, 33 milliseconds one way or the other would be quite noticeable). By dividing SMPTE frames into subframe units based on SMPTE code's actual bit rate the resolution in these digital audio editors is improved by a factor of 100 over video editing, and about a factor of 10 over razor editing. To equal the precision of electronic editing with a razor blade, one would have to cut the tape to within one hundredth of an inch of the desired spot.

The crossfade time in electronic editors is usually selectable, a very valuable feature for delicate classical editing. Furthermore, a fader is provided, which enables level matching between the two sections being connected, or fade-ins and fade-outs to be performed. All of this manipulation is done in the digital domain by special purpose hardware in the editor.

There are, of course, limitations with this system. The most obvious is that at least two tape machines, an editor, and a processor (for monitoring) are needed, which can start to get into some real money. It should be kept in mind that the processor can do double duty in mastering, and the decks can be used in mastering, or, of course, video work. Nonetheless, the price is thought-provoking.

The other major problem with these setups is that a lot of time is spent shuttling machines back and forth, and waiting while the material following the edit plays to its conclusion to complete the dub. This can be disconcerting when paying an hourly rate at a session.

**LOW COST ROTARY HEAD TAPE SYSTEMS**

Some attempts are being made at very cost-effective versions of some of these ideas. These systems are based around Sony's PCM-F1 processor. The PCM-F1 was not originally intended for professional applications, and no provision was made for editing. In fact, the low cost of the unit is partially due to compromises made in the design which would not have been made in a professional recording product. PCM-F1 recordings use a significantly different interleaving system from professional processors and employ a multiplexing strategy in A/D and D/A conversion, which make direct usage of the F1 with current professional editing systems impossible. This provides a unique set of problems in editing tapes made with this system.

There have been two approaches to solving this problem. One has been to

—PAGE 90



*The CLUE logging/editing system is designed to work with tapes recorded in the Sony PCM-F1/701 digital format.*



# AMEK at Music Annex

## The AMEK M-2500

can be configured for applications in music recording and stereo video teleproduction.

All AMEK consoles are built with the finest components and are entirely hard-wired—even the patch bay. By avoiding high-speed manufacturing techniques and other short cuts, you're assured of superior performance and that consistently unbeatable AMEK transparent sound.

- 36 to 56 VCA Inputs
- 36 to 56 In-line Monitors
- 24 to 48 Outputs
- 4 Band Variable Q Parametric EQ
- Variable Hi Pass/Low Pass Filtering
- 6 EFX Sends
- VU or 40 segment PPM/VU LED Metering
- Patching to over 1000 points
- 10 VCA Subgroups
- Solo in place
- Two Line Inputs per channel
- Differential or Transformer Balancing
- Full Master Status Switching
- Automation compatible with MasterMix, Massenburg, Arms, and Optimix

AMEK M-2500 at  
Music Annex  
970 O'Brien Drive  
Menlo Park, CA 94025  
(415) 328-8338



*Call or write for more information about  
AMEK's complete line of consoles.*

*In the US: AMEK CONSOLES, INC.  
10815 Burbank Boulevard, North Hollywood, California 91601  
Phone (818) 508-9788 • Telex 662526*

*In Canada: AUDIO CONCEPT  
3400 Losch Blvd., Unit 14, St-Hubert, Québec, Canada J3Y 5T6  
Phone (514) 445-2662 • Telex 05-268728*

*In the UK: AMEK SYSTEMS & CONTROLS, LTD.  
Islington Mill, James Street, Salford M3 5HW, England  
Phone (061) 834-6747 • Telex 668127*

Syntech presents... *Music Digital*

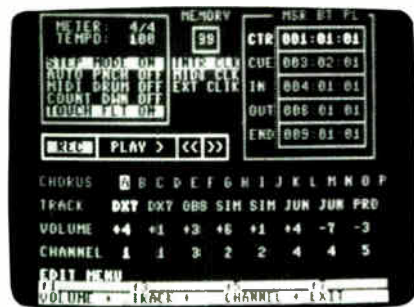

**"MUSICIAN FRIENDLY"**

**MIDI SOFTWARE**

**Featuring:**

16 sequences • 8 tracks/128 tracks total • 16 midi-channels • seq appending • track merging • seq/track naming • seq/track transposing • step inputting • solo/mute controls • int/ext/midi clocks • cut & paste song mode • digital delay • automated punch in/out • cueing • auto-correcting • interactive velocity controls • 14 velocity settings • taper/drum sync • midi-echo/thru • looping • 6 selectable menus • 72 editing commands ... and a lot more!

- COMMODORE STUDIO 1 ..... \$225.95
- APPLE STUDIO 2 ..... \$225.95
- IBM STUDIO 3 ..... COMING SOON
- SONG PLAYER (Commodore) ..... \$179.95

Live performance software with editing & enhanced playback features

Software operates on Syntech/Passport/Yamaha and Sequential Circuits interfaces

**MIDI HARDWARE INTERFACES**

- COMMODORE/APPLE w/drum sync .. \$129.95
- COMMODORE/APPLE with tape/drum sync ..... \$199.95
- IBM with tape/drum sync (available for developers) ..... \$299.95

**YAMAHA ACCESSORIES**

**DX-7/RX-11 RAM CARTRIDGES** ..... \$99.95  
Made to Yamaha specifications, no battery required

Chroma Midi-Converter ..... please call

**MIDI THRU BOXES**

- 1 IN/4 THRU ..... \$69.95
- 2 IN (A/B selectable)/8 thru ..... \$149.95

C.O.D. & Credit card orders accepted or call for your local dealer (818) 704-1307

**Syntech Corporation**

23958 CRAFTSMAN RD., CALABASAS, CA 91302  
**(818) 704-8509 telex 650-254-8720**

Syntech/Passport/Commodore/Apple & IBM are registered trademarks of Syntech Corp. Passport Designs Inc. Yamaha Int'l Corp. Commodore Computer Inc. Apple Computer Inc. International Business Machines Inc. & Sequential Circuits Inc.

Circle #026 on Reader Service Card

**■ DIGITAL 86**

At the top of the horizontal bar to the right of the cross you will see a small blinking white dot. This is the vertical sync pulse which aligns the data into separate fields. It is important that this pulse remain within the horizontal bar well isolated from the data. Otherwise your processor will have severe problems deciphering the data coming from the VCR.

At this point it might be helpful to summarize the specifications of the 1610 "pseudo-video" format. We have mentioned that each horizontal line is 193 bits long, containing nine 16 bit data words, three 16 bit CRCC words, and one control bit. Each video field is 262.5 horizontal lines long, but of these

only 245 are used for actual data (262.5 - 17.5) because of the switching point. Each field then contains a total of 2205 data words, of which one-third are redundant, yielding actually 1,470 discrete data words per field, 2,940 per frame (x 2), and 88,200 per second (x 30). Phew!

Each field contains seven independent "interleave" blocks of data, each 35 horizontal lines long. The data words are interleaved or scrambled within a block to minimize the effects of a burst error on the videotape. The start of each interleave block can be found by locating the emphasis bit (when emphasis is on = black) which occurs on the first horizontal line of each block.

One 1610 video field:

inter-leave block

emphasis/sampling rate bits

#1	L	R	L	CRC	R	L	R	CRC	L	R	L	CRC
	R	L	R	CRC	L	R	L	CRC	R	L	R	CRC
35H	..	...										
#2												
#3												
#4												
#5												
#6												
#7												

**PCM-F1**

The PCM-F1 modulates its 14 or 16 bit code into a different "pseudo-video" signal than the PCM-1610. Its signal requires less bandwidth than the 1610 and as you will see there are actually fewer redundancy and error detection words written with the data.

When you put the F1 into the "mute"

mode you'll find a mostly black screen with two white stripes at the far left, used for horizontal sync, and several white stripes at the far right where the 16 bit CRCC words are written. In between (presently black) is reserved for data words each 14 bits wide. One horizontal line holds only 128 data bits in the following configuration:

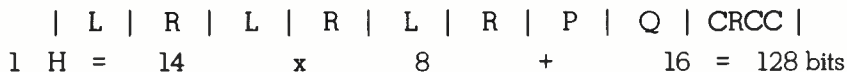

In the 14 bit mode both the P and Q words are used for error correction. In the 16 bit mode the Q word becomes a bin for the 15th and 16th bits of the other seven data words.

When you take off the mute and gradually increase a signal going into

the analog inputs you'll notice, as you did with the 1610, that the bands begin to shrink as the mosaic of tiny bits to their right grows. Again, these are the least significant bits of the data words. You will also find similarities with the

—PAGE 83



# Digital Services

48 Track Digital Recording—Nationwide  
Rentals • Consulting • Engineering

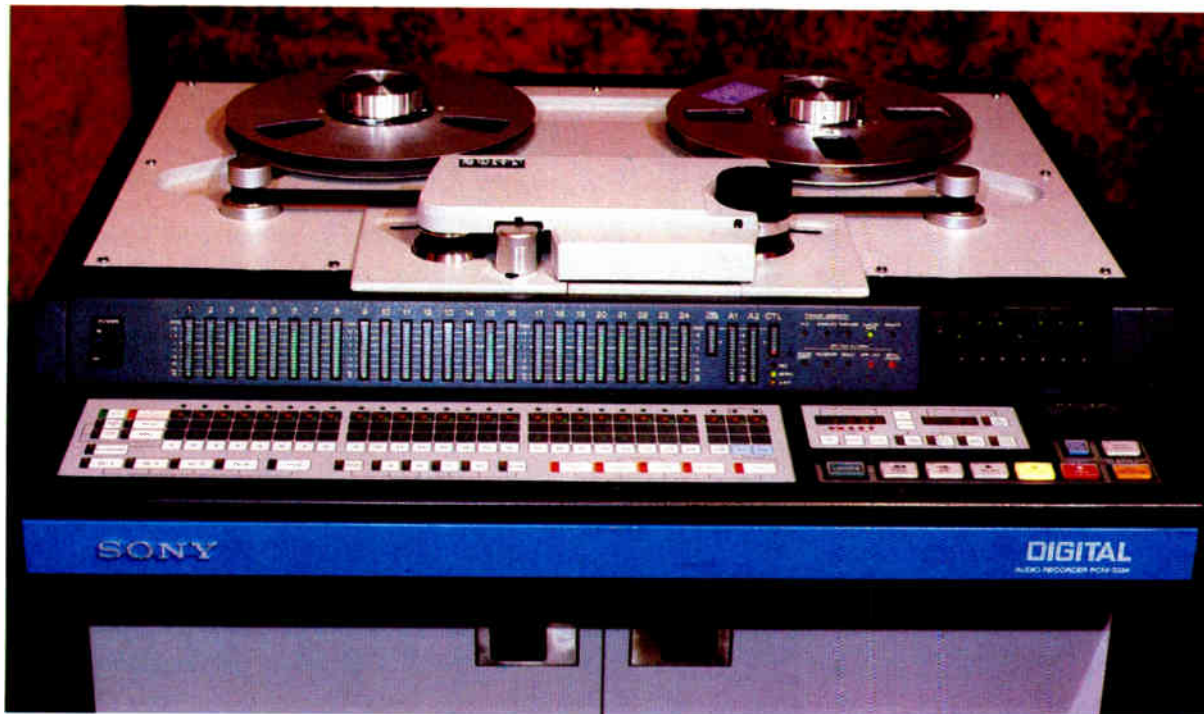

**The Digitals:** 4 Sony PCM 3324 Digital Multitracks • Complete PCM 1610/DAE 1100 Electronic Editing System • RTW/F1 Portable Digital Recorders and Format Transferring

**The Facilities:** Any studio, remote, or post production facility your project may use. Our Remote Truck and Studios offer complete Digital or Analog multitrack production with automated mixing and SMPTE interlock.

**The Experience:** First Sony multitrack owner/operator • First Digital Audio to Film Optical Transfer for Movie Sound • Our clients include Neil Young, Frank Zappa, Neil Diamond, Barbra Streisand, CBS Masterworks, Telarc Records, Talking Heads, Texas Chamber Orchestra, plus many others.

John Moran	(713) 520-0201	Houston, TX
David Hewitt	(914) 425-8569	New York, NY
Elliot Mazer	(415) 644-4321	San Francisco, CA
Mark Wolfson	(818) 506-5467	Los Angeles, CA

## Digital Services

2001 Kirby Dr., Suite 1001, Houston, TX 77019 Telex 790202

Circle #027 on Reader Service Card

# AUDIO-APPLICATIONS

## Digital Mixing Consoles

by Ken Pohlmann

Just as the Compact Disc appears destined to supersede the Long Playing record, all the analog components in the audio recording and reproduction chain face competition and perhaps obsolescence from digital components. There are a number of factors which dictate the lifespan of a technology. Manufacturing cost, product performance, market penetration, user

boredom, and innovative competition all move technological evolution forward, and expectations upward.

We have observed the first stage of digital audio's introduction into the professional and consumer marketplaces. Computer technology has perfected highly sophisticated methods for digital storage of data via magnetic media. It was inevitable that methods developed for that market would find their way to the audio market, in the guise of digital audio tape recorders. Fittingly, some of the technology introduced by the audio community will be returned to the computer industry; for example, CD-ROM will enhance the storage capability of small computers. Of

course, as one link is upgraded, the next weak link is revealed.

The introduction of the Compact Disc, and the consumer's unrestrained love of the format has persuasively necessitated the upgrading of professional recorders. In a recent projection, the Ampex Magnetic Tape Division estimated that by 1993, 80 percent of all installed studio recorders will be digital, with a total population of 8,000 digital 2-channel and 4,000 digital multi-channel recorders. They estimated that the number of analog recorders will peak in late 1985, then slowly dwindle, with the number of digital 2-channel recorders surpassing analog recorders in 1990, and the number of digital

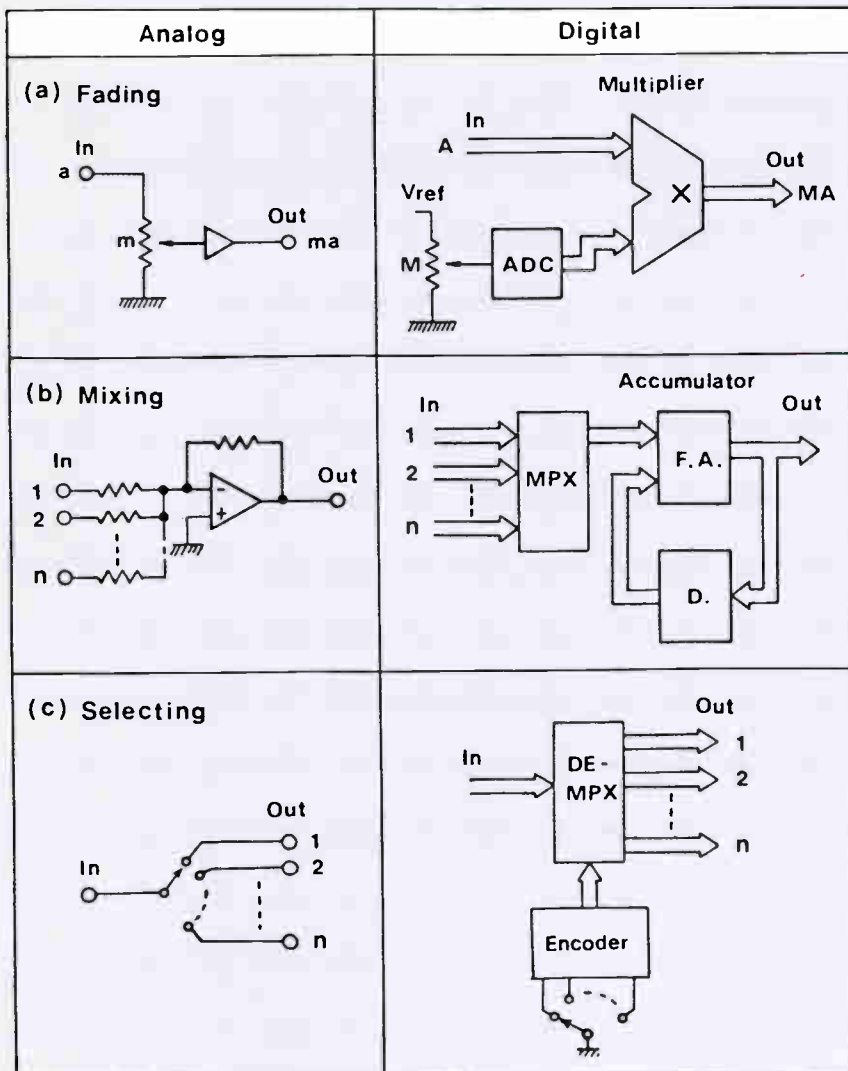

Figure 1. Comparison between analog and digital fading.

Figure 2. Comparison between analog and digital mixing.

Figure 3. Comparison between analog and digital selecting.

(from "A Professional Digital Audio Mixer")



# We've earned our great track record mixing great record tracks

After twenty-five years, Neve remains the industry standard in audio mixing; a name synonymous with quality sound.

Those who have benefitted most from our achievements are those who have contributed most to our success: our customers.

Twenty-five years is a long time to stay on top in a technically sensitive business where the demands for greater track capacity and processing power show no signs of slowing down.

That's why today, as always, Neve responds: to our customers, our industry, ourselves.

We respond with the finest totally instinctive automation systems; Necam; the state-of-the-art in digital recording, DSP; and millions of dollars in analog and digital research to ensure our record company leadership in the studios of today and tomorrow.

For twenty-five years, respected record producers and engineers have relied on Neve for audio excellence and the extra conveniences that help deliver a hit.

We've earned quite a reputation from their achievements. After twenty-five years we're still leading the race in audio technology. And we're about to establish even greater records.

## Neve

*RUPERT NEVE INCORPORATED: Berkshire Industrial Park, Bethel, CT 06801 (203) 744-6230 Telex 969638 Facsimile: (203) 792-7863 • 7533 Sunset Blvd., Hollywood, CA 90046 (213) 874-8124 • P.O. Box 40108, Nashville, TN 37204 (615) 385-2727 Telex 786563  
RUPERT NEVE OF CANADA, LTD. represented by: Sonotechnique, 2585 Bates, Suite 300, Montreal, P.Q. H3S 1A9 Canada (514) 739-3368 Telex 055-62171 • NEVE ELECTRONIC INTERNATIONAL, LTD. Cambridge House, Melbourn, Royston, Hertfordshire, SG86A England Phone (0763) 60776 • RUPERT NEVE GmbH: 6100 Darmstadt Bismarckstrasse 114, West Germany Phone (06151) 81764.*

multi-channels surpassing analog models a year later in 1991. The same motivation underlying that change-over, the consumer's preference for digital recordings on CD, will certainly dictate other changes in the professional studio. Following closely behind tape recorders, the next link in the threatened analog recording chain appears to be mixing consoles.

For example, the higher fidelity standards of digital storage media reveal the inadequacies of analog components in the form of hard-pressed amplifiers, as the wide dynamic range of digital recordings exercises those components as never before. In addition, more sophisticated production values necessitate more flexible production equipment. The combination of higher fidelity standards, and greater user versatility seem to point designers in the direction of a digital mixing console as the most cost-effective solution.

As a number of audio manufacturers will testify, the design of digital mixing consoles is quite complex. While many of the insurmountable obstacles omnipresent in analog technology are completely lacking in digital, seemingly trivial exercises in signal processing can require sophisticated digital circuits. In addition, the task of real-time computation of digital signal processing presents problems unique to digital architecture. In short, the digital manifestation of audio components requires a complete rethinking of analog architectures, and originality in the use of existing digital techniques.

A digital mixer avoids numerous

problems encountered by its analog counterpart, but its simple task of providing the three basic functions of attenuating, mixing and selecting of signals entails significant design complexity. The problem is augmented by the simple realization that all operations must be interfaced to the user's analog world. A keyboard programmable-only mixer would be *much* easier to design than one with potentiometers and other creature comforts.

The first fundamental task of a mixing console is gain control. In analog, this is realized with only a potentiometer; however, a digital preamplifier would require a potentiometer, an A/D converter to convert the analog position information of the variable resistor into digital form, and a multiplier to adjust the value of the digital audio data, as shown in Fig. 1. The mixing console's second task, mixing, could be accomplished in the analog domain with several resistors and an operational amplifier, but would require a multiplexer and accumulator in a digital realization, as shown in Fig. 2. The third task, signal routing, is accomplished in analog with a multi-pole switch, but would require a demultiplexer and encoding circuit to read the desired selection, as shown in Fig. 3. The nature of the problem is more fully understood when it is realized that all processing steps must be accomplished on each audio sample in each channel in real-time, that is, within the span of one sample period, 1/48,000 second or so.

The multiplier presents the most likely bottleneck in a digital audio process-

ing system. Many types of hardware multipliers have been developed for many applications: serial-parallel multipliers using pipeline methods, parallel multipliers using array methods, and ROM multipliers using logarithm and dividing methods. Hardware cost, computing speed and computing accuracy must all be considered. The example of a digital system for fader and balance control in Fig. 4 illustrates the type of signal flow we might expect in a digital preamplifier. By using an adder for low speed computation such as user input, the amount of high speed computing at the multiplier may be reduced. Input data from two channels is multiplexed by parallel processing, and position information from the balance control is converted at low speed by an A/D and stored in RAM. The digital position data is synchronized with the audio data and together they are supplied to an accumulator to successively add data words together.

An overflow circuit might be included to scale the information to prevent distortion at the multiplier. This can occur because of the nature of data addition: when  $m$  channel signals of  $k$  bits, each are added in the accumulator, the number of bits contained in the result may increase to a maximum of  $P = k + \log_2 m$  bits. Thus a digital signal processor accepting and outputting 16 bit audio data may internally require processing capacity of words of 32 bits or more. The data is then applied to the multiplier to accomplish the actual manipulation of the data. A parallel to serial conversion prepares the data for

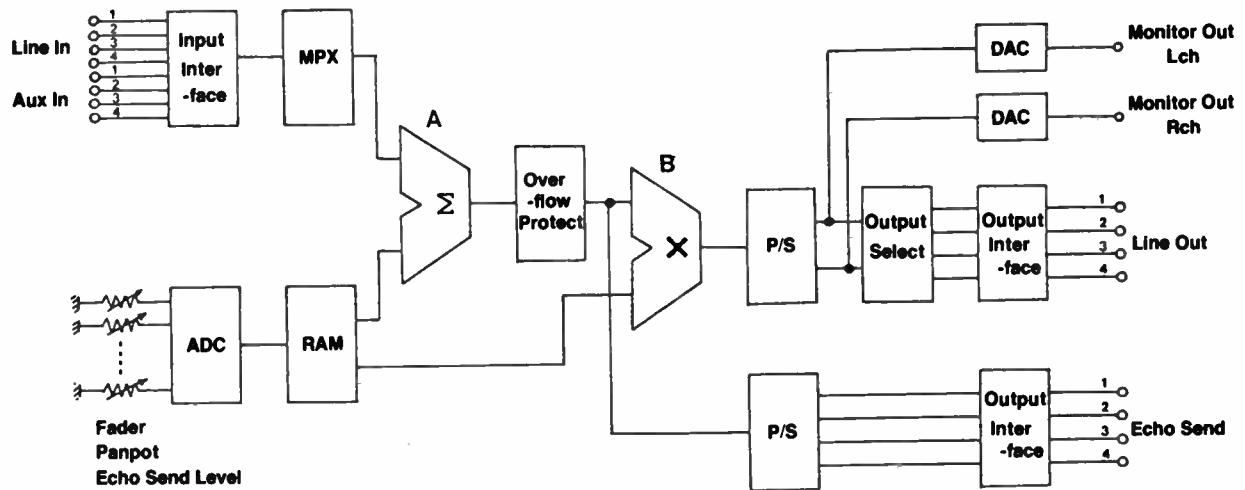
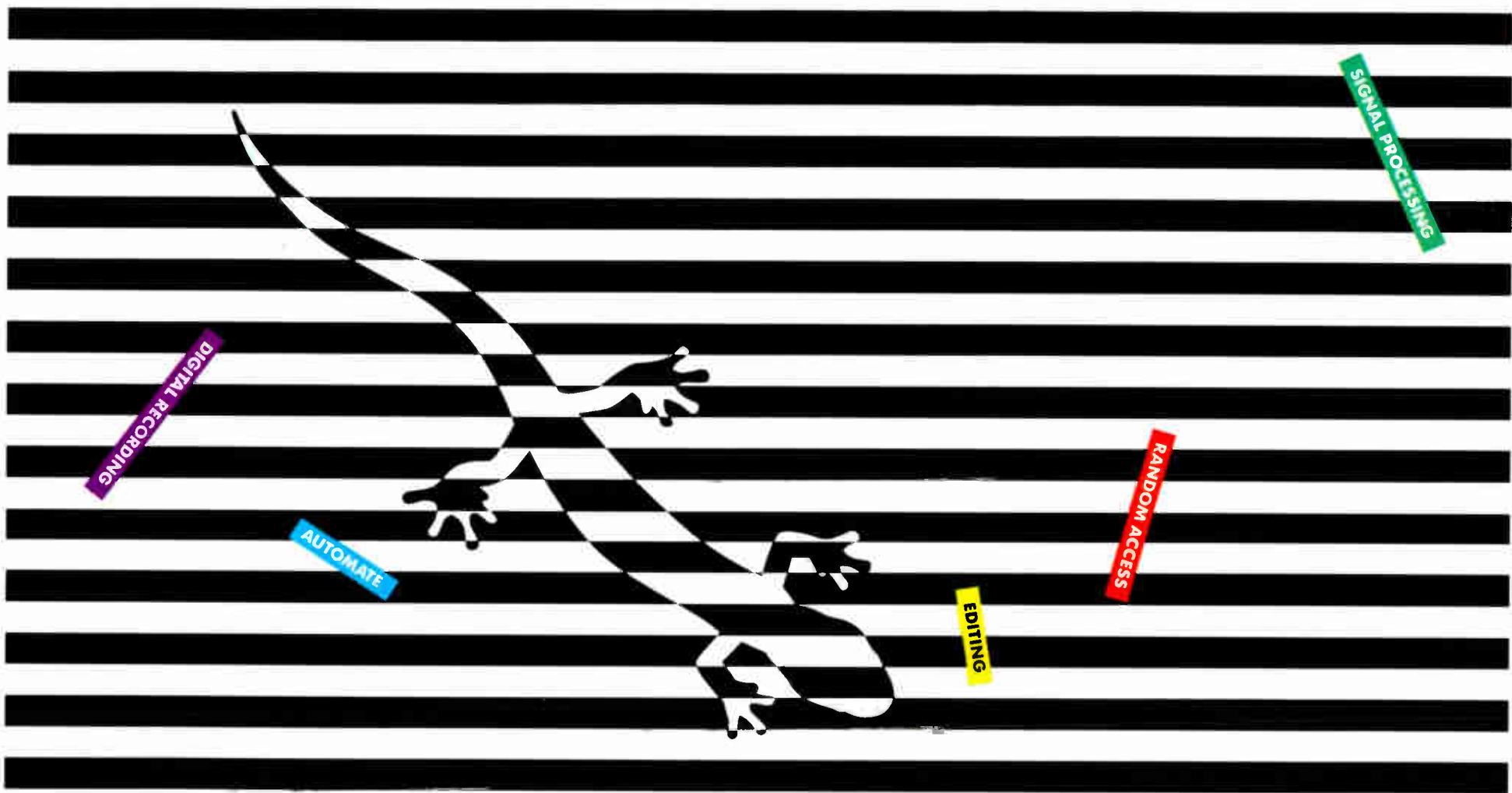

Figure 4. Digital fader and balance control (from "A Professional Digital Audio Mixer").





**CHAMELEON.** The CompuSonics DSP-2002 Digital Audio Computer. It's a tape deck, an editor, and a mixing console all in one. In fact, it's capable of emulating most of the audio gear in your editing suite. Except your ear. ■ Its ultra high fidelity digital recording system records on a computer disk with a 96 dB dynamic range, a S/N ratio of 91dB, unweighted, no wow or flutter, and needs no noise reduction. None. (For compact disk mastering, there's a digital input/output to the Sony 1610.) ■ Computer memory is very fast. With the CompuSonics DSP-2002, you select the music segments you want spliced together, and the DSP-2002 does it. Instantly, in playback. No tape shuttling. No tape handling. Ever. ■ When it's a mixer, familiar fader controls appear on a full color display screen and can be manipulated by means of a trackball array. ■ Operation is easy. You don't need to know a thing about computers. All you have to know is words like "record," "playback" and "rewind." The DSP-2002 does the rest. ■ And CompuSonics technology allows you to store extraordinary amounts of audio—an entire recording session, if you want—with any portion of it instantly accessible for playback or editing.

65 Let the DSP-2002 show you its true colors today. Call CompuSonics for a demonstration 1-(800) 223-1821. **CompuSonics**



# IF YOU'RE A MUSICIAN

**I**f you're a musician, your profession is more challenging and exciting than ever before. New technologies are giving you tools for self-expression that no one dreamed of just a few years ago. Digital synthesizers, portable multi-tracks and signal processing equipment have brought a whole new dimension to composing and performing; digital recorders and improved sound systems have made it possible to capture your music with remarkable clarity and dynamic range.

MIX is the publication that can best help you stay informed about this revolution in music technology. Every month MIX brings you columns and feature articles about subjects like MIDI, computer music systems, and how top performers get the sounds that keep them on the charts. MIX also features new product columns, reviews the newest instruments and other gear, reports on new artists and recording projects, and interviews the top names in music today. And MIX directories are your best source for information on industry services and facilities!



If you're a musician, you're in the MIX!—the magazine that ties together the worlds of creativity and technology. If you're not a subscriber, take advantage of our low subscription rates to receive MIX at home. Because in today's changing industry, you need information as never before...

## ...YOU'RE IN THE MIX



digital and analog output. In such a digital mixer, no signal deterioration would result in terms of dynamic range, distortion, and frequency response due to the processing.

The performance of such a system relative to cost will ultimately be the deciding factor for market penetration. While such processing units have been performing arithmetic functions for many years, they have never been configured for audio applications, except on a custom basis. However, with the decreasing cost of digital technology, and the expansion of the professional and consumer digital marketplaces, it will soon become cost-efficient to mass produce such audio processing units, using hardware selected from off-the-shelf electronics. Items such as an 8085 or 68000 microprocessor, AM9511 A arithmetic processing unit, 6847 CRT controller, 8279 I/O controller and RAM are typical pieces of any contemporary microcomputer system, however the result of such a system is recognizable audio features such as equalization curves. The combination of OEM electronics, specially-developed audio integrated circuits, and relatively large production runs should bring the cost of digital audio mixers within economic reach of many recording studios.

Several digital mixing consoles and systems have, of course, already left the drawing board. The Digital Recording Corporation's Soundstream digital recording and editing system uses disk packs and a minicomputer for interactive or batch processing, with sophisticated graphic displays. The Lucasfilm ASP (Audio Signal Processor) achieves real-time processing of equalization of level control and mixing, as well as real time synthesis, with a multi-processor architecture; the ASP can be used in conjunction with the EditDroid video editor for complete picture and sound editing. The Compusonics DSP-2000 is another example of a multi-processor digital console for mixing and live recording.

The most celebrated studio digital audio console is the Neve DSP; the first commercially-available system was installed at CTS Studios in Wembley, London, during Christmas, 1984. The console is 4½ meters long (not particularly large for a film-scoring console), and processing electronics is contained in six externally-located racks; the two are connected by two 50 micron diameter optical fibers in a single cable. The use of optical cable eliminates high frequency loss, crosstalk, RF, hum, etc. The console allows for 48 microphone inputs, 32 group outputs, 72 line level inputs, and eight auxiliary

sends. The AES-EBU digital interface is adhered to, with a sampling rate of 48 kHz. Unfortunately, A/D and D/A conversions must be performed when interfacing the DSP to outboard digital devices because of manufacturer's disobedience to the standard. The channel processor uses 24 bits; this is equivalent to a 144 dB S/N, thus equalization may be performed without fear of pre-fader overload. The mixing processor uses 32 bits; this 192 dB of S/N is virtually overload-proof.

In the digital domain, time manipulations become relatively simple, albeit dependent upon storage capacity. The DSP provides a variable time delay of approximately 0 to 100 milliseconds per channel to control arrival of signal times, thus providing the opportunity of bringing otherwise incoherent multi-microphones into phase coherence. The other time advantage of digital, multiplexing, allows efficient use of buss structures. In the 20.8 microseconds between audio samples, there is time for 128 other samples to travel the same buss for trips through equalizers or compressors, for example. Multiplexing also eliminates the need for massively parallel patchbays; when source and destination is specified, the rest is handled internally.

Since the top panel of the DSP is merely a remote control of the processing circuits located in the rack, it is a simple matter to offer assignable functions. Although the top panel of the DSP emulates a conventional analog console, with parallel controls, one set of controls could be used to manipulate all of the signal channels, using the control set as a selectable window through which to view and control all the mix elements. Along these lines, there is no need to limit controls to the equivalent fixed analog circuit parameters. Thus rotary knobs, for example, have no end stops and can be programmed for any function, or resolution. For example, equalization could be accomplished in fractions of decibels; the selected values are displayed in alphanumeric LEDs.

Console set-up is accomplished via a typewriter keyboard, and particular configurations can be saved on floppy disk, or pre-programmed for rapid changeover in a real-time application. Of course, flexibility can be more of a curse than a blessing if the operator is required to build his own software console from scratch each time, thus five console preset configurations are available: track laying, mixdown, combination of track laying and mixdown (for bouncedown, etc.), return to previous setting, and a fail-safe minimum mode in the event of system problems. A con-

sole configuration can be read from disk and the console completely reconfigured, in 20 seconds.

A video display shows graphic representations of console blocks as well as their order in the signal path, useful when the default setting of delay, filter, EQ, dynamics and fader is varied. In addition, each path is named, and its fader assignment shown, as well as its mute group, solo status, phase reverse, phantom power on/off, time delay, etc. The video display is also of use to the maintenance engineer; the DSP runs background diagnostics, and a problem may be pinpointed by stepping down into the appropriate level of screen information: The Neve DSP thus provides the flexibility of digital processing, with ergonomics which surpass that of analog consoles. The result is a console which offers superior production capability, and of course, digital sound quality.

The Compact Disc has raised the standard required of an audio recording system. Higher quality system components are needed to meet the CD's playback fidelity. How will recording engineers and studio owners perceive the still-increasing demands of digital audio, and the availability of even more analog-unorthodox equipment? There may not be much flexibility in their response. Only with the advent of digital audio components such as digital mixing consoles will audio recording system standards more generally match those of the Compact Disc reproduction system. Otherwise there exists a paradoxical yet very real danger that consumer digital audio expectations might surpass professional standards.

## References

1. Edwin Engberg, "The Digital Studio: A Look at the Future," Ampex Magnetic Tape Division, Pro Sound News, June 10, 1985.
2. N. Sakamoto, S. Yamaguchi, A. Kurahashi, "A Professional Digital Audio Mixer," Acoustic Research Laboratory, Matsushita Electrical Industrial Co., Ltd, internal document, 1983.
3. K. Kitagawa, K. Endoh, Y. Ishizawa, "A Proto Model of a Digital Audio Control Center," Toshiba Corporation, AES preprint #2204, October, 1983.
4. H. Yamauchi, H. Takahashi, Y. Hayashi, T. Konishi, Y. Usui, M. Tanaka, "Eight Channel Digital Mixer for Digital Mastering and Recording," Sony Corporation, AES preprint #2173, October, 1984.
5. D. Schwartz, "Specifications and Implementation of a Computer Audio Console for Digital Mixing and Recording," Compusonics, AES preprint #2139, October, 1984.
6. M. Jones, "The Digital Mixing Console," Studio Sound, October, 1983.
7. K. Spencer-Allen, "DSP at CTS," Studio Sound, March, 1985.

# Emulator II. We set the standard. Now we've raised it.

In 1981 E-mu Systems created the original Emulator digital sampling keyboard and introduced the power of digital sampling to a world of musicians, composers, producers and sound effects designers. Now, drawing on four years of experience as the pioneers in affordable professional sampling technology, E-mu Systems presents the Emulator II™—an instrument that sets new standards of sonic realism, creative power and expressive control.

## Superior sound quality

Like its predecessor, the Emulator II is a completely self-contained professional sampling system. With it you can digitally record literally any sound and play it back polyphonically from its keyboard. But that's just the beginning. The Emulator II uses a new data encoding technique that results in truly stunning sound quality. From the sound of the rosin on the bow of a violin to the screaming overtones of a heavy metal guitar, every nuance of a sound is reproduced with startling realism.

The Emulator II comes with a full 17 seconds of sampling time (at maximum sampling rate) and a built-in floppy disk drive to let you store and reload your sounds. You can select disks from our extensive library of digitally recorded sounds or use the Emulator II's user sampling facility to create a personal sound library of virtually limitless size.

## Creative control

Once you've sampled a sound, the Emulator II's real creative power comes into play. Its velocity sensing keyboard gives you precise expressive control over loudness, timbre and articulation (you can even program its dynamic response to match your personal playing style). You can assign multiple samples anywhere on the keyboard with up to 60 programmable splits. Or assign two sounds to the same range and use keyboard velocity to control a crossfade between them.

A variety of analog and digital sound processors let you tailor each sample

to your specific needs. Samples can be tuned, transposed, truncated and looped (our new AutoLoop™ function uses the Emulator II's powerful computer to help you find the best possible loop points). The inclusion of programmable filters, VCAs, and envelope generators for each channel allows extensive sound modification and reshaping. A backwards mode facilitates the creation of satanic messages. Or you can use the digital splicing function to create completely new sounds from parts of other samples (imagine an instrument with the attack of a piano, the sustain of a violin, and the decay of a guitar).

Each channel also includes its own LFO with programmable delay and a unique random variation mode that helps you create realistic ensemble passages by assigning a slightly different vibrato rate to each note you play.

## Powerful MIDI sequencer

To help take full advantage of the Emulator II's compositional capabilities, we've included an extremely powerful polyphonic sequencer. Its features include auto correct (that works!), full programming of keyboard dynamics, and complete track oriented editing



**E-mu Systems, Inc.**  
applied magic for the arts  
2815 Chanticleer  
Santa Cruz, CA 95062  
408.476.4424





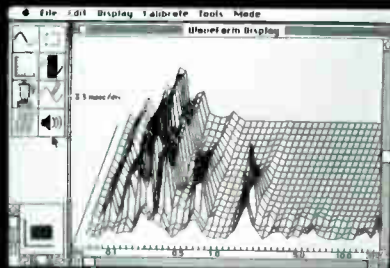
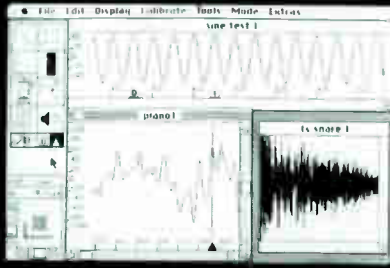

The Digidesign Sound Designer™ turns your Emulator II into a complete computer music system

with punch-in, punch out, and track bouncing. What's more, it can also function as a stand-alone multichannel MIDI sequencer capable of controlling up to eight other MIDI instruments and drum machines with a storage capacity of over 90,000 notes!

### Multiple interface flexibility

Add to all this an RS-422 computer interface, a 24 pulse per quarter note clock, a full MIDI implementation, and a built-in SMPTE code reader/generator

and you have a complete music and sound effects production facility in a single portable package.

### Designed for the future

From the start we designed the Emulator II for expansion. Options that you can add now or in the near future include a hard disk for vastly expanded sound storage (and a two second load

time!), a SMPTE-based event oriented sequencer for the production of automated sound effects tracks, and, probably most exciting, the Digidesign Sound Designer™ which turns your Emulator II and an Apple Macintosh™ into an advanced computer music system complete with 3-D graphic waveform analysis, waveform modification, multi-algorithm digital synthesis, music printing and editing, and more. All at a fraction of the price of other comparable systems.



*To find out more about the Emulator II (and there's a lot more to find out) visit your nearest E-mu Systems dealer for a complete demonstration. Or send us \$2.00 for a demo record and color brochure.*

**The Emulator II. The new standard from E-mu Systems.**



**Digital  
REVERB**

PART FOUR

the roundtable

by Larry Oppenheimer

Here at *Mix*, we just don't know when enough is enough. Otherwise, how did a three-part series on digital reverberation turn into a five-part one? Actually, the case is more that you can't get enough of a good thing: after the overview in the first part, the explanation in the second part, and introduction to the roundtable in the third part, we found that there was still too much valuable information left to just print Part 4 and call it a day.

The roundtable conversation held during the 78th Audio Engineering Society convention in Anaheim, involved Anthony Agnello (Eventide), Jeffrey Borish (Droid Works/Lucasfilm), David Griesinger (Lexicon), Gary Hall (Sony Corporation), Christopher Moore (Ursa Major), Richard Neatrour (ART), and this writer. The discussion ranged across many topics, and the participants let their thoughts and ideas flow casually and freely. This produced an important glimpse into the nature and state of the art in digital reverberation and some of the people shaping that art. In Part 4, a number of subjects are touched on; in Part 5 a smaller number are explored in more depth. Without further ado:

**Early Reflections**

**Larry Oppenheimer:** It seems that early reflections are sort of a large issue here. I mean, with a plate we're talking about the lack of them, with halls or rooms they largely typify the

space. Obviously everybody's taken different approaches to early reflections in their work. Yamaha has really gone out there; they've completely oriented the whole machine around it, but I'm not sure that people really have a grasp on what typifies early reflections of a small room as opposed to a hall. If they're sitting down and have some control over early reflections, whether it be pushbutton control or being able to individually set where early reflections are, I'm not sure that if people want to simulate something real they have any idea where early reflections fall in terms of time, level, or spectrum. Does anybody want to talk about early reflections?

**Jeffrey Borish:** The biggest difficulty in simulating early reflections in the context we're discussing is that it's very important that they reach listeners from the appropriate direction to create the subjective effect that they create in a concert hall. If they don't reach listeners from those directions, that is, if they're added in with the reverberant sound that's added to the direct sound, the cumulative stereo signal, then they're coming from the wrong direction, and that distortion is going to result in a simulation that sounds overly reverberant. So, in my research I found that it was absolutely essential that those early reflections be recreated from a direction outside the arc of the stereo speakers, which makes it very difficult to utilize them in reverberators.

**David Griesinger:** If Jeffrey hadn't said that, I was going to say it. At this point in time, I think if you can't reproduce them from a different direction than two front loudspeakers then they don't serve a useful purpose, with the exception of film work. If you ask 80 percent of the recording engineers in the world that do classical music what they think of early reflections, then they would say, "The fewer, the better," and you'll find they do extraordinary things to get them out of their recordings.

If you've ever seen a Philips recording session of the Boston Symphony, what do they do? They take out all of the audience seats, move the orchestra off of the stage onto the floor where they're as far away as possible from any wall or any reflecting object whatsoever, and they mike them there. What is the reason for this? My experience as a recording engineer is just what Jeffrey says: you don't want 'em. If you get them in the sound, they are detrimental to clarity, they're detrimental to music. I can see their usefulness in a film situation, only under the condition where you're trying to match a sound to a sound that you did

**Anthony Agnello:**  
"I go through periods where I'm tired of playing with reverberation, and then something will occur to me and I'll get excited again."

live, the sound you did live was overly reverberant, and you don't want a discontinuity when you add something that's been dubbed. In that case, it's my experience that almost anything will do. Throw something in, it will all sound bad, as long as you get the right total energy, and have some spatial incoherence, you'll be okay. Otherwise, leave them alone.

**Anthony Agnello:** I get the impression that some algorithm designers feel that adding a single tap out of a delay line is good enough to represent an early reflection. That's not at all what happens inside a room. Obviously, a sound wave impinging on a wall is going to be diffused no matter how



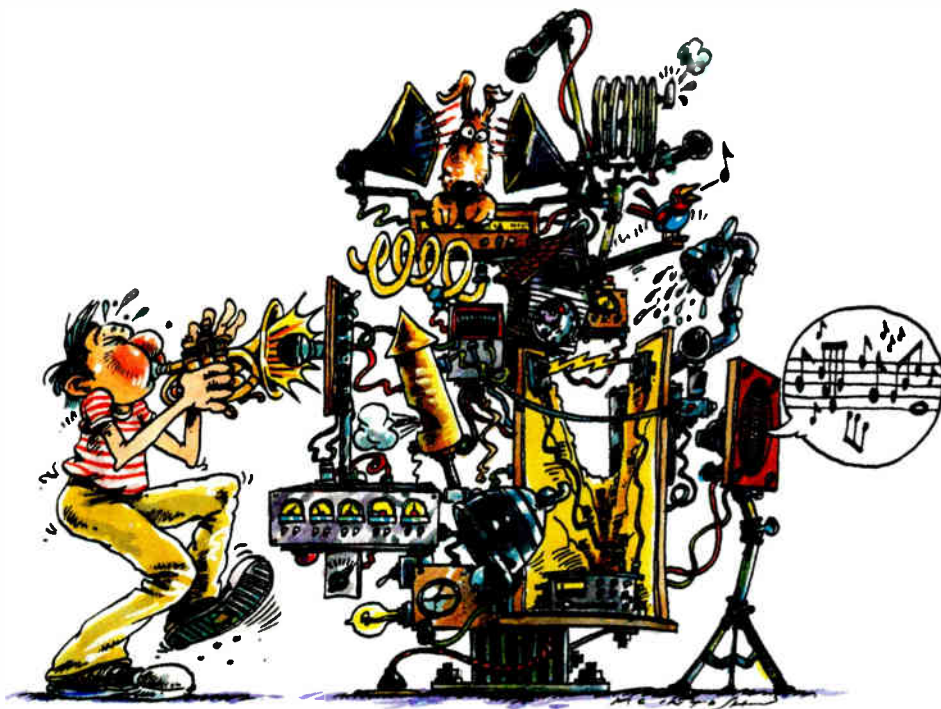

## HARRY, THERE *HAS* TO BE AN EASIER WAY.

MEMO:

Listen, Harry, I *know* you keep saying we need "creative sound processing" to stay competitive. I *loved* the way you hung the mikes inside a 24-gallon aquarium for the Fred's Fish Food jingle (too bad Fred's singing goldfish dropped dead, though). And your reverse hyperspatial time-delay effects for the "H.G. Wells Concerto" were *incredibly brilliant*. Real award-winning stuff.

But I gotta tell you: these complicated set-ups of yours are driving me crazy. First I spend *all day* rigging equipment. Then I go *all night* de-bugging the effects so they sound right.

Harry, there just *has* to be an easier way to produce interesting acoustic environments.

And I think I found it: Ursa Major's new *StarGate 626*. The 626 puts just about every effect we need—digital reverb, delays, and special effects—inside *one box* with *one set*

of controls. The reverb programs all sound *absolutely professional* (this is an Ursa Major unit, after all)—but the 626 goes way beyond straight reverb. There's mono and stereo delay lines, for example, an effect called "reverse reverb," a stereoized dual echo, and the brightest plate simulation I've ever heard. Plus a lot more—16 pre-tuned "rooms" in all, with 256 possible *variations* on each effect.

Anyway, Harry, I want you to cancel everything on your calendar tomorrow morning. I'm taking you to hear a *live demo* of the 626. Don't forget the checkbook, either. We *need* this thing—and the sooner the better.

Regards,

*Ozzie*

---

### THE STARGATE 626

---



# URSA MAJOR, Inc.

Box 28, Boston, MA 02258 USA • Telephone (617) 924-7697  
Telex: 921405 URSAMAJORBELM

Circle #031 on Reader Service Card

World Radio History

hard and flat it is, there's going to be a lot of things happening, depending

**Jeffrey Borish:**  
**"The biggest difficulty in simulating early reflections is that it's very important that they reach listeners from the appropriate direction."**

on the actual surface, the angle of incidence, things like phase shift and frequency modifications. It's kind of dangerous to just take a single tap, or a small group of taps and create these horrible comb filters, and you can't try to adjust them.

**LO:** When you're going to build a reverb and give some sort of control to a user, how do you deal with that?

**AA:** In my room algorithm, there's digital EQ and phase shift on each of those early reflections.

**LO:** So you use a reasonable amount of processing on them?

**AA:** There's quite a bit. In terms of how the user interacts with it, there really is no provision for the user to manipulate the individual reflections. I did something that just seemed logical, to have a room position parameter so that the listener can move his position from the front of the hall to the rear. More recently I've done a stereo version of our room, and I've done some work with left-right, but it's not very convincing to me. I'm doing something wrong there.

**Christopher Moore:** You mean a stereo input version?

**AA:** Yes. I wanted to have the listener actually be able to place himself inside the enclosure. In fact, I think I spent months just on that one parameter, that simulation of moving inside a room. A good chunk of the processing that's going on in there is to deal with those early reflections and to make that convincing.

**Richard Neatrou:** I found a relation of these early reflections: you put a spike in and you've got, who knows, maybe 12 to 40 of these early reflections of pulses happening, it takes a lot of work to get them. They not only give

you the localizations, but typically they drive into the rest of your reverberator; they define a lot of other characteristics that come later in the reverberator.

**LO:** David, I'm interested by your comment that a recording engineer will basically say, "I don't want any room reflections." I'm not sure that holds for all kinds of music recording.

**AA:** I think David's talking about discrete early reflections, very coherent early reflections.

**DG:** I guess I'm talking about discrete early reflections, yes, but they don't have to be too discrete to be a problem.

**AA:** Just discrete enough to be annoying.

**DG:** There are some wonderful places I record that have stage areas that are no bigger than this room, with walls that are like this, only they may be fairly well-textured, but the fact is the walls are too close to the orchestra, and the sound bouncing back and forth in there results in a very confusing sound quality. It's much better if you can get the orchestra out of there.

**AA:** But the reflections are coherent enough to be...

**DG:** I'm not sure that's the problem. I think the problem is the time delay is too short and there's too much energy in there compared to your pickup of direct sound.

**LO:** So you're saying that nobody really cares about the early reflection features that are on most of the reverb units that are out there?

**DG:** I think they're overrated. This is pure, blatant, personal opinion. People

**David Griesinger:**  
**"The question is, if you have a studio recording can you make it sound like that? The answer, theoretically, is no. But you can do something, and that's worth trying."**

have spoken about them and given them much more thought than they're worth. For classical music, to my ear, they're detrimental. You don't want them there. The question is, what do you want? And if I knew the answer, I

might tell you, but I don't, so it's safe.

**LO:** But is classical music the only place these things are being used?

**DG:** Oh no. I think another place, as I

**Gary Hall:**  
**"The striking thing to me about user feedback is how widely variant it is. There seems to be room for virtually everything in the market."**

said, is in film work, where you're trying to make something sound as bad as something else that you recorded, and you're trying to match one bad sound to another. In that case they have a very distinct use.

**RN:** I'd agree with David on the classical music. One thing I've found is providing the user with the ability to really smear the front end of his signal with early reflections. It's a smearing process more than anything else. There are more creative applications for different types of music that are not really involved at all in creating a natural environment. For a lot of people involved in new music, very contemporary music, synthesizer works, and especially drum machines, their aim is more the opposite. People want to get very tight sounds, but smear some of the information coming out of the drum machine.

**DG:** I would agree with that completely. There's certainly lots of room for that.

**LO:** What I was really wondering was, how happy will Phil Collins be if you take away his early reflections? And the answer is probably, 'not very'.

**RN:** Exactly. Some things will sound like two drumsticks together and that's not what he wants to hear there. He wants to hear two drumsticks with this other little envelope around them.

**DG:** You might want to make more of a snare sound out of it, thicken the snare somehow. Yes, that's very valid. In that application, anything goes.

**CM:** This early reflection issue is interesting. In my mind, the two products that represent the extreme approaches are the Quantec, in which the role of early reflections is essentially denied, at least discussions with Wolfgang





**Spacious,  
Sparkling,  
Expansive,  
Effervescent,  
and yes,  
Beautiful.**

The new XT digital reverb from Alesis. With features usually found only in units bearing sky-high price tags. Like 14Khz frequency response. And extended delay options like Pre-Delay and Slap-Back. Wide range decay time control. Diffusion, Damping, and filters. With the XT you can fatten drums, fill in dry strings or simply set vocals back into the deepest, smoothest acoustic cushion imaginable. All in full stereo.

The XT mixes reverb into a signal directly from the front panel or connects to any board with echo sends.

Digital reverb technology finally comes down to Earth. See the Alesis model XT at better music stores and studio supply centers everywhere.

Made in USA, suggested retail price \$795.

**ALESIS**

Alesis Corporation, P.O. Box 3908, Los Angeles, California, 90078 Telex 855310.

Circle #032 on Reader Service Card

Schwarz have indicated that he doesn't feel that it's part of the process that needs to be reproduced, and the Yamaha REV1 at the other extreme.

**AA:** Well, there's room for both. There is room for a product like the REV1 where the user can play with individual reflections, even for one more open-ended than the REV1 because it has fixed patterns, but if the user had the ability to set each of those taps in amplitude and delay, he could do very interesting things that wouldn't sound like a room. That's why this thing is so open-ended, though. Most of our motivations have been to digitally simulate a real room, but what you begin to realize is that there are a lot of other possibilities. I guess that most of the things we've played with have sounded natural to us.

**Limits of Stereophonic Reproduction of Reverb**

**CM:** There seems to be a related aspect of the spatial characteristics of reverberation, which is that if it's bad news to have the reflections come out of the main stereo pair of speakers in the front of the room, the only pair of speakers, then there's a real question about the validity of the reverberation also coming only from those speakers.

**DG:** Absolutely correct.

**CM:** Reverberation, of course, is coming from all around you, and when these devices get used in two-channel recording and reproduction in the consumer's home, it's not going to be

**Christopher Moore:**  
**"There are really important questions as to whether or not you want to give so much control of the parameters of the machine that it can be adjusted to sound bad."**

realistic from that standpoint.

**DG:** This isn't really true. There are things you can do in the recording situation that are valid. A recording engineer will tell you that it isn't hopeless reproducing things through stereo loudspeakers. There are very nice recordings that get played through stereo loudspeakers, and they have rever-

beration on them. The question is, how do you get *that* reverberation to come out of the loudspeakers, and I think it's a solvable problem. It's not a *really* solvable problem; again, you can only do an approximation, but you can do a worthwhile approximation. But you have to be thinking about energy and densities that are much greater than single reflections, in fact, as big as you can get them. You do things with time delays and space, and in some cases some rather large time delays, and rather carefully thought out amounts of energy to get that to happen.

**JB:** Now, I'm not quite with you. Are you suggesting some signal processing during playback?

**DG:** No. You don't have to have signal processing during playback of a well-made recording. You should be able to duplicate that.

**JB:** I took Chris' comment to mean that you can only obtain limited benefit from reverberation that's been recorded, due to the fact that it's always produced by speakers in front of you, whereas in the concert hall, of course, you're surrounded by this incoherent sound.

**DG:** That's right. It would be much better to be surrounded, but in fact there are very good recordings made with

**T H E E D G E**



*In pro-audio, the edge is a combination of talent and technology.*

**DR1 DIGITAL REVERB SYSTEM**

- FULL 16-BIT TECHNOLOGY/14KHz BANDWIDTH
- FULL FUNCTION REMOTE CONTROL INCLUDED
- OVER 100 PRESETS/USER PROGRAMMABLE
- FULL MIDI CAPABILITY
- STEREO IN/OUT/FULL MIX CONTROL
- SOFTWARE BASED/UPDATEABLE



Full Function Remote Control

Our brand new software based DR1 Digital Reverb has 16-bit technology and 14KHz bandwidth, giving you wide dynamic range and frequency response. This range and response result in high definition performance.

Couple this technology with the convenience of full function remote control, over 100 user presets and full MIDI capability. Add your talent and you've got the edge in high definition.

And that's not all. We've gone several steps beyond by providing stereo in and out with full mix

control and our famous FIR programs so that all the sound you're looking for can be realized.

There's one more thing. Our powerful software is updateable. That means when you buy a DR1 today, you won't lose your edge tomorrow.



**Applied Research & Technology Inc.**  
 215 Tremont Street  
 Rochester, New York 14608  
 (716) 436-2720

■ DR1 DIGITAL REVERB ■ DR2 DIGITAL REVERB ■ 1500 DIGITAL DELAY ■ 1/3 OCTAVE EQUALIZER ■ 2/3 OCTAVE EQUALIZER ■ PITCH TRANSPOSER PACKAGE

Circle #033 on Reader Service Card



# CLARIFIED SOUND

## THE SPII PROJECTOR FROM DOD



Two very pleasant things happen when you plug the DOD SPII projector into your audio system.

1. You hear unsurpassed clarity... both in individual vocals/instruments and in frequency range.
2. Hearing fatigue from distortion caused by high volume and excessive high end EQ is practically eliminated.

The technical term for the DOD SPII projector is "psychoacoustic" two-wide processor. Yes, the SPII is a very sophisticated piece of electronic hardware. It is not a limiter, equalizer or compressor. The SPII's unique circuitry is designed to "shape" sound specifically for the human ear without distortion, without irritating substance, without noise.

Although the SPII is the perfect compliment for just about any mixing or recording application it is also ideal for live performance. Used on solo instruments or vocals it will enhance and clarify even the subtlest passage of instrumental sync. It will project the upper reaches of the human hearing spectrum without the necessity of increasing volume. It is a purest audio component. It is state-of-the-art. It comes only from DOD Electronics.



natural reverb that play on only two loudspeakers. The question is, if you have a studio recording, can you make it sound like that? And the answer is, theoretically, very definitely no. But you can do something, and that's worth trying.

**Characteristics of Plates:**

**RN:** One thing I've found that's interesting: a plate is totally different than a room. There's a lot of little things that we all do differently between simulating a plate and a room, but I don't know if I've heard the perfect plate yet, electronically.

**CM:** My impression of a plate is that

you won't get any kind of sense of being in an acoustic space because it all happens so fast that there's nothing in the early period far enough apart that your ear can work on. It almost immediately gets in a kind of a statistical process, but that's more of an intuitive understanding than based on taking any data or really looking at plates.

I wonder how many people who have designed programs that are called "plates" around this room really have spent that much time with plates, because my confession is that I really haven't. I've gone to a studio and occasionally listened to one, but I've never had one around as a reference for a

protracted period of tuning. I carry with me a mental idea that the whole thing better get going fast and sounds pretty bright, but it's literally as loose as that.

**RN:** That I'd agree with. In a plate, the gains of the early reflections change from a room. I found also that they're almost a burst right at the front end. There are things about when you try and simulate them, like your FIRs or your early reflections all happen very fast. You almost want to turn a click into a gated noise burst or a shotgun sound.

**DG:** I've made a plate; I know about sound waves in membranes. Does anybody have a recorded impulse response?

**AA:** Yeah, I was about to say, I did do that. It looks, I think, like the impulse response of most of our plate simulations, at least marginally.

**DG:** How quickly does it rise?

**AA:** Within 20 ms it's peaked.

**Questions of User Control**

**RN:** You can take a little work and make something that sounds reasonable. I don't know if it's necessarily a great thing to have a user go in and move one tap of an early reflection, because he changes a whole lot of things, and it's real easy in moving one or two of the localization cues to just throw off the whole image. As products evolve I think that you should provide the ability for users to change proportionally or with some method, the distances of those early reflections, or maybe bank switch to a different algorithm that provides straight halls rather than a square room, but within the context of when he's in a square room, there are certain relations within those early reflections that help define the square room and I don't know if it's appropriate for the user to move every tap. Providing software so that you can move relations of the tap and possibly level relations over time would be interesting.

**Gary Hall:** It is awkward to put that kind of very specific atomic control in the hands of the user and make sense of it. It's more global; you head towards architectural definitions. What you'd ultimately like to say is: we are in a room of these dimensions with the walls and floor set like this, I am here in it and the sound source is there in it, and work from that.

**LO:** What about very demanding applications like film where there may be particular ambiances you need to create? In other words, the audience is looking at the ambient space and it may have specific characteristics you wish to duplicate. Do you think that it's at all necessary to have the kind of control to deal with that situation, or do

**W**hether in Multi-Track Recording or Sound Reinforcement, AHB brings to you over 14 years of experience in the design and manufacture of mixing consoles. This experience has been incorporated into the System 8 Series of mixers, making them one of the most reliable and versatile consoles on the market, while offering one of the best cost-to-performance ratios within the industry.

*We invite you to Look, Listen, and Compare . . . You will agree that the System 8 Series of mixers are Designed not only to handle your present needs, but also your needs of the Future!*



**Allen & Heath Brenell Ltd.**  
69 Ship St. Brighton, BN 1 1AE England  
Telephone: (0273)24928 / Telex 878235

**Allen & Heath Brenell (USA) Ltd.**  
Five Connair Road  
Orange, Ct. 06477 / (203) 795-3594

Canadian Distributor: Heint Electronics Inc. / 1-416-727-1951

Circle #035 on Reader Service Card



# Everyone Says They're Better – We Prove It!



- Time Delay
- Reverberation
- Crossovers
- Tape Noise Reduction
- Compressor / Limiters
- Expanders
- Spectrum Analyzers
- Parametric EQ

With all the strong claims by advertisers, it's not easy to distinguish between the hot air and the hot products. That's exactly why we prepared this demonstration album. In it we show you what our products do and how they compare with the best of our competition under identical circumstances.

You will hear our phenomenal MICROPLATE™ Reverb with over 18 KHz bandwidth in side by side reverb only comparisons with the EMT™ Plate on percussion and vocals. No other spring reverb would dare attempt such a comparison! The cost is incredible too, under \$600 mono, \$1,200 in stereo!

We also show our CLX-2 Compressor/Limiter/Expander in side by side comparisons with the dbx™ 165 and illustrate the CLX's audibly superior freedom from distortion as well as its other abilities of De-Essing, Expansion, Keyed Expansion, Push button Stereo Tracking, and Ducking.

Other demos feature our exceptionally versatile parametric equalizers, time delays and tape noise reduction. Examples are drawn from the master tapes of top 40 Hits and show some of the most sophisticated recording techniques ever devised. Let your ears decide who sounds best before you buy. Only direct sales allow us to offer a superior product at prices lower than the competition.

Write or call for a free 24 page brochure and demo album.

**LT Sound, Dept. MX-1, P.O. Box 338,  
Stone Mountain, GA 30086 Phone (404) 493-1258**

## **LT Sound**

**We Make A Better Product**

ily create these structures, and also make decisions on what parts of this structure can be controlled by the user.

The more I do this stuff, the less I'm sure about it. There really are a lot of possibilities. Just sitting here, new things come to mind that I'd like to try, but there are only so many hours in the day. I'm interested to see other people playing with algorithms. I'd really like to see some algorithms published. I don't know how important that is, but I'd be curious.

**DG:** Can you tell me if anyone has taken you up on your "build it yourself" concept? How many of those have you sold, if any?

**AA:** I don't want to sell any just yet, and I'll tell you why. We've installed one so far at some university, and we're also porting it to the IBM-PC. I think the documentation is finished, but I'm living in mortal fear of having four or five of these out there, and having my phone ring day and night. For my agreement with Richard Factor at Eventide, he said, "OK, we'll release this system, but we're giving out *your* phone number." [Laughter from all] So I'm nervous about the documentation being complete, and we are moving very slowly in releasing it. What we've done with it is that with the documentation I felt was complete late last year, we took on two new engineers, and each engineer's first task was to do something with this box without asking me anything, just referring to the documentation and keeping a log. That's what they did, and the last eight months have been used modifying and completing the documentation.

**DG:** Have you had inquiries?

**AA:** A few, but again we just recently started publicizing it.

**CM:** How far off from the IBM version are you?

**AA:** The IBM version is now being ported and it should be ready for the next AES in the fall. We're going to sell the HP version. Right now if someone wanted to buy the HP version I'd be prepared to sell it. Columbia University's used it, and the first two weeks we got six phone calls, the next week one or two.

**DG:** That sounds wonderful. I think you've done a public service for everyone.

**CM:** Me, too.

**AA:** Let's not get carried away.

**DG:** If someone from Columbia publishes a billion algorithms, then we can all talk to each other.

**AA:** Exactly. [General laughter] Really. Hallelujah. I go through periods where I'm tired of playing with reverberation, and then something will occur to me and I'll get excited again. I'd like to see

other people doing it.

### The Market

**AA:** There are a lot of reverbs out there right now, and obviously people have had a chance to play with them. It's really the first wave of digital reverbs, and it would be nice to have some feedback. Some of us are users in our own right; but basically we're designers and we can do with some feedback at this point.

**GH:** The striking thing to me lately about the user feedback is how widely

**Larry Oppenheimer:  
"Do you decide that  
you're not going to  
give anyone the  
control because  
there are some people  
out there who  
don't know how to  
handle it?"**

variant it is. It really points out the total subjectivity. I recently took a unit around for sales purposes, and I walked into a room where they were already using a system made by one of you fine gentlemen. I came in with this other system and the guy turned around with a big smile on his face, saw what I was carrying and said, "Oh boy, oh boy, a real reverb!" About a week later I took the same reverb to another engineer, had him evaluate it and he said, "This is absolutely useless. I'm going back to the unit made by the same fine gentleman who made the system that was rejected at point A." There seems to be room for virtually everything in the market.

**AA:** Frightening, isn't it?

**LO:** So how do you guys deal with that? Do you just say, "I can make anything I want and as long as I package it reasonably well, it'll sell."

**CM:** No.

**AA:** Well, we can try. [Laughter]

**RN:** We wish it were that simple.

**AA:** Sometimes I feel like we're in the fashion industry. The fads come and go. I guess any art form is going to have its fads. Some reverb sounds that are popular now are clearly not natural reverb, what we would consider natural reverberation, but they're quite popular, and that's OK.

**GH:** It used to be that I was trying to sell

somebody a digital reverb. Now I'm selling them their second, third, fourth or fifth digital reverb, and it's now a matter of repertoire. I can actually sell somebody something on the point, "You don't have one of these yet, do you? It does sound different than that, doesn't it?" And they say, "Yeah, you're right. We better fill out the spectrum here."

**RN:** Reverb is possibly a good example, just like digital delays used to be, that there's always a high end, whether it's Kurzweils or whatever. That becomes a mid-level after a couple years, as the technology gets a little cheaper. The first products that come in the high end come from three or four different directions, and possibly in reverbs now there are four or five different approaches that the user sees, and everyone has their own favorites. They can kind of coexist in a way. As the technology makes it a little cheaper, and we get more feedback from users, we refine the product a little more and make it a little more user-accessible.

At the same time, the product is becoming a little lower in cost so you're broadening the market of the users. You're changing with the comments that are coming back from the users. DDLs in their life-cycle have gone through the same thing. You reach a point where you're selling them their second DDL, and you're selling it for different reasons. There are valid reasons why they need two. Any new auditory illusion that answers a problem or creates new options goes through this life-cycle. The point that's called "high end" moves.

With synthesizers, it was Minimoogs at one point, or something equivalent. It's Kurzweil and it's Droid Works items right now. Five years from now some of the things in those infinite computing power machines that may answer some of the questions will be in a user's hands, and as they go through that cycle some of the refinements that help to make them accessible and usable features would be worked out, sometimes the hard way. But those random questions coming back would start to show up in all of our next versions of our products, giving them more flexibility but at the same time always kind of sensing that point where you buffer the user from the problems that you go through in trying to make the unit work; so that as you go through the problems trying to get your prototypes and first run out into the market and deal with the users who say, "Well, that's great but it always sounds bad to me," you modify the product and it smooths out, the high end moves, and you go for a different product. ■



# THE MIXING LINK



Space-age technology has raised the horizon for stereo and hi-fi sound... extending from digital levels to hi-bit sampling, sophisticated processing, and putting it all together.

Enter TOA's D-4... the first electronic music mixer.

The D-4 is a 4-input stereo rack system... expandable to 16-in. designed to handle the varying messages and complex ambience produced by stereo and hi-fi gear.

For live performance... the D-4 delivers balanced XLR mic inputs, stereo and mono mixing, and ground lifting.

For recording applications... the D-4 supports a vast range of source levels and provides 40-volt phantom power and MIDI/TAPE patching.

For post-production work... there's plenty of accessory patch points, selectable pre-amp boost... a direct output for every input, and headphone cue monitoring.

The TOA D-4... the evolution continues.

For complete technical details or write: TOA Electronic, Inc., 6750 West 12th Street, Suite 100, Golden, CO 80401, USA. Tel: 303-440-2800.

In Canada: TOAE Electronics, 1000 161 Street, West, World Radio Vision, P.O. Box 5511, Surrey, BC V4E 2S1.

*We give you the kind of information about professional audio products you won't find in the brochures.*



**H**ands-on experience. First-hand information. Our sales staff does more than quote brochures. Every one of us has extensive hands-on experience with the equipment we sell. And even *with equipment we do not sell.* We can answer your questions about the differences and provide you with comparison information you can get nowhere else.

**More Professional Brands**

We sell more brands of professional consoles and tape machines than any other dealer in the western United States.

Call us for a list of the more than 200 brands of professional audio equipment we sell.



Equipment Sales  
Factory-Trained Service Technicians  
Studio Design

**EVERYTHING  
AUDIO**

16055 Ventura Blvd., Suite 1001  
Encino, California 91436  
Phone (818) 995-4175 or (213) 276-1414



**—FROM PAGE 60, VIDEO CUES**

1610 as far as overloading the A/Ds and DC offset go. Now let's discuss a few important differences.

If you feed signal only into one channel (left or right) you will see the bits from every other word column disappear. This is because the F1 does not use an alternating channel scheme (1610) for each horizontal line. Another

difference is that the control bits of the PCM-F1 are not integrated into the data as with the 1610. If you switch the monitor to the "cross pulse" mode you will find a trail of control bits on the lower edge of the horizontal bar. Starting to the right of the cross (upper left video corner) you will see a series of alternating black and white bits with this consistent pattern:

black white black white black white ...  
 1 1 0 0 1 1 0 0 1 1 0 0 ... (56 bits long)

These are field sync bits which act as a header to every video field. They are followed by data content bits and address bits (all black = 0 = not used) which run off the screen to the right.

Now read from the left of the cross (the upper right video corner). There are 16 CRCC bits followed by four control bits. In order to see these four bits better you may have to move the hori-

zontal hold of your picture more to the right. If you are able to switch various functions on your F1 or 701 (if modified) you will be able to see the changes made in this part of the control bit block. Here are examples of two different conditions: 14 bit quantization (both P and Q active as error correction words) no copy prohibit, emphasis on:

Copy P Q Emph CRCC

X	X	X	X	X				X	X	X			X		X	X	X			X
4 bits				16 bits .....																

16 bit quantization (only P active as error correction word) copy prohibit, emphasis off:

Copy P Q Emph CRCC

	X							X	X				X	X			X			
4 bits				16 bits .....																

The block structure of the F1 also differs from the 1610. While there are exactly seven interleave blocks in one 1610 field, there are slightly over two in every F1 field, each block being 112 H

long. The main consequence of this is that video frame editing with the F1 will almost inevitably cause the disruption of a block array at the edit point.

One F1 video field:

control bits

interleave block #1

112 H

interleave block #2

interleave block #3.....

L	R	L	R	L	R	P	Q	CRCC

Nb. No portion of this article may be reproduced or published without the author's expressed permission. ■

# SMPTE

## ALMOST FREE!

Turn your Apple's unused cassette port into a SMPTE/EBU time code reader using NO hardware!

Reads and displays time and user bits at play speed from coded audio or video tapes

## SO CHEAP - JUST \$50

Save 90% over ordinary readers!

- Manual/auto "freeze"
- "Mark" stack for note-taking
- Other wonderful things

ALSO AVAILABLE:  
 Code Calculator  
 Code Generator

For more information contact  
 Jim Mack at: (313) 459-4618

**EDITING SERVICES CO.**  
 615 FAIRGROUND  
 PLYMOUTH, MI 48170

Circle #037 on Reader Service Card

# SKYELABS INC.

THE MOBILE RECORDING UNIT

- Dual 24 Track
- Live Recording, Broadcast, Mixdown
- Audio for Video

ANYWHERE



58 W. TIDBURY DRIVE  
 DOVER, DE 19901  
 302/697-6226

Circle #038 on Reader Service Card



*The CompuSonics DSP-1000 digital disk recording and playback system.*

# DIGITAL

N · E · W · S

# UPDATE

## **CD Players into Fourth Generation**

It has been about three and a half years since Compact Disc players were first offered to the consumer. The first models were minimal in features, with most being of the front load variety to easily interface with the hi-fi trend toward rack mounting of equipment. Prices began in the \$500 to \$1,000 range, with CDs running from about \$15 to \$20.

These days, with disks heading down to the \$10 level, CD players have quickly evolved to better performance, more sophisticated features and lower, as well as higher price tags...that is, generally prices have come down significantly, with many manufacturers introducing top end units with matching price tags.

With CD players predicted to sell 600,000 units this year, the current third generation of production models

feature remote control with access to up to 99 indexed bands in under one second, compared with the first players' 16 seconds to cover only 15 tracks.

The first models of many CD players were also criticized for sounding hard and shrill. The players these days have better filters, allowing smoother sound. The English firms Meridian and Mission did quite a bit of upgrade work on the filter circuitry of the early Phillips/Magnavox players, resulting in significantly smoother mids and highs.

A fourth generation of players is now on the way with further improvements including even better digital filters of as much as 96th order, versus 12th order in the first generation. Oversampling is now four times the original 44.1 kHz in playback, allowing for simpler filters with much less ring than the early generations.

For those who thought that a CD player is a CD player is a CD player, the subtleties of audio progress are here to prove that there is still room for continual improvement. The same people who hot rodded their turntables into \$2,000 track stars, will now find that that kind of investment in the Compact Disc department will put the best of the audio world at their fingertips.

—Nate Garfinkle

## **CompuSonics DSP-1000 Production Begins**

CompuSonics has begun pilot production of its DSP-1000 digital disk recording/playback system, and plans



to begin consumer product deliveries during the fourth quarter of this year. According to CompuSonics president David Schwartz, the first 50 DSP-1000 units will be tailored for use in broadcast applications at radio stations, where the CompuSonics system will replace the tape cartridge machines presently in use.

The CompuSonics broadcaster's DSP-1000 is a heavy duty version of the company's consumer product system, except for the record/play time, which is less than 10 minutes for full frequency response high fidelity sound. In the broadcast market, 90 percent of all tape cartridge machines are used for single records, advertisements, and spot announcements that are less than four minutes in length.

Field testing of the company's first consumer recording system will begin by the end of this summer, according to Schwartz. "We are presently developing a 50-megabyte floppy disk drive that, when coupled with our CSX digital audio encoding software, should yield the promised 45-minute consumer recording/playback time." In anticipation of a fall 1985 delivery date, the company has formed a national consumer sales organization of 12 manufacturer's representatives. Also, the company has begun interviewing select dealers in major markets. A total of 75 high-end audio dealers will comprise the company's initial audio distribution base.

### *EditDisc Service for EditDroid™ Users*

Technidisc, Inc. (of Troy, Michigan) and The Droid Works (the California-based affiliate of Lucasfilm Ltd. and Convergence Corporation) have announced a new disk-making service provided by Technidisc to users of the EditDroid video editing system.

The new service will include a film-to-tape-to-disk transfer or tape-to-disk transfer for EditDroid users. Since Technidisc is affiliated with Producers Color Service, it can tailor services to fit customers' special requirements. An EditDroid user can ship a videotape to be transferred to videodisc, or have Technidisc perform the film-to-tape transfer and color correction as well as the conversion to disk.

Technidisc will supply specially manufactured DRAW disks—called "EditDiscs"—providing durable disks quickly and economically. According to Ron Balousek, president of Technidisc, Inc., these high-quality disks are not subject to information degradation which can occur in normal handling. The disks produced by Technidisc will be in the



*The EditDroid*

# NOISE REDUCTION FOR UNDER \$10.

MIXING CONSOLES

SWITCHES

MICROPHONE CONNECTORS

SNAKE CABLES

BATTERY CONTACTS



ALL PLUGS & JACKS  
(XLR, PHONE, PHONO, DIN, MIDI, ETC.)

PATCHBAYS

FADERS, POTS

TERMINAL STRIPS

SPEAKER TERMINALS

## CRAMOLIN®

Even the finest equipment in the world can't guarantee a noise-free recording. One "dirty" connection anywhere in the audio/video chain can cause unwanted noise or signal loss.

### "MORE THAN A CONTACT CLEANER"

**CRAMOLIN®** is a fast-acting, anti-oxidizing lubricant that cleans and preserves all metal surfaces, including gold.

When applied to metal contacts and connectors, **CRAMOLIN®** removes resistive oxides as it forms a protective molecular layer that adheres to the metal surfaces and maintains maximum electrical conductivity.

#### CRAMOLIN® - USED BY THOSE WHO DEMAND THE BEST:

Ampex	General Electric	MCI(Sony)	RCA
Capitol Records	Hewlett Packard	Motorola	Studer-Revox
Dolby Laboratories	McIntosh Labs	NASA	Switchcraft

SINCE 1956

**CAIG LABORATORIES INC.**

1175-O Industrial Ave., (P.O. Box J) Escondido, CA 92025 0051 U.S.A. • (619) 743 7143

Circle #039 on Reader Service Card

*Lexicon has released new software updates for both the 224X and the Model 200 reverberators.*

LaserVision format, and can be played on a variety of videodisc players. Prices will range from \$300 to as low as \$150 per disk, depending on the quantity of material to be transferred and the number of duplicate disks produced.

For further information on "EditDisc" services and prices, please contact Sheryl Zachary at Technidisc, Inc., 2250 Meijer Drive, Troy, Michigan 48084. Telephone: (800) 321-9610.



**New Lexicon 224XL and 200 Software**

Lexicon Inc., Waltham, Massachusetts, is shipping expanded software packages for the 224XL Digital Reverberator/Effects Processor and Model 200 Digital Reverberator/Room Simulator. Both models now offer additional reverb programs and enhancements. With the improved software, the Lexicon 224XL digital reverberation and effects processor offers four new reverb programs: inverse room, rich chamber, rich plate and rich split.

The inverse room program simulates very small rooms, creates real-time backwards reverb and creates a gated reverb sound. The rich chamber program emulates the sound of a wide variety of acoustic spaces, in addition to synthesizing reverberation that does not exist in nature. The rich plate program has been improved to produce denser, smoother sound similar to that of a gold-toil plate. Both the rich chamber and rich plate programs now feature a time-dependent gate which provides precise control over the reverb tail. The new rich split program now enables users to create split reverbs with different, independently variable sizes when the 224XL is split into a pair of separate reverbs.

The apparent sizes of all new 224XL programs, and many earlier ones, are now continuously variable—an additional enhancement. Infinite reverb is another new effect added to the Lexicon 224XL rich plate and rich chamber programs, simulating reverberation that never decays. Infinite reverb also gives new flexibility to post-production studios in creating room tone for scene-to-scene dialog matching in film and television.

The new software for Lexicon's moderately priced Model 200 gives it a total of six programs, with new ones for inverse room, rich chamber and rich plate that are similar to their 224XL counterparts. Also, a fourth new program—split chamber—has been added

**KENDUN D,**  
*the studio that:*  
 Kent Duncan, Tom Hidley,  
 Anita Baker, George Benson,  
 Cock Robin, Norman Connors,  
 Chick Corea, Dazz Band,  
 Bobby DeBarge, DeBarge,  
 Lamont Dozier, Michael Jackson,  
 Jermaine Jackson, LaToya Jackson,  
 Janet Jackson, the Jackson Five,  
 Jefferson Starship, Brothers Johnson,  
 Quincy Jones, Kingston Trio, Klique, Klymaxx,  
 Gladys Knight and the Pips,  
 Carrie Lucas, Sergio Mendes,  
 Chuck Negron, Oingo Boingo,  
 Donny Osmond, Jimmy Osmond,  
 Bonnie Pointer, Gilda Radner,  
**R E O S p e e d w a g o n ,**  
 Ready for the World, Red 7,  
 Helen Reddy, Lee Ritenour,  
 Shalamar, Third World,  
 Frankie Valli, Bobby Womack, Y & T  
 and Frank Zappa\* built, has been  
 acquired by **ENCORE!**  
 We'd like to add your name to  
 the list.

**E**  
*ncore*

721 S. Glenwood Place,  
 Burbank CA 91506

818/842-8300

Telex: 697-2449 ENCO UW

**YOU DESERVE IT WHEN YOU'RE GOOD.**

\*just some of the artists who recorded or mixed at Kendun

Circle #040 on Reader Service Card



to enable a Lexicon 200 to function as a discrete stereo reverb or as two independent reverbs.

The new software packages, in the form of plug-in ROM chips, are incorporated in the Lexicon 224XL and 200 units now being marketed by Lexicon, and earlier units can easily be retrofitted. The new 224XL software is available to present owners at no cost. There is a \$95 charge to cover a media package which includes: 11 EPROMS, new 224XL owner's manual, ROM puller, installation instructions, shipping and handling. The model 200 software is being sold at a suggested retail price of \$240.

### EMI Plans Swindon CD Plant

EMI Music has announced a major investment in the mastering and manufacture of Compact Discs in the United Kingdom, at Swindon, Wilts. Initial pro-



duction is scheduled to begin early next year with annual capacity gradually building up to between eight and ten million Compact Discs.

The CD mastering and manufacturing equipment will operate alongside the current THORN EMI video High Density (VHD) disk plant. Staffing levels at the plant will be increased in line with production. The choice of Swindon as the site for EMI Music's first Compact Disc plant was influenced by the availability of high quality factory facilities and services. The new mastering and manufacturing capability will significantly increase EMI Music's Compact Disc supplies which are currently being met by manufacturing services in Europe and Japan.

### Digidesign's Sound Designer Software

Now available from Digidesign Inc., of Palo Alto, California, the Sound De-

# Celebration ams Jacket

In 1984 AMS was honoured to receive England's highest award to industry – Her Majesty the Queen's Award for Export Achievement.

To be one of the handful of companies to win this award is a great honour. To win the Award again in 1985 is exceptional.

To celebrate this fact, each of the next 100 AMS digital audio processors shipped to America (serial numbers 3500 to 3600) will come complete with a celebration "Leading the World" quilted satin tour jacket bearing both AMS and the dual Queen's Award logos.

Check with your local dealer now.

## Get The Jacket!

#### ADVANCED MUSIC SYSTEMS

(A division of AMS Industries plc)

Wallstreams Lane,  
Worsthorne, Burnley,  
Lancs. BB10 3PP  
England  
Tel: (0282) 57011  
Telex: 63108 AMSC



#### DEALER INFORMATION:

HARRIS SOUND SERVICES  
6640 Sunset Blvd.,  
Suite 110, Hollywood,  
CA 90028 U.S.A.  
Tel: (800) 233 1580  
or  
Tel: (213) 469 3500

Jackets offered on a first come, first served basis and subject to availability.

Circle #041 on Reader Service Card

**df first...**

- AUDIO FOR FILM & VIDEO
- SWEETENING
- SCORING
- MIXING

- COMPACT DISC & RECORD MASTERS
- 24 TR. ANALOG
- SONY DIGITAL
- REALTIME DUP.

MEMORABLE WORKING ATMOSPHERE • SOLID SOUND • EFFICIENT PRO SERVICE

**DIGITAL SOUND RECORDING**  
 607 NORTH AVENUE 64  
 LOS ANGELES, CA. 90042  
 (213) 258-6741

Circle #042 on Reader Service Card

signer™ Version 1.0 is a computer music software program for the Apple Macintosh computer and the Emulator II digital sampling keyboard from E-mu Systems. Sound Designer's primary

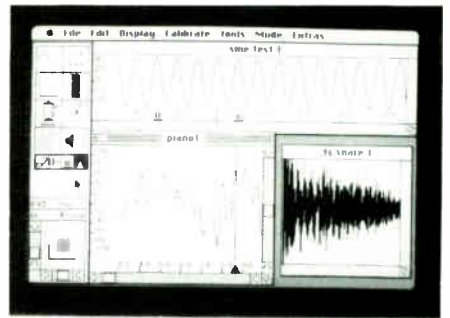

Macintosh screen display of Digi-design's Sound Designer™ program.

use is the editing, analysis, and modification of sampled sounds, as well as the creation of entirely new sounds using a variety of synthesis and digital signal processing techniques.

Sound Designer includes an interface that allows sampled sounds to be transferred between the Macintosh and Emulator II at very high speed (500,000 bits per second). Sound waveforms are displayed on the Macintosh's high-resolution screen (up to three waveforms may be displayed simultaneously). The waveform display can be magnified to show extremely fine detail, with editing accuracy to 1/30,000 of a second. Calibration scales provide exact readouts of time and amplitude values at any location in the waveform, and the waveform display can be horizontally and vertically scrolled.

Sound Designer also includes FFT (Fast Fourier Transform) based frequency analysis/sound modification, digital equalization, enveloping, digital mixing, digital compression, as well as a variety of other digital waveform processing functions. Direct digital synthesis (including FM and waveshaping) can be performed on the Macintosh, and the resulting sounds transferred to the Emulator II for playback.

Programming of all Emulator II parameters is greatly simplified by Sound Designer's Emulator II graphic programming aids. Filter response curves, ADSR curves, and other graphically represented parameters can be "drawn" using the Macintosh mouse, and keyboard set-ups, MIDI assignments, controller assignments, etc. can be quickly programmed using on-screen menus. Sound Designer carries a retail price of \$995, which includes the software, example disks, full documentation and interface cable.



**STUDIO M**

This world-class studio and the fabulous 3M 32-track digital mastering system are now available at the lowest possible prices.

For more information, call Tom Mudge, Studio Manager **612 • 293 • 5403**

STUDIO M • 45 East Eighth Street • St. Paul • Minnesota • 55101

Circle #043 on Reader Service Card



# NOW THAT DIGITAL IS HERE, A RECORDING STUDIO DOES NEED A PIANO THIS GOOD.

Times have changed.

Digital technology produces recordings of magnificent clarity, full dynamic range, and virtually zero distortion. The piano, to capitalize on this technology, must deliver exemplary tone, timbre, and presence.

Steinway® is the logical choice.

Its expense, however, has tempted some studio owners to consider buying a lesser piano. A fact that many musicians accept with reluctance. When performers sit down at a Steinway piano, they know they are playing the best.

Having a Steinway speaks for the overall integrity of your studio. It also attracts return business. And now it's easier than ever to have one.

## LEASE A STEINWAY \$350/mo.

Steinway & Sons is now leasing new Steinway grands directly to recording studios. A model B leases for \$350.00 per month. This leasing includes an attractive option to buy at the end of the term.

For full details, contact Mr. Ed Bezursik at Steinway & Sons, Steinway Place, Long Island City, NY 11108. Or call him at: (718) 721-2600.

Be sure to visit the Steinway Suite at this year's Audio Engineering Society (A.E.S.) Show, New York Hilton Hotel, October 13-16.

STEINWAY & SONS 



In use at the recording studio: Kampo Cultural Center, New York.

Circle #044 on Reader Service Card

—FROM PAGE 56, DIGITAL EDITING

transform F1 data into a professional format (typically that used by the Sony PCM-1610) with a hardware modification or add-on box, and edit it using a professional system. The other solution has been to build an editor for the F1. Examples of the first approach are Audio and Design's internal modification for the Sony PCM-701 (a non-portable version of the F1 design), and Harmonia Mundi Acustica's bw102, which will do digital-to-digital conversions between several different digital audio formats, throwing in some signal processing features to boot.

David Smith at Editel/New York has developed an editing system for the F1/701 using a co-processor for the required data manipulation. The British CLUE system also provides F1/701 editing and logging with a rack-mount computer system. The limiting factors in this kind of endeavor are: the amount of hassle involved with the required hardware modifications to the processor or VCR, and the point at which the price nullifies the system as a low-cost alternative. These units, therefore, have considerably less capability and flexibility than their professional counterparts; often only butt-splicing can be performed. But they are cheaper than purchasing, or even renting in the long run, professional equipment.

Tape-based electronic editing offers some strong advantages over razor editing, but it also has some very significant drawbacks. It is likely that this type of editing will prove to be a transitional phase which serves the purpose

of familiarizing the industry with some of the strengths of electronic editing, but will yield to new forms of mass storage as they become cheap enough to be practical.

### RANDOM ACCESS DISK SYSTEMS

Magnetic tape as a storage medium has relatively low cost and a lot of material can fit on one tape, but there also are a number of disadvantages. The need to physically handle the storage medium is one, but perhaps most significant is the long access time. Tape is a sequential access system: one must move forward or backward from the current tape position to the desired tape position. Fast-forwarding and re-winding can take what seems like an inordinate amount of time in the heat of inspiration during an editing session.

Computer disks do not need to store information in contiguous areas. The drives rotate the disk at a high speed and the head can move in and out, which results in the ability to access any point on the disk quite quickly. This high-speed random accessibility is the key to the strengths of disk-based editing systems.

Experimentation at universities and labs with storing audio information on disk probably dates back to around the invention of computer disks, but only recently have systems become commercially accessible. The first one was the aforementioned Soundstream system, which came on line about 1976. Music was recorded onto a stationary head tape system, and then dumped onto disks for editing. Newer systems,

such as the CompuSonics DSP-2000, Droid Works' SoundDroid, and the newly announced AudioFile from AMS record directly onto the disk.

The fact that any portion of the recorded material can be quickly accessed translates into the ability to perform extremely complex editing tasks in a much shorter time. No shuttling time, no dubbing time. Furthermore, a disk-based system does not need to be SMPTE-based, which removes a lot of the editing resolution barrier. Pastiches consisting of sounds only milliseconds long can be easily created. This comes in quite handy when doing film sound, which often calls for sound effects created from slivers of a number of different source materials.

Although CompuSonics is developing a floppy-disk based recording system, most of the disk systems that have appeared have used some form of hard disk. Unfortunately, these disks cannot hold as much music as might be needed (a 300Mb disk, used in the prototype that became SoundDroid could hold only about 5 minutes of 50kHz, 8-channel sound), and they can get quite expensive when several are needed. These factors have dictated a very high price tag for current disk-based systems.

In all fairness, however, it should be noted that all three of the above named systems offer impressive amounts of signal processing, both for editing and other jobs. Crossfade times on some of these machines can be programmed to be as short or as long as needed, sophisticated user interfaces are usually available (CompuSonics offers a track ball array, Droid Works offers a touch sensitive screen linked to a virtual console), and provision is usually made to interface to other systems, such as the aforementioned tape systems. It behooves a company, when designing an expensive digital audio signal processing system, to consider generalizing the architecture so that the unit's range of possible functions is broadened. This means that systems like these will often have software available, now or in the future, which will offer functions far beyond editing.

### CONCLUSION

The age of digital audio recording demands the development of digital audio editing systems. At present, the market is split in several different directions, each with their proponents, strengths, and weaknesses. Many aspects of this technology are still in flux, following developments in mass storage and signal processing. There is no doubt that we are not the same cutups we were ten years ago. ■



The CompuSonics DSP-2000, a disk-based audio recording/mixing/editing/retrieval system, is based on four-track digital storage modules.



# One man's disc weapon is another man's screaming monkey.

Frank Serafine — Motion Picture  
Sound Designer/Musician  
Credits: Tron, Star Trek I  
and III, Brainstorm,  
The Pirates

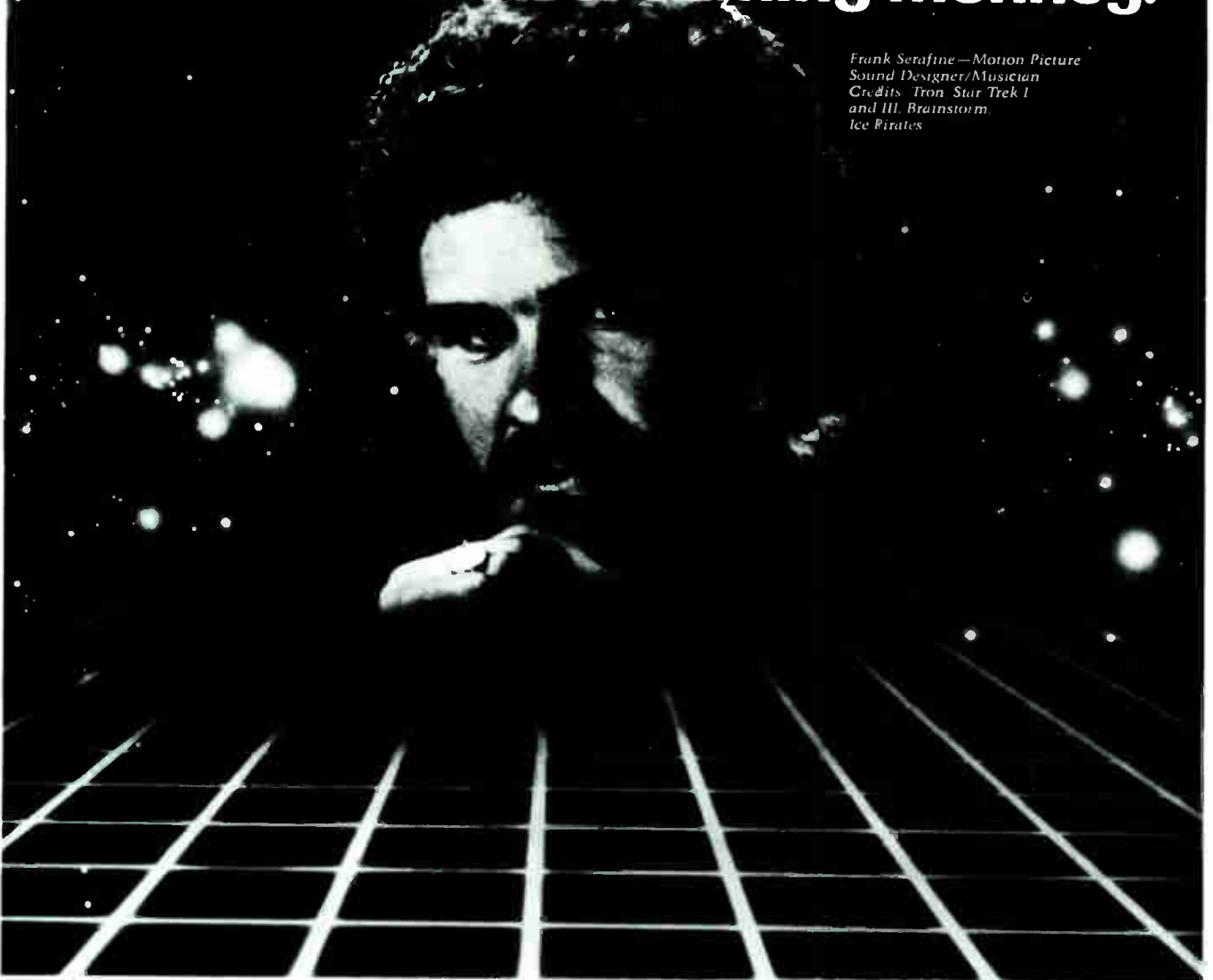

For the movie Tron, Frank Serafine altered the shriek of a screaming monkey to create the unique sound of the disc weapon. In movie after movie he's taken sound to the outer limits. By any stretch of the imagination, that's the innovative use of technology.

Nikko Audio has been making substantive contributions to technology for 50 years. We were first with MOS FETs, first with DC servo-lock. And now, for the first time, Nikko's LABO Series of commercial components. Just like all Nikko components, they're built to last.

As a primary manufacturer with demanding double QC aerospace tolerances, it's no wonder Nikko Audio offers a fully transferable, unconditional 3 year warranty.

Nikko Audio and Frank Serafine. Stretching the power of technology to the limit... and beyond.

**NIKKO AUDIO**  
*The power of technology.*

5830 South Triangle Drive, Commerce, CA 90040

Nikko Audio systems and components are available exclusively through Authorized Nikko Audio Dealers.

Circle #045 on Reader Service Card



# BEYER RIBBON MICROPHONES AND



**THE DYNAMIC DECISION**



# THE DIGITAL RECORDING PROCESS

## *Digital technology holds forth the promise of theoretical perfection in the art of recording.*

The intrinsic accuracy of the digital system means any recorded "event" can be captured in its totality, exactly as it happened.

Naturally, the ultimate success of digital hinges on the integrity of the engineer and the recording process. But it also depends on the correct choice and placement of microphones, quite possibly the most critical element in the recording chain. This can make the difference between recording any generic instrument and a particular instrument played by a specific musician at a certain point in time.

The exactitude of digital recording presents the recordist with a new set of problems, however. The sonic potential of total accuracy throughout the extended frequency range results in a faithful, almost unforgiving, recording with no "masks" or the noise caused by normal analog deterioration. As digital recording evolves, it places more exacting demands on microphones.

**Ribbon microphones are a natural match for digital because they are sensitive and definitively accurate.** The warm, natural sound characteristic of a ribbon mic acts as the ideal "humanizing" element to enhance the technically perfect sound of digital.

Beyer ribbon mics become an even more logical component of digital recording due to an exceptional transient response capable of capturing all of the nuances and dynamic shifts that distinguish a particular performance without the self-generated noise and strident sound generally

attributed to condenser mics.

**Beyer is committed to the concept of ribbon microphones.** We manufacture a full range of ribbon mics for every vocal and musical instrument application.

The Beyer M 260 typifies the smoothness and accuracy of a ribbon and can be used in stereo pairs for a "live" ambient recording situation to record brass and stringed instruments with what musicians listening to a playback of their performance have termed "frightening" accuracy.

Because of its essential double-ribbon element design, the Beyer M 160 has the frequency response and sensitive, transparent sound characteristic of ribbons. This allows it to faithfully capture the sound of stringed instruments and piano, both of which have traditionally presented a challenge to the engineer bent on accurate reproduction. Axis markers on the mic indicate the direction of maximum and minimum pickup. This allows the M 160 to be used as a focused "camera lens" vis a vis the source for maximum control over the sound field and noise rejection.

Epitomizing the warm, detailed sound of ribbon mics, the Beyer M 500 can enhance a vocal performance and capture the fast transients of "plucked" stringed instruments and embouchure brass. Its diminutive, durable ribbon element can also withstand extremely high sound pressure levels.

The Beyer M 130's bi-directional pattern enables the engineer to derive maximum ambience along with clean, uncolored noise suppression. Two M 130s correctly positioned in relationship to each other and the source can be used as part of the

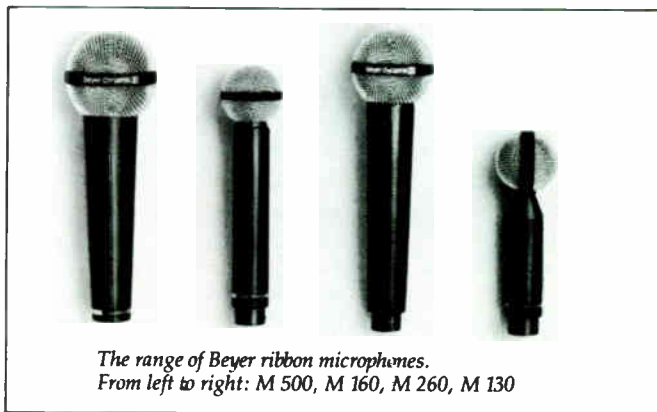

The range of Beyer ribbon microphones. From left to right: M 500, M 160, M 260, M 130

Mid-Side miking technique. The outputs from the array can be separated and "phase-combined" via a matrix of transformers to enable the most honest spatial and perceptual stereo imaging — sound the way we hear it with both ears in relationship to the source.

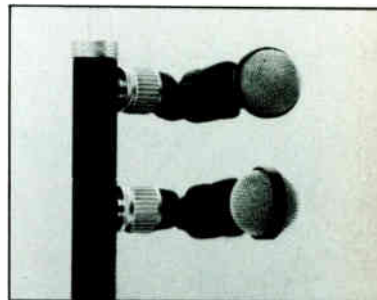

**Given the high price of critical hardware used in digital recording, the relative price of microphones is nominal.** Realizing that microphones are the critical sound "source point," no professional can allow himself the luxury of superficial judgements in this area. Especially when one considers the value of on-going experimentation with miking techniques. For this reason, we invite you to acquaint yourselves with the possibilities of employing Beyer ribbon technology to enhance the acknowledged "perfection" of digital recording technology.

Beyer Dynamic, Inc.,  
5-05 Burns Avenue, Hicksville,  
New York 11801

**beyerdynamic**)))

Circle #046 on Reader Service Card

# DIGITAL RESOURCE

## GUIDE

The following guide is a listing of digital recorder manufacturers, studios, mastering houses, and rental facilities in the United States and throughout the world. Many of the studios here-in also offer digital recorder rentals, and facilities are constantly adding new equipment and upgrading, so call ahead to verify formats and availability. We encourage other commercial digital audio facilities to contact us, to be included in our next update. Companies marked with a ● have digital multi-track systems.

**COMPUSONICS CORPORATION**  
7315 East Peakview Street  
Englewood, CO 80111  
(303) 793-0060 or (800) 223-1821  
James Woodworth, natl. sales manager

**COMPUSONICS STUDIOS**

- Glen Glenn Sound  
900 N. Seward Street  
Hollywood, CA 90038  
(213) 469-7221  
Tom Kobayashi
- Regent Sound  
1619 Broadway  
New York, NY 10019  
(212) 245-2630, 245-3100  
Sandi Morrof
- Paul Vitello & Associates  
4942 Vineland  
North Hollywood, CA 91601  
(818) 505-0061  
Rick Eisman

**DIGITAL ENTERTAINMENT CORPORATION (Headquarters)**

Subsidiary of Mitsubishi Electric  
Sales America  
225 Parkside Drive  
San Fernando, CA 91340  
(818) 898-2341  
Tore Nordahl, president

New York Office:  
555 West 57th Street, Suite 1530  
New York, NY 10019  
(212) 713-1600  
Lou Dollenger, marketing manager

Nashville Office:  
2200 Hillsborough Road  
Nashville, TN 37212  
(615) 298-6613  
Tom Behins

**MITSUBISHI DIGITAL STUDIOS (U.S.A.)**

- Alivity Productions  
14755 Ventura Blvd. #1715  
Sherman Oaks, CA 91403  
(213) 872-3033  
Craig Hundley
- Amigo Studios  
1114 Cumpston Street  
North Hollywood, CA 91601  
(818) 980-5605
- Audio Affects  
Box 6327  
Beverly Hills, CA 90212  
(818) 980-4006  
Thom Brown
- Audioforce, Inc.  
147 W. 24th Street  
New York, NY 10011  
(212) 741-0919  
Sid Zimet
- The Burbank Studios  
4000 Warner Blvd.  
Burbank, CA 91505  
(213) 954-6000  
Tom McCormack
- Clinton Recording  
653 10th Avenue  
New York, NY 10036  
(212) 246-2444  
Bruce Merley
- Criteria Recording Corporation  
1755 NE 149th Street  
Miami, FL 33181  
(305) 947-5611  
Mack Emerman
- Digital Associates  
P.O. Box 422  
Spring Hill, TN 37174  
(615) 256-4487  
Rick Horton
- Digital Audio Disc Corporation  
1800 N. Fruitridge  
Terre Haute, IN 47804  
(812) 466-6821
- Digital Music Products  
44 Farley Road  
Scarsdale, NY 10583  
(914) 725-4135  
Tom Jung
- Editel  
301 East Erie Street  
Chicago, IL 60611  
(312) 440-2360  
Lenard Pearlman

- The Enterprise  
4628 W. Magnolia Blvd.  
Burbank, CA 91505  
(818) 980-2010  
Derra Shelley
- ERAS Recording  
226 E. 54th Street  
New York, NY 10022  
(212) 832-8020  
Boris Midney
- Fantasy Studios  
10th at Parker  
Berkeley, CA 94710  
(415) 549-2500  
Roy Segal
- Future Disc Systems  
3475 Cahuenga Blvd. W.  
Hollywood, CA 90068  
(213) 876-8733  
Gary Rice/Steve Hall
- Greene Street Recording  
112 Greene Street  
New York, NY 10012  
(212) 226-4278  
Robyn Sansome
- Larrabee Sound  
8811 Santa Monica Blvd.  
Los Angeles, CA 90069  
(213) 657-6750  
David Mills
- Legonks W. Recording Studio  
5430 Sunset Blvd. #1500  
Hollywood, CA 90028  
(213) 461-3277  
George Duke, president
- Lion Share Studios  
8255 Beverly Blvd.  
Los Angeles, CA 90048  
(213) 658-5990  
Terry Williams
- Masterdisk  
16 W. 61st Street  
New York, NY 10023  
(212) 541-5022  
Jill Dix
- Muscle Shoals Sound Studios  
100 Alabama Avenue  
Sheffield, AL 35660  
(205) 381-2060  
Jimmy Johnson
- Omega Audio  
8036 Aviation Place  
Dallas, TX 75235  
(214) 350-9066  
Paul Christensen
- R&B Digital  
5922 Elmhurst  
Alta Loma, CA 91701  
(714) 980-4106
- Sound Arts  
5 Lindy Lane  
Oakhurst, NJ 07712  
(201) 930-8666  
Frank Spann





# INTEGRITY RELIABILITY SUPPORT.

The Hy James modus operandi.  
It's on all our price tags  
But it doesn't cost a penny more.

Serving the Great Lakes and beyond  
with the ultimate in professional audio  
and audio post production equipment  
and consultation.



## **HY JAMES**

*the audio professionals*

24166 Haggerty Road  
Farmington Hills, MI 48024  
(313) 471-0027 994-0934 - Ann Arbor

Circle #047 on Reader Service Card

**THANK YOU  
RECORDING INDUSTRY  
FOR NOMINATING  
STEVE HALL AND  
FUTURE DISC SYSTEMS  
FOR THE TECHNICAL  
EXCELLENCE AND CREATIVITY  
AWARD IN MASTERING**



**COMPLETE ANALOGUE  
& DIGITAL MASTERING  
SERVICES FOR  
COMPACT DISC,  
RECORD & CASSETTE  
MANUFACTURING**

**FUTURE DISC  
SYSTEMS**

3475 Cahuenga Boulevard West  
Hollywood, California 90068  
(213) 876-8733

Soundcastle Recording  
2840 Rowena Avenue  
Los Angeles, CA 90039  
(213) 665-5201  
Buddy King

- Sound Stage  
10 Music Circle South  
Nashville, TN 37203  
(615) 256-2676  
Pat Meyer

Sound Summit Studio  
Americana Lake Geneva Resort  
Highway 50  
Lake Geneva, WI 53147  
(714) 640-3587  
Phil Bonnano

- Soundworks Recording  
254 W. 54th Street  
New York, NY 10019  
(212) 247-3690  
Charles Benanty

Squires Productions  
196 Maple Avenue  
White Plains, NY 10601  
(914) 997-1603  
Greg Squires

Sterling Sound, Inc.  
1790 Broadway  
New York, NY 10019  
(212) 757-8519  
Lee Hulko

Streeterville Recording Studios  
161 E. Grand Avenue  
Chicago, IL 60611  
(312) 644-1666  
James C. Dolan

- United Western Studios  
6000 Sunset Blvd.  
Hollywood, CA 90028  
(213) 469-3983  
Jerry Barnes

- Universal Recording  
46 East Walton Street  
Chicago, IL 60611  
(312) 642-6465  
Murray Allen

University of Miami  
School of Music  
Gusman Concert Hall  
1314 Miller Drive  
Coral Gables, FL 33124  
(305) 284-2439  
Thomas Vicari  
15247 Rayneta Drive  
Sherman Oaks, CA 90039  
(818) 783-2510

- The Village Recorder  
1616 Butler Avenue  
Los Angeles, CA 90025  
(213) 478-8227  
Kathy Konop

Woodland Sound Studios  
1011 Woodland Street  
Nashville, TN 37206  
(615) 227-5027  
Glenn Snoddy

**MITSUBISHI DIGITAL STUDIOS  
(International)**

**European Distributor:**  
AEG-Telefunken  
Bueklestrasse 105, D-7750 Konstanz  
Federal Republic of Germany  
(0 75 31) 86-1.  
Ingo Joch, manager, professional tape  
recorder department



**AUDIO  
INTERVISUAL  
DESIGN**  
SYSTEMS FACILITATORS



EXOTIC MICROPHONES & EQUIPMENT  
FOR HIRE

are pleased to present

**DIGITAL SHOPPING LIST**

**DIGITAL EQUIPMENT AVAILABLE FOR RENTAL:**

SONY PCM-3324 24 track recorder	\$1,000.00 per day
SONY PCM 1610 Digital processor	425.00 per day
SONY BVU 800 D ¾" video transport	200.00 per day
(1) SONY 1610 and (2) BVU 800 D's System	700.00 per day
(1) SONY 1610 and (1) BVU 800 D System	550.00 per day
SONY F-I Digital processor with external sync modification (an Audio Intervisual Design exclusive)	50.00 per day
SONY SL-2000 portable Beta	25.00 per day

*\*\*All rates are based on a 4 day week, 3 week month\*\**

**DIGITAL AUDIO TAPE**

D-½-1460 half hour digital tape for PCM 3324	200.00 per reel
D-½-2920 hour digital tape for PCM 3324	350.00 per reel
KCA-60 BRD hour ¾" U-matic tape for BVU 800D	45.00 per reel
D-¾-75 U 75 min. U-matic tape for BVU 800D	70.00 per reel
RH-10DA 10 ½" empty reel	35.00 per reel
RH-14DA 14" empty reel	45.00 per reel

*\*\*Courtesy discounts extended to studios for bulk purchases\*\**

**FOR FURTHER INFORMATION, PLEASE CONTACT  
MICHAEL AT LIVINGSTONE AUDIO (213) 653-0270 or  
CANDY AT AUDIO INTERVISUAL DESIGN (213) 653-0240**

Circle #048 on Reader Service Card



**Canada:**

• Amber Studios  
735 Queen Street West  
Toronto, Canada, M6J 1G1  
George Semkiw

**Denmark:**

• Puk Studios  
65 Kaerbjvej  
Gjerlev, Denmark, 8983  
06-47 46 76  
John Quist

**England:**

British Broadcasting Corporation (BBC)  
Broadcasting House  
London, W1A 1AA  
(01) 580-4468 Telex: 265781

• Jacob's Studios  
Ridgway House  
Runwick  
Nr. Farnham,  
Surrey  
(0252) 723518

**Federal Republic of Germany:**

Miller International  
Schallplatten GMBH (Miller  
International Record Company)  
Justus-Von-Liebig-Ring 203.  
2036 Quickborn  
(04) 106-5001 Telex: 212 386

• Soundstudio "N"

Unter Kirschen 8, 5000 Cologne 30  
(02) 215-3406 1-63

Tennessee Tonstudios GMBH  
(Tennessee Recording Studios)  
Wandsbecker Zollstrasse, 87-89  
200 Hamburg 70

**Japan:**

Mitsubishi Electric Corporation  
Mitsubishi Denki Building  
2-3 Marunouchi, 2-chome  
Chiyoda-ku, Tokyo 100  
(03) 218-2111 Telex: J24532  
Cable: Melco Tokyo  
Mr. Awazu

Itokuchizaka Studios  
4-3-31 Kudan, Chiyoda-Ku, Tokyo  
(03) 263-1097  
Mr. Ono

King Records  
2-12-13 Otowa, Bunkyo-ku, Tokyo  
(03) 945-2116  
Mr. Kikuta

• Nippon Columbia Records (Denon)

4-14-14 Akasaka, Minato-ku, Tokyo  
(03) 584-8111  
Mr. Takasu

• Toshiba-EMI Records

2-2-17 Akasaka, Minato-ku, Tokyo  
(03) 587-9188  
Mr. Moriwaki

**Norway:**

Grieghallen Bergen  
(Edvard Grieg Auditorium)  
N-500, Bergen  
22 00 10, Lars Hillesgt. 3A

**Switzerland:**

Mr. Patrick Mimran  
32, Chemin Des Princes  
1253 Vandoeuvres/GE  
52 47 17 Telex: 22679

**U.S.S.R.:**

Melodija Moskau  
(Melodia Moscow) VIA  
Maschpriborintorg, Smolenskaja-Pl.  
32-34 Moscow  
244-2775 Telex: 7235, 7236

**JVC COMPANY OF AMERICA**

41 Slater Drive  
Elmwood Park, NJ 07407  
(201) 794-3900  
Larry Boden,  
special products manager  
West Coast Office:  
1111 West Artesia  
Compton, CA 90220  
(213) 537-6020

**JVC DIGITAL STUDIOS (U.S.A.)**

American Multimedia  
Route 8, Box 215-A  
Burlington, NC 27215  
(919) 229-5554  
Richard Clark

## VIDEO MASTERING BY THE MASTERS

- **Four years ago, Master Digital**, using digital audio techniques, proved to the recording industry that we could consistently duplicate real-time audio cassettes that exceed the quality of records.
- **Three years ago, Master Digital** pioneered the synchronization of digital audio to video, giving masters an audio dynamic range never before associated with video.
- **Two years ago, Master Digital** began compact disc mastering and has since produced the

largest single compact disc order to date for the world's largest electronic retailer.

- **One year ago, Master Digital** started engineering the most sophisticated video cassette mastering facility. Now we are pleased to announce that our new facility is on line producing stereo VHS Hi-Fi, Beta Hi-Fi and U-Matic duplication. Our video mastering division has consistently produced the highest degree of video and audio quality that our broad client base has come to expect.

Based on the principles of high technology and dedicated customer service, we would like to add you to our list of satisfied customers. If your company demands the highest quality product at a more than competitive price, delivered when promised, then call our V.P. of Sales, Paul Addis, and **experience the Master Digital difference!**

**(213) 452-1511**

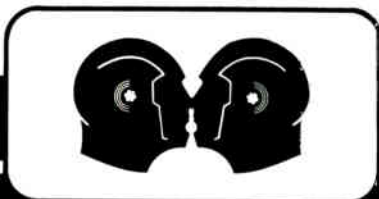

**Master Digital, Inc.**

1749 14th Street • Santa Monica, CA 90404

Circle #049 on Reader Service Card

Capitol Records Studios  
1750 North Vine Street  
Hollywood, CA 90028  
(213) 462-6252 •  
Charles Cornelli

CMS Digital Rentals  
453 East Wapello  
Altadena, CA 91001  
(818) 797-3046  
Fred Mitchell

Digital by Dickinson  
9 Westinghouse Plaza  
Bloomfield, NJ 07003  
(201) 429-8996  
Frank Dickinson

JVC Cutting Center  
RCA Building, Suite 500  
6363 Sunset Boulevard  
Hollywood, CA 90028  
(213) 467-1166

Master Technologies  
28 Music Square East  
Nashville, TN 37203  
(615) 327-4533  
Glenn Meadows

Treasure Isle Recording  
2808 Azalea Place  
Nashville, TN 37204  
(615) 327-2580  
Fred Vail

## JVC DIGITAL STUDIOS (International)

### Canada:

Le Studio  
201 Perry Road, Morin Heights  
Quebec J0R 1H0  
(514) 226-2419  
Yael Brandeis

### England:

Abbey Road Studios  
3 Abbey Road, St John's Wood  
London, NW8 9AY (01) 286 1161  
Ken Townsend

### France:

Disque Erato  
60 Rue de Chausse D'antini  
Paris, France 75009  
Mr. P Lavoix

### Japan:

JVC Adyama Studios  
2 211 Jingue mae, Shibuya-ku  
Tokyo 150  
(03) 403-0111  
Mr Kiyoshi Okumura

JVC Yokohama Cutting Center  
3-12 Moriya-Cho  
Kanagawa ku, Yokohama  
(045) 453 1111  
Mr Niimi

Camerata Tokyo  
4 26-32 Jingue mae  
Shibuya ku, Tokyo  
(03) 405-6081  
Hiroshi Isaka

Nippon Phonogram  
Wako Building, 4 8 5 Roppongi  
Minato ku, Tokyo  
(03) 479-3713  
Mr T Atarashi

### Mexico:

Universidad Veracruzana  
Teatro Del Estado  
Xalapa, Veracruz  
(281) 8-08-34  
Jonathan Wearm

## SONY PROFESSIONAL AUDIO PRODUCTS DIVISION

#1 Sony Drive  
Park Ridge, NJ 07656  
(201) 930-1000  
George Currie, general manager

## SONY PROFESSIONAL AUDIO PRODUCTS DIVISION

700 West Artesia Boulevard  
Compton, CA 90220  
(213) 537-4300

## SONY DIGITAL STUDIOS (U.S.A.)

A&M Recording Studios  
1416 N La Brea Avenue  
Hollywood, CA 90028  
(213) 469-2411

American Gramophone  
206 South 44th Street  
Omaha, NB 68131  
(402) 553-1164  
Don Sears

- Atlantic Recording Studios  
1841 Broadway  
New York, NY 10023  
(212) 484-6093  
Paul Slotnick

- Al/Scharff Rentals  
1619 Broadway  
New York, NY 10019  
(212) 582-7360  
Peter Scharff

- Audio Intervisual Design  
8474 West Third Street  
Los Angeles, CA 90048  
(213) 653-0240  
Jina Pace

Audiotechniques  
1619 Broadway  
New York City, NY 10019  
(212) 586-5989  
Jim Flynn or Gene Perry

- Blank Tapes  
37 W. 20th Street  
New York, NY 10011  
(212) 255-5313  
Lou Vetter

Capitol Records, Inc.  
1750 North Vine Street  
Hollywood, CA 90028  
(213) 462-6252  
Charles Cornelli

- CBS Recording Studios  
49 East 52nd Street  
New York City, NY 10022  
(212) 975-2958  
William Townley

Clover Recording Studios  
6232 Santa Monica Boulevard  
Hollywood, CA 90038  
(213) 463-2371  
Dan Moorehouse

CMS Digital Rentals  
453 East Wapello  
Altadena, CA 91001  
(818) 797-3046  
Fred Mitchell

Custom Mastering  
14 17th Avenue  
Nashville, TN 37203  
(615) 244-8132  
Hollis Flatt

- Dallas Sound Labs  
4 Dallas Communications Complex  
Suite 119  
6305 North O'Conner Street  
Irving, TX 75039  
(214) 869-1122  
Johnny Marshall

Digital Audio Disc Corporation  
1800 North Fruitridge  
Terre Haute, IN 47804  
(812) 466-6821  
Alan Ater

Digital by Dickinson  
9 Westinghouse Plaza, Box 547  
Bloomfield, NJ 07003  
(201) 429-8996  
Erin Ohlsen

- Digital Magnetics  
1800 North Argyle Avenue #310  
Hollywood, CA 90028  
(213) 463-0279  
Stewart Whitmore

- Digital Services Recording  
1001 River Oaks Bank Tower  
2001 Kirby Drive  
Houston, TX 77019  
(713) 520-0201  
John Moran

Digital Sound Recording  
607 North Avenue 64  
Los Angeles, CA 90042  
(213) 258-0048  
Van Webster

- Electric Lady Studios  
52 W. 8th Street  
New York, NY 10011  
(212) 677-4700

Electrosound Group  
(Monarch Record Mfg.)  
9545 San Fernando Road  
Sun Valley, CA 91352  
(818) 767-8833

Europadisk Ltd.  
75 Varick Street  
New York, NY 10013  
(212) 226-4401

Everything Audio  
16055 Ventura Blvd., #1001  
Encino, CA 91436  
(213) 995-4175  
Brian Cornfield

Frankford/Wayne Mastering Labs, Inc.  
1697 Broadway, 14th Floor  
New York, NY 10019  
(212) 582-5473  
Tom Steele

Future Disc Systems  
3475 Cahuenga Blvd. West  
Hollywood, CA 90068  
(213) 876-8733

- Glen Glenn Sound  
900 N. Seward Street  
Hollywood, CA 90038  
(213) 469-7221  
Tom Kobayashi

- The Hit Factory  
237 West 54th Street  
New York, NY 10019  
(212) 664-1000  
Troy Gerinano

- January Sound  
3341 Towerwood, Suite 206  
Dallas, TX 75234  
(214) 243-3735



IVC Cutting Center  
RCA Building, Suite 500  
6363 Sunset Boulevard  
Hollywood, CA 90028  
(213) 467-1166

K Disc Mastering  
26000 Springbrook Avenue  
Saugus, CA 91350  
(818) 365-3991, (805) 259-2360  
John Golden

Laser Video  
1120 Cosby Way  
Anaheim, CA 92806  
(714) 630-6700  
Scott Larson

Master Digital  
202 Main Street  
Venice, CA 90291  
(213) 399-7764  
Roger Pryor

Masterdisk  
16 West 61st Street  
New York, NY 10023  
(212) 541-5022  
Doug Levine

Matrix Video  
727 11th Avenue  
New York, NY 10019  
(212) 265-8500  
Ron Lieberman

- Elliot Mazer  
Digital Audio Consultant  
Fantasy Studio Building  
10th & Parker  
Berkeley, CA 94710  
(415) 644-4321

MCA Whitney  
1516 Glenoaks Boulevard  
Glendale, CA 91201  
(818) 245-6801  
Frank Kejmar

Middle Ear Recording Studios  
1801 Bay Road  
Miami Beach, FL 33139  
(305) 672-2390  
Dale Peterson

Miller & Kreisel Sound  
10391 Jefferson Boulevard  
Culver City, CA 90230  
(213) 204-2854  
Ken Kreisel

- Modern Video  
7165 Sunset Boulevard  
Los Angeles, CA 90046  
(213) 851-8070  
Moshe Barkat

Motown/Hitsville USA  
7317 Romaine Street  
Los Angeles, CA 90046  
(213) 553-1164  
Guy Costa

- New Age Sight and Sound  
120 Interstate North Parkway East  
Suite 164  
Atlanta, GA 30339  
(404) 956-7956  
William Allgood

- New Music Group (Kashif)  
Box 15687  
Stamford, CT 06901  
(203) 322-6992  
John Harris

New York Digital Recording Inc.  
200 Varick Street  
New York, NY 10014  
(212) 553-1164  
MacDonald Moore

# Mother Dubbers

*Our name says it all.*



## In a rush?

We finish your job on time, every time, and *never* sacrifice quality.



## Need a new master?

We offer you the use of our full-service, eight-track recording studio and extensive music & sound effects library for advertising, a/v production, and music demos.



## Video services?

✓ specializing in professional speakers, workshops, & seminars  
✓ video duplication



## Tape duplication? Of course!

✓ audio or video    ✓ superior sound reproduction  
✓ competitive rates  
✓ cassette, reel-to-reel, 8-track—all formats, all quantities

***We meet your deadlines . . . AND your standards.***

Mother Dubbers Inc. 13626 Gamma Rd. □ Dallas, Texas 75234 □ 214-980-4840

Circle #050 on Reader Service Card

## Optimize — don't compromise:



If you demand optimum performance from  
your tape recording equipment . . .  
you need our services!

JRF maintains a complete lab facility insuring precision relapping and optical alignment of all magnetic recording heads and assemblies. Worn unservicable heads can be restored to original performance specifications. 24-hour and special weekend service available.

- Broadcasting
  - Mastering
    - Recording Studios
    - Tape Duplicating

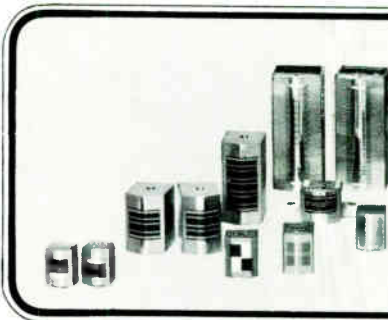

**New and reconditioned replacement heads from mono to 24-track . . . Many in stock.**

**For repair or replacement, we're at your service!**

Call or write.

## JRF/Magnetic Sciences, Inc.

101 LANDING ROAD, LANDING, NJ 07850 • 201/398-7426

Circle #051 on Reader Service Card

Northeast Digital  
12 Sadler Avenue  
Shrewsbury, MA 01545  
(617) 753-1192  
Toby Mountain

- Oasis Studios (Giorgio Moroder)  
4162 Lankershim Boulevard  
Universal City, CA 91602  
(818) 761-6906  
Laurie Howard

Pacific Video  
809 North Cahuenga Boulevard  
Hollywood, CA 90038  
(213) 462-6266

- Power Station  
441 West 53rd Street  
New York, NY 10019  
(212) 246-2900  
Dianna Alleyne

- RCA Studios  
1133 Avenue of the Americas  
New York, NY 10036  
(212) 930-4062  
Larry Schnapf

- Record Plant  
8474 West Third Street  
Los Angeles, CA 90048  
(213) 653-0240  
Rose Mann

- Redwood Digital (Neil Young)  
16206 Skyline Boulevard  
Woodside, CA 90038  
(415) 851-1195  
John Nowland

- Nile Rodgers Productions  
c/o Skyline Studios  
36 West 37th Street  
New York, NY 10018  
(212) 594-7484  
Bud Tunick

- Sheffield Audio Video Productions  
13816 Sunnybrook Road  
Phoenix, MD 21131  
(301) 628-7260  
Rick Van Horn

Sound Recorders  
206 South 44th Street  
Omaha, NE 68131  
(402) 553-1164  
John Boyd

- Soundworks  
254 West 54th Street  
New York, NY 10019  
(212) 247-3690  
Charles Benanty

Sterling Sound  
1790 Broadway, 9th Floor  
New York, NY 10019  
(212) 757-8519  
Lee Hulko

- Sync Sound  
450 West 56th Street  
New York, NY 10019  
(212) 246-5580  
Elissa Kline

Telarc Records  
23307 Commerce Park Road  
Cleveland, OH 44122  
(216) 464-2313  
Jack Renner

Trutone Records  
163 Terrace Street  
Haworth, NJ 07641  
(201) 385-0940

- Utility Muffin Research Kitchen  
(Frank Zappa)  
Box 5265  
North Hollywood, CA 91616  
(818) 764-0800  
Mariel Sloatman

- The Village Recorder  
1616 Butler Avenue  
West Los Angeles, CA 90025  
Kathy Konop

Wakefield Manufacturing  
P.O. Box 6073, 1745 West Linden Street  
Phoenix, AZ 85005  
(602) 252-5644

West American Sound  
8120 Webb Avenue  
North Hollywood, CA 91605  
(818) 768-6100

- Wonderland  
(Black Bull Music, Stevie Wonder)  
4616 Magnolia Boulevard  
Burbank, CA 91505  
(213) 877-8383  
Melba Simpson

Allen Zentz Mastering  
7083 Hollywood Boulevard, Suite 302  
Hollywood, CA 90028  
(213) 851-8300

# We Deliver Digital ANYWHERE



- Digital Recording • Digital Editing • Compact Disc Mastering •  
Rentals and Delivery anywhere in the world

call Toby Mountain

**...ndr...**

**NORTHEASTERN DIGITAL RECORDING, INC.**

617/353-0963 (Boston office) 617/753-1192

Circle #052 on Reader Service Card



**SONY DIGITAL STUDIOS**  
*(International)*

**Canada:**

- McClear Place  
225 Mutual  
Toronto, Ontario M5B 2B4  
(416) 977-9740  
Phil Sheridan
- Sounds Interchange  
506 Adelaide Street, East  
Toronto, Ontario M5A 1N6  
(416) 364-8512

**Czechoslovakia:**

Suprophon  
Praha 1, Palacheho 1  
Telex: 121218  
M. Kulhan

**England:**

Abbey Road Studios  
1 Abbey Road, St. John Woods  
London, NW8 9AY  
(01) 286-1161  
Ken Townsend

Air Studios  
214 Oxford Street  
London, W1  
(01) 637-2758  
Dave Harries

Britannia Row  
35 Britannia Row, Islington  
London, N1 8QH  
(01) 226-2377  
Richard Kelly

CBS Studios  
31-37 Whittfield Street  
London, W1  
(01) 636-3434  
Roger Bain

Chandos Records  
41 Charing Cross Road  
London WC2  
(01) 437-1448  
Brian Couzens

- CTS Studios  
The Music Centre, Engineers Way  
Wembley, Middx., HA9 ODR  
(01) 903-4611  
Peter Harris

- Do Not Erase Productions  
Flat 2, 18 Priory Terrace  
London NW 6  
(01) 328-9003  
Steve Levine

- Feldon Audio  
126 Great Portland Street  
London, W1N 5PH  
(01) 580-4314  
Roger Cameron

Fisher Lane Studios  
Fisher Lane Farm  
Chiddingfold, Surrey  
(01) 439-8451  
Geoff Callingham

HHB Sales and Hire  
Unit F, New Crescent Works  
Nicoll Road, London NW10 9AX  
(01) 961-3295  
Ian Jones

Marquee Studios/NJF  
10 Richmond Mews, Dean Street  
London W1  
(01) 437-6731  
Simon White

Master Room  
59-61 Ridinghouse Street  
London W1P 7PP  
(01) 637-2223

- Mayfair Recording Studios  
11A Sharpeshall Street  
London NW1  
(01) 586-7746

Nimbus Records  
Wyastone Leys, Monmouth  
06-600 890682  
Gerald Reynolds

Queen Productions  
46 Pembroke Road  
London W11  
(01) 486-0597  
Jim Beech

Peter Self/Digital Audio Systems  
Unit A, Coburg House, Western Road  
Wood Green, London N22 6UH

Sutton Sound Mobile  
80 Queensway  
London W2 3RL  
(01) 262-9066

Tape One/Mobile One  
27/28 Windmill Street  
London W1  
(01) 580-0444  
Bill Foster

# AUDIO AFFECTS

—LA.'s LARGEST FULL SERVICE RENTAL COMPANY—

**(213) 871-1104 (818) 980-4006 (800) 252-2010**

## NEW!!!

AMS Keyboard Interface for DMX 15 80S ■ Dyno-My-Chorus  
Cyclosonic Panner FSI ■ Otari MTR20 ■ API Mic Preamp  
Otari 50/50 1/2" 8 Track w/remote ■ UREI 1176's ■ API Limiters  
Transportable Satellite Earth Station 41.5 db gain w/redundant electronics

Yamaha Rev I • Publison 90 • Drawmer Tube Compressor  
Massenberg EQ & Limiter • ADR Panscan • Otari 4 & 24 track • AMS  
Mitsubishi 2 & 32 track • Q.Lock 3/4" video • EMT • Synclavier II • Lexicon  
Quantec • Simmons SDS7 • SRC • Master Beat • MXI • Linn 9000  
Emulator II • Dynamite • dbx • Tube Mics • Kepex II

**...and LOTS MORE! Call THOM or DERRA today!**

Circle #053 on Reader Service Card

Townhouse Studios  
150 Goldhawk Road  
London W12  
(01) 743-9313  
Brian Collins

Unicorn Records  
7 Hillgate Place  
London W8  
(01) 727-2893  
Nigel Brandt

**Federal Republic of Germany:**

EMI Electrola GMBH  
Maarweg 149, 5000 Kohn 41  
0221-4902/1  
Mr. Rotha

Harmonia Mundi Acustica GMBH  
Inden Sigristmatten 6  
7800 Freiburg 0761-491506  
Mr. Benjamin Bernfeld

Suedwest-Tonstudio GMBH  
Liederkrantzhalles, Lortzingstr. 25  
7000 Stuttgart 0711-69130  
Mr. Neubronner

Teldec Telefunken-Decca, Schallplatten  
GMBH  
Heussweg 25, 030-833103  
Mr. Fouque

Tonstudio Bauer GMBH and Co. KG  
Markgroeningenstr. 46  
7140 Ludwigsburg-Eglosch  
07141-31098  
Mr. T. Bauer

Tonstudio Ulrich Kraus  
Inderstorferstr. 60  
8000 Muenchen 21  
Mr. Kraus

Tonstudio, Bernhard Mahne  
Thierschstr. 31  
8005 Muenchen 22 089-227639  
Mr. Mahne

Tonstudio, Teije Van Geest  
Mkckensturmerstrs. 24  
6805 Heddagheim 06203 43185  
Mr. Van Geest

**France:**

Erato  
60 Rue de la Chaussee  
d'Aupin 7500g  
(01) 280-6919  
M. Laroix

Pathe Marconi-EMI  
62 Rue de Sevres  
F-92100 Boulogne  
(331) 603.17.11  
Claude Lamy, studio manager

Studio d'Enregistrement Itinerant  
82 Rue St. Fiagre  
F-91580 Auvers-St. Georges, Etrechy  
(1) 080 44.69  
Gilbert Preneron, owner

Translab  
12-14 Boulevard de l'Hospital  
Paris 75005  
(01) 707-5486  
Christian Oysiui

**Holland:**

CBS, Manufacturing Service Centre  
Nijooheidsweg  
32-26, 2031 CP, Haarlem  
023-319419 ext. 331  
Mr. H. Niggebrugge

Polygram Record Operations  
P.O. Box 23, 3740 AA  
Baarn, The Netherlands  
02154 19338  
Mr. B. Scoothaak

**Hungary:**

Hungaroton Qualiton  
H-1051 Budapest  
Vorosmarty Ter. 1  
428 546  
Dr. F. Takacs

**Italy:**

FonitCetra  
45 Via Meda  
Milan, 20141, Italy

**Japan:**

Canion Records, Inc.  
4-3-31, Kudankita  
Chiyoda-Ku, Tokyo  
(03) 265-6484  
Mr. Kuroda

CBS/Sony Shinanomachi Studio  
6-8 Minamimotomachi  
Shinjuku-ku, Tokyo  
(03) 358-8071  
Mr. K. Hazama

King Record Company Ltd.  
12-13, 2-Chome, Otowa  
Bunkyo-Ku, Tokyo  
(03) 945-2116  
Mr. S. Chiba

Nippon Columbia Co., Ltd.  
14-14, 4-Chome, Akasaka  
Minato-Ku, Tokyo  
(03) 584-8111  
Mr. A. Takasu

Polydor, Inc.  
1-8-4, Ohhashi  
Meguro-Ku, Tokyo  
(03) 462-5131  
Mr. Takahashi

Toshiba EMI Inc.  
2-2-17, Akasaka  
Minato-Ku, Tokyo  
(03) 585-1111  
Mr. Furusawa

Warner-Pioneer Inc.  
Roppongi Fuji Building  
4-11-10, Roppongi  
Minato-Ku, Tokyo  
(03) 479-1131  
Mr. Matsumoto

Yamaha Ongaku Shinkokhai Epiculous  
Studio  
8-27, Sakuragaoka  
Shibuya-Ku, Tokyo  
(03) 476-3261  
Mr. Kaminari

**Sweden:**

Swedish Radio  
Oxenstiernsgatan 20  
S-105 10 Stockholm  
Mr. Christer Grewin

**3M DIGITAL AUDIO SYSTEMS**

3M Center, Building 223-55  
St. Paul, MN 55144  
(612) 736-1149  
Tom Kenny, market development  
manager



**AUDIO • VIDEO RECORDING STUDIOS  
251 W 30th St., NYC 594-7554**

**New Music Masters** John Cale Kid Creole and the Coconuts David Sigeron **Serious Funk and R&B Stars** Chaka Khan Manhattans Kool and the Gang **Rap and Boof Artists** Whodini Jean Michel Basquiat **Techno Disco Acts** Jocelyn Brown Mike Theodore Victor Willis **Jazz Greats** Peter Erskine Michael Brecker Gato Barbieri Barry Finnerty Mike Maneri **Exercise** Jane Fonda "Prime Time" **National Commercials** Nabisco Colt 45 plus the ever **Hard-Rockin'** Ramones have all found the technology, experience and attention to personal style they needed to get the job done at a reasonable price

PLANET operates two recording studios with up to 48 track capability (64 for mix) It is owned by gold record producers and Grammy award winning engineers

**Recording Consoles** include a computerized MCI 500 Series and a Trident Series 80 with 40 input modules **Tape Machines** are Studer 24 track and MCI 24 track **Mix Machines** are Studer A80 and Ampex ATR both set for 1/2" mixdown

A partial list of **Outboard Equipment** includes Lexicon 224X Digital Reverb, EMT Stereo Plate, Valley People Dynamites and DBX Gates, DBX 165 & 160, Urei 1776 Limiters, Marshall Time Modulators, Pan Scan, Lexicon PCM 42's, Eventide Harmonizers, Chorus, Flanging and Phasing Effects and much more

Any additional **Exotic Units** such as AMS Delay, Reverbs and Emulators are available with reasonable notice

**Synthesizers** (Midi equipped) include Yamaha DX7 Digital, O88, Moogs, Drum Machines include Linn and DMX with DSX Sequencer and Dr. Click

**Monitor Systems** in both studios are Urei 813's Time Aligned, Haffer and Crown powered

**Recording Areas** are both live and dead end in design, featuring an incredible live drum environment

**PLANET SOUND IS PROUD TO HAVE WORKED WITH  
CHAKA KHAN ON HER NEW HIT LP I FEEL FOR YOU.**

Circle #054 on Reader Service Card



**3M DIGITAL STUDIOS  
(U.S.A.)**

- Amigo Studios  
1114 Cumpston Street  
North Hollywood, CA 91601  
(818) 980-5605
- Castle Recording Studio  
Route #11 Old Hillsboro Road  
Franklin, TN 37064  
(615) 791-0810  
Jozef Nuyens
- Digital by Dickinson  
9 Westinghouse Plaza  
Bloomfield, NH 07003  
(201) 429-8996  
Frank Dickinson
- January Sound  
3341 Towerwood, Suite 206  
Dallas, TX 75234  
(214) 243-3735
- Soundworks Digital Audio/Video  
Recording Studios, Ltd.  
254 W. 54th Street  
New York, NY 10019  
(212) 247-3690  
Charles Benanty
- Studio M, Minnesota Public Radio  
45 E. 8th Street  
St. Paul, MN 55101  
(612) 221-1500  
Tom Voegeli, Tom Mudge
- Treasure Isle Recording Studio  
2808 Azalea Place  
Nashville, TN 37204  
(615) 327-2580  
Fred Vail



- Universal Recording Corporation  
46 E. Walton Street  
Chicago, IL 60611  
(312) 642-6465  
Murray Allen
- University of Miami  
School of Music  
Box 248165  
Coral Gables, FL 33124  
(305) 284-2439
- Warner Bros. Records  
1114 Cumpston Avenue  
North Hollywood, CA 91601  
(213) 980-5605  
Lee Herschberg

- Westlake Audio  
7265 Santa Monica Boulevard  
Los Angeles, CA 90046  
(213) 851-9800  
Glenn Phoenix

**3M DIGITAL STUDIOS  
(International)**

*England:*

- Decca Recording Services Ltd.  
254 Belsize Road  
London, NW6 4BT  
(01) 625-4481  
David Frost
- Jacob's Studios  
Ridgway House, Runwick Lane  
Farnham, Surrey T23518  
Andy Fernback

# The Aphex Aural Exciter.™

## The Best Way to Improve Your Sound System.

By now you've probably invested in flangers, reverbs, delays, and other accessories for special effects. But, there's still something missing in your sound. The excitement of an Aphex Type B Aural Exciter.

The Type B generates the same psycho-acoustic excitement pros have used for years for that *extra punch*. The Type B restores natural brightness, presence and detail. Your live sounds fill the room with-

out all the problems of high frequency EQ. Even multitrack tapes made on narrow format machines sound like they were made on expensive studio recorders! All for less than \$500.

Hear the difference an Aural Exciter can make at your dealer today. Or, write us for the name of your nearest dealer and a demonstration record that's fun and informative, "Trouble at Madame Dong's."



**Aphex Systems Limited**  
13340 Saticoy St., N. Hollywood, California 91605  
(818) 765-2212 TWX: 910-321-5762

Aural Exciter is a trademark of Aphex Systems Ltd. © 1985 Aphex Systems Ltd.

Circle #055 on Reader Service Card

# quality price service

These are what set IAN apart from other duplicating companies.

From 100 to 100,000 copies you'll find the same consistent quality in each tape.

- Audio & Video Tape Duplication in all formats. AGFA, BASF, 3M
- In House Printing & Packaging
- Full Line of Studio Supplies

**ian** Communications Group  
10 Upton Drive • Wilmington, MA 01887  
(617) 658-3700

Circle #056 on Reader Service Card

## The art of shaping sound.

SONEX is a high-performance acoustical foam that upgrades your studio inexpensively. Ideal for a temporary isolation booth, it can also eliminate slap echo and harsh resonances in the main room or silence noisy tape equipment in the control booth.

Write for our color brochure today.



**Alpha  
Audio**®

2049 West Broad St.  
Richmond, VA 23220 (804) 358-3852

Circle #057 on Reader Service Card

## DIGITAL 86

- Roundhouse Recording Studios  
100 Chalk Farm Road  
London NW1 8EH  
(01) 485-0131  
Mark Darnley

- Townhouse Studios Ltd.  
150 Goldhawk Road  
London W12 8E1  
(01) 743-9313  
Geoffrey Atter

### Federal Republic of Germany:

- Avrophon Schall-Platten  
Hauptstr. 41  
7813 Stauffen  
(07) 633-7171  
M. Ullmann

- Bauer Tonstudio GMBH  
Markgroeninger Str. 46  
D-7140 Ludwigsburg 10  
(07) 141-31097  
Rolf Bauer

- Dierks-Studios GMBH  
Haupt. Str. 33  
D-5024, Pulheim, 3  
(02) 238-3333, 30-40  
Dieter Dierks

- Farton Studios  
Die Sang 7  
6365 Rosbach  
(06) 003-8081  
Frank Farian

- Polygram  
Kluesriede 26  
3012 Hannover-Langehagen  
(05) 11/7306-236  
Mr. Meister

- 3M Germany  
Carl-Schurzstr. 1  
4040 Neuss 1  
(02) 101/142898  
H. Viering

### France:

- Societe Translab  
12 and 14 Bld Del Hopital  
75005 Paris  
(01) 707-54-86  
Mr. Orsini

- Studio de la Grande Armee  
12 Av. de la Grande Armee  
75017 Paris  
(01) 764-13-47  
Mr. J. Dubois

- Studio Guillaume Tell  
52 Ave. Du President Wilson  
39210 La Plaine-St. Denis  
(01) 241-70-70  
Mr. Guillotel

- Studio Marcadet  
52 Ave. Du President Wilson  
93219 La Plaine-St. Denis  
(01) 241-88-66  
Mr. G. Blumenfeld

### Japan:

- Alfa Record  
3-5-39 Shibaura  
Minatoku, Tokyo 108  
(03) 455-1791  
K. Murai

- Onkyo House  
1-23-8 Ginza  
Chuoku, Tokyo 104  
(03) 654-4181  
H. Ryojoji

### Sweden:

- Polar Music Studios  
Polar Music AB, St. Friksgatan  
58-60, 511234 Stockholm  
(08) 54-06-95  
Leif Mases

## Directory of Digital Equipment Manufacturers

### ADA

2316 Fourth Street  
Berkeley, CA 94710  
(415) 548-1311, (800) 241-8888

### ADS/DeltaLab

One Progress Way  
Wilmington, MA 01887  
(617) 658-5100

### Advanced Music Systems (AMS)

USA Distributor: Harris Sound Systems  
6370 Santa Monica Blvd.  
Hollywood, CA 90038  
(213) 469-3500 or (800) 637-5000

### Agfa-Gevaert

Magnetic Tape Division  
275 North Street  
Teterboro, NJ 07608  
(201) 288-4100

### Akai Professional Products

Box 2344  
Fort Worth, TX 76113  
(817) 336-5114

### Alesis Corporation

Box 3908  
Los Angeles, CA 90078  
(213) 467-8000

### Ampex

Audio-Video Systems Division  
401 Broadway  
Redwood City, CA 94063  
(415) 367-2911

### Applied Research & Technology (ART)

215 Tremont Street  
Rochester, NY 14608  
(716) 436-2720

### Audio + Design Recording

Box 786  
Bremerton, WA 98310  
(206) 275-5009, 275-5010

### Audio/Digital Inc.

85335 Sarvis Berry Road  
Eugene, OR 97405  
(503) 687-8412

### CompuSonics

7315 East Peakview Street  
Englewood, CO 80111  
(303) 793-0600 or (800) 223-1821

### Con Brio Digital Systems

975 San Pasqual #313  
Pasadena, CA 91106  
(213) 795-2192

### J. L. Cooper Electronics

1931 Pontius  
West Los Angeles, CA 90025  
(213) 473-8771

### dbx Incorporated

Professional Products Division  
71 Chapel Street  
Newton, MA 02195  
(617) 964-3210



**Decillionix**

P. O. Box 70985  
Sunnyvale, CA 94086  
(408) 732-7758

**Digital Entertainment Corporation**

Headquarters: 225 Parkside Drive  
San Fernando, CA 91340  
(818) 898-2341  
New York Office: 555 West 57th Street  
Suite 1530  
New York, NY 10019  
(212) 713-1600

**Digital Keyboards, Inc.**

105 Fifth Avenue  
Garden City Park, NY 11040  
(516) 747-7890

**Digital Music Systems**

137 Pearl Street  
Boston, MA 02105  
(617) 542-3042

**DOD Electronics Corporation**

2953 South 300 West  
Salt Lake City, UT  
(801) 485-8534

**E-mu Systems**

2815 Chanticleer  
Santa Cruz, CA 95062  
(408) 476-4424

**Ensoniq Corporation**

363 Great Valley Parkway East, Ste. 10  
Malvern, PA 19355  
(215) 647-3930

**Europa Technology, Inc.**

1638 W. Washington Blvd.  
Venice, CA 90291  
(213) 392-4985

**Eventide**

One Alsan Way  
Little Ferry, NJ 07643  
(201) 641-1200

**Fairlight Instruments, Inc.**

2945 Westwood Blvd.  
Los Angeles, CA 90064  
(213) 478-8221  
also: 575 Madison Avenue  
New York City, NY 10022  
(212) 605-0296

**Fostex Corporation of America**

15431 Blackburn Avenue  
Norwalk, CA 90650  
(213) 921-1112

**Garfield Electronics**

Box 1941  
Burbank, CA 91507  
840-8939

**Gotham/EMT**

741 Washington St.  
New York, NY 10014  
(212) 741-7411

**Hybrid Arts, Inc.**

11920 W. Olympic Blvd.  
Los Angeles, CA 90064  
(213) 826-3777

**Ibanez**

Box 2009  
Idaho Falls, ID 83401  
(208) 522-8691

**Industrial Research Products, Inc.**

321 Bond Street  
Elk Grove Village, IL 60007  
(312) 439-3600

**JVC Digital Systems**

1111 West Artesia  
Compton, CA 90220  
(213) 537-6020

**Kawai America Corporation**

24200 S. Vermont Ave.  
Harbor City, CA 90710

**Kinetic Sound**

11 Maryknoll Drive  
Lockport, IL 60441  
(815) 838-0005

**Klark-Teknik Electronics**

262a Eastern Parkway  
Farmingdale, NY 11735  
(516) 249-3660

**Korg/Unicord**

89 Frost Street  
Westbury, NY 11590  
(516) 333-9100

**Kurzweil Music Systems, Inc.**

411 Waverly Oaks Road  
Waltham, MA 02154  
(617) 893-5900

**Lexicon, Inc.**

60 Turner Street  
Waltham, MA 02154  
(617) 891-6790

**Linn Electronics**

18720 Oxnard Street  
Tarzana, CA 91356  
(213) 708-8131

**LT Sound**

Box 338  
Stone Mountain, GA 30086  
(404) 493-1258

**Marshall Electronics**

1205 York Rd., Ste. #14  
Lutherville, MD 21093  
(301) 484-2220

**MCI/Sony**

1400 West Commercial Blvd.  
Fort Lauderdale, FL 33309  
(305) 491-0825

**Mitsubishi Digital**

(see Digital Entertainment Corporation)

**Music Technology Inc. (Siel)**

105 5th Avenue  
Garden City Park, NY 11040

**Nakamichi U.S.A.**

19701 South Vermont Ave.  
Torrance, CA 90502  
(213) 538-8150

**Neptune/NEI**

934 N.E. 25th Avenue  
Portland, OR 97232  
(503) 232-4445

**Rupert Neve Incorporated**

Berkshire Industrial Park  
Bethel, CT 06801  
(203) 744-6230

**New England Digital Corporation**

Box 546  
White River Junction, VT 05001  
(802) 295-5800

**Oberheim/ECC Development Corp.**

2230 South Barrington Avenue  
Los Angeles, CA 90064  
(213) 479-4948

**Octave Plateau**

51 Main Street  
Yonkers, NY 10701  
(914) 964-0225

**Passport Designs**

116 North Cabrillo Highway  
Half Moon Bay, CA 94019  
(415) 726-0280

**Peavey Electronics Corporation**

711 A Street  
Meridian, MS 39301  
(601) 483-5365

**Power USA**

11 Avenue of the Americas  
New York, NY 10013  
(212) 219-0988

**Publison**

#9 Rue Crespin du Gast  
75011 Paris, France  
(01133-1) 357-6407

**Quantec**

(see Europa Technology)

**Rane Corporation**

6510 D 216th SW  
Mountlake Terrace, WA 98043  
(206) 774-7309

**RolandCorp US**

7200 Dominion Circle  
Los Angeles, CA 90040  
(213) 685-5141

**Sequential**

3051 North First Street  
San Jose, CA 95134  
(408) 946-5240

**Simmons Group Centre, Inc.**

23917 Craftsman Road  
Calabasas, CA 91302  
(818) 884-2653

**Solid State Micro Technology for Music**

2076B Walsh Avenue  
Santa Clara, CA 95050  
(408) 727-0917

**Solid State Logic**

200 West 57th Street  
New York City, NY 10019  
(212) 315-1111

**Sony Professional Audio Products**

Sony Drive  
Park Ridge, NJ 07656  
(201) 930-1000  
also: 700 West Artesia  
Compton, CA 90220  
(213) 537-4300

**Studer/Revox**

1425 Elm Pike  
Nashville, TN 37210  
(615) 254-5651

**Technics**

One Panasonic Way  
Secaucus, NJ 07094  
(201) 348-7000

**3M Digital Audio Systems**

3M Center, Building 223-55  
St. Paul, MN 55144  
(612) 736-1149

**360 Systems**

18730 Oxnard Street #215  
Tarzana, CA 91356  
(213) 342-3127

**Ursa Major Incorporated**

Box 18  
Belmont, MA 02178  
(617) 489-0303

**Yamaha International Corporation**

Box 6600  
Buena Park, CA 90622  
(714) 522-9240



## Tascam Studio 8

The Tascam Studio 8 is a complete integrated recording system which incorporates an eight-channel, fully-assignable mixer; 8-track open reel recorder (7-inch reel capacity) and built-in dbx noise reduction. The mixer section includes eight input channels (with both balanced XLR and 1/4-inch line in connectors), three-band parametric EQ, eight program out busses, left/right stereo buss, auxiliary and effect busses, and ten VU meters with peak LED indicators. The recorder section utilizes a 1/4-inch 8-track format at 7.5 ips, and features full SMPTE/EBU synchronization capability, defeatable dbx noise reduction (also with a separate NR defeat switch on channel eight for time code recording), real time tape counter, automatic locator functions (return to zero, search to cue, and repeat from zero to cue),  $\pm 15\%$  pitch control, and a load mode which insures that the tape will not accidentally run off the reels.

The Tascam Studio 8 is priced at \$3,495, and optional accessories include a remote punch in/out switch, remote transport controller, and a ten-point auto-locator.

Circle #058 on Reader Service Card

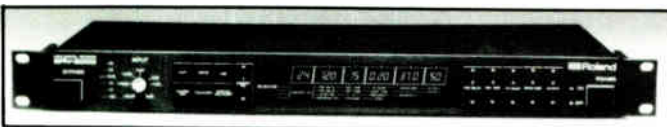

## Roland SRV-2000 Digital Reverb

The SRV-2000 digital reverb from Roland can store up to 32 settings of front panel controls (except the input attenuator), which amounts to having that many room simulations in memory or automatically recallable via MIDI. All programmed data (attack gain and time, gate time, reverb time and density, early reflection density, high frequency damping, room size and output level) is set by confirming values on the unit's numeric displays. Reverberation times from 0.1 to 99 seconds can be produced with a frequency response of 30 to 10k Hz (+1, -2.5dB). The unit also features two equalizers—a low frequency control and a two band parametric—whose parameters can be digitally displayed and stored in memory with each reverb setting. The Roland SRV-2000 is priced at \$1,495.

Circle #059 on Reader Service Card

## Computer-Aided Speaker Design Program

Scientific Design Software, of Northridge, CA, has released a new version of its popular Apple computer program, Computer-Aided Speaker Design, which allows the complete modelling of loudspeaker systems, accurately predicting system response before prototypes are built. Version 2.0 now comes as a two disk set: besides the main program disk, a file disk allows data storage on up to 800 speaker drivers and is shipped loaded with data on over 120 drivers from various manufacturers. Both sealed and vented systems are covered.

A complete crossover program assists in the design of 6-24 dB/octave crossovers with impedance correction circuits. Nine utility programs calculate various other functions, including reference efficiency from Thiele/Small parameters, vent tunings, passive radiator mass, etcetera, while a file maintenance program allows the updating of driver files.

The CASD program comes with a 90-page manual, and is priced at \$99.95. Computer requirements are: an Apple II with 64k memory, Applesoft ROM and two disk drives. The grappler parallel printer interface is supported for graphic screen printouts. An IBM version is now under development.

Circle #060 on Reader Service Card



## Audix OM-1 Microphone

Recently introduced by Audix Corp., of San Ramon, CA, the OM-1 is a hypercardioid dynamic microphone with a stated 50-18,000 Hz frequency response. The mike has a balanced brass body housing a shockmounted 200 ohm capsule which is field replaceable. Two versions are available: one is a probe type for instrumental applications and the other has a ball end with pop filter for vocal work. The Audix OM-1 carries a list price of \$325, and can be ordered in either black or matte gray finishes.

Circle #061 on Reader Service Card

## Annis Trans-Field Bulk Erasers

The Trans-Field line of bulk erasers from the R.B. Annis Company of Indianapolis, IN, provides fast, effective degaussing of magnetic audio and video tapes, cassettes, computer disks, etc. All the units in the line carry a continuous duty rating, and a standard erasing field intensity of 2,400 gauss, although other intensities can be supplied. Trans-Field erasers can handle material ranging from eight to 20 inches wide, and prices in the line begin at \$3,950.

Circle #062 on Reader Service Card



## The AMPLIFIER: Hill Audio DX500

### The POWER:

Dual channel (per channel)  
280 watts into 8 ohms  
425 watts into 4 ohms  
600 watts into 2 ohms

Bridged MONO  
825 watts into 8 ohms  
1150 watts into 4 ohms

### The SPECS:

(within rated power)

Distortion THD better than 0.01% at 4 ohms, 1kHz,  
IMD SMPTE better than 0.015% at 4 ohms  
Damping Factor 650  
Slew Rate 40V/microsec  
Noise -105dB A weighted

### The TECHNOLOGY: 'total symmetry'

A unique transformer coupled driver stage, featuring identical ultra-linear NPN output devices connected in a 'Super A' sliding bias configuration, exhibiting a much more linear response than conventional amplifiers using NPN and PNP devices. The transformer coupled driver stage allows the amplifier to perform perfectly safely and reliably without any protection devices in the audio signal path, with significant sonic benefit particularly at or beyond clipping.

### The FEATURES:

'000' Series\* power amplifier technology  
Toroidal power supply  
Fully protected against persistent overdriving, component malfunction, short circuit etc. by activating a protection relay.  
balanced and unbalanced inputs  
2 rack spaces  
mono bridging switch on front panel  
level controls on front panel  
LED indication of signal present, clip, power on and protect on  
2 thermally tripped fans  
handles

The PRICE: \$999.00 (suggested retail)

## The CHOICE: is yours!

\*the '000' power amps - dx1000, dx1000A, dx2000 and dx3000



Hill Audio, Inc. • 231 Marquis Court, Lilburn, GA 30247, U.S.A. • (404) 923-3193 • TLX 293827 HLAD  
Hill Audio, Ltd. • Hollingbourne House, Hollingbourne Kent, ME17 1QJ, England • (062 780) 555/6/7 • TLX 966641 HILL  
Headwater Industries • 635 Caron Avenue, Windsor, Ontario, N9E 5B8, Canada • (519) 256-2454

Circle #063 on Reader Service Card



## Rane PE15 Parametric EQ

The PE15 five-band parametric equalizer/notch filter from the Rane Corporation of Mountlake Terrace, WA, combines fully independent bandwidth, frequency and gain controls with the ability to control all parameters over a wide range. The bandwidth control of each band is constantly variable from 1/30th to 1.5 octaves; each band covers a range of four octaves and provides +15dB boost and -20dB cut. The two outer bands can be switched from peak-type to shelving characteristics. The Rane PE15 is priced at \$389, and both 1/4-inch and XLR-type balanced input and out connectors are included.

Circle #064 on Reader Service Card

## Neumann U47/U48 Parts Available

Gotham Audio Corp. of New York City, the U.S. importers for Neumann microphones, have announced that the German company has re-manufactured a limited supply of replacement parts for the U47 and U48 models, including housing tubes, head grilles, output transformers, and many other parts which had been unavailable since the early 70s. The microphone capsule has been in production all along, and will continue to be available. Gotham is also offering a restoration service for U47 and U48 microphones at the normal service fee plus parts.

Circle #065 on Reader Service Card



## Low Cost dbx Compressor/Limiter

Introduced at the summer NAMM Show in New Orleans, the Model 163X compressor/limiter from dbx is a low-cost (\$149 retail) stereo-strappable unit incorporating the company's well-known OverEasy compression. The amount of compression is controlled by a single front panel slider and is visually indicated by a 12-segment LED display. Line level input and output jacks are of the 1/4-inch variety, as is a front panel high impedance instrument jack which automatically defeats the rear input. Two units can be combined as a master/slave stereo pair via a single connection cable and the touch of a switch. The 163X can be rack mounted singly or in pairs, as shown.

Circle #066 on Reader Service Card

## StudioForms

StudioForms, Inc. of Glen Cove, NY, has developed a line of standard forms and labels specifically designed for the recording industries. The complete line includes pressure sensitive box and reel labels, track sheets, tape inventory sheets, session log sheets, quote sheets, session proposals, work order forms, maintenance forms, credit/deposit slips, invoices & appointment cards, with new forms slated for a future release. The forms are available in different quantities and come printed with the studio's name, address and phone number.

Circle #067 on Reader Service Card

## Decillionix MIDI-Madness Program

The MIDI-Madness program from Decillionix (Sunnyvale, CA), is a link allowing any MIDI-equipped keyboard to function as a live controller for Decillionix's DX-1 sound sampling system. Any sound sampled on the DX-1 can be recalled via a MIDI keyboard and up to eight samples can be user assigned anywhere on the keyboard. Velocity sensing is supported and sounds can be individually tuned over at least a five-octave range with both coarse and fine tuning controls. The program permits the keyboard to be split in up to 16 places.

MIDI-Madness is priced at \$99, and includes an operator's manual and software diskette. The DX-1 sound sampling system (also available from Decillionix) and an Apple II MIDI card are required.

Circle #068 on Reader Service Card



## Stellavox TD 9 Multi-format Recorder

Stellavox of Switzerland have introduced the TD 9, a versatile recording system capable of accepting 11 different standards in the 1/4-inch, 1/2-inch, and 16mm perforated magnetic film formats. The conversion of the basic TD 9 to another format can be accomplished in a matter of minutes, due to the recorder's modular design. Available formats include 1/4-inch mono, mono neo pilot, stereo master recording, stereo pilot synchrotone; 1/2-inch stereo master and 4-track; and 16mm mono, stereo and 4-track pilot.

Among the TD 9's other features are 14-inch reel capacity, synchronization with or without time code, AC or DC powering, selsync, six available tape speeds, variable speed, computer interface port, zero locator, digital real-time counter with selectable minutes/seconds/frames or hours/minutes/seconds display, rack mountable, edit control capability, and a built-in monitor speaker.

Circle #069 on Reader Service Card

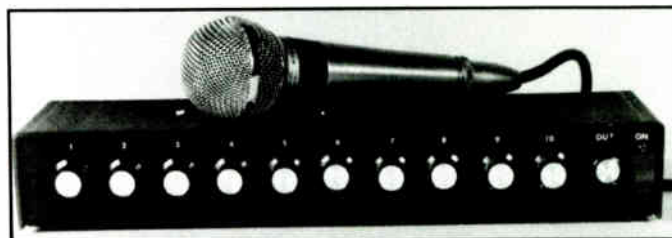

## Barcus Berry Model 101 Mixer

The Model 101 from Barcus Berry, Huntington Beach, CA, is an ultra-compact mixer providing ten input channels with independent, non-interactive controls plus a master. The



unit can accept inputs from virtually any high impedance source, such as musical instrument transducers, guitar pickups, electronic keyboards, and high-Z dynamic microphones. Four of the inputs can be switched to handle signals from Barcus Berry electret-type transducers designed for cymbals, high-hat, harmonica, violin and other instruments. Typical applications include PA submixing, monitor mixing, and multi-track recording. The Model 101 is powered by two nine-volt batteries, utilizes standard 1/4-inch connectors, and is priced at \$195.

Circle #070 on Reader Service Card

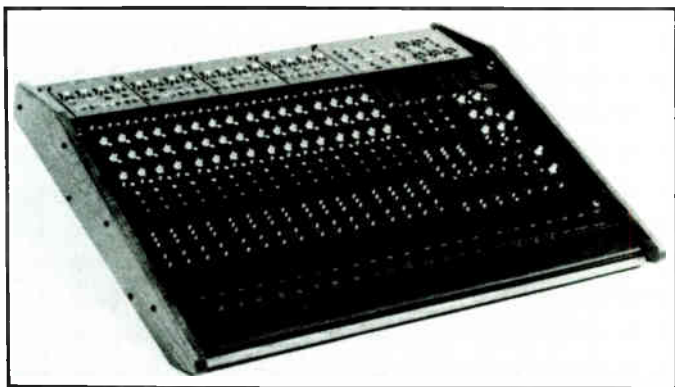

### Audio Centron Stage/Studio Mixers

The Stage/Studio series of mixing boards from Audio Centron (distributed by SLM Electronics of St. Louis, MO) feature convertible subgroup configurations. The standard 16x4x2x1 converts to 16x6x1 at the touch of a button. Other

features include high and low impedance inputs, three-band EQ on each input, two pre-auxiliary sends, two post-aux sends, and 10-segment LED displays on all sends and main buses, while all returns and inputs have peak LEDs. The Stage/Studio series also offers headphone monitoring on any bus, trim controls on the sub masters to prevent overload, a talkback circuit, and BNC lighting connector.

Circle #071 on Reader Service Card

### "Imagescope" from B&B Systems

B&B Systems of Valencia, CA have introduced the Imagescope, a single instrument designed to give a graphic visual representation of the dispersion pattern of a stereo audio signal. According to the manufacturer, the unit yields a true real time representation of the balance, separation and level of the signal, thus reducing the chance of phase errors. Applications include recording and music production studios, video facilities, and stereo AM/FM/TV broadcasters.

Circle #072 on Reader Service Card

### Tannoy SR-840 Power Amplifier

Designed for high level studio monitoring and sound reinforcement applications, the Tannoy SR-840 is a stereo power amplifier delivering 250 watts RMS into eight ohms. Other specifications include 440 watts/ch into four ohms, 645 watts/ch into two ohms, bridged mono outputs of 860 watts into eight and 1220 watts into four ohms, THD under .05% at any power over a 20 to 20k Hz bandwidth, and a full power bandwidth of 15 to 40k Hz (+0, -0.5dB). The SR-840 carries a U.S. list price of \$2,598.

Circle #073 on Reader Service Card

OVER 120  
MANUFACTURERS  
REPRESENTED

**FLANNER'S  
PRO-AUDIO, INC.**  
*Serving The Recording & Broadcast Industries*

• SALES • SERVICE • DESIGN • INSTALLATION •

- EXHIBITS
- SEMINARS
- SPECIAL EVENTS

**IF IT'S WORTH DOING,  
IT'S WORTH DOING RIGHT!**

**COME TO THE  
CHICAGO MUSIC EXPO '85**

THE HOTEL CONTINENTAL  
SEPTEMBER 20-22

**LET US SHOW YOU HOW!**

FOR MORE INFORMATION CALL:  
FLANNER'S PRO-AUDIO, INC. (414) 785-9166  
OR  
KBA ENTERPRISES (312) 279-8323

**WE DO IT ALL IN THE MIDWEST!**

2323C BLUEMOUND RD. • WAUKESHA, WISCONSIN 53186

Circle #074 on Reader Service Card

# INTERNATIONAL UPDATE



*Phil Collins, one of HHB's first digital customers, is pictured with a Sony PCM 701ES and PCM 1610 at Genesis' studio.*

## **British Company Pioneers New Markets for Digital**

HHB Hire & Sales, a company comprised of 11 people, based in Harlesden, North London, is now playing a leading role in introducing digital audio, not just to Britain's recording studios but to large organizations like British Telecom, the British Gas Corporation, the Home Office and a number of educational establishments.

HHB's success with digital audio began to take off with the introduction of Sony's low-cost digital processors at the end of 1982. The portable PCM-F1 and PCM-701ES digital processors are capable of high quality digital recording of a professional standard, ideal for the exacting medium of Compact Disc.

HHB has also researched and developed its own computer controlled logging and editing system—CLUE—which made both the PCM-F1 and PCM-701ES even more relevant to the professional user. HHB now markets the CLUE/PCM package to professional audio companies in many growing world markets including continental Europe, Scandinavia, North America and, most recently, Australia.

## **Something Old, Something New...**

Britannia Row Studio 1, located in a 100-year-old church hall in Islington,

London, has recently undergone a complete refurbishment and renovation under the supervision of Hutchinson & Partners, architects. Acoustics have been designed by Westlake Audio, and a new console has been installed by Solid State Logic of Oxford, England. The 48-channel SL 4000E is fitted with Total Recall, and will be controlling a Studer A-800 multi-track. While the studio will be commercially available, the first projects in the new room will be performed by Britannia Row's owner Nick Mason, who was formerly Pink Floyd's drummer.

Swanyard Recording Studios, another new facility in Islington which opened in July of this year, is built into a converted dairy, with plenty of space for a very large control room designed with keyboards and associated equipment in mind. The control room, designed by Neil Grant for Discrete Research Ltd., accommodates up to eight musicians and is equipped with a 48-channel SL 4000E Master Studio System by Solid State Logic. The SSL is equipped with Total Recall and interfaced with Otari MTR-90 multi-tracks housed in a separate area.

## **UK Guild for Producers**

After almost a year of planning and consultation, the inaugural meeting of

the APRS Producers Guild, held April 15th, brought together some of the best-known names in this field in the UK. Although very familiar to the record buying public, both at home and abroad, the founder/committee members of the Producers Guild had in most cases never met each other. Those attending included Tony Swain and Steve Jolley, Mike Vernon, Robin Millar, Alan Parsons, Gus Dudgeon, Rupert Hine, and Phil Wainman who, as owner of Utopia Studios, is a member of the APRS Executive. Other Executive members present were Simon White of Marquee Studio and Bob Hine of BASF—who was the prime motive force behind the setting up of the Guild.

The meeting covered a wide range of subjects including digital technology, education and training in the recording industry, and various aspects of the record producer's relationship with artists and record companies.

The Producers Guild is affiliated with the APRS, and its business will be administered by the association's secretariat. Bob Hine, Simon White and Phil Wainman will maintain close liaison between the Guild and the APRS Executive.

## **Agfa Brings Together German and American Duplicators**

Some of the most important duplicators, recording engineers and studio heads from Germany, England, France, Holland and Switzerland were the guests of the Magnetic Tape Division, Agfa-Gevaert, Inc., at a luncheon at the World Trade Center in New York, where they had opportunity to meet with their American counterparts.

Maria Curry, Director of Marketing for the Magnetic Tape Division of Agfa-Gevaert, Inc., who hosted the luncheon, took the opportunity to brief the foreign guests on the size and state of the U.S. market in terms of both audio and video tape duplication. This led duplicators from both sides of the ocean to exchange methods, procedures, problems, etc.

## **MUSEXPO '85**

MUSEXPO '85—10th International Record and Music Industry Market—will be held in London from October 16 to 18, 1985.

Some 5,000 record and music industry executives, radio and TV pro-



grammers, and professionals from 45 countries around the world will gather to do business and buy, sell, license, distribute, negotiate, meet, discover and promote their companies and productions internationally in London.

To be held concurrently is VIDEXPO '85—4th International Video Market and Conference—with international participation from home video, cable and pay TV executives, programmers and distributors.

On this 10th MUSEXPO Anniversary, two new annual international events open concurrently to MUSEXPO participants will also be inaugurated: the first truly International Music Video Festival with over 500 of the latest music video entries worldwide, the best of which will receive top awards; and the first International New Music Seminar, with international participation from new music makers.

#### Precision Power for Tokyo Plaza

Thirty-thousand watts of the Swiss-made FM Acoustics power amplifiers were recently acquired by Sun Plaza Hall in Tokyo to drive their new four-way loudspeaker systems. As they had to be located as close to the flown loudspeakers as possible, special versions of FM 600A and FM 800A precision power amplifiers were manufactured. An additional five-way cable was run from each amplifier to the control room, where level displays and indicators for each individual amplifier exist on a special display panel, allowing the engineer to monitor the status and level fed to each amplifier from his mixing desk.

This demonstration revealed the capabilities of FM Acoustics' amplifiers for the first time in Japan.

#### Red Bus and Marquee Studios, London, England, Order New Harrison Series 10

Red Bus Studios, as part of an extensive upgrading program for their recording and videos in London, have ordered one of Harrison's new Series 10 totally automated mixing console systems, to be delivered in January of 1986. This will represent the first installation of the new Series 10 console in the UK.

Not far behind Red Bus, Marquee Studios also recently announced that they have ordered Harrison's Series 10, to be delivered in March of 1986. The console will become an integral component of Marquee's extensive rebuilding and expansion plans presently underway at their London Wardour Street complex.

The Series 10 for both Marquee and Red Bus Studios will be supplied and installed by F. W. O. Bauch Ltd., the sole UK distributor for Harrison Systems, Inc.



SPECIAL

## RECORD IT REPLAY IT REMIX IT

150 PRODUCT LINES FOR THE PROFESSIONAL

TAPE RECORDERS • MIXERS • AMPLIFIERS • TURNTABLES • SIGNAL PROCESSING  
MICS • TAPE • CASSETTES • TEST EQUIPMENT • SPEAKERS • HEADPHONES • INTERCOMS

FULL COMPASS SYSTEMS

TOLL FREE IN ALL  
50 STATES

1 (800) 356-5844

IN WISCONSIN

1 (800) 362-5445

LOCAL (608) 271-1100

6729 SEYBOLD RD., MADISON, WI 53719

Circle #075 on Reader Service Card

# AKAI



MG 1212  
12 Channel Mixer  
12 Track Recorder  
**\$6995.00**

**Write:**  
Akai Professional Products  
P.O. Box 2344  
Fort Worth, TX 76113

Please Send Technical Information on The AKAI MG 1212.

Name \_\_\_\_\_

Address \_\_\_\_\_

City \_\_\_\_\_

State \_\_\_\_\_

Zip \_\_\_\_\_

Dept. A-4

Circle #076 on Reader Service Card

# SOUND ON STAGE



PHOTO: KAREN TUVERSON

*Surrounded by a sea of broadcast and production trailers outside JFK Stadium, the four Stars portable transmitters provided communications for BBC, MTV, U.S. syndication, and a world uplink.*

## SOME NOTES ON

# LIVE AID

by George Petersen

Putting together a large stadium concert is a major undertaking, involving hundreds of hours of pre-production, but when such an event involves simultaneous shows on two continents with dozens of the hottest performers in the industry and live audio/video satellite feeds to almost every part of the globe, the comparison becomes rather trifling indeed. Yet all the hard work and effort paid off rather handsomely, as the Live Aid benefit—held July 13, 1985 at London's Wembley Stadium, and JFK Stadium in Philadelphia, and touted as the largest single musical event in history—brought in scores of millions in contributions for African hunger relief.

Certainly one of the event's most interesting technical aspects was the complex web of satellite links put together by Synsat, (Hollywood, CA) a service of Group W Productions' TVSC and Novo Communications' Bonded Services, which connected the stage action with the rest of the world. A total of 13 satellites and 22 separate transponders using a combined total of 322 hours of air time were required to reach an estimated audience of 1.5 billion viewers.

Jim Tuverson, the west coast head of Synsat, noted that help came from every segment of the industry: "In order to deliver a satellite feed to more than 105 countries throughout the world plus more than 107 U.S. television stations, we had to enlist the aid of a lot of industry friends. Hughes Commu-

nications donated two of their Galaxy satellite transponders for the U.S. distribution. Brightstar, a company of Visnews, Ltd. and Western Union, coordinated all of the international satellite traffic including the donation of one of Western Union's satellite transponders; Equatorial Communications Company donated a Galaxy III transponder for the event; Rainbow Network Communication donated transponder time and the use of one of their uplink antennas for miscellaneous satellite feeds. Stars, a Houston-based satellite and transmission company, coordinated the use of four 40-foot portable transmitter trucks plus the donation of their two uplink transmitters at the Houston International Teleport. Atlanta-based Videostar handled the all-important downlinks of the BBC-produced London satellite feed from Wembley Stadium plus other events from venues throughout the world. Additional help came from the Foundation of Global Broadcasting (Washington, D.C.) and the United Kingdom's BTI."

Clair Brothers, of Lititz, PA, brought in an appropriately massive sound system into JFK for the occasion, fed from a circular 60-foot rotating stage (originally built for the 1974 Emerson, Lake & Palmer tour), which was divided into two parts (Stage I/Stage II) via a central wall allowing for extraordinarily fast set ups between acts. The downstage apron area and "celebrity" stages (for broadcast commentary) at the left and right sides of the platform provided ample room for performers to work around.

Audio for the television/radio broadcast feeds was coordinated by David Hewitt of Remote Recording Services, who contracted Le Mobile, Mobile Audio, and the Record Plant "Black" and "White" trucks to handle the live music mixing from JFK. Le Mobile (outfitted with an outboard Neve mixer to

### Synsat's satellite distribution network for Live Aid.

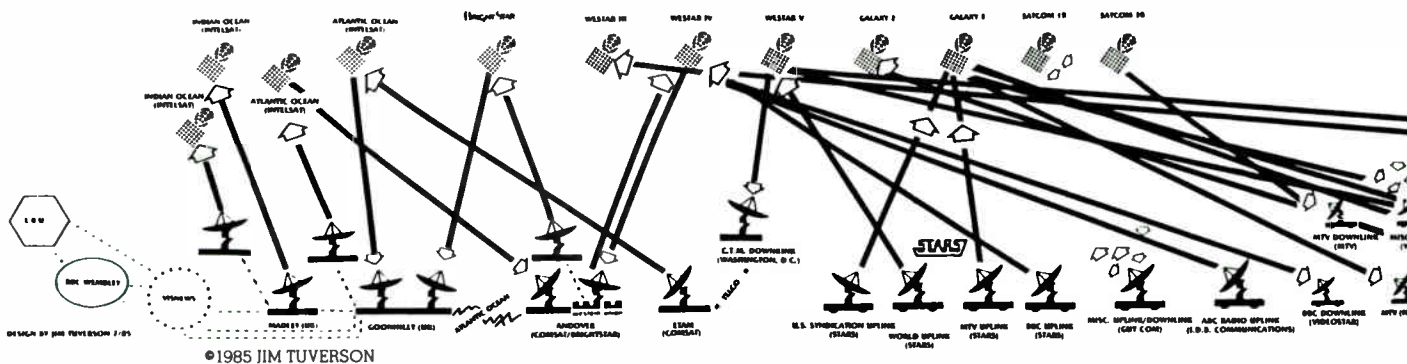

©1985 JIM TUVERSON



supplement the truck's 8058 console for over 50 input capability), with Bob Clearmountain at the board, mixed Stage I; he alternated with Bob Liffin, who was stationed in the "Black" truck to mix acts on Stage II. Mobile Audio's 45-foot trailer was called in for double-duty—with Rod O'Brien providing audience ambience and apron/side stage mixes, while the on-board overdub lounge was fitted with desks, copy machine, and line monitors, serving as Hewitt's command central between the four trucks, the various broadcasters, and on-stage contact Phil Gitomer. All three trucks fed the "White" truck, with Ed Green combining the three mixes to be sent out to the numerous media feeds via banks of distribution amplifiers in the ABC transmission trailer.

Across the Atlantic, at Wembley Stadium, the live concert sound was supplied by M.H.A. of Hollingbourne, Kent, who not only provided a 120,000 watt system comprised of Hill Audio components, but also the production and stage management crew. The completely flown mains system went up very quickly—the entire PA was up and running three hours after the staging was completed. BBC handled the broadcast sound, both in and out of Wembley, and had access to all 80 stage inputs via an active splitter system, as well as the stereo outputs from the Hill J3S 40-into-8 house consoles.

Commenting on what it was like working on the event, Hewitt notes: "I think the description 'logistical nightmare' probably fits. It got pretty crazy trying to jam everything in there and get it running because there were so many diverse factions—Bill Graham's stage crew, the PA people and all the broadcasters—ABC, MTV, independents, radio—and then when you throw in about a dozen unblimped generators going full tilt, it was cacaphony squared. It was really nuts, but everything went so smoothly that there must have been some higher order looking after things. There were a lot of areas where it could have gone down the tubes, but everybody worked really hard to keep it together. It was a magic event."

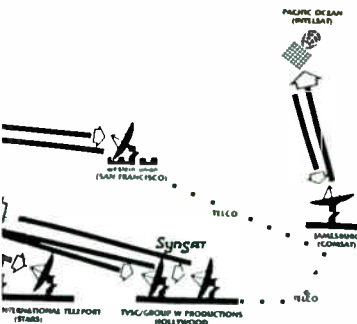

*We're Flying High Because of You!*

Thank You, MIX Readers, for nominating A-1 Audio Systems for a TEC Award in the category **SOUND REINFORCEMENT COMPANY OF THE YEAR.** A-1 Audio Offices are located in Hollywood, Atlantic City, Las Vegas, & Reno/Lake Tahoe. . . call 800-466-4466 or, in California, 213-465-1101. Ask us about our V.I.P. Loudspeaker System. . . one reason why we're flying high with sound reinforcement

Circle #077 on Reader Service Card

## **rh** SMART and SMART JR.

### HI-TECH SOUND SYSTEMS pats. pend.

Microprocessor electronics control very compact R-H speaker systems to achieve studio monitor quality sound at very high sound pressure levels.



X-SERIES PROCESSORS



- Incredible 134 dB SPL, 40Hz-17KHz
- Fail-Safe System Overload Protection
- Time Coherent System Performance
- Compact Modular Array for Fast Set-up
- Optional Flying Hardware

**NEW FOR 1985**

**SMART SUBWOOFER** compact and fail-safe.  
**SMART JR. SYSTEMS** with cost-effective single amplifier operation.

*Designed for:*  
 LIVE MUSIC  
 CLUBS • DISCOS  
 THEATERS  
 CHURCHES  
 CONCERT RE-  
 INFORCEMENT

**WRITE OR CALL TODAY FOR FULL INFORMATION**



**RENKUS-HEINZ, INC.** DRIVERS • HORNS • SPEAKER SYSTEMS  
 17851AB Sky Park Circle • Irvine CA 92714 • (714) 250-0166

Circle #078 on Reader Service Card

## WIGTOWN

*Jerry  
Marotta's  
Artist  
Refuge*

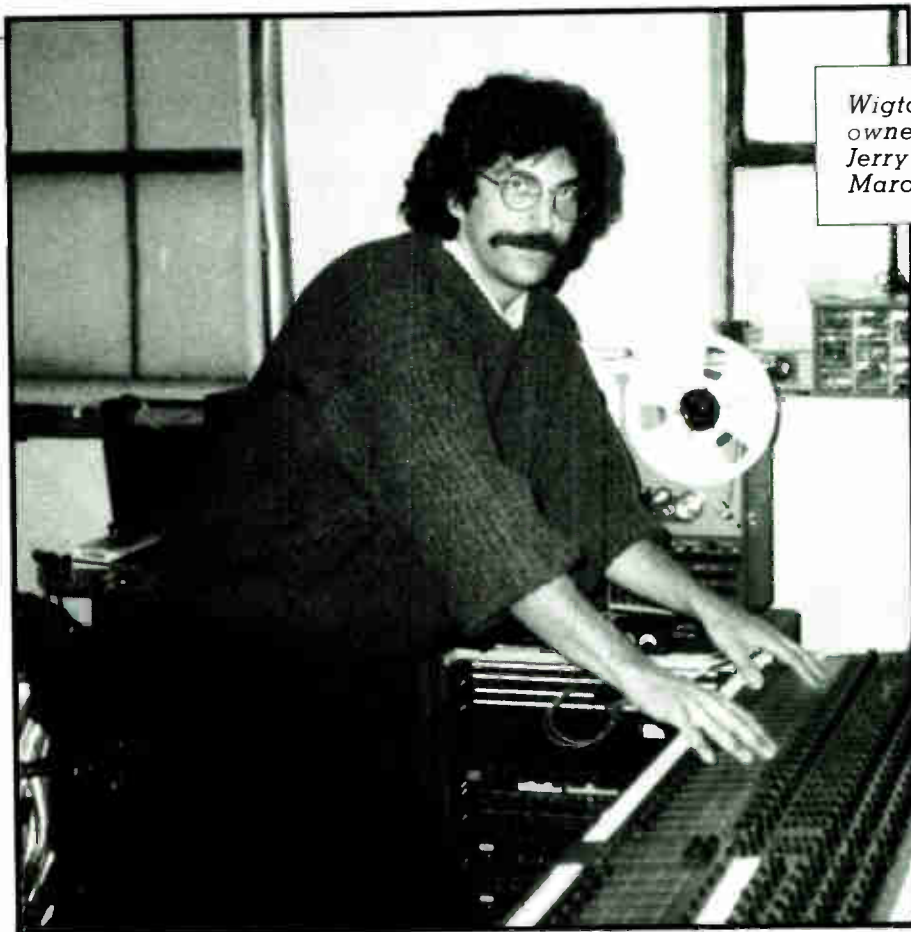

Wigtown  
owner  
Jerry  
Marotta

PHOTO: DAN DALEY

### WIGTOWN EQUIPMENT LIST

**Consoles:** Allen & Heath 1628 24 x 16 x 8, HH Electronic stereo 12-channel desk.

**Tape decks:** Fostex B-16, Revox B-77, NAD cassette deck.

**Monitors:** Meyer 833 Reference Monitors.

**Power Amps:** Sansui BA-F1, Crown Micro-Tech 1000.

**Outboard Effects:** (2) Yamaha 1/3 octave EQ, Yamaha R-1000 digital reverb, Lexicon PCM-60 digital reverb, Roland Dimension D, Drawmer comp/limiter (2), Drawmer gates (2), MXR digital delay, Boss digital delay, Ibanez digital delay, MXR Pitch Transposer, large assortment of wigs.

**Musical Gear:** (2) Yamaha DX7, Korg Poly 800, Roland MSQ-700 digital sequencer, full Yamaha kit, Dynacord digital drums, Linn LM-2.

**Engineering Staff:** Mark Mandelbaum, Todd Levine.

by Dan Daley

Right across the East River from Manhattan lies an industrial neighborhood known as Long Island City, in Queens. It's drab and dreary, even on the sunniest of days, warehouses and factories lining the narrow, cobblestoned streets. By day, trucks load and unload in seemingly endless succession; by night, it's all but deserted.

Except for Wigtown.

Wigtown studio is the progeny of Jerry Marotta, currently the drummer with Peter Gabriel. Marotta's patented "behind the beat" percussion approach has graced the records and live shows of Orleans, Hall & Oates and Tears for Fears, among many others, as well as the recently completed Paul McCartney album. This drummer's musical aspirations don't lie solely behind a kit, though; hence, Wigtown. "I wanted the studio because I have a real strong interest in writing and producing," says Marotta. "Wigtown is essentially an R&D lab where I can be in control of the elements that go with writing and producing."

(The name "Wigtown" is the sort of joke you had to be there for, and we weren't. It stems from a shop featuring polyester wigs that Marotta noticed one day in Manhattan and found humorous in an off-beat fashion.)

His ambitions as a producer manifest themselves in an array of projects that he has undertaken in the past in between the bread and butter gigs. But going into established studios in New York and elsewhere pursuing these projects became costly—prohibitively so. "There was also the sense of impermanence," he adds. "You walk away from a studio while you're doing a project and another project comes in to that studio. The space changes."

So back in the summer of 1984, Marotta began planning in earnest for his own recording space. What made his thoughts into a reality was the recent proliferation of high-tech, affordable recording and signal-processing equipment. He began checking into the available 16-track formats, after deciding that eight tracks were not enough in terms of flexibility. "I decided on the Fostex B-16 because I was really im-





The Linn 9000 is conceived for every artist, every songwriter whose creativity demands the finest in technology.

Designed for musicians by musicians, the Linn 9000 incorporates the world's most sophisticated touch sensitive digital drum machine with the most advanced 32 track MIDI sequencer. There is virtually no songwriting style that it cannot accommodate, instantly. There is no manner of performance or personal expression that it cannot precisely duplicate.

A glance at the control panel tells you that when inspiration arrives, the 9000 makes it effortless to capture, arrange and edit your music. What you can't see are its user sound sampling capabilities and the extensive Linn library of professional quality sounds.

Isn't it about time you visited your Linn dealer and experienced the Linn 9000 for yourself?



Imagine the possibilities.

*The inventors of the digital drum machine now offer you the most sophisticated compositional tool ever created. The Linn 9000.*

**Linn**

Linn Electronics, Inc.  
18270 Oxnard Street, Tarzana, CA 91356  
(818) 708-8131 TELEX #298949 LINN UR

of charted dance records and has worked as a freelance engineer at Power Station and The Record Plant studios in New York and at Phase One in Toronto. "The studio is still in a pretty raw state," he told us. "The place was wired by Mike Malfesi (who also worked with Marotta doing monitor mixing on the road) but he left out a few studio-isms that we're re-designing in. It was very much a live approach in terms of the original design, since that was Mike's strongest suit, but he didn't know what I needed as a studio engineer, like a more studio-oriented logical signal path."

Overall, though, Mandelbaum is pleased with the studio. "The intent of

the studio originally was to be a writing and production tool for Marotta. Now he's making it available to other musicians and engineers like myself to help bring ideas to fruition. As a production resource, there's so much here, and the atmosphere is incredibly relaxed. It's not so much a compromise as it is a challenge. We do bounces, since it is 16-track, but that's no problem. We're exploring SMPTE right now, keeping in mind that there are plans to go 24-track in the future. I'm absolutely convinced that I can do anything I want to, sonically, in this environment."

The larger room provides excellent ambience with its brick, glass and cement composition. "We try to use the

acoustic spaces we have to their best advantage," says Mandelbaum. "This room makes the drums sound like thousands of dollars of digital signal processing just by judicious use of carefully placed mikes. It takes a little more time to get the sounds, but it's worth it. I get sounds I couldn't get anywhere else." He uses every nook and cranny of the building in achieving those sounds, including stairwells for vocals. The area is almost completely silent at night, so outside noise really isn't a problem at all, according to Mandelbaum. Vocals are monitored over headphones during recording and then played back over the Meyer 833 monitors.

"When we started out, I didn't think in terms of tuning the room," says Marotta. "We haven't gotten to that point yet. We're real into getting the live sounds by putting the amps and mikes in the right places."

While Wigtown is not an interior decorator's dream, with an esthetic ambience similar to that of a college frat house, the sounds it produces are amazing. "The idea is to keep the cost down, for us and the artist," states Marotta. "There's so much you can do for pre-production in here."

Both he and engineer Mandelbaum feel that once the fine-tuning process is complete they can produce competitive masters at the facility. Having opened its doors in January, the studio is so new that there are few things finished in terms of recorded projects at this writing. Marotta and other musical partners are in the midst of finishing up some production projects originating through Marotta's fledgling production company, also called Wigtown (as is the band he is putting together). He and bandmate Tim Cappello, now on the road with Tina Turner, have scored an episode of the PBS series *Frontline* there, and Gerard McMahan has recorded some tracks for the television series *Fame* at Wigtown.

With 24 tracks on the horizon, Marotta also voices his desire for other upgrading gear, like an AMS or a Quantec. For the time being, though, he finds the Lexicon PCM-60 and the Yamaha R-1000 to be excellent for his digital reverb needs. "We're going to have all that stuff eventually," he says, "but we're just feeling our way for now."

Marotta is no stranger to portable high-tech. Both he and his brother, Rick—also a drummer whose credits include Linda Ronstadt and Warren Zevon—each carry a Radio Shack TRS-80 portable computer wherever they go. It's tied in by phone modem to an electronic mail service in Baltimore, Maryland, instantaneously beaming their typed conversations to each other.

"Jerry sends me settings for the Linn-

# THE SPOILERS

**OTARI** - Soundcraft - C.A.R.



**SPOIL YOUR CLIENTS WITHOUT SPOILING YOUR BUDGET WITH OTARI'S NEW MX70 16 TRACK AND SOUNDRAFT'S SERIES 600 RECORDING CONSOLE. STATE OF THE ART PERFORMANCE, RELIABILITY, AND SERVICE AT A PRICE YOU WON'T BELIEVE.**

- EQUIPMENT SALES
- SERVICE
- SYSTEM DESIGN . . .

**C.A.R.**

PROFESSIONAL AUDIO  
2641 East McDowell  
Phoenix, Arizona 85008  
(602) 267-0600



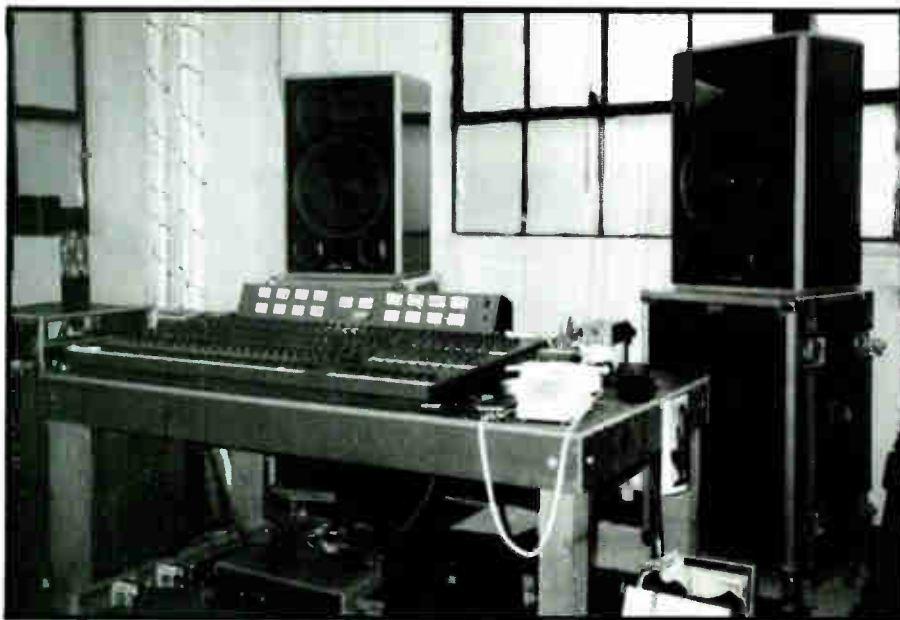

PHOTO: DAN DALEY

Drum that he's come up with," says older brother Rick, based in L.A., "and he asks me to check prices for him on equipment."

What Wigtown is, ultimately, is an artistic refuge. It is also the springboard for what Marotta hopes will become a thriving production career. But beyond that, Wigtown is also a testament to the revolution in recording technology

that allows for state-of-the-art sounds at reasonable budgets. Marotta indicates that he is heavily invested in the studio, providing all the financing personally, and that that is the measure of his commitment to both the studio and his career. "I have every intention of Wigtown becoming a lucrative enterprise, both commercially and artistically," he states.

*With a limited budget, emphasis was placed on equipment rather than decor.*

That's going to take some time, he admits, since Wigtown is not actively soliciting clients on an hourly basis, but rather looking for developmental projects that Marotta or another associate would produce. When the subject of rates came up, he was whimsical: "One day it's \$29.37 an hour, the next it's \$52.18 an hour. It's our own private joke," he laughs, "because we get to spend so much time in there without someone looking over our shoulders."

Marotta has given the running of the business operations of the studio over to his cousin, Frank DelTorto, who evaluates projects from the financial point of view, leaving Marotta free to concentrate on the artistic considerations. DelTorto indicated that, in the long run, the studio will begin taking on hourly clients in the future.

Wigtown is an unconventional enterprise created by an unconventional musician. It's an R&D lab for the creative spirit. It's a mix of ambient sounds and direct recording. It's a lot of fun, too.

Dan Daley is a freelance writer and producer based in New York City.

## MX1688 Recording Mixer

16 x 8 x 2 with control room mixing

The Carvin MX1688 recording console offers the professional quality features and signal performance you've grown to expect from Carvin! Use of the finest components and professional audio design enable the MX1688 to interface with any professional tape deck. For additional info on this console and Carvin's complete product line send \$1 to Carvin, Dept. MX62, 1155 Industrial Ave., Escondido, CA 92025. A similar 16 x 4 x 2 MX1644 mixer is available for \$1995.

### Recording Features

- Eight Track Studio Control Center
- Input/Output Channel Organization
- Independent 8 Into 2 Monitor Mixer
- Four Auxiliary Busses w/ Pre/Post
- Three Band Parametric EQ w/ Defer Switch
- Mute and Solo on all Input and Output Channels
- Two Effects Returns w/ Pan and Solo
- Talkback w/ Built-in Mic and Monitor Dimming
- Peak Warning Indicators w/ Peak Stretching
- Patch Points on all Channels
- Microphone Phantom Power
- Cue and Effects Sends from Output Channels
- Alternate Metering of Cue and Two-Track
- Quick Tape Playback Through Monitors
- Independent Mic and Line Preamps
- Studio Feed w/ Source Selection
- Totally Modular Internal Construction
- Input Noise of -127 dBv, THD less than .05%
- 20 dB headroom at All Stages

### P.A. Features

- Eight Sub-Groups w/ Solo and Mute
- Channels Assignable to L & R Stereo Output
- Four Independent Monitor Mixes Available
- Headphone Monitoring of Main or Monitor
- 11 Step Gain Controls for Easy Set-up
- Talkback to Monitors

## MX1688

**\$2995 + 49 Frt.**

### Product Information

Toll Free 800-854-2235

Calif 800-542-6070

Circle #063 on Reader Service Card

**CARVIN CATALOG**  
 \$1 for Bulk Mail  \$2 for Rush 1st Class Mail  
 Name \_\_\_\_\_  
 Street \_\_\_\_\_  
 City \_\_\_\_\_ State \_\_\_\_\_ Zip \_\_\_\_\_

MX62

by Bruce Nazarian

In an earlier column, I explained the importance that the clock signal plays in synchronous recording. Some of the problems we have been solving involve regenerating, correcting, or otherwise manipulating the master clock signal, the "lifeline" of the drum machine—sequencer connection. To help in these applications, devices like Dan Garfield's "Dr. Click" family of clock interface units were designed. The original interface units that were developed had provisions for manipulating the TTL, FSK and DIN Sync clocks used by

## Some Tricks With MIDI SEQUENCERS

the more popular manufacturers. With the introduction of new MIDI sequencers, and MIDI drum machines that do not have TTL or DIN Sync clock inputs, we must find new ways to make the "clock connection." Here's a real example that recently occurred during a client's project:

### OUR MISSION...

Prior to booking the studio time to record his EP, my client had completed pre-production on his material in the typical, cost-effective synthesizer tradition. He had meticulously recorded each and every keyboard part on his computer-based sequencer, and had recorded, sequenced, and stored all of his LinnDrum parts as well. Bringing his cassettes and data disks to the studio, we proceeded to hook up his Apple-based MIDI sequencer, and prepared to begin recording what should have been an easy project. Well, it

—PAGE 123

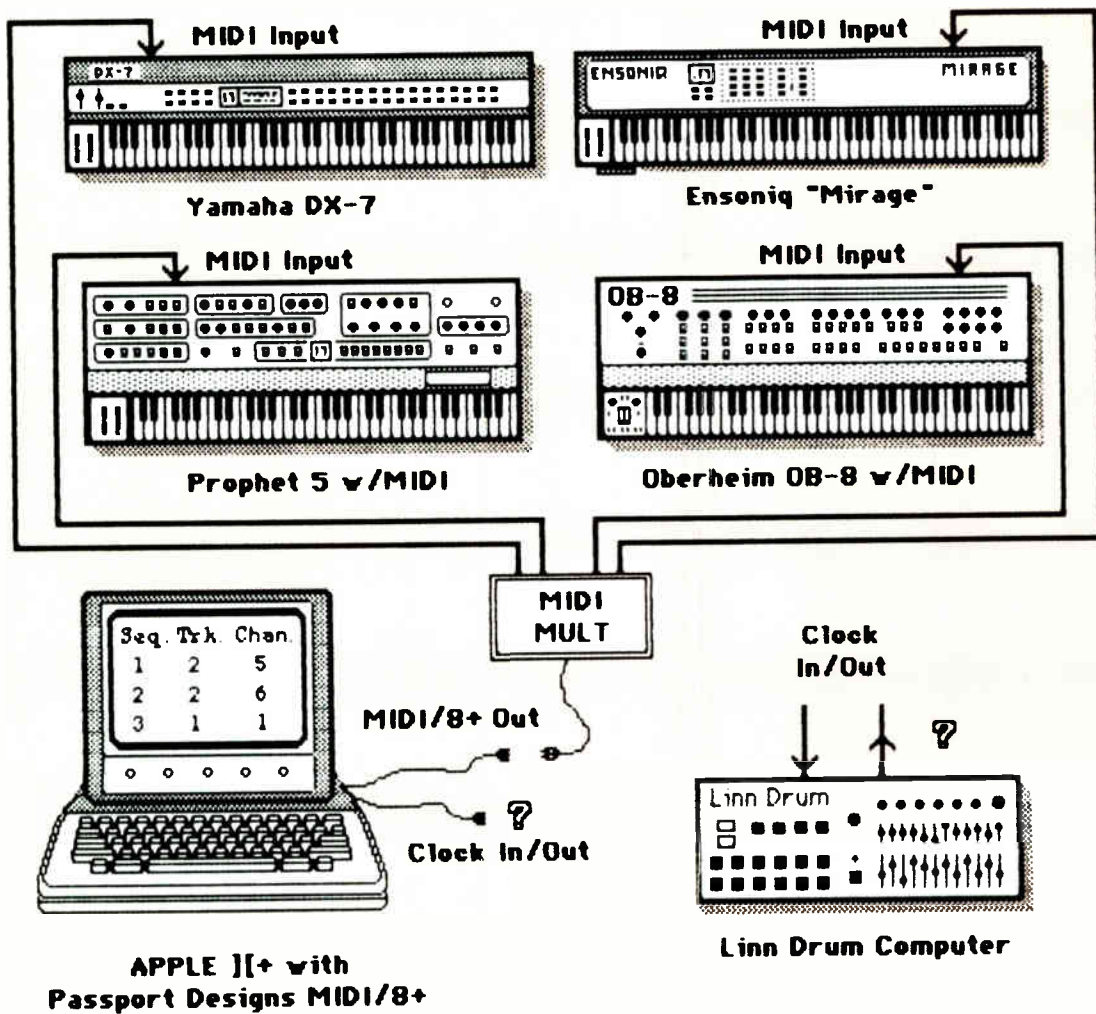

PHOTO: ARTWORK ©1985 — BRUCE NAZARIAN

Figure 1: Desired Setup for Recording Project



# BE A TRAK STAR!

Keep your music on the "right track" with the new Multi-Trak, TOM and MAX from Sequential!

## THE AMAZING NEW MULTI-TRAK!

Take a look at Sequential's new Multi-Trak! Features include a 5 octave velocity-sensitive keyboard for controlling loudness, brightness or modulation. A powerful built-in digital recorder lets you record up to 1600 notes and provides 4 independent sequence locations, an audible metronome, 5 different resolutions of auto-correction, sequence appending and the ability to erase your recorded music by track or by single note. To facilitate your recording needs, each sequence track has its own audio output.

Unique to the Multi-Trak is its polyphonic "SuperStack" mode. "SuperStack" lets you layer two, three, or six sounds and play them

"live" from the keyboard! Also featured are a stereo chorus with programmable On Off and adjustable rate and depth, a cassette interface for program and sequence storage, and a latching arpeggiator with transposition at the touch of a key.

## MAX: THE ULTIMATE MIDI EXPANDER!

MAX is a 6-voice, polyphonic synthesizer designed to let you play six completely different instrument sounds at one time. And MAX's comprehensive MIDI implementation makes it the ultimate MIDI expander!

## TOM: A UNIQUE NEW DRUM MACHINE

Like all Sequential drum machines, TOM features programmable tuning and volume. TOM adds to these features unique new capabilities like programmable stereo pan for each instrument and the ability to play sounds in reverse! Other features include a programmable "Human Factor" to add subtle variances to instrument tuning and volume levels during playback. And there's a new feature called "Improv", that subtly alters your rhythm patterns with the automatic introduction of occasional "fills". These exciting features let TOM more exactly mimic a "live" drummer! TOM comes with 3 digitally recorded percussion instrument sounds. A cartridge port is provided for easy sound expansion!



MAX  
suggested retail \$599.00



TOM  
suggested retail \$799.00



Multi-Trak  
suggested retail \$1499.00

# SEQUENTIAL

For a complete catalog, please send \$2.00 to Sequential,  
3051 North First Street, San Jose, CA 95134.

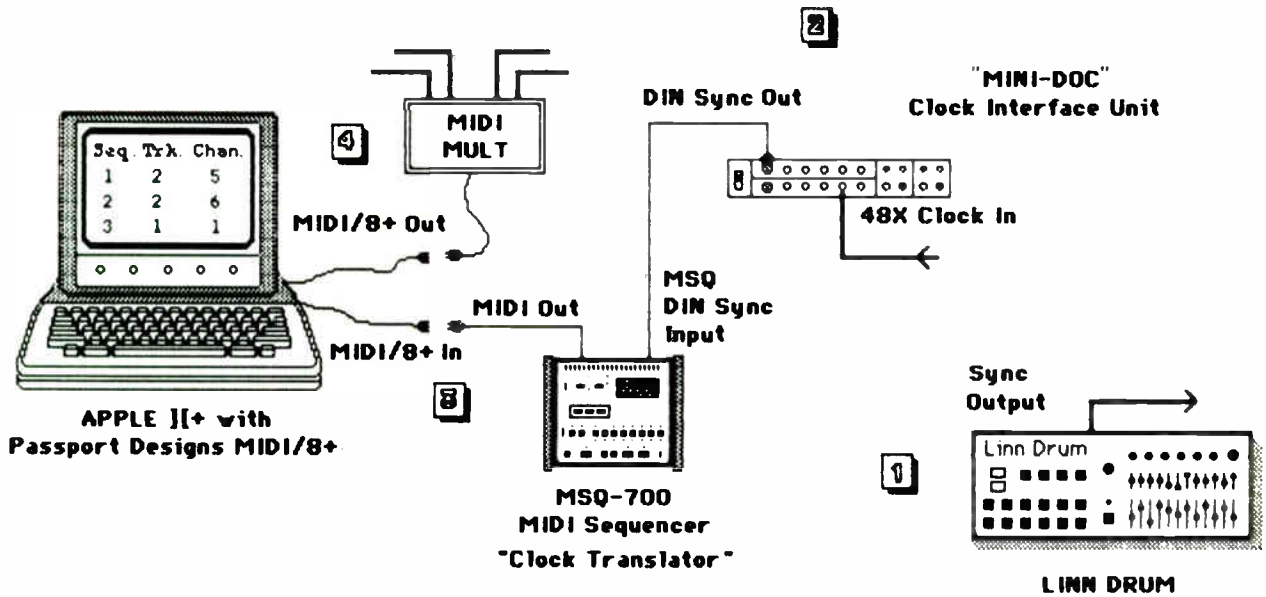

ARTWORK ©1985 — BRUCE NAZARIAN

Figure 2: TTL-to-MIDI Clock Translation using MSQ-700

**WOULD YOU LIKE A SAMPLER™ FOR LESS THAN \$1,000.00?**  
(SO WOULD 348,000 OTHER SYNTHESIZER PLAYERS!)



Now the **S-612 SAMPLER™** by AKAI enables thousands of synthesizer owners the freedom of sampling technology without mortgaging their wife and kids! AKAI has introduced and is delivering a 12-bit, 32K Band width, 6-voice SAMPLER™ for \$995.00. Remember ... nothing is sacred with an AKAI

612 SAMPLER™. Sample a ... voice, a train, a bell or any analog or digital signal ... and then 8 seconds later be playing it on **any** MIDI keyboard.

Call or write for all the AKAI SAMPLER™ facts and see it at your local dealer.

**AKAI**

**AKAI PROFESSIONAL PRODUCTS**  
P.O. Box 2344 Fort Worth, TX 76113  
(817) 336-5114

**IN CANADA: AKAI AUDIO-VIDEO CANADA**  
121 Watline  
Mississauga, Ontario, Canada L4Z1P2  
(416) 890-2300

Circle #084 on Reader Service Card



—FROM PAGE 120, IN SYNC

should have been easy, but it wasn't. The sequencer he was using only had provision for two types of external clock input. Either we used its own sync-to-tape signal, or we had to clock it via MIDI. Because we expected to overdub many drum tracks, and wanted to lock the LinnDrum to its own sync tone as much as possible, we elected to have the Linn as the "Master" clock source. This meant translating its TTL clock output into a MIDI clock that could drive the sequencer. Fortunately, we had a device handy that provided the solution to this problem: the Roland MSQ-700 MIDI Keyboard Recorder.

### A GREAT PROBLEM SOLVER

The designers at Roland had enough insight to include almost every kind of interface connector on the MSQ-700 that they thought might be needed. And, as it turns out, we did need them. Figure 1 shows the setup we were using: an Apple-based sequencer (Passport's MIDI-8 Plus), our studio's rack of synthesizers, and a LinnDrum. Normally, we use the TTL clock from the Linn to drive a Garfield "Mini-Doc," which, in turn, clocks all of our sequencers. Since the client's MIDI-8 Plus sequencer only accepted a MIDI clock, we had to improvise. Luckily, it was quite easy. One nice feature of the MSQ-700 really helped: when you clock the DIN Sync input, the MSQ simultaneously generates a MIDI clock, available at the MIDI OUT connector on the back panel. Amazingly, this function is not documented anywhere in the MSQ-700 owner's manual!

Figure 2 shows how we wired it.

1) Prior to recording, we calculated the tempo needed for each song, and laid a LinnDrum sync tone of the proper tempo on Track 24 of the master tape. For each 3½-minute song we cut about 4 minutes of sync tone. This allows for count-ins, and long fades on the out choruses.

2) Routing the output from Track 24 into the Mini-Doc 48X input, we used the Mini-Doc's DIN Sync output to clock the MSQ-700. As mentioned, the MSQ translated the DIN Sync input into a MIDI clock output, in perfect sync with the original Linn clock from the master tape.

3) This MIDI clock was fed to the MIDI input of the Passport interface card. Since we did not need the MSQ as a sequencer, we could dedicate it to the task of being "clock translator" for the duration of this recording project.

4) The MIDI output from the Passport card was routed through a MIDI Mult Box (Roland MM-4) directly to all of the keyboard MIDI IN connectors.

This wiring setup functioned flawlessly throughout the entire week's worth of

sessions, and took less than an hour to think up and rewire! Needless to say, the client got his EP finished on time and well within his original budget, and we managed to preserve all of the programming work he had done prior to getting to the studio. With the time he saved by pre-programming synth parts at home, the client had more time to spend in the studio programming the MIDI-driven layers of synthesizers that he had heard in his head.

### A LITTLE LOGIC GOES A LONG WAY

Solving this problem was actually a pretty simple bit of logical thinking, helped along by a little detective work

done a few months earlier. You see, I had discovered the Sync-to-MIDI clock translation trick while testing out the MSQ-700 when I originally purchased it for the studio. I kept that function buried in my "trivial info" file, until the time it was needed. With a little detective work on your part, you can acquire a storehouse of useful knowledge, too. It is this knowledge, and a good grasp of logical thinking that help you sort out problems when they arise, and create solutions when others create failure. Like any other computerized system, MIDI sequencers always operate in a very logical manner. Find the flow of the logic, and you've found the solution to the problem. ■

## DOES YOUR MIDI EQUIPMENT KEEP YOU PLUGGING AWAY?

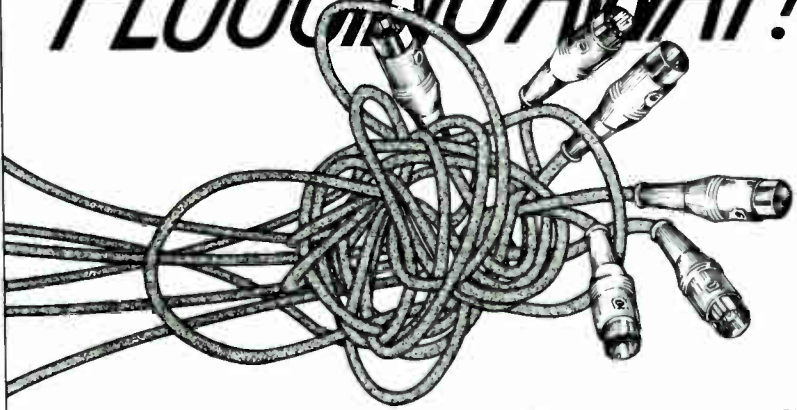

So you're getting together a great collection of MIDI equipment: You can attach your Roland\* to your Yamaha\* to your Oberheim\* by just plugging in a MIDI cable. Great, isn't it? But you are probably also starting to get back problems from leaning over your equipment re-plugging cables every time you want to reconfigure the set-up. The J. L. Cooper MIDI SWITCH BOX™ series has an answer to your MIDI patching problems. From a straight MIDI ON/OFF footswitch with LED indicator to a microprocessor controlled programmable 8 IN and 16 OUT unit, we have a switcher for you! Call us at 213-827-4884 for the name of your local dealer.

- **MSB-1:** a 1¾" rack unit with 8 MIDI inputs and 10 outputs. Each output has a rotary switch that selects which input is attached to that output. All connections are on rear of unit. Use this for manual control of large set-ups. *Retail Price \$395*
- **MSB 16/20:** the absolute top-of-the-line switcher. This 3½" rack unit has 16 MIDI inputs and 20 MIDI outputs under microprocessor control. Three methods of changing the configuration are provided: First, by touching a button, a given output may be attached to one of the inputs. Second, the pressing of two buttons can call up one of 64 battery backed-up programs that define the entire set-up. Finally, the unit may be set to receive MIDI program change commands from a MIDI master device. A display on the front panel shows both switching configuration and program number. A must for QX-1† owners! *Retail Price \$1395*
- **MSB-3:** just the answer to less complex switching needs. The MSB-3 has 2 MIDI inputs and 4 outputs and can hold two patch setups selected via front panel switches. At the touch of a switch, the alternate patch may be selected, with an LED indication current patch number. May be used either counter-top or on floor as a foot-controlled unit. *Retail Price \$220*
- **MSB-4:** a foot operated MIDI ON/OFF switch with an LED indicator of status. Just the thing to turn a slave device on or off. *Retail Price \$75*

\*Roland, Yamaha and Oberheim are registered trademarks of RolandCorp US, Yamaha International, Corp. and Oberheim Electronics, Inc.  
† QX-1 is a registered trademark of Yamaha International Corp.

**JL COOPER ELECTRONICS**

1931 Pontius Ave.  
West Los Angeles, CA 90025  
213/473-8771

Circle #085 on Reader Service Card

# M. I. U P D A T E

by Craig Anderton

The ultimate MI update, the Summer NAMM show, was held in New Orleans from June 21 through June 24. As usual, there were a bunch of new prod-

## NEW! IMPROVED! THE BEST OF SUMMER NAMM

uct, but most of these were improvements on existing devices. Here are some of the trends I noted; bear in mind, though, that one person can't see everything.

- **The return of the guitar synthesizer.** IVL, a Canadian company whose products are distributed in the USA by Cherry Lane, showed a guitar-to-MIDI converter based on technology similar to that in their "Pitchrider" voice/woodwind-to-MIDI converter. The projected price is under \$1000, which buys you a hex pickup that mounts near the bridge of your guitar and a rack-mount electronics package that provides the MIDI output. Although IVL did not let people test out the thing for themselves, the demo was impressive and the device does seem to track reliably. Ibanez was demoing a prototype guitar-



*Emulator SP-12 by E-mu Systems, Inc.*

to-MIDI interface, and I did have a chance to play this one. Tracking was good, and once the controls were properly adjusted, it felt very natural. Like the IVL (and Roland GR-700 for that matter), the MIDI output is quantized into half-tone steps, which means you lose a fair amount of the expressive-

ness that normally occurs with string-bending. However, Octave-Plateau, best known for their high-end Voyetra keyboard synthesizer, introduced a \$2000 guitar-to-MIDI controller that did allow for pitch bend. Instead of the usual pitch-to-voltage conversion design, this device uses string sensing and

August 1985 issues of *Mix*.) Yamaha introduced a new high-end unit, while Alesis, ART, DOD, and Lexicon all showed their low-cost (under \$1500) reverbs. This looks like the next effect to go through the same downward price spiral that digital delays have gone through in the past decade.



*(above) The Kurzweil 250 Expander and (Above top) the Kurzweil MIDI-BOARD.*

wired frets to produce a virtually glitchless guitar/synth interface. Bass players were not forgotten; Roland showed their G-77B bass synthesizer, which had a separate microprocessor for each string to insure optimum tracking.

- **MIDI's ubiquity.** There were even MIDI guitar amps, by Engl and Peavey. Both allow you to store particular amp settings and recall them via MIDI program change commands. Peavey also had a companion MIDI-output foot-switch for calling up different programs from the amp. And there were MIDI controlled delay lines (Roland, Korg, Yamaha, DeltaLab, et al), lighting controllers (JL Cooper Electronics), wireless MIDI transmitters (LEMI), prototype MIDI fiber optic cables (Samson), and of course, MIDI controlled microwave ovens (just kidding).

- **The coming of age of digital reverbs.** Digital reverbs were the big news in signal processing. (For interesting background information, check out Larry Oppenheimer's articles in the July and

- **Electronic percussion moves from machines to humans.** Rhythm machines are giving way to better electronic drum controllers for "real" drummers. When you think about it, some of the reasons for using rhythm machines have less to do with programming options than convenience—no miking or transportation problems, for example. Electronic drum controllers solve many of those same problems and also give you the advantage of having a human in control. What's more, many of the new drum units (like the Simmons SDS9) have MIDI outputs for controlling a wide variety of sound generating devices. Drum machines were not forgotten, however; E-mu introduced their SP-12, which lists for \$2745. It emphasizes variety of sound via multiple tuning and dynamics options, along with user sampling of up to eight different sounds.

- **The great MIDI sequencer proliferation.** There were MIDI sequencers everywhere; everyone's getting into the act, from one-person software oper-



# M P S

In this confusing new world of music software someone has finally created a computer program that is so powerful that it allows musicians to forget about learning computerese and get back to what they like doing best—music. Only now with more control and creative potential than ever before. Behind this program is the same company responsible for some of the music industry's greatest achievements. The company, of course, is Roland. And the product is called MPS. It stands for the Music Processing System. **What** if a musician could harness the same computer power to create music that writers use in word processing? That's exactly what MPS does. It gives you the creative freedom to develop, edit and shape your ideas into a complete piece of music, all under computer control, totally at your direction. Working together with Roland's MPU-401 intelligent interface, any IBM PC (or compatible) computer and your MIDI instruments, MPS takes you every step of the way from first inspiration to a beautifully realized printed score. **The** MPS system's power is unleashed in its three operating

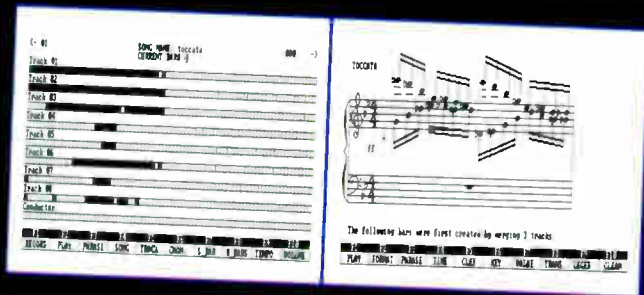

modes: Song, Score and Print. All modes are totally interactive, so that any change made in one is automatically made in the others. In the Song Mode, you assemble musical phrases into complete compositions. Use any MIDI instrument as an input device. Once phrases are entered, they can be altered, edited, combined and recombined at will. MPS Software gives you eight tracks to fill with music. Each track can be assigned to any of 16 MIDI channels and used to drive any MIDI instrument. Merge tracks or phrases as needed and reassign MIDI channels to check out how a passage sounds on different instruments. A clear, concise on-screen display keeps you up to date on track status on a measure-to-measure basis. **The** process continues as you move on to the Score Mode. Here, the music you've created becomes a graphic score, which can be further polished and perfected. You define keys, clefs and time signatures, transpose octaves, assign accidentals and rests...even change the direction of note flags and stems for a highly legible, musically correct score. There are three different areas on the staff to spell out song lyrics, verbal cues and instructions—everything you want to put into words. **When** you've finished perfecting your score, you're ready for the MPS Print Mode. Everything you've put into your on-screen score can be transformed into an attractive hardcopy printout via the MPS Hi-Resolution Print Mode. As always with MPS software, **you're** in control. "Cut and paste" your score to meet your own specific needs. You can print out single parts for individual players or a complete score representing your entire composition. Print copies on your computer's standard printer with or without song lyrics or in any quantity you desire. Break into the future of electronic music production—harness the power of Music Processing with the MPS—the Roland of Music Software. For more information contact: RolandCorp US, 7200 Dominion Circle, Los Angeles, CA 90040 (213) 685-5141. **Hardware** Required: IBM-PC or full compatible (256K minimum, up to 640K), 2 disk drives recommended, IBM color graphics card and CRT monitor, Roland MIF-IPC interface card, Roland MPU-401 MIDI Processing Unit, Any MIDI-equipped Instrument(s), Optional dot matrix graphics printer (IBM compatible).



For more information contact: RolandCorp US, 7200 Dominion Circle, Los Angeles, CA 90040 (213) 685-5141. **Hardware** Required: IBM-PC or full compatible (256K minimum, up to 640K), 2 disk drives recommended, IBM color graphics card and CRT monitor, Roland MIF-IPC interface card, Roland MPU-401 MIDI Processing Unit, Any MIDI-equipped Instrument(s), Optional dot matrix graphics printer (IBM compatible).

Roland Music Software Division  
**MPS**  
 Music Processing System  
 Version No. 1.0

**Roland Music Software**

Circle #086 on Reader Service Card  
 marks: IBM and PC, IBM Corp., Roland and MPS, Roland Corp

## In A/B tests, this tiny condenser microphone equals any world-class professional microphone. Any size, any price.

Compare the Isomax II to any other microphone. Even though it measures only  $5/15"$  x  $5/8"$  and costs just \$189.95,\* it equals any world-class microphone in signal purity.

And Isomax goes where other microphones cannot: Under guitar strings near the bridge, inside drums, inside pianos, clipped to horns and woodwinds, taped to amplifiers (up to 150 dB sound level!). Isomax opens up a whole new world of miking techniques — far too many to mention here. We've prepared information sheets on this subject which we will be happy to send to you free upon request. We'll also send an Isomax brochure with complete specifications.

Call or write today.

\* Pro net price for Omnidirectional, Cardioid, Hypercardioid, and Bidirectional models.



COUNTRYMAN ASSOCIATES INC.  
417 Stanford Ave., Redwood City, CA 94063 • (415) 364-9988  
Canadian Distributor: Gerr Audio, 363 Adelaide Street, Toronto, Ont. M5A 1N3



Circle #087 on Reader Service Card

## Take me to your rack



### Model PL-8 A.C. Power Conditioner and Light Module

Take the PL-8 to the top of your rack and let its eight switched outlets power up your equipment while two slide-out light fixtures provide shadow free illumination for all their controls. But, the PL-8 is more than just a convenient source of light and power. . . .

#### Double Filtered A.C.

The PL-8 protects your electronic equipment while improving its performance by combining a High Voltage Surge and Transient Suppressor with an HF/RFI Interference Filter. This means better signal-to-noise and longer life for all the gear in the rack.

### Features

- Lamps use standard nightlight-type bulbs, available anywhere, and easily replaced without removing the unit from the rack.
- Fast acting Suppression Circuitry responds in nanoseconds, clamping spikes and surges to safe levels.
- HF/RFI Filter works to prevent noise from fluorescent lights, electric motors, and similar sources of "electronic pollution" from leaking from the AC line into the audio.
- Filters only act on noise and transient components, assuring continuous flow of power.
- Eight circuit breaker protected outlets (10 amp max.).

For complete information call or write:

Furman Sound, Inc.  
30 Rich Street  
Greenbrae, CA 94904  
(415) 927-1225

© 1984, Furman Sound, Inc.



Quality. Reliability. Guaranteed!

Circle #088 on Reader Service Card

ations to large companies testing the software waters. In addition to the usual Apple II/Commodore/IBM PC compatible products, many programs now support the Macintosh. Looming over all this were rumors of Commodore's impending introduction of the Amiga computer, whose hype precedes it. But maybe there's something to the hype; I heard that one major software company was phasing out development of all non-Amiga programs, so they certainly must have been impressed enough with the machine to see it as the wave of the future.

Meanwhile, more people are realizing that MIDI sequencers make a great adjunct to multi-track recorders. . . sync up a sequencer to tape, drive some MIDI instruments, and you've got a bunch of "virtual tracks" in addition to the ones recorded on your multi-track. Along with computer add-on sequencers, there were self-contained devices from Yamaha and Korg (2-track) and Casio (4-track).

• **Keyboards:** Plus ça change, plus c'est la meme chose. Yamaha re-packaged their FM technology into the TX7 expander, DX21 "entry level" FM synthesizer, and DX5 (essentially two DX7s in a single package). Kurzweil re-packaged the 250 into a separate MIDI-BOARD controller and 250 rack-mount expander. Oberheim re-packaged the Xpander into the Matrix-6, which features a velocity keyboard and many of the features of the Xpander. Korg re-packaged their DW-6000 with a velocity keyboard and some added features to end up with the DW-8000. Casio re-packaged a couple of CZ-101s, a sequencer, and a bigger keyboard into the CZ-5000. Incidentally, Yamaha's rumored sampling keyboard was not there and its existence denied by company officials.

• **Increasing sophistication of home studio products.** Tascam had a new Portastudio (with such features as dual-speed operation) and the Studio 8, a mixer/8-track recorder package combination that accommodates 7-inch reels of 1/4-inch tape. Fostex had the A Series Model 80 1/4-inch 8-track, which replaces the A-8 for under \$2000, and the 2-track Model 20 with center channel recording for SMPTE or sync. Speaking of SMPTE, Fostex also showed their autolocator and synchronizer, while the Synchronous Technologies booth was locking audio to video with the SMPL Lock add-on for the basic SMPL system.

Of course, there was a lot more at the show, but there's only so much space in the magazine. We'll cover other notable developments as they mature in future editions of "MI Update." ■



# THE PEAVEY CELEBRITY™ SERIES

## Designed to have everything ... except competition.

At Peavey Electronics we're dedicated to our commitment to design and manufacture high performance products at realistic prices. We've underlined that philosophy with our Celebrity Series line of microphones.

The Celebrity Series feature large diameter diaphragm/voice coil structures for increased sensitivity with the ability to handle high sound pressure levels. These higher output levels allow for significantly less mixer gain and are a tremendous aid in maintaining good signal-to-noise ratios.

Perhaps the most important characteristic of any performing microphone is reliability. The design of our cartridge/shock mount system increases ruggedness as well as isolation capability to insure long-term performance under severe field conditions.

Our microphone screen utilizes extremely heavy gauge wire that has been "junction locked". Once the screen is formed, we do not stop there. The heavy wire screen is "fired" in an oven after forming, thus causing the plated wire to "fuse" at all

interconnecting points. The result is an unbelievably durable "brazed" wire windscreen that will hold together under the most severe abuse. After the ball windscreen is formed, brazed and coated, a precision urethane foam pop filter is fitted to minimize the undesirable proximity effects. This special acoustically transparent foam protects the entire sound system by breaking up explosive high SPL pressure waves created by close vocals or close miking



percussion instruments. For those applications requiring even more acoustic screen from wind noise, etc., Peavey offers special external colored wind noise filters that slip over the screen and internal pop filter.

While outwardly, the appearance of the Celebrity Series is somewhat conventional, the aspect of "feel" has been given heavy emphasis since our experience has shown that performers prefer a unit that not only sounds right and looks right, but must also have a comfortable balance, weight, and overall tactile characteristics.

Special "humbucking" coils (models CD-30" & HD-40") have been designed into the microphone element that effectively counterbalance any hum that might be picked up from external sources. Performers who play clubs where hum from light dimmer switches or other sources are a problem can appreciate this unique feature.

We invite comparison of our Celebrity Series with other cardioid microphones. You'll see why we feel that in terms of performance, features, and price, there is no competition.



For a complete catalog featuring the entire line of Peavey sound reinforcement equipment send \$1.00 to Peavey Electronics, Dept. A, 711 A Street, Meridian, MS 39301

Circle #089 on Reader Service Card

©1984



PHOTO: ELIZABETH FENNIMORE

## Billy Cobham's Coming of Age

by Robin Tolleson

Billy Cobham thinks he's learned his lesson. Following on the heels of drummers like Elvin Jones and Tony Williams, Cobham staked new turf with a flamboyant, thrilling, often bombastic style in the early '70s, rapping out hot funk, cool sheets of bop, and punctuating it with awesome single stroke rolls around a giant kit. But things haven't been going exactly as planned for the Panama-born percussionist, from a solo recording career that lost focus and steam in the late '70s and a disappointing stint with Bobby & the Midnites, to a Mahavishnu Orchestra "reunion" that never came to be.

The drummer is back with a new album, *Warning*, and a new attitude at 41 years of age. "I really have to start going out there and supporting myself in my own projects, doing my own thing. There's nothing in it for me to be supportive of anyone who only wants the advancement of his or her own wants and needs, without returning anything," he says. "Plus, I think I have something valid to say as an artist, and I should take that step forward."

Born to a family of instrument-makers, Cobham remembers playing his first timbale at the age of two. His family moved to New York when he was a boy, and William attended the city's High School of Music and Arts, known today as the subject of the *Fame* TV show. Before he was out of high school, Cobham had performed on drums with James Brown, Sam & Dave, Esther Phillips, and the Jazz Samaritans. He joined the Army after graduating, serving in the Military Ocean Terminal Base band, playing for ships coming and going.

Shortly after Cobham got his discharge from the military in 1968, George Benson asked him to play on *Giblet Gravy*. Cobham soon co-founded the group Dreams in New York, and did a couple of records with them for CBS. Larry Coryell called the drummer to play on *Spaces*, and soon Miles Davis took Cobham in to record parts of *Jack Johnson*, *Live Evil*, *Get Up With It* and *Big Fun*. In the spring of '71, Cobham recorded *My Goal's Beyond* with guitarist John McLaughlin, a month later the two formed the Mahavishnu Orchestra along with keyboardist Jan Hammer, violinist Jerry Goodman and bassist Rick Laird. He recorded *The Inner Mounting Flame*, *Birds of Fire*, and *Between Nothingness and Eternity* with

the band before McLaughlin broke it up in Detroit on New Year's Eve '73 following a massive tour.

Cobham had already recorded his first solo album by the breakup, the acclaimed *Spectrum*, which featured the late guitarist Tommy Bolin, Jan Hammer, and bassist Lee Sklar. Drummers were not the only ones who also gobbled up his next efforts, *Crosswinds* and *Total Eclipse*, as the drummer played young Art Blakey, showcasing a hot new horn section of Randy and Mike Brecker and Glenn Ferris, and guitarists John Abercrombie and John Scofield. In 1976 Cobham co-led a band with George Duke that toured Europe and recorded a live album. Stanley Clarke wrote an excellent showcase for the drummer on his *School Days* album that year, "Life Is Just A Game." Cobham's own records began to suffer, both from the vanishing fusion audience and from the leader's lack of musical focus. *Magic*, *Inner Conflicts*, and *B.C.* probably could be condensed to an excellent single record. Cobham also took a crack at producing, working on projects by former E Street Band keyboardist David Sancious, and Pete and Sheila Escovedo.

In 1980, Cobham teamed up with legendary bassist Jack Bruce for a tour and the album *I've Always Wanted To Do This*. "There's the cat," says the drummer, "and he's gotten better as he's gotten older. It would have been good if we could have worked things out to stay together. But it was another one of those situations where you have promise of doing well, it looks like things are going to go, the record looks like it's going to do well. You get paid just enough to want to stay, but not enough to really earn a living. You find yourself deteriorating from the fact that you're doing something you really love, but not getting anything out of it, not even breaking even. That was even more prevalent in Bobby & the Midnites."

You couldn't have dreamed up a more unusual, seemingly polarized musical combination than Bobby & the Midnites. The intrepid Cobham, always straining at the leash, and session jazz-master Alphonso Johnson, with the Grateful Dead's Bob Weir and Brent Mydland, Matthew Kelly and Bobby Cochran. Besides being upset by Weir's lack of rehearsals, Cobham longed for something that he could sink his chops into. He found that with John McLaughlin's 1984 *Mahavishnu* album, but again for the drummer, it was not the



experience he'd hoped for. "I'm very sorry the people were deprived the chance to hear the Mahavishnu Orchestra as the original band again," he says. "Especially ten years after our demise. It's a crime that it didn't happen."

"I think we would have had something very valuable to say. But in order to say that, we would have all had to have contributed as equals, not as the king and his slaves. And unfortunately, that kind of equality was not part of the environment of the person who started the band and the name." Cobham was the only other original Mahavishnu Orchestra member to do the record with McLaughlin, but says he still hasn't heard it. "I was never made privy to any playbacks of it at all. I know nothing about what happened. No one ever sent me a copy, yet I was told I got a 'thank you' for playing on the album, which is rather unique." Cobham says he was never contacted about playing the tour with McLaughlin last year.

"I don't blame the Midnites or Weir or the Mahavishnu thing—it's all been a lot of circumstances as far as the business situation is concerned. So I just decided it's time for me to get out there and do something by myself, with my band. If I'm going to make mistakes, I'm going to make them on my own."

Cobham has been living in Switzerland since 1980. He recorded two records for Elektra Musician in '82-'83 with his group Glass Menagerie. But his new album, *Warning*, is on the smaller, GRP label, run by keyboardist Dave Grusin and drummer Larry Rosen. He likes the atmosphere. "Professional cats," he says. "It's really hip, because you're a part of every step. All of the executive offices are around the recording studio, which is great, because you come out of the mixing room and talk to the head honchos about each session."

The skinsman composed all the material on the instrumental album, which features guitarist Dean Brown (of the Glass Menagerie), Jerry Etkins on keyboards, bassist Baron Brown, and percussionist Sa Davis. Basics on the album were recorded at Spyro Gyra's Bear Tracks studio in Suffern, New York. "It's a real audiophile kind of record," says Cobham. "Lots of stereo spread, done on a PCM Sony 24-track, and we're working on it being the first video-graphics CD."

"It's going with the trend now towards better sounding records, by way of Compact Disc digital audio, which is really where it's all at. For drums, Simmons look out. There's no need to play that stuff anymore. You can play your drum set on the record clear as a bell. And there's a little MIDI-interfaceable unit that turns analog information into digital. You can have any kind of sound treatment you want and still have your

natural-sounding drum set. It means though, you have to know how to play drums. You can't just hit the thing anymore and get a roll. You really have to know how to play a roll, and how long a roll you should play for the situation. Just normal basic rudimentary procedure, which is the way it's supposed to be."

Cobham has done a lot with drum electronics and processing over the years, but eschews all of that on *Warning*. "At first I thought there was some kind of effect on the drum set, because it sounded like *my drums*. I used two Remo doughnuts inside each bass drum—didn't use a moving blanket or a cinder block. I just put an AKG D-12 inside and got the best bass drum sound ever. Blew me totally away." The drummer was also enthusiastic over the sound of his deep Tama snare. "We started to use a Simmons snare to be triggered, but it sounded so good by itself. All this stuff was recorded flat. We used a noise gate, made it cut off. It's a nice effect. Phil Collins does that to a much greater degree."

The drummer hopes to move back to the U.S. soon, live and teach in Southern California, and tour the States with a band of his own. It may be a while before he's a sideman again, where his speed, technique and flash sometimes works against him. He admits he plays a lot, even overplays sometimes.

"It's the way I hear the music, and I know it's going to be a problem," he says. "I don't play to stay in the background. People get upset immediately even from looking at what (kit) I'm playing. I've seen other people playing bigger drum sets, Carl Palmer for one. But it's what you put through the drum set. If you're playing that kind of instrument, then have something to say on it. I would assume that Carl had something to say on his drum set, that's why it was there—he did whatever he had to do with those instruments. Tony Williams has his set up a certain way to do what he has to do. Art Blakey's is smaller. Connie Kay's is even smaller, but they're all effective at what they do."

## Wayne Johnson is Keeping His Day Job

by Joseph Woodward

The Wayne Johnson Trio—a bright and bristling example of the folk-hued, bucolic fusion popularized by Pat Metheny and others—has released three engaging, energetic albums, each on a different small label (*Arrowhead* on Inner City, *Grasshopper* on ITI, and the recent *Everybody's Painting Pictures* on the new Zebra label), and each of which represents a step forward in



musical and interactive cohesion. But despite a core following in Los Angeles and expanding audiences in various pockets around the country, the Trio is only gradually climbing out of the small world of alternative-radio airplay and humble-sized jazz clubs.

Don't start sending canned goods and sympathy cards, though—these musicians are decidedly not in it just for the money. Consider their respective "straight" gigs: drummer Bill Berg spends his days as an animator at Walt Disney, bassist Jimmy "Flim" Johnson has lately become one of LA's most in-demand session players, in addition to backing guitar icon Allan Holdsworth [ed. note: Flim's workload recently made it necessary for him to bow out of the Trio], and Wayne Johnson himself has been earning his way towards a

### THE FAR SIDE

By GARY LARSON



Life on cloud eight

# DID YOU KNOW?

- ★ 1. *The Hollywood Athletic Club built in 1924 was the tallest building in Hollywood and broadcast the first "Emmy Awards" in 1949.*
- ★ 2. *Is one of the three most famous buildings in Hollywood Built by Meyer and Holler, the same architects who designed the Grauman's Chinese and the Egyptian Theaters.*
- ★ 3. *Visited and used by legendary super stars of the Golden Era including the following:*

Douglas Fairbanks  
Mary Pickford  
John Wayne  
Johnny Weismuller  
Bebe Daniels  
Mary Astor  
Ben Blue  
Jack Benny  
Ward Bond  
Jimmy Durante

W.C. Fields  
Paulette Goddard  
Frances X. Bushman  
Groucho Marx  
Cecil B. de Mille  
Tyrone Power  
Ronald Coleman  
Joan Crawford  
Howard Hughes  
Errol Flynn

Mae West  
Cornell Wilde  
Buster Crabbe  
Rudolf Valentino  
John Barrymore  
Edgar Bergen  
Humphrey Bogart  
Walt Disney  
Clark Gable  
John Garfield

Jean Harlow  
Bela Lugosi  
Tom Mix  
Charles Chaplin  
Charles Coburn  
Ed Wynn  
Douglas Fairbanks Sr.  
Gilbert Roland

- ★ 4. *In 1978 became the BERWIN ENTERTAINMENT COMPLEX and is used, leased and visited by today's News Makers, Superstars and people of the 80's.*

1980 Reggae Form  
Chrysalis Records  
Music Connection  
Van Halen  
Fleetwood Mac  
Peter Frampton  
Berlin  
Quarterflash  
Fixx  
L.A. Magazine  
L.A. Times  
Daily News  
Variety  
Hollywood Reporter  
Hollywood Close-up  
Good Morning America  
Entertainment Tonight  
Gallery Talk Show  
Sunday Show  
ABC TV  
KNXT CBS  
KHJ TV  
Woman In Film  
California Motion Picture Council  
Film Advisory Board  
Benson  
Beach Boys  
E.T. Steven Spielberg  
Dallas  
48 Hours  
Filmex

Spinal Tap  
Love Streams  
KZLA Radio  
KEZY Radio  
KFAC Radio  
KABC Radio  
Return Of The Jedi  
Pilm Souls  
Madonna  
Denise Williams  
Motown Records  
American Cancer Society  
National Film Society  
City of Hope  
March of Dimes  
Paul Harris  
The Thallians  
Young Presidents  
Baby-O Recording Studios  
Island Records  
Barbara Gardner & Associates  
John Ferraro  
Sally Field  
Police  
Marvin Kaplan  
Oingo Boingo  
Julio Iglesias  
Pointer Sisters  
Journey  
The Rockettes  
Stevie Wonder

Marvin Gaye  
Muhammed Ali  
Frankie Goes to Hollywood  
George Barris  
March Fong Eu  
Mayor Bradley  
Peggy Stevenson  
Pentax  
Alice Cooper  
Lakeside  
L.A. Olympic Organizing Committee  
Greater L.A. Visitors Bureau  
L.A. Library Association  
ABC Catholic Committee  
Hollywood Chamber  
Jose Feliciano  
Ed Asner  
Mike Farrell  
Bonnie Raitt  
Teena Marie  
John Casavettes  
Honey Garcia  
Rodney Dangerfield  
Ford  
Taco Bell  
Ben Hogan  
Dorritos  
IBM  
Hunt Wesson  
Coast Federal  
Jane Fonda

Iasuzu  
Kodak  
Kellogg  
Trans America  
Northwest Bank  
Toshiba  
Inglenook Wine  
Honda  
Disney Studios  
Great Western  
Sean Connery  
McDonalds  
Yamaha  
Wrangler  
Kawasaki  
Sho Gun  
Mel Brooks  
The Cars  
George Lucas  
Star Wars  
Sony  
7-Up  
Pepsi  
Dick Van Dyke  
E.G. Marshal  
Patty La Belle  
Gov. Jerry Brown  
Rockwell  
The Jacksons  
Jon Reiner  
Ed Begley Jr.

Shelley Duvall  
Karen Black  
Johnny Rivers  
Terri Garr  
Pam Dawber  
Roddy McDowell  
Howie Mandel  
Dick Shawn  
Jean Stapleton  
Herve Villechaise  
Fred Willard  
Buck Henry  
Harry Hamlin  
Laura Johnson  
Rex Smith  
Jamie Ball  
Beverly D'Angelo  
Glenn Frey  
The Doors  
Art Laboe  
Bill Gazzari  
Bobby Hoffman  
William Shallert  
Will Greer Singers  
Peter Yarrow  
Gene Kelly  
Paul Newman  
Walter Matthau  
Lily Tomlin  
Jon Volght  
Henry Fonda

- ★ 5. *Did you know the BERWIN ENTERTAINMENT COMPLEX has the most reasonable rates in Hollywood today?*

## NOW LEASING OFFICE SPACE

*Best location in Hollywood. Prestigious landmark building.  
Good Parking. 24-hour security.  
Unique Tower Suites and Beautiful Garden Suites*

Great for: Film Locations • Private Parties • Weddings  
• Luncheons • Meetings • Fund Raisers • Special Events

**BERWIN ENTERTAINMENT COMPLEX • 6525 SUNSET BOULEVARD**  
Circle #090 on Reader Service Card



**CALL (213) 464-0700**



gold watch as the guitar mainstay for Manhattan Transfer.

While Johnson obviously prefers the avenues of self-expression provided by his own project, he appreciates the versatility of the Transfer. "In a given two-hour concert, I'll play straight-ahead chunka-chunk rhythm on an old bebop tune," Johnson explains, "then play '50s rock and roll, and then something contemporary. In the band solo, we play Chick Corea-type fusion tunes by [keyboardist] Tom Kellogg. It's a real challenge to do all of that well. It keeps me intrigued with the gig."

Much of the Wayne Johnson Trio's material is deceptively simple—harmonically conventional, melodically infectious, free of the more deliberate intricacies bred in the jazz-rock stratosphere, but with fine-tuned dynamics, textural twists, and myriad rhythmic punches. The inherent spaciousness of this music—the balance of structure and openness—is best served in a live setting, where it's possible to explore and expand upon ideas without the time constraints of vinyl. "Our live playing involves communicating real well together," Johnson allows. "But as much as you capture that in the studio, you can only do it to a certain extent, after which it's overplaying."

For all its billowing vigor, *Grasshopper* had an intentionally loose feel on the whole. *Everybody's Painting Pictures*, on the other hand, is a tighter and more diverse affair, with nine—count 'em, *nine*—cuts and a stronger compositional glue than its predecessors. The title cut is a model of organization, building from a soft and waltzy chordal passage to a strident climax complete with a vocal chorus intoning the syllables of the title like a peppy mantra.

The Trio's accessible meld of sonorities has frequently been compared to the Pat Metheny sound, especially in Johnson's warm yet ringing guitar tone and elements such as bouncing triadic motifs more evocative of the Heartland than of Harlem. The similarity is not so much a case of Johnson aping Metheny as it is a common musical denominator: both guitarists studied at the Berkeley College of Music and were heavily influenced by vibist Gary Burton.

Burton helped to jury a jazz competition in Johnson's hometown of Spokane, Washington. The young guitarist made a strong enough impression that Burton advised him to apply to Berklee. There, Johnson studied with guitarist Mick Goodrick (like Pat Metheny, an alumnus of Burton's group), and he also learned a great deal from Burton himself. "He has a thorough background in jazz and harmony, of course," Johnson says of Burton, "but he tends to have a country flavor because he's a Midwesterner."

# MIX WORDS

©1985 Armand E. St. Martin

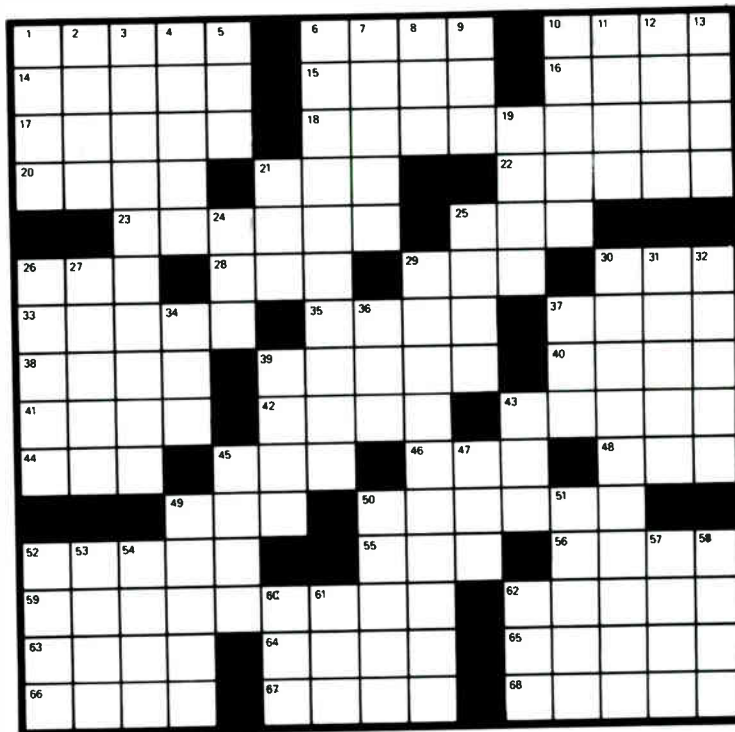

## PROGRESSION PROCESSION

### ACROSS

1. Cavalry sword
6. "\_\_\_\_\_ Ladder to the Moon," Jack Bruce tune.
10. Paint layer
14. "Green \_\_\_\_\_"
15. Having to do with an historical period
16. "Alice's Restaurant" writer
17. Griddle-cooked wheat cake (Brit)
18. Adjust recording equipment
20. Piece of vital info
21. "Le Jazz \_\_\_\_\_" ('30s)
22. Reference book
23. Sedate, decorous
25. \_\_\_\_\_ de France
26. \_\_\_\_\_ Watson
28. Jan \_\_\_\_\_ Dean
29. 45 or 33
30. Welcome \_\_\_\_\_
33. Reduce
35. Words of understanding
37. Regulation
38. Front end of an F-18
39. Varnish producing resin
40. Many
41. Jobs program under Carter
42. Taj Mahal site
43. Say
44. Type of curve
45. Post Classics IV band (Abbr.)
46. Err
48. "Love \_\_\_\_\_ Rose," Ronstadt hit
49. Raw material
50. Rigorously scrupulous
52. Hobby wood
55. Links accessory
56. War god
59. Device for emphasizing or de-emphasizing frequencies
62. Keeping up
63. Vocalized
64. Simple, utter
65. Famed record label
66. Type of herb or advice
67. Hang
68. Glacial run-off ridge

### DOWN

1. Back-talk
2. Bookkeeper
3. Airings
4. French income
5. Compass pt.
6. Tapes and disks, often

7. Speak
8. "\_\_\_\_\_ Joey"
9. Yalie
10. A la \_\_\_\_\_
11. Type of tradition
12. Canadian prov.
13. Certain digits
19. Aromatic ointment
21. Asian invader
24. Ms. West
25. Fencing need
26. "\_\_\_\_\_ With Me," Orleans hit
27. Reed instruments
29. Made the acetate again
30. Type of recorder
31. Century plants
32. Tropical fish
34. Word with bag or pot
36. Gawain or Lancelot
37. Stoolie
39. Swiss river
43. Prefix with verse or cycle
45. Russian range
47. Madden
49. Orange type
50. Hinder part
51. Cod and Good Hope
52. Porgy's girl
53. Water (prefix)
54. Respiratory organ
57. "\_\_\_\_\_ Homo!"
58. Scorch
60. Pixie
61. Tappan
62. King Sunny \_\_\_\_\_

### Solution to August Mix Words

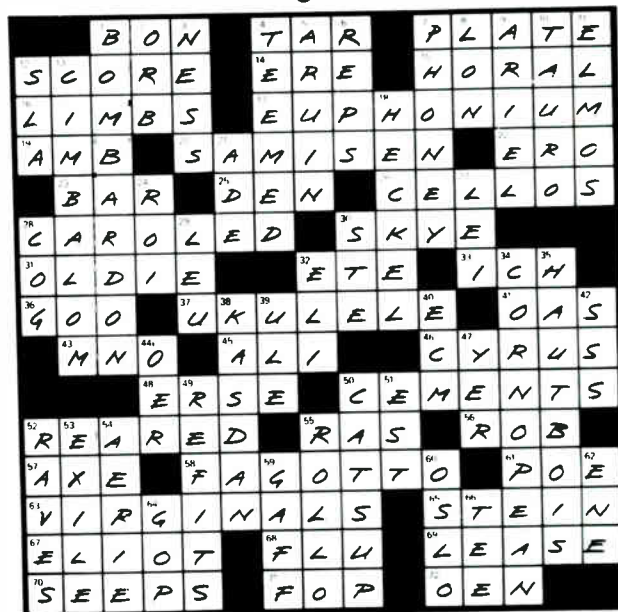

Being around a keyboard helped Johnson escape many of the guitaristic cliches to which six-stringers often fall prey. "I'm not looking at positions and fingerings and strings—I'm looking at my guitar more like a keyboard," he says. "That gets you away from that ladder playing you hear all the time. Playing horizontally, you tend to play more lyrically..."

After two years at Berklee, Johnson headed for Minnesota, where he linked up with Berg and Jimmy Johnson. Around that time (in 1976), Johnson passed an audition with the Transfer—and he's been enjoying a double life ever since. Whereas Manhattan Transfer is a structured gig, the Wayne Johnson Trio operates on a much freer basis.

"It's important to throw out the rules," Johnson comments. "Learn them, digest them, and then file them away in your subconscious. When you're talking about being an artist, you're talking about creating something—and to have to rely on rules doesn't make sense to me."

Musical roles are often reversed in the Trio, with Johnson laying down rhythm parts while drummer Berg splashes impressionistically with a Tony Williams-like ebullience. "Bill's a scary creature," says Johnson, "because he never practices. He just plays with the Trio. The hardest thing for him to do is play consciously and do something the same way every time. That's the hardest thing for me, too, because then you have to *be* there. I like *not* being there."

Determined to make the most of a trio format without resorting to bombastic space-filling techniques, Johnson has amassed an array of effects that he uses tastefully along with a customized double-neck guitar and a pair of Roland JC120 amps. At the core are four MXR digital delays, each at a different setting, used in conjunction with a digital reverb and a pitch transposer (which he likes to set an octave above incoming signal) routed through a delay to create the call-and-response effect heard in "Glis" on the new album.

Johnson's guitar, made of solid mahogany ("It's pretty heavy—I have to do shoulder exercises to be able to hoist the thing") was built by luthier Dudley Gimble along the lines of Johnson's '59 Gibson ES-335. One crucial difference is the placement of the 12-string neck in the lower position. Johnson uses it mostly for sporadic dashes of harmonics. "I started using harmonics in some of the guitaristic keys, and I thought, 'If I could just turn around and go *ching*...' I wanted it to sound like an autoharp or a harpsichord."

Johnson has also recently joined the synthesizer generation with a Roland GR700 (which he uses sparingly), and plans to MIDIify soon. He's wary of technological doublespeak, though. "It's like getting sucked in. I could play a great flute sound, and the fact that it's played on a guitar would be novel, but that's not enough to warrant doing it. That's like saying we can justify blowing up the Earth because we've made it possible. It's bass-ackwards."

Analyzing his musical persona, Johnson points to the circumstances of his education, particularly the Burton Factor: "If I had had a different teacher at Berklee, if I had had the skills to play great bebop, I would probably have gone in that direction. I still have that attitude. There are times in a piece where that certain emotion comes about and you've just got to tear it up. Any way you can is viable, whether it's playing technically complex lines or beating your guitar—which I love to do."

## The Flying Pickets: A Cappella Antics Across the Atlantic

by Bill Milkowski

Picture Monty Python jamming with The Persuasions. That might give you some idea of what the Flying Pickets are up to.

These six wacky Brits have been winning converts in London and throughout England and Australia with their clever *a cappella* renditions of classic

## Puzzled by Audio/Video/MIDI Sync Lock? It's SMPL™

Yesterday it took lots of money and hassle to implement a truly contemporary Audio for Video Studio.

You needed a box to lock a Video transport to the Audio. And boxes to autolocate the Audio and Video transports. And a box to lock and locate the "virtual" MIDI tracks. And more boxes to convert the sync your sequencer likes to the kind your drum set favors.

And an Engineering Degree to tie it all together and work it, and a very friendly banker to help pay for it.

But, today, Sync Tech's SMPL System performs all of these functions and MORE. In one easy to use, low cost package you get a complete Audio editing, Video lock-up, Instrument syncing system that includes:

- Two machine (Audio or Video) Sync Lock
- 10 point autolocator for both transports.
- MIDI Sync/Autolocate
- 24, 48, 96 Tick/Beat instrument sync
- Automatic Punch In/Out
- DF, NDF, 25 F/S, 24 F/S SMPTE Time Code Generator
- 8 programmable EVENT gates
- Transport remote controls

Best of all, the SMPL System is for real — no "gotchas". Works with equipment from every major manufacturer from inexpensive Portable Studios to 2" transports, even consumer quality VCRs.

For more information and the name of the nearest dealer who can SMPLify your life, call or write:

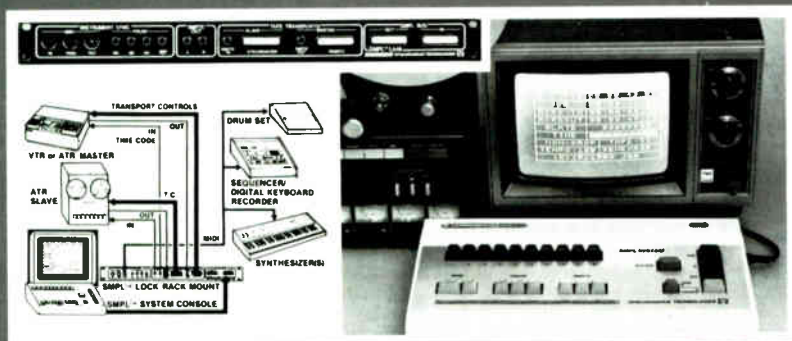

**SYNCHRONOUS TECHNOLOGIES**  
P.O. Box 14467 • 1020 W. Wilshire Blvd. • Okla. City, OK 73113 • (405) 842-0680

Circle #091 on Reader Service Card



pop fare. Their debut album, *Lost Boys* (on Virgin/10 Records), includes such hits as Marvin Gaye's "I Heard It Through the Grapevine," Smokey Robinson's "The Tears of a Clown," Dylan's "Masters of War," and Bruce Springsteen's "Factory." Perhaps the most inspired piece of the album is a cover of the Talking Heads classic, "Psycho Killer."

One of the co-authors of "Psycho Killer," Talking Heads bassist Tina Weymouth, was in attendance at one of the Pickets' rare New York appearances. She stood wide-eyed and grinning as the sextet sang, and when they struck fierce poses to sing the ominous line, "Don't touch me, I'm a real live wire," she couldn't help but laugh out loud.

Humor is a central part of the Pickets' stage show. As the clean-headed Picket, Red Stripe, explains, they come by their theatricality quite naturally: all six Pickets are accomplished actors. "We had all been around for a few years, acting and singing in plays," he says. "At one point we all got cast in the same production, a musical about miners. There were no instruments, just the six of us singing. We toured around in that play for two years, and driving to and from gigs we'd sit in the back of the van and sing together just to amuse ourselves."

They started off singing their favorite songs from the '50s and '60s, with an emphasis on Tamla/Motown, an interest common among the six. Gareth Williams gravitated toward the bass end, while Stripe, Rick Lloyd, Ken Gregson, Brian Hibbard, and David Brett shifted comfortably among the tenor, alto and falsetto roles. "We tend to change around quite a lot," says Stripe. "We don't have a single lead vocalist, and none of us has had any voice training—we just sing, ya know? That contributes to our uniqueness."

Some of the Pickets' earliest gigs were in pubs around London's East End. "We'd often do three gigs a night," Stripe recalls. "We'd travel between pubs on bicycles and sing behind the bar with customers on the other side watching and drinking. And, of course, we had no gear to tote around—not even microphones—which made things easier for us. We just sang as you would sing on a street corner."

That was back in 1981. Since then, due to their popularity in London, they've been showcased in 3,000-seat theaters around England and Australia—and now they use microphones.

During their formative years, the Pickets were quite unaware of the American doo-wop tradition and street-corner practitioners such as the Persuasions and 14 Karat Soul. "We didn't even know that what we were doing was called a *cappella* until we had

been at it for about six months," says Stripe.

The rise of the Flying Pickets has spawned a whole *a cappella* singing movement in England. "A lot of bands like us are coming up now in London," says Stripe, "and not just men, either. There's a group called Fat Lips, and another called the Mint Juleps, both women *a cappella* bands. It's really quite interesting, because this movement grew in complete ignorance of the American, particularly New York, tradition of a *cappella* singing."

The Flying Pickets make no attempt to imitate the vocal stylings of black *a cappella* groups. Their version of "Tears of a Clown" doesn't even follow Smokey's soulful lead, and their rendition of Leiber and Stoller's "Shopping for Clothes" steers clear of the jive-talking approach Rickie Lee Jones emulates in her version. Instead, the Pickets remain true to themselves and render the tune in the British equivalent of jive: Cockney.

"We can't do what American black bands do, and we wouldn't want to imitate them," Stripe asserts. "We're trying to find our own style, which is why we're also interested in covering more modern stuff like 'Psycho Killer.' We just released a single of Eurythmics' 'Who's That Girl?' And we're also interested in the relationship between synthesizers and the human voice... how the human voice can accurately recreate electronic sounds."

Stripe says one big difference between the Flying Pickets and American *a cappella* groups is their attitude toward the material. "We appreciate the form of the song 'You've Lost That Lovin' Feeling'—it's a classic, you could not do better—but the sentiments behind it, as with a lot of American popular music, are dubious. They're founded on romantic myths about relationships. A lot of American rock and roll is really sexist in tone. We adopt a fairly critical and ironic stance toward the lyrics, meanwhile appreciating the genius of the arrangements and composition." Which is where all the on-stage mugging and Pythonesque schtick comes in.

Although the music of the Flying Pickets has yet to make a big splash Stateside (the album is still only available as an import here), Yank audiences will get a chance to experience their *a cappella* antics firsthand when the group tours America this fall. ■

In this issue:  
Bonzai meets Zappa!  
See page 40.

## SOUND SYSTEM

# BUZZ

ITS TOO BAD YOU  
CANT ALWAYS KEEP IT CLEAN

BUT NOW  
ITS ONLY TEMPORARY  
INTERFERENCE WITH  
A  
**MODEL PS-1**



In addition to reducing RFI the PS 1 can also protect your sound reinforcement equipment from:

HIGH VOLTAGE TRANSIENTS  
UNEXPECTED POWER UP TRANSIENTS  
IMPROPER LINE POLARITY



linear & digital  
systems, inc.

46 marco lane  
centerville, oh.45459

Circle #092 on Reader Service Card



DeCUIR  
SAMPLE CASE  
COMPANY

LOS ANGELES, CALIFORNIA  
"EXCELLENCE WITHOUT EQUAL"

Your only source for the finest in sound enclosures for P.A. systems, amp racks, monitors and speaker cabinets when quality and affordability counts. All solid core plywood construction with premium carpet covering for a rugged performance. Most models come complete with fiberglass, phonejacks and recessed handles. Completely constructed and assembled in the U.S.A. A complete line of guitar and band instrument cases are also available.



WHOLESALE & DEALERS ONLY

DeCuir Sample Case Company  
4012 So. Broadway Pl.  
Los Angeles, CA 90037  
Tel. (213) 233-4184

Circle #093 on Reader Service Card

## WOODSTOCK REMASTERED

# HALF A MILLION DRIPPING HIPPIES LIKE YOU'VE NEVER HEARD THEM BEFORE!

by Glenn Lambert

Woodstock! Three days of Peace, Love, and Music!

Yeah, for the audience, maybe. For the recording team at the 1969 mega-concert, it was more like three days of hum, feedback, and threatened electrocution as they struggled through 18-hour sessions in monsoon weather.

When the last brown puddle and the last unfortunate consumer of the brown acid were long gone—and when the engineers blearily emerged from months in the studio—out came the famous *Woodstock* album. Three disks, parts of which had sound as muddy as Max Yasgur's pastures. The *Woodstock Two* album followed a couple of years later, for a total ten sides of varying performance and audio quality.

Eric Blackstead, the producer, felt compelled to put a disclaimer on the back of the *Woodstock* album: "Technical flaws, resulting from equipment failure as well as human overload, are inevitable in a venture of this size... Consider them like the scars in fine leather, proof of the origin and authenticity of the material in which they are found."

Cut to 15 years later: Chatsworth, California, home of Mobile Fidelity Sound Labs. Mobile Fidelity, well known for their audiophile remasterings, has just released a limited edition boxed set of all of the *Woodstock* material, in both half-speed mastered analog and CD formats.

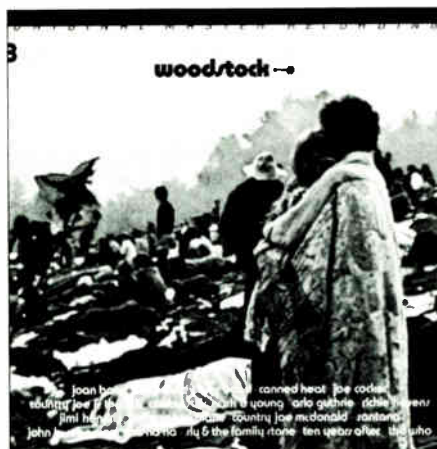

Why would a company known for impeccable sound quality release such questionable material? We slogged through the smog to Chatsworth to find out.

We found Mobile Fidelity in a building sporting a "For Rent" sign out front. [Shortly after our visit, the company announced its move from Los Angeles, mecca of the recording industry, to Petaluma, California, mecca of the egg-laying industry.]

Mobile Fidelity got its start, and name, in 1977, with Brad Miller recording train sounds on his portable Uher. Miller enlisted engineer Stan Ricker, who'd been involved with half-speed mastering since the days of CD-4, and began releasing product as demo records for hi-fi salons. When consumers insisted on buying the albums along with their component systems, he saw

he had a good thing going.

So Miller approached record companies in search of licensing agreements. Since ABC starts the alphabet, he contacted them first. Herb Belkin, at that time executive VP at ABC, was impressed—so impressed that he licensed Mobile Fidelity its first product in 1978. Shortly after, ABC bit the dust and Belkin came to work for Mobile Fidelity, ultimately taking over when Brad Miller sold out.

The company's first breakout success was the 1979 remastering of Pink Floyd's *Dark Side of the Moon*, which easily sold out its 200,000-copy limited edition. Since then, Mobile Fidelity has built a business selling mostly through consumer electronics stores, with the balance of sales through record retailers and upper-crust direct mail marketers such as Neiman-Marcus. The combination of excellent material—such as their boxed Beatles, Rolling Stones, and Sinatra collections—with the collectibility factor of limited editions has given the company a solid niche in the marketplace.

Then came CD, and a crisis for Mobile Fidelity. Record executives cooled on licensing to Mobile Fidelity, instead seeing the new technology as a way to control the high-end market themselves.

"The record companies were perceiving Compact Discs as an end-all and a be-all," Herb Belkin says. "There was not in their minds a quality differentiation between what they could do and what we could do, which meant that



ATTEND \_\_\_\_\_

# CHICAGO MUSIC EXPO

Presented by *KBA Enterprises, Inc.*

Sponsored by

**FLANNER'S  
PRO AUDIO, INC.**

Serving The Recording & Broadcast Industries.

**CHICAGO • HOTEL CONTINENTAL  
SEPT. 20 • 21 • 22**

a three-day showcase of the midwest music industry featuring nationally-known speakers and seminars led by experts in the music industry. Come and share their expertise!

- **Pro-audio gear:** see and buy the latest equipment
- **Independent labels:** find distributors
- **Recording studios:** generate new clients
- **Music business entrepreneurs:** build your own company
- **Talent showcases:** hear all styles and media
- **Agents and managers:** broaden your contacts

Call or write:

**CHICAGO MUSIC EXPO**

110 Schiller, Suite 205  
Elmhurst, IL 60126

**312-279-8323**

To showcase your band  
contact Lynnette Fuerst  
312-279-8384



Seminars by  
**naras** and  
NATIONAL ACADEMY OF RECORDING ARTS AND SCIENCES



**CENTER  
FOR  
MUSIC  
BUSINESS  
STUDIES**

"Finding your  
place in the  
music business."

**279-8323**

Circle #094 on Reader Service Card

our licensing rights were going to be somewhat limited."

Mobile Fidelity responded in two ways. First, by going after older recordings which the record companies weren't so interested in re-releasing on CD; and second, joining the game by getting into CD technology themselves, starting in 1983.

"We still remain unconvinced that—with the proper care and treatment—the Compact Disc is superior to a high-

who supervised the Woodstock remastering and who worked on the original film and record versions, shares Belkin's reservations about CDs. "Because it's digital, it has its own set of inherent problems. Namely, what a lot of people call 'the digital tizzies,' some kind of a grainy or strained top end."

Is that because the sampling rate isn't fast enough? "That's my personal opinion," says Hunt. "It doesn't give you enough useful bandwidth.

**“W**e probably perceive ourselves at times as taking a sow's ear and turning it into a silk purse. I would have to confess to you that [with *Woodstock*] if we attained the level of a satin purse, we're real happy.

quality vinyl pressing, especially in older analog recordings," Belkin says.

"Let's put it this way," he goes on. "There is a tremendous amount of difficulty to take an older, problematic, analog recording and bring it up to the standards that digital requires without magnifying the inefficiencies, the areas of difficulty with analog. That's our specialty now."

Belkin saw a *Woodstock* remastering as a way to demonstrate Mobile Fidelity's expertise in both the analog and digital technologies. "We all knew that it would be an undertaking that no record company would take the effort to do, because it is a hellacious recording," he says. "I mean, it was the first live remote outdoors—a real difficult situation," he says.

"We had gained a year of experience working with our overshoot and ringing device and the other A-to-D circuits that we had developed. So we said, we have taken chances in the past, let's take a chance and do it.

"What we set out to do was to demonstrate that you could A-B this thing and there would be very little difference. It was a challenge to bring it to digital, and also at the same time to take it and use our best efforts to make the analog sound comparatively the same as the digital."

Mobile Fidelity engineer Jack Hunt,

"The digital system has a brick wall filter at 20 kilohertz in order to keep out of the way of the sampling rate at 44.1 kHz. There's what they call the Nyquist area, which is half of the sampling rate. You're in all kinds of deep trouble if a signal of that frequency gets through. So they cut it off at 20, safely below there.

"It affects the sound," Hunt says. "You miss something. In my opinion, digital was introduced too soon. It was done to help boost an ill industry. I believe that some day it's going to be an extremely formidable medium, but I don't think it's there yet.

"So we're trying to work within the parameters of the system and make it sound as musical as possible. That's our whole philosophy."

Mobile Fidelity's director of R&D, Greg Schnitzer, attacked the "digital tizzies" with hardware. "We looked at a square wave through the digital system, and it's pretty hellacious the way it goes through and comes out," Hunt explains. "If you can get a piece of electronics to pass a very good square wave, so that it looks like a square wave coming out, it's going to have a very musical sound. So we addressed that problem and solved it. Our CDs sound different than everybody else's, 'cause we have a black box."

It's touted to clients as the "detail processor," but in-house it's just "the

black box"—which it literally is, with three wires and four cannon plugs coming out of the back, and "just some tuning and stuff" on the front, says Hunt as he waves it around too fast to let us see what anything is before returning it to its hidden spot.

"The sound goes in, and it comes out," he elucidates. "This is ahead of the PCM processor. What it does is undo what a square wave looks like, so when a square wave comes out, after going through this box, through the processor, it looks like... a square wave. The technology is very proprietary." Clear?

On the other end of the CD process, Mobile Fidelity is using the "HR" process of coating the disks with an acrylic resin to protect against wear and warping. *Woodstock* is the first large-scale release by an American company with the process.

Reworking *Woodstock*, both for CD and analog, involved a special set of problems. Mobile Fidelity does all its remastering from the original 2-track masters. "We're really borrowing something and, if we're successful, improving on it as it is—Ours is not to tamper," Herb Belkin says. So any shortcomings of the original mixed master would still be there.

Jack Hunt outlined some of the history. "Given the difficulties under which they were working, it was a brilliant piece of work. If it had been one band doing a concert tour, or something like that, and they had a crew that was going along with them to record it and film it, then it's not very good. But given that kind of historical event, with that number of people, and dealing with what they had to deal with, it was absolutely brilliant.

"They were all 8-track tapes. There were the usual problems: hums and snaps, reverse phase, and all kinds of things on those multi-tracks. Actually, only six tracks were involved with music. There was one track used as a guard band, and the eighth track had a sync pulse for the film. Not a SMPTE track—it was just a 60-cycle pulse that all of the cameras were run off when they were shooting the acts on stage," Hunt recalls.

For the original movie soundtrack remix, the engineers had to do an 8-track to 8-track dub of every bit of the three days of material, using every trick in the book. "Filtering, equalization, trying to notch out the hums, and so on," Hunt says. "We couldn't do any editing, because of the sync pulse. They had to wait, if they were going to do any kind of fine editing of trying to remove ticks and stuff, until it was transferred to magnetic film.

"The record release went back to the original 8-tracks, and was a whole sepa-



rate mix. Fortunately, having been through it once to clean it up for the film, you had an idea of where some of the problems lay, so it made it a little bit easier.

"I remember there was a hysterical number of 8-track reels of tape. Sixty or 70, something like that," he says. "On New Year's Eve before the film was released, I was invited up to the editing suite and I saw an eight-hour film of Woodstock that was phenomenal. They laid out a huge buffet, and we went in there and just watched Woodstock for eight hours."

Altogether, Hunt devoted over six months, full-time, to remixing the *Woodstock* material. He thought he'd seen the end of it, until last year when he learned of Mobile Fidelity's plans at a staff meeting.

"The tapes appeared. I have a unique way of putting album masters together, and I can recognize my own work: the way I mark the tape, the edits—and I saw this stuff going by, and then I heard some of my own slates, and I said 'My God, my past is coming back to haunt me! I can't get away from it!' Hunt laughs.

"From a cutting standpoint, I had never dealt with them, so it was all fresh to me," he continues, "and it had been

so many years that I had totally forgotten about the project. Then as I got into the tapes, little thoughts started coming back about the problems I had had and the things I was thinking about at the time. I spent about three weeks solid working those sides up to cut.

"It was a fun challenge to see what I could do with it, because the tapes had been put away for so many years. There was a lot of work that needed to be done in cutting.

"When they did the original cutting, they made what they called an EQed lathe copy, and all future lacquers were cut off the EQed copy. That way you could just put it up and cut it flat, cut it straight, and everything was taken care of. We will not work from a copy; we work from nothing but the original 2-track masters. So every part that I cut, I had to go through every one of those changes and steps. I have quite copious notes on the cutting—azimuth adjustments, level, EQ changes, again trying to match the levels," Hunt says.

Of course, there were some hums and other imperfections that were just too deeply imbedded in the music to be taken care of. "But they were the type of thing that you just couldn't do anything about," says Hunt. "It would affect the music so much that you had to let it go.

"There were a lot of telexes back and forth between myself and Japan,"—where JVC presses all of Mobile Fidelity's product—"because they check all the mothers. They would say 'strange noise at this point!' and I would send a telex back, 'that noise is on the tape.'"

Even so, the result (based on comparison with the analog version) is remarkable. As usual for Mobile Fidelity, the quality of the pressing is superb, with absolutely no surface noise to be heard. The audio quality is less than perfect, but the improvement is clear, with much more presence and dynamic range. As my brother, who took a mud bath at the original festival, remarked, "You can almost smell the cow shit." Now, if only Mobile Fidelity could do something about Roger Daltrey's horrible singing on "See me, feel me..."

"We probably perceive ourselves at times as taking a sow's ear and turning it into a silk purse," Herb Belkin sums up. Of the *Woodstock* recordings, he says, "I would have to confess to you that if we attained the level of a satin purse, we're real happy. There's no way outside of alchemy that we could have attained silk status. And I think that we probably did come close to satin. So we accomplished what we set out to accomplish." ■

## Give Your Staff an Extra Pair of Hands

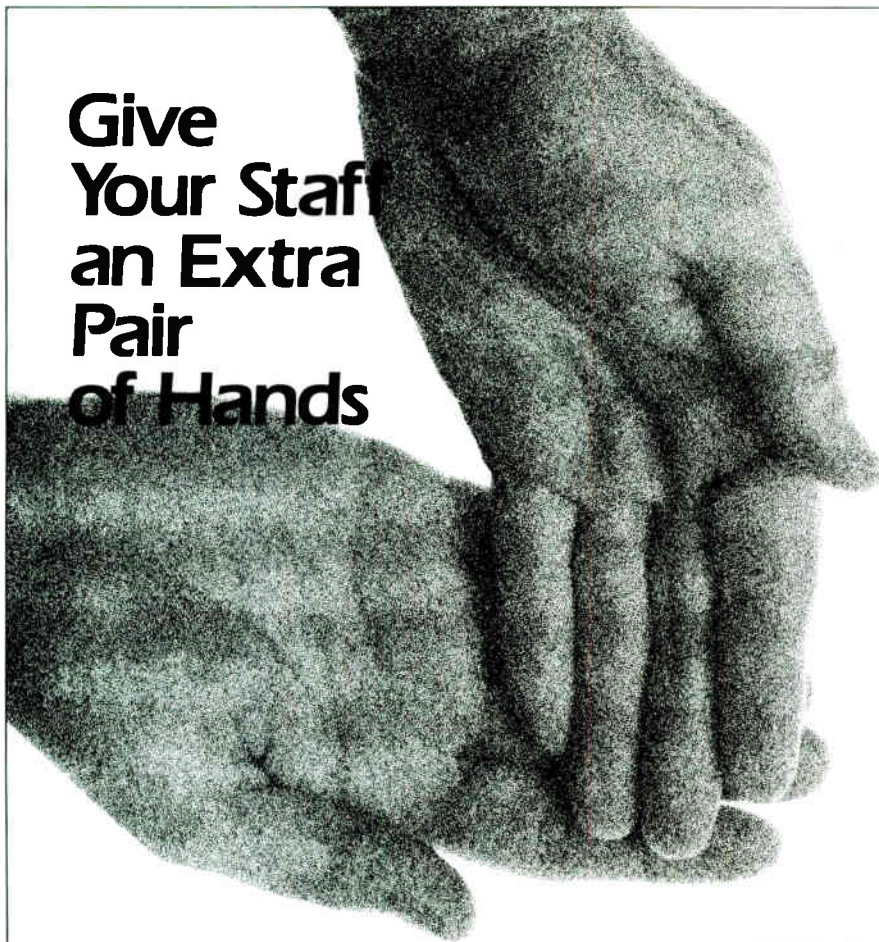

The new communications media can give demonstrations of your products or a procedure and allow customers and clients to learn at their own pace—and without using a great deal of staff time. Eye-care specialists use them to teach patients how to insert and remove contact lenses. Dentists use them to illustrate how to clean teeth properly. Retail outlets and stores use them to demonstrate the use of products such as cooking equipment and handy-man items.

*Let us help give your staff that extra pair of hands.!*



Circle #095 on Reader Service Card



# VIDEO NEWS

After an initial burst of outrage, music-video programmers at independent TV stations and clubs are meekly submitting to a CBS pay-for-

by Mia Amato

## PAY FOR PLAY ROUND 2

play contract that demands a monthly fee for use of its videos.

TV stations using clips cried "unfair" in the summertime upon being asked to shell out several hundred to several thousand a month (exact fee based on market size) for "second-hand" merchandise, as the MTV exclusivity deal with CBS keeps the hottest clips out of the market for months at a time. Most

programmers signed up; some dropped all CBS artists from their playlists.

The UHF TV stations that play 24-hour clips are reluctant to speak out at all, perhaps less afraid of upsetting record company suppliers than broadcasting their timidity. "Please understand where we are," said one programming VP at a struggling UHF. "We've got problems enough getting advertisers, with the FCC, and getting a must-carry status on cable systems. Six months from now, maybe we can take them to the mat on this, but for now, the last thing I need is to be embroiled in a controversy."

As the source of formerly free music programming dries up, programmers have become more innovative. *Telegenic's* club pool has come up with I.P.M.—Images Per Minute—compilation reels of public domain material and private reels, tightly edited to a

rhythm track concocted by *Steve Blackwell* of *Private Eyes*. Each half-hour tape has a different beats-per-minute; club DJs can use them as visuals for popular tunes they don't have the video for. The images are choice, crisp and clear, and provide a viable alternative to bootlegging tapes.

### Computers: A Bright Idea

*Source Point Design*, whose lighting credits include the *Madonna* "Virgin Tour," *Jacksons* "Victory Tour" and video clips for the *Police*, *Joan Jett*, and *Hank Williams, Jr.*, are making available a computer-aided drafting instrument to plot stage and TV lighting. "AutoCAD" and "Instaplot" work with a personal computer so drawings of any size can be created, edited via mouse, drawing tablet or menu, and stored on a floppy disk, then plotted to any size required. For more information, con-

### SMPTE STEREO FOR TV SEMINAR

At a recent stereo television seminar, held by the Society of Motion Picture and Television Engineers (SMPTE) at Norris Cinema Theatre on the University of Southern California campus, the various problems and opportunities that stereo transmission affords were addressed by a panel of experts who shared their experiences with multi-channel production and transmission. The theme of the seminar, "A Whole Different Ballgame" was quite appropriate considering the expensive changes in hardware and design that stereo broadcasting requires.

Among the highlights of the program, Peter Butt of NBC presented a number of computer generated models (utilizing a program designed by Jensen Transformers) of the comparative performance of the matrix (L+R/L-R) and discrete systems of stereo recording. According to Butt, stereo localization problems and high frequency comb filtering plague the matrix system, and these anomalies are further frustrated by level fluctuations inherent in the recording medium and imperfections in one-inch C-format video recorders. Butt's findings have resulted in

NBC's recent decision to use the discrete method to distribute programming to its affiliates. Butt summarized, "There is no perfect system. You can just minimize the damage. . . I feel the damage to the stereo pair using a matrix transmission system is much more difficult to control and much more severe than it is for a discrete, stereo, left plus right transmission system, given the same types of degradation (which ordinarily occur)."

Tom Holman, of Lucasfilm, presented the results of tests made by contrasting 3-track mag film and C-format one-inch video which show that when making film to tape transfers, engineers have to be cognizant of the wider dynamic range of mag film, which can saturate video tape.

The afternoon session dealt with editing, post-production, conversion of existing program material to stereo and transmission. John Bonner of Warner/Hollywood shared how they mix feature films for television in stereo. One of the main considerations, according to Bonner, is making sure that monitors are close to the screen when mixing so that the audio does not seem to wander off the screen.

Demonstrating the various stereo synthesizer systems was Shawn Murphy of Disney. Such synthe-

sizers are being used by stereo television stations to make mono program material replicate stereo. Among the synthesizers tested were those by Orban, Kintec, Ursa Major, AMS and Studio Technologies. Rick Chase, of Rick Chase Productions, gave a synopsis of a proprietary system his company has developed that allows stereo synthesis of mono material and is "steerable." Don McCroskey discussed the obstacles that have to be overcome in transmission, like the sheer number of components, such as routing switchers, that a program must pass through before it gets to the viewer at home. He stated that if a matrix system is used, a mere 1dB difference in signal can reduce stereo separation from 35 dB to 24dB. Polarity shifts at any point can cause total cancellation in mono. Noise problems can also be a problem in a matrix setup since the difference (L-R) channel won't be used except for effects and music. (Dialogue is usually in mono.)

Another highlight was the demonstration by chief audio engineer Ron Estes of stereo clips from the *Tonight Show*, featuring Willie Nelson and Steve and Edie Gormet showcased in a superb television mix and stereo image.

—Tony Thomas



tact Ginny Buckley, (212) 365-6600.

### Studio Report

Developers giveth and developers taketh away... *Reeves Teletape Corp.*'s 81st Street Stage, for many years host of *Sesame Street* and numerous independent video productions, was sold off to a real estate firm that plans to demolish the studio and build condominiums. A large West Coast film and video stage complex is planned for Emeryville, CA, under the aegis of local government and enthusiastic support of the local production community. Spiritual godfather for the project is *Charles West* of *Espresso Productions*, who says the complex will house film and tape service companies feeling the squeeze of rising rents in San Francisco.

*Sheffield Audio-Video Productions* (Phoenix, MD) has a new 30-ft. mobile truck, designed for location digital recording with a Sony PCM-3324 multi-track recorder and Trident Series 80 console. *One Pass Video* (San Francisco) has added a computer controlled audio in all video edit suites with the purchase of several Sound Workshop Series 30 consoles, and has installed four Ampex VPR-3 one-inch format video recorders to its Type C VTR lineup.

*Pacific Video* (Hollywood) has been busy posting *Frank Zappa In Concert* with an all-digital soundtrack, and "The Heart of Rock & Roll," a *Huey Lewis & The News* special for Showtime and *Tall Pony Productions*. *Today Video's* David Seeger posted the music clip promoting the movie, "Perfect," providing a new 8-track audio mix and film-on-video editing for director *Bob Giraldi*. *Silvercup Studios* (NY) hosted *Talking Heads* for the performance clip of "Stay Up Late." *Teddy Bafaloukos* directed.

For the record: large chunks of the credit for managing the worldwide television broadcast of the "Live Aid" concert telethon belong to *Hal Zuckerman*. A freelance "packager" of live sports events whose credits include tech manager for the 1984 Olympics, Zuckerman worked with producer *Michael Mitchell* and dozens of video and audio companies.

Mobile video facilities for the 18-camera, 14-hour live show were provided by *F & F Productions* (Tampa), *E.J. Stewart* (Philadelphia) and *Teleproductions Ltd.* (Tulsa). Stereo audio feeds for TV and radio were handled by *Le Mobile* (Los Angeles), *Record Plant* (New York) and *Mobile Audio* (Rome, GA). Seventeen satellites were coordinated by *Synsat*, with portable uplinks and downlinks supplied by *STARS* of Houston. Everybody worked at "extremely reduced rates," according to Zuckerman.

### Video People

Most pretentious clip of the year has to be "Highwayman," an elaborate concept clip which poses *Willie Nelson*, *Kris Kristofferson*, *Waylon Jennings* and *Johnny Cash* as the Four Horsemen of the Apocalypse. *John Small* produced and co-directed this epic with *Peter Israelson*, supplying each performer with a tragic death scene on locations that spanned five states.

*David Hogan* directed *John Denver's* first music clip, though the shoot was less laid-back than expected. Denver flew off to Mexico after shooting his segments for the clip, but when they had to be re-shot, the production staff found itself radioing half a dozen tiny airstrips south of the border to locate the singer and complete the clip before deadline.

Director *Zbigniew Rybczynski* (Art of Noise, etc.) has opened a production company, *Zbig Visions*, in New York; rock video founding mother *Kris P.* (Puskiewicz) has left *Island Records* to join him as sales rep. *Karen Rae* succeeds Kris as head of video promotions for Island. Video artist *Mitchell Kriegman* is handling all video programming for the Palladium disco in Manhattan.

*David Rathod* went on the road for *Translator*, shooting "Come With Me" in and around Bombay with the help of

his dad, *Kantilal Rathod*, who's a well-known feature film director in India. *Graeme Whifler* directed L.A. paisley-pop band *Three O'Clock's* clip, "Her Head's Revolving." *Steve Barron* directed live action sequences, and *Mike* and *Candy Patterson* of L.A. created the rotoscope animation for the wonderful fantasy clip introducing Swedish band *A-ha*.

Post-production has just been completed at *Sunset Post, Inc.* Glendale, CA, on *Christine Lakeland's* cover of *Eric Clapton's* "Ain't Going Down." The live performance clip was lensed at *Showlites, Inc.* and directed by *Simon Miles*; A.D. *John Sherlock*. Final audio mix was by *Charlie Paakari* at Capitol Records. This is the first footage of Lakeland since her appearance in the 1981 documentary *J.J. Cale & Co.* She is backed up on the video by her present band, The Code.

*Heart* are producing a 30-minute documentary on their performances and recording it entirely on one-inch tape, using the Ampex VPR-5. *Fred Garland* of *Stone Wall Productions* and lead guitarist *Howard Leese* are putting it all together. Both *Eric Clapton* and *Foreigner* will supply original music for episodes of *Miami Vice* this fall; look for *Apollonia 6* as a guest star on *Falcon Crest*. ■

Coming in November...

## Video Production Supplement SMPTE Show Issue

**Mix** brings video into focus in its special **Video Production Supplement**. To be distributed at the SMPTE Conference in Los Angeles (October 27 - November 1), this exclusive **Mix** feature will include the following:

- **Posting Huey Lewis:** A play-by-play account of the post-production for the new video by one of rock's top performers.
- **MVP:** Low-cost computer graphics—a survey of less expensive hardware and software for music video graphics and titles.
- **Music Video Directors' Forum:** Several of the medium's hottest directors discuss the latest technology, current trends in programming and other topics.
- **Stereo Television Update:** Report on the recent developments in the technology that's rearranging TV.

If your company provides video production or post-production services, the **Video Production Supplement** is an ideal place to attract new business! Call today for advertising information: (415) 843-7901.

**Deadline for Space Reservations: September 9th**  
**Materials Due: September 15th**

# Playing the Home Video Distribution Game

by Neal Weinstock

Sal Agnello is the proprietor of this author's local video rental store, CVS Video. When *Thriller* was hot, his music video display was in the window. Eventually it was moved to a display case near the window, then to one farther back, then to one lower down. In a little shop with 25 cases full of rental titles, music still occupies just one. Sal says, "Sure, there are a few music titles that do very nicely. I think there'll always be about a half dozen that will rent out three or four times a week."

This is a very average, successful video shop with a 4,000 member club in a half affluent, half working class neighborhood where music continually blares on the streets. Sal's sales figures interpolate to roughly approximate national retail home music video revenue of about \$25 million this year (according to the Video Software Dealer's Association). But his experience suggests that income must be split among up to 30 "successful" titles in a year—not to mention all the unsuccessful ones.

Thus, the state of the home music video business right now is that 30 one-hour tapes may sell a half-million copies, net \$5 million each for their distributors, and rightly pay their producers as much as half that, depending on their deal-making clout. But, "Ten-to-one odds is not a bad guess for the success of any music video title," says Vestron Video's top man, Austin Furst.

Thus, the state of the home music video business right now is that as many as 300 one-hour tapes will be bought, with an average of one to five percent of hoped-for \$5 million revenues being appropriate for producers. Typical producers' income should run from \$50,000 to \$250,000.

(Obviously, Prince counts on more; makers of such as the Smithsonian jazz series put out by Sony count on less. We concern ourselves with the mean, for now.)

What sort of programming is the mean being bought by homevid distributors? "Whatever is successful as an album," says producer Steve Kahn.

Meaning that home video sales come *after* record sales. Not before, like free clips shown to promote records; not even at the same time—record sales *always* come first. "You don't want to compete with your own video if your record deal is better than the video deal," says producer/director Martin Kahane. Record deals are usually better because video deals are more iffy (even as iffy as record sales are to predict, video sales are understandably harder).

This makes the home rental and sale market into a sort of Valhalla [note to editors: since the Bay is so big on the Ring now, I thought you'd enjoy this] for heroic clip-makers who have seen their products achieve such success that record sales were good—and therefore they can finally pick up a little extra income from home video. How-

ever, this heaven is not only for those soldiers who meekly serve and wait: a few home video music tapes have achieved success without successful albums first, and even a few without successful movies first, either.

The most successful of success formulae for home video seems to involve planning it all from the start, with a cognizance of the interdependence of the various media a property can be turned into. In other words, if the artistic property is transformed from concert artist to record to video clip to long form TV special to midnight movie to home video (not necessarily in this order) with the right timing, each form promotes and increases the profitability of all forms.

This process was something discovered accidentally by the movies and theater, as projects in one medium were slowly turned (over the course of many years) into commercial projects in other media. Media critic James Monaco looks at Christopher Isherwood's *Berlin Stories* in his *American Film Now* (New York Zoetrope, 1984), for example. The book was published in the early '30s; by the late '40s John Van Druten had transformed it into a play, *I Am a Camera*, which was soon made into a movie; in the middle '60s this was transformed into a Broadway musical, *Cabaret*, which was soon transformed into a movie and albums of both play and film. The property has missed only an existence as a TV series to have made the rounds of every popular medium.

The transformation process started out as accidental, but as it snowballed it became more and more a planned exploitation of proven resources. In its accidental beginnings, the process of transformation resembles the way fairy tales are spun and changed and respun, and yet remain essentially the same. Canny and crass movie and record producers have always copied the moment's successes, from not-so-innocent imitations of Swanee River through disco analyses of beats-per-minute and beyond. However, it took the sharp minds of the '70s New Hollywood (with Stanley Kubrick reading Bruno Bettelheim on fairy tales, and George Lucas and Steven Spielberg reading Joseph Campbell on myth) to realize that fairy

**"I** *f the artistic property is transformed from concert artist to record to video clip to long form TV special to midnight movie to home video with the right timing, each form promotes and increases the profitability of all forms."*



tale-like transformations of properties could be thought out like a marketing battle plan.

The music industry had been a bit slow to initiate this sort of market planning, but music video has lately been giving the industry golden opportunities to do so. Because music video is a hybrid of media, a common question has been, "Is it promotion or does it stand on its own terms?" This and similar questions are easy to argue over forever just because, as the hybrid medium it is, music video is implicitly more than one medium, and promotion for other media as well as for itself. Music video fills gaps between previously unconnected forms of communication, and allows pop songs, TV commercials, TV specials, movies, etc., to transform themselves into each other with ease. Music video is the successful equivalent of those little translating lap computers people once hoped would replace phrase books: a fast media translator.

"If you remember high school biology," says Rick Sklar, former programming director of New York's WABC and now a consultant to many music video operations, "you cross two breeds to get a superbreed. A hybrid can be stronger than both."

Now, a deep question we must leave unanswered is just why commercial entertainment properties transform like fairy tales: why does the public keep buying repeats of similar structures? Philosophers have writ large on this through the ages, and have certainly made some progress. However, one doesn't have to be Noam Chomsky or Claude Levi-Strauss to see how one may use the phenomenon to economic benefit. (It probably helps *not* to be one of the above gentlemen.) Or to see the likeness of middle-aged moguls in our modern consumer capitalist society marketing videos at teenagers, to traditional parents telling fairy tales to the youngsters: there's profit in indoctrination these days.

To get some of it, you've got to be adept at changing your story to fit the occasion. If you're not using music videos as the bridge between disparate marketing media that it can optimally be, you're missing the money train. Co-producer/director of a current Heart rock doc project meant for LP, single, clip, 30-minute and 90-minute video, Fred Garland says, "You plan your marketing approach comprehensively, based on all these ways of reaching the public. It used to be just a single hyping an album; now it's all these ways working together."

Why go into all of this in a discussion of home video? For music even more so than for any other type of video programming, the home videocassette

market is the most ancillary of all—the last market in line and, by all proper economic planning, probably the last thought of. In fact, however, many music video makers think (very wishfully) first of home video. "If the business is going to grow, home video's the way," says Antony Payne of GASP! Productions. It may not be the only way, or anywhere near the best way for the moment, but look what the home market has done for feature films, after all.

All right then, why aren't people renting and buying home music video in the same quantities that they do features? (Certainly audio record sales are not nearly so far behind theatrical film grosses as home music video is behind home video movies—comparison of Recording Industry Association of America, Motion Picture Association of America, and VSDA figures indicates home music video is over 10 times smaller, compared to home video movies, than vinyl is to theatrical celluloid.) An answer may be found by close academic investigation of the structural reasons why the public prefers one sort of fairy tale over another—or it may be found by using the workaday world's equivalent of this: market research.

MTV is one of, if not the most heavily researched product ever offered to the consuming public. Its parent company has a home videocassette arm—so they are very capable of thinking in that direction—but MTV is not very interested in home video. "It's just not happening yet for music," says a top researcher who did not want to be named. Why not? When will it happen? "When the VCR population gets high enough so most teenage kids have their own, in their own rooms," he says.

It so happened, at the Chicago Consumer Electronics Show this June, that the Electronic Industries Association released their own comparison of the growth rate of VCR penetration compared with that of color TV before. They concluded that VCRs are entering American households perhaps a year or two faster than color TV did. A similar comparison with audio penetration is a bit harder competition, since small monaural systems were acceptable enough to spur record sales even while stereo's penetration was small. But since color TV became virtually universal in the U.S. in 25 years, it seems likely VCR penetration will reach most upstairs teenage bedrooms in that time—or only 10 years from now.

Will MTV want its own associated home video label when this comes to pass? "It has been mentioned," says our insider. It's an easy media transformation, after all.

Even if you can't transform home video into dollars yet, hold onto those rights!

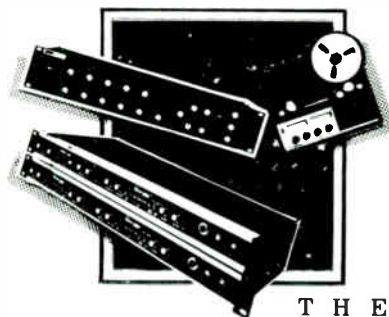

## THE FRONT OF NEW TECHNOLOGY

IN STOCK FOR  
IMMEDIATE SHIPMENT

AKG	JBL	Rane
Aphex	Klark-	Roland
A.T	Teknik	Sennheiser
Countryman	Lexicon	Simmons
Crown	Linn	Soundcraft
dbx	Oberheim	Symetrix
Emulator	Otari	Technics
Postex	QSC	Turbosound
Hill	Ramsa	UREI

THOROUGHbred



MAIL ORDER  
WORLDWIDE

2204 East  
Hillsborough Ave.  
Tampa, FL 33610

(813)237-5597

Mastercard•Visa•American Express

Circle #096 on Reader Service Card

## VINTAGE RECORDERS

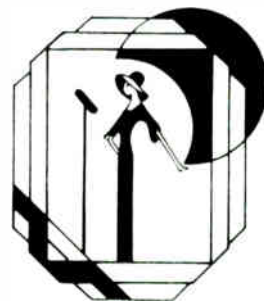

Do these clients know  
something you don't?

Huey Lewis	Against All Odds
Stevie Nicks	Steve Smith
Peter McLean	Lindsay Buckingham
The Crusaders	Alice Cooper
Glen Campbell	Mick Fleetwood
Jimmy Iovine	Christine McVie

Entertainment Tonight

24-track studio  
Trident • Studer

featuring  
The Kurzweil 250  
at \$35 per day/session

24-track recording time:  
\$50 per hour

4831 N. 11th Street, Suite D  
Phoenix, Arizona 85014  
(602) 241-0667

Circle #097 on Reader Service Card

(Left) One of Compact Video's three plush sweetening studios includes a voice over room, a wide screen television and a comprehensive library of sound effects.

*Fame.* Most recent music video work was for the Steven Spielberg/Cyndi Lauper "Goonies."

### Audio for Film

Compact's Film Sound Services department houses two re-recording studios, ADR/Foley Stage, and magnetic and optical transfer rooms with appropriate screening and editing facilities. Each re-recording stage is equipped with 48-input Harrison consoles and Magna-Tech high speed dubbers with 4-track and 6-track "spread" Dolby stereo capability.

The 6-track spread places signals at extreme left, left center, center, right center, extreme right with one track for sound surround. Film Sound Services, managed by Tex Rudloff, uses their 16/24-track Ampex 1200 recorders for feature film production by assigning four tracks each for dialogue, sound effects and music. This technique, in addition to saving time, facilitates stereo TV and foreign language versions. With the increasing number of sound effects being used in action films and music, the facility has been set up to accommodate the "three man mix session." Recent music video projects include work for The Police, Duran Duran, and Tina Turner's "Mad Max." Sound Services can handle half-inch, 3/4-inch, one-inch and 2-inch videotape, and 16mm and 35mm film. One application that seems to be increasing in demand has been the reformatting of videos made for TV for 35mm big screen presentation. This is accomplished by creating a "phantom center point" in the transfer. All formats can be interfaced and are SMPTE time code and fully compatible with both NTSC and PAL video sync rates at 50, 59.9 or 60 cycles and 24, 25 or 30 frames per second.

### Telecine: Film to Tape Transfer

Compact Video Telecine Services handles an enormous flow of made-for-TV movies and series shot on film, transferred and edited on video tape. The Telecine is one of the most creatively open-ended post-production tools and probably one of the least understood ingredients in the assembly of the finished production. Computer controlled, scene-by-scene color



# COMPACT VIDEO

## THE FUTURE IS HERE NOW

by Lou CasaBianca

The first thing you notice about Compact Video's headquarters is its resemblance to the corporate presence of a bank or major Fortune 500 corporation: reflective glass, marble elevator lobby; it's a multi-story high-tech high-rise housing a diverse professional staff dedicated to providing services and products to the film and video communications industry.

Compact Video, Inc. has assembled one of the most advanced and comprehensive video and film production facilities in the world. Clients include the television networks, cable TV, the major motion picture studios, ad agencies, independent film and television producers, and more recently music video producers.

Compact is really three different companies: Compact Video Services (production and post-production services, Telecine services, tape and film sound services and satellite services), Image Transform (film to video, video to film, standards conversion and film processing), and RTS Systems (intercommunications equipment and pro-

fessional audio products).

Compact facilities are located in four different buildings in Burbank, California, the home of Walt Disney Productions, NBC, Universai, Warner Brothers and Bob Hope.

### Audio for Video

The Compact Video Tape/Sound Services has three dual 24-track state-of-the-art sweetening studios. Each room is equipped with Ampex 1200 ATRs, large screen monitors, and sound booths for announce and foley work with a comprehensive library of sound effects. Managed by Ms. Terry Auerbach, Sound Services has created two customized "L" systems for laydown and layback for one-inch "C" and two-inch quad, with format transfer capability to most of the other formats. Audio tracks are "built" on Ampex 1200 16/24-track off-line audio suites. The rooms are equipped with Neve 5106 or API 2988 boards.

Compact does an enormous amount of broadcast television work for clients including *The Cosby Show*, *Family Ties*, *Solid Gold*, *Bizarre*, *Not Necessarily the News*, *American Top 10*, and



correction by Rank Cintel Flying Spot Scanners, is capable of single frame corrections for precise color control throughout a given piece of film. A Grass Valley provides split screen and split scene comparison.

### Video Post-production

On any given day the Compact Video Services bookings for its 19 cameras, 20 VTRs, eight production bays and two Telecine suites could include NBC, Warner Brothers Television, Dick Clark Productions, Bob Banner Productions, Scotti Brothers, Barry Enright, and Robert Abel and Company.

The high level comfort zone created by the ergonomic and gastronomic environment at Compact is legendary. Almost all of Compact's video post-production services are for features, series or long-form programming with around-the-clock production schedules requiring a certain amount of electronic hibernation and semi-residence in the studio/edit bay. The lighting and the furniture in the audio and video edit bays at Compact are designed for maximum efficiency and creature comfort.

Compact engineers have developed their own customized computer editing system with auto assembly and a look ahead capability of 100 frames, which

allows one edit to be made while the next edit is being set up. The suites are equipped with four channels of DVE (Digital Video Effects) which can be tied into ADO (Ampex Digital Optics) 3-D composite video effects.

### Laboratory Services

Image Transform, Inc., Compact's Transfer Service and Laboratory is charged with the development of proprietary signal processing techniques used for the direct conversion of 16mm and 35mm positive and negative to any tape format, directly to any world broadcast standard, NTSC, PAL or SECAM. In addition to standards conversion and duplication, Image Transform has developed the "Video Sweetening™" system to realign and correct color, eliminate smearing, sharpen and enhance the picture, and reduce the visible "noise" or graininess by 75 percent.

### Intercommunications

Intercom and talkback systems provide the command level local area network for verbal communications on location and on the set. RTS Systems, Inc. was one of the first companies to specialize in professional quality audio intercommunications for television. The TW Intercom System is considered the in-

dustry standard for personal intercommunications systems with over 30,000 components currently in the field.

### Satellite Services

Recently Compact entered into a joint venture agreement with Netcom International, a satellite television transmission company, and formed Compact Satellite Services which is one of the largest satellite networks in the country. Capabilities include transponder service, two ten-meter microwave uplinks capable of simultaneous uplink/downlink transmission to and from all domestic satellites. Network services include a fleet of transportable uplink units and 300 transportable antennae throughout the U.S. ■

### Oops!

In our July column, we got cut off before we finished our message. If you were wondering what we were starting to say, here it is: For more information on satellite technology, you may want to refer to "Satellite Orbit" Magazine, a monthly "TV Guide" for satellite TV users. The "1985 Whole Earth Station Catalog," is another valuable resource covering satellite operators, trade shows and earth station dealers. Check these titles out at your local book or magazine dealer.



# NAGRA IV-S TC

Post another advance in recording technology for NAGRA! The new NAGRA IV-S TC incorporates unique Time Code circuitry which permits time code record/playback (via switch selection) of the five film or video SMPTE/EBU standards.

What's more, there's an eleven key, slide-out, mini keyboard to enter or read data and check system operation, plus a seven segment eight digit LCD readout.

Of course, the recording quality, the functionality, are what you've come to expect from NAGRA . . . . . just this side of perfect

KUDELSKI S.A. CH-1033 Cheseaux / Switzerland; phone: (021) 91.21.21  
 U.S.A. Nagra Magnetic Recorders Inc., 19 West 44th Street, N.Y. 10036 New York; (212) 840.09.99  
 Nagra Magnetic Recorders Inc. CA, 1147 North Vine Street, Hollywood CA 90038; (213) 469.63.91  
 Canada Arri-Nagra Inc., 6467 Northam Drive, L4V 1J2, Mississauga (Ontario); (416) 677.40.33

**NAGRA KUDELSKI**  
 a passion for perfection

Circle #098 on Reader Service Card



# RADIO with PICTURES

by Neal Weinstock

Several local TV stations around the country have sprung up with all-music formats; the first in a major market is Boston's WVJV, known more commonly as "V66." Former Boston radio jocks Arnie "Woo-Woo" Ginsburg and John Garabedian own V66, and have made the Framingham, MA-based broadcaster (on-air since February 12) into a unique entity in many more ways than just being first. And what is unique about V66 is also specially valuable to the music and video production industries.

What is special about the station begins with what is special about its market. The sixth largest broadcasting market in the country, Boston is home to a college-age population of some 300,000 that is uncounted by either Nielsen or Arbitron; programming and advertising there becomes a matter of feel, more so than any other market. Only 40 percent of the market is wired for cable, according to Ginsburg, so, "MTV is not an important factor in the Boston market at present."

Things get more interesting... Boston is a big UHF town, with much of the major league sports action and most good movies already coming in on the little round antenna. The new Channel 66 even has another station, 68, above it on the dial. It hasn't been hard to get people to tune in.

More and more interesting... Since MTV has signed its exclusivity agreements with several major acts, these

videos are effectively unseen by most of Boston. Ginsburg says that V66, playing less-well-known groups (and local groups as much as possible) therefore winds up breaking hits, for lack of available ready-made hits. This is a function he clearly relishes; in the earlier days when Woo-Woo Ginsburg fronted records on AM, Boston broke far more than its share of national hits. The college-age market and the lack of measurement made for a willingness to experiment that MTV's unavailable exclusivity now compounds.

V66 has traveled a very first class route onto the airwaves. Broadcasting with 3.2 million watts from a transmitter taller than the Empire State Building

(not an easy task to build, in zoning-conscious Boston), V66 is the strongest signal in the area. "They said it couldn't be done," says Ginsburg. "And we did it."

His company raised \$10.5 million in a public offering last year, and another \$5 million just for equipment. With a staff of 62, a promotion budget of \$1 million for the first year, and a schedule loaded with local news coverage (twice an hour), a great deal of their own in-studio production, and out-of-studio production like a Saturday night show that originates in a local club, Ginsburg and Garabedian do not expect to be profitable for two or three years yet.

"But we're already way ahead of schedule," says Arnie. He says Nielsen called him two weeks before April's National Association of Broadcasters show: "They said we were going to be in the March ratings book. I said that's crazy! This is a box-metered town, it's 40 percent cabled and most of the cable companies weren't carrying us yet. In spite of that, we were in the March book, after being on the air less than a month."

Rick Sklar, who built New York's WABC into the most successful radio station ever in the '60s and '70s, is a consultant to V66. He says, "The concept was to do a music video format,

*Point West Place, Framingham, MA. V66 studios and offices location.*







# JAN HAMMER

WORKING HARD FOR MIAMI VICE

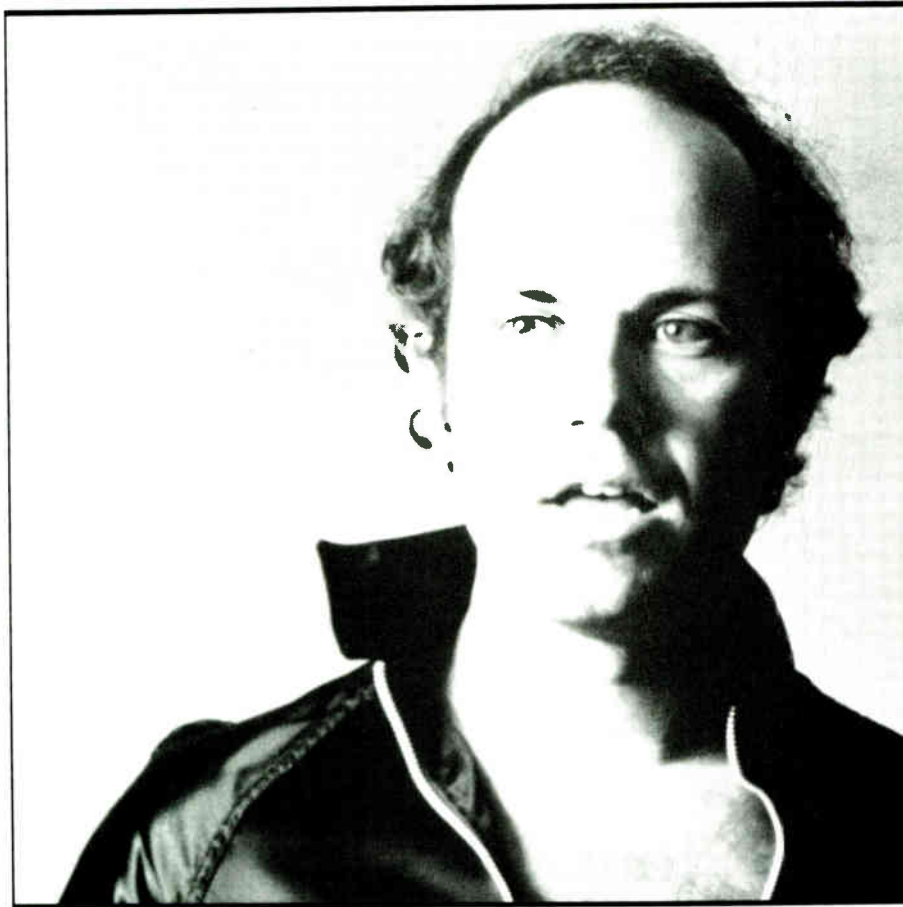

by Bruce C. Pilato

"This has been some half-year. I was coming close to the wall, as far as just seeing black," says Jan Hammer from the seclusion of his Red Gate Recording Studios, located on his upstate New York farm. "But now," he smiles, "I'm off. I'm turning everything down. I'm turning things down now that only a year ago I would have killed for."

It is Friday, May 10, and tonight the final episode for the regular season of *Miami Vice* is airing. Jan Hammer couldn't be happier. Now, for the first time in what seemed like an eternity, Hammer is taking some time off from his 80-hour work week to relax with his family.

Last summer, when the show's two-hour movie pilot was being made for NBC, executive producer Michael Mann asked Hammer to write the theme and do the initial show's music. What he got blew him away. He was so impressed that he not only gave Ham-

mer a contract for the entire season, he also gave him full artistic control to add whatever music Hammer felt was appropriate at whatever point in the show he wanted.

For Hammer, this is the music gig he has always wanted. Aside from full artistic control, he is able to write and record nearly every style of music imaginable. In one episode, it is not unusual for him to incorporate funk, new wave, reggae, classical, pop and avant-garde experimental jazz music, all of it original. In addition, he is able to write, record and produce it all alone in the privacy of Red Gate with no one checking up or bothering him.

In fact, he has done his job so well that many critics and several of those involved with the show credit much of the series' success to Hammer's creative scoring, as well as the program's slick art design.

After only a few episodes *Miami Vice* became kingpin in the brutal TV ratings war, knocking *Falcon Crest* off

its mighty throne and restoring both programming credibility and solid advertising revenues to an ailing NBC.

"None of us knew it was going to take off like this," says Hammer, who adds that the show is a hit because of the way it is produced and the fact that it looks different than any other show currently on network television. "It has a 'look;' the art direction is so unique. You see one frame from the show and you definitely know what you're watching."

A price tag of \$1 million per episode might account for part of it. Shot on location in Miami with post-production done at Universal City in Burbank, Hammer's studio, located a few hours from Manhattan, is the show's east coast connection.

Each week, via courier express, Hammer delivers to the producers of the show a half-inch stereo master tape with sync, including all the cue slates. "Then I'm on the phone for the good part of the next day with my music editor, Jerry Cohen. We simply lay the stuff down over the phone." Despite the phone bills ("Believe me, it's worth it!" he adds, laughing) Hammer insists on remaining away from the show's production in L.A.

"I won't move to L.A. as long as I don't have to. It might be easier, in terms of logistics, to do it there, but the environment I'm working in cannot be duplicated there. I don't mean technically; it's just something about this place that is very nurturing and inspiring. I go to L.A. periodically for production meetings, or whatever, but I could not imagine living there full time...forget it."

Born in Prague, Czechoslovakia in 1948, Hammer came to the United States in 1968, just prior to the Soviet invasion of the Czech capital. The son of a jazz vocalist, he studied classical music composition at the University of MUSE Art in his homeland, before transferring to Berklee College of Music in Boston. After six months he dropped out to become pianist and musical director for the Sarah Vaughan Trio for two years, traveling around the world in the process. In 1970, he moved to Greenwich Village in Manhattan where he began jamming with an odd troupe of jazz musicians that included guitarist John McLaughlin, drummer Billy Cobham, bassist Rick Laird, and violinist Jerry Goodman. A year later they made musical history as The Mahavishnu Orchestra, and helped inspire the term "jazz fusion."

After three albums and several tours between 1971 and 1973, the group split and Hammer went on to pursue a somewhat successful career playing jazz-rock. His own group, however, never really took off. Between stints with his band, he recorded and toured with the likes of Al Di Meola, Carlos Santana, Stanley Clarke, Tony Wil-



Glenn Frey (center) on "Miami Vice" with stars Don Johnson (left) and Phillip Michael-Thomas (right).



liams, John Abercrombie and Jeff Beck. It is Hammer who is often credited with bringing Beck back into the mainstream music scene, (though he has also been criticized for sparking the British guitarist's interest in jazz, a dubious "change" Hammer nonetheless denies.)

Around 1978, Hammer began growing tired of jazz and moved his musical direction into more straight ahead rock and roll. (In fact, when asked if he is still a snobby jazz player he replies with laughter: "No, now I'm a snobby rock player!"). In 1979 he formed a short-lived rock unit called simply Hammer, and in the two years that followed, recorded two rock LPs with Journey guitarist Neal Schon.

Angered by the lack of commercial success from his second record with Schon ("Journey took a precedent there; I still hold a big grudge for the person that squashed that album"), Hammer decided he'd had enough of the writing-recording-touring-promotion cycle. He wanted to do film soundtracks.

Through the aid of his manager, Elliott Sears, the transition into film began. It was a long, hard road that took two

solid years before the break to do *Miami Vice* came. The offers were slow at first; an occasional jingle or station ID, themes for some European television shows, and the score for the Canadian Broadcast System's 1981 documentary called *Oceans*.

In 1983, Hammer completed his first

original movie soundtrack for the film *A Night In Heaven*. Described by one critic as a "weak 'male' version of *Flashdance*," it was, in a word, a bomb. It did, however, give Hammer a chance to work in the medium that would become his future.

"Throughout a picture, music can establish thematic connections and make the storyline flow," he says. "At best, it

# NEVE NECAM • SSL 3M and MITSUBISHI DIGITAL

Film Mixing • Music • Video Sweetening



Murray Allen - president  
Foote Kirkpatrick - studio manager



## UNIVERSAL RECORDING CORPORATION

46 East Walton Street • Chicago, Illinois 60611 • 312/542-6465

can bring about the total expression of an emotion, mood or feeling that can only be implied by the actor, director, cinematographer working without music. When images, story and music are perfectly in tune, a film becomes the highest form of magic."

His attitude about the connection between music and film made him, in the eyes of the producers, the right choice to do *Miami Vice*. Through an associate of his manager, Danny Goldberg, Hammer's music was brought to the attention of Michael Mann, who had a vision for the show and insisted on working with only the absolute right individuals. Soon, it was clear to him that Jan Hammer would be one of them.

Although he jumped at the opportunity to do a weekly television series, Hammer quickly fell into a period of self doubt. "After the third or fourth show I started really having the cold sweat," he now admits. "'Am I going to be able to keep this up?' Plus, at that time, my wife and I had just had our second child and that was the craziest time of my life, ever.

"I make it harder on myself by writing truly original music for each scene, unlike most shows which are done with recycling snippets of the theme done with different drumbeats. That's not done here. Each show has truly origi-

nal music."

Hammer estimates that in the one year he has done the show he has written, recorded and mixed at least 12 albums worth of music. How does he do it? His philosophy is simple and direct: "You just get up in the morning and crank. Let's put it this way: I certainly *earn* my money."

When Hammer receives the musicless episode each week, he watches it two or three times and then begins to build up a stock of music for that week's show that he later draws from. Fortunately, he has not been plagued with writer's block. "So far, I've been lucky, but I have had periods where I thought I couldn't do it. Somehow, the mode of operations always works and I respond to it emotionally."

With the exception of the pilot, Hammer has never seen a script for the show. He prefers to work from the visuals and says that a script would simply confuse him.

The show is sent to Hammer on 3/4-inch video cassette. In the course of a week, he will usually receive several new versions. It is not unusual for him to get as many as four updates on the show, starting with the rough edit, the director's edit, the producer's edit and finally, the final cut. Through the use of a BTX Shadow, his JVC U-Matic video

deck is synchronized to his Otari MTR-90 24-track audio tape machine. Red Gate is equipped with a Soundworkshop 34 B automated board, and a full array of outboard gear that includes Studio Technologies Ecoplate reverb, Lexicon 200 digital reverb, DeltaLab Acousticcomputer reverb, Ibanez digital delays, UREI 1176 limiters, and assorted noise gates, flangers, filters, and graphic equalizers.

His monitors are JBL 4333s (powered by McIntosh amps) and his playback speakers are JBL L200s (powered by Cerwin Vega amps). His 2-track machines include a Studer/Revox A700 modified to B67 specs, and an Ampex ATR 104 30 ips half-inch.

Although he has used all 24 tracks on some segments, most of the music for the show is done on 12 or 13 tracks, plus an additional 3 tracks for pulse and sync tracks. While recording, he usually watches that particular segment on a huge TV monitor.

For all the music on the *Miami Vice* series, he is the sole musician. He writes and records everything using a Fairlight CMI (for the rhythm tracks), a Steinway Grand, a Memory Moog, a Roland Jupiter 8 and Hammer's favorite keyboard, the Yamaha DX7. He occasionally records his Fender Stratocaster and a set of Gretch drums.

## **BETTER THAN REAL-TIME CASSETTE DUPLICATION...**

**OUR OTARI DP-80 64:1 DUPLICATION SYSTEM WITH DOLBY HX-PRO WILL  
DELIVER A MORE CONSISTENT HIGH-QUALITY PRODUCT THAN REAL-TIME**

**CALL OR WRITE FOR A SAMPLE**



**Music Annex  
Recording Studios**

970 O'BRIEN DRIVE  
MENLO PARK, CA 94025  
(415) 328-8338

Circle #101 on Reader Service Card



His Fairlight is stacked with an ever-increasing library of sound samples that range from a myriad of percussion instruments to a typewriter to the sound of broken glass. Hammer also programs as much of the music in the Fairlight as possible, so that it can be shortened or lengthened by computer to fit a segment.

In just a week, Hammer writes, records and produces anywhere from 17 to 25 minutes of original music. He sends back a stereo master which is then edited (via long distance telephone) to the original 35mm film.

"I only use the SMPTE here to synchronize my recording process, so I can actually do fine tuning and very tight scoring. From that point on, I just mark the timings and do everything over the phone. It's all instinctive as far as where the music is placed. I like to watch the show once or twice and then feel for where I need the music. I look at it and there are obvious spots that need music, and there are other spots where my emotional response writes the music."

According to Hammer, the producers "very rarely" instruct him when or what kind of music to add. "Unless they have something very specific in mind, 95 percent of the time it's left up to me."

"The last half year has really gotten crazy scoring a weekly television series. I had no idea how crazy it was going to get, especially with the number of changes and the last minute rewrites that goes into *Miami Vice*. The show is pretty much approached like a movie, rather than a television series; the fine tuning is really outrageous. A lot of times I finish scoring only three or four days before air time. I just finished Monday working on tonight's [Friday's] show."

There's no question that the music for *Miami Vice* has played a key role in its success. In addition to Hammer's theme and weekly score, the show also uses current pop hits to supplement a particular broadcast's theme. The pilot included Phil Collins' "In The Air Tonight" and the show's best-watched episode was based around Glenn Frey's hit, "Smuggler's Blues." In addition to using the song, Frey himself played a pilot on the show.

The show's music has become so popular that MCA's record division is releasing a *Miami Vice* album this summer, which Hammer is producing. Aside from including Hammer's more interesting scoring music and the theme, the record will also include a few of the hits utilized by the show, such as "Smuggler's Blues." Hammer has even asked artists such as Eric Clapton and Foreigner's Lou Gramm to write new music for next season.

Hammer says that in the near future major artists will be writing original pop tunes to be incorporated in the

show. He also sees the show as another way to break hits, and is "trying to get a lot of other people involved."

Somehow, Hammer has also been able to squeeze in other projects, including the ARMS tour (which he did just prior to starting *Miami Vice* on a regular basis), writing, performing on and producing new records for Styx's James Young and his old friend Jeff Beck, not to mention, a two-week stint in the Bahamas helping Mick Jagger record his first solo album. He also scored the music for a recent Robert Conrad TV movie and two other feature films, *Gimme an F...*, and *Secret Admirer*.

It is scoring feature films, says Hammer, that he eventually will settle into. "I'm committed to the next season of *Miami Vice*; after that I'm going to do more feature films. It's so exciting and so fresh and it gives me a lot of freedom."

The world of scoring seems to be distinctly divided between the "old breed" of orchestrators like John Williams, Dave Grusin, and Jerry Goldsmith and the "new breed" of musical technicians, as exemplified by Giorgio Moroder. Somewhere in the middle, falls Jan Hammer.

"I'm a total hybrid," he says. "I'm the freak. You see, I started as a totally educated composer and now I've come full circle because even though I'm now doing hot rock 'n' roll scoring, I can still use all my skills from the past. The score I did for Robert Conrad's *Two Fathers*, I'm really happy with. There was a lot of classical stuff in that one; a lot of piano and strings."

Although Hammer doesn't currently have a record contract (his last release was on Elektra in 1980), he says the problem is not that he can't find a deal (he's had several offers), but rather not knowing what to do. "I just don't know what I *should* do. I want to do hit pop-rock music, but at the same time I like a lot of instrumentals like the stuff on *Miami Vice*."

He also says he's through with putting bands together and touring to promote records. "I think those days are over," he says philosophically. "I like occasional big bashes like the ARMS tour. Things of that sort I'm more attracted to than putting together a band and going through that grind again. I get much more satisfaction out of recording music."

After his four-month hiatus, Hammer will begin work on the next season of *Miami Vice*. The first show will be a special two-hour episode shot on location in New York. Though his vacation is foremost on his mind, he is eagerly looking forward to resuming the show's 80-hour-per-week work load.

"It's a wonderful job," he says casually, "if you can deal with the tremendous pressure." ■

## TAPE SYNCHRONIZERS!

SYSTEM 2600  
"Building Blocks"

from  to 

### PLAY-SPEED SYNCHRONIZING

- lock ATRs together
- lock ATRs to video sync
- lock ATRs to projectors
- lay back audio to video



### CHASE SYNCHRONIZING

- sweeten audio-for-video
- add ATRs to video editing systems
- synchronize to automated mixers
- slave VCRs for digital audio



### REMOTE TRANSPORT CONTROL

- ours, yours or theirs\*
- our modular remote (to 500') control panels
- your computer, terminal or keyboard
- their\* edit controllers or mixers
- \* CMX, Solid State Logic, Calaway, others



### FULL-FUNCTION AUDIO-FOR-VIDEO EDITING CONTROL SYSTEMS

- cueing, trimming, looping, displaying, jogging, rehearsing, recording, audio event editing, and lots more



FOR DETAILS ABOUT  
SYSTEM 2600 BUILDING BLOCKS,  
CALL, WRITE OR WIRE:

## ADAMS•SMITH



34 Tower Street  
Hudson, MA 07149 USA  
Tel.: 617-562-3801  
NYC.: 516-352-2341  
TWX: 710-347-0096

# Chris Stone



PHOTO: SCOTT LOCKWOOD

*Groundbreaking ceremony, July 10, 1985, at the future site of the Record Plant Sycamore Street Studios.*

**C**hris Stone, owner of the L.A. Record Plant, is a figurehead and a unique visionary in the world of recording. As a graduate of UCLA with a Masters in marketing, he honed his business skills for ten years with General Electric, Mattel and Revlon. In 1968 he opened his first studio and has maintained world class facilities ever since. This year, the legendary Third Street facilities of the L.A. Record Plant are being torn down and a new 2 million dollar studio will open November 15th on Sycamore Street in L.A., where the equally legendary Radio Recorders' Annex operated during the '40s, '50s and '60s.

---

---

## RECORDING'S LEAD ENTREPRENEUR REBUILDS HIS FUTURE

---

---

by David Goggin

A founding member, past president and chairman of SPARS and a consistently high-profile recording industry spokesman, Chris has continually put his reputation and his profits on the line in order to stay ahead of the game. In this interview, he discusses the past two decades and the future of this volatile business.

*You've been a studio leader now for almost 20 years—how did it all start?* Well, in 1967, I was national sales manager for Revlon Cosmetics and met a very exciting fellow by the name of Gary Kellgren. We got together because my wife had just had our first child and his wife was about to have their first. A mutual friend introduced us so the ladies could talk about having



babies. He and I had nothing to talk about—he knew nothing about my business and wasn't interested so I started asking him about his work. At the time he was working at Mayfair, a little studio off Times Square. He invited me down and at my very first session I saw a guy inside a grand piano with his legs sticking out—he was strumming the strings. It turned out to be Frank Zappa doing a Luden's cough drop commercial with backwards coughs. The second artist I met was Jimi Hendrix—Kellgren used to do all his work. I noticed that Gary worked very, very hard.

*He was engineering?*

He was one of the best audio engineers in the business. He did Dylan, Zappa, Hendrix, The Beatles. You name them, and he probably recorded them in the '60s and early '70s. He helped to find Three Dog Night—took me to see them in a tiny little bar one night. He was a brilliant audio technician in the sense that we would discover musicians, work with them, absorb their music and become part of their scene. In those days, a patchbay on a console was Gary getting underneath with a soldering iron and pulling a wire off one place and sticking it somewhere

else. He was very busy and I was getting bored just hanging around, so one night I asked him to let me into the bookkeeping office.

“The record labels are driving the studios out of business. We have to make our money in the visual business.”

*Was this his studio?*

No, but he was the only engineer. He even cleaned up at night. It was just a little one-room studio. He worked six or seven days a week and made \$200. That got to me because I could see there was a lot of business going on. I looked at the books and the owner was billing about \$5,000 a week. The next day I grabbed Gary and we went to see this turkey. When we walked out of the meeting, Gary was making \$1,000 a

week. Well, of course, that endeared me to him and he started talking about how he always wanted to have his own studio. I was getting bored with Revlon so we decided to start a studio. We borrowed \$100,000 and called it The Record Plant. We opened the first room on March 13, 1968. The more I saw, the more I liked, because at the time there were very few business people involved. It was mostly just engineers, techies, artists and people who wanted to get in and rub elbows with the “in crowd.”

We ran the studio like a real business from day one. We had everything covered because Gary knew the recording side of things and I knew the business side. Our first hit was *Electric Ladyland*, our first big mixing session was for *Woodstock* and our first remote recording was the *Concert for Bangladesh*.

*How did you get to Los Angeles?*

Even in 1968, we could see that the business was moving out here. We didn't have enough money to come out, so we merged our company with Television Communications Corporation, a cable TV company that was looking to integrate into the music business. Kellgren came out in 1969 and built

# Why do Jensen Transformers have Clearer Midrange and Top End?

The high frequency rolloff of a *Jensen Transformer* is optimized, by computer analysis, to fit the *Bessel Low Pass Filter* response. This means *minimum overshoot and ringing* and *flat group delay* for best *time alignment* of all spectral components of the musical waveform.

In other words, the harmonics arrive at the same time as the fundamental frequency.

The result is a clear midrange and top end without the harsh, edgy sound which has been one of the most objectionable sonic complaints about transformers.

There's no "midrange smear."

Only *Jensen* has this benefit of hi-tech computer optimization.

Visitors by appointment only. Closed Fridays.

10735 BURBANK BOULEVARD • NORTH HOLLYWOOD, CA 91601 • (213) 876-0059

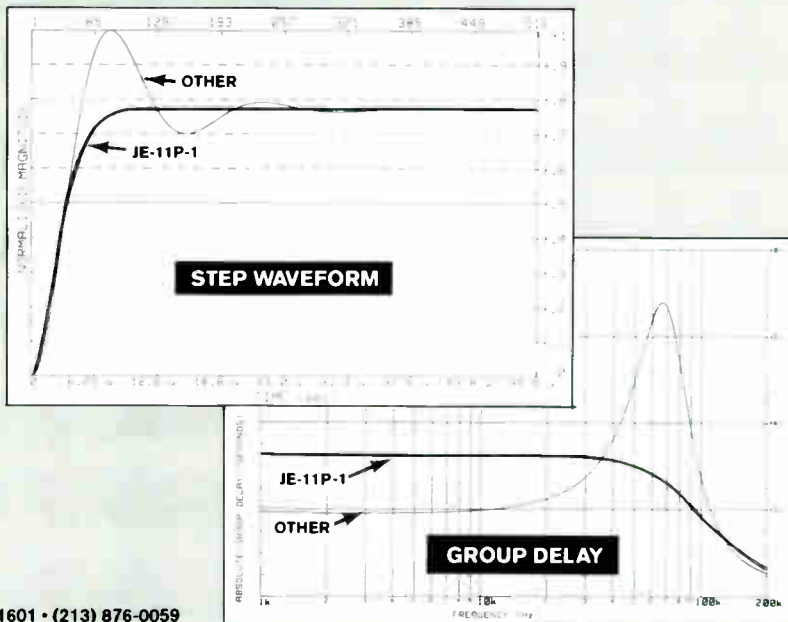

**jensen transformers**  
INCORPORATED

Circle #103 on Reader Service Card

**YOU DESIRE/L.D. SYSTEMS DESIGNS  
YOU REQUIRE/L.D. SYSTEMS PROVIDES**

Our showroom has recently been enlarged to accommodate a constantly increasing range of pro-audio and lighting products.

Our sales staff, designers and technical support people are field and factory-trained professionals. L.D. Systems will design, construct and install the best system for your needs, studio to stage.

**YOU EXPECT/L.D. SYSTEMS SURPASSES**

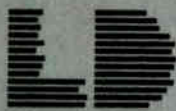

**SYSTEMS**

467 West 38th, Houston, TX 77018

(713) 695-9400

audio and lighting sales, service and rentals

Adams-Smith  
Agfa  
AKG  
Amek  
Ampex  
Ashly  
Audio-Technica  
Community  
Crest  
Crown  
dbx  
Deltalab  
Electrovoice  
Eventide  
EXR  
HME  
Interface  
Ivix  
JBL  
Klark-Teknik  
Lexicon  
Micmix  
MXR  
Orban  
Otari  
QSC  
Ramsa  
Scotch  
Shure  
Soundcraft  
Tascam  
TurboSound  
Urei  
Ursa

Circle #104 on Reader Service Card

**MIDCOM**  
*known in the Southwest  
by the companies we keep*

And by the companies who keep us.

Only by meeting a wide range of equipment needs has Midcom, Inc. grown as the pre-eminent supplier of prestige audio equipment in the Southwest. Exclusive dealer for prestige lines like the Otari MTR 90 24-track recorder and NEVE consoles. Studios and broadcasters all over the southwest depend on Midcom for expert consulting, engineering and installation. Midcom's inventory features Otari, Soundcraft, JBL, Lexicon, Neumann, Auditorics and Sound Workshop. The wide variety of high quality audio equipment is why, in the Southwest, demanding audio professionals depend on Midcom.



PRODUCTION AUDIO EQUIPMENT AND FACILITIES FOR THE SOUTHWEST

**Midcom, Inc.**

(214) 869-2144

Three Dallas Communications Complex

Suite 108/LB 50/6311 N. O'Connor/Irving, TX 75039-3510

Circle #105 on Reader Service Card

the L.A. Record Plant and I stayed in New York and ran the New York operation, which by then had three rooms booked solidly. The L.A. studio opened December 4, 1969 and we sold the New York studio in 1972. We built the Sausalito studio and opened that on October 31, 1972. We had two rooms in L.A. and rented out the rest of the building to a company shooting a Saturday morning kid's show with chimpanzees—which made a crazy business even crazier. I had moved out here full time by '72. By '74 we had two rooms in Sausalito, four in L.A. and three remote trucks. We were cooking right along, shuttling people back and forth from Sausalito, which was like a country club, and Los Angeles, where we would do strings and horns and the bigger sessions. We used to say the rooms sounded the same, but acoustics in those days wasn't the science it is today. We hired Tom Hidley when he was a maintenance man at TTG and made him our chief technician in 1970. We helped him build his first studio and set him up in Westlake Audio and over the years he has rewarded us by always designing our studios.

That's a thumbnail history of the early days. By 1975 we were really cooking and then in 1977 we had a major trauma—Gary drowned in his swimming pool, and then in '78 Studio C burned down. But things have gone well since that difficult time.

*When did you let Sausalito go?*

We sold Sausalito in 1980 because the business in the Bay Area had just died and gone to heaven. We decided to focus entirely on the L.A. operation.

*What have the major technological changes been over the past 20 years?*

In 1965, 8-track was the new thing, with most of the work still being done with 4-track recorders. When we entered the business in 1968 we were the only studio in New York with 12 tracks. It gave us a competitive edge, because we could take an 8-track tape and add four more. Scully came out with the 12-track machine that used one-inch tape with the heads closer together. Once we got someone in and turned their tape into a 12-track recording, they couldn't go anywhere else because the machine clipped the edges off the eight tracks to make room for four more. Gary designed a console in '67 that was 20 in and 12 out—eight just for effects. It was the first console with what Gary called the "juke box," which we now call the monitor section. The reason Gary built it was so that the producers would have something to play with and leave him alone to do his engineering. The producer could have a great time without having any effect



on what was actually being recorded.

By 1972, the business was solidly 16-track and by '75 it was 24, which makes the most sense for two-inch tape. Jeep Harned and MCI tried to get a three-inch tape machine going with 32 tracks, but the reel weighed about 22 pounds—you could hardly lift it off the recorder. It never came to pass. We were one of the first studios around with 24-track, and in '79 the first to move into multi-track digital recording.

Acoustically speaking, I think Record Plant has made some big contributions. When we started out, studios were hospitals—fluorescent lights, white walls and hardwood floors. Kellgren turned them into living rooms and the greatest compliment an artist could pay us was, "Goddamn, I'd like to live here!" And sure enough, he would. Our famous jacuzzi room came about because Gary wanted to build a swimming pool in the backlot and I wouldn't let him. At the time, I used to come out once a month to take care of business, because Gary was the absolute antithesis of the business person. We were well-suited to each other, and from an aesthetic angle, he created the living room environment which is the norm today.

In the beginning, there was no such thing as serious acoustics. Our first studio in New York had a flat piece of glass with five Tannoys above, and behind the mixer was a Sears & Roebuck curtain hung in front of a window. Today, acoustics is an exacting science and Hidley, for example, is now building rooms with absolutely no monitor equalizers that are plus or minus 2dB, which is what we will have at our new studios on Sycamore in Hollywood.

Tom has also designed some new monitors that are unbelievable. We felt they would be well suited to film work so we sent Bruce Botnick over to Hawaii to check them out. Bruce made a name for himself as The Doors' engineer, then went on to producing and for the past few years has been doing the music for films like *Raiders of the Lost Ark* and *Poltergeist*. The studio in Hawaii was the nearest one with the new room design and the new monitors. Bruce took his film music over there and did his mixing and came back raving about the quality for both films and records.

*What is so special about the new Hidley rooms?*

Well, he started building rooms back in 1969 with our Studio A. His first room outside the Plant was for Cherokee (which was then MGM Studios). To date, he has built over 400 studios in just about every country of the world but Russia, and he's just made a deal to build one there. What is special is the shape of the room, and the position of

the mixer. The monitors are focused precisely at the mixer's ears and the sound is clean, and then dissipates into traps behind so there is no bounce back effect. He also takes into account the large consoles with their massive reflective areas. Our new rooms are designed for 56-input SSLs with a side car, as we call it. It's basically the SSL 4000E console expanded for the needs of film scoring, such as an 8-track buss to go directly to mag recorders, with eight additional cue systems because of the complexity of working with orchestras. The problems of film scoring are very different from the problems of making good records. The record business has pushed the state-of-the-art to the point where it is very exacting, and

now the visual business—film and video—has to catch up. Film and video have become a very important part of the music business since the record industry went in the bag in 1978.

Here's a classic example: when we took over the Paramount Stage "M" from Glen Glenn, the room had not been touched between 1968 and 1982. Our Studio A had gone through three sets of monitors and four major acoustical changes in that same period of time. Major changes have taken place in the past 20 years. When we started we had flat plaster walls, hardwood floors, no goboes, no traps, no drum booths, no string rooms, no variable acoustics—nothing. The business has become very exacting.

## ULTRA PARAMETRIC



## PE 15 PARAMETRIC EQUALIZER AND NOTCH FILTER

The PE 15 brings an unprecedented degree of performance capability to the single-space parametric equalizer format:

- Five complete bands with four-octave frequency sweeps
- Bandwidth range from 1.5 down to 0.03 (1/30) octave
- +15dB boost and -20dB cut for notch filter capability
- Bands 1 and 5 switchable to shelving mode
- .¼" and three-pin balanced/unbalanced inputs and outputs
- Up to 20dB input gain for low level EQ such as electric guitar or bass

Backed with low-noise/low distortion circuitry and reliable Rane construction, the PE 15 would be a studio, sound reinforcement or broadcast "must have" at any reasonable price. With a suggested list price of only \$389, however....! See, hear and covet a PE 15 for yourself at your nearest Rane dealer.

**RANE**  
CORPORATION

6510 216th SW, Mountlake Terrace, WA 98043 (206) 774-7309

CANADA: Head-water Ind., 635 Caron Ave., Windsor, ONT. (519) 256-5665

Circle #106 on Reader Service Card

At the same time, the listener has become very sophisticated because of these giant strides in recording science: new acoustical design, digital recording, new echo devices, limiters, gates—things we have taken from the missile industry where everything long ago went solid state. When I first met Kellgren, he was working on an all-tube console with no patchbay. No one would work in that environment today.

*I'd like to talk about survival in this business. It seems that the key is to stay in touch with the technology, ripping things out and replacing them when needed—a frightening thought for studio owners, or those planning to build. How do you stay in business? If you don't bet, you can't win. There*

have to be pioneers and for many years that has been our position. We still are pioneers, but in a different way. We won't take the chances we took in the past on new equipment, because we got burned too many times.

*Is that because the financial boom of the mid-'70s is gone?*

Oh, yeah. Also, things were changing quickly and the prices were more reasonable. I bought my first 24-track for \$17,500—today, a 24-track Sony digital machine costs \$104,000. When we built Studio A plus a half-finished Studio B in New York in '68, it cost us \$80,000. Thirteen years later we opened Studio D in Los Angeles for \$1,300,000. When we opened the New York studio we charged \$85 an hour; thirteen years

later we charged \$155 an hour. There is no parity between those numbers. This is why there has been such a fatality rate in the studio business. And this is why the business that makes its money only from records is doomed.

*Which brings us to the new visual business...*

Absolutely. Unless the record companies stop grinding down the studios, the studios are not going to be able to keep up with the technology. Survival in the '80s is based on the technological improvements and the fact that the visual industries have become music conscious. Five or six years ago, music was an "unfortunate necessity" for the film business. Today, thanks to films like *Flashdance*, *Footloose* and even *Urban Cowboy*, music is important. *Purple Rain* sold 9 million albums. *Flashdance* has sold almost a million videocassettes and 7 or 8 million albums. The record feeds the movie, the movie feeds the record. There's a lot of money to be made and that's what the film business is all about. It's run by businessmen. The recording studio that is unable to compete for the business, because they don't have the money to stay technologically current is going to go out of business. The record labels, in my opinion, are driving the studios out of business. We have to make our money in the visual business—the video and film people are the ones who will pay for the technology and the acoustic improvements that we must continually put in. We plow back every penny of our profit. I am not a rich man—it all goes into improvements and more equipment.

*And now you're going to demolish this great museum of musical history and start all over again...*

Well, people have said that I'm destroying a shrine, but it's really not true. There are magnificent memories, but it's like a person who is a car buff and his favorite car starts to get a little rough around the edges. He has his eye on a newer and better model. Record Plant, on Third Street, has reached the point where if we wanted to keep it we would have to eventually redo all the acoustics—a multi-million dollar undertaking. Because the nature of the business has changed and gone visual we would have to redo the entire place in the next 18 months. The success of the Compact Disc, the coming digital cassette, the laserdisk DRAW system with read and write capability—these are all things that require absolute clarity in recording, both from the technology the acoustic design of the studio. Dan Wallin redesigned Studio "M" on the Paramount lot with variable acoustics, so that we could record a 30-piece orchestra, or a 100-piece orchestra. We are able to change the room, with louvers and

## Bo Tomlyn's KEY CLIQUE Announces The ADVANCED DX-7 LIBRARY

Bo Tomlyn, well known for synthesizer programming in studio and in-store clinics, now offers his NEW ADVANCED DX-7 LIBRARY to you! The highest quality sounds at a price everyone can afford! Bo Tomlyn has programmed for: Toto, The Jacksons, Bruce Springsteen, Lionel Richie, and others.

The KEY CLIQUE Floppy DOS™ (Disk of Sounds) contains 128 new sounds for your DX-7 every month. New banks of orchestral, analog, piano, strings, lead line, split keyboard foot-controlled programs, and more expand your DX-7 capabilities to levels never before experienced. Each month's DOS Directory features valuable playing and programming hints. KEY CLIQUE's Newsletter and Question Ear™ will allow you to share your ideas with members worldwide and participate in the development of future KEY CLIQUE products. (\$50.00 per month or \$240.00 for 6-month subscription.)

### SYS / EX™

The first software which allows you to store synth and drum programs on one floppy disk. SYS/EX eliminates the need for separate software programs for each piece of equipment you own. SYS/EX is excellent for saving and loading your KEY CLIQUE library. (Note: SYS/EX only compatible with MIDI systems-exclusive equipped gear.) Priced at \$85.00 (Non-members \$125.00)

### What you need to "Get On Board" with KEY CLIQUE:

- The Floppy DOS is a voice library for the DX-7. You'll need a DX-7! • The Floppy DOS is available for Apple, Atari, Commodore, IBM, Macintosh, Yamaha QX-1 and CX-5 (Cassette). You'll need one of those!
- If your computer isn't already MIDI'ED, you'll need the KEY CLIQUE MIDI Interface Card (or another manufacturer's card designed for your specific computer).
- Finally, you'll need software to enter the KEY CLIQUE library into your synthesizer.

KEY CLIQUE is compatible with the following software: KEY CLIQUE's SYS/EX, DX-Pro, DX-Heaven, Mimetics, Hybrid Arts MIDI Patch, Personal Composer and Music Works.

NAME _____			
ADDRESS _____			
CITY/STATE _____		ZIP _____	
PHONE NUMBER ( ) _____			
<b>Please Check the Following</b>			
1. Computer you currently use	Apple	Atari	Commodore 64
	Qx 1	CX 5 (Cassette)	IBM
2. Software you currently use	SYS/EX	Mimetics	DX Pro
	Personal Composer	Hybrid Arts MIDI Patch	DX Heaven
3. MIDI Interface Card you currently using	KEY CLIQUE MIDI Interface Card	Mimetics	
	Roland 401	Passport Designs/Yamaha	
	Other		
<b>Please Send Me:</b>			
1 Month Subscription	\$ 50.00		
6 Month Subscription	240.00		
SYS/EX (Non-members \$100)	85.00		
CA Residents Add 6 1/2% Sales Tax			
<b>TOTAL AMOUNT ENCLOSED</b>			
(Please allow 5 weeks for delivery)			
Mail check or money order to		MIX	
<b>KEY CLIQUE, INC.</b>			
3960 Laurel Canyon Blvd. Suite 374			
Studio City, California 91604			

### How To Subscribe:

Please fill out the subscription coupon with your check or money order and send to



3960 Laurel Canyon Blvd. Suite 374  
Studio City, California 91604  
(818) 845-7866

KEY CLIQUE dedicated to musicians  
at a time when equipment is  
becoming harder to understand

Although the programming of this product provided services for the aforementioned groups, their inclusion in this ad does not constitute an endorsement of this product.

© 1985 Key Clique, Inc.



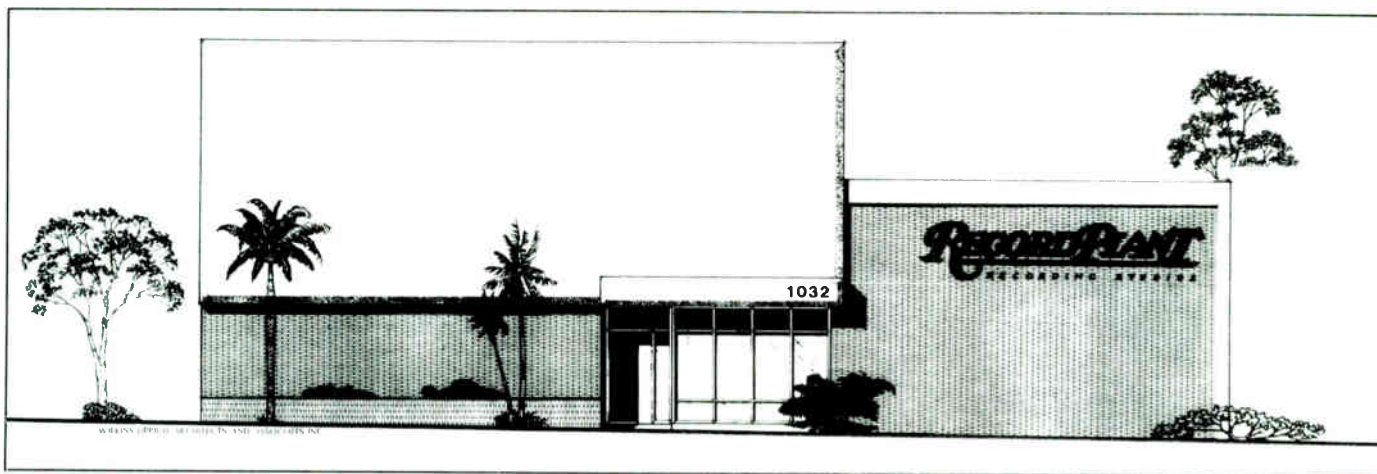

Rendering of new Record Plant studios, designed by architect Leslie Lippich.

goboes, on the spot, for the particular session. We can't do that at the studio on Third Street. And we can't modify the studio to keep up with recent developments in acoustic design.

Another major reason for our move is the fact that synthesizers are playing such a role in both records and films. I just lost a big movie score date because our control rooms were not big enough. The composer had so much equipment, the only control room big enough was "M," and that was booked. So, we're building a new facility that

accommodates these changes in the industry.

Because our Third Street location was such valuable property, we got a price that allowed us to finance the new facility. We've made the decision to build only two rooms there and we feel that all the innovations in this business are still coming from the people making records. They are the innovators that will cross over and make the visual music, the music of tomorrow. We want to attract those people and also be able to do the leading films and video pro-

jects. We are building a medium-sized room for records and television, and a very exotic mix overdub room with an attached electronic music room and production transfer room that allows you to transfer anything to anything, for video, for mag, for analog or for digital. The internal dimensions of our control rooms are identical—31 feet deep and 29 feet wide. To accommodate synthesizers, they are even larger than our Stage M control room.

The electronic musicians going directly into the consoles must hear as

# BRYCE and TASCAM

## A Sound Partnership

The inside story? At TASCAM the business is providing tools for audio production that deliver high quality performance at an affordable price. At BRYCE the business is providing accurate and timely product information by an experienced technically expert sales force that is focused on your individual needs. Tascam Series 30 recorder/reproducers bring you 1985 technology at 1975 prices. Series 30 heads are made of new, higher density permalloy material which is 30% harder and has at least 20% longer life than previous permalloy compounds. Erase heads are made with a high beta material that provides 25% higher magnetic flux density at saturation than previous heads. You get more



complete erasure for quieter tapes overall and less leakage on overdubs. On the Tascam 38 heads are mounted on a precision diecast and machine blocked which keeps them aligned. Tapes won't swish, nor will high frequencies disappear due to inter-track phase cancellation. The mount is so rigid that after heads are aligned you can plug in a replacement assembly in the field without extensive mechanical realignment. The 38 operates at nominal 15 ips and uses an 8 track 1/2" format. It comes with IEC record/play equalization. To find out more about Tascam Series 30, call Bryce at 212-575-8600 or out of state—1-800-223-1346. BRYCE—34 years of experience making the complex familiar.

TURNING TECHNOLOGY INTO ENJOYMENT

# BRYCE

115 WEST 40th STREET · NEW YORK, N.Y. · (212) 575-8600

Circle #108 on Reader Service Card

**KABA**  
**REAL TIME**  
 AND DOUBLE SPEED  
**4-TRACK**  
**CASSETTE**  
**DUPLICATION SYSTEM**

Produces true audiophile quality cassettes from any master-cassette, digital, reel-to-reel — at a fraction of the system cost of a 64 X bin system of equal production capacity.



Call or write for details



AN AFFILIATE OF  
**KENNETH A. BACON ASSOC.**  
 24 Commercial Blvd., Suite E  
 Novato, CA 94947, USA  
 415-883-5041  
 800-231-TAPE



Chris Stone

well as the engineer. You design the control room so that you have a "sweet spot"—the monitors are aimed at the mixer's ears and behind him is a triangular listening area. For the new Sycamore street rooms we will be able to have three or four synth players behind the mixer, and they will all be able to hear what the mixer hears and to see a visual playback. Playing with earphones is limiting and we are doing away with it for applications such as these. Outside of the control room you still need an acoustical environment. For example, with the "Quantum Leap" project we recorded, which had nine synth players, we still had live vocals and real drums. By having a large control room and a relatively smaller "studio" area we are able to have the best of both worlds—an acoustical, technological environment with the latest in computerized solid state toys.

*Have automated consoles helped you to diversify?*

Absolutely. We are completely SSL—we were one of the first studios to have the consoles and became their bell cow. At one time we had more SSLs than anyone in the world except the BBC. We've worked very closely with the SSL group and are great believers in their technology. With total recall every single knob and button pops up on the television monitor so that you can reset the entire console with its 56 inputs in no more than 20 minutes. You can move a number of clients in and out during the day and still give them the feeling of a locked-out studio set up.

*What's significant about the new Hidley monitors?*

He's come up with a design and cabinet composition that is astounding. They're actually called the Hidley/Kino-

shita monitor after the Japanese fellow who was co-developer. They use a Japanese wood called Apitong—it's so dense that the cabinets weigh almost 200 pounds. The speakers sit on concrete shelves. Mass is the key to good speaker sound and that's part of the reason for no need of equalization in these new Hidley rooms. We will have the new Meyer 833 programmable monitors as well so that we can satisfy any ears. With the Meyer monitors you can make the control room sound like Carnegie Hall, or a closet if you want. The client can have the purity of the Hidley sound or the versatility of the Meyers—which figures in perfectly with our new company, Audio Intervisual Design.

*It's an interesting angle in this studio survival game—your own pro-audio equipment company, with the studio as the working showroom for the products...*

We've always had a great deal of trouble explaining to the manufacturers exactly what we need. That's one of the reasons a group of us formed SPARS a few years ago—we saw an ever widening gap between the manufacturers and the studio users. Audio Intervisual Design was set up so that we could introduce the visual industry to new audio equipment and digital devices in particular. It's a systems company aimed at bringing the visual industries up to the speed of the audio industry. We also made the decision that A.I.D. would not handle any products that are not used in The Record Plant. If it hasn't passed the test with our clients—because we only use independent engineers—then A.I.D. won't sell it. We extend this testing through our rental company, Livingstone Audio, so that the new gear is given an acid test in the outside world. We just did it with the new LYNX time code modules and Tim Jordan Rentals. Tim does a lot of high-end synchronization of multi-tracks with video and film equipment. He tried them out and bought six. The LYNX system is a very good example of the type of product that A.I.D. represents: Sony digital recorders, format converters, computer control systems, etc.

Studios have to be very careful, economically, with their investments in equipment. The rental business gives them a chance to try before they buy, rather than waiting for a demo. They may want to try something with their favorite clients before they make the cash commitment. A.I.D. can serve a very valuable function, and can afford to invest in equipment, knowing that it can make the money back through rentals, whereas the studio can't afford a capital equipment decision mistake. With the new studio, the rental company and A.I.D. we are able to test



equipment and then offer specifically-designed systems packages that make sense to studios. We can even go so far as to offer complete studio designs—being the first studio in the country with the new Hidley design, and Tom's representative in the 11 western states, we can show them the whole concept in practical everyday use.

*Where do you see the audio industry in the next ten years?*

Well, I could get out of the business right now, sit back and be a consultant, but I'm not ready to retire. I'm very excited about the future of audio. I've been in the current facility for 16 years and it's time to move on and remember it as a wonderful place rather than one that starts to fray around the edges. I expect to be in the new studio on Sycamore for the next 16 years.

Ten years from now, the major changes will no longer be in acoustics. The major changes will be in the musical instruments, namely synthesizers, and in the way we record, which will be using hard disk. The wave of the future will be built around systems like Lucas' "SoundDroid," and similar concepts that will allow everything to be done within the control room. Musicians will literally be able to phone in their parts. A lot of composers are building very sophisticated electronic music studios in their homes right now. In the next couple of years they will be able to hook up a modem and phone in their music to the studio. People will be able to work wherever they like and send it to a central location—the studio.

I think that sprocketed film will disappear, high definition TV will come into the forefront, large video screens will become common, and audio/visual media will be delivered via satellite. I just saw the new digital cassette recorders in Japan. They record at 32K, for the satellite, 44.1, the AES standard, and at 48K, the audiofile sampling level.

*It sounds like the future recording studio will be more of a master control center, an audio processing plant.*

Exactly. It will be a processing point crammed with technology. Our two new rooms cost \$1.5 million per (including equipment)—ten years from today a room will cost at least 2 or 3 million. Recording will be very decentralized and the studio will have to directly receive material from sources all over the world, although mixing and critical listening will always require the creative touch of the engineers and producers. I'm very glad that we have had a solid history of remote recording, because one of the only recording techniques left requiring an artful approach will soon be the art of mike technique on location. ■

## Don't lose your head

**Recondition It The Professional Way**  
**AMP Services Will Make Your Worn Magnetic Recording Heads Perform Like New Again!**  
**Just Compare Our Quality, Service and Prices To Anyone!**

Featuring:

- Optical Alignments
- New Replacement Heads Available
- Ultrasonic Cleaning Of Flutter Filters
- Free Written Evaluations
- 24 Hour Service
- All Work Guaranteed

**AUDIO MAGNETIC PROFESSIONAL SERVICES INC.**



(305) 964-5414 • 6270 Wauconda Way West • Lake Worth, FL 33463

Circle #110 on Reader Service Card

## Complete Sound Reinforcement Service



United "State of the Art" Packages

Audioarts • Eventide • Otari  
 Tascam • DeltaLab

SALES • RENTAL • SERVICES

912 North Midkiff  
 Midland, Texas 79701  
 (915) 684-0861

Circle #111 on Reader Service Card

## —FROM PAGE 8, SESSIONS

**Mastering** New York: new single releases by **The O-Jays**, **Grand Master Flash** and **Shannon**; Also, **Dom Romeo** engineered the new **Newcleus** single for Sunnyview Records... **Graham Nash** was in at **Longview Farm** (North Brookfield, MA) recording and mixing his first solo album in several years. **Stanley Johnston** and Grammy-winner **Craig Doerge** produced. **Jay Parti**, **Jesse Henderson** and **Bill Ryan** shared the engineering chores. Also, the **J. Geils Band** finished recording and mixing the title soundtrack for Columbia Pictures release **Fright Night**. **Steve Marcantonio** engineered... The jazz duo **Pendulum** were in **Inner Ear** cutting material from their current repertoire. Production was handled by **Ted Piltzecker** and **Jim Hodgkinson**. Engineering was handled by **Steve Vavagiakis**... At **Secret Sound Studio** in NYC, **The Spinners** were in with **Warren Bruleigh** and **Bob Brockman** engineering... **Eastern Standard Productions'** cassette tape duplication facility recently completed duplication for the **King Snakes' Take a Chance** album on Blue Wave Records. Produced by **Mark Doyle** and engineered by **Bill Scranton**, the entire project was recorded digitally... At **Classic Sound**, NYC, recent album projects included the **Joanne Brackeen Trio** for Concord Jazz, **Carl Jefferson** producing; and albums by **James Williams** and **Billy Pierce** for Sunnyside, **Francois Zalacain** producing... **UTFO** was in at **Sound Heights** in Brooklyn recording "Pick Up the Pace" produced by **Full Force**. **Questar Welsh** engineered, with **Shaun James** assisting... At **39th Street Music** in NYC, **Billy Terrell** produced dance mixes of **Donna Garraffa's** "Midnight Hunger" and "One Two Three," with **Stephen Guardoli** engineering... At **Power Play Studios**, Atlantic Records turned the new **Spinners** single over to producer **Patrick Adams** to do overdubs and mix the tracks... At **E.A.R.S.** in East Orange, NJ, **Isley, Jasper, Isley** completed their new album for CBS Records. The entire album was engineered by **Dave Dachinger** and assisted by **Tom Vercillo**... Recent clients at **Evergreen Recording** in NYC included **Bill Laswell** with **Afrika Bambaata** for Tommy Boy-Anton Fier for Celluloid, and **Sly & Robbie** with **Gwen Guthrie** for the Taxi Gang... At **Michael Levine's Studio** in NYC, tracking was completed on a segment of underscore to be used in the movie **The Color Purple**. **Sy Johnson** was arranger/producer with **Quincy Jones** as executive producer. **Michael Levine** was engineer and violin soloist...

## SOUTHEAST

**Robin Gibb** was in Miami's **Criteria Studios** putting the finishing touches on his latest solo album. His brother, **Maurice Gibb**, along with **Tom Dowd**, were the producers with **Dennis Hetzendorfer** engineering and **Lee Shapiro** assisting... **Alpha Audio**, of Richmond, VA, has completed the production of the soundtrack

for a seven-minute multi-image show, **Imagination**, for the Visitor's Center at the Kodak Apparatus Division in Rochester, New York. The **Fantasia**-esque soundtrack was written and produced with a classical feel by **Carlos Chafin** and **Eric Heiberg** of Alpha Audio, and was the first project completed using Alpha's newest acquisition, the Kurzweil 250 computerized musical instrument... At the **Music Mill** in Nashville, **Alabama** cut tracks on their upcoming Christmas album with **Harold Shedd** producing and **Jim Cotton**, **Joe Scaife** and **George Clinton** engineering... At **Woodland Sound Studios** in Nashville, **Charlie Daniels** and his band were in studio "B" completing two more songs for their new album. **John Boylan** produced and **Paul Grupp** was the independent engineer... Recent activities at Atlanta's **Cheshire Sound Studios** included **Illusion** mixing their debut album for Geffen Records with **Jeff Glixman** producing and engineering; and former Dregs axeman **Steve Morse** laying tracks for his upcoming album with **Tom Wright** engineering, **Lewis Padgett** assisting, **Steve** and **Rod Morgenstein** producing... **Jean Knight** completed work for her latest album, **My Toot Toot**, at New Orleans' **Sea-Saint Studio**. It was produced by **Isaac Bolden** and engineered by **Clarence Toussaint** and **Bob Kearney**... At **Morrisound Recording** in Tampa, FL, Bronco Records gathered together several local musicians, along with the Chamberlain High School Choir, to record the theme song for the **National Safety Council for Missing Children**. **Jim Morris** was behind the console... Pianist **Dino Kartsonakis** was in Nashville's **Treasure Isle** recording his new album for Light Records. It was produced by **Nathan DiGesare** and engineered by **Ed Seay** assisted by **Tom Harding** and **Richard Maurant**. Also utilizing the 3M 32-track digital recorder at the studio have been heavy metal artists **Hard Knox** and **Triple X**, both produced by **Tom Harding** and **Tom Gregory**... At **Bias Recording** in Springfield, VA, the Seldom Scene's **Mike Auldridge** did overdubs for **Kate Wolf's** next Kaleidoscope Records LP. **Bias' Bill McElroy** engineered... **International Sound** in North Miami Beach had Styx's **James Young** working with engineer **Barry Mraz** mixing, assisted by **Carlos Santos**... At **Crawford Post Production** (Atlanta) co-producers **Mike Thacker** and **Phil Ehart** put the finishing touches on the soundtrack music for the new Warner Brothers film release **Vacation II**, starring Chevy Chase... **Southern Winds** were at **Wally Cleaver's Recording** (Fredericksburg, VA) working on tracks for their first album with **Stewart Smith** producing and **Peter Bonta** engineering... **North-West Records, Corp.** of Atlanta had writer/arranger/producer **Cirocco** in, who recently completed mixdowns of "Oooh Sha Sha" by **KeeKee**, and "Vicious Rap" by **eze "T"**... Pianist-arranger-composer **Tom Decker** completed three new albums at **The Music Factory** in Mobile, AL: **In Love With Piano**, **The Serindipitydoodah Orchestra**, and **The Steps of Atlantis**... **Steve Schaffer**, presi-

dent of Music Resources and one of Nashville's leading consultants on computerized music production, is currently programming his studio's Synclavier computer synthesizer system for the scoring of the upcoming 20th Century Fox film, **Uphill All the Way**...

## SOUTHWEST

In Willie Nelson's **Pedernales Recording Studio** in Austin, **Aaron Neville** of the Neville Brothers and **Rob Wasserman** of David Grisman's group recorded a bass and vocal duet of "Stardust" produced by **Ray Benson** of Asleep at the Wheel and engineered by **Larry Greenhill** and **Bobby Arnold**. This song was cut as part of a solo album done by Rob Wasserman with various vocalists including Shelly Bentyne of the Manhattan Transfer, Rickie Lee Jones, Dan Hicks and others... **John Wagner Recording Studios** in Albuquerque, NM, finished recording the latest album on Al Hurricane's group **Bandito** for Musart Records of Mexico, **Morrie Sanchez** producing... Noted World Wrestling Federation manager **Jimmy "The Mouth of the South" Hart** was in at **Lone Star Recording** in Austin, recording and mixing songs with producer **Rod Tanner** and engineer **Jay Hudson**... Jazz drummer and Piaste exhibitionist **Toni DuPuis** recently cut tracks at **Darci Sound Recording Studio**, Beaumont, TX... **Studio Southwest** in Dallas had **Leslie Phillips**, a contemporary Christian recording artist, recording her latest album for Word Records. It was a cooperative effort between **Jeremy Smith** (Phil Collins), **Bill Schnee** (Steely Dan, Jacksons) and Studio Southwest... **Mark Felsot** produced **Rockline** (a syndicated radio show) featuring **Robert Plant** for Global Satellite Network in Studio A of **Dallas Sound Lab**. Studio A was uplinked via satellite by the D/FW Teleport to the production studio in Los Angeles, CA, where it was then uplinked to radio stations across the country. Engineer on the project was **DSL's Rusty Smith**... Writer and guitarist **Greg Wietzel** has been recording at **Planet Dallas Studios**. Also **Craig Wallace** and **Bret Reed** have been co-writing for an upcoming album project. Engineering was **Rick Rooney**... At **Sumet-Bernet Sound Studios** in Dallas, **Jim Gasewicz** engineered and produced **The Underground's** debut single, "Double Standard" b/w "Street Light Melody"...

## SOUTHERN CAL

At **Soundcastle Studio Center** in L.A., **Bobby Harris** produced and **F.B. Clark** engineered the **Dazz Band** for Motown with **Elmer Flores** assisting; and **Dennis Lambert** produced **Smokey Robinson** for Motown with **Dennis McKay** engineering and **Bino Espinoza** assisting... Former Eagle **Don Felder** was in at **Mama Jo's** (No. Hollywood)



mixing a tune for the movie *Secret Admirer*, with *Jack Joseph Puig* engineering... *Third Ear Recording* in Solana Beach recorded *Talk Back*, a new band on A&M, at the Belly Up Tavern. The Record Plant truck was brought in... At *Artisan Sound Recorders*, disk mastering engineer *Greg Fulginiti* mastered LPs for *Fletch* and *Secret Admirer*, *Style Council*, *Count Basie*, and others... At *Fast Forward Recording* (Hollywood) the psychedelic group, *Angel of the Odd*, was in cutting a 45. The project was self-produced with *Shepherd Ginzburg* engineering... At *Sigma Sound*, Philadelphia, *Teddy Pendergrass* has been working on his new album for Elektra Records. Production duties have been divided between *Womack & Womack*, *Pendergrass* and *Jimmy Carter*, and *Linda Creed*, *Bill Neale*, and *Dennis Matkosky*. Engineering was by *Arthur Stoppe*, *Joe Tarsia*, and *Peter Humphreys*, assisted by *Randy Abrams* and *Scott MacMinn*... Recent projects at *Crystal Studios* in Hollywood have included *Weather Reports'* *Wayne Shorter* working on a solo album for Columbia, *Howard Siegel* engineering, *Jim McMahon* assisting... At *Rock Steady Studio* in Hollywood, Gap Band lead singer *Charlie Wilson* was in producing a new funk project called *Billy and Baby Gap*, with *R. Xeno* engineering and *Marika Murphy* assisting... *Sound Image Studio*, North Hollywood, had producer *Horacio Lanzi* in with artist *Valeria Lynch* for a new RCA Records release, with *Bryan Stott* engineering... The *Del Fuegos* were in *Sunset Sound Factory* working on their new album for Slash Records. *Mitchell Froom* produced, with the engineering handled by *Dennis Kirk*, assisted by *Troy Krueger*. Also, *The Bangles* laid down tracks for their new album, with *David Kahne* producing, *Tchad Blake* engineering, with assistance from *Mike Kloster*... At *Group IV Recording* in Hollywood, singer *Keeley Smith* put down tracks for a new Fantasy Records album with producer *Richard Bock* and engineer *Dennis Sands*, assisted by *Andy D'Addario*... At *Conway Recording*, Hollywood, *Charlie Sexton* completed his MCA album with *Keith Forsey* producing and *Mick Guzauski* engineered with assistance from *Richard McKernan* and *Daren Klein*. *Burt Bachrach* and *Carol Bayer-Sager* were in producing *Dionne Warwick's* Arista project. Mick Guzauski engineered with assists from *Daren Klein* and *Richard McKernan*... *Lee Majors* was in *Harlequin Studios* in Northridge with X-Ray Productions recording the theme for the *Stuntman's Awards*. The theme was written and sung by Ray Kennedy (writer of "Sail on Sailor"), and *Paul* and *Jeff Stillman* manned the console... At *Skip Saylor Recording* engineer *Skip Saylor* was in doing overdubs for Motown Records female group *Pal*. *Curtis Nolan* and *Kim Bullard* produced the project... At *Monterey Sound* in Glendale, *Bill Maxwell* was in producing composer-artist *Bob Ayala* for an upcoming LP. Engineering was by *Win Kutz* and *Christopher Banniger*

Get into the *Mix!* Send your press releases to: *Sessions/Studio News, Mix Magazine, 2608 Ninth Street, Berkeley, CA 94710.* Photographs are also welcome and will be used as space permits.

assisted by *Matthew Warnick*... *Mark K. Smith*, producer for such artists as BTO, Rick Springfield, Dwight Twilley and Patrick Simmons, worked at *Clover Studios* (Hollywood) with a new pop group from Texas called *The Kids*. Assisting was *Squeak Stone*... *Geno Austin* put down tracks at Burbank's *Pisces Soundworks* for his upcoming release; *Jae Jarrett*, *Steve Dancz* and *Marvin Valentine* produced; *Steve Thume* engineered... *Mikey Davis* was at the controls at *Encore Studios*, Burbank, with the rock group, *Aircraft*, produced by Motley Crue engineer, *Duane Baron*... Recording at *OTR Studios* in Belmont was oboist *Russell Walder*. It will be his second album on Windham Hill Records...

## CHEROKEE RECORDING STUDIOS WISHES TO HONOR AND THANK THE FINEST TEAM OF PROFESSIONAL STAFF AND ASSOCIATES IN THE RECORDING WORLD

Keith Albright	Anna Haddon
Jim Amlotte	Robin Hart
AmpeX Tape Division	Cliff Kane
Audio Affects	Lon Lamasters
George Augspurger	Lightning Messenger Service
Tom Biener	Con Merten
John Bogosian	Tim Mongovin
Steve ("CoCo") Brandon	E. L. Payne Air Conditioning
Alan Brunswick, Attorney	R.C.A. Communications
Burbridge & Mehlworm, C.P.A.	Sylvia Reyes
Milton Chan	Tim Schaeffer
Scott Church	Brian Schueble
Phil Dapeer, Attorney	George Seaman
Brian DeFrew	Jim Simon
David Eaton	Greg Thompson
Chuck Ferry	Brian Van Leer
Toby Foster	Mark Wennar
Eric Frost	Toby Wright
Garth Frost	Brent Yochem
Jeff Gilbert	

Circle #112 on Reader Service Card



SUNNY DAYS  
FOR

# SOUTHERN CALIFORNIA

## S · T · U · D · I · O · S

by **Linda Johnson and Blair Jackson**

These are interesting times for the record business. Big acts are selling at nearly unprecedented numbers, and both Gold and Platinum certifications have been on the rise for the last couple

on the vine, but then, to a degree, it has always been that way.

The fact that record companies are being more cautious in their signings generally signals rough days for recording studios, but there are other factors at play here that have conspired to

the lucrative youth market into the theaters by lacing their films with contemporary rock and roll. And what smart producer would balk at that? Not only does a hit song from a film frequently generate business for a movie, but successfully landing a video of a song from a film on MTV or the other music programs is like getting three-plus minutes of free advertising for the film. From Eddy Grant's title tune for *Romancing the Stone* to Pat Benatar's current hit "Invincible" (from *The Legend of Billie Jean*) the formula for the movie-video has been to show a lot of clips from the movie surrounded by not very much of the singer. And because most soundtracks try to use several different artists (to maximize the possibility of having more than one hit, and hits among different listening groups—pop, black, AC, etc.), some studios are finding that there is more smaller work coming their way—just a song or two from this or that band. This, in turn, can lead to more work for both artist and studio. A relative unknown who lands a song on a popular soundtrack album instantly improves his or her chance at getting an album contract. Would people like Michael Sembello or John Paar be considered viable artists if they hadn't scored hits with songs from popular "youth" films (*Flashdance* and *St. Elmo's Fire*, respectively)? Possibly, but having the film tie-in certainly didn't hurt.

Across the board, we see studios increasingly striving to accommodate the demands of the video age. If some of the grandiose plans involving shooting stages and multiple camera purchases of a year or two ago have been tempered somewhat in the intervening period, there is still a boom market in



*Sound Affair Recording*

PHOTO: STEVE BROADDUS

of years. Quite a few new groups have successfully broken through to the public thanks to a gradual opening of radio playlists (in some markets) and, of course, the popularity of MTV. Yet one also senses that not as many new bands are actually being signed and less money is being spent on promotion for new bands, meaning that in most cases, only groups and performers that show some immediate response from radio and MTV ever have a chance of keeping a record alive for more than a few weeks. A lot of good music is dying

keep most of the larger studios on the upswing. For one thing, the continued strength of independent labels has kept many rooms filled; artists may not be getting giant signing bonuses from these smaller companies, but in many cases they are at least recouping their recording costs, which is good news for everybody. But more important in the continuing health of the studio business has been the massive upsurge in rock soundtracks for films. The past year has seen literally dozens of big budget Hollywood films trying to draw



synchronization equipment, and in both video and film there is an increasing understanding that quality audio is more than just a desire—it is a must to compete in a decade that is seeing unprecedented advancements in both professional and consumer electronics.

At The Complex in Los Angeles, studio manager Richard Salvato reports that business has been very good, with the studio attracting a broad cross-section of clients. "In word-of-mouth, this is one of the studios in the top five percentile in the United States," he boasts, and a look at who's been using the facility recently would seem to back him up. Prince, his Purple Oddness himself, was in working on a secret project (as usual). He had used one of The Complex's two soundstages to rehearse before his last tour and liked the place well enough to come back for more work. Among the other artists who have worked there this summer are Sting, Pat Benatar, and Linda Ronstadt (making her third record with master orchestrator Nelson Riddle). One of the soundstages has gotten a full workout from the production of F-TV (a parody of you-know-what, as well as a generally irreverent comedy show-to-be, profiled in the April issue of *Mix*). In addition, The Complex has its own touring PA system; at last report it was on loan to soul crooner Jeffrey Osborne.

The action never stops at The Burbank Studios, where soundtrack work is generally the order of the day. TBS, have firmly committed to the digital age, buying a Mitsubishi 32-track recorder and making their custom Quad-8 console completely compatible with it. "We haven't had any problems at all," commented one TBS engineer about their new digital acquisition and echoing a sentiment we've heard from other studios. "It's like you get the machine, you plug it in and it works, with no alignment necessary. The flexibility it offers can't be beat." Recent films that utilized TBS's scoring stages and recording facilities included the latest from Disney, *The Black Cauldron* (which was done in 6-track, split surround sound), *My Science Project*, *Natty Gan*, *The Journey*, *Pale Rider*, *National Lampoon's European Vacation*, *Police Academy II* and the forthcoming Pee Wee Herman epic, the last scored by Oingo Boingo leader Danny Elfman. And lest you imagine movie scoring at TBS as a hundred aging violinists playing in a big room with a couple of overhead mikes, you should know that synthesizers galore are employed there—*Ghostbusters*, for example, used a complement of 17 synthesizers in addition to an 80-piece orchestra.

At Preferred Sound in Woodland Hills, upgrading and expansion con-

## THE MASTERING LAB

AN INDUSTRY LEADER IN DISK MASTERING  
SINCE 1967

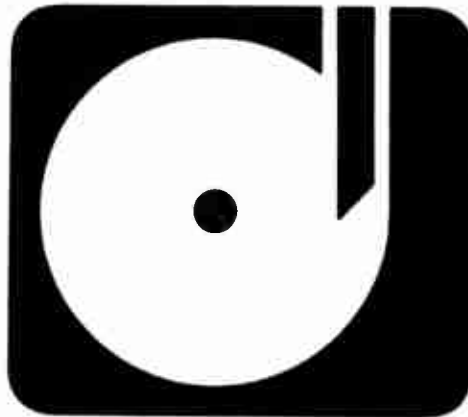

213-466-8589  
LOS ANGELES

Circle #113 on Reader Service Card

## Studiobuilders...just what you'd expect ... for all your professional recording needs.

on demo..Sound Designer  
Macintosh+E-II software!!



Tascam..E-Mu..AXE..Hafler..Bimix..Orban..  
Electro-Voice..Alesis..BGW..Beyer..AKG..  
Linn..Auratone..ValleyPeople..Furman..  
Scotch..C-Ducer..Ramko..MRL..Nakamichi..  
Omni-Mount..Neutrik..Ramsa..Rebis..Revox..  
Sennheiser..Soundtrac..Symetrix..AMEK..  
Ursa Major..Klark-Teknik..Han-d-mag..Loftech  
Smpl..Atlas....(call for new products!)

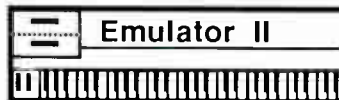

Music Computer Specialists! SMPTE & MIDI....  
System packages & Studio DESIGN networks...  
Pro-Audio SALES, In-House SERVICE....  
(on demo..TASCAM MS-16 / 1" 16 Track..)

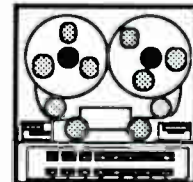

Hi-Tech Audio Merchants

919 North Victory Blvd. Burbank  
(818) 842-9526

Circle #114 on Reader Service Card



## NBC—New Strides in Audio

The march towards the widespread acceptance of stereo television is gradually beginning to pick up speed, with ever-increasing numbers of consumers opting for the new dual channel sets, and the major networks have been busily gearing up for the coming revolution.

NBC, in particular, has been very active in this area, from their generation of stereo programming—the *Tonight Show* has been recorded in stereo for nearly three years (see "The *Tonight Show* Goes Ster-

eo," November, 1984 *Mix*)—to a substantial financial investment in better audio for their Burbank studios. The network's audio Post-Production Suite One (PPS-1) has been fully operational for over a year now; while construction is nearing completion on new audio control rooms for video studios two and four (studio three is used for the *Carson* show).

PPS-1 manager Allen Brewster feels that NBC had other equally valid reasons behind this major upgrading: "They would never have spent the money putting what amounts to a world class studio in here had there not been a strong interest in stereo TV, but it's also part of their overall commitment to the creative mind: providing a good environment to work in." The decision to revamp PPS-1 has turned out very well for the network, as the room has not only provided sweetening for NBC projects, but also for a number of outside clients as well, including a Barbara Walters special and some Hanna-Barbera sessions.

The room features a Quad-Eight Coronado console, Ampex ATR-124 and ATR-116 multi-tracks with 40 tracks of Dolby-A noise reduction, Ampex ATR-102/104 mastering recorders, and a wide assortment of outboard gear. Clients have a choice of monitor speakers: UREI 813s, Auratones, and a JBL system mounted in the center of the front wall for mono imaging. Synchronization is handled by the house CMX system, which also offers the benefit of allowing users to pre-edit and load sound effects for auto assembly on the multi-track.

PPS-1 and both of the new studio control rooms were designed by Chips Davis, who incorporated an LEDE (Live End-Dead End) approach to the rooms. Jerry Jacob, who markets the acoustician's services, explains that the LEDE concept is well suited for television work. "Chips Davis rooms translate well into any medium—PPS-1 is not a listening room, it's a neutral environment. A control room should be just that: a *controlled* environment. It's the same with monitors: they should allow the engineer to *monitor* what's going on with the sound. The audio part of a video signal is becoming more important in involving all your senses, and making the special effects special. NBC understands that better audibility in the home leads to better programming and better ratings."

—George Petersen



### AKA: Warner Brothers Recording Studios

- 3 Fully Digital, Automated Studios
- Featuring: 3M 32 Track Digital Systems (The One You Can Edit)
- SSL, Sony and Harrison Automated Consoles
- Sony PCM-1610, Mitsubishi, MFO and 3M Digital Mastering and full Editing Systems for all Formats. (Yes! We can prepare your CD master.)

### New Disc Mastering Facilities

Featuring:

- DMM (Direct Metal Mastering) as well as state-of-the-art Lacquer Mastering
- Neumann VMS 80 and 82 lathes
- Neumann SP79C Console
- Studer Mastering Machines (Wonder what a direct to disc DMM record would sound like?)

Amigo Studios, Inc.  
11114 Cumpston Street, North Hollywood, CA 91601  
(818) 980-5605

Circle #115 on Reader Service Card



tinues at the studio's luxurious location (swimming pool, jacuzzi, sleeping accommodations, etc.) away from the hustle and bustle of Hollywood. Producers Joe Chiccarelli, Kevin Beamish and Paul Sabu are just a few of the top names to take advantage of Preferred's Otari and Studer recorders, Amek console, various digital reverbs (AMS, Lexicon) and delays and impressive selection of outboard gear. Among the notable artists passing through Preferred of late was PAL, a three-piece all-female pop-wave band discovered by Motown Records. Their album should be out this month.

Mad Hatter Studios, owned by keyboard great Chick Corea, was so busy this past summer that they were forced to turn away a number of potential clients, an enviable position, to be sure. The studio has long since moved past the stigma of being simply Chick Corea's "jazz" studio, to the point where a wide variety of clients are rapping on their door. In late July, for example, Billy Crystal was in recording his first comedy record for A&M with Bob Tischeler producing. Mikki Yamaoka cut an album there for Columbia-Japan, and Janey Street, a much talked about young singer, cut some demo sides for Arista with east coast producer Jimmy Ienner. Jingle producer John Trivers has seen to it that there's plenty of work coming Mad Hatter's way—Levi's, AT&T, Hidden Valley Ranch, and Apple Computers are just a few of the clients he's worked on spots for at the studio. And, oh yes, amid all the flurry of activity there, Chick Corea will begin recording a new album at Mad Hatter in December. We just hope he can get the studio time!

Lion Share Studios has been typically busy recently. Michael Omartian was in working on the third album by Christopher Cross, with engineer John Guess and assistant Tom Fouce. Michael Sembello cut some new tracks with producer Dick Rudolph and engineer Tommy Vicari. It was superstar city in Studio A with Michael Jackson producing a tune for his good friend Diana Ross, with Humberto Gatica engineering. Gatica also worked there with Tina Turner. On the equipment front, the studio has purchased a new Studer 4-track, to help with the increased load of soundtrack work the studio has been attracting. Also, in the near future, Lion Share will take delivery on a second, updated Mitsubishi digital 32-track (model X-850) with greatly enhanced editing capability.

Amigo Studios in North Hollywood has seen a whirlwind of activity recently, both in terms of equipment additions and sessions. According to owner Chet Himes, the studio has put in a new mastering room with a Neumann VMS-80 lathe, SP-79 console, Sontec equalizers

## ATTENTION MCI 600 OWNERS:

### Your mic-inputs will sound much better with the MPC-600 Mic-preamp card!

**990 DISCRETE OP-AMP:** Faster, quieter, more powerful and better sounding than the stock 5534. Performance that monolithic op-amps can't approach. The 990 is the best op-amp.

**JENSEN JE-16-B MIC-INPUT TRANSFORMER:** Better than transformerless because it eliminates input capacitors that degrade sound quality. Ultra-low distortion, ultra-high linearity and signal levels. If you thought transformers were a compromise, you haven't heard the JE-16-B! It significantly outperforms all other transformers.

**SERVO CONTROL OF DC OFFSET ELIMINATES CAPACITORS:** Coupling and gain-pot capacitors are eliminated along with their signal degradation, resulting in much better sound.

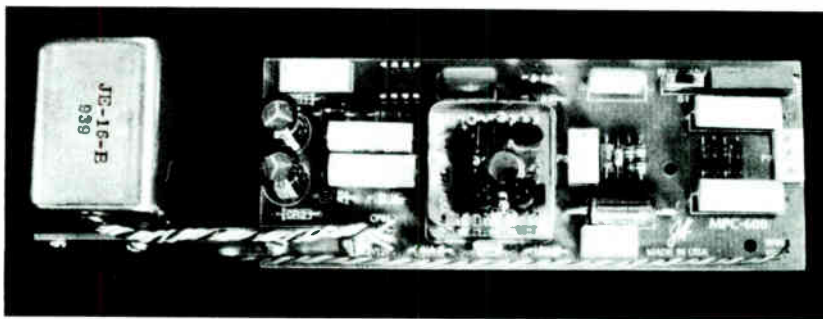

THE HARDY CO. □ P.O. BOX AA631 □ EVANSTON, IL 60204 USA

Circle #116 on Reader Service Card

## Your Recordings Can Only Sound as Good as the Cables Used to Record Them

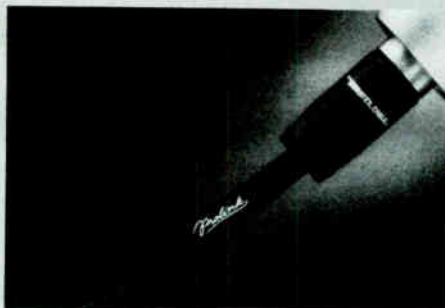

### Introducing Prolink™ High Performance Studio Cables by Monster Cable®

Many people in the recording business used to think that cables were just cables. And in fact, many of us still do.

**A Sound of their Own.** Many engineers have found that the opposite is true. They are discovering that ordinary cables have "a sound of their own" and distort music recording and reproduction in ways that we were never even aware of. Critical areas such as clarity, depth of bass response, quickness

of transients, and the "naturalness" and "presence" of voices and instruments, are all lost through conventional cables.

**A Monster New Technology in Cable Design.** Monster Cable has shown music listeners worldwide that the sound of their playback systems could be significantly improved simply by changing their cables to the Monster. Now you can obtain an improvement in the sound of both recording and playback that will sur-

prise the most critical and skeptical of engineers, simply by switching from your current connecting cables to Prolink by Monster Cable.

**Come Hear the Monster.** We invite you to hear our entire line of microphone, speaker, and studio hookup cables. Put them through your most critical listening and durability testing. You'll discover just how good your recordings can really sound.

*Prolink™*

For your free brochure please call or write Paul Stubblebine, Professional Products Division Manager.

Monster Cable® Products, Inc.  
101 Townsend, San Francisco CA 94107  
415 777-1355 Telex: 470684 MCSYU1

**MONSTER CABLE®**

Circle #117 on Reader Service Card





Remodeled this past January, Studio B at The Village Recorder in West Los Angeles has recently played host to album projects by Tom Petty, The Eurythmics, Lone Justice and Stevie Nicks. Principal equipment includes Neve 8108 console with Necam automation, Studer A-800 and Sony projection with lock to picture for video synchronization with audio.

and much more. Lee Hirschberg and Terry Donovan are the mastering engineers. They use any of four different mastering machines: Studer, Mitsubishi, Sony, and 3M, which Himes feels is

the "most flexible and maybe the best-sounding of them all, though they're all great and work well for different things." Also new at Amigo is Studio E's Sony MX-P3000 modular mixing console, which was just introduced at the last AES. "It's pretty amazing," Himes notes. "It really does remember everything you're doing on it. I know the term 'user-friendly' is over-used, but this really seems to be easier to use." An SSL 4000E is the centerpiece of the

new mix-down room at Amigo, and if all these equipment additions aren't enough, the studio has also re-done its lounge and added an office for producers using the studio. Also worth noting is the arrival of two distinguished "guests" who will help out on projects here and there: namely Roger Nichols' phantom electronic drummer Wendell, and the machines that constitute Cyborg Productions.

There has been session work aplenty at Amigo, including projects by Stevie Ray Vaughn, Lou Ann Barton (both are Austinites, like Himes), Jennifer Warnes, jazz guitarist David Brecker (who did a fully digital project), the Christian heavy metal band Stryper, Delbert McClinton, and X. Himes is particularly excited by a live-to-metal mastering project that synth wizard Michael Boddicker is cutting in the studio with a number of session heavies. At press time, the list of luminaries set to appear on the record was still growing—just like Amigo.

Cherokee Studios is celebrating its tenth year in the business, and studio manager Con Merten reports that it's been a sensational last few months for the venerable facility. The studio's latest customized Trident board is scheduled to be operational in early September; that brings to four the number of the studio's Tridents that Cherokee chief engineer Toby Foster has modified. Among the artists who have worked at Cherokee in the last several months are Motley Crue, Tina Turner (working with producer Michael Chapman and engineer George Tutko), The Divinyls (in with the same team), Epic's Jeff Scott (produced by Bill Pfordresher and engineer Brad Guilderman), Barry Manilow (produced by Howard Rice), and Arista's dynamic group Cruzados, produced by Rodney Mills. Pat Benatar also was in for some work on her latest.

Barry Brenner of Burbank-based Studiobuilders attests to the industry-wide interest in improving audio-for-video and post-production facilities. Studiobuilders specializes in designing and equipping these sorts of rooms, and business has been positively booming. Pacific Telephone brought in Brenner's firm to set up a new audio-dialog room for commercial work and in-house productions. *Entertainment Tonight*/Paramount called on Studiobuilders to completely re-do one of their old audio rooms to facilitate a move to stereo; that meant a re-thinking of the room's acoustics, as well as the installation of a new monitoring system. At Candlewick Productions, Studiobuilders got involved with extensive wiring and equipment work on that facility's Foley and ADR areas, and they were similarly busy at Visual Eyes, a post-production house concentrating on video and audio editing. "There's a

CALL FOR PRODUCTION CONSULTATION AND STUDIO VISIT

MAD HATTER RECORDING STUDIOS

"The building of Mad Hatter Studios is the realization of an old dream of having a place where musicians could make music in a free, easy atmosphere.  
Our technical concept is: clarity of sound—  
Our musical concept is: the artist's vision realised."  
— *Chick Corea*

CONTACT: RON MOSS, STUDIO MANAGER - BERNIE KIRSH, CHIEF ENGINEER  
MAD HATTER RECORDING STUDIOS, 2635 GRIFFITH PARK BOULEVARD, LOS ANGELES, CALIFORNIA 90039 (213) 664-5766

Circle #118 on Reader Service Card



lot going on out there," Brenner says. "There seems to be more interest in quality audio-for-video than ever before." And that puts Studiobuilders in a very good position.

David Epstein of Sound Solution in Santa Monica reports that in the last year since upgrading to 24-track, his studio has become strongly established in the independent record market, working with such artists as Atilla, Tierra, Robin Gagos, and the Babylon Warriors. "We pride ourselves in our ability to produce great results on budgets," says Epstein. And though album work is the major emphasis at Sound Solution, video and film soundtrack work has been abundant as well, a Doris Day television series (produced by her son Terry Melcher) and various local/national TV commercials keeping the eight-year-old facility busy.

Speaking of busy, Van Webster, owner of L.A.'s Digital Sound Recording, says that business is better than ever. With a 24-track studio, a digital audio studio, and a video production and post-production room, Digital Sound Recording has been working on projects ranging from presentations for the 1985 NAMM Convention, to digital album work with Paul Cacia and Artie Shaw, to Compact Disc master transfers for Phil Collins, Toto, and Emmylou Harris. And though busy in several fronts, Webster notes that he is especially pursuing video production. "We're using digital audio to stretch the frontiers of sound production for video," he says. "We're right on the cutting edge of that." Indeed, nearly all recent upgrades at Digital Sound Recording have been in the video realm: Hitachi Z31 computer camera, Crosspoint Latch 7209 switcher, Fortel time base corrector, Ikegami broadcast video monitor, and an Adams-Smith 2600 system.

Another facility keen on video is The Post Group, who have just added a new audio sweetening room to their facility. "Our continued expansion clearly indicates that we're doing real well," says Meryl Lippman. The new room is equipped with a brand new Neve 8128 automated console, Otari recorders, Adams-Smith and Time Line synchronizers, and the list goes on and on. But it is the way they've chosen to design the room that makes it unique, according to senior vice president Rich Thorne. "It was designed by mixers and engineers who wanted to build a room that could do everything more simply," he says. "For example, we can lock machines together now in three seconds. This is a custom set-up." Besides this new room addition, recent projects at The Post Group also reveal the facility's good health: post-production on U.S.A. for Africa and Live Aid, several *Tonight Show* anniversary spe-

**Scotch**  
AUDIO & VIDEO TAPES  
**NUMBER ONE**  
**IN THE WORLD OF THE PRO**

**3M**

Hi-Fi  
duplication  
Analog  
Digital

**T A P E**

• **COMPETITIVE PRICES**  
• **EXTENSIVE INVENTORY**

IMMEDIATE SHIPMENT FROM STOCK

**PROJECT ONE A/V**  
6669 Sunset Blvd  
Hollywood, CA 90028

• **FAST DEPENDABLE SERVICE**  
• **NO MINIMUM ORDER**

[213] 464 • 2285

Circle #119 on Reader Service Card

**University of Sound Arts**  
in Hollywood

Offering 5 wk / 10 wk / 6 month  
**RECORDING ENGINEERING WORKSHOPS**

For the last nine years, **The University of Sound Arts** has been producing tomorrow's recording engineers and video producers today.

We use the finest and the most modern state of the art equipment in the world, thus producing engineers that are most effective and current in their approach.

**Also available: 1 yr. program in Audio-Video Technology**

CALL COLLECT in California 213-467-5256 or 1-800-228-2095 or write to  
University of Sound Arts, 6363 Sunset Bl., RCA Bldg., Hollywood, CA 90028

Circle #120 on Reader Service Card

# FEEDBACK PROTECTION. WITHOUT SACRIFICING RESPONSE.



Our remarkable MD 431 lets performers work with amplification as loud as they wish—up to 6 dB over other microphones—without feedback. And without sacrificing the clarity of full, rich response.

**SENNHEISER®**

Sennheiser Electronic Corporation (N.Y.)  
48 West 38th Street • New York, NY 10018 • (212) 944-9440  
Manufacturing Plant: D-3002 Wedermark, West Germany  
©1985, Sennheiser Electronic Corporation (N.Y.)

**NOW WITH 2-YEAR LIMITED WARRANTY**

Circle #121 on Reader Service Card

## IMPERIAL TAPE COMPANY

**SERVICE • QUALITY • INTEGRITY**  
MEMBER OF INTERNATIONAL TAPE ASSOCIATION

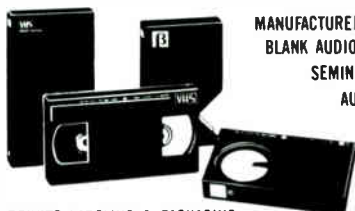

MANUFACTURERS OF CUSTOM LENGTH  
BLANK AUDIO & VIDEO CASSETTES  
SEMINAR RECORDING  
AUDIO/VIDEO

PRIVATE LABELING & PACKAGING  
TOP QUALITY AUDIO & VIDEO CASSETTE DUPLICATION  
NATION'S LEADING AUTHORIZED DISTRIBUTOR  
CARRYING FULL LINE OF

**AMPEX**  
**Scotch**  
PROFESSIONAL AUDIO & VIDEO  
RECORDING TAPES

SHIPMENTS WITHIN 24 HOURS • SAME DAY L.A. SERVICE  
HIGH SPEED CASSETTE DUPLICATOR DEALER

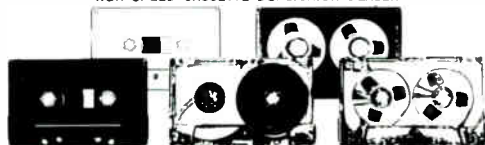

CALL HOWARD  
PERSON-TO-PERSON COLLECT

(213) 393-7131

1014 BROADWAY  
SANTA MONICA, CA 90401

cial, and various programs for the Playboy Channel. Also, Shelley Duvall recently used one of the two sound stages available for her Platypus Productions. But beyond all the aforementioned projects and features of The Post Group, it is special effects work that keeps them busiest, according to Lippman, who notes that they did computer graphics for the Olympics last year.

At the other end of the studio spectrum, Billy James of the newly opened Encore Studios in Burbank reports that business in the world of music is going very well for them. Having taken over the old Kendun studios in April and renaming it Encore, James says that the history of the room helped them get started, as it has been used in the past by several major record companies. "That's how we got MCA right when we opened," says James. Some artists currently recording at Encore include Shalamar, Carrie Lucas, Klique, Klymaxx, Red 7, and Y & T. But James remarks that it is the artists on the Encore Music Productions label that get priority time in the studio, groups such as Doublevision, Jamie & the Smashers, and T-Men. "Filling the room is a second priority for us," says James. "Our primary goal is to succeed as a record production company."

In his own attempts to succeed in this business, Dan Hillard of Dream Maker Studios in Thousand Oaks has decided to move his facility closer to his clients, to an area where he hopes to get into larger projects as well. Relocating to Woodland Hills this month, Dream Maker will maintain the same name and the same clients, which include Tommy Tutone, Ian McLagan, and Al Schmidt. Though only recently upgraded to 24-track, Dream Maker will also—upon its move south—be equipped with a Neotek Elite console. Until the move though, Dream Maker will keep busy with various album projects, and sound effects work for a nationally-syndicated radio show entitled *Rockline*.

North Hollywood's Sound Image, a custom audio sound company that makes its living by traveling across the states, reports that business is very good. Offering a complete package of its own unique Phase-Lock sound system, Sound Image recently went on the road with Jimmy Buffett, providing both sound and technicians. Outside of tour projects, Sound Image has also been busy installing permanent custom sound systems in sports arenas, auditoriums, churches, and other facilities in need of systems that counter specific acoustical problems.

And while not on the subject of actual recording studios... S.I.R., a rental company that provides musical instruments, 12 rehearsal studios, a music film stage, and audio equipment, reports steady work. "Business is good,"



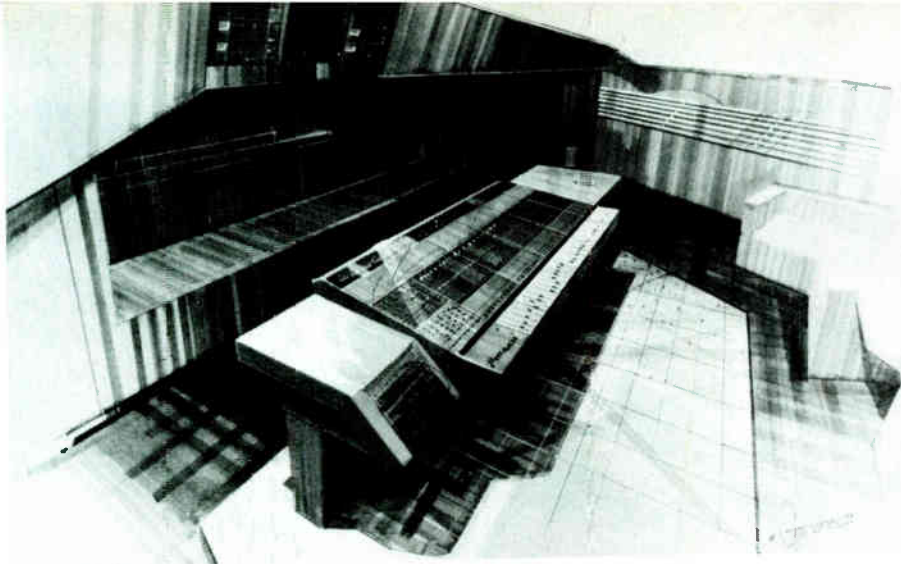

Artist's mock-up of Cherokee Studios' latest modified Trident board

says Tom Espby, "especially in regards to our film stage. People are doing a lot of music films and videos." The stage was recently put to use as Limelight Productions shot Prince's video "Raspberry Beret." Other groups shooting videos included Apollonia 6, and the Motels. Espby also notes that summer being a prime season for touring, many groups are using the rehearsal studios before going on the road, Tina Turner and Motley Crue some recent visitors.

Hollywood Vaults, a new storage facility in L.A., is due to open about the time this article comes out. The vaults will be available for any type of media material storage, from motion picture film to computer tape. The 6,000 sq. ft. facility is fully refrigerated and humidity controlled to avoid color fading problems with film or magnetic drop-out problems with audio tapes. David Wexler of The Vaults notes that the facility will cater to the smaller studios in the L.A. area who are into film, television or audio work. One-hundred-and-fifteen individual vaults will hold 150,000 cans of film or tape, each vault having a high-security, pick-proof locking system so clients may be sure that their master tapes or films are guarded against being stolen and/or duplicated. Rates at the Hollywood Vaults will range from \$50/month to \$350/month, depending on the size of the unit to be used.

Rob Corn reports that old Neve consoles are hot items at Ocean Audio, a used equipment outlet, adding that business for the three-year-old company has definitely picked up from last year. Corn says that other popular sellers (or is that re-sellers?) are SSLs, EMT 250s and other high-tech reverb units and delays. Some studios who have recently taken advantage of Ocean Audio's service (of finding a specific piece of equipment for a particular studio) include: Amigo Studios (who are leasing an SSL board), Cou-

gar Run, and Can Am.

Ron Leeper of Sound Affair, in Santa Ana, says they've added a lot of new equipment to their 24-track facility, including an Eventide SP-2016 signal processor, UREI Time Aligns, and two Tannoy monitors, and a 16-track API console (which, incidentally, was previously owned by Jimmy Page and John Paul Jones). "We're growing well," says Leeper. "We keep adding new equipment every few months." Their recent purchases have been put to good use as Sound Affair has been working on album projects with Choir Invisible and the Suburban Lawns. "I try to gear myself to record/music/demo production," explains Leeper. "The studio isn't really geared for, and I don't like to gear myself for, video or commercials. I'll do them, but I prefer doing music."

Jeremy Christian of Pacific World Limited (previously Pacific West) would like to maintain a middle ground between the two worlds of video/film and music production. "We're planning to have the best studios and video production facilities on the west coast within the next couple of years," says Christian. Though busy with album projects for the likes of Devon Payne, and Marquee, Christian also enthusiastically notes Pacific World's first attempt at film soundtrack work, *Rocky IV*. Hoping to continue in this direction, Leeper says they've recently invested in a complete MIDI keyboard system with Emulator II, Prophet, DX7, and Oberheim synths bought specifically for film soundtrack projects. Other new equipment recently installed in the studio includes a Trident console, and AMS, and Eventide outboard gear. As if all this weren't enough, by the first of the year Pacific World plans to have a full production facility for video. "We'll be working closely with MGMM videos in New York," says Christian. "We'll be the west coast division of them." ■

# Los Angeles Recording Workshop

## 10 Week Recording Engineering Certificate Program

5287 Sunset Boulevard,  
Hollywood, CA 90027  
(213) 465-4254

Circle #123 on Reader Service Card

**RCA**   
**Test Tapes**

*A Sound Measure*

- Cassettes
- Open Reel up to 1"
- Custom Formats

For a catalogue of standard test tapes or further information contact:

**RCA TEST TAPES**  
DEPT M  
6550 E. 30th St.  
Indianapolis, IN 46219  
(317) 542-6427

Circle #124 on Reader Service Card

# OUR STUDIOS TOWER OVER EVERYBODY!

- NEVE 8068 and 8108 NECAM
- 2 STUDER A-800 24 TRK
- STUDER A-80 VU MK-III 24 TRK
- Q-LOCK SYNCHRONIZER
- AMPEX ATR 102-104½"
- DIGITAL 2 TRK SONY AND JVC
- DIGITAL 2 TRK MASTERING
- 8 LIVE CHAMBERS
- EMT PLATE • EMT 250



- AMS REVERB & DDL • SUPER PRIME TIME • LARGE ASSORTMENT OF NEW & CLASSIC OUTBOARD EQUIPMENT AND MICROPHONES • DIRECT TO DISC MASTERING •
- CUSTOM LACQUER AND XDR CASSETTE MASTERING •
- STUDIO A (60 x 45)



STUDIO B ▲

THE PERFECT COUPLE

▼ MIXDOWN C



Member of EMI World Music Group which includes such well known studios as Abbey Road (England), 301 (Australia) and Toshiba EMI (Japan).



Capitol Studios, 1750 N. Vine Street, Hollywood, California 90028 (213) 462-6252, Ext. 442

©1984 CAPITOL RECORDS INC

Circle #125 on Reader Service Card

World Radio History





# SOUTHERN CALIFORNIA

S · T · U · D · I · O · S

## DIRECTORY

---

### CONTENTS

---

170	LOCATION INDEX
172	4 & 8 TRACK STUDIOS
178	16 TRACK STUDIOS
182	24 TRACK STUDIOS

**Mix** listings procedure: Every month, **Mix** mails questionnaires to recording studios and/or other vital facilities and services for the recording, sound and video production industries. Basic listings (name, address, contact) are provided free of charge. Extended listings (equipment, credits, specialization), and photographs or company logos may be included at a nominal charge. If you would like to be listed in a **Mix** Directory, write or call Lauri Newman, **Mix** Directories, 2608 Ninth Street, Berkeley, CA 94710, (415) 843-7901.

Upcoming Directory Deadlines:  
Mastering, Pressing, Tape Duplication Facilities: **Sept. 9, 1985**  
Northwest U.S. Recording Studios: **Oct. 4, 1985**

---

# SOUTHERN CALIFORNIA

## S · T · U · D · I · O · S

### LOCATION INDEX

<b>Agoura Hills</b>	
24 Larkfield Studio.....	193
<b>Alhambra</b>	
24 Martinsound Recording Studios.....	194
<b>Arroyo Grande</b>	
8 Central Coast Recording.....	172
<b>Atascadero</b>	
16 Sutton Sound Studio.....	181
<b>Bakersfield</b>	
8 Creative Productions.....	172
8 Custom Audio Recording.....	172
<b>Baldwin Park</b>	
24 Morning Star Sound Recorders.....	196
<b>Buena Park</b>	
16 Apollo Recording Studio.....	178
8 JSL Recorders.....	173
<b>Burbank</b>	
24 Alpha Studios, Inc.....	182
16 B&B Sound Studios.....	178
24 EFX Systems.....	188
24 Encore Studios.....	188
24 The Enterprise.....	189
24 Evergreen Recording Studios, Inc.....	189
16 Fatrux Studios.....	178
24 Juniper Recording.....	193
24 Master Control.....	196
4 PIC.....	174
24 PYP Dreams.....	199
24 RSC/Recording Services Co.....	199
24 The Synth Room.....	208
<b>Camarillo</b>	
4 R.E. Copsy Recording.....	172
24 Poiema Studios.....	198
<b>Canoga Park</b>	
8 Charlie's Studio.....	172
24 Rumbo Recorders.....	200
<b>Cardiff-by-the-Sea</b>	
8 Maxtrax Recording Studios.....	174
<b>Chatsworth</b>	
24 Aztec Studios.....	182
8 Hammer Sound Company.....	173
<b>Claremont</b>	
8 The Attic.....	172
24 Winetree Recording Studio.....	213
<b>Compton</b>	
16 Sound Off Studio.....	180
<b>Costa Mesa</b>	
24 Golden Goose Recording.....	190
8 Mad-Den Studio.....	174
4 Moffett Manor Recording.....	174
24 3-D Studios.....	210

<b>Culver City</b>	
16 Bare Trax.....	178
24 Studio II.....	206
16 Sunburst Recording & Productions.....	181
8 Write Track Studio.....	177
<b>Downey</b>	
8 Jay Staggs Cassette Duplication.....	176
<b>El Cajon</b>	
24 Fanfare Recording Studios.....	189
16 Stonecutter Recording Studio.....	181
<b>El Centro</b>	
16 Rose Studios.....	180
<b>Encino</b>	
4 Sigma Recording.....	175
<b>Fresno</b>	
16 Kenjo Audio, Inc.....	180
8 Red Button Recording Studio.....	174
16 Studio B Productions.....	181
24 Trac Record Co.....	211
24 Triad Recorders.....	212
<b>Fullerton</b>	
16 Casbah Recording.....	178
8 IR West Sound Recorders.....	173
<b>Garden Grove</b>	
16 Audio Paragon.....	178
4 Creative Media.....	172
<b>Glendale</b>	
8 Berkens Sound Recording Labs.....	172
16 Ritchie Carbajal Music.....	178
24 MCA Whitney Recording Studio.....	196
24 Monterey Recording Studios.....	196
24 Promise Productions.....	199
24 The Truck Mobile Recording Facility.....	212
24 Yamaha Research & Development Studio.....	213
<b>Glendora</b>	
8 New Creation Recording Studio.....	174
<b>Goleta</b>	
8 J.E.R. Studios.....	173
<b>Grover City</b>	
4 Boomerang.....	172
8 Emerald City Recording.....	173
<b>Hemet</b>	
4 McCay Mobile Audio & Cassette Duplication.....	174
<b>Hermosa Beach</b>	
4 Open Door Sound Studio.....	174
<b>Highland</b>	
24 Sun-Dwyer Recording Studios.....	206
<b>Hollywood</b>	
24 A&M Recording Studios.....	182

24 Artisan Sound Recorders.....	182
8 Ascot Recording Studio.....	172
24 Baby 'O Recorders, Inc.....	182
24 Bell Sound Studios, Inc.....	184
24 California Recording.....	184
24 Capitol Recording Studios.....	185
24 Cherokee Recording Studios.....	185
24 Clover Recorders.....	185
24 Conway Recording Studio.....	185
24 Crystal Sound Recording Studios.....	186
16 D-Town/Platinum Sound Recording.....	178
24 Fast Forward Recording.....	189
24 Glen Glenn Sound.....	190
24 Hollywood Sound Recorders, Inc.....	192
24 Image Recording, Inc.....	192
16 Kitchen Sync Recording.....	180
24 MRI.....	196
24 Music Box Recording Studio.....	197
24 Music in the Bank.....	197
24 Music Lab Recording Studios.....	197
16 Mystic Records Inc.....	180
4 O, Baby.....	174
24 The Pasha Music House.....	197
8 Platinum Sound Recording.....	174
4 R. Productions and Video Events.....	175
24 Rock Steady Studios.....	199
24 Rusk Sound Studios.....	200
24 Sage and Sound Recording.....	202
24 Sound Labs.....	205
16 Studio 9 Audio/Video Labs.....	181
24 Sunset Sound.....	207
24 Sunset Sound Factory.....	208
24 Sunwest Studio.....	208
24 Total Experience Recording Studios.....	211
8 Waves Sound Recorders.....	177
24 Wide Tracks.....	213
<b>Huntington Beach</b>	
24 Adamo's Recording.....	182
24 Moriah Recording Services.....	196
<b>Inglewood</b>	
4 Target Recorders.....	176
8 Underground Studio.....	176
<b>Irvine</b>	
4 The Creative Word.....	172
<b>La Manana</b>	
24 Ryan Recording.....	202
<b>La Mesa</b>	
4 BLT Productions.....	172
<b>Laguna Beach</b>	
8 Laguna Sound Stage.....	173
<b>Lakewood</b>	
8 H.M.E.A.'s "State-of-the-Heart" Studio.....	173
<b>LaVerne</b>	
8 Dragonville Studios.....	173
<b>Long Beach</b>	
8 Cantrax Recorders.....	172
8 db Productions.....	173
16 Don Harper Productions, Inc.....	178
8 Max Sound.....	174
8 Garrison Putney.....	174
8 Soundgraphics Studio.....	175
24 Trianon Recording.....	212
8 Greg Youngman Music.....	177
<b>Los Angeles</b>	
16 Acrasound Recording Studio.....	178
4 AT&T Recording.....	172
24 Blue Dolphin.....	184
24 Britannia Studios, Inc.....	184
16 Buzzy's Recording Services.....	178
8 Chalet Studios.....	172
8 The Control Center.....	172
4 Daily Planet Studio.....	173
24 Detroit Sound Studio.....	186
24 Digital Sound Recording.....	186
24 Fiddler's Recording Studio.....	189
24 Fiesta Sound & Video.....	189
8 Fission Enterprises.....	173
8 Fullersound A.V. Recording.....	173



24 Craig Harris Music .....	191	<b>Pasadena</b>	24 Audio Engineering Association.....	182	<b>Somis</b>	8 King Recording Studio .....	173													
24 Hit City West.....	191	4 Cassette Book Recorders.....	172	<b>Studio City</b>	8 Bull Hiit Productions .....	172	24 Fidelity Studios.....	189												
24 Hitman Recording Studio.....	191	24 Sound Chamber Recorders.....	204	8 Rhode House Recorders .....	175	24 Saban Productions.....	202	24 Sunswep Studios .....	208											
24 Jingle Bells Production Co.....	193	24 Studio America.....	206	<b>Playa Del Rey</b>	24 Sun Valley	24 Perspective Sound.....	197	<b>Tarzana</b>	24 Can-Am Recorders, Inc.....	184										
8 Joe's Place.....	173	4 Rag Recording.....	174	<b>Port Hueneme</b>	8 Temple City	8 Syntrax Productions.....	176	<b>Temple City</b>	8 Syntrax Productions.....	176										
4 Lane Audio & Records.....	174	4 T.K.O. Productions & Media Services.....	176	<b>Poway</b>	<b>Thousand Oaks</b>	16 Future Sound.....	178	<b>Toluca Lake</b>	24 Tim Pinch Recording.....	197										
24 Larrabee Sound .....	193	8 Southland Multitrack.....	176	<b>Rancho Mirage</b>	24 Topanga	8 Hotlix Productions .....	173	<b>Topanga Park</b>	24 Skyline Recording .....	203										
24 Lion Share Recording Studio, Inc.....	194	24 A&R Recording Services.....	182	<b>Rancho Palos Verdes</b>	8 Topanga	24 Skyline Recording .....	203	<b>Torrance</b>	24 Audio Achievements.....	182										
24 Loyola Marymount University Studios A & B.....	194	24 Sunset Records .....	207	<b>Redlands</b>	8 Topanga	24 Dynasty Studio.....	186	24 Dynasty Studio.....	186	8 Louder Gnob Recording.....	174									
24 Mad Hatter Studios .....	194	8 Star Trak Studio.....	176	8 Redondo Beach	24 Piper Recording Studio.....	197	8 Songwriter's Service .....	175	<b>Tustin</b>	8 Millennium Studio .....	174									
16 Mirage Pro Recorders .....	180	4 Padded Cell Sound Recorders .....	174	16 RK Cole Studios .....	178	<b>Universal City</b>	8 Mazzetti Audio Remote.....	174	<b>Van Nuys</b>	8 D.M.O. Productions.....	173									
24 Music Grinder Studio.....	197	16 Total Access Recording.....	211	24 Total Access Recording.....	181	24 Kingsound Studios.....	180	16 Kingsound Studios.....	180	4 Roger's Jam Land Recordings .....	175									
16 Musik Trak Studio.....	180	16 W.E. Studios.....	181	<b>Rowland Heights</b>	8 I&J Music & Sound.....	173	24 Salty Dog Recording .....	202	24 Sound City Inc. ....	205	24 Sutton Place Recording .....	208								
4 O.K. Studios .....	174	<b>Salinas</b>	4 Matrix Communications, Inc. ....	174	<b>San Diego</b>	4 Advent Studios.....	172	24 Sound City Inc. ....	205	24 Sutton Place Recording .....	208	24 Westworld Recorders.....	212							
24 Quad Teck Studios.....	199	4 Broken Records.....	184	8 Audiovision .....	172	8 Broken Records.....	184	8 The Buddy Holly Review.....	172	24 Circle Sound Studios.....	185	8 Demo Trak Studio .....	173							
24 Record Plant.....	199	4 The Buddy Holly Review.....	172	24 Broken Records.....	184	24 Circle Sound Studios.....	185	24 Circle Sound Studios.....	185	8 Demo Trak Studio .....	173	8 High Sea Recording.....	173							
24 Record Plant.....	199	8 The Buddy Holly Review.....	172	8 Broken Records.....	184	8 Demo Trak Studio .....	173	8 High Sea Recording.....	173	16 Hit Single Recording Services.....	178	24 Mixmasters Audio Production Specialists... 196	8 Musicreations .....	174						
24 Skip Saylor Recording.....	203	8 Broken Records.....	184	8 Broken Records.....	184	8 High Sea Recording.....	173	16 Hit Single Recording Services.....	178	24 Mixmasters Audio Production Specialists... 196	8 Musicreations .....	174	8 Roxy West .....	175						
24 Sound Arts.....	204	4 The Buddy Holly Review.....	172	8 Broken Records.....	184	8 High Sea Recording.....	173	16 Hit Single Recording Services.....	178	24 Mixmasters Audio Production Specialists... 196	8 Musicreations .....	174	24 Seacoast Recording Studio.....	203						
24 Soundcastle Recording Studios.....	204	24 Circle Sound Studios.....	185	8 Broken Records.....	184	8 High Sea Recording.....	173	16 Hit Single Recording Services.....	178	24 Mixmasters Audio Production Specialists... 196	8 Musicreations .....	174	8 Roxy West .....	175						
8 Spectrum Light & Sound.....	176	8 Demo Trak Studio .....	173	8 Broken Records.....	184	8 High Sea Recording.....	173	16 Hit Single Recording Services.....	178	24 Mixmasters Audio Production Specialists... 196	8 Musicreations .....	174	24 Seacoast Recording Studio.....	203						
24 Studio 55 .....	206	8 Demo Trak Studio .....	173	8 Broken Records.....	184	8 High Sea Recording.....	173	16 Hit Single Recording Services.....	178	24 Mixmasters Audio Production Specialists... 196	8 Musicreations .....	174	8 Roxy West .....	175						
24 Studio Masters .....	206	8 Demo Trak Studio .....	173	8 Broken Records.....	184	8 High Sea Recording.....	173	16 Hit Single Recording Services.....	178	24 Mixmasters Audio Production Specialists... 196	8 Musicreations .....	174	24 Seacoast Recording Studio.....	203						
8 Supersound Studio .....	176	8 Demo Trak Studio .....	173	8 Broken Records.....	184	8 High Sea Recording.....	173	16 Hit Single Recording Services.....	178	24 Mixmasters Audio Production Specialists... 196	8 Musicreations .....	174	8 Roxy West .....	175						
24 Taj Soundworks.....	208	8 Demo Trak Studio .....	173	8 Broken Records.....	184	8 High Sea Recording.....	173	16 Hit Single Recording Services.....	178	24 Mixmasters Audio Production Specialists... 196	8 Musicreations .....	174	24 Seacoast Recording Studio.....	203						
8 Theta Sound Studio.....	176	8 Demo Trak Studio .....	173	8 Broken Records.....	184	8 High Sea Recording.....	173	16 Hit Single Recording Services.....	178	24 Mixmasters Audio Production Specialists... 196	8 Musicreations .....	174	8 Roxy West .....	175						
24 Track Record .....	211	8 Demo Trak Studio .....	173	8 Broken Records.....	184	8 High Sea Recording.....	173	16 Hit Single Recording Services.....	178	24 Mixmasters Audio Production Specialists... 196	8 Musicreations .....	174	24 Seacoast Recording Studio.....	203						
16 Watermark Studios.....	181	8 Demo Trak Studio .....	173	8 Broken Records.....	184	8 High Sea Recording.....	173	16 Hit Single Recording Services.....	178	24 Mixmasters Audio Production Specialists... 196	8 Musicreations .....	174	8 Roxy West .....	175						
24 Westlake Audio .....	212	8 Demo Trak Studio .....	173	8 Broken Records.....	184	8 High Sea Recording.....	173	16 Hit Single Recording Services.....	178	24 Mixmasters Audio Production Specialists... 196	8 Musicreations .....	174	24 Seacoast Recording Studio.....	203						
<b>Los Osos</b>	16 Dog Bark Recording.....	178	<b>San Gabriel</b>	8 Trends in Professional Sound & Video Dimensions.....	176	<b>San Luis Obispo</b>	8 Kibble Sound Company .....	173	<b>Sand City</b>	16 Black Olive Recording Studio.....	178	<b>Santee</b>	24 Western Audio Recording Studios.....	212						
<b>Lynwood</b>	24 NSP Studios.....	197	8 Trends in Professional Sound & Video Dimensions.....	176	8 Kibble Sound Company .....	173	<b>Sand City</b>	16 Black Olive Recording Studio.....	178	<b>Santee</b>	24 Western Audio Recording Studios.....	212	<b>Santa Ana</b>	8 Moser Sound Productions .....	174					
<b>Malibu</b>	24 Indigo Ranch Recording Studio-Malibu.....	193	<b>San Gabriel</b>	8 Trends in Professional Sound & Video Dimensions.....	176	<b>San Luis Obispo</b>	8 Kibble Sound Company .....	173	<b>Sand City</b>	16 Black Olive Recording Studio.....	178	<b>Santee</b>	24 Western Audio Recording Studios.....	212	24 Sound Affair Studios .....	203				
<b>Marina Del Rey</b>	8 J.C. Studios.....	173	8 Trends in Professional Sound & Video Dimensions.....	176	<b>San Luis Obispo</b>	8 Kibble Sound Company .....	173	<b>Sand City</b>	16 Black Olive Recording Studio.....	178	<b>Santee</b>	24 Western Audio Recording Studios.....	212	<b>Santa Ana</b>	8 Moser Sound Productions .....	174				
24 Warthog Studios .....	212	<b>Mission Viejo</b>	4 Incidental Sound.....	173	<b>San Gabriel</b>	8 Trends in Professional Sound & Video Dimensions.....	176	<b>San Luis Obispo</b>	8 Kibble Sound Company .....	173	<b>Sand City</b>	16 Black Olive Recording Studio.....	178	<b>Santee</b>	24 Western Audio Recording Studios.....	212				
<b>Montebello</b>	4 Humanoise.....	173	<b>Mission Viejo</b>	4 Incidental Sound.....	173	<b>San Gabriel</b>	8 Trends in Professional Sound & Video Dimensions.....	176	<b>San Luis Obispo</b>	8 Kibble Sound Company .....	173	<b>Sand City</b>	16 Black Olive Recording Studio.....	178	<b>Santee</b>	24 Western Audio Recording Studios.....	212			
<b>Montecito</b>	8 Sundial Recording Studio .....	176	<b>Montebello</b>	4 Humanoise.....	173	<b>San Gabriel</b>	8 Trends in Professional Sound & Video Dimensions.....	176	<b>San Luis Obispo</b>	8 Kibble Sound Company .....	173	<b>Sand City</b>	16 Black Olive Recording Studio.....	178	<b>Santee</b>	24 Western Audio Recording Studios.....	212			
<b>Newport Beach</b>	16 JEL Recording Studios .....	180	<b>Montecito</b>	8 Sundial Recording Studio .....	176	<b>San Gabriel</b>	8 Trends in Professional Sound & Video Dimensions.....	176	<b>San Luis Obispo</b>	8 Kibble Sound Company .....	173	<b>Sand City</b>	16 Black Olive Recording Studio.....	178	<b>Santee</b>	24 Western Audio Recording Studios.....	212			
4 Phusion .....	174	<b>Newport Beach</b>	16 JEL Recording Studios .....	180	<b>San Gabriel</b>	8 Trends in Professional Sound & Video Dimensions.....	176	<b>San Luis Obispo</b>	8 Kibble Sound Company .....	173	<b>Sand City</b>	16 Black Olive Recording Studio.....	178	<b>Santee</b>	24 Western Audio Recording Studios.....	212				
<b>North Hollywood</b>	24 Amigo Studios .....	182	<b>Newport Beach</b>	16 JEL Recording Studios .....	180	<b>San Gabriel</b>	8 Trends in Professional Sound & Video Dimensions.....	176	<b>San Luis Obispo</b>	8 Kibble Sound Company .....	173	<b>Sand City</b>	16 Black Olive Recording Studio.....	178	<b>Santee</b>	24 Western Audio Recording Studios.....	212			
24 Audio Video Alliance.....	182	4 Customcraft Recordings.....	173	<b>North Hollywood</b>	24 Amigo Studios .....	182	<b>San Gabriel</b>	8 Trends in Professional Sound & Video Dimensions.....	176	<b>San Luis Obispo</b>	8 Kibble Sound Company .....	173	<b>Sand City</b>	16 Black Olive Recording Studio.....	178	<b>Santee</b>	24 Western Audio Recording Studios.....	212		
24 Devonshire Studios .....	186	24 Devonshire Studios .....	186	<b>North Hollywood</b>	24 Amigo Studios .....	182	<b>San Gabriel</b>	8 Trends in Professional Sound & Video Dimensions.....	176	<b>San Luis Obispo</b>	8 Kibble Sound Company .....	173	<b>Sand City</b>	16 Black Olive Recording Studio.....	178	<b>Santee</b>	24 Western Audio Recording Studios.....	212		
24 Enactron/Magnolia Sound.....	188	24 Flores Recording Studios .....	189	<b>North Hollywood</b>	24 Amigo Studios .....	182	<b>San Gabriel</b>	8 Trends in Professional Sound & Video Dimensions.....	176	<b>San Luis Obispo</b>	8 Kibble Sound Company .....	173	<b>Sand City</b>	16 Black Olive Recording Studio.....	178	<b>Santee</b>	24 Western Audio Recording Studios.....	212		
24 Flores Recording Studios .....	189	4 Koala Studio.....	173	<b>North Hollywood</b>	24 Amigo Studios .....	182	<b>San Gabriel</b>	8 Trends in Professional Sound & Video Dimensions.....	176	<b>San Luis Obispo</b>	8 Kibble Sound Company .....	173	<b>Sand City</b>	16 Black Olive Recording Studio.....	178	<b>Santee</b>	24 Western Audio Recording Studios.....	212		
4 Koala Studio.....	173	24 Mama Jo's Recording Studio.....	194	<b>North Hollywood</b>	24 Amigo Studios .....	182	<b>San Gabriel</b>	8 Trends in Professional Sound & Video Dimensions.....	176	<b>San Luis Obispo</b>	8 Kibble Sound Company .....	173	<b>Sand City</b>	16 Black Olive Recording Studio.....	178	<b>Santee</b>	24 Western Audio Recording Studios.....	212		
24 Mama Jo's Recording Studio.....	194	24 One on One.....	197	<b>North Hollywood</b>	24 Amigo Studios .....	182	<b>San Gabriel</b>	8 Trends in Professional Sound & Video Dimensions.....	176	<b>San Luis Obispo</b>	8 Kibble Sound Company .....	173	<b>Sand City</b>	16 Black Olive Recording Studio.....	178	<b>Santee</b>	24 Western Audio Recording Studios.....	212		
24 One on One.....	197	24 Present Time Recorders.....	199	<b>North Hollywood</b>	24 Amigo Studios .....	182	<b>San Gabriel</b>	8 Trends in Professional Sound & Video Dimensions.....	176	<b>San Luis Obispo</b>	8 Kibble Sound Company .....	173	<b>Sand City</b>	16 Black Olive Recording Studio.....	178	<b>Santee</b>	24 Western Audio Recording Studios.....	212		
24 Present Time Recorders.....	199	24 Sound Image Studio.....	205	<b>North Hollywood</b>	24 Amigo Studios .....	182	<b>San Gabriel</b>	8 Trends in Professional Sound & Video Dimensions.....	176	<b>San Luis Obispo</b>	8 Kibble Sound Company .....	173	<b>Sand City</b>	16 Black Olive Recording Studio.....	178	<b>Santee</b>	24 Western Audio Recording Studios.....	212		
24 Sound Image Studio.....	205	24 Sound Master Audio/Video Recording Studios .....	205	<b>North Hollywood</b>	24 Amigo Studios .....	182	<b>San Gabriel</b>	8 Trends in Professional Sound & Video Dimensions.....	176	<b>San Luis Obispo</b>	8 Kibble Sound Company .....	173	<b>Sand City</b>	16 Black Olive Recording Studio.....	178	<b>Santee</b>	24 Western Audio Recording Studios.....	212		
24 Sound Master Audio/Video Recording Studios .....	205	24 That Studio Recording Services.....	208	<b>North Hollywood</b>	24 Amigo Studios .....	182	<b>San Gabriel</b>	8 Trends in Professional Sound & Video Dimensions.....	176	<b>San Luis Obispo</b>	8 Kibble Sound Company .....	173	<b>Sand City</b>	16 Black Olive Recording Studio.....	178	<b>Santee</b>	24 Western Audio Recording Studios.....	212		
24 That Studio Recording Services.....	208	24 John Thomas Studio .....	210	<b>North Hollywood</b>	24 Amigo Studios .....	182	<b>San Gabriel</b>	8 Trends in Professional Sound & Video Dimensions.....	176	<b>San Luis Obispo</b>	8 Kibble Sound Company .....	173	<b>Sand City</b>	16 Black Olive Recording Studio.....	178	<b>Santee</b>	24 Western Audio Recording Studios.....	212		
24 John Thomas Studio .....	210	24 George Tobin.....	210	<b>North Hollywood</b>	24 Amigo Studios .....	182	<b>San Gabriel</b>	8 Trends in Professional Sound & Video Dimensions.....	176	<b>San Luis Obispo</b>	8 Kibble Sound Company .....	173	<b>Sand City</b>	16 Black Olive Recording Studio.....	178	<b>Santee</b>	24 Western Audio Recording Studios.....	212		
24 George Tobin.....	210	24 UMRK Mobile.....	212	<b>North Hollywood</b>	24 Amigo Studios .....	182	<b>San Gabriel</b>	8 Trends in Professional Sound & Video Dimensions.....	176	<b>San Luis Obispo</b>	8 Kibble Sound Company .....	173	<b>Sand City</b>	16 Black Olive Recording Studio.....	178	<b>Santee</b>	24 Western Audio Recording Studios.....	212		
24 UMRK Mobile.....	212	24 Weddington Studio.....	212	<b>North Hollywood</b>	24 Amigo Studios .....	182	<b>San Gabriel</b>	8 Trends in Professional Sound & Video Dimensions.....	176	<b>San Luis Obispo</b>	8 Kibble Sound Company .....	173	<b>Sand City</b>	16 Black Olive Recording Studio.....	178	<b>Santee</b>	24 Western Audio Recording Studios.....	212		
24 Weddington Studio.....	212	<b>Northridge</b>	24 HQL/Harlequin .....	192	<b>North Hollywood</b>	24 Amigo Studios .....	182	<b>San Gabriel</b>	8 Trends in Professional Sound & Video Dimensions.....	176	<b>San Luis Obispo</b>	8 Kibble Sound Company .....	173	<b>Sand City</b>	16 Black Olive Recording Studio.....	178	<b>Santee</b>	24 Western Audio Recording Studios.....	212	
<b>Northridge</b>	24 HQL/Harlequin .....	192	8 The Precision Recorder.....	174	<b>North Hollywood</b>	24 Amigo Studios .....	182	<b>San Gabriel</b>	8 Trends in Professional Sound & Video Dimensions.....	176	<b>San Luis Obispo</b>	8 Kibble Sound Company .....	173	<b>Sand City</b>	16 Black Olive Recording Studio.....	178	<b>Santee</b>	24 Western Audio Recording Studios.....	212	
8 The Precision Recorder.....	174	24 Your Recording Studio.....	213	<b>North Hollywood</b>	24 Amigo Studios .....	182	<b>San Gabriel</b>	8 Trends in Professional Sound & Video Dimensions.....	176	<b>San Luis Obispo</b>	8 Kibble Sound Company .....	173	<b>Sand City</b>	16 Black Olive Recording Studio.....	178	<b>Santee</b>	24 Western Audio Recording Studios.....	212		
24 Your Recording Studio.....	213	<b>Oceanside</b>	8 Exxel Recording Studios.....	173	<b>North Hollywood</b>	24 Amigo Studios .....	182	<b>San Gabriel</b>	8 Trends in Professional Sound & Video Dimensions.....	176	<b>San Luis Obispo</b>	8 Kibble Sound Company .....	173	<b>Sand City</b>	16 Black Olive Recording Studio.....	178	<b>Santee</b>	24 Western Audio Recording Studios.....	212	
<b>Oceanside</b>	8 Exxel Recording Studios.....	173	<b>Ojai</b>	4 Centersound Productions.....	172	<b>North Hollywood</b>	24 Amigo Studios .....	182	<b>San Gabriel</b>	8 Trends in Professional Sound & Video Dimensions.....	176	<b>San Luis Obispo</b>	8 Kibble Sound Company .....	173	<b>Sand City</b>	16 Black Olive Recording Studio.....	178	<b>Santee</b>	24 Western Audio Recording Studios.....	212
<b>Ojai</b>	4 Centersound Productions.....	172	<b>Ontario</b>	8 The Reel Thing.....	174	<b>North Hollywood</b>	24 Amigo Studios .....	182	<b>San Gabriel</b>	8 Trends in Professional Sound & Video Dimensions.....	176	<b>San Luis Obispo</b>	8 Kibble Sound Company .....	173	<b>Sand City</b>	16 Black Olive Recording Studio.....	178	<b>Santee</b>	24 Western Audio Recording Studios.....	212
<b>Ontario</b>	8 The Reel Thing.....	174	16 Trilogy .....	181	<b>North Hollywood</b>	24 Amigo Studios .....	182	<b>San Gabriel</b>	8 Trends in Professional Sound & Video Dimensions.....	176	<b>San Luis Obispo</b>	8 Kibble Sound Company .....	173	<b>Sand City</b>	16 Black Olive Recording Studio.....	178	<b>Santee</b>	24 Western Audio Recording Studios.....	212	
16 Trilogy .....	181	<b>Orange</b>	24 Advanced Media Systems.....	182	<b>North Hollywood</b>	24 Amigo Studios .....	182	<b>San Gabriel</b>	8 Trends in Professional Sound & Video Dimensions.....	176	<b>San Luis Obispo</b>	8 Kibble Sound Company .....	173	<b>Sand City</b>	16 Black Olive Recording Studio.....	178	<b>Santee</b>	24 Western Audio Recording Studios.....	212	
<b>Orange</b>	24 Advanced Media Systems.....	182	8 South Coast Recording.....	175	<b>North Hollywood</b>	24 Amigo Studios .....	182	<b>San Gabriel</b>	8 Trends in Professional Sound & Video Dimensions.....	176	<b>San Luis Obispo</b>	8 Kibble Sound Company .....	173	<b>Sand City</b>	16 Black Olive Recording Studio.....	178	<b>Santee</b>	24 Western Audio Recording Studios.....	212	
8 South Coast Recording.....	175	<b>Palm Springs</b>	16 Mercantile Recording.....	180	<b>North Hollywood</b>	24 Amigo Studios .....	182	<b>San Gabriel</b>	8 Trends in Professional Sound & Video Dimensions.....	176	<b>San Luis Obispo</b>	8 Kibble Sound Company .....	173	<b>Sand City</b>	16 Black Olive Recording Studio.....	178	<b>Santee</b>	24 Western Audio Recording Studios.....	212	
<b>Palm Springs</b>	16 Mercantile Recording.....	180	<b>Pasadena</b>	24 Audio Engineering Association.....	182	<b>North Hollywood</b>	24 Amigo Studios .....	182	<b>San Gabriel</b>	8 Trends in Professional Sound & Video Dimensions.....	176	<b>San Luis Obispo</b>	8 Kibble Sound Company .....	173	<b>Sand City</b>	16 Black Olive Recording Studio.....	178	<b>Santee</b>	24 Western Audio Recording Studios.....	212
16 Mercantile Recording.....	180	4 Cassette Book Recorders.....	172	<b>North Hollywood</b>	24 Amigo Studios .....	182	<b>San Gabriel</b>	8 Trends in Professional Sound & Video Dimensions.....	176	<b>San Luis Obispo</b>	8 Kibble Sound Company .....	173	<b>Sand City</b>	16 Black Olive Recording Studio.....	178	<b>Santee</b>	24 Western Audio Recording Studios.....	212		
<b>Pasadena</b>	24 Audio Engineering Association.....	182	24 Sound Chamber Recorders.....	204	<b>North Hollywood</b>	24 Amigo Studios .....	182	<b>San Gabriel</b>	8 Trends in Professional Sound & Video Dimensions.....	176	<b>San Luis Obispo</b>	8 Kibble Sound Company .....	173	<b>Sand City</b>	16 Black Olive Recording Studio.....	178	<b>Santee</b>	24 Western Audio Recording Studios.....	212	
24 Audio Engineering Association.....	182	24 Studio America.....	206	<b>North Hollywood</b>	24 Amigo Studios .....	182	<b>San Gabriel</b>	8 Trends in Professional Sound & Video Dimensions.....	176	<b>San Luis Obispo</b>	8 Kibble Sound Company .....	173	<b>Sand City</b>	16 Black Olive Recording Studio.....	178	<b>Santee</b>	24 Western Audio Recording Studios.....	212		
24 Cassette Book Recorders.....	172	<b>Playa Del Rey</b>	4 Rag Recording.....	174	<b>North Hollywood</b>	24 Amigo Studios .....	182	<b>San Gabriel</b>	8 Trends in Professional Sound & Video Dimensions.....	176	<b>San Luis Obispo</b>	8 Kibble Sound Company .....	173	<b>Sand City</b>	16 Black Olive Recording Studio.....	178	<b>Santee</b>	24 Western Audio Recording Studios.....	212	
24 Sound Chamber Recorders.....	204	<b>Port Hueneme</b>	4 T.K.O. Productions & Media Services.....	176	<b>North Hollywood</b>	24 Amigo Studios .....	182	<b>San Gabriel</b>	8 Trends in Professional Sound & Video Dimensions.....	176	<b>San Luis Obispo</b>	8 Kibble Sound Company .....	173	<b>Sand City</b>	16 Black Olive Recording Studio.....	178	<b>Santee</b>	24 Western Audio Recording Studios.....	212	
24 Studio America.....	206	<b>Poway</b>	8 Southland Multitrack.....	176	<b>North Hollywood</b>	24 Amigo Studios .....	182	<b>San Gabriel</b>	8 Trends in Professional Sound & Video Dimensions.....	176	<b>San Luis Obispo</b>	8 Kibble Sound Company .....	173	<b>Sand City</b>	16 Black Olive Recording Studio.....	178	<b>Santee</b>	24 Western Audio Recording Studios.....	212	
<b>Playa Del Rey</b>	4 Rag Recording.....	174	<b>Rancho Mirage</b>	24 A&R Recording Services.....	182	<b>North Hollywood</b>														

# SOUTHERN CALIFORNIA

## S · T · U · D · I · O · S

### 4 & 8 TRACK

#### ● ADVENT STUDIOS

4304 Randolph Terrace, San Diego, CA 92103  
(619) 296-7599  
Owner: Jim Morlino  
Studio Manager: Jim Morlino

#### ● ASCOT RECORDING STUDIO

1654 N. Harvard Blvd., Hollywood, CA 90027  
(213) 663-6269  
Owner: James Rayton  
Studio Manager: James Rayton

#### ● AT&T RECORDING

501 N. Larchmont Blvd., Los Angeles, CA 90004  
(213) 466-7756

#### ● THE ATTIC

678 California Dr., Claremont, CA 91711  
(714) 621-7768  
Owner: Dr. A. John Mallinckrodt  
Studio Manager: Dr. A. John Mallinckrodt

#### ● AUDIOVISION

3191 Adams Ave., San Diego, CA 92116  
(619) 280-7941  
Owner: Jon A. Cline

#### ● BERKENS SOUND RECORDING LABS

*also REMOTE RECORDING*  
1616 W. Victory Blvd., Suite 104, Glendale, CA 91201  
(818) 246-6583  
Owner: William Berkuta, Richard P. Stevens II  
Studio Manager: William Berkuta  
Engineers: William Berkuta, Rick Stevens  
Dimensions of Studio(s): 12 x 24.  
Dimensions of Control Room(s): 12 x 13.  
Tape Recorders: Tascam 80-8 8 track; TEAC A-2340sx 4 track; (2) Revox B77 2 track; Ampex 300 2 track; Fisher CR-4020 cassette; Technics M22 cassette.  
Mixing Consoles: Opamp Labs BSRL 14-4-2.  
Monitor Speakers: JBL 4310  
Echo, Reverb & Delay Systems: DeltaLab Effectron II ADM 1024, (2) Opamp Labs spring reverbs.  
Other Outboard Equipment: TEAC DX-8, dbx II 122, 124.  
Microphones: Sennheiser, AKG, etc.  
Instruments Available: 6 and 12 string acoustic guitars, sax, Yamaha clarinet, violin, trumpet, Casio Casiotone 202, piano.  
Rates: \$8.50 for 4 and 8 track recording.  
Extras: Radio drama recording and production including live sound effects; music demo recording, production and duplication; theatrical sound design and consultation; voice tape production and duplication; songwriters' workshops.  
Direction: Flexibility, effectiveness and cooperation are the key elements in the operation of this growing studio facility. Resident producers are available to share their expertise to help you realize your project.

#### ● BLT PRODUCTIONS

Box 519, La Mesa, CA 92041  
(619) 562-6077  
Owner: Tom Kelley  
Studio Manager: Bill Martin

#### ● BOOMERANG

P.O. Box 1310, Grover City, CA 93433  
(805) 481-0670  
Owner: C. Stepp  
Studio Manager: Eric Severaleyes

#### ● THE BUDDY HOLLY REVIEW

*also REMOTE RECORDING*  
3759 Elco St., San Diego, CA 92111  
(619) 268-9789  
Owner: Hayes Kolb  
Studio Manager: Hayes Kolb

#### ● BULL HITT PRODUCTIONS

12535 Kling St., Studio City, CA 91604  
(818) 508-0164  
Owner: Rick Lee Vinson  
Studio Manager: Richard Levinsohn

#### ● CANTRAX RECORDERS

*also REMOTE RECORDING*  
2119 Fidler Ave., Long Beach, CA 90815  
(213) 498-6492  
Owner: Richard Cannata  
Studio Manager: Nancy Cannata

#### ● CASSETTE BOOK RECORDERS

*also REMOTE RECORDING*  
P.O. Box 7111, Pasadena, CA 91109  
(818) 799-4139  
Owner: Paul Dempster  
Studio Manager: Paul Dempster

#### ● CENTERSOUND PRODUCTIONS

P.O. Box 1630, Ojai, CA 93023  
(805) 646-4882  
Owner: Paul Hunter  
Studio Manager: Talisyn Hunter

#### ● CENTRAL COAST RECORDING

684 Stagecoach Rd., Arroyo Grande, CA 93420  
(805) 489-7861  
Owner: Robert & Ruth Montano, Robert Barr

#### ● CHALET STUDIOS

3247 Shasta Cir. N., Los Angeles, CA 90065  
(213) 256-5350  
Owner: Greg Tiner  
Studio Manager: Greg Tiner

#### ● CHARLIE'S STUDIO

8342 Penfield #21, Canoga Park, CA 91306  
(818) 998-8110  
Owner: Charlie Mustafa, Wendy Shannon  
Studio Manager: Charlie Mustafa

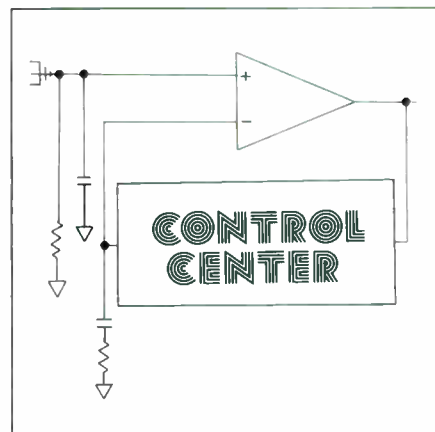

THE CONTROL CENTER  
Los Angeles, CA

#### ● THE CONTROL CENTER

128 N. Western St., Los Angeles, CA 90004  
(213) 462-4300, (213) 413-2522  
Owner: Aseley Otten, Rick Altschuler  
Studio Manager: Rick Novak  
Engineers: Aseley Otten, Rick Altschuler, Rick Novak, Steve Catania, Frank E. Blew, Curt Wilson  
Dimensions of Studio(s): 18 x 24 main room; 7 x 12 live room  
Dimensions of Control Room(s): 12 x 16  
Tape Recorders: Otari 5050 8 track w/VSO; Otari 50-50B 2 track w/VSO; TEAC A4010S 1/4 track; Technics M-45 cassette; Sony TC-FX44.  
Mixing Consoles: Sound Workshop 1280, 12 in x 8 out; w/super EQ and meter bridge.  
Monitor Amplifiers: BGW, Crown.  
Monitor Speakers: JBL 4312, Auratone SC.  
Echo, Reverb, and Delay Systems: Ursal Major Space Station, Digital reverb and delay, (2) MXR digital delays, Tape delay, Eventide 910 harmonizer and delay.  
Other Outboard Equipment: (2) dbx 161 compressors, stereo chorus, MXR flanger, DOD flanger, UREI LN1176 limiter, patchbay, pinball game!  
Microphones: AKG 414-EB; Neumann U87; Sennheiser 441, 421; Shure SM57, SM77; Sony ECM 22-P.  
Instruments Available: Howard baby grand piano, Hammond B-3 w/Leslie, Rogers drum, Precision bass, LinnDrum.  
Rates: Call for rates.

#### ● R.E. COPSEY RECORDING

*also REMOTE RECORDING*  
P.O. Box 367, Camarillo, CA 93010  
(805) 484-2415  
Owner: Reese E. Copsey  
Studio Manager: Reese E. Copsey

#### ● CREATIVE MEDIA

7271 Garden Grove Blvd., Suite E, Garden Grove, CA 92641  
(714) 892-9469  
Owner: Tim Keenan  
Studio Manager: Tim Keenan

#### ● CREATIVE PRODUCTIONS

*also REMOTE RECORDING*  
3128 Linden Ave., Bakersfield, CA 93305  
(805) 325-3676  
Owner: Roger Thiesen  
Studio Manager: Roger Thiesen

#### ● THE CREATIVE WORD

17885 B-2 Skypark Cir., Irvine, CA 92714  
(714) 261-8273  
Owner: Bryan Hill

#### ● CUSTOM AUDIO RECORDING

*also REMOTE RECORDING*  
929 California Ave., Bakersfield, CA 93304  
(805) 324-0736  
Owner: Trenton T. Houston  
Studio Manager: Kenneth S. Houston



- **CUSTOMCRAFT RECORDINGS**  
also *REMOTE RECORDING*  
5440 Ben Ave., N. Hollywood, CA 91607  
(818) 509-9649  
Owner: Dean Talley  
Studio Manager: Thomas D. Talley
- **DAILY PLANET STUDIO**  
922 N. San Vicente, Los Angeles, CA 90069  
(213) 659-9569  
Owner: Jim Caprio  
Studio Manager: Jim Herter
- **db PRODUCTIONS**  
also *REMOTE RECORDING*  
P.O. Box 21273, Long Beach, CA 90802  
(213) 433-7727  
Owner: Dan Brown, Bruce Crook  
Studio Manager: Bruce Crook
- **DEMO TRAK STUDIO**  
also *REMOTE RECORDING*  
629 5th Ave. Lower Level, San Diego, CA 92101  
(619) 234-7724  
Owner: John D. Beneventi
- **D.M.O. PRODUCTIONS**  
5821 Cantaloupe Ave., Van Nuys, CA 91401  
(818) 994-4279  
Owner: Gary McLaughlin  
Studio Manager: Ophir Shur
- **DRAGONVILLE STUDIOS**  
1768 N. White Ave., LaVerne, CA 91750  
(714) 596-4371, 596-8205  
Owner: Barbara King  
Studio Manager: Diane Schmidt
- **EIGHT BALL STUDIO**  
414 S. Arcade, Ventura, CA 93003  
(805) 648-5613  
Owner: Steve Diggle  
Studio Manager: Wendy Diggle
- **EMERALD CITY RECORDING**  
1050 Griffin, Grover City, CA 93433  
(805) 489-9455  
Owner: Bruce Sanroian, Jake Dunn  
Studio Manager: "Lumpy"
- **EXXEL RECORDING STUDIOS**  
also *REMOTE RECORDING*  
102 N. Ditmar St., Oceanside, CA 92054  
(619) 722-8284  
Owner: J. Richard Lee  
Studio Manager: Bill Berry  
Engineers: Bill Berry, Allen Paris  
Dimensions of Studio(s): A: 22 x 14; B: 12 x 8 voiceover booth.  
Dimensions of Control Room(s): A: 16 x 8; B: 12 x 9.  
Tape Recorders: Otari 5050 MKIII 8 track; Otari 5050 BQ-II 2 track; (2) Otari 5050 2 track; (2) Ampex AG440-C 2 track; Ampex ATR700 2 track; Revox A700 2 track.  
Mixing Consoles: Biamp Bimix 2016 20 x 16, Yamaha MC1204 12 x 4.  
Monitor Amplifiers: Hoffer, Yamaha, Crown, SAE, JBL.  
Monitor Speakers: JBL, Yamaha, Aurestone.  
Echo, Reverb & Delay Systems: (2) Yamaha digital reverbs, Orban stereo spring, DeltaLab Super Time Line programmable DDL.  
Echo, Reverb & Delay Systems: dbx Type 1 on all channels, Valley People Dyna-Mile 430 2-channel multi-processor, EXR SPII 2-channel exciter, UREI 565 notch filter set, complete remote systems with auto-locator, Technics 1200 MKII turntables.  
Microphones: (2) AKG 414, E-V RE-20, Sennheiser MD421, SM-58s, SM-56s, AKG C-12, others.  
Instruments Available: Yamaha DX7, Sequential Circuits, digital drum machine, Seil DK-600 synthesizer with EXP 600 expander with 100 voices, Roland MSQ-700 digital keyboard sequencer.  
Rates: Very, very low — Please call or come visit.
- **FISSION ENTERPRISES**  
also *REMOTE RECORDING*  
9419 National Bl., Los Angeles, CA 90034  
(213) 839-7851  
Owner: Don Holmes  
Studio Manager: T.J.
- **FULLERSOUND A.V. RECORDING**  
P.O. Box 65051, Los Angeles, CA 90039  
(213) 660-4914  
Owner: Creative Support Services/Buy-Out Music  
Studio Manager: Michael M. Fuller
- **GARAGE AUDIO AND VIDEO**  
also *REMOTE RECORDING*  
W. Covina, CA 91790  
(818) 337-7943  
Owner: Patrick Woertink  
Studio Manager: Alan Clark
- **HAMMER SOUND COMPANY**  
9612 Lurline Ave, Unit N, Chatsworth, CA 91311  
(818) 998-9641  
Owner: I. Christopher & R. Brian Aphorh  
Studio Manager: I. Christopher Aphorh
- **HIGH SEA RECORDING**  
P.O. Box 84737, San Diego, CA 92138  
(619) 270-8568  
Owner: Rob Gworek  
Studio Manager: Rob Gworek
- **H.M.E.A.'s "STATE-OF-THE-HEART" STUDIO**  
also *REMOTE RECORDING*  
P.O. Box 453, Lakewood, CA 90714  
(213) 423-0273  
Owner: Harpezo! Ministries Evangelical Assoc.  
Studio Manager: Duane Everts  
Engineers: Duane Everts, Tom Brewis  
Dimensions of Studio(s): 15 x 21, iso: 6 x 8.  
Dimensions of Control Room(s): 9 x 11  
Tape Recorders: Tascam 38 8 track; Tascam 32-2B 2 track; Dokorder 1140 4 track; (12) logic-controlled Pioneer CT-F550 cassettes.  
Mixing Consoles: (2) TEAC Model 5 16 in x 8 out, (2) TEAC Model 1 16 in x 4 out.  
Monitor Amplifiers: Sanyo P-55 100 w/ch., Marantz, TOA.  
Monitor Speakers: JBL 4311, KLH  
Echo, Reverb & Delay Systems: Imagineering Audio's "Echo Digital Recorder" 16 sec. delay w/forward and reverse play, Fostex reverb, MXR flanger/doubler, MXR autollanger.  
Other Outboard Equipment: MXR dual fifteen band EQ; (2) Fostex stereo compressor/limiters; 8 channels noise reduction (dbx); Spectrum analyzer; Rock Trek II guitar preamp.  
Microphones: Shure SM57s, SMS8a, 545.  
Instruments Available: Blackhurst custom electric bass; Blackhurst custom electric six string.  
Video Equipment & Services: Video production van, ISI 902 camera switcher; character generator w/downstream key edger; Sony and Contrac monitors; JVC U-matic recorder; CVS time base corrector; TEAC model 3 audio console; Sony cassette deck; Tektronix WFM and vector-scope; Faroudja image enhancer.  
Rates: Under certain conditions "FREE"; call or write for rate card.
- **HOLLY PRODUCTIONS**  
119 1/2 N. Vista St., W. Hollywood, CA 90046  
(213) 876-2128  
Owner: Holly Schoch  
Studio Manager: Jean-Jacques Schoch
- **HOTLIX PRODUCTIONS**  
also *REMOTE RECORDING*  
21405 Colina Dr., Topanga, CA 90290  
(213) 455-3328  
Owner: Bill Glasser  
Studio Manager: Bill Glasser
- **HUMANOISE**  
also *REMOTE RECORDING*  
1245 S. Carob Way, Montebello, CA 90640  
(213) 721-9818  
Owner: William Almas  
Studio Manager: Richard Behan
- **INCIDENTAL SOUND**  
26847 Poveda, Mission Viejo, CA 92691  
(714) 643-1697  
Owner: Frederic B. Hodshon  
Studio Manager: Frederic B. Hodshon
- **J.C. STUDIOS**  
3401 Pacific #2B, Marina Del Rey, CA 90292  
(213) 822-7776  
Owner: Jeremy Christian  
Studio Manager: James Fox, Dusty Rucker
- **J&J MUSIC & SOUND**  
also *REMOTE RECORDING*  
P.O. Box 8474, Rowland Heights., CA 91748  
(818) 965-9386  
Owner: J&J Kubal  
Studio Manager: R.J. Kubal
- **J.E.R. STUDIOS**  
485 S. Kellogg Way, Goleta, CA 93117  
(805) 964-4512  
Owner: John & Debra Esparza  
Studio Manager: John or Debra Esparza
- **JOE'S GARAGE**  
417 S. Astell Ave., W. Covina, CA 91790  
(818) 919-2691  
Owner: Joe Schiff  
Studio Manager: Joe Schiff
- **JOE'S PLACE**  
8033 Sunset Blvd. #1010, Los Angeles, CA 90046  
(213) 659-3940  
Owner: Hollywood Spectrum, Inc.  
Studio Manager: Joe Klein
- **JR WEST SOUND RECORDERS**  
also *REMOTE RECORDING*  
1025 N. Ferndale, Fullerton, CA 92631  
(714) 645-8492  
Owner: Jack Roberts  
Studio Manager: Jack Roberts
- **JSL RECORDERS**  
also *REMOTE RECORDING*  
6179 San Ramon, Buena Park, CA 90620  
(714) 995-8818  
Owner: Jeff S. Landgraf, Jeannette F. Landgraf  
Studio Manager: Jeannette F. Landgraf
- **KIBBLE SOUND COMPANY**  
also *REMOTE RECORDING*  
204 California Blvd. #8, San Luis Obispo, CA 93401  
(805) 541-3255  
Owner: Bandito Kibble  
Studio Manager: Kevin M. Chew
- **KING RECORDING STUDIO**  
P.O. Box 883, Somis, CA 93066-0883  
(805) 987-2424  
Owner: Don King  
Studio Manager: Geoffrey King
- **KOALA STUDIO**  
also *REMOTE RECORDING*  
6748 Clybourn Ave. #124, N. Hollywood, CA 91606  
(818) 506-4205  
Owner: Jack Adams  
Studio Manager: Jim Romero
- **LAGUNA SOUND STAGE**  
2147 Laguna Canyon Rd., Laguna Beach, CA 92651  
(714) 497-5530  
Owner: Don Whitlatch, Dennis Keany  
Studio Manager: Don Whitlatch  
Engineers: Michael Canipe, Phillip Morgan, Jim Cochran  
Dimensions of Studio(s): Main studio 15 x 20, isolation booths 4 x 6 and 7 x 10.  
Dimensions of Control Room(s): 15 x 16.  
Tape Recorders: TEAC 80 8 track; TEAC A-3340S 4 track; TEAC 124 Syncacassette 2 track; Optonica RT-660S 2 track; Pioneer 1/2 track.  
Mixing Consoles: Sound Workshop 1280B, 12 in x 8 out.  
Monitor Amplifiers: Phase Linear, Crest, Marantz.  
Monitor Speakers: Altec, JBL, Cerwin Vega.  
Echo, Reverb & Delay Systems: Space Echo, MXR digital delay, Sound Workshop stereo reverb, Furman limiter/compressor, Furman parametric EQ, Soundcraftsman EQ.  
Other Outboard Equipment: 8-channel dbx, various amplifiers.  
Microphones: Shure, Sennheiser, Electro-Voice.  
Instruments Available: Acoustic piano, Hammond organ, Prophet 600, Korg Poly 800 synthesizer, Roland 707 digital drum machine, acoustic drum set.  
Video Equipment & Services: Lights, color filters, contract video service.  
Rates: Rehearsal (not subject to recording): \$10 per, \$8 block. Recording: \$25/hr, \$20 block.  
Direction: As any musician will tell you, the magic comes not from the instruments you use but how you use them. At Laguna Sound Stage, our engineers know their equipment inside and out. Their years of experience as accomplished musicians and engineers, combined with your songs and

—LISTING CONTINUED ON PAGE 174

**● SOUTHLAND-MULTITRACK**

P.O. Box 632, Poway, CA 92064  
(619) 748-2050

Owner: Memphis Lee Records/The Memphis Lee Organization

Studio Manager: N.K. Elder

**● SPECTRUM SIGHT & SOUND**

7011 Sunset Blvd., Los Angeles, CA 90028  
(213) 462-0812

Owner: Spectrum Sight & Sound, Inc.  
Studio Manager: Bill Froggatt

**● JAY STAGGS CASSETTE DUPLICATION**

also REMOTE RECORDING

7332 Florence Ave. Suite D, Downey, CA 90240  
(213) 928-7516

Owner: Jay Staggs

Studio Manager: Jay Staggs

**● STAGGS VISUAL MATRIX/SIMONS**

AUDIO-VIDEO

also REMOTE RECORDING

1820 S. Grand Ave., Santa Ana, CA 92705  
(714) 556-3899

Owner: Steve Simons, Kenny Staggs

Engineers: Steve Simons, Al Block, Dave Edwards (audio), Kenny Staggs (video).

Tape Recorders: Tascam 80-8 1/2" 8 track; Sony (digital processor) 501 2 track; (3) Tascam C-3 cassettes, 1/2 track 1/4" available.

Mixing Consoles: Biamp 1642, 16 x 4 x 2.

Monitor Amplifiers: Soundcraftsman, Crown.

Monitor Speakers: JBL 4311, Yamaha NS-10, Yamaha NS-5. Echo, Reverb & Delay Systems: ART 01 digital reverb, digital delay, Furman RV-1 reverb, great alley outside.

Other Outboard Equipment: 4 channels of noise gates, parametric EQ, graphic EQ, stereo compressor, limiters. Microphones: AKG 414 P-48, Shure SM51s, SMS8s, Tascam condensers, E-V RE-20, Sennheiser 421.

Instruments Available: Yamaha DX7, LinnDrum, Ludwig drum set, Ampeg bass amp, Rickenbacker bass, Fender, Ibanez, Gibson guitars, Mesa Boogie guitar amp, plus others.

Video Equipment & Services: 3/4" JVC editors, 3/4" & 1/2" portable VCRs, 3 and 1 tube cameras, camera switcher, sound stage & lighting, tilting, slo-motion & key effects, studio & location shooting, concept or live videos, promo tapes, custom logos & artwork, band portrait photography.

Rates: Call for rates.

**● STAR TRAK STUDIO**

also REMOTE RECORDING

30 Ryan, Redlands, CA 92373  
(714) 793-8075

Owner: John Wichman

Studio Manager: John Wichman

**● KRIS STEVENS ENTERPRISES**

14241 Ventura Blvd #204,  
Sherman Oaks, CA 91423

(818) 981-8255

Owner: Kris Erik Stevens

Studio Manager: Denise Cox

**● STRAT-O-SOUND**

also REMOTE RECORDING

812 Chelham Way, Santa Barbara, CA 93108  
(805) 969-4131

Owner: Neil Mietus

Studio Manager: Neil Mietus

**● SUNDIAL RECORDING STUDIO**

P.O. Box 5426, Montecito, CA 93150  
(805) 969-6926

Owner: Don Messick

Studio Manager: Kay Wisnesky

**● SUPERSOUND STUDIO**

8946 Ellis Ave., Los Angeles, CA 90034

(213) 836-4028

Owner: Morris David Goldner

**● SYNTRAX PRODUCTIONS**

4847 Camellia Ave., Temple City, CA 91780  
(818) 285-3698

Owner: Bill Pearson

Studio Manager: Bill Pearson

# SOUTHERN CALIFORNIA

## S · T · U · D · I · O · S

### 4 & 8 TRACK

**● TARGET RECORDERS**

also REMOTE RECORDING

1123 Rosewood Ave., Inglewood, CA 90301  
(213) 419-4017

Owner: A.R. Thomas

Studio Manager: Bonita C. Thomas



**THETA SOUND STUDIO**  
Los Angeles, CA

**● THETA SOUND STUDIO**

Los Angeles, CA 90027

(213) 669-2772

Owner: Randy Tobin

Studio Manager: Cyndie Tobin

Engineers: Randy Tobin, Wally August

Dimensions of Studio(s): 13 x 14 plus drum booth

Dimensions of Control Room(s): 10 x 12

Tape Recorders: Tascam 38 1/2" 8 track; Tascam 34 4 track; Technics RS1520 2 track (12 channels of dbx noise reduction), (4) Onkyo 630D cassette decks; Advent 201 cassette deck.

Mixing Consoles: Roland RM-1600 16 x 16 x 5, Tapco 6100RB/EB 14 in x 9 out.

Monitor Amplifiers: Kenwood Pro Series High Speed DC amplifier, Rane HC-6 headphone amplifier system.

Monitor Speakers: JBL 4301B, Yamaha NS-10M, Auratone 5C.

Echo, Reverb & Delay Systems: LT Sound TAD-4 stereo echo/delay, (2) Yamaha R1000 digital reverb systems, MXR digital delay w/full memory, 20ms fixed delay doubler.

Other Outboard Equipment: Dyna-Mite, Symetrix, MXR, and dbx compressor/limiters; Soundcraftsman and Symetrix Sound Systems graphic EQs; 4 channel parametric EQ; Ibanez Harmonics Delay; Inter City exciter; Dual 1229 turntable w/Shure V-15 Type V cartridge, Dr. Flick digital metronome/clock synchronizer.

Microphones: AKG 414; Countryman EC-101 and Isomax II; Shure SM-57; Beyer M-160, M-500.

Instruments Available: Yamaha C5 6'6" Conservatory grand piano w/Forte MIDI Mod (for controlling all of our MIDI synths from the piano), (2) Yamaha DX7 synths, Roland Jupiter-8 synth w/MIDI, Roland MSQ 700 MIDI Sequencer, ARP Omni synth, 1972 Fender/Rhodes piano, SCI Drum-tracks drum computer, Simmons SDS 8, Slingerland drum kit w/Tama hardware and cymbal assortment, Gibson Ripper bass, Fender and Sunn amplifiers, assorted percussion.

Video Equipment & Services: Sony SL-2710 Beta HiFi VCR, Toshiba Monitor.

Rates: 8 track—\$30/hr; 4/2 track, editing, and voice elimination—\$25/hr; tape duplication—\$20/hr (4 cassettes at once).

Extras: Computer-generated cassette labels, record production, packaging, art and graphics, photography, radio spots, jingles, voice elimination (for budget demos), recording classes and DX7 programming classes.

Direction: Our philosophy has been for the past seven

years, "Back to the Real Sound!" We have been providing excellent quality demos and masters to a talented but budget-minded clientele. We are constantly expanding and adding new items to the studio, making Theta Sound one of the best 8/4/2 track facilities in Southern California. Some of our clients include: Durell Coleman, Robin Williamson, Dale Gonyea, Misha Segal, Harriet Schock, August, Michael Scott & Doug Norwine - EW1, Nia Peoples, and John Strauss.

**● T.K.O. PRODUCTIONS & MEDIA SERVICES**

also REMOTE RECORDING

P.O. Box 862, Port Hueneme, CA 93041  
(805) 488-0523

Owner: T.R. Scharf, K.L. Scharf

Studio Manager: Tom Scharf

**● TRENDS IN PROFESSIONAL SOUND & VIDEO DIMENSIONS**

also REMOTE RECORDING

1220 N. Rosemead Blvd. Suite 108,  
San Gabriel, CA 91775

(818) 287-0921

Owner: Tony Bohlin

Studio Manager: Todd Barry

**● UNDERGROUND STUDIO**

also REMOTE RECORDING

652 W. Arbor Vitae, Inglewood, CA 90301  
(213) 671-6108

Owner: Tom Cherry

Studio Manager: Richard Sandford

Engineers: Richard Sandford, Richard Jallis, Dave Levine, Eddie Call.

Dimensions of Studio(s): main room: 15 x 20; isolation booth: 7 x 5.

Dimensions of Control Room(s): 9 x 13

Tape Recorders: Otari 5050-8 MK III 8 track; (2) TEAC A3340S 4 track; Technics RS1500US 2 track; Sony TCK81 cassette; Sansui SC3110 cassette.

Mixing Consoles: Studiomaster 1608, 16 x 8 x 2; Studiomaster 1604, 16 x 4 x 2; Shure M68, 5 x 1.

Monitor Amplifiers: Marantz, BGW, Crest.

Monitor Speakers: JBL, Auratones, custom.

Echo, Reverb & Delay Systems: MasterRoom MICMIX XL305 stereo reverb, Eventide digital delay, Effectron digital delay, (2) Roland RES01 chorus echo.

Other Outboard Equipment: Eventide Omnipressor, UREI limiter/compressors, Audioarts stereo parametric EQ, dbx 160x compressor/limiters; professional series dbx noise reduction Technics turntable.

Microphones: Neumann, AKG, Sennheiser, Sony, Beyer, E-V, Shure, direct boxes (Westlake and Jensen).

Instruments Available: CMI Fairlight, LinnDrum w/custom chips, full Simmons SDS-8, Yamaha DX7, Roland Juno 60, Oberheim OBXa, Sequential Circuits, Prophet 600, 5 & 10, complete Apple IIe computer w/MIDI, Ludwig & Gretsch drums, extensive percussion and effects, ARP Omni 2, Ampeg, Marshall, Fender, Music Man amps, acoustic piano, electric and acoustic guitars, sound effects library, Rockman 1 & 2, Oberheim OBSX, Ensoniq "Mirage."

Rates: 8 track \$18/hr—block rate \$15/hr. Rehearsals \$7/hr—block rate \$6/hr. For equipment, computer or live PA rentals, call for quote. Staff producers, arrangers and engineers available on an hourly and project basis, call for quote. Full rate cards are available, please phone.

**● VCA STUDIOS**

also REMOTE RECORDING

4436 Katherine Ave., Sherman Oaks, CA 91423  
(818) 783-0386

Studio Manager: Michael Sullivan

Engineers: Michael Sullivan, Liz Saly

Dimensions of Studio(s): 17 x 15 x 12

Dimensions of Control Room(s): 10 x 17

Tape Recorders: Fostex A-8 8 track; Fostex B-16 16 track; Otari MX5050B-II 2 track; TEAC/Tascam 22-2 2 track; Akai 4000-DB 2 track.

Mixing Consoles: Biamp Custom 1621 32 in x 4 out.

Monitor Amplifiers: Crown, Yamaha.

Monitor Speakers: Custom JBL design

Echo, Reverb & Delay Systems: Lexicon, DeltaLab, Ibanez

Other Outboard Equipment: Technics SL-210 VSO turntables, Valley People Dyna-Mite limiter/compressor, ADC graphic EQ, DOD phasers & flangers.

Microphones: Neumann, AKG, Beyer, Audio-Technica, Shure, Nady Systems wireless.

Instruments Available: Yamaha CP-70 electric grand piano, Prophet 600 MIDI synthesizer, Fender Rhodes 73, EMU Drumulator (50 sounds), DX7 drums, Sequential Circuits

Pianoforte, glockenspiel, acoustic guitars, Fender electric bass, Fender amplifiers.

Video Equipment & Services: Broadcast-quality production/postproduction/audio sweetening. All professional formats, IVC BY-110 camera, Sony video switcher/SEG.

Rates: Reasonable! Call for more information.



•• WAVES SOUND RECORDERS  
 also REMOTE RECORDING  
 1956 N. Cahuenga, Hollywood, CA 90068  
 (213) 466-6141  
 Studio Manager: Stewart Sloke

•• DANA WHITE PRODUCTIONS  
 2623 29th St., Santa Monica, CA 90405  
 (213) 450-9101  
 Owner: Dana C. White  
 Studio Manager: Dana C. White

•• WRITE TRACK STUDIO  
 3805 Huron Ave. #4, Culver City, CA 90230  
 (213) 838-4463  
 Owner: Eric Sclar  
 Studio Manager: Eric Sclar  
 Engineers: Eric Sclar, Larry Kornfield  
 Dimensions of Studio(s): 12 x 14  
 Dimensions of Control Room(s): 14 x 6  
 Tape Recorders: Otari 5050 MXIII-8 8 track; Otari 5050  
 MXIII-2 2 track; Revox A77 2 track; Tascam 122B 2 track.  
 Mixing Consoles: Soundworkshop 1600 20 in x 16 out.  
 Monitor Amplifiers: Hafler 220  
 Monitor Speakers: JBL 4411  
 Echo, Reverb & Delay Systems: (2) Lexicon 200 reverbs,  
 Lexicon Super Prime Time.  
 Other Outboard Equipment: dbx 165 comp/limiter, Val-  
 ley People; (3) Maxi Qs, (3) Kepey's, (4) preamps, (2) gain  
 brains; UREI 250 direct box.  
 Microphones: (2) AKG C414P48, (2) Audio-Technica ATM  
 31, (2) Audio-Technica ATM 63, (3) Shure SM57, Shure  
 SM58.  
 Instruments Available: DX7, LinnDrum, Fender Stratocas-  
 ter, Champ amp, Ibanez bass, Martin D35, Mansfield upright  
 grand piano.  
 Rates: \$20/hr includes engineer and use of all instruments.

•• GREG YOUNGMAN MUSIC  
 P.O. Box 8102, Long Beach, CA 90808  
 (213) 425-9597

•• ZACUTO AUDIO  
 1316 3rd St., Santa Monica, CA 90401  
 (213) 394-4932  
 Owner: Gary Zacuto  
 Studio Manager: Gary Zacuto

# DON'T Make a Move!!!

Without telling us where to send your MIX! Please fill out this form or use one of the postage paid subscription cards in this issue to **CHANGE YOUR ADDRESS**. Please allow four to six weeks and be sure to complete all the information requested.

OLD LABEL HERE OR PREVIOUS ADDRESS

## New Address:

Name \_\_\_\_\_

Co. \_\_\_\_\_

Address \_\_\_\_\_

City \_\_\_\_\_ State \_\_\_\_\_ Zip \_\_\_\_\_

*LaSalle stocks over 250 product lines, giving you the widest choice.*

*LaSalle's prices are the lowest, offering you the best values. Their product*

*knowledge and service are expert, supporting you both before and after your purchase.*

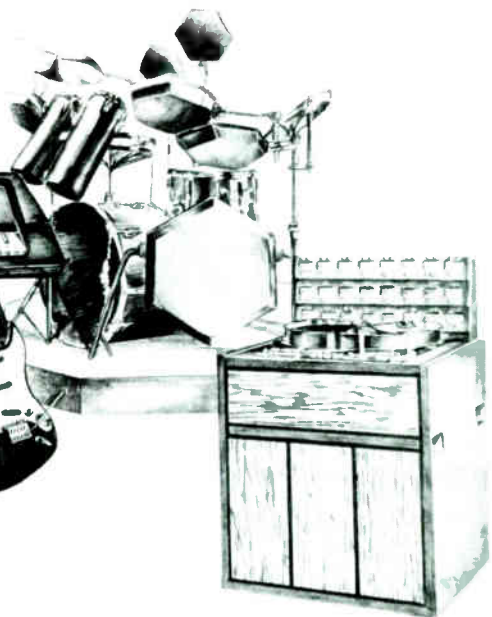
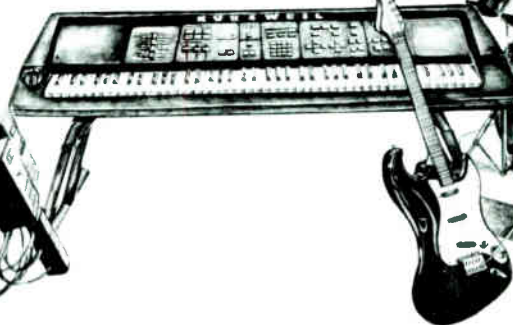
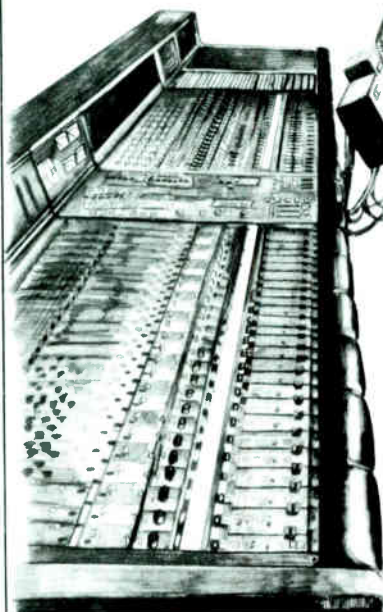

**Call:**  
 inside MA (617) 536-0066  
 Nationwide (800) 533-3388

**or Visit:**  
 1116 Boylston Street  
 Boston, MA 02115  
 22 LaSalle Road  
 West Hartford, CT 06107

**LaSalle**  
 Professional Audio & Musical Instruments

Circle #127 on Reader Service Card

# SOUTHERN CALIFORNIA

## S · T · U · D · I · O · S

### 16 TRACK

●●● **ACRASOUND RECORDING STUDIO**  
5951 Venice Blvd., Los Angeles, CA 90034  
(213) 936-7788 or 93-MUSIC  
Owner: Edward Zinkow  
Studio Manager: Steve Zinkow

●●● **APOLLO RECORDING STUDIO**  
6142 Beach Blvd., Buena Park, CA 90621  
(714) 994-3761  
Owner: Ace Simpson, Ron Brady, Tom Chisholm  
Engineers: Ace Simpson (chief), Ron Brady, Sam Burke, and Jim Goodwin  
Dimensions of Studio(s): 24 x 20  
Dimensions of Control Room(s): 12 x 20  
Tape Recorders: 3M 16 track; 3M 8 track; Tascam 25-2; TEAC 3340 4 track discrete; TEAC 450 stereo cassette.  
Mixing Consoles: Tangent Series 16 (expanded).  
Monitor Amplifiers: Marantz 1050 & 1070 plus cue boost amplifier.  
Monitor Speakers: JBL 4311s control room, JBL L100s studio, Auratone mixing cubes.  
Echo, Reverb & Delay Systems: Tapco 4400 reverb, variable pitch tape delay, tape phasing (VSO), Ibanez DM 1000 digital delay, Ibanez HD 1000 harmonizer.  
Other Outboard Equipment: Teletronix compressor/limiter; SE30 compressor; ADC graphic EQ; Moog parametric EQ, stereo synthesizer; Vocal eliminator; Aphex Aural Exciter.  
Microphones: AKG D-200E, D-190, D-119; Sennheiser MD-421 H; Altec 659-A; Shure SM-57; Electro-Voice 627-B; RCA 77-D, BX-11A; Sony F-121; various quadres of each, direct boxes.  
Instruments Available: Acoustic baby grand piano (no fee), Fender Rhodes, bass guitar, electric guitar, 25W Fender tube amp, Wah-Wah pedal and various percussion, large set of Rogers drums; also: synthesizer and Wurliizer electric piano available by special arrangement, Yamaha D80 organ and Crumar string machine, Drumulator drum machine.  
Video Equipment & Services: Recording, editing and dub service up to ¾" format.  
Rates: 16 track: \$35/hr; 8 track: \$30/hr basic. Negotiable depending on requirements. Dubbing or copying \$20/hr. special rates for block time (50 hrs minimum).

●●● **AUDIO PARAGON**  
also **REMOTE RECORDING**  
11612 Knott St. Suite 16, Garden Grove, CA 92641  
(714) 898-8373  
Owner: Emmitt Siniard  
Studio Manager: Emmitt Siniard

●●● **BARE TRAX**  
P.O. Box 4988, Culver City, CA 90231  
Owner: Jon Bare  
Studio Manager: Jon Bare

●●● **B & B SOUND STUDIOS**  
3610 W. Magnolia Blvd., Burbank, CA 91505  
(818) 848-4496  
Owner: Ken Berger

●●● **BLACK OLIVE RECORDING STUDIO**  
1745 Hickory St., Sand City, CA 93955  
(408) 394-7176  
Owner: Nick Olivo  
Studio Manager: Lee Carter  
Engineers: Lee Carter, Nick Olivo  
Dimensions of Studio(s): 24 x 16 (vocal booth 5 x 10).  
Dimensions of Control Room(s): 11 x 19  
Tape Recorders: Tascam MS-16 w/dbx 16 track; Tascam 80-8 w/dbx 8 track; TEAC 3340-A 4 track; Tascam 25-2 w/dbx 2 track; (2) TEAC cassette decks.  
Mixing Consoles: Tascam M-520 20 in x 8 out; Tascam 5 8 in x 4 out; Tascam M-1 8 in x 4 out.  
Monitor Amplifiers: Yamaha 2200, Crown D-150A, Rane HC6 (headphones).  
Monitor Speakers: JBL 4311, Auratones  
Echo, Reverb & Delay Systems: Ursa Major Star Gate 323. Master-Room reverb stereo, DeltaLab II, DeltaLab 1024, MXR.  
Other Outboard Equipment: Aphex Aural Exciter Type B, Orban de-esser, (2) dbx 165 compressor/limiters; UREI Limiter 1176, Tascam EQ, Symetrix SG-2 noise gate, Getex USAudio noise gate, Furman parametric EQ (stereo).  
Microphones: Neumann U87, Sennheiser 421, E-V RE-20, Sony ECM 56F, (2) Shure SM 57, (8) SM 58.  
Instruments Available: Electric/acoustical Kawai 88", Ludwig drums, E-mu Drumulator, Fender & Yamaha guitars & bass guitars, Fender & Roland guitar amps, DX7, PolySix Korg, ARP Axse, effect pedals, Countryman direct boxes, Peterson 420 tuner, Rockman & bass Rockman. Always updating.  
Rates: Please call or write for further information. Thank you!

●●● **BUZZY'S RECORDING SERVICES**  
6900 Melrose Ave., Los Angeles, CA 90038  
(213) 931-1867  
Studio Manager: Larry Lantz

●●● **RITCHIE CARBAJAL MUSIC**  
637 Kimlin Dr., Glendale, CA 91206  
(818) 956-0723  
Owner: Ritchie Carabajal  
Studio Manager: Ritchie Carabajal

●●● **CASBAH RECORDING**  
1895 Commonwealth Ave. Suite "N"  
Fullerton, CA 92633  
(714) 738-9240  
Owner: Chaz Ramirez, Kim Larson  
Studio Manager: Rollo Ramirez

●●● **RK COLE STUDIOS**  
157 Paseo Dela Concha #4, Redondo Beach, CA 90277  
(213) 378-5995  
Owner: Randy Coleman  
Studio Manager: Randy Coleman

●●● **DOG BARK RECORDING**  
1269 8th St., Los Osos, CA 93402  
(805) 528-6939  
Owner: Jon Iverson  
Studio Manager: Photon

●●● **D-TOWN/PLATINUM SOUND RECORDING**  
also **REMOTE RECORDING**  
1680 N. Vine, Suite 515, Hollywood, CA 90028  
(213) 460-4000  
Owner: D-Town Records, Inc.  
Studio Manager: Mark Johnson

●●● **DUCHESS STUDIOS**  
also **REMOTE RECORDING**  
7923 Duchess Dr., Whittier, CA 90606  
(213) 698-7715  
Owner: Chuck & Madeline Minear  
Studio Manager: Chuck Minear  
Engineers: Chuck Minear, Chuck Mitchell, independents  
Dimensions of Studio(s): Studio A: 18 x 23; Vocal booth: 12 x 10; Production Studio C: 8 x 10  
Dimensions of Control Room(s): A: 17 x 13; C: 8 x 10  
Tape Recorders: Ampex 1100 16 track; Ampex AG350 2 track; Ampex ATR 500 2 track; (2) Revox B-77 1 & 2 track; (2) Revox A-700 2 track; (2) Revox A-77 ¼" 2 track; Revox B-700 cassette; TEAC 80-8 8 track.  
Mixing Consoles: Amek 2500 20 in x 20 out, Kelsey Pro 2/3 12 in x 3 out.  
Monitor Amplifiers: McIntosh 2100 - Opamp  
Monitor Speakers: UREI 811s, Philips 545, Yamaha NS-10M, Auratone 5  
Echo, Reverb & Delay Systems: Lexicon 200 reverb & PCM-42; AKG BX10; Klark-Teknik DN-36; EXR-3  
Other Outboard Equipment: Limiters: dbx 160, UREI 1176, Symetrix gates, Mighty Mite  
Microphones: AKG, Beyer, Neumann, Shure, PZM, Sennheiser, RCA, etc.  
Instruments Available: Kawai 74" grand piano, Rhodes, Roland JX-3P, Conn 2 man theater organ, guitar (ACC). Rentals available.  
Video Equipment & Services: Dubs from ¾" to VHS & Beta  
Rates: 16 track: \$40; 8 track: \$30

●●● **E.D.B. AUDIO & VIDEO**  
27417 Onlee Ave., Saugus, CA 91350  
(805) 259-0828  
Owner: Eric Di Berardo  
Studio Manager: Eric Di Berardo

●●● **FATTRAX STUDIOS**  
4108 Burbank Blvd., Burbank, CA 91505  
(818) 841-6423  
Owner: Chris Brosius, Craig Fall  
Studio Manager: Chris Brosius

●●● **FUTURE SOUND**  
also **REMOTE RECORDING**  
1842 Burselon, Thousand Oaks, CA 91360  
(805) 496-2585  
Owner: Randy Dew  
Studio Manager: Randy Dew

●●● **DON HARPER PRODUCTIONS, INC.**  
730 E. Third St., Long Beach, CA 90802  
(213) 436-5053  
Owner: Don Harper

●●● **HIT SINGLE RECORDING SERVICES**  
also **REMOTE RECORDING**  
College Grove Center, Lower Ct. #4  
San Diego, CA 92115  
(619) 265-0524  
Owner: Scottman Ltd.  
Studio Manager: Rick Bohlman  
Engineers: Rick Bohlman, Randy Fuelle, John Hildebrand, indies welcome.  
Dimensions of Studio(s): 27 x 23  
Dimensions of Control Room(s): 19 x 18  
Tape Recorders: Stephens 811C-16 8/16 track; Tascam 80-8/dbx 8 track; MCI JH-110 2 track; Pioneer RT-1050 2 track; Onkyo/Akai cassette decks.  
Mixing Consoles: Soundcraft 1624 transformerless 18 x 16 x 16 groups, 34 channels total.  
Monitor Amplifiers: BGW w/Klark-Teknik 1/3 octave EQ (mains), BGW (headphones).  
Monitor Speakers: UREI 813, JBL 4311, EPI 90, Auratone 5C.  
Echo, Reverb & Delay Systems: Lexicon PT93, Effectron 1024, MXR DDL, Ecoplate II, Roland RV-800 stereo spring.  
Other Outboard Equipment: Eventide Instant Phaser, (2) dbx 160, (2) UREI LA-4, dbx 128, (2) Valley People Dyna-Mite, EXR Exciter, (2) MXR 31 band & 15 band EQ, (2) Spotmaster Studio-Pro turntables, Commodore C-64 w/D.

—LISTING CONTINUED ON PAGE 180



# ROSS **4x4** THE GO ANYWHERE MACHINE!

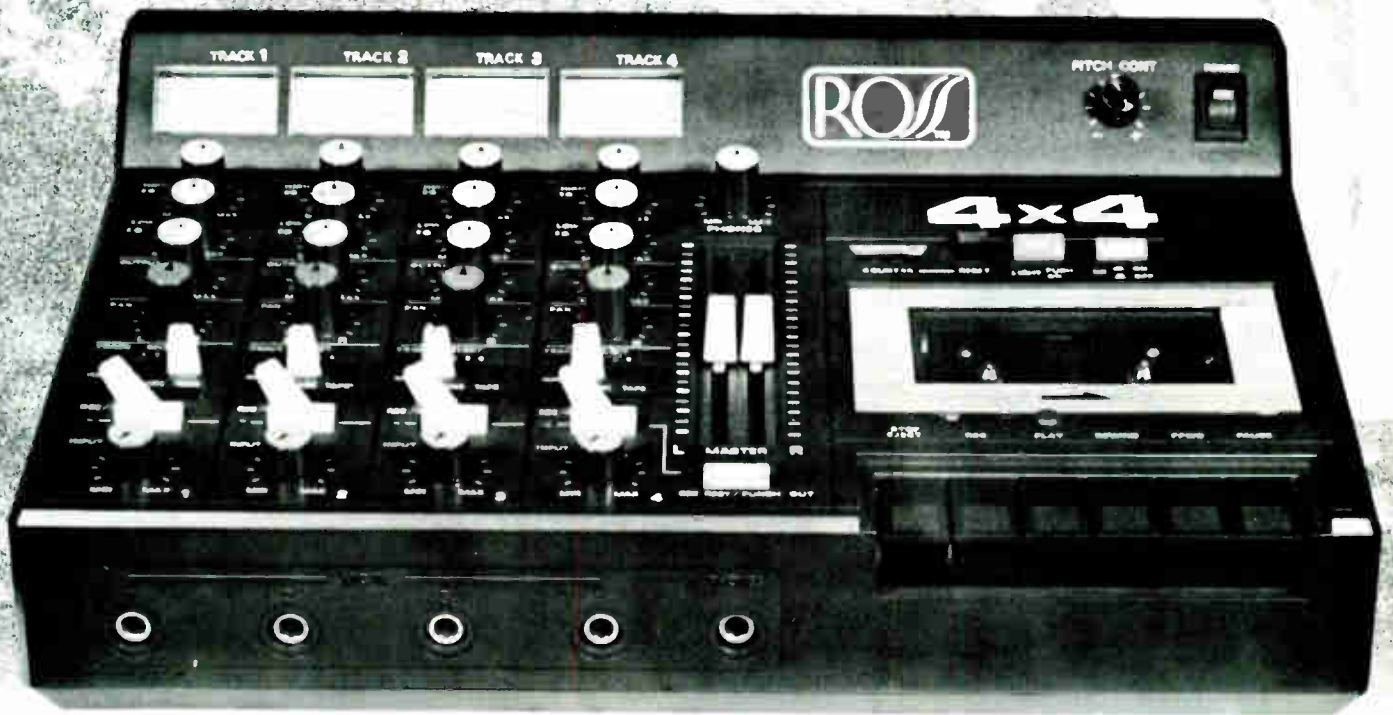

The new ROSS 4X4 multi-track personal recorder is a true **technology breakthrough** in the under \$500.00 MTR market.

Stepping out in front of all competitors . . . the ROSS 4X4 MTR features 4 mic/line inputs and will record on **all 4 tracks simultaneously** or in any ping pong multiple (3 on 1, 2 on 1, etc.)! Maintaining the VU meter bridge level control, the ROSS 4X4 feels more like an up-market machine than a battery toy! With built-in noise reduction, easy punch-in/punch-out, full 2-band function EQ and

monitor level controls, the ROSS 4X4 is in a league by itself!

The ROSS 4X4 mini MTR studio is equipped with all the basic accessories, like A.C. adapter and carrying case. Remember, with ROSS, there are no after purchase "zingers"!!!

Our ROSS 4X4 is truly the go anywhere MTR dream! Being battery operated allows unlimited off road adventure or hook in your U.L. approved A.C. adapter for the more domestic environment. ROSS will do it all!

ONLY **\$499<sup>95</sup>**

Complete with Case and A.C. Adapter

For more information, contact the MTR people at:



ROSS SYSTEMS  
A DIVISION OF IMC  
P.O. Box 2344  
Fort Worth, TX 76113  
(817) 336-5114

Circle #128 on Reader Service Card

# SOUTHERN CALIFORNIA

## S · T · U · D · I · O · S

### 24 TRACK

●●●● **A&M RECORDING STUDIOS**  
*also REMOTE RECORDING*  
 1416 N. Sycamore Ave., Hollywood, CA 90028  
 (213) 469-5181  
 Owner: Herb Alpert, Jerry Moss  
 Studio Manager: Don Hahn, v.p., gen. mgr.

●●●● **A&R RECORDING SERVICES**  
*also REMOTE RECORDING*  
 71906 Highway 111, Rancho Mirage, CA 92270  
 (619) 346-0075  
 Owner: Scott B. Seely  
 Studio Manager: Nick Mandala, Scott Seely  
 Engineers: Nick Mandala, Scott Seely  
 Dimensions of Studio(s): 30 x 18  
 Dimensions of Control Room(s): 12 x 12  
 Tape Recorders: Soundcraft 382 24 track; Ampex ATR-102 2 track; Revox A77 2 track.  
 Mixing Consoles: NEOTEK Series 2, 24 out x 24 in.  
 Monitor Amplifiers: BGW 700, Crown 60, Crown D-150s.  
 Monitor Speakers: JBL 4311s, Altec 604s, Auratone 5Cs.  
 Echo, Reverb & Delay Systems: Master-Room XL-210, Acoustic Computer MXL-305, Lexicon PCM60.  
 Other Outboard Equipment: dbx 160, Orban 424A, Delta-Lab DL2, Kepex, Denon and Akai GX-M50 cassette decks, Ashly SC-66As, Clap Trap, Eventide H949 Harmonizer.  
 Microphones: Neumann U47 tube, AKG P48s & 414, E-V RE-20s, SM-58s, Audio-Technica.  
 Instruments Available: Steinway A grand piano, ARP String Ensemble, Prophet 5 - 1000, Minimoog, MiniKorg, Rhodes Pro piano modified, Yamaha CE25 synth.  
 Video Equipment & Services: Available in-house or remote location; 2 cameras available.  
 Rates: On request.

●●●● **ADAMO'S RECORDING**  
 16571 Higgins Cir., Huntington Beach, CA 92647  
 (714) 842-2668  
 Owner: Jerry Adamowicz

●●●● **ADVANCED MEDIA SYSTEMS**  
*also REMOTE RECORDING*  
 833 W. Collins Ave., Orange, CA 92667  
 (714) 771-1410  
 Owner: Daniel R. Van Patten  
 Studio Manager: Kathryn Bartlett  
 Engineers: Michael Hutchinson, Steve Anderson, Michael Mikulka, Daniel R. Van Patten  
 Dimensions of Studio(s): 25 x 30  
 Dimensions of Control Room(s): 18 x 20  
 Tape Recorders: Studer A-80 MKIII 24 track; Otari MTR-12 ½" 2 track; TEAC V-4X cassette.  
 Mixing Consoles: NEOTEK Series III-C 40 in x 24 out.  
 Monitor Amplifiers: Eagle 7A, (2) Fostex M-600, (3) Uni-sync 50s, Soundcraftsmen PCR-700, AB Systems 720.  
 Monitor Speakers: JBL 4435s, JBL 4331s, Yamaha NS-10s, Auratones.  
 Echo, Reverb & Delay Systems: Lexicon 224XL w/updates, Ecoplate III, (2) Roland digital reverbs, (4) Roland



**ADVANCED MEDIA SYSTEMS**  
 Orange, CA

SDE-3000 digital delays, ADA digital delay.  
 Other Outboard Equipment: (2) UREI 1176s, (2) dbx 165A, dbx 900 rack w/(2) de-essers, (6) gates, Roland Vocoder, P.L. analyzer.  
 Microphones: (2) AKG "The Tube," Neumann U87s, Neumann U89s, KM-84s, AKG CB-414s, 460s, Sennheiser 421s, PZMs, E-V RE-20s, Fostex M-80s, Shure 57s.  
 Instruments Available: Roland System 700 modular synthesizer, Moog Model 15 modular, Roland Model 100-modular, Roland Juno-60, Roland MC-4B, Tama Techstar electronic drums, Roland JX 3-P, Ludwig and Slingerland drum kits, Gibson '59 Flying V, Gretsch Silver Jets ('55 and '56).  
 Note: All synths can be MIDI controlled! Emulator II, Fairlight and Oberheim Xpander available on a per session basis.  
 Rates: Please call for rates.  
 Extras: Daniel R. Van Patten is an independent producer/engineer with gold and platinum album credits. Please call for further information.  
 Direction: Advanced Media Systems is a production studio whose clients in the past year have included Berlin, Roland Corp., All American Boys Chorus, David Diamond (formerly of Berlin), Agent Orange, Psychobud, Human Therapy, and Chris Ruiz-Velasco (songwriter/guitarist).

●●●● **ALPHA STUDIOS, INC.**  
 4720 W. Magnolia Blvd., Burbank, CA 91505  
 (818) 506-7443  
 Owner: Denny Shaw, Gary Brandt, Del Lewis  
 Studio Manager: Gary Brandt  
 Engineers: Gary Brandt, Denny Shaw (2nd engineer), Dana Collins.  
 Dimensions of Studio(s): Audio: 44 x 22 x 12+ sound lock and attached 50 x 50 stage with 35 x 40 cyc.  
 Dimensions of Control Room(s): 20 x 24

**Tape Recorders:** Ampex 1200 & 1100 24 in x 16 out; ATR 2 and 4 tracks; Ampex VPR II video recorders with TBC; JVC ¾"; Scully carts.  
**Mixing Consoles:** Alpha Studios/API custom 40 in x 24+ out (up to 72 with monitor foldback).  
**Monitor Amplifiers:** BGW 750, Phase 700A.  
**Monitor Speakers:** TAD TSM-1.  
**Echo, Reverb & Delay Systems:** EMT 140 stereo, RMX 16, Lexicon DDLs, Roland DDLs, Eventide Harmonizers.  
**Other Outboard Equipment:** dbx gates and de'ess, Kepex gates and limiters; Pultec EQs; UREI limiters.  
**Microphones:** All current Neumann, AKG, Shure, etc., and a collection of tube mikes.  
**Instruments Available:** Steinway B grand piano  
**Video Equipment & Services:** Complete BTX lock-up system with Cypher time code gen, RS170 A sync sources, Video DA's, etc. Back screen RCA 50" in main studio for sweetening. We do all forms of audio post for the entertainment industry plus video edit production for commercials and music video. Film production and ultimate uses on our stage. We specialize in high quality audio and simultaneous video production. Music recording/audio post.  
 Rates: Priced under market, call for quotes.

●●●● **AMIGO STUDIOS**  
 1114 Cumpston St., N. Hollywood, CA 90028  
 (818) 980-5605  
 Owner: Chel Himes, Steve Shields, Barry Wilson  
 Studio Manager: Bob Carroll

●●●● **ARTISAN SOUND RECORDERS**  
 1600 N. Wilcox, Hollywood, CA 90028  
 (213) 461-2751  
 Studio Manager: Greg Fulginiti (chief engineer)

●●●● **AUDIO ACHIEVEMENTS**  
 1327 Cabrillo Ave., Torrance, CA 90501  
 (213) 533-9531  
 Owner: Audio Achievements, a Calif. Corp.  
 Studio Manager: Donovan Smith

●●●● **AUDIO ENGINEERING ASSOCIATES**  
*also REMOTE RECORDING*  
 1029 N. Allen Ave., Pasadena, CA 91104  
 (818) 798-9127, (818) 684-4461  
 Owner: Wes Dooley and Sara Beebe  
 Studio Manager: Janet Dodson  
 Engineers: Janet Dodson, Wes Dooley, Peter Bergren, David Baker  
 Dimensions of Studio(s): 30 x 23 x 14; isolation booth: 10 x 7 x 8  
 Dimensions of Control Room(s): 17 x 13 x 12  
 Tape Recorders: Studer AB0RC-II ½" 2 track; Studer AB10 ¼" 2 track; Studer A80 MKIV 24 track; Otari MX5050 MKIII-8 ½" 8 track; Soundcraft 760 2" 24 track; Sony PCM-F1/SL2000 2 track digital; Otari MX5050B MKII ¼" 2 track; Tascam 16 track 1"; misc. other recorders by Revox; cassettes: Revox, Studer, Nakamichi.  
 Mixing Consoles: Soundcraft 2400 24 x 16 x 24, Soundcraft 600B 16 x 14 x 2, Tascam, Ramsa. Custom-built 6x2 portable consoles.  
 Monitor Amplifiers: Haller, Fostex, UREI, Bryston, Crown.  
 Monitor Speakers: KEF, JBL, UREI, Auratones; headphones by Beyer, Fostex, Yamaha, Koss, AKG.  
 Echo, Reverb & Delay Systems: Lexicon, DeltaLab, Fostex, Ursa Major.  
 Other Outboard Equipment: Wide variety of equipment by AKG, dbx, UREI, Lexicon, Ashly, Klark-Teknik, Fostex, DeltaLab and others.  
 Microphones: AKG, Schoeps, Neumann, Crown PZM, Shure, RCA ribbon, Beyer, E-V, Sennheiser.  
 Instruments Available: Steinway model M grand piano.  
 Rates: 2 track: \$50/hr; 8 track: \$60/hr. Remote rates and special rates by quotation.

●●●● **AUDIO VIDEO ALLIANCE**  
*also REMOTE RECORDING*  
 5816 Lankershim Blvd. #7, N. Hollywood, CA 91601  
 (818) 506-0824  
 Owner: Steve Mitchell, Steve Katz  
 Studio Manager: Steve Mitchell, Steve Katz

●●●● **AZTEC STUDIOS**  
 20531 Plummer St., Chatsworth, CA 91311  
 (818) 998-0443  
 Owner: A.E. Sullivan  
 Studio Manager: A.E. Sullivan

●●●● **BABY 'O RECORDERS, INC.**  
 6525 Sunset Blvd., Hollywood, CA 90028  
 (213) 464-1330  
 Owner: Rafael Villafane, Enrique Senker, Rick Perrotta



# EASTERN ACOUSTIC WORKS!



## FIRST PRIZE WINNER OF THE JAPAN AUDIO CONSULTANT SOCIETY COMPETITION

### IT REALLY REALLY WORKS!

It works in the industrial installation in Tokyo—where the testing took place that resulted in Nippon Onkyoka Kyokai naming the EAW-based Unicus System the best-performing high-level sound system in the world.

And it works in EAW's new FR Series, shown above: FR222, FR102, FR253, FR122, FR153.

The FR Series is our third-generation professional full-range loudspeaker system. It shares in the same advanced technology that helped win the international prize. And it now brings that technology

within everybody's reach.

There are important reasons for the extraordinary quality of the FR Series. There's the crossover, for example—the most sophisticated you can get in a compact system. It comes as close you can get to absolutely flat power response.

It all began with Kenton Forsythe calculating the design parameters with mathematical precision—and then adjusting them flawlessly in extensive and painstaking listening evaluations.

Exact acoustic measurement followed—based on a third order (13dB per octave) filter that achieves precise phase and response coherence. Then, special response-compensation equalizes the drivers

There's the testing. A random sample of every driver production run is tested for a full hundred hours. Further, each completed system is tested individually, as well. So, no chances are taken with anything going out that isn't up to EAW's full quality standards.

And along with everything else, there are the real wood enclosures of cabinet-maker quality. We use cross grain, 18-ply-to-the-inch, laminated European birch plywood that doesn't flex—and stands up even under the most rigorous travel conditions.

But the real prize—the one that counts most to us—is knowing that we've built into our product the kind of science and craftsmanship and integrity that makes our sound as close to perfect as it can sound.

And at prices that don't come close to the quality they buy



59 Fountain Street Box 111  
Framingham, Massachusetts 01701  
(617) 620-1478

Circle #131 on Reader Service Card

World Radio History

●●●● BELL SOUND STUDIOS, INC.  
 also REMOTE RECORDING  
 916 N. Citrus Ave., Hollywood, CA 90038  
 (213) 461-3036  
 Owner: Sandra Marshall, Don Piestrup, John Francis  
 Studio Manager: Chris Smith

●●●● BLUE DOLPHIN  
 650 N. Bronson Ave., Los Angeles, CA 90004  
 (213) 467-7660  
 Owner: Bruce Langhorne, Morgan Cavett, Stan Young  
 Studio Manager: Morgan Cavett



**BRITANNIA STUDIOS INC.**  
 Hollywood, CA

●●●● BRITANNIA STUDIOS, INC.  
 3249 Cahuenga Blvd. West, Hollywood, CA 90068  
 (213) 851-1244  
 Owner: Gordon Mills, Tom Jones

**SOUTHERN CALIFORNIA**  
**S · T · U · D · I · O · S**  
**24 TRACK**

Studio Manager: Greg Venable  
 Engineers: Ed Barton (chief eng.), Mark Coffin (2nd eng.),  
 Mike Hamm (2nd eng.)  
 Dimensions of Studio(s): 32 x 45 (accommodates 45  
 musicians).  
 Dimensions of Control Room(s): 18 x 18.  
 Tape Recorders: MCI JH-114 24 track; MCI JH-110A 2 track;  
 MCI JH-110 4 track.  
 Mixing Consoles: MCI JH-536 36 in x 32 out.  
 Monitor Amplifiers: BGW  
 Monitor Speakers: JBL, Yamaha, Auratone.  
 Echo, Reverb & Delay Systems: Lexicon Model 200 digital  
 reverb, two large acoustic live room chambers.  
 Other Outboard Equipment: Harmonizer with DDL; Lexi-  
 con Prime Time DDL; UREI limiters; Dolby noise reduction;  
 Orban parametric equalizers; Orban de-esser; phasers, etc.  
 Microphones: Neumann, AKG, Electro-Voice, Shure, Sony,  
 Sennheiser.  
 Instruments Available: Steinway B grand piano, Fender  
 Rhodes electric piano.  
 Video Equipment & Services: ¾" videotape playback  
 w/SMPTE lock-up and big screen projection for TV and  
 motion picture scoring.  
 Rates: Call for rates.  
 Extras: Large lounge w/kitchen and television.  
 Direction: Serving the television, video and motion picture  
 industries. Member I.A.T.S.E.

●●●● BROKEN RECORDS  
 17471 Plaza Otonal, Suite 16, San Diego, CA 92128  
 (619) 942-9817  
 Owner: T.I.P. Inc.  
 Studio Manager: A. Bell

●●●● BROOKHILL  
 13715-A Ventura Blvd., Sherman Oaks, CA 91423  
 (818) 788-0300  
 Owner: Tim O'Brien  
 Studio Manager: Studio M: Steve McDonagh



**CALIFORNIA RECORDING**  
 Hollywood, CA

●●●● CALIFORNIA RECORDING  
 5203 Sunset Blvd., Hollywood, CA 90027  
 (213) 666-1244  
 Owner: American Music Industries Inc.  
 Studio Manager: John Brady  
 Engineers: John Brady, Tim Garrity  
 Dimensions of Studio(s): Studio A: 25 x 40; Studio B: Dub-  
 bing and Production  
 Dimensions of Control Room(s): 20 x 18  
 Tape Recorders: MCI JH-24 track; Ampex AG-440 2 track;  
 Ampex ¼" 4 track; Ampex ATR 102, cassette machines by  
 Technics, TEAC, Pioneer, and Akai, Sony 5800 video deck.  
 Mixing Consoles: NEOTEK Series III (totally transformer-  
 less), 28 in x 24 out.  
 Monitor Amplifiers: Yamaha, Crown, BGW, and SAE.  
 Monitor Speakers: Altec 604Es w/Mastennq Lab Cross-  
 overs in DeMedio cabinets, Auratones.  
 Echo, Reverb & Delay Systems: EMT 140, Lexicon  
 Prime Time, Harmonizer, Lexicon 224XL.  
 Other Outboard Equipment: LA-2A, 1176, dbx 161 limiter,  
 Kepex, Pullec EQ; digital metronome; Rolana flanger; (2)  
 Lexicon PCM 442 DDIs and Valley People Kepex noise  
 gates.  
 Microphones: Telefunken M-251, Neumann U-48 tube, U-  
 87, KM-84, RCA 77-DX, 44, AKG 414-EB, 451, Sony C37-A  
 tube, C37-FET; E-V RE 20, RE-15, 665; Sennheiser 421;  
 Beyer M-160; Smau 54S, S7, etc.  
 Instruments Available: Steinway B grand piano, Rhodes.  
 Video Equipment & Services: Complete Audio/Video  
 interlock for audio sweetening for TV shows, commercials  
 and film production, BTX Softouch synchronizer, digital  
 ambience reverberation, Sony 5800 video deck, SFX  
 library, Sony monitors.  
 Rates: Please call for rates.

●●●● CAN-AM RECORDERS, INC.  
 18730 Oxnard St., Tarzana, CA 91356  
 (818) 342-2626  
 Owner: Can-Am Corp.  
 Studio Manager: Larry A. Cummins  
 Engineers: Brian Malouf, Stan Katayama  
 Dimensions of Studio(s): 25 x 40 x 14, plus 2 iso booths  
 Dimensions of Control Room(s): 20 x 25  
 Tape Recorders: Studer A800 MKIII 24 track; Ampex ATR  
 124 24 track; Ampex ATR 102 ¼" & ½" 2 track; MCI JH-110A  
 2 & 4 track; (2) Yamat. a C200 cassettes, (2) Technics RS M8S  
 cassettes; Pioneer RT-701 ¼ track.  
 Mixing Consoles: SSL 4000E 52 in x 52 out.  
 Monitor Amplifiers: Crown, Yamaha, Technics  
 Monitor Speakers: JBL, Yamaha, Auratones  
 Echo, Reverb & Delay Systems: EMT Tube 140, EMT 240  
 Gold Foil, AMS RMX-16, Lexicon 224XL, Lexicon Prime  
 Time 1 & 2, H949 & H910 Harmonizers, Roland SDE 3000  
 delays, DeltaLab delays, Klark-Teknik DN-34.  
 Other Outboard Equipment: UREI LA 4 & 1176 limiters,  
 dbx 160 & 165 limiters, dbx 3BX, Kepex II, dbx de-essers,  
 Orban parametrics, EX3 & 4 exciters, Dynafangers, Dolby,  
 Drawmer noise gates

"guaranteed quality with fast service at better prices."

# CREATIVE SOUND

Sunset Vine Tower  
 6290 Sunset Boulevard  
 Hollywood, CA 90028  
 213-871-1010

**Finest Studio Production - Audio & Video  
 Complete Record Manufacturing**

(Daily Capacity: 60,000 12"/35,000 7")

**Cassette Tape Duplication**

(Daily Capacity: 100,000)

**Video Tape Duplication**

**Premium Quality/Digital Capability**

**Award-Winning Art Design**

**Quality Printing of Jackets & Inserts**



Representing the world's finest technology

Circle #132 on Reader Service Card



Microphones: Neumann, AKG, Sennheiser, Beyer, Shure, PZM, Sony, Superscope, E-V, A-T, Fostex.  
**Instruments Available:** Yamaha C7 grand piano, Fender Rhodes, ARP, LinnDrum, Simmons drums, amps.  
**Rates:** Please call for rates.



**CAPITOL RECORDING STUDIOS**  
 Hollywood, CA

●●●● **CAPITOL RECORDING STUDIOS**  
 1750 N. Vine St., Hollywood, CA 90028  
 (213) 462-6252

**Studio Manager:** Charles Comelli; **booking:** Barbara Hein  
**Engineers:** Hugh Davies, Jay Ranelliucci, Bob Norberg, Steve Himelfarb, Gary Hollis, Larry Welsh, Peter Doell, Nick Dofflemyer, Sam Ramos, Jeff Malham, Charlie Paakkari, Jeff Minnich, John Sands, Alberto Coronel; **Mastering:** Wally Traugott, Eddy Schreyer.  
**Dimensions of Studio(s):** A: 60 x 45 x 25, B: 33 x 31 x 25 w/iso booth; C: 10 x 12 overdub booth  
**Dimensions of Control Room(s):** A: 15 x 20; B: 33 x 31; C: 18 x 22  
**Tape Recorders:** (2) Studer A-800 24 track; Studer A-800

16 track; Studer A-80 24 track; (6) Ampex ATR-100 1/4" & 1/2" 2 track; (4) Sony PCM-1610/BVU-800 digital 2 track; (2) JVC 8200 digital & editor.

**Mixing Consoles:** A: Quad 8 custom 32 in x 16 out; B: Neve 8068 w/Necam 32 in x 16 out; C: Neve 8108 w/Necam 48 in x 32 out.

**Monitor Amplifiers:** Hafler, McIntosh, BGW.

**Monitor Speakers:** A: JBL; B: JBL custom; C: UREI aux. monitors, Yamaha NS-10s, Auratones, Mitsubishi DS-28, JBL 4320 & 4311.

**Echo, Reverb & Delay Systems:** (8) Live echo chambers, EMT-140, EMT-250, AMS reverb, AMS DDL, Super Prime Times, Roland 3000 & Eventide DDLs & Harmonizers.

**Other Outboard Equipment:** Fairchild stereo limiters, Fairchild mono limiter, UREI LA-2As, LA-3As, 1176 LNs, Kepex IIs, Drawmer gates, Neve 8078 EQs, Trident parametric EQs, Pultec EQs, Klark-Teknik graphic EQs, ITT parametric EQs.  
**Microphones:** 200 plus microphones; all popular makes and models available upon request.

**Instruments Available:** Steinway grand piano, Yamaha concert grand, Wurilizer electric, celeste, Hammond B-3, Fender Rhodes 73 & 88, vibes.

**Video Equipment & Services:** Q.Lock w/BVU-800, Sony monitor 24 or 48 track lock-up.

**Rates:** Day—A: \$125, B: \$135, C: \$135; Night—A: \$135, B: \$150, C: \$150.

**Extras:** Library of sound effects. Two mastering rooms, digital recording, editing and mastering. Four edit rooms. Facility tie lines to interconnect studios. Direct-to-disk recording.  
**Direction:** A complete in-house and custom facility that incorporates live studio tracking, mixdown and lacquer mastering, & editing both digital and analog.

●●●● **CHEROKEE RECORDING STUDIOS**  
 751 N. Fairfax Ave., Hollywood, CA 90046  
 (213) 653-3412

**Owner:** Cherokee Inc.  
**Studio Manager:** Con Merten

●●●● **CIRCLE SOUND STUDIOS**

also **REMOTE RECORDING**  
 3465 El Cajon Blvd., San Diego, CA 92104  
 (619) 280-7310  
**Owner:** R&B Music Corporation  
**Studio Manager:** Richard Bowen

●●●● **CLOVER RECORDERS**  
 6232 Santa Monica Blvd., Hollywood, CA 90038  
 (213) 463-2371

**Owner:** Chuck Plotkin  
**Studio Manager:** Scott Weinstein  
**Engineers:** Scott Weinstein, Squeak Stone & independents.  
**Dimensions of Studio(s):** 26 x 23 x 10 1/2; iso booth: 15 x 16 x 10 1/2; vocal booth: 5 x 6 x 10 1/2.

**Dimensions of Control Room(s):** 15 x 15  
**Tape Recorders:** MCI JH-16 24 track; Studer A-80 1/4" & 1/2" 2 track; Studer B-67 2 track; Ampex ATR-100 1/4" & 1/2" 2 track; Otari 2 track; Sony PCM-FI digital 2 track.

**Mixing Consoles:** API/Jensen custom 2844 32 x 24 x 2  
**Monitor Amplifiers:** Hafler, Crown  
**Monitor Speakers:** UREI Time Aligns, Yamaha NS-10M, JBL-4311, Auratones, Advents

**Echo, Reverb & Delay Systems:** EMT-250, (2) EMT-140S, Ecoplate, Publison DDL, Eventide DDL.

**Other Outboard Equipment:** Teletronix LA-2A, (2) UREI LA-3A, (3) 1176 LN, (2) EMT PDM-156, Eventide Omnipressor, (4) Kepex gates, (2) Roger-Meyer gates, (2) Allison Gain Brains, (2) Marshall time modulators, Orban parametric EQ, SAE 1/2-octave EQ, Orban de-esser, Eventide instant flanger, BEL flanger, Eventide Harmonizer, Pultec filters.

**Microphones:** Full complement of: Neumann, Telefunken, AKG, Beyer, E-V, Sony, Sennheiser, Shure

**Instruments Available:** Steinway B grand piano  
**Rates:** Please call for rates.

●●●● **CONWAY RECORDING STUDIO**  
 655 N. St. Andrews Place, Hollywood, CA 90004  
 (213) 463-2175

**Owner:** Buddy & Susan Brundo  
**Studio Manager:** Nadine White  
**Engineers:** Mick Guzunski, Csaba Petocz, Joe Chiccarelli, F. Byron Clark, Steve Toby

**Dimensions of Studio(s):** 30 x 60 x 16  
**Dimensions of Control Room(s):** 26 x 25 x 16  
**Tape Recorders:** (2) Studer A-800 (Q.Lock) 48 track; Ampex ATR-102; Ampex ATR-104.

**Mixing Consoles:** Neve w/Massenberg moveable fader automation 8109 48.

**Monitor Amplifiers:** Perreaux  
**Monitor Speakers:** JBL, TAD, Augspurger  
**Echo, Reverb & Delay Systems:** EMT-250, 224X, plates, AMS DDL, etc.

—LISTING CONTINUED ON PAGE 186

# Proven Success

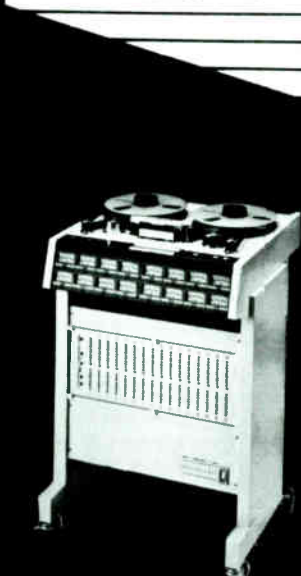

## OTARI MX-70 1" 16 Track Recorder

MX-70 features a microprocessor-controlled constant-tension transport, a full-function remote controller, exceptional audio electronics, and connectors for interfacing to any SMPTE/EBU time code based editing system, controller, or synchronizer.

**RETAIL PRICE \$14,950.00**

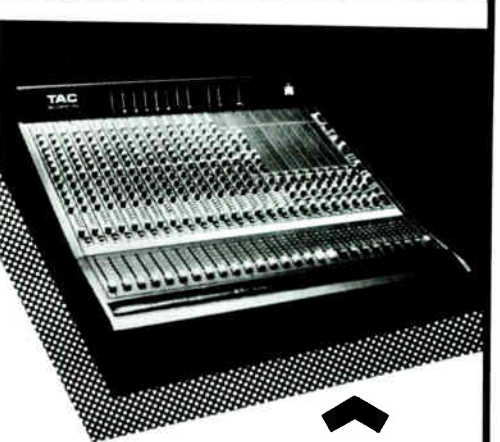

## AMEK/TAC SCORPION

- 2 Chassis Sizes: 16 x 8 x 2 and 24 x 16 x 2
- Fully Modular Construction
- 12 - 32 Inputs
- 4 Band EQ, Swept Mids, high/low shelving
- 8 and 16 Tape Monitors/Effects Returns
- 8 and 16 Bus Outputs/Subgroups
- 4 EFX/Cue Sends
- 4 EFX Send Masters with AFL
- Transformerless Mic Preamps
- 48 Volt Phantom Power each Channel
- Direct Outs on all Inputs

**RETAIL PRICE FROM \$6,495.00**



Our New Location  
 619 South Glenwood Place  
 Burbank, CA 91506  
 (818) 843-6320

Circle #133 on Reader Service Card

(805) 529-5148

\$30/HR  
INTRODUCTORY RATE



## 24 TRACK

New MCI 24 Track  
Soundcraft 24x16 Desk  
Westlake Monitors  
Plate Reverb  
Lexicon 200 Reverb  
Lexicon Prime Time  
(2) DentLab DDLs  
Kepex Noise Gates  
Dyna-Mite Gates  
Orban Parametric EQ  
Aphex Aural Exciter  
Gain Brains  
dbx 165A Comp/Limit  
Neumann, AKG, Shure  
Sennheiser Mics

Services Include:  
Professional, Creative  
Engineers  
Staff Music Arranger &  
Drum Programmer  
Session Players  
& Singers  
Unlimited use of:  
Oberheim DMX Drum  
Computer  
Oberheim OB-8 (MIDI)  
Yamaha DX7 (MIDI)  
Roland Juno 60 (MIDI)  
Yamaha Baby Grand  
Minutes From L.A.  
Peaceful Atmosphere

**I KNOW A PLACE  
WHERE DREAMS ARE MADE...**

Circle #134 on Reader Service Card

## Attention: Audio/Video/Music Schools

Your students deserve the most up-to-date information in the field of music and recording technology. They can get it each month in MIX Magazine, provided to you on a convenient basis through our special school distribution plan.

For more details on how you can provide MIX to your students, contact Allison Hershey at (415) 843-7901 or write to MIX Magazine, 2608 9th St., Berkeley, CA 94710.



## SOUTHERN CALIFORNIA S · T · U · D · I · O · S 24 TRACK

—FROM PAGE 185



CONWAY RECORDING STUDIO  
Hollywood, CA

Other Outboard Equipment: Everything.  
Microphones: Lots of everything plus 251s, 47s, 49s, 67s, C-24.  
Instruments Available: 9' Yamaha concert grand piano.  
Rates: \$2,400/ day lock-out.  
Extras: Park-like atmosphere in middle of Hollywood.  
Direction: Formulating plans for Studio 2, which will be unique, to say the least.

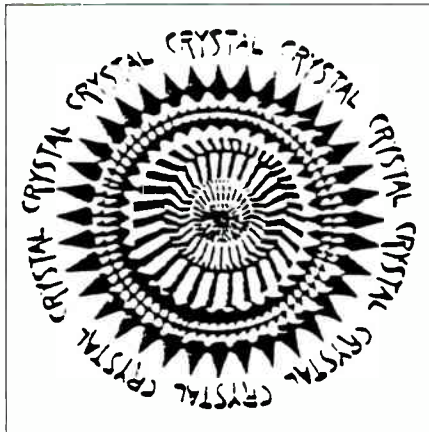

CRYSTAL SOUND RECORDING STUDIOS  
Hollywood, CA

•••• CRYSTAL SOUND RECORDING STUDIOS  
1014 N. Vine St., Hollywood, CA 90038  
(213) 466-6452  
Owner: Andrew Berliner, Pres.  
Studio Manager: Robert Margouloff  
Dimensions of Studio(s): 40 x 50 x 15; fully adjustable acoustics on wall and ceiling. Drum platform and vocal booth.  
Dimensions of Control Room(s): Studio A: 27 x 30 x 16  
Tape Recorders: Studer tape machine.  
Mixing Consoles: 48 x 24 x 32 Crystalab system console; Crystalab model 2424, 40 in x 24 out; Mastering Room: Neumann Lathe 5X74 head and Crystalab electronics.  
Microphones: Extensive microphone selection—many tube mikes.  
Instruments Available: Yamaha 9' concert grand piano, Hammond B3 orban w/Leslie, Fender Rhodes electric piano; ARP String synthesizer.  
Rates: Available on request.

•••• DETROIT SOUND STUDIO  
also REMOTE RECORDING  
P.O. Box 43609, Los Angeles, CA 90043  
(213) 299-5002  
Owner: Frank H. Jackson  
Studio Manager: Frank Jackson

•••• DEVONSHIRE STUDIOS  
10729 Magnolia Blvd., N. Hollywood, CA 91601  
(818) 985-1945  
Owner: David K. Mancini  
Studio Manager: Dee Mancini



DIGITAL SOUND RECORDING  
Los Angeles, CA

•••• DIGITAL SOUND RECORDING  
(Formerly The Hope Street Studio)  
also REMOTE RECORDING  
607 N. Ave. 64, Los Angeles, CA 90042  
(213) 258-6741, 258-0048  
Owner: Van Webster  
Studio Manager: Manellen Urban  
Engineers: Van Webster, George Sanger, Manellen Urban  
Dimensions of Studio(s): Studio A 40 x 32 x 11, plus 7 x 12 x 11 vocal booth.  
Dimensions of Control Room(s): 16 x 16 x 10  
Tape Recorders: Analog: 3M Mincom 79 24 track; Studer 67 2 track; Ampex 440 2 track; TEAC 3300 2 track; Sony PCM 1600/1610 2 track.  
Mixing Consoles: MCI 428B, 28 in x 24 out.  
Monitor Amplifiers: SAE 2400L, SAE 2600 biamped w/SAE crossovers, McIntosh 275, Dyna, JBL  
Monitor Speakers: JBL, Auratone, RSL.  
Echo, Reverb & Delay Systems: Digital-reverb, live chamber, Eventide phaser and harmonizer, Marshall time modulator, Sound Workshop time delay, Master-Room Stereo Super C, tape delay, Scamp.  
Other Outboard Equipment: Adams-Smith 2600 synchronizer system, Scamp rack, Burwen DNF/1000 noise filter; Limiters: Scamp, UREI, Teletronix LA-2A, Inovonics, dbx; Expanders: 3BX, Kepex, Scamp; Pultec filters, Orban stereo synthesizer and sibilance controller, VXO, parametric EQ, 3M Selectake II.  
Microphones: Neumann SM2 (tube), UM 64 (tube), Neumann U-47 FET, & U-47 tube, U-87, IM-84; AKG 451, 452, 224E, C-60 (tube type); Electro-Voice RE-20, RE 15, 666; Sennheiser 421, 403; RCA 77DX; Shure 545-SD, SM-58, PE-54D; Sony F-121; direct boxes.  
Instruments Available: Steinway Model B grand piano, Oberheim OB-X, Roland Jupiter 4, Sequential Circuits Prophet 5, Minimoog, Roland SH-5, Wavemaker 6, Serge Modular System, Synthi AKS, Fender amps, Gulbransen upright piano.  
Video Equipment & Services: Full video production services for broadcast and industrial productions. Complete audio sweetening services and interlock to 3/4" video masters. Sony recorders, Hitachi camera, Crosspoint Latch special effects, Fortel TBC, 3M character generator, Ikegami monitors. Digital audio services for Beta and VHS HiFi masters.  
Rates: Call for rates  
Direction: Digital Sound Recording is your first choice for Compact Disc mastering, digital audio for film and video and music mastering recording. We have the longest record of continuous Sony digital audio recording service in Southern California. In addition, we are widely experienced in all phases of video and audio sweetening.

•••• DYNASTY STUDIO  
1614 Cabrillo Ave., Torrance, CA 90501  
(213) 328-6836  
Owner: Phil Kachaturian  
Studio Manager: Phil Kachaturian



# That British sound

▶ ACES TR-2: 1/2", 1/4" 2 track

\$4,950.00

■ ACES TR-4: 1/2" 4 track \$6,950.00

## 24 TRACK TAPE MACHINE FEATURES:

- +4dBm IN/OUT
- 15/30ips
- Full-function 9 cue position remote-autolocator
- stand
- 50% range vari-speed

◀ ACES TR-24: 2" 24 track

Recorder/Reproducer

\$19,950.00

■ 2" 16trk., pre-wired 24 trk

\$14,950.00

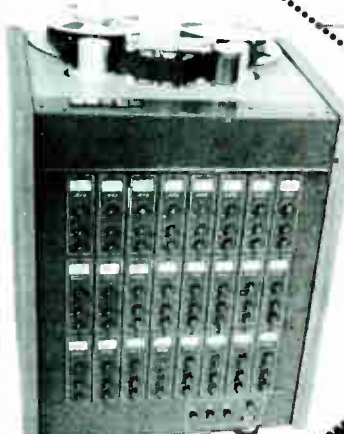

▶ ACES ML24:

I/O console, 32 in x 24 buss,  
Integrated wired patch bay

\$17,025.00

■ ACES SM16: Split console,  
32 in x 16 buss \$15,665.00



**BOTH CONSOLES FEATURE:** Fully modular construction

- Audiofad long-throw conductive plastic faders
- 5 Aux sends
- 5 band switchable EQ
- Input LED PPM's
- Stand
- +48v phantom power
- LED display (optional)
- Two year parts warranty
- Other frame sizes available
- Many options available

Circle #136 on Reader Service Card

**PROFESSIONAL  
AUDIO SERVICES  
AND SUPPLY CO.**



**EFX SYSTEMS**  
Burbank, CA

●●●● **EFX SYSTEMS**

919 N. Victory Blvd., Burbank, CA 91502  
(818) 843-4762, (213) 460-4474

Owner: Partnership

Studio Manager: Jere Mendelsohn

Engineers: Leslie Baerwitz, Deni King, Sherry Klein, Gerry Lentz, Carolyn Tapp, Jeff Vaughn, Scott Wolf

Dimensions of Studio(s): M: 35 x 47 x 20, S: 14 x 14 x 10

Dimensions of Control Room(s): M: 22 x 26, S: 14 x 14

Tape Recorders: Studer A800 24 track, Sony JH24 24/16

track; MCI JH114 24/16 track, Sony JH110C 8 track, Sony

JH1103 "C" layback; Sony 5002 1/4" & 1/2" 2 track, Sony

JH110C 1/4" & 1/2" 2 track.

Mixing Consoles: Amek 2500/2000A 36 x 24; Bimix

3224 32 x 24.

Monitor Amplifiers: Sundholm, QSC, Crown, Yamaha,

Technics

Monitor Speakers: Altec Time Aligned, JBL, Yamaha, Aura

tone, Tannoy, Electro-Voice

Echo, Reverb & Delay Systems: Lexicon, EMT, Klark

Teknik, Ursa Major, Eventide, Audio Digital, Stocktronics

**SOUTHERN CALIFORNIA**  
**S · T · U · D · I · O · S**  
**24 TRACK**

**Other Outboard Equipment:** Our incredible "Wall O' Equipment" in each of our rooms includes all of your favorites. Limiters by UREI, Orban, Teletronix, Symetrix, and dbx. Gates by Allison, Valley People, Rebis, and Symetrix. EQs by Lang, Altec, Trident, UREI. Noise Reduction by Dolby, dbx, Dynaflex, Phase Linear, and Burwen. Hair by Marcee of Hollywood

**Microphones:** A veritable smorgasbord including vintage tube models (U47, KM56, C12, etc.), modern esoterics (AKG P48, PML DC63, Schoeps, Neumann U89), and everything in between. 168 mikes available!

**Instruments Available:** Steinway grand piano, Mason Hamlin grand piano, Rhodes 88, Hammond B3, Clavinet and an entire room full of synths including DX7, the Emulators I and II, and all the latest toys.

**Video Equipment & Services:** Full synchronizing services with multiple transport lockup. We have a full digital sound fx library, and full sweetening, ADR and Foley capabilities.

**Rates:** Suited to your project's requirements.

**Extras:** Full audio postproduction planning for music videos, film and television. Our experienced staff speaks many languages, including "SMPTE" and "sprockets." We can guide you through the stages of production and post-production budgeting and scheduling. Let us help you meet the highest quality standards without breaking your budget.

**Direction:** This facility was designed from the ground up to serve the modern recording artist and independent production company. Our high ceiling room and top of the line equipment reflect our commitment to high fidelity. Our rate

card reflects our commitment to being cost effective. Our excellent staff reflects our commitment to the fact that people make the difference between a good facility and a great one. From 60-piece orchestras to synth overdubs; from film sound effects to simple voice overs, we are committed to being the "Total Audio Complex." If you are tired of working in a conventional studio, give EFX a call.

●●●● **ENACTRON/MAGNOLIA SOUND**  
5102 Vineland Ave., North Hollywood, CA 91601  
(818) 761-0511  
Owner: Brian Ahern  
Studio Manager: Franny Parrish

●●●● **ENCORE STUDIOS**  
721 S. Glenwood Place, Burbank, CA 91506  
(818) 842-8300

Owner: Robert M. Andreoli  
Studio Manager: Billy James

Engineers: Les Cooper (chief), Dan Marnien, Julie Last, Dave Farragher, Jim Dineen, Keith Cooper, Irv Howe

Dimensions of Studio(s): 25 x 40

Dimensions of Control Room(s): 26 x 26

Tape Recorders: Studer A 800 24 track; Studer A-80 1/2" 2

track; Studer A-80 1/4" 2 track; Technics 1500 2 track; (2)

Technics M-85 cassette; Technics M 95 cassette; Sony TCD-

5M cassette.

Mixing Consoles: SSL SL4000B 48 in x 32 out

Monitor Amplifiers: Studer A68

Monitor Speakers: Sierra/Hidley TM 8 biamped monitor

system, Sierra quad monitors, JBL 4311s, Yamaha NS-10s,

Auratones.

Echo, Reverb & Delay Systems: (2) EMT 140 tube echo

plates, Lexicon 224 XL, AMS digital echo.

Other Outboard Equipment: Studer TLS tape lock system;

AMS digital reverb; AMS digital delay; Lexicon Prime Time;

Lexicon Super Prime Time; Eventide Harmonizer H-949;

Eventide digital delay; ADR Vocal Stresser; Inovonics, UREI

and dbx compressor/limiters; Kexep and Roger Mayer

gates; rack of 24 Dolbys.

Microphones: Neumann, Sennheiser, AKG, Electro Voice,

Beyer, Sony, Shure, RCA, PMI, tube and vintage.

Instruments Available: Yamaha 9' grand piano, Yamaha

DX7, Oberheim DX drum machine, Tama electric drums

Video Equipment & Services: On request.

Rates: Upon request.

**STUDIOS ARE OUR BUSINESS,**  
**WHATEVER YOUR NEEDS, WE HAVE IT**

**FEATURED PRODUCTS**

**FOSTER**

B 16 16 TRACK

M 80 8 TRACK

M 450 MIXER

**THE AKAI M61212**

**SOUNDTRACS**

CM4400 CONSOLE

**ALLEN & HEATH**

CMC24 AUTO MIXER

**PULSAR LABS**

**STUDIOMASTER**

OVER 200 LINES OF

THE BEST GEAR

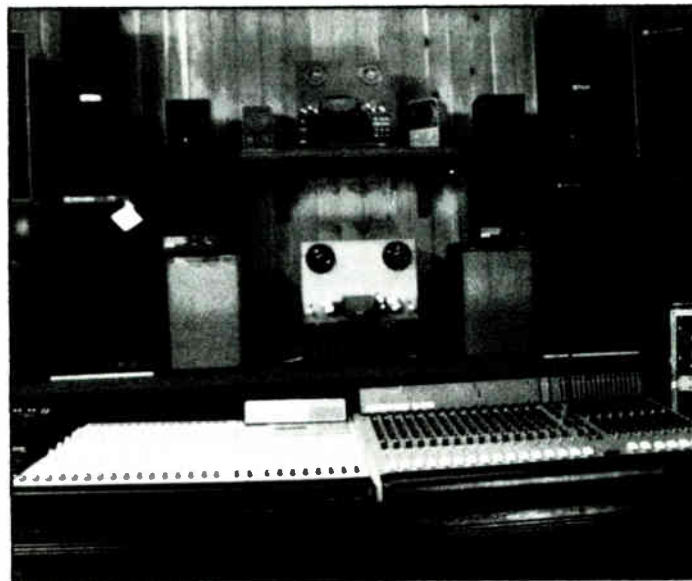

**FILAMENT PRO AUDIO**

143 E. ARROW HIGHWAY

SAN DIMAS, CALIF. 91773

714-592-2848 818-339-0081

**SEND US YOUR DREAMS WE'LL MAKE THEM REALITY**

Circle #137 on Reader Service Card



**◆◆◆ THE ENTERPRISE**

4628 W. Magnolia Blvd., Burbank, CA 91505  
(818) 980-2010

Owner: The Enterprise Recording, Inc.

Studio Manager: Derra Shelley

Engineers: Craig Huxley, Andy Schatz, Greg Edwards, Eric Levinson

Dimensions of Studio(s): 22 x 27, 10 x 16

Dimensions of Control Room(s): 25 x 30, 25 x 27, 20 x 21, 12 x 18.

Tape Recorders: Mitsubishi X-800 digital 32 track; Mitsubishi X-80 digital 2 track; Otari MTR 90-II 24 track; Otari MTR 124 4/2 track; Synclavier 128 voice 64 track.

Mixing Consoles: Amek/Massenburg 3500 56 in x 32 out, Amek/MasterMix 2500 48 in x 24 out.

Monitor Amplifiers: Threshold, Yamaha

Monitor Speakers: custom

Echo, Reverb & Delay Systems: EMT, AMS, Yamaha, Lexicon, Eventide SP2016, Publison Infernal 90, Quantec.

Other Outboard Equipment: Massenburg EQ & compressors, dbx, Dolby SP, Drawmers, LA-2As, SRC, Simmons SDS7, Yamaha DX1 w/computer & MIDI racks.

Microphones: AKG C24, C12; Neumann SM69, M49, M50, U47; Tele 251, PML DC63

Instruments Available: Steinway; Synclavier Velocity Keyboard w/guitar, sampling, printing; Yamaha system, Linn 9000.

Video Equipment & Services: 6 x 12 screens, Cinema Beam, 3/4" 8250, Q Lock, 1" Ampex.

Rates: vary; video, mixing, dubbing, recording, IA, digital programming.

**◆◆◆ EVERGREEN RECORDING STUDIOS, INC.**

4403 W. Magnolia Blvd., Burbank, CA 91505  
(818) 841-6800

Owner: Charles Fox, Arte Butler

Studio Manager: Sandra Smart

Engineers: Marc Gebauer (chief tech. eng.), John Richards (chief eng.), Murray McFadden, Mike Hatcher, Gary Luchs, Jim Behrendt, David Marquette.

Dimensions of Studio(s): A: 46 x 70; overdub room: 12 x 17; rhytm stage: 16 x 8; B: 35 x 35 & drum booth; iso room: 14 x 27.

Dimensions of Control Room(s): A & B: 20 x 26

Tape Recorders: (3) Ampex MM1200 24 track; (5) Ampex ATR 104 4 track; (5) Ampex ATR 102 (w/1/2" headstack capability) 2 track; (2) Magna-Tech w/6, 4, or 3 track overdub capability; (3) Magna-Tech 3 or 1 track dummies; (2) Magna-Tech 3 or 1 track recorders; (2) Magna-Tech PR635 hi-speed projectors w/Xenon lamps.

Mixing Consoles: Studio A: Harrison (custom) 4832 48 in x 32 out; Studio B: Harrison (custom) 4032 40 in x 32 out.

Monitor Amplifiers: Crown PSA-2 in control rooms and for playback in studios.

Monitor Speakers: UREI Time Aligned, JBL 4311s, Yamaha NS-10s, Hitachi, Auratones.

Echo, Reverb & Delay Systems: (2) live chambers, (2) EMT stereo 140s, Lexicon 224.

Other Outboard Equipment: Eventide Harmonizers, Lexicon Prime Times, Marshall Time Modulators, Kepex IIs, dbx 165s, Dolbys, UREI, Inonovics, plus: EECO MQS100A synchronizer in studio B and Adams-Smith TS605 synchronizer in studio A. Complete transfer facilities: mag, reel-to-reel, cassettes.

Microphones: Neumann, AKG, Shure, Sony, E-V, Sennheiser, and most standard makes and models.

Instruments Available: Yamaha grands in each studio, Fender Rhodes

Video Equipment & Services: (2) 3/4" VCRs w/monitors for control rooms and studios.

Rates: Record and film scoring rates; call for information.

**◆◆◆ FANFARE RECORDING STUDIOS**

(div. of Rondel Audio Ent. Inc.)  
120 E. Main St., El Cajon, CA 92020  
(619) 447-2555

Owner: Ronald L. Compton

Studio Manager: Carol A. Compton

Dimensions of Studio(s): 25 x 30; isolation room #1: 10 x 12; isolation room #2: 7 x 7

Dimensions of Control Room(s): 17 x 20

Tape Recorders: MCI JH-24 24 track; MCI JH-16 16 track; MCI JH-100 2 track; Ampex 440B 1 track; Ampex 440B 4 & 2 track; (2) Revox A 77 2 & 1/4 track; Nakamichi 700 B cassette.

Mixing Consoles: MCI 636 (full mixing automation, trans amp inputs), 36 in x 36 out.

Monitor Amplifiers: BGW & Crown.

Monitor Speakers: JBL, Auratones, Altec, Sennheiser, AKG headphones.

Echo, Reverb & Delay Systems: EMT Stereo Plate; Lexicon 224 w/all programs and non-volatile memory; Eventide Harmonizer; DeltaLab digital delay.

Other Outboard Equipment: (4) Orban parametric EQs, (4) UREI LA-4A compressors, 1176 LN limiters, (2) Gain Brains, (4) Kepexes, Orban silbance controller, UREI digital metronome, Pultec EQ, Orban stereo synthesizer, EXR Exciter, (2) dbx 124 compressors, Dolby noise reduction.

Microphones: Neumann U-87, KM-86, KM-84, U-47, AKG

414, 202E, 119; Shure SM-56; Electro-Voice RE-15, RE-10, Sony 337 (4); Altec 198; RCA 44BX; over 50 mikes to choose from.

Instruments Available: 7' Yamaha conservatory grand piano, Hammond B-3 organ w/tube type Leslie speaker, Fender Rhodes electric piano, Ludwig drums w/concert toms, Syn-drums, ARP Omni, ARP Odyssey, congas, orchestra bells, chimes, percussion devices, Drumulator, and Mirage digital sampling keyboard w/extensive software library.

**◆◆◆ FAST FORWARD RECORDING**

6428 Selma Ave., Hollywood, CA 90028  
(213) 465-3457

Owner: Shepherd Ginzburg, Jill Leibert

Studio Manager: Jill Leibert

**◆◆◆ FIDDLER'S RECORDING STUDIO**

7430 Melrose, Los Angeles, CA 90046  
(213) 655-6087

Owner: Michael Claussen

**◆◆◆ FIDELITY STUDIOS**

4412 Whittsett Ave., Studio City, CA 91604  
(818) 763-6323

Owner: Artie & Phyllis Ripp

Studio Manager: Violet Truxall

Engineers: Larry Elliott, Cliff Zellman, Steve Lang, Bernard Fnnngs, Bob Bridges, Steve Powell, Jim Taibi

Dimensions of Studio(s): A: 23 1/2 x 16 x 12 + 2 booths B: 23 x 16 1/2 x 8 + 2 booths.

Dimensions of Control Room(s): A: 18 x 13 x 9 + transport room; B: 16 x 12 x 9.

Tape Recorders: Ampex MM1200 (w/Heider/Butt modification) 16/24 track; Stephens 821B-40 16/24/32 track; Ampex ATR 104 4/2 track; (2) Ampex ATR 102 2 track, (4) Otari MX5050 2 track;

Mixing Consoles: A: MCI automated IX-500 41 in x 32 out; B: Aengus/B&B custom 24 in x 8 out.

Monitor Amplifiers: Haller, BGW, Phase Linear.

Monitor Speakers: A: UREI 838 Time Align, Yamaha NS 10M, Auratones; B: JBL 4311, Tannoy Super Reeds, Yamaha NS-10M, Auratones.

Echo, Reverb & Delay Systems: AMS DMX 80S stereo delay/pitch changer, EMT 250 and Lexicon 224 digital reverbs, (2) EMT 140s plates, AKG BX-20, Lexicon Prime Time, (2) Eventide 910 Harmonizers, Marshall Time Modulator.

Other Outboard Equipment: Limiters: LA-2A, (4) LA-3A, (4) 1176LN, (2) dbx 160, RM-58 stereo, Orban Silbance Controller, ADR vocal stresser. Gates: (4) Kepex II, Kepex, (7) Roger Mayer. EQs: (8) B&B EQF-1, (2) Pultec EQP-1R. Noise reduction: Dolby 24 track M-Series, (4) 361s. Sync: BTX Softouch, (2) Shadows, Cypher.

Microphones: AKG: 414 P48, 451EB, C-24, C-12, C-60; Neumann: U87, U67, M49, KM56; Sennheiser: MD421, MD441; Sony: ECM 22P, ECM 250, C500, C37A, C38; E-V: RE-20, RE-666; Shure: SM56, SM57, SM545.

Instruments Available: A: Yamaha grand piano, Hammond B-3 w/Leslie. B: Mason & Hamlin grand piano, Hammond B-3 w/Leslie, Roland IX-3P.

Video Equipment & Services: RCA Colortrak 2000 monitor; BTX Softouch, (2) Shadows, Cypher; VCR hookups

Rates: Please call.

**◆◆◆ FIESTA SOUND & VIDEO**

also REMOTE RECORDING  
1655 S. Compton Ave., Los Angeles, CA 90021  
(213) 748-2057

Owner: R.G. Robeson

Studio Manager: Irma Lopez

Engineers: Brian Levi, Octavio Villa

Dimensions of Studio(s): 30 x 60 plus isolation room.

Dimensions of Control Room(s): 25 x 15

Tape Recorders: MCI 24 track; MCI 2 track; Otari 2 track.

Mixing Consoles: MCI 428, 24 in x 24 out.

Monitor Amplifiers: Crown DC-300

Monitor Speakers: JBL 4333.

Echo, Reverb & Delay Systems: Lexicon 200 digital reverb, Eventide H969 Harmonizer, Lexicon DDL, Master Room III echo.

Other Outboard Equipment: UREI graphic EQs, 31-band EQ, Dolbys, 1176 and dbx 160 compressor/limiters, Orban 424 comp/limiter.

Microphones: Neumann U-87s, KM-84s, AKG C-452s, C-414s, Sennheiser MD-421s, Shure SM-57s, SM-7s, Sony ECM 33Fs, E-V RE-20s.

Instruments Available: Steinway 6-foot grand piano, Fender Rhodes electric piano, D-6 clavinet, ARP Omni, ARP Odyssey syn., Fender Twin Reverb amp.

Rates: Call for rates. We encourage block booking.

**◆◆◆ FLORES RECORDING STUDIOS**

11115 Magnolia Blvd., N. Hollywood, CA 91601  
(818) 508-5216

Owner: Flores Productions, Inc.

Studio Manager: David Flores

# STUDIO INSTRUMENT RENTALS



MUSICAL INSTRUMENT SPECIALISTS

- ★RENTALS
- ★REHEARSALS
- ★SOUND STAGES
- ★STORAGE
- ★CARTAGE

SOUND  
REINFORCEMENT  
TOURS  
LIGHTING  
AUDIO  
PIANOS  
STEREOS

## STUDIO INSTRUMENT RENTALS

HOLLYWOOD

6048 SUNSET BLVD.

(213) 466-1314

SAN FRANCISCO

826 FOLSOM ST.

(415) 495-3200

Circle #138 on Reader Service Card

Puzzled about  
Pro Audio?  
Leo's has the  
solutions.



featuring

Sony Professional Audio Products

leo's audio  
and music  
technologies

Anticipating the needs of musicians  
and audio professionals since 1956.

5447 TELEGRAPH AVENUE  
OAKLAND • CA 94608 • (415) 652-1553

Circle #139 on Reader Service Card

# CLEAN PATCH BAYS NO DOWN TIME

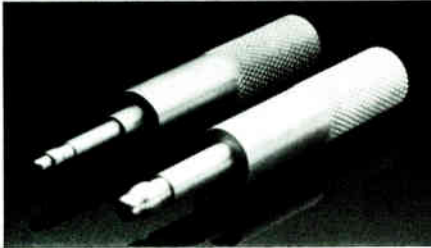

## VERTIGO BURNISHER AND VERTIGO INJECTOR RESTORE ORIGINAL PERFORMANCE TO YOUR PATCH BAYS

### VERTIGO 1/4" TRS AND TT BURNISHERS:

Each eliminates noise in main contacts under normal patching situations

### VERTIGO 1/4" TRS AND TT INJECTORS:

Each injects cleaning solvent to eliminate intermittent in breaking contacts (normals) when patch cord has been removed

**ONLY \$29.95 EA.** Please write for additional information and order form today

### VERTIGO RECORDING SERVICES

12115 Magnolia Blvd #116  
North Hollywood, CA 91607

Circle #140 on Reader Service Card

## Specializing in Magnetic Audio Head Services

Complete Precision Head  
Relapping; Recontouring  
and Optical Alignment

Free Evaluation

24 Hour Turnaround

New Replacement Heads  
Available

**AUTERI**  
Associates Inc.  
(516) 331-5022

AUTERI ASSOCIATES, INC  
9 HENEARLY DRIVE,  
MILLER PLACE NEW YORK 11764

Circle #141 on Reader Service Card

## SOUTHERN CALIFORNIA S · T · U · D · I · O · S 24 TRACK

### — FROM PAGE 189

Engineers: David Flores, Victor M. Sanchez, Andy Waterman, Bobby Marinas, and independents  
Dimensions of Studio(s): Studio A 37 x 25 Studio B 13 x 28  
Dimensions of Control Room(s): Studio A 19 x 25 Studio B 19 x 25  
Tape Recorders: (2) Studer A80VUMKII 24 track, (2) Studer A80VUMKII 2 track, (2) 3M M79 24 track, (5) 3M M79 2 track, Ampex MM 1100 16 track, Otari 7800 8 track  
Mixing Consoles: (2) Harrison 3232.32 in x 24 out  
Monitor Amplifiers: JBL 6233, Crown, Studer  
Monitor Speakers: UREI 813 Yamaha NS 10 Auratone  
Echo, Reverb & Delay Systems: (4) EMT 140 echo chamber, Lexicon 224XL, AKG BX10 DeltaLab DL 2, Eventide 1745 digital delay  
Other Outboard Equipment: (6) Kexex II, (10) Kexex 500, (4) UREI LA 4 (8) UREI 1176, (4) Eventide 2830 Omnipresor (2) LA2s compressor/limiters tube type, (4) Max1 Qs, (4) Gain Brains, (2) Spectra Sonics limiters  
Microphones: Telefunken U47 tube type, Telefunken Elam 251, Neumann U87, U47 FET, KM86 KM84 AKG 414EB, Sennheiser 421, MD 402U, Electro Voice RE-20, RE 15 CS 15 Shure SM 57 SM 7  
Instruments Available: 9' Yamaha concert grand piano in Studio A 6' Yamaha concert grand piano in Studio B  
Video Equipment & Services: Please call for details  
Rates: Available upon request

### ●●●● FOOTPRINT SOUND STUDIOS

13216 Bloomfield St., Sherman Oaks, CA 91423  
(213) 872-1854  
Owner: Jerry Fuller  
Studio Manager: Annette Fuller  
Engineers: Engineers on call Brian Friedman, Technician Neil Hopper  
Dimensions of Studio(s): 27½ x 16½ w/20' high string room plus isolation booth, drum booth and projection room/loft  
Dimensions of Control Room(s): 10 x 12  
Tape Recorders: Ampex MM1200 24/16 track, ATR 100 Ampex 350 2 track w/VSO, Sony 2 various ¼ track, Technics cassette (2)  
Mixing Consoles: Trident Series 80 w/mixing capabilities up to 56 tracks  
Monitor Amplifiers: SAE, Crown, Yamaha P2100, Hafler 225s (2)  
Monitor Speakers: MDM 4s Time Aligned, JBL 4311s, Auratones, Yamaha NS10M  
Echo, Reverb & Delay Systems: AKG BX 10, Orban dual reverb Quad/Eight reverb Eventide DDL, Harmonizer, Lexicon Prime Time, Ecoplate  
Other Outboard Equipment: UREI 1176, LA 3A, dbx 160 comp/limiters, GT 4 noise gates, UREI 527 A and Speech Acoustics graphics EQ, Orban parametrics EQ, UREI digital metronome, Orban de esser  
Microphones: Neumann, AKG, Electro Voice, Shure, Sony, Sennheiser Crown PZM  
Instruments Available: Complete 7 piece drum set Yamaha 6' grand piano, grand piano, Yamaha DX7 w/ROM carts, Sequential Circuits Prophet 5, Iso Box, Fender bass/guitar amps, Rockman amps, percussion  
Rates: 24 track from \$55/hr to \$95/hr plus special rates (all equipment plus 2nd engineer included)  
Extras: Production assistance available Musicians' lounge, coffee, tea, refreshments, swimming pool, basketball, nearby restaurants, liquor store/market, guest room available.  
Direction: Quality affordable product in relaxed environment Clientele: Glen Campbell, Tanya Tucker, Bobby Goldsboro, Bobbie Gentry, Jerry Fuller, Johnny Mathis, Al Wilson, Kimberley Springs, etc

### ●●●● GLEN GLENN SOUND

900 Seward St., Hollywood, CA 90038  
(213) 469-7221  
Owner: Tom Kobayashi, Pres.  
Studio Manager: Jacobus Rose, V Pres. Mktg.  
Extras: Specialization in ADR, Foley, videotape audio editing and mixing utilizing film formats. Largest 3 mixer film style videotape mixing studio in Hollywood containing 16

video projection, all stereo formats, large videotape Foley and ADR studios, film-style sound effects editing utilizing videotape offering complete stereo sound effects and dialogue editing.  
Direction: Complete digital audio facilities including 100% digital sound effects editing, digital sound effects library, digital recording of Foley and ADR, and digital film mixing. 35 opticals made from digital masters. 70mm stripping from digital masters. 14 studios available, 6 transfer rooms for both film & tape, laydown/layback telecine, music scoring, 70mm stripping, 16mm & 35mm opticals complete the Glen Glenn complex, offering services in every audio format, including beta cam, in use.

### ●●●● GOLDEN GOOSE RECORDING

also REMOTE RECORDING  
2074 Pomona Ave., Costa Mesa, CA 92627  
(714) 548-3694  
Owner: Golden Goose Inc  
Studio Manager: Dennis Rose

### ●●●● GOLDMINE RECORDING STUDIO

1393 Callens Rd., Ventura, CA 93003  
(805) 644-8341  
Owner: Goldmine Productions  
Studio Manager: Tim Nelson  
Engineers: Jeff Cowan, Ken Felton, Tim Nelson  
Dimensions of Studio(s): 40 x 26 x 12, 26 x 16 x 12 iso, 9 x 10 x 12 iso.  
Dimensions of Control Room(s): 18 x 16  
Tape Recorders: Otari MTR-90 24 track, TEAC 80-8 8 track, Otari 5050 2 track, Technics 1506 2 track.  
Mixing Consoles: NEOTEK Series II, 28 in x 24 out.  
Monitor Amplifiers: Hafler DH500, Fostex 600, Phase Linear 700B  
Monitor Speakers: UREI 813, Yamaha NS 10, All-Tones.  
Echo, Reverb & Delay Systems: Ecoplate II, Yamaha 1000, DeltaLab Effectron, MXR DDL, H910 Harmonizer.  
Other Outboard Equipment: LA-2A limiters, UA175 limiter, dbx 161s noise gates, etc.  
Microphones: Neumann, AKG, Sony, Sennheiser, PZMs, Shure, E.V.  
Instruments Available: Yamaha C-7 grand piano, Yamaha CP 80, Yamaha DX7, Yamaha PF-15 piano, LinnDrum, Marshall guitar amp  
Rates: 24 track \$45; 8 track \$30; 2 track \$20.

### ●●●● GOOD VIBES STUDIO

Woodland Hills, CA  
(818) 703-8600  
Owner: Victor Feldman  
Studio Manager: Josh Feldman

### ●●●● GOPHER BAROQUE PRODUCTIONS

7560 Garden Grove Blvd., Westminster, CA 92683  
(714) 893-3457  
Owner: Michael Mikulka, Steve McClintock  
Studio Manager: John McConnell  
Engineers: Michael Mikulka, Steve Kempster, independents welcome.  
Dimensions of Studio(s): A: 45 x 22 18' ceiling (4 iso areas), B: 16 x 12 x 10 w/9 x 10 iso.  
Dimensions of Control Room(s): A: 18 x 15; B: 16 x 12  
Tape Recorders: MCI JH 24 24 track; Tascam 85-16B 16 track, Tascam 80-8 8 track; TEAC 3340 4 track; Ampex ATR 2 track, Tascam 25-2 2 track; Technics M-85 cassette.  
Mixing Consoles: Studio A: custom console—24 mike/line inputs w/4 band sweepable EQ, 6 sends, 8 additional line inputs w/EQ & 2 eff. sends, 10 eff. returns & sub groups. Studio B: Allen & Heath 16 x 8.  
Monitor Amplifiers: Hill, Crown, Hafler.  
Monitor Speakers: JBL 4435s, 4311s, NS-10s, Auratones.  
Echo, Reverb & Delay Systems: Lexicon 224-X, Yamaha REV 7, MXR 01, MICMIX 305, and (7) DDLs.  
Other Outboard Equipment: (8) limiters, (6) gates, parametric EQ, Aphex, BBE, digital drum machine.  
Microphones: Neumann, Telefunken, AKG, Sony, Sennheiser, E.V., Shure, Milab, PZM.  
Instruments Available: 7' grand piano, full drum kit, B-3 w/Leslie, Rhodes, clavinet, string synth.

### ●●●● GROUND CONTROL

1602 Montana Ave., Santa Monica, CA 90403  
(213) 453-1255  
Owner: Paul Ratajczak  
Studio Manager: Lisa Roy  
Engineers: Paul Ratajczak (chief eng.)  
Dimensions of Studio(s): 40 x 30 w/16' ceilings, w/isolation rooms; 10 x 7 and 12 x 10.  
Dimensions of Control Room(s): 15 x 22  
Tape Recorders: Studer A-800 MKIII 24 track, Lyrec (Denmark) 24 track; Ampex ATR 102 2 track; 440B 2 track; Sony cassette TCK 777; TEAC cassette C-1.  
Mixing Consoles: Amek (England) M3000, 36 x 24 x 4, 8 returns.  
Monitor Amplifiers: PMF 2150B Perreux, Carver PM-1, 5.





**GROUND CONTROL**  
Santa Monica, CA

**Monitor Speakers:** TAD TSM 1, Sony APM 700, Yamaha NS-10s, Auratone, along w/Stein electrostatic headphones and Dahlquist DQ-10s for additional reference.

**Echo, Reverb & Delay Systems:** EMT 140 plate (tube), 7 Ecoplate, AKG BX-20E, a live room chamber and for electronic digital reverberation the new AMS RMX 16. Delay systems include Eventide 949, MXR Delay IIs, MXE, Delay I, phaser and flangers, Marshall Time Modulator, AMS simx 15-80S, Lexicon 224XL.

**Other Outboard Equipment:** Compressor/limiter selections include UREI LA-2A, LA-3A, dbx 165; Spectra Sonics 610, Allison Gain Brains, and for noise gates and key effects, Allison Kepex II system.

**Microphones:** Neumann U67 and U87, KM84, U47F; Cinc Church; AKG G12, D12E, 451s, PML DC63, 414s, C50s, Telefunken 251; RCA 77; E-V 666; Sennheiser 421; Altec 195; Shure SM57s.

**Instruments Available:** Yamaha 7'4" grand piano, ARP 2800, selection of acoustic and electric guitars.

**Video Equipment & Services:** Available upon request.  
**Rates:** Please call.

●●●● **CRAIG HARRIS MUSIC**  
P.O. Box 36A45, Los Angeles, CA 90034  
(818) 508-8000  
Owner: Craig Harrison  
Studio Manager: Miles Joseph



**HIT CITY WEST**  
Los Angeles, CA

●●●● **HIT CITY WEST**  
6146 W. Pico Blvd., Los Angeles, CA 90035  
(213) 852-0186

Owner: Jason Bell

Studio Manager: Jason Bell

Engineers: Avi Kipper (chief), Jason Bell, Ron McCoy, Kevin O'Connor, Becky Heninger

Dimensions of Studio(s): Studio A. 18 x 30; Studio B. 13 x 5.

Dimensions of Control Room(s): Studio A. 16 x 15, Studio B. 13 x 15.

Tape Recorders: Studio A: MCI (transformerless) w/ Auto-locator-III JH-114 24/16 track; Ampex (transformerless) ATR-102 2 track; NAD cassette decks. Studio B: Tascam 85-16B 16 track; MCI JH-110A 2 track; Ampex 440-C 2 track; Akai

GX-624 1/4 track; NAD and Aiwa cassette decks.

**Mixing Consoles:** Soundcraft 2400, transformerless w/bar-graph, 28 mike in/52 line in/24 out; Tascam M-16 16 x 16 x 2.

**Monitor Amplifiers:** HH, Crown, SAE, Technics

**Monitor Speakers:** Bi-amped custom time-aligned cabinets w/ wood horns and TAD drivers, Yamaha NS-10s, Auratone 5Cs, JBL 4313, JBL 4311.

**Echo, Reverb & Delay Systems:** Lexicon 224X digital reverb, EMT gold foil, Master-Room Super C, Master-Room XL-305 stereo reverb, Ursa Major Space Station, Countryman flanger/phaser, DeltaLab DL-2 Acousticcomputer, Eventide 910 Harmonizer, Eventide 949 Harmonizer, Eventide Instant Flanger, Lexicon Prime Time, Lexicon Prime Time II, Roland SDE-300 digital delay.

**Other Outboard Equipment:** UREI Model 545 parametric EQ, UREI Model 537 1/3 octave graphic EQ, Soundcraftsman 1/3 octave graphic EQ, Technics Model 9010 parametric EQ, dbx 160, dbx 165, dbx 160X, UREI 1176, Allison Gain Brains, Allison Kepex gates, Drawmer dual gate, Orban de-esser (5 channels), ADR Vocal Stresser, EXR SPII Psychoacoustic Projector, UREI digital metronome.

**Microphones:** AKG, RCA, Beyer, Countryman, Crown Neumann, Sennheiser, Sony and Telefunken.

**Instruments Available:** Steinway "A" grand piano, DMX drum machine, miscellaneous percussion.

**Video Equipment & Services:** Video sync-lock w/SMPTE code.

**Rates:** Please call for rate information.

**Extras:** Producer's lounge w/piano. Full real-time tapeduplication service. Sound effects and music library. Video sync-lock.

**Direction:** Bobby Womack, Wall of Voodoo, Motley Crue, Babylon Warriors, The Dillards, Freddy Hubbard and major advertising agencies are among the clients who have found that our experienced, knowledgeable staff, the professionally designed state-of-the-art studio, and comfortable working environment make Hit City West an ideal place to bring their projects.

●●●● **HITMAN RECORDING STUDIO**  
815 N. Fairfax, Los Angeles, CA 90046  
(213) 852-1961  
Owner: John Smith  
Studio Manager: Debbie Watkins

## PULSAR LABORATORIES, INC. NOW AVAILABLE A MONTHLY LEASING PROGRAM

\* 100% Financing  
\* No Collateral Required

\* 100% Tax Write Off  
\* Investment Tax Credit

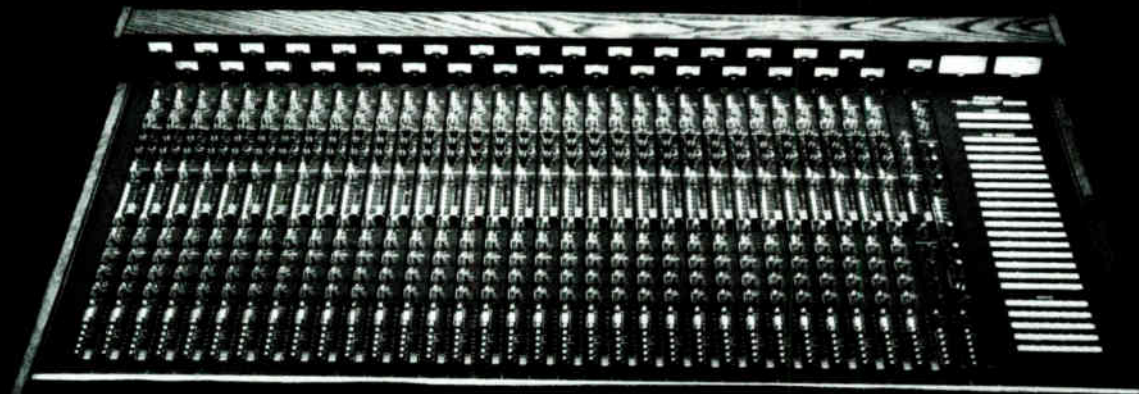

**"ON TRACK" I/O recording consoles**  
24 channel @ \$475 a month  
32 channel @ \$600 a month

**SERIES 80 front consoles**  
32x8 @ \$250 a month  
24x8 @ \$215 a month  
**M8 monitor consoles**  
32x8 @ \$250 a month  
32x16 @ \$515 a month

\* Call for additional pricing and information 216-784-8022 \*

Circle #142 on Reader Service Card

*The Sound Source*

P.O. Box 1495  
Hollywood, CA 90028

## SYNTHESIZER & AUDIO RENTALS

*featuring*

YAMAHA • AMS • MASSENBURG  
EM-U II • PUBLISON • MITSUBISHI  
OBERHEIM • SONTEC • LEXICON  
LINN • EVENTIDE • DOLBY  
P P C • DRAWMER • DBX

Call (213) 876-2400 - 24hrs/day  
FAST, FRIENDLY, DEPENDABLE  
**THE BOTTOM LINE: SERVICE**

Circle #143 on Reader Service Card

## TANDEM VMS 80 NEUMANN DISC CUTTING SYSTEMS

SONY PCM 1610  
DIGITAL MASTERING  
WITH DAE 1100 MUSIC EDITING  
NOW AVAILABLE

**Kdisc mastering**

6550 Sunset Boulevard, Hollywood, California 90028  
(213) 466-1323

Circle #144 on Reader Service Card

## SOUTHERN CALIFORNIA S · T · U · D · I · O · S 24 TRACK

●●●● HOLLYWOOD SOUND RECORDERS, INC.  
6367 Selma Ave., Hollywood, CA 90028  
(213) 467-1411

Owner: Jesse Hodges  
Engineers: Tom Perry, John Guess, Mike Wuellner, Bob Mockler, Clyde Norwood, independents  
Dimensions of Studio(s): 30 x 30, 35 x 45, 20 x 30  
Dimensions of Control Room(s): 20 x 16, 20 x 20, 20 x 14.  
Tape Recorders: 3M 79 24 track; 3M 79-½ 2 track.  
Mixing Consoles: Neve 8108 w/Neacm 48 in x 32 out, (2) API Bushnell 40 in x 24 out.  
Monitor Amplifiers: Mac-275, Crown 300  
Monitor Speakers: Massenburg (5-way) & 604E/Big Red System.  
Echo, Reverb & Delay Systems: EMT large plate, (2) EMT gold foil, (4) acoustic chambers (tile), Delta DDLs, Super Prime Time II, AMSs, Lexicon.  
Other Outboard Equipment: Kepex II, Gain Brains, de-essers, Dolbys, tape delay, 949 Harmonizers, (newest toys).  
Microphones: AKG, Neumann, Shure, E-V, Sony, U47s, U48s, U87s, U89s, C12s C60s, 452s 414s, RE-20s, KM84s, KM88s. \$100,000 in microphones.  
Instruments Available: All DX (Yamaha), Emulator II, sequencers, C7-B, pianos, MIDI.  
Video Equipment & Services: ¾" video playback & synchronize to multitrack recorders.  
Rates: Negotiable.

●●●● HQ1/HARLEQUIN  
19347 Londelius St., Northridge, CA 91324  
(818) 993-4778

Owner: Paul & Jeff Stillman  
Studio Manager: Audio/Video — Jeff & Paul Stillman  
Engineers: Jeff Stillman, Paul Stillman, Dave Hogan, Brian McLaughlin, Roger Curly, Gary DuLac, and others.  
Dimensions of Studio(s): Audio: 20 x 30 x 16 (live) iso booth: 12 x 12 x 15; Video: Soundstage 42 x 35 x 16.  
Dimensions of Control Room(s): Audio: 14 x 22 x 12; Video: 20 x 12 x 8.  
Tape Recorders: Stephens 821B-24 w/auto locator 24 track; Tascam 38 w/remote 8 track; 3M M64 2 track; Otari 5050B 2 track; Technics RS1500 2 track; TEAC 3440, 3300ST 4/2 track; (6) Kenwood 630 cassettes; Technics RS-B100 cassette; Fostex 250 4 track cassette.  
Mixing Consoles: Customized Tangent 3216 32.  
Monitor Amplifiers: Hafler P500s (bi-amped), 220, 200  
Monitor Speakers: JBL 4435 (bi-radials), JBL 4311s, Yamaha NS10s.  
Echo, Reverb & Delay Systems: Lexicon 200 digital, Williams reverb, Eventide Harmonizer 910, DeltaLab DL 2, AAD 250 delay, MXR delay, Lexicon PCM 42 delay  
Other Outboard Equipment: dbx 160X, 161, UREI 1176, Delta Graph 10 bands, Biamp 10 bands, Williams parametrics, noise gates, EXR Exciter, Biamp.  
Microphones: Neumanns, AKGs, Sennheiser, etc.  
Instruments Available: Fairlight, Emulator, Chamberlin, dbx, Prophet 5, 7' grand piano, drums, Simmons, Linn, etc.  
Video Equipment & Services: 1", ¾", ½" formats. Sound stage, lighting grid w/lights, 2 scene (24k) board, 2 wall cyc, velvet curtains, dressing rooms. Production staff w/numerous credits. Ikes, 310s, M3s, 8 cam switcher w/effects.  
Rates: Call for rates.

●●●● IMAGE RECORDING, INC.  
1020 N. Sycamore Ave., Hollywood, CA 90088  
(213) 850-1030

Owner: Harry Maslin, John Van Nest  
Studio Manager: John Van Nest  
Engineers: John Van Nest, Steve Krause  
Dimensions of Studio(s): 20 x 40 x 20  
Dimensions of Control Room(s): 14 x 20 x 10  
Tape Recorders: Analog: MCI JH-24 48 track; Ampex ATR-102 ½" 2 track, Ampex ATR-102 ¼" 2 track; Digital: Sony PCM-F1 2 track.  
Mixing Consoles: Harrison 3232C 40 in x 32 out; Neve input modules.  
Monitor Amplifiers: McIntosh 2300, Nakamichi 100W.  
Monitor Speakers: UREI Time Aligned monitors, Yamaha NS10M, Auratones.  
Echo, Reverb & Delay Systems: AMS digital reverb, EMT



140 plate, AMS DM80S stereo harmonizer/digital delay, Lexicon Prime Time, Lexicon Delta T, Marshall Tape Eliminator, Lexicon 200 reverb.

**Other Outboard Equipment:** Eventide Harmonizer, Eventide flangers, AMS flangers, ADR Panscan, dbx noise gates, de-essers, limiters, Kepex noise gates, Drawmer noise gates, limiters by UREI, Inovonics, Teletronix, Dolby noise reduction, Doctor Click Mini-Doc.

**Microphones:** Over 60 available, including 30 Neumann. **Instruments Available:** Yamaha C7 7' grand piano, Hammond organ, Simmons drums, Roland vocoder, Vox amp. **Video Equipment & Services:** Sony Syncmaster synchronizer, Sony 3/4" video cassette recorder. **Rates:** On request.

◆◆◆ **INDIGO RANCH RECORDING STUDIO-MALIBU**  
P.O. Box 24-A-14, Los Angeles, CA 90024  
(213) 456-9277

**Owner:** Richard Kaplan, Michael Hofmann  
**Studio Manager:** Michael Hofmann  
**Engineers:** Chris Brunt, Richard Kaplan  
**Dimensions of Studio(s):** 22 x 30 plus iso. rooms  
**Dimensions of Control Room(s):** 20 x 20 (keyboard player's dream)

**Tape Recorders:** 3M M-79 24 track; 3M M-79 1/4" 2 track; 3M M-79 1/4" or 1/2" 2 track; Stephens 821 1/2" 4 track; (3) Sony 777 cassette decks; (2) Technics M-65 cassette decks; Technics M-85 cassette deck.

**Mixing Consoles:** "Deane Jensen"/Aengus custom 32 x 24 fully automated plus 8 echo returns and 14 sends.

**Monitor Amplifiers:** H & H Custom bi-amp 1600 watts per side, Crown DC 300As, EA-31s.

**Monitor Speakers:** Custom 4-way JBL, Yamaha NS-10, Visonik Little Davids, Auratones, Brauns.

**Echo, Reverb & Delay Systems:** EMT 25, (3) EMT plates, (Publison Infernal 90 & AMS available on request), MXR 01, Ursa Major, Telefunken reverb, MICMIX Master-Room reverb, Loft flanger, Roland 3000, MXR DDLs, (2) Eventide DDLs, (3) Eventide Harmonizers, Marshall Time Modulator, Cooper Time Cube, Eventide Instant Phaser.

**Other Outboard Equipment:** Teletronix LA-1, LA-2, LA-2As; ADR stereo comp./limiters; ADR stereo selective processor, Pultecs, Lang, Fairchild, UA-175 & 176s, Collins 26, RCA BA6A, UREI 1176s, dbx 160s, Gain Brain limiters; Orban parametric, API, B & B, Aengus EQs, Kepex & RM noise gates; UREI Little Dippers.

**Microphones:** AKG C12, C12A, C28, C60, C61, C451, C456; Neumann U47, M49, KM53, KM54, KM56, U67, U64, KM64, KM84, KM86, U87; Sony C37A, C37P, C57, C107, ECM22, ECM54, ECM56, C500; Schoeps, E-Vs, Altec, Sennheisers. Over 250 mikes to choose from; most in sets of 4 or more; over 100 vacuum tube mikes!

**Instruments Available:** Steinway grand piano, (2) Clap-Traps, guitar accessories, etc. Most things available on request.

**Video Equipment & Services:** The Indigo Ranch Studios support facilities and grounds (orchards, mountains, canyon and ocean view) are very picturesque, private and conducive for film & video production.

**Rates:** Please call for rates.

**Extras:** Secluded 60 acre ranch, with satellite TV, minutes from beach; living and cooking facilities. Great for artist from out of town and a wonderful retreat for those living in the Southern California area.

**Direction:** Indigo Ranch provides a unique environment conducive to musical creativity in a home-like but professional setting. Located in the Malibu Hills overlooking the Pacific Ocean, Indigo services top recording artists from all over the world. The sixty-acre ranch offers sleeping accommodations, kitchen facilities, and a gourmet cook (on request). The ranch and its full equipped, state-of-the-art studio are beautifully maintained by an experienced and conscientious staff, doing its utmost to make clients feel welcome and comfortable. We are pleased to announce that Indigo Ranch Studios is entering its 2nd decade of continuous service to the musicians, producers, and engineers of Los Angeles and the world.

◆◆◆ **JINGLE BELLS PRODUCTION CO.**

1260 N. Havenhurst Dr. #104, Los Angeles, CA 90046  
(213) 656-3990

**Owner:** Michael Hurwitz  
**Studio Manager:** Michael Hurwitz

◆◆◆ **JUNIPER RECORDING**

719 S. Main St., Burbank, CA 91506  
(818) 841-1249

**Owner:** Geoff Levin, Stephen Sharp  
**Studio Manager:** Ian Harrison  
**Engineers:** Stephen Sharp (chief), Jim Emrich, James Stewart, Brian Vessa  
**Dimensions of Studio(s):** Main Room: 24 x 12 x 16; Drum Booth: 7 x 9; Iso Room: 18 x 11; Piano Iso: 13 x 5 x 8.  
**Dimensions of Control Room(s):** 19 x 19  
**Tape Recorders:** MCI JH-114 w/autolocator II 24/16 track;

TEAC A3340S 4 track; MCI JH-110C 2 track; (2) Hitachi cassette decks.

**Mixing Consoles:** Amek-Pac Matchless MCDS 32 in x 32 out; Valley People "Trans-Amp" (transformerless preamps) 9 in x 9 out.

**Monitor Amplifiers:** Accuphase 180; Nikko; Dyna Kit; BGW.

**Monitor Speakers:** Tannoy "Golds," Auratone, Yamaha NS-10s.

**Echo, Reverb & Delay Systems:** Lexicon 224X digital reverb w/LARC, Korg programmable digital delay, DeltaLab Effectron

**Other Outboard Equipment:** Aphex Aural Exciter, MXR pitch transposer, Aphex Compeller limiter, dbx 160X, UREI LA-3A limiters, Burwen noise filter, UREI digital metronome, "Dyna-Mite" limiter/gates, Nikko 10-band graphic EQs, Omni Craft noise gates, Eventide Harmonizer.

**Microphones:** Neumann U87; AKG 414, 451, 414EB, D25; Sennheiser 421, 441; Electro-Voice 666; Sony C37P, 56P, ECM 50P, ECM 33P, 22P, 9P; Crown PZM; Shure SM-81, SM-56, SM-57. Rental: Neumann U67.

**Instruments Available:** Minimoog synthesizer, Crumar Orchestrator, Steinway "A" grand piano, Pearl drum kit, DX7 Yamaha synth.

**Rates:** 24 track: \$38/hr; 16 track: \$33/hr.

◆◆◆ **LARKFIELD STUDIO**

28205 Agoura Rd., Agoura Hills, CA 91301  
(818) 889-1000

**Owner:** Joe Vannelli, Gino Vannelli  
**Studio Manager:** Diane Ricci

◆◆◆ **LARRABEE SOUND**

8811 Santa Monica Blvd., Los Angeles, CA 90069  
(213) 657-6750

**Owner:** Dolores Kaniger, Jackie Mills

**Studio Manager:** David Mills

**Engineers:** Scott Pathel (chief tech.)

**Dimensions of Studio(s):** Studio A: 27 x 42; Studio B: 20 x 30  
**Dimensions of Control Room(s):** Studio A: 18 x 30; Studio B: 12 x 26

**Tape Recorders:** Analog: (8) Ampex ATR 102 2 track, Ampex ATR 104 4 track, (2) Studer A-800 24 track, Studer A80 24 track; Digital: Mitsubishi X80 2 track; (4) 1/2" head stacks for ATRs.

**Mixing Consoles:** SSL Series E 56 channel, API 3232 32 in x 24 out.

**Monitor Amplifiers:** Bryston amp-high end, (2) BGW amps-low end, White EQs and crossovers.

—LISTING CONTINUED ON PAGE 194

# "PART OF THE OVERALL DIMENSION OF MY COMPACT DISC PROJECTS HAS BEEN THE RESULT OF THE AN-2"

Tom Jung, President  
Producer/Engineer  
Digital Music Products, Inc.

"Recently, I did a project, Music for Christmas by Keith Foley, with 9 synthesizers all MIDI-interfaced together and fed into the console. The AN-2 really opened up the sound and spread it out . . . it sounded three dimensional and very interesting. Anybody

that has a synthesizer rack should have an AN-2.

I have also used the AN-2 on a lot of guitars—makes them sound great! It's as useful as reverb itself!"

For the name of your local dealer call Studio Technologies, Inc. at 312/676-9177.



## STUDIO TECHNOLOGIES INC.

7250 NORTH CICERO AVENUE • LINCOLNWOOD, ILLINOIS 60646

Circle #145 on Reader Service Card

—FROM PAGE 193

**Monitor Speakers:** Custom George Augspurger w/Cetec drivers. Also: Yamaha NS10s, Auratones, 4312 JBLs, Sentry 100s

**Echo, Reverb & Delay Systems:** (4) live stereo chambers, (2) EMT reverb units, AMS DX-X 15-805 w/4.8 second & chorus controller, AMS RMS 16, Lexicon 224, Lexicon 224-XL, Super Prime Time, (2) Eventide digital delays, Lexicon Prime Time, (2) Eventide Harmonizers, (8) Kepex II, (2) dbx 160X

**Other Outboard Equipment:** Audio Kinetics Q Lock 310, (2) Technics 1700s ¼ track reel-to-reel, flanger, phaser, Omnipressor, UREI LA 2As, LA-4As, 1176s, Inovonics limiters, Graphic 527 A EQs, Pultec EQs, Roger Mayer noise gates, 30 channels of Dolbys, (8) API 550A EQs, dbx de-esser, Orban de-esser

**Microphones:** Large selection of Neumann, AKG, Sony, Shure, Sennheiser, Beyer and tube microphones; (2) B&K 4007

**Instruments Available:** (2) Kawai grand pianos, Wurlitzer electric piano, clavinet.

**Rates:** Upon request

●●●● **LION SHARE RECORDING STUDIO, INC.**

8255 Beverly Blvd., Los Angeles, CA 90048

(213) 658-5990

Owner: Kenny Rogers

Studio Manager: Terry Williams

Engineers: Larry Fergusson, Tom Fouce, Jay Antista (chief eng.), Paul Bassett, Howard Weiss, Khalq Glover, Laura Livingston, James Golorth

**Dimensions of Studio(s):** Studio A 20 x 36, Studio B 17 x 18, Studio C 18 x 20

**Dimensions of Control Room(s):** Studio A 18 x 13, Studio B 13 x 15, Studio C 17 x 20

**Tape Recorders:** Analog: Studer A800 24 track, Studer A80 FC ½ & ¼ 2 track, Studer A80 VU ½ & ¼ 2 track, 3M 79 24 & 2 track, Digital: Mitsubishi X800 32 track, Mitsubishi X80A 2 track, Mitsubishi X80 2 track

**Mixing Consoles:** Neve 8108 56 in x 48 out, Neve 8128 48 in x 32 out, API DeMedio 36 in x 24 out

**Monitor Amplifiers:** Bryston 4B, 2B; H&H V800, V500, Studer A68

**Monitor Speakers:** JBL (custom), JBL TAD (custom), Yamaha 1000, Auratones T66, T6

**Echo, Reverb & Delay Systems:** (3) live stereo echo chambers, (6) EMT 140s, (3) Lexicon 224X LARC, (3) AMS RMX-16 reverb, (3) AMS DMX 15-80s DDL, EMT 250 reverb, Quantec room simulator

**Other Outboard Equipment:** Publison DHM 89-B2, Harmonizers, ADR Vocal Stressor, (3) Lexicon Prime Time, Super Prime Time, Aphex II Aural Exciter, Eventide DDL lines and compressors, Harmonizers, phasers and flangers, Scamp rack, 48 track of Dolbys; Limiters: Neve, (3) Massenberg dual limiters, Teletronix LA-2As, Inovonics, dbx 160, 160X, 165, 162 stereo, UREI LA-3As, (3) Massenberg dual parametric EQs

**Microphones:** Neumann M-49 tube, U48 tube, U47 tube, U67 tube, U87, U47, KM84, KM86, KM88; Shure SM81, SM7, 546, SM57, SM56; Sennheiser 416, 435, Binaural 2002, 421; AKG 412, 414, 452, C24 tube; E V RE 20, RE-15, Telefunken 250 tube

**Instruments Available:** Sequential Circuits Prophet 10 synthesizer, LMI drum machine, Bosendorfer grand piano, (2) Steinway grand piano, Eddy Reynolds Rhodes 88, Hammond B-3

**Video Equipment & Services:** Ampex VPR 2B, Sony BVU 800, BVU 200, Beta & VHS ½" recorders, BTX synchronizer, Studer TLs 2000 Postproduction sweetening and mixing using Necam automation w/48 track analog and/or 32 track digital to picture. Sound EFX included.

**Rates:** Open. Upon request

●●●● **LOYOLA MARYMOUNT UNIV. STUDIOS A & B**

also **REMOTE RECORDING**

Loyola Blvd. at W 80th St., Communication Arts

Los Angeles, CA 90045

(213) 642-3034

Owner: Loyola Marymount University (studios available by arrangement)

Studio Manager: Gary Parisi, others

●●●● **LYCEUM SOUND RECORDERS**

also **REMOTE RECORDING**

2801B Ocean Park Blvd. Studio 156

Santa Monica, CA 90405

(213) 390-5800

Owner: Vitus Matari

Studio Manager: Vic Abascal

●●●● **MAD DOG STUDIO**

1715 Lincoln Blvd., Venice, CA 90291

(213) 306-0950

Owner: M.D. Productions

Studio Manager: Mark Avnet

Engineers: Dusty Wakeman, Mark Avnet, Stuart Schonwetter, Eric Westfall, Randy Burns

## SOUTHERN CALIFORNIA S · T · U · D · I · O · S 24 TRACK

**Dimensions of Studio(s):** 25 x 18, 10 x 5 iso.

**Dimensions of Control Room(s):** 20 x 15

**Tape Recorders:** Otari MTR 90 24 track, Ampex ATR-102 2 track, Technics 1500 2 track; Sony TC-K777 cassette.

**Mixing Consoles:** Amek Angela 28 x 24 w/parametric EQ, 6 echo sends, 4 stereo subgroups.

**Monitor Amplifiers:** Crown, BGW, HH.

**Monitor Speakers:** Westlake BBSM 12, Auratone SC, JBL 4311, Yamaha NS-10.

**Echo, Reverb & Delay Systems:** Lexicon 224 digital reverb w/level 4.3 programs, MICMIX Master-Room XL-305, DeltaLab DL-2 Acousticcomputer, Eventide Harmonizer, MXR digital delay w/all cards, Sequential Circuits ProFX programmable digital delay, Lexicon PCM-60 digital reverb, Korg digital delay.

**Other Outboard Equipment:** Limiters: dbx 165, dbx 161, UREI LA-4A, UA 175 tube Misc: EXR 4 exciter, EXR SP exciter, Kepex II, Symetrix keyable gates, Roland stereo flange/chorus, White EQ, Biamp EQ, Orban stereo synthesizer, Ingergerable Simmons-like drum synthesizer

**Microphones:** Neumann U87, U67 tube, PLM, AKG 414, 452, Shure 57, 58, 81, 33, SM7; Electro-Voice; Beyer; Sennheiser; more

**Instruments Available:** LinnDrum, Alembic basses (fretted and fretless), Guild and Martin acoustic guitars (6 and 12 string), Gibson and Fender electric guitars (6 and 12 string), synthesizers and programmers, Yamaha grand piano

**Video Equipment & Services:** On request

**Rates:** On request



**MAD HATTER STUDIOS**  
Los Angeles, CA

●●●● **MAD HATTER STUDIOS**

2635 Griffith Pk. Blvd., Los Angeles, CA 90039

(213) 664-5766

Owner: Chick Corea

Studio Manager: Ron Moss, Evelyn Brechtlein (ass't)

Engineers: Bernie Kirsh, Gary Wagner, Duncan Aldrich, Gerry Brown, Ira Rubnitz, Richard McKernan

**Dimensions of Studio(s):** Studio A 35 x 30; Isolation Room 16 x 10

**Dimensions of Control Room(s):** 25 x 20

**Tape Recorders:** Studer A-80 MK II 24 track, (2) Studer A80 RC stereo mastering recorders (modified by Mark Levinson Audio Systems); Otari 8080 4 track; (2) Nakamichi 582 cassette decks

**Mixing Consoles:** Trident modified series 80, 40 in x 24 out.

**Monitor Amplifiers:** John Meyer

**Monitor Speakers:** John Meyer ACD system, Auratones, Yamaha

**Echo, Reverb & Delay Systems:** (2) EMT 140 stereo plates, EMT 240 Gold Foil, Lexicon 224X digital reverb, Lexicon Super Prime Time, Lexicon Prime Time.

**Other Outboard Equipment:** Teletronix LA-2A limiters, UREI 1176LN limiters, Klark-Teknik graphic EQs, Sontec parametric EQs, Kepexes, Eventide instant phaser/flanger,

Eventide 9494 Harmonizer.

**Microphones:** Neumann, Schoeps, Bruel & Kjaer, AKG, Sennheiser, Shure, Senken.

**Instruments Available:** Steinway D Hamburg 9' concert grand, Bosendorfer 9' concert grand, Yamaha GS-1.

**Rates:** Rate available on request.

**Direction:** Very friendly, relaxed environment. Clients include: Yellowjackets, Ramsey Lewis, Roy Ayers, Teena Marie, Cheryl Lynn, Rodney Franklin, Stanley Clarke, Black Sabbath, Chick Corea, Roger Williams, Lita Ford, Billy Griffin, Chaka Kahn, John Klemmer, Nancy Wilson, Jean Luc-Ponty, and many more...

●●●● **MAGNOLIA SOUND & ENACTRON**

5102 Vineland Ave., N. Hollywood, CA 91601

(818) 761-0511

Owner: Brian Ahern

Studio Manager: Franny Parrish



**MAMA JO'S RECORDING STUDIO**  
North Hollywood, CA

●●●● **MAMA JO'S RECORDING STUDIO**

8321 Lankershim Blvd., N. Hollywood, CA 91605

(818) 982-0305

Studio Manager: Ten Piro

Engineers: Steven Bradley Ford, Todd Van Etten

**Dimensions of Studio(s):** Main Room: 23 x 22 w/15 x 10 alcove; 1st Iso Booth: 16 x 12; 2nd Iso Booth: 12 x 10.

**Dimensions of Control Room(s):** 23 x 20

**Tape Recorders:** (2) MCI JH 16 24 w/ auto locators 24 track; (2) MCI JH-110A w/¼" & ½" assemblies 2 track.

**Mixing Consoles:** Trident Console Series 80 40 in x 24 out w/64 input mixing, GML Moving Fader Automation System.

**Monitor Amplifiers:** 'NOYB' Amp.

**Monitor Speakers:** Custom 604-E w/Mastering Lab cross-overs.

**Echo, Reverb & Delay Systems:** (2) EMT 140 stereo plates, Lexicon 224.

**Other Outboard Equipment:** EQs: API 550A EQ, B & B, UREI 545, Klein & Hummel UE 400, Langevin 251; Limiters: UREI LA-2A, UREI LA-3A, UREI 1176LN, Inovonics 201; Gates: Allison Kepex II, Drawmer noise gates, Aphex CX-1; tube mike pre amps; Roland 3000 DDLs; DeltaLab DL2; Lexicon Prime Time; Eventide 949 Harmonizers; Eventide DDL w/pitch card.

**Microphones:** Telefunken 250s, Telefunken 251s, Neumann U47s, M49s, U67s, U87s, KM56s, KM54s, KM84s, KM88s, AKG C-412s, C-414s, C-451s, C-452s, C-12A, C-24s, and many more.

**Instruments Available:** Yamaha C7 grand piano, Hammond B-3 w/Leslie.

**Rates:** Please call for studio rates. Special rates on block bookings.

**Extras:** EMT 250, EMT 251, Dolby MH 24 noise reduction unit, AMS DMX-15-80 DDL, Pultecs, Fairchild 660 mono limiters, Fairchild 670 stereo limiter, UREI LA2 limiter, Prophet 5, DMX drum machine, BTX Shadow Unit, SMPTE transfers.

**Direction:** We have made a "commitment to excellence" so we are constantly pursuing the best in equipment whether it's new or old vintage type. The studio gives an at-home feeling w/a full kitchen area and comfortable lounge. We have recently done work on LP projects for Amy Grant, Russ Taff, Maurice White, Melissa Manchester, Bus Boys, Don Felder, Robbie Buchanan.

●●●● **MARTINSOUND RECORDING STUDIOS**

1151 W. Valley Blvd., Alhambra, CA 91803

(213) 283-2625

Owner: Joe Martinson

Studio Manager: Annette Martinson



# Back Issues

- 1984 January, Northwest Studios. Reference Monitors. Michael Sembello. Video Hardware/Software. Steve Smith Studio. Huey Lewis.
- 1984 February, Independent Engineers & Producers. NAMM Show. Allen Holdsworth. Keyboard Artists Forum. Ronnie Lane.
- 1984 March, Southeast Studios. Microphone Techniques. Sound in Australia. Religious Recording. Oak Ridge Boys.
- 1984 April, Video Production & Post Production Facilities. Video Supplement. Time Code Special. Jeff Baxter Interviews Brian Setzer.
- 1984 May, Northeast Studios. Digital Recorder Forum. Studio Computers. Roger Nichols. NASA Sound. Robert Moog. Jim Boyer and Billy Joel.
- 1984 June, Remote Recording & Sound Reinforcement Listings. Computer Music. Big Country. George Benson Studio. Chrissie Hynde.
- 1984 July — SOLD OUT
- 1984 August — SOLD OUT
- 1984 September, Southern California Studios. Film Sound '85. Digital Resource Guide. Interactive Disks. Jeff Beck.
- 1984 October, Fall AES New Products. New York Soundstages. Lindsey Buckingham. Optical Disk Update. Amadeus. Steve Miller.
- 1984 November, North Central & Canadian Studios. Video Supplement. SMPTE Conference. Canadian Spotlight. Fee Waybill.
- 1984 December, Tape to Disk Listings. Mastering Engineers Forum. Bell Labs. Compact Discs. Rupert Hines. Hal Blaine.
- 1985 January, Northwest Studios. Superbowl Sound. Springsteen on Stage. Ray Parker Jr. Leon Russell.
- 1985 February, Independent Engineers & Producers. Brian Eno. The Art of Touring. Roger Powell on MIDI. Les Paul.
- 1985 March, Southeast Studios. Loudspeaker Technology. Martin Rushent. "Cotton Club" Sound. John Fogerty.
- 1985 April, Video Production Supplement with Facilities Listings. Compact Power Amps. Radio Recorders' Harry Bryant. Eurythmics.
- 1985 May, Northeast Studios. Digital Reverb. Flo & Eddie. Holophonics. Emmylou Harris. Humberto Gatica.
- 1985 June, Sound Reinforcement & Remote Recording Listings. Location Recording Tutorial. Grateful Dead Sound. Weird Al Yankovic. Synthesizer Oriented Studios. David Sanborn.
- 1985 July, Recording School Listings and Southwest Studios. Mixing Consoles. Dr. Demento. Kashif's Studio. Roger Nichols and John Denver.
- 1985 August, Studio Design Issue: Listings of Designers & Suppliers. Control Room Acoustics. Thomas Dolby. Orchestral Recording. On the Road with Prince. Neil Young.

**CHECK THE ISSUES YOU'RE INTERESTED IN.**

# of BACK ISSUES CHECKED ABOVE at \$4.00 each (\$5.00 outside U.S.) \_\_\_\_\_

CHECK ENCLOSED FOR TOTAL (U.S. Funds)  
Payment must accompany order. \$ \_\_\_\_\_

NAME \_\_\_\_\_  
ADDRESS \_\_\_\_\_  
CITY \_\_\_\_\_ STATE \_\_\_\_\_ ZIP \_\_\_\_\_

MAIL TO: Mix Back Issues, 2608 Ninth Street, Berkeley, CA 94710.  
Make checks payable to Mix Publications; allow four weeks for delivery within U.S.

(Cut Here and Return Upper Portion)



# Binders

MIX MAGAZINE is a year-round reference tool. Keep your issues protected, ordered, and readily accessible.

Both handcrafted styles are bound in textured crimson leatherette, embossed with the gold-leaf embossed MIX logo and gold transfer slips for indexing volume and year.

**SATISFACTION GUARANTEED OR YOUR MONEY REFUNDED!**

**LIBRARY FILES:** 12 issues are organized for storage and slide out individually for use.

**BINDERS:** 12 issues are bound for protection and open flat for easy reference.

**MAIL TO:** Jesse Jones Box Corp., P.O. Box 5120, Dept. MIX, Philadelphia, PA 19141. **Make check payable to Jesse Jones Box Corp.;** allow six weeks for delivery.

Quantity \_\_\_\_\_ Please send me  
LIBRARY FILES @ \$6.95, 3 for \$20.00, 6 for \$36.00 \$ \_\_\_\_\_  
BINDERS @ \$8.50, 3 for \$24.75, 6 for \$48.00 \$ \_\_\_\_\_  
CHECK ENCLOSED FOR TOTAL (U.S. Funds) \$ \_\_\_\_\_

NAME \_\_\_\_\_  
ADDRESS \_\_\_\_\_  
CITY \_\_\_\_\_ STATE \_\_\_\_\_ ZIP \_\_\_\_\_



## HOLLYWOOD VAULTS

Private Secure Storage  
Vaults for Audio & Video  
Tape, All Media Materials  
and Business Records.

Temperature & Humidity  
Controlled Space.  
24 Hour Self-Service  
Access.

742 N. Seward Street  
Hollywood, CA 90038

**(213) 461-6464**

Circle #146 on Reader Service Card

**QUICK SERVICE**

## ATTENTION TASCAM OWNERS:

2-4-8-16 track

Looking for expert service  
and calibration of your equip-  
ment with a maximum of  
one week\* turnaround time?

We can keep you running.  
Call

**R-TEK**  
Tascam Service  
1620 West Foothill Blvd.  
Upland, CA 91786  
(714) 985-5307

\*if parts in stock

Circle #147 on Reader Service Card

## SOUTHERN CALIFORNIA S · T · U · D · I · O · S 24 TRACK



MASTER CONTROL  
Burbank, CA

•••• MASTER CONTROL  
3401 W. Burbank Blvd., Burbank, CA 91505  
(818) 842-0800

Owner: Aseley Otten, Steve Catania  
Studio Manager: Aseley Otten, Steve Catania  
Engineers: Steven Catania, Aseley Otten, independents  
Dimensions of Studio(s): Main Room: 58 x 24; Iso Room:  
14 x 18; Vocal Booth: 7 x 8  
Dimensions of Control Room(s): 20 x 24  
Tape Recorders: Studer A80 VU-MK III 24 track; Studer  
A80 RC-MK II (1/4" & 1/2") 2 track; Revox PR-99, Studer A710  
cassette deck.  
Mixing Consoles: Trident custom 80B 32 x 24 x 24.  
Monitor Amplifiers: Crown PSA-2, Studer A-68.  
Monitor Speakers: JBL 4435, JBL 4311, Tannoy SRM 12B,  
Yamaha NS-10M, Auratones 5C, Realistic Minimus 7.  
Echo, Reverb & Delay Systems: AMS RMX 16 digital  
reverb, Lexicon 200 digital reverb, Great British Spring  
reverb, DeltaLab 1024 Effectron II.  
Other Outboard Equipment: UREI LA-2A, 1176 limiters,  
Eventide 949 Harmonizer w/de-glitch, dbx 160X limiter/  
compressors, Valley People 430, Dyna-Mite limiter/gate,  
CBS Audimax II RZ limiters, Pultec EQP-1, EQP-1A, EQP 1-S,  
API 560 graphics.  
Microphones: AKG 414 EB-P48, "The Tube," Beyr M160,  
Neumann U87, U47 FET, KM84, KM85, Sennheiser  
MD421, 441, Shure SM57, SM77, Crown PZM, RCA 77DX,  
American DR 332, E-V 665, 666.  
Instruments Available: Steinway C grand piano, Ham-  
mond B-3 w/ Leslie, LinnDrum and others upon request.  
Rates: Very competitive, call for specifics.

•••• MCA WHITNEY RECORDING STUDIO  
1516 W. Glenoaks Blvd., Glendale, CA 91201  
(213) 245-6801, (818) 507-1041  
Owner: MCA Records Inc.  
Studio Manager: Gene Wooley  
Engineers: Dave Hernandez, Paul Elmore, Tom Baker,  
Robert Corti, Doug Schwartz, Jim Phillips  
Dimensions of Studio(s): Studio A, 35 x 60; Studio B, 25 x  
25; Studio D, 18 x 20  
Dimensions of Control Room(s): Studio A, 25 x 25; Studio  
B, 20 x 20; Studio D, 18 x 20  
Tape Recorders: (3) Studer A800 Mark III 24 track with TLS  
2000; (13) ATR 100 2 track (1/4" and 1" heads); (1) ATR 100 4  
track (1/4" and 1" heads); Sony BVU 800 with 1610 (3/4"  
digital); JVC VP 900 with CR 8250 U (3/4" digital).  
Mixing Consoles: Studio A, Neve A94 24 x 16; Studio B,  
Neve A1085 24 x 16; Cassette 1" Mastering, MCA Custom  
Design Console; Disk Mastering, Neumann SP75, Real Time  
Cassette Room, Cybersonics Digital Switching and Monitor-  
ing Console.  
Monitor Amplifiers: Hafler P500, Hafler P220, McIntosh  
MC240.  
Monitor Speakers: UREI 813 B, Myers Sound 833, Studers

2706, JBL 4311, NS 10 M, Auratones T6.  
Echo, Reverb & Delay Systems: (1) AMS DMX 1580S  
Delay with 4.8 sample; (1) AMS RMX 16 digital reverb; (2)  
Lexicon PCM42 Digital Delays; (2) Live Echo Chambers; (2)  
EMT 140 Plates; (2) EMT 251 Reverb Units; (1) Roland Space  
Echo; (1) Eventide H910 Harmonizer; (2) Eventide 1745 M  
Digital Delays.  
Other Outboard Equipment: (2) racks (6 cards each) Val-  
ley People Kepex Noise Gates, (1) rack 6 cards dbx 900  
series, (4) 904 gates, (2) 902 de-essers, various Pultec EQ;  
LA 2A Techtronics Limiters; dbx 160X, 165A, 160 Limiters; (2)  
UREI 1176 Limiter/Compressors; Sphere EQ; 48 channel  
Dolby (M16). More comprehensive listing of outboard  
equipment available upon request.  
Extras: MCA Whitney Studio offers various extra services  
which include JVC Sony Digital Transfers and Conversions,  
Disk Mastering, Real Time cassette duplication with 40  
simultaneous copies on Tanberg 3014 cassette decks, First-  
Ever Custom 1" cassette mastering (opened 6/20/85); var-  
ious other services using JVC and Sony components such as  
CD prep, video layback and sweetening.

•••• MIXMASTERS AUDIO PRODUCTION  
SPECIALISTS  
(Formerly NEW WORLD)  
also REMOTE RECORDING  
4877 Mercury St., San Diego, CA 92111  
(619) 569-7367  
Owner: Charles DeFazio  
Studio Manager: Louie Stevens  
Engineers: Louie Stevens (chief eng.), Alan Harper, Bob  
Goold, Charles DeFazio, independents  
Dimensions of Studio(s): Studio A: 28 x 26; Studio B:  
10 x 10.  
Dimensions of Control Room(s): Control Room A: 19 x 17;  
Control Room B: 11 x 11  
Tape Recorders: Otari MTR-90 II 24/16 track; Otari MTR-  
12 2 track; Otari MTR-10 2 track & mono; Otari MK III-8 8  
track; Tascam 44 4 track; Nakamichi MR-1 cassette; Tascam  
122 cassette.  
Mixing Consoles: Studio A: NEOTEK Series III 36 in x 32  
out; Studio B: Soundcraft 500 16 in x 8 out.  
Monitor Amplifiers: Crown PS-200, Crown PS-400, Crown  
DC-300, Crown D75, Hafler P500, Hafler P225.  
Monitor Speakers: JBL 4435s, JBL 4312s, MDM 4s, JBL  
4425s, Auratones.  
Echo, Reverb & Delay Systems: Lexicon 224, DeltaLab  
Super Time Line, Lexicon 200, Lexicon Super Prime Time,  
Lexicon Prime Time II, DeltaLab Effectron 1024.  
Other Outboard Equipment: Eventide H949 Harmonizer,  
(2) Valley People Kepexes, (2) Valley People noise gates, (2)  
Valley People Gain Brains, (2) dbx 160X compressors, (2)  
dbx 902 de-essers, (2) dbx 903s, (3) dbx 904s, Orban 622B  
EQ, Klark-Teknik DN3030 EQ, UREI digital metronome,  
Orban 424A gated compressor/de-esser, Thompson VE-2  
vocal eliminator.  
Microphones: (2) Neumann U87s, (2) Neumann U89s, (2)  
Neumann KM84s, Neumann KM86, Neumann U47 tube  
mike, (2) AKG C414 EBs, AKG C61 tube, (2) Sennheiser  
MD441s, (5) Sennheiser MD421s, (3) Shure SM57s, Electro-  
Voice RE-20, Crown PZM.  
Instruments Available: Yamaha C7 conservatory grand  
piano, Yamaha DX7 synthesizer, Emulator synthesizer, Linn  
9000 drum machine, Prophet 5 synthesizer, Fender deluxe  
amp, Gibson Les Paul guitar, Yamaha 12-string, Fender  
Rhodes piano.  
Video Equipment & Services: Post-video audio sweeten-  
ing w/Sony 5850 3/4", Q.Lock, Otari KMSB, 1/2" formats  
also available.  
Rates: Available upon request.

•••• MONTEREY RECORDING STUDIOS  
230 S. Orange St., Glendale, CA 91204  
(818) 240-9046  
Owner: Jack Daugherty  
Studio Manager: Sherie Sallee

•••• MORIAH RECORDING SERVICES  
21032 Hagerstown, Huntington Beach, CA 92646  
(714) 964-9598  
Owner: Glenn Brooks  
Studio Manager: Glenn Brooks

•••• MORNING STAR SOUND RECORDERS  
4115 N. Maine, Baldwin Park, CA 91706  
(818) 960-7308  
Owner: Steve & Becky Brown  
Studio Manager: Steve Brown

•••• MRI  
7060 Hollywood Blvd., Hollywood, CA 90069  
(213) 462-6897  
Owner: Garry Ulmer  
Studio Manager: Bernice Moschini



**●●● MUSIC BOX RECORDING STUDIO**  
 1146 N. Western Ave., Hollywood, CA 90029  
 (213) 462-7761  
 Owner: Edward Perry  
 Studio Manager: Socorro Lanzas  
 Engineers: Edward Perry, George Belle, Paul Dobbie, Chuck Britz  
 Dimensions of Studio(s): 17 x 35  
 Dimensions of Control Room(s): 17 x 20  
 Tape Recorders: Studer A80 24 track; Studer A80 4 track; Studer A 80 2 track; Studer cassette.  
 Mixing Consoles: Trident Series 80 32 in x 24 out.  
 Monitor Amplifiers: McIntosh, Crown.  
 Monitor Speakers: TAD TSM-1, JBL, Yamaha NS-10s, Auratones.  
 Echo, Reverb & Delay Systems: EMT stereo plate, Lexicon 200 digital reverberator, ADA digital delay, Eventide digital delay, DeltaLab DDL.  
 Other Outboard Equipment: 24 track Dolby noise reduction, UREI 1176 LN limiters, Eventide harmonizer, UREI 565 filter set, UREI digital metronome, Valley People Dyna-Mites, Orban de-esser, Aphex Aural Exciter, Drawmer noise gates.  
 Microphones: Neumann, AKG, Electro-Voice, Sennheiser, Shure, RCA, tube mikes: U67s, M49.  
 Instruments Available: Yamaha 7'4" grand piano, DX7, clavinet, LinnDrum  
 Video Equipment & Services: SMPTE video interlock available.  
 Rates: Please call for information.

**●●● MUSIC GRINDER STUDIO**  
 7460 Melrose Ave., Los Angeles, CA 90046  
 (213) 655-2996  
 Owner: Ron Filecia, Gary P. Skardina  
 Studio Manager: Ron Filecia

**●●● MUSIC IN THE BANK**  
 6331 Hollywood Blvd., Hollywood, CA 90028  
 (213) 652-5837  
 Owner: Randall Hall  
 Studio Manager: Wayne Stevenson

**●●● MUSIC LAB RECORDING STUDIOS**  
 1831 Hyperion Ave., Hollywood, CA 90027  
 (213) 666-3003  
 Owner: Chaba Mehesh  
 Studio Manager: Craig W. Durst

**●●● NSP STUDIOS**  
 3320 E. Century Blvd., Lynwood, CA 90262  
 (213) 636-2573  
 Owner: Nonstop Productions, Inc.  
 Studio Manager: L. Marlene Wright

**●●● ONE ON ONE**  
 5253 Lankershim Blvd., North Hollywood, CA 91601  
 (818) 761-3882  
 Owner: James David  
 Studio Manager: James David

**●●● THE PASHA MUSIC HOUSE**  
 5615 Melrose Ave., Hollywood, CA 90038  
 (213) 466-3507  
 Owner: Spencer D. Proffer  
 Studio Manager: Hanspeter Huber

**●●● PERSPECTIVE SOUND**  
 also REMOTE RECORDING  
 11176 Penrose St., Sun Valley, CA 91352  
 (818) 767-8335  
 Owner: Vince Devon  
 Studio Manager: Gene Nash

**●●● TIM PINCH RECORDING**  
 also REMOTE RECORDING  
 10000 Riverside Dr. #16, Toluca Lake, CA 91602  
 (818) 841-8247  
 Owner: Tim Pinch  
 Studio Manager: Tim Pinch

**●●● PIPER RECORDING STUDIO**  
 1425 Marcelina Ave., Torrance, CA 90501  
 (213) 328-8208  
 Owner: Ben Piper  
 Studio Manager: Allen Kaufman  
 Engineers: Allen Kaufman, Ben Piper, qualified engineers on call.  
 Dimensions of Studio(s): 25 x 25, main room including drum booth (6 x 8), isolation booth (live ambience) (12 x 12); also 6 x 12 isolated room.  
 Dimensions of Control Room(s): 20 x 24 (w/ lots of working space).

—LISTING CONTINUED ON PAGE 198

**SOUND AFFAIR RECORDING**  
**IN FUTURE WITH THE ARTS**



- ★ 3 studios and 2 control rooms
- ★ Live string and drum room
- ★ Automated MCI JH-600 32/32 and API 1608
- ★ Ampex MM-1200 24/16 track tape machines
- ★ Ampex ATR 102 1/2" 2 track
- ★ Custom BI Amp, JBL and Urei monitors
- ★ Eventide SP-2016 and 949 Harmonizer
- ★ Lexicon 224 Digital Reverb Prime Time and Super Prime Time
- ★ Urei, DBX, Scamp, ADR, Klark Teknik, API Gold Line, Delta Lab, EXR
- ★ Less than 1 hour from Los Angeles
- ★ Accommodations available

2727 Croddy Way, Suite G / Santa Ana, CA 92704

(714) 540-0063

Circle #148 on Reader Service Card

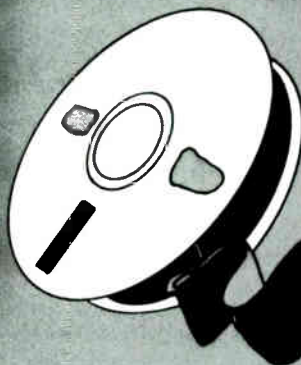

*When the tape runs out,  
call United Tape Company*

Manufacturers of BASF Custom-Length  
Chrome Cassettes

Authorized Distributor of:  
**AMPEX** Blank Recording Tape  
**BASF** Calibration Cassettes  
**CAPITOL** Audiopak Carts  
**TEAC** Accessories  
**SONY** Accessories



10746 Magnolia  
North Hollywood, CA (818) 980-6700

Call for our free 40-page catalog

Circle #149 on Reader Service Card

**—FROM PAGE 197**

**Tape Recorders:** MCI JH-16 24 track; Tascam 80-8 8 track, Scully 280 2 track, (3) Ampex 440 2 track; TEAC 3340 4 track, Marantz 5030B cassette, TEAC 25-2 2 track.  
**Mixing Consoles:** Trident B-range discrete console (30 channel) w/412 point patch bay.  
**Monitor Amplifiers:** Crown DC-300s, Crown DC-150, Marantz 300DC, Dynaco.  
**Monitor Speakers:** JBL 4344s, Auratones.  
**Echo, Reverb & Delay Systems:** AKG BX10, Cooper Time Cube, DeltaLab Super Time Line 2048.  
**Other Outboard Equipment:** UREI 1176s, LA-3As, Omnipressor, Quantum limiters, Kepex, noise gates, Eventide instant flanger, Moog parametric EQ, Orban Parasound de-esser, UREI HF filter.  
**Microphones:** Neumann U47, U87, KM84; AKG 414, 452, 451; Sennheiser 421; Shure SM57, (more than one of each—plus others).  
**Instruments Available:** Kawai Classic grand piano, Ovation guitar, Gibson 1200 acoustic guitar, synthesizers, drums, Simmons drums, Hammond organ, etc.  
**Rates:** Please call.

**◆◆◆ POIEMA STUDIOS**  
**also REMOTE RECORDING**  
 P.O. Box 651, Camarillo, CA 93010  
 (805) 482-7495

**Owner:** Bill & Marsha Cobb  
**Studio Manager:** Marsha Cobb  
**Engineers:** Bill Cobb and independents  
**Dimensions of Studio(s):** 17 x 18, iso booth 8 x 9.  
**Dimensions of Control Room(s):** 12 x 13  
**Tape Recorders:** Stephens 821B 16 & 24 track w/Autolocator; Ampex ATR 100 w/1/4" and 1/2" head assemblies; Scully 280 4 and 2 tracks; Technics 1520 2 and 1/4 tracks; Technics RM 85 cassette decks.  
**Mixing Consoles:** Soundcraft Electronics Series 2400, 28 in x 24 out, fully automated, transformerless w/52 input mix capability.  
**Monitor Amplifiers:** AB Systems Series 720, 810, 730; Spectra Sonics 700, 840 watts (14 cards).  
**Monitor Speakers:** JBL 4333As biamped, JBL 4411s, Westlake Audio BB SM6Fs Nearfields, Yamaha NS-10s, Auratones.  
**Echo, Reverb & Delay Systems:** Lexicon 224 digital reverb system, EMT 140 plate reverb, Lexicon Prime Time digital delay, DeltaLab Acoustocomputer, Marshall Time

**SOUTHERN CALIFORNIA**  
**S · T · U · D · I · O · S**  
**24 TRACK**

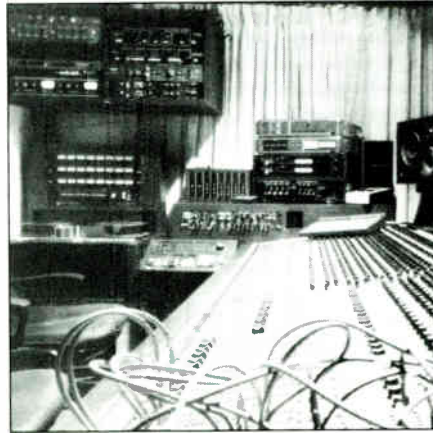

**POIEMA STUDIOS**  
 Camarillo, CA

**Modulator:** Korg SDD 3000 digital delays (2), Roland SDE 3000 digital delays (2), MXR digital delay.  
**Other Outboard Equipment:** dbx 900 Series noise gates,

compressors & de-essers; Eventide Harmonizer/DDI, Eventide Instant Flanger, ADR Vocal Stresser, ADR Express limiter, Spectra Sonics compressor/limiter, Aphex Aural Exciter, dbx 160 compressor/limiter, Orban/Parasound 622B parametric EQ, Orban stereo synthesizer, multi-sync VSO.  
**Microphones:** Neumann U87s; Telefunken 251; AKG 414s, 451s, 501s, 202s; Sennheiser 421Us; Shure SM57, SM53, SM81s; Electro-Voice RE-20, Crown PZMs, Sony ECM 22P.  
**Instruments Available:** Mason & Hamlin 7' grand piano, Synclavier II 32 voice digital synthesizer, 2 Polytone Mini-brute II guitar amps, Conn strobe tuner.  
**Rates:** Rates available upon request.  
**Extras:** Full kitchen facilities, overnight accommodations easily arranged; Sync interlock to 46 tracks available by special arrangement.  
**Direction:** Poieima Studios provides an alternative to the hustle and high pressure of the city, but yet maintains a state-of-the-art recording environment. Situated on a half acre in the countryside, just 45 minutes north of L.A., the studio provides a relaxed creative atmosphere. We desire to serve the artists and producers with affordable rates without compromise to quality.

**◆◆◆ PREFERRED SOUND**  
 22700 Magarita Dr., Woodland Hills, CA 91364  
 (818) 883-9733  
**Owner:** Scott Borden  
**Studio Manager:** Bill Thomas  
**Engineers:** Bill Thomas, Matthew Spindell, Robert Stamps, Joe Chiccarelli, David Devore, various independents.  
**Dimensions of Studio(s):** Main Room: 18 x 23; Booths: 9 x 10, 11 x 12  
**Dimensions of Control Room(s):** 16 x 18  
**Tape Recorders:** Otari MTR-90 MK I 24 track; Studer A80 2 track; Scully 280B 2 track; (2) Hitachi D2200M cassettes.  
**Mixing Consoles:** Amek 2000 Series 24 input.  
**Monitor Amplifiers:** Acoustal, SCS.  
**Monitor Speakers:** UREI 811 Time-Aligned, Yamaha NS-10M, JBL 4401, Auratones.  
**Echo, Reverb & Delay Systems:** AMS RMX 16 digital reverb, Lexicon 224 digital reverb, Cunningham Ecoplete II, AMS DMX 1580-S digital delay & pitch, (2) Lexicon Prime Times, Roland SDE 3000 digital delay, Eventide Harmonizer.  
**Other Outboard Equipment:** (4) Kepex 11s, (2) 1176 limiters, LA-4 comp/limiter, (2) dbx 165 limiters, Teletronix LA-2A tube limiter, UREI digital metronome, MXR flanger/doubler, Roland stereo flanger, Simon Systems integrated

**LESS THAN ONE PERCENT FAILURE!**



**Meyer UPA-1 Loudspeaker System, U.S. Patent 271967**

We were pleased, but not surprised, when our distributors and dealers told us that buyers of Meyer Sound equipment reported **less than a one percent failure rate** in the new gear they purchased.\*

At Meyer Sound we take extraordinary precautions to ensure that **all** the components used in our systems are of the highest quality obtainable. All the parts in each piece of Meyer equipment are **100 percent tested** to guarantee reliability and consistent performance. Each assembled unit is thoroughly tested again before leaving our factory.

At Meyer Sound reliability isn't just a word to sell loudspeakers—it's the philosophy on which our reputation is built. If you've heard about Meyer, but you haven't *heard* Meyer, call or write us. We'll give you the name of a dealer who can arrange a demonstration.

\*Figure includes warranty and non-warranty repairs on an annual basis.



**Meyer Sound Laboratories**  
 2832 San Pablo Avenue  
 Berkeley, CA 94702

**(415) 486-1166**



direct boxes RDB-400 (8).

**Microphones:** Tube 47 (Neumann), 87, KM84, KM88, AKG 414s, Sennheiser 421s, MKH 405s, AKG D12E, AKG C-451E, Shure SM57s, SM58s, SM81s, Sennheiser 441, Sony ECM 22P, Sony C-37A, Crown PZMs, Beyer M88, M500s, Electro-Voice RE-20s, etc.

**Instruments Available:** Ampeg B-15 bass amp, Fender guitar amp, Kawai baby grand piano, various percussion instruments, numerous guitars and amps available through Norm's Rare Guitars.

**Rates:** Call for rates, block rates available.

**Extras:** Living facilities for 5 available with studio by the month. Amenities include sun deck, swimming pool, jacuzzi, pinball machines and a comfortable, creative atmosphere. **Direction:** More hit records in the future! Recent clients include Joe Chiccarelli, Kevin Beamish, Paul Sabu, all well-known producers. Precious Metal, Robert Tepper, Break-through, Stevie Nicks, Scott Goddard and Laura Branigan are some of our satisfied clients of late. We are continuously upgrading and expanding. Do your ears a favor and come listen!

◆◆◆ PRESENT TIME RECORDERS

5154 Vineland Ave., North Hollywood, CA 91601  
(818) 762-5474

Owner: Bob & Grace Wurster  
Studio Manager: Bob Wurster

◆◆◆ PROMISE PRODUCTIONS

1416 Dorothy Dr., Glendale, CA 91202  
(818) 242-8582

Owner: D. Watson

Studio Manager: D. Watson

Engineers: D. Watson, B. Chrysler, independents

Dimensions of Studio(s): 24 x 12, 4 x 12 amp chamber.

Dimensions of Control Room(s): 24 x 24

Tape Recorders: MCI JH-116 24 track; Tascam 85-16 16 track; Tascam 80-88 track; Tascam 32 2 track; Otari MTR 12 2/4 track.

Mixing Consoles: Soundcraft custom 1600 40 x 8 x 24.

Monitor Amplifiers: Haller, Yamaha

Monitor Speakers: UREI w/custom 18" sub bass, E-V, Auratone.

**Echo, Reverb & Delay Systems:** Ecoplate; AMS RMX 16; Lexicon 200, 102 & Prime Time; (2) SDE 3000s, tape echo; Ibanez; Marshall Time Modulator.

**Other Outboard Equipment:** Scamp rack, (2) 1176s, (2) dbx 160s, 165, 162, Vocal Stresser, Castile phase shifter, Tri Stereo Chorus, EXR Exciter, (3) stereo gates, (3) stereo parametrics.

**Microphones:** Neumann, AKG, Sennheiser, E-V, Shure, Sony, Beyer.

**Instruments Available:** Chickering 7' grand, Hammond C-3 & Leslie, Moog IIC, Yamaha DX7, Prophet-TB, 360 Systems digital, OBX, LinnDrum, Roland MSQ 700, Roland Vocoder, Rhodes 88, Tama electronic drums, Oberheim OB-8, DSX, DMX & Xpander, Emulator II.

**Rates:** Please call for current rates and available discounts.

◆◆◆ PYP DREAMS

3917 Riverside Dr. #9128, Burbank, CA 91505  
(818) 848-1004

Owner: Phil A. Yeend

◆◆◆ QUAD TECK STUDIOS

4007 W. 6th St., Los Angeles, CA 90020  
(213) 383-2155

Studio Manager: Hank & Joani Waring

◆◆◆ RECORD ONE

13849 Ventura Blvd., Sherman Oaks, CA 91423  
(818) 788-7751

Owner: Val Garay

Studio Manager: Dub Maitland

◆◆◆ RECORD PLANT

also REMOTE RECORDING & FILM SCORING  
8456 W. Third St., Los Angeles, CA 90048  
(213) 653-0240

Owner: Chris Stone

Studio Manager: Rose Mann

Engineers: Michael Stone (chief eng.), Mike Beiriger, Phil Jamtas, Ricky Delena, David Bianco, Dan Wallin (scoring mixer)

Dimensions of Studio(s): A: 40 x 20 x 15, w/isolation booth; B: 8 x 15 x 20; C: 50 x 35 x 23, w/stage & 2 iso booths; D: 23 x 46 1/2 x 22; M: 70 x 80

Dimensions of Control Room(s): A: 15 x 15; B: 16 x 16; C: 16 x 20; D: 19 x 22; M: 35 x 45

Tape Recorders: Sony 24 track digital; Studer Mark III 24 track; 3M 79 4 track; 3M 79 24 track; 3M 64 2 track; 3M 64 4 track; Ampex 440-C 4 track; Ampex ATR-100 2 track; Technics RMS/280 cassette decks.

Mixing Consoles: Solid State Logic E Series, 48 in x 32 out; Solid State Logic 4000E, 40 in x 32 out w/Record Plant



RECORD PLANT  
Los Angeles, CA

custom, 32 in x 8 out (film submix console); SSL E Series 48 in x 32 out, with Total Recall; custom designed consoles; all have automated mixdown and groupers.

Monitor Amplifiers: Studer A68, Crown DC 300A, Phase Linear 700B, Hafler DH200, BGW 750.

Monitor Speakers: Westlake TM-1, Altec 604Es with Mastering Lab crossovers, JBL 4312s, Record Plant custom JBL BM3, Klipsch M1900, Auratone 5Cs; anything available by request; TAD 2 way system available.

**Other Outboard Equipment:** Any Eventide, UREI, Pultec, EMT, ADR, dbx, Dolby, Allison (inc. Allison 65K computers) units in-house; including live chamber, EMT 251 digital echo, EMT 140ST and 240, plus AKG BX-20. Any item on request.

**Microphones:** Neumann, AKG, Shure, Electro-Voice, Altec, Sony, Sennheiser, Studer, Telefunken, etc. Any mike on request.

**Instruments Available:** Hammond B-3 organ and Leslie, Yamaha piano and grand piano. (Piano and organ included in rates.)

**Rates:** Call studio manager for rates.

**Extras:** Two game rooms, Jacuzzi, sauna, Projection w/multi-track magnetic film chain fully equipped. Record Plant has opened a new scoring facility, Studio M on the Paramount lot at 5555 Melrose Avenue.

**Direction:** Record Plant Studios has diversified music recording into 3 divisions: scoring, records & remote. We feel in this way we can best service our segment of the video & film audio industry. We remain the premier state-of-the-art music studio with 5 studios, digital recording, new 35mm film chain & 2 recording trucks.

◆◆◆ ROCK STEADY STUDIOS

7000 Santa Monica Blvd., Hollywood, CA 90038  
(213) 464-7747

Owner: Golden Sound Corporation

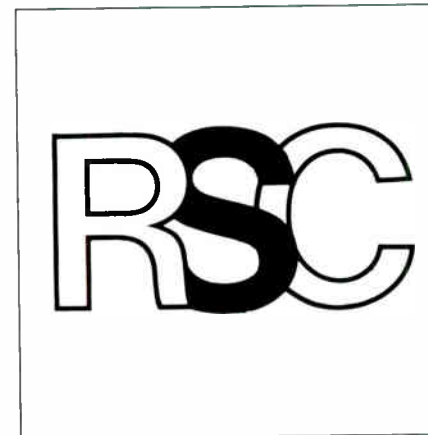

RSC / RECORDING SERVICES COMPANY  
Burbank, CA

◆◆◆ RSC / RECORDING SERVICES COMPANY

2414 W. Olive Ave., Burbank, CA 91506  
(818) 843-6800

Owner: Recording Services Company, Inc.

Studio Manager: Ken Dahlinger

Engineers: On request

Dimensions of Studio(s): 8 x 10 vocal booth

Dimensions of Control Room(s): 14 x 20 control room, 8 x

-LISTING CONTINUED ON PAGE 200



Amek • Parametric EQ • Transformerless

Otari MTR 90 • Studer 2 Track • Hitachi

Monitors: UREI, JBL, Yamaha, Auratone

AMS Reverb • Lexicon 22-1 • AMS DDL

Acoustat, Crown, SCS Power Amps

2 Lexicon Prime Times

Eventide • Roland SDE3000

4 Kepex Noise Gates

Teltronics • dbx • UREI

Mics. Neumann Tubes. AKG. Sony. RCA. EV

Kawai Studio Grand

Swimming Pool, Jacuzzi & Fun

*Preferred  
Sound*

Do Your Ears a Favor  
Come and Listen!  
Call for Rates  
(818) 883-9733

Circle #151 on Reader Service Card



We mixed audio and video and came up with Media Sciences Institute. We offer 6 month California state approved certificate courses in Audio Engineering, Record Production, Studio Technology, Musicology/Arrangement, Electronic Instrument Operation, Video Technology, and Acting. If your future is in media, Media Sciences Institute is the start to your future. Classes forming now. To receive catalog send \$2.00 to Media Sciences Institute, P.O. Box 4678, San Diego, California 92104. Attn. Admission Office.



Circle #152 on Reader Service Card

**GRD**  
**AMERICA'S MOST EXPERIENCED REAL TIME DUPLICATOR**

The world's largest state-of-the-art cassette duplication facility continues to give you incredible sonic excellence. GRD was first to introduce Real-Time cassette duplication at a reasonable cost, and elevated the cassette to audiophile quality. This year GRD has taken the next step into the future with Digital Duplicating, AGFA's super-extended normal bias 612 tape and high bias 627 tape. GRD will faithfully reproduce your most demanding programs without compromise... in Real-Time at unreal prices.

HIGH QUALITY PRINTING  
 AND ASSEMBLY  
 CUSTOM LOADED BLANK  
 AGFA CASSETTES, CHROME, 612

(602) 252-0077  
 P.O. BOX 13054  
 PHX., AZ 85002

THE RECORDERS Quartzlock, Auto  
 Bias, 30-20,000 Hz, 0.25% w/r.m.s.  
 Dolby B - more than 67 db  
 S/N ratio

Circle #153 on Reader Service Card

Sound Image Announces

## Break-through the Sound Barrier

The sound barrier. For decades it represented the challenge of a lifetime to pilots bent on beating the odds.

Sound Image, the specialists in quality sound reinforcement systems, faced a similar challenge: To design a unique system that would help performers break-through the barrier of a huge auditorium with punching clarity.

With their new **Phase-Loc** sound reinforcement system, Sound Image has beaten new odds to do just that.

**Phase-Loc** represents state-of-the-art technology with a unique design which allows the cabinets to be played for increased coverage without sacrificing the acoustic coupling.

The modular interlocking cabinet design allows **Phase-Loc** to fly four high so there's no barrier

between the performer and his audience

This unique design not only gives the sound punch, but it also keeps the system flexible enough for the most demanding travel and set-up schedules.

**Phase-Loc** sound reinforcement system. It broke through the sound barrier to become the system of choice for the industry.

Only from Sound Image.

**Phase-LOC**  
 SOUND IMAGE  
 The Sound Decision

FOR MORE INFORMATION: SAN DIEGO - NASHVILLE - (619) 744-8460

Circle #154 on Reader Service Card

## SOUTHERN CALIFORNIA

### S · T · U · D · I · O · S

## 24 TRACK

—FROM PAGE 199

10 machine room, 13 x 8 remote truck control room.  
**Tape Recorders:** Ampex MM1200 24/16/8 track; Ampex ATR 100 4/2 track; Otari MTR 90 11 24 track; Otari MX-5050 8/4 track; Stephens 821 A 24/16 track.

**Mixing Consoles:** Audiotronics 501 26 x 16 x 24; Audiotronics 108 24 in x 8 out; NEOTEK Series 1 28 x 8 x 24; Soundcraft 2400 28 x 24 x 24.

**Monitor Amplifiers:** BGW 750, BGW 250, Crown D 60  
**Monitor Speakers:** UREI 813A, JBL 4311, Yamaha NS-10, Auratones.

**Echo, Reverb & Delay Systems:** Lexicon 224X w/LARC, Lexicon 200 digital reverb, Lexicon Super Prime Time, Eventide 949, AKG BX-10.

**Other Outboard Equipment:** Q.Lock 3.10 synchronizer, BTX Shadow synchronizer, Dolby MH-24 noise reduction, Dolby SP-24 noise reduction, Dolby Cat 43A, Orban 622B parametric, UREI LA 2A, LA-3A, LA 4A, 1176LN, dbx-160, Valley People, Kepex II, dbx 902 & Orban 526A de-essers, ITC cart player, JVC turntable

**Microphones:** AKG 414, 452; E-V RE-20; Sennheiser 416, 421, 441; Shure SM-57, SM-58.

**Instruments Available:** Emulator II digital sampling keyboard for sound effects or musical instruments.

**Video Equipment & Services:** Ampex VPR-1 C with TBC-1, Sony BVU 800 3/4", JVC 6650 3/4", Sony SL 5800 Beta, Akai VHS HiFi, Video laydowns and laybacks in all formats, mix to picture with your choice of synchronizers, SMPTE burn in and tape transfers.

Rates: On request

#### ●●● RUMBO RECORDERS

20215 Saucy St., Canoga Park, CA 91306  
 (818) 709-8080

Owner: Daryl Dragon & Toni Tennille  
 Studio Manager: John Desautels



RUSK SOUND STUDIOS  
 Hollywood, CA

#### ●●● RUSK SOUND STUDIOS

1556 N. La Brea Ave., Hollywood, CA 90028  
 (213) 462-6477

Studio Manager: Ganapati  
 Engineers: Independents

**Dimensions of Studio(s):** Approx. 1500 sq. ft. Several areas may be isolated by sliding glass doors if desired.

**Dimensions of Control Room(s):** 500 sq. ft. Eastlake type  
**Tape Recorders:** Ampex MM1200 w/XT24 24 track; Stephens 821 24 track; Ampex ATR104 4 track; (2) Ampex ATR102 1/4 & 1/2" 2 track; Revox HS77 2 track; Sony & TEAC 1/4 track 4 channel; Yamaha and Technics cassettes.

**Mixing Consoles:** Harrison 3232B/C automated w/sonic improvements and extra sends, 32 in/out plus 8 echo returns.

**Monitor Amplifiers:** Bryston, BGW, Crown, Yamaha, etc.  
**Monitor Speakers:** Sierra/Eastlake, 604Es, JBL 4311s and

—LISTING CONTINUED ON PAGE 202



# TANNOY NFM-8;

The industry's most accomplished musicians, mastering engineers and dealers **KNOW**.

**CHET ATKINS**  
Instrumentalist of  
the year award 1984

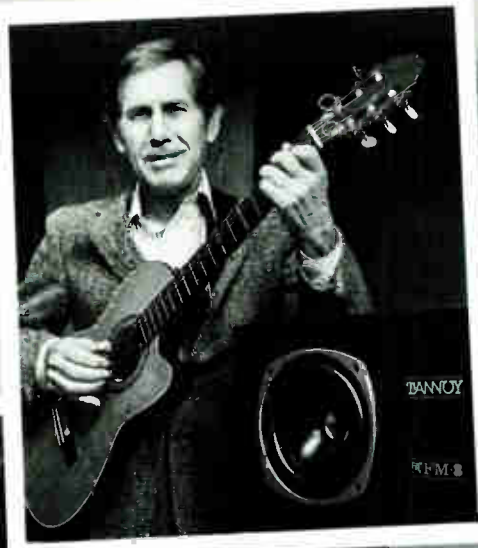

**JERRY MILAM**  
Tannoy's largest  
Professional Dealer  
in the USA, 1984.

**RANDY KLING**  
Mastering Engineer of  
the year award 1984



**NFM-8:** "A pleasure to work with! Since the sixties I have mastered over a hundred gold and platinum albums. Today I work with pop and country music's biggest stars, such as Alabama and Waylon Jennings, who depend on me to make the best of their musical abilities. I, in turn, depend on Tannoy for their exceptional accuracy. The new NFM-8 continues that tradition of precision, meeting or exceeding the merits of most primary control monitors."

*Randy Kling*

Disc Mastering  
30 Music Square W.  
Nashville, TN 37203

**NFM-8:** "British quality, Swiss timing and accuracy. It's so rare to find a truly portable monitor whose sonic attributes I can trust so emphatically, I take them everywhere I go. The ability to reproduce the most difficult musical passages naturally makes the NFM-8 a friend I can rely on."

*Chet Atkins*

**NFM-8:** "The emerging new standard of reference-accurate monitoring. Advanced speaker technology has aided in the production of a number of near-field monitors that are small, reasonably flat and decent sounding. While many such monitors have proved adequate for secondary mixing systems, few have a high degree of sonic quality coupled with high power handling."

"With the introduction of Tannoy's NFM-8 reference monitor, small-enclosure sound took a quantum leap forward. The majority of recording engineers, mixers and producers comparing NFM-8's to their present systems, find a marked improvement in imagery, accuracy, fullness and headroom."

*Jerry Milam*

Milam Audio  
1470 Valle Vista Blvd.  
Pekin, IL 61554

## TANNOY®

The Name for Loudspeakers

TANNOY NORTH AMERICA INC. 97 VICTORIA ST. N. KITCHENER ONT. CANADA 1-519-745-1158

See us at the AES in the Regency Room at the Sierra Towers

Circle #155 on Reader Service Card

World Radio History

**LOOKING FOR A  
RECORDING STUDIO?**



**S.R.S.** is a free service that will recommend the perfect studio to meet your individual needs. **S.R.S.** will make sure you get the highest quality, best personal care, and fairest price for your project.

**S.R.S.** represents over 150 facilities with a complete range of formats, rates, and capabilities. Records, Commercials, Demos, Videos, Film Scores, Transfers, Remotes, Mastering, Pressing — we handle it all. You will be astonished at the amount of time and money one call to **S.R.S.** will save you!

**CALL  
(818) 508-8828**

Circle #156 on Reader Service Card

**AMPEX**

**MCI**

**3M**

**REPLACEMENT  
HEADS  
RECORDER PARTS  
REFURBISHMENT  
REPAIRS**

**800-553-8712**

**800-325-4243 N CA**

**SPRAGUE  
MAGNETICS  
INC.**

**IN STOCK  
IMMEDIATE  
SHIPMENT**

**818-994-6602**

15759 STRATHERN STREET  
VAN NUYS, CA 91406  
TELEX: 754239

Circle #157 on Reader Service Card

**SOUTHERN CALIFORNIA  
S · T · U · D · I · O · S  
24 TRACK**

—FROM PAGE 200

L100s, Yamaha NS-10, Auratones.

**Echo, Reverb & Delay Systems:** EMT 251, 250 digital reverb, Lexicon 224X-LARC B.2, Ecoplate I (large EMT 140s type), classic live chamber; Lexicon PCM-60; AKG BX10; small plate; AMS 1580S; Eventide 949 and 910 Harmonizers; Prime Time; Roland SDE 3000 programmable delay; Marshall Time Modulator; DeltaLab 1024 and DL1 (3 out) delays; Roland Space Echo; and tape delays.

**Other Outboard Equipment:** Teletronix LA2 (tube) limiter; (2) UREI 1176LN; (2) dbx 161, dbx 160, 2 channels Drawmer gates; 1 channel Aphex gate; (4) Valley People Dyna-Mites; 4 channels Omni Craft gates; Dolby 361s, dbx 154, Dynaflex; Eventide Instant Flanger, MXR doubler/flanger, MXR Auto Flanger, MXR pitch changer, Orban and Furman parametric EQs; (2) B+B EQF-1 EQs; SAE 20 and 10 band graphic EQs; Aphex Aural Exciter; Phase Linear 1000 Autocorrelator; Orban 3 channel de-esser; UREI LA-3A, ADR 969 vocal stresser.

**Microphones:** Telefunken 251E; Neumann U67 (3), U87 (3), U47 FET, KM84 (4), KM85; AKG 414EB (3), 451EB (4), D1000E, D190; RCA 77DX; Sony C-37A; ECM 22P (2); Sennheiser 441, 421, MK40; E-V RE-20, RE-15, 666; Crown PZMs (2), Shure 57s (5), SM53.

**Instruments Available:** Yamaha C-7 7'6" grand piano, Steinway grand piano, Emulator, LinnDrum, Prophet 5, Serge Modular synthesizer, ARP 2600 synthesizer, Farfisa organ, electric sitar; various guitars and amps available on request, various percussion.

**Video Equipment & Services:** Wired for video loop throughs throughout studio, video lockup available. BTX 4500 synchronizer and 4200 SMPTE reader-regenerator. Rates: Please phone, we will try to work out the best value for your project.

**Extras:** Any equipment available on request. We have a comfortable private lounge with video games, coffee, etc. Direction: Rusk is a fully equipped world class recording studio that recognizes the importance of service, comfort and privacy to our clients. Rusk has been used to record platinum and #1 records for artists such as Donna Summers, Blondie, Steel Breeze, Billy Idol, The Sylvers, Giorgio Moroder, Laura Branigan, Elton John, John Cougar and also film scores, jingles and radio and TV spots. Phone about our new synth/direct recording and production room.



**RYAN RECORDING**  
La Manana, CA

●●●● RYAN RECORDING

3324 Cornerstone Circle Dr., La Manana, CA

(call information for current phone listing)

Owner: Carl Ryan

Studio Manager: Mr. Bonzai

Engineers: Carl Ryan, Smilin' Deal Eddie Edwards, Layla Lane.

Dimensions of Studio(s): 8 x 15 x 47

Dimensions of Control Room(s): 10 x 12 x 15, Kent Korn-

kooper Live Head/Dead Head Design.

**Tape Recorders:** Custom Stanley 32 track; Atrax 2 track; Lantz 8 track cartridge; Authentic cassette machine.

**Mixing Consoles:** SuperSonic II w/Plasma Vue, Pneumatic Semi-automation, 48 x 5'2".

**Monitor Amplifiers:** Modzilla Cube Loops.

**Monitor Speakers:** Lektron Time Designs, Permasonic "Little Dippers," and Oralphones.

**Other Outboard Equipment:** Evinrude De'Flatter, 5-X Slop-Master, Omega Labs Digital Flanger/Fuzzer, Abba-Dabba Drum Exciter, and 3D noise gates.

**Microphones:** RKO, EEG, Erlichmanns, and vintage tubes. **Instruments Available:** Phaser "Stundrums," nose harmonica, Deusendorfer 13' grand piano, Clavinator II.

**Rates:** Our book rate is \$220/hr. but we have, on occasion, negotiated as low as \$15/hr. Please call.

**Extras:** Chaise lounge, unicycle, motel accommodations, vegetarian catering, mini-limousine service, 24-hour medical supervision. Telephone nearby.

**Direction:** We are very sensitive to the incredible pressures that musicians are subjected to. We maintain our equipment and recreational activities at a highly professional level. Credits: Johnny Terrific, Lorne Rogers, Morris Edward and many others whose attorneys requested they remain unnamed.

●●●● SABAN PRODUCTIONS

11724 Ventura Blvd., Studio City, CA 91604

(818) 985-3805

Owner: Haim Saban, Shuki Levy

Studio Manager: Andrew Dimitroff

●●●● SAGE AND SOUND RECORDING

1511 Gordon, Hollywood, CA 90028

(213) 469-1527

Owner: Jim Mooney

Studio Manager: Jerry Wood

●●●● SALTY DOG RECORDING

14511 Delano St., Van Nuys, CA 91411

(818) 994-9973

Owner: David Coe

Studio Manager: Janis Thompson

Engineers: Patrick Cyclone and various independents.

Dimensions of Studio(s): 50 x 30

Dimensions of Control Room(s): 20 x 25

**Tape Recorders:** 3M 79 24 track; 3M 79 2 track; (2) Ampex 440B 2/4 track (1/4" and 1/2" head assemblies); Sony 654-4 2/4 track.

**Mixing Consoles:** MCI 528, 28 in x 28 out, with many sonic improvements.

**Monitor Amplifiers:** SAE, Crown, Marantz, Bryson.

**Monitor Speakers:** UREI 813 Time-Aligned, Auratones, JBL 4311.

**Echo, Reverb & Delay Systems:** AMS RMX-16 Digital Reverb, Lexicon PCM60, (2) EMT 140 stereo, Lexicon Prime Time, Cooper Time Cube, Marshall Time Modulator, MXR digital delay.

**Other Outboard Equipment:** UREI 1176 LN limiters, UREI LA-4As, Inovonics 201 limiters, Fairchild stereo compressor, UREI notch filters, Haeco CSG-4, MXR Phasor, MXR Flanger, Orban 516 de-esser, disc playback, Kepex, Gain Brains, dual cassette, line level mikes, Vocal Stressor, Harmonizer and more.

**Microphones:** Neumann KM-84s, U87s, U47s (tube), U48 (tube), AKG 414s, 451s, 452s; Sennheiser 421s, 441s; Sony C37As, ECM 22Ps, Shure 57s, 58s; RCA 44; E-V RE-15; and more.

**Instruments Available:** Yamaha C5 grand piano, AB Chase upright piano w/tack strap; Hammond C-3 w/Leslie speaker included in studio rate.

●●●● SANTA BARBARA SOUND RECORDING, INC.

33 W. Haley St., Santa Barbara, CA 93101

(805) 963-4425

Owner: Dean O. Thompson

Studio Manager: Linda Silva, Daniel Protheroe

Engineers: Terry Nelson, Daniel Protheroe, Paul Dugre'

Dimensions of Studio(s): 1400 sq. ft., 22' ceiling, 2 isolation booths.

Dimensions of Control Room(s): 400 sq. ft.

**Tape Recorders:** Studer A80 III 24 track; Studer A80 RC 2 track; Ampex MR-70 2 track.

**Mixing Consoles:** MCI JH528-LM w/JH50 Jensen & Trans-amp inputs.

**Monitor Amplifiers:** Phase Linear 700B, Accuphase M-60, Accuphase P-300.

**Monitor Speakers:** UREI 813, JBL 4311, JBL 4310, Altec 604E/620/M.L., Auratone.

**Echo, Reverb & Delay Systems:** Lexicon 200, EMT 140ST, AKG BX20E, DeltaLab DL-4, Eventide 910, Marshall 5002.

**Microphones:** Neumann: U87, U67, U47, M49, KM84, KM54; AKG: C24, C60, C12A, 414EB, 452EB; Telefunken: 251, U47; Sony: C37A, C500, C55, ECM50; E-V: RE-20, RE-15, 635; RCA: 44, 77; Shure: 57, 58, 545, SM53; Sennheiser: 441, 421.

**Instruments Available:** Yamaha C-7 grand piano, Hammond B-3 w/Leslie

Rates: Call for rates.





**SKIP SAYLOR RECORDING**  
Los Angeles, CA

◆◆◆◆ **SKIP SAYLOR RECORDING**

506 N. Larchmont Blvd., Los Angeles, CA 90004  
(213) 467-3515

Owner: Skip Saylor

Studio Manager: Skip Saylor

Engineers: Skip Saylor, Tom McCauley and various independent engineers.

Dimensions of Studio(s): Main Room: 22 x 20; Isolation Rooms: 15 x 10 and 17 x 4.

Dimensions of Control Room(s): 17 x 11

Tape Recorders: Ampex MM1200 24 track; Ampex ATR 102 2 track 1/2" and 1/4" headstack; Ampex ATR 104 4 track 1/2" headstack; Ampex ATR 800 2 track 7 1/2, 15 and 30 ips; rental equipment available.

Mixing Consoles: Trident Spectra Sonics customized 38 in x 24 out.

Monitor Amplifiers: Crown.

Monitor Speakers: Control room tuned by George Augspurger; JBLs, Yamaha NS-10Ms; Auratone T-6s and Cubes; and Hemispheres.

Echo, Reverb & Delay Systems: Lexicon 224X LARC, Lexicon PCM60, Lexicon Prime Time, Lexicon Prime Time II; (3) stereo Ecoplates; (2) Studio Technologies Reverb Processors; Eventide Harmonizer 910, DDL 1745M; Roland Chorus Echo SRE-555, Roland Digital Delay SDE-2000.

Other Outboard Equipment: (10) API 550A EQs, Teitronix LA-2A tube limiter, (3) UREI 1176LN, (2) dbx 160X (stereo), UREI LA-4A, (2) Kepex, (4) Drawmer noise gates, Roland phase shifter SPH-323, Roland stereo flanger SBF-325, (2) dbx de-essers, (2) dbx noise gates, dbx flanger, Roland Dimension-D SDD-320, Orban parametric EQs, (4) Orban de-essers, Furman parametric EQs, UREI Little Dipper, UREI 550A Hi-Lo Pass Filters, Studio Technologies Stereo Simulator, SMPTE and 60 Hz sync, UREI digital metronome, VSO, AKG and Koss headphones.

Microphones: AKG "The Tube," 414s, 452s, D12E, Neumann U87, Sennheiser 441 and 421s; Beyer M400s, E-V RE-20, RE-15s; Shure SM57s and more.

Instruments Available: Yamaha grand piano and Mini-moog.

Video Equipment & Services: Rental equipment available. Rates: Please call for rates.

◆◆◆◆ **SEACOAST RECORDING STUDIO**

926 Turquoise St., San Diego, CA 92109  
(619) 270-7664

Owner: Elliott Audio Enterprises

Studio Manager: Jack Elliott

◆◆◆◆ **SKYLINE RECORDING**

1402 Old Topanga Canyon Rd., Topanga Pk., CA 90290  
(213) 455-2044

Studio Manager: Lisa Bacon

◆◆◆◆ **SOUND AFFAIR STUDIOS**

2727-G S. Croddy Way, Santa Ana, CA 92704  
(714) 540-0063

Owner: Ron Leeper

Studio Manager: V. Leeper

Engineers: Ron Leeper, Brian Burns and independents. Maintenance: John Goetz

Dimensions of Studio(s): A: 36 x 30, drum booth 12 x 10, vocal booth 7 x 6; B: 26 x 24 x 16, drum booth 11 x 9; A: Piano trap 12; C: 18 x 12.

Dimensions of Control Room(s): A: 20 x 18; B: 18 x 14.

Tape Recorders: Ampex MM 1200 24 track w/locator, Ampex MM 1200 16 track w/locator, Ampex ATR 100 1/2 & 1/4" 2 track, Ampex 440 2 track; Otari 50-50 2 track.

Mixing Consoles: MCI JH600 automated 36 in x 24 out; Sound Workshop 1600 20 in x 16 out.

Monitor Amplifiers: Crown DC 300A, Crown D175, BGW

—LISTING CONTINUED ON PAGE 204

# Need a reliable employee?

**Mix Classifieds** are the place to advertise for management, sales and technical personnel. They all read **Mix**, the audio industry's largest, most widely-distributed magazine!

To place a **Mix Classified** ad, call Lauri Newman at **(415) 843-7901**. Deadline: 10th of month, two months prior to publication.

THE RECORDING INDUSTRY MAGAZINE

## RECORDING STUDIOS AUDIO & VIDEO LOWEST PRICES ON AMPEX AUDIO & VIDEO TAPE SPECIAL

### Ampex 456 Grand Master Studio Mastering Tape

Metal Reel	97G111	2"	\$108.65
Metal Reel	573111	1"	50.17
Metal Reel	273111	1/2"	28.98
Metal Reel	17311J	1/4"	16.40

All AMPEX prices F.O.B., Waco, TX.

All AMPEX Tape Products  
C.O.D. or Company Check.

### AMPEX Videocassettes

Catalog Number	CTY.	SUGG. QTY.	LIST	(1 Carton)
197 BCA-10	10		\$26.25	\$11.20
197 BCA-20	10		30.86	12.60
197 BCA-60	10		46.97	18.95
187 KCA-60	10		45.29	16.20
187 KCA-30	10		31.69	11.50
196-1630 CA	5		73.10	43.95

### Lowest Prices on ALL AMPEX Audio & Video Tape!

- \* Video Cassette Duplication
  - \* Stereo Cassette Duplication
  - \* AMPEX 466 Digital Audio Tape, 1/4" - 1"
  - \* Custom Loading of VHS 1/2" Video Cassettes
  - \* AMPEX 187 & 197 3/4" U-MATIC Videocassettes
  - \* AMPEX Broadcast Video Tape 1" Helical
  - \* "Custom" Loading of BASF Pure Chrome Audio Cassettes
- (Price Example 5M C-30 @ .69¢)

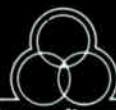

**Hix Recording Co., Inc.**

Hix Recording Co., Inc.  
1611 Herring  
Waco, Texas 76708  
(817) 756-5303

Limited Time Offer. Special Expires 10/31/85.

Circle #159 on Reader Service Card

CONNECTORS AND MICROPHONE CABLES 	 BLANK-LOADED AUDIO CASSETTES
 TAPES & CASSETTES from AMPEX AGFA BASF MAXELL TDK 3M	EMPTY REELS AND BOXES 
NAB BROADCAST CARTRIDGES 	CASSETTE BOXES, LABELS, ALBUMS 
ACCESSORIES 	

Ask for our  
**44 PAGE CATALOG**  
of  
**PROFESSIONAL  
SOUND RECORDING  
& DUPLICATING SUPPLIES**

Recording Supply Div. of Polyline Corp  
1233 Rand Road, Des Plaines IL 60016  
(312) 298 - 5300

35

Circle #160 on Reader Service Card

**FREE 20 PAGE BOOK** the essential planning and price guide for all your custom record and tape needs

**45's, EP's, ALBUMS, CrO<sub>2</sub> CASSETTES**

**CALL NOW TOLL FREE**  
**1-800 263-7798**  
(Continental U.S. Only)

Ultra gloss board jackets/virgin vinyl/inhouse graphics/VMS 80 lathe  
**3 WEEK PREPAID AIR DELIVERY**



**WORLD RECORDS**  
Baseline Road West  
BOWMANVILLE, ONTARIO  
L1C 3Z3

Circle #161 on Reader Service Card

## SOUTHERN CALIFORNIA S · T · U · D · I · O · S 24 TRACK

—FROM PAGE 203



**SOUND AFFAIR STUDIOS**  
Santa Ana, CA

100, BGW 210 (2), UREI 6500, UREI 6150.  
Monitor Speakers: JBL 4430 and 4311, Tannoy SRM-12B, Yamaha NS10M, Auratones 5-C.  
Echo, Reverb & Delay Systems: Lexicon 224 digital reverb Ecoplate, Super Prime Time, Eventide Harmonizer 949, MICMIX Super C, DeltaLab Effectron DL2, Lexicon Prime Time, Sound Workshop Vocal Doubler, Eventide SP-2016.  
Other Outboard Equipment: UREI 1176, LA-2A, LA-4A; 535 graphic EQs, ADR Voice Stressor, dbx 161 limiter, EXR Exciter, HPXX display, full Scamp rack, White 4001 EQs, Furman Parametric EQs, Eventide Phasers, ADR auto panner, Gold Line RTA.  
Microphones: AKG: The Tube, 414, 451; Neumann: U47, U87, KM84; Electro-Voice RE-20, PL95, DX35; Sennheiser MD 421, MD 441, MKH 405; Crown P2M; Calrec CB21C; Altec 195-A; RCA DXFF; Shure SM56, 57.  
Instruments Available: (2) grand pianos, drums, electric piano, organ, sound effects and library.  
Video Equipment & Services: We are currently expanding for in-house video production and remote, color effects, editing, interlock.  
Rates: Please call.  
Extras: Studio A: Carefully planned and constructed for perfection in acoustic sound w/drum and vocal iso. Live piano trap areas, accommodations for approx. 22 musicians. Studio B: Designed with a 16' ceiling and live ambience areas. Suitable for strings, choral groups, and ensembles. Trios and small groups find it ideal to expand and enhance their sound. Also favored by drummers who seek that big drum sound. Both studios can be used in conjunction.  
Direction: Our goal has been for Sound Affair to be one of Southern California's finest studios. We are proud of our steady growth in many directions. This has been our most busy year.

●●●● SOUND ARTS  
2825 Hyans St., Los Angeles, CA 90026  
(213) 487-5148  
Owner: Bob Walter, Jim Cypher, John Berkman, Rick Johnston, Aseley Otten.  
Studio Manager: Bob Walter, Connie Mellors.  
Engineers: Jim Cypher, Aseley Otten. Resident Synthesists: Rick Johnston, Jim Cypher.  
Dimensions of Studio(s): 36 x 22  
Dimensions of Control Room(s): 24 x 22  
Tape Recorders: Ampex MM-1200 24 track; ATR 104 4 track; Ampex ATR-102 2 track.  
Mixing Consoles: Trident Series 80, 32 in x 24 out.  
Monitor Amplifiers: Crown DC-300s, DC-150s, BGW 250B.  
Monitor Speakers: Sierra Hidley IIIs, JBL 4315s, 4311s, Auratone 5Cs.  
Echo, Reverb & Delay Systems: Lexicon 224, AKG BX-10, Eventide DDL and Lexicon Prime Time, Roland SDE-3000.  
Other Outboard Equipment: Orban parametric EQs;

UREI 1176, LA-3A, LA-2A; digital metronome, Eventide 949 Harmonizer, Allison Gain Brains and Kepexes, Orban Sibilance Controller, Moog Vocoder, dbx 162 comp/limiter, Ampex VSO, 360 Systems and Bode frequency shifters, Roland Space Echo w/chorus, Dr. Click, Adams-Smith Synchroizer, Pullec & Melcor EQs, J.L. Cooper MIDI box, Roland SBX 80 synch box.  
Microphones: PML DC-63s; Neumann U87s, KM84s; E-V RE-20, RE-15s; AKG 451s, 124E, D-1000E; RCA 77Ds; Shure SM-77s, SM-54s, SM-57s, SM-58s; Sony C-38P, C-55Ps; Sennheiser 421s, 441s.  
Instruments Available: Fairlight CMI, Yamaha DX7, Memory Moog, Roland Jupiter 8, Moog Model 55C expanded modular system, Prophet 10, Yamaha CS80, Oberheim 4-voice, Polymoog, Minimoog, ARP string ensemble, Roland SH 1000, Sequential Circuits digital sequencer, Baldwin electric harpsichord, Hammond B-3, Steinway grand piano.  
Rates: Call for rates.



**SOUNDCASTLE RECORDING STUDIOS**  
Los Angeles, CA

●●●● SOUNDCASTLE RECORDING STUDIOS  
2840 Rowena Ave., Los Angeles, CA 90039  
(213) 665-5201  
Owner: Buddy King  
Studio Manager: Darryl Caseine



**SOUND CHAMBER RECORDERS**  
Pasadena, CA

●●●● SOUND CHAMBER RECORDERS  
27 S. El Molino Ave., Pasadena, CA 91101  
(818) 449-8133  
Owner: Richard McIlvery, Randy Farrar, Tim Kenelick  
Studio Manager: Richard McIlvery  
Engineers: Richard McIlvery, Randy Farrar, Tim Kenelick, independents.  
Dimensions of Studio(s): 18 x 40 x 18 ceiling; 12 x 12 drum booth  
Dimensions of Control Room(s): 18 x 17  
Tape Recorders: Stephens 821 24 track; Ampex ATR 102 2 track, 1/4" & 1/2"; Technics 1500 2 track; TEAC cassette.  
Mixing Consoles: Trident Series 80B 32 x 24.  
Monitor Amplifiers: Metron, Cerwin-Vega, BGW.  
Monitor Speakers: UREI 813, JBL 4311, Yamaha NS10M, Auratone 5C.  
Echo, Reverb & Delay Systems: Lexicon 224X w/LARC, EMT 140s (tube), Ecoplate I, Lexicon Prime Time II, Eventide 949 Harmonizer.



**Other Outboard Equipment:** UREI 1176 LNs, UREI LA-4s, dbx 163s compressor/limiters, Orban stereo parametric EQ, Galax gates, Aphex gate/compressors, UREI digital metronome, 2 tracks of Dolby 361.  
**Microphones:** Neumann U87, KM84; AKG C414, CA52; Sennheiser MD421; Shure SM57, 54, 546.  
**Instruments Available:** Yamaha C-7 7'4" grand piano, Hammond B-3 organ w/Leslie, Yamaha DX7 synthesizer, Fender Rhodes, Prophet 5, LinnDrum.  
**Rates:** Please call.

**●●●● SOUND CITY INC.**

15456 Cabrito Rd., Van Nuys, CA 91406  
 (818) 787-3722, 873-2842

**Owner:** Joe Gottfried, Tom Skeeler  
**Studio Manager:** Paula Salvatore  
**Engineers:** John Hanlon, Bruce Barris, Rick Polakow, Teri Swenson, Bret Newman, Andy Udoff. **Maintenance:** William Elswick, John Hanlon.  
**Dimensions of Studio(s):** Studio A: 40 x 50; Studio B: 40 x 30  
**Dimensions of Control Room(s):** Studio A: 26 x 20; Studio B: 20 x 20  
**Tape Recorders:** Studer A800 24 track; Studer A80 MK II 24 track; Studer A80 1/2", Studer A80 1/4", (2) B67 2 tracks; Revox/Sony 1/4 track.  
**Mixing Consoles:** Neve (Studio A) w/Necam computer mix, 26 in x 32 out; Neve (Studio B), 28 in x 32 out.  
**Monitor Amplifiers:** Crown DC-300; for the Q system, Yamaha P-2200.  
**Monitor Speakers:** A & B: JBL (custom designed and tuned by George Augspurger).  
**Echo, Reverb & Delay Systems:** EMT, AKG, Lexicon Delta-T digital delay, (2) Harmonizer, 949, Eventide flanger, Orban de-esser, Eventide digital delay, AMS RMX-16 digital reverb.  
**Other Outboard Equipment:** Parametric EQ, dbx 165As, Pultec EQs, filters, Teletronix LA-2A limiters, Neve limiters, UA 1176, Dolbys.  
**Microphones:** Neumann U47, U67, U47 FET, U84, U86, U87, KM84, KM86, M49; AKG 541Es, C 451E, C-24, C-12A, 460s, M49; Electro-Voice RE-20, RE-15, 635s; Shure 545s, SM-57, SM-58; Sennheiser MD-421; Sony C-37s, EC 50.  
**Instruments Available:** Hammond C-3 organ w/Leslie, (2) Steinway grand pianos.  
**Rates:** Call for rates.

**●●●● SOUND IMAGE STUDIO**

6556 Wilkinson Ave., North Hollywood, CA 91606  
 (818) 762-8881

**Owner:** Sound Image Entertainment, Inc.  
**Studio Manager:** Chuck Kopp

**●●●● SOUND LABS**

1800 N. Argyle Ave. #202, Hollywood, CA 90028  
 (213) 466-3463

**Owner:** Bob Gaudio, Frankie Valli  
**Studio Manager:** Marvin Hall

**Studio Manager:** Barbara Ingoldsbay  
**Engineers:** Brian Ingoldsbay, Ken Ingoldsbay, Ed Dupper, Dan Shimai, Dan Talia.

**Dimensions of Studio(s):** 33 x 35 x 14'H plus drum booth and vocal booth

**Dimensions of Control Room(s):** 21 x 21  
**Tape Recorders:** (2) MCI JH-16 24 track; (2) MCI JH-110-A 2 track; MCI JH-110-A 4 track; (2) Revox A77-H 2 track; Ampex AG-440-C 2 track; Pioneer RT-701 1/4 track; (2) Nakamichi cassette 1000 2 track; (4) video recorders 3/4" JBL 8560; video recorder 1" Ampex 1001; (4) video recorders VHS and Beta 7000 & 3700.

**Mixing Consoles:** Quad/Eight Coronado automated compu-mix 3, 40 in x 40 out.

**Monitor Amplifiers:** Tri-amped Ashly crossover, Soundcraftsman Model 5001, BGW-750C and 100B.

**Monitor Speakers:** Custom design Goodman control room quad; Studio: L300 JBL; various auxiliary monitors available.  
**Echo, Reverb & Delay Systems:** AKG BX-20, Quad/Eight CPR 16, Soundcraftsman 262 stereo, Sound Workshop 262 stereo reverb.

**Other Outboard Equipment:** 26 channels of Dolby, 32 channels of dbx noise reduction systems, SMPTE time code JH 45, Autolocator 3, Prime Time, Lexicon PCM 41, Harmonizer Eventide, D250 Advanced Audio Design, 265 Dynaflinger. Limiters: dbx 165s, UREI 1176s, dbx 161s, Quad/Eight compressor/expanders, Quad/Eight de-essers. Noise gates: 16 Quad/Eight and Kepex, Orban parametric, UREI 527A, MXR phaser, Eventide Instant Phaser, Marshall Time Modulator, Eventide DDL 1745.

**Microphones:** Shure Bros. complete line, Electro-Voice, Audio-Technica, PZMs, AKG, Sony, Beyer, Neumann, Altec, RCA, Sennheiser, Vega wireless, Edcor wireless, over 350 microphones including old tube types.

**Instruments Available:** Steinway 7'7" grand piano, Yamaha 6'6" grand, B-3 w/Leslie, Linn LM-1 computerized drum machine, timbales, orchestra chimes, string synthesizer, and varied array of hand percussion instruments.

**Video Equipment & Services:** Full video production house on-site. Video studio dimensions: 30 x 40. Computerized postproduction editing with Chromakey character generator, digital special effects, freeze-frame and frame store, Ikegami and JVC color cameras, also ENG. Program pre-planning, design, script writing, and in-house tape duplication.  
**Rates:** Available on request.

**Extras:** On-site disk mastering studio equipped w/Tandem Cyberonics disk cutting lathes w/Ortolon heads, and computerized digital Cyberonics console. Also, three mobile

—LISTING CONTINUED ON PAGE 206

**SOUND MASTER**



**RECORDING STUDIOS®**  
**and**  
**VIDEO PRODUCTION**

SOUND MASTER AUDIO/VIDEO  
 N. Hollywood, CA

**●●●● SOUND MASTER AUDIO/VIDEO RECORDING STUDIOS**

**also REMOTE RECORDING**

10747 Magnolia Blvd., N. Hollywood, CA 91601  
 (213) 650-8000

**Owner:** Brian & Barbara Ingoldsbay

## USED RECORDING EQUIPMENT FOR SALE

### MICROPHONES

AKG: C61, C28, C29, C12A, C12, C24, D15, D202. Neumann: KM54, KM254, KM53, KM253, KM56, KM64, U67, U47, M49, M50, U48, SM23, SM2, SM69. Telefunken: M260, Elam 251. RCA: BK5 A, BK5 B, 77B. Schoeps: CM51V, M221, CM61. Sennheiser MKH 405. Sony: C500, ECM377. Beyer M101. Altec tube mic. Shure SM53. B & O ribbon mic.

### RECORDING CONSOLES

Aengus wired for 16x8x16 has 8x8x8 in place, 2 phono inputs with map EQ • MCI 542 with 28 I/O modules • API 20 input 8 groups, 16 monitor 550 EQ • Trident Series 80 5 years old: \$25,000 • Trident Series 80 B 40 inputs/as new/EQ on monitors • Neve 30 in/6 outputs 1060 modules \$9,500 • Helios consoles: 3 available • API 24 inputs 24 monitors fair condition \$15,000 • Neve 38 inputs 1066 modules 24 monitors \$65,000 • Neve 16 inputs 4 groups 1066 modules \$15,000... Call for details.

### TAPE RECORDERS

24 tracks: Otari MTR-90 MK 2 24 track; 3M M79 \$17,500 • Ampex MM1200 with 24 and 16 track heads \$19,000. 16 tracks: MM1000 late model w/DC servo

and sync switching \$9,500 • Scully 280-16 with VSO; counter. \$10,000 • Ampex 440B-8 1 inch..\$3,750 • Scully 280-8 w/4 track & 2 track heads • Studer A80 8 track • 3M M64 4 track • 3M M64 2 track. Cassette Decks: Technics RS 45 • Hitachi D7500.

### OUTBOARD GEAR

DeltaLab DL-1 digital delay • Eventide 1745M digital delay • Eventide Instant Phaser • AKG BX-10 reverb • UREI 1109 cards • Orban de-esser • RCA BA6A limiter • EMT stereo plate reverbs • Roland SPH323 stereo phaser • MXR digital delay • UREI Little Dipper • Lexicon 122S DDL.

### RACK MOUNT EQUALIZERS

Furman PQ-6 parametric • UREI 545 parametric • Pultec HLF-3 hi/lo filter • Altec graphic • Furman parametric • U.A. 550 hi/lo filter • White 3400 1/3 octave graphic.

### RACK MOUNT LIMITERS

Decca tube limiter • Electrodyne compressor limiter • Pye limiters • Altec tube limiter.

### EQUALIZER MODULES

Melcore GME • API 550 • Map EQ • Altec 9061A • Orange County sweep EQ • B & B EQF-1.

### LIMITER MODULES

Allison Gain Brain 1 • API 525A • API 525C.

### AMPLIFIERS

McIntosh MI-75 • McIntosh MC-75 • McIntosh MC-30 • McIntosh MC-40 • Crown D-60 • Langevin AM-16 • Marantz 240 • Crown SA 30-30.

### CONSOLE COMPONENTS

Neve 1060 input module • API 515Q assign module • API 512 input module • API 325 line amp cards • API 312-5 line amp cards • API 575 oscillator.

### MISCELLANEOUS

Pultec MH-4 mixer • Stephens VSO as is.

**Dan Alexander Audio**  
**Box 9830**  
**Berkeley, CA 94709**  
**415/527-1411**

Circle #162 on Reader Service Card

—FROM PAGE 205

trucks, remote recording; sound reinforcement; and video. Direction: Looking ahead to the future Sound Master has incorporated full color video capabilities into a state-of-the-art recording studio facility to accommodate the current growing audio/video fusion in the recording industry. Our aim is to provide you with technical sophistication as well as personal attention.



**THE SOUND SOLUTION**  
Santa Monica, CA

◆◆◆ **THE SOUND SOLUTION**  
1211 Fourth Street, Santa Monica, CA 90401  
(213) 393-5332  
Owner: Solution Enterprises, Inc.  
Studio Manager: Keith Wechsler  
Engineers: Keith Wechsler (chief), Steve Barnard (chief producer), David Blade, Richard Jellis, Rod Clark, Jennie Cirillo, David Feuer (maintenance)  
Dimensions of Studio(s): 32 x 14, plus iso booth 4 x 8  
Dimensions of Control Room(s): 14 x 16  
Tape Recorders: MCI JH-114 24/16/8 track with autoloca-

## SOUTHERN CALIFORNIA S · T · U · D · I · O · S 24 TRACK

tor and VSO; Ampex ATR-102 1/2" and 1/4" 2 track, Ampex AG 440B 2 track; Technics 1500 2 track; Sony TC 854-4 4 track, Sony TC K777 cassette decks; Otari 1/2" 8 track recorder available.

Mixing Consoles: MCI 428 modified 28 in x 24 out.  
Monitor Amplifiers: Hafler P 500, Crest 3500, QSC P-3500, BGW 100B, Uni-sync 50.

Monitor Speakers: Altec/Master Lab 604 Es, JBL 4311s, Sony APM 700's, Yamaha NS10Ms, Horrotones.  
Echo, Reverb & Delay Systems: Lexicon 224 XL digital reverb, EMT 140S, Ecoplate III, AKG BX 10E, (2) Lexicon M 93 Prime Time digital delays, Eventide H949 harmonizer, DeltaLab ADM 1024, Effectron II digital delay, Roland SRE-555 tape echo with chorus.

Other Outboard Equipment: (3) UREI 1176 LN Limiters, (2) LA-3A limiters, (2) dbx 165A limiters, (3) dbx 163 limiters, (2) Allison Gain Brain limiters, (6) Allison Kepex noise gates, (2) Orban 622B dual channel parametric EQs, Klark-Teknik DN 30/30, DN 27, DN 22 graphic EQs, Systech 7012 flanger.

Microphones: Over 100 mikes including Neumann, Sennheiser, AKG, Shure, Sony, Beyer, EV, RCA.

Instruments Available: Yamaha C7 7-4" grand piano, Yamaha DX-7 digital programmable synthesizer, Minimoog, LinnDrum computer, Premier drums with Zildjian cymbals, Yamaha and Fender guitars and bass, misc. amplifiers, pedals and effects.

Rates: Hourly rate includes all equipment and engineer. Please call for specific quote.

Extras: Musicians, arrangers, composers and rentals of any

instruments or equipment available, (air conditioning and digital coffee machine.) Producer Steve Barnard available on a project basis. The studio has nearby parking and restaurants and is located 4 blocks from the beach in sunny smog-free Santa Monica. So beat the heat and move your feet on down to The Sound Solution.

Direction: The purpose of The Sound Solution is to create an environment where people are inspired to perform to their absolute limits, and beyond...effortlessly. Recent clients have included Hoytt Axton, Dudley Moore, Free-Flight, Carl Anderson, Henry Lewy, Bruce Johnston, CBS Records, Arista, EMI, Doris Day and numerous TV and radio commercials and identities.

◆◆◆ **STUDIO AMERICA**  
also **REMOTE RECORDING**  
50 N. Mentor, Pasadena, CA 91106  
(818) 440-9919

Owner: Denny Dooley, Roy Oropallo, Joe Pollard  
Studio Manager: Joe Pollard

◆◆◆ **STUDIO 55**  
5505 Melrose Ave., Los Angeles, CA 90038  
(213) 467-5505

Owner: Richard Perry  
Studio Manager: David Dubow

◆◆◆ **STUDIO MASTERS**  
8312 Beverly Blvd., Los Angeles, CA 90048  
(213) 653-1988

Owner: Randolph C. Wood  
Studio Manager: Laurence Wood

◆◆◆ **STUDIO II**  
(Affiliate of Indigo Ranch)  
9733 Culver Blvd., Culver City, CA 90230  
(213) 558-8832

Owner: Richard Kaplan, Jason Wolchin  
Studio Manager: Jason Wolchin  
Engineers: Richard Kaplan, Carl Lange, Jason Wolchin  
Dimensions of Studio(s): 18 x 45, designed by Jeff Cooper  
Dimensions of Control Room(s): 12 x 12, designed by Jeff Cooper

Tape Recorders: Stephens 821 A 24 track; Stephens 821 A 1/2" 4 track; 3M 79 1/4", 1/2" 2 track (transformerless); Scully 280 15-30 ips 1/4" 2 track; Scully 280B 1/4" 2 track; (3) Ampex 350 2 track; (3) Sony TCK-777 cassette decks.

Mixing Consoles: Aengus-Jensen, 32 in x 24 out (the only other "Indigo Ranch"-type "Deane Jensen" console); and soon—12 additional tube mike preamps.

Monitor Amplifiers: BGW 750Cs, Crown DC 300As, Technics 400W class A to small speakers, Mattes 100.

Monitor Speakers: Custom 4-way JBL, Yamaha NS-10

Echo, Reverb & Delay Systems: (2) EMT stereo plates, Publison Internal 90 stereo audio computer, Yamaha digital reverb, MXR-ART 01 digital reverb, Ursa Major Space Station, Ecoplate, Master-Room reverb, Sennheiser reverb, old Telefunken reverb, Eventide 1745A, Eventide 1745M, (2) Eventide H910 Harmonizers, (2) Roland SDE 3000 digital delay, Marshall Time Modulator, (2) Cooper Time Cubes, Lexicon Prime Time, Loft 440 stereo flanger, (3) MXR DDLs, MXR pitch shift/doubler, MXR flanger doubler, Mutron stereo bi-phase, Eventide instant phaser.

Other Outboard Equipment: Limiters: LA1 (tube), LA-2A (tube), EMT 156 stereo, dbx 162 stereo, Eventide Omnipressor, Inovonics limiter, UREI 175 tube, UA-176 tube, Altec 436C tube, (3) RCA tube limiter, Orban de-esser, EQ: Pultecs, SAE graphics, APIs, B&Bs, Aengus graphics, Collins & Cinema Engineering w/Pultec boosters, Altec filters, Gates: (8) Kepex, (4) RM noise gates; Roland guitar pre-amp; White 140 analyzer; dbx Boom box, bass synthesizer.

Microphones: Telefunken 251 tube; Neumann U47 tube, KM53 tube, KM54 tube, KM56 tube, KM64 tube, KM84, KM86, U-64 Neuvistor, U67 tube, U87s, SM69 stereo, M269 tube; AKG C12A, C60, C61, C28, C451, C452, C414; E-V: RE-20, 666, 65-15, 731, 670; Calrec 1050; Sony C-37Ps, C220, ECM 16, ECM 22, ECM 56, ECM 65, ECM 54; Shure: SM56, SM57, SM58, 545, 565; Altec 22, 29A, 150A, 175A tubes; etc.

Instruments Available: Grand piano, Clap-Trap.  
Video Equipment & Services: Available  
Rates: Only \$55/hr.

◆◆◆ **SUN-DWYER RECORDING STUDIOS**  
also **REMOTE RECORDING**  
26483-A Baseline, Highland, CA 92346  
(714) 864-3333

Owner: Charles Whittington  
Studio Manager: Terry Dwyer  
Dimensions of Studio(s): 22 x 32  
Dimensions of Control Room(s): 15 x 20  
Tape Recorders: Ampex MM1200 24 track; Ampex ATR 102 2 track; Ampex AG 350 2 track; (2) Revox A77 2 track.  
Mixing Consoles: Neve/custom 24 in x 28 out w/DC grouping.

## studio consultants, inc.

321 West 44th Street, New York, NY 10036 (212) 586-7376

### A wide range of equipment and services for professional audio facilities and broadcasters

We offer the products of a small number of quality-conscious manufacturers, design systems and studios, and provide extensive technical support both before and after sales.

- **Bryston**—Superb, reliable power amplifiers from 50W/channel stereo to 800W bridged mono, with balanced inputs, modular channel electronics, and dual independent power supplies. Professional preamps also.
- **API**—Classic audio module designs, including the 560A graphic and the all-discrete 550A three-knob program equalizers. Powered racks for these and other components.
- **White**—Equalizers and crossovers, active and passive, including third and sixth octave room EQ.
- **Westlake**—High-quality monitor speakers, large and small.
- **Fostex**—Phase-coherent coaxial reference monitor speakers.
- **Audio Digital**—Digital delay and effects, including the TC-3 Pre-Delay.
- **Ursa Major**—Digital reverb and signal processing, including the new MSP-126, which synthesizes a rich, convincing stereo image with excellent mono compatibility and **no coloration**. Seven other delay-based effects programs as well.
- **Audio Kinetics**—Versatile, intelligent Q-LOCK audio/video synchronizer systems.

—and other fine products.

Circle #163 on Reader Service Card





**SUN-DWYER RECORDING STUDIOS**  
Highland, CA

**Monitor Amplifiers:** McIntosh 2500, Crown D 150s, (5) AB Systems

**Monitor Speakers:** UREI 813s, JBL 4311s, Auratones, Altec 604s.

**Echo, Reverb & Delay Systems:** Lexicon 224, Ecoplate II  
**Other Outboard Equipment:** Eventide Harmonizer, Pandora DDL, Compu-Effector, UREI 1176, dbx 160s, UREI LA-4, Valley People Dyna-Mites, Orban 622 parametrics, etc.

**Microphones:** Neumann U87, KM84, AKG 451, 414; Sennheiser 441, 421; Shure SM7; E-V RE-20; etc.

**Instruments Available:** Yamaha C5 grand piano, Fender Rhodes, LinnDrum, synthesizers. Rentals available.

**Rates:** We're competitive!

◆◆◆ **SUNSET RECORDS**

also **REMOTE RECORDING**

6716 Eddinghill Dr., Rancho Palos Verdes, CA 90274  
(213) 377-7186

**Owner:** J. David Lahey, Perry M. La Marca

**Studio Manager:** J. David Lahey, Perry M. La Marca

◆◆◆ **SUNSET SOUND**

6650 Sunset Blvd., Hollywood, CA 90028  
(213) 469-1186

**Owner:** Paul Camarata

**Studio Manager:** Craig Hubler, gen. mgr.

**Engineers:** Eric Benton (chief tech. eng.), Peggy McCreary, Bill Jackson, Steven Shelton, Murray Kunis, Coke Johnson, George Binder

**Dimensions of Studio(s):** Studio 1: 22 x 36 w/separate string room; Studio 2: 30 x 40; Studio 3: 20 x 50 w/2 iso rooms

**Dimensions of Control Room(s):** Studio 1: 19 x 20; Studio 2: 16 x 23; Studio 3: 18 x 21

**Tape Recorders:** Analog: Ampex MM 1200 16/24 track; Ampex ATR 100 2/4 track; Aiwa F660 cassette decks; Digital: All formats available upon request.

**Mixing Consoles:** Consoles in Studios 1 & 2 feature Necam automation; Studio 1: Custom/Sunset Industries 68 in x 68 out; Studio 2: Custom/Sunset Industries 32 in x 24 out; Studio 3: Custom/Sunset Industries 32 in x 24 out.

**Monitor Amplifiers:** H&H; BGW; Crown; Marantz.

**Monitor Speakers:** JBL custom/George Augspurger design in all control rooms.

**Echo, Reverb & Delay Systems:** (3) Live acoustical chambers; Eventide 1745M DDL, EMT 250; EMT 251; EMT Plates. Ecoplate reverb; AKG BX-20; Lexicon Prime Time I & II, Lexicon 1025 DDL.

**Other Outboard Equipment:** Harmonizers, phasers, parametric EQs, Inovonics 201 limiters, UREI LA-2A, UREI LA-3, UREI LA-4 limiters, VSO, ADR Vocal Stressor, Allison Kepex I & II and Gain Brains, Roger Mayer noise gates, Drawmer noise gates, B&B Sub-mixer Groupier, 12-channel consolette; 8-channel consolette; Q.Lock 3.10 SMPTE synchronizer.

**Microphones:** Neumann U64, U47, U87; KM84, U47 FET, M49, U67; Electro-Voice RE-20, 635A; Altec 21D, 633A; RCA 77D, 44BX; Beyer MB301; Sennheiser MKH405, 421, 441; Sony ECM22P, C-37; AKG 414, 451; Shure SM60, LSM546, SM56, SM57, SM59; Crown PZM 130, PZM 150; Telefunken 251.

**Instruments Available:** Steinway "B" concert grand in each studio; upright tack piano; LinnDrum machine.

**Video Equipment & Services:** Sony monitors; 3/4" U-matics; SMPTE interlock; Audio-for-video postproduction for commercials and television audio sweetening.

**Rates:** Studio 1: \$140/hr; Studio 2 & 3: \$125/hr. Dolby noise reduction and assistant engineer included in rate; Sunset Sound first engineer extra.

**Extras:** Main lobby game room w/ snack & coffee bar and lounge; lounges for each studio equipped w/ refrigerator.

—LISTING CONTINUED ON PAGE 208

# BRYSTON



## Bryston's 2B-LP

Bryston has been known and respected for years as the manufacturer of a line of amplifiers which combine the transparency and near-perfect musical accuracy of the finest audiophile equipment, with the ruggedness, reliability and useful features of the best professional gear. Thus, Bryston amplifiers (and preamplifiers) can be considered a statement of purpose to represent the best of both worlds – musical accuracy and professional reliability to the absolute best of our more than 20 years' experience in the manufacture of high-quality electronics.

The 2B-LP is the newest model in Bryston's line, and delivers 50 watts of continuous power per channel from a package designed to save space in such applications as broadcast monitor, mobile sound trucks, headphone feed, cue, and any installation where quality must not be limited by size constraints. As with all Bryston amplifiers, heatsinking is substantial, eliminating the requirement for forced-air cooling in the great majority of installations. This is backed up by very high peak current capability (24 amperes per channel) and low distortion without limiting, regardless of type and phase angle of load. In short, the 2B-LP is more than the functional equivalent of our original 2B in spite of the fact that it occupies only half the volume, and will fit into a single 1.75" rack-space.

The usefulness of the 2B-LP is extended by a long list of standard features, including: Balanced inputs; female XLR input jacks; dual level-controls; isolated headphone jack; and individual two-colour pilot-light/clipping indicator LEDs for each channel. In addition, the channels may be withdrawn from the front of the amplifier while it is in the rack, vastly facilitating any requirement for field-service, including fuse-replacement.

Of course, in keeping with Bryston's tradition of providing for special requirements, the 2B-LP can be modified or adapted to your wishes on reasonably short notice, and at nominal cost.

Best of all, however, the 2B-LP is a Bryston. Thus the sonic quality is unsurpassed. The difference is immediately obvious, even to the uninitiated.

Other amplifiers in Bryston's line include the model 3B at 100 watts per channel, and the model 4B at 200 watts per channel. All ratings continuous power at 8 ohms at less than 01% THD.

IN THE UNITED STATES

PROSPECTIVE VERMONT  
RFD#4, Berlin, Montpelier, Vermont 05602

IN CANADA

BRYSTON MARKETING LTD  
57 Westmore Dr., Rexdale, Ontario, Canada M9V 3Y6

Circle #164 on Reader Service Card

## TAPE-TO-DISK ISSUE

**WHEN:** December, 1985

**WHO:** Mastering Studios, Pressing Plants, Tape Duplicators

**WHAT:** The annual issue of **Mix** devoted exclusively to record and tape processing, including the industry's most complete directory of mastering facilities, pressing plants, tape duplicators and CD manufacturers.

This issue will be saved and referred to by **Mix** readers for a whole year. Don't miss this opportunity to reach thousands of potential customers. Call today for complete advertising information: (415) 843-7901.

**DEADLINE FOR SPACE RESERVATIONS:**

**October 7th**

**MATERIALS DUE: October 15th**

## audio for video

NO PROJECT IS COMPLETE WITHOUT  
SOUND EFFECTS, MUSIC, NARRATION, OR  
REPLACING BAD DIALOG. IN MONO OR STEREO  
YOU CAN DO ALL THIS AND MORE

### THE SYSTEM

\$ 55/hr at

1054 Cahuenga Blvd., Hollywood, CA 90038

P.S. 3/4" TIME CODE EDITING \$25/hr.

461-3000

FULL SOUND EFFECT LIBRARY AVAILABLE

Circle #165 on Reader Service Card

## The Complete Recording Engineer...

is fully trained in audio/video  
production; has studied  
with today's pros in a  
\*state-of-the-art studio.

The Institute of Audio/Video  
Engineering offers you a realistic,  
up-to-date approach.

Be Sure You're Getting  
The Right Education

INSTITUTE OF AUDIO

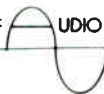

VIDEO ENGINEERING

\*24-track, in-house automated  
studio. Complete video production  
and post-production

8-Month, State-approved  
Diploma Sequence

## OUR GRADUATES WORK

Write or call for free brochure

Institute of  
Audio/Video Engineering  
1831 Hyperion Avenue, Dept. E  
Hollywood, California USA 90027  
(213) 666-3003

Circle #166 on Reader Service Card

## SOUTHERN CALIFORNIA S · T · U · D · I · O · S 24 TRACK

—FROM PAGE 207

Sony TV, and private phone. Ample parking facilities. Basket-  
ball court and ping pong. Picnic tables and summer cook-  
outs. Full security service for complete protection.

**Direction:** As one of the oldest and most respected record-  
ing studios in Los Angeles, Sunset Sound provides a down-  
home high-tech atmosphere for its clientele. Our profes-  
sional staff and superior quality are unequalled, and we are  
dedicated to providing the finest in recording services to our  
customers. We look forward to another 24 years as the leader  
in our industry.

•••• SUNSET SOUND FACTORY  
6357 Selma Ave., Hollywood, CA 90028  
(213) 467-2500

Owner: Paul Camarata

Studio Manager: Philip MacConnell

Engineers: Ion Dressel (chief eng.), Tchad Blake, and  
independents

**Dimensions of Studio(s):** A: 26 x 16, isolation room: 20 x  
12½, isolation booth: 12 x 7; B: 20 x 22, isolation booth: 9½ x  
6½

**Dimensions of Control Room(s):** A: 19 x 13; B: 18 x 16

**Tape Recorders:** Ampex MM 1200 24 track; Ampex ATR  
102 2 track; Ampex ATR ½" 2 track; Technics 1500 ½ track/  
¼ track; Ampex ATR 4 track and Aiwa cassette machines.  
**Mixing Consoles:** A: API, 28 in x 24 out; B: API, 32 in x 32  
out.

**Monitor Amplifiers:** Phase Linear, McIntosh, Crown.

**Monitor Speakers:** Altec 604E w/Mastering Lab crossovers  
(both rooms), Yamaha NS10s, JBL 4310s, JBL L19s, Braun  
L500s, Auratones, Auratone T-6s.

**Echo, Reverb & Delay Systems:** EMT 140 stereo Eco-  
plates, EMT 251, EMT 970 delay, Cooper Time Cubes, Lexi-  
con 224X w/LARC, Lexicon Prime Time, Eventide 1745  
delay.

**Other Outboard Equipment:** Dolby, Kepexes, Gain Brains,  
1176s, LA-3As, LA-2A, de-esser, harmonizers, flangers, Fair-  
child 602, EMT 156, Lang PEQ-2, UREI 550A, Lang EQ  
259A, ITI MEP 230 PEQ, digital metronome, Kepex IIs,  
Orban 621B-EQ, API 550A & 560 EQs.

**Microphones:** Neumann U67, U47, U47 FETs, U87s,  
KM84s, KM86s, KM88s, M49s; Telefunken ELAM 251s;  
RCA 77s, 44s; Altec RDC 123; Sony C65, ECM50, ECM22P,  
C37As, 201, C500s; AKG C12As, 414EBs, 202s, 224s, 452s,  
E-V RE-20s, 666s, 1751s; Shure SM53s, SM56s, SM57s, 585,  
544; Sennheiser 421s, 441s, 815s.

**Instruments Available:** Steinway model B grand pianos  
(both rooms), Hammond B-3 organ w/Leslie speaker.

**Rates:** Call for rates.

•••• SUNSOUND  
9590 Chesapeake Drive, San Diego, CA 92123  
(619) 565-8011

Owner: Edward Peters

Studio Manager: Jim Norr

•••• SUNSWEEP STUDIOS  
4181 Sunswep Dr., Studio City, CA 91604  
(818) 980-6220

Owner: John Hoier

Studio Manager: John Hoier

•••• SUNWEST STUDIO  
5533 Sunset Blvd., Hollywood, CA 90028  
(213) 463-5631

Owner: Robert Williams

Studio Manager: Rena Winters

•••• SUTTON PLACE RECORDING  
14751½ Oxnard St., Van Nuys, CA 91411  
(818) 786-2261

Owner: Jamie Sutton

Studio Manager: Jamie Sutton

Engineers: Jamie Sutton

**Dimensions of Studio(s):** Main Room: 25 x 20 x 10, iso: 7 x  
8, 8 x 9

**Dimensions of Control Room(s):** 17 x 14

**Tape Recorders:** Aces 24 track; Otari 2 track 30 ips; Sony

cassette decks.

**Mixing Consoles:** Audioarts SX transformerless, 8 buss &  
directs on all inputs via fader.

**Echo, Reverb & Delay Systems:** Lexicon 200 & PCM 60  
digital reverbs.

**Other Outboard Equipment:** Lexicon 41s, Eventide 949  
Harmonizer, 201 Instant Flanger, DeltaLab II, dbx 160X, 166,  
Symetrix 522, Orban 622B, UREI 545 EQ, Omni Craft gates.

**Monitors:** Tannoy SRM15X, Auratone T6.

**Microphones:** Neumann, AKG, Sennheiser, Beyer, Shure

**Rates:** \$35/hr.

**Direction:** Sutton Place started out as a four track, then  
graduated to 8 and to 16, and finally to 24 track. Our engi-  
neers are musicians, as well as technicians, and we are  
conscious of the needs of the musicians who record here,  
although we do a lot of hard rock/metal type bands, we  
have also done many other styles of music, as well as numer-  
ous radio & TV spots.

We are moving to a custom built facility in late fall—with  
about 2000 sq. ft. of recording space & 1000 sq. ft. sound  
stage. Future updates include a postproduction room.

### •••• THE SYNTH ROOM

919 N. Victory Blvd., Burbank, CA 91502

(818) 843-4762, (213) 460-4474

Owner: EFX Systems

Studio Manager: Jere Mendelsohn

**Direction:** This 24 track studio is designed especially for the  
composer/keyboard musician, with access to over 15 mod-  
ern electronic instruments including DX7, Emulator I & II,  
LinnDrum and Linn 9000, Memorymoog, etc. The Synth  
Room differs from conventional studios in that complete  
songs and entire film scores come out of this studio with no  
microphones used at all. However, that option is available by  
using our vocal overdub booth. Full video synch is available  
for film, commercial and advertising projects, and the room  
is set up in a logical, accessible manner if the composer/  
musician is working alone. The Synth Room is also ideal for  
sound effects building, album overdubs and sweetening  
projects at extremely reasonable rates. Put the latest tech-  
nology to work for you. Give us a call!

### •••• TAJ SOUNDWORKS

8207 W. Third St., Los Angeles, CA 90048

(213) 655-2775

Owner: The Beltaire Group, The Hugh Benjamin Corp., Ed-  
ward Bannon

Studio Manager: Debra Prusa

Engineers: Ed Bannon (director of engineering), T.E. Sadler,  
Greg Orloff, Sheri Klein, Jimmy Ashwill

**Dimensions of Studio(s):** 25 x 50 (available for Foley, ADR,  
and music)

**Dimensions of Control Room(s):** 17 x 22

**Tape Recorders:** MCI JH 24/24 R/R, MCI JH 110x2; Tas-  
cam 52, Sony SLO 383 VCRs, 35mm mag transports: MTM  
4035 SS R/R; KEM K-800 Telecine.

**Mixing Consoles:** Custom MCI JH 528 28 x 28 w/B&B  
Audio VCA's & pre-amps.

**Instruments Available:** Baldwin 76" grand piano, Fender  
Rhodes, Minimoog, Hohner D-6 clavinet, Hammond B-3.

**Video Equipment & Services:** Barco video projection,  
Steward filmscreen 7' x 9' silver screen, Audio Kinetics  
Q.Lock 3.10-3 w/ADR software, MultiMicro Computer Multi-  
Mainframe w/Cinesoft Editorial software, special high-per-  
formance audio cable by Monster Cable.

**Direction:** Taj Soundworks is proud in the past 12 months  
alone to have participated in the postproduction sound for  
"Thriller," "Terms of Endearment," "Footloose," "Swing  
Shift," "Gremlins," "Streets of Fire," "To Be or Not to Be,"  
"Sixteen Candles," "Trading Places," "Jaws 3-D," "Racing  
With the Moon," "The River," "No Small Affair," "The Slug-  
ger's Wife," "Body Double," among others. While our pri-  
mary focus continues to be superior postproduction sound for  
film and video including ADR, Foley, scoring and sweeten-  
ing, we continue to set the industry standard by exploring  
and developing new technologies in the fields of high per-  
formance audio cable, computer software, and advanced  
effects recording and reproduction techniques for all audio  
media.

### •••• THAT STUDIO RECORDING SERVICES

also REMOTE RECORDING

P.O. Box 958, North Hollywood, CA 91603

(818) 764-1421

Owner: That Studio, Inc.

Studio Manager: Richard Holbrook

Engineers: Richard Holbrook, Denny McLane, Steve  
Seboldt, independents

**Dimensions of Studio(s):** 30 x 20 w/extensive trapping  
(live and dead areas); 8 x 9 live isolation room/chamber

**Dimensions of Control Room(s):** 14 x 9 (studio); 12 x 8  
(truck)

**Tape Recorders:** Otari MTR 90 24/16 track; Otari MTR 12 2  
track; Otari MX5050 2 track; Otari MX5050 8 track; TEAC  
3340s 4 track; Technics M85 cassette; Aiwa F770 cassette.

**Mixing Consoles:** Studio: Harrison MR-4 (automated) 28 in  
x 24 out; Truck: Audiotronics 110-8 (modified) 24 x 8 x 2.

**Monitor Amplifiers:** Crown, BGW, Yamaha, QSC, Altec.

—LISTING CONTINUED ON PAGE 210



# THE MIX BOOKSHELF



The MIX BOOKSHELF Catalog is a selection of the best audio/video/music books and tape courses currently available from more than forty leading industry publishers.

Now it is simple and convenient to order these hard-to-find titles from a single source by phone or through the mail. Send for our free catalog.

**104) RECORDING STUDIO HANDBOOK**, John Woram A complete handbook dealing with every major aspect of recording technology, including transducers, compressors, tape recorder alignment, mike techniques, limiting and expanding, noise and noise reduction, signal processing, magnetic recording, and recording consoles and techniques.  
481 pp.(H) \$39.50

**120) CRITICAL LISTENING COURSE**, F. Alton Everest This invaluable course specifically addresses the important nuances of the audio world. The 106 page training manual with ten pre-recorded lessons on cassette tapes lead you from basic to advanced listening techniques in increasing progression. Topics include estimating frequency, frequency band limitations, sound level changes, components of sound quality, frequency response irregularities, various types of distortion, reverberation effects on speech and music, signal vs. noise, and voice colorations.  
\$129.95

**130) BUILDING A RECORDING STUDIO**, Jeff Cooper, M. Arch., S.M., S.B., B.S.A.D. A step by step guide to recording studio construction for small or large budgets. Thorough coverage of the principles of acoustics, how acoustics affect recording, soundproofing a room, plus chapters on the studio, the control room, and a glossary of the 100 most misunderstood terms in acoustics.  
209 pp.(P) \$30.00

**140) SOUND SYSTEM ENGINEERING**, Don & Carolyn Davis This excellent volume offers a concise and encyclopedic treatment of the decibel notation system, loudspeaker directivity and coverage, the acoustic environment, acoustic gain, interfacing electrical and acoustical systems, installation, equalization, and instrumentation. Includes sample design applications.  
295 pp.(P) \$21.95

**201) VIDEO PRODUCTION GUIDE**, Lon McQuillin A broad overview placing emphasis on the human organizational aspects with lively, comprehensive coverage of both studio and location production from the viewpoint of the producer and director. Divided into four parts: pre-production, production, postproduction, and other important topics.  
382 pp.(P) \$28.95

**217) VIDEO EDITING & POSTPRODUCTION: A PROFESSIONAL GUIDE**, Gary H. Anderson A new "real world" guide to both technical and non-technical factors of videotape postproduction by a four-time Emmy Award winner. Complete and detailed info on time codes, formats, offline and online editing, digital effects, future trends, and more. Includes glossary and selected directory of equipment manufacturers.  
165 pp.(H) \$34.95

**310) HOW TO MAKE AND SELL YOUR OWN RECORD**, Diane Sward Rapaport This brand new edition offers technical information, practical tips, and business guidance for self-production of record and cassette releases. Every aspect of a recording project is covered, from planning and budgeting through sales and promotion. Includes sample forms and worksheets as well as advice on raising money and negotiating contracts.  
167 pp.(P) \$12.95

**334) INSIDE THE MUSIC PUBLISHING INDUSTRY**, Paula Dranov Examines what music publishing is, how it works, and why it can be so profitable. Thoroughly explains the role and economics of the major licensing organizations and the impact of the Copyright Act of 1976. Includes profiles of leading publishers and shows how and why many are moving increasingly into production and packaging.  
185 pp.(H) \$29.95

**341) AN INSIDER'S GUIDE TO ADVERTISING MUSIC**, Walt Woodward An excellent reference for advertising music professionals which goes right to the heart of the jingle industry. Detailed, informative, and insightful, it covers how and why music works in advertising, when and how to use it, and all crucial elements of production for quality radio and TV campaigns.  
126 pp.(H) \$14.95 Optional cassette \$5.95 extra

**370) THE RECORD PRODUCERS**, John Tabler & Stuart Grundy Profiles based on exclusive interviews with 13 of the greatest hitmakers, Leiber & Stroller, Tom Dowd, Phil Spector, Richard Perry, Bill Szymczyk, Todd Rundgren, George Martin, Mickie Most, Glyns Johns, Tony Visconti, Chinn & Chapman, Roy Thomas Baker, and Chris Thomas.  
248 pp.(P) \$10.95

THE RECORDING INDUSTRY RESOURCE CENTER • 2608 NINTH STREET • BERKELEY, CA 94710



## MIX BOOKSHELF

PLEASE SEND BOOKS TO:

NAME \_\_\_\_\_

COMPANY NAME \_\_\_\_\_

ADDRESS \_\_\_\_\_

CITY \_\_\_\_\_

STATE \_\_\_\_\_

ZIP \_\_\_\_\_

Please send complete Bookshelf Catalog (FREE)

MIX Bookshelf, 2608 Ninth St., Berkeley, CA 94710

Allow 4-6 Weeks for Delivery

Book #

Qty.

Price

_____	_____	_____
_____	_____	_____
_____	_____	_____
_____	_____	_____
_____	_____	_____

**SUBTOTAL** \_\_\_\_\_

\$2.00 postage & handling per book (\$3.00 outside US)

CA residents add 6.5% tax \_\_\_\_\_

**TOTAL** \_\_\_\_\_

Check enclosed for total.

Bill to:  VISA  MC

Credit Card # \_\_\_\_\_

Exp. Date \_\_\_\_\_

Signature \_\_\_\_\_



**THAT STUDIO RECORDING SERVICES**  
North Hollywood, CA

**Monitor Speakers:** JBL 4315, JBL 4313, Altec 604s, Yamaha NS 10s, Auratones, E V Sentry 100As  
**Echo, Reverb & Delay Systems:** Lexicon digital reverb 200, Lexicon Prime Time DDLs, MICMIX Master Room plate Sound Workshop reverb  
**Other Outboard Equipment:** Eventide 910 Harmonizer, dbx 160, 161, 162 160Xs Audio Design and Recording Scamp Rack w/noise gates, Audio Panner, etc. dbx noise reduction, Biamp EQs, Lexicon PCM 41  
**Microphones:** Neumann AKG Crown PZM, Beyer, Sennheiser PML, Sony, Electro Voice Shure  
**Instruments Available:** Yamaha C7 grand piano, Hammond B 3 w/Leslies, Sonor drum kit, G&L bass guitar, mono and stereo Rhodes, assorted acoustic guitars and amps, Juno 6 synth, LinnDrum a wide range of percussion instruments and other toys when reserved in advance  
**Video Equipment & Services:** Available upon request  
**Rates:** Please call for color studio brochure and rate card

## SOUTHERN CALIFORNIA STUDIOS 24 TRACK

**Extras:** We have just added a new live isolation booth/small chamber for tracking and overdubs. There is a client lounge, coffee and kitchenette area, storage, video games and TV. That Studio also offers a wide range of audio services, including custom record and disk production, sound reinforcement, audio consultation and installation, and demo production assistance. Please call us and see how we can fill your needs in recording

•••• **JOHN THOMAS STUDIO**  
12123 Oxnard St., North Hollywood, CA 91606  
(818) 760-4444  
Owner: John Thomas

•••• **3-D STUDIOS**  
204 Cabrillo St., Costa Mesa, CA 92627  
(714) 548-0479  
Owner: Doug Doyle  
Studio Manager: Doug Doyle

•••• **GEORGE TOBIN**  
(formerly STUDIO SOUND RECORDERS)  
11337 Burbank Blvd., N. Hollywood, CA 91601  
(818) 506-4487  
Owner: George Tobin  
Studio Manager: Brad Schmidt  
Engineers: Staff Alan Hirshberg David Koenig Independ-



**GEORGE TOBIN**  
N. Hollywood, CA

dents: Les Brockman, Howard Lee Wolen, Bill Smith, Sheridan Eldridge, Steve Mitchell, Cisco DeLuna, Hal Neiderman  
**Dimensions of Studio(s):** Studio A: 45 x 25 w/2 isolation booths approx. 10 x 12 each; Studio B: 30 x 15  
**Dimensions of Control Room(s):** 20 x 20 each (both control rooms were built to identical specs)  
**Tape Recorders:** Ampex MM1200 24 track; (3) Ampex ATR 102 1/2" & 1/4" 2 track  
**Mixing Consoles:** Harrison 3624 w/Allison 65K automation; studio A—30 in x 24 out, studio B—28 in x 24 out.  
**Monitor Amplifiers:** H&H M900  
**Monitor Speakers:** UREI 813 Time Align, 'BL 4313, Auratones, Yamaha NS10  
**Echo, Reverb & Delay Systems:** EMT 251, EMT 240, Lexicon 224, AKG BX10 Roland SDE 3000, Lexicon Prime Time Eventide 349 and 910 Harmonizers.  
**Other Outboard Equipment:** Pultec, Lang & Klark Teknik EQs, ADR Vocal Stresser, dbx, UREI & Fairchild limiters, Drummer gates, Kepex, Gain Brain, EXR Exciter, Orban de-esser.  
**Microphones:** Telefunken 251 tube, Neumann U47 tube,

# PRESTIGE EQUIPMENT FROM A WORLD CLASS SOURCE

### CLASSIC AUDIO CONSOLES

SSL 4040E, MINT.	
40/32/40. Recall Ready w/Computer	150k
API Omedio. VG 24/16/24 550 Eq's	17k
API VG 28/16/24 550A 4 ret w/EQ	35k
API VG 32/16/24 550A 4 ret Auto	35k
AMEK 3000. EX. 36/32/36. Automated	55k
Audtronic 501 G. 26/16/26. 5534 IC's	12k
Audtronic 501. VG. 26/16/26. Jensen Tx	15k
Harrison MR-2. EX. 48/32/48. Auto	60k
MCI JH 5288 VG. 28/24/28. LM/JH-50	35k
MCI JH 536C. EX. 36/32/36. LM/JH-50	65k
MCI JH 556D. EX. 56/32/56. LM/JH-50 8 Returns	90k
MCI JH 636 VU. EX. 32/24/32 8 Para. JH-50	30k
MCI JH 636 VU. EX. 28/24/28. Auto. 28 param	32k
Neve 8108. EX. 48/48/48. Necam I	150k

Neve 8038. VG. 36/16/24. Ex Crescent Studio U.K.	75k
Neve 8038. VG. 38/16/24. 1074 EQ. Ex CTS. London	65k
Neve 8068. EX. 32/16/32. 4 Returns. 2 Limiters	70k
Neve 8068. MINT. 32/16/32. Refurbished	85k
Neve 8078. VG. 36/16/24. Necam. 2 1081 EQ. 8 ret	145k
Soundcraft 1624. EX. 24/8/24. 4 Band EQ	15k
Soundcraft 3B. EX. 32/24/24. 8 Returns	22k
Soundworkshop 30. EX. 28/24/24. 8 para	15k
Trident 808. MINT. 32/24/24. 7 Months old	28k
Trident Series 70. NEW	
28/16/24. Auto Ready. Para. 8 Ret	20k
Trident TSM. EX. 40/24/40. Refurb. Ex Vineyard. U.K.	55k

### TAPE TRANSPORTS

3M Digital System. 32T. 4T. Editor	90k
Ampex ATR 102	6.5k
Ampex ATR 104	7.5k
Ampex MM 1200. New Head. 24T All Mods	22k
MCI JH 100/24T. Loc I	12.5k
MCI JH 100/24T. Loc II. New Heads	14k
MCI JH 110 B 2T	4.2k
MCI JH 110B 4T	7k
MCI JH 16/24T. Loc III	17k
MCI JH 114/24T. Loc III	17k
MCI 16T. New Heads	3k
Orari MTR-90 Mark 2. 24T. w/Locator	27k
Studer A80RC. 2-Track	8k
Studer A800 Mk III/24T.	
Locator. 2 remotes. 1 TLS 4000	46k
Tascam 85/16. 16 Channels. DBX	8.5k

### UNIQUE PROCESSING GEAR

ADR Vocal Stresser. #769XR—Limit/Expand/Gat/EQ	1.1k
Dolby M24H	13k
Dolby 361. MINT	850
EMT 140 ST. Tube Stereo	5.5k
EMT 250	18k
Eventide 1745M. with Pitch/Shift	800
Fairchild 670. Tube limiter	2k
Lexicon 224 XL	8.5k
Lang PEQ-1	500
Lang PEQ-4	500
Necam II 40 Channel. Retrofit Neve. Trident. API	40k
Neve EQ 4 Band. 1091	1.2k
Neve EQ 3 Band. 1064. 1073. EC	750
URIE 1176 LN	450

### TUBE MICROPHONES

3-AKG C-24. EX	2.2k
2-AKG C-12. MINT	2k
1-AKG C12A. MINT	1k
2-Neumann U-47let. VG	600
4-Neumann M-49. VG	1.6k
10-Neumann KM-54. VG	200
4-Neumann U-67. VG	1.2k
3-Neumann SM-69 VG. Stereo Tube	1.6k
5-Neumann U-87. G	650
2-Neumann M-250. EX	2k
10-Neumann KM-254. EX	170
5-Sennheiser 421. NEW	170

Ask about our unique Console Rent/Purchase Plan  
Looking for something special? Call us!

## OCEAN AUDIO INTERNATIONAL, INC.

(213) 454-6043    TELEX (316706)    IMC (OCEANAUDIO-US)

Circle #167 on Reader Service Card



U67 tube, U87, KM86, KM84; AKG 452EB, D-12; Sennheiser 406; MD-416, 421, 441; E-V RE-20, RE-15, RE-10, RE-11, 635A; RCA 77; Sony EC-9P, ECM 50.  
**Instruments Available:** Kurzweil 250, Kawai acoustic grand piano, Hammond organ, Rhodes, Wuritzer, Sequential Circuits Prophet, Pro 1, LinnDrum machine, Jupiter 6.  
**Rates:** \$135/hr. Negotiable. Please call for quotes.

◆◆◆ **TOTAL ACCESS RECORDING**  
 612 Meyer Lane #18, Redondo Beach, CA 90278  
 (213) 376-0404  
**Owner:** Allan Davis, Alan H. Juckes  
**Studio Manager:** Allan Davis  
**Engineers:** Allan Davis (chief eng.), Wyn Davis, Mike Lardie, Pabini Gabriel, Pete Butt (chief of maintenance).  
**Dimensions of Studio(s):** Main studio: 25 x 30; live chamber: 15,000 cu. ft.; various smaller specialty rooms.  
**Dimensions of Control Room(s):** Approx. 25 x 20.  
**Tape Recorders:** Ampex ATR-124 2" 24 track; Ampex ATR-102 1/4" 2 1/4 track; Sony PCM701 digital 2 track; MCI JH-110A 1/4" 2 track; Nakamichi ZX-7 cassette; Akai GFX-95 cassette.  
**Mixing Consoles:** Fully modified MCI S28B, 28 in x 28 out; Yamaha 1602, 16 in x 4 out.  
**Monitor Amplifiers:** (2) BGW-500, 250, 100; Hafler-500; Crown Power Line 400; headphone amps: Phase Linear 400.  
**Monitor Speakers:** UREI 813s w/Altec 604s, Canton, JBL 4311s, Spendor (West German radio standard), Horrotones, JBL 4315s.  
**Echo, Reverb & Delay Systems:** Lexicon 224XL w/updated software, AMS 16-80s, Lexicon 95, Lexicon 93, Roland SE-3000, EMT 240 Gold Foil, AKG-BX20, Eventide 910, Quantec room simulator, any device you've ever seen or heard of on request.  
**Other Outboard Equipment:** (8) Drawmer noise gates, (3) UREI 1176s, (2) UREI LA-3As, (2) Sontec parametric tape and disk mastering EQs, (2) dbx 160As, (2) dbx 165As, Pultec tube EQ, Audio and Design Vocal Stresser... lots more!  
**Microphones:** Full complement of condenser mikes including Neumann 86, 87, 84, 88, AKGs, Schoeps, and some old tube types. Complete selection of dynamic mikes: Shure, Electro-Voice, Sennheiser, Beyer, Sony, etc.  
**Instruments Available:** 7 Steinway grand piano, Juno 60, LinnDrum, Yamaha DX7, custom Stratocasters, Gibson, Les Paul, lots of very fine old and rare acoustic guitars of many makes and designs.  
**Video Equipment & Services:** Sony 3/4" playback Beta and VHS record and playback decks, color monitors  
**Rates:** Rates are not carved in stone—flexible, call for specifics.  
**Extras:** Kitchen, lounge, TV, VCR, video games, very comfortable living accommodation located 1.5 miles from the Pacific Ocean, the most competitive rates on rented instruments and outboard equipment.  
**Direction:** Our philosophy is to give our clients the absolute best environment in which to work. We are not a TV production studio or a jingle studio—we make records for people who are interested in the finest audio quality without blowing their budgets out of the water. Our staff will and do support every one of our clients in every possible way. We have pampered some of the world's most demanding clients and have left some of our most private artists on their own to work in the way that suits them. Satisfied clients include: producer Ken Scott, producer Michael Wagener, producer and artist Don Dokken, Tears for Fears, Kaja, Dokken, Great White, Eric Carmen, Level 42, The Rads, Cockrobin, Joe Pizzulo, "X", Black Flag, Husker Du, Meat Puppets, White Sister, many more.

◆◆◆ **TOTAL EXPERIENCE RECORDING STUDIOS**  
 6226 Yucca St., Hollywood, CA 90028  
 (213) 466-9202  
**Owner:** Lonnie Simmons  
**Studio Manager:** R.A. Higgins, Jr.

◆◆◆ **TRAC RECORD CO.**  
 170 N. Maple, Fresno, CA 93702  
 (209) 255-1717  
**Owner:** Stan Anderson  
**Studio Manager:** Stan Anderson

◆◆◆ **TRACK RECORD**  
 5249 Melrose Ave., Los Angeles, CA 90038  
 (213) 467-9432  
**Owner:** Thomas M. Murphy  
**Studio Manager:** Rickman  
**Engineers:** Tom Murphy, John Carter, Bill Metoyer, Dave Jenkins, Rickman, Ken Polalekovich, Edgar Garcia.  
**Dimensions of Studio(s):** 14 x 25 x 13 and 14 x 18 x 14  
**Dimensions of Control Room(s):** 15 x 20 x 12  
**Tape Recorders:** MCI JH24 24 track; Ampex ATR 100 2 track; Otari MTR 12 2 track.  
**Mixing Consoles:** Trident Series 80, 40 in x 24 out.  
**Monitor Amplifiers:** H&H w/White 1/3-octave EQ, SAE.  
**Monitor Speakers:** UREI 813 Time Align, JBL 4301s, Yamaha NS 10M, Auratones.  
**Echo, Reverb & Delay Systems:** Ecoplate I and II, live

—LISTING CONTINUED ON PAGE 212



# PUZZLED

by your **SOUND SYSTEM?**

**SOUND SYSTEM HANDBOOK, Vol. 1**  
*Designed to help the Beginner put the pieces together!*

- types of microphones • miking techniques
- mixers • amplifiers • speakers
- portable sound systems
- plus . . . a glossary of audio terms



A product of **Sound Investment Enterprises** P.O. Box 4139, Thousand Oaks, CA 91359 (818) 991-3400

**YES** — Please rush \_\_\_\_\_ copies of **Sound System Handbook, Vol. 1** to:

Name: \_\_\_\_\_ Phone: \_\_\_\_\_

Address: \_\_\_\_\_ City: \_\_\_\_\_

State: \_\_\_\_\_ Zip: \_\_\_\_\_ Visa/MasterCard Accepted

Cardholder Name: \_\_\_\_\_ Card #: \_\_\_\_\_

Expiration Date: \_\_\_\_\_ I've enclosed \$39.95 + \$3.00 shipping & handling

**MAIL YOUR ORDER TODAY!** (California residents include sales tax)

Circle #168 on Reader Service Card

# HUSH!



There is only one **HUSH**. But there are three models. and all three come from Rocktron. We call them the **HUSH II** Series. If you aren't using a **HUSH II**, you aren't getting peace and **QUIET!**

Ask the pros. They're already using **HUSH IIs** to quiet their guitars, and their guitar effects, and keyboards, and keyboard effects, and amplifier pre-amps, and p.a. systems, and monitors, and studio tracks, and tapes, and records, and single-coil pickups, and to eliminate unwanted feedback, and to quiet mixdowns, recording systems, compressors, digital delays and anywhere else they have a noise problem.

With an effective single-ended noise reduction of greater than 30dB, nothing can compare to a **HUSH II**, or a **HUSH IIB**, or a **HUSH IIC**.

See Your Rocktron Dealer.

All products patent pending.



**ROCKTRON CORP.**  
 2146 Avon Industrial Drive Auburn Heights, Michigan 48057 (313) 853-3055

Circle #169 on Reader Service Card

—FROM PAGE 211

chamber, Harmonizer 910, Lexicon Prime Time, DeltaLab DL1 and DL2 Acousticcomputer, Cooper Time Cube, MXR digital delay, 224X Lexicon w/LARC, Bel BD-80 (8 seconds of sampling).

**Other Outboard Equipment:** (2) UREI 1176LN, Teletronix LA-2A, (4) Trident limiter compressor, (2) Altec 436C, (2) Pultec EQH2, (2) Trident parametric EQ CB9066, UREI 535 graphic EQ, Cinema Eng program EQ, Phase Linear Auto-correlator, (4) Kexpe tube direct boxes and overdrive units, custom stereo Aural Exciter, CompuEditor CPE-800 console automation, dbx 165A limiter, Drawmer gates, Kexpe II & I, Pultec MEQ 5, Trident stereo compressors, Roland Dimension "D".

**Microphones:** U47 tube Telefunken, U47 FET Neumann, (3) U87, (2) KM84, (3) KM64 tube; AKG (2) 452, (3) 451, 414P48, 414EB; RCA 77DX; Sennheiser (3) 441, (2) 421; E-V (2) RE-20; Shure SM7, (6) SM56, PML DC63.

**Instruments Available:** 7" Kawai grand

**Video Equipment & Services:** JVC ¾" video cassette recorder Model CR-665OU, Panasonic and NEC monitors & Audio Kinetics 3.10 Q.Lock synchronizer.

**Rates:** 8 hrs. for \$299, Video Q.Lock rates on request.

●●●● TRIAD RECORDERS

also REMOTE RECORDING

2727 N. Grove Industrial Dr. #111, Fresno, CA 93727

(209) 255-1688

Owner: P.F. Communications

Studio Manager: Leigh Ratliff-Studio Bookings

●●●● TRIANON RECORDING

1435 South St., Long Beach, CA 90805

(213) 422-2095

Owner: John A. Vestman

Studio Manager: Joy Suskie

**The Power and Magnificence of the Moment of Glory**

No Studio Can Capture It

**the truck**  
MOBILE RECORDING FACILITY

You never sounded so good.

**818-507-TRUK**

**THE TRUCK MOBILE RECORDING FACILITY**  
Glendale, CA

●●●● THE TRUCK MOBILE RECORDING FACILITY

only REMOTE RECORDING

P.O. Box 4573, Glendale, CA 91202

(818) 507-TRUK

Studio Manager: Bruce Black

●●●● UMRK MOBILE

Box 5265, North Hollywood, CA 91616

(818) 764-0800

Owner: Frank Zappa

Studio Manager: Manel Sloatman

●●●● THE VILLAGE RECORDER

1616 Butler Ave., W. Los Angeles, CA 90025

(213) 478-8227

Owner: Geordie Hormel, Michael Geller (exec. dir.)

Studio Manager: Kathy Konop

Engineers: Jeff Harris; Assistant engineers: Cliff Jones, Tom Nist, Steve Hirsch, Jay Willis, Doug Williams; Sales: Dick La Palm. Chief of maintenance: David Clark; Video: Jeff Harris, Radames Pera, Digital Rental Agent & Assistant to Mr. Geller: Gail Sacks

**Tape Recorders:** Analog (2) Studer A800 w/Dolby MKIII 24 track; Studer A80 RC ½" 2 track; Ampex ATR 104 4 track; Ampex ATR 102 ¼" & ½" 2 track; Digital (3) Sony PCM 3324 24 track. Sony PCM 1610 w/BVU 800 2 track; Mitsubishi X800 32 track; (2) Mitsubishi X80A 2 track

**Mixing Consoles:** Studio A: Neve 8058 28 in x 24 out; Studio B: Neve/Necam 8108 48 in x 32 out; Studio D: Neve/Necam 8078 40 in x 24 out; Studio F: Fairlight CMI production room w/rhythm machines. Realtime tape duplication, 2 track to metal bias cassette

**SOUTHERN CALIFORNIA**  
**S · T · U · D · I · O · S**  
**24 TRACK**



**THE VILLAGE RECORDER**  
W. Los Angeles, CA

**Monitor Amplifiers:** McIntosh, Crown PSA-2  
**Monitor Speakers:** Village custom design, JBL and TAD components, bi-amped 3-way.

**Echo, Reverb & Delay Systems:** EMT 250s, Lexicon 224s w/4.3 programs, EMT 140s, live chamber, EMT 240, AMS 15 80 RMX 16, Capitol live chamber, Roland SDS 3000, Eventide 1745 M, H910, 949, Lexicon 102S Prime Time.

**Other Outboard Equipment:** UREI, Teletronix, dbx, Orban, Drawmer, Valley People, ADR Scamp, Aphex III, API, Lanq, Pultec, EMT, Neve 10 x 2 mixer.

**Microphones:** Complete Neumann, AKG, Beyer, Shure, RCA, Sennheiser, Electro-Voice, Sony, Telefunken, Schoeps, PZM.

**Instruments Available:** Yamaha & Steinway grands w/MIDI, Fairlight CMI.

**Video Equipment & Services:** ¾" interface all studios, synchronizers, Q.Lock 310, Studer TLS 2000, CMX Compatible Convergence 103B Controller Editing Bay, Sony 5850s, BVU 800, Fairlight CVI, A/B Roll, mixed video effects, ADR/Foley, sweetening, custom sound effects, 10' large screen projection, production.

**Rates:** Upon request

**Direction:** Complete audio, video, film postproduction facility with in-house production staff.

●●●● WARTHOG STUDIOS

also REMOTE RECORDING

2554 Lincoln Blvd. Ste. 296, Marina del Rey, CA 90291

(213) 827-0505

Owner: Samuel Longoria

Studio Manager: Barbara Vetter

●●●● WEDDINGTON STUDIO

11128 Weddington St., North Hollywood, CA 91601

(818) 508-5600

Owner: Robert Colton

Studio Manager: Glen Heard

●●●● WESTERN AUDIO RECORDING STUDIOS

9851 Prospect Ave. Suite B, Santee, CA 92071

(619) 258-1400

Owner: Harlan Lansky, Bob Bishop

Studio Manager: Matthew Silver, Kevin Schmuki

●●●● WESTLAKE AUDIO

8447 Beverly Blvd., Los Angeles, CA 90048

(213) 654-2155

Studio Manager: Judy Spreen

●●●● WESTLAKE STUDIOS

also REMOTE RECORDING

31320 Via Calinas #118, Westlake Village, CA 91362

(818) 991-5452

Owner: Jim Cerrotta

Studio Manager: Felix Girard

Engineers: Bruce Jackson (chief eng.), Robb Klein

Dimensions of Studio(s): 21 x 19 plus iso room (10½ x 12)

Dimensions of Control Room(s): 12 x 15

**Tape Recorders:** Otari MTR-90 MKII 24 track; Otari MTR-12 2 & 4 track; Studer/Revox PR-99 2 track; TEAC 2 & 4 track.

**Mixing Consoles:** Trident 70, 28 in/56 remix.

**Monitor Amplifiers:** Haller 500 & 220

**Monitor Speakers:** JBL 4411, JBL 4401, Yamaha NS-10, Auratones

**Echo, Reverb & Delay Systems:** Lexicon 200 digital reverb, 01 reverb, Ecoplate, Lexicon Prime Time, PCM 41, ART DDL, (2) Eventide Harmonizers.

**Other Outboard Equipment:** dbx 900 rack w/(4) noise gates, (2) de-essers, (2) parametrics; (4) UREI 1176 limiters; dbx 161, 160X, 165A limiters, Ashly parametric, Altec tube compressors, Symetrix limiters, Symetrix phone interface, Aphex & EXR Exciters.

**Microphones:** Neumann, AKG, Sennheiser, Shure, PZM, all the usual.

**Instruments Available:** guitars, Kawai grand piano, drum computers, synths, etc. Complete music production composition.

**Video Equipment & Services:** Complete video production packages studio/location. Ikegami HL79 D & E cameras, ½" & ¾" and 1" recording. Postproduction editing, off-line & on-line, video 24 track sweetening, video duplication, VHS, Beta, ¾", 1".

**Direction:** Complete rate card available upon request for all services



**WESTWIND**  
Westlake Village, CA

●●●● WESTWIND

41 N. Duesenberg Dr., Westlake Village, CA 91362

(805) 497-6911, (818) 991-6762

Owner: Larry Muhoberac, Billy Walker

Studio Manager: Ron Capone

Engineers: Ron Capone

Dimensions of Studio(s): 40 x 40

Dimensions of Control Room(s): 24 x 20

**Tape Recorders:** MCI JH-16 w/VSO 24 track; MCI JH-110 w/VSO 2 track; MCI JH-110 w/VSO 2 track.

**Mixing Consoles:** MCI 24/16 24 track.

**Monitor Amplifiers:** (2) BGW 750 C, BGW 250 D, BGW 150

**Monitor Speakers:** UREI time Aligned #838.

**Echo, Reverb & Delay Systems:** EMT, AKG, Eventide, Marshall.

**Other Outboard Equipment:** An array of outboard equipment.

**Microphones:** AKG, Neumann, Shure, Sennheiser, Electro-Voice.

**Instruments Available:** Yamaha grand piano, Yamaha CS-80, Fender Rhodes, Minimoog synthesizer/Ludwig drums.

**Rates:** Call for rate quote.

**Extras:** 35 min. from Hollywood, Westwind offers a "safe" and relaxing atmosphere. Offering lounge, kitchen, privacy, video games and 5000 sq. ft. of the latest in acoustic & interior design. Hotel accommodations nearby.

**Direction:** With the studio we have an in-house production company that writes, performs, records and produces radio and TV commercials. Some of our commercial accounts are 7-11, ABC, CBS, Olympia Beer, & Bob's Big Boy.

●●●● WESTWORLD RECORDERS

7118 Van Nuys Blvd., Van Nuys, CA 91405

(818) 782-8449

Owner: Robert Schreiner

Studio Manager: Jerry Pearson



●●●● **WHITE FIELD STUDIO**  
 2902 W. Garry, Santa Ana, CA 92704  
 (714) 546-9210  
 Owner: White Field Studios, Inc.  
 Studio Manager: Thom Roy  
 Engineers: Chris Taylor, Dan Willard, Derald Daugherty, Thom Roy  
 Dimensions of Studio(s): A: 25 x 25; B: 20 x 25 w/2 iso booths. Video: 40 x 40 (lighting grid at 18')  
 Dimensions of Control Room(s): 20 x 25  
 Tape Recorders: Stephens 821 A24 24 track; Ampex ATR 102 1/2" 2 track; Ampex ATR 102 1/4" 2 track; Ampex AG440-C 2 track.  
 Mixing Consoles: Ford Audio/BA Roth custom w/Allison automation, 32 in x 24 out.  
 Monitor Amplifiers: AB Systems, Spectra Sonics, Crown 300A, Crown D150, Uni-Sync 100.  
 Monitor Speakers: Altec 604E/Utah w/Mastering Lab crossover, JBL, Auratone.  
 Echo, Reverb & Delay Systems: EMT 240, Ecoplate II, Lexicon 224, Prime Time, Loft 450, Eventide 949 Harmonizer, DL2.  
 Other Outboard Equipment: UREI LA-2A, LA-3A, Universal 175, 1176, Orban de-esser, Stephens de-esser, EXR, Roger Mayer noise gates, Kepex II, Biamp graphics, dbx 902, 903, 907.  
 Microphones: Neumann U47 tube, U67, M49, M269, KM54, KM56, KM84; Sony C37A, C57, C500; Telefunken 250, 251E; AKG C12A, C24, C60, 414, 452, 224; Beyer 160; RCA 77DX, E-V RE-20; Sennheiser 421, 441.  
 Instruments Available: Steinway 9' concert, B-3 w/Leslies, Rhodes, Wurliizer 140, guitar amps, drums.  
 Video Equipment & Services: Crosspoint switchers, Sony M3s, Convergence 203, Apert Herzog H2 TBC, Fortel Y688 enhancer, 3/4" production and post services, A/B Roll edit, Chyron UP2, SMPTE, prop shop, 24 channel 2 scene lights, hard cove cyclorama.  
 Rates: Upon request.

●●●● **WIDE TRACKS**  
 6429 Selma Ave., Hollywood, CA 90028  
 (213) 460-6949  
 Owner: Wide Tracks, Inc.  
 Studio Manager: Dennis Parker

●●●● **EVAN WILLIAMS RECORDING**  
 also **REMOTE RECORDING**  
 1519 S. Grand Ave., Santa Ana, CA 92706  
 (714) 543-6155  
 Owner: Evan Williams  
 Studio Manager: Evan Williams

●●●● **WINETREE RECORDING STUDIO**  
 224 N. Indian Hill Blvd., Claremont, CA 91711  
 (714) 625-3288  
 Owner: R.S.D. Productions  
 Studio Manager: Bob Dire

●●●● **YAMAHA RESEARCH & DEVELOPMENT STUDIO**  
 1019 S. Central Ave., Glendale, CA 91204  
 (818) 500-0230  
 Owner: Yamaha International Corporation  
 Studio Manager: Norm Dlugatch  
 Engineers: Keith Seppanen  
 Dimensions of Studio(s): Studio A: main room 30 x 26, iso booth 14 x 15, vocal booth 12 x 10; Studio B: 26 x 22.  
 Dimensions of Control Room(s): Studio A: 18 x 21; Studio B: 18 x 22  
 Tape Recorders: Ampex ATR 124 24 track; Ampex ATR 104 4 track; Ampex ATR 102 2 track.  
 Mixing Consoles: Solid State Logic SL4000E 48 in x 32 out.  
 Monitor Amplifiers: Yamaha P2200, Yamaha PC 5002M  
 Monitor Speakers: Augspurger, NS-10, 4311, NS-1000, Auratones, UREI 813.  
 Echo, Reverb & Delay Systems: Yamaha REV-1, Yamaha YDD-2600, Yamaha R1000, Ecoplate, EMT 251, AMS stereo, Lexicon 93, Yamaha D-1500.  
 Other Outboard Equipment: Kepex II, Gain Brain II, Eventide H949, UREI 1176, dbx 160X, Yamaha E1010, AMS DMX 15-80s, dbx 902 de-esser  
 Microphones: Neumann U87, U47, U67, KM84, KM88, AKG 452, 414, C24; Sony ECM50, Shure SM56, SM57, SM58; E-V RE-16, RE-20; Sennheiser MD421, Crown PZM, RCA 77, Beyer M160, M101.  
 Instruments Available: Yamaha S400B, CF II grand pianos, TX816, TX7, QX1, QX7, KX88, CX5M computer, Apple IIe w/DX-Pro and DX Heaven (over 4,000 sounds), DX7, DX9, DX1, FX20.  
 Video Equipment & Services: Audio Kinetics synchronizer for 3 machines, ATR 124 and ATR 104 can be utilized.  
 Rates: Please call.

●●●● **YOUR RECORDING STUDIO**  
 18044 Raymer St., Northridge CA 91325  
 (818) 701-7802  
 Owner: David Lee  
 Studio Manager: Alan Hart

## Attention: Northwest Studios!

The January, 1986 issue of **Mix** will include our annual listings of studios in your region. Featured will be the studios of Northern California, Northern Nevada, Oregon, Washington, Idaho, Montana, Wyoming, Utah, Alaska and Hawaii.

Don't miss this **once-a-year** opportunity to inform the industry about the equipment and services your studio has to offer. If you have not received a questionnaire, call Lauri Newman at (415) 843-7901 today!

**Deadline for Returning  
Questionnaires: October 1st**

**Don't miss it!**

**October, 1985**

# AES/New Products Issue

If you're a recording or sound professional, you can't afford to miss the October issue of **Mix!** The AES/New Products Issue, to be distributed at the 79th AES Convention in New York City (October 13-17), will include our annual **New Products Directory**, with nearly 100 pages of new equipment and supplies for the audio, video and music production fields.

Also featured in the October AES issue:

- **Testing and Measurement; Devices and Methods:** **Mix** editors and writers examine one of audio's most critical topics.
- **Interpreting Specs:** A guide to figuring out what specifications actually mean.
- **Abbey Road Studios:** Richard Elen takes a look at current activities at one of the world's most famous studios.
- **Special Advertising Supplement:** Northeast Studios AES Spotlight.
- **TEC Awards Preview:** A look at the nominees and a preview of the first TEC Awards celebration.

This is an issue you'll save and refer to for months to come. Pick it up wherever **Mix** is sold. If you're not already a subscriber, use the coupon in this issue to subscribe to **Mix** today.

**If you're in the studio... you're in the Mix!**

# CLASSIFIEDS

## Acoustic Consulting

### ACOUSTIC SPACES DESIGNER/BUILDER

All aspects of recording studio and video facility design and construction. residential and commercial soundproofing and renovations. PO Box 884 Woodstock, NY 12498 914-331-1726

\*Currently completing the 40-track automated Dreamland recording facility, just outside of Woodstock, NY.

## Employment Offered

### ELECTRONIC TECHNICIAN

Cassette tape manufacturing plant is in need of an experienced, electronic technician to troubleshoot & maintain high speed duplicating equipment. Must have good background in electronics & understanding of electronic theory. Send resume to: ELECTROSOUND L.A., 9545 San Fernando Rd., Sun Valley, CA 91352.

Opportunities at Studer Revox: DIRECTOR OF PROFESSIONAL PRODUCTS MARKETING — Top level position requiring proven track record in marketing of audio/video systems. Scope of position determined in large part by talents of successful candidate. Direct responsibility for sales & support of products sold through pro dealers and to government agencies. Effective communication with staff, dealers, and end users extremely important. A key position in determining future of company with correspondingly high potential for compensation. ADMINISTRATIVE AND MARKETING ASSISTANT — Entry level position involves planning of product introductions, field coordination of sales & marketing projects, convention planning, and dealer relations. Previous technical, sales, or marketing experience preferred; audio experience preferred. Good communication and organizational skills a must. Some travel required. Apply to: Thomas E. Mintner, VP and General Manager, Studer Revox America, 1425 Elm Hill Pike, Nashville, TN 37210.

## Equipment For Sale

Otari 1" 8 trk MX-7800 mint (under 250 hours) remote avail. First \$3,900

takes it. Call (weekdays) Jay (408) 296-6034 (Calif.).

FOR SALE: MCI 528B highly modified. (415) 459-2888.

Scully 280 2 trk, Russ Lang cabinet 7 1/2/15, good condition; Scully 280 2 trk, Scully cabinet, 15/30, good condition; Scully 280 4 trk w/3 trk head assembly/sync, good condition; 3M M64 2 trk, 7 1/2/15, good condition; 3M M64 2 trk mastering machine 7 1/2/15, good condition; 3M M79 4 trk, w/2 trk head assembly, mint condition; MCI 24 trk JH114 w/AL II excellent condition; Eventide H910 Harmonizer, excellent condition; JH45 Autolock w/2 MCI interface boxes, mint condition; U67 Neumann tube mike, excellent condition; M249 Neumann tube mike, mint condition w/power supply. Ardent Recording Inc. (901) 725-0855. Contact Pat Scholes or John Hampton.

### TRIDENT TSM

40 in, 24 out, 32 monitor, fitted 32-24-24. Parametric 4 band EQ, 6 sends, 4 returns, customized patch bay. Extensive modification, matching outboard rack \$55,000. (416) 291-9553.

LOW OVERHEAD MEANS LOWEST PRICES. We carry most major lines of pro audio & recording equipment. **Get your best price, then call me.** 3M Tape and accessories at factory prices.

### S.C.M.S.

East U.S. Toll Free: (800) 438-6040  
West & N.C.: (704) 889-4509

Sam Ash Music Store Mail Order Service. Deal with the professionals. N.Y.C.'s largest inventory and best prices on musical instruments, sound and recording gear. 1-800-645-3518. N.Y. State 1-800-632-2322.

### SYNTHESIZER BLOWOUT!

Tired of impersonal service? You think you're getting your best deal? Try Starsound Audio for free! 1-800-354-7252. Fluid synthesis spoken here. Studio mixer, \$1,500; Tascam Model 10 \$500. Most major lines in stock. Call for free studio gear hot sheet. Crown, T.E.F. analysis available IN YOUR STUDIO or here. David, Tom, Scott or Bob.

### VINTAGE MIKES

Call Bill Bradley (312) 751-1216

DANBURY ELECTRONIC MUSIC CENTER, 84 Federal Road, Dan-

bury, CT, 06810, (203) 792-2794. New England's oldest and most experienced Tascam dealer. All professional recording equip. and supplies from stock plus widest selection of electronic keyboards including Yamaha DX-PF.

USED/DEMO EQUIPMENT SALE Tascam 8516B w/locator, 80-8 x/DX8, Ecoplate II, Otari MKIII 2 tr w/locator, Otari OCF duplicator, Neumann U64s, Nagra IV-S. Also SOUNDSCRAFT, LEXICON, OTARI, NEOTEK, TRIDENT, UREI, ORBAN, EVENTIDE.

E.A.R. PROFESSIONAL AUDIO (602) 267-0600

## Reliable Music

### The Finest in Professional Audio With Service to Back It Up!

Crown, JBL, Tascam/TEAC, Yamaha, Biamp, Technics, Orban, Gauss, Eventide, dbx, UREI, Neumann, AKG, Sennheiser, Beyer, Sony, Shure, Otari, MICMIX, MXR, RTS, Revox, Cetec-Vega, E-V, Omnicraft, Symetrix, Sescorm, Ursa Major, Whirlwind, Audio-technica, Ramsa, Lexicon.



(704) 375-8662  
1001 S. Independence Blvd.  
Charlotte, N.C. 28202

Looking for Eventide SP-2016 or H949? Space Station Banner RTA, ADR Scanner. Need AKG, BGW, dbx, E/V, Neumann, Orban, Sennheiser, Shure, Technics, UREI or White products? Call UAR for the best quote: (512) 690-8888, 8535 Fairhaven, San Antonio, TX 78229.

### NEW API PRODUCTS

Modules—Equalizers—Parts Factory Warranty! Immediate delivery at CLOSEOUT PRICES! For further information call:

RAATA AUDIO SYSTEMS, INC.  
1446 N. Cherokee Ave.,  
Hollywood, California 90028  
(213) 469-9593 Telex 910-321-4465

### IF YOU'RE NOT USING IT —SELL IT!

Your national clearinghouse for used audio and video! Call for free copy of our latest listings, or to list your used gear free.

The Bertech Organization  
(818) 352-3181  
THINK BERTECH FIRST!

NEOTEK SERIES III: 28x24 with 16 busses, 6 echo returns custom "pre-return" submaster fader, extra patch bay, producer's desk, leg set, patch

cords, spare parts, exc. cond. White 32-band EQ's \$550 ea. 312-864-4460.

Tascam 90-16 16-track recorder w/full remote, dbx & auto loc. Excellent condition. Will include alignment tapes, \$7,800. Call Kurt at (215) 642-2346.

### SIGMA SOUND STUDIOS GREAT EQUIPMENT BUYS:

24, 2-trk recorders, console automation, synchronizers, hi speed dupe equip plus lots of audio processing gear.

Call or Write:

212 N. 12th St., Phila., PA 19107  
(215) 561-3660

**Excess Stock** — Audio manufacturer liquidating unused wire, connectors, transformers, components, heatshrink tubing, hardware, multi-cable, roadcases and many Kelsey mixing consoles at wholesale prices. Call Craig for a complete listing (201) 423-1300.

**New Used & Demo Soundcraft**, Neotek, Otari, Akai, Klark-Teknik, dbx, EV, Crest & Ursa Major. Best prices on the best gear. MCI JH-16 24 track w/AL3 \$18,500. Audionics 501 18x 16-26 channel mainframe \$4,800. Like new Otari MX 7800 w/remote \$5,900. EMT 140S Tube \$4,000. UREI 6500 new \$1,499. ADR Scamp system. Call **Pyramid Audio Inc** (312) 339-8014.

### Call Us Last!

**STEREO CASS. DUPLICATOR** TELEX 300. Makes 9 copies. Cassette & 1/4 Trk R-R masters, rewind mod. 3 blue telex cab. adj. bias & record EQ. New heads. 10K when new! Asking \$4,500. (703) 521-1871. Arlington, VA.

GERALD LEWIS RECORDING

### NEUMANN LATHE

Scully Preview Tape M., Ampex 2-tr. AG440, Neve Patch Bays, Steinway Model B Grand Piano. Call Glenn (615) 227-5027.

Equipment Sale in Stock: Crown DT-1000, Akai MG-1212, Orban 414A, dbx 160x, Neumann U-87Z, Tannoy, EV Sentry 100A, Sanken, Sennheiser ME-88/K3U, Sony digital audio tape. We make your Dolby "M" into a "MH," \$100 per channel. Super sale on 24-trk MCI. John or Linda (615) 366-1890 Studio Supply, Nashville, TN.

Roland Rack Mount Digital Delays SDE1000-\$349; SDE2000-\$595; Boss DE200-\$239; TR707-Digital drums \$429; Juno 106 synth-\$785; Boss SCC700 effects controller (no case) \$299; Korg Digital drums or perc.-\$229. Great prices on all our



product lines including Shure, Rocktron, Gibson, Pearl, Washburn, G & L, etc. U-CREST MUSIC CENTER (716) 684-5143.

KURZWEIL, AKAI & AUDIO-TECHNICA. Best prices on the new Kurzweil 250 & Akai MG1212. Complete studio packages available. New & used, buy and sell. SOUND ADVICE (205) 252-2632.

Automated Processes Console 16x4 x2 w/24 mainframe, custom built w/550 EQs, 515B input modules, 2-525 limiters, 575 oscillator, 475 faders, in place solo, 23 meters. \$10,500, (2) Neumann 267, (3) E-V RE20, (2) UREI 527, (2) UREI 813 monitors, Harmonizer, EXR Exciter, (2) API 525 limiters, (2) Kepex, (2) Gain Brains, (2) JBL 4320 monitors, 73 key Fender Rhodes. (205) 595-8497.

Sound Workshop Series 30; ARMS automation with Super-Group. Full 336 pt. TT patch bay. 28 Main Frame, 251/Os. IMMACULATE CONDITION! Must sell. \$14K. Contact: Michael Creamer at (305) 298-3917.

16-Track Tascam 85-16 w/dbx \$7,000 Speck 800-C 16x8 console w/patch bay, 3 band sweep EQ 16 channel monitor, DeltaLab DL-2 stereo digital delay and reverb \$750, MXR rack-2 compressors, (1) phaser, (1) flanger \$350, MICMIX XL-305 stereo reverb \$700 Shure SM81s \$400 pr. (305) 772-0864 Mike.

Specializing in used MCI equip. JH10, JH400 from modules & cards to 2 trks thru 24 trks. Parts & service available. Many used 24 trks from \$16K up. Randy Blevins (615) 361-8429 or (615) 361-6768. List available.

MCI JH542B console with 28 I/O modules, Automated Plasma Meters SACRIFICE \$25,000 or B/O, call Bobby (212) 921-1711.

GOING 24! Itam 1610 16 trk 1" 7 1/2-15-30 ips complete with remote and 15 + 30 ips test tapes 7.5K. AKG BX-10 reverb 1.1K. Full size plate reverb with extra driver (brand new) 6K. All equipment excellent condition, some prices negot. Ask for Ray (301) 982-9288.

MCI 400 series 24 in/24 out recording console and MCI JH-100 24-track recorder. Good working condition. \$22,000 for package. (615) 577-5597.

SOUNDCRAFT SER. 1600 mixing console, 1 1/2 years old, 24-inputs, 8 busses, 24-outputs, producer-patch-bay, stand, etc. Lists for \$21,000.00 plus, now only \$12,950.00. OTARI 5050-III-8, 8-channel recorder, never used, 2 months old, \$3,995.00. Call (312) 872-1665.



## MICROPHONE

Neumann, AKG, etc. Tube and FET vintage, used, new. Best prices. (213) 473-9004

## 2" HEAD ASSEMBLY

(only) for an OTARI MTR 90 16 TRACK Just re-lapped. Excellent Condition. \$2,500 or Best Offer. Contact Sister Salvatore, Daughters of St. Paul, Boston, MA 02130 (617) 522-8911.

BTX SHADOW SYNCHRONIZER w/wide band reader card plus remote keyboard \$3,200. Call Greg at BRITANNIA STUDIOS, (213) 851-1244.

Scully 280B 15-30 ips vs \$1,500, dbx 208 8 channel new in box \$2,100, dbx 180 \$380, dbx 157 8 channel \$900, dbx 155 \$370, Nakamichi 600 \$300, AKG N66-PS \$180, dbx 411 new \$160, DeltaLab DL2 \$850, EV RE15 \$80, AKG 202 \$100, Shure Audiomaster \$100. Trade considered, Don (215) 776-1455.

Tangent 3216 owners: I/O modules, \$400 each, meters \$80 each, plus mainframe expanders, 16 + 24 empty frames, mother boards, armrests, power supply, lots more. Large quantity discounts. Call for complete list. The Process (919) 855-1941.

Lexicon 224 XL w/new software, new demo \$8,200. MCI/Sony JH-110 4 trk, excellent \$3,500, MCI Sony JH-24 16 trk w/auto loc. Ill only 40 hours was \$21,000 now \$12,000, Ampex MM-1100, 16 trk, very good condition \$9,500, Soundworkshop Logex 20x8 console like new, was \$12,000 now \$5,500. Equipment Exchange (206) 623-7860.

## API

WOLFF ASSOCIATES has just purchased the entire API product line as of June 24, 1985. We are now the source for all API products. API Audio Products, Inc., 7953 Twist Lane, Springfield, VA 22153 (703) 455-8188.

SPHERE ECLIPSE B Console — 20 channel, 8 with graphic EQ in good shape at a good price. 360 SYSTEM DIGITAL SAMPLE KEYBOARD — excellent condition and priced to sell. ALLEN & HEATH System 8 console 16X8. Call Jim R. at (614) 663-2544.

Otari MTR-90 MKI 24 trk \$19,500, Trident Series 80B, 3 months old \$36,950, also AMS for sale (813) 238-3900.

Tascam model 15 24x24x8 console \$5,500 mint. Scully 8 track machine 1-inch \$4,700, with 4 extra 280 modules. Also Tascam 85-16 \$7,000. (501) 972-0321.

MIKES FOR SALE: AKG (1) C12, (2) C12A, (2) C412, (1) C60, (1) D12, (3) U87, (1) U67, (2) KM84, (1) 77DX, (1) 666, (1) Altec Lipstick, (1) 1176 LN, (1) Pultec HLF-3C EFX, FLT, (1) NK-48A Neumann supply complete — Excellent. Best Offer. B. Karr, 3319 45th, Highland, IN 46322.

Neve 80 Series (special custom), 28 channels 8 group, 24 T monitoring, prof. maintained in excellent condition, great track record \$47,000 or

b/o, call Alex, London, ENGLAND 01-521-2040.

Dolby model 330 prof. 2 channel tape dup. unit for Dolby B encoding — record & playback \$1,200. AKG BX 10-III stereo reverb \$800. 2 AKG The Tube mikes & power supplies \$1,300 each. (703) 521-1871. Gerald Lewis Recording, Arlington, VA.

Otari-DP1010 Duplicating System includes 1-DP1310 Master; 3-DP1510 Slaves; Bin Loop (BL-1310 Q 1/2"); Cassette Loader (2700). 4 years old. Excellent Cond. \$18,000. Contact Sister Salvatore, Daughters of St. Paul, Boston, MA 02130 (617) 522-8911.

## CHEROKEE RECORDING STUDIOS, OFFERS FOR SALE WORLD FAMOUS TRIDENT "A" RANGE RECORDING CONSOLE

36 Mic./Line Inputs, 24 Monitor Positions w/EQ and Full Aux Sends. Assignable to Stereo Buss to give a total of 60 Remix Positions. Highly modified to greatly increase reliability. Custom cabinetry including Aux Gear Rack: Asking price \$85,000. Also 3 Ampex ATR 102's, (2) 1/2" \$5,500 each, (1) 1/4 1/2" \$7,500. Package price negotiable. Please phone (213) 653-3412

Synclavier II Digital Synthesizer 16-voices, expanded memory, two effects pedals, disk drive, software and cases \$16,000. Call (212) 879-6255.

## Equipment Rental

NEW YORK NASHVILLE



"The Audio Rental People"  
DIGITAL RECORDERS • EFFECTS SYNTHESIZERS • WIRELESS MICS  
AUDIO FOR VIDEO • TIME CODE  
1619 Broadway NY (212) 582-7360

## Instruction

BE A RECORDING ENGINEER!  
New classes quarterly.  
INSTITUTE OF AUDIO/VIDEO ENGINEERING  
1831 Hyperion, Dept. E  
HOLLYWOOD, CA 90027  
(213) 666-3003

## LEARN FROM THE PROFESSIONALS

### ELECTRIC BASS

By Carol Kaye:  
How to Play the Elec. Bass ..... \$4.95  
Elec. Bass Lines #1 ..... 3.95  
Elec. Bass Lines #2 ..... 3.95  
Personally Yours ..... 4.95  
Elec. Bass Cassette Course ..... 35.00  
Elec. Bass Lines #3 ..... 3.95  
Elec. Bass Lines #4 ..... 4.95  
Elec. Bass Lines #5 ..... 3.95  
Elec. Bass Lines #6 ..... 3.95

How to Play Elec.

Bass Chords ..... 4.95  
and:

Easy Elec. Bass  
(Carroll/Kaye) ..... 4.95

### And Much More!

Please write for a free catalog.

Foreign postage: \$2.00 1st book, \$1.00 ea. additional. \$1.50 for cassette. \$8.50 C.K. Bass Cassette Course - \$13.50 to Australia, N.Z. & Asia.

Sorry, no CODs. Colorado add 6% tax. Good store discounts.

**GWYN PUBLISHING CO.**  
177 Webster St., #272  
Monterey, CA 93940

GOOD MUSIC MAKES  
A HAPPY WORLD

## Digital Sampling Demo

Lucid demonstration of changes in sampling parameters. Recording and accompanying report explain the effects of changing sampling rate and bit resolution.

Send: \$15.00 for Sampling Demo Cassette and Report.

To: Sounds Digital  
PO Box 4660  
Stamford, CT 06907

## Instruments For Sale

Bill's Music has thousands of hard to find new & used musical instruments and accessories in stock. We ship anywhere! Call or write! Bill's Music Warehouse, PO Box 3157, Baltimore, MD 21228 (301)788-8900.

## Maintenance Services & Repair

**New York Technical Support, Ltd.**  
IS SERVICE



"We are factory trained by Studer, Otari, MCI, Ampex, 3M, Neve, Trident, and Scully. Our work is guaranteed."

CALL  
**GREG HANKS**  
914-776-2112

1440 Midland Ave., Suite 10  
Bronxville, NY 10708

### AMPEX

Parts — Tape — Recorders  
Northwestern Ind.  
1-800-547-2252

## Records & Tapes

### REAL-TIME

Best Quality Cassettes using Nakamichi decks only. Custom loaded Agfa or BASF Chrome. Label and in-

sert printing, shrinkwrap, blank tapes.  
**SUPERB QUALITY**  
**AT LOW PRICES**  
 Uni-Sette, Inc. 5125 Marconi Ave.,  
 Carmichael, CA 95608. (916) 485-  
 9534.

**FACTORY DIRECT  
 PRICES ON 3M TAPE**  
**We can save you money.**  
 Over 60 lines of professional  
 recording equipment.  
**STUDIOWORKS**  
 (800) 438-5921

**CASSETTE PRODUCTIONS, INC.**  
 35 years state-of-the-art tape dupli-  
 cating. Real-time or high-speed.  
 Full service, fast delivery, any quanti-  
 ty. Call JULIUS KONINS, (201) 666-  
 3300, 109 Prospect Pl. Dept. M, Hills-  
 dale, NJ 07642.

**ROCK BOTTOM PRICES**  
 AGFA, AMPEX, 3M-SCOTCH  
 AUDIO & VIDEO TAPE, 1/4"-2".  
 Custom Agfa cassettes. Reels,  
 boxes, leaders, splicing tapes,  
 metal reels & specialty items.  
 Catalog upon request.  
**BURLINGTON AUDIO TAPES**  
 106 Mott St., Oceanside  
 NY 11572 1-800-331-3191  
 in N.Y. (516) 678-4414

**DISC MASTERING** — Cut from  
 your tapes at low cost — Plating,  
 Pressing, Labels & Jackets —  
 LPs, EPs & 45s. Write for free  
 information:  
**THE CUTTING EDGE**  
 Box 217 M  
 Ferndale, NY 12734  
 (914) 292-5965

**PROFESSIONAL RECORDING  
 SUPPLIES**  
 We are a major distributor of Am-  
 pex, Agfa & 3M bulk & reel mas-  
 ter tape from 1/4" to 2". We also  
 stock empty reels, boxes, video  
 cassettes, Norelco boxes & other  
 recording supplies. We manufac-  
 ture custom length bulk cas-  
 settes using top quality tapes.  
 Cassette duplication service  
 available. Please call or write for  
 our FREE catalog.  
**Advance Recording Products**  
 7190 Clairmont Mesa Blvd.,  
 San Diego, CA 92111  
 In Calif.: (800) 858-1061  
 CA Phone No: (619) 277-2540  
 Outside Calif.: (800) 854-1061

**REAL-TIME CASSETTE DUPLI-  
 CATION** Superb quality from  
 your Analog or Digital masters.  
**VIDEO CASSETTE DUPLICA-  
 TION** Stereo VHS HiFi, or U-  
 Matic. Competitive rates. (303)  
 751-2268 Mirror Image.

**AMPEX AUDIO TAPE**  
 Competitive prices on all widths and  
 sizes. Shipped from large stock. Call  
 (718) 886-6500 or (212) 675-4971.

5 screw bl cassette C-46 (40¢) C-76  
 (50¢) — C1 soft poly cassette boxes  
 (4¢) — Gray cassette albums with  
 clear outside pocket great for lit. or

## How to Place a Mix Classified

Please print or type in **CAPITAL LETTERS and lower case**. There are 8 lines to the inch and approximately 24 **CAPITAL** letters per line or 32 lower case letters. \$60 per inch — 1" minimum. Additional lines \$10 per line. **Bold type** \$10 per line. Black border or gray screen \$10 extra. Logos or display advertising up to 4" will be charged at \$75/inch. Multiple insertion rates available — Call for information. **Payment by check, money order or charge must accompany ad. DEADLINE is the 10th of the month, 1½ months prior to publication.**

### Categories Available (Check one.)

- |   |   |   |
|---|---|---|
| <input type="checkbox"/> Business Opportunities | <input type="checkbox"/> Equipment Wanted       | <input type="checkbox"/> Rehearsal Space          |
| <input type="checkbox"/> Employment Offered     | <input type="checkbox"/> Instruction            | <input type="checkbox"/> Session Player Available |
| <input type="checkbox"/> Employment Wanted      | <input type="checkbox"/> Maintenance Services   | <input type="checkbox"/> Studio for Sale          |
| <input type="checkbox"/> Equipment for Sale     | <input type="checkbox"/> Record & Tape Supplies | <input type="checkbox"/> Miscellaneous            |
| <input type="checkbox"/> Equipment Rentals      | <input type="checkbox"/> Recording Services     |   |

Name \_\_\_\_\_

Address \_\_\_\_\_

Phone \_\_\_\_\_

I am paying by (Check one.):  VISA  MASTERCARD

Card #: \_\_\_\_\_ Expiration Date \_\_\_\_\_

Signature: \_\_\_\_\_

Check or Money Order #: \_\_\_\_\_ Amount Enclosed: \$ \_\_\_\_\_

### Mail to:

Mix Classified, 2608 Ninth Street, Berkeley, CA 94710  
 (415) 843-7901

labels (40¢). Call (412) 937-0600.

Eastern Standard Productions



**ABSOLUTELY the BEST  
 QUALITY and SERVICE at  
 ABSOLUTELY the BEST PRICES  
 FREE BOXES with any order**

Real Time Cassette Duplication  
 Printing and Packaging  
 26 Baxter Street  
 Buffalo, NY 14207 (716) 876-1454

## Diskmakers



**RECORD PRESSING  
 CASSETTE DUPLICATION**  
 SEND FOR OUR PRICE LIST  
**CALL TOLL FREE**  
**1-800-468-9353**  
 925 N. 3rd St., Phila., PA 19123

## Studios For Sale

### BUSINESS OPPORTUNITY

Sacramento, CA, established clientele, excellent reputation, premium location and facility, 2400 sq. ft., comfortable environment, w/office space and room for growth, reasonable lease, well equipped 16 track facility, \$60,000. (916) 424-8772.

Outstanding opportunity in central Manhattan. Top 16 track studio, fully equipped. Also includes grand piano, synthesizers, percussion, amplifiers, etc. Established business. \$60,000 or B.O. Write or call Noise New York, 257 W. 34th St., NY, NY 10001, (212) 947-0048.

### RECORDING STUDIO FOR SALE OR LEASE

2200 sq. ft. recording facility in New York City. Office, tape library, two control rooms, two studios, fully air conditioned. Excellent village location. Perfect for personal or small recording/production/publishing company. (212) 260-5226.

**CHICAGO RECORDING STUDIO**  
 Completely equipped 24x8 profes-  
 sional recording and mastering stu-  
 dio. Prewired for 24x24. Includes 2

bdrm apt, 2 offices, basement & 1½  
 baths. Extensive list of state-of-the-  
 art equip. Sheldon F. Good & Co., 11  
 N. Wacker, Chicago, IL 60606 (312)  
 346-1500.

**RECORDING STUDIO FOR SALE**  
 Turn-key 16-track operation located  
 Sunset Blvd., Hollywood, CA. Estab-  
 lished clients, 9 year reputation. Ex-  
 cellent opportunity for independent  
 producer, writer/artist, or engineer.  
 Good sounding room, pro equip. in-  
 stalled and working (213) 463-2375.

### RECORDING STUDIO

15 ips 4 track porta studio. Anvil  
 cases. 2 polyphonic synthesizers.  
 Computer Roland rhythm composer.  
 Digital delays. Pitch shift. Doublers.  
 Echos, Studiomaster 16 mixer \$40,000  
 value. \$14,000 asking price or b/o.  
 (915) 381-2814.

## Miscellaneous

### Studio Forms

Get box labels, track sheets, invoices,  
 etc., printed with your studio's name &  
 address! **FREE** Catalog of specialized  
 forms for the recording industry.  
**StudioForms, Inc.**  
 186 Glen Cove Ave, Suite 201/M1  
 Glen Cove, NY 11542 \*516-671-1047



# ADVERTISERS INDEX

## PAGE ADVERTISER

113 A-1 Audio  
 149 Adams-Smith  
 180 Advance Recording Products  
 87 Advanced Music Systems (AMS)  
 53 Agfa Audio  
 111, 122 Akai/IMC  
 73 Alesis  
 205 Dan Alexander Audio  
 76 Allen & Heath Brenell  
 104 Alpha Audio  
 57 Amek Consoles  
 162 Amigo Studios  
 157 AMP Services  
 219 Ampex  
 103 Aphex Systems  
 74 Applied Research & Technology (ART)  
 101 Audio Affects  
 34 Audio & Design Recording  
 43 Audio Intervisual Design  
 38, 39 Audio Kinetics  
 190 Auteri Associates  
 156 Kenneth A. Bacon Associates  
 23 Bananas At Large  
 130 Berwin Entertainment Complex  
 92, 93 Beyer Dynamic  
 116 Bobadilla Cases  
 155 Bryce Audio  
 207 Brystonvermont  
 85 Caig Laboratories  
 168 Capitol Studios  
 119 Carvin  
 159 Cherokee Studios  
 135 Chicago Music Expo  
 65 Compusonics  
 123 J.L. Cooper Electronics  
 126 Countryman Associates  
 184 Creative Sound  
 19 Crown International  
 55 dbx, Inc.  
 133 DeCuir Sample Case Company  
 61 Digital Services  
 88 Digital Sound Recording  
 75 DOD Electronics  
 7 Dolby Laboratories  
 186 Dream Maker Recording  
 118 E.A.R. Pro Audio  
 183 Eastern Acoustic Works (EAW)  
 83 Editing Services  
 145 El Mar Plastics  
 68, 69 E-mu Systems  
 86 Encore Studios  
 48 Eventide Clockworks  
 82 Everything Audio  
 188 Filament Pro Audio  
 157 Fitz Co. Sound

## PAGE ADVERTISER

109 Flanner's Pro Audio  
 117 Fostex Corporation of America  
 111 Full Compass Systems  
 126 Furman Sound  
 96 Future Disc Systems  
 175 Alan Gordon Enterprises  
 200 GRD  
 42 Bernie Grundman Mastering  
 163 Hardy Company  
 107 Hill Audio  
 196 Hollywood Vaults  
 203 HRC Magnetics  
 95 Hy James Audio  
 104 IAN Communications  
 44 Ibanez  
 137 ICIA  
 166 Imperial Tape  
 116 Innovation Specialties  
 208 Institute of Audio/Video Engineering  
 151 Jensen Transformers  
 99 JRF Magnetic Sciences  
 192 K-Disc Mastering & Pressing  
 154 Key Clique  
 46, 47 Kurzweil Music Systems  
 177 LaSalle Music  
 152 LD Systems  
 189 Leo's Audio & Music Technologies  
 11 Lexicon  
 133 Linear & Digital Systems  
 115 Linn Electronics  
 96 Livingstone Audio  
 167 Los Angeles Recording Workshop  
 77 LT Sound  
 164 Mad Hatter Studios  
 97 Master Digital  
 161 The Mastering Lab  
 199 Media Sciences Institute  
 198 Meyer Sound Laboratories  
 152 Midcom, Inc.  
 163 Monster Cable  
 99 Mother Dubbers  
 148 Music Annex  
 143 Nagra Magnetics  
 63 Rupert Neve, Inc.  
 42 New World Audio  
 91 Nikko Audio  
 100 Northeastern Digital Recording  
 210 Ocean Audio  
 180 Ocean Records  
 27 Orban Associates  
 4 Otari Corporation  
 127 Peavey Electronics  
 102 Planet Sound

## PAGE ADVERTISER

204 Polyline Corporation  
 199 Preferred Sound  
 36, 185, Professional Audio Services  
 187 & Supply  
 165 Project One A/V  
 191 Pulsar Laboratories  
 41 Rainbo Records  
 153 Rane Corporation  
 167 RCA Records  
 113 Renkus-Heinz  
 211 Rocktron Corporation  
 125 RolandCorp US  
 179 Ross/IMC  
 196 R-Tek  
 31 Sanken Microphone Company  
 166 Sennheiser  
 121 Sequential  
 83 Skyelabs  
 17 Solid State Logic  
 9 Sony Pro Audio  
 197 Sound Affair  
 200 Sound Image  
 211 Sound Investment Enterprises  
 192 Sound Source  
 220 Soundcraft Electronics  
 29 Soundtracs  
 59 Soundworks Digital A/V  
 202 Sprague Magnetics  
 89 Steinway & Sons  
 2 Studer Revox  
 206 Studio Consultants  
 189 Studio Instrument Rentals  
 88 Studio M  
 202 Studio Referral Service  
 193 Studio Technologies  
 161 Studiobuilders  
 175 Swintek  
 132 Synchronous Technologies  
 60 Syntech  
 208 The System  
 201 Tannoy  
 21 Tascam  
 33 Technical Audio Devices (TAD)  
 141 Thoroughbred Music  
 24, 25 3M Corporation  
 81 TOA Electronics  
 197 United Tape  
 147 Universal Recording  
 165 University of Sound Arts  
 71 Ursa Major  
 190 Vertigo Recording Services  
 141 Vintage Recorders  
 145 Wise Music  
 204 World Records  
 12, 13 Yamaha International

# F E E D B A C K

Dear Mix,

As a recording engineer and instructor I have always found *Mix* to be both enjoyable reading and a very useful tool for keeping in touch with the latest developments in the field. I feel compelled to write now, though, to express my disappointment in the new "Field Test" series of articles.

I looked forward to this series since I assumed that it would provide a much more in-depth and objective evaluation of new equipment than what is offered by advertisements or the "preview" section. Instead, it seems that *Mix* has simply offered the manufacturers another opportunity to display their products.

In his article on the Fostex B-16, for example, Joe Van Witsen was enthusiastically positive about every aspect of the unit, although only one specification (S/N ratio) was mentioned. Of course, no one would deny that half-inch 16-track is an impressive achievement, but this article gave the impression that the B-16 offered comparable sound quality to popular 2-inch machines. It's hard to believe that no sonic compromises (or at least, differences) are evident in this new format.

The article on the Akai MG1212 goes even farther in its effort to avoid critical comment. After an exhaustive list of the features (which could probably be gotten just as easily from the manufacturer) Robert Missbach goes on to say:

"Okay, it's got a lot of great features, but how does it sound? For the number of tracks you get, it sounds real good."

And that's it! As far as I can tell, Missbach has pinned down the sound quality of the Akai as being somewhere between a Fostex cassette 4-track and a Mitsubishi digital 32-track. Thanks for the help!

It's hard to imagine why these articles are even called "Field Tests" since no testing of specifications has actually been done. Only the manufacturer's specs are quoted.

*Mix* has a deservedly high reputation in the audio world, but this will only be damaged if it continues to disguise obvious advertisements as serious articles. Surely *Mix* has access to both the test equipment and the "golden ears" needed to carry out a truly insightful investigation into a product.

Sincerely,

David Zuckerman

Chief Engineer

Splice of Life Recording Studio  
Brighton, MA

Dear David,

You hit a real nerve here, David. When we began our Field Test series, the idea behind it was, why bother to review a poor product? If the reviewer were dissatisfied with the performance of a unit, it didn't seem to make much sense to devote much space to criticizing it. A phone call to the manufacturer would suffice. So we felt that a more useful way to use the limited space would be to provide a little more first-hand communication on products of particular noteworthiness. The Field Test does not attempt to recreate a "laboratory work bench" situation; it is purely a subjective analysis from the writer.

On the other hand, we are always open to your suggestions on how we can improve the quality of the editorial coming out of these pages. If you'd like to submit a product review, as you see it being most useful, please send it in. Anyone else with comments on how "Field Test," or any other *Mix* feature, could work better is encouraged to drop us a line.

—Editor

Dear Mix,

I was completely overjoyed when I read the June issue's piece on "Signing Artists" from the A&R perspective. It was with this same feeling that I quickly mixed down a few tunes from my studio and sent the master along with my promo package to Larry Hamby of Epic Records. Imagine my surprise after reading his statements in the article when my tape came back in an Epic Records envelope marked "unsolicited material—refused."

After tape, insurance and postage I paid \$6 and some odd cents to have it shipped back to me in an envelope that Epic paid \$2.43 to mail.

In the interview, Hamby says he is looking not only for hits, but also for art. I sincerely wonder exactly where his looking is taking place—certainly not at Epic.

I have been in music for 22 years, recorded over 30 albums and have released on my own label seven albums and six 45s, so professionalism is not a missing factor here. It seems to me that it would be a great service to your readers to let them know that this is what can be expected if they, too, felt that perhaps "Signing Artists" was pro-

viding them with the names of some open ears. Otherwise, I enjoy your magazine greatly.

Sincerely,

Nicodemus

Zedekiah Records

Detroit, MI

Dear Nicodemus,

We're sorry your experience with Epic Records was so troubling. We would recommend that artists interested in submitting tapes to any label contact the company in advance to determine each company's tape submission policy.

—Editor

Dear Mix,

Thanks for the magazine. Generally, we tend to stay away from magazines because of the distinct lack of quality useable information. Your publication seems to bypass cheap overused buzzwords and reflects a desire to present information of real interest to audio/video professionals. Keep it clean and distortion-free and you have my promise that the issues will be read and your advertisers will be rewarded with our business where applicable.

Sincerely,

Mark Slocombe

Slocombe Sound Co.

St. Louis, MO

Dear Mix:

I want to compliment you on a great article! Audio Applications "A Winning Strategy" (July '85 issue) really set things straight on the importance of a proper education for getting started in the audio field.

It reaffirmed my belief in the opportunity available and cleared up some questions I had.

It was a great inspiration to continue my studies after successfully completing my first year of college.

Thank you,

Jim Pohlson

Berklee student

Boston, MA

**Correction:** Contrary to what was stated in our June issue, Music Motions, a company involved with the theatrical distribution of music video clips, does not pay artists and record companies "a flat fee." Rather, Music Motions pays labels a royalty fee based on the rental performance of the specific clip. Our apologies for the error.





# THE EVOLUTION OF SUCCESS

To stay number one, you've got to make the best even better. Which is why for ten years Ampex has continued advancing the performance of mastering tape. Through a decade of increased performance and reliability, Grand Master 456 remains the tape behind the sound of success. Which is why more top albums are recorded on Ampex tape than any other tape in the world. For Grand Master 456, the beat goes on.

**AMPEX**

Ampex Corporation, Magnetic Tape Division, 351 Broadway, Redwood City, CA 94063 415/367-3809 Ampex Corporation • One of The Signal Companies

Circle #170 on Reader Service Card

**AND THE BEAT GOES ON**

World Radio History

A P P R O P R I A T E

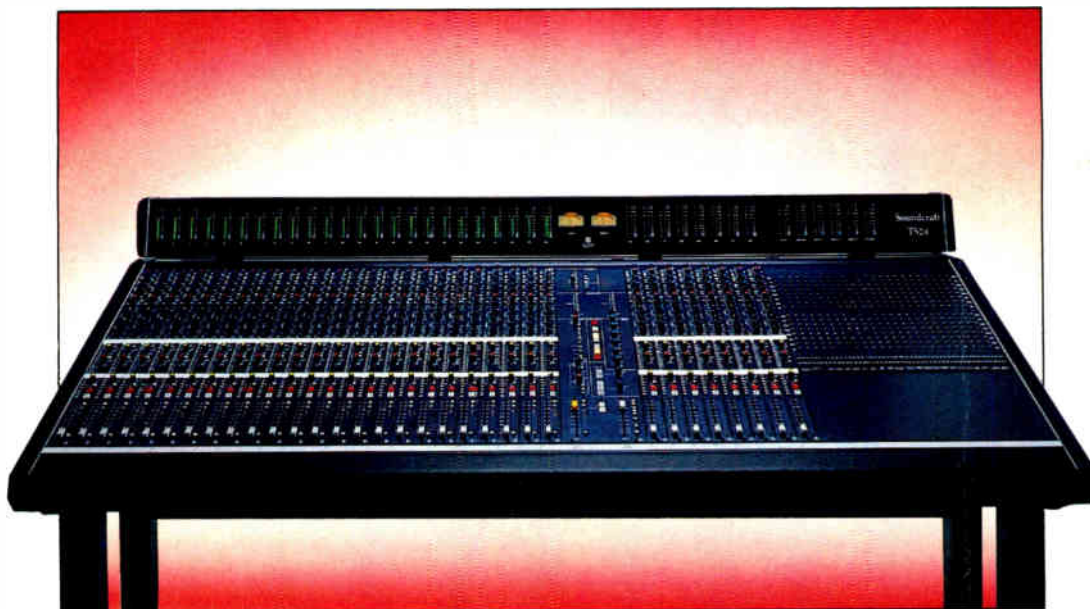

T E C H N O L O G Y

When high technology meets the needs of the user, only then does it become appropriate.

That's the philosophy Soundcraft has applied to their new TS 24 in-line console. A philosophy that has revolutionized in-line console design, producing a meticulously engineered console, with the engineer in mind. Designed for audio purity, not egocentricity.

Master status switching reconfigures the console for each stage of recording and remixing. This allows the engineer to create; not search for a lost signal within the console.

The Soundcraft TS24 is an example of intelligent engineering combined with the common sense necessary for *today's* successes.

When choosing your new console, consider the technology *appropriate* for your requirements. Consider the TS24. And, consider profitability for *yourself*, not just the console manufacturer.

# Soundcraft

L O N D O N · L O S A N G E L E S · M O N T R E A L

1517 20th Street, Santa Monica, CA 90404 (213) 453-4591 Telex: 664923