

FOR THE PRO & SEMI PRO

RECORDING INDUSTRY DIRECTORY

VOL 3 ISSUE 2

MARCH 1979

# the Mix

*Listings*

S. California Studios

*Armin Steiner*

The Mix Master

*Ron Nevison*

Producer at Large

*SNMPT& Time Code*

by Ed Lever

*Audio for Television*

by Ken Fay

**FREE**



# Versatile...

is the word for Everything Audio. We have a wide range of clientele because we satisfy a wide range of needs. From the most elaborate studio design and installation to the smallest equipment need, we are ready to serve you.  Pictured at left is one of our



installations, **Spectrum Recording Studios** in Venice, California. Our involvement in this project was limited to that of design—to maximize their available funds, the owners had their own builders handle construction.  Pictured at right is **Compact Video Systems** in Burbank, California, an advanced



audio/video facility utilizing computer assistance in the post production audio room. It is one of our newest and most elaborate installations. We designed this facility in an existing structure, supplied the audio equipment, and assisted their crew during construction, clarifying and modifying the plans as the work progressed. The combined effort of the Compact Video crew and the Everything

Audio staff resulted in an installation that is innovative in its technology as well as its finish and materials.

Another of our recently completed studios is the

**Record Star** in Hamburg, West Germany. (We have representation in Great Britain, Germany, Australia, and Mexico.) We



supplied the plans in metric measurements and, through local representation kept involved in the project until its completion. In all of our projects—anywhere in the world—the home office keeps abreast of everything with on-site inspections.  If you are contemplating upgrading or building a new facility, we'd like to show you what we can do for you. Or if you're just looking for a new piece of equipment—let us help.  From total design and installation, to supplying the smallest equipment need—we do it all.

**EVERYTHING  
AUDIO**

16055 VENTURA BLVD., SUITE 1001 • ENCINO, CALIFORNIA 91436 • (213) 995-4175

Versatility: Let it work for you.



# Studio quality microphones that don't need a studio to survive.

## The CS15P condenser cardioid

microphone is equally at home in a recording environment or broadcast studio. When hand-held it puts sex appeal in a voice with its bass-boosting proximity effect. With shaped high-frequency response and its ability to handle high sound pressure levels (140dB with 1% THD at 1kHz), the CS15P is ideal for close-up vocal or solo instrument miking applications.

When boom mounted, the CS15P has better gain-before-feedback and a better signal-to-noise ratio than most shot-guns. It's phantom powered and it's rugged.

## The CO15P condenser omni

extends frequency response to the very limits of audibility, 20 to 20,000 Hz. Unlike other "omni's," the CO15P maintains its omnidirectional polar pattern at the very highest frequencies.

Perfect for the distant miking of an entire orchestra as well as up close on individual instruments. And like the CS15P, it's phantom powered and it's rugged.

## The Electro-Voice warranty

Electro-Voice backs up these two microphones with the only unconditional warranty in the business: for two years we will replace or

repair your CS15P or CO15P microphone, when returned to Electro-Voice for service, at no charge -- no matter what caused the damage!

We can do this because we build these microphones to meet our standards for performance, ruggedness and durability. We accept nothing less, and if you're a professional, buying a professional quality microphone, you shouldn't either.

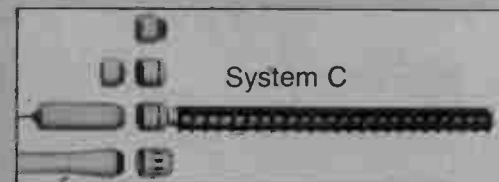

**EV** **Electro-Voice**<sup>®</sup>  
a **gulton** company

600 Cecil Street, Buchanan, Michigan 49107



# Professionals Swear by Them, Competitors, at Them.

They're the new BGW pro amps you'll go for - From top to bottom, The Model 10 Electronic Crossover, The Model 100B Power Amp, and the 250E Power Amp. Each one an extension of our basic philosophy at BGW; The Best.

Whether it's a simple resistor or a complex semiconductor, BGW is dedicated to the principle that a pro knows the difference between "good enough" and "outstanding." Because we know that quality in a pro product is indeed something you can see, touch and hear, everything that goes into a BGW product, everything we do in its manufacture, is designed to back up the man who depends on our gear to make his living. And, like all BGW products, the new 250E with our exclusive arc-scale power indicators joins with the new 100B and Model 10 in answer to your demands. They're worthy additions to the solid-gold reputation that's been earned in recording studios, discos and concert stages throughout the world.

If you're not already a BGW Pro we invite you to compare any of our products with anybody else's. Anybody's. You'll then see why so many of your pro friends swear by us. And our competitors, at us.

## Go For The Best



BGW Systems, Inc.  
 13130 South Yukon Avenue,  
 Hawthorne, California 90250  
 In Canada: Omnimedia Corp.,  
 9653 Cote de Liesse  
 Dorval, Quebec H9P 1A3



# the Mix

Recording Industry Publications

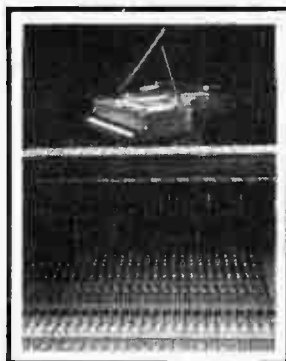

Britannia Studios  
3249 Cahuenga Blvd. West  
Hollywood, CA

Studio Design: Greg Venable  
Architect: John Cowles  
Interior Design: Art Bridgford  
Electrical Installation:  
Audio Industries  
Owner: Gordon Mills and  
Tom Jones  
Credits: Eagles, Crosby, Stills &  
Nash, Beach Boys, America  
Photography: Dennis Bayer

MARCH 1979

VOLUME 3, NO. 2

FEATURES

LISTINGS

- 6** INSIDE TRACKS
- 8** AUDIO FOR TELEVISION  
by Ken Fay
- 10** ARMIN STEINER INTERVIEW  
by David Schwartz
- 14** SMPTE TIME CODE  
by Ed Lever
- 18** RON NEVISON  
by Kenneth Kubernik and Saul Davis
- 20** PROGRESSIONS  
by Larry Blakely
- 24** SOUND ADVICE  
by Dr. Richie Moore
- 35** CLOSE-UP  
The Gizmotron
- 92** FEEDBACK



- 26** RECORDING ARTS SCHOOLS AND PROGRAMS
- 29** STUDIO LOCATION INDEX
- 30** 4 TRACK
- 36** 8 TRACK
- 46** 16 TRACK
- 58** 24 TRACK
- 89** INDEPENDENT ENGINEERS AND PRODUCERS OF SOUTHERN CALIFORNIA
- 92** INDEX OF ADVERTISERS

PUBLISHER/EDITOR

David M. Schwartz • William I. Laski • Penny Riker Jacob

ART DIRECTOR  
Skeeter

OPERATIONS MANAGER  
Mary Lowman

CONTRIBUTING EDITORS

Saul Davis  
Ken Kubernik  
Larry Blakely  
Dr. Richie Moore

ART DEPARTMENT  
Henry Harrison McUmber  
Leslie Wozniak

DISTRIBUTION MANAGERS  
Dean Coy  
Frank Grygus

PRODUCTION MANAGER  
Sandy Cann

EDITORIAL ASSISTANTS  
Grace O'Conner  
Henajette Brands

PHOTOGRAPHY

Dennis Bayer  
Penelope

The Mix is published at 956 San Pablo Ave., Albany, CA 9476, and is © 1979 by Mix Publications. This is Volume 3, Number 2 March 15, 1979.

The Mix is distributed free in recording studios, pro-audio stores, music stores and other related businesses. If you have a recording or music related business and would like to distribute The Mix, please give us a call.

Please address all correspondence & changes of address to The Mix, P.O. Box 6395, Albany Station, Berkeley, CA 94706, (415) 526-6102.

Display advertising rates and specs are furnished upon request. Ad closing for next issue: April 5, 1979.

The Mix is published 8 times per year. Subscriptions are available for \$12.00 per year, single issue price is \$2.00.

This publication may not be reproduced or quoted in whole or in part by mimeograph or any other printed means, or for presentation on radio or television without written permission of the Publishers.

Controlled circulation paid at Berkeley, California.  
Publication # 445070.

# Subscription

SINGLE ISSUE PRICE \$2.00

ONE YEAR \$12.00

Send Check or Money Order to:

The Mix  
P.O. Box 6395  
Albany Branch  
Berkeley, CA 94706

name

company name

address

city

state

zip



## in it up to our ears

Staying on top of our fast moving industry can become a career in itself. As we attempt to comprehend the developments, updates and trends in audio, we seem to leave ourselves little time to do anything else. Many of us are in just enough over our heads that we feel compelled to subscribe to every audio oriented publication, study every spec sheet within our access, and despair that we can't afford to buy the level of sound equipment that our professional ears deserve.

With knowledge comes frustration. With enough knowledge and enough frustration comes the Quicksand Effect. This is the realization that we are in it up to our ears. We've built a career out of a sideline/our hobby has become our religion. We realize that we have been captured by the audio industry and admit that no other line of work would satisfy us, anyway. It's one-way, no U-turns.

### Trade Shows

If you happen to be an information junkie, there is no better way of keeping tabs on the state-of-the-art than by attending the various industry trade shows. This can also be a career in itself for the compulsive conventioneer. For most of us, time, money and energy limit our participation at audio fairs, so we would like to take an inch or two-here to mention some of the more major events you may want to plan on in the coming months.

The granddaddy of audio shows, the Audio Engineering Society Convention will convene May 15-18 at the Los Angeles Hilton. With national conventions twice each year (the Nov. show is in New York), the AES is a showcase for new equipment, processes and research in professional audio. More information on this show is available through the AES office at (212) 661-2355.

Technology spreads quickly to the consumer audio market, being where the bucks seem to hide. The Consumer Electronics Show meets twice a year (June 3-6 in Chicago, January 5-8 in Las Vegas). You can call (202) 457-4919 for specifics.

Musical instruments are vital to our industry and the National Association of Music Merchants presents a semi-annual trade show (June 9-12 in Atlanta, January in Anaheim). Call (321) 263-0261 for more details.

Another strong audio overlap occurs in the broadcast industry where the National Association of Broadcasters and the National Radio Broadcasters Association stage annual get-togethers. The NAB show (March 25-28 in Dallas) is the

all encompassing exhibit and technical be-in for radio and television, while the NRBA (Oct. 7-10 in Washington, D.C.) is a smaller, but young and aggressive show dealing exclusively with radio. NAB: (202) 293-3506, NRBA: (202) 466-2030.

If you deal with 35mm film or television post-production work, you may want to check out the Society of Motion Picture and Television Engineers meeting (Oct. 21-26 in Los Angeles). The SMPTE info-line is (914) 472-6606.

### Feature Articles

Armin Steiner continues to be a pioneer in the art/science of mixing. Our interview with Armin reveals a man of perception and intellect who has contributed a great deal to our enjoyment of music and to the recording industry.

The Engineer/Producer is rapidly becoming a modern folk hero. Contributing editors Saul Davis and Ken Kubernik have put together a profile of Ron Nevison, an E/P with credits for folks like The Who, Bad Company and Dave Mason.

Television audio has been a sore point among progressives for many years, so we asked Dolby

Labs' application engineer, Ken Fay, to tune us in. In "Audio for Television", Ken writes that help is on the way and, in fact, the near future has some pleasant surprises in store.

The founder of Canyon Recorders, Ed Lever has presented us with a wonderfully understandable explanation of the SMPTE Time Code. A system for locking tape machines together. The SMPTE Time Code has opened important channels for the film, video and multitrack audio industries.

We welcome Larry Blakely, a new featured columnist, to our pages. In Progressions, Larry will keep us abreast of the latest developments in audio and discuss how the future of the industry will affect all of us. With chops as an engineer, producer, musician, inventor, audio dealer, manufacturer's marketing director and teacher, Larry brings to us years of experience and a fresh perspective.

Another first appearance, Sound Advice presents the talents of Dr. Richie Moore to answer questions about audio and recording. An engineer with 275 album credits (15 gold, 5 platinum), three years of experience as Wally Heider's chief engineer and a PhD to boot, Richie is the man with the answers.

### Listings

Our studio listing section exhibits 200 of Southern California's finest. The next update of this area will be in the September issue, so if you know of a studio that we missed, please get in touch or return the coupon on page 52.

Also listed in this issue is a survey of recording arts schools and programs in California, and independent engineers and producers of Southern California.

Don't forget to pick up our May issue which will feature an update of new audio products and lots of surprises.

## COMING IN MAY

### Listings:

New Audio Products — Spring Update

### Doug Sax

Behind the scenes at The Mastering Lab

### Architectural Acoustics in Studios

by Joel Lewitz and Dennis Paoletti

### Record Pressing

A tour of the new Monarch pressing plant

### Time Modulation

by Steve St. Croix

### Digital Technology — Where it's at

by Michael Lerner

and much more...



# CLEAN UP YOUR TRACKS WITHOUT CLEANING OUT YOUR POCKETS.

The past few years have seen a proliferation of exciting, inexpensive new multi-track hardware. Unfortunately, this hardware retains two shortcomings which prevent the small studio from really competing with the "big boys"—noise and lack of headroom. These shortcomings become especially apparent when the tracks you're bouncing start sounding like a transmission from outer space.

dbx, maker of state-of-the-art tape noise reduction for the world's leading studios, also makes a line of products designed for the small studio: the 155, the RM-155 and the 158. All offer the same 30dB of tape noise reduction and 10dB of headroom improvement as our more expensive units, with which they are fully compatible.

The 155 offers four channels of tape noise reduction, switchable to record, play or bypass. Each channel is self-contained on a user-changeable modular circuit board. All this, for under \$600. Also available rack-mounted (RM-155) for four-channel simultaneous or eight-channel switchable use.

The 158 offers eight channels of simultaneous tape noise reduction, rack-mounted in a compact chassis. It lets you monitor the noise-reduced signal while you record. Spare channel included.

A dbx tape noise reduction system is simple to install and use. It will give your demos the sound quality of master tapes. And when you're ready to expand, your dbx system grows with you, easily and inexpensively.

Above all, the product you produce will be very close to that of the "big boys," for a lot less bucks. That is why, for the small studio, dbx tape noise reduction is a necessity, not an accessory. dbx, Incorporated 71 Chapel Street, Newton, MA 02195 617-964-3210



**dbx**  
UNLOCK  
YOUR EARS



Television sound has traditionally been so mediocre that TV audio has for the most part been ignored by those whose livelihoods depend on the high quality recording and reproduction of music. However, these days the television broadcasting industry itself is taking sound far more seriously. In particular, a number of recent improvements throughout the TV audio chain now provide the potential for bringing TV sound up to the quality associated with the other electronic entertainment media.

These improvements start, appropriately enough, with the way in which the audio track is put together for videotaped programs. It used to be that dialogue was recorded with the picture directly on the quadruplex videotape recorder, and that post production work was then carried out using two VTRs. Each time something new had to be added to the original dialogue — hoofbeats, gunshots, atmospheric sounds, music, — the track was re-recorded from one VTR to the other. Thus, the final track was often many generations away from the original dialogue recording, and had all the expected degradations.

The introduction of the SMPTE time code, and a wide variety of equipment to take advantage of it, has changed the post production process, much to the advantage of sound quality. More often than not today, a separate two-channel audio tape recorder is locked to the VTR; one track records the dialogue while the other records the time code (the dialogue is also recorded on the videotape as a safety track). Thereafter, the audio track can be mixed separately, apart from VTRs and their audio limitations, using 16-track audio recorders for adding music and effects. Only after the mix has been carried out on professional audio equipment is it transferred as a last step back to the videotape. Furthermore, the audio equipment used for post production work is often of very high quality. For example, CBS has Neve consoles and Studer recorders in its



Jim Wiseman and Leigh Blicher sitting at the TK-76 multi-camera van console, One Pass Video in San Francisco

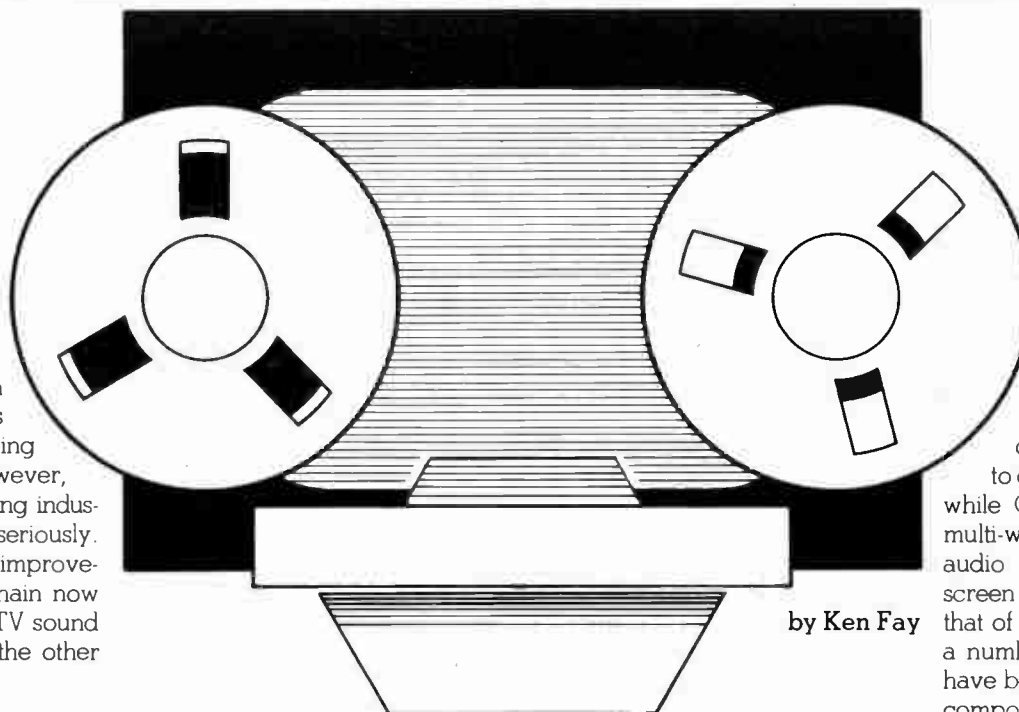

by Ken Fay

# AUDIO FOR TELEVISION

Television City complex; Compact Video, a leading post production facility, uses fully automated API consoles and Ampex audio recorders; ABC has just installed new, lavishly equipped multi-channel facilities in Los Angeles and New York; and indeed, Dolby noise reduction is often used throughout the mixing stages.

The next link in the TV audio chain — the audio track of VTRs — is also undergoing improvement. While older quadruplex VTRs provided an audio signal-to-noise ratio of about 46 dB and a bandwidth to about 8 kHz, the newer machines provide a 15 kHz bandwidth and lower noise. The new generation 1" helical scan machines currently going into service have a 56 dB s/n and a 15 kHz bandwidth. Furthermore, the newer machines can be brought very close to the performance of professional audio recorders through the use of noise reduction (for example, all PBS 2" videotapes with two-channel sound for simulcasting, such as Boston Symphony concerts and the Great performances series, have Dolby encoded tracks).

The improvements discussed so far would of course be to little avail if the sound still had to pass through 5 kHz landlines on its way from network to local station. However, this bottleneck was recently broken by A.T. & T., which now provides duplexed audio links. As many as four channels of audio, each with a 15 kHz bandwidth and 65 dB s/n, can be distributed by the networks to their affiliates all across the country, maintaining the higher fidelity available as a result of the improvements in the earlier stages of production and post production. In addition, this new facility opens the way to stereo sound with TV broadcasts — a format already in use in Japan.

The next link in the chain, the local station's transmission, as a result of FCC regulations has always had an audio capability similar to that of FM broad-

casting. That leaves us with the final stage: reproduction of the sound at home. Here too there are signs of improvement. Many Sony color receivers use audio equalization to extend response of the built-in speaker, while Quasar has a line of sets featuring multi-way wide range speaker systems. The audio performance of prestigious large-screen projection sets is usually superior to that of most conventional sets; and recently a number of high quality TV audio tuners have become available from such large hi-fi component manufacturers as Pioneer.

While this activity, in all fairness, is just a start, there is at least one important difference today: the chicken/egg circle has been broken. Set manufacturers need no longer point to the dearth of quality signals as a reason for not improving receiver performance. Indeed, some would probably WANT to provide up-market models with better sound systems. On the other side, the TV broadcast industry is apparently looking to the future by going right ahead with the improvements we've outlined, without using the millions of existing lower-fi TV sets as an excuse not to do so.

All in all, it's an exciting time in television audio. The serious effort expended over the years to provide a first-rate color picture is now being matched by a similar effort to provide first-rate sound. For anyone interested either casually or professionally in the growth of quality sound reproduction, the TV industry is well worth watching.



Control room at Compact Video Systems, Burbank

*Presently serving as Applications Engineer for Music Studios at Dolby Laboratories in San Francisco, Ken Fay has seen action as Chief Engineer for Paragon Recording Studios in Chicago and has performed technical wizardries at such notable institutions as Martin Audio, Audio Techniques and Scully/Metrotech.*

*When not motorcycle touring or instructing courses in motorcycle safety, Ken can usually be found, screwdriver in hand, preparing to fix something. :)*



# WHY SETTLE FOR THEIR BEST, WHEN OUR SECOND BEST IS BETTER.



You see, the Series 79 Professional Audio Recorders may not be 3M's new digital sound, but you'll be hard-pressed to find more dependable analog sound.

Start with an unusual way to have lower wow and flutter and keep head contact. It's our patented 3M Isoloop differential capstan-drive. Which cuts unsupported tape length down to  $3\frac{1}{2}$  inches.

Then design it all into a no-warp metal deck base plate.

Finally, choose from expandable 8, 16 and 24 channel models.

For more information, phone R. J. Brown at (612) 733-1262 or write Mincom Division, 3M Company, St. Paul, MN 55101.



# 3M



# Armin Steiner

## Mixing Business with Pleasure

by David Schwartz

*Making a business out of mixing was the idea in Armin Steiner's mind when he opened Sound Labs in Hollywood in 1971, the world's first facility designed solely for the purpose of mixing multi-track tapes. This innovation was part of a pattern of firsts, either designed or implemented by Steiner, which included LA's first 8-track studio, the first positional (left, ml, c, mr, r) matrixed monitoring console in a studio and even the first studio to have 24-track monitoring.*

*Considering his lifelong involvement on the technical end of recording, it is interesting to observe how his classically trained musical background has contributed to a deep involvement with such sensitive productions as the Jimmy Webb and Richard Harris albums, "MacArthur Park", and "The Yard Went On Forever", Neil Diamond's "Hot August Night", most of the music by David Gates and Bread and the future classic*



**"I believe we were the first studio to use condensers like the U-47's."**

*production of Burt Bacharach with band and orchestra, due for release in early Spring.*

*Spotlighting a true pioneer of the modern recording industry, our interview reveals Armin Steiner to be a man with musical integrity, technical awareness, sincere gratitude, and an uncanny sense for being at the right place at the right time.*

### How did you start out in the business?

My dad started me out in this business when I was about ten or eleven years old. We had a studio in our house and he used to record Gypsy music direct-to-disc, in those days. Mike Rettinger, who is a well-known acoustician, was a very good friend of my dad's and was at that time, I think, chief engineer of RCA Victor in the motion picture development area. So, while I was very much interested in electronics and sound reproduction, those elements from early childhood had their influence on me.

My first job in a recording studio, when I was 15½, was at Electrovox on Melrose Ave. The owner, Bert Gotshalk, gave me a job there for \$25 a week and I worked in the disc library, mainly with sound effects. Tape wasn't really in vogue at that time and most of the work was transcription. I worked at Electrovox a very short period of time and then was fired and told that I had no talent for this business.

Through my dad I was taken to Radio Recorders, which was the basis for most of the engineers of an era. It was the only place that you could get a total and fundamental background in the recording business. They had 35 engineers and it was the largest recording studio at the time. This was before the studios of RCA Victor or Decca or any of the major labels. All of the independents and major labels were handled by Radio Recorders and they had the monopoly. And so, with the advent of the tape recorder in about 1947, Radio Recorders had the first 200 Ampex recorders and the tape business was launched on a large scale. It was an enormously fantastic organization with an almost father to son relationship between the older engineers and the younger people coming in. I haven't seen that kind of program duplicated anywhere in the industry. It was a great fraternity of



**"When the Supremes would come to town, my mom would usually make lunch for everybody."**

learning and you just couldn't help but learn.

During that time I went to college, first to City College where I was actively involved in remote recording, simply because it was a way of learning, a way of doing things with my hands and it was also a way to get a parking pass. In those days we had a first class symphony orchestra, a first class dance band, opera and we had the basic vehicles to build an incredible library of recorded music. So from that standpoint, I was in the right place at the right time.

### When did you get involved with your own studio?

Except for those early days, I've always had my own studio. My first studio I built when I was about 20, in the home I was born in. We converted the 10' x 14' bedroom into the control room and the 25' x 15' living room turned into the music studio. This was one of those apartments over a garage where off to the side was a nice little kitchen. We tore that kitchen out and made it an alcove, part of it becoming an isolation room.

### What was the technical situation in that studio?

Much of the technical work at the studio was done with Bert Sax, who I met through his brother Doug Sax of the Mastering Lab. Bert is a very talented self-taught electronics man and we've worked very closely through the years.

We had two Ampex 350 two-tracks and an Ampex 400 mono machine and some very good microphones. I believe we were the first studio to use condensers like the U-47's. That microphone was never designed to work in a close-up situation and those were the days when we were making the transition from distant to close miking. So we had to be very careful that the high intensity sound levels did not overload the equipment.



Actually we were not yet doing close miking — it was more like 'closer' miking. A drum kit would consist of one U-47 over the top and, in many cases, no separate mic for the kick drum. Originally the U-47's were used for symphonic recordings and were placed at a 15 or 20 foot distance over the orchestra. All those microphones have a curve that boosts the high end a little from about 8KHz to 15KHz. That used to be known as the U-47 bump and was designed because of high frequency attenuation through the air when used at a 15 - 20 foot distance over the symphony orchestra. As closer miking came to pass, especially with vocalists, we had some tremendous sibilance problems.



***“I think quad was a difficult time for all of us because it was really put on us by the hardware manufacturers.”***

#### **What kind of projects did you do at The garage Studio?**

The Formosa St. Garage Studio, as it was known by friends, became very successful and we had a lot of hit records over the seven years that it operated. The first record that we did, and I believe we did it in about two hours on a Sunday afternoon, was Dick and Dee Dee's "The Mountain's High And The Valley Is Deep" and it became a number one record in a very short period of time.

There was a real family feeling in that studio. When the Supremes would come to town my mom would usually make lunch for everybody. We would work all through the night and sometimes I would be doing a session in my pajamas or a bathrobe. Herb Alpert once came over with Hal Blaine to do a tamborine part at 2 A.M. so that he could master the next morning. These kinds of things were common and all of us were growing with the industry in those early days. Once again it was being in the right place at the right time with the right idea.

I was very heavily involved with the early Motown hits. It was the beginning of a lot of rhythm and blues that was so important in those days. We were experimenting, trying to find out how much we could push the medium to be able to get the emotional style in the music so that it would, when played on a jukebox or in a home, have that kind of impact. We have not seen, in the last few years, this kind of soul music. It's gone more into a pop element. But in those days, to do a Supremes record, a Marvin Gaye record, a

Temptations record or a Four Tops record, that was something that we really looked forward to. The excitement that was generated by those kinds of records in those days is something that we, for the most part, don't experience anymore.

We finally got evicted from the garage studio, not because of the music leaking out, but because of the cars coming and going at all hours of the night. I moved all of my equipment to Radio Recorders and, shortly thereafter, we put together a group to build Sound Recorders, where Total Experience is now located.

#### **How did Sound Recorders come together?**

We built Sound Recorders more or less on a shoestring. This was six months after the garage studio closed and about 1966 or 1967. Cal Frisk, a dear old friend from Radio Recorders and a very knowledgeable and experienced electronics man, was very involved with the studio building, as was Roger Standridge, who was instrumental in the design of the console in Studio 1, a console with several early automated functions that were about ten years ahead of their time.

Sound Recorders had one room and we were the first people to have eight track. Actually it was the first eight track independent studio because Columbia Records was experimenting with locking two four-track machines together mechanically.

#### **What kind of eight-track machine did you use?**

We built our own eight-track machine. Along with the equipment that I pulled out of the garage studio, I had two Ampex 200's. We figured that the deck drive, with those huge motors, would certainly pull one-inch tape, and all we would have to do is have the guides machined in such a way that it would handle the one-inch tape. For the heads, we contacted the chief engineer of a company called IEM in Chicago, a place that built 12 and 14 channel heads for satellite communication. We figured if they could build communications heads, they could build audio heads. He was very intrigued with the idea and built us an incredible recording head. It had no automatic tape lifting and we had to manually pull the headgate. We couldn't go too close to the end of the reel because the machine would slow down when it got tired and was pulling a lot of tape.

Also in this studio we had five position monitoring on two speakers — left, mid-left, center, mid-right and right, using a geometric switch. We have this in our consoles even today, for convenience and so you can return to the same point without having to pan to find it. This studio also had a mastering room with the first Neumann installation on the West Coast, although this was mainly a convenience for our clients.

Our next major conversion was to sixteen track with a 3M M56, a wonderful tape recorder. Wally Heider had the first and I had machine number three or four and, as you would expect, there were a lot of modifications to be made. Thanks to the integrity and persistence of people like 3M's Gordon Menard that machine is as good today as the day it came out of the factory.

At Sound Recorders, we were the first studio to have 24 track monitoring, long before 24 track came out. You might say that we've always been looking to the future.

#### **Tell us the story of Sound Labs.**

One day I looked across the street from Sound Recorders and came up with an idea. I was talking with my wife and I said, "What would you say if we built a special room just for the business of mixing?" Everybody had his favorite place to record but the biggest problem was having a room that was accurate enough and had enough tools in it to be able to put those sounds together with as much of a degree of predictability as possible. That was the premise for Sound Labs.

This was in 1971 and I decided to stick my neck out as far as I could so I went across the street and signed a lease with no idea of how I was going to put the studio together. As it turned out we had budgeted the studio out to practically the last dollar and we opened Sound Labs with about \$100 to our name. We built Studio One as a quad room because we figured that if quad was going to go, we wanted to have a studio and an environment for it.

#### **Quad must have been a real disappointment for you.**

I think quad was a difficult time for all of us because it was really put on us by the hardware manufacturers and it got to the point where it just died a natural death. I think it's still a marvelous medium to be used in a natural ambient manner, though. I made many albums that way. In fact there was one album, Neil Diamond's "Jonathon Livingston Seagull", where we actually recorded the thing on the Burbank stage with ambient microphones and it was wonderful. It created a real 'stretch' in the orchestra.



***“My feeling is that the digital tape machine is going to show up a lot of the problems in the rest of the equipment.”***

#### **What was the equipment situation when you put Sound Labs together?**

We built the console in Studio One ourselves. The only standard part was the API fader. We had EQ for the rear speakers and also a control called mid frequency panning. The idea of having mid

*cont'd on page 12*



Do not miss the . . .  
**AUDIO ENGINEERING SOCIETY'S**  
**63<sup>rd</sup>**  
**Technical Meeting and Exhibition of Professional Equipment at the Los Angeles Hilton May 15-18**

For details, write or phone:



**AUDIO ENGINEERING SOCIETY**

60 East 42nd Street  
 New York City 10017  
 212/661-8528  
 and 661-2355

*cont'd from page 11*

frequency panning was to be able to take those solistic instruments and make them sort of step out in the spectrum. So in different sections of the orchestra we were able to take, for instance, 4db at 5000 cycles and pan it forward from front to rear. I've never seen that on another console and right now, back in two channel stereo, it sits there as an old friend to remember some of our experiments.

**How about the monitoring system?**

An interesting story. Doug Sax of the Mastering Lab took home an Altec 604 speaker system and he asked himself "If this is the standard of the industry, why is it that it doesn't have the high end? Why does it have certain distortion properties?" So he did something very simple. He took a condenser and he made a simple crossover network. Now while it wasn't flat, he found that it really sounded musical. And so developed the Mastering Lab speaker system, through a very simple experiment and a lot of Doug Sax integrity. And we've got the first system with coils that Bert Sax hand-wound and it's a wonderful system.

**That became a pretty famous mixing system.**

Studio One became a major mixing room with people coming from all over the world to work there. It became a comfortable room for a lot of people, and not as acoustically dead a room as you might expect a control room to be. It's very much like a living room atmosphere. I also built onto it a 12' x 17' overdubbing room because I felt a great need for people to overdub in perspective with the mix.

We continued to expand our facilities and about five years ago we added a recording room, which was against our original idea of just having a mixing room. We most recently built Studio Three, a nice little room for tape copies or for rough mixes with a twenty-four track machine. It's an overflow room with a lot of flexibility.

**Let's get to the present. What projects are you working on now?**

I've recently been involved in a very important project with someone who is well known to the world. This is how it happened:

I received a telephone call in August from Burt Bacharach, who said to me, "Would you like to do a live recording with me, the Houston Symphony Orchestra and a band?" Now, my background was in classical music and, as a violinist, I had played with symphony orchestra, ballet, and opera from a very young age. So, needless to say, I jumped at the opportunity.

So we went down to Houston with the Record Plant remote truck and my very good friend Jack Crymes, who I had done many remotes with.

Burt wrote the material, played piano and conducted the band and orchestra. This was a concept arranged and conceived by Burt and Michael Wolcocks, the manager of the Houston Symphony, who coproduced the album with me.

I must say that it turned out spectacularly and is due to be released very soon on A & M. In fact this session should be a topic for an article all by itself. It was a very special event. We cut two albums in seven hours of recording and it all worked just magnificently.

**What was the material like?**

The two albums that we did were, first, the conventional album with Burt's standard songs. Then we did an album with all new material that I believe is going to be musically very important to people. A great deal of love and energy went into it and our single most important goal was to make the best album possible with this material.

Another exciting thing for me about this album is that it is the first time that I have had my name on a record as a producer. I really hope people will feel all of the enthusiasm that went into this record.

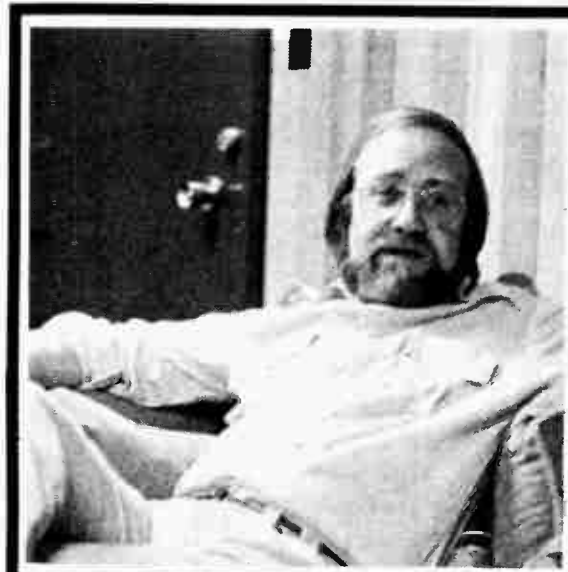

***"Boredom is the biggest waste of time to me."***

**How do you feel about some of the technical things that are happening in the industry?**

I would like very much to get involved in the digital area because I think it is a natural progression. I think it is going to involve a lot more than just putting a tape machine in a control room. My feeling is that the digital tape machine is going to show up a lot of problems in the rest of the equipment, noises and distortions that were heretofore masked by the tape medium itself. However, if I can get involved in the transition from the analog to the digital world, that would suit me very well.

**You've had quite an illustrious career in this industry. Besides being in the right place at the right time, you seem to have boundless energy.**

I like to give a hundred percent of a hundred percent. I don't like to be bored. Boredom is the biggest waste of time to me. If I could get by with less sleep and have more things to do, I would like that very much.

The industry has been very good to all of us, even though we may not always agree with it. But it has been very good to us and I think we should never forget that. 🎧

*Edcor*  *Cabrec*  
**CM 1000, 2000, 2100**  
**Capacitor**  
**Microphone**  
**System**

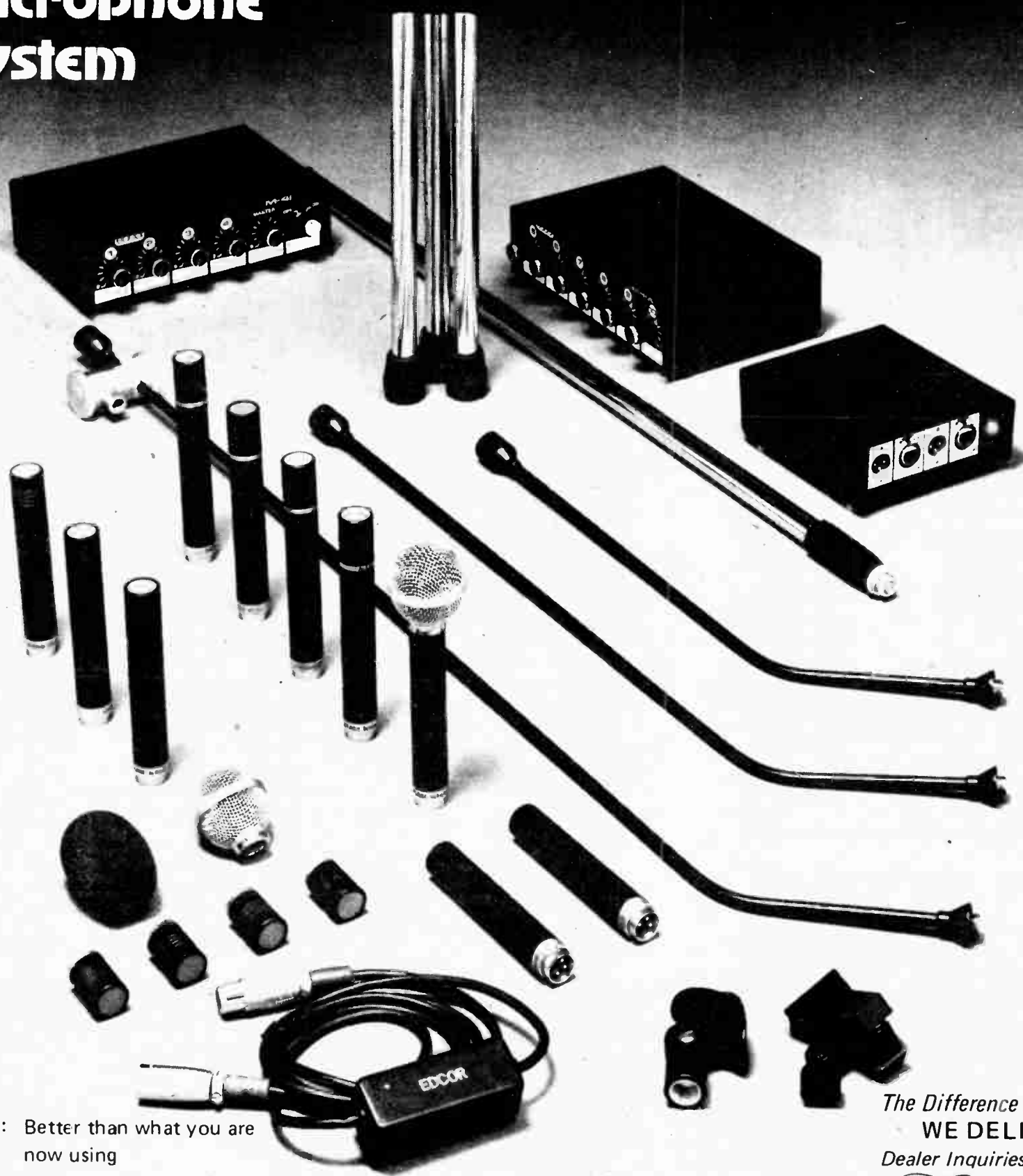

**Quality:** Better than what you are now using

**Pricing:** A shade less

**Service:** Quicker than what you are use to

**Specs:** Please compare

**Delivery:** How quick do you want them?

*The Difference*  
**WE DELIVER**  
*Dealer Inquiries Invited*

*Edcor*

16782 Hale Avenue • Irvine, CA 92714 • (714) 556-2740



# SMPTE

## Time Code

by Ed Lever

*The Society of Motion Picture and Television Engineers (SMPTE) Edit Code is a binary digital signal used by the broadcast and television industry as a standard method of indexing particular magnetic tape locations by means of a unique code "address". Once printed (recorded) on the tape, it can provide an accurate reference for logging, editing or electronically synchronizing audio or video program material recorded on separate reels. Through a mainstay in the video industry, its applications were slow to gain*

*acceptance in music recording. Over the last couple of years, however, interest and enthusiasm for tape synchronization has grown in the industry. As hardware costs have come down and more sophisticated control systems developed, SMPTE code use has proven to be another valuable tool in music production.*

### How is SMPTE time code being used now?

Well, perhaps the most popular application so far has been in the use of multiple machine recording and mixing techniques. More and more frequently the groups, engineers, and producers are finding that they need more tracks to work with than are available on either 16 or 24, so they are using a second machine running synchronously with the first to provide an extended number of available channels on which to print the program. Also, in some cases, if the more particular artists or producers find that 24 channel machines aren't providing an acceptable sound quality, they can take advantage of the superior signal to noise ratio of the 16-track format, but regain a number of sacrificed tracks by locking more than one 16 track together.

### How flexible is it?

Multiple machine recording also opens up a wide variety of special effects techniques under a high degree of control (real flanging, crossfades, etc.).



In addition to machine synchronization with SMPTE, the code on the tape can be used as a reference to control peripheral signal processing devices at particular tape locations. A good example is the Neve "Necam" automation system. Instead of recording the fader programming code on the tape itself the Necam uses a minicomputer to store the mix information on a floppy disc memory which corresponds each move to the SMPTE address for that particular tape location.

### Can you give us some specific examples?

Sure, the Supertramp album. The idea was to make more available tracks.

### Which Supertramp album?

The one that is currently in production. I think it is called "Breakfast in America". The method begins like any other album recording. They used a 24 track to print the basic program material, like the basic rhythm section and other primary tracks. Afterwards they transferred some rough mixes or combinations of those already recorded tracks onto a second machine while simultaneously stripping SMPTE time code into a single track of each tape. This was a cute method for a couple of reasons. Since the group could use the combined transferred tracks for cue or foldback, they could then put the original master away and continue working on the second 24 track

tape alone, adding tracks until they'd completed their arrangement. This had the dual advantage of allowing the group to work with a single machine during the extensive overdubbing process, and also save the vital transient information contained in the basics from the numerous passes over the heads. Anyway, they finally brought the reel pairs for each tune back together again by synchronizing the two machines while mixing, thus using all the discreet program for up to 46 channels of source material.

Another somewhat more creative example of SMPTE use was during the recently released Toto album. The dual-machine approach for track expansion was also used. Here, however, through a method called "offsetting", we were able to take a vocal or guitar track which was performed in a certain place and move it around to another section of the tune. Let's say the arrangement you laid down did not call for background vocals in the first chorus, but they did appear in the second and third choruses. Later, you decide you want those vocals in the first chorus too. By the creative use of offset, you can perform this.

### Please explain what you mean by offset.

Okay, first it helps to know that the SMPTE time code is laid down in bursts of pulses called frames — 30 frames to the second. Each frame is unique from the rest, since the sequence of pulses which makes up that frame contains coded information defining a particular moment in time, so that a particular frame may be identified as, say 14 hours, 23 minutes, 4 seconds and 17 frames, shown by 14:23:04:17. As the tape moves forward, these frames or "addresses" progress sequentially. Now the synchronizer reads the code from one machine which it calls the Master machine. The synchronizer then assumes control over the capstan of the second machine, called the Slave, and speeds it up or slows it down until the code being read off the



slave exactly corresponds frame by frame with that of the master. In general, this is the normal mode of operation that is, for the two tape's time codes to cruise by in identical address sync, the slave following the master.

However, it is possible with certain synchronizers to initiate an offset in time code address between the two machines. Let's say that the difference in time between the first chorus and the second chorus is 41 seconds and 12 frames. If you key into the box an offset of 00:00:41:12 you can retard the slave so that it will always run exactly that far behind the master, regardless of where the two tapes are. That way, when the master is playing the second chorus, the slave will be playing the first. It is then a simple matter to transfer any program tracks that appear on the master tape to open tracks on the slave tape, or the process could be reversed (Slave to Master) depending upon what you want to move. Of course, once you have completed the transfer, you disengage or defeat the offset so that all the music will again be rolling in real time. So you now have duplicated program material where there was none before.

### Is offsetting a standard synchronizer feature?

Several manufacturers (such as Studer, EECO, BTX, and MCI) offer the offset feature, but I believe that the newest EECO unit offers the most flexible and sophisticated option.

### Some of the companies you mentioned are tape machine manufacturers. Can their synchronizers be used with other machines?

Well, the EECO and the BTX are not tape machine manufacturers, and they can deal with a wide variety of machines. However, the Studer, for example, can only work with Studer machines. Same for MCI, but they plan to have interfaces for other machines.

### You mentioned "interface". Is this one of the things we need to know about before we can plan to use a synchronizer?

The most important thing to find out first is whether or not the synchronizer you have in mind will satisfy your application requirements in so far as available operational features, and then, if it will interface correctly with the tape machines that you are planning to use. An interface in this case means an electronic device or circuit that converts the synchronizer's control signals, such as capstan velocity and deck control commands into information that the tape machine can understand. For example, the Mincom M79 series requires a variable voltage for external capstan servo control, whereas the Ampex MM1200 external capstan control responds to a variable frequency. A good example would be the BTX versus the EECO MQS systems. The BTX has interface capabilities for a wider variety of machines: 3M's Ampex's, MCI's, and so forth, whereas the MQS100, although it offers many more features and is more sophisticated in its functions, at this time cannot interface with as wide a variety of machines. However, more interfaces are in the planning stages. This would be an example of a decision you might have to make; sacrifice functions to accommodate a preference of tape machine configuration, or choosing a different machine to be able to use a slicker box.

### You mentioned several major machine manufacturers. Can any of these systems operate with a wider variety of machines, say half-inch 8 track or one-inch 16 track?

Well, yes and no. To better understand what is and isn't possible with the available equipment, it helps to group synchronizers into two basic categories; the simple synchronizers and the more complex automatic control systems. Since the simple synchronizers perform no control functions on the master machine, they require only an audio connection for the master code input. Any machine with an audio track of sufficient bandwidth to reproduce SMPTE time code can act as the master. The master machine could actually be a cassette machine or a video machine where an audio track has the SMPTE code on it. To function as a "slave", however, a tape machine must have a capstan whose speed can be varied (controlled) from an external source. It may be possible to modify or construct an interface yourself for the synchronizer to operate your machine as a slave unit. However, at this time the most readily usable configurations would be with the major manufacturer's tape machines as slaves. In the case of the more sophisticated boxes, virtually all of the slick operations they perform require total control over both master and slave machines and therefore complete interfacing of both machines.

### You mentioned video. What's the relation?

Well, you should know that SMPTE time code and synchronizing techniques came out of the video-tape technology and these procedures have been used for a long time in synchronizing tape machines together for logging, editing and sweetening purposes.

### What about cost?

The EECO and BTX synchronizers run about \$10,000 to \$20,000, of course this does not include the cost of a second machine, interfacing, or expanding your consoles for the required number of inputs.

### What if you only need these systems occasionally?

Well, it is economically feasible on many projects to rent these systems, and there are companies, ourselves included, who make available these systems, both the machines and the synchronizers, on a rental package basis.

### That sounds like a plug.

Well, not really, most studios seriously looking at a SMPTE system are doing so because they have a project that requires it or are looking to add it to an updated or new facility since the studio business moves quickly in many directions. The advantage, at least on a project basis, is the experience of the rental companies. They can advise and consult on the application, handle maintenance, and packaging of the system. Some examples of how you could use their experience are, 1. If you are planning to cut your master tape don't print SMPTE until you have completed all your edits. 2. Don't print SMPTE next to extremely transient tracks. 3. Don't print SMPTE on an edge track if you suspect tape edge damage. There are other examples we don't have time to go into now.

### How do you think SMPTE time code will be used in the future?

Well, as I mentioned before, it will expand the flexibility of the recording/mixing process. Again, the future holds many great things depending on the control systems that are developed.

### How So?

The merging of the audio and video fields is a prime example. People who are heavily involved with record production are now getting into the visual aspects as well. I don't mean just on stage. They are now involved with making shorts, as sales aids for record stores and movie theatres. They are doing television specials, feature length films, and commercials for prime time. The more involved they get, the more they realize that the audio and visual mediums must be properly combined for maximum effectiveness. This responsibility usually falls to those concerned with the music (sound). By using the SMPTE format, they are provided with a means of controlling the mixing process while watching the action on a screen and having the whole come out in sync at the end. And, with the convenience of doing it at a studio (if so equipped) of their choosing.

### Well, that's about all the time we have. Is there anything you would like to say in closing?

Yes, you must remember that these techniques and devices are not cure-alls or panaceas. They are merely tools and should be treated as such. With this in mind, by implementing these systems you should find an expansion of your creative capabilities.

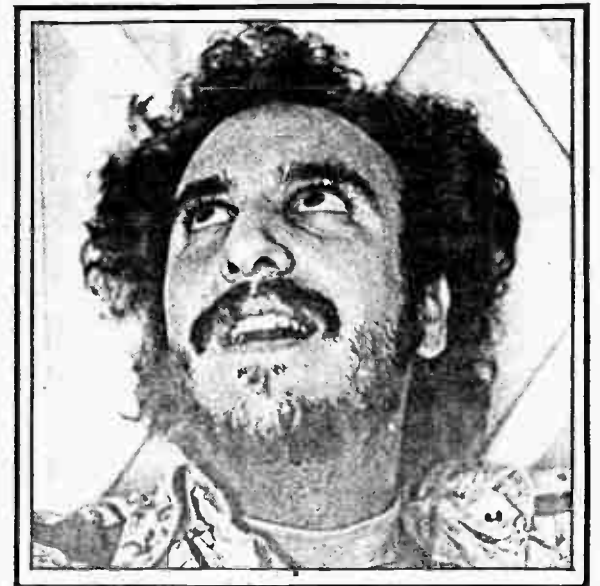

*Ed Lever's background includes recording studio experience with major album credits as a recording/mixing engineer, work as a professional musician and six years of study in applied physics at the University of California at Berkeley.*

*Ed is founder of Canyon Recorders, a Los Angeles based firm specializing in synchronizer and tape machine rentals. They have provided equipment and technical support for several motion pictures ("The Last Waltz", "Hair", "The Rose") and album projects (Rod Stewart, Supertramp, Captain & Tennille, etc.).*



# THE BEST VALUE IN A PROFESSIONAL TAPE RECORDER

When you compare a tape recorder, here are the most important areas to consider for value, quality, and sound.

## PERFORMANCE:

Overall Signal-to-Noise: 66 dB unweighted at 520 nWb/m (30 Hz to 18 kHz audio filter).

Playback Signal-to-Noise (electronics): 72 dB unweighted (with audio filter).

Headroom: +24 dB. Maximum Output: +28 dBm.

Overall Frequency Response (15 ips): 30 Hz to 22 kHz  $\pm 2$  dB.

Playback Frequency Response (MRL test tape): 31.5 Hz to 20 kHz  $\pm 2$  dB.

**RELIABILITY:** An unmatched 4-year track record of on the job performance for the original compact professional recorder. Day in, night out. Just ask someone you trust.

**ALIGNABILITY:** Any tape recorder must be aligned to achieve maximum performance. With the MX-5050-B, all primary alignments including record bias and level are on the front panel. So is a 1-kHz test oscillator. Secondary alignments are inside the bottom panel. You or your maintenance people can align it fast and easy. This saves you time, money, and enhances your reputation.

**INTERFACEABILITY:** With a flick of the output switch you can plug-in to any system: +4 dBm 600 ohm or -10 dB high impedance. No line amps or pads to mess with. A perfect match everytime.

**ADDITIONAL BENEFITS:** Three speeds, dc servo  $\pm 7\%$ ,  $\frac{1}{4}$  track reproduce, full edit including indexed splicing block, over-dubbing, noise free inserts, XLR connectors, NAB/CCIR switching, unique 3-position alignment level switch.

**PRICE:** Suggested retail price \$1,945 (USA).

## MX-5050-B: THE CHOICE IS OBVIOUS

# OTARI

Call Ruth Pruett on 415/593-1648 for the name of your nearest Otari professional dealer.

Otari Corporation, 981 Industrial Rd., San Carlos, CA 94070 TWX 910-376-4890

® In Canada: BSR (Canada, Ltd.), P.O. 7003 Sta. B, Rexdale, Ontario M9V 4B3 416/675-2425







**Nevison**

# Névisón, Ron, n [from rock and roll]

**1. recording engineer;**

**Record Plant, Los Angeles; Quadrophenia, The Who; Tommy Soundtrack; Bad Company.**

**2. record producer; Dave Mason; UFO; Babys; Lion.**

by Kenneth Kubernik and Saul Davis



Up until the early Sixties, popular music, for the most part, was produced by individuals more concerned with marketing and packaging than with artistry and imagination. Hits flowed with a mad momentum and crazed entrepreneurs foamed with enthusiasm over their latest discoveries. Artists were assembled and dismantled according to the dictates of a new wave consciousness; i.e. the consumer. But the building blocks of this new musical expression were continually obscured by frivolous huckstering and the DNA of rock 'n roll remained a mystery.

The breakthrough was the discovery of a missing link; the force that sculpted and infused the music with personality and individuality, or, as Tom Wolfe described him, "The First Teen-age Tycoon of Rock 'n Roll," Phil Spector. His recognition of the studio as an instrument with unique and invaluable characteristics elevated pop music from the anonymity of the Fifties into the glorious Sixties. His noble and worthy accomplishments laid the foundation for the role of the producer as a mover, a creator, an instigator, a channel for vascillating artistic energies. Skilled producer plus talented artist yields a plentiful harvest — a formula that has endured.

Producer/engineer Ron Nevison, although stylistically light years removed from the *Spector wall of sound*, shares Phil's philosophical space: "As a producer, you want to make sure you have all the ingredients before you even agree to be this person. You look at the artist or the group and if they have enough to work with, only then can you even consider the project. You have to work yourself into a position where you take projects not because you need the money but because it's a good place to be. If someone comes to me with two songs out of ten, no way. But if they have seven or eight, I then have something to work with. You have to have the material. You have to have all the component parts. Then your job is to make the best use of the time and the people involved. The producer is an

organizer, a supervisor; you get the best people and you get the best work out of them. Of course you're going to likely get a result, depending on the artist's qualities, that only you could get. Each producer interprets differently. Songs can be speeded up, slowed down, done reggae, done disco, or done in several various ways within the rock genre itself. You need to end up with the best Ron Nevison/Who album possible at that time, or the best Ron Nevison/Lion album, whoever.

"I think that getting a successful sound for an artist is far more important than getting a producer. It's like typecasting sounds. If you look at the albums I do; UFO, The Babys, Dave Mason, none of them sound anything alike. The key is to get the artist a sound, an identity. Obviously there's going to be a thread that runs through the things I do, maybe because I use a lot of the same people, arrangers for instance, or the same studio. There're going to be comparisons. But I strive completely to bring forth the individual and unique sounds from whomever I'm working with. Other producers may have another idea of how to work."

Nevison's much-acclaimed musical instincts have guided him through a myriad of recording experiences; from engineering The Who's 'Quadrophenia' and 'Tommy' Soundtrack, the first three Bad Company LPs, Led Zeppelin's 'Physical Graffiti', and The Stones 'Love You Live' to co-production with Dave Mason on his 'Certified Live,' 'Let it Flow' and 'Mariposa De Oro' albums. Similarly, his full production credits on LPs by UFO, The Babys and his latest project, Lion, reveal a singularity of thought and action that has coalesced into a standard operating procedure: "From 'Quadrophenia' on and to this day, I've never worked with a producer, never. I've never sat with another engineer and learned. Since 1973, I've worked only with artists who produced themselves or I produced them and engineered. I've come to things that I'd never recorded

before, obviously, and I didn't know what the hell to do. Result, trial and error. You put up a mike and if it sounds okay you push the record button. Basically I have a very unorthodox way of working but it works for me. There's no substitute for experience but you have to make due.

"If I felt I wasn't cutting it as the engineer, I'd replace myself. Some people say that you can't be objective in both roles. I think I work faster like that, it helps me. Sometimes working with an engineer means you have to satisfy him, you have to compromise. I don't want to compromise. At least not for someone else's sake, for artistic purposes okay. As soon as you start compromising, the quality vanishes. Remember, I've always worked like this, by myself. I started this way and I've developed it."

Nevison's extraordinary track record developed out of a fortuitous set of circumstances that snowballed into the uniquely satisfying position that he holds today. "Simply, I had a lot of contacts," he remarks candidly. "The three tours of America I worked on as a sound mixer before going to work for Island Records in England were Derek and the Dominoes, Mad Dogs and Englishmen and Traffic. After the Island Studio affair I went to work for Eric Clapton as a roadie. I needed a gig, he's a friend of Pete Townshend, it all just sort of unfolded. I did a lot of sessions and bits of LPs in England but the first credible one was 'Quadrophenia'. Following my experience with Townshend I did the next Led Zeppelin LP, 'Physical Graffiti', and from there, Bad Company.

"When I was supposed to begin recording 'Physical Graffiti' with Led Zeppelin, John Paul Jones was in the midst of a family matter and couldn't make it. So we recorded old Elvis Presley songs for a few days and postponed the sessions. At this time their manager, Peter Grant, had taken Paul Rodgers under his wing. I'd already helped Paul and Bad Company



record some demos so Peter said that since we had the studio rented anyway, why don't you record them instead. That became the first Bad Company album. We recorded it in ten days and mixed it at Olympic in another ten and there it was.

"No question that these things mushroom; but, with groups like that, you don't work with them because you worked with someone else big but rather simply because of the actual sound you were able to achieve. You become a name and that name gets tossed around if it's time for a new producer or engineer. 'Ron Nevison? Who has he done? The Who, right, I liked that sound, let's check Nev out.' That's the form it takes."

Nevison's interest in music was originally cultivated in Philadelphia where, as a young child, he was a featured soloist in a boys choir. Inevitably his voice changed but the shift in octaves did not undermine the firmly established musical impulse. "I sang in groups for years, be-bopping in the subways of Philadelphia, my hometown. After high school, I got out of music, at least I didn't consider it as a career. It was drummed into me to go to college and 'be something'. I really didn't get back to music for a few years until the time when I started promoting concerts with a friend in the Philadelphia area. We didn't do very well but the guy I hired to do the sound and I later formed a company and we started doing sound and lighting and staging. I did that for a couple of years. During that time I mixed the sound on the road for a lot of people like Traffic, Joe Cocker, Eric Clapton. Then I decided that the next step for me — this was in '68-69 — would be in the studio.

"No one has schooling background in recording. I didn't learn recording until I was in the studio. I learned about sound and music performance, but I didn't have a clue about recording techniques. I knew what happened, but I didn't know how it happened, how to make it happen. From there I met Chris Blackwell, the head of Island Records, who was also managing Traffic at that time. He said, 'If you're interested in working in the studio, come over to England and I'll put you to work.' So I went over and worked in the studio for a few weeks, very petty.



Pete Townshend

I liked the sound, I liked the state of the art, but the seniority trip, I just didn't dig the atmosphere. So I left.

"I knew so many people in the music business — I was one of the best live sound mixers from the States at that time. Compared to now, concert sound was pretty primitive but I made a lot of contacts. I formed a company with John Alcock and Pete Townshend called Track Plan which was initially formed to

build recording studios for musicians and friends, eight-track studios in their homes. It would make it easier for them to do their demos, etc. And, from that effort we built studios for various people in the United Kingdom; Roger Daltry, Cat Stevens, Ronnie Lane, and Ronnie Wood. We also constructed one for The Who called Rampart.

"We weren't present in the beginning stages of the Who's studio. It was pretty much of an abortion by the time we got our hands on it and we helped straighten it out. It was at that time that I cut 'Quadrophonia' with The Who. Their control room wasn't ready so we used the remote truck that I'd built for Ronnie Lane in an Airstream trailer which, at that time, was an eight-track. We cut all the tracks for that album on eight-track and on one weekend I, myself, converted the whole truck to sixteen-track. Then I went to Olympic Studios and did eights to sixteens on everything and we started back on Monday on sixteen-track. Then we mixed it at Pete Townshend's new house. The result being that a lot of work went into "Quadrophonia" but I was never happy with it sonically. I was *very* pleased with it artistically. I thought it was brilliant, but then, Peter is brilliant. Again, it suffered generation loss from going from eight to sixteen. The bass is remarkable, though, but John Entwistle is responsible for that. Sometimes there are sounds that stand-up through anything regardless who records them. John's one guy who always knows what's right.

"'Quadrophonia' was the biggest thing I'd undertaken up to that time but then I haven't undertaken anything that big since, except for maybe the 'Tommy' Soundtrack. 'Quadrophonia' was a double album and Pete and I went out to the south of England, Cornwall, with the remote truck for three days and just recorded quadraphonic seas noises. We pulled up to the beach — because we had this fantastic idea that this was going to be a quad album — and we did a lot of work that went for naught. We had all sorts of equipment over there and MCA couldn't make up their mind as to what quad system they wanted to use, this being 1973. So we were very disappointed, we did a lot of effects — things spinning around the room — of course quad as a soundform failed.

"I went out to Regents Park to get things like brass bands. I'd sit there for half-an-hour and they wouldn't play the kind of thing we needed so we'd ask for a Sousa march — we went to extraordinary lengths to get the sound effects together — the BBC library was very limited, they only had mono effects. We bribed the train conductor in Victoria Station to blow the whistle for the song "5: 15". I spent two days in a tent in Wales for a lot of the rain noise that we used. Pete and I and my assistant and a guy who worked for Pete all contributed to the effects. You can't just command thunder to happen.

"In the States, especially in Los Angeles, there are and were extensive sound effect libraries but there were quite a few unique sounds we were looking for; picketers and rioting, people shouting, etc. I took my tape recorder to Hyde Park and stuck the mike at Speakers Corner and I got arrested by two policemen who said that you weren't allowed to record anything in the Park.

"When you work with a guy like Pete Townshend, well... it took me awhile at first to function properly, in my own mind at least. I was in awe of him but, by the time we were into the project, we'd established a working relationship.

"I can't think of anyone that I respect more as a creator or innovator than Pete. But he has his shortcomings. He's too short with people sometimes. You need, or a producer needs to give each individual enough space and time where they can develop to their potential. It's essential to having your project the best that it can be for that time with that combination of songs and people.

"I was learning with The Who. Between 'Quadrophonia' and the 'Tommy' Soundtrack I spent about two years working with Pete and The Who. I really didn't have the experience that one would expect the engineer to have working on such 'world class' projects. People around me gave me the confidence to do it. I made mistakes but I contributed. For instance, as far as Keith Moon goes, I felt that on previous albums he'd been much too slick. I visualized him as much more primitive and brutal and that's the way I tried to record him. I put my two cents in and I presented ideas. If they liked them, great. It took a few years before I had total participation in projects or total control.



The Babys

"Producing can be very difficult, very tedious. And once you've committed yourself, you're in for the duration. If you're a professional you don't lose interest mid-project. The first Babys album was done by a capable producer but the LP didn't happen. I think he just lost interest. I think that with the next LP, the one I did with them, we made a good record. And with the newest one, 'Head First', we've done it good again...

"Dave Mason had a few years where the LPs just weren't coming together properly. It was due maybe to a number of forces, I don't know, but I think that as we worked together on the three LPs, we brought him back up to where he should be.

"UFO was a group that had three albums out, produced by Leo Lyons, a very talented bass player from Ten Years After, but he wasn't a producer. 'Lights Out' was the first one I did with them, then 'Obsession' and now a live album, 'Strangers in the Night', is out. I feel that this new one brings their whole catalogue up to date. I'd always liked them but it never sounded powerful enough or state-of-the-art.

"I hadn't done a new artist in a long time, Lion is the first one. I've actually known the guys for years and been watching them. I have been listening to their songs for the past eighteen months and once they got a deal (A&M) and I had some time we got into it. It's a great album and we all have high hopes for it. I wouldn't do a new artist unless I was ready to do a couple of albums with them. My commitment must be no less than the commitment the artist makes to his music." 🎧





*A professional musician, music publisher, inventor, author, Larry Blakely has been actively involved in the high fidelity and professional recording industries for more than twenty years. Prior to becoming Director of Marketing for dbx, Incorporated, Larry served as a recording engineer at Sunset Sound in Hollywood, and invented a number of devices in the audio signal processing field, including the first parametric equalizer, in 1966.*

**W**e are living at a time when the advancements in electronic technology are taking place at a very rapid rate in the world around us. Historically, advances or changes in recording equipment have usually taken place at a slow pace, however, the majority of recording equipment developments over the years have not been as radical as those facing us now. The evolution of multi-track recording has brought perhaps one of the largest changes in the industry, not only in the tape recorders themselves, but also in functions added to recording consoles and even the way the recording process is done. The Dolby tape noise reduction system brought about another significant change in recording, followed by other tape noise reduction systems such as the dbx and the Telcom. A few years ago the concept of automated mixdown was introduced and this has also made its mark on the industry.

Years ago a friend told me, "There is nothing more permanent than change". Consequently, I feel that it is important that we all prepare ourselves for what ever changes in equipment and recording procedures may come along. In my past twenty years in this industry I have seen many changes, but these changes are nothing to those we will all face in the near future. Recording equipment is rapidly evolving into

# IT'S TIME TO RE-THINK OUR PROCESS FOR EVALUATING RECORDING EQUIPMENT

by Larry Blakely

high technology equipment. Digital and other advanced recording and signal processing techniques will be continually placed in front of us by manufacturers and it will be a responsibility for each of us to look at this equipment, use it, and evaluate it to see if it does indeed meet our needs and if it sounds acceptable to us. I have just hit the meat and the purpose of this article. "DOES IT SOUND ACCEPTABLE TO US". Every recording engineer has selected and used recording equipment that sounded good to him or provided him with a certain desired effect. We always have had, and always will have, the responsibility of evaluating recording equipment for our own uses.

Recently I have been talking with many people regarding digital tape recording, a whole new ball game in the way tapes are recorded and reproduced. Is the sonic quality of digital tape recording satisfactory for our purposes? Sooner or later we will have to evaluate digital and make our own decision. When we have the opportunity to evaluate it, how will we do it? This has been a subject of great concern to me. I want to give you some of my thoughts and related experiences as to the ground rules one should use and why, when making such an important evaluation.

**M**any recording engineers do not like electronic signal processing of the entire signal. Such a type of signal processing is that done by compander type tape noise reduction systems such as Dolby, dbx, and Telcom. Many engineers feel that such noise reduction systems do too much electronic manipulation of the signal and that this is undesirable. Digital recording converts the entire signal to a set of digital numbers, stores them on tape, and then converts them back into an analog signal. This is a major electronic manipulation of the entire audio signal. Sooner or later we will have to evaluate this digital recording process and maybe even other processes that manipulate the entire audio signal. It has been my personal experience

that most times such an evaluation is done incorrectly.

An example that I will share with you happened to me many times when I was working at dbx and demonstrating the dbx tape noise reduction system. Focus your attention on the evaluating processes.

**I**would go into a studio control room and set up an A-B-C comparison. 'A' would be direct to the tape recorder (no noise reduction). 'B' would be on another track that was processed with the Dolby system. 'C' would be on yet another track that was processed by the dbx tape noise reduction system. I would have a musician go into the studio and play while we would record a monoral signal on all three tracks of the recorder with the noise reduction systems connected as described above. When the musician was finished playing, we rewound and played the tape, selecting the recorded A, B, or C tracks for comparison. After this comparison the first comment that I usually heard was that the dbx track had lost high frequency response. I would look back at the engineer and say that he was right and wrong. I would then send the musician back to the studio to play again and tell the engineer that we would do yet another comparison. This time we would do only an A-B comparison between the signal from the console monitor section (the signal that was feeding the tape recorder inputs) and the dbx signal off tape. We would do this A-B comparison while the musician was playing. I would then look at the engineer and ask if he heard any loss of high frequency. He would look back at me and say, "No".

The original A-B-C comparison was made from recorded tracks, a conventional tape track, a Dolby tape track (that he was familiar listening to) and a dbx track (that he was not familiar listening to). The engineer heard something wrong when he compared the new dbx process to a recording process he was familiar listening



to. However, when the dbx track (that he was unfamiliar with) was compared only to the console monitor signal (live sound) he heard no loss of high frequencies. Let us look at some of the reasons why he heard a difference in the frequency response.

Ever since we have used tape recording in this industry, we have been living with tape hiss. Tape hiss is a steady background noise level that the ear will usually tune out or subconsciously interpret as high frequency content in the recorded music.

**T**here is yet another phenomenon that takes place in analog tape recording called tape modulation noise. Tape modulation noise is sidebands of noise that will increase and decrease with the level (amplitude) of the signal. In other words, this is a hiss envelope that is added to the recorded signal. Tape modulation noise goes up and down in level with the signal and is usually masked by the constant background tape hiss. This hiss envelope will also make an analog tape recording sound like it has additional high frequency response. The presence of a constant background hiss and tape modulation noise can trick the ear into thinking it hears additional high frequencies when, indeed, it is only hearing two types of noise that have been added to the recorded signal. These are only two of many problems that exist and have always existed in analog tape recording.

When someone comes along with an entirely new process of tape recording (like digital) what is the first thing we are likely to do? We will compare recorded material on it to recorded material on our own analog tape recorder. WRONG!! We have all used analog tape recorders for years and have often blindly accepted this recording process with all of its problems and faults because it was the only game in town. We are at a point where we may have to admit to ourselves that what we have all known, used, and trusted so long may not be so good after all.

When making a critical comparison between two types of recording processes (analog and digital) we must first know that we are comparing apples with apples, and not bananas with apples. It's back to the basics. What do we record? We record live sound! What are we trying to capture on tape? We are trying to capture the live sound as accurately as possible. If we are to compare the sound of two different types of tape recorders, one will have a specific set of problems and the second may have yet another set of problems. The only decision that we can arrive at comparing recorded material of two recording formats is which set of problems do we prefer. We will likely be inclined to choose the set of problems we have lived with and are used to.

The only meaningful and truthful comparison that can be made must be made between the live signal (console monitor) and the signal off tape. A comparison of the audible sound between the recorders is simply comparing one imperfect format to another format that may be more perfect or even possibly less perfect.

**W**e are all going to have to stop and think seriously about what we have accepted as good recorded sound over the years. Our choice may not be so good after all, and on the other hand it may be just fine. But we must stop and think. We must also make meaningful and fair comparisons. The only fair and meaningful comparison of any recording process or recording format must be made directly to that of live music. 🎧

# Multi-VU Eyestrain? Get the Red out with VIDIGRAF®

Our new Model 970 VIDIGRAF display generator makes any standard TV monitor or receiver a bar graph display of up to 32 multi-channel audio level meters (VU Meters) or frequency spectrum increments. Ballistics closely approximate VU meter standards. Alpha numeric symbols are electronically displayed on the screen; no overlay masks required. The composite video output drives any NTSC monitor; an optional RF adapter converts any NTSC TV set to a bar graph display. Input cards for 16 and 32 channels, VU or spectrum, make the 970 modular and expandable, and very affordable.

So, get the Red out. Rest your eyes on a VIDIGRAF at your UREI dealer.

**UREI**  
QUALITY  
OF COURSE

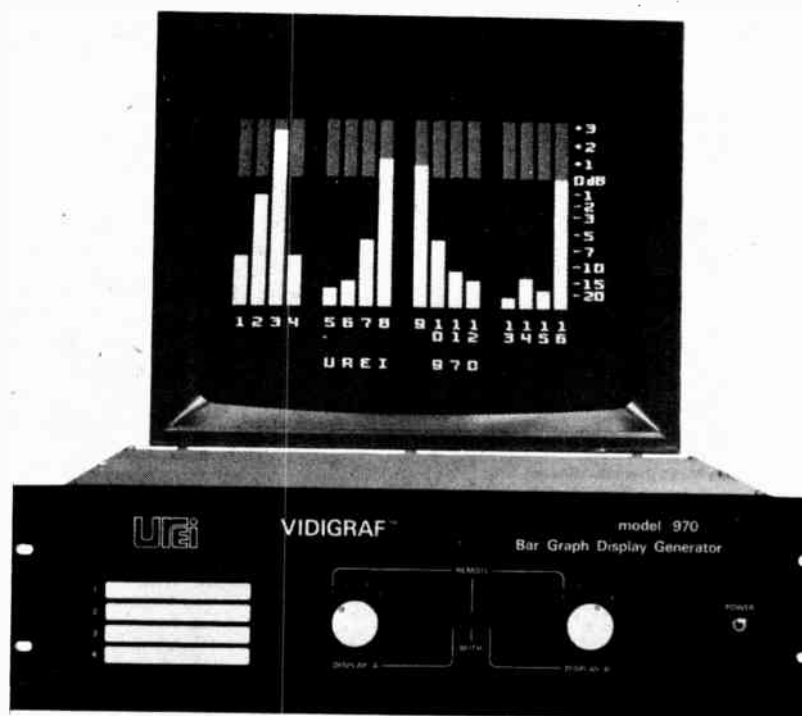

8460 San Fernando Road, Sun Valley, California 91352, (213) 767-1000  
Exclusive export agent: Gotham Export Corporation, New York

# OUR VARIABLE SPEED CONTROL WILL MAKE YOU CHANGE YOUR TUNE.

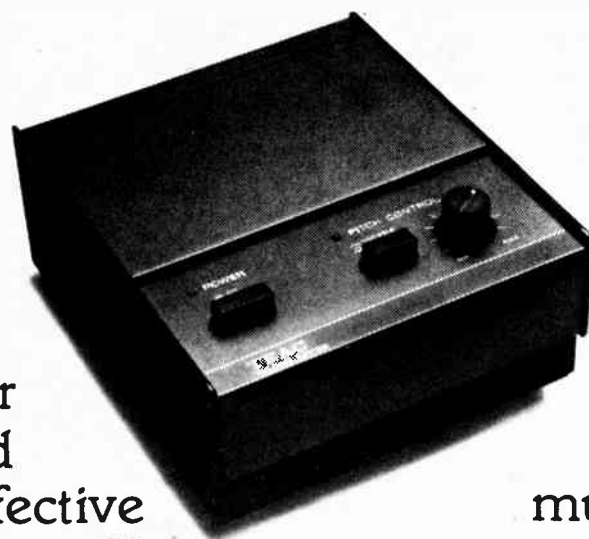

If you're already working with an 80-8 or 40-4, our Variable Speed Control is a very cost-effective addition. For just \$350\* you'll adjust 15 ips to the tune of  $\pm 20\%$ .

And you'll get a brand new single speed servo-controlled DC motor in the deal. Your multichannel recorder becomes more versatile. And it ends up lasting longer. Remember trying to over-



dub a piano only to find it out of tune with the track? Or sweat-

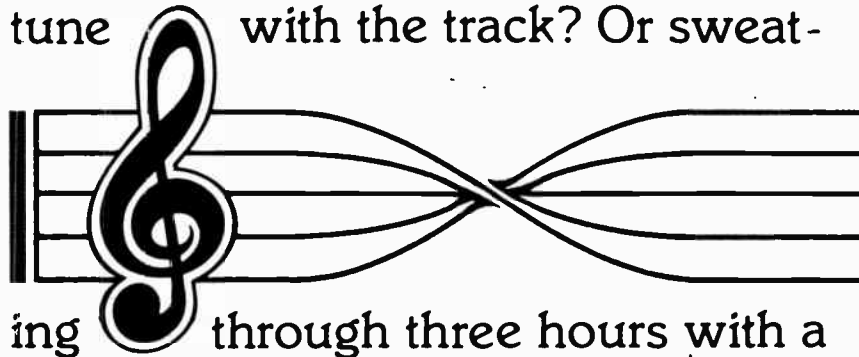

ing through three hours with a singer who flatted the last note of an otherwise flawless performance? You'll turn these late-night horror stories into lullabies with Variable Speed Control.

Try it for adding a "tunable tom" effect to your song. Then experiment with other rhythmic twists.

Turn two singers into a chorus of eight. Add harmonies. Transpose from A up to C, or back down to

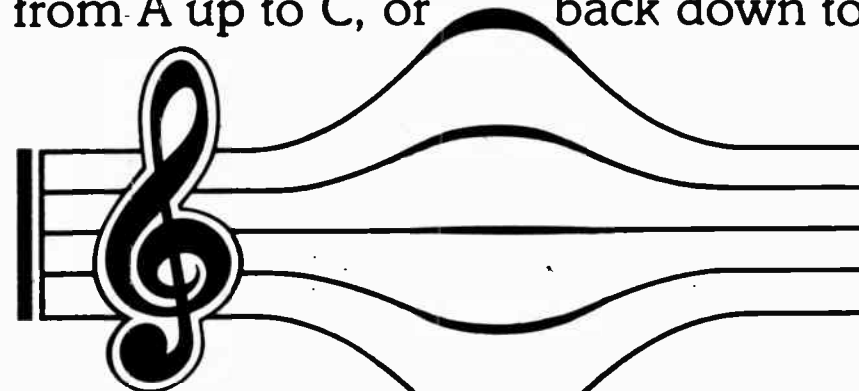

F#. With the 80-8, you have eight tracks to build your song.

When you're working with synthesizers, you can spend hours experimenting. Or seconds repairing an out-of-tune tone. Try creating your own special effects, bending and shaping other instruments to fit your ideas. Whether you have an 80-8 or 40-4, you have the capability to turn basic music into complex arrangements.

As a production aid, our Variable Speed Control becomes Executive Producer when that beautiful radio spot comes in at 32

seconds. Just rewind the tape, set the control and 28 seconds later you're right on the money.

For audio-visual soundtracks, slide or filmstrip audio tracks, Variable Speed Control lets you solve tough cueing and timing problems. Without re-recording, wasting time and losing money.

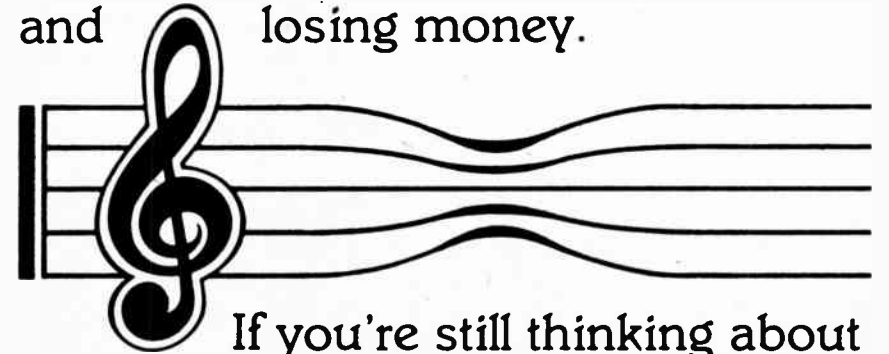

If you're still thinking about buying your 80-8 or 40-4, now is an ideal time because you have the option of taking it home with Variable Speed Control and new DC motor completely installed.

Let your Tascam Series dealer give you a hands-on demonstration. You'll hear how our new Variable Speed Control lets your 80-8 or 40-4 sing a new tune.

\*Suggested list price, optional with dealer; installation required.



**TASCAM SERIES**  
TEAC Professional Products

TEAC Corporation of America, 7733 Telegraph Road, Montebello, CA 90640.

# sound advice

## Editor's Note:

*Something bothering you about the studio business? Does it have to do with production, studio facilities, ancillary equipment, how a new product works, or just a question about the studio/audio business in general? This is a column for those nagging headaches caused by an acute lack of answers.*

*To treat these maladies we have retained the services of Dr. Richie Moore.*

*Richie has been in the audio/studio business for more than 15 years. He started out in San Francisco doing live audio for the early days of the "San Francisco Sound". After taking what audio classes were available in college, he migrated to England and secured a position at EMI Studios on Abbey Road. With two years of extensive learning as a tape operator for the Beatles, Pink Floyd, and many other groups, Richie returned to California to continue his career in Los Angeles. For the next 12 years it was college and work in the studio; doing groups like Little Feat, Canned Heat, WAR, Pablo Cruise, and about 275 other albums and artists. He helped design the Village Recorder and contributed modifications and design for Wally Heider's in L.A. as chief mixer for three years. In the process, he earned a Ph.D in Communications Science from the University of Southern California and a Masters in Film from UCLA. With some 16 Gold Records, 5 Platinum, and an Emmy, we think that Dr. Moore can be of assistance to you in whatever you want to know about the studio business.*

*For a prompt reply send your questions to Dr. Richie Moore, Mix Publications, P.O. Box 6395, Berkeley, CA 94706.*

Dear Dr. Moore,

As a musician with a low budget recording band, I am curious as to how the number of tracks a studio has relates to the quality of the work they can do. Can you shed some light on this for me?

Steve Logan  
Modesto, CA

Dear Steve,

The question of how many tracks, be it 40, 32, 16, 8, etc., seems to come into the planning of every recording session. It is an important decision, whether it be a demo or a master. It appears that the more tracks you use, and can afford, the better the product will be. This is definitely not necessarily so.

The point is that there are alternatives to the thought of *multimulti* track recording. What you need is a basic knowledge of recording fundamentals, the songs that you are going to record, and the quality of musicianship involved. A thorough examination of your recording game plan will tell you what you best have to do in selecting a studio and the amount of tracks you will need.

To help you analyze the track format you will choose for your project, let's examine a short history of the recording process. Over

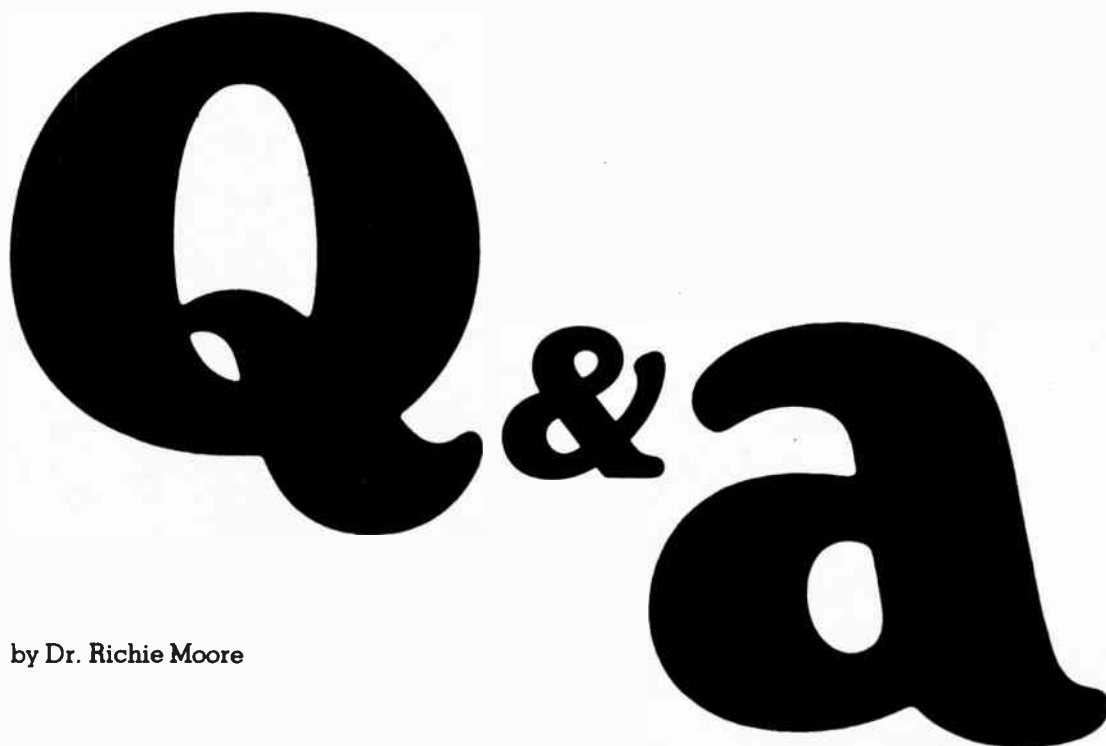

by Dr. Richie Moore

the past hundred years, we have progressed from the Edison Gramophone through wire and tape to 32 track digital recording. We have gone from live-to-disc to recording on a mono, 2, 4, 8, 16, 24, or 32 track tape; the ability to do it all at once, or piece it together one thing at a time.

When you go to record, get the tone of all your instruments to blend well with each other; then choose the proper mike and placement for the capturing of the sound. It should all blend well in mono, if not on a cassette machine, then on one channel of a reel-to-reel tape machine.

Let us remember that the Beatles were recorded in mono, two, four, and eight track for the most part. We all know that Sgt. Pepper was done in four track. The first track was probably done drums, bass, guitar, and something else. The second track may have been piano plus another two guitars. There was one track for vocals, and the final track was for everything else that had to be overdubbed. The idea was three or four things were assigned to one track. The key was just a good balance within the mix to that track.

Let us take a hypothetical case. Suppose in your production of a record that you wish to have the following instruments and vocals: bass, drums, acoustic guitar, synthesizer, lead vocal, harmony vocals, background vocals, live strings (90), fill toms, Leslie electric guitar, acoustic guitar double lick, and hand claps... at least twelve tracks, right? Wrong! The actual song in this hypothetical case was done on an eight track — "Here Comes The Sun" on the Beatles' "Abbey Road" LP.

The equipment now available to the artistic public is of very high quality. The material and devices that are reasonably available for your garage or nearby 4, 8, or 16 track studio can turn out tapes of master quality that will astound many an individual. All you have to do is find a competent engineer who knows his axe, a good working relationship, and a facility that feels comfortable to you and cares about your project. You may find that you don't have to spend a fortune for fancy names of products, a lot of tracks, and being just another client. In many cases, you the artist may find that less is more.

Dear Dr. Moore,

I'm in college and have a slight background in music. My major goal is not to create it but to capture it as a recording engineer.

It seems the trend in the industry today is toward specialization. I've read the brochures from the University of Sound Arts and Sherman Oaks, but now I would like your opinion — are these schools worth the rather costly tuition? And what about workshops or local sessions?

I've run up against a great stone wall with regards to information and instruction in the Bay Area, with the exception of the Mix, and would be willing to re-locate to Los Angeles if necessary.

Finally, what is the industry position on specialized education? Do Columbia, ABC Records, WEA, et al, respect the ability of these schools, or do they prefer to do their own training? As of yet I've received no responses from the big labels with regards to these questions, so any comments or opinions that you offer would be deeply appreciated.

Pete Maloney  
Hayward, California

Dear Pete,

Following this response you will find information on some of the various schools and workshops that are currently available to the aspiring recording engineer.

There is no real trend today as far as specialization in the audio field. However, you might consider there to be areas of better ability, rather than specialization. By this I mean that a person may be a good mixer in the studio, a good remote mixer, a good disc mastering engineer, or a good live P.A. mixer. All of these positions have one thing in common: a good underlying knowledge of audio technology. Of course you have to start somewhere to build this knowledge.

The record labels like Columbia, ABC, Warners, Elektra, all have their own studios, but use outside ones even more so. People that they



hire are usually well trained for many years. However remote, there remains the possibility that they might hire a "gofer" with some audio knowledge and let him work his way up. There is no harm in trying for a position with a major label studio, or any studio for that matter, but your letter of application or query is just one of very many received. In regard to local sessions, you could take the initiative to talk to various studios and their engineers about sitting in on a session. But a recording session by its own peculiar nature may preclude this possibility.

Even though I have written the curriculum for, and taught classes at the University of Sound Arts, I am a very adamant believer in the apprenticeship method of learning to become an audio engineer, no matter what particular area you plan to get into: studio, remote, live, disc mastering, etc. There is no substitution for a one-on-one learning situation in any field. Here it is very important to find a very competent engineer who is well rounded and not wanting to withhold the process of any technique.

I learned how to engineer from the ground up. Doing studio floor sweeping, answering phones, setting up microphones, being a tape-op, and just a general "gofer" for about 4 years, before doing a major session on my own. Other examples of this system of learning are Biff Dawes, Filmways/Heider's hottest remote mixer, Ken Calliat, Producer and Engineer of Fleetwood Mac's "Rumours" Platinum LP, and Terry Stark, President of Filmways/Heider. All started at Wally Heider's in the early 70's and now are at the top. I think that these people more than amply testify to the apprenticeship method. They are also a testimonial to Wally Heider — a great engineer and a wonderful man.

Wally Heider could recognize a potentially great engineer when he met one. All they needed was honesty, drive to be a self-starter, a non-quitter, and last but not least, to have the desire to do right by the clients and the industry as a whole.

In closing, there are no guarantees expressed or implied as far as employment goes in the recording engineer field, from the schools or anyone else. It is really up to you. ☺

Following is a short list of places in California which offer training and education in various phases of recording arts.

The information below has been provided by those listed. The Mix cannot assume responsibility for the accuracy of the information supplied to us. We suggest that the reader call the school for more specific information.

#### CALIFORNIA STATE UNIVERSITY

5151 State University Dr., Los Angeles, CA 90031  
(213) 224-3348

Contact: Michael Fruchter.

**Course Description:** Recording courses offered through the Music Department: Introductory course teaches basic recording techniques. Intermediate "Studio Recording" carries students through actual recording and mixdown sessions. Advanced course also offered. Audio electronic courses are offered through the engineering department. Program offers students a broad background in music and recording.

**Frequency:** Quarter system: classes start each quarter.

**Prerequisites & Registration Procedure:** No prerequisites for beginning course. Students must be registered at University.

**Accreditation:** Yes.

cont'd on page 26

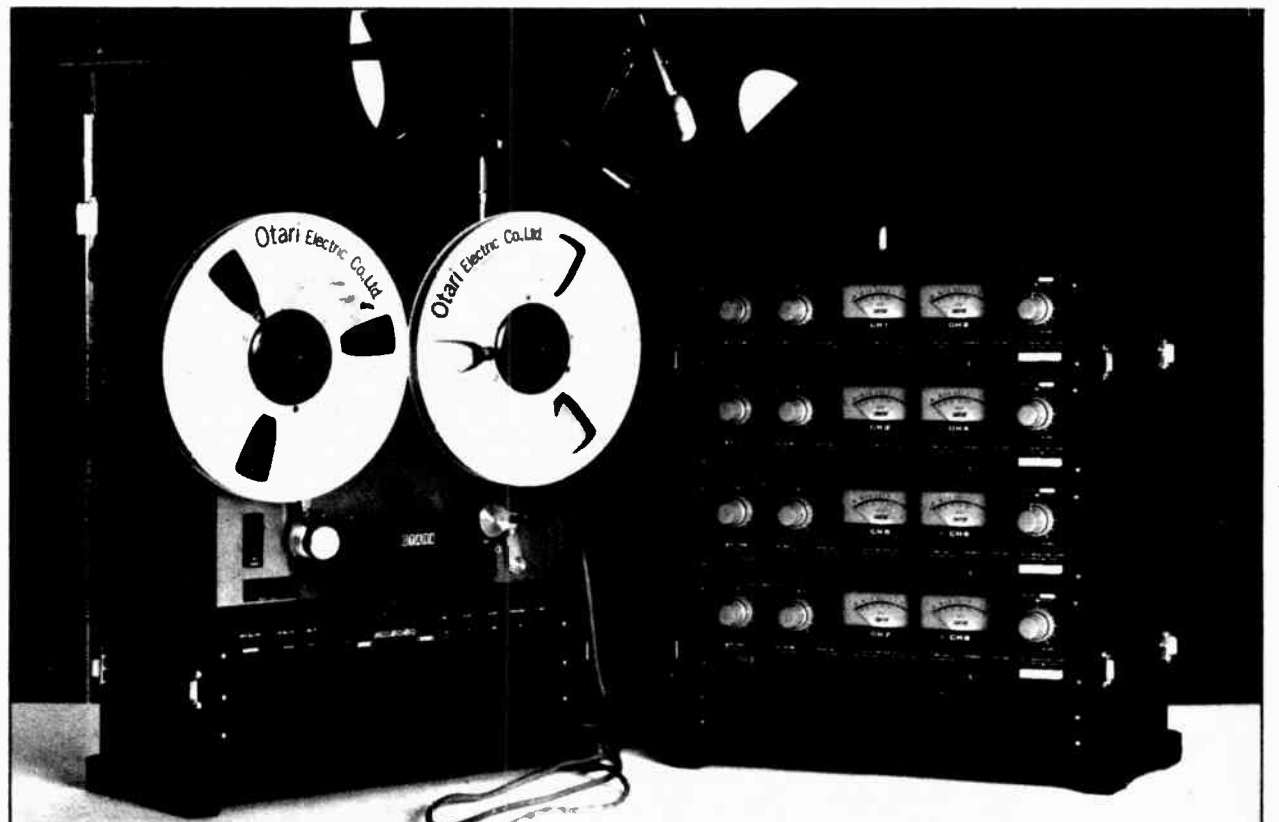

## OTARI MX-5050-8

### The Full Professional Half-Inch Eight Track

More features, better performance and reliability than any other half-inch eight track.

For less than \$5000, Otari's new MX-5050-8 let's you get started in eight track without sacrificing production flexibility, performance, or reliability.

Compare these features:

Dc capstan servo (standard, not an optional extra) for tighter speed control and  $\pm 10\%$  pitch adjustment; separate electronics and transport for convenient portable or console mounting; 15 and  $7\frac{1}{2}$  ips speeds (not just 15 ips); professional 600 ohm+4 dB output level with XLR's (not phono plugs); standard size VU meters; 19 dB headroom; synchronous reproduce with full frequency response for overdubbing; minutes/seconds counter (not reel rotation); front panel edit and cue controls; DBX or Dolby interface plug; all electronics adjustments front or rear accessible without panel disassembly; test oscillator for bias and level calibration; full motion sense logic and click-free punch-in and out; separate optimized erase/record/reproduce heads with direct amplifier coupling for reduced distortion and reliable off-tape monitoring.

See your Otari professional dealer for the full story.

(Incidentally if your requirements demand a one-inch eight track, check out the best-buy MX-7800 with optional synchronous reproduce remote control.)

# OTARI

Available at:



# SUNTRONICS

1620 W. Foothill Blvd., P. O. Box 734  
Upland, CA 91786  
(714) 985-0701

# Q & A

## Recording Schools

cont'd from page 25

**Degrees Offered:** Bachelor of Music, Bachelor of Arts, Masters.

**Equipment Used:** 4-track studio on campus. Advanced students also work in professional studios in area.

**Breakdown of Lecture/Hands On:** First Semester: 90% lecture, 10% hands-on; Second Semester: 10% lecture, 90% hands-on.

### CALIFORNIA STATE UNIVERSITY, NORTHRIDGE Northridge, CA 91324 (213) 885-3391

**Contact:** Dale Manquen, Dept. of Electronic and Computer Engineering.

**Course Description:** California State College at Northridge offers a unique course related to the recording field called "Audio Design Engineering" aimed toward people wanting to design professional and consumer audio equipment including tape recorders, consoles, outboard gear, etc. "Fundamentals of Audio" is the orientation course.

**Frequency:** Courses offered every semester. 4½ year BS program.

**Prerequisites & Registration Procedure:** Music, Physics of Music, and Engineering courses are required.

**Accreditation:** Yes.

**Degrees Offered:** Bachelor of Science degree.

**Equipment Used:** laboratory with equipment up to 16-track. No studio.

**Job Placement:** Yes. There is also an internship program set up to place juniors and seniors in audio manufacturing field.

### COLLEGE FOR RECORDING ARTS 665 Harrison St., San Francisco, CA 94107 (415) 781-6306

**Contact:** Leo de Gar Kulka

**Course Description:** Basic, Intermediate and Advanced classes offered in "Audio Engineering", "Music Production", "Studio Electronics". Advanced classes in "Recording Workshop". Also classes in Music Law, Business and Finance of Music, Synthesizer Principles and Disc Mastering. Classes limited to 15 in workshops and 35 in lecture courses.

**Frequency:** Three semesters per year, 14 weeks.

**Prerequisites & Registration Procedure:** No prerequisites for basic classes. Students are required to complete Evaluation Criteria Letter for school.

**Accreditation:** Approved by California State Board of Education.

**Degrees Offered:** Diploma issued for satisfactory completion of total course. Certificate of Completion for classes completed.

**Equipment Used:** Professional 24-track recording studio with state of the art equipment, Radio Production Studio, Disc Mastering facility and numerous synthesizers.

### COLLEGE OF MARIN Kentfield, CA 94904 (415) 485-9461

**Contact:** Music Department.

**Course Description:** "Basic Studio Recording Techniques" is offered as part of the Adult Education evening program with no credit. The study program includes teaching of all basic ideas behind modern recording and treats recording techniques one-by-one in a classroom and workshop setting. Toward the end of the course, students do a recording and mixdown session in a first-rate 24-track studio. Once a year, a 3 credit course in "Synthesizers and Electronic Music" is offered through the Music Dept.

**Frequency:** "Synthesizer and Electronic Music" offered each fall, and "Basic Studio Recording Techniques" offered 3 times a year.

**Prerequisites & Registration Procedure:** No prerequisites for "Basic Studio Recording Techniques". The first year of Music Major Program is required for "Synthesizer and Electronic Music".

**Accreditation:** yes. Community College.

**Degrees Offered:** Associate of Arts Degree.

### EVERYTHING YOU ALWAYS WANTED TO KNOW ABOUT DEMOS BUT WERE AFRAID TO ASK.

5249 Melrose Ave., Los Angeles, CA 90038

(213) 467-9432

**Contact:** Bob Safir.

**Course Description:** Workshops on the demo-making process designed for musicians and songwriters to familiarize them with basic recording techniques and studio procedures. Classes limited to 10 students.

**Frequency:** Every four weeks, 2 hours on Saturday.

**Prerequisites & Registration Procedure:** None.

**Equipment Used:** Professional 8-track studio.

**Breakdown of Lecture/Hands-on:** Combination.

### FOOTHILL COLLEGE

12345 El Monte Rd., Los Altos Hills, CA 94022

(415) 948-8590

**Contact:** Ray Tankersley, Counselor

**Course Description:** Three courses offered through the Music Dept. 1. Introduction to Audio Recording Techniques. 2. Basic Sound Reinforcement. 3. Musical Acoustics.

**Frequency:** Every quarter.

**Prerequisites & Registration Procedure:** No prerequisites needed for introduction to Audio Recording Techniques or Basic Sound Reinforcement. High school credits in music, physics and algebra required for Musical Acoustics.

**Accreditation:** Yes. Community College.

**Degrees Offered:** Associate of Arts Degree, Commercial Music Major 2 years study.

**Job Placement:** Yes. Two placement services on campus: field office for the California State Employment Service plus campus placement service for graduates of special programs.

### GOLDEN WEST COLLEGE

15744 Golden West St., Huntington Beach, CA 92647

(714) 892-7711

**Contact:** Evan Williams.

**Course Description:** Recording classes are offered as part of the Commercial Music Program. "Recording Engineering" is a two-year vocational education program which features lectures and recording sessions beginning with two-track recording and working up to more complex recording techniques involving the recording of acoustic, jazz, classical and pop music. Support classes include "Technical Math", "Basic Electronics", "Music Theory", Guide to the Music Industry" and "Basic Music". Synthesizer courses are required as part of Recording Major.

**Frequency:** Courses start each fall.

**Prerequisites & Registration Procedure:** Students must pass entrance exam.

**Accreditation:** Yes. Community College.

**Degrees Offered:** Associate of Arts Degree. Certificate of Completion for vocational students.

**Equipment Used:** MCI 16 track and 2 track tape machines, TEAC 3340, Nakamichi cassette. Neve console modified for 16 track. Crown amps, JBL monitors, Kepex, Harmonizer, Eventide Flanger, Neve and UREI comp/limiters, live reverb chamber, Orban reverb, many mics and instruments. Full synthesizer lab available.

**Breakdown of Lecture/Hands-on:** ½-hour lecture, ½-hour lab each week.

### HEAVENLY RECORDING STUDIOS

1020 35th Ave., Sacramento, CA 95822

(916) 428-5888

**Contact:** Steve Somers

**Course Description:** "Professional Recording Techniques I" is a nine week course which features lectures and demonstrations on the theory and techniques of recording with a 16-track recording and mixdown session at the end. "Professional Recording Techniques II" is a follow-up 9-week course with sessions in the studio. PRT I is limited in class size to 8 and costs \$300.00. PRT II is limited in size to 5 and costs \$375.00.

**Frequency:** Classes meet for four hours a week and are offered year round.

**Accreditation:** Credit offered through some local colleges.

**Equipment Used:** Professional 16-track studio with Quad/Eight Pacifica console, MCI JH16 track recorder, Scully mastering machine and numerous pieces of outboard equipment.

### MUSIC RECORDING SCHOOL

229 Shipley, San Francisco, CA 94107

(415) 546-6464

**Course Description:** "Recording Studio Engineering" teaches basic recording techniques and studio procedure in an 8-track studio. Classes meet twice a week for 10 weeks. Cost of course is \$500.00

**Frequency:** New classes offered four times a year.

**Prerequisites & Registration Procedure:** The only requirement is an avid interest in music and recording.

**Breakdown of Lecture/Hands-on:** Sixty total hours breaks down to 30 hours of lecture and 30 hours of hands-on time.

### NATURAL SOUNDS STUDIO

9851 Prospect Ave., Santee, CA 92071

(714) 448-6000

**Contact:** Dave Goldstein.

**Course Description:** Recording Institute of America course offering Beginning and Advanced classes designed for musicians to teach the basics of audio and recording techniques and to familiarize them with studio operations and procedures. Class size limited to 12 people.

**Frequency:** Classes offered every 13 weeks on Saturdays.

**Prerequisites & Registration Procedure:** None.

**Degrees Offered:** Recording Institute of America Certificate.

**Equipment Used:** 24-track professional recording studio.

**Breakdown of Lecture/Hands-on:** 3 hours of lecture, 27 hours of hands-on time.

**Job Placement:** Personal recommendation.

### SAN FRANCISCO STATE UNIVERSITY

1600 Holloway, San Francisco, CA 94132

(415) 469-1507

**Contact:** Paul Smith.

**Course Description:** As part of the regular curriculum SF State has Basic, Intermediate, and Advanced Audio Courses within the Broadcast Communications Arts program.

They also offer a special Summer session called "Stereo Recording Workshop". Beginning students are familiarized with all recording techniques and procedures. Classes are limited to 30 and students rotate between three instructors in: 1. Live studio recording sessions. 2. Mixdown sessions. 3. Lecture seminars. Students are exposed to all aspects of studio work. Advanced course includes simulated remote, editing and additional work in business and procedures.

**Frequency:** Summer session: 3 weeks, five days a week.

**Prerequisites & Registration Procedure:** Registration is in April for following summer session. No prerequisites required.

**Accreditation:** Yes. Summer session: 3 units of BCA credit, transferable.

**Breakdown of Lecture/Hands-on:** 2/3 hands-on, 1/3 lecture.

### SHERWOOD OAKS EXPERIMENTAL COLLEGE

6353 Hollywood Blvd., Hollywood, CA 90028

(213) 462-0669

**Contact:** Gary Shusett

**Course Description:** Sherwood Oaks offers "Introduction to Recording" which is a lecture course, and "Beginning", "Intermediate", and "Advanced" Workshops in Recording. Optional classes in "Producing", "Disc Mastering", "Legal and Business Aspects of Music". Once a year there is an Engineering Conference. There is also an intensive 5-week course offered to out-of-state students. "Introduction" costs \$250.00, Workshops cost \$600.00. Classes limited to 8 students.

**Frequency:** Classes last for 10 weeks, four times a year.

**Prerequisites & Registration Procedure:** None except "Introduction". The school has an Open House before each semester.

**Accreditation:** Yes. Through Immaculate Heart College.

**Degrees Offered:** Certificate of Completion from school.

**Equipment Used:** The school uses Original Sound, a professional 16-track studio with other studios available for instructional purposes.

**Breakdown of Lecture/Hands-on:** "Introduction" is lecture class, others are 100% hands-on.

### SOUND MASTER RECORDING ENGINEER SCHOOLS/INSTITUTE OF AUDIO ENGINEERING

P.O. Box 8327, Universal City, CA 91608

(213) 650-8000 call for counseling appointment.

**Course Description:** "Record Engineering" Beginning, Intermediate and Advanced courses. Beginning class teaches basic audio technology. Recording Workshops are

cont'd on page 44



# More Than Great Specs, Great Ideas.

For the past three years we've been telling you about the benefits of using graphic equalizers; now we've made it even easier to appreciate them. Introducing the MXR Dual Fifteen and Thirty-One Band Equalizers. Two equalizers designed with the imagination and understanding to solve your toughest equalization problems. Designed for use in either studios or sound reinforcement situations, our new eqs offer features not previously available at any price.

The Dual Fifteen Band Eq features two channels of equalization with the bands set two-thirds of an octave apart. By breaking the frequencies down further than conventional octave equalizers, you now have the flexibility to contour your music with much greater selectivity. As most musical information occurs in the midrange, this is where you need even more definition, and the Dual Fifteen Band Eq gives you six bands of contour in this area rather than the usual four. In addition, each channel has its own level control.

The Thirty-One Band Eq divides the frequency spectrum even further. A single channel unit, the Thirty-One Band features frequency bands set one-third of an octave apart, generally regarded to be the optimum amount of resolution.

When used in conjunction with any PA system, our equalizers can make a bad environment sound good, and a good performance sound great. Unlike parametric equalizers, the frequency response change is immediate and easily visible, so that when you shape a response curve you know what it's going to sound like.

Both units feature a range of -12 to +12 decibels on each band, standard 19" rack mount, and the rugged construction you always get with an MXR product. Both units also feature phone plug input/output connections, (the Thirty-One Band also features Cannon type XLRs), high slew rate (7V/microsecond), and incredibly low noise (better than -90 dBm). But not only do we offer great specifications, we produce great ideas... you wouldn't expect any less from us.

MXR Innovations, 247 N. Goodman Street, Rochester, New York 14607, (716) 442-5320.

**MXR** Professional  
Products Group



# Why settle for a copy . . .



## when Tangent gives you the original?

Why settle for an imperfect copy of your sound, when Tangent will give you the original?

Tangent's crystal-clear transparency allows your original sound to flow cleanly to the tape, with only the coloration that **you** add.

And beyond this foundation of solid quality, Tangent invites comparison on these features:

### Automation

Automation from Tangent uses the innovative and widely-respected Allison 65K programmer and Fadex designs. Tangent chose the Allison system because it is **the** proven-in-the-field system.

### VCA Grouping

For those not needing full automation, Voltage Controlled Amplifier (VCA) Grouping utilizes up to **nine** VCA groups, while other manufacturers normally use fewer.

### Sub-Group Solo

Programmable Sub-Group Solo allows the engineer to solo an entire sub-group in place by pushing only one button. This convenience is not found in all competing VCA grouping or Automation systems.

### Semi-Parametric EQ

Three-band sweepable frequency equalization on each channel is a standard Tangent feature. Not an expensive option as with some competing systems.

### Transformerless Balancing

Transformerless Balancing keeps your original sound pure with incredible transient response. Noise is within 3 dB of the theoretical limit.

Transformerless Balancing is suddenly a big deal among the other console manufacturers. It should be. Tangent's been doing it for years.

### 16 Submasters

Tangent's 16 submaster busses plus "Direct" allow tremendous flexibility for 16 or 24-track work.

### FET Switching

Electronic FET switching silently rearranges the signal flows for maximum convenience and minimum repatching.

### Lots of Extras

Penny & Giles faders, multiple Echo and Cue send, Phase Reverse, Tape Return Gain, and many other features on each channel give full professional control and reliability.

Compare Tangent's features to consoles costing twice as much and you'll see what a value Tangent is.

As for comparing Tangent's quality, well, you just can't get better than the original.

## Tangent Model 3216

Available at:

**AUDIO CONCEPTS, INC./DAVE KELSEY SOUND**

7138 Santa Monica Boulevard • Hollywood, California 90046 • (213) 851-7172

THE PROFESSIONAL SOUND PEOPLE

TECH  
**EXPRESS**  
SOUND CO.  
in reverent quest of the last dB

**tangent**

1833 newport blvd.  
costa mesa, ca. 92627  
(714) 645-8501



# Southern California STUDIO LOCATION INDEX

All studio information listed has been supplied to the Mix by studios responding to questionnaires mailed in January, 1979. People, equipment and locations change, so please verify critical information with the studios directly. The Mix does not take responsibility for accuracy of information supplied to us by the studios.

Page	Studio	No. of tracks	Page	Studio	No. of Tracks	Page	Studio	No. of Tracks
68	<b>ALHAMBRA</b> Martinsound Studios	24	51	Original Sound Studios	16	84	United Western Studios	24
37	<b>ANAHEIM</b> Chateau East Sound Productions	8	72	The Pasha Music House	24	<b>PASADENA</b> Alderaan Productions	4	
34	Nouveau Studio	4	72	Pranava productions	24	31	Distinctive Impressions	4
31	<b>BAKERSFIELD</b> Custom Audio Recording Service	4	75	Producers Workshop	24	64	Fifty Four East Sound Recorders	24
37	<b>BUENA PARK</b> Apollo Recording Studio	8	76	Rudy Records	24	72	Pasadena Sound Recorders	24
32	Glacier Record Production	4	84	Rusk Sound Studios	24	78	The Sound Chamber	24
59	<b>BURBANK</b> The Burbank Studios	24	42	Sunwest Recording Studios, Inc.	24	<b>RANCHO CUCAMONGA</b> Quad/Cee	4	
67	Kendun Recorders	24	42	Studio B/Newjack	8	<b>RANCHO MIRAGE</b> A&R Recording Services	8	
68	Magic Wand Recording Studio	24	42	Studiohouse	8	<b>RESEDA</b> Wattever Recorders	8	
40	<b>CAMARILLO</b> R.E. Copsey	8	82	Studio 9 Sound Labs	8	<b>REDONDO BEACH</b> Redondo Pacific Studios	24	
34	<b>CANOGA PARK</b> Sound On Sound	4	56	Sunset Sound	24	<b>RIVERSIDE</b> George's Recording Studio	4	
42	Starsound Recording	8	42	T.A.P.E. Recorders, Inc.	16	39	Main St. Studios	8
32	<b>CHATSWORTH</b> Hammersound Recorders	4	56	The Tone Zone Sound Services	8	<b>SAN BERNARDINO</b> Sun-Dwyer Recorders	16	
78	Smoketree Ranch	24	84	Total Experience Recording Studio	24	<b>SAN DIEGO</b> Accusound Recording Studio	8	
34	Tapelog	4	84	TTG, Inc. Recording Studio	24	30	Audio Recorders	4
54	<b>COMPTON</b> Sound-Off Recording Studio	16	44	Uncle Morris Sound Services	8	37	Blue Light Recording Studio	8
47	<b>COSTA MESA</b> Golden Goose Recording	16	<b>HUNTINGTON BEACH</b> Adamo's Audio	8	46	Circle Sound Studios	16	
34	Moffett Manor Recorders	4	36	<b>INGLEWOOD</b> Blue Power Records	4	37	Doctor Sound	8
40	Orion Recording Ltd.	8	30	Gahlorie Recording Studio	8	54	Soundtrax	16
51	Overland Recording Studio	16	38	The Underground	4	82	Straita-Head Sound	24
31	<b>COVINA</b> Filament Audio	4	35	<b>IRVINE</b> International Automated Media	24	82	Studio West	24
50	<b>CUCAMONGA</b> Houston Recording	16	66	<b>LA HABRA</b> Studio Orange	16	62	<b>SAN FERNANDO</b> Dawnbreaker Recording Studio	24
36	<b>CULVER CITY</b> "A Music School Studios"	8	54	<b>LONG BEACH</b> Centrax Recorders	4	54	<b>SAN MARCOS</b> Starburst Recording, Inc.	16
65	Golden Age Recorders	24	31	Worldwide Audio	16	<b>SANTA ANA</b> J.R. West Sound Recorders	4	
36	<b>EL CAJON</b> Antell Recording	8	58	<b>LOS ANGELES</b> ABC Recording Studios Inc.	24	40	Moser Sound Productions	8
47	Fanfare Studios	16	58	Allen Zentz Recording Studio	24	34	Myrical of Sound	4
50	<b>FRESNO</b> Kenjo Studios	16	46	A&M Records	24	68	Maranatha Studios	24
34	<b>FULLERTON</b> Mixed Up Studios	4	30	Annex Studios	16	52	Sound Affair Recording Studio	16
30	<b>GLENDALE</b> Berkens Sound Recording Labs	4	30	Audible Sounds	4	84	United Audio Corporation	24
70	MCA Whitney Recording Studios, INC.	24	30	The Audio Group	4	<b>SANTA BARBARA</b> Don Messick Studio	4	
47	<b>GRANADA HILLS</b> Home Recording Studios	16	59	Canyon Recorders	24	76	Santa Barbara Sound	24
40	<b>HACIENDA HEIGHTS</b> Mel's Sound of Music	8	31	CCI	4	42	Spectrum Studio	8
50	<b>HERMOSA BEACH</b> Media Art	16	60	Cherokee Recording Studio	24	60	<b>SANTA MONICA</b> Dalton Recorders	24
56	<b>HIGHLAND</b> Westwind Recording	16	64	Elektra Sound	24	51	<b>SANTEE</b> Natural Sound Recording Studio	16
40	<b>HOLLYDALE</b> Spectrasound Recording Studio	8	37	Fuller Sound	8	<b>SHERMAN OAKS</b> Backroom Recorders	24	
37	<b>HOLLYWOOD</b> Ascot Recording Studio	8	66	Heritage Studios	24	39	Kris Stevens Enterprises	8
58	Barnum Recording Studio	24	47	Hit City West	16	<b>STUDIO CITY</b> Bonwhit Records	16	
46	Blue Dolphin	16	66	The Hope Street Studio	24	64	Excalibur Studios	24
46	Blue Seagull	16	67	Koala Studio	4	64	Fidelity Recording Studio	24
59	Britannia	24	67	Larrabee Sound	24	50	Mom & Pops Company Store	16
46	California Recording Studios, Inc.	16	68	Love N' Comfort Recording Studio	24	76	Sierra Pacific Studios, Inc.	24
59	Capitol Records Studio	24	70	Music Grinder Studio	24	82	Studio Sound Recorders	24
60	City Recording Services	24	72	One Step Up Recording Studio	24	<b>TARZANA</b> Can-Am Recorders, Inc.	24	
60	Clover Recorders	24	70	Paramount Recording Studio	24	31	<b>THOUSAND OAKS</b> DeWitt Associates	4
60	Conway Recording Studios	24	72	Quad-Teck Studios, Ltd.	24	38	Futuristic Sound Studios	8
60	Crystal-Sound	24	75	Record Plant	24	<b>TORRANCE</b> Travel Tracs Recording Service	8	
62	Doctor Musix Recording Studio	24	75	RPM Int'l. Studios	24	75	Quantum Recording Studio	24
62	Eldorado Recording Studio	24	52	Silverlake Recording Studio	16	<b>VAN NUYS</b> Salty Dog Recording Studio	24	
64	The Enactron Truck	24	76	Silvery Moon Studios	24	78	Sound City	24
64	Filmways/Heider Recording	24	78	Sound Arts	24	56	Westworld Recorders	16
65	Gold Star Recording Studio	24	78	Sound Castle Recording Studios	24	<b>VENICE</b> Shooting Star Studio	4	
65	Golden Sound Studios	24	78	Sound Investment	24	81	Spectrum Studios	24
47	Golden West Sound Studios	16	78	Sound Labs	24	<b>VENTURA</b> Goldmine Recording Studio	8	
65	Group IV Recording	24	81	Startrack Recording Studios	24	<b>WEST COVINA</b> The Reel Recording Company	8	
32	Hark's Sound Studio	4	42	Sunburst Recording & Productions	8	40	<b>WEST HOLLYWOOD</b> Big Ween Studios	4
66	Hollywood Central Recorders	24	35	Tony Beecher	4	30	<b>WEST LOS ANGELES</b> Sounds Good Recording	24
66	Hollywood Sound	24	44	Track Record	8	78	<b>WHITTIER</b> Broadcast Assistors	16
50	HoundDog Recording Studio	16	84	Upside Down Studio	24	38	Gramophone Studios	8
38	Kitchen Sync Sound Recorders	8	<b>MALIBU</b> Indigo Ranch Recording Studio	24	38	JPM Recording Studio	8	
70	Motown Recording Studios	24	<b>MANHATTAN BEACH</b> Sound Suite Recorders	16	<b>YUCCA VALLEY</b> North Star Productions	8		
70	Music Lab	24	<b>MARINA DEL REY</b> Electronic Sounds	8				
70	Music Recorders	24	<b>MARINA DEL REY</b> Chateau Recorders, Inc.	24				
51	Music Sound Studios	16	37	Electronic Sounds	8			
70	NSP Studios	24	<b>MARINA DEL REY</b> Electronic Sounds	8				
			<b>NEWPORT BEACH</b> JEL Recording Studio	16				
			Lyon Recording Studio	24				
			<b>NORTH HOLLYWOOD</b> Brian Elliot	24				
			Chateau Recorders, Inc.	24				
			Customcraft Recording	4				
			Devonshire Sound Studios	24				
			Gladstone Recording	8				
			Jennifudy	24				
			John Thomas Studio	24				
			Mama Jo's	24				
			P.D. Recorders	16				
			Present Time Recorders	16				
			<b>ONTARIO</b> Little Recording Studio	8				
			<b>PANORAMA CITY</b> E.A.R. Recording	4				



• **ALDERAAN PRODUCTIONS**

*\*also REMOTE RECORDING\**  
**P.O. Box 1243 South Pasadena, California 91030**  
**(213) 799-5611**  
**Owner:** Jonathan Stromp, Harry Woo, Mai Ying Woo.  
**Engineers:** Jonathan Stromp, Harry Woo.  
**Dimensions of Control Rooms:** 12' x 16'.  
**Tape Recorders:** TEAC Model A3340S 4 track; Nakamichi Model 550 cassette 2 track; Ampex Model 601 1 track; Technics Model RS 1500 2 track.  
**Mixing Consoles:** Sony Model MX 16, 8 in x 4 out; TEAC Model 2, 6 in x 4 out.  
**Monitor Amplifiers:** McIntosh Mc 75.  
**Monitor Speakers:** JBL 4311, Auratone Cubes.  
**Outboard Equipment:** dbx 155 noise reduction; Spectro Acoustics 210 equalizer; Clover spring reverb.  
**Microphones:** Sony ECM 22; Beyer M69, M101; Electro-Voice RE-15; AKG D200E.  
**Extras:** Telex high speed cassette duplication; complete portable color video production unit; complete video production for industrial users.  
**Rates:** Audio recording on location \$25/hr, block rates and packages are available. Video production \$75/hr. On location packages available.  
**Direction:** Quality audio and video services for people on a budget. We have done work for churches, schools, realtors. our cassette duplication system is capable of producing quality copies of computer programs for the Commodore PET and Radio Shack TRS 80 computers.

• **AUDIBLE SOUND SYSTEMS**

*\*also REMOTE RECORDING\**  
**7858 Midfield Ave., Los Angeles, CA 90045**  
**(213) 670-1719**  
**Owner:** Richard Castleberry, George Castleberry, Wesley Sharpe.  
**Engineers:** Richard Castleberry, Wesley Sharpe.  
**Tape Recorders:** Ampex 4 track; Akai 2 track.  
**Mixing Consoles:** Yamaha Model PM1000, 16 in x 4 out; Yamaha Model PM1000, 32 in x 4 out.  
**Monitor Amplifiers:** Crown.  
**Monitor Speakers:** JBL.  
**Outboard Equipment:** Altec 1/3 octave band equal-

izers, dbx compressor, Roland Space Echo.  
**Microphones:** Shure, AKG.  
**Extras:** Swimming pool, rehearsal space.  
**Rates:** \$10/hour.  
**Direction:** We specialize in PA rentals for tours and one nighters. Also remote recording.

• **THE AUDIO GROUP**

**590 N. Vermont Ave., Los Angeles, CA 90004**  
**(213) 654-6972 or 660-5449**  
**Owner:** Sheldon I. Altfeld.  
**Engineers:** Daniel Katz, Chris Calnan.  
**Dimensions of Studios:** 17' x 21'.  
**Dimensions of Control Rooms:** 6' x 10'.  
**Tape Recorders:** TEAC Model 3340S 4 track; TEAC Model 3300-SX2T 2 track; Tascam Series 50 full mono; Spotmaster carts full mono; Sony Model TC-270 1/4 track.  
**Mixing Consoles:** Tascam Model 3, 8 in x 4 out.  
**Monitor Amplifiers:** Spectro Acoustics Model 202.  
**Monitor Speakers:** Auratone 5C's.  
**Outboard Equipment:** Graphic EQ, dbx, echo send.  
**Microphones:** Beyer M-500; Electro-Voice RE-10, RE-16; Sony ECM 16; Electro-Voice 635A; RCA 44B.  
**Instruments Available:** None.  
**Extras:** Sound reinforcement services, writing, producing, scoring, promotion, distribution, record pressing, program syndication and complete 1/4" or 1/2" video tape facilities. ENTIRE CBS SOUND EFFECTS LIBRARY.  
**Rates:** Mono, 2 or 4 track: \$25/hr; commercial voice-over demos: \$15/hr; legitimate theatre sound tracks: \$30 complete (including lobby music & effects).  
**Direction:** Specialists in dramatic radio production (soap operas, sci-fi's, children's programs, etc.), for either radio syndication or cassette duplication. The Audio Group also prepares complete legitimate theatre sound tracks custom-gearred to any stage production; slide program, film-strip and multi-media audio tracks; commercial voice-over audition tapes and radio commercials. All clients receive supervision and assistance from owner Sheldon I. Altfeld, radio-TV-film and stage producer for nearly 30 years.

• **AUDIO RECORDERS**

**3843 Richmond, San Diego, CA 92103**  
**(714) 296-6355**  
**Owner:** J.A. Mullen  
**Engineers:** 3  
**Dimensions of Studios:** 17' x 30'.  
**Dimensions of Control Rooms:** 17' x 13'.  
**Tape Recorders:** Ampex Model 350 1 track; Ampex Model 351 2 track; Ampex Model 300 4 track.  
**Mixing Consoles:** Tascam Model 10, 12 in x 4 out.  
**Monitor Amplifiers:** McIntosh.  
**Monitor Speakers:** JBL.  
**Outboard Equipment:** dbx.  
**Microphones:** Neumann, Electro-Voice, AKG, Sony.  
**Rates:** \$35 per hour.



• **BERKENS SOUND RECORDING LABS**

**1616 W. Victory Blvd., #104, Glendale, CA 91201**  
**(213) 248-8583**  
**Owner:** William Berkuta, Richard P. Stevens II.  
**Engineers:** William Berkuta, Richard P. Stevens II.  
**Dimensions of Studios:** Studio A: 12' x 12', Studio B: 24' x 13'.  
**Dimensions of Control Rooms:** 12' x 12'.  
**Tape Recorders:** Ampex model 300-4 (BSRL/Opamp) 4 track; Ampex Model 350 2 track; Ampex Model 400 1 track; Realistic Model 909-B 2 interleave; TEAC/Becht 8 track dup.; Superscope Model CD-301 and CD-301-A stereo cassette.  
**Mixing Consoles:** Collins Radio Model 212-A, 8 in x 2 out; Opamp Recording Studio Model BSRL-1A, 6 in x 4 out; (2) Realistic (aux. mixers) Model 23-468, 4 in x 2 out.  
**Monitor Amplifiers:** Opamp 34.  
**Outboard Equipment:** Opamp reverb units Model 3155, Russco cue masters, Cartrtape II mono 1-record/play, 1-play only, a lot of 45 rpm records and some LP's.  
**Microphones:** Akai; condensers; AKG D-1000E; Shure 515 SBG; Electro-Voice 605; and some cheap ones.  
**Instruments Available:** Este cabinet grand piano, clarinet, violin, classical guitar, trumpet, flutophones, (with advance notice a Rhodes 88 with bass amp, drum set, deposit needed).  
**Extras:** Servial very small refrigerator, playing of records during breaks, small TV.  
**Rates:** Inquire about project and block rates; we can tailor one just for you.  
**Direction:** We would like to help those people who record radio shows on tape. We have the equipment for producing just about any kind of show. To the people who could not get in touch with us, there are two things you can do: 1. Send a note in the mail or 2. Call us here after 7:00 PM. We can also help if you need printing for your project.



• **BIG WEEN STUDIO**

**922 San Vicente, West Hollywood, CA**  
**(213) 659-9569**  
**Owner:** Daily Planet.  
**Engineers:** Chuck Roth, Jim Herter.  
**Dimensions of Studios:** Main room 12' x 14'; Drum isolation booth 10' x 10'.  
**Dimensions of Control Rooms:** 12' x 6'.  
**Tape Recorders:** TEAC Model 3340-S 4 track; Akai 2 track; Akai cassette.  
**Mixing Consoles:** Acoustic 880, 12 in x 3 out.  
**Monitor Amplifiers:** Scott.  
**Monitor Speakers:** Jensen.  
**Outboard Equipment:** dbx compressor/limiter, MXR flanger, reverb, analog delay.  
**Microphones:** Shure, Electro-Voice, others available.  
**Instruments Available:** Fender Rhodes, Yamaha CP 10 organ, percussion.  
**Extras:** In-house musicians, back-up vocalists, smoking lounge w/color TV (2 chan), free hot dogs.  
**Rates:** \$10/hr; \$70/8 hrs.  
**Direction:** We specialize in top quality demo recordings, with help in arrangement and production for single artists and groups. In addition, rehearsal space, Electro-Voice PA system, Times Square lighting system is available.



• **BLUE POWER RECORDS CO.**

**1065 E. Fairview Blvd., Inglewood, CA 90302**  
**(213) 674-6546, 672-2349**



### • CANTRAX RECORDERS

4787 Pacific Cst., Long Beach, CA 90804  
(213) 597-7302

Owner: Richard Cannata, Nancy Cannata.

Engineers: Richard Cannata, David Pace.

Dimensions of Studios: 20' x 20'.

Dimensions of Control Rooms: 7' x 10'.

Tape Recorders: TEAC Model A-3440 4 track; Studer Revox A-700 2 track; Lafaya Model 13BX 1 track.

Mixing Consoles: Tascam Model 5A, 8 in x 4 out.

Monitor Amplifiers: Marantz 1150.

Monitor Speakers: JBL L-100, Auratones.

Outboard Equipment: Marantz 6300 turntable, various cartridges, we feature full EQ, echo (by Revox), and by the time we go to print, dbx and digital delay; various Sennheiser stereophones.

Microphones: Various Electro-Voice, Sennheiser, Shure.

Instruments Available: Guild F40 acoustic, Fender Strat, Gibson Melody Maker (rewired), Pignose amp.

Extras: Coffee (free), kitchen, color TV.

Rates: 4 track \$10/hr, free set-up, tape extra; mix-down \$6/hr; duplicating \$5/hr; remote \$20/hr; sweetening after initial session \$6/hr.

Direction: We are new on the scene but know our business well — we will be adding and upgrading our equipment constantly. We will be purchasing new Studer tape machines and Crown amps in the very near future, also we'll be expanding our outboard equipment line up. Heading to 16 track.

### • CUSTOM AUDIO RECORDING SERVICE

\*also REMOTE RECORDING\*

929 California Avenue, Bakersfield, CA 93304  
(805) 324-0736

Owner: Trenton T. Houston.

Engineers: Trenton T. Houston.

Dimensions of Studios: 18' x 25'.

Dimensions of Control Rooms: 18' x 12'.

Tape Recorders: Ampex Model 300-C 4 track; Revox Model A-77 2 track; TEAC Concertone Model 932 track.

Mixing Consoles: Custom built, 8 in x 4, 2, and 1 out.

Monitor Amplifiers: Sony 3130F, SAE IV, Pioneer.

Monitor Speakers: Bose 301's.

Outboard Equipment: Graphic EQ, spring reverb, etc.

Microphones: Shure, Telefunken, AKG.

Rates: \$25/hr for studio time and tape, \$12/hr for mixdown, overdubbing, etc.

Direction: We've been in business for 10 years, offering budget studio facilities, demo sessions, etc. We do location recording, PA services and rentals, tape copying, radio and TV soundtrack production work. We also offer portable disco service — music catered for the private party of your choice.

### • CUSTOMCRAFT RECORDINGS

\*also REMOTE RECORDING\*

5440 Ben Ave., N. Hollywood, CA 91607

(213) 766-1298

Owner: Dean Talley.

Engineers: Dean Talley, Tom Talley, Kevin Collier.

Dimensions of Studios: 26' x 27'.

Dimensions of Control Rooms: 5' x 18'.

Tape Recorders: TEAC Model 3340S 4 track; Revox 2 track; Ampex Model F-44 4 track; Ampex Model 601 ½ track; Concertone Model 505 2 track.

Mixing Consoles: Sony Model MX-20, 8 in x 4 out.

Bogan MXM 5 in x 1 out.

Monitor Amplifiers: Dynaco PAT 4 and 120 amp, Scott A416 integrated preamp and amplifier.

Monitor Speakers: Altec 604 B, Stevens 15" full range. (2 each.)

Outboard Equipment: TEAC AN-300, noise reduction unit, ADC 500 dynamic EQ, TEAC echo unit, Marantz 5420 cassette deck, transcriber 8-T cartridge deck.

Microphones: RCA, Altec, Sony, Shure.

Instruments Available: Piano.

Rates: \$12.50/hr.

Direction: We specialize in complete recording service, album design, mastering, pressing, label design, recording live concerts, and producing complete albums, customized to each job.

### • DEWITT ASSOCIATES

\*also REMOTE RECORDING\*

88 Teasdale St., Thousand Oaks, CA 91360

(805) 495-3405

Owner: Monty and Rosey DeWitt.

Engineers: Monty DeWitt, Steve Wager, Doug DeWitt.

Dimensions of Studios: 400 square feet (combined).

Dimensions of Control Rooms: 7' x 13'.

Tape Recorders: TEAC Model 7030 2 track; Tascam Model 704 track.

Mixing Consoles: TEAC Model 5, 8 in x 4 out; Sony Model MX20, 8 in x 4 out. Assorted Shure mixers, headphones.

Monitor Amplifiers: McIntosh.

Monitor Speakers: AR 3A's in studio, AR 4X's on location.

Outboard Equipment: Infonics Model 200 cassette tape duplication system, MICMIX Master-Room Super C reverb, EQ dbx, Dolby.

Microphones: Neumann KM-86's, KM-84's; AKG D-224E's, C-451E's; Shure dynamics (assorted).

Instruments Available: Kawai grand piano.

Extras: Coffee and tea.

Rates: 2 or 4 track \$25/hr (2 hour minimum). Over 3 mics: ½ of hourly rate for set-up. Call for complete rate list. Mileage charges outside of radius of service.

Direction: We have been established since 1968 and feature on-location recording along with an intimate studio for smaller groups. Complete custom record and tape service is available with your label or ours. We are currently under contract with Conejo Symphony and California Lutheran College. All our work is guaranteed. We now have the highest quality hi-speed custom cassette duplication capability. We have recorded school bands, choirs, churches and youth groups; completed demo tapes and records. Our philosophy is: "Whatever you do, do heartily unto the Lord".

# TRACK 4 TRACK

### • DISTINCTIVE IMPRESSIONS

\*also REMOTE RECORDING\*

3790 Mohawk St., Pasadena, CA 91107

(213) 792-9604 or 796-4414

Owner: Dwight and Janet Crumb.

Engineers: Dwight and Janet Crumb.

Tape Recorders: Tascam Model 70 ½-inch 4 track; Revox Model A77 hi-speed 2 track, TEAC Model 7030 hi-speed 2 track; Fisher Model 5120 cassette, Sony Model 350 (¼).

Mixing Consoles: Tascam Model 10 (modified) 8 in x 4 out; Gately, 6 in x 2 out.

Monitor Amplifiers: Crown D-40, Heathkit.

Monitor Speakers: Custom JBL, Advent A2.

Outboard Equipment: 2 channels A-type Dolby; 4-channels B-type Dolby (dbx available), Orban/Parasound stereo synthesizer, Pioneer PL71 direct drive turntable, stereo spring reverb, Sony 3-band active crossover, dbx 161 compressor/limiter, multiple heads and feeds, 15 pr. snake, 6 pr. snake.

Microphones: Neumann KM-84; AKG C-451 with CKI capsule; E-V 634A; others available on request.

Extras: Photography, darkroom, 200 slide sorter, Clearlight Diamond media program equipment available on request, record production, coffee.

Rates: Negotiable. 2 track \$50/3 hrs.

Direction: We are a family owned and operated company interested in quality at affordable prices. We specialize in remote concerts, multimedia, and record production.

### • DON MESSICK STUDIO

62 Humphrey Road, P.O. Box 5426,

Santa Barbara, CA 93108

(805) 966-3636

Owner: Don Messick.

Engineers: Don Messick, Dave Miller, Jim Williams.

Dimensions of Studios: 9' x 16'.

Dimensions of Control Rooms: 6' x 11'.

Tape Recorders: Ampex Model ATR-700 1 (full) track; Ampex Model 600-B 1 (full) track; Otari Model MX 5050 4 (¼) track; Magnecord Model 1028 2 (½) track; Technics Model 1506 2 (¼) track; Sony Model 777 2 (½) track.

Mixing Consoles: TEAC/Tascam Model 3, 8 in x 2 out.

Monitor Amplifiers: Kenwood RA 5700.

Monitor Speakers: Merit (booth), RTR (studio).

Outboard Equipment: Two QRK 12-C turntables.

Microphones: Sennheiser MD 421 (two), Shure 330 (ribbon).

Extras: Library of recorded sound effects.

Rates: \$35/hour.

Direction: Studio is basically a "voice over" production facility, not geared for music.

### • E.A.R. RECORDING

P.O. Box 4073, Panorama City, CA 91402

(213) 343-4896

Owner: Earl Dingman, Alan Mayer, and Rodney Fong.

### • FILAMENT PRO AUDIO

1058 E. Edna Place, Covina, CA 91724

(213) 339-1955, 331-9024, 337-4945

Owner: Frank Offenstein

Engineers: Frank Offenstein, Dave Speers, Tom Messner.

Dimensions of Studios: 16' x 20', 8' ceiling.

Dimensions of Control Rooms: 12' x 9', 8' ceiling.

Tape Recorders: TEAC Model 3340S 4 track; TEAC Model 2300SD 2 track; Revox Model A77 2 track; Sony Model TC1535d 2 track.

Mixing Consoles: (2) Allen & Heath Model SD12/2, 24 in x 4 out.

Monitor Amplifiers: Crown DC300A's, ESS 500M's.

Monitor Speakers: Altec 604E's.

Outboard Equipment: ADI 1500 stereo 10-band EQ's, ADI 1503 ½ octave EQ's, SAE ½ octave EQ, Sound



CCI STUDIOS, Los Angeles

### • CCI

\*also REMOTE RECORDING\*

6900 Santa Monica Blvd., Los Angeles, CA 90038  
(213) 466-8511

Owner: Bill Muster.

Engineers: Rick Morris.

Dimensions of Studios: 20' x 11'.

Dimensions of Control Rooms: 12' x 10'.

Tape Recorders: MCI Model JH110 4 track; Pioneer 4/2 track; Nagra Model IV 2 track; Nagra Model 4.2 mono; MTM 16/35mm film recorder and dubbers.

Mixing Consoles: Quantum, 12 in x 4 out.

Monitor Amplifiers: Crown.

Monitor Speakers: JBL 4311/Altec 604E.

Outboard Equipment: UREI graphic EQ, UREI compressor/limiter, Orban/Parasound reverb.

Microphones: Neumann U-87; E-V RE-20; Beyer M-500; Sennheiser 421; Shure SM-57, 58.

Extras: KEM "Rapid S" flatbed film editors; Sony ¼" video cassette; Spindler Saube AV cueing system accommodating 6 Ektagraphic projectors for multi-screen AV presentation. Location recording.

Direction: CCI is a top quality facility for sound recording, film making and audio visual production. The studio is an ideal acoustic environment designed by John P. Edwards and is equipped with a variety of the best available recorders in both tape and mag film format. The studio is available to independent film and AV producers, ad agencies, and recording artists for original music recording, radio commercials, AV production, and motion picture dubbing.



# TRACK 4 TRACK

craftsmen stereo 10-band EQ's, Echoplex, spring reverb, Allen & Heath limiter, ADI spectrum analyzer.

**Microphones:** 40 in all. Shure SM57's, 56's, 58's, 545's, 565's, 548's, SM53's; Sony ECM22P; Sennheiser 402; Altec 650A, 650B; AKG D1000E, 2000E, 200E, 451's.

**Instruments Available:** Guitar and bass amps and keyboard amps.

**Extras:** Air-conditioned rehearsal studios, rental of amps and PA's, lounge area, coke machine, coffee machine, concert sound lighting and staging, pro-audio sales, talent booking and promotion, 24-hour - 7 days a week availability.

**Rates:** 4 track recording \$20/hr. One hour free set-up time. Mix down and 2 track time is \$10/hr. Project rates available. We can make copies and we are available for remote. Rehearsal studios are \$2.50/hr or \$4.50/hr with PA. Monthly is \$125 for 80 hours with locker.

**Direction:** Expansion of studio to 8 track with Otari unit. 32 or 24 by 8 either Kelsey or Allen & Heath mixer, dbx noise reduction, digital delay, Harmonizer, flanger, phaser. Also add baby grand piano and video capabilities. We want to be a highly professional studio that can turn out high quality demo tapes and discs at prices that are realistic. We are a full service music company.



• **GEORGE'S RECORDING STUDIO**  
4375 Highland Place, Riverside, CA 92506  
(714) 682-8942

**Owner:** George Williams

**Engineers:** George Williams

**Dimensions of Studios:** 20' x 20'

**Dimensions of Control Rooms:** 20' x 7'

**Tape Recorders:** TEAC Model 3340S 4 track; TEAC Model A-1500-W 2 track; TEAC 2 track cassette.

**Mixing Consoles:** TEAC Model 5, 8 in x 4 out.

**Monitor Amplifiers:** Pioneer.

**Monitor Speakers:** Pioneer.

**Outboard Equipment:** Tapco reverb.

**Microphones:** TEAC ME-80; Shure SM-57, 58; Sennheiser 421.

**Instruments Available:** Knabe baby grand, Rhodes, Martin D-28, electric bass and guitar, Mini Moog, String Ensemble, Hammond B-3, drums.

**Extras:** Free set-up, refreshments, free breaks, a relaxed atmosphere, the best people.

**Rates:** Recording: \$15/hr; mixdown: \$12.50/hr; bulk rates available.

**Direction:** George's is a Christ centered business. Jesus Christ is the studio's foundation. Without Him the studio would not exist. Though I am a Christian, I do not shove my religious convictions down the throats of non-believing customers. If customers do not want to hear about my faith, I keep my mouth shut and do a good job and do it for less. George's was created in order to provide struggling artists with a budget recording studio. We record demos as well as complete album production, covers, mastering, labels, shrink-rap, - the whole thing. And we do it for a price that beats ANY Los Angeles competitor. We also do radio jingles for local radio stations. Our jingles are top notch and we will proudly compare them with L.A. radio jingles. We also produce artists and do arranging. We provide in-house musicians for people who need help with their projects. We also inform songwriters about selling their songs, publishing, lead sheets and copyright. We serve all as Jesus served all.



• **GLACIER RECORD PRODUCTIONS**  
6212 Darlington Ave., Buena Park, CA 90621  
(714) 835-0352

**Owner:** John Alderette.

**Engineers:** Rick Stoner, John Alderette.

**Dimensions of Studios:** A: 30' x 20' (is video monitored into B); B: 20' x 20'.

**Dimensions of Control Rooms:** 10' x 10'.

**Tape Recorders:** TEAC Model 3340S 4 track, 15 ips;

TEAC Model 3300 1/2 track, 15 ips; Dokorder Model 7140 4 track; Dokorder Model 8140 4 track; Tandberg Model 6000 1/2 track.

**Mixing Consoles:** Carvin modified, 26 in x 8 out; Carvin 8-channel, 8 in x 2 out; Shure stereo mixer.

**Monitor Amplifiers:** Custom built power amps.

**Monitor Speakers:** Auratone, JBL's (video camera).

**Outboard Equipment:** 20-band equalization, dbx, Dolbys, custom built limiters, slap echo, reverb tanks modified.

**Microphones:** Shure, Sony, Turner, AKG, Altec.

**Instruments Available:** Ludwig concert drum set, guitar amps, Morley pedals, sustainers.

**Extras:** Liquor store and restaurant next door.

**Rates:** Very flexible, please call.

**Direction:** We are concert promoters, and we keep active with the record labels. Our engineering staff have worked, and mixed for renowned recording artists. Song writers, you can look forward to a host of talented studio musicians, should you need help putting your demo package together. "The Live Mix" is our speciality... for information regarding a "live mix" or eight hour block discount rates call (714) 994-4350.

## Glacier is Proud to Announce New Improvements:

**Wet Bar  
Color T.V.  
Hot Food Service  
much more studio equipment**

**Call for details**

**(714) 835-0352**

or

**739-9988**



• **HAMMERSOUND RECORDERS**  
9612 Lurline Ave., Unit N, Chatsworth, CA 91311  
(213) 998-9641 studio - 24 hours.  
(213) 885-0418 Office - 9-5 seven days.  
**Owner:** Chris Apthorp, R. Brian Apthorp.  
**Engineers:** Chris Apthorp, Brian Apthorp, Joe Charlap-Hyman.

**Dimensions of Studios:** Main Studio 26' x 30' with 15' x 10' drum booth and 5' x 7' vocal booth.

**Dimensions of Control Rooms:** 15' x 20'.

**Tape Recorders:** TEAC Model 3340S 4 track; TEAC Model 3300 1/2 track 2 track; Ampex 1/4 track; 2 (each direction); Nakamichi Model 600 cassette deck.

**Mixing Consoles:** Tascam Model 5, 8 in x 4-8 out; Tascam 85EX June '79, 16 in x 4-8 out.

**Monitor Amplifiers:** BGW, Marantz.

**Monitor Speakers:** Hammersound Model 3 (cts drivers), Yamaha NS-500.

**Outboard Equipment:** dbx, compressor limiters, Tapco 4400 echo, digital delay, Hammersound Model 2 varidistant, etc.

**Microphones:** Sony, Shure, AKG, Sennheiser, Electro-Voice Nakamichi.

**Instruments Available:** Keyboards, amps, guitars.

**Extras:** Den, TV, small kitchen with refrigerator, basketball court.

**Rates:** \$10 - \$15/hr based on time of day, block rates available. Visa/Mastercharge.

**Direction:** We have been very successful in assisting some very talented people produce many fine recordings, which have been of great benefit in furthering their careers. Among them are jazz bassist, Miroslav Vitous, Moon Martin and Del Shannon. Our staff includes a full, on-call, compliment of session players. Most of our engineers are professional musicians as well, and they understand what it takes. We have been at this long enough to know how to do it well, but we are still fresh enough to care. Give us a call and let us work with you personally. Let us tailor our services to you. Don't give up the ship!

• **HARK'S SOUND STUDIO**  
1041 N. Orange Drive, Hollywood, CA 90038  
(213) 463-3288

**Owner:** H. Harland Harker

**Engineers:** H. Harland Harker.

**Dimensions of Studios:** 30' x 35'.

**Dimensions of Control Rooms:** 30' x 25'.

**Tape Recorders:** MCI Model JH-110-1 1 track; MCI Model JH-110-2 2 track; MCI Model JH-110-4 4 track; TEAC Model 3340 4 (1/4) track.

**Mixing Consoles:** Quantum Model QM-12-8, 12 in x 4 out.

**Monitor Amplifiers:** Crown 150 (control room), Bogen 100 (studio talk/playback).

**Monitor Speakers:** JBL 4311 (2)

**Outboard Equipment:** Akai 725D 3-head cassette recorder, Magnasync 16mm recorder, Magnasync 35mm recorder, Califone 3675 sync cassette recorder, dbx 4 channel noise reduction, Bryant Engineering 101 pulse signal generator, UREI 565 "Little Dipper" filter set, UREI 1176N limiter, Orban/Parasound dual reverb, stereo turntable accommodates 16" discs.

**Microphones:** Neumann U-87's, Shure SM-58, SM-59.  
**Extras:** Very extensive sound effects library, and signator to several music libraries.

**Rates:** \$35/hr anytime.

**Direction:** Between Highland & La Brea 100 feet south of Santa Monica Blvd. in Hollywood.

I specialize in Audio-Visual presentations for industrial and educational slide films. Also TV voice-overs and radio commercials. Our building also houses animation department, film and video tape editing, and large shooting stage.



J.R. WEST SOUND RECORDERS, Santa Ana

• **J.R. WEST SOUND RECORDERS**  
\*also REMOTE RECORDING\*  
Santa Ana, California  
Mailing Address: 1025 N. Ferndale,  
Fullerton, CA 92631

(714) Jack Roberts 526-1022, Ray Deleon 834-0577

**Owner:** Jack Roberts, Ray Deleon.

**Engineers:** Jack Roberts, Ray Deleon.

**Dimensions of Studios:** 281 sq. ft.

**Dimensions of Control Rooms:** 640 cu. ft.

**Tape Recorders:** TEAC Model A-3340-S 4 track; TEAC Model A-7300 2 track; JVC Model 3030 cassette.

**Mixing Consoles:** TEAC (2) Model 5A's cascaded, 16 in x 4 out.

**Monitor Amplifiers:** Crown D-60 studio monitors and cue system.

**Monitor Speakers:** Phillips RH 544 motional feedback; Auratones.

**Outboard Equipment:** dbx 161 comp/limiters, Orban/Parasound 111B dual reverb, dbx 154 noise reduction, AKG N66E phantom power supply, electronic metronome, direct boxes, mike splitters, 19 pair 100 ft. snake for remotes.

**Microphones:** AKG 452 EB, 414 EB; Beyer M-500; Electro-Voice Re-20, RE-15's, CS-15, 635A; Neumann U-87; Sennheiser 421's.

**Instruments Available:** Piano, drum set.

**Rates:** Studio \$15/hr (recording/mixdown plus tape). No charge set-up time. Remote: rates variable, call for quote.

**Direction:** J.R. West Sound Recorders offers a wide variety of recording services including demos, jingles and remote location work. Our excellent micro-



# YOU DESERVE THE BEST



AKG	EDITALL	SHURE
ALPHA	ELECTROVOICE	SPECTRO ACOUSTICS
AMPEX	EVENTIDE	SONAR RADIO
AUDIO ARTS	HAMMOND IND.	SONY MICS
AUDIO FILE	JBL PRO	SOUND CONCEPTS
AUDIO TECHNICA	KEITH MONKS	SOUND WORKSHOP
AUDIO TECHNOLOGY	KLARK-TEKNIK	STANTRON
AURATONE	LEXICON	STL
BIAMP	MIC MIX	SWITCHCRAFT
BOZAK	MICRO SEIKI	TABER MFG
BURWEN	MRL	TAPCO
BEYER	NEPTUNE	TASCAM
COILCRAFT	NORTRONICS	TDK
COUNTRYMEN ASSOC.	OTARI	TEAC
CROWN	RAMKO	UNI-SYNC
DBX	SCOTCH-3M	URSA MAJOR
DISCWASHER	SENNHEISER	SPACE STATION

We specialize in 2, 4, 8 and 16 track recording systems for audio installations and multi-media Production, which includes application for Professional, college and home use.

(714) 985-0701 P. O. Box 734  
1620 W. Foothill Blvd. UPLAND, CA

# TRACK 4 TRACK

phones, high quality recording equipment and informal atmosphere assure you the highest quality results at minimum cost. We are always more than happy to assist our clients with production and arranging ideas, if desired. We thoroughly enjoy our work and consider it extremely important that you are completely satisfied with results at all stages of your projects.

## • KOALA STUDIO

*\*also REMOTE RECORDING\**

603 N. New Hampshire Avenue  
Los Angeles, CA 90004 (Next to Hollywood  
Freeway — easy access (ground level).  
(213) 665-3670

Owner: John J. and Shirley J. Adams

Engineers: John J. Adams (Chief Engineer), Shirley J. Adams (Assistant Engineer).

Dimensions of Studios: 10' x 11', 11' x 17'.

Dimensions of Control Rooms: 10' x 11'.

Tape Recorders: TEAC Model A-2340SX 4 (¼) track; Revox Model A77(HS) selsync, varipitch 2 (½) track; Sankyo cassette 2 (¼) track.

Mixing Consoles: TEAC Model 2, 6 in x 4 out.

Monitor Amplifiers: Marantz.

Monitor Speakers: JBL.

Outboard Equipment: Echo, flanging, reverb, filters, dbx.

Microphones: 3M, Shure.

Instruments Available: Synthesizers (polyphonic, sequencer, keyboard 3 voice, studio patchable), clarinet, sax's, much percussion.

Extras: Tape Techniques (Musique Concrete) record library, tape library, many musicians/instruments available, arranging, sweetening, copies, editing, mixdown, lead sheets, remote recording, soundtracks, scoring for films/video/commercials.

Rates: On request.

Direction: Good music, good workmanship, highest quality; attention to detail, professional attitude and operation.

## • MIXED UP STUDIOS

Fullerton, California.

(714) 525-7748

Owner: Eddie Joseph.

Engineers: Dan Jackson, Steve Arambula.

Dimensions of Studios: 15' x 17'.

Dimensions of Control Rooms: 10' x 15'.

Tape Recorders: (2) TEAC A-3340 4 track; JVC Model KD-10 stereo cassette.

Mixing Consoles: Yamaha PM1000, 16 in x 4 out EQ.

Monitor Amplifiers: Crown.

Monitor Speakers: JBL.

Outboard Equipment: Sound Workshop 242C stereo reverb, (2) UREI LA3A audio levelers.

Microphones: AKG.

Instruments Available: Acrosonic piano, Ampeg bass amp 300 W., (2) Marshall guitar amps 120 W.

Extras: Cokes, beers, chips, color TV, dancing girls, etc.

Rates: Outlandish and pigheaded.

Direction: We specialize in punk rock/New Wave projects with particular interest in having our recordings pressed into singles for independent promotion and distribution. We are primarily interested in recording fast, original, or original arrangements of good copy, rock and roll. We would like to help new unknown people get a start so, when they get big they can totally ignore us. We offer the poorest quality at unreasonable rates. Our motto is: "If it's loud we'll hear it. If it's loud and fast, we'll record it".

## • MOFFETT MANOR RECORDERS

2152 Canyon Dr., Costa Mesa, CA 92627

(714) 646-3838 or 776-0660 (message).

Owner: Robert Moffett.

Engineers: Robert Moffett.

Dimensions of Studios: 11' x 22'.

Dimensions of Control Rooms: 6' x 8'.

Tape Recorders: Dokorder Model 1140 4 track; Toshiba Model 3060 2 track cassette.

Mixing Consoles: TEAC Model 2, 6 in x 4 out.

Monitor Amplifiers: Sony 7015, Sansui 2000X.

Monitor Speakers: MMR customs, Hot Cubes, Advents.

Outboard Equipment: Bi-Amp graphic 20-band. Depending on the session, we can rent just about anything.

Microphones: Altec 650A, Shure PE-55, Shure SM-58, PE-56.

Instruments Available: Gulbransen piano, congas, timbales, drums, tenor-sax, rentals upon deposit.

Extras: Coffee, tea and T.L.C.!

Rates: \$10 to \$20 per hour, or swap. We're very flexible. Please call us first, then shop around.

Direction: Christian owned and operated, Moffett Manor Recorders' primary interest is in the development of inspiration of the artist, and not the expiration of his wallet! We are production oriented, therefore, all customers are screened beforehand to determine whether or not we can help. God Bless You!

## • MYRICAL OF SOUND

1420 E. Ebinger Ave., Suite 110,  
Santa Ana, CA 92705

(714) 558-0558

Owner: H. Kevin Harkins

Engineers: Daniel Weadon, John Donan.

Dimensions of Studios: 32' x 12'.

Dimensions of Control Rooms: 8' x 12'.

Tape Recorders: Dokorder Model 1140 4 track.

Mixing Consoles: Edcor 16-channel prototype (original model) with full equalization and reverb

Monitor Amplifiers: Pioneer 1010.

Outboard Equipment: Magnacord 15ips recorder, Pioneer MA62 2-channel mixer.

Instruments Available: Vocals; lead, rhythm and bass guitars, french horn, piano, harpsichord, pedal steel guitar, percussion incl. conga and drums, tenor sax, flute, harp, oboe, harmonica, string synthesizer, slide steel guitar, country fiddle concert violin.

Extras: Air-conditioned studios, lead sheet services, duplicating, producers and arrangers, and promotion services.

Rates: \$20/hr for up to 4 hours. \$19/hr for 5-14 hours. \$18/hr for 15-34 hours. \$17.50/hr for 35 hours and up.

Direction: Custom recording. "A Miracle of Sound".

## • NOUVEAU STUDIO

1258 E. Broadway, Anaheim, CA 92805

(714) 533-6642, (714) 956-0695

Owner: Servando, E.J. Warmack, Jeri Gonzalez.

Engineers: E.J. Warmack, Servando, & Jeri Gonzalez.

Dimensions of Studios: 20' x 20'.

Dimensions of Control Rooms: 8' x 10'.

Tape Recorders: TEAC Model 3340 4 track; TEAC Model A-2300 SD 2 track.

Mixing Consoles: Tascam Model 10, 8 in x 4 out.

Monitor Amplifiers: Kenwood KA-5500.

Monitor Speakers: Jansson Classic 770's, AFS Kriket 750 cubes.

Outboard Equipment: Ibanez model AD-220 analog delay and flanger, Sankyo cassette recorder and 8 track cartridge recorder, Tapco 6000R reverb, 2-track Dolby, United Audio turntable.

Microphones: Various Shure, AKG, and E-V.

Instruments Available: Acoustic piano with mandolin attachment, Fender amps and guitars, Peavey Musician amp, Elka electric piano, Epiphone acoustic guitar, various percussion instruments, Quilter bass amp, Ludwig basic drum set.

Extras: Record pressing service, copyrighting service, in-house video taping service, non-union studio musicians available, air-conditioning.

Rates: \$8/hr recording and mixdown.

Direction: As musicians we built the studio for our own use, later realizing the experience that could be gained by recording others. As a result, we've been charging what we believe to be the lowest price for the quality of recording we get at our modest little studio. (2 years old.) Quality will be further improved soon with the addition of 4-track dbx. Five demo records have been produced at our studio, to date. Our latest venture is the introduction of a video-taping service.

## • QUAD/CEE

9040 Caballero Dr., Alta Loma,  
(Rancho Cucamonga) CA 91701  
(714) 989-7246

Owner: Richard Dow.

Engineers: R. Dow, M. Dow, D. Quizarro

Dimensions of Studios: 12½' x 26'.

Dimensions of Control Rooms: 12½' x 10½'.

Tape Recorders: TEAC Model A-3440 4 track; TEAC Model A-3300/2T 2 track; TEAC A-3300/4T 2 track; TEAC Model PC-10 2 track.

Mixing Consoles: TEAC Model 3, 8 into 4 plus 8 into 2.

Monitor Amplifiers: Crown D-150A, Technics SE-9060.

Monitor Speakers: JBL 4301, and Altec 604-8G in custom horns, also Auratone 5C.

Outboard Equipment: dbx noise reduction system, Bi-Amp graphic equalizer, Sync-Pulse generator, dbx compressor/expander, Thorens/Ortofon phono, Crown IC-150A preamp, talk-back system

Microphones: AKG D-190E, TEAC ME-80.

Instruments Available: Piano, guitar (acoustic).

Extras: Production music and effects library, in-house professional narrator/announcer, audio-visual scripting service.

Rates: Quote per job and per budget, no set hourly rate.

Direction: Specialize in audio-visual soundtracks for business and education; radio commercials and programming; effects tracks for stage (music demo sessions as studio available.)

## • SHOOTING STAR STUDIO

Venice, CA 90291

(213) 399-5617 or 822-9986

Owner: Planet Productions

Engineers: Don Tittle.

Dimensions of Studios: 19' x 19'.

Dimensions of Control Rooms: 10' x 10'.

Tape Recorders: Pioneer Model RT-2044 4 track; Pioneer Model RT-2022 2 (½) track; JVC cassette.

Mixing Consoles: TEAC/Tascam Model 5, 8 in x 4 out, TEAC Model 2, 6 in x 4 out.

Monitor Amplifiers: Phase Linear 400 — control room monitors; Spectro Acoustics 202C headphones.

Monitor Speakers: JBL 4311.

Outboard Equipment: dbx 157 noise reduction, Orban/Parasound reverb, Bi-Amp graphic EQ, dbx 118 dynamic range enhancer.

Microphones: Sennheiser 421's, Shure SM-58's, Sony ECM 280, Electret condensers.

Instruments Available: Kawai studio upright piano, Fender Rhodes, ARP Odyssey, RMI computer keyboard.

Extras: Producing, arranging, copying, transcribing charts. We have musicians of every type available.

Rates: \$15/hr, \$5 tape rental fee, \$5/session instrument rental.

Direction: Our studio is owned and operated by musicians, thus we are geared toward the musician. We are looking toward the time when we can expand beyond a 4 track studio and provide creative musicians with most musical services they will need. In the meantime, we pride ourselves on our quality products coming out of a quite comfortable, "easy to work in" atmosphere.

## • SOUND ON SOUND

20529 Kittridge St., Canoga Park (L.A.), CA 91306

(213) 887-7028

Owner: Philippe Aubuchon.

Tape Recorders: TEAC Model 3340S and TEAC Model R1000 ½ track.

Mixing Consoles: TEAC Model 2 and Sony MX20.

Outboard Equipment: dbx noise reduction.

Microphones: AKG D-1000, 3D-120's; Sony ECM56F; Shure PE58; Superscope.

Rates: \$15/hr. \$90/day (8 hours).

Direction: We specialize in small groups of ALL kinds. Back-up musicians are available. We will work with you to get the sound that you want. We care.

## • TAPELOG

10511 Keokuk Ave., Chatsworth, CA 91311

(213) 882-4433

Owner: Don A. Hollingsworth

Engineers: Don A. Hollingsworth, Stephen P. Brown.

Dimensions of Studios: 20' x 22', home studio in converted garage.

Dimensions of Control Rooms: Control room and



studio in same room.

**Tape Recorders:** Sony Model 854 4 track; TEAC Model 3340 4 track; TEAC Model 7300 2 track; TEAC cassette Model 450; Wollensak Model 4766 cassette; Pioneer Model HR-99 cartridge 8 track.

**Mixing Consoles:** Yamaha Model PM-1000, 16 in x 4 out; Sony Model MX-16, 8 in x 4 out.

**Monitor Amplifiers:** Dynaco 416.

**Monitor Speakers:** Altec 848A.

**Outboard Equipment:** dbx consumer and semi-pro, Pioneer reverb, cue headphones.

**Microphones:** Sony ECM 22P, ECM 33P, C-37; Electro-Voice RE-20, DS-35; Beyer M-500; Superscope E7, E9; various lapel and dynamic mics.

**Instruments Available:** Univox and Fender Rhodes electric pianos, Hammond M1 organ, Yamaha console piano.

**Extras:** Bass and guitar amplifiers, direct boxes, Otari cassette high speed duplicator, 3M high speed cassette duplicator, rack of 12 Wollensak 4766 cassette decks for 1-1 duplication. JVC color video camera and tape deck.

**Rates:** \$20/hr recording and \$10/hr mixdown.

**Direction:** Recording facilities will expand to 8 track but will remain small. Duplication facility and equipment will grow and become primary activity. In the distant future will be color video duplicating.



• **TONY BEECHER**  
\*REMOTE RECORDING\*  
(213) 276-8441

**Owner:** Tony Beecher.

**Engineers:** Tony Beecher.

**Dimensions of Studios:** All recordings done on location - workroom for copies and editing.

**Tape Recorders:** TEAC (2) Model 3340 4 track; Pioneer Model CTF 1000 cassette; Revox Model 1104 1/4 track; Revox Model 1102 HS 2 track.

**Mixing Consoles:** TEAC Model 3, 8 in x 4 out.

**Outboard Equipment:** Mitsubishi turntable, MXR equalizers.

**Microphones:** AKG condensers and other mics available as needed.

**Rates:** Recording In-Performance concerts (classical or Big Band (swing) only. NO ROCK. \$85.00 plus tape. Lectures and meetings \$100.00 per 8 hours. Outside L.A. County add \$30.00. Duplication and tape \$12/hr plus tape. Editing \$15/hr. Special rates for students.

**Direction:** I specialize in "In-Performance" concert recording. Symphonic classical, solo instrumental recitals, opera, lectures, and business meetings. Locations include Royce Hall, UCLA, Dorothy Chandler Pavillion Music Center, Wilshire Ebell, Bovard Aud., USC, etc. I have recorded opera productions for USC, broadcasts for KUSC & KFAC and I've made recent recordings of the Romero Family for Delos Records. I offer highest quality recordings at reasonable rates.



• **THE UNDERGROUND**  
652 West Arbor Vitae, Inglewood, CA 90301  
(213) 672-4632

**Owner:** Richard Sandford

**Engineers:** Richard Sandford.

**Dimensions of Studios:** 13' x 19'.

**Dimensions of Control Rooms:** 9' x 13'.

**Tape Recorders:** TEAC Model A3340S 4 track; Revox Model HS1102 2 track; Wollensak Model 1520 full track; Sansui cassette.

**Mixing Consoles:** Allen & Heath pop mixer, 16 in x 16 out; Shure Model M68, 4 in x 1 out.

**Monitor Amplifiers:** Marantz 240's.

**Monitor Speakers:** JBL 4311, custom built Cetec/Gauss.

**Outboard Equipment:** MXR digital delay, Gain Brain, Kepex, Bi-Amp graphic equalizer, dbx limiter/compressors, direct boxes. Anything is available at the customers request.

**Microphones:** Neumann KM84, Sennheiser 421, 441; Sony ECM 33P, Shure SM-57, Beyer MN160C, AKG D202E, any microphone available on request.

**Instruments Available:** Piano, drums (Rogers & Ludwig, many different snares to choose from), guitar, bass, percussive devises, amps, synthesizers available.

**Extras:** On location showers, refrigerator, coffee machine, private drive/entrance; experienced & talented personnel, studio musicians on call; production and management assistance; video equipment available on request.

**Rates:** \$5/hr rehearsal. \$10/hr recording 4 track. Block time available, mixdown and duplication available, open nights, holidays, weekends.

the  
**Mix**

## CLOSE UP

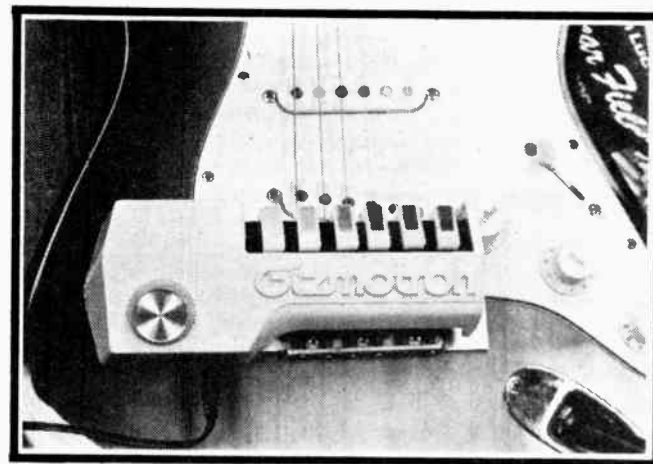

### The Gizmotron

An ingenious product from the unconventional minds of ex-10cc'ers Kevin Godley and Lol Creme, the Gizmotron is a mechanical device designed to turn a guitar into a string section.

When fixed to an electric guitar (models are available for most brands of electrics) the Gizmotron can 'bow' any combination of the six strings. Six buttons on the unit indicate the choice of string(s) affected as each button engages a rotating wheel that rubs against a string, the wheel's spinning serrated edge creating the bowing effect.

Although the original concept for the Gizmotron was conceived by Leonardo da Vinci half a millenium ago, the application of the Gizmotron idea emerged eight years ago as Kevin and Lol were looking for an alternative to hiring orchestras to do their string arrangements. The two had formed Hotlegs, scoring a hit with the single "Neanderthal Man" and, oddly enough, putting England's Strawberry Studio on the map.

For the next two years Godley and Creme did R&D work on the Gizmotron at Strawberry as the band 10cc came together. When the demands of recording and touring began to grow, the Gizmotron went to the shelf for about 4 years until 10cc divided in half. Lol and Kevin left the group to do their own albums, the technically ambitious triple disc "Consequences" and the more simplified "L", as well as return to developing the Gizmotron. Lol and Kevin eventually brought the prototype Gizmotron to Musitronics for manufacturing.

As it has since turned out, Musitronics sold its previous line of products to ARP and Musitronics became Gizmo Inc., exclusively producing the Gizmotron.

The Gizmotron is now available for about \$250 from many guitar and musical instrument dealers. A list of dealers can be obtained from: Gizmo Inc., P.O. Box 57, Rosemont, N.J. 08556, or call (609) 397-2000. ☺



*Lol Creme demonstrating the Gizmotron on a Fender Stratocaster*





•• "A MUSIC SCHOOL STUDIOS"  
4710 Inglewood Blvd., Culver City, CA 90230  
(213) 397-1227  
Owner: Dr. Charlie Frederick.  
Engineers: Dan Wright and Charlie Frederick, Jr.  
Dimensions of Studios: 23' x 16' x 10'.  
Dimensions of Control Rooms: 8' x 8' x 7'.  
Tape Recorders: Scully Model 280 8 track; TEAC Model A-3300-SX 2 track; TEAC Model A-103 cassette.  
Mixing Consoles: Tascam Model 10, 12 in x 4 out, modified for separate monitor mix.  
Monitor Amplifiers: Crown DC-300.  
Monitor Speakers: Auratone 5C Sound Cube  
Outboard Equipment: Custom made reverb, compressor, limiter.  
Microphones: Sennheiser 421, E-V 664, Sony ECM 22, Shure.  
Instruments Available: Piano.  
Extras: Cold drinks, coffee, individualized attention and service.  
Rates: \$15/hr for 2 and 4 track; \$17/hr for 1" 8 track; 30 minute set-up free, engineer provided.  
Direction: Providing low cost quality service for the struggling artist, writer and groups. Dr. Frederick works extensively with the development of products which deal with various social issues such as alcohol and other drug abuse, bigotry, prejudice, and poor people's causes. Future directions include franchising "A Music School Studios" to other areas.

•• ACCUSOUND RECORDING STUDIO  
4274 1/2 El Cajon Blvd., San Diego, CA 92105  
(714) 281-6693  
Owner: John Hildebrand, Eric Denton, Craig Bartok.  
Engineers: John Hildebrand, Eric Denton, Craig Bartok.  
Dimensions of Studios: 22' x 42'.  
Dimensions of Control Rooms: 22' x 12'.  
Tape Recorders: Ampex 1-inch 8 track; TEAC/Tascam 4 track; Ampex 2 track; Tascam Model 80-8 8 track; Tascam Model 3340S 4 track; Revox and Otari 2 track.  
Mixing Consoles: Tascam (modified) Model 10B, 12 in x 8 out; Tascam Model 10, 12 in x 4 out.  
Monitor Amplifiers: Crown D-150A's, Crown D-60's.

Monitor Speakers: JBL 4311, Auratones.  
Outboard Equipment: MICMIX Master-Room reverb, Kepex's, Gain Brains, LA3A limiters, Roland Space Echo, MXR flanger, phase shifter, extra EQ.  
Microphones: Neumann U-87, U-47; Sennheiser 451; Beyer, AKG, Shure, Sony, etc.  
Instruments Available: Baby grand piano, Hammond B-3 with Leslie, Fender Rhodes 88, Mini Moog, ARP Omni (strings), Oberheim four voice and sequencer, Ludwig drum set, Wurlitzer electric organ and more.  
Extras: Air-conditioned, good central location, right behind San Diego County's largest instrument rental shop. (We have arranged 50% off all instruments.)  
Rates: 8 track — 1-inch: \$35/hr, 1/2-inch: \$30/hr; 4 track \$25/hr; 2 track \$20/hr; mixdown \$25/hr.  
Direction: The engineers recently purchased the studio and changed the name (formerly Meiner's). We are keeping our famous quality which included many albums and several 45's from some of San Diego's top acts. We had over three songs to our credit on last year's KGB Homegrown album and many commercials, some still on the air. We are sure to be the top 8 track studio in San Diego County. With our quality already peaking at its finest, we are investigating into aesthetics such as topless mermaids and the like. Please call us.

•• ADAMO'S AUDIO  
16571 Higgins Circle, Huntington Beach, CA 92647  
(714) 842-2668  
Owner: Jerry Adamowecz.  
Engineers: Jerry Adamowecz.  
Dimensions of Studios: 20' x 20'.  
Dimensions of Control Rooms: 13' x 16'.  
Tape Recorders: Tascam Model 80-8 with dbx 8 track; TEAC Model 3340 with dbx 4 track; TEAC Model 7030 with dbx 2 track; TEAC Model A 4010 S 2 track; TEAC Model A107 cassette.  
Mixing Consoles: Sound Workshop with Super EQ, Model 1280B and 882, 20 in x 8 out.  
Monitor Amplifiers: Dynaco 400.  
Monitor Speakers: JBL L300's, Auratone 5C.

**Outboard Equipment:** dbx noise reduction, Marshall Time Modulator (for flanger, delay, Doppler effect), UREI 1176-LN compressor/limiters, Sound Workshop 242A stereo reverb.

**Microphones:** Neumann KM-84's, U-47; AKG C-452's, D-1000E's, 202's; Beyer 160; Shure SM-57's; Altec tube.

**Instruments Available:** Yamaha 6' grand piano, Hammond C-3 with Leslie, basses, guitars, and amps available.

**Rates:** \$20/hr plus tape.



ADAMO'S AUDIO, Huntington Beach

•• ANTELL RECORDING  
\*also REMOTE RECORDING\*  
Box 2863 El Cajon, CA 92021  
(714) 449-4093, 444-3371

Owner: Danny Antell.  
Engineers: Danny Antell & Michael O'Dollins & Victor Marquez.  
Studio Musicians: Danny — vocal, guitar, bass, and harmony. Victor — vocal, guitar, drums, congas, bass, harmony. Michael — vocal, guitar, bass.  
Dimensions of Studios: 12' x 20', 10' x 15'.  
Dimensions of Control Rooms: 6' x 12' mobile recording van.  
Tape Recorders: Ampex 300-8 8 track; Ampex Model 403-2 2 track; TEAC Model 3340 4 track; Telex Magnecord 2 track; Hitachi Model D-720 cassette.  
Mixing Consoles: Antell-Eddor Model MX-5, 16 in x 8 out; Antell-Eddor Model MX-1, 16 in x 2 out  
Monitor Amplifiers: McIntosh, BGW, Eico.  
Monitor Speakers: JBL, E-V.  
Outboard Equipment: Echo, flanger, reverb, EQ; most effects available; musicians supply is around the corner.  
Microphones: Shure SM-58, SM-57; Antell MK-1, MK-2; E-V 357; AKG elec cond, Sony, Realistic, Teledyne, etc; what ya need; direct boxes.  
Instruments Available: Fender bass, drums, piano, Music Man and Fender amps, acoustic guitar, etc.  
Extras: Mobile recording van. Full record production, draw music ASCAP, Antell Records, MEA Record labels, will perform for songwriters.  
Rates: Depends on customers wants and needs. From demo cassettes to album production including graphic art work and album design.  
Direction: Teaching multi-track engineering, designing and engineering electronic products. Working with digital computers. Working with the groups Bostonia and Knock. Instructing two jr. engineers Michael O'Dollins and Victor Marquez. Performing club act as single artist with 3340 TEAC accompaniment. (The 3340 is my side man.) Producing more albums and 45's under Antell Records label in 1979. Can't stop now — been doing for too many years.



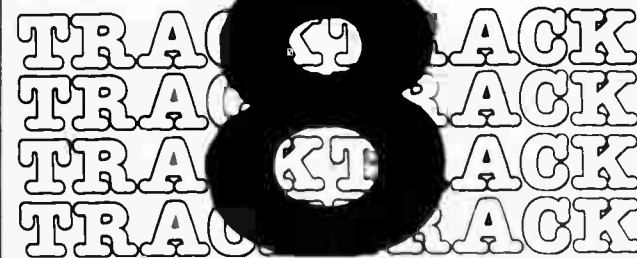

**•• APOLLO RECORDING STUDIO**  
6142 Beach Blvd., Buena Park, CA 90621  
(714) 994-3761

**Owner:** Jim Davis and Ace Simpson.  
**Engineers:** Ace Simpson, Assistants: Jim Davis Jr. and Bob Simpson.

**Dimensions of Studios:** 24' x 20'.

**Dimensions of Control Rooms:** 12' x 20'.

**Tape Recorders:** 3M Model 23 8 track (one inch format); Tascam Model 2T 2 track (half track); TEAC Model 3340S 4 track; TEAC Model 420 cassette recorder; dubbing recorder.

**Mixing Consoles:** Tascam Model 5, 16 in x 8 out; (2 Model 5's cascaded for 8 independent outputs).

**Monitor Amplifiers:** Marantz 1070, McMartin 10 Watt cue booster amp.

**Monitor Speakers:** JBL 4311 — control room; JBL L100 — studio; Auratone Mixing Cubes.

**Outboard Equipment:** Teletronix LA2A compressor/limiter; Fairchild Conax stereo peak limiter; Tapco 4400 reverb system; VSO System for 3M Model 23 recorder; 8 track active combiner and panner for mix-down.

**Microphones:** RCA 77D, BX11A; Sennheiser MD-421; Altec 659A; Shure SM-57; AKG D190E, D200E; Electro-Voice 627B; Sony F-121; two direct boxes.

**Instruments Available:** Acoustic piano (no fee), Framus bass guitar, electric guitar, electric piano, Fender amp (25W), wah-wah pedal and various percussion. (No drums).

**Rates:** 8 track: \$30/hr; 4 track or less: \$20/hr; dubbing or copying: \$15/hr; special rates available for block time (50 hours or more).

**Direction:** Both owners have professional musical background and have been associated with other recording studios, publishers, and record companies over a period of 15 years. Future plans are to expand to 16 track facilities.



**•• A & R RECORDING SERVICES**  
71906 Highway 111, Rancho Mirage, CA 92270  
(714) 346-0075

**Owner:** Scott Seely

**Engineers:** Jim Holt, Scott Seely.

**Dimensions of Studios:** 18' x 30'.

**Dimensions of Control Rooms:** 18' x 6'.

**Tape Recorders:** Ampex Model 440 8 track; Ampex Model 440 2 track; Revox A77 2 track.

**Mixing Consoles:** Quantum Model 168A, 16 in x 8 out.

**Monitor Amplifiers:** Crown (2).

**Monitor Speakers:** Altec and RSL.

**Outboard Equipment:** dbx compressor/limiter, Clo-Ver echo.

**Microphones:** Neumann 87, AKG 414, RCA 77, E-V 636, Altec.

**Instruments Available:** Steinway Grand, ARP String Ensemble, Korg synthesizer, Gibson organ.

**Extras:** We offer production and packaging for albums and singles.

**Rates:** On quote.

**Direction:** Capable of master quality. Can accommodate up to medium sized groups, excellent overdub studio.



**•• ASCOT RECORDING STUDIO**  
5904 Sunset Blvd., Hollywood, CA 90028  
(213) 466-8355

**Owner:** James Rayton

**Engineers:** James Rayton

**Dimensions of Studios:** 18' x 25'.

**Dimensions of Control Rooms:** 12' x 15'.

**Tape Recorders:** Stephens 8 track; Ampex 4 track; 3M 2 track; Ampex full-track; Pioneer 1/2, 1/4 track stereo; Kenwood cassettes (2).

**Mixing Consoles:** Opamp Labs Model 1204, 12 in x 4 lines + 12 modules out.

**Monitor Amplifiers:** Opamp 423's.

**Monitor Speakers:** Altec 604E's.

**Outboard Equipment:** Eventide Harmonizer with digital delay; Fairchild reverb; UREI limiters; graphic EQ; Burwen noise reduction; chorus modulator (fx); disc cutting system.

**Microphones:** Neumann U-67, U-87; E-V 666; AKG D-1000, D-19; misc. RCA's, Altec, Stephens and direct boxes.

**Instruments Available:** Grand piano, Lowrey organ with synthesizer.

**Extras:** Good vibes, good coffee. Central location close to Freeway, with easy ground-level access. Free set-up.

**Rates:** \$24/hr 2 track; \$30/hr 4 and 8 track; 6 days/wk. Add 1/2 after 6 PM.

**Direction:** Ascot provides a comfortable working atmosphere, attentive work, and great sound. A new vocal booth and studio improvements make that sound even better. Keep an ear on Ascot!



**•• BLUE LIGHT RECORDING STUDIO**  
11211-M Sorrento Valley Rd., San Diego, CA 92121  
(714) 455-6381

**Owner:** Terry W. Williams

**Engineers:** Terry W. Williams

**Dimensions of Studios:** Main Studio: 22' x 24'. Drum isolation room: 11' x 12' with platform.

Includes three offices and musicians lounge; all rooms air-conditioned.

**Dimensions of Control Rooms:** 13' x 14'.

**Tape Recorders:** Tascam Model 80-8 8 track; TEAC Model 3340S 4 track; Revox Model A-77 2 track.

**Mixing Consoles:** Tascam Model 10, 8 in x 4 out; TEAC Model 2, 6 in x 4 out.

**Monitor Amplifiers:** Spectro-Acoustics 202C.

**Monitor Speakers:** JBL 101, JBL L26, Auratones.

**Outboard Equipment:** Sound Workshop 242A reverb, dbx 161 comp/limiters, Spectro Acoustics 210R stereo graphic equalizer, Spectro Acoustics 217 pre amp, TEAC Model 1 mixers, Kenwood KR 6600 amplifier for headphones, 192 point patch bay.

**Microphones:** AKG 414, Sennheiser MD 421, Shure SM-56, Sony ECM-50PS, Nakamichi CM-100.

**Instruments Available:** Yamaha UD-1 professional upright piano, 8 piece Rogers drum kit with hydraulics, Univox Stringman, Univox Korg Poly Ensemble, Roland SH-1000 synthesizer, Music Man guitar amps, Gibson, Ibanez, and Fender electric, acoustic guitars and basses.

**Extras:** Panasonic WV-2200 color video camera with NV-3085 1/2-inch reel video tape recorder, Akai VT-150 color video camera with 1/4-inch video tape recorder, Sony SL 7200 Betamax video tape recorder.

**Rates:** 2, 4, 8 track: \$30/hr. Color video recording: \$40.00 per hour.

**Direction:** We are most interested in the production of original music. Our direction is in offering a balanced studio which incorporates creative audio and video possibilities at a reasonable price. With the advent of high resolution home video players, we feel the time is right for the smaller studios to offer their clients the "dynamite" audio/video demo package. We are also moving toward 16-tk recording.



**•• CHATEAU EAST SOUND PRODUCTIONS**  
*\*also REMOTE RECORDING\**

1040 North Grove St., Suite R, Anaheim, CA 92807  
(714) 630-0145

**Owner:** Joseph G. Truxaw, Steve Hager, Wally Younger.

**Engineers:** Joseph G. Truxaw, Steve Hager, Wally Younger.

**Dimensions of Studios:** 24' x 40', booths: 12' x 12' x 8', and 6' x 6'.

**Dimensions of Control Rooms:** 7' x 12'.

**Tape Recorders:** Tascam Model 80-8 8 track; TEAC Model 3340S 4 track.

**Mixing Consoles:** TEAC/Tascam Model 5, TEAC/Tascam Model 2, TEAC/Tascam Model 1.

**Monitor Amplifiers:** BGW, Pioneer, Toshiba.

**Monitor Speakers:** JBL, Altec.

**Outboard Equipment:** Tape echo, Sound Workshop reverb, MXR flanger, 2 stereo cue mixes.

**Microphones:** AKG, Shure, Electro-Voice, Beyer, Sony, Turner, Sears Best.

**Instruments Available:** Fender Rhodes 88, Kogler & Campbell upright piano, Steinway Rosewood grand piano, Hammond C-2, Leslie, Oberheim 2-voice and Sequential Circuits, Prophet 5 polyphonic synthesizers, Telecaster Thinline, Rickenbacker and Fender Precision basses, Wurliizer electric piano, Gretsch drums, multitudinous percussion.

**Extras:** Mobile recording, in-house production and musicians, audio synthesist, professional arranger, musician referral, full record production service.

**Rates:** \$20/hr, block rates upon request.

**Direction:** Moderate prices, professional results. The difference at Chateau East is the manner in which each project is treated. Musicians own and operate the studio. Their attitude is receptive, and the surroundings are comfortable — no Jacuzzis or pin-ball machines, just friendly people who strive to make magic on tape.

**•• DOCTOR SOUND**

*\*also REMOTE RECORDING\**

3191 Adams Ave., San Diego, CA 92116  
(714) 563-0164

**Owner:** Rick Gord, Steve Rock.

**Dimensions of Studios:** Approx. 850 sq. ft.

**Dimensions of Control Rooms:** Approx. 250 sq. ft.

**Tape Recorders:** Tascam Model 80-8 with dbx (DX-8); (2) Revox Model 1102 high speed half-track; TEAC Model 3340; Nakamichi Model 550; JVC Model CD-1636 cassette machine.

**Mixing Consoles:** Modified Tapco 6200B (total of 24 channels).

**Monitor Amplifiers:** Crown DC-300A, Crown D-60's; SAE for studio.

**Monitor Speakers:** JBL 4311, Auratones (for control); Altec A-7's (for studio).

**Outboard Equipment:** SAE EQ's, Tapco reverbs, Burwen DNF 1201-A's, dbx 162, UREI LA3A limiters.

**Microphones:** Group 128 (electret condensers); Shure SM-52, SM-53, SM-56, SM-57; Sennheiser MD-421 and MD-441; Sony ECM-33P, ECM-65P; E-V 635A and RE-50.

**Instruments Available:** Kawai baby grand piano, Hammond B-3 with Leslie tone cabinet, Fender Rhodes, Fender Bandmaster amp with JBL speakers. (No charge for any of the above.)

**Extras:** Free production counseling (enables client to utilize studio time most effectively), coffee.

**Direction:** Simplicity is the key at Dr. Sound. We feel acoustics are more important than equipment — if the sound in the studio isn't excellent the best mikes can't improve it. Both the studio and control room were designed to be totally non-parallel. Both rooms are finished in a variety of acoustic surfaces from live to dead. This enables us to capture a full, open, and natural sound as opposed to the "boxy" sound rectangular rooms have. Our operating philosophy is: "It's not what you have, it's what you do with it." The electronics in our system are very simple and we know how to get ANY desired results out of it! We have completed a variety of projects in our first year of existence. Happy customers use us for radio and television commercials, film music, multimedia soundtracks, public address (high quality sound reinforcement), radio programs, and tons of songwriter demos. Our rates are more than reasonable and we have bulk rates. Please call for more details and unforgettable personal service!



**•• ELECTRONIC SOUNDS**  
4267 Marina City Dr., Suite 1108, West Tower,  
Marina Del Rey, CA 90291  
(213) 822-3475

**Owner:** James Robeson.

**Engineers:** James Reson.

**Tape Recorders:** Tascam Model 80-8 with Dolby 8 trk.  
**Instruments Available:** All electronic equipment furnished.

**Rates:** \$25/hour.

**Direction:** We specialize in electronic music.



**•• FULLER SOUND**  
P.O. Box 65051, Los Angeles, CA 90065  
(213) 660-4914

**Owner:** Mike Fuller.

**Engineers:** Mike Fuller, Bob Baker.

**Dimensions of Studios:** Announce booth 10' x 10'; "conference" 13' x 25'.

**Dimensions of Control Rooms:** 10' x 10'.

**Tape Recorders:** Tascam Model 80-8 8 track; TEAC Model 3340 4 track; Sony TC-650 2 track; Otari Model MX-5050 2 track; Spotmaster cart mono; Teico cart mono; Realistic 8 track mono; Superscope Teico cart mono; Realistic 8 track 2 track; Superscope stereo cassette 2 track.



# TRACK TRACK TRACK TRACK

**Mixing Consoles:** Tapco Model 6200A, 6 in x 2 out; Tapco Model 6200B, 6 in x 2 out; Lamb Model PML 420, 4 in x 2 out; Shure Model SE-30, 3 in x 1 out; Shure Production Master, 4 in x 1 out; Sony Model MX-12, 6 in x 2 out.

**Monitor Amplifiers:** Kenwood KA-2500.

**Monitor Speakers:** JBL 4311's, Koss Electrostatic headsets.

**Outboard Equipment:** Kepex, Inovonics Dynex (2), Parasound Dynamic sibilance controller, Parasound parametric EQ, UREI graphic EQ, dbx 161 limiters (2), dbx 154 noise reduction (2), Fisher reverb, auto correlator, Burwen dynamic noise filter.

**Microphones:** Neumann U-87; E-V RE-16, RE-11, 1176, 635; Shure 300 ribbons.

**Instruments Available:** Upright piano.

**Extras:** Broadcast turntables, cart machines, sound effects, music library, slide projectors, multi-media programmer and dissolve, light tables.

**Rates:** \$25/hr, 1 hour minimum plus materials. All formats except slide show programming \$30/hr.

**Direction:** Fuller Sound is primarily a voice-over facility designed to handle radio production and audio visual sound tracks. Although we have the facilities to record a client's jingle or custom track for a radio spot or A.V. presentation the voice-over itself and the artistic use of canned music and effects is the direction we see ourselves going.



## •• FUTURISTIC SOUND STUDIOS

1842 Burlison, Thousand Oaks, CA 91360  
(805) 496-2585

**Owner:** Randy Dew.

**Engineers:** Randy Dew.

**Dimensions of Studios:** 24' x 20'.

**Dimensions of Control Rooms:** 10' x 12'.

**Tape Recorders:** Tascam Model 80-8 8 track; Tascam Model 25-2 2 track; TEAC Model 1600 2 track; TEAC Model A-650 cassette 2 track.

**Mixing Consoles:** Custom built Tascam 5 and 5EX, 20 in x 8 out.

**Monitor Amplifiers:** BGW.

**Monitor Speakers:** JBL 4311's.

**Outboard Equipment:** 10 channels of dbx noise reduction, MXR digital delay, dbx 160 compressor/limiters, Roland RV-800 stereo reverb.

**Microphones:** AKG C-414 EB's, C-452 EB's, C-505 E's; Electro-Voice RE-20's; Shure SM-57's.

**Instruments Available:** Gibson electric guitar, Fender bass, Fender amplifiers.

**Extras:** Billiard room.

**Rates:** \$20/hr plus tape.

**Direction:** I am a professional musician. We have done many demos, 45's and albums. All tape is available through us. In the near future we will be moving to a new location. We have a very relaxed atmosphere.



## •• GAHLORIE RECORDING STUDIO

10121 South Vermont Ave., Inglewood, CA 90044  
(213) 754-2971 or 754-2972

**Owner:** Jim Saunders

**Engineers:** Jim Saunders, Chester Forrest.

**Dimensions of Studios:** 80' x 65' x 18'.

**Dimensions of Control Rooms:** 20' x 20'.

**Tape Recorders:** Custom 440 Series 8 track; Ampex Model 3545 2 track.

**Mixing Consoles:** Custom built 20 in x 8 out; Peavey 1000, 10 in x 2 out.

**Monitor Amplifiers:** Dynaco Mark III.

**Monitor Speakers:** Altec 604E's, JBL.

**Outboard Equipment:** LA3A limiters, Shure professional mic mixers.

**Microphones:** Shure SM-58's, SM-57's; Electro-Voice RE-15's, 623, 664's.

**Instruments Available:** Piano, organ bass amp, drums.  
**Rates:** 8 track \$25/hr. 2 track \$15/hr. Tape copies, editing or mixdowns \$15/hr.

**Direction:** Future plans are to expand to 24 track. I have worked with many major studios, was Chief Engineer for Ike and Tina, and am now employed the The Burbank Studios as an engineer. Gahlorie has been in existence for 2 years and has recorded 12 albums and many 45's. We specialize in gospel recording only.



## •• GLADSTONE RECORDING

6846 Vineland Ave., N. Hollywood, CA 91606  
(213) 762-3125

**Owner:** Gary Gladstone.

**Engineers:** Gary Gladstone and independents.

**Dimensions of Studios:** 20' x 18' with isolation booth.

**Dimensions of Control Rooms:** 10' x 7'.

**Tape Recorders:** Tascam Model 80-8 8 track; TEAC Model A-3340-S 4 track; TEAC Model 3300-S ½ track; (3) Sansui Model SC-1110 stereo cassette machines.

**Monitor Speakers:** JBL 4311's, Auratone 5C's.

**Outboard Equipment:** 8 channels of dbx, UREI 1176 limiting, SAE 20 band/channel graphic EQ, Orban/Parasound 106-C reverb, Pultec program equalization, Tapco reverb, flanging, echo, noise gates.

**Microphones:** AKG 414 EB, many AKG, Shure, Electro-Voice, also 1 Barcus Berry.

**Instruments Available:** Many electronic keyboards for \$25/day.

**Extras:** Free use of 8 track tape (if desired), and use of many effects boxes.

**Rates:** \$15/hr or \$100/8-hour day when booked in advance. No extra charges.

**Direction:** To continue doing more and more mixes on tapes recorded at competitive studios, as well as entire projects. Also, the studio is now recording syndicated radio shows and specials, etc.



## •• GOLDMINE RECORDING STUDIO

1393 Callens Rd., Ventura, CA 93003  
(805) 644-8341

**Owner:** Tim Nelson.

**Engineers:** Tim Nelson, Terry Nelson.

**Dimensions of Studios:** 30' x 15' x 12' with 9' x 10' x 12' booth.

**Dimensions of Control Rooms:** 14' x 18' x 12'.

**Tape Recorders:** Tascam Series Model 80-8 8 track; TEAC Model 3340; Sansui cassette deck 1110.

**Mixing Consoles:** Sunn, modified, 24 in x 24 out; Tascam Model 10 with expander.

**Monitor Amplifiers:** Quatre 250.

**Monitor Speakers:** Altec 604E.

**Outboard Equipment:** Phase Linear auto correlator, dbx 161 compressor/limiter, Ashly Audio SC 66 stereo parametric EQ, Multi-Track dual EQ reverb, Tapco 4400 reverb, Altec ½ octave graphic EQ.

**Microphones:** Electro-Voice RE-20, 1751; AKG 451E, D-100E; Sony ECM 22P; Shure SM-57, SM-54, SM-58; Sennheiser 421; Neumann U-87.

**Instruments Available:** Drums, grand piano, Hammond organ B-3.

**Rates:** \$20/hr 8 track.



## •• GRAMAPHONE STUDIOS

13889 Meyer Road, Whittier, CA 90604  
(213) 941-6640 & (714) 994-6375

**Owner:** Dave Paton.

**Engineers:** Dave Paton, Phil Amador.

**Dimensions of Studios:** 24' x 32'; drum enclosure — 12' x 14'.

**Dimensions of Control Rooms:** 12' x 20'.

**Tape Recorders:** Tascam Model 80-8 8 track; TEAC Model 25-2 2 track; TEAC Model 3340S 4 track; Sony Model 730TC 2 track; Dokorder Model 7010 4 track.

**Mixing Consoles:** Tangent (special design for studios) Model 1202, 12 in x 4 out.

**Monitor Amplifiers:** ESS 500C, Sansui, Crown DC-60.

**Monitor Speakers:** Special series "Gruezar", TSS cubes, Sansui mini monitors.

**Outboard Equipment:** Dolby, dbx, Orban/Parasound reverb, Ibanez analog delay, flanger, Sansui reverb, Fender reverb, SAE 10-band EQ, Motrotec 4-channel, AKG reverb.

**Microphones:** Altec 456A; Shure 545, SM57, SM54; Electro-Voice RE10, RE16, DS35; Sennheiser 451E; Univox condenser; Sony 22P condenser.

**Instruments Available:** 1906 John Church piano (re-built), Roger drums w/cymbals, in-house old Gibson amps, percussion accessories. All rental equipment available at a discount through Whittier Music Company.

**Extras:** Refrigerator, restrooms, air-conditioned, easy access to studio.

**Rates:** \$15/hour, \$10/engineer, plus tape cost. Mix-down \$15/hour.

**Direction:** A large part of our business is for "Top 40" groups to do copy material for bookings. As a small studio, we have been booked for session time a month and a half in advance for months! We have just installed a new ¾ inch video with color monitors for commercial use. The Whittier studio will be expanding its facilities within the year. Enlarged control room and game room are in the plans. As for expanding costs and tracks — we are staying the same — our combination works!



## •• JPM RECORDING STUDIOS

11745 E. Washington Blvd., Whittier, CA 90606  
(213) 696-0211

**Owner:** John Peters (Owner/Chief Engineer).

**Engineers:** Denny Hardesty.

**Dimensions of Studios:** 33' x 19'.

**Dimensions of Control Rooms:** 19' x 16'.

**Tape Recorders:** Ampex Model AG 440C 8 track; Ampex Model AG 440 4 track; Ampex Model AG-440 2 track; Revox Model A77HS 2 track; TEAC Esoteric Series cassette (stereo).

**Mixing Consoles:** Quantum custom, 12 in x 8 out.

**Monitor Amplifiers:** Crown.

**Monitor Speakers:** JBL 4310's.

**Outboard Equipment:** Marshall Time Modulator, Gain Brain limiters, Kepex audio gates, Ashly parametric equalizers, VSO, Altec 1567A tube mixers, Miracord 10H turntable, Sound FX library.

**Microphones:** Electro-Voice RE-20; RCA BK-5B and 77-DX; Sony ECM 22P; (Neumann and others SOON); direct boxes (transformerless active, and with transformer); currently — 12 mics.

**Instruments Available:** Piano, drums, Mini Moog, percussion instruments.

**Rates:** \$25/hour — all hours 7 days a week. (Special tape copy rates, open reel and cassette).

**Direction:** Recently we've been having some fun on the side with a science fiction sound effects album we recorded. This album plus other custom effects are used by disc jockeys, planetariums, Ringling Bros. Circus, and sci-fi films and audio dramas. The majority of our work continues to be demos of master quality and masters. Our rooms are tuned flat so your mix sounds great through small speakers as well. We work fast and efficiently, yet love to take the extra time to help you fine tune your creative sound. We are looking hopefully ahead to 16/24 track facilities. Live long and prosper!



## •• KITCHEN SYNC SOUND RECORDERS

5325 Sunset Blvd., Hollywood, CA 90028  
(213) 466-3035

**Owner:** Michael Hamilton, Jeff Snyder, Larry Menshek

**Engineers:** Michael Hamilton, Jeff Snyder, Larry Menshek.

**Dimensions of Studios:** 16' x 14' x 9', Vocal booth 5' x 5' x 7'.

**Dimensions of Control Rooms:** 12' x 13' x 9'.

**Tape Recorders:** TEAC Model 80-8 8 track with dbx; TEAC Model 3340S 4 track with dbx 124; Otari Model MX-5050 2 track with VSO; TEAC Model 7030 2 track; TEAC Model A-3300-S 2, ¼ track; Akai Model 570D cassette.

**Mixing Consoles:** Sound Workshop Model 1280B, 12 in x 8 out; Ampex Model MX-10 (tube), 4 in x 2 out.

**Monitor Amplifiers:** SAE MK III, SAE MK 31B, Sony, Marantz.

**Monitor Speakers:** JBL L-100's, Auratone 5C, RSL 3300's in studio, Bogussound 5" in lounge.

**Outboard Equipment:** dbx 161 limiters, Delta-Graph octave graphic EQ's, MXR digital delay, Orban 111B stereo reverb, Sennheiser HD-400 headphone system, dbx noise reduction, Bozak Time Mutilator.

**Microphones:** AKG 414, 501's; Electro-Voice RE-20; Sony ECM-22's, 23F; Sennheiser 421's; Shure SM-57's, SM-53's; Nakamichi CM-300.

**Instruments Available:** Kawai 6 foot grand piano, Gretsch Wood Drum Kit, Gretsch bass, Pignose amps, Fender Twin Reverb amp, low rental rates on other instruments.

**Extras:** Lounge with TV, games; kitchen (with sink), separate low-cost copying facility, free off-street parking, sound effects library.

**Rates:** 8 track, 2 track: \$25/hr. 4 track, ¼ track: \$15/hr. 2-hour minimum. Copying: \$10/hr (basic rate).



**Direction:** At Kitchen Sync you can always count on quality sound, reliable service, and personal involvement. We go the extra distance to make your project stand out from the crowd, whether it's a demo or a master. Our room, although small, was designed and constructed to exacting acoustic and aesthetic standards. It looks, feels, and sounds great! Our clients include some of LA's top publishing, advertising, and record companies. Our product is in the stores, on the radio, and on the charts. Call us for a free studio tour and latest information. We plan to expand to 16-track this year.



KITCHEN SYNC, Hollywood



•• KRIS STEVENS ENTERPRISES, INC.  
14241 Ventura Blvd., Sherman Oaks, CA 91423  
(213) 981-8255

**Owner:** Kris Erik Stevens  
**Engineers:** Michael Jordan, Fred Lindgren.  
**Dimensions of Studios:** Studio A: 8 performers, Studio B: 6 performers.  
**Dimensions of Control Rooms:** Control A: 12' x 20'. Control B: 10' x 12'.

**Tape Recorders:** Ampex Model 440 2 track; Tascam Model 80-8 8 track; Tascam Model 40-4 4 track; several TEAC Model 7300's 2 track, and TEAC Model 6100's 2 track; TEAC, Nakamichi and Sony cassette decks; ITC and Spotmaster cartridge decks.

**Mixing Consoles:** Tascam Model 10, 12 in x 8 out; Tascam Model 5, 8 in x 8 out.

**Monitor Amplifiers:** Crown, SAE.

**Monitor Speakers:** JBL's, RSL's, Auratone mix-down cubes.

**Outboard Equipment:** dbx limiters, 440 reverb, VSO, graphic EQ, phaser, filters, Russco stereo turntables — (2) per studio, Heinen-Fisher digital clocks, Heathkit countdown clocks, dbx noise reduction all channels, multiple stereo headphone monitoring, custom disc jockey console for syndicated radio programs including mic control, talkback, countdown clocks, headphones and monitor level control.

**Microphones:** Neumann U-87's, Sennheisers, RCA's, Electro-Voice, Beyer's, Shure.

**Instruments Available:** Fender Rhodes.

**Extras:** Coffee, comfort, convenience, plus plenty of free parking.

**Rates:** Please call for rates and information.

**Direction:** We specialize in radio and TV commercials and syndicated radio programs including Dr. Demento, American Disco Network, and The Top Ten Hits Of All Time. Our commercial productions for major advertising agencies and retail chains include access to our high sound-effects library, production music library, plus a direct telephone line patch system to produce/direct a session from anywhere in the world. Additionally we produce jingles, cast talent, and provide complete duplication services.



•• LITTLE RECORDING STUDIO  
P.O. Box 1161, Ontario, CA 91762  
(714) 986-4747

# TRACK 8 TRACK

**Owner:** Charles Currie.  
**Engineers:** Charles Currie.  
**Dimensions of Control Rooms:** 9' x 12'.  
**Tape Recorders:** Tascam Model 80-8 8 track; TEAC Model A-3300-SX-2T 2 track; TEAC Model A-700 cassette.  
**Mixing Consoles:** Tascam Model 3, 8 in x 4 and 8 out.  
**Monitor Amplifiers:** Accuphase P-20.  
**Monitor Speakers:** Auratone 5C Super Sound Cubes, and custom made 12-inch 3-ways.  
**Outboard Equipment:** dbx noise reduction, Soundcraftsmen equalizer, TEAC AX-10 Sound On Sound and echo unit.  
**Microphones:** TEAC ME-80's (more on the way).  
**Instruments Available:** Cat electronic synthesizer; huntington upright piano.  
**Rates:** 8 track \$12/hr, location \$15/hr; 2 track \$8/hr, location \$11/hr. Price of tape extra. Two hour min.  
**Direction:** We are a very small 8-track studio catering to the art of the acoustic guitar.



LITTLE RECORDING STUDIO, Ontario



•• MAIN ST. STUDIOS  
4051 Main St., Riverside, CA 92501  
(714) 684-3785

**Owner:** Kevin Lamb, John Sexton, Richard Bendix, Bruce Terry.

**Engineers:** John Sexton, Richard Bendix, Bruce Terry.  
**Dimensions of Studios:** 17' x 22'.

**Dimensions of Control Rooms:** 12½' x 14½'.

**Tape Recorders:** TEAC/Tascam Model 80-8 w/dbx noise reduction, 8 track; TEAC Model 3300 2 track; ¼ track and cassette available.

**Mixing Consoles:** TEAC Model 15, 16 in x 8 out.

**Monitor Amplifiers:** Spectro Acoustics, Sansui.

**Monitor Speakers:** JBL 4311's, Auratones.

**Outboard Equipment:** dbx noise reduction, dbx compressor/limiter, Tapco 4400 reverb, outboard EQ and other signal processing devices available.

**Microphones:** Sennheiser MD 421's, AKG D1000E's, Shure SM-57, 58, 59's; E-V RE-10; TEAC ME-80's.

**Instruments Available:** Yamaha baby grand and other keyboards, amplifiers, etc. available on a rental basis.

**Extras:** Air-conditioning, ample parking, comfortable atmosphere.

**Rates:** \$30/hr.

**Direction:** High quality recording at a reasonable cost.



## Outside it's BLACK Inside it's TRANSPARENT



- INDESTRUCTIBLE EXTRUDED HOUSING
- RECESSED CONNECTORS AND SWITCHES
- BATTERY OR PHANTOM POWERED
- INTERNAL PAD FOR SPEAKER BRIDGING
- TRUE GROUND ISOLATION—EVEN WHEN PHANTOM POWERED
- R.F. FILTERED ON INPUT AND OUTPUT
- ACTIVE CIRCUIT—DOES NOT LOAD PICKUPS
- LESS THAN 2µV NOISE
- RESPONSE ±.5dB 20 Hz TO 20 KHz
- .05% HARMONIC DISTORTION

COUNTRYMAN ASSOCIATES  
424 Stanford Avenue  
Redwood City, CA 94063  
Phone (415) 364-9988



# TRACK TRACK TRACK TRACK

## •• MEL'S SOUND OF MUSIC

3148 1/2 E. Colima Rd., Hacienda Hts., CA 91745  
(corner of Hacienda Blvd and Colima)  
(213) 961-2475

**Owner:** Mel Arakelian

**Engineers:** Mel Arakelian, Tom Manasian.

**Dimensions of Studios:** 12' x 19'

**Dimensions of Control Rooms:** 8' x 8'

**Tape Recorders:** TEAC/Tascam/DX8 Model 80-8 8 track; TEAC Model TCA-43 4 track; Sony 2 track; Aiwa/cassette Model AD-6300 2 track.

**Mixing Consoles:** Tascam Model 10, 8 in x 4 out.

**Monitor Amplifiers:** Sansui AV517.

**Monitor Speakers:** JBL L100's.

**Outboard Equipment:** Orban/Parasound dual reverbation.

**Microphones:** Shure SM-57, SM-58, PE-54, PE-56D; AKG C-501E.

**Instruments Available:** Schneihofer baby grand, synthesizers, drums, electric pianos, electric organ (B-3 sound), amps, and many different brands of guitars.

**Extras:** Studio musicians available, musical arrangers available, vocal background singers available if needed, multi-copies of either cassette or records available.

**Rates:** \$25/hr or block time rates available.

**Direction:** Pomona Frwy to Hacienda Blvd (approx. 3 1/2 miles E. of 605 Frwy), go south for 2 miles, turn right at Colima. We're in the Alpha Beta Shopping Center on the south-west corner of Colima and Hacienda Blvd.



## •• MOSER SOUND PRODUCTIONS

1923 W. 17th Street, Santa Ana, CA 92706  
(714) 541-6801

**Owner:** Richard Moser

**Engineers:** Richard Moser

**Dimensions of Studios:** 20' x 15'; 10' x 7'

**Dimensions of Control Rooms:** 14' x 8'

**Tape Recorders:** Otari Model 5050-8 8 track; Do-korder Model 1140 4 track; Otari Model 5050 2 track.

**Mixing Consoles:** Sound Workshop Model 1280 B-8 EQ, 12 in x 8 out.

**Monitor Amplifiers:** BGW 250C.

**Monitor Speakers:** JBL 4311, E-V Sentry V.

**Outboard Equipment:** Marshall Time Modulator, UREI graphic EQ, UREI limiters, Orban parametric EQ, MICMIX Master-Room reverb, dbx compressors, dbx 158 noise reduction.

**Microphones:** Neumann U87, KM84; AKG 452; Sennheiser 441, 421; E-V RE15; Shure SM56.

**Instruments Available:** Yamaha piano, Hohner clavinet, guitars.

**Extras:** Hot tub, kitchen, 24 hour Jack-in-the-Box and Taco Bell next door. Ambulance service across the street.

**Rates:** \$25/hour plus tape.

**Direction:** Since we're into recording (almost) any kind of music, we can vary our room acoustics from live to dead for the sound you need. Come in with anything from complete arrangements to a tune you can hum and we can work from there. Musicians and arrangers are available.



## •• NORTH STAR PRODUCTIONS

56624 Joshua Drive, Yucca Valley, CA 92284  
(714) 365-7145

**Owner:** Mark Bransford, Greg Bransford, Mark Price.

**Engineers:** Greg Bransford, Nick Mandola.

**Dimensions of Studios:** 16' x 20'

**Dimensions of Control Rooms:** 9' x 12'

**Tape Recorders:** Tascam Model 80-8 8 track; TEAC Model 2300 1/4 track; Pioneer Model RT-1050 1/2 track.

**Mixing Consoles:** Tascam 5-A, 8 in x 4 out; Tapco Model 6200, 6 in x 2 out; Tapco Model 6100RB, 6 in x mono.

**Monitor Amplifiers:** Crown D-150; Crown D-60; Kenwood KA-7100.

**Monitor Speakers:** Our own custom design with JBL's and Advent loudspeakers.

**Outboard Equipment:** dbx noise reduction, Roland RE-201 space echo, Tapco 2200 graphic EQ, Sound Workshop reverb, flanger, MXR noise gate.

**Microphones:** Neumann U-47 tube; E-V RE-20, RE-10, CS-15 condenser; AKG D-900 shotgun; Sony ECM-16 condenser, EC-9P condenser; Shure SM-58's, 545's, 515's; TEAC ME-120 condensers, IMP-2 direct boxes.

**Instruments Available:** Electric guitars and amps, Rickenbacker bass, various percussion instruments, Ludwig drums.

**Extras:** Lots of hot coffee or tea, good people and plenty of peace and quiet.

**Rates:** 8 track: \$25/hr. 4 track \$18/hr. 2 track: \$5/hr. Mixdown \$20/hr. Block rates and tape prices available on request.

**Direction:** Being located in the beautiful surroundings of the hi-desert just north of Palm Springs, our studio was designed with the serious musician in mind. We are staffed with qualified engineers and musicians to get you "rolling" with the sound you want, without all the hassle of the city. Please call for information about our other services in the recording field.



## •• ORION RECORDING LTD.

636 Baker St., Costa Mesa, CA 92626  
(714) 546-5718

**Owner:** Larry Travis.

**Engineers:** Larry Travis, various independents.

**Dimensions of Studios:** One room studio/control room 19' x 25', approx. 356 sq. ft. floor space in studio area. Control area approx. 140 sq. ft.

**Tape Recorders:** TEAC Model A7300 SX-2 2 track; TEAC Model A3300 SX-2 2 track; converted Ampex FR-100 1/2" 8 track.

**Mixing Consoles:** Custom built console with two sections... The right side of the console is set up for doing broadcast programs and commercials, the left side is designed for multi-track recording. Total, 18 in x 10 out.

**Outboard Equipment:** Orban 111B dual reverb, Bi-Amp graphic equalizer, Tapco graphic equalizer, 2 Technics SL-1500-MK2 turntables, cassette and 8 track cartridge dubbing facilities, Audiotronics high speed tape duplicator, mini-transmitter for checking recorded material on car radios in parking lot.

**Microphones:** Sennheiser MD-441U, AKG D-170E, Shure 533-SB.

**Rates:** Please call for rates.

**Direction:** Studio has been designed primarily as a broadcast oriented studio; (radio commercials, jingles, programs, voice-overs, slide presentations, etc...) Studio is made available to musicians for doing inexpensive demo tapes. The studio also supplies a "Talent Library" to clients looking for announcers, actors, musicians, etc. for commercials, jingles, etc. All local artists are encouraged to send tapes for inclusion in the library free of charge. (Sorry, no tapes can be returned.) Also 16mm film sound transfer and mixing.



## •• R.E. COPSEY RECORDING

*\*also REMOTE RECORDING\**

P.O. Box 367, 2021 Buena Vista Drive,  
Camarillo, CA 93010

(805) 484-2415

**Owner:** Reese and Ceil Copsey.

**Engineers:** Reese Copsey.

**Dimensions of Studios:** 10' x 19', high ceiling, plus 6' x 7' booth.

**Dimensions of Control Rooms:** 10' x 13'

**Tape Recorders:** Wollensak Model 8075A 8-track cart.; Wollensak Model 2551 AV cassette; Pentagon Model C1 cassette duplicator; Ampex Model 351-8, 1 inch 8 track; Ampex Model 351-4 1/2 inch 4 track; Ampex 351-2 2 track; Ampex Model 440-2 2 track; Revox Model A77 1/4 track; Nakamichi Model 1000 cassette.

**Mixing Consoles:** Ampex Model MX-35, 8 in x 4 out; Altec custom, 10 in x 2 out.

**Monitor Amplifiers:** Marantz Model 9's, Dynaco stereo 70's.

**Monitor Speakers:** Tannoy Dual Autograph CRF's, Quad Electrostatics, JBL 4311's.

**Outboard Equipment:** dbx 157 noise reduction (2), Altec 9062A graphic EQ's (2), Universal Audio 500-A equalizers (4), RCL spring reverb, UREI LA3A audio leveler.

**Microphones:** Neumann U-87's; AKG C-451E's, D-224E's; Sennheiser MD-421U's; Electro-Voice RE-20's; Sony C-22 FET's.

**Instruments Available:** Wurlitzer studio model acoustic piano.

**Extras:** Sideman musicians and narrators, slide sound-track specialty, comfortable informal studio working conditions, hot coffee, a desire to please every customer completely, 7 years experience.

**Rates:** Studio: 8 & 4 track \$25/hr plus tape. 2 track and edit \$20/hr plus tape. Location: 2 track \$25/hr, 4 track \$30/hr, 1 hour set-up charge.

**Direction:** We specialize in location recording and provide a small but cozy studio. We use top quality equipment to do the job for a reasonable price with fewer gadgets and extras. We prefer Ampex 456 tape without noise reduction to give us a clean product; dbx is also available. We produce cartridge, cassette, and reel copies as well as high-speed cassettes and records. Our work includes A/V narration, radio jingles, sound tracks, and demos with sidemen.



## •• THE REEL RECORDING CO.

P.O. Box 2161, West Covina, CA 91793  
(213) 967-0264

**Owner:** Tony Demme.

**Engineers:** Tony Demme.

**Dimensions of Studios:** 18' x 20'

**Dimensions of Control Rooms:** 10' x 12'

**Tape Recorders:** Tascam Model 80-8 with dbx 8 track; Tascam Model 25-2 with dbx 2 track; TEAC Model 3300SX 1/4 track; Pioneer Model CTF-9191 cassette stereo deck.

**Mixing Consoles:** 2 Tascam Model 5's patched together, 16 in x 8 out.

**Monitor Amplifiers:** Spectro Acoustics 202C/100 Watts per channel.

**Monitor Speakers:** JBL 4311's and Auratone 5C Sound Cubes.

**Outboard Equipment:** Bi-Amp 210 graphic equalizers, Spectro Acoustics 210 R graphic equalizer, Tapco 440 reverb unit, Tascam Model 1's, used for independent headphone mixes, tape delay echo.

**Microphones:** Sennheiser 421's; Shure SM-57's, SM-58's; TEAC ME-80's.

**Instruments Available:** Baldwin studio acoustic piano, 6 and 12 string acoustic guitars, Les Paul custom electric guitar, electric bass guitar, Pig Nose amplifier.

**Extras:** Coffee, patio, close to restaurants, central air-conditioning and heating, specially engineered for minimum noise level.

**Rates:** 8 track: \$20/hr; block and package prices on request - tape extra.

**Direction:** We are a full service studio, offering song-writers, groups, churches, and single artists a comfortable and private atmosphere to create highly professional, master quality demos. We also have formed our own production company, specializing in original jingles, which we write and produce for radio. In addition, we offer tape duplicating and record pressing services. Our direction for the future is to continue our record of high quality recordings and customer satisfaction.



## •• SPECTRASOUND RECORDING STUDIO

P.O. Box 2323 Hollydale, CA 90280  
(213) 633-9245

**Owner:** Jay Staggs

**Engineers:** Jay Staggs, Norm Davis.

**Dimensions of Studios:** 35' x 15' (large enough for a stage band).

**Dimensions of Control Rooms:** 15' x 10'

**Tape Recorders:** Tascam Model 80-8 8 track; Tascam Model 25-2 full 2 track.

**Mixing Consoles:** Tascam Model 5A, 8 in x 4 out.

**Monitor Amplifiers:** (See Monitor Speakers).

**Monitor Speakers:** JBL self-powered 4301E's.

**Outboard Equipment:** Tapco 4400 reverb, phase control.

**Microphones:** Shure Pro line.

**Instruments Available:** Amps, accessories, plus discount instrument rental from local dealer.

**Extras:** Comfortable lounge area, soft drink machine, plenty of parking, studio completely air-conditioned.

**Rates:** Please call for quotes.



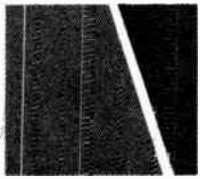

# fact: the Pro Master™ sound system is not an evolution... it's a full-blown REVOLUTION!



The PRO MASTER modular sound system ushers in a new generation of sound system versatility, reliability, and quality for today's entertainers, musicians, and speakers — for use in settings as diverse as intimate clubs, lounges, large auditoriums, churches, and schools. Its multitude of performance-proven features is the result of sophisticated computer design techniques, advanced materials, and countless hours of personal consultation with performers and sound technicians.

## Revolutionary New Console

Finally! The best of *both* worlds. A console so easy to use that it won't overwhelm the beginning group, yet with the advanced features and capabilities required by experienced professional performers — such as pre-fader monitor mixing, effects and/or built-in reverb, with their own tone controls, LED clipping indicators with attenuators on each input, and full patching facilities for every system component. Super power: *twin 200-watt solid-state power amplifiers!* Doubles as a stereo recording console for groups that want to "lay down a few tracks" without paying for studio time, or can be used as an ultra-sophisticated keyboard mixer with power. Unitized ARMO-DUR™ structural foam combination case and chassis makes it more durable than steel. Ultra-light: only 47 pounds.

## Revolutionary New Loudspeaker

Every extra ounce — every unnecessary cubic inch — has been computer designed OUT of the PRO MASTER loudspeaker. Modern materials and molding techniques accommodate a high-performance 15-inch woofer and a high-frequency horn and compression driver in a startlingly small, efficient enclosure. Less than 28 inches high, 23 inches wide, 16 inches deep. Weighs an easy-to-handle 58 pounds. Yet, the power handling capacity is a remarkable 150 watts, and the frequency response is 50 to 15 kHz.

## Revolutionary: Variable Dispersion Sound System

Advanced new variable dispersion high-frequency horn system projects your sound — everywhere in the house, giving you a choice of 60° long-throw, or 120° wide-angle dispersion with the twist of a knob. Tailors the sound to the room — even L-shaped rooms.

## Revolutionary: FEEDBACK FINDER™/ Equalizer

Controls feedback — the number one enemy of a successful performance. FEEDBACK FINDER visually indicates the troublesome frequencies for precise adjustment of the twin 10-band equalizers. Enables you to equalize for maximum gain on the house and/or monitor system. Nothing else like it!

## Revolutionary: PATCH BLOCK™ Patch Panel

The back panel is a unique combination block diagram and patch panel with 12 patching jacks located at appropriate points on the block diagram. For the beginner who is taking his act on the road for the first time, the PRO MASTER works "as is," with no special connections. But with the PATCH BLOCK, the professional can create a wide variety of setups and add auxiliary equipment without makeshift connections. And you can change setups at a moment's notice without confusion. Simplicity and versatility, the PRO MASTER has them both!

## Revolutionary: LED Status Indicators

Alerts you to developing trouble *before* it gets serious! You have time to correct the problem before it interrupts the performance.



## Replaces All This Equipment... And Does More!

The impressive array at left includes a mixing console, two graphic equalizers, a pair of 200-watt power amps, a monitor mixer and an octave analyzer. The PRO MASTER gives you all these capabilities — plus features that you can't find in any other console, at any price: Unique FEEDBACK FINDER™ circuit, exclusive PATCH BLOCK™ patch panel, wide-range LED peak output and input clipping indicators. Plus pre-fader monitor send controls, LED power amp overload, temperature warning and shutdown indicators, 0 to 30 dB input attenuators, full stereo features, simultaneous effects and reverb on each channel. What's more, you have Hi-Z and Lo-Z balanced transformer-coupled mic inputs on all six mic channels, (can handle 12 mics simultaneously), plus two additional auxiliary input channels for adding synthesizers, tape players, tuners, sub mixers or any other high level output components. And each Lo-Z input features built-in simplex powering for condenser microphones.



Hear the Revolutionary New Sound!

 **SHURE**®  
**PRO MASTER™ sound system**

Shure Brothers Inc., 222 Hartrey Ave., Evanston, IL 60204 In Canada: A.C. Simmonds & Sons Limited  
Manufacturers of high fidelity components, microphones, sound systems and related circuitry.

Ask for  
Brochure  
AL581A



# TRACK TRACK TRACK TRACK

**Direction:** Spectrasound Recording Co. is involved with production and promotion of musical talent that is struggling to achieve success on their own terms. Our company maintains a BMI-affiliated publishing company, TKO Records (an independent label), close work with a record manufacturer, a production staff and hook-ups with name producers and radio stations. Also under roof of our 5000 sq. ft. complex are other departments such as photography, vocal development, choreography, dance and more. Our direction is always up.

## •• SPECTRUM STUDIO

*\*also REMOTE RECORDING\**

666 Camino Campana, Santa Barbara, CA 93111  
(805) 967-9494, 966-6461

**Owner:** Don Ollis, Brad Royer.

**Engineers:** Don Ollis, Brad Royer.

**Dimensions of Studios:** 21' x 21' x 11'.

**Dimensions of Control Rooms:** 12' x 10' x 8'.

**Tape Recorders:** Tascam Model 80-8 8 track; TEAC Model 3340S 4 track; Revox Model A77 2 track; Sony TC 366 1/2 track; Harman Kardon 200 cassette.

**Mixing Consoles:** Custom designed, 18 in x 8 out; custom designed mobile, 8 in x 4 out; custom designed mini-mobile, 4 in x 2 out.

**Monitor Amplifiers:** Southwest Technical Super Tigers, 80 Watts a side.

**Monitor Speakers:** JBL 4311, 4301, Interaudio 1000's, Auratones.

**Outboard Equipment:** Marshall Time Modulator, (special effects, flanging, phasing, delay), Spectra Sonics 610 Complimenter, SAE 2800 parametric EQ, Sound Workshop 242 and Tapco 440 stereo reverbs, Tascam DX-8 dbx noise reduction, Sennheiser HD-414 headphones, Dual 1019 turntable, Uni-Sync direct box.

**Microphones:** AKG 414 EB's, 451E; Sennheiser MD-421's; Shure SM-57's, PE-50 SP; Sony 22P, 33P's; various talkback mikes.

**Instruments Available:** 7' Steinway B grand piano, (1878); ARP String Ensemble; Polymoog; Fender Rhodes; Fender and Marshall amps; Fender Jazz and Rickenbacker basses; acoustic guitars; Ludwig, Gretsch, Zildjian drum equipment.

**Extras:** 7-sided isolation booth, air-conditioning, TV area, video games, kitchen.

**Rates:** \$20/hr for 2 & 4 track; \$25/hr for 8 track; free set-up time.

**Direction:** We are building an 18 in, 16 out console with LED-ladder readouts, 16-band EQ per channel (peaking and shelving), multiple headphone mixes, and 34-channel snake. It should be completed by March 79. We are mostly oriented to demos, ads, mobile recording, and budget singles and LP's. We have a distribution link through Rockpile Records in Santa Barbara.

## •• STARSOUND RECORDING

6531 Winnetka Ave., Canoga Park, CA 91306  
(213) 989-5619, 347-2645

## •• STUDIO B/NEWJACK

1717 N. Highland Ave., Suite 613,  
Hollywood, CA 90028  
(213) 466-6141, 466-5351

**Owner:** Alan Barzman, Bob Bain.

**Engineers:** Fred Jones, Ed Wilson, Loretta Salyers.

**Dimensions of Studios:** Studio A: 12' x 12'; Studio B: 13' x 7'.

**Dimensions of Control Rooms:** Studio A: 13' x 9'; Studio B: 11' x 11'.

**Tape Recorders:** Ampex Model 440B 8 track; Ampex Model 440B 4 track; (3) Ampex Model 440C 1 track; Ampex Model 351 2 track; (6) Ampex Model 351 1 track.

**Mixing Consoles:** Tangent Model 3216, 16 in x 16 out; Audio Concepts Concept I, 12 in x 8 out.

**Monitor Amplifiers:** Crown D-60 (one in each room).

**Monitor Speakers:** Studio A: Electro-Voice Sentry V; Studio B: JBL 4311.

**Outboard Equipment:** Nakamichi 700, Orban/Parasound dual reverb, dbx noise reduction, Dolby noise reduction, dbx limiter/compressors, Spectro Acoustic graphic EQ, Multi-Track parametric EQ, various turntables, 16mm and 35mm mag tape machines.

**Microphones:** Neumann U-87's; Shure SM-7, SM-57; Sennheiser MKH 405; E-V RE-20, DS-35, RE-16.

**Extras:** Extensive music & sound effects library. We are also capable of doing "phone-patch" sessions anywhere in the country. A Nagra portable machine for remote sessions (full track mono).

**Rates:** Mono and 2 track: \$60/hr. 4 track: \$70/hr; 8 track: \$80/hr.

**Direction:** Studio B/Newjack is a facility geared to the demanding recording requirements of creative radio and television commercial production: simple, complex or somewhere in-between. Narration and production for film, slide film and sales presentations are recorded here. We can handle small music sessions — and have 2 great rooms for mixing-down music recorded in other studios, up to 8 tracks. And outside engineers are welcome to book the facility. dbx noise reduction is available at no charge, Dolby 'A' is available at a slight additional charge. To help you in your production, we have the complete Capitol and Southern music libraries, and one of the most extensive sound-effects libraries in the world. To assure you that the quality of your master is preserved in the copies you give your clients, we feature 'real-time' audio tape duplication. We're equipped to handle ANY quantity, and our delivery time is usually within a day (large runs take a little longer). We do reel-to-reel dubs in full-track mono, half-track mono, 2-track mono or 2-track stereo. We do cassettes in mono or stereo. And our rates are VERY competitive.

## •• STUDIOHOUSE

6565 Sunset Blvd. #120, Hollywood, CA 90028  
(213) 464-1133

**Owner:** George Gilbreath.

**Engineers:** Bob Guarino, Bob Luttrell, Don Hills.

**Dimensions of Studios:** 13' x 14'.

**Dimensions of Control Rooms:** 13' x 16'.

**Tape Recorders:** Scully Model 280B Series 8 and 2 track.

**Mixing Consoles:** Studio Concepts Concept 1, 16 in x 8 out.

**Monitor Amplifiers:** Crown.

**Monitor Speakers:** E-V Sentry V.

**Outboard Equipment:** R 500 Clover echo; dbx noise reduction, dbx limiters.

**Microphones:** Neumann U-47, U-87; AKG Dynamic.

**Instruments Available:** Synthesizer, production studio sound effects and music library, plus live sound effects truck.

**Extras:** Outdoor garden, patio.

**Rates:** \$50/hour.

**Direction:** From the beginning, our goal has been to create a more complete recording environment; that is, a cheerful, upbeat, and stimulating place to work. Our 8 track recording room was designed and built specifically for voicing, commercial production, and radio dramatic production. The equipment is all new — it is the latest and the best.

## •• STUDIO 9 SOUND LABS

5504 Hollywood Blvd., Hollywood, CA 90068  
(213) 462-9714, 353-7087, 466-7129

**Owner:** John Gillies.

**Engineers:** John Gillies, Steve Blazina.

**Dimensions of Studios:** 20' x 25'.

**Dimensions of Control Rooms:** 20' x 15'.

**Tape Recorders:** Tascam 70 Series with VSO 8 track; TEAC Model A-3340-S 4 track; Sony Model TC 366 2 track; Sansui SC 1110 cassette.

**Mixing Consoles:** (2) Tascam Model 3's, 16 in x 16 out.

**Monitor Amplifiers:** Sansui AVC 5500, 75 Watts per side.

**Monitor Speakers:** JBL's and Auratones.

**Outboard Equipment:** Tapco 4400 reverb chamber, dbx 161 compressors and limiters, Tapco 2200 graphics, tape delay, dbx 122, VSO, noise gates, Sony turntable, Echoplex, flanging, tone generators, + 128 point patch bay.

**Microphones:** Sennheiser 421's; Shure SM-58's, SM-57's, SM-56's; Electro-Voice RE-20's; AKG D-1000's; Sony ECM-33 condensers.

**Instruments Available:** Upright baby grand piano, electric bass, Peavey 100 Watt PA with 8' 12"

speakers, Rhythm Maker, many perc. instruments.

**Extras:** Complete list of pro studio musicians at \$6/hr; instrument rentals available at very low rates, lounge with comfortable atmosphere, big view window, 24-hour service, friendly schooled engineers at no extra cost, central location, air-conditioned, free production assistance.

**Rates:** 8 track \$13/hr. 4 track \$9/hr.

**Direction:** We are preparing our 16 track facility for opening in the early part of '79. Of course we will still offer our 8 and 4 track services. Our studio offers a unique opportunity to the record producer, in that we offer one of our engineers at no charge to accompany the client and consult on mastering sessions for ANY tape recorded at Studio 9. We offer free production assistance in all phases of recording, from simple vocal demos, to radio spots, to mastering and pressing 45's and LP's. We get involved and we care!

## •• SUNBURST RECORDING AND PRODUCTIONS

7815 Kittyhawk Ave., Los Angeles, CA 90045  
(213) 649-2873

**Owners:** Bob Wayne and Richard McAndrew

**Engineers:** Bob Wayne and Richard McAndrew.

**Dimensions of Studios:** 14' x 18'; isolation booths:

**Dimensions of Studios:** 14' x 18'; isolation booths:

Vocal/piano — 6' x 8'; drum — 7' x 8'.

**Dimensions of Control Rooms:** 6' x 18'.

**Tape Recorders:** Tascam Model 80-8 with dbx 8 track; Tascam Model 25-2 with dbx 1/2 track; TEAC Model A 3340S 4 track; Fisher Model CR 5120

Dolby cassette deck.

**Mixing Consoles:** Sound Workshop Model 1280B-8 EQ, 12 in x 8 out with meter bridge.

**Monitor Amplifiers:** BGW 250, Dynaco 120 for musicians' cue.

**Monitor Speakers:** Electro-Voice Sentry V's, custom Altec's, Auratones.

**Outboard Equipment:** dbx noise reduction (Professional & 122-124 series), Orban/Parasound 111 B dual reverb, dbx limiters, Phillips 212 turntable, complete patch bay facilities.

**Microphones:** AKG 414, 451's, 1000's; E-V RE-15's; Sony ECM-33P, ECM-21; Shure 565.

**Instruments Available:** On premises — Schiller upright grand piano, Hammond B-3 organ with Leslie 122 speaker, ARP string ensemble, Fender Rhodes 73, Fender Telecaster electric guitar, Gibson J45 acoustic guitar, Fender Precision Bass guitar, Therman, Ludwig drum set, various percussion instruments, Fender Twin Reverb and Pro Reverb guitar amps, Pignose Amp, MXR flanger, phasers, and distortion box, Mutron III effects unit; other instruments available upon request.

**Extras:** Inflatable party dolls.

**Rates:** Flat rate \$20/hr. Block rate \$16 to \$18/hr.

**Direction:** To offer our experience as engineers, musicians and songwriters assisting you in achieving optimum results in an 8-track format. We provide a professional but relaxed and friendly atmosphere to achieve these ends.

## •• THE TONE ZONE SOUND SERVICES

6515 Sunset Blvd., Suite 309,  
Hollywood, CA 90028  
(213) 462-9089

**Owner:** Alan Kirk and Tod Andrews.

**Engineers:** Alan Kirk and Tod Andrews.

**Dimensions of Studios:** 20' x 20' — Professional acoustic design; not a store-front or garage.

**Dimensions of Control Rooms:** 10' x 10'.

**Tape Recorders:** Otari Model MX 5050 8 track; TEAC A-3340S 4 track; TEAC Model A-3340 SX 2 track; Pioneer Model CT F-9191 2 track.

**Mixing Consoles:** Sound Workshop Model 1280 B, 12 in x 8 out.

**Monitor Amplifiers:** JBL, Crown, Pioneer.

**Monitor Speakers:** JBL, Auratone.

**Outboard Equipment:** Orban/Parasound reverb, parametric EQ, UREI compressors, dbx 158 and 155 noise reduction, Eventide Harmonizer/Digital Delay, MXR Phase 100 and various other effects devices, test equipment.

**Microphones:** Neumann, AKG, Sennheiser, Shure, Sony, E-V, Altec.

**Instruments Available:** Kawai grand piano, Rhodes, Oberheim synthesizer, Fender Jazz Bass, Fender Stratocaster, misc. percussion and sound effects.

**Extras:** Free set-up, air-conditioning, coffee and comfortable surroundings, also a complete line up of pro musicians, vocalists and arrangers on call.



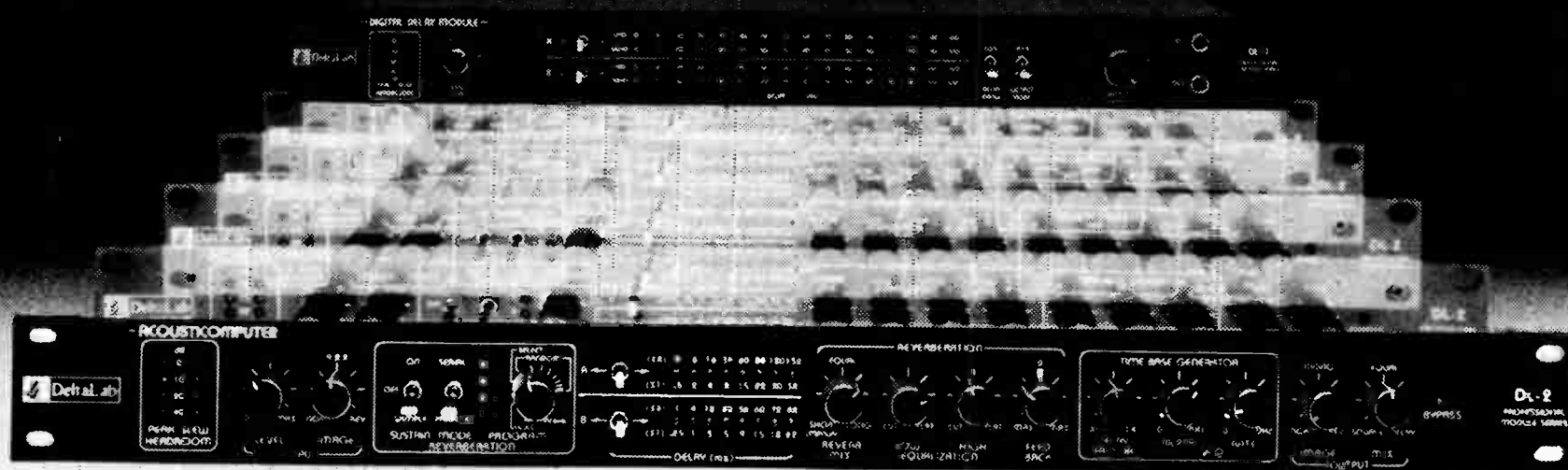

# How's THIS for an encore?

Modern Recording called our DL-1 Delay "probably the best we have encountered" . . . a tough act to follow.\* Now after more than a year in development DeltaLab introduces its encore - the ACOUSTICOMPUTER® - a combination digital-delay and special-effects processor designed for use both on-stage and in the studio, providing well-known functions (echo, doubling, chorusing, vibrato, flanging, etc.) plus new effects not available in any other device.

- Pre-reverb delay with two independent delay channels, variable from 0.25ms to 152ms with LED display.
- Delay up to 240ms in serial (mono) mode.
- Built in VCO with external control input at rear.
- Same no-compromise sound quality as in our DL-1 Digital Delay: Full 20-15 kHz bandwidth at all delay lengths with 90 dB dynamic range.
- Computer-synthesized acoustic space with 16 selectable reverb programs plus a new special effect in which the ACOUSTICOMPUTER scans the 16 programs.
- Two channels in and out. Built in reverb mixing and stereo imaging controls.
- Foot-switch controlled bypass.

It's impossible to describe in this space everything the ACOUSTICOMPUTER does; you'll have to experiment with it yourself. By carefully minimizing the number of separate controls and grouping them logically, we've made it easy for non-engineers to operate the ACOUSTICOMPUTER.

For further information call or write Phil Markham at DeltaLab Research, Inc., 25 Drum Hill Road, Chelmsford, MA 01824 Tel. (617) 458-2545.

\*See Modern Recording "Hands On Report," Sept. 1978.



DeltaLab Research, Inc. 25 Drum Hill Road, Chelmsford, Mass. 01824

Available at Quality Dealers

## AUDIO CONCEPTS, INC./DAVE KELSEY SOUND

7138 Santa Monica Boulevard • Hollywood, California 90046 • (213) 851-7172

THE PROFESSIONAL SOUND PEOPLE

# TRACK RECORD

**Rates:** 8 track \$30/hr; 4 track \$25/hr; mono and 2 track \$20/hr; tape duplication \$15/hr; block rates available.  
**Direction:** A professional attitude in a relaxed atmosphere. The owner/operators, being experienced musicians as well as competent engineers, are dedicated towards achieving a balance between the artist and the electron.

## •• TRACK RECORD

5249 Melrose Ave., Los Angeles, CA 90038  
 (213) 467-9432

**Owner:** Bob Safir.

**Engineers:** Bob Safir, Debi Neal, Kevin Braheny.

**Dimensions of Studios:** 14' x 23'.

**Dimensions of Control Rooms:** 14' x 20'.

**Tape Recorders:** TEAC Model 80-8 8 track; TEAC Model 3340S 4 track; TEAC Model 2300S 2 track; Sony ½ track; Akai 702 cassette deck; Technics Model 1500 2 track; TEAC Model 2300 ¼ track.

**Mixing Consoles:** 2 Tascam Model 5's, 16 in x 8 out.

**Monitor Amplifiers:** Yamaha CA 600, Crown D-40.

**Monitor Speakers:** JBL 4320, TEAC Model 1 for headphone mix; JBL 4311's.

**Outboard Equipment:** dbx 161 limiters, dbx 119 compressor, Tapco 4400 reverb, Tapco 2200 graphic EQ, full patch bay.

**Microphones:** Sennheiser MD 421; Shure SM-58, SM-57; AKG D-100E, S-120E; Sony ECM 280, ECM-22P.

**Instruments Available:** Baldwin acoustic piano, Fender Mustang bass, Gretch electric (customized), Wurlitzer electric piano, Martin 12-string, congas, timbales, full set of Ludwig drums, Univox rhythm unit.  
**Extras:** Coffee.

**Rates:** 8 track: \$20/hr; 4 track: \$15/hr.

**Direction:** Track Record is a studio designed for songwriters. Bob Safir is an accomplished songwriter, musician, engineer and producer. Track Record has a "track record" of demos that have been successfully placed with publishers and record companies. Our goal has always been very high quality demos at affordable rates. We also assist in production when requested. We have just expanded to 8-track. We also do voice-overs and radio commercial work.

## •• TRAVEL TRACS RECORDING SERVICE

\*also REMOTE RECORDING\*

1354 W. 220th St., Torrance, CA 90501

(213) 320-8664

**Owner:** Donald Briggs

**Engineers:** Donald Briggs and independents.

**Dimensions of Control Rooms:** 7' x 12' control room built in a 20' International Harvester Loadstar 1700 truck.

**Tape Recorders:** Otari Model 5050-8 8 track; Technics Model RS-1600 (½ track) 2 track; TEAC 3340 (¼ track) 4 track.

**Mixing Consoles:** Sound Workshop Model 1280-B with custom mods., 12 in x 8 out.

**Monitor Amplifiers:** BGW 250 stereo amp, Crown D-150.

**Monitor Speakers:** JBL 4311 studio monitors.

**Outboard Equipment:** Audio Design & Recording (ADR) "Scamp" compressor/limiters. Additional signal processing available during mixdown: Orban/Parasound 111B stereo reverb, MXR digital delay with 4 cards, Technics stereo graphic equalizer, dbx compressors.

**Microphones:** AKG 414's, 452's with CK1 & CK 2 capsules; Sennheiser 421's; Electro-Voice RE-20; Shure SM-57's; Uni-Sync 1101 direct boxes and Uni-Sync microphone splitters.

**Instruments Available:** Fender Stratocaster, Guild Starfire 6, Ovation Balladeer, Hardman stand up grand piano, Mystred phase shifter, Univox echo chamber, various percussion instruments.

**Extras:** No frills, just excellent professional recording. Album & 45 packages available. Cassette packages available. Studio & mixdown facilities available.

**Rates:** 120/hr plus tape. Location recording over 30 miles from base add \$50. Block rates available.

**Direction:** Travel Tracs was designed to meet the needs of working musicians needing professional quality location recording, at a price that's within their financial parameters. The truck was designed by professionals, to insure quality sound reproduction as our finished product. At Travel Tracs we would rather have you choose which environment is most conducive to your creative moods.

## •• UNCLE MORRIS SOUND SERVICES

7231 Franklin Ave., Suite 19, Hollywood, CA 90046  
 (213) 876-3588

**Owner:** Uncle Morris, Eric Acosta

**Engineers:** Eric Acosta, Jerry Yester, Van Karlsson, Uncle Morris.

**Dimensions of Control Rooms:** 25' x 18'.

**Tape Recorders:** Stevens Model 811-C 8 track; Electro Sound Model 505-C ¼ track; Ampex/MCI 351 ½ track; Tascam 80-8 ½" 8 track; Otari QXHD ¼" 4 track; Nakamichi Model 1000 & 550 cassettes; Tandberg 33/4-7½-15 ips Model 10XD ¼ track.

**Mixing Consoles:** Custom design utilizing API 550-A EQ modules/faders, 16 in x 8 out.

**Monitor Amplifiers:** Custom cards 200W/100W; Crown D 150A.

**Monitor Speakers:** Altec bi-amped; cards as above, 604E; JBL Model 4311; Auratone 5-C.

**Outboard Equipment:** AKG BX-10 reverb, UREI LA4A, UREI 1176, dbx 162 limiter, Pultec mid range EQ #MEQ-5, UREI filters (assortment), Orban 516 sibilance controller, Orban 245 stereo synthesizer, Dolby 361, dbx K-22 cards, Yamaha YB-801 BL turntable, SAE 5000 "click & popper".

**Microphones:** Neumann U-87's, U-67's, U-47's, KM-84, KM-86; Sennheiser 421's; Electro-Voice RE-15, RE-20; Sony C-37's, ECM-22's, C-500's; AKG 451's, 414's; Beyer M-500's; RCA 44's, 77's; Assorted Shure Dynamics.

**Instruments Available:** New Mason-Hamlin studio upright, Fender Rhodes, maracas.

**Extras:** Swimming pool, coffee, herb teas, Acme Supreme juice machine, bar/kitchen featuring original Uncle Morris gastro. delights.

**Rates:** Tell us your needs and we'll do you righteous.

## •• WATTEVER RECORDERS

\*also REMOTE RECORDING\*

17804 Hatton St., Reseda, CA 91335

(213) 342-0257 and 886-3143.

**Owner:** Michael Bremer, Michael Singletary, Steve McDonald.

**Engineers:** Michael Bremer, Michael Singletary, Steve McDonald.

**Dimensions of Studios:** 15' x 15'.

**Dimensions of Control Rooms:** 10' x 10'.

**Tape Recorders:** Otari Model 5050-8 8 track; TEAC Model A3340S; Revox Model B77 ½ track; TEAC Model A1200 ½ track; TEAC, Tandberg and 2 Sony ¼ track; Dual, Kenwood and Akai cassettes.

**Mixing Consoles:** Sound Workshop Model 1280, 12 in x 8 out; Tascam Model 5, 8 in x 4 out; plus small auxiliary boards.

**Monitor Amplifiers:** Ampzilla, Son of Ampzilla, Crown D-150.

**Monitor Speakers:** Altec 602; Altec Voice of the Theater; ADS 710; Electro-Research 310; IMF Super Compact; Stax Electrostat Earspeakers.

**Outboard Equipment:** dbx noise reduction (8-channels), Tapco and Sound Workshop reverbs, ADR Gemini compressor/limiter, custom-built flanger.

**Microphones:** Altec N21; AKG 451's, 202, 190's; Beyer M88; Sennheiser 421's, 211's; Superscope EC9P's; TEAC ME-80's; E-V RE-10's, 1741's; Shure SM-57.

**Extras:** Pool, kitchen, guitar amps, coffee, tea, location recording, synthesizer and programmer available.

**Rates:** Up to \$20/hr depending upon the complexity of the job. Call for details.

**Direction:** Our three engineers are also musicians, and have worked with all types of music; classical, blues, jazz, folk, experimental, electronic, and of course rock. Our plans for the immediate future include the purchase of extensive signal processing devices and more mikes. Our products have been published, pressed and screened, with more on the way. We're open to almost anything to do with recording and many things that aren't.

## Recording Schools cont'd from page 26

held in professional studios equipped with 24-track computer automated consoles. Students record live bands and work with musicians and producers in actual sessions. A Disc Mastering class is also part of the curriculum. Also offered are elective classes in "Producing" and "Sound Reinforcement".

**Frequency:** Two semesters per year. Continuous enrollment.

**Prerequisites & Registration Procedure:** High school diploma required. Entire course is one year long and includes "Basic Theory", "Recording Studio Workshop", "Advanced Theory", "Advanced Workshop" and "Disc Mastering".

**Accreditation:** Approved by the California State Board of Education. Also approved for veterans and foreign students.

**Degrees Offered:** Certificate of Completion from school.

**Equipment Used:** 24-track studio.

**Breakdown of Lecture/Hands-on:** Theory classes: lecture. Workshops: Hands-on.

**Job Placement:** Yes. 88% of the graduates are placed in jobs.

## TRES VIRGOS STUDIO

1219 West California Ave., Mill Valley, CA 94941

(415) 388-7799

**Contact:** Robin Yeager

**Course Description:** "Multi-Track Recording Workshop". Two day intensive workshop designed for musicians and aspiring recordists. First day covers basic recording theory and techniques. Second day, students record and mix a live session in a professional 8-track studio. Course is set up to give students the basic tools necessary to get the most out of their recording experiences.

**Frequency:** Once a month on a weekend. Eight hours per day, lunch provided.

**Equipment Used:** Soundcraft Series II console, Otari 7308 1-inch recorder, Ampex ATR-100 mastering deck, UREI 813 monitors, BGW, Crown, SAE amps, Lexicon Prime Time, Marshall Time Modulator, UREI LA-4's, great mic selection and other outboard gear.

**Breakdown of Lecture/Hands-on:** 50% lecture, 50% hands-on.

## UNIVERSITY OF SOUND ARTS

6671 Sunset Blvd., Hollywood, CA 90028

(213) 467-5256

**Contact:** Karen Armstrong or Terri Dent.

**Course Description:** USA offers a number of courses related to recording: "Recording Engineering", "Record Production", "Maintenance Engineer", "Road Technology", "Film Recording". Also available for graduate students is a 20 week "Record Label Class". Class size is limited to 10 in all courses.

**Frequency:** Quarter system. Meetings twice a week.

**Prerequisites & Registration Procedure:** Students are required to take an aptitude test, those scoring 85 or more come for a second interview with a counselor and are then qualified to register.

**Accreditation:** Approved by the California State Board of Education.

**Degrees Offered:** Certificate of Completion from school.

**Equipment Used:** School uses major recording studios in the area so that students get to work with several different engineers in several different studios.

**Breakdown of Lecture/Hands-on:** 28 hours per quarter is hands-on studio time, 20 hours per quarter is lecture.

## VEGVARI ENTERPRISES

317 S. Harbour Blvd., La Habra, CA 90631

(213) 691-4191

**Contact:** Ted Vegvari

**Course Description:** Recording Techniques and Engineering Workshop designed for musicians, songwriters and producers as an introduction to studio recording. Cost is \$120.00 plus tape costs.

**Frequency:** Three hours, twice a week for four weeks.

**Equipment Used:** Classes are given in a professional 16-track studio.

**Breakdown of Lecture/Hands-on:** 100% hands-on.







**Microphones:** Neumann U-47 FET, U-47 tubes (available), KM-84; AKG 414, 452, 451, 224; Sennheiser MD-441, 421; Beyer M-88, 500, 260, 69; RCA 77; Sony ECM 22P; Shure SM-54, 57.

**Instruments Available:** Piano, Hammond B-3 with Leslie, Les Paul stereo guitar.

**Extras:** Broadcast Assistors maintains a full list of studio musicians who are available to assist on our various projects. Arrangers and producers are also available. We have a small kitchen with refrigerator.

**Rates:** 16 track \$40/hr. 2 track/mono editing etc: \$27.50/hour. Block booking rates available.

**Direction:** Broadcast Assistors Studio is dedicated to producing the cleanest and best sound possible. We are continually upgrading our equipment to provide our clients with the tools they need to produce the sound they want. We offer complete record album packages, as well as stereo cassette duplication. Our clients include record labels, agencies, independent producers, and most important, individuals.



••• CALIFORNIA RECORDING STUDIOS, INC.  
5203 Sunset Blvd., Hollywood, CA 90027  
(213) 666-1244

**Owner:** Delton E. Kacher.  
**Engineers:** Studio Manager: Michael Zellner  
**Dimensions of Studios:** 24' x 40'.  
**Dimensions of Control Rooms:** 25' x 25'.  
**Tape Recorders:** Ampex Model MM-1100 multi-track.  
**Mixing Consoles:** Quad/Eight, 28 in x 16 out.  
**Monitor Amplifiers:** McIntosh 2105.  
**Monitor Speakers:** Altec 604E with custom cabinets and Mastering Lab crossovers.  
**Outboard Equipment:** Equalizers, UREI limiters, 1176, LA2A, etc., UREI digital metronome; Instant phaser; various filters; EMT stereo plate.  
**Microphones:** Various Neumanns, U-48's, U-47's, KM-84's, etc.; Telefunken 251's; RCA and Beyer ribbons; Sennheiser and Shure dynamics; others available.  
**Instruments Available:** Steinway B grand piano; various electronic keyboard instruments.  
**Extras:** Very spacious and comfortable control room area.  
**Rates:** Call for rates.  
**Direction:** Specializing in high quality music production for records, TV and film.

••• ANNEX STUDIOS  
1032 N. Sycamore, Los Angeles, CA 90038  
(213) 464-7441



••• BLUE DOLPHIN STUDIOS  
650 N. Bronson Ave., Hollywood, CA 90004  
(213) 467-7660



••• BLUE SEAGULL RECORDING STUDIO  
1831 Hyperion Ave., Hollywood, CA 90027  
(213) 666-4227

**Owner:** C.M. Sorenson, Sr. & Charles M. Sorenson, Jr.  
**Engineers:** Head Engineer: Ralph Grasso; C.M. Sorenson, Sr., Chris Thompson.  
**Dimensions of Studios:** Room A: 16' x 25'; Room B: 12' x 12'; Room C: 12' x 15'; Spec. effects room 6' x 14'.  
**Dimensions of Control Rooms:** 12' x 20'.  
**Tape Recorders:** MCI Model JH-16 16 track; Ampex Model AG-440-8 8 track; Ampex Model AG-440B 2/4 track, Ampex Model 350 2 track.  
**Mixing consoles:** MCI Model JH 428, 18 in x 24 out.  
**Monitor Amplifiers:** BGW 500D, BGW 250B, BGW 100.  
**Monitor Speakers:** JBL 4333A, JBL 4311 WX, Sprite car speakers.  
**Outboard Equipment:** UREI 1176-CN limiters; AKG BX-10 reverb; UREI, Cooper Time Cubes; Klark Tekniks DN-27 graphic equalizers.  
**Microphones:** Neumann KM-84's, U-47's; AKG 451's, 412's; Shure SM-57's, SM-58's; Sennheiser 421's; Electro-Voice DS-35's.  
**Instruments Available:** Yamaha G2 5' 7" piano; Yamaha and Ovation guitars.  
**Extras:** Musicians lounge with free coffee, listening room with 4 & 2 track tapes, cassette and phone.  
**Rates:** \$45/hour.

**Direction:** Our 16 track studio is completely wired for 24 tracks, which we plan to expand to within six months. Blue Seagull was designed and built to give musicians a totally relaxed, creative atmosphere and produces a state-of-the-art efficiency sphere and produces a state-of-the-art efficiency. No matter what your project consists of, we are here to help — from arranging, lyric composition, technical advice to marketing and sales. Blue Seagull invites you to come on in and enjoy our good old country hospitality.



••• BONWHIT RECORDS  
11700 Ventura, Studio City, CA 91604  
(213) 769-7511



••• BROADCAST ASSISTORS STUDIO  
*\*also REMOTE RECORDING\**  
7923 Duchess Dr., Whittier, CA 90606  
(213) 696-5503

**Owner:** Chuck and Madeline Minear, Sr.  
**Engineers:** Chuck Minear, Steve Brown, Dennis Lyall.  
**Dimensions of Studios:** Main room 18' x 13', drum and vocal room 10' x 12'.  
**Dimensions of Control Rooms:** 13' x 17'.  
**Tape Recorders:** Ampex Model 1100 16 track with search and cue; Ampex Model AG350 2 track; Revox Model A-700 2 track; Revox Model A-700 1 track/mono; Revox Model A-77 1/4 track; TEAC Model 7030 1/2-2 track.  
**Mixing Consoles:** Opamp Labs Model 210, 16 in x 6 out, modified for broadcast production as well as 16 track recording.  
**Monitor Amplifiers:** Control room: McIntosh 2100, Studio: Philips A 544.  
**Monitor Speakers:** Sentry III, Auratones.  
**Outboard Equipment:** Klark-Teknik DN-36 analog time processor, AKG BX-10 reverb, UREI 1176 LN limiter, dbx 160 limiters, dbx 157 NR, cassette and eight-track decks.



CIRCLE SOUND STUDIOS, San Diego

••• CIRCLE SOUND STUDIOS  
3465 A El Cajon Blvd., San Diego, CA 92104  
(714) 280-7310

**Owner:** Richard J. Bowen, Robert A. Bowen.  
**Engineers:** Steven Penacho, Richard Bowen.  
**Dimensions of Studios:** Studio A: 27' x 30'; Isolation booth 9' x 9'; Studio B: 16' x 18'.  
**Dimensions of Control Rooms:** Room A: 15' x 20'; Room B: 10' x 18'.  
5000 sq. ft. Rehearsal, video and showcase hall with 16' x 32' stage.



# TRACK 16 TRACK

**Tape Recorders:** MCI Model JH-16 16 track; MCI Model JH 110-8 8 track (15, 30 ips); Otari Model MX-5050 ½ track 2 track; Dokorder Model 1140 4 track; Nakamichi Model 550 cassette.

**Mixing Consoles:** Quantum custom Model 168, 16 in x 8 out; 16 track monitor console has just been modified and updated.

**Monitor Amplifiers:** Specta Sonics 701.

**Monitor Speakers:** Altec 604-8G with Mastering Lab crossovers, Auratones, JBL.

**Outboard Equipment:** Eventide Harmonizer, Lexicon Prime Time, dbx noise reduction, dbx comp/limiter, Orban parametric EQ 622B, AKG BX-10, live echo.

**Microphones:** Neumann, AKG, Sennheiser, E-V, Beyer, Shure.

**Instruments Available:** Baldwin grand, Hammond M-3, Leslie 147, drums (full set), congas and perc., guitars and amps, ARP and Elka strings, Mini Moog, clavichord.

**Extras:** Coffee, atmosphere and comfort.

**Rates:** Please call for studio rates (very reasonable). Rehearsal, showcase, video, (please phone).

**Direction:** We are currently working towards going 24-track MCI with automation. We specialize in album production. Our atmosphere is excellent and roomy. The 5000 sq. ft. rehearsal, video and showcase hall is one of a kind, with its 1930 ballroom decor. Please call for further information. NOTE! San Diego is the next logical step, and is now in the process of happening — join us.



FANFARE RECORDING STUDIO, El Cajon

### ••• FANFARE STUDIOS

**Office:** 110 E. Main Street, Suite 1.

**Studios:** 120 E. Main St., El Cajon, CA 92020  
(714) 447-2555

**Owner:** Ronald L. Compton.

**Engineers:** Ron Compton, Ken Robertson, Dave Pollard

**Dimensions of Studios:** 25' x 33'

**Dimensions of Control Rooms:** 17' x 20'

**Tape Recorders:** MCI Model JH-16 16 track; Ampex Model MM-1000 16 & 8 track; MCI Model JH-110 2 track; Ampex Model 440B 4 and 2 track; Ampex Model 440B mono, full track; Revox (3 machines) Model A77's ½ track and ¼ track.

**Mixing Consoles:** Pacific Recorders custom, 20 in x 16 out.

**Monitor Amplifiers:** BGW.

**Monitor Speakers:** JBL.

**Outboard Equipment:** UREI limiters and compressors, Orban/Parasound EQ, MXR phaser and flanger, Orban stereo synthesizer, Orban D'Esser, Pollard metronome, Eventide Harmonizer and DDL, Amber audio spectrum display.

**Microphones:** Neumann U-87, KM-84, KM-86, U-47; AKG 414, 202E; Electro-Voice RE-10, RE-15, 625A; Altec 29B, 28A; Sony ECM 377; Shure SM-58, 545.

**Instruments Available:** Yamaha 7' grand piano, Hammond B-3, Fender Rhodes electric piano, Syn-drums, Ludwig drum set with concert toms, ARP Odyssey synthesizer, ARP Omni strings, Roland Strings.

**Rates:** 16 track \$70/hr. 8 track \$50/hr. 4 track \$35/hr. 2 track \$30/hr.

### ••• GOLDEN GOOSE RECORDING

**2074 Pomona Ave., Costa Mesa, CA 92627  
(714) 548-3694**

**Owner:** Dennis Rose.

**Engineers:** Dennis Rose, Steve Arambula, Ken Rains, Lester Claypool, Donald Ford.

**Dimensions of Studios:** 25' x 23'

**Dimensions of Control Rooms:** 18' x 18'

**Tape Recorders:** Sony Digital Recorder Model PCM-1 2 track; MCI Model JH-10 16 track; Ampex Model ATR 100 2 track; Ampex Model AG 440 C 2 track; Scully 280-4 4 track; Nakamichi Model 600 cassette.

**Mixing Consoles:** Spectra Sonics Model 1024, 24 in x 24 out.

**Monitor Amplifiers:** BGW 500, 4 channels, Marantz 260, Marantz 260 cue amp with spare amps available.

**Monitor Speakers:** Main system control room, 4-channel Altec 604E. Aug. system control room 1, JBL 4311, studio, Electro-Voice 12TRXB.

**Outboard Equipment:** dbx 160 comp/limiters, Allison Kepex's, Orban/Parasound parametric EQ, Altec graphic EQ, (passive) AKG reverberation, Roland delay line, UREI digital metronome, Altec ½ octave monitor equalization.

**Microphones:** Neumann U-47 tube type, KM-84/83; AKG C-414E's, C-414EB's, C-451's, matched stereo pair with swivel capsules and stereo bar; RCA 77-DX's; Beyer Dynamic M-160, ribbon mics; Sony C-500, C-37A's, ECM 22P, ECM-250, ECM-21's; Sennheiser MD-421; Electro-Voice RE-20, RE-15, 666; Shure SM-57.

**Instruments Available:** Steinway D grand piano 1923 model totally rebuilt, Wurlitzer upright tack piano, hand made Jose Ramirez Flamenco guitar, Guild F50, Fender String Master 8 steel guitar, misc. Latin percussion, Fender Twin Reverb, 15 Watt Goose amp.

**Extras:** Beautiful outdoor patio with Bar-B-Q, large shade trees, and ponds and fountains. For our clients, our engineers will work with disc mastering engineer and sub-contract record pressing, for the best possible product available. We are a complete production company with in-house publishing and record label.

**Rates:** 16 track \$50/hr. 4 or 2 track live recording \$35/hr. 2 track transfer or duplication \$25. Digital recording \$500/day (8) hours. Block rates 16 track (40 hour min.) \$1800, payable in advance. Rates do not include tape or other extra material.

**Direction:** We have a pleasant country atmosphere with uptown quality but no uptown BS or rates. We contract a full catalog of studio musicians, vocalists and arrangers, from rhythm sections to strings and horns and background vocals on call. We try to please the creative artist. Future expansion plans: Near 24 track/further R&D in digital recording. Since we have worked professionally through the era of mono recording, through 3&4 track recording, we specialize in in-studio live performance recording for the more discriminating jazz, classical, country, bluegrass and new wave rock artists, who prefer no over-dubbing. This is exceptionally noticeable in the digital format, all music, no noise.



### ••• GOLDEN WEST SOUND STUDIOS, INC.

**6429 Selma Ave., Hollywood, CA 90028**

**(213) 461-4231**



### ••• HIT CITY WEST

**6146 West Pico Blvd., Los Angeles, CA 90035  
(213) 852-0186**

**Owner:** Jason Bell and Ken Kravitz.

**Engineers:** Andy Wallace, Avi Kipper, John Hutson.

**Dimensions of Studios:** 17' x 30' including two isolation booths.

**Dimensions of Control Rooms:** 14' x 16'

**Tape Recorders:** Ampex Model 1100 16 track; Ampex/3M Model 440/400 8 track; Ampex Model 440 2 track; Ampex Model 351 2 track; Dokorder Model 1140 4 track; Sony and Aiwa cassettes, VSO available for all machines.

**Mixing Consoles:** Quantum Model QA-1000, (console has been modified to include 16-channels of 3-stage MAP parametric equalization; 2 cue systems; 18 mic, 18 line in x 8 out.)

**Monitor Amplifiers:** SAE, Crown.

**Monitor Speakers:** JBL 4333, Auratone.

**Outboard Equipment:** dbx 160 comp/limiters, Allison Gain Brain, Kepex's, UREI 527A 27-band graphic equalizers, Countryman 968 phase shifter, MXR phasers, MICMIX Master-Room Super C reverb system, Tapco 4400 stereo reverb system. All other outboard equipment available as rentals.

**Microphones:** Neumann U-87, KM-84; AKG 414, 451, 501; E-V RE-20; Sennheiser 441, 421; Beyer M-500; Assorted Shure and Sony mics.

**Instruments Available:** 1890 Steinway grand piano, Cable & Sons upright piano, Wurlitzer electric piano, Fender Super Reverb amplifier, Fender Bassman amplifier, All other instruments available as rentals.

**Extras:** Lounge with free coffee service, full tape duplication facilities.

**Rates:** Please call for information.

**Direction:** Hit City West is currently re-designing its facilities. April 1, 1979 will unveil Studio A as a 24/16 track room, while Studio B will be an 8 track production room. The same concern about quality and environment will be utilized, as well as our desire to provide full service to every client.



HIT CITY WEST, Los Angeles



### ••• HOME RECORDING STUDIO

**P.O. Box 3754, Granada Hills, CA 91344**

**(213) 365-6287 or 365-0709**

**Owner:** Dave Mertens.

**Engineers:** Chief Engineer: Kim Segel.

**Dimensions of Studios:** 32' x 20'. Vocal booth, lounge 11' x 12'.

**Dimensions of Control Rooms:** 10' x 6'.

**Tape Recorders:** 3M Model 56 16 track; Otari Model 7308 8 track 1" tape; TEAC Model 3340 4 track; Revox Model A-77 2 track.

**Mixing Consoles:** Speck Model 800-C, 16 in x 16 direct out.

**Monitor Amplifiers:** Quatre — DG — 250 gain cells.

**Monitor Speakers:** JBL 4311.

**Outboard Equipment:** UREI LA4 comp/lim, Orban/Parasound 111-B reverb.

**Microphones:** Neumann U-87, E-V RE-20, RE-15, Sennheiser 421, AKG 414.

**Instruments Available:** Sohmer grand piano, manual Chamberlin Farfisa pro-combo organs, acoustic and electric guitars, Moog Satellite synthesizer.

**Extras:** Lounge, TV, and cold fridge.

**Rates:** 16 track \$30/hr, 8 track \$20/hr, 4 track \$12/hr.

**Direction:** The past year has been very good for us in a number of ways, we've made some good friends and good music and we were able to experience a wide variety of sessions. Everything from a 17-piece jazz orchestra, to a string ensemble, to a film sound and noise track, along with our usual custom albums and demo sessions. At this moment we're branching out into a full in-house production company capability and expect '79 to be an excellent growth year. However, even as we continue to grow and improve, we still intend to keep our prices as low as possible and our services top rate.



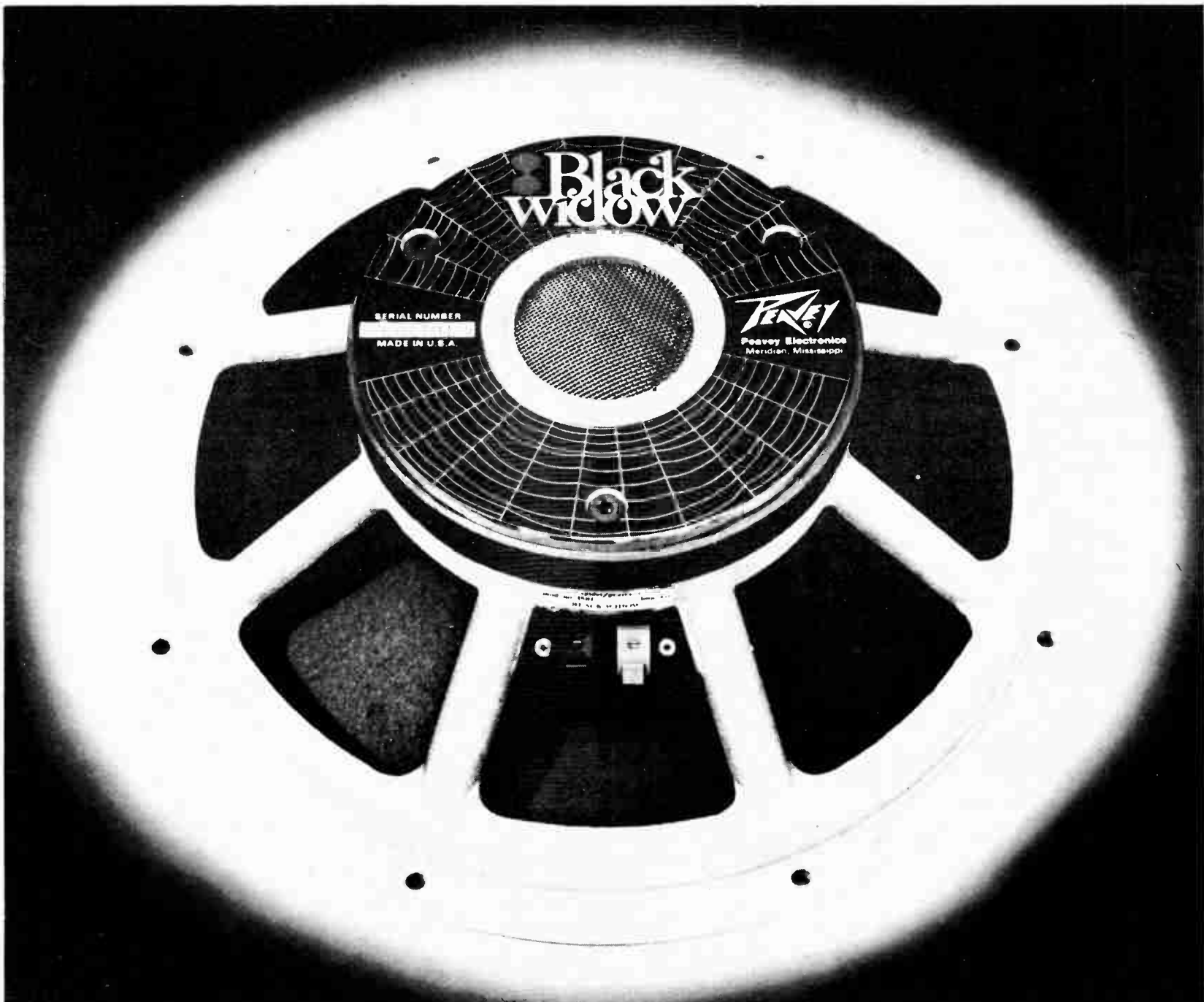

# THE BLACK WIDOW

## ...because the best wasn't good enough.

You're looking at one of the finest loudspeakers in the world...the Peavey Black Widow. They were created to fill a serious void,...speakers that could match the sophistication of today's sound reinforcement technology. For years we have employed the finest speakers from the most respected manufacturers in our equipment and through years of experience, have re-discovered the value of that

old cliché, "if you want it done right, do it yourself." We did.

Since its introduction several years ago, the Black Widow has been praised by sound experts and musicians for its excellent efficiency, bandwidth, and power handling capabilities in applications that range from high powered concert sound reinforcement to studio recording.

The Black Widow's unique

characteristics are the result of optimized procedures and concepts in design and manufacturing that provide a complete integration of form and function.

Unlike the other established manufacturers who are still building the speakers they designed back when a 100 Watt amp was a big deal, Peavey has designed the Black Widow with today's technology for today's high powered music.



The combination of a rigid cast-aluminum frame and high-efficiency magnetic structure is a feature found in many professional quality loudspeakers. What places the Black Widow Series far ahead of its competition is its field replacable basket assembly.

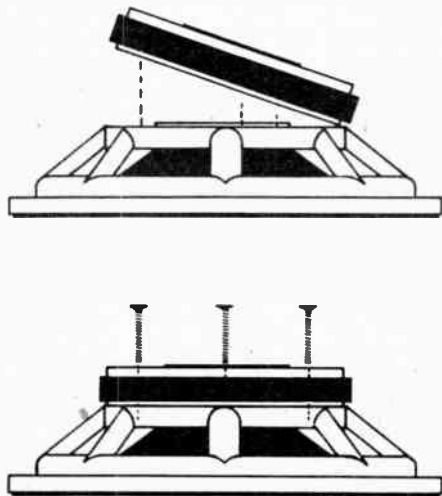

This feature, usually found only in high quality compression drivers, allows the user to be "back in business" in a matter of minutes, rather than days or weeks.

The high efficiency and high power handling capabilities found in the Black Widow make each model the best choice for its sound reproduction application. Again, what separates

the Black Widow from other high quality transducers is its unique integral coil form/dome structure. When a loudspeaker is subjected to very high power levels, the voice coil temperature rises very rapidly, causing the loudspeaker impedance to increase. The result of this increase is a loss of efficiency. The Black Widow Series provides a most effective method of minimizing any impedance increases due to heat by utilizing the one-piece coil form/dome as a heatsink. Just as high power amplifiers use aluminum heatsinks to dissipate heat, the Black Widow coil form/dome is produced with low mass, high rigidity aluminum.

Each Peavey Black Widow is subjected to extensive quality control procedures to insure long field life and high reliability. The manufacturing methods employed by Peavey, such as numerical and computer controlled machining equipment, allow the Black Widow to maintain the close tolerances necessary for previously unattainable levels of quality and consistency.

Each Black Widow has a four-inch edge-wound

aluminum wire voice coil to provide maximum energy conversion. The cone assemblies provide the required frequency response shapes with minimum weight and maximum structural integrity for high mechanical reliability. Each magnetic structure is fully removable and will provide minimum flux density of 12,000 gauss with very precise operating clearances. The magnetic structure uses a large rear vent to assist in further voice coil temperature control.

The Peavey Black Widow is now offered as standard equipment or as an option in most Peavey enclosures and will soon be available "over the counter" at selected Peavey Dealers.

The Peavey Black Widow,...for those who can't accept less than maximum performance and reliability from their speakers.



**PEAVEY ELECTRONICS**  
711 A Street  
Meridian, Mississippi 39301

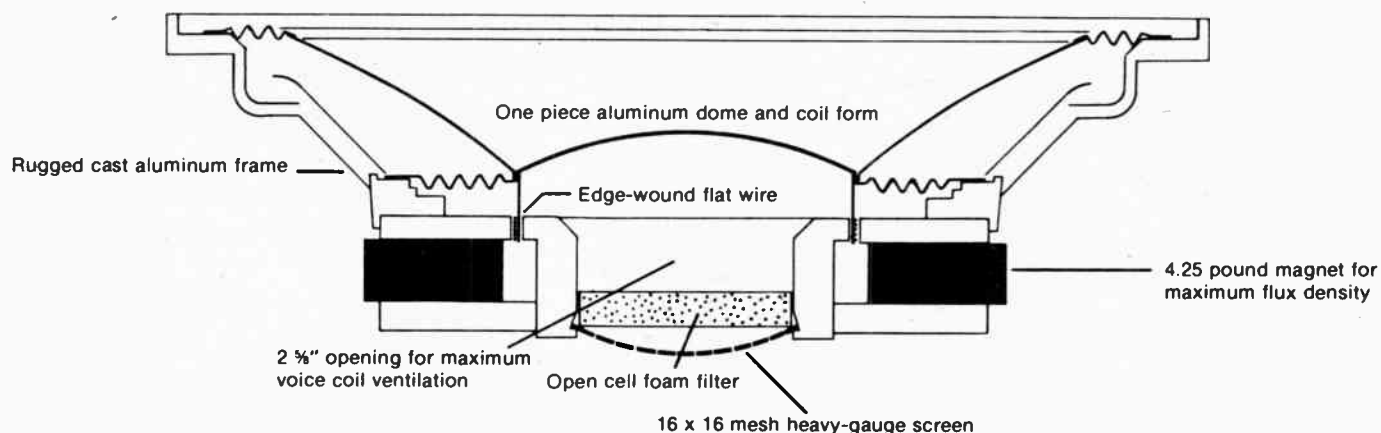

MODEL NO.	DIAMETER	NOMINAL IMPEDANCE	POWER HANDLING CAPACITY CONTINUOUS	POWER HANDLING CAPACITY PROGRAM	SENSITIVITY 1w, 1m on axis	VOICE COIL DIAMETER
1201	12"	4/8	150W	300W	101 dB	4"
1501	15"	4/8	150W	300W	103 dB	4"
1502	15"	4/8	150W	300W	101 dB	4"
1503	15"	8	150W	300W	102 dB	4"
1801	18"	4/8	150W	300W	99 dB	4"

# TRACK 16 TRACK

### ••• HOUND DOG RECORDING STUDIO

*\*also REMOTE RECORDING\**

1644 Cherokee Ave., Hollywood, CA 90028  
(213) 661-7777

**Owner:** Bill Cook, Doug Williams, Joel Porter Muncie,  
**Engineers:** Joel Porter Muncie, Bill Glasser, Steve Paul.

**Dimensions of Studios:** 19' x 8'.  
**Dimensions of Control Rooms:** 19' x 8'.

**Tape Recorders:** Ampex Model MM-1000 16 track;  
Ampex Model 300 1/2 & 1/4 track; Ampex Model MR-70 1/2 track.

**Mixing Consoles:** Opamp Labs custom, 20 in x 10 out.  
**Monitor Amplifiers:** Phase Linear 700B, SAE Mark IV.  
**Monitor Speakers:** 5'6" x 3' custom engineered JBL built-ins; JBL 4310 control monitors, and Auratones.

**Outboard Equipment:** JMF digital tuning scope, complete patch bay, Sennheiser, AKG, and Superex phones, UA limiter, Pultec Hi-Lo cutoff filter, two Altec 24 point graphic equalizers, two Opamp Labs limiters, Oberheim phaser, Procast compressor, and echo.

**Microphones:** Neumann U-87, U-88; Norelco C-60's; Sennheiser 421's; Shure 556, SM-54, SM-56's.

**Instruments Available:** Ludwig drum kit, Kirshner arrangers piano, Pre-CBS Fender Twin Reverb, Fender Rhodes, Latin percussion, bongos, misc. percussion.

**Extras:** We are a completely self-contained control room and studio located in the largest GMC bus ever built. Come to us at our homebase by Cherrywood Rehearsal Studios, or we can come to you!!

**Rates:** Call for rates.

**Direction:** Designed in conjunction with professional musicians, artists, and audio design specialists. Set up for 16 track master recording and mixing. Comfortable atmosphere combined with State-of-the-art technology. Our motto — "Relax & Record".



### ••• HOUSTON RECORDING

*\*REMOTE RECORDING\**

9340 Foothill #32, Cucamonga, CA 91730  
(714) 987-0379

**Owner:** Rich Houston

**Dimensions of Control Rooms:** 18' x 8' truck.

**Tape Recorders:** 3M Model M-56 16 track; MCI Model JH-110A 2 track; Sony 1/4 track.

**Mixing Consoles:** Custom Speck, 20 in x 16 out; custom submixers, 24 in x 6 out.

**Monitor Amplifiers:** Dynaco 400.

**Monitor Speakers:** JBL 4311, Auratone.

**Outboard Equipment:** MICMIX stereo echo, closed circuit TV, 1 camera, 2 monitors, RTS 2-channel intercom, 54 3-way mic. splitters, UREI LA3 limiters.

**Microphones:** AKG C-451, C-452, D-190; E-V RE-11; Neumann KM-84; Sennheiser MD-421; Shure SM-57; Sony ECM-22.

**Extras:** Air-conditioned/heated, dimmable lighting, refrigerator, transformer-isolated AC power feed to stage.

**Rates:** \$1200.00 per 12 hour day within S. Calif. Special rates available for multiple bookings, custom equipment needs or areas outside of S. California.

**Direction:** We have just completed the first phase of our updating program, which has resulted in an extremely accurate monitoring system set in a super plush environment. Our goal was to eliminate the feeling of being in a truck; and judging by the comments of our clients, we have successfully achieved that goal. The second phase of our program will be to install a 24 track tape machine and console. Target date for completion is May 1st. Give us a call and we'll show you a new concept in remote recording.



### ••• JEL RECORDING STUDIO

6100 Westcoast Highway # D,  
Newport Beach, CA 92663  
(714) 646-5134

**Owner:** Edo Guidotti.

**Engineers:** Edo Guidotti, Dave Jones.

**Dimensions of Studios:** 30' x 30' plus 2 iso. booths.

**Dimensions of Control Rooms:** 16' x 18'.

**Tape Recorders:** Ampex Model MM1100 16 track; TEAC Model 80-8 8 track; Otari 2 track; Revox 1/4 track; Nakamichi cassette deck.

**Mixing Consoles:** Sound Workshop Model 1620, 20 in x 16 out.

**Monitor Amplifiers:** BGW, Marantz.

**Monitor Speakers:** E-V Sentry IV, JBL 4311, Auratones.

**Outboard Equipment:** Marshall Time Modulator, Allison Kepex, Gain Brain, dbx comp/limiters, dbx dx-8, MICMIX reverb, Sound Workshop reverb, spectrum analyzer, UREI digital click track.

**Microphones:** Neumann U-87, KM-84; E-V RE-20; AKG C-414, 452, 451, 405; Shure SM-57, SM-7.

**Instruments Available:** Kawai grand piano, Fender Rhodes piano, Mini Moog, clavinet.

**Extras:** Arranging, production, contracting.

**Rates:** 16 track \$65/hr. 8 track \$35/hr. Block rates available.

**Direction:** To offer a comfortable atmosphere, which we feel shows in the final product. We're involved in album projects, commercial jingles, film and TV scores, as well as artists and publishing demos. Our engineer is currently working with Paul Williams and has available some of the finest studio musicians and singers.



JEL RECORDING STUDIO, Newport Beach



### ••• KENJO STUDIOS

607 East Belmont, Fresno, CA 93701  
(209) 266-9681

**Owner:** Studio Operations: J. Craig Van Selow.

**Engineers:** Chief Engineer: Eric Seaberg, Associate Engineer: Michael Stribling.

**Dimensions of Studios:** Main Studio: 18' x 25' with 9' x 9' isolation room and 5' x 9' vocal booth.

**Dimensions of Control Rooms:** Studio A: 18' x 18'; Studio B: 9' x 11'.

**Tape Recorders:** Ampex Model MM1100 16 track; Ampex Model ATR 102 2 track; (2) Ampex Model AG-440-B 2 track; Ampex Model 351 FT 1 track; (2) Tandberg 310 cassette.

**Mixing Consoles:** Audio Designs and Manufacturing Model NCR 2416, 24 in x 16 out; Allen and Heath, 16 in x 16 out.

**Monitor Amplifiers:** AB Systems 720 bi-amplified, Crown, Uni-Sync.

**Monitor Speakers:** Altec 604-8G, Auratone.

**Outboard Equipment:** Eventide 1745A Digital Delay, Eventide Instant Flanger, (2) Eventide Omnipressors, UREI LA2A, LA3A, 529 EQ, AKG BX-20E reverb, dbx 187.

**Microphones:** Neumann U-47; Sennheiser 421, 441, 211; Electro-Voice RE-10, RE-15, RE-20, 635A; Sony C-37A, C-57; RCA 77DX; Shure SM-57.

**Instruments Available:** Yamaha C-7B grand piano, ARP Omni, Mini Moog, Hohner, extensive variety of percussion instruments from orchestral to Syndrum.

**Extras:** Complete production services available upon request. Arrangements, musicians and experienced production supervision, from concept to final product, including assistance in cutting, processing and pressing. Please inquire.

**Rates:** 16 track \$50/hr; 2 track \$25 - \$40/hr.

**Direction:** Kenjo Studios has recently completed construction of a George Augspurger room at their main studio. The design accomplishes an intimate atmosphere with superior acoustics. Great care has been taken to achieve fine esthetics, a warm atmosphere and, most of all, a quality recording facility. We encourage all inquiries, to see and hear this room, and for information on our musical production services. Please call or write for information.



MEDIA ART, Hermosa Beach

### ••• MEDIA ART

111 Pier Ave., Hermosa Beach, CA 90254  
(213) 374-1214

**Owner:** David Tarling, Rolf Erickson, Allen Glenn.

**Engineers:** David Tarling, Rolf Erickson, Allen Glenn. Spot and qualified independents.

**Dimensions of Studios:** 25' x 30'.

**Dimensions of Control Rooms:** 25' x 20'.

**Tape Recorders:** 3M Model M-56 16 track; Ampex Model 440B 2 track; TEAC Model 3340 4 track; Revox Model A-700 1/2 and 1/4 track; (2) Nakamichi Model 600B cassettes; Sony PCM digital recorder 2 track.

**Mixing Consoles:** Tangent Model 3216, 28 in x 16 out.  
**Monitor Amplifiers:** Cerwin Vega A 3000, Phase Linear 400's.

**Monitor Speakers:** JBL 4333, Auratones, JBL 4311, ARCST.

**Outboard Equipment:** UREI 1176's, LA4's, dbx 261 stereo limiter, 4-channel dbx noise reduction, Master-Room Super C stereo reverb, noise gate, SAE graphic EQ, VSO, electric metronome, MXR Flanger, MXR Digital Delay.

**Microphones:** Neumann 87's, 67's; AKG 414 EB's, D-20, D-224; Sony 377's, ECM-50, ECM-56's, assorted Dynamic mics.

**Instruments Available:** 6' Kawai grand piano, Hammond B with Leslie, synthesizer, String Machine, Fender Jazz Bass, Rickenbacker 12 string.

**Extras:** Color video tape facilities, lounge, kitchen, we're one block from the ocean.

**Rates:** \$25/hr, subject to change.

**Direction:** Media Art offers professional rooms, equipment, and engineers. At the same time, our rates are more than reasonable and will remain that way even when we go to 24 track. Artists such as Supertramp (A&M), Hartan Collins (Island), Richie Hayward of Little Feat and Dave Clark have used our facilities. We are one block east of the Pacific Ocean and 10 minutes from LAX in relatively smog free Hermosa Beach.



### ••• MOM & POPS CO. STORE

4028 Colfax Ave., Studio City, CA 91604  
(213) 769-7282

**Owner:** Christine & Freddie Perren

**Engineers:** Rick Clifford, Ed Biggs.

**Dimensions of Studios:** A: 30' x 23'; B: 21' x 15' x 15'.



**Dimensions of Control Rooms:** A: 16' x 13' x 9'; B: 11' x 9½' x 8'.  
**Tape Recorders:** 3M Model 79 24 track; MCI Model JH-100 24 track; MCI Model JH-110 4 track; MCI Model JH-110 2 track.  
**Mixing Consoles:** Harrison Model 4032 with Allison 65k, 40 in x 40 out; MCI Model 416, 24 in x 24 out.  
**Monitor Amplifiers:** Crown D-150's, Crown D-60's, Phase Linear 700.  
**Monitor Speakers:** Altec 604E's, Mitsubishi D-28B, JBL 4311, Auratones.  
**Outboard Equipment:** Allison Kepex, UREI 1176LN, UREI LA4A, Pultec, Cooper Time Cube, Eventide Instant Flanger, digital metronome, Eventide DDL, Lexicon DDL, Orban parametric EQ, Orban D'Esser, ECCO synching equipment, SMPTE generator, 2 live echo chambers (stereo), EMT echo, MICMIX echo springs.  
**Microphones:** Neumann U-87, U-67, U-47 (FET), KM-84; AKG 414, 452E; Electro-Voice RE-20, 16, 666; Sennheiser 421, 441; Sony C-22; RCA 77, 44; Shure 57, 545, 546.  
**Instruments Available:** Baldwin grand piano, baby grand piano (enclosed chamber), Hammond B-3 with Leslie, Harpsichord, Fender Rhodes, Hohner clavinet, ARP Pro Soloist synthesizer, ARP Omni synthesizer, Syndrums, Pearl drums, Wurlitzer piano, vibes, orchestra bells.  
**Extras:** 2 full 24 track facilities with lounge and patio area for your artist with color TV and separate washroom facilities.  
**Rates:** Please call for specifics.

**Instruments Available:** Steinway grand piano, Hohner clavinet, Wurlitzer electric piano, Univox electric organ. (The client pays no rental charge for instruments, only tuning fees).  
**Extras:** Mystic rehearsal room is available to our clients at no charge.  
**Rates:** \$25/hr, \$200 all day (10 hours). Cassette and tape duplicates reasonable.  
**Direction:** We specialize in making master demos and albums at low cost. 1000 LP cost approx. \$1500 plus recording and tape. 500 single 45's cost 1350. 1000 costs \$425. We also specialize in making TV and movie soundtracks. Mystic has an extensive basic track library suitable for vocal or instrumental overdubbing. Doug Moody (Owner) has personally produced 18 Gold Records and has been involved in 60 Gold Records. He is building a new label called Mystic Records. We have a club for one night a month to showcase new artists and products. Our rehearsal room is available to our clients at no charge.

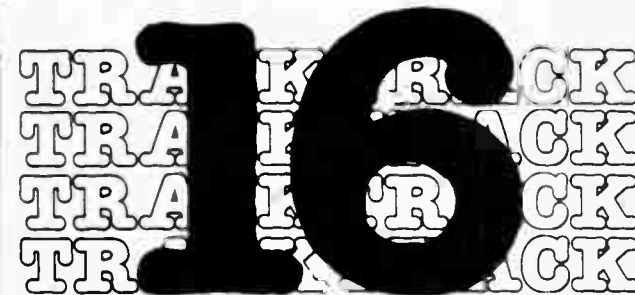

**NEWJACK/  
 STUDIO B**  
 See our listing  
 in the 8-track section  
 under  
**STUDIO B/  
 NEWJACK**



**MYSTIC SOUND STUDIO, Hollywood**  
 from: Doug Moody-Owner, Steve Fuji-Chief Engineer  
 Steve Saulter-Studio Manager

••• **MYSTIC SOUND STUDIO**  
 (Div. of Mystic Music Center, Inc.)  
 6277 Selma Ave., Hollywood, CA 90028  
 (213) 464-9667  
**Owner:** Doug Moody and Mystic Records (1968)  
**Engineers:** Traffic Manager: Steve Saulter. Chief Engineer: S. Fujinami.  
**Dimensions of Studios:** 20' x 20' with built-in drum platform and baffled for special sound. Second room is redwood; fluted 17' x 10', (this room can be used for separation).  
**Dimensions of Control Rooms:** 20' x 10' (direct boxes and vocal microphones are available for recording in control room).  
**Tape Recorders:** Ampex Model MM-1000 16 track, 15 and 7½ ips; Ampex Model MM-1000 8 track, 15 and 7½ ips; Ampex Model AG-440 2 track, 15 and 7½ ips; TEAC Model 7030 ½ track; TEAC A-2300 ¼ track; Akai Model 200 ¼ track.  
**Mixing Consoles:** Spectra Sonics Model 1012, 16 in x 16 out.  
**Monitor Amplifiers:** Spectra Sonics, bi-amped.  
**Monitor Speakers:** JBL 4320's in control room, JBL 3410 in studio.  
**Outboard Equipment:** We have limiters and compressors, we prefer to rent equipment in order to keep cost-per-hour to a minimum and to have access to the latest developments in outboard gear.  
**Microphones:** AKG, Shure, Electro-Voice; also available on request Neumann 414's, C-12, etc.

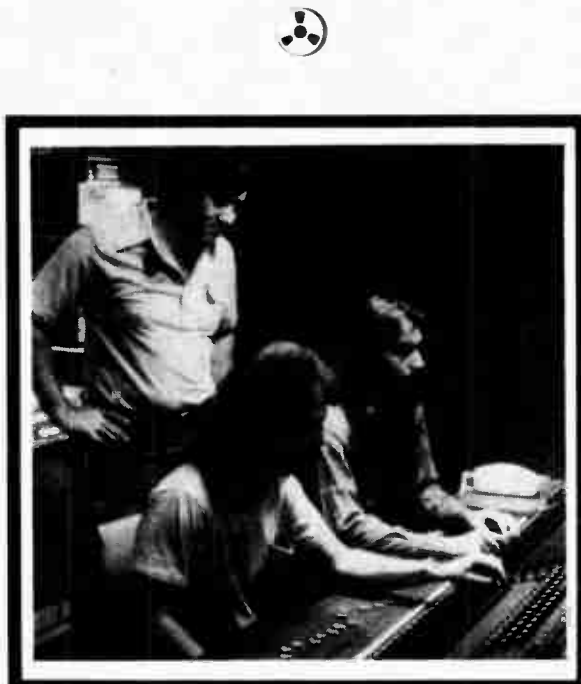

**NATURAL SOUND STUDIO, Santee**  
 Lou Mattazaro, Jeff Mattazaro, Dave Goldstein

••• **NATURAL SOUND RECORDING STUDIO**  
 9851 Prospect Ave., Santee, CA 92071  
 (San Diego County)  
 (714) 448-6000  
**Owner:** Louis Mattazaro  
**Engineers:** Lou Mattazaro, Jeff Mattazaro, Dave Goldstein, Kathy Leech.  
**Dimensions of Studios:** 34' x 30'.  
**Dimensions of Control Rooms:** 18' x 22'.  
**Tape Recorders:** Ampex Model MM1000 16 track; Scully Model 280 8 track; Scully 2 track; Technics Model 1500 2 track; Hitachi and Pioneer cassettes.  
**Mixing Consoles:** Soundcraft Series III, 24 in x 24 out.  
**Monitor Amplifiers:** Crown DC 300, Crown DC 150.  
**Monitor Speakers:** Altec 604E, JBL 4333, Auratone.  
**Outboard Equipment:** Marshall Time Modulator 5002, Lexicon Prime Time, dbx 158 - 16 track; dbx compressor/limiter, Scamp noise gate, compressor, parametric EQ, BX10 reverb, Soundcraftsmen graphic EQ.  
**Microphones:** Neumann U-87; AKG 414, 452; Sony ECM 50; Sennheiser 441, 421; E-V RE-20, RE-15, RE-10, 666; Shure SM-7, SM-53, SM-57, SM-56.  
**Instruments Available:** Yamaha C7-B grand piano, 12 piece customized drum set.  
**Extras:** Lounge with coffee, soda, beer and snacks, listening room, disc mastering, all new air-conditioned plush studio complex.  
**Rates:** 16 track \$65/hr. 8 track \$35/hr. 2 track \$25/hr. (16 track dbx included).  
**Direction:** In less than two months we will be a 24 track studio with a new Ampex Model 1200. Due to the superb design of our studio, done by Dave Gold of Gold Star Studios in Hollywood, we have enjoyed a tremendous amount of business in the short time we have been opened (July 78). We have specialized in albums of new artists, TV and radio spots, as well as many great demos. We believe we can offer you the best sound for your money. Located north of Hwy 8, off Hwy 67 in the quiet city of Santee, San Diego County.

••• **ORIGINAL SOUND STUDIOS**  
 7120 Sunset Blvd., Hollywood, CA 90046  
 (213) 851-1147 or 851-2500  
**Owner:** Art Laboe.  
**Engineers:** Ben C Jordan, also Studio Manager.  
**Dimensions of Studios:** 40' x 33'.  
**Dimensions of Control Rooms:** Production room 25' x 8'; Control Rooms 30' x 21'.  
**Tape Recorders:** Ampex Model 1100 16 track; Ampex Model AG-445B 4, 3, 2, 1 track; Ampex Model 351 1 track, Ampex Model 350-2 2 track; Ampex Model 354-2 2 track.  
**Mixing Consoles:** Quad/Eight 2082, 20 in x 20 out; Gates 3 track stereo, 8 in x 3 out.  
**Monitor Amplifiers:** Crown DC-300, McIntosh 300.  
**Monitor Speakers:** JBL 4320; Altec 604E's with Mastering Lab crossovers; Rodger Sound Labs (production).  
**Outboard Equipment:** Lang equalizers, Countryman phaser, Cooper Time Cube, variable speed oscillator, Dual turntables, Kepex, Gain Brain, Lo & Hi pass filters, Pultec EQ's, UREI LN-1176 limiters, Allison's Memories Little Helper, (sound effects at request), EMT plate stereo echo.  
**Microphones:** AKG, Neumann, RCA, Shure, Altec, Sony, E-V's.  
**Instruments Available:** 8' Steinway grand piano, Hammond B-3 with Leslie speaker, electric clavichord, electric Rhodes piano, Moog, ARP 2600, Electric bass and guitar amps, electric Wurlitzer piano.  
**Extras:** Free coffee and tea.  
**Rates:** 9:00 AM to 6:00 \$70/hr. Block booking at a reduced rate upon request.  
**Direction:** We are ideally situated in the heart of Hollywood at Sunset and LaBrea Avenue. There is ample parking in the rear of the building. Our engineers are experts in the audio field, with over 200 Gold Records and are creative in all modes of recording, TV, motion picture, radio spots, and good Rock & Roll. Free coffee, tea, and... Performance! We offer you the finest sound available. Complete We offer you the finest sound available. Complete automation on hand.

••• **OVERLAND RECORDING STUDIO**  
 3176 Pullman St., Suite 123, Costa Mesa, CA 92626  
 (714) 957-0633  
**Owner:** Freeman & Haws, Inc. (Paul Freeman, Tony Brito, Michael Anthony)  
**Engineers:** Paul Freeman, Al Lyon, Tony Brito.  
**Dimensions of Studios:** 30' x 25'; Isolation booth:



# lost in the mix?



If you have a commercially available recording studio, 4 track or more, and would like to be listed, free, in our next directory, fill in the coupon below and return to:

The Mix  
P.O. Box 6395  
Albany Branch  
Berkeley, CA 94706

PLEASE PUNCH ME INTO THE MIX

- 4 TRACK     16 TRACK  
 8 TRACK     24 plus TRACK

Name \_\_\_\_\_

Studio Name \_\_\_\_\_

Address \_\_\_\_\_

City \_\_\_\_\_ State \_\_\_\_\_ Zip \_\_\_\_\_

Phone \_\_\_\_\_

Comments: \_\_\_\_\_

\_\_\_\_\_

\_\_\_\_\_

\_\_\_\_\_

# TRACK 16 TRACK

10' x 5'; Vocal booth: 6' x 9'; Drum booth: 7' x 12'.  
**Dimensions of Control Rooms:** 16' x 20'.  
**Tape Recorders:** MCI Model JH-24 24/16 track; Otari Model 5050 2 track; TEAC Model 40-4 4 track.  
**Mixing Consoles:** Sound Workshop Model 1600, 28 in x 24 out with Arms automation.  
**Monitor Amplifiers:** BGW 250's, 100's.  
**Monitor Speakers:** JBL 4333 in control room; E-V Sentry V in studio.  
**Outboard Equipment:** EXR Exciter, Allison Kepex's, Allison Gain Brains, Eventide Flanger, MXR DDL, MICMIX reverb, Orban parametric EQ, UREI LA3A's.  
**Microphones:** Neumann KM-84's, U-87's; AKG 451's, 452's; Sennheiser 421; Shure SM-57's; Electro-Voice RE-20's, RE-16's.  
**Instruments Available:** 5'8" Yamaha baby grand piano, Fender Rhodes, Martin & Mossman guitars, Hammond organs, Fender Super Reverb amps.  
**Extras:** Kitchen, lounge, conference room, included under the roof of a downhome, old west atmosphere (A "Little Caribou", some have said!) and a staff that will remain conscious of your budget and that ticking clock.  
**Rates:** Call Doris or Michael for rates.  
**Direction:** Overland Recording is part of Freeman & Haws, Inc. — A full service creative house, which includes as subsidiary companies: Michael Anthony Productions, Rana Productions, SCR Records, and Anthony Ventures, Ltd. The respective functions of each of the above include: record production and distribution; feature film, television, and radio production; mobile recording and disco programming; personal management; bookings (actors, musicians and bands); publishing; accounting and consulting; advertising; and concert production and promotion via our in-house P.R. division.

••• **P.D. RECORDERS**  
 12055 Burbank Blvd., North Hollywood, CA 91411  
 (213) 766-9164 or 769-9393  
**Owner:** John Phillips.  
**Engineers:** Robert Grogan, Willy Stites.  
**Dimensions of Studios:** 20' x 40'.  
**Dimensions of Control Rooms:** 12' x 18'.  
**Tape Recorders:** Ampex Model MM1000 16/8 track; Ampex Model 351-2's 2 track; Ampex Model 351-4 4 track.  
**Mixing Consoles:** Custom design Op-Amp, 20 in x 8 out.  
**Monitor Amplifiers:** McIntosh (main), Fisher (studio), Electro-Voice (cue).  
**Monitor Speakers:** Altec 604-D's.  
**Outboard Equipment:** Soundcraftsmen 20-12, dbx 160's, Eventide Instant Flanger (FL-201), Telefunken reverb, Sound Workshop reverb.  
**Microphones:** Neumann U-87; Electro-Voice 667, 664, 665, 635A, RE-10, RE-11, 636; Sony C-37A, ECM 22P; PML EC-71; AKG 1000E; Altec; Sennheiser MD-421, MKH 415T; Shure SM-57.  
**Instruments Available:** Bradbury baby grand piano, Hammond organ with Leslie, Roland SH 2000 synthesizer, Roland string synthesizer.  
**Rates:** 1 hour \$60. 2-6 hours \$50/hr. 7-15 hours \$45/hr. 16 hours and up \$40/hr.  
**Direction:** We offer complete service from tape to finished records. We believe we can offer you the best sound for your money. If you already have tapes mixed, we can arrange to have your records pressed, labels made and covers printed from 7" 45's to 33 1/3 LP's. Our jobs include the movies, "Dirt", "Wishbone Cutter", "Dogs", "Death Force", "Grey Eagle" and others. We can give you what you want; just ask!

••• **PRESENT TIME RECORDERS**  
 5154 Vineland Ave., N. Hollywood, CA 91505  
 (213) 762-5474  
**Owner:** Robert L. Wurster.  
**Engineers:** Robert L. Wurster, Mike Sabatini.  
**Dimensions of Studios:** 15' x 17'.  
**Dimensions of Control Rooms:** 15' x 17'.

**Tape Recorders:** MCI Model Jh-10 16 track; Tascam Model 80-8 8 track; Revox Model 77 2 track; TEAC Model 7070 2 track; (5) Sankyo Model 1800 2 track cassette recorders.  
**Mixing Consoles:** Quantum Model QA-3000, 18 in x 16 out.  
**Monitor Amplifiers:** Dyna.  
**Monitor Speakers:** JBL, Auratone, MG's.  
**Outboard Equipment:** Digital, flanging, reverb, dbx limiters.  
**Microphones:** E-V 20's, 15's; Sennheiser 421, 416; AKG 202, 200, 1000; Shure.  
**Instruments Available:** Piano.  
**Rates:** \$20/hr 16 track; \$15/hr 8 track.

**Direction:** We're now having a custom MG5 Technology 24 track machine built and expect at least 30 db of Headroom. The studio is going to be over double its present size in a few months, and a lot of extras will be added. Like a new grand piano and a live echo chamber.



**SILVERLAKE RECORDING STUDIO,**  
Los Angeles

••• **SILVERLAKE RECORDING STUDIO**  
 2413 Hyperion Ave., Los Angeles, CA 90027  
 (213) 663-7664  
**Owner:** Steve Millang, Greg Scelsa, Dan McTague.  
**Engineers:** Steve Millang, Niko Bolas.  
**Dimensions of Studios:** 24' x 30' with 10' x 10' isolation booth and 8' x 10' drum booth.  
**Dimensions of Control Rooms:** 15' x 12'.  
**Tape Recorders:** Ampex Model MM1100 16 track; 3M Model 64 2 track; Sony Model TC-854-4 4 track; Sony Model TC-850 2 track.  
**Mixing Consoles:** Sound Workshop Model 1600, 20 in x 16 out, "automated".  
**Monitor Amplifiers:** SAE 2400.  
**Monitor Speakers:** UREI 604 Time-Aligned.  
**Outboard Equipment:** Limiters: UREI 1176, LA3A's; Eventide Harmonizer; 3 Kepex's, live echo chamber, AKG BX-10 echo, SAE graphic EQ.  
**Microphones:** Neumann U-87's, U-47's, AKG C-414's, Sennheiser 421, Electro-Voice, Shure, RCA.  
**Instruments Available:** Piano, ARP String Ensemble, Fender Rhodes, orchestra bells, guitar amps, RMI Rock-Si-Chord, misc. rhythm instruments.  
**Extras:** Lounge.  
**Rates:** 16 track \$40/hr.  
**Direction:** We are a new studio with new equipment and very qualified engineers. All three deliver excellent quality recordings.

••• **SOUND AFFAIR RECORDING STUDIOS**  
 2727 Unit G, Croddy Way, Harbor Warner Business Center, Santa Ana, CA 92704  
 (714) 540-0063  
**Owner:** Ron Leeper.  
**Engineers:** Ron Leeper, 2 assistants.  
**Dimensions of Studios:** 20' x 36', drum isolation — 9' x 12', vocal 6' x 7'.  
**Dimensions of Control Rooms:** 20' x 18'.  
**Tape Recorders:** Ampex Model MM 1200 16 track; TEAC Model 701 8 track; Otari Model MX 5050 2 track stereo.  
**Mixing Consoles:** Sound Workshop Model 1600, 20 in x 16 out, 2-channels parametric EQ.





# TASCAM

## Model 15



**8 x 8\***

**12 x 8\***

\* Exclusively by Suntronics

**16 to 24 x 8**

SUNTRONICS now has available the Teac Tascam Model 15 Recording Mixing Console, available with 8 to 24 input module configurations, which are determined by your particular requirements. This allows you to maintain eight outputs and add extra input modules for effects and microphone inputs, as needed.

#### PRICES

8 x 8*	\$5,500
12 x 8*	\$6,500
16 x 8	\$7,500
20 x 8	\$8,500
24 x 8	\$9,500

Additional modules are available for \$250 each (exchange) with blank filler Panel.

These Prices include Teac cables for hookup to the recorder and auxiliary equipment (cables up to 10 feet).

Quantity to be determined at point of sale.

**(714) 985-0701**

P. O. Box 734  
1620 W. Foothill Blvd. **UPLAND, CA**

# TRACK 16

**Monitor Amplifiers:** Crown DC300A, Crown D175, BGW 100.  
**Monitor Speakers:** Electro-Voice, Sentry III, JBL 4311, Auratone Cubes.  
**Outboard Equipment:** ADR limiters, dbx limiters, ADR noise gates, Lexicon Prime Time, DDL, Sound Workshop 220 vocal doubler, Furman parametric EQ Model PQ-3, dbx 8-channels 154 noise reduction, MICMIX Super C reverb unit.  
**Microphones:** Neumann U-87; AKG 414, 451, 452; Shure SM-56, 57; Sennheiser MD-421; Electro-Voice RE-20.  
**Instruments Available:** Grand piano, Rogers drums, vibes.  
**Extras:** Complete kitchen and lounge area, we are equipped for any size group, complimentary food and beverage is provided.  
**Rates:** 8 track: \$25. 16 track: \$50. Reduced rates for 6 hour blocked sessions. A special rate offer 1st-time-trial 16 track \$25. A 4 hour limit. All sessions have free set up time.  
**Direction:** We opened Sound Affair Nov. 1st. It has been a success far beyond expectations. All bookings are repeat with steady growth. We have album projects, advertising projects, audio for laser beam, and audio for leading commercials. We are proud of our beautiful studio and the response from artists and producers. We are currently into projects with A.V. III Productions, Natural Sound West.



**SOUND AFFAIR RECORDING STUDIO,**  
Santa Ana

**... SOUND-OFF RECORDING STUDIO**  
 200 North Long Beach Blvd., Compton, CA 90221  
 (213) 637-5845  
**Owner:** Jack Lauderdale.  
**Engineers:** Jack Lauderdale.  
**Dimensions of Studios:** 11' x 27' with 10' x 10' x 8' isolation booth.  
**Dimensions of Control Rooms:** 11' x 14'.  
**Tape Recorders:** Ampex Model MM1000 16 track; Ampex Model AG-350 1/2 and 2 track; TEAC Model 3300S 1/4 and 2 track; TEAC Model A400 cassette; Toshiba 8 track cartridge.  
**Mixing Consoles:** Soundcraft Series II, 16 in x 16 out.  
**Monitor Amplifiers:** BGW 250 (monitor), Crown D-60 headphone cue amp.  
**Monitor Speakers:** Altec.  
**Outboard Equipment:** Bi-Amp stereo graphic equalizer, dbx 161 comp/limiter, Sony, Craig and AKG headphones, AKG BX-10 echo unit.  
**Microphones:** RCA D77; AKG 451, 505E, D-170, D-1000; Electro-Voice 666, 664; Sennheiser 421-05; Shure 565.  
**Instruments Available:** Freemans String Ensemble, Fender Rhodes.

**Extras:** Rear lounge, front lobby.  
**Rates:** 16 track \$35/hr; special rates offered for extended hours and block time.  
**Direction:** "Sound-Off" Studio's goals are to provide quality low-cost recording to its clients and to establish itself as an independent recording company.



**... SOUND SUITE RECORDERS**  
 P.O. Box 66 Manhattan Beach, CA 90266  
 (213) 973-1999 or (213) 884-0435  
**Owner:** Gary Young, Craig Moulton.  
**Engineers:** Larry Thatt, Mark McPhail  
**Dimensions of Studios:** 20' x 40'.  
**Dimensions of Control Rooms:** 10' x 20'.  
**Tape Recorders:** 3M Model 56 16 track; TEAC/Tascam Model 80-8 8 track; Revox Model A77 2 track.  
**Mixing Consoles:** TEAC/Tascam (2) Model 3's, 16 in x 16 out.  
**Monitor Amplifiers:** Kenwood.  
**Monitor Speakers:** Altec, Auratone.  
**Outboard Equipment:** Tapco reverb, dbx compressor/limiters, SAE equalizer, Marshall Time Modulator.  
**Microphones:** Sennheiser 421, K-2; AKG D1000E; Shure SM-56, SM-57; Neumann U-87.  
**Instruments Available:** Fender Rhodes, Hammond B-3 with Leslie, ARP Axex, ARP String Ensemble, ARP Pro Soloist, Wurlitzer electric piano, acoustic piano, guitars (acoustic and electric) Ludwig drums.  
**Extras:** Pong game.  
**Rates:** 16 track \$16/hr; 8 track \$10/hr.  
**Direction:** We offer low cost, high quality 16 and 8 track recording services to producers, publishers, managers, songwriters and musicians in the Los Angeles area. We've been doing business in the South Bay area for over 6 years. Having moved into our present location 2 years ago, we have expanded and grown to be the finest and lowest cost 16 track facility in L.A.



**... SOUNDTRAX**  
 8170 Ronson Rd., San Diego, CA 92111  
 (714) 560-8449  
**Owner:** Soundtrax Recording Studios, Inc.  
**Engineers:** Jim Papageorge, C.J. Hutton, Dave Lynch  
**Dimensions of Studios:** 30' x 20'.  
**Dimensions of Control Rooms:** 18' x 17'.  
**Tape Recorders:** Ampex Model 1100 16 track; Tascam Model 70H-8 8 track; Ampex Model ATR-700 2 track; Studio/Revox Model A-700 full; Kenwood/Tandberg cassette decks.  
**Mixing Consoles:** Tangent Model 3216, 24 in x 16 out.  
**Monitor Amplifiers:** SAE Mark XXXI-B; SAE Mark IVC.  
**Monitor Speakers:** JBL 4343 4-way monitors in control room; JBL L166 3-way in studio.  
**Outboard Equipment:** Marshall Time Modulator, Furman parametric EQ, stereo SAE graphic EQ, Altec Acoustivoice 1/2 octave EQ (control room), SW-242-A reverb tank, 200 cubic ft. live echo room, multiple channels of: Kepex, dbx compression, MXR signal devices.  
**Microphones:** Neumann U-87's, U-67's, tube U-47; Beyer 160's; Altec 626; Sennheiser 421, 441; misc. Shure, Sony, Electro-Voice.  
**Instruments Available:** Steinway studio piano, ARP 2600 with outboard pitch to voltage converter, Rhodes electric piano, drums, congas, tympani, timbales, large collection of percussion effects.  
**Extras:** Musicians lounge with marine aquarium, kitchen, beautiful new, air-conditioned studio complex.  
**Rates:** 16 track \$65/hr. 8 track \$35/hr. By the day rates and complete album packages available.  
**Direction:** The friendly pros at Soundtrax are most proud to announce the completion (May 1978) of our new 16-track facility. In our old four and eight track studio we made some great music, but in our first six weeks in the new studio we did a session with Dionne Warwick, music score for a national TV documentary, and began work on 6 album projects featuring various Southern California talents. We enjoy our work and treat every client, large and small, like they were all doing gold record work. We are happy to bid on any kind of audio project, and our in-house production company stands ready to help you anyway we can. Recording can and should be professional and fun !! SOUNDTRAX !!



**... STARBURST RECORDING INC.**  
 1402 Descanso Rd., Suite F, San Marcos, CA 92069  
 (714) 744-9733  
**Owner:** Starburst Corporation  
**Engineers:** James Henry, Assistant Ken Huncousky.

**Dimensions of Studios:** 35' x 20' x 10'; drum booth 9' x 10' x 8'; vocal isolation booth 5' x 8' x 7'.  
**Dimensions of Control Rooms:** 20' x 17' x 10'.  
**Tape Recorders:** Stephens Model 811C-16 16 track; Studer Revox Model A77-HS 2 track; TEAC Model 3340S 4 track; Sony 756 2 track; Pioneer Model CTF 1000 cassette.  
**Mixing Consoles:** Tangent Model 3216, 24 in x 16 out.  
**Monitor Amplifiers:** Phase Linear 400.  
**Monitor Speakers:** JBL 4333, and mixing cubes.  
**Outboard Equipment:** Marshall Time Modulator, Eventide Flanger, Orban/Parasound reverb, Tapco 4400 headphone reverb, SAE parametric; SAE graphic equalizers, dbx 160 and 161 limiter/compressors, dbx noise reduction.  
**Microphones:** AKG C-414's, C-451E's, D-1000's, D-200E's, D-190's; Shure SM-57's, 545, 566, SM-82's, SM-7's; E-V RE-15; Sony ECM-22's; Sennheiser MD-421's; Beyer 260.  
**Instruments Available:** Steinway baby grand piano.  
**Extras:** Musicians lounge with TV and video games. Free coffee and tea; talking parrots, fully air-conditioned, very private studio-control room area.  
**Rates:** 2, 4, and 8 track \$35/hr; 16 track \$45/hr; As of April 1, 79, 24 track \$60/hr. Reduced rates for block bookings by the week or monthly.  
**Direction:** As musicians we are aware of the positive effect a comfortable environment has on the final product, and our recent renovation reflects our firm commitment to provide a productive, comfortable and creative environment. Our Los Angeles friends find the clean air and mellow atmosphere in Northern San Diego County a pretty good environment itself. Our production staff is headed by a nationally known recording and touring artist. Our goal has been to provide a mastering quality studio at the lowest possible rates with no compromise to quality, we offer professional rooms, engineering, and equipment. Future plans include 24 tracks; a fully automated mixdown facility, and a record label.



## STUDIO ORANGE

We're still the best professional 4 & 8 track studio for the lowest price. We also have lots of studio instruments for your free use.

API — 3M — TEAC —  
2, 4, 8 & 16 Track

(714) 524-7980  
OR  
(213) 691-4191

**... STUDIO ORANGE**  
 317 S. Harbor Blvd., La Habra, CA 90631  
 (213) 691-4191, (714) 524-7980  
**Owner:** Ted M. Vegvari, Jeff Mulick.  
**Engineers:** Ted M. Vegvari, Jeff Mulick, Anthony Cassella.  
**Dimensions of Studios:** 15' x 30' (soon to be expanded to 3600 Sq. Ft.)  
**Dimensions of control Rooms:** 18' x 15'.  
**Tape Recorders:** 3M Model M56 16 track; 3M Model M56 8 track; TEAC Model 80-8 8 track; TEAC Model 3340 4 track; Pioneer stereo half-track 2 track.  
**Mixing Consoles:** API Model 2016, 20 in x 16 out.  
**Monitor Amplifiers:** BGW, McIntosh, Kenwood.  
**Monitor Speakers:** Custom JBL system, Altec, Auratone, cue A and B headphones and monitor system.  
**Outboard Equipment:** dbx for 2, 4, and 8 track recording, Eventide FL201 Phlanger, Scamp limiters and compressors, stereo reverb, tape echo, doubling, optional: dbx-16, Dolby, digital proc., Kepex, video.  
**Microphones:** Neumann, PML, E-V, Shure, AKG, Sennheiser, Altec, Sony.  
**Instruments Available:** Gibson Les Paul custom, L-6-S, Fender Precision Bass, Maxi Korg, Hammond M-3 and Leslie, Fender Rhodes, ARP String Ensemble,



# MODEL 50

## Professional Power Amplifier



The Model 50 delivers 50 watts per channel into 8 ohms. With its dual power supply, specially designed heat sink and transformers, the Model 50 is the most powerful amplifier in a 1 3/4" high package. Write for details or ask your



dealer for UNI-SYNC.

742 Hampshire Road/Westlake, California 91361 • (805) 497-0766  
 Uni-Sync Div. of BSR (Canada) Ltd., 26 Clairville Rd., Rexdale, Ontario M9W5T9 • (416) 675-2402

# MODEL 100

## Professional Power Amplifier



Headlining the Professional Amplifier marketplace is the Model 100 which delivers 100 watts into 8 ohms. Ruggedly built to handle the road and easy to service. The Model 100 features a dual power supply which delivers more



actual sound power to you. Write for details or ask your

742 Hampshire Road/Westlake, California 91361 • (805) 497-0766  
 Uni-Sync Div. of BSR (Canada) Ltd., 26 Clairville Rd., Rexdale, Ontario M9W5T9 • (416) 675-2402

# MODEL 200

## Professional Power Amplifier



Headlining the Professional Amplifier marketplace is the Model 200 which delivers 200 watts into 8 ohms. Ruggedly built to handle the road and easy to service. The Model 200 features a dual power supply which delivers more



actual sound power to you. Write for details or ask your

742 Hampshire Road/Westlake, California 91361 • (805) 497-0766  
 Uni-Sync Div. of BSR (Canada) Ltd., 26 Clairville Rd., Rexdale, Ontario M9W5T9 • (416) 675-2402

# MODEL 350

## Professional Power Amplifier



Headlining the Professional Amplifier marketplace is the Model 350 which delivers 350 watts into 8 ohms. Ruggedly built to handle the road and easy to service. The Model 350 features a dual power supply which delivers more



actual sound power to you. Write for details or ask your

742 Hampshire Road/Westlake, California 91361 • (805) 497-0766  
 Uni-Sync Div. of BSR (Canada) Ltd., 26 Clairville Rd., Rexdale, Ontario M9W5T9 • (416) 675-2402

Available at:



1620 W. Foothill Blvd., P. O. Box 734  
 Upland, CA 91786  
 (714) 985-0701

# TRACK 16 TRACK

ARP 2600 acoustic piano, Ovation acoustic guitar, also amplifiers, and percussion toys.

**Extras:** Coffee, Microwave oven, refrig, studio musicians, writing, arranging, professional production, live recording, sound reinforcement.

**Rates:** Please call for your special rate information. Block time available. We are also interested in special projects.

**Direction:** After six years of providing quality recording services we are now offering you our new 16-track facility with equipment that has a history of Gold Records from great artists such as the Grass Roots, Four Tops, Mamas and the Papas, Dusty Springfield, Jim Croce, The Dramatics, Marilyn McCoo and Billy Davis Jr., Hamilton Joe Frank and Reynolds, the Heywoods, and many more. We know what you want and expect, and will work closely with you to insure the success of your project from beginning to end, and at a price you can't beat.



**••• SUN-DWYER RECORDERS**

1424 N. Waterman Ave., San Bernardino, CA 92404 (714) 889-9040

**Owner:** Terrance Dwyer, Steve Sun.

**Engineers:** Terrance Dwyer.

**Dimensions of Studios:** 17' x 22'.

**Dimensions of Control Rooms:** 12' x 13'.

**Tape Recorders:** Ampex Model MM1100, 8 and 16 track; Revox (2) Model A77 2 track (1/2 & 1/4).

**Mixing Consoles:** Speck Model C, 16 in x 16 out.

**Monitor Amplifiers:** BGW 750C and Crown D-150.

**Monitor Speakers:** JBL 4313 (pair), 4311 (pair).

**Outboard Equipment:** dbx limiters, Dolby A, AKG reverb.

**Microphones:** Electro-Voice, Neumann, Sennheiser, AKG.

**Instruments Available:** Baldwin piano, Rogers Drums, Fender Rhodes, Gibson acoustic.

**Extras:** Musicians contract service, disc mastering and pressing, record distribution.

**Rates:** 8 track \$30/hr. 16 track \$40/hr.

**Direction:** We've been involved in many aspects of the music industry. As song writers, published in Nashville and Los Angeles and producers with records charted in both billboard and cashbox. We built our facility to satisfy a need in San Bernardino, for a professionally equipped and staffed studio. The response has been gratifying. Since our opening in April of '78, our facility has produced recordings that won the American Song Festival, recordings covered by such artists as Chicago and Leo Sayer band. Demo's that have opened the doors to Clive Davis, George Clinton and many more. We know you can't please everyone, but at Sun-Dwyer you'll know we've tried.



**••• T.A.P.E. RECORDERS, INC.**

1606 N. Highland Ave., Hollywood, Ca 90028 (213) 464-1106

**Owner:** John Bahler, Tony Asher.

**Engineers:** Kevin Clark, Bruce Gowdy.

**Dimensions of Studios:** 33' x 14' with 12' x 15' isolation booth.

**Dimensions of Control Rooms:** 14' x 12'.

**Tape Recorders:** 3M Model M56 16 track; Otari Model MX 5050 8 track; Tascam Series 70 4 track; Tascam Series 70 mono; Panasonic Model 1500 2 track; TEAC Model 7030 2 track; TEAC Model 3340 4 track.

**Mixing Consoles:** Quantum Modified QM 168, 16 in x 8 out.

**Monitor Amplifiers:** SAE 2700-B graphic equalizers,

**Monitor Speakers:** 604E with UREI crossovers; UREI 529 room equalizers; JBL 4311's, Auratone 5C sound cubes.

**Outboard Equipment:** SAE 2700-B graphic equalizers, UREI 1176 limiters, UREI LA4 compressors, UREI digital metronome, custom VSO, 16 channels of dbx,

live stereo echo chamber, MICMIX stereo spring chamber, Technics 677 cassette with dbx compression, TEAC A-1200 1/4 track, TEAC 6010 1/4 track - 1/2 track, Roland DC-10 analog delay, Mutron bi-phase, Roland Boss Chorus Ensemble.

**Microphones:** Neumann U-87's, KM-86's, KM-84's; AKG 414's, 451's, 707's; Sennheiser 402; Shure SM-57's; Electro-Voice RE-20, RE-15; Sony ECM 50's, 22P, 33P, 21; RCA 44, 77.

**Instruments Available:** Yamaha 7' grand piano, Fender Rhodes 88, Pearl drums, (no cymbals), ARP 2600 synthesizer with sequencer.

**Extras:** Polytone bass amp, custom Fender Princeton, assorted percussion instruments, full line of MXR effects, pedals.

**Rates:** Rate sheet available on request.

**Direction:** Since going 16 track our facility has been working around the clock. We still "mix with our ears" proving once again that the final "sound" of your master is almost totally dependent upon the "ears" of the mixer. Ours are the best!! Joining our list of friends: Quincy Jones, Tennessee Ernie Ford, Dave Grusin, Andy Williams, Tom Bahler, Burt Bacharach, Seawind and John Davidson are: United Artists Music, Filmways, Inc., Klein & Herman Edel and Producers' Music Service.



**••• WESTWIND RECORDING**

\*also REMOTE RECORDING\*  
26483 East Baseline St., Suite A,  
Highland, Ca 92346  
(714) 862-0404

**Owner:** Frank H. Cervantes and James G. Zebrowski.

**Engineers:** Frank Cervantes, James Zebrowski.

**Engineers:** Frank Cervantes, James Zebrowski.

**Dimensions of Studios:** 27' x 30'.

**Dimensions of Control Rooms:** 12' x 25'.

**Tape Recorders:** 3M 16 track; Tascam Model 70-8 8 track; TEAC Model 3340S 4 track; Tascam Model 25-2 2 track.

**Mixing Consoles:** Tangent Model 3216, 24 in x 16 out.

**Monitor Amplifiers:** BGW Model 500D.

**Monitor Speakers:** JBL Model L300's, Auratone 5C Super Sound Cubes.

**Outboard Equipment:** dbx Model 154 Noise reduction system, dbx Model 161 compressor/limiters, SAE Model 2700B octave EQ's, Roland Model RE-201 Space Echo, Sound Workshop Model 242A stereo reverb.

**Microphones:** Shure SM-53, SM-56, SM-57, SM-58; Sennheiser MD-421; Beyer M-500; TEAC ME-120.

**Instruments Available:** Baby grand piano, studio drum set, Hammond D-3 organ, Yamaha 6 string acoustic, Ovation Classical.

**Extras:** 11' x 25' lounge with wet bar.

**Rates:** \$50/hr 16 track; \$25/hr 8 track.



**••• WESTWORLD RECORDERS**

7118 Van Nuys Blvd., Van Nuys, CA 91405  
(213) 782-8449

**Owner:** Robert Schreiner.

**Engineers:** Robert Schreiner, Phil Van Allen, Roy Braverman.

**Dimensions of Studios:** 500 sq. ft.

**Dimensions of Control Rooms:** 350 sq. ft.

**Tape Recorders:** 3M Model 56 16 track; Telex Model 728 2 track; Sony Model 777 1/4 track; Kenwood cassette.

**Mixing Consoles:** RLS Sound Console with separate 16 track cue and monitor systems, 20 in x 20 out.

**Monitor Amplifiers:** Phase Linear, Marantz, JBL, McIntosh.

**Monitor Speakers:** JBL, Altec, and Quadraflex.

**Outboard Equipment:** Melcor limiters, SAE and Alpha graphic equalizers, Melcor peaking and custom parametric equalizers, flanger/phasers, Eventide Digital Delay and Harmonizer, two echo systems: custom design and AKG BX-20.

**Microphones:** Shure 545's, AKG 451's, Sony C-37, Neumann U-47; RCA 44's; Telefunken CM61's, Electro-Voice electret microphones.

**Instruments Available:** Baldwin piano, Rhodes electric piano, clavinet, Hammond B-3 organ.

**Extras:** Conveniently located near six restaurants.

**Rates:** Please call for rates.

**Direction:** This comfortable studio was designed for people who want to make records in a soothing and professional atmosphere. It is staffed by craftsmen who give all of their talent and energy to each of our patron's projects. We appreciate our clients and they appreciate us.

**••• WORLDWIDE AUDIO**

1435 South St., Long Beach, CA 90805  
(213) 422-2095

**Owner:** John A. Vestman.

**Engineers:** John A. Vestman, David Baker, Steve Taylor, Bill Jeffery.

**Dimensions of Studios:** 18' x 24' plus 6' x 9' drum booth and 2 additional isolation rooms.

**Dimensions of Control Rooms:** 14' x 15'.

**Tape Recorders:** MCI Model JH-100 16 track; TEAC Model 3340 4 track; Dokorder Model 1122 2 track; TEAC Model 450 cassette.

**Mixing Consoles:** MCI Model 428, 24 in x 24 out.

**Monitor Amplifiers:** BGW 250 B.

**Monitor Speakers:** Altec 9849, Auratones.

**Outboard Equipment:** UREI 1176, dbx 162, tape delay, flanging, phasing, Sound Workshop stereo reverb.

**Microphones:** Neumann, AKG, Sennheiser, Sony, Shure.

**Instruments Available:** Hamilton and Wendell grand piano, Fender Vibratone (Leslie), various percussion instruments.

**Extras:** Free string tracks (the real acoustic kind) — up to 16 violins and violas performed at no cost, and the sound is 100% guaranteed! Arrangements available, plus refreshment/relaxation area with couch, TV, free coffee and tea.

**Rates:** 16 track \$50/hr. 2 and 4 track \$35/hr.

**Direction:** Our studio has been acoustically designed and engineered to give maximum sound versatility in a comfortable atmosphere. We pride ourselves in the clean, crisp, dynamic sound we give our clients. The "live" floor in the studio and four isolation rooms give presence and natural clarity to any kind of music. In addition to disc projects we do radio and TV commercial production, film scores, and great demo packages. We take a personal interest in every client and our strong musical backgrounds facilitate our ability to make every session a productive and successful experience.



# DISTRIBUTE

If you have a recording or music related business and would like to be a distribution point for The Mix, please mail the coupon below and we will give you a call.

name \_\_\_\_\_

business name \_\_\_\_\_

address \_\_\_\_\_

city state zip \_\_\_\_\_

phone \_\_\_\_\_

The Mix  
P.O. Box 6395  
Berkeley, CA 94706  
(415) 526-6102



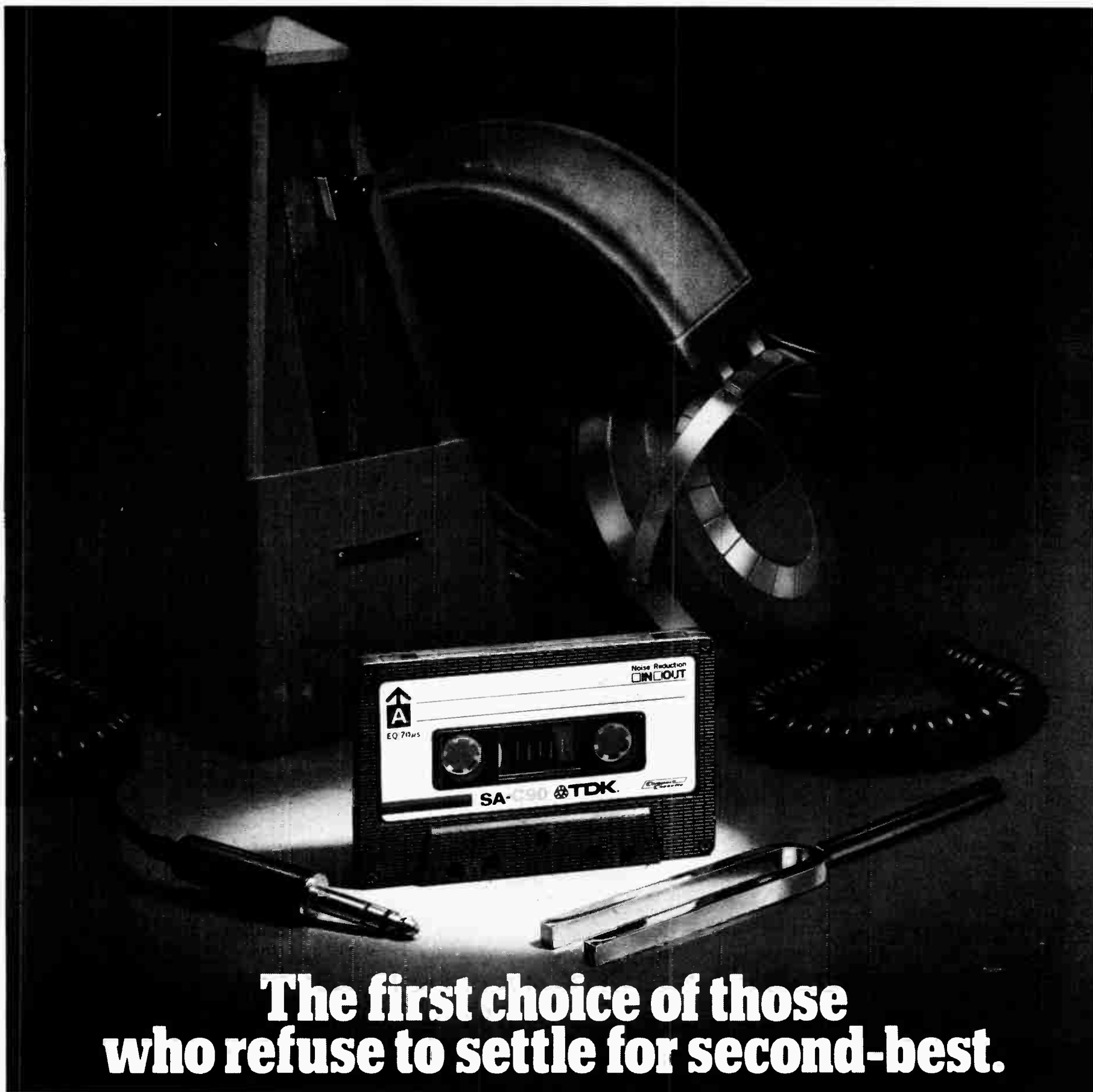

## The first choice of those who refuse to settle for second-best.

The true audio perfectionists are those who demand state-of-the-art performance from every part of their system. For these trend setters, second-best just won't do.

At TDK we consider ourselves perfectionists, too, so it's gratifying to know that TDK SA is the number one selling cassette to these critical listeners.

Perfectionists demand the best possible sound quality. SA is the high bias reference standard; most quality manufacturers set up their decks in the factory to sound best with SA.

© 1979 TDK Electronics

Perfectionists appreciate technological superiority. SA's advanced cobalt-adsorbed gamma-ferric oxide particle formulation made it the world's first non-chrome high bias cassette. And many parts of its super precision mechanism, such as its double hub clamp and bubble surface liner sheet have yet to be equalled.

Perfectionists insist on reliability, and they know that TDK was first with a full lifetime warranty\*—more than 10 years ago.

You may not be an audio perfectionist; you may not be able to afford

an ultimate, cost-no-object stereo system. But it's comforting to know you can get better performance from your present system by using the tape you'd buy even if you had a million to spend—TDK SA. TDK Electronics Corp., Garden City, New York 11530.

\* In the unlikely event that any TDK cassette ever fails to perform due to a defect in materials or workmanship simply return it to your local dealer or to TDK for a free replacement.

 **TDK**  
The machine for your machine.



•••• A & M RECORDS

1416 N. La Brea, Hollywood, CA 90028  
(213) 469-2411

**Owner:** Herb Alpert, Jerry Moss (director of Recording: Tom May).

**Engineers:** Dick Bogert, Larry Forkner, Ray Gerhardt, Don Hahn, Dave Iveland; Henry Lewy, Steve Mitchell.

**Dimensions of Studios:** A: up to 50 musicians, B: up to 20, C: up to 8, D: up to 30.

**Tape Recorders:** MCI 24 track.

**Mixing Consoles:** Custom 32 in x 24 out.

**Monitor Speakers:** Altec 604's with Mastering Lab crossovers.

**Outboard Equipment:** Equalizers: UREI Graphics, Pultecs, Lang's, Quad/Eight, API, Orban parametrics. Limiters: UREI 1176, Gain Brain, Fairchild. Filters: Langevin, UREI Little Dipper, UA, Haeco. Other: Kepex, Harmonizers, Eventide Phasers, Digital Delay, Orban D'Esser, Cooper Time Cube.

**Microphones:** Nearly all types of Shure, Sennheiser, Neumann, Sony, Beyer, RCA.

**Instruments Available:** Steinway grand pianos, Hammond B-3 organ, Celeste.

**Rates:** Please call for rates.

**Direction:** A & M Studios have been open since 1969, going public to custom clients (ie., Columbia, RCA, Arista) in 1971. In addition to the 4 studios, we have 3 mixdown rooms, 1 of which has undergone renovation to accommodate full 24 track mixing (32 inputs, 8 outputs). The other 2 mixrooms will be renovated this year. We also have 3 mastering rooms, with Bernie Grundman, Frank DeLuna, and Bob Carbone in-house staff.



•••• BACKROOM RECORDERS

13547 Ventura Blvd., (in rear)  
Sherman Oaks, CA 91423  
(213) 995-0427

**Owner:** John Morell

**Engineers:** Jim Ackley

**Dimensions of Studios:** 25' x 40' main room; 14' x 12' booth; 12' x 12' vocal booth.

**Dimensions of Control Rooms:** 14' x 12' booth.

**Tape Recorders:** MCI Model JH100 (Autolocator) 24 track; Ampex Model 300 2 track.

**Mixing Consoles:** Auditronics (modified), 24 in x 16 out.

**Monitor Amplifiers:** BGW.

**Monitor Speakers:** 4311 JBL's, Auratones.

**Outboard Equipment:** dbx 160's, 1176 UREI limiters.

**Microphones:** Sony, Shure, Sennheiser, AKG 414's, RCA, Neumann U-87.

**Instruments Available:** 7' Kawai grand.

**Rates:** \$50/hour.



•••• BARNUM RECORDING STUDIO

723 N. Seward St., Hollywood, CA 90038  
(213) 462-0726

**Owner:** H.B. Barnum and James R. Alfrey

**Engineers:** Pete Abbott, Tony Alfrey, Ralph Grasso.

**Dimensions of Studios:** 35' x 19' plus isolation booth 6' x 12'.

**Dimensions of Control Rooms:** 18' x 20'.

**Tape Recorders:** MCI Model JH24-16 with autolocator 24/16 track; MCI Model JH-120 with remote 2 track; TEAC Model A2300S 2 track; Nakamichi Model 500 cassette recorder 2 track.

**Mixing Consoles:** MCI Model JH428, 28 in x 24 out.

**Monitor Amplifiers:** BGW 750A with BGW 250A for cue systems.

**Monitor Speakers:** JBL 4341 Quad.

**Outboard Equipment:** GrayGhost Phantom mic supply; UREI 1176N, LA3A. Limiters: UREI 527A graphic equalizers, Orban 621B parametric equalizers, Orban 516 EC D'Esser; stereo MICMIX Model MRIV reverb; VSO; Syn Pulse; UREI digital metronome; phasers; Koss headphones plus rental at cost of any other equipment requested.

**Microphones:** Neumann U-87; Electro-Voice RE-15, RE-20, CS-15; Sennheiser MD 441, MD 421; Shure SM-57, SM-58, SM-7; various shotgun and special purpose mics.

**Instruments Available:** Steinway "B" grand piano, Fender Rhodes electric piano, Hohner D6 clavinet, Model 2600 ARP synthesizer plus rental at cost, of any instrument required.

**Extras:** Hot coffee, tea and ample parking.

**Rates:** 16 track: \$105/hr. 24 track: \$120/hr. Including engineer.

**Direction:** The studio was opened in 1975 by H.B. Barnum and Jim Alfrey. Credits include Tom Jones, Nancy Wilson, Supremes, Thelma Houston, Diana



ABC STUDIOS, Los Angeles

•••• ABC RECORDING STUDIOS, INC.

8255 Beverly Blvd., Los Angeles, CA 90048  
(213) 658-5990

**Owner:** President: Brian D Ingoldsby; Gen. Mgr: Jimmy Lockert; Studio Mgr: Rosemary Franchimone; Dir. Eng: Jerry Ferree.

**Engineers:** Reginold Dozier, Bruce Brown, Zoli Osaze, Al Schmitt, Jr.

**Dimensions of Studios:** A: 10' x 15'; B: 15' x 30'; C: 15' x 25'.

**Dimensions of Control Rooms:** A: 12' x 15'; B: 15' x 18'; C: 15' x 18'.

**Tape Recorders:** (4) 3M Model 79 24 track; (2) 3M Model 79 4 track; (8) 3M Model 79 2 track; (1) Ampex Model 1200 24 track; Ampex Model ATR-100 2 track; (2) Ampex Model 440B 2 track.

**Mixing Consoles:** Amek, 32 in x 24 out; (2) DeMedio custom automated, 36 in x 24 out.

**Monitor Amplifiers:** Crown DC 300A.

**Monitor Speakers:** Custom JBL 3-way, all rooms.

**Outboard Equipment:** UREI, Eventide, Pultec, Kepex, Burwen, SAE.

**Microphones:** All professional types are available.

**Instruments Available:** Bosendorfer piano, Steinway pianos, clavinet, Hammond B-3 organ, Wurlitzer electric piano, Hohner electric piano.

**Extras:** House noise reduction: dbx-all channels, all consoles! Also available 52 channels of Dolby, Neumann SAL 79 disc mastering available. Can do direct to disc recording.

**Rates:** Studio A: \$120/hr; Studios B and C: \$140/hr.



•••• ALLEN ZENTZ RECORDING STUDIO/

Allen Zentz Mastering Studio  
1020 N. Sycamore St., Hollywood, CA 90038  
(213) 851-8300

**Owner:** Allen Zentz.

**Engineers:** Steve Conger — recording; Brian Gardner — mastering; Rick Ash — recording; Chris Bellman — mastering; Allen Zentz — mastering.

**Dimensions of Studios:** Recording studio 22' x 40'; Mastering studio 13' x 21'.

**Dimensions of Control Rooms:** 14' x 22'.

**Tape Recorders:** Telefunken Model M15A 32 and 24 track; Telefunken (5 machines) Model M15A 2 track; Telefunken Model m15A preview (disc studio) 2 track.

**Mixing Consoles:** Harrison Model 4032, 40 in x 32 out. Neumann (disc mastering) Model SP-75, 2 in x 2 out.

**Monitor Amplifiers:** McIntosh MC 2300.

**Monitor Speakers:** UREI Model 813 (Altec 604 Time Aligned system).

**Outboard Equipment:** UREI Lexicon, EMT, K & H, Eventide, Teletronix, Inovonics, Trident, Dolby, Telcom, dbx.

**Microphones:** Neumann, AKG, Shure, Electro-Voice, Sennheiser, PML, RCA, Sony, Beyer.

**Instruments Available:** Bluthner 7' grand piano, Polymoog, Mini Moog, tack piano, Fender Rhodes.

**Extras:** EMT 250 digital reverb, EMT 140 reverb, plate, acoustic echo chamber, Harrison Auto Set (computer mix), Telefunken "Telcom" noise reduction system (2 and 24 track).

**Rates:** 24 track: \$160/hr. 32 track: \$180/hr.



Ross, Dennis Edwards, Johnny Mathis, Sons of the Pioneers, Lola Falana, Bobby Vinton, Donald O'Connor, Frank Sinatra, Jr., Gene Page, Paul Kelly, Maxine Anderson, Mac & Katie Kissoon, The O'Jays, The Pointer Sisters, Gilbert O'Sullivan, Lovelace Watkins, The Impressions, Jun Fukamachi, Michelle Wiley, Hodges, James & Smith, The Coasters, Bonnie Tyler, and innumerable radio and TV spots, movie scores and TV shows (pre-recordings). Label credits are Capitol, Atlantic, Columbia, Motown, Epic, UA, Warner Bros., ABC, Granite, ATV, RCA, Premore.



•••• **BRIAN ELLIOT RECORDING**  
5146 1/2 Colfax Ave., N. Hollywood, CA.  
(213) 761-7320

**Owner:** Brian Elliot, J. McCauley.  
**Engineers:** Steve Paul, John McCauley, Skip Saylor.  
**Dimensions of Studios:** 15' x 30'.  
**Dimensions of Control Rooms:** 16' x 12'.  
**Tape Recorders:** Ampex Model MM1200 24 track; Ampex Model 440 2 track; Sony Model 880-2 2 track; Nakamichi Model 550 cassette 2 track; TEAC Model 3340 2/4 track.  
**Mixing Consoles:** Trident Fleximix, 24 in x 4 out.  
**Monitor Amplifiers:** Crown DC 300, Crown DC-150A.  
**Monitor Speakers:** UREI 813 Time-Aligned Altecs, JBL 4311, JBL 4320, Auratones.  
**Outboard Equipment:** Harmonizer, digital delay, 1176, LA3A limiters, Gain Brains, noise gates, flanger, parametric EQ, digital metronome, 140 EMT stereo echo plates, space echo.  
**Microphones:** Neumann U-47, 67, 87, KM-84; AKG 414, 452; 32 Sennheiser 405, 421, 441; E-V RE-15, RE-20; Sony ECM 33.  
**Instruments Available:** New Kawai 6' 8" grand, clavinet, Rhodes, Ludwig drums, M4 Chamberlin.  
**Extras:** Peaceful area but 4 restaurants and liquor store are all within 100 yards.  
**Rates:** Low and negotiable.  
**Direction:** Clean, punchy sound at low prices.



•••• **BRITANNIA**  
3249 Cahuenga Blvd. West, Hollywood, CA 90068  
(213) 851-1244  
**Owner:** Gordon Mills.  
**Engineers:** Greg Venable.  
**Dimensions of Studios:** 45' x 30'.  
**Dimensions of Control Rooms:** 25' x 25'.  
**Tape Recorders:** MCI 24 track; MCI 2 track; MCI 4 track; Nakamichi cassette.  
**Mixing Consoles:** MCI Model 536 computerized, 36 in x 36 out.  
**Monitor Amplifiers:** BGW 1000's.  
**Monitor Speakers:** Custom JBL, Auratones.  
**Outboard Equipment:** Everything.  
**Microphones:** E-V, Neumann, AKG, Shure.  
**Instruments Available:** Steinway B piano, Clavinette, Fender Rhodes, Kimball organ.  
**Extras:** Big lounge with full kitchen.  
**Rates:** \$160/hr at all times, no extra charge for noise reduction.  
**Direction:** We serve the recording industry with the best equipment available.



•••• **THE BURBANK STUDIOS**  
4000 Warner Blvd., Burbank, CA 91522  
(213) 843-6000  
**Record Recording Administrator:** Bill Lazerus.  
**Direction:** Total film and record recording.



•••• **CAN-AM RECORDERS, INC.**  
18730 Oxnard St., Suite 212, Tarzana, CA 91356.  
(213) 342-2626 or 342-7271  
**Owner:** Larry A. Cummins, Lanny Williamson, William Wasson.  
**Engineers:** Lanny Williamson, Larry Cummins, Ron Herara, Mark Wasson.  
**Dimensions of Studios:** 25' x 35' with separate drum booth and vocal isolation booth.  
**Dimensions of Control Rooms:** 20' x 25'.  
**Tape Recorders:** MCI Model JH-24 24 track; MCI (2) Model JH 110A-2 VP 2 track; Nakamichi cassette; Pioneer 1/4 track; Revox A77.  
**Mixing Consoles:** Quad/Eight Coronado with automation, 40 in x 40 out.

**Monitor Amplifiers:** BGW 1000, Crown DC 300, Crown DC 150, Technics 150.

**Monitor Speakers:** Custom design Goodman reference loudspeakers, JBL 4311, Auratones, Koss electrostatic headphones.

**Outboard Equipment:** 28-channels Dolby, EMT 240 Gold Foil reverb, Quad/Eight CPR-16, UREI 1176 comp/lim, Quad/Eight CL22 comp/lim with D'Esser, MXR phaser, MXR flanger, MXR mini-limiter, Delta Labs DDL, Delta Labs Acousti-computer, 16 Quad/Eight effects gates, Orban parametrics, Marshall Time Modulator, Harmonizer, ESE-30 digital timing system, Lexicon Prime Time, RV-10 reverb, EXR Exiter.

**Microphones:** Full array of Neumann, AKG, E-V, Sony and Beyer.

**Instruments Available:** Grand piano, Fender Rhodes 88, ARP String Ensemble, amplifiers, Profit synthesizer.

**Extras:** Artists lounge, plenty of food and drink.

**Rates:** Available upon request.

**Directions:** Take Ventura Fwy. to Reseda Blvd. off-ramp. Proceed north two stop-lights to Oxnard. Turn left, go 2.5 blocks to 18730, turn left to suite 212.



•••• **CANYON RECORDERS**  
11941 Wilshire Blvd., Suite #1,  
Los Angeles, CA 90025  
(213) 479-4466

**Owner:** Ed Lever.  
Call for information and rates.



**CAPITOL RECORDS STUDIO**, Hollywood

•••• **CAPITOL RECORDS STUDIO**  
1750 North Vine Street, Hollywood, CA 90028  
(213) 462-6252

**Engineers:** Studio: David Cole, Hugh Davies, Charles Faris, Don Henderson, Cecil Jones, Bob Norberg, Jay Ranelluce, Mitch Tannenbaum. Disc mastering engineers: Ken Perry, Wally Traugott, Gene Thompson, Jay Maynard, Bill Tennis.

**Dimensions of Studios:** A: 60' x 45' x 25'; B: 33' x 31' x 25' with isolation booth; C: 20' x 20' x 18' with isolation booth.

**Dimensions of Control Rooms:** A: 15' x 20'; B: 33' x 31'; C: 15' x 20'.

**Tape Recorders:** (3) 3M Model 79 24 track; (2) 3M Model 56 16 track; (2) MCI Model JH-110 2 track; (2) Studer 2 track; (2) Ampex Model ATR-100 2 track.

**Mixing Consoles:** A: Quad/Eight 32 in x 16 out; B: Neve/Necam with automated mixdown, 32 in x 24 out; C: Quad/Eight 20 in x 8 out.

**Monitor Amplifiers:** McIntosh, Marantz, Phase Linear.

**Monitor Speakers:** JBL component - Capitol design.

**Outboard Equipment:** Eventide Instant Phaser, SAE equalizers, Eventide DDL/Harmonizers, ITT parametrics, Trident parametrics, Cooper Time Cube, Kepex, UREI 1176 limiters, UREI LA3A limiters, Quad/Eight limiters, dbx, 58-channels of Dolby, Pultec filters, MXR auto flangers, 8 live stereo echo chambers.

**Microphones:** Neumann U-47, U-67, U-87, KM-86, U-48, SM-69; AKG C-24, 414, 452, C-12, D-190, D-202, D-1000; Altec 21, M-51; Sony C-37, 22P, 33P, ECM-51,

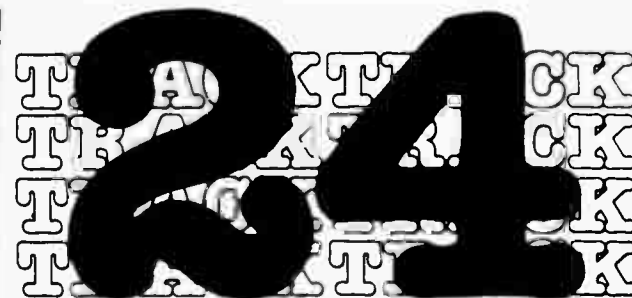

21N; Electro-Voice RE-15, RE-16, 655A, 635A, 666; Shure 545, 548, 81, SM-57, SM-33; RCA 44, 77D; Sennheiser 421.

**Instruments Available:** Fender Rhodes, Hammond B-3 organ with 2 Leslies adaptable for other instruments, 3 Steinway grand pianos, Wurlitzer electric piano, Celeste, vibes (no fee).

**Extras:** Library of sound effects, 8 live stereo echo chambers, studio B has private artists' lounge overlooking the studio. We offer you great service in a relaxed creative atmosphere.

**Rates:** Studio A: \$120/hr. Studio B: \$140/hr. Studio C: \$90/hour.

**Direction:** Complete in-house facility from tracking to mastering with 2 Neve consoles and 2 Neumann SAL 74 mastering systems — both with Studer 2-track playback. We have been chosen by Great American Gramophone Company and others for the major direct-to-disc sessions on the west coast. Superior studio acoustics and the wide variety of equipment available draw clients from all major record labels as well as Capitol. Let us help make your next hit record.



**CHATEAU RECORDING STUDIO**,  
North Hollywood

•••• **CHATEAU RECORDERS INC.**  
5500 Cahuenga Blvd., N. Hollywood, CA 91601  
(213) 769-3700

**Owner:** Stephen R. Jones Pres., Dallas Smith V.P.  
**Engineers:** Ken Scott Producer/Engineer, Independent; Ed Thacker Engineer, Independent.

**Dimensions of Studios:** 30' x 45' with 10' x 15' isolation booth.

**Dimensions of Control Rooms:** 25' x 30'.

**Tape Recorders:** Studer Model A-80 24 track; Studer Model A-80 16 track; Studio Model T.L.S. 2000 Synchronizer 38 track; (2) Studer Model B-67's 2 track; Studer Model A-80 2 track.

**Mixing Consoles:** Trident A Series, 62 in x 24 out.

**Monitor Amplifiers:** Spectra Sonics, tri-amped.

**Monitor Speakers:** JBL, Gauss, Auratones, Visoniks.

**Outboard Equipment:** UREI LA3A's, LA4A's, full Dolby, Trident parametric EQ, Teletronix LA2A's, Kepex, Orban D'Esser, (2) EMT 250's, AKG BX-10, BX-20, etc.

**Microphones:** Neumann U-87's, U-67's, KM-84's; Shure SM-57, SM-56; Sony C-37P; Sennheiser 421's; Telefunken 251; AKG 451, 414; Electro-Voice RE-20.

**Instruments Available:** Hammond B-3 organ with Leslie, Mason and Hamlin grand piano, Harpsichord.

**Extras:** Video games, coffee, refrigerator, microwave.  
**Rates:** \$155/hr 24 track, \$45/hr extra for sync to 38 tracks.

**Direction:** We have recorded such artists as Stanley Clarke, Devo, Dee Dee Bridgwater, Neil Diamond,



# 24

Temptations, Miracles, Dixie Dregs, Jean Luc Ponti, Chick Corea, Sea Wind, Ronnie Laws, and Producers such as Bob Gaudio, Ken Scott, Gary Katz, Wayne Henderson.



**•••• CHEROKEE RECORDING STUDIOS**  
751 North Fairfax Ave., Los Angeles, CA 90046  
(213) 653-3412.

**Owner:** Cherokee, Inc.  
**Tape Recorders:** 3M Model M64 4 track; MCI Model JH24 24 track; MCI Model JH1624 16/24 track; MCI Model JI-100 24 track; Ampex Model 440 2 track; Ampex Model ATR100 2 track; 3M Model 56 16 track.  
**Mixing Consoles:** Trident Model A Series, 36 in x 24 out; Trident Model A Series, 28 in x 24 out; Trident Model TSM, 32 in x 24 out.  
**Monitor Amplifiers:** Crown DC-300, BGW.  
**Monitor Speakers:** Custom JBL and 604.  
**Outboard Equipment:** Digital delay, Harmonizer, Kepex, Pultec EQs, Trident parametric EQ, Orban vocal stessor, UREI LA2A, 3A, 1176 limiter/compressors, phasers, Cooper Time Cube, Lang frequency shifter, Watt Nott product generator, Multi-Sync VSO, Inovonics limiters, and dbx.

**Microphones:** Neumann U-47, U-67, U-87, M-49, KM-83, KM-84, KM-86; Sony C-37, C-37A, ECM 22, E-V RE-20; AKG C60, D202; MKH 415; RCA 44, DX-77, C-12, C-24, C-20; VEGA 8-10; Shure SM-58, SM-53, SM-57; Sony C-500, C-50, ECM 33P, E-V 666, Sennheiser 421, 441, MKH 415, MD 409; Beyer 160.

**Instruments Available:** Electric guitar, bass, Cameo, Premier and Ludwig drums, tympani, chimes, Wur-litzer piano, Rhodes 77 electric piano, Steinway acoustic piano, tack piano, 9 Roland synthesizers.

**Extras:** Various games.  
**Rates:** Please call for rates.

**Direction:** We have recorded albums for numerous artists, some of which include: Rod Stewart, ELO, Bay City Rollers, Art Garfunkel, Jeff Beck, Carmine Appice, Neil Diamond, Bee Gees, Cat Stevens, Pablo Cruise, Ringo Starr, Alice Cooper, Olivia Newton John, Hall & Oates, Franki Valli, Dusty Springfield, Sly Stone, Aerosmith, Marilyn McCoo & Billy Davis Jr., David Bowie, Rick Nelson, Bob Seger, Seals & Crofts, Burton Cummings, Manhattan Transfer, Bobby Womack, Gladys Knight & The Pips, War, Diana Ross, Stephen Bishop, Chic Corea, Angel, Cheap Trick, Joan Baez, Donovan, America, Evonne Elliman, Steely Dan, and many others. We also have done work for films and television including the Sgt. Pepper Lonely Hearts Club Band movie, Starland Vocal Band Special, Jigsaw John, The Wiz, Neil Diamond Special, Rock and Roll Olympics, and several others.



**•••• CITY RECORDING SERVICES**  
1438 North Gower Blvd., Level B,  
Hollywood, CA 90028  
(213) 464-6558

**Owner:** Scott Norton, Larry Dunlap.  
**Engineers:** We use independent engineers, some of which are Wizard, Ed Barton, Taavi Mote, Jim Hilton and more.

**Dimensions of Studios:** 50' x 25'.  
**Dimensions of Control Rooms:** 20' x 12'.

**Tape Recorders:** MCI 24 track; MCI 16 track, 3M 1/2 track; various TEAC's and cassettes.

**Mixing Consoles:** Custom Tangent Model 1632, 28 in x 28 out.

**Monitor Amplifiers:** SAE 2800, SAE 2200, McIntosh.

**Monitor Speakers:** UREI "Time-Align", JBL 4311 (4), Auratones.

**Outboard Equipment:** 27 channels of dbx, full Scamp system (limiters, parametric and shelving EQ, expander gates), Delta Lab DDL, MXR DDL, Harmonizer, Lexicon Prime Time, UREI limiters (1176LN), plate reverb.

**Microphones:** Neumann U-87's, AKG 451's, 414's; E-V RE-20's; Sennheiser 421's; Shure 56's, 57's, 58's; Sony's, others available on request.



**CITY RECORDING SERVICES, Hollywood**

**Instruments Available:** 7' grand piano.  
**Extras:** Lounge, office space available.  
**Rates:** 24 track \$75/hr; 16 track \$55/hr (second engineer included).  
**Direction:** We want our studio to be a place where an engineer, producer, or artist can enjoy working and feel confident that what they hear is both accurate and competitive. We offer the extensive facilities and experience of a major studio and the personal attention to services of a small studio.



**•••• CLOVER RECORDERS**  
6232 Santa Monica Blvd., Hollywood, CA 90038  
(213) 463-2371

**Owner:** Chuck Plotkin (Dan Morehouse and Toby Scott - Co-Managers).

**Engineers:** Toby Scott and Dan Morehouse.

**Dimensions of Studios:** 26' x 23' x 10 1/2'; Isolation booth: 15' x 16' x 10 1/2'; Vocal booth: 5' x 6' x 10 1/2'.

**Dimensions of Control Rooms:** 15' x 15'.  
**Tape Recorders:** MCI Model JH114 24/16 track with Auto-Locator III; Studer Model B67 2 track; Ampex Model 440B 2 track; Revox Model A77 2 track.

**Mixing Consoles:** API/Jensen Model 2844, 24 in x 24 out.

**Monitor Amplifiers:** Phase Linear Dual 500; Crown DC-300; Crown DC-40.

**Monitor Speakers:** UREI Time-Align speakers, Altec 604E's with Mastering Lab crossovers, JBL 4311's, Auratones.

**Outboard Equipment:** Dolbys, DDL, Harmonizer, flangers (2), Marshall Time Modulator, UREI and Teletronics lim/com, EMT PDM 156 lim/com/exp, Kepex, Allison Gain Brain.

**Microphones:** Full compliment of dynamic and condenser mics including many older tube types. Brands: Neumann, AKG, Beyer, E-V, Sennheiser, Sony, etc.

**Instruments Available:** Steinway B grand piano.

**Extras:** Pinball, darts, TV, drinks, nearby stores.  
**Rates:** \$135/hr including engineer (no extra charge for Dolbys or outboard equipment).

**Direction:** Some of the artists that have worked at Clover include Rod Stewart, Andrew Gold, Neil Sedaka, Linda Ronstadt, The Section, Booker T. & the M.G.'s, Average White Band, Manhattan Transfer, and many other. For the future, we plan to expand the size of the control room and add additional monitoring facilities. Also, we are continuing to update machines and equipment to provide the best product for our clients, while maintaining a studio atmosphere enjoyable for making records.



**•••• CONWAY RECORDING STUDIOS**  
655 N. St. Andrews Pl., Hollywood, CA 90004  
(213) 463-2175

**Owner:** Susan and Buddy Brundo

**Engineers:** Peter Chaikin, Denis Degher, Buddy Brundo. Also independents. Chief Maintenance and Design Dan Gwynne/Electro-Media Systems.

**Dimensions of Studios:** 30' x 25' x 18'.  
**Dimensions of Control Rooms:** 30' x 25' x 16'.

**Tape Recorders:** 3M Model 79 24 track; (2) 3M Model 79 2 track; all latest mods and no input transformers.



**CONWAY RECORDING STUDIO, Hollywood**  
Denis Peigher

**Mixing Consoles:** API Model 2432, 32 in x 32 out; all Jensen trans., 65K automation, 8 groupers.

**Monitor Amplifiers:** BGW, Crown.

**Monitor Speakers:** Super Reds, 4311, Auratone, Little David's.

**Outboard Equipment:** UREI 1176, LA3A, LA4A; Cooper Cube; ADR vocal stessor; Harmonizer; Prime Time; Delta 92; Kepex; Gain Brain; D'Esser; digital metronome, parametric EQ, Lang's, live echo, EMT 240 Gold Foil, Marshall Time Modulator, at no extra charge.

**Microphones:** Neumann U-47 & U-67 tubes, U-87, KM-84, KM-88; AKG 414, 452; many Sennheiser, Shure, E-V, Sony, etc.

**Instruments Available:** Steinway B.

**Extras:** Patio and lounge.

**Rates:** Please call.

**Direction:** Bigger, better, and louder.



**•••• CRYSTAL-SOUND RECORDING STUDIOS**  
1014 N. Vine St., Hollywood, CA 90028  
(213) 466-6452

**Owner:** Andrew Berliner: President. John Fischbach: Vice President.

**Engineers:** John Fischbach, Jeff Sanders, James Hill, Charlie Brewer.

**Dimensions of Studios:** 40' x 50' Studio A. Fully adjustable acoustics on walls and ceiling.

**Dimensions of Control Rooms:** Studio A: 27' x 30'. Also 24 track mixdown control room "B".

**Tape Recorders:** Studer tape machines as follows: Model A-80 2 track, Model A-80 disc preview 2 track, Model A-80 24 track, A-80 16 track; Crystalab modified Model A-80 16/24 playback machine; Nakamichi cassette machines.

**Mixing Consoles:** Studio A: Crystal Custom Console, 30 in x 24 out; Studio B: Crystalab Model 2424, 40 in x 24 out; computer assisted digital board with 300 megabyte on line disc storage.

**Monitor Speakers:** Custom with JBL components.

**Outboard Equipment:** Dolby available on all tape machines, (2) EMT 250 digital reverberation synthesizers, (2) Marshall Time Modulators, 18 modules of Scamp devices, also UREI, Teletronix, Audio Design, EMT limiters, EMT 140, AKG BX-10, 2 live echo chambers.

**Microphones:** Selection of over 80 mics including, Neumann, Telefunken, Sony, Sennheiser, Group 128, RCA, Shure, Electro-Voice, AKG.

**Instruments Available:** Yamaha 9' concert grand.

**Extras:** Musicians individual headphone mixing systems. Complete disc mastering facilities with Studer preview machine, Neumann VMS 70/SAL 74 cutting system. Mastering Engineer: Jeff Sanders.

**Rates:** 24 hour by appointment. Please call for rates.



**•••• DALTON RECORDERS**  
3015 Ocean Park Blvd., Santa Monica, CA 90405

**Owner:** Dirk Dalton, Studio Manager: Melody Shepherd.

**Engineers/Producers:** Dirk Dalton, Joel Goldsmith.



# FREE REFERENCE DISC FROM YOUR MULTI-TRACK MASTER

I.A.M. is announcing a new addition, Our Mastering Facility, complete with Neumann cutting system, SX74 cutting head and computer controlled cutting lathe.

Now we know that the only way to appreciate a system like this is to see and use it.

So, in order to get you into our studio, we're putting out the bait.

Simply bring us your multi or two track master and we'll cut a reference disc for you. **ABSOLUTELY FREE.** No strings attached.

And once we've reeled you in, you might want to take a look at our 40 track fully automated recording studio and our broadcast and industrial video facilities.

Just fill out the coupon below requesting your **FREE** reference disc, or better yet, get on the line and ask for Skip Konte. Either way, do it now.

Because once you're here, we've got you hooked.



**I'm no fish, but**

I'll go for this hook, line and master

Have your representative call for an immediate appointment

I'd like to wait a while, but send me your brochure and rate information

Name \_\_\_\_\_

Company \_\_\_\_\_

Street \_\_\_\_\_

City \_\_\_\_\_

State \_\_\_\_\_ Zip \_\_\_\_\_ Phone \_\_\_\_\_

To: International Automated Media 17422 Murphy Ave., Irvine, CA 92714 (714) 751-2015





# 24



**DALTON RECORDERS**, Santa Monica  
Joel Goldsmith — Staff Engineer/Producer  
Melody Shepherd — Studio Manager



Christine McVie (of Fleetwood Mac) and Cheryl Tiegs pause outside control room

**Dimensions of Studios:** 30' x 20' with 10' x 8' isolation and 10' x 10' keyboards room. Rehearsal studio 20' x 14'.  
**Dimensions of Control Rooms:** 20' x 10'.  
**Tape Recorders:** Ampex MM1100 24 & 16 track, (with dual remotes, auto locator, and readable step-calibrated VSO); Ampex Model ATR-100 2 track; Revox Model A-700 2 track; Revox Model A-700 4 track; Tandberg Model 9200 GX 4 track; Nakamichi Model 1000 cassette; Tandberg TCD 300 cassette, Panasonic RS 803 cart.  
**Mixing Consoles:** Sphere 3424 custom console, 34 in x 24 out, transformerless, 18 freq. EQ, switchable peak or VU level metering on all busses via Audio Designs Vue-Scan.  
**Monitor Amplifiers:** Crown.  
**Monitor Speakers:** Tannoy (dual 15" bi-amped and equalized flat), JBL 4311, Auratone.  
**Outboard Equipment:** Orban/Parasound parametric EQ, Eventide Harmonizer/DDDL, Dolby and dbx noise reduction (26 channels), UREI and Allison limiter/compressors, Systems Technology stereo phaser, Koss electrostatic headphones, AKG stereo chambers, Systems Technology Flanger, Allison Kepex's, Roland 301 chorus/echo, Ivie spectrum analyzer, etc.  
**Microphones:** AKG 414's, 452's; Neumann 87's, 47's,

84's; Sennheiser 421's, 441's; Shure 57's, etc.  
**Instruments Available:** Rhodes, Wurliizer (electric), Mini Moog, Yamaha CS-80, Orchestrator, Hammond with Leslie, pianet, harpsichord, Mini-Korg, superb 9' concert grand piano, Rhodes key bass, Fender P. Bass, Strat., Les Paul, Ovation, complete 12 pc. drum set, numerous amps, PA, pedals (all sorts), percussion, Korg tuner, etc.  
**Extras:** Pinball, soft drinks, free beer, television, pong, catered meals, accomodations and travel arrangements. Deluxe rehearsal studio. Complete contemporary music store in same building with studios. Complete repair service.  
**Rates:** Recording, mixing, dubbing, editing, playback, including engineer and basic outboards: \$110/hr. Block contracts available. Rehearsal: \$30/day, \$150/week, \$500/month.  
**Direction:** We strive to put on tape the cleanest, most commercial sound possible, whether we're recording pop, rock, jazz, or film scores. Every member of the staff has had at least 15 years of individual experience in the music recording and performing fields. We live and breathe music and sound. Our clients have included CBS, Warner Bros., ABC, Motown, and other fine labels, with artists including Jose Feliciano, Shaun Cassidy, The Beach Boys, Van Morrison, and others. Upcoming developments: automated mixdown/mastering suite, video lock-up to facilitate scoring and Foley, etc., Melody, our delightful traffic officer and studio manager, is happy to answer further questions anytime.



**•••• DAWNBREAKER RECORDING STUDIO**  
216 Chatsworth Dr., San Fernando, CA 91340  
(213) 361-1283  
**Owner:** L. Shelton and J. Bogan.  
**Engineers:** Chief Engineer: Joe Bogan. Engineers: Thom Wilson, Kelly Kotera. We welcome independents.  
**Dimensions of Studios:** 35' x 37' x 14'.  
**Dimensions of Control Rooms:** 35' x 30' x 12'.  
**Tape Recorders:** Studer/Revox Model A-80 24 track; Ampex Model ATR-100 Electro Sound 2 track; Nakamichi Model 700 cassette.  
**Mixing Consoles:** Helios English custom designed, 32 in x 24 out.  
**Monitor Amplifiers:** Great American Sound.  
**Monitor Speakers:** JBL custom designed dual woofer Quad System, Altec 604's with Mastering Lab crossover, JBL 4311's, 4301's, Auratones and Visoniks.  
**Outboard Equipment:** UREI LA3A's, UREI 1176 limiters, UA 175, Spectra Sonics 610 Complimiter, UREI 550 filter, UREI 527-A EQ, Eventide 1745 DDL, Eventide Digital Delays, Harmonizer, flanger, phaser, Allison Kepex and Gain Brain, Technics EQ, ITI EQ, Pultec and Lang EQ, Orban D'Esser, Aphex Aural Exciter.  
**Microphones:** Neumann U-47, KM-86, KM-88, U-87; AKG 414, 412, 224-E, 451; Beyer 360, M-260, M-500; Sony C-37, C-500, ECM-22; Shure SM-57, SM-7; Sennheiser 416, 421; RCA DX-77, 44; Pearl DC-63.  
**Instruments Available:** Ludwig 5-piece drum, Yamaha C-7 grand piano, Fender Rhodes, Hohner clavinet D6, RMI 368X electric piano, ARP Odyssey synthesizer, Fender Princeton reverb, Gretsch Pro Bass 6170, Roland Ensemble. There is no extra charge for instruments.  
**Extras:** Viewing loft above studio, comfortable lounge with TV and pinball, outdoor patio with plants, flowers and trees.  
**Rates:** \$150/hr (includes 2nd engineer). Block rates available.  
**Direction:** Dawnbreaker is two years old. Our projects include artists such as: Rufus/Chaka Khan, Seals & Croft, Maureen McGovern, Allesi Bros., Lindis Farme, Bell & James, Cafton & Majors, Detective, England Dan & John Ford Coley, Art Garfunkle, The Jacksons, John Klemmer, Moir Sisters, Jennifer O'Neill, Juice Newton, Paul Parish, Prisoner, Lee Ritenour, Norman Fillitt, and Cory Welles. We have also served Hanna Barbera, Memorax Corp., and Don Kirshner. Future plans include a second studio.



**•••• DEVONSHIRE SOUND STUDIOS**  
10729 Magnolia Blvd., N. Hollywood, CA 91601  
(213) 985-1945  
**Owner:** David K. Mancini.  
**Engineers:** Ron Malo, Jerry Hudgins, Russell Schmitt, Maurice Leach.  
**Dimensions of Studios:** Studio 4: 60' x 45'.  
**Dimensions of Control Rooms:** Studio 3: 40' x 20'.  
**Studio 4:** 24' x 15'.  
**Tape Recorders:** (3) MCI Model Jh-114 24 track; MCI Model 110 4 track; (4) MCI Model 110 2 track.  
**Mixing Consoles:** Room 4: MCI Model 500 automated, 38 in x 32 out; Room 1: MCI Model 428, 28 in x 24 out; Room 2: MCI Model 416, 24 in x 24 out.  
**Monitor Amplifiers:** Phase Linear 700B.  
**Monitor Speakers:** UREI Time-Align, E-V Sentry III, Altec 604.  
**Outboard Equipment:** Eventide DDL, Flanger, Harmonizer; UREI peak limiters, Dolby and dbx.  
**Microphones:** Neumann U-87; E-V RE-20, DS-35; AKG 452, 414; RCA 77-DX; Sennheiser 421.  
**Instruments Available:** B-3, Rhodes, Yamaha grand, Polymoog, clavinet, tack piano, string ARP.  
**Extras:** 3 live echo chambers.  
**Rates:** \$125 to \$160/hr including engineer.  
**Direction:** Our 4th 24 track room will be finished in 4 months. We can do 48 track also. We have just completed Weather Report's "Mr. Gone" album. We have also done their last three albums. We have just completed the Beach Boys new single not released yet. Just finished Maxine Nightengale.



**•••• DOCTOR MUSIX RECORDING STUDIOS**  
6715 Melrose Avenue, Hollywood, CA 90038  
(213) 930-2501  
**Owner:** Peter and Cynthia Hirsh.  
**Engineers:** Peter Howard Hirsh.  
**Dimensions of Studios:** Room 1 which is divided into 4 separate areas: Main section of studio, drum booth, isolation booth, piano area.  
**Dimensions of Control Rooms:** Room 1.  
**Tape Recorders:** Stephens Electronics Model 821, A/104 w/16 track and 24 track heads; Studer Model A80 RC/2/2 2 track; Ampex 440G 2 track; TEAC Model 3300 SX 1/4 track.  
**Mixing Consoles:** Speck Electronics Model SP 800 C 200, 32 in x 16 out.  
**Monitor Amplifiers:** Crown DC 300; (2) Crown D-150 A; (2) Crown D75; Crown D60.  
**Monitor Speakers:** Bi-amped JBL 4333A's (AWX) with Crown VFX 2R crossover network, JBL 4315 in studio for playback, JBL 4311 on console, JBL 4301 E on console and Auratone Cubes.  
**Outboard Equipment:** Eventide DDL w/Harmonizer, AKG BX 10 E stereo echo, 8 Kepex, 2 UREI 1176 LN limiters, 3 types of tape delay and live echo chamber.  
**Microphones:** AKG C-414 EB's, 451E's, 452 EB's; RCA D77 SX's; Shure SM-56's, 57's, SM-81, SM-58, SM-59; Sennheiser MD-402-U's, MD 421-U, 441; E-V RE-20; Sony CP-37A; Neumann U-87.  
Please note that all equipment used in our studio is brand new as we have been open at our present location only since Sept. '78.



**Instruments Available:** Yamaha concert grand, pair of congas.  
**Extras:** We are still under construction, but our plans consist of 2 recording studios and 1 sweetening O.D. mix room, lounge, kitchen, Jacuzzi and conference room all will be completed by Dec. '79.  
**Rates:** Please phone information regarding rates (213) 930-2501.  
**Direction:** The new room which is just being completed, second room completed by August '79 with mixing room soon to follow. We plan to make our second room 32 track or multiple thereof as soon as they decide where the industry is at, I hope they decide soon. We feel that a comfortable atmosphere is important so we will try to provide what will keep the producer and independent engineer and producer working at their top form.

**•••• ELDORADO RECORDING STUDIO**  
1717 N. Hollywood, CA 90028  
(213) 467-6151  
**Owner:** Studio Manager: Nadya Gordonrae-Bell.  
**Engineers:** John Cevetello, Bill Dashiell, Toni Greene, M. Squeaky.  
**Dimensions of Studios:** Large room: 26' x 30', plus vocal/string room 11' x 20'.  
**Dimensions of Control Rooms:** 18' x 20' and 10' x 14' cutting room with Neumann lathe.  
**Tape Recorders:** Ampex Model MM1100 16-24 track; Ampex Model ATR 100 2 track; Ampex Model 440 8 and 2 track; Scully 4 track; Ampex Model 351 mono; TEAC Model 3340 4 track; TEAC Model A-170S cassette.  
**Mixing Consoles:** Cevetone custom console, 28 in and 24 out.  
**Monitor Amplifiers:** McIntosh 200's, 100's, 75's.  
**Monitor Speakers:** Altec 604's, Mastering Labs



# Music Annex announces the opening of studios B and C.

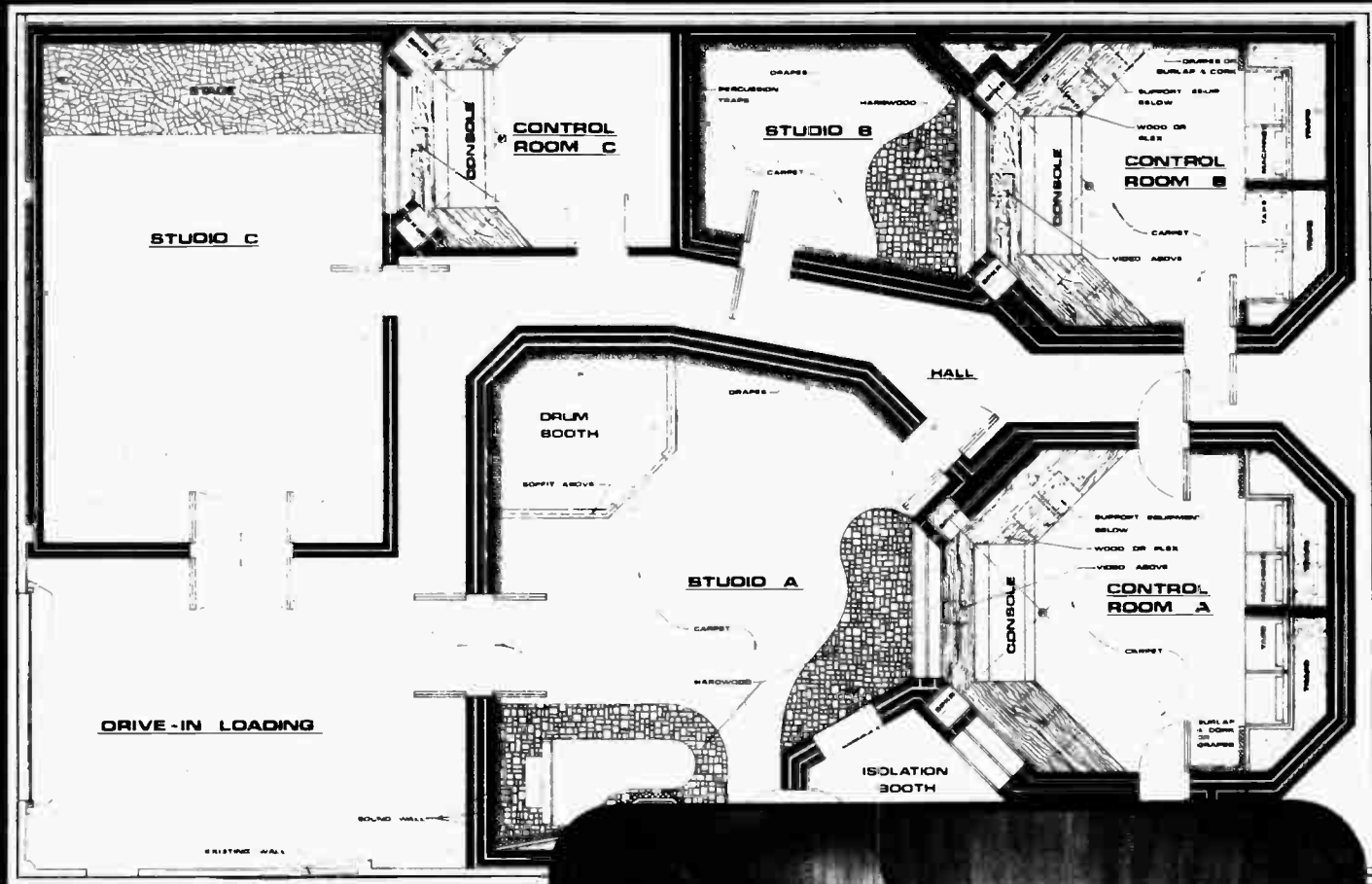

Music Annex now has four great rooms in the Bay Area: Studios A, B, and C located near Highways 84 and 101 in Menlo Park, and our Cowper Street studio in Palo Alto. Call (415) 328-8338 for rates.



MCI 16/24 track • Amek 28/24 consoles  
Studios designed by Everything Audio



Music Annex Recording Studios

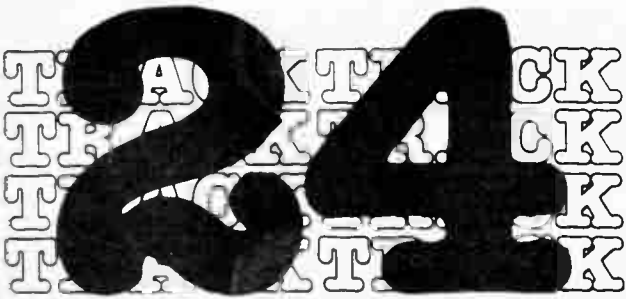

crossovers, Big Reds.

**Outboard Equipment:** Eventide Harmonizer Eventide Digital Delay, Eventide Phaser, Eventide Flanger; Cooper Time Cube; sibilance control; digital metronome; AKG echo; Kepex; Gain Brain; parametric EQ; Lang EQ; UREI Teletronix, LA3 limiters, LA2A limiters, 1176 limiters, 176 limiters; Omnipressor; Allison automated programmer; Cevetone Energizer.

**Microphones:** E-V RE-20, 666; AKG C-12, 451E; Telefunken 251; Beyer 160; Sony ECM 250, C-37, 22P; Shure 546, 57, SM-58; Altec 650B; Sennheiser 451, MKH 41ST; Neumann U-47; RCA 44BX; Technics 385DE, 3550E.

**Instruments Available:** Steinway grand piano, Hammond B-3 organ with Leslie, ARP Odyssey, (clavinet on notice).

**Extras:** Best pizza in town at Fred's around the corner served by the prettiest female engineers in the industry.

**Rates:** Call — Block rates available.

**Direction:** It has been said by many New York based producers, who fly in to record in our studio, that they feel at home as it reminds them of a New York operation. Rightfully so, as this is where it all began for us. Many top groups from Europe and Japan also enjoy recording at Eldorado, and now with the completion of the Cevetone Energizer, and the addition of it to our outboard equipment, we can now boast that we are second to none.



•••• ELEKTRA SOUND RECORDERS

962 N. La Cienega Blvd., Los Angeles, CA 90069  
(213) 655-8280



•••• THE ENACTRON TRUCK

Enactron Studios, Inc.

\*also REMOTE RECORDING\*

5102 Vineland Ave., N. Hollywood, CA 91601  
(213) 761-0511

**Owner:** Brian Ahern.

**Engineers:** Stuart Taylor, Donivan Cowart, Lon Neuman.

**Dimensions of Studios:** Studios in home base, overdub room in truck, full set of baffles for location recording.

**Dimensions of Control Rooms:** 40' x 8' truck.

**Tape Recorders:** Stephens 24 track; Scully Model 280-18 1/2 track; Sony Model TC-850 1/2 track; Akai Model GXC 760D 3-head cassette.

**Mixing Consoles:** Neve, 28 in x 16 out; Yamaha Model PM-1000, 16 in x 4 out.

**Monitor Amplifiers:** Bryston Pro 2.

**Monitor Speakers:** Klipsch (Belle and La Scala), Advent, Auratone.

**Outboard Equipment:** 2 x 13 x 20 reverb, Dolby A361, Eventide DDL, Pultec mid-range, dbx compressors, Orban D'Esser, UREI graphic EQ, UREI filter set, closed circuit TV system, two cameras, 4 monitors.

**Microphones:** We have a selection of 50 microphones, including Neumann, PML, AKG, Reslo, E-V, Shure, Sennheiser.

**Instruments Available:** Amps, piano.

**Extras:** Ping-pong, basketball & net, kitchen.

**Rates:** Remote: approximately \$2800 per day (cost for each gig is figured individually). Home Base: \$150/\$135/hr.

**Direction:** A recording studio on wheels that offers more than many studios and the ability to turn any location into a comfortable recording situation are the main features... but we don't stop there. We can continue the process down to the delivery of the final mix with the highest quality sound. Also, we are currently constructing a new studio (this one's not on wheels). Major credits: Emmylou Harris (all albums), Barbara Streisand "A Star is Born", Bob Dylan, Jesse Winchester, The Band "The Last Waltz", Jonathan Edwards, Quincy Jones, Mary Kay Place, Willie Nelson, Bette Midler "The Rose", plus many others.

•••• EXCALIBUR STUDIOS

11324 1/2 Ventura Blvd., Studio City, CA 91604  
(213) 761-0759

**Owner:** Steve Singer, John Hoier.

**Engineers:** John Hoier, Tony Rockcliff, and other independents.

**Dimensions of Studios:** 30' x 25'; isolation booth 10' x 10'.

**Dimensions of Control Rooms:** 17' x 17'.

**Tape Recorders:** MCI (new, with Quior and auto-locate) Model JH-16 24 track; Tascam Model 80-8 8 track; Revox 1/2 track; TEAC Model 7030 GSL 1/2 track; Sony Model TC-640B 1/4 track; various cassette recorders; MCI 2 track.

**Mixing Consoles:** Quantum QA 3000, 24 in x 16 out.

**Monitor Amplifiers:** BGW 500, 'sae 300, SAE 50, Crown D-150.

**Monitor Speakers:** Altec 604E with Mastering Lab crossovers, JBL 4311's.

**Outboard Equipment:** Eventide Clockworks Harmonizer, AKG BX-10, graphic EQ, UREI LA3A limiters, etc.

**Microphones:** Neumann U-47, U-87's; AKG C-12, C-61's, Sony P-37's; Electro-Voice, Shure, etc.

**Instruments Available:** Yamaha grand, Fender Rhodes, Univox Mini-Korg K2, numerous percussion pieces.

**Extras:** Private outdoor patio, close to stores and good food.

**Rates:** \$50/hr. Quantity High-speed and one-to-one cassette and tape duplicating — call for rates.

**Direction:** We have a winning combination of friendly, talented people and a safe, comfortable space. We offer a truly hassle-free, relaxed and creative atmosphere. Natural woods, deep pile carpeting, cozy corners to curl up in, or a secluded outdoor patio to unwind in; track lighting in all the colors of the rainbow to create your own personal mood — it's the next best thing to recording in your own home. Nestled in the foothills of Studio City, Excalibur is just minutes from fine hotels and restaurants, shops and major television and film facilities. Our final product isn't just a perfect tape, it's a customer who is totally satisfied with the complete realization of his creative vision.



•••• FIDELITY RECORDING STUDIO

4412 Whitsett Ave., Studio City, CA 91604  
(213) 985-3800

**Owner:** Artie Ripp.

**Engineers:** Chief Engineer: Joel Soifer. Engineers: Larry Elliott, Boris Menart. Studio Coordinator: Lisa Marie.

**Dimensions of Studios:** Studio A: 17' x 30' plus 3 isolation booths; Studio B: 25' x 25' plus 3 isolation booths.

**Dimensions of Control Rooms:** Studio A: 15' x 15', Studio B: 10' x 12'.

**Tape Recorders:** Ampex Model MM1200 16-24 track; 3M Model M79 16 track; Ampex Model ATR-100 2 track; Inovonics Model 375 2 track; Otari Model MX 5050 2 track; Tandberg Model 330 cassette; Nakamichi Model 550 cassette.

**Mixing Consoles:** Aengus custom non-transformer, 24 in x 50 out; Quantum custom non-transformer, 24 in x 24 out.

**Monitor Amplifiers:** Phase Linear 700B, Crown DC 300, McIntosh 2105.

**Monitor Speakers:** UREI Time-Aligned monitor system, Altec 604E, Auratone.

**Outboard Equipment:** 24 track Dolby; EMT 250 echo unit; EMT-TS140 echo plate; AKG BX20E echo chamber; Marshall Time Modulator; Eventide Harmonizer and DDL; Audio Design vocal stressor, 8 Roger Mayer noise gates; 2 UREI LA3A limiters; 4 UREI 1176 limiters; Roger Mayer stereo limiter; Teletronics LA2A limiter; 24 B&B parametric equalizers; 12 Aengus graphic EQ; 4 Melcor SME20 EQ; Melcor GME20 EQ; 3 Pultec EQ; 2 AP EQ; Aphex VCA mixdown.

**Microphones:** KM-56's; Neumann U-87's, U-67, U-64, U-47; AKG 414EB's, C-60's, C-12's; Shure SM-56's, SM-57's; Sony C-37's, ECM 22P's, C-500's; RCA 77DX; Electro-Voice RE-20's, RE-15's; Sennheiser 421, 441MD's; ECM 250's.

**Instruments Available:** Hammond B-3 organ with Leslie, Mason & Hamlin grand piano, Yamaha electric grand, upright tack piano, Ampeg B-15 bass amp, ARP String Ensemble, Fender Super Reverb guitar amp, Fender Rhodes electric piano.

**Rates:** A: 24 track \$125/hr, 16 track \$100/hr, both include engineer, Dolbys and all outboard equipment. B: 24 track \$75/hr, 16 track \$50/hr, both include engineer.

**Direction:** The cleanest, punchiest sound ever can now be yours at Fidelity Recording Studio. Three years' work has gone into developing

the console to give you this sound. And, this technology has been extended to every piece of equipment in use at Fidelity Recording Studio. One of the major electronic concepts of our studio is that it is totally transformerless. Add to this a combination of parametric, graphic and detent equalization plus UREI Time-Aligned monitors and a flat no coloration control room and you have a sound that cannot be improved upon. Come to Fidelity Recording. We'll be happy to meet you and let you hear for yourself.



•••• FIFTY-FOUR EAST SOUND RECORDERS

54 East Colorado Blvd., Pasadena, CA 91105  
(213) 681-9892 and 796-5630

**General Manager:** D. McWhorter

**Engineers:** Fred Mitchell-Head, Four available.

**Dimensions of Studios:** 36' x 30' x 12'.

**Dimensions of Control Rooms:** 20' x 20' x 12'.

**Tape Recorders:** Ampex Model 1200 Series (search to cue) 24 track; Ampex 1100 Series 16 track; Ampex Model ATR-100 Series 2 track; TEAC (industrial model) 1/4 track; Kenwood Model 1030 SD cassette.

**Mixing Consoles:** API Automated with VCA grouping (custom), 44 in x 40 out; (Mini mag for tape machine sync).

**Monitor Amplifiers:** BGW.

**Monitor Speakers:** Custom design, bi-amped JBL's, JBL 4311 and Auratone (for control room), JBL for studio playback.

**Outboard Equipment:** dbx, UREI limiters, digital delay line, phaser, flanger, graphic equalizers, Lang equalizers, 2 live chambers, 2 Spring, Dolby available.

**Microphones:** AKG, Neumann, Sennheiser, Sony, Electro-Voice, Shure, Beyer.

**Instruments Available:** Baldwin grand, Hammond organ, Fender Rhodes.

**Extras:** Kitchen area for snacks.

**Rates:** 40 tracks \$115/hr; 24 tracks \$95/hr; 16 track \$95/hr. Minimum 4 hour booking. Rates include 1 second and 1 staff engineer.

**Direction:** We are still dedicated to the creative processes of the state of the art recording and cater to the independent producer and engineer. All rates are subject to change.



FILMWAYS/HEIDER RECORDING, Hollywood  
Terry Stark, President

•••• FILMWAYS/HEIDER RECORDINGS

\*also REMOTE RECORDING\*

1604 N. Cahuenga Blvd., Hollywood, CA 90028  
(213) 466-5474

**Owner:** Filmways, Inc., Century City, CA., President: Terry Stark.

**Engineers:** Biff Dawes, Grover Helsley, Jimmy Hite, Peter Granet, Mic Leitz, Phil Cross (disc mastering).

**Dimensions of Studios:** A: 50' x 75'; B: 50' x 75'; C: 24' x 36'; 1: 9' x 24'; 3: 15' x 31'; 4: 32' x 39'; 5: 16' x 18'; 7: 12' x 17'.

**Dimensions of Control Rooms:** A: 19' x 33'; B: 18' x 29'; C: 18' x 23'; D: mixdown 15' x 25'; 1: 12' x 15'; 3: 19' x 19'; 4: 18' x 19'; 5: 16' x 18'; 7: 10' x 10' and two remote trucks.

**Tape Recorders:** Ampex Model MM1100/MM1200 24 track; 3M Model M56 16 track; Ampex Model 440





8 track; Ampex Model 440 2, 4 track and mono; 3M Model 79 24 track; Magnasync Model 3000 3 track; Sony 1/4-inch video tape rec. Model VO 2850 2 track; Sony 1/4-inch video tape player Model VP 2000 2 track.

**Mixing Consoles:** Neve 32 in x 24 out; API 32 in x 24 out; DeMedio 32 in x 24 out.

**Monitor Amplifiers:** McIntosh 2100, Twin 75; Yamaha P2200; Phase Linear 700B.

**Monitor Speakers:** UREI 838 Time Align; Altec 604 (C thru E); Truesonic 15-inch; Mastering Lab crossover; portable speakers; JBL 4311; Auratone, etc.

**Outboard Equipment:** Parametric EQ's, Eventide Instant Phaser; Kepex; D'Esser, Cooper Time Cube, Ampex VSO's, Gotham delay, Neve limiters, Dolby's, (single and 24-track); Eventide Digital Delays; EMT Echo; Harmonizers, live echo chambers.

**Microphones:** RCA 44's, 77's, BY5's; Neumann U-87's, U-47 RET's, U-47 tube, U-67's, KM-84's; AKG C-414, C-451; Beyer Dynamic M-500, M-250; Shure SM-53, SM-54, SM-56, SM-57, SM-58, SM-59, SM-7, SM-82; Electro-Voice 635A, DE-11, DE-15, DE-20; Sony C-37 FET, EMC 377, C-500.

**Instruments Available:** 5 Steinway grands and 1 Yamaha grand.

**Extras:** Pool table, ping-pong, pinball, electronic games, microwave, lounges.

**Rates:** Please call for rates.

**Direction:** Filmways/Heider is the largest independent recording studio complex in the United States, with the finest of equipment, studios and remote facilities. As originators of the rock and roll studio concept, we understand the questions and needs of the *Neophyte*. We haven't always been the largest, but we've always been the first and the best. That's the way it's been and that's the way it will be.



**\*\*\*\*\* GOLDEN AGE RECORDER**  
9733 Culver Blvd., Culver City, CA 90230  
(213) 559-6058

**Owner:** Golden Age Recorders Inc.

**Engineers:** Carl Lange.

**Dimensions of Studios:** 14' x 30'.

**Dimensions of Control Rooms:** 10' x 12'.

**Tape Recorders:** Stephens W/VSO 24 track; Scully Model 280B 2 track; Otari Model MX-5050 2 track; Akai Model 6X640, 1/4 track; Nakamichi Model 700II cassette.

**Mixing Consoles:** Amek Model M2000, 28 in x 24 out.

**Monitor Amplifiers:** Ampzilla 150, BGW 750.

**Monitor Speakers:** Little Reds, JBL 4315's, JBL 4311's, Little Davids, Auratones.

**Outboard Equipment:** 28 channels dbx, EMT 240 Gold Foil chamber, Eventide Harmonizer, MXR digital delay, Audio Designs compex-limiters, dbx 160 limiters, Scamp parametric EQ, Scamp ADT flangers, Scamp expander gates, Scamp compressors, MXR Phaser and Flanger.

**Microphones:** Neumann U-87's; AKG 414's, 451E's; Sennheiser 441U's, 421U's; E-V CS-15's; Shure SM-57's.

**Instruments Available:** 6' Kawai grand piano, Rodger's drums, Gibson Les Paul, Martin D-24, Fender Precision Bass.

**Rates:** \$100/hr.

**Direction:** We have just completed a total studio and control room renovation. Acoustic design was done by Jeff Cooper. The esthetic treatment of our room has been tailored to keep in our direction of catering to sensitive, new age, and spiritually oriented artists. We've created a beautiful atmosphere of rich oak wood and plush velvet to record in. The main area of the studio also has a large custom stained glass sky light, which provides a truly unique atmosphere. We are also awaiting the arrival of the new Amek automated update module to automate our board in early spring.



**\*\*\*\*\* GOLDEN SOUND STUDIOS**  
7000 Santa Monica Blvd., Hollywood, CA 90038  
(213) 464-7747

**Owner:** Norman Ring

**Engineers:** Paul Ring, Richard Perrotta.

**Dimensions of Studios:** Live room 35' x 20' with Producers' elevated observation tower, 18' x 12', with full communication.

**Dimensions of Control Rooms:** 24' x 18'.

**Tape Recorders:** 3M Model 79 24 track; Studer Model A80 2 track; Ampex Model ATR 100 2 track; Studer Model A700 2 track (2) Revox Model A77 1/4 track; JBC, Technics cassettes.

**Mixing Consoles:** Harrison Model 3232, 32 in x 32 out.

**Monitor Amplifiers:** JBL's, BGW, Crown.

**Monitor Speakers:** UREI Time-Aligned, Auratones,

JBL 4311's.

**Outboard Equipment:** Harmonizer, Eventide DDL, Audio & Design Compex limiter, A & D vocal stressor, UREI 1176 limiters, LA3A, LA4A limiters, 24-channels dbx, live echo chamber, EMT 140 plate, Kepex's.

**Microphones:** Everthing including old RCA 44's & 77's.

**Instruments Available:** 9' Yamaha grand.

**Extras:** Completely equipped broadcast quality video rooms, lounge and kitchen facilities.

**Rates:** Please call for rates.



**\*\*\*\*\* GOLD STAR RECORDING STUDIOS, INC.**  
6252 Santa Monica Blvd., Hollywood, CA 90038  
(213) 469-1173

**Owner:** Dave Gold, Stan Ross.

**Engineers:** Stan Ross, Dave Gold, Jerry Napier, Bruce Gold, Ed Epstein, Don Snyder, Larry Levine, Rick Uro.

**Dimensions of Studios:** A: 25' x 35'. B: 26' x 44' with 15' x 14' isolation booth. Annex 8' x 12' booth.

**Dimensions of Control Rooms:** A: 13' x 20'. B: 15' x 25'. Annex: 16' x 18'.

**Tape Recorders:** (2) Ampex Model MM 1200 24 track; Ampex Model MM 1100 16 track; Scully Model 280 8 track; Scully Model 280B 4 track; Scully 280B 2 track; Technics Model 1506 1/4 track; Nakamichi Model 700 & 1000 cassette deck.

**Mixing Consoles:** A: Gold Star custom design, 24 in x 24 out. B: Gold Star custom design, 28 in x 24 out.

**Monitor Amplifiers:** McIntosh.

**Monitor Speakers:** Altec 604E custom design.

**Outboard Equipment:** 4 live acoustic echo chambers, EMT stereo plate echo, Eventide DDL, Harmonizer, Flanger; Kepex's; UA digital metronome; Orban parametric EQ; UREI 1176 limiters; UA 177 tube limiters; DSG 1050 limiters, Dolby, dbx.

**Microphones:** A selection of over 100 - AKG C-414EB, 202E, 1000E; Electro-Voice DS-3E, RE-15, RE-20, 666; PML DC-63; RCA 44, 77, 74B; Neumann M-49, U-47, U-48A, U-67, U-87; Sony C-37A, C-37FET, C-500, ECM 22P, ECM 50, ECM 377; Shure SM-53.

**Instruments Available:** 2 Steinway grand pianos, Hammond B-3 organ, Conn Theater Ensemble, tack piano, Celeste.

**Extras:** Annex - Narration studio (commercials), disc mastering - Neumann/Westrex 3D11A.

**Rates:** Studio A: 8 track \$70/hr, 16 track \$90/hr, 24 track \$110/hr. Studio B: \$135/hour with all outboard equipment. Annex \$45/hr.

**Direction:** Gold Star continues with it's tradition of consistently innovative recording of superb quality which has been the foundation of our fine reputation for the past 28 years.



**\*\*\*\*\* GROUP IV RECORDING**  
1541 N. Wilcox Ave., Hollywood, CA 90028  
(213) 466-6444

**Owner:** Angel L. Balestier, Dennis S. Sands.

**Engineers:** Angel L. Balestier, Dennis S. Sands.

**Dimensions of Studios:** 1600 sq. ft. (accommodates up to 60 musicians).

**Dimensions of Control Rooms:** 450 sq. ft.

**Tape Recorders:** MCI Model JH-100 24 track; MCI Model JH-100 4 track; (2) MCI Model JH-110 2 track; Studer 2 track.

**Mixing Consoles:** Trident Model A, 32 in x 24 out.

**Monitor Amplifiers:** Marantz 240, Marantz 510 (bi-amped system).

**Monitor Speakers:** JBL 4350 (quad) 4311, various small speakers.

**Outboard Equipment:** dbx, Marshall Time Modulator, EXR, Dolby, DDL, Kepex, Orban/Parasound D'Esser, flanger, Cooper Time Cube, Omnipressor, Harmonizer, EMT Gold Foil chamber, video monitoring system, 35 mm high speed forward, reverse sync pulse 59.94, 60 CPS.

**Microphones:** Large selection list upon request.

**Instruments Available:** Tack piano, Rhodes 73, ARP Omni, 9' concert grand Steinway piano, CS80.

# Free Script subscription

SINGLE ISSUE PRICE \$2.00

ONE YEAR \$12.00

Send Check or Money Order to:

The Mix  
P.O. Box 6395  
Albany Branch  
Berkeley, CA 94706

name		
company name		
address		
city	state	zip



# T 24 CK

**Extras:** Spacious kitchen and instrument holding area.  
**Rates:** Weekdays 9:00 AM - 6:00 PM \$160/hr.  
 6:00 PM - 12:00 MID \$170/hr. 12 MID - 9 AM  
 \$180/hr. Weekends and holidays \$200/hr anytime.  
**Direction:** Our growth plans include two additional studios.



•••• **HERITAGE STUDIOS**  
 1207 N. Western Ave., Los Angeles, CA 90029  
 (213) 466-3244

**Owner:** Windt Audio, Inc.  
**Engineers:** Freelance.  
**Dimensions of Studios:** 35' x 24' x 14'.  
**Dimensions of Control Rooms:** 17' x 15' x 13'.  
**Tape Recorders:** MCI 16-24 track; MCI 2 track;  
 TEAC Model 3340S 4 track.  
**Mixing Consoles:** Custom.  
**Monitor Amplifiers:** Yamaha P-2200, Crown DC-300,  
 McIntosh MC-250.  
**Monitor Speakers:** Modified Altec 604E's, Auratones.  
 JBL 4320's in studio.  
**Outboard Equipment:** LA2A, 117 LM-UREI, Trident  
 parametric EQ's, Eventide digital delay line, Kepex,  
 dbx, Dolby, EMT-240, and live echo chamber and  
 vocal (isolation) booth.  
**Microphones:** Neumann U-87's, U-47; Sennheiser  
 442's; AKG 451's; Electro-Voice RE-15's, RE-20's;  
 Sony C-22's; Shure SM-58's, SM-57's.  
**Instruments Available:** Steinway grand piano, Ham-  
 mond B-3 organ.  
**Extras:** Lounge with coffee, tea, pop machine, and  
 Arrowhead water.  
**Rates:** \$125/hour. All equipment included — no  
 extra charges.  
**Direction:** We are a first-class, professional studio  
 with a relaxed, down-home atmosphere.



•••• **HOLLYWOOD CENTRAL RECORDING**  
 1538 Cahuenga, Hollywood, CA 90028  
 (213) 463-2131

**Owner:** Jack Lees, John Rhys.  
**Engineers:** Jack Lees, John Rhys, Reed Stanley.  
**Dimensions of Studios:** 40' x 20'.  
**Dimensions of Control Rooms:** 18' x 15'.  
**Tape Recorders:** 3M Model 79 24 track; Studer  
 Model B67 2 track, Ampex 2 track.  
**Mixing Consoles:** DeMedio, 32 in x 24 out.  
**Monitor Amplifiers:** McIntosh 2105.  
**Monitor Speakers:** Mastering Lab System "Big  
 Red", ADS, Auratones.  
**Outboard Equipment:** Anything necessary, including  
 2800 cubic ft. live echo chamber.  
**Microphones:** Neumann, Telefunken, Sennheiser, etc.  
**Instruments Available:** 9' Baldwin concert grand.  
**Rates:** 24 track: \$100/hr.  
**Direction:** We are expanding right now. We have  
 done work with Eric Jacobson, Warner Brothers,  
 Twentieth Century, etc. We are in to great, clean,  
 tight sound and have one of the best tracking rooms  
 in town.



•••• **HOLLYWOOD SOUND**  
 6367 Selma Ave., Hollywood, CA 90028  
 (213) 467-1411



•••• **THE HOPE STREET STUDIO**  
 607 N. Ave. 64, Los Angeles, Ca 90042  
 (213) 258-6741

**Owner:** Van Webster.  
**Engineers:** Van Webster, Jim Bauerlein.  
**Dimensions of Studios:** A: 20' x 30' plus 7' x 12'  
 vocal booth. B: 8' x 9'.  
**Dimensions of Control Rooms:** A: 15' x 16' x 10.  
 B: 10' x 9' x 9'.



**HOPE STREET STUDIO, Los Angeles**

**Tape Recorders:** 3M Mincom Model 79 24 track;  
 Scully Model 100 16 track; Ampex Model AG 440  
 2 track; TEAC Model 3340S 4 track; TEAC Model  
 A-3300-S 2 track.  
**Mixing Consoles:** MCI 428B, 28 in x 24 out; Tascam  
 Model 10, 18 in x 8 out.  
**Monitor Amplifiers:** SAE 2400L, SAE 2200 bi-amped  
 with SAE crossovers, McIntosh 275, Dyna amp.  
**Monitor Speakers:** JBL, Auratone, RSL.  
**Outboard Equipment:** UREI, dbx, Pandora limiters,  
 3M Selectake II, live echo chamber, Master-Room  
 Super C stereo echo, DDL, Marshall Time Modu-  
 lator, Kepex, parametric EQ, VSO.  
**Microphones:** Neumann U-47 FET, U-87, KM-84;  
 AKG 451, 452, D-224E; Electro-Voice RE-20, RE-15,  
 666; Sennheiser 421, 403; Shure 545-SD; Sony F-121;  
 direct box.  
**Instruments Available:** Steinway Model B 7' grand  
 piano, Fender amplifiers, RMI Electrapiano, Gulbransen  
 upright piano.  
**Extras:** Kitchen, guest house, market/liquor store,  
 super sandwich shop next door.  
**Rates:** Studio A \$95/hr 24 track. Studio B \$45/hr.  
**Direction:** My commitment to superior service re-  
 mains paramount. As an owner/operator, I believe  
 that every client deserves a comfortable, classy,  
 creative atmosphere; well maintained equipment,  
 and progressive, open-minded engineering. A project  
 at the Hope Street Studio is the pleasure you've  
 always expected recording to be.



•••• **INDIGO RANCH RECORDING STUDIO,**  
**MALIBU.**

**P.O. Box 24A-14, Los Angeles, CA 90024**  
**(213) 456-9277**  
**Owner:** Michael Pinder, Richard Kaplan, Michael  
 Hoffman.  
**Engineers:** Chris Brunt, Richard Kaplan.  
**Dimensions of Studios:** 25' x 20' plus isolation room.  
**Dimensions of Control Rooms:** 18' x 20'.  
**Tape Recorders:** 3M Model M-79 24 track; 3M  
 Model M-79 2 track; Studer Revox 2 track.  
**Mixing Consoles:** Aengus-Jensen custom, 32 in x  
 24 out.  
**Monitor Amplifiers:** McIntosh, Crown, E.A.  
**Monitor Speakers:** Custom JBL's.  
**Outboard Equipment:** 32 channels of dbx noise  
 reduction, dbx 160's, UREI 1176 LN, UREI UA 175's,  
 Altec 436C limiter, Teletronix LA2A's, Kepex's, Har-  
 monizer, phasers, UREI 550 Little Dippers, Orban/  
 Parasound parametric EQ, EMT echo, MXR Digital  
 Delay, Select tape, and much more.  
**Microphones:** Over 150 to choose from, including:  
 AKG, Altec, Beyer, Calrec, Electro-Voice, Neumann,  
 RCA, Sennheiser, Shure, Sony, etc., with many tube-  
 type condensers and unusuals.  
**Instruments Available:** Steinway grand piano, Fender  
 Rhodes 88, Clavinet D-6, Farfisa Mini, guitar amps,  
 and accessories.  
**Extras:** 60-acre mountain lot with kitchen and 3  
 bedrooms.  
**Rates:** \$145/hr. Daily rate \$1,500.  
**Direction:** Indigo Ranch provides a unique environ-  
 ment conducive to musical creativity in a home-like  
 but professional setting. Located in the Malibu Hills  
 overlooking the Pacific Ocean, Indigo serves top

recording artists from all over the world. The sixty-  
 acre ranch offers sleeping accommodations, kitchen  
 facilities, and a gourmet cook (on request). The ranch  
 and its fully equipped, state-of-the-art studio are beau-  
 tifully maintained by experienced and conscientious  
 staff, doing its utmost to make clients feel welcome  
 and comfortable.



**INTERNATIONAL AUTOMATED MEDIA,**  
 Irvine

•••• **INTERNATIONAL AUTOMATED MEDIA (IAM)**  
 \*also REMOTE RECORDING\*  
 17422 Murphy Ave., Irvine, California 92714  
 (714) 751-2015

**Owner:** I.A.M. Corporation, Jerry Shirar, Skip Konte.  
**Engineers:** Jerry Shirar, Bill Harlan, Scott Spain,  
 Bob Harlan, Don Dorsey.  
**Dimensions of Studios:** Studio A: 34' x 24' with  
 34' x 14' iso. and 12' x 8' drum booth and 26' x 18'  
 rehearsal room.  
**Dimensions of Control Rooms:** Studio A: 21' x 19';  
 Mastering 17' x 20'.  
**Tape Recorders:** 3M Model 79 24 track; 3M Model  
 79 16 track; 3M Model 79 4 track; (2) 3M Model 79  
 2 track; Revox 2 and 1/4 track; Nakamichi Model 1000  
 cassette; 3M Selectake II computer locating; MCI  
 mastering machine.  
**Mixing Consoles:** Studio A: Harrison 4032 with  
 Allison Memory plus automation, 40 in x 32 out;  
 Mastering: Custom built mastering console with  
 Neumann SX-70 cutting system and SX-74 cutter head.  
**Monitor Amplifiers:** Crown DC-300A's, Crown DC-  
 150's.  
**Monitor Speakers:** Studio A: Westlake Audio TM-1;  
 Mastering: UREI Model 813 Time-Aligned studio  
 monitors; also available: JBL 4311, Auratones, Electro-  
 stratic.  
**Outboard Equipment:** Allison Kepex, Allison Gain  
 Brain, Dolby A, UREI LA3A's, UREI 1176's, Pultec  
 P1EQ, Eventide DDL with pitch change, Eventide  
 Flanger, Orban/Parasound D'Esser, Scamp System,  
 Marshall Time Modulator, EECO SMPTE time code  
 synchronizer, Datatron SMPTE code generator, EMT  
 140 and 240, AKG BX-20, Amber 4550 spectrum  
 analyzer, IAM SMPTE code offset and insert editor,  
 dbx noise reduction, Burwen 1000 dynamic noise  
 filters, PSE 26A stereo limiters, compressor, expander.  
**Microphones:** Neumann U-87's, KM-84's; Beyer  
 M-500's, AKG 414's, 452's, 224's; Sennheiser 421's,  
 Electro-Voice RE-20's, RE-16's; Shure SM-57's.  
**Instruments Available:** 9' Yamaha concert grand,  
 Hammond B-3 with Leslie 122's & 900, Chamberlin  
 M-4 & Rivera 800, ARP Odyssey, ARP Soloist,  
 Fender Rhodes 73 EP, Wurlitzer EP, Oberheim 4-voice,  
 Hohner clavinet D6 and C, vibes, misc. percussion.  
**Extras:** 4 built-in Sony 1650 color cameras, automated  
 pan, tilt & zoom, production desk, Shintron 370 SEG,  
 Conrac & Unimedia color monitors, Tektronics sync  
 generator, Sony sync distributor and phase shifter,  
 Sony 2850 VCR, remote control drapes to tune the  
 studio, tech facilities, lounge, kitchen, conference  
 room with projection, recreation area, and rehearsal  
 facilities.  
**Rates:** Studio A: Mono, 2, 4, 16 track \$115/hr.  
 24 track \$135/hr. 32 & 40 track \$155/hr (base rates  
 include all modes day or night). Mastering: \$95/hr,  
 (please call for rates). Rehearsal: please call for block  
 rates.  
**Direction:** International Automated Media is a family  
 of media talent, working in a state-of-the-art environ-  
 ment to produce audio and video recording.



•••• JENNIFUDY RECORDING STUDIOS  
11115 Magnolia Blvd., N. Hollywood, CA 91601  
(213) 980-3872

**Owner:** The Kewve Company.  
**Engineers:** Phil Kaye, Dennis Eveland, John Banuelos, Gary Goodman. Studio Manager: Peggie Needleman.  
**Dimensions of Studios:** Studio A: 37' x 25'; Studio B: 13' x 28'.  
**Dimensions of Control Rooms:** Control Rooms A and B: 26' x 25'.  
**Tape Recorders:** 3M Model M79 24 track; 3M Model M79 2 track.  
**Mixing Consoles:** Harrison Model 3232, 32 in x 32 out.  
**Monitor Amplifiers:** JBL 6233.  
**Monitor Speakers:** UREI 813 "Time-Aligned"; JBL 4311's; also Mitsubishi DS-35B and Auratones.  
**Outboard Equipment:** 24 channels Dolby, Kepex, Omnipressor, digital delay with pitch, LA3A, 1176 limiters.  
**Microphones:** Neumann: U-47, U-87, KM-84; AKG C-414; Electro-Voice RE-15; Shure 546, SM-7; Sennheiser MD-402, MD-421.  
**Instruments Available:** Studio A: Yamaha 9' concert grand piano; Studio B: Yamaha 6' C-5 conservatory piano.  
**Extras:** Lounge, rec-room, mini-kitchen, microwave oven, shower and changing room. And featuring "Joe", the newest innovation in 24 track recording!!  
**Rates:** Call Studio Manager for rates.  
**Direction:** Our goal is the same as yours - to produce excellent products within your budget and time frame. From tracking to mixdown, to the security of your masters, Jennifudy offers the personalized service and attention your project deserves.



•••• JOHN THOMAS STUDIOS  
12123 Oxnard St., N. Hollywood, CA 91606  
(213) 769-6202

**Owner:** John Thomas.  
**Tape Recorders:** Ampex Model MM1200 24 track; Ampex Model ATR 102 2 track; Ampex Model AG 440C 2 track; TEAC Model A-3340-S 4 track; cassette deck.  
**Mixing Consoles:** QAL QA-3000 programmable, 32 in x 32 out.  
**Monitor Amplifiers:** Crown DC-300.  
**Monitor Speakers:** JBL.  
**Outboard Equipment:** Eventide Omnipressor, digital delay, Harmonizer, phaser, Orban/Parasound D'Esser, Eventide Flanger, AKG BX-20 echo chambers, Parasound reverb chambers, Pultec program EQ, UREI 1176 limiters, LA3A compressors, Kepex, Cooper Time Cube, VSO, metronome, multi-sync timer.  
**Microphones:** AKG 414 EB, 452 EB, D-1000E; Sony C-500, ECM-50, ECM-22P; Neumann U-87, U-47, KM-84, KM-86; Sennheiser 421-U; Electro-Voice RE-15, RE-20; Shure SM-56, SM-57, SM-54; Beyer M-160, M-260, M-67.  
**Instruments Available:** Steinway grand piano, ARP Omni.  
**Extras:** 2 isolation booths, silent central heating and air-conditioning.  
**Rates:** 24 track \$45/hr.  
**Direction:** Our recording credits include Gary Wright, England Dan and John Ford Coley, Peter Dinklage, Captain Beefheart, The Section, Crazyhorse, Jiva, The Limelitters, Glenn Yarborough, Joe Frazier, Ringo Starr, Universe, Iggy Pop and many more. We have also received gold and platinum record awards from Warner Brothers Records. Our label credits include Epic-Columbia, Motown, Big Tree-Atlantic, Warner Brothers, ATV-Pye, Mercury, Sky, Bomp, Claridge, Brass Dolphin, GRT, etc. We have also done major film scores and commercials for radio and television.



•••• KENDUN RECORDERS  
619 S. Glenwood Place, Burbank, CA 91506  
721 S. Glenwood Place, Burbank, CA 91506  
(213) 843-8096

**Owner:** Kent R. Duncan.  
**Engineers:** Kent Duncan, Carl Yanchar, John Golden, Geoff Sykes, Jo Hansch, Baker Bigsby, Joe Laux, Terry More, Bob Bullock, Jackson Schwartz, Jim Sintetos, Steve Williams, Joe Gastwirt.  
**Dimensions of Studios:** Studio 1: 40' x 50'; Studio 2: 40' x 30'; Studio D: 25' x 40'.  
**Dimensions of Control Rooms:** Studios D, 1, 2, 3, 5: 26' x 26'.  
**Tape Recorders:** Studer Model A-800 24 track; Ampex Model MM-1200 (2 in each studio) 24 track; Ampex Model ATR 100 2 track; Studer custom preview machines; Studer Model A-80 2/4 track;

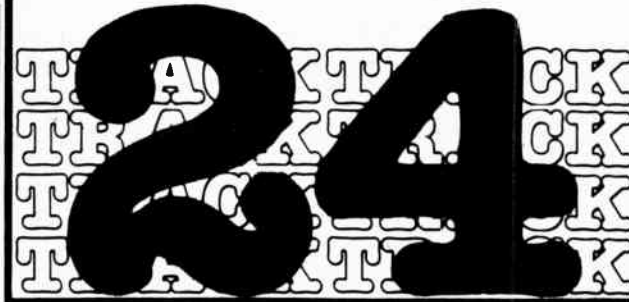

MCI 4 track.  
**Mixing Consoles:** Studio 1: Harrison Model 3232, 32 in x 32 out; Studio 2: Automated Processes Model 2824, 32 in x 32 out; Studio D: Solid State Logic Ltd. Model SSL-SL4000, 40 in x 32 out; Studios 3 and 5: Sierra Audio disc mastering.  
**Monitor Amplifiers:** Crown.  
**Monitor Speakers:** Sierra/Hidley SM II Tri-Amped Monitor System; Sierra/Hidley SM II Quad Monitor System, JBL 4311, Auratone, Big Red, Sierra Hidley TM 7 Playback System.  
**Outboard Equipment:** Eventide DDL, Harmonizer, phaser, flanger, Orban D'Esser, Dolby, dbx, Neve expander, PDM limiter, 171 parametric EQ, Lang Program EQ, EMT 240, EMT-244, EMT-140, MICMIX, Sierra Audio Acoustic chamber, UREI 1176 LN, UREI LA3A, UREI LA4, Inovonics 201, Allison Kepex, Allison Gain Brain, Allison Automation, UREI 527A graphic EQ, Orban stereo matrix, CSG, API Minimag, Lexicon Model 93 DDL, Orange County Vocal Stressor, Eventide Omnipressor, Pultec EQ.  
**Microphones:** AKG 414EH, C-24, 451, D202, 452; Beyer 160, M-500, M-88; Electro-Voice RE-15, RE-20, 666, 635A, DS-35, CS-15; Neumann KM-84, KM-86, KM-88, U-47, U-67, U-87, SM-69; Sennheiser 406, 421, 441, 2002; Shure SM-53, SM-54, SM-57, SM-58, SM-82, SM-7, SM-81, 545; Sony C-37, C-55, C-500, ECM-22, ECM-50.  
**Instruments Available:** 3 Yamaha grand pianos, Baldwin tack piano.  
**Extras:** Lounge, ping-pong, kitchen, Jacuzzi.  
**Rates:** Studio 1 & 2: \$190/hr. Studio D: \$250/hr. Studio 3 & 5: \$125/hr.  
**Direction:** Throughout our seven years of operation, Kendun Recorders' purpose is and has been to provide the most technically advanced facilities and superlative services that the art demands. Constantly being updated, the acoustic environment and electronic equipment work together as a system, complete, yet unobtrusive. Every staff member is keenly tuned to the client's creative endeavor. Special attention is paid to creating the atmosphere, both physical and mental, which enables the client and producer to do what they do best... make music.



•••• KSR STUDIOS  
1680 Vine, Suite 515, Hollywood, CA 90028  
(213) 467-0768

**Owner:** Kenneth Story.



•••• LARRABEE SOUND  
8811 Santa Monica Blvd., Los Angeles, CA 90069  
(213) 657-6750

**Owner:** Jackie Mills, Dolores Kaniger.  
**Engineers:** Bob Stone, Randy Tominage, Mick Gzauski, Taavi Mota, Marc Piscitelli, Sherry Klein.  
**Tape Recorders:** (2) Studer Model A80's with remotes, 24 track; Ampex Model 1200 with remote 24, 24 track; (6) Ampex Model ATR 100 2 track; Ampex Model ATR 400 4 track; (3) Technics 1/4 track, and (3) Nakamichi cassette decks.  
**Mixing Consoles:** (2) API automated custom model, 32 in x 32 out.  
**Monitor Amplifiers:** Bryston hi BGW lo bi-amped with White crossovers and 1/2 octave EQ.  
**Monitor Speakers:** Gauss & Cetec custom speakers.  
**Outboard Equipment:** Eventide Phaser, Flanger, Omnipressor, DDL and Harmonizer; parametric and graphic equalization; D'Esser, Roger Mayer and custom noise gates; UREI 1176's, LA4's, Inovonics limiters, Dolby noise reduction.  
**Microphones:** Large selection.  
**Instruments Available:** Wurlitzer electric piano, Kawai grand pianos, clavinet.  
**Extras:** Lounge with TV.



**we'll show you  
ours, if you'll  
show us yours!**

The Mix is interested in finding out who our readers are. We'd appreciate it if you would fill out the form below and return it to us so we can learn more about you and what you like. To show our appreciation, we will send you a free copy of The Mix New Product Directory. Thanks for your time.

1. What is your age?  
 15-25     25-34     35-40     over 50.
2. Are you  male or  female?
3. What is your occupation?  
A. RECORDING STUDIO  
 Owner  
 Engineer  
 Staff  
 Independent  
 Maintenance  
 Producer  
 Independent  
 Staff  
 Studio Employee  
B. MUSICIAN  
 Full Time  
 Part Time  
 On contract to record label  
C. PROFESSIONAL AUDIO  
 Manufacturer  
 Dealer  
 Store Owner  
 Employee  
 Manufacturers Rep.  
 Designer  
 Consultant  
D. MISCELLANEOUS  
 Radio/TV  
 Student  
 Other (please specify) \_\_\_\_\_
4. How long have you been involved in recording?  
\_\_\_\_\_
5. How much time do you spend in recording studios in one month?  
\_\_\_\_\_
6. What other recording related publications do you read?  
\_\_\_\_\_  
\_\_\_\_\_
7. Do you have recording equipment in your home?  
 professional     reel to reel     cassette
8. Where did you get your copy of The Mix?  
\_\_\_\_\_  
\_\_\_\_\_
9. What other listings, features or articles would you like to see in future editions of The Mix?  
\_\_\_\_\_  
\_\_\_\_\_
10. Comments or suggestions?  
\_\_\_\_\_  
\_\_\_\_\_

Please return this form to:  
The Mix Publications  
P.O. Box 6395  
Albany Branch  
Berkeley, CA 94706

name \_\_\_\_\_  
address \_\_\_\_\_  
city \_\_\_\_\_  
state \_\_\_\_\_ zip \_\_\_\_\_

Thank you, watch for your free copy of The Mix New Product Directory to be delivered by June 1, 1979.





**LYON RECORDING STUDIO**, Newport Beach  
 (to r: David Goggin, Curt Lyon)

..... **LYON RECORDING STUDIO**  
**2212 Newport Blvd., Newport Beach, CA 92663**  
**(on the Balboa Peninsula)**  
**(714) 675-4790**  
**Owner:** Curt Lyon.  
**Engineers:** Curt Lyon, David Goggin.  
**Dimensions of Studios:** 35' x 35' plus 20' x 18' isolation booth and 15' x 8' isolation booth.  
**Dimensions of Control Rooms:** 25' x 25'.  
**Tape Recorders:** Ampex Model MM-1100 w/search to cue, 24/16/8 track; Studer Model B67 2 track; Technics Model 1500-2 2 track; TEAC Model 3340 4 track; Uher Model 4200 report stereo, 2 track portable; Nakamichi cassette.  
**Mixing Consoles:** MCI Model 528-C with automation 28 in x 32 out.  
**Monitor Amplifiers:** Quatre 250's, Crown DC 150, Crown DC 60's.  
**Monitor Speakers:** UREI Time-Aligns, JBL 4333A's, Auratones.  
**Outboard Equipment:** UREI 1176 limiters, Delta T digital delay, Scamp noise gates, Orban/Parasound parametric EQ, AKG reverb, flangers, phasers, etc.  
**Microphones:** Neumann U-87's; AKG 414's, 451's, 452's, D 202; Shure SM-57's; Electro-Voice RE-20's, RE-50, RE-15's; Sony ECM 280; Sennheiser 421's.  
**Instruments Available:** Kawai grand piano 7' 4", Fender stereo Rhodes 73, Hohner clavinet Mini Moog, ARP String Ensemble, Guild acoustic guitar, Rickenbacker electric guitar and bass, Reynolds flute, full percussion compliment.  
**Extras:** Pacific Ocean across the street, finest seafood restaurant next door, health food bar, motels and hotels nearby, kitchenette, color TV.  
**Rates:** 24 track \$100/hr. 16 track \$80/hr. Block rates available with or without accommodations.  
**Direction:** Many artists and producers are finding Newport the ideal location for album projects. We are close enough to L.A. to make commuting business convenient, but far enough to make recording a private affair. Our studio is across the street from the Pacific Ocean and the 40' yacht Sirenuse is available for twilight cruises. With our new automated console, spacious control room, special block rates and accommodations, we create a package for the "working vacation". We have recorded major artists, film scores, and jingles and can provide copyists, arrangers, musicians, and narrators. Our clients include Warner Bros., Toshiba-EMI (Japan), Copacabana (Brazil), Paramount (The Warriors), A & M, Elektra-Asylum, Sanrio Comm., RCA, Infinity, etc.

..... **LOVE N' COMFORT RECORDING STUDIO**  
**5274 West Pico Blvd., Los Angeles, CA 90019**  
**(213) 930-1131**  
**Owner:** Clay and Karen McMurray.  
**Engineers:** Clay McMurray, Bob Winder, Kevin Dixon.  
**Dimensions of Studios:** Main area approx. 14' x 12', with isolation booth approx. 8' x 10'.  
**Dimensions of Control Rooms:** Septagon — approx. 400 sq. ft.  
**Tape Recorders:** MCI Model JH-114-24 24 track; (2) MCI Model JH-110A 2 track; TEAC Model A-3340 4 track; Akai Model GXC-760D (cassette) 2 track.  
**Mixing Consoles:** MCI Model JH-536C (automated) 36 in x 32 out.  
**Monitor Amplifiers:** BGW 750B, BGW 250C, BGW 100  
**Monitor Speakers:** UREI 813 (Time-Aligned), Auratones, JBL 4311.  
**Outboard Equipment:** Eventide Harmonizer with extra output, MICMIX Dynaflanger, dbx 162 stereo compressor, UREI LA3A limiters, UREI 565 Little Dipper, Inovonics 201 peak/avg. limiters, Orban 622B parametric EQ, Lexicon Prime Time DDL, EMT 240 stereo echo chamber.  
**Microphones:** AKG C-24's stereo, D-1000E's; Sony C-500; Neumann U-87; Beyer M-260's; Shure SM-56.  
**Extras:** Console: MCI JH-50 automation, extra echo returns, metered send levels, Spectra-Vue, plasma display level meters, phase meter, producer's desk. 24 track machine: auto-locator, tape velocity indicator and variable speed control. 2 track machines: 14" capacity, 30 15 & 7½ ips, built-in return to zero with digital tape timer.  
**Rates:** \$100/hr. Automated mixing: \$125/hr.  
**Direction:** We are a brand new (opened Jan 79) 24 track automated studio specializing in mixdowns and overdubs in a private professional atmosphere. We offer a comfortable working environment with all new state-of-the-art equipment at a very reasonable rate. Our future plans include a large guest lounge, live echo chambers, a disc mastering room, and a full service studio.

..... **MAGIC WAND RECORDING STUDIOS**  
**1010 Oak St., Burbank, CA 91506**  
**(213) 843-2112, 843-2137, 843-2221**  
**Owner:** Angelo Difrenza Corp.  
**Engineers:** Robert "Inky" Incorvaia, Bill Hennigh.  
**Dimensions of Studios:** 27' x 30' x 14' plus an 8' x 10' x 8' vocal isolation booth and a 12' x 10' x 8' horn booth, plus a 10' drum booth video linked.  
**Dimensions of Control Rooms:** 17' x 17' sloped ceilings.  
**Tape Recorders:** MCI Model JH-114-24 16 and 24 track.  
**Mixing Consoles:** Oliver Systems Co. Model 32-34, 32 in x 24 out, with 56 track mixing capability with individual EQ control for all 56 tracks.  
**Monitor Amplifiers:** 4 Oliver Systems Co. 600's with tri-amplifiers; 4 Oliver Systems Co. 400's with quad-amplifiers; Yamaha tri-amp.  
**Monitor Speakers:** JBL, Barcus Berry tri-amped systems; JBL 4311's, Altec 604's, Auratones, Mastering Lab crossover.  
**Outboard Equipment:** Kepex, Gain Brains, (3) digital delays, 3,000 cu. ft. live chamber, AKG BX-10E, 4' x 8' quad EMT plate, phaser, flanger, VSO's Lang, Orban, Pultec, UREI EQ's LA3A's, 1176's and Pultec limiters, Harmonizers, 24 Dolby's, 24 dbx's, Orban D'Esser.  
**Microphones:** Neumann U-87's, U-47's, KM-86's, KM-84's, KM-88's; AKG; Sennheiser's; Beyer's; RCA's; Electro-Voice's; Sony's; Shure's.  
**Instruments Available:** Steinway 9' concert grand, B-3, guitar amps, Hammond Organ, drums.  
**Extras:** Lounges, listening room, game room.  
**Rates:** \$100 one engineer. \$110 two engineers. All inclusive.  
**Direction:** The basic concept of Magic Wand has been to make available to the artist the newest and most innovative state of the art technology in an atmosphere of relaxed comfort with personnel both qualified and personable which adds up to your music coming out on tape as you want to hear it.

..... **MAMA JO'S**  
**8321 Lankershim Blvd., N. Hollywood, CA 91605**  
**(213) 982-0305**  
**Owner:** Freddie Piro, Studio Manager: Teri Piro.  
**Engineers:** Billy Taylor, Joe Bellamy, Tom Ferguson, Mark Waldrep.  
**Dimensions of Studios:** 800 sq. ft.  
**Dimensions of Control Rooms:** 16' x 20'.

**Tape Recorders:** Stevens 24 track; 3M Model M56 16 track; MCI 2 track; Scully Model 280 2 & 4 track.  
**Mixing Consoles:** Spectra Sonics custom, 28 in x 24 out.  
**Monitor Amplifiers:** Spectra Sonics Model 700.  
**Monitor Speakers:** Mastering Lab.  
**Outboard Equipment:** UREI limiters, Spectra Sonics limiters, Eventide DDL, 175M, Kepex's, Eventide Flanger and Phaser, Orban/Parasound D'Esser and parametric EQ.  
**Microphones:** Neumann 87's, 47's, 49's, KM84's; Telefunken M250's; AKG 414's, 451's; Sony C500's, C37's; RCA 77's, 44's; Sennheiser MD 421.  
**Instruments Available:** Yamaha 74" grand, Hammond B-3 and 122 Leslie.  
**Rates:** Please call for current rates.  
**Direction:** We are currently enlarging the studio. This will allow for twice the current space and a lounge. We plan on decorating the lounge in an atmosphere where the artists, producers and musicians, etc., feel that they are getting completely away from the studio. We will be putting in various games, TV, radio, dart boards, etc. We want everyone to feel at home and become part of the growing family at Mama Jo's.

..... **MARANATHA I STUDIOS**  
**2902 W. Garry Ave., Santa Ana, CA 92704**  
**(714) 546-9210**  
**Owner:** Maranatha Music — Principal contact: Sharon McLaughlin, Traffic Manager. Ted Bleymaier, Studio Manager.  
**Engineers:** Jonathan Brown, Dan Willard, Chris Taylor.  
**Dimensions of Studios:** John P. Edwards Design — A: 25' x 25'. B: 20' x 25' (two isolation booths).  
**Dimensions of Control Rooms:** 20' x 25'.  
**Tape Recorders:** Stephens 24 track; Ampex Model ATR-102 2 track; Ampex Model AG-440C 2 track; Sony Model 854-4 4 track.  
**Mixing Consoles:** Ford Audio/B.A. Roth Custom, 32 in x 24 out.  
**Monitor Amplifiers:** Crown DC-300 (mono), Spectra Sonics 700, Crown D-150 (playback cue amps).  
**Monitor Speakers:** Altec 604E/Utah with Mastering Lab crossover, JBL, Auratones.  
**Outboard Equipment:** EMT 240, AKG BX-20, UREI LA3A, Universal 175 limiter, Spectra Sonics 610 Complimiter, Lexicon Prime Time.  
**Microphones:** Neumann U-47 tube, U-67, M269, M-49, KM-54, KM-56, KM-84; Sony C-37A, C-57, C-500; Telefunken 250, 251E; Sennheiser 421, 441; Electro-Voice RE-20; RCA 77DX; Beyer 160; AKG C-60, C-12A, C-24, 452, 224, 414.  
**Instruments Available:** 1915 Steinway 9½' concert grand, B-3 with 2 Leslies, Wurliitzer, Rhodes stereo 73, Hohner D-6 clav., ARP Odyssey, ARP String Ensemble, guitar amps, drum kit.  
**Extras:** Lounge, kitchen.  
**Rates:** Please contact Sharon or Ted for rates.  
**Direction:** We are a Christian ministry whose desire is to glorify Jesus Christ. This facility is dedicated to that purpose in service. We desire to be of service to likewise purposed Christian ministries.

..... **MARTINSOUND STUDIOS**  
**1151 W. Valley Blvd., Alhambra, CA 91803**  
**(213) 283-2625**  
**Owner:** Joe Martinson  
**Engineers:** Jack Joseph Puig, Christopher Banninger, Greg Thompson, Mark King.  
**Dimensions of Studios:** Studio I: 45' x 47'; Studio II: 23' x 14'.  
**Dimensions of Control Rooms:** 15' x 14'.  
**Tape Recorders:** MCI Model JH114 24 track; ATR Model 100 2 track; MCI Model JH110A 4/2 track; ElectroSound Model ES505; MCI 16 and 8 track also available.  
**Mixing Consoles:** (2) MCI Model JH428, 28 in x 28 out.  
**Monitor Amplifiers:** Crown DC 300A, IC 150, Marantz 240.  
**Monitor Speakers:** UREI Time-Aligns, JBL 4340, Mastering Lab 604 with extended bottom.  
**Outboard Equipment:** Dolby, Cooper Time Cube, Harmonizers, digital metronome, UREI 1176 limiters, phaser, D'Essers, 3 EMT 140's, AKG BX-20, live chamber, graphic equalizer, parametric equalizer.  
**Microphones:** Telefunken 251, Neumann U-47, U-67, U-87, KM-84, KM-88; AKG 452, 414; Sennheiser 421; Electro-Voice RE-20's, RE-16's.  
**Instruments Available:** Fender Rhodes, ARP strings, ARP Pro Soloist, 2 acoustic grand pianos, Yamaha



Available for immediate delivery at:

**The Burbank Sound Co.**

1317 N. San Fernando, Burbank, CA 91504 (213) 841-0062 & 327 E. 1200S., Orem, Utah 84057 (801) 224-4848



# The deck that separates the pros from the amateurs.

There is a difference between so-called consumer decks and professional decks. Several, in fact.

That's why TASCAM SERIES created its Model 40-4 Recorder/Reproducer. While consumer decks are designed for play, our Model 40-4 is meant for work. Hard work.

It's a tough, heavy-duty deck with the professional specs, features and functions it takes to qualify for professional, in-studio use. But our Model 40-4 costs a lot less than its in-studio peers.

Our Tascam 40-4 has a suggested retail price of \$1600\*. That's more than most consumer decks, but it's designed to do a lot more.

The 40-4 transport is the same as our 80-8 half-inch eight-

track deck. Designed to move heavier half-inch tape, the 40-4 handles lighter quarter-inch tape smoothly without strain.

It's rugged enough to take the constant wind and rewinding to build your tracks to where you want them. The 40-4's tape transport system is a good example of the mechanical overkill that separates our 40-4 from lesser decks.

Okay. If you're just beginning, you can buy any consumer deck, TEAC makes the best around.

But if your commitment is serious enough to require a four-track recorder/reproducer you can rely on for a long time and produce studio-quality results, it's our Tascam 40-4.

Check out the details below, then check in at your authorized TASCAM SERIES Dealer.

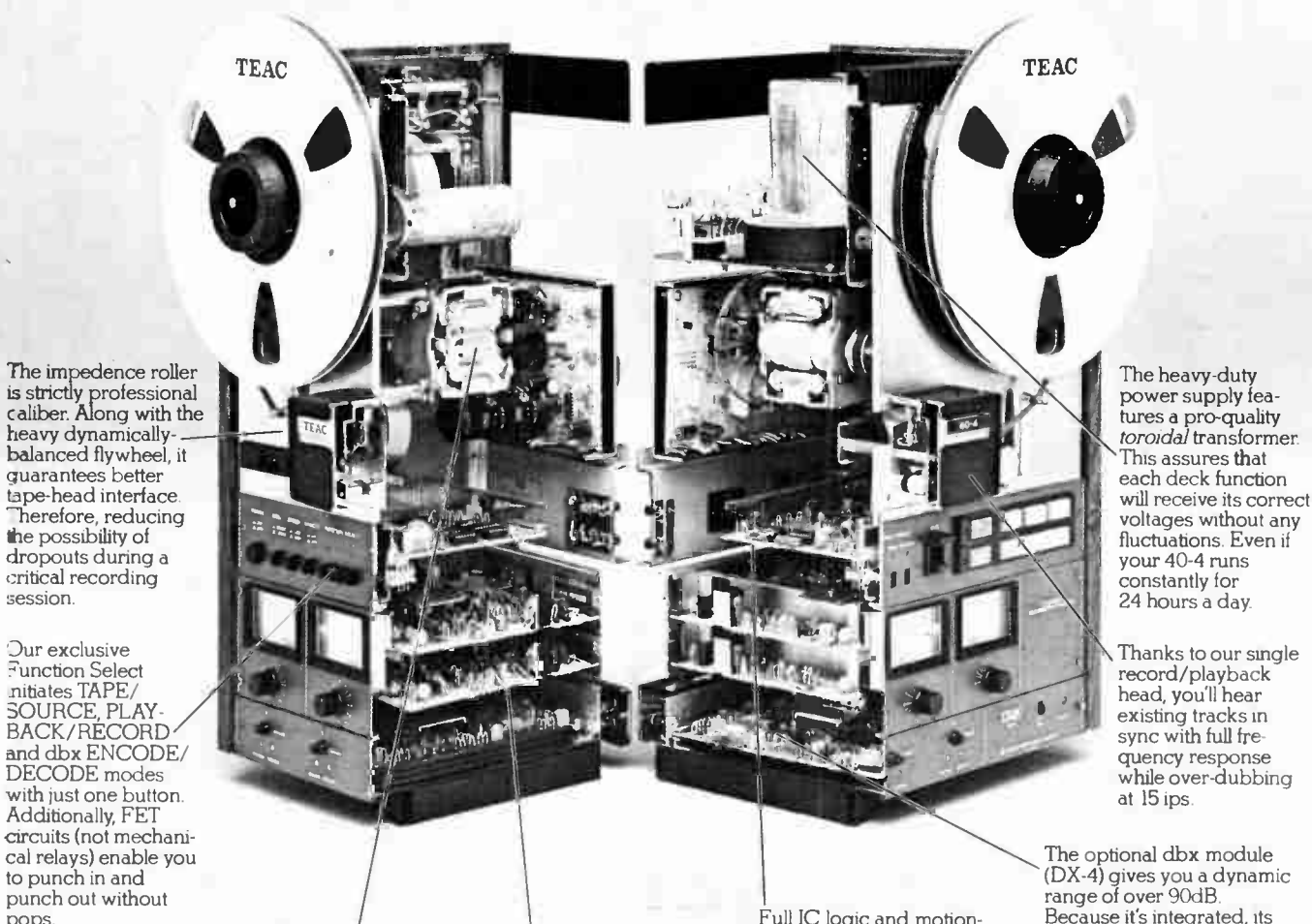

The impedance roller is strictly professional caliber. Along with the heavy dynamically-balanced flywheel, it guarantees better tape-head interface. Therefore, reducing the possibility of dropouts during a critical recording session.

Our exclusive Function Select initiates TAPE/SOURCE, PLAY/BACK/RECORD and dbx ENCODE/DECODE modes with just one button. Additionally, FET circuits (not mechanical relays) enable you to punch in and punch out without pops.

Heavy-duty motors, bearings and brakes assure you of smooth tape handling throughout the long hours of the multitrack recording process.

Individual, removable PC cards carry the electronics for record, reproduce and bias amps. So calibration or replacement comes quick and easy. Just swing down the meter panel for quick access.

Full IC logic and motion-sensing circuit lets you enter play mode quickly without risking tape spill or stretch.

The optional dbx module (DX-4) gives you a dynamic range of over 90dB. Because it's integrated, its electronics are perfectly calibrated to match the recording/reproduce circuits of the 40-4.

The heavy-duty power supply features a pro-quality toroidal transformer. This assures that each deck function will receive its correct voltages without any fluctuations. Even if your 40-4 runs constantly for 24 hours a day.

Thanks to our single record/playback head, you'll hear existing tracks in sync with full frequency response while over-dubbing at 15 ips.

\*Price subject to dealer preparation charges where applicable.

## TASCAM SERIES BY TEAC®

A new generation of recording instruments for a new generation of recording artists.

TEAC Corporation of America • 7733 Telegraph Road, Montebello, California 90640 • In Canada TEAC is distributed by White Electronic Development Corporation (1966) Ltd.



# 24

G70 and Steinway B, Hammond B-3 organ, Yamaha electric grand.

**Extras:** 2 lounges.

**Rates:** \$70/hour to \$120/hour.

**Direction:** We are presently building a third studio on the premises and are giving our facilities a face-lift in many areas.



## •••• MCA WHITNEY RECORDING STUDIO, INC.

1516 West Glenoaks Blvd., Glendale, CA 91201

(213) 245-6801

**Owner:** MCA Records, Inc.

**Engineers:** Frank Kejmar, Terry Brown, Paul Elmore, George Charouhas, Steve Hall, Eddy Schreyer, Larry Boden.

**Dimensions of Studios:** A: 45' x 35', B: 30' x 22', D: 20' x 16'.

**Tape Recorders:** MCI Model J110, 24 & 2 track; 3M Model 79 24 & 2 track; Ampex Model 1100 16/24 track; Ampex Model ATR 100 4/2 track; 3M Model 56 8 & 16; Scully Model 280B 2 & 4 track.

**Mixing Consoles:** Neve (Studios A & B), 36 in x 24 out; Electrodyne (Studio D), 16 in x 8 out.

**Monitor Amplifiers:** JBL, Crown, McIntosh, Harman Kardon Citation, Cerwin Vega.

**Monitor Speakers:** JBL, Altec, UREI Time-Align.

**Outboard Equipment:** Eventide DDL and Flanger, Kepex, Harmonizer, dbx, Dolby, Orban/Parasound high frequency equalizer, Orban D'Esser, Sphere equalizers, Roland Chorus Echo, parametric equalizer, EXR Exciter.

**Microphones:** Neumann, AKG, RCA, Shure, Electro-Voice, Sony, Sennheiser.

**Instruments Available:** Yamaha and Steinway grand piano, tack piano, Celeste, Morton pipe organ, Hammond B-3 with Leslie speaker.

**Extras:** Echo: live chambers, EMT's, AKG. Disc mastering: Neumann SAL 74 Tandem system. Tape duplicating: high speed reel to reel, cassette and 8 track cartridge.

**Rates:** Studio A, day time, 24 track: \$125/hr. Studio D: 8 track demo rate \$55/hr.

**Direction:** A custom facility presently recording pop, country, disco, gospel, rock for various record and production companies.



## •••• MOTOWN RECORDING STUDIOS/ HITSVILLE, U.S.A.

7317 Romaine St., Hollywood, CA 90046

**Owner:** Motown Records.

**Engineers:** Jack Andrews, Jane Clark, James Green, Glen Jordan, Robert Robitaille, Art Stewart, Russ Terrana.

**Dimensions of Studios:** Sunset 38' x 38'; Sunrise 18' x 24'; Dawn 14' x 16'; Twilight 8' x 10'.

**Dimensions of Control Rooms:** Sunset 20' x 26'; Sunrise 20' x 24'; Dawn 18' x 22'; Twilight 14' x 18'.

**Tape Recorders:** (6) 3M Model 79 24 track; (6) 3M model 56 2/4 track; 20 misc.

**Mixing Consoles:** Sunset: Quad/Eight, 24 in x 24 out; Sunrise: Quad/Eight, 24 in x 24 out; Dawn: Neve/ Necam Model 8078, 40 in x 32 out; Twilight: custom.

**Monitor Amplifiers:** JBL, Marantz.

**Monitor Speakers:** Custom JBL/Cetec.

**Outboard Equipment:** All EQ including electronic instruments.

**Microphones:** 120 microphones all mfg.

**Instruments Available:** Piano, organ, drum, 88, clav., etc.

**Extras:** Telecime, video, mini-mag, BTX.

**Rates:** Average rate: \$135/hr.

**Direction:** 1. Have contracted for two additional Neve consoles scheduled for 1979. (April - Nov.).

2. New studio construction started 11/1/79.

3. Total of \$1,300,000 to be added thru 1979. and now open to outside clients.

## •••• MUSIC GRINDER STUDIO

7460 Melrose Ave., Los Angeles, CA 90046

(213) 655-2996, 655-3306

**Owner:** Gary P. Skardina, Ron Filecia.

**Engineers:** Gary P. Skardina, John Kovarek, Robert Feist.

**Dimensions of Studios:** Studio 1: 30' x 15'; Production room 10' x 10'.

**Dimensions of Control Rooms:** 15' x 15'.

**Tape Recorders:** MCI Model JH-114 24 track; MCI Model JH-16 16 track; MCI Model JH-100 2 track; Technics Model 1506 2 track; TEAC Model 7300/3300 2 track; Tascam Model 80-8 8 track.

**Mixing Consoles:** MCI Model 428B, 28 in x 24 out.

**Monitor Amplifiers:** JBL 6233 Ice Cube, Crown DC-300, Marantz 240B, Crown DC-40.

**Monitor Speakers:** Custom UREI Time-Align system, JBL 4311's, Auratone 5C mixing cubes, Adventure SM-4800's.

**Outboard Equipment:** UREI 1176 limiters, Lexicon Prime Time digital delay, Orban/Parasound parametric equalizers, Orban/Parasound D'Esser, Eventide Omnipressor, Eventide Harmonizer, Kepex noise gates, MXR flanger, dbx 160 compressor/limiter, Nakamichi 1000-II cassette, Fisher CR5120 cassette machine, Marantz 5220 cassette, Marantz 6100 turntable, EMT-240 echo, AKG BX-10 echo.

**Microphones:** Telefunken 251; Neumann U-87's, U-47's; AKG C414's, 452EB; Electro-Voice RE-20; Sony C37-P, ECM-22P; Shure SM-54, Shure SM-56's, SM-57's, SM-58; Sennheiser 421-MU; etc.

**Instruments Available:** Yamaha grand piano, Ampeg Gemini amplifier, some percussion, etc.

**Extras:** Kitchen, color TV in lounge, electronic ping-pong.

**Rates:** \$90/hr day until 6:00 and \$100/hr after 6:00. Block booking rate upon request.

**Direction:** Some of the people who have recorded here include: Donna Summer, Melissa Manchester, Kim Fowley, David Castle, Player, Brooklyn Dreams, Lenny Williams, The Mighty Clouds of Joy, Martin Mull, Jimmy Haskell, David Campbell, Peter Noon, Lee Ritenour, Gavin Christopher, Diana Canova, Larry McNeely, Gabriel Mekler, Tommy Bolin, Ray Manzarek, Jerry Corbetta, Walter Becker & Donald Fagen, The Wonderland Band, and more!!!



## •••• MUSIC LAB

1836 Hyperion Ave., Hollywood, CA 90027

(213) 666-9000 or 662-3965

**Owner:** Chaba Mehes.

**Engineers:** Gary Coppola, John Sacchetti, Alex Cima, Kevin Kelly.

**Dimensions of Studios:** Studio A: 40' x 30' x 14'; Studio B: 30' x 20' x 12'.

**Dimensions of Control Rooms:** A: 20' x 16' x 10'; B: 20' x 18' x 10'.

**Tape Recorders:** MCI with auto locator 24 track; Ampex Model MM-1100 with search and cue 16 track; Tascam Model 80-8 8 track; Otari Model 5050 2 track; TEAC 3440 and 3340 4 track; TEAC Model 4010 and 3300 SX-2T and 4300 2 track; Nakamichi Model 500 2 track.

**Mixing Consoles:** Audiotronics, 54 in x 24 out; Tangent Model 3216 with parametric EQ, 30 in x 16 out.

**Monitor Amplifiers:** BGW 100, BGW 250, SAE 2400, SAE 2200.

**Monitor Speakers:** JBL 4320 (bi-amplified), JBL 4301, Auratone.

**Outboard Equipment:** Eventide Harmonizer; Marshall Time Modulator; Kepex; UREI 1176, LA3A; dbx 160, 154, 155, DX-8; Pultec MEQ-5, H2; MICMIX SC; Orban/Parasound; Altec limiter.

**Microphones:** Neumann U-87, KM-84; AKG 451, 452; Beyer 160, 500; Sennheiser 421, 441; Electro-Voice RE-20, 16, 11; Shure 57, 58; Sony C-37A (tube).

**Instruments Available:** Baldwin grand piano; ARP Omni, ARP 2600; Hammond organ; Ludwig drums; Fender Rhodes; Steiner Syntha System; Synthacon; guitar - Slavedriver; Vocoder; Chapman Stick.

**Extras:** 3 isolation booths, live room, ground level studios, easy parking, lounge room, kitchen, shower, air-conditioning, central location, editing room, copying, mixing, synthesizer room, rehearsal room; open 24 hours, instrument rental and transportation, synthesizer workshop.

**Rates:** 16 track \$30/hr. 8 track \$20/hr. 4 or 2 track editing \$10/hr. Rehearsal \$4.50/hr. Cassette copying \$1/cassette. American Express, Visa and Master Charge accepted. Special block rates available.

**Direction:** We offer the finest and the largest collection of recording equipment and the widest selection of music production services among the professional economically oriented recording studios.

## •••• MUSIC RECORDERS INC.

1680 North Sycamore Ave., Hollywood, CA 90028

(213) 462-6897

**Owner:** Garry Ulmer.

**Engineers:** Garry Ulmer, Michael Perricone; Studio Manager: Linda Feldman.

**Dimensions of Studios:** Main studio accomodates 20 musicians. String isolation room acc. 20, plus 2 additional isolation rooms for vocals (complete visibility by conductor).

**Tape Recorders:** MCI 24 track; MCI 4 track; 3M 4 track; MCI 2 track; Ampex 2 track; Ampex mono.

**Mixing Consoles:** Automated Processes custom console with automated mixdown, 32 in x 32 out.

**Monitor Amplifiers:** Crown.

**Monitor Speakers:** Westlake Monitors.

**Outboard Equipment:** Complete interlock system for dubbing, sweetening and scoring to picture, quad playback for TV broadcast, complete sound effects library.

**Microphones:** Neumann, AKG, Sony, Electro-Voice, RCA, Shure, Sennheiser.

**Instruments Available:** Grand piano, ARP Odyssey, B-3 organ, harpsichord.

**Extras:** 2 lounges.

**Rates:** Call for rate brochure.

**Directions:** Music Recorders Est. 1969, became the first studio in the U.S. with automated mixdown in 1973 and the first studio to computer mix a final dub with picture. We are currently involved in dubbing TV shows, recording film scores, sound track albums and TV commercials.



## •••• NSP STUDIOS

6362 Hollywood Blvd., Suite 216,

Hollywood, CA 90028

(213) 462-6524

**Owner** Arthur G. Wright. Studio Manager: Linda C. Robinson.

**Engineers:** Kevin Wright, Boris Thompson, E.J. Emmons, Bob Smith.

**Dimensions of Studios:** 315 sq. ft., drum booth: 72 square feet.

**Dimensions of Control Rooms:** 221 square feet.

**Tape Recorders:** MCI 24 track; MCI 2 track; A & W 2 track; TEAC 1/4 track; Sony and TEAC cassettes; Concertone 90.

**Mixing Consoles:** Custom designed A & W Electronics - 24, 24 in x 24 out, with 26 LED meters and solo mute.

**Monitor Amplifiers:** A & W and Yamaha 2200.

**Monitor Speakers:** Custom designed Model 315.

**Outboard Equipment:** 1/2 octave graphic EQ, UREI LA3A limiters, Kepex, compressor.

**Microphones:** Electro-Voice, Neumann, Shure, AKG.

**Instruments Available:** Acoustic piano, Wurlitzer, Panther organ.

**Extras:** Lounge.

**Rates:** 24 track: \$125/hr; 16 track: \$100/hr; 4 track: \$55/hr; 2 track: \$45/hr.

**Direction:** Arthur G. Wright, a well known producer, arranger and conductor also owns a production company (Non Stop Production) as well as a publishing company (Competition Music), in which fine talent is developed and presented to the record industry. Our recent project is Raul de Souza of Capitol Records; most recent arrangements are: Diano Ross, Thelma Houston, Fifth Dimension, Bloodstone, etc. Our studio offers the latest in recording equipment with highly experienced engineers to provide that personal touch in assisting the producer and artist. We are still designed to provide that private and personal touch.



## •••• PARAMOUNT RECORDING STUDIOS

6245 Santa Monica Blvd., Los Angeles, CA 90038

(213) 461-3717

**Owner:** Brian G. Bruderlin.

**Engineers:** Kerry McNabb, Larry Hirsch, Roger Dollard plus numerous free-lance engineers.

**Dimensions of Studios:** Studio A: 45' x 38' with 22 foot ceiling. Studio B: 14' x 20' with 8 foot ceiling.

**Dimensions of Control Rooms:** Studio A: 20' x 27'; Studio B: 14' x 38'.

**Tape Recorders:** 3M Model M-79T, 24/16 track; Studer Model A-80 2 track; Studer Model A-80 4 track; 3M Model M-79 2 track.

**Mixing Consoles:** Studio A: Spectra Sonics 2416, 24 in x 16/24 out; Studio B: Automated Processes Model 2488, 32 in x 24 out.

**Monitor Amplifiers:** Crown Model DC-300A, BGW.



# NOT JUST ANOTHER FLANGER...

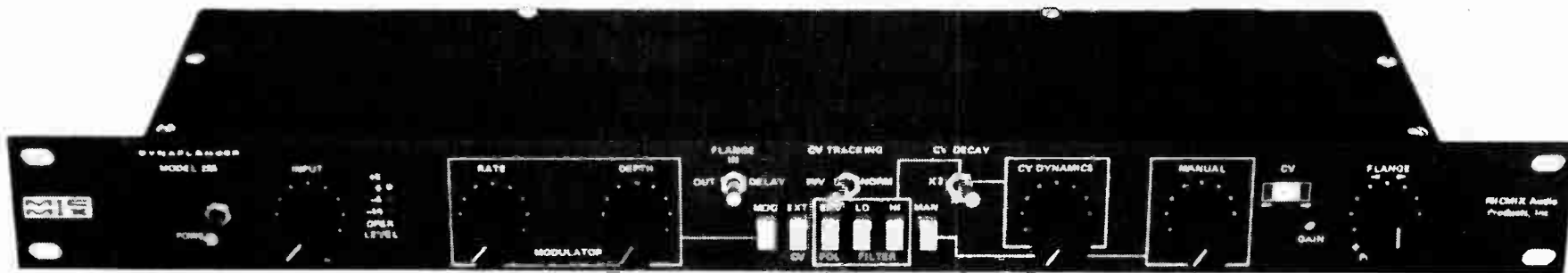

## DYNAFLANGER™

**Dynamically Controls Flanging Effects Automatically In Response To Frequency or Amplitude Variations Of The Program Material.**

**True Automated Flanging from the people who bring you MASTER-ROOM. "No 1 Rated American Reverb" — Billboard Magazine**

**MIX** MICMIX Audio Products, Inc.

(214) 352-3811

2995 Ladybird  
Dallas, Tx 75220

### btx presents the 30-track audio recorder

The btx 4500 SMPTE interlocking system lets you operate any two multi-track recorders in tandem for 14, 22, 30 or 46-track capability. Using standard SMPTE time code written on one track of each machine, any two recorders may be synchronized, including video to audio. You can even mix makes, formats, speeds, and numbers of tracks, with or without servo controlled capstan drive. The btx 4500 is a micro-processor-based system capable of tracking within 50 microseconds of an actual mechanical lock. It's an economical direct plug-in system that's easy to use and ultra-reliable. For complete information, call:

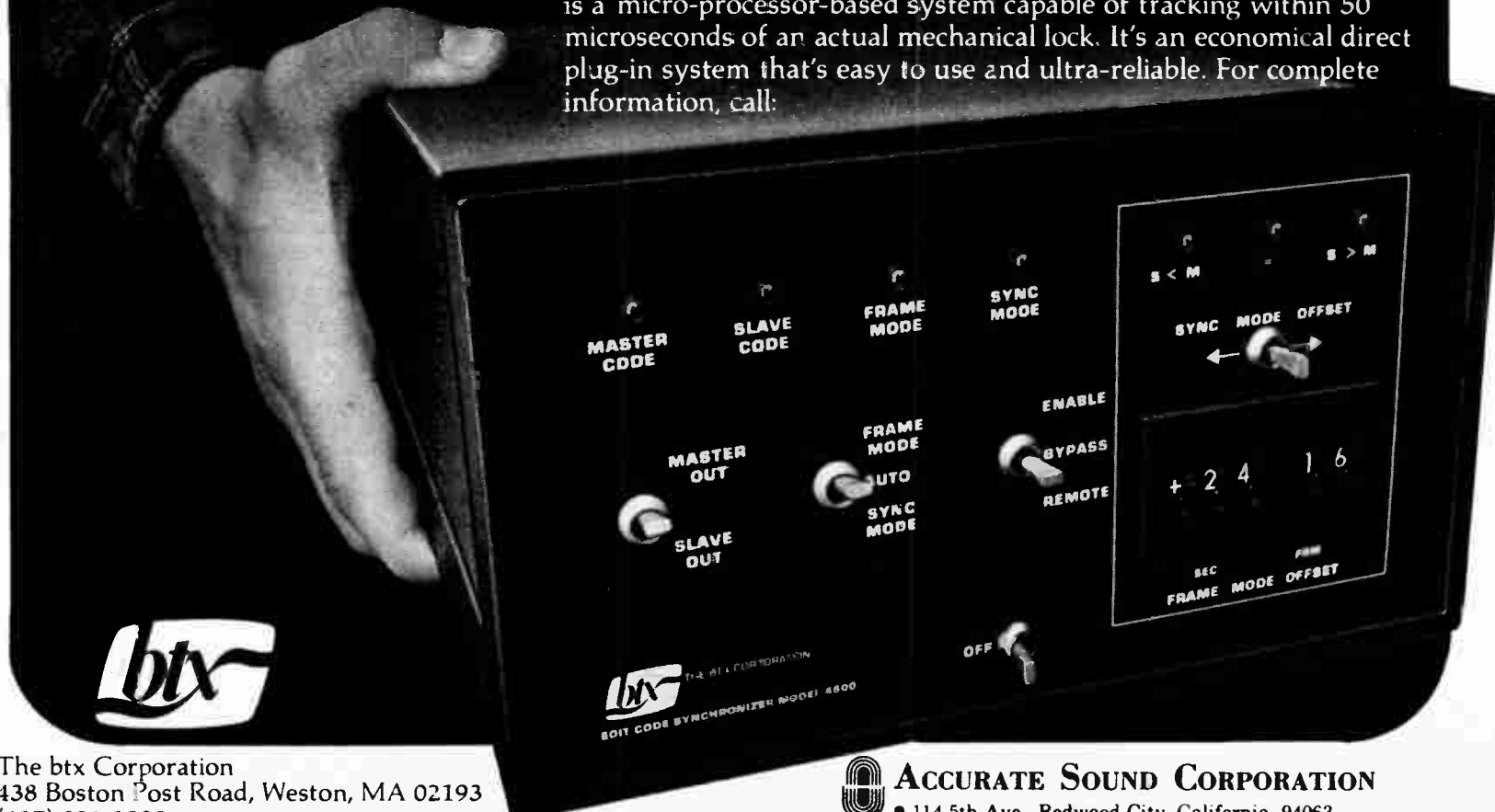

The btx Corporation  
438 Boston Post Road, Weston, MA 02193  
(617) 891-1239

**ACCURATE SOUND CORPORATION**  
• 114 5th Ave. Redwood City, California 94063



**Monitor Speakers:** Studio A: Westlake TM-1, Altec 604E w/Mastering Lab crossover; Studio B: Altec 604E w/Mastering Lab crossover.

**Outboard Equipment:** Eventide Harmonizers, Teletronics LA2A limiters, Pultec equalizers, Pultec filters, Eventide Flanger, DDL, Lang equalizers, UREI 1176LN limiters, Kepex's.

**Microphones:** Neumann U-87, U-67, KM-86, KM-84, U-47; Sony C37A, ECM-22, C-500; Shure 545; AKG 414, 412, C-24; Electro-Voice RE-20, RE-15.

**Instruments Available:** Hammond B-3 with Leslie, stereo Rhodes, 9' Steinway grand piano, and various electrical instruments.

**Extras:** Private baths and showers off each control room. (See below.)

**Rates:** \$150/hour.

**Direction:** The studio's main philosophy is to provide the artists and producers with a friendly professional atmosphere conducive to creativity and productivity. The approaching addition of Studio C will see the installation of the new Harrison 40 in/32 out console with the Westlake monitoring system, providing advanced technical facilities, while clients enjoy the convenience and luxury of Jacuzzi, kitchen facilities, game rooms and living quarters, allowing maximum freedom and encouragement to the production of music. Gold Record credits include: Johnny "Guitar" Watson's "Ain't That A Bitch" and "A Real Mother For Ya"; Frank Zappa's "Overnight Sensation" and "Apostrophe"; Peter McCann's "Do You Want To Make Love"; Diana Ross's "Love Hangover"; Thelma Houston's "Don't Leave Me This Way"; and George Duke's "Reach For It".

#### •••• ONE STEP UP RECORDING STUDIOS 8207 W. Third St., Los Angeles, CA 90048 (213) 655-2775

**Owner:** Allan H. Goodman. **Manager:** Mary Rigby. **Engineers:** Ed Bannon Director of Engineering; Rick Barcellona, James Simcik; 2nd Engineers: Nicki Turner and Dan Everhart.

**Dimensions of Studios:** 50' x 26', 17' arched ceiling.

**Dimensions of Control Rooms:** 20' x 19'.  
**Tape Recorders:** MCI Model JH-114 24 track with 16 track head stack; MCI Model JH-110 2 track; TEAC Model 33405 ¼ track; Electro Sound Model 505 2 track; Yamaha cassette recorder.

**Mixing Consoles:** MCI Model JH-528, 28 in x 28 out with new B&B Audio VCA's.

**Monitor Amplifiers:** Phase Linear 700B, Crown, BGW. **Monitor Speakers:** Custom "Big Red" System, JBL 4311 and 4333, ADS, Auratone, Sansui, AKG and Koss headphones.

**Outboard Equipment:** 1176's, LA3A's, Kepex, Gain Brains, MXR Phasing & Flanging, Eventide Flanging, Eventide DDL with pitch change, Eventide Harmonizer, Eventide Omnipressor, AKG BX-10, EMT 240, Parasond D'Esser, Multi-Track parametric EQ, API 550A EQ, Electrodyne CA-702, compressor/limiter, 361 Dolby's for 2 track, 24 track MN Dolby package for multi-track, Aphex.

**Microphones:** Shure SM-56; Sennheiser 211, 421; Electro-Voice RE-15, RE-20, RE-50, 635; AKG C-452 EB, C-12, C-414 EB; Neumann U-87, KM-84, KM-86.

**Instruments Available:** Baldwin (1952) grand piano, Fender Rhodes 88 (suitcase), Hammond B-2 organ.

**Extras:** Fully equipped kitchen with microwave oven, complete electronics lab for maint. and servicing all studio equipment, engineering services available for interfacing any outside equipment brought in.

**Rates:** \$160/hr for everything.

**Direction:** To provide state-of-the-art technology and the highest quality of service.

#### •••• PASADENA SOUND RECORDERS 276 N. Raymond Ave., Pasadena, CA 91103 (213) 796-3077

**Owner:** James M. & Gil Jones.

**Engineers:** Gil Jones.

**Dimensions of Studios:** 24' x 40' x 16'h. with 10' x 10' x 8'h. isolation booth.

**Dimensions of Control Rooms:** 17' x 25' x 10'h.

**Tape Recorders:** Ampex Model MM1000 24 track; Ampex (2) Model AG 350 2 track; Ampex Model 351 1 track; Ampex Model AG 500 2 (¼) track.

**Mixing Consoles:** Sound Techniques Model A Range, 22 in x 8 out patch 22.

**Monitor Amplifiers:** SAE MK III C & CM, Crown DC 300, Haeco 2-50.

**Monitor Speakers:** Altec 604E, (studio) Altec 9470A, disc lab: JBL 4301.

**Outboard Equipment:** Limiters: UREI 1176, UREI LA3A, Teletronics LA2A, Orban/Parasond D'Esser, Orban parametric, RCL spring echo, 3 live echo chambers.

**Microphones:** Telefunken Elam 251, AKG C-414EB, Telefunken M-410, E-V CS-15, RE-20, RCA 77, 44B, Western Electric 639, Altec 21B, E-V 666, Sony EC 22, AKG D-190.

**Instruments Available:** 6½' Mehlin grand piano, Hammond C-3 organ, Kohler upright piano.

**Extras:** Central air-conditioning, professional photographer available and that "Homey" feeling.

**Rates:** \$75/hr 24 track; \$30/hr 2 track, includes engineer. All other \$15/hr.

**Direction:** Now with "Taste of Honey's" Platinum Album out of the way, we hope for a big success, with an album soon to be completed for Warner Bros. by "The Mizells". (The producers of "A Taste of Honey" and "Donald Bird and the Black Birds"). Plans are being modified after the recent death of Andrea Robinson (an artist of Wiesman Prod. Group of America) for the release of her album in Europe. Otherwise it looks like a promising year for more good recording.

#### •••• THE PASHA MUSIC HOUSE A Division of The Pasha Music Organization 5615 Melrose Avenue, Hollywood, CA 90038 (213) 466-3507

**Owner:** Spencer Daniel Proffer.

**Engineers:** Larry Brown (Chief Engineer); Drew Bennett, Duane Baron, Mike Sanders, Bob Stringer, Sasha DePalma, Stephen Hoge.

**Dimensions of Studios:** Studio A: 28' x 35'; Studio B: 15' x 18'.

**Dimensions of Control Rooms:** Studio A: 19' x 20'; Studio B: 12' x 14'.

**Tape Recorders:** MCI Model JH-24 w/ ALIII 24 track; MCI Model JH-24 w/ ALII 24 track; MCI Model JH-110 2 track; Studer Model A-80-VU 2 track; Ampex Model 350 w/440 electronics and autolocator and Stephens 214 Capstan Supply, 2 track; Ampex/MCI Model 440 w/JH5 electronics 2 track.

**Mixing Consoles:** MCI Model JH 528 with B&B Audio VCA's, 28 in x 32 out; MCI modified JH-416, 24 in x 24 out.

**Monitor Amplifiers:** Phase Linear 700 Series 2; Marantz 250B; Crown D-60.

**Monitor Speakers:** Custom Big Reds with Mastering Lab crossovers, JBL 4311, Auratones.

**Outboard Equipment:** Lexicon Prime Time, Kepex, Gain Brains, Eventide DDL & Harmonizer, Full-Time Aphex, UREI LA2A, LA3A, 1176, Cooper, EMT 140, Inovonics 201, AKG BX-10, BX-20, Marshall Time Modulator, 24 tracks of Dolby A, (dbx on request), MXR Phaser & Flanger.

**Microphones:** Full range including Neumann, AKG, Sennheiser, PML, Sony, Shure, Telefunken, E-V. Specials available on request.

**Instruments Available:** Yamaha 9' concert grand piano, Steinway grand piano, Hammond B-3, double keyboard Mellotron with all tapes, Fender Rhodes 88, Yamaha electric piano, Hohner clavinet, Roland SH 5 synthesizer, Roland string machine.

**Extras:** Tastefully decorated studios and lounge with fireplace. Closed circuit TV.

**Rates:** Studio A: \$140/hr. Studio B: \$100/hr.

**Direction:** Pasha is a Division of The Pasha Music Organization, a major industry production company run by Producer Spencer Proffer. It has six artists signed to labels such as Atlantic; Polydor; WEA Ltd.; EMI Records, Ltd; Capricorn; and Polydor International. The studio was built by Spencer Proffer and Engineer/Producer Larry Brown from a producer and engineering vantage point and has many custom built features from the layout of the room to the monitor systems. Recent clients have been Proffer's English rock artists: Allan Clarke (Hollies); Dave Lambert (Strawbs); John Entwistle (Who); Billy Thorpe; Arlan Greene; and others such as England Dan & John Ford Coley.

#### •••• PRANAVA PRODUCTIONS Hollywood, CA 90048 (Please call for appointment) (213) 464-8489 or 466-7127 (message)

**Owner:** Ganapti.

**Engineers:** Hal Helleman, Vince Devalocich, Caryl Woodford and other free-lance engineers.

**Dimensions of Studios:** 18' x 15' with 10' x 10' isolation booth and 8' x 5' vocal booth.

**Dimensions of Control Rooms:** 15' x 10' acoustically designed.

**Tape Recorders:** Stephens Model 821A 24 track; Stephens Model 811C w/3M M56 transport 16 track; Dokorder Model 1140 4 track; Studer/Revox HS77 2 track; Aiwa Model 1800 cassette.

**Mixing Consoles:** Speck Electronics SP-800-C, 32 in x 16 out with 3-band continuously variable center frequency EQ, 3 sends, full patching.

**Monitor Amplifiers:** Sony 3200F's, 100 Watts per channel.

**Monitor Speakers:** JBL 4311's, Auratone Cubes.

**Outboard Equipment:** Eventide Harmonizer/EMT 140 type plate reverb, digital delay, Eventide Instant Flanger, MXR auto flanger, UREI 1176 limiters, dbx 161 limiters, Ampeg expanders, dbx noise reduction, SAE graphic EQ, Sound Workshop stereo reverb, tape delay.

**Microphones:** Sony C-37A's, ECM 22's, ECM 21's; Neumann U-87's; AKG 414EB, C-451's, 1000E, 190E; Sennheiser 441, 421; Electro-Voice RE-20, 666, RE-10's, RE-15; Shure SM-57's.

**Instruments Available:** Steinway grand piano, ARP 2600 synthesizer.

**Rates:** 24 track \$35/hr. 16 track \$25/hr.

**Direction:** Our philosophy is to provide an excellent recording environment with friendly, professional engineers. The studio has all the facilities required for recording master-quality basic tracks and overdubs. The studio is excellent for mixdown (acoustically flattened control room). We have recorded releases for major record companies, independent labels, network TV, as well as many successful demos.

#### •••• PRODUCERS' WORKSHOP 6035 Hollywood Blvd., Hollywood, CA 90028 (213) 466-7766

**Owner:** American Variety International. **Studio Manager:** Sue Harris.

**Engineers:** Galen Senogles, Rick Hart, Ed Schaff, John Rosenthal, David Baer, Steve Crimmel.

**Dimensions of Studios:** Studio 1: 20' x 15'.

**Dimensions of Control Rooms:** Studio 1: 20' x 15'. Studio 2: 20' x 15'.

**Tape Recorders:** (2) Stevens 24 track; (3) 3M Model M79 2 track; (2) Scully Model 280 2 track.

**Mixing Consoles:** Special 32 in x 8 out, special 32 in x 16 out.

**Monitor Amplifiers:** Marantz 240's.

**Monitor Speakers:** Big Reds with Mastering Lab crossover.

**Outboard Equipment:** UREI 1176 limiters, Inovonics 201 limiters, LA2A limiters, Cooper Time Cubes, Eventide Digital Delay, Eventide Phaser, UREI 550 filters, Kepex's, Gain Brains, Stevens D'Esser.

**Microphones:** Neumann U-67, U-87, M-49, U-47, KM-88, KM-84, U-64; AKG 414, 451, 452, X-61; Sennheiser MD-421U, MD-441U, MD-21U; Shure SM-56; E-V 666.

**Instruments Available:** Baldwin 9' piano, Fender Rhodes 88, ARP String Ensemble.

**Rates:** 24 track \$125/hr (Studio 1); 16 track \$106/hr (Studio 1); 8 track \$80/hr (Studio 2).

#### •••• QUAD TECK STUDIOS LTD. 4007 West 6th St., Los Angeles, CA 90020 (213) 383-2155

**Owner:** Studio Manager: Joani Waring & Hank Waring

**Engineers:** Staff Engineers: Hank Waring, Pat Burnette, Randy Cox, Dave Travis. **Free Lance Engineers:** Tony McCashen, John Greek, Jim Cone. **Second Engineers:** Jim Williams, Larry McComas.

**Dimensions of Studios:** Studio 8: 40' x 25' with 2 isolation booths (one for drums). Studio 6: 17' x 15' disc mastering room. Studio 5: 10' x 8' for narration.

**Dimensions of Control Rooms:** Studio 8 16' x 25'. Studio 7 20' x 18'. Studio 5 8' x 8'.

**Tape Recorders:** 3M Model 79 24 track; MCI Model JH 24 track; MCI Model JH 8/16 track playback only; Ampex Model AG 440B 2 track; Ampex Model 354 ¼ track; Ampex Model AG 440B 4 track; Scully Model 280 2 track.



# THE TAPE THAT'S TOO GOOD FOR MOST EQUIPMENT.

Maxell tapes are not cheap.

In fact, a single reel of our most expensive tape costs more than many inexpensive tape recorders.

Our tape is expensive because it's designed specifically to get the most out of good high fidelity components.

So it makes no sense to invest in Maxell unless you have

no one gets into our manufacturing area until he's been washed, dressed in a special dust-free uniform and vacuumed.

**WE CLEAN OFF THE CRUD OTHER TAPES LEAVE BEHIND.**

After all the work we put into our tape, we're not about to let it go to waste on a dirty tape recorder head. So we put special non-abrasive head cleaner

**OUR TAPE COMES WITH A BETTER GUARANTEE THAN YOUR TAPE RECORDER.**

Nothing is guaranteed to last forever. Nothing we know of, except our tape.

So our guarantee is simplicity itself: any-time you ever have a problem with any Maxell cassette, 8-track or reel-to-reel tape, you can send it back and get a new one.

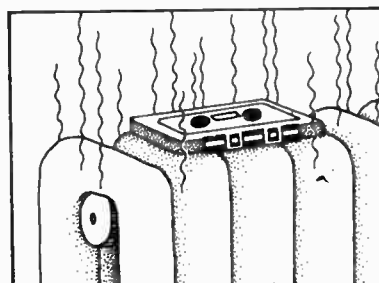

Our guarantee even covers acts of negligence.

sounds at your nearby audio dealer.

(Chances are, it's what he uses to demonstrate his best tape decks.)

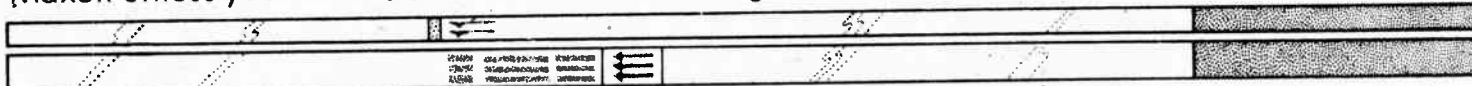

No other tape starts off by cleaning off your tape recorder.

equipment that can put it to good use.

**THE REASON OUR TAPE SOUNDS SO GOOD IS BECAUSE IT'S MADE SO CAREFULLY.**

Every batch of magnetic-oxide we use gets run through an electron microscope. Because if every particle isn't perfect, the sound you hear won't be either.

And since even a little speck of dust can put a dropout in tape,

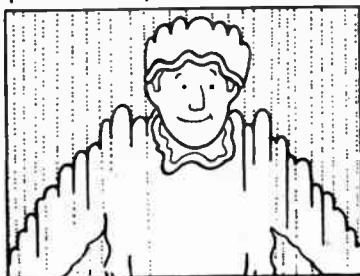

Every employee, vacuumed.

on all our cassettes and reel-to-reel tapes. Which is something no other tape company bothers to do.

**OUR CASSETTES ARE PUT TOGETHER AS CAREFULLY AS OUR TAPE.**

Other companies are willing to use wax paper and plastic rollers in their cassettes. We're not. We use carbon-impregnated material. And Delrin rollers. Because nothing sticks to them.

A lot of companies weld their cassettes together. We use screws. Screws are more expensive. But they also make for stronger cassettes.

**GIVE OUR TAPE A FAIR HEARING.**

You can hear just how good Maxell tape

You'll be surprised to hear how much more music good equipment can produce when it's equipped with good tape.

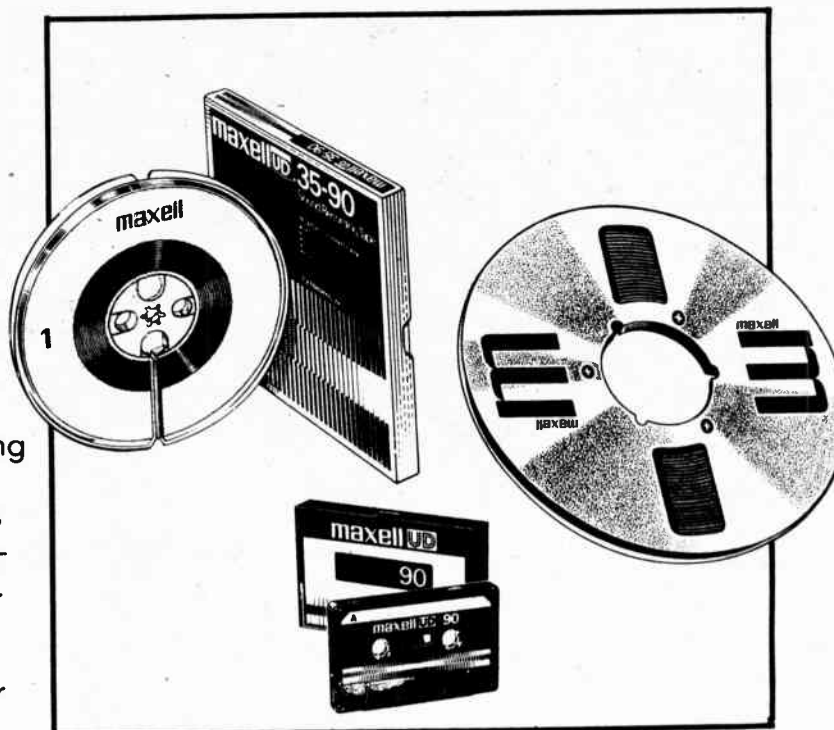

ALL CONFIGURATIONS ARE AVAILABLE FROM STOCK! The place to buy all MAXELL and other pro-audio products is:



COAST RECORDING EQUIPMENT SUPPLY INC  
6114 SANTA MONICA BOULEVARD • HOLLYWOOD, CALIFORNIA 90038  
CALL CRES (213) 462-6058



## *These Manufacturers know us*

ADI	Community Light & Sound	Kliegl	Sennheiser
AKG	Crown	Lexicon	Shure
AB Systems	dbx, Inc.	MRL	Sony
Allison Research	Detalab Research	Meteor	Soundworkshop
Altec	Diversitronics	MICMIX	Sound Craftsman
Altman	Dolby	3M	Soundolier
Ampex	Edit-all	Keith Monks	Stanton
Anvil	Electro Control	MXR	STL
Atlas	Electro-Voice	Neumann	Stran Century
Audioarts	Emilar	Orban	Studer
Audio and Design Recording	El Tech	Otari	Switchcraft
Auditronics	ESE	Panasonic Video	TDK
Automated Processes, Inc.	Eventide	Quantum	Tangent
BGW	Galaxy	Raymer	Tapco
Berkey Colortran	Gauss	Revox	TEAC/Tascam
Beyer	Genie Industries	Robins/Fairchild	Technics
BiAmp	GLI	Rosco	Times Square
Bobadilla	Great American Market	Russco	Union Connector
Burwen	Inovonics	SAE	Uni-Sync
Cetec	IVIE	Scotch	UREI
Clearcom	Klark-Teknik	Scully	White

## *You should too*

LOS ANGELES:  
 Burbank Sound  
 1317 N. San Fernando  
 Burbank, CA 91504  
 (213) 841-0062

UTAH:  
 Burbank Sound  
 327 E. 1200 S.  
 Orem, Utah 84057  
 (801) 224-4848





**Mixing Consoles:** Custom, 32 in x 24 out; Quad/Eight, 30 in x 8 out; Tascam, 10 in x 4 out; Electrodyne, 16 in x 4 out.

**Monitor Amplifiers:** SAE 200, ESS 1000, McIntosh 200, Crowns.

**Monitor Speakers:** JBL 4310, JBL 100's, JBL 4332, Auratone Cubes, facilities for hooking up your own speakers in Studios 7 & 8, Altec 604E w/Mastering Lab crossover.

**Outboard Equipment:** Teletronics LA2A's, UREI LA3A's, LREI 1176's limiters; UREI digital metronome, Eventide Phase, Eventide Harmonizer, 14" 30 ips recorders; EXR Exciter, VSO, Kepex's; Ampex tape loop 30/60 ips w/VSO; Pultec EQ's, Lang EQ's, graphic EQ's, EMT echo, AKG echo, Pultec program filters, Neumann SX 74 cutting system for mastering.

**Microphones:** All types, Neumann, Sony, Shure, Electro-Voice, Etc, direct boxes.

**Instruments Available:** Yamaha grand piano, Hammond B-3 organ with Leslie speaker.

**Extras:** Stereo disc mastering studio; reference dubs 7" 45 D/F \$18.00. Master's 45 \$25/side. 12" 33 D/F \$60.00. 33 LP \$65/side plus any EQ time at \$80/hr min. 1/4 track at \$20.00.

**Rates:** Prime time \$140/hr live recording. \$110/hr for mixing and over dubbing. Off hours \$95/hr recording and mixing.

**Direction:** Studio 5 Editing, tape and cassettes copies plus narration. Studio 6 stereo mastering studio - EQ time \$80/hr plus price of masters. Studio 7 24-track mixdown studio. Studio 8 24-track live recording and mixdown studio. Some of our clients are: MCA Records, RCA Records, UA Records, Columbia Records, Warner Bros. Records, Casablanca Records, Amhurst Records, Savoy Records, Cream Records, Claridge Records, Sound Like a Winner Prods, Ltd., Roger Williams, April Backwoods Music, Jobete Music, Gray Advertising and many, many more. Thank you. Hank Waring.



**QUANTUM RECORDING STUDIO**  
1425 Marcelina Ave., Torrance, CA 90501  
(213) 775-1340

**Owner:** Don Sciarrotta.

**Engineers:** Don Sciarrotta, Rick Lawler, Glenn Wallace.

**Dimensions of Studios:** 60' x 40'.

**Dimensions of Control Rooms:** 30' x 30'.

**Tape Recorders:** MCI Model JH-24 24 track; (3) MCI Model JH-2 2 track; Scully Model 280 2 track; (4) Marantz Model 5030B cassettes.

**Mixing Consoles:** Harrison Model 36-24, 36 in x 24 out.

**Monitor Amplifiers:** Crown DC-300, Marantz 510-M, Marantz 170DC.

**Monitor Speakers:** JBL 4343, Quantum cubes.

**Outboard Equipment:** UREI LA3A's, 1176's, 556 band pass filter; Cooper Time Cube; Eventide 1745M DDL with pitch control, Harmonizer, Omnipressor, Flanger; Kepex, Gain Brain, graphic EQ; Langevin filters; EMT; AKG echo, VSO, 60 ips tape echo.

**Microphones:** Neumann U-87, KM-84, U-47, U-67; AKG C22, 451, 452, 414; Sony C-37, C-500, C-47; Electro-Voice RE-20, RE-16; Shure SM-56, SM-53; Sennheiser 421, 424, 440, 405.

**Instruments Available:** Meletron, ARP, harpsicord, Mini Moog, drums, grand piano, guitar amps, organ.

**Extras:** Kitchen, color TV, game room, pong game.

**Rates:** \$100/hour.

**Direction:** Audio consulting-recording eng. Our direction is to continue to stay with the state-of-the-art....Credits: Kenny Rogers, Rod Stewart, Gary Puckett, Rufus, Jim Stafford, Gary Wright, Rare Earth, Wolfman Jack, Styx, Candy Staton, Jackie Lomax, Three Dog Night, Cold Blood, Daddy Dewdrop, Chaka Kahn, Barry White, Hudson Bros., Moms Mabley, Papa John Creech.



**RECORD PLANT, Los Angeles,**  
"Studio C"

**RECORD PLANT**

\*also REMOTE RECORDING\*

8456 West Third St., Los Angeles, CA 90048  
(213) 653-0240

**Owner:** Chris Stone.

**Engineers:** Lee DeCarlo (Chief Engineer); Bob Merritt, Gary Ladinsky, Mike Stone, John Stronach, Michael Braunstein, Deni King, Mike Beiriger.

**Dimensions of Studios:** A: 40' x 20' x 15'; with isolation booth 8' x 15' x 10'. B: 30' x 15' x 12'. C: 50' x 35' x 23' with stage and 2 isolation booths. D: 12' x 12' x 10' over-dub room.

**Dimensions of Control Rooms:** A: 15' x 15'. B: 16' x 16'. C: 16' x 20'. D: 16' x 16'.

**Tape Recorders:** 3M Digital Sound Recording system 32 track; 3M Model 79 4 track; 3M Model 79 24 track; 3M Model 79 2 track; 3M Model 64 2 track; 3M Model 64 4 track; Ampex Model 440-C 4 track.

**Mixing Consoles:** API's Model 2136, 32 in x 24 out; API Model 2290, 40 in x 24 out; API Model 2206 32 in x 24 out; custom designed consoles; all have automated mix-down and groupers.

**Monitor Amplifiers:** Studer A68, Crown DC 300A, Phase Linear 700B.

**Monitor Speakers:** Westlake TM-1, Altec 604E's with Mastering Lab crossovers, JBL 4311's, Auratone 5C's, anything available by request.

**Outboard Equipment:** Any Eventide, UREI Pultec, EMT, ADR, dbx, Dolby, Allison (inc. Allison 65K computers) units in house, including live chamber, EMT 250 digital processor, EMT 140ST and 240, plus AKG BX-20. Any item on request.

**Microphones:** Neumann, AKG, Shure, Electro-Voice, Altec, Sony, Sennheiser, Studer, Telefunken, etc. Any microphone available upon request.

**Instruments Available:** Hammond B-3 organ and Leslie, Yamaha piano and Steinway grand piano. (Piano and organ included in rates).

**Extras:** Two game rooms, Jacuzzi, sauna, private band living room with full bath and TV, private bedrooms with full bath.

**Rates:** Call Studio Manager for rates.

**Direction:** The Record Plant has 3 remote facilities capable of any recording situation (Wings - London Town, Cal. Jam 2, Aerosmith Live, Blues Brothers LP). Contact Sharon Presser - coordinator. Our new Studio C, designed by Tom Hidley of Eastlake Audio and Lee DeCarlo (Record Plant's Chief Engineer), represents the most advanced in acoustic and electronic technology. The custom API console's versatility in recording or remix including 40 inputs, 120 automated functions and unequalled flexibility of control in any mode, allows total freedom for producer and engineer. We are the first independent studio in the world to feature the new 3M 32 track digital sound recording system.



**REDONDO PACIFIC STUDIOS**

612 Meyer Lane #18, Redondo Beach, CA 90278  
(213) 376-4766, 652-9523, and 652-9498

**Owner:** Leigh Geriss, Patricia Yarborough; Mark Yarborough; General Manager; Office Managers: Robin Robinson and Catharina W. Masters.

**Engineers:** Roger Paglia, Dave Jerden, Bob Elia. Staff producers available at reasonable rates.

**Dimensions of Studios:** 35' x 25' x 14'.

**Dimensions of Control Rooms:** 20' x 20'.

**Tape Recorders:** Custom-modified Ampex Model MM1200 24 track; MCI Model JH110A 2 track; TEAC Model 3340S 4 track; Aiwa Model 6800 cassette.

**Mixing Consoles:** MCI Series 500 Model JH528 with automation, 28 in x 32 out.

**Monitor Amplifiers:** BGW 250B, BGW 250C, Vanalstine M250, BGW 100, and BGW 500D.

**Monitor Speakers:** Flush mounted UREI custom time-aligned 604E, JBL 4311's, Visonik-David 50's, Visonik-David 80's, and Auratones.

**Outboard Equipment:** AKG BX-20 echo chamber, EMT 240 Gold Foil echo chamber, 26 channels dbx, Eventide Harmonizer and Omnipressor, Kepex noise gates, Loft digital delay, Orban/Parasound parametric EQ, UREI 1175 limiters, UREI LA-3A audio levelers, and Prime Time digital delay phaser/flanger unit.

**Microphones:** Neumann KM-881's, KM-841's, KM-861's, U-87's; AKG C-414's, 452's; Beyer 201's, 250's, M69N's, 160, 260's; Shure SM-57's, SM-7; Sony ECM 220's, ECM 56F's; Electro-Voice RE-20's, RE-15's, 635A; Sennheiser 441's, 421's; and U-47 tube type Neumann.

**Instruments Available:** Steinway B grand piano; all rentals available.

**Extras:** Conference room and lounge available.

**Rates:** 24 track: \$85/hr; 24 track with automation: \$95/hr; block booking rates available. Ampex Grand Master 456 (2") tape: \$105.00 per reel.

**Direction:** We are professional engineers and studio coordinators to assist in creating your ultimate sounds. In the summer of 1979 we will open our second control and studio rooms to assist you, and the growing demand for quality and professional recording facilities.



**REDONDO PACIFIC STUDIOS, Redondo Beach**  
l to r: Bob Elia, Roger Paglia, Dave Jerden



**RPM INTL. STUDIOS**

2107 W. Washington, Los Angeles, CA 90019  
(213) 737-8000

**Owner:** Ray Charles.

**Engineers:** Bob Gratts.

**Rates:** \$65/hr.

**Direction:** We are a full service 24 track studio.



**RUDY RECORDS**

1550 Crossroads of the World,  
Hollywood, CA 90028  
(213) 464-4311

**Owner:** Rudy Records Corp. Graham Nash, President

**Engineers:** Independents, Don Gooch, General Mgr.

**Dimensions of Studios:** 25' x 35'.

**Dimensions of Control Rooms:** 20' x 17'.

**Tape Recorders:** MCI Model JH 110 24 track; 3M Model 56 16 track; 3M 2 track; (2) MCI 2 & 4 track.

**Mixing Consoles:** Custom DeMedio, 32 in x 16 out.

**Monitor Amplifiers:** Custom monitor system.



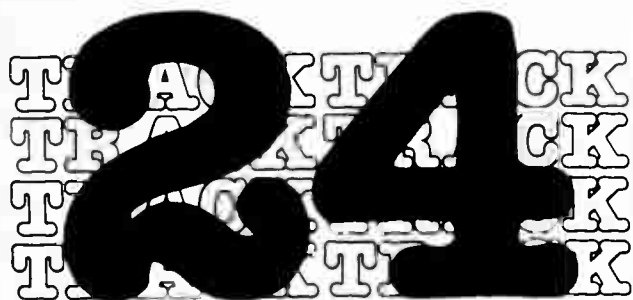

**Monitor Speakers:** Custom.  
**Outboard Equipment:** Dolby, dbx 28-channels, digital delay line, digital echo chamber, (2) UREI 1176 limiters, Delta delay line, Orban D'Esser.  
**Microphones:** 50 different microphones available including Neumann, Beyer, AKG, Sennheiser, Neumann SM-69 stereo mic, Neumann tube mics.  
**Instruments Available:** Yamaha C-3 grand, Fender guitar amp.  
**Extras:** Drum and vocal booth.  
**Rates:** \$125/hr plus tape. Block booking rates.



•••• RUSK SOUND STUDIOS

1556 N. La Brea Ave., Hollywood, CA 90028  
 (213) 462-6477

**Owner:** Randy Urlik, Sam Kaufman.  
**Engineers:** Steve Smith, Chief Engineer. Roman Olearczuk, Chief Technical Engineer. Carolyn Tapp, Assistant. Tony Cassella, Assistant.  
**Dimensions of Studios:** 30' x 60'.  
**Dimensions of Control Rooms:** 20' x 20'.  
**Tape Recorders:** Ampex Model MM1200 24 track; Ampex Model ATR 102 2 track; Ampex Model ATR 104 4 or 2 track; TEAC Model 7010 1/4 track; TEAC Model 7400 2 track with VSO.  
**Mixing Consoles:** Harrison Model 3232B w/Allison 65-K programmer (automation).  
**Monitor Amplifiers:** Crown DC300A.  
**Monitor Speakers:** Sierra Hidley monitors, Altec 604E's, JBL 110's, Auratone 5PC Superpro's.  
**Outboard Equipment:** (4) 1176 UREI limiters, (2) dbx 160 limiters, dbx 162 stereo limiter, Orban stereo parametric equalizer (622B), Eventide DDL 1745-A Digital Delay, Pultec program equalizer, digital metronome, Cooper Time Cube, BX-20 reverb (echo chamber) 0 to 4 1/2 sec., stereo live echo chamber 3 - 5 sec. delay, (2) Kepex noise gate/expanders.  
**Microphones:** Sennheiser MD421/9, MKH 405; AKG D224E, C452 EB, C451; Electro-Voice RE-20, RE-15, L751; Sony C22; Neumann U-67, U-47, U-47 FET; Shure SM-60, 545, SM-59, SM-7; Altec 175 base with 29A head; RCA 44B, 77; AKG D202E, 414 EB; Shure 545.  
**Instruments Available:** Yamaha grand piano, Hammond C-3 organ with Leslie, tack piano.  
**Rates:** \$150/hour.



•••• SALTY DOG RECORDING STUDIO

14511 Delano St., Van Nuys, CA 91411  
 (213) 994-9973

**Owner:** David Coe.  
**Engineers:** Freelance engineer, second engineer provided by studio.  
**Dimensions of Studios:** 50' x 30'.  
**Dimensions of Control Rooms:** 20' x 25'.  
**Tape Recorders:** 3M Model M79 with intelocator 24 track; Ampex Model 440B 2 track; Ampex Model 440B 2/4 track; Ampex Model 440B 8 track; TEAC Model 3340S 4 track; Sony Model 654-4 4 track.  
**Mixing Consoles:** MCI Model JH 528, 28 in x 32 out with many sonic improvements.  
**Monitor Amplifiers:** SAE.  
**Monitor Speakers:** Altec System and Auratones.  
**Outboard Equipment:** Kepex, Gain Brain, UREI 1176 LN limiters, UREI LA4A's, Inovonics 201 limiters, Cooper Time Cube, UREI notch filter, stereo EMT echo plate, Marshall Time Modulator, Orban 516 EC D'Esser, Haeco CSG-4 turntable, MXR phaser, MXR flanger, cassette recorder, line level microphones and direct boxes.  
**Microphones:** Neumann KM-84's, U-87's, tube U-47's; AKG 414's, 452's; Sennheiser 421's; RCA 44; Sony C-37 A's; line level mics (custom design).  
**Instruments Available:** Steinway grand piano, AB Chase upright with tack attachment.  
**Extras:** lounge with extras.  
**Rates:** 24 track \$130/hr, 8 track \$55/hr, 2 track \$55/hr. Call Pam for complete booking information.

**Direction:** In operation since October, we have been proud to work with the top talent of the industry. Our exclusive line level microphones and powered direct boxes are giving us the sonic superiority we had hoped for. The monitors and room have excellent resolution and imaging with no monitor EQ, and the staff completes the package with excellent, helpful service.



SALTY DOG STUDIO, Van Nuys



•••• SANTA BARBARA SOUND RECORDING

33 W. Haley St., Santa Barbara, CA 93101  
 (805) 966-6630

**Owner:** Dean Thompson.  
**Engineers:** Daniel Protheroe.  
**Dimensions of Studios:** 35' x 30', isolation booth #1 16' x 12', isolation booth #2 18' x 12'.  
**Dimensions of Control Rooms:** 20' x 17'.  
**Tape Recorders:** Ampex Model MM-1200 24 track; Ampex Model MM-1000 16 track; Ampex Model MR70 2 track; Studer Model A80 2 track.  
**Mixing Consoles:** MCI Model JH500 with automation, 28 in x 28 out.  
**Monitor Amplifiers:** Phase Linear 700, Accuphase M60, Accuphase 300.  
**Monitor Speakers:** UREI 813, Altec 604, JBL 4310, Auratone.  
**Outboard Equipment:** UREI 1176, RCA BA6A limiter, EMT 156 stereo limiter, MXR digital delay, Pultec EQ, White EQ, EMT 140 ST, AKG BX-20 reverb, Nakamichi and Revox copy machines, Kepex, UREI LA3A, Countryman phaser, Gain Brain, Dolby M24, Dolby 361, ADR Scamprack, Lexicon delay, Marshall Time Modulator, Sontec MEP 250A, API 550A EQ, API 525 limiter.  
**Microphones:** Sony C-37A, C-55P, C-500; AKG 414, X-12A, C-60, C-24, 451; Neumann U-47, U-67, U-87, KM-84, KM-54, M-49, SM-23; Sennheiser 441, 421; Shure SM-53, 57, 58, 545; Electro-Voice RE-15, RE-20, 633; Telefunken 251.  
**Instruments Available:** Kawai 6 1/2" piano, Yamaha 7'4" grand, Hammond B-3 with Leslie, 24-hour instrument rental nearby.  
**Extras:** Kitchen, shower.  
**Rates:** Please call for quotes.  
**Direction:** The musician comes first. The studio was designed to be comfortable and efficient. We are in this because we love it!



•••• SIERRA PACIFIC STUDIOS, INC.

11739 Ventura Blvd., Suite 5, Studio City, CA 91604  
 (213) 769-3344

**Owner:** Robert Apperson, Patrick McDonald. Studio Manager J.C. Stone.  
**Engineers:** Patrick McDonald, Reed Stanley, Larry Staffen.  
**Dimensions of Studios:** Approximately 700 sq. ft.  
**Dimensions of Control Rooms:** Approximately 250 sq. ft.  
**Tape Recorders:** 3M Model 79 24 track.  
**Mixing Consoles:** Amek Model 2000, 28 in x 24 out.

**Monitor Amplifiers:** SAE, Crown, BGW, Tapco.  
**Monitor Speakers:** E-V Century Five, Auratone, JBL.  
**Outboard Equipment:** EMT ST140 reverb, Eventide Harmonizer, Eventide FL201 Flanger, UREI LA4 compressor/limiter, UREI 1176 limiter, Universal Audio 565 notch filter set, Lang PEQ-4 equalizer, 24 tracks of Dolby with dbx cards.  
**Microphones:** Neumann U-87's; Sony ECM 22's; AKG D-202E, C-452 EB's; Sennheiser MD-421's; Electro-Voice RE-20's, RE-11's; Shure SM-56's, and Sony C-37A.

**Instruments Available:** Kawai grand piano.

**Extras:** Kepex (4).

**Rates:** Reasonable rates upon request.

**Direction:** We have been located at the same place for the past two years and have had increasing success and look forward to a great '79, with the improvements made. Our clients this past year have included: Edwin Starr, Billy Barty, Lane Caudel, the Dallas Cowgirls, Brian Ahern, John Stewart, Keni St. Lewis, MCA Records, Warner Brothers Records, 20th Century Records, RSO Records, Phonogram, Ariola Records, Prospect Records, Electra-Asylum Records, Arrow Records, Butterfly Records, Carousel Records, Quest Records, and Covenant Records, WNET-New York Channel 28, KCOP TV Channel 13, MGM Films, and Gallerie International Films. Look out '79!



SIERRA PACIFIC STUDIOS, INC., Studio City



•••• SILVERY MOON STUDIOS

326 1/2 North La Cienega Blvd.,  
 Los Angeles, CA 90048  
 (213) 659-0688

**Engineers:** Rick Bralver, Micheal Boshears, Rick Wilson, Mark Hanen.  
**Dimensions of Studios:** 30' x 22' with 25' x 10' isolation booth.  
**Dimensions of Control Rooms:** 22' x 12'.  
**Tape Recorders:** MCI Model JH-100 24 track; Ampex Model 440/B 2 track; Ampex Model 440/C 2 track.  
**Mixing Consoles:** ASD Model 3024, 30 in x 24 out.  
**Monitor Amplifiers:** ASD custom.  
**Monitor Speakers:** Gauss, JBL.  
**Outboard Equipment:** Lang EQ, Q-Metric EQ, LA3A limiter, UREI 1176 LN, Omniphase, MXR Phaser, Eventide Phaser, DDL, Orban, Kepex, Gain Brain and anything else needed to alter time, space and tonality.  
**Microphones:** Sony, Shure, Electro-Voice, Beyer, Neumann, AKG, etc.  
**Instruments Available:** Steinway grand piano, Hammond B-3 organ.  
**Extras:** Lounge.  
**Rates:** \$125/hour.  
**Direction:** We began as an eight track studio in December of 1972 and did the usual bootstrap to 24 track. Credits include: Rusty Weir, Richie Havens, Steven Fromholtz, Lily Tomlin, Flash Cadillac, Flower, Richard Baskin, Shotgun, Jiva. We have done soundtracks to: "Welcome to L.A.", "Nashville", "The Late How", "California Split", and "The Buddy Holly Story"; also Afro-Cuban Band, Traveler, and Moulin Rouge.





## **The Problem....**

...is you need more than just equipment to be sure you achieve the business you're looking for. Whether it's better quality, increased profits, greater flexibility or reduced costs, each piece of equipment has to be evaluated as an integral part of your system.

For years, we at ACCURATE SOUND CORPORATION have been helping our clients translate their needs into the equipment that will give them what they are looking for. Modernizing, expanding or just starting out, we are familiar with your problems. And we can help you come up with the right answers.

## **The Solution...**

... may lie with one of the numerous brand names we represent like 3M, HARRISON and QUAD EIGHT.

... or our own equipment may be more appropriate. Our products include:

### **2400 Duplicator and 2600 Transport**

Now you can go from original to copy in two easy steps. Together, they provide the finest Real Time performance for high-speed and low-cost duplicating.

### **Starbird Microphone Boom**

For years the standard of excellence, the Starbird reduces costly set-up time dramatically, and assures maximum safety for studio personnel. Its design permits quick and precise "spotting", with maximum extension and height flexibility.

### **4000 Cassette Logger**

This rugged rack-mounted system performs efficiently for low speed logging, normal cassette record/playback and medium-speed duplication. Compatible with any cassette head format, the modular design gives you greater flexibility than other loggers.

... or perhaps you just need to talk to one of our experienced staff. Ask for an Audio Analysis, and one of our consultants will be happy to tell you more about our system concepts, acoustical designs and leasing programs.

**Remember, Your bottom line is our top priority.**

*"... BECAUSE SOUND COMES FROM A SYSTEM"*



**accurate  
sound corporation**  
CONSULTANT · STUDIO EQUIPMENT AND DESIGN  
RECORDING EQUIPMENT · MANUFACTURING  
SALES & SERVICE

114 - 5TH AVENUE  
REDWOOD CITY, CA. 94063  
Telex: 34-8327  
(415) 365-2843

# 24

•••• **SMOKETREE RANCH**

**9752 Baden Ave., Chatsworth, CA 91311  
(213) 998-2097**

**Owner:** Doug Parry. Studio Manager: Michael Rand.  
**Engineers:** In-house and outside independents.  
**Dimensions of Studios:** 23' x 37'.  
**Dimensions of Control Rooms:** 17' x 23'.  
**Tape Recorders:** MCI Model JH 24 track; MCI Model JH 16 track; (2) MCI Model JH-110A 2 track; Tandberg Model TC-330 cassette; Nakamichi Model 550 cassette; TEAC Model A3340.  
**Mixing Consoles:** MCI Model JH-500 with automation.  
**Rates:** Please call for rates.



•••• **SOUND ARTS**

**2825 Hyans St., Los Angeles, CA 90026  
(213) 487-5148**

**Owner:** Peter Bergren, Bob Walter, Dan Wyman, Jim Cypherd.  
**Engineers:** Peter Bergren, Jim Cypherd; Resident Synthesists: Dan Wyman, Jim Cypherd, Rick Bowls.  
**Dimensions of Studios:** 20' x 20'.  
**Dimensions of Control Rooms:** 24' x 20'.  
**Tape Recorders:** Ampex Model MM1200 24 track; Ampex Model ATR 102 2 track; Nagra Model 4SL 2 track.  
**Mixing Consoles:** Quantum, 26 in x 8 out.  
**Monitor Amplifiers:** Crown Model DC 300, BGW Model 250B.  
**Monitor Speakers:** JBL 4315's, JBL 4310's.  
**Outboard Equipment:** Eventide Digital Delay, Orban/Parasound parametric EQ's, 360 systems frequency shifters, Bode frequency shifter, Roland space echo with chorus, Gain Brains, UREI digital metronome, Ampex VSO.  
**Microphones:** Neumann U-87's, KM-84's; Shure SM-54's; E-V RE-15; AKG 124E, D-1000E, C-12A's; FRAP and Barcus Berry.  
**Instruments Available:** Moog Model 55C+ modular system, Sequential Circuits Prophet synthesizer, Oberheim 4-voice with programmer, Yamaha CS-80, Polymoog, ARP 2600, Mini Moog, ARP String Ensemble, Moog Model 15, Maxi Korg, Roland SH1000, Baldwin electric harpsichord, Yamaha EX42 organ, Hammond B-3, Hohner clavinet, Steinway grand piano.  
**Rates:** \$105/hr for studio with all synthesizers; \$95/hr for block booking rates.  
**Direction:** We are a production team of synthesists and engineers who have set up a 24 track studio with one of the largest arrays of professional synthesizers ever assembled. In addition to our own production, we work with outside producers and composers on electronic tracks that run from rock and roll to orchestral scores to specialized sound for films, television productions and commercials. Our strength as a studio is that our synthesizers and sound modification gear are already interfaced with the recording system so we can produce complex synthesizer tracks more quickly and efficiently than has been possible before.



•••• **SOUNDCASTLE RECORDING STUDIOS**

**2840 Rowena Ave., Los Angeles, CA 90039  
(213) 665-0008, 665-5201, 665-5202**

**Owner:** Buddy King.  
**Engineers:** Rilk Donaldson, 2nd — Bino Espinoza.  
**Dimensions of Studios:** 26' x 32' 16' ceiling.  
**Dimensions of Control Rooms:** 18' x 22'.  
**Tape Recorders:** Ampex Model MM 1200 VSO 24  
**Mixing Consoles:** Harrison VCA computer ready, 32 in x 32 out.  
**Monitor Amplifiers:** Crown DC 300.  
**Monitor Speakers:** UREI Time-Align.

**Outboard Equipment:** Orban/Parasound D'Esser, (2) Kepex's, Allison Gain Brain; limiters: (4) 1176's, UA 175B, Teletronix; Equalizers: full parametric EQ, ITI, Pultec outboard EQ tube mid-range; Echo: AKG BX20, BX10, EMT 240 Gold Foil reverb; Eventide Instant Flanger, Eventide Instant Phaser, Eventide Harmonizer, Eventide Digital Delay.

**Microphones:** Neumann U-87's, U-67, KM-84's, U-47's, M-49's; AKG C-12, 452's, 414EB's; Sony C500's; Sennheiser MKH 415T, MD421, Re-20, Sm-53, SM-56's, SM-57's, and others.

**Instruments Available:** Yamaha Grand.  
**Rates:** \$100/hr including engineer.

**Direction:** From Hollywood: Sunset Blvd. east to Hyperion Ave., left on Hyperion to Rowena, right 2 blocks to 2840 Rowena. From the valley: Golden State Fwy. south to Los Felix Blvd. exit, west on Los Felix Blvd. to Griffith Park Ave., left on Griffith Park Ave. to Rowena, left on Rowena approx. 8 blocks to 2840 Rowena.



•••• **THE SOUND CHAMBER**

**27 So. El Molino Ave., Pasadena, CA 91101  
(213) 795-0217**

**Owner:** Richard McIlvery, Randy Farrar.  
**Engineers:** Richard McIlvery, Randy Farrar.  
**Dimensions of Studios:** 16' x 40'.  
**Dimensions of Control Rooms:** 16' x 12'.  
**Tape Recorders:** Stephens 24 track; Ampex Model AG 440 8 track; TEAC Model 3340 4 track; Sony cassette.  
**Mixing Consoles:** Tangent Model 3216, 16 in x 16 out; Bi-Amp Model 1202, 12 in x 2 out.  
**Monitor Amplifiers:** Cerwin-Vega M400, Marantz thirty-two, Cerwin-Vega A1800.  
**Monitor Speakers:** JBL 4311, Cerwin-Vega R123.  
**Outboard Equipment:** UREI limiters, Cerwin-Vega graphic equalizer, Bi-Amp stereo reverb, flangers.  
**Microphones:** Shure, AKG, Sony, Sennheiser.  
**Instruments Available:** Hammond organ with Leslie speaker, Fender Rhodes, clavinet, Chamberlin string & horn keyboard, Moog & ARP synthesizers.  
**Extras:** Affiliated with Sound Chamber Music Co. retail store. Many instruments effects and amplifiers available for studio rental at reasonable prices. Music copying, arranging, musicians, and production available.  
**Rates:** 24 track \$70/hr; 8 track \$25/hr; 2 & 4 track \$15/hr; Rates do not include tape. Block rates available.  
**Direction:** Dedicated to giving the customer his money's worth. We are open to working with people with limited budgets with no sacrifice in sound quality. All personnel have had extensive experience in all areas of professional recording.



•••• **SOUND CITY**

**15456 Cabrito Road, Van Nuys, CA 91406  
(213) 787-3722, 873-2842**

**Owner:** Jow Gottfried and Tom Skeeter.  
**Engineers:** Steve Excallier, Bill Drescher, Gary Lubow, Tori Swenson, and various independent engineers.  
**Dimensions of Studios:** A: 40' x 40'; B: 20' x 30'.  
**Dimensions of Control Rooms:** A: 25' x 15'; B: 25' x 20'.  
**Tape Recorders:** Studer Model A-80 24 track; Ampex Model MM-1200 24 track; Studer Model A-80 2 track; Ampex Model AG-440 4 track.  
**Mixing Consoles:** Neve, 28 in x 16 out; Neve, 32 in and 24 out.  
**Monitor Amplifiers:** SAE MK III A, Crown DC-300.  
**Monitor Speakers:** JBL (custom designed and tuned by George Augspurger), Auratones.  
**Outboard Equipment:** Lexicon DDL, Eventide DDL, flanger, Harmonizer, Lang and Pultec equalizers, Teletronix, UREI Pye and Neve limiters, Cooper Time Cubes, D'Esser.  
**Microphones:** Neumann U-47, U-67, U-47 FET, U-87, KM-84, KM-86; AKG C-451E, C-12A; Electro-Voice RE-20, RE-15; Shure SM-7, SM-56, SM-57; Beyer M-160; RCA 77DX; Sennheiser MD-421.  
**Instruments Available:** Hammond C-3 organ with Leslie, two Steinway grand pianos.  
**Extras:** Pinball, ping pong, darts, TV and lounges.  
**Rates:** \$125/hr (includes Dolbys and an engineer or second).  
**Direction:** Sound City is in the construction stage of building a mixdown room, which should be ready within six months. The monitor system will include JBL's and 604E's, both George Augspurger designed.



•••• **SOUND FACTORY**

**6357 Selma Ave., Los Angeles, CA 90028  
(213) 467-2500**



**THE SOUND INVESTMENT COMPANY,**

Los Angeles

Cisco De Luna

•••• **SOUND INVESTMENT**

**1655 Compton, Los Angeles, CA 90021  
(213) 748-2057**

**Owner:** Richard Robeson, Ben Casares.  
**Engineers:** Cisco De Luna.  
**Dimensions of Studios:** 30' x 60'.  
**Dimensions of Control Rooms:** 25' x 10'.  
**Tape Recorders:** MCI 24 track; MCI 2 track; Otari 2 track.  
**Mixing Consoles:** MCI Model 428, 24 in x 24 out.  
**Monitor Amplifiers:** Crown DC 300.  
**Monitor Speakers:** JBL 4333.  
**Outboard Equipment:** 1176 limiters, UREI graphic EQ's, Dolbys, Master-Room III echo, EMT Gold Foil.  
**Microphones:** Neumann U-87's, KM-84's; AKG 452's, C-414; Sennheiser MD-421; Shure SM-57's, SM-7's; Sony ECM 33F.  
**Instruments Available:** Steinway 6' grand piano.  
**Extras:** \$60/hr, we encourage block booking.  
**Direction:** We are in a very secluded and private environment. We work well with large string sections, with room for 30 musicians in our large, live room.



•••• **SOUND LABS, INC.**

**1800 N. Argyle Ave., Los Angeles, CA 90028  
(213) 466-3463**

**Owner:** Armin Steiner.  
**Tape Recorders:** Studer Model A-80 UUII, 24 track; 3M Model M79 24 track; 3M Model M56 16 track; 3M Model M64 4 track; Scully Model 280B 2 track.  
**Mixing Consoles:** Quad/Eight, 32 in x 24 out; Sound Lab Model 201, 24 in x 24 out; Sound Lab Model 301, 26 in x 4 out; Sound Lab outboard, 8 in x 2 out.  
**Monitor Amplifiers:** Harman Kardon Citation 12.  
**Monitor Speakers:** Altec 604 with Mastering Lab crossovers.  
**Outboard Equipment:** Cooper Time Cubes, Instant phasers, Orban D'Esser's, UREI limiters, Little Dipper, EMT plate stereo chambers, live chamber in Studio 1, Gold Foil chamber in Studio 3.  
**Microphones:** Neumann U-87, U-47, KM-84, KM-88; AKG C-412, C-451, C-452; Sennheiser 441, 421; Shure 545, SM-53; RCA 77 DX.  
**Instruments Available:** All rental except upright piano in Studio 1 and grand piano in Studio 2.  
**Extras:** Game room, TV.  
**Rates:** Please call.



•••• **SOUNDS GOOD RECORDING**

**11323 Santa Monica Blvd.,  
West Los Angeles, CA 90025  
(213) 478-6416**

**Owner:** Bill Fletcher.



# RECORDING STUDIOS

# MUSIC PRODUCTIONS



MUSIC LAB offers the finest and the largest collection of equipment and the best selection of music production services among the professional economically oriented recording studios.

**Cassette Copies: \$1.00 each!**

**1, 2, 3, 4, 8, 16, & 24 tracks.**

**Easy parking!**

**24 Track: \$38.**

**Open 24 hours.**

**{213} 666-9000 & 662-3965**

**Hollywood, California**

**Master Charge, VISA, & American Express.**

Time-Based Effects . . . Without the Side-Effects.  
Introducing the 440 Delay Line/Flanger from Loft Modular Devices.



There is a new solution for time-based effects. Filling the gap between expensive digital lines and low cost 'black boxes', the Series 440 Delay Line/Flanger delivers the amazing depth and dramatic realism rightly associated with analog delay effects. Yet it avoids so many unwanted side effects you expect from analog and even some digital systems.

Now, you don't have to sacrifice the dimensional impact of your music to severely limited bandwidths, nor lose that bright crisp edge to compromised electronics. Gone too, are the 'thumps', 'whistles', background oscillations, quantizing noise, 'grainy' digital audio, and other strange distortion you may have noticed before. Even headroom, a real problem with so many units, is no problem with the Series 440 Delay Line/Flanger.

All you get is great sounding delay combined with the creative flexibility of VCO time based processing. Mixed to any degree with straight delays from .5msec all the way out to 160msec., VCO processing permits such effects as resonant flanging, Leslie-type sounds with different 'rotation' speeds, vibrato, double tracking with realistic pitch and timing errors, or a wide range of more subtle effects to control the spatial perspective of your music. In addition to the built-in VCO feature, control voltage jacks allow further modification of the system's special effects capability. Impressive? We think so, but there is more. Why not check out the details at a representative dealer near you.

The Series 440 Analog Delay Line/Flanger is in stock and ready for immediate delivery.

LOFT MODULAR DEVICES, INC. 91 Elm St. Manchester, CT 06040 (203) 646-7806

# GET A FREE ANVIL CASE & ARP PERFORMANCE STAND WHEN YOU BUY AN OMNI-2!

The ARP Omni-2 is the hottest selling — and hottest sounding — synthesizer in music.

Now, through March 31, 1979, you can get all the great sounds the Omni-2 has to offer — strings, horns, and sounds from harp to harpsichord — plus a FREE Anvil road case and ARP performance stand. A \$250 retail value, *free!*

If you're a keyboard player, you know the kind of value we're offering. But time is limited. Visit one of the participating Certified ARP Dealers listed here today. Offer expires March 31, 1979.



## ONLY AT THESE CERTIFIED ARP DEALERS

**HANICH MUSIC**  
235 N. Azusa Avenue  
West Covina, CA

**DAVID ABELL FINE PIANOS**  
8162 Beverly Blvd.  
Los Angeles, CA

**CHARLES MUSIC STORE & STUDIO**  
421 N. Glendale  
Glendale, CA

**SIGHTSINGER MUSIC**  
3723 S. Bristol  
Santa Ana, CA

**SIGHTSINGER**  
804 N. Tustin Avenue  
Orange, CA

**WEST L. A. MUSIC**  
11345 Santa Monica Blvd.  
West Los Angeles, CA

**COLEMAN MUSIC COMPANY**  
390 Bernard Street  
Bakersfield, CA

**BRAVIROFF PIANO & MUSIC COMPANY**  
1170 North E Street  
San Bernardino, CA

**DEAN'S MUSIC CITY**  
82704 Miles Avenue  
Indio, CA

**PRO SOUND MUSIC**  
6549 Magnolia Avenue  
Riverside, CA

**APEX MUSIC CO.**  
702 Broadway  
San Diego, CA

**CASTLE MUSIC CENTER**  
5796 Calle Real  
Goleta, CA

## The Orban 672A: A Dream Equalizer at a Practical Price

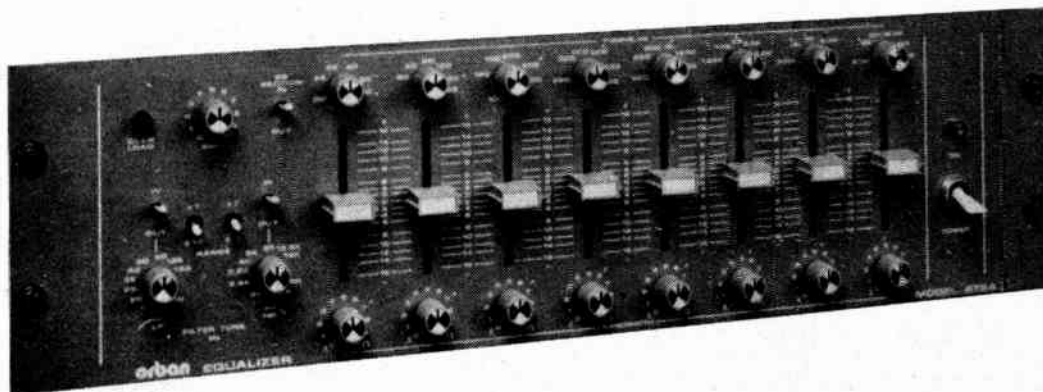

The 672A is a single-channel equalizer offering astonishing control and versatility. There are eight non-interacting parametric bands with reciprocal curves and the convenience of graphic-style controls. Highpass and lowpass filters with 12dB/octave slopes that tune continuously over a 100:1 frequency range. And, separate outputs that let you use the 672A as an eight-band parametric cascaded with an electronic crossover in reinforcement and monitor tuning applications.

The dream equalizer is usable practically *everywhere* in professional and semi-pro-

fessional sound: recording studios, cinema, theater, reinforcement, broadcasting, disco — you name it! Yet its price is down-to-earth: \$499\*. And, it's built to full professional standards.



**Orban Associates Inc.**  
645 Bryant St.  
San Francisco, CA 94107  
(415) 957-1067

\*suggested list



Check it out at your ORBAN DEALER.

**A-1 Audio Rentals**  
Hollywood  
(213) 465-1101

**Acromedia**  
Culver City  
(213) 390-4407

**Audio Concepts**  
Hollywood  
(213) 851-7172

**Audio Industries Corp.**  
Hollywood  
(213) 851-4111

**Coast Recording and Equipment Supply**  
Hollywood  
(213) 462-6058

**Compact Video Sales**  
Burbank  
(213) 843-3232

**Everything Audio**  
Encino  
(213) 995-4175

**Express Sound**  
Costa Mesa  
(714) 645-8501

**Hollywood Sound Systems**  
Hollywood  
(213) 466-2416

**Pacific Recorders and Engineering Corp.**  
San Diego  
(714) 453-3255

**Paramount Sound Systems**  
Glendale  
(213) 242-4102

**Sound System Labs**  
Camarillo  
(805) 482-5081

**Studio Maintenance**  
North Hollywood  
(213) 877-3311

**Video Systems Network**  
Los Angeles  
(213) 871-0677

**Westlake Audio**  
Los Angeles  
(213) 655-0303

**West L.A. Music**  
Los Angeles  
(213) 477-1945



**Engineers:** Joel Moss, Andy Sells.  
**Dimensions of Studios:** 16' x 28'.  
**Dimensions of Control Rooms:** 15' x 14'.  
**Tape Recorders:** Stephens Model 821A 24 track.  
**Mixing Consoles:** API, 30 in x 16 out.  
**Monitor Amplifiers:** BGW 750.  
**Monitor Speakers:** JBL 4311.  
**Outboard Equipment:** Harmonizer, DDL, MXR auto flangers, Eventide, Instant Phaser, Teletronix LA2's, 1176, SAE graphic EQ, EMT 240 echo, AKG BX10.  
**Microphones:** Neumann U-87, U-47; E-V RE-20; AKG C-414, C-421, D100E; Sony 22P; RCA 77, 44; Shure 56, 57.  
**Instruments Available:** Grand piano, bass amp, misc. percussion.  
**Extras:** Coffee and variety of teas, refrigerator.  
**Rates:** 24 track and 16 track \$65/hr.



•••• **SPECTRUM STUDIOS**  
 3015 Ocean Front Walk, Venice, CA 90291  
 (213) 399-9218 or 392-2663  
**Owner:** Arne M. Frager.  
**Engineers:** Joe Quentin Hall, Arne Frager.  
**Dimensions of Studios:** 25' x 30' with 8' x 12' isolation booth.  
**Dimensions of Control Rooms:** 15' x 15'.  
**Tape Recorders:** 3M Model 79's: 24, 4, and two 2 tracks.  
**Mixing Consoles:** Harrison w/Allison automation Model 2824, 28 in x 24 out.  
**Monitor Amplifiers:** Crown D150's, SAE 2400's.  
**Monitor Speakers:** JBL 4333A (bi-amped), Altec 604E with Mastering Lab crossover.  
**Outboard Equipment:** EMT 250 digital reverb, Kepex, Gain Brain, UREI 1176 limiters, parametric EQ, phaser, flanger, DDL, Harmonizer, Dolby, EMT 140 reverb chamber, Cooper Time Cube.  
**Microphones:** A selection of over 40 of the best solid state, condenser, dynamic and ribbon mikes including Neumann, AKG, Sennheiser, E-V, and tube U-47's and U-67's.  
**Instruments Available:** Yamaha grand piano, Hammond B-3 organ with Leslie, Polymoog and ARP 2600 synthesizers, Fender and Acoustic amps.  
**Extras:** We're on the beach near shops, great restaurants, bike path, roller skating, fishing pier. Warm intimate studio, attentive staff, great location.  
**Rates:** 24 track \$125/hr. 16 track \$100/hr. 24 track mix with automation and/or EMT 250 \$135/hr. 2, 4 or post production \$100/hr.  
**Direction:** This past year we have recorded LP's for the following artists: David Soul, Richie Furay, Cy Walkin', David Castle (1978 Grammy nominee), Marshall Royal, Laurindo Almeida (1978 Grammy nominee), Joe Farrell with Chick Corea, and many others. We continue to seek out and develop new artists for our own productions. We're looking forward to our first releases in 1979.



•••• **STARTRACK RECORDING STUDIO**  
 8615 Santa Monica Blvd., Los Angeles, CA 90069  
 (213) 855-1171  
**Owner:** J. Russell Webb  
**Engineers:** Brian Levi, Joe Cannizzaro, Bryce Robbley.  
**Dimensions of Studios:** 22' x 16'.  
**Dimensions of Control Rooms:** 22' x 15'.  
**Tape Recorders:** MCI with Auto Locator Model JH-114 24, 16, 8 track; MCI with Auto Locator JH-110 2 track; Ampex Model AG 440 2 track; TEAC Model 3340 4 track; Nakamichi cassette.  
**Mixing Consoles:** MCI Model JH 428-28, 28 in x 24 out.  
**Monitor Amplifiers:** Yamaha P2200; McIntosh.  
**Monitor Speakers:** Altec 604E's, w/Mastering Lab crossovers; UREI room equalizers; JBL Auratone.  
**Outboard Equipment:** UREI limiters, Allison Kepex's, Orban parametrics.  
**Microphones:** Neumann, Sennheiser, AKG, Shure, Electro-Voice.  
**Instruments Available:** Yamaha 7'4" grand, Oberheim polyphonic, Serge modular synthesizers.  
**Extras:** Game room, kitchen.  
**Rates:** 24 track: \$115/hr. 16 track: \$85/hr. 8 track: \$60/hour.  
**Direction:** Startrack Recording Studio offers the ultimate in creative atmosphere and strives to provide you with a new experience in sound recording. Startrack is a total service studio, serving you with competence, creativity and understanding.

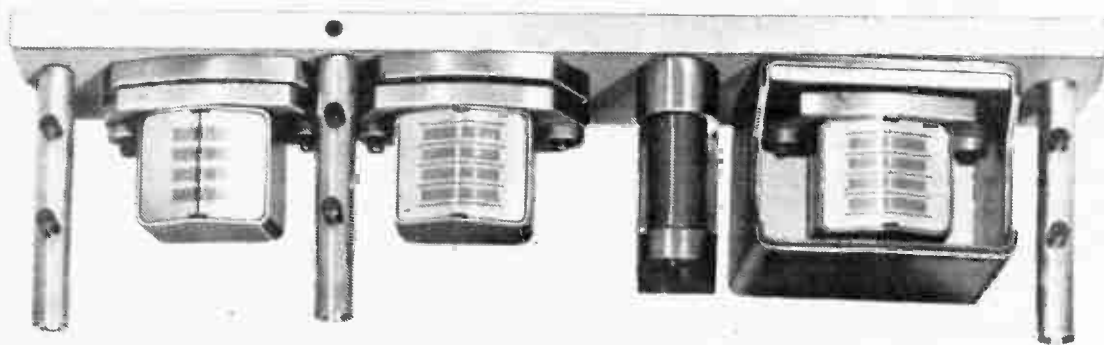

## NORTRONICS STOCKS

REPLACEMENT MAGNETIC HEADS FOR VIRTUALLY EVERY PRO RECORDER EVER BUILT.

For the name of your nearest Nortronics distributor, write: Nortronics Company, Inc. 8101 Tenth Ave North, Minneapolis, Minn 55427 Telephone (612) 545-0401, Telex 290304

For more information, call our toll free number 800 328-5640.

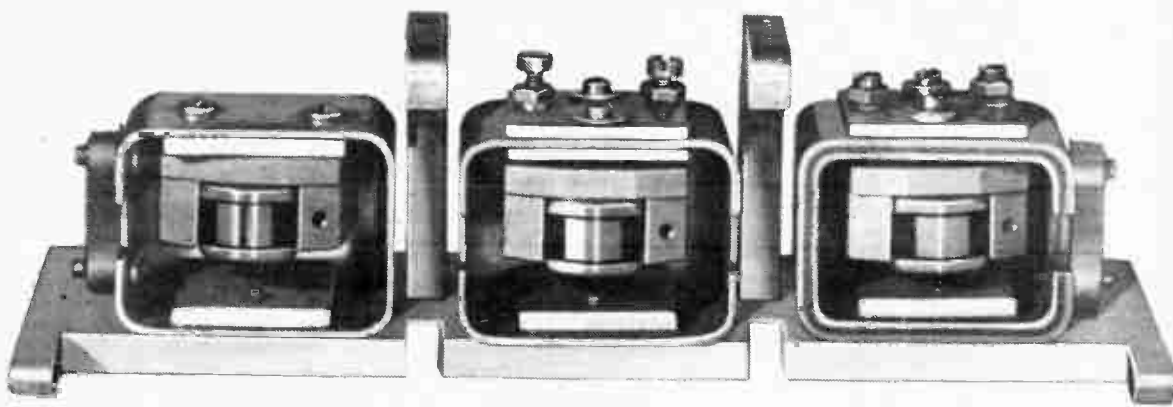

1  
6  
OCTAVE

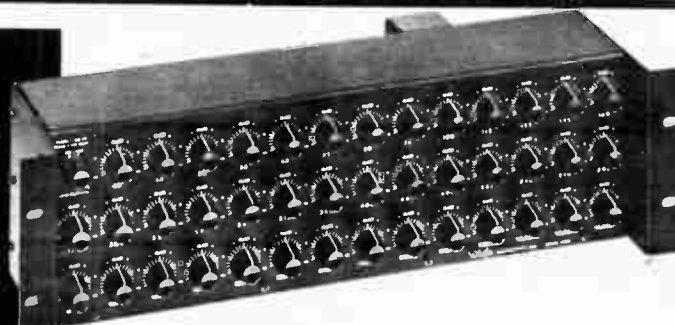

SERIES 4300 ACTIVE EQUALIZERS

## A new standard in equalizers!

- 28 ONE SIXTH octave bands from 40 Hz through 894 Hz on and between I.S.O. one-third octave centers.
- 13 one-third octave bands from 1000 Hz through 16 kHz on I.S.O. Centers.
- 10 dB boost or cut on continuous, calibrated, Mil-Spec controls
- Equal Q in both boost and cut conditions.
- Precision inductors in magnetically shielded enclosures for maximum hum rejection.
- Noise guaranteed — 90 dBv or better
- Accessory socket to permit insertion of 12 dB/octave or 18 dB/octave low-level crossover networks for bi-amping or tri-amping.
- Mid and high frequency output trimmers accessible from front panel.
- Input attenuation control variable to 20 dB of attenuation accessible from front panel.
- Variable high-pass filter 20 Hz through 160 Hz, 12 dB/octave
- Security cover

White

ONE SIXTH OCTAVE REAL TIME ANALYZERS AVAILABLE  
 instruments incorporated • P.O. BOX 698 • AUSTIN, TEXAS 78767  
 512/892-0752



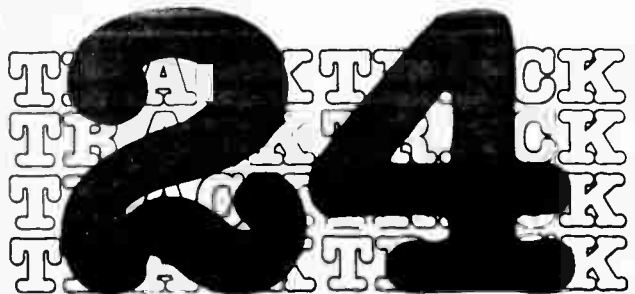

**\*\*\*\* STRAITA-HEAD SOUND**

*\*also REMOTE RECORDING\**

**7578 El Cajon Blvd., San Diego, CA 92041  
(714) 465-9997, 464-1196**

**Owner:** Gary Stauffer.

**Engineers:** Gary Stauffer, Jeff Quistad.

**Dimensions of Studios:** 25' x 20'; 25' x 18'; 65' x 100'.

**Tape Recorders:** Stephens 24 track; Stephens 16-8 track; Ampex Model 440 2 track; Revox Model A700 2 track; Revox Model A77 2 track.

**Mixing Consoles:** Straita-Head Model M81, 32 in x 24 out; Straita-Head Model M12, 32 in x 16 out; Straita-Head Model 200, 32 in x 24 out.

**Monitor Amplifiers:** Crown D60, DC300.

**Monitor Speakers:** JBL 4332, 4315; Altec 604E.

**Outboard Equipment:** Kepex, Gain Brain, Cooper Time Cube, AKG BX 20, UREI, SAE, Lang, dbx, live echo chambers.

**Microphones:** Neumann U-87, U-47, KM-88, KM-86, KM-84; Sennheiser, AKG, Sony, RCA, Electro-Voice, Shure, Beyer.

**Instruments Available:** Hammond B-3, Steinway grand, Spinnet piano.

**Extras:** Live recording theatre 650 capacity, sound stage, rehearsal hall, game room, sauna and spa, complete kitchen and dining room, apartment, video production room, conference room, catering.

**Rates:** Subject to change: 2 track: \$30/hr. 8 track: \$50/hr. 16 and 24 track: call for quotes.

**Direction:** Two remote trucks available; we are a total communications complex, we work with film, video and recording. We also build recording studios for clients from an advisory capacity to a turn-key operation, Straita-Head builds custom and production mixing consoles for studio and PA application.



**\*\*\*\* STUDIO SOUND RECORDERS**

**11724 Ventura Blvd., Suite A, Studio City, CA 91604  
(213) 985-9157**

**Owner:** George E. Tobin

**Engineers:** Mike Piccirillo, Howard L. Wolen, Ryan Ulyate.

**Dimensions of Studios:** 32' x 24'.

**Dimensions of Control Rooms:** 24' x 20'.

**Tape Recorders:** MCI Model JH24 24 track; MCI 2 track; TEAC Model 3340 2 track; TEAC cassette 2 track.

**Mixing Consoles:** Harrison automated, 28 in x 24 out.

**Monitor Amplifiers:** Phase Linear 700; Crown DC 300.

**Monitor Speakers:** UREI Time-Align, JBL 4311, Aura tones.

**Outboard Equipment:** Harmonizer, UREI limiters, Gain Brains, Kepex's, digital delay, tape echo, EMT Gold Foil echo, AKG stereo reverb.

**Microphones:** Neumann KM-84's, KM-86's, U-87's; AKG 451's, D-12; Electro-Voice RE-20's, RE-16's, RE-11's, RE-10's; Sennheiser 421's, 441's, MD-409; RCA 44; Shure SM-56's, SM-57's, SM-58's; Sony electrets; Beyer M500 ribbon.

**Instruments Available:** 7'4" Kawai grand piano, Camco drums.

**Extras:** Pinball, soda, beer.

**Rates:** \$85/hr - 9 AM to 6 PM, Monday thru Friday. \$95/hr - 6 PM to 9 AM, including weekends and holidays.

**Direction:** The studio offers the finest equipment available and automation for about 50% of the current L.A. market price. The owner is a producer currently recording 4 acts for major labels and offers all other available studio time at low prices.



**\*\*\*\* STUDIO WEST**

**5042 Ruffner St., San Diego, CA 92111  
(714) 277-4714**

**Owner:** Leroy H. Carroll & David C. Johnson

**Engineers:** Chief - Leroy H. Carroll; Jeff Johnson, Larry Owens, Dan Milner.

**Dimensions of Studios:** Studio A: 26' x 35' soon to be enlarged with two drum booths, and completely remodeled. Studio C: 15' x 12' (voice production).

**Dimensions of Control Rooms:** Studio A 26' x 17'. Studio C 12' x 12'.

**Tape Recorders:** Stephens with autolocate computer, Model 821A-24 16 and 24 track; Scully Model 280-8 8 track; Scully Model 280-2 2 track; Scully Model 280 mono (2); Ampex Model 440-B 2 track; (2); also Ampex Model 440-B 4 track; and MCI Model JH10 mono.

**Mixing Consoles:** MCI - greatly modified to discrete, Model 428, 28 in x 24 out; Auditorics Model 110-2MF, 10 in x 2 out.

**Monitor Amplifiers:** Studio A: Threshold 400A / SAE 2200 (3 units); Studio B: Crown DC 60 (3 units).

**Monitor Speakers:** Studio A control: JBL 4331A; Studio A studio: JBL 4320; Studio C: JBL 4311.

**Outboard Equipment:** Live echo chambers for Studio A; MICMIX echo unit for Studio C; (5) Allison limiters; (2) UREI 1176LN limiters; (4) UREI LA3 limiters; (2) Allison Kepex noise gates; Orban 3-channel D'Esser; Eventide Harmonizer; (2) Trident parametric equalizers; dual channel Techniques parametric equalizer; UREI graphic equalizer; UREI digital metronome; (2) ITC cart machines; (5) digital production clocks; Stephens SMPTE synchronizer; (2) Gray SMPTE code reader-character generators; (3) Sony Trinitron monitors; (2) IVC one-inch video tape machines; Sony U-Matic video cassette recorder.

**Microphones:** Neumann condensers: U-87, U-86, KM-84, KM-83, KM-88, U-48, U-67 - 15 Neumanns total. Sennheiser 421's, 441U; RCA 77BX, 44BX; E-V RE-10's, 666's, 635A's; AKG; Shure; Sony.

**Instruments Available:** Rhodes electric piano, Steinway B 7' grand.

**Extras:** Musician's lounge area and pool table. Music copy service on premises. Arranger's room with bond copier. Cassette duplication department, with Otari 8-1 high speed cassette duplicator.

**Rates:** Studio A: 24 track \$80/hr, 16 track \$70/hr, 8 track \$50/hr, 2 track \$35/hr, rates in Studio A are for both live and mix. No increase at night or weekends. Studio C: \$25/hr for all - one through four tracks.

**Direction:** We are ¼ mile off of Highway 805 in San Diego. Take Clairemont Mesa Blvd. east ¼ mile to Ruffner. We are mainly specializing in commercials and radio-TV production and have both "IBA" and "CLIO" award nominations for our work. Eight years experience in multi-track recording. This last year we serviced several national accounts including Suzuki, Denny's Restaurants, and Budweiser. Commercials were produced for these national accounts and aired on national radio and TV.



**\*\*\*\* SUNSET SOUND**

**6650 Sunset Blvd., Hollywood, CA 90028  
(213) 469-1186**

**Owner:** S. Camarata, Bill Robinson - General Manager, Debbie Prusa - Operations.

**Engineers:** Jim Isaacson, Corey Baily, Peggy McCreary, Mark Linett, Raffaello Mazza, Michael Swartz, Eric Benton - Chief Engineer.

**Dimensions of Studios:** Studio 1: 22' x 36'. Studio 2: 30' x 40'. Studio 3: 12' x 16'.

**Dimensions of Control Rooms:** Studio 1: 16' x 19'. Studio 2: 16' x 23'. Studio 3: 18' x 21'.

**Tape Recorders:** Ampex Model 1200 24-16 track; Ampex Model 1100 24-16 track; Studer model A-80 2 track; Ampex Model ATR-100 2 track; MCI Model JH-100 24-16 track.

**Mixing Consoles:** Custom designed in all studios, 32 in x 24 out.

**Monitor Amplifiers:** BGW 250, BGW 750, Crown DC-300, Marantz 250.

**Monitor Speakers:** JBL custom.

**Outboard Equipment:** Digital delay, Harmonizers, phasers, parametric equalizers, D'Essers, limiters, VSO, acoustical reverberation chambers, EMT plates, AKG echo chambers, A&D vocal stressor.

**Microphones:** Neumann U-87, KM-84, U-67, U-47, U-64; AKG 414E, 451; ELAM 251; E-V RE-20; Shure SM-56, SM-57.

**Instruments Available:** Hammond B-3, Steinway concert grand pianos.

**Extras:** Main lobby game room and coffee bar, extra game room for Studio 3 with TV, coffee, etc.

**Rates:** 16 track: \$110/hr. 24 track: \$135/hr. Long term bookings include Dolby's.

**Direction:** More than 90% of our business is by independent engineers. We provide them with the best tools to create their product. Our 2nd engineers are highly qualified to provide the back-up required for a smooth session. We are intensely interested in the cost of recording to the manufacturer and we are constantly devising methods to help reduce those costs. A "home like" atmosphere prevails at Sunset. Security services provide a sense of complete protection. We are a professional studio yet we do demo work. We have completed one of the finest mixdown rooms available, isolated yet included in our complex. Our list of credits is like a who's who in the recording industry. Since 1961 we have recorded the Rolling Stones, Captain Beefheart, Herb Alpert and the TJB, Linda Rondstadt, Little Feat, Elton John, Ringo Starr, Carly Simon, Doobie Brothers, Neil Diamond and many others. Our success is based on fair dealing with major labels and competitive rates for a professional studio in a creative atmosphere. We are committed to giving our clients the finest recording possible and the best engineering backup in the industry.



**\*\*\*\* SUNWEST RECORDING STUDIOS, INC.**

*\*also REMOTE RECORDING\**

**5533-39 Sunset Blvd., Hollywood, CA 90028  
(213) 466-9611 or 463-5631**

**Owner:** Charles D. Sullivan.

**Engineers:** Phil Seretti, Tom Huth, Richard Masci, John Walker, Ron Bryan; 2nd's: Dena Okrand, Eric Levinson, Gregg Teall, Rex Lundy; Maintenance: Gary Wells, Steve Potter.

**Dimensions of Studios:** A: 60' x 80', B: 20' x 30', C: 12' x 16', D: in construction.

**Dimensions of Control Rooms:** A: 18' x 20', B: 14' x 20', C: 26' x 26', D: in construction.

**Tape Recorders:** Ampex Model 1100 8 and 16 track; Ampex Model 1200 8, 16, and 24 track; Ampex Model AG-440-B/C 2 and 4 track; Ampex Model ATR 100 2 and 4 track; Ampex Model AVR 2 Quad video tape; JVC Model 825 helical video tape; Nakamichi Model 100 II 2 track.

**Mixing Consoles:** API modified Model 1604; Cetec Model 200; Quad/Eight modified Model 2084.

**Monitor Amplifiers:** BGW and Crown with Bi-Amp electronic X-over and acousta-voicing.

**Monitor Speakers:** Altec 604-8G; JBL; Auratone.

**Outboard Equipment:** dbx limiters, 1176 LN limiters, LA2 & 3A leveling amps, Lang EQ, Pultec EQ, Orban/Parasound D'Esser, 565 Dippers, 550 filters, Gain Brains, Kepex's, Dolby NR, Harmonizer/DDL, EECO dual cue/synchronizers.

**Microphones:** Neumann, Beyer, AKG, E-V, Shure, Sennheiser, Sony.

**Instruments Available:** Yamaha and Steinway grand, Hammond B-3 organ with Leslie, upright tack piano, Moog Micro synthesizer.

**Extras:** Kitchen, lounge, client office area.

**Rates:** Audio \$110 - \$135/hr; video: \$145 - \$200/hr.

**Direction:** We specialize in video tape audio, both pre and post productions, in addition to record projects. We have Emmy nominated staff mixers. Our clients are served from start to finish. Remote truck recording is also available for records and TV.



**TOTAL EXPERIENCE RECORDING STUDIO**

Hollywood, Bob Hughes, Engineer  
see listing on page 84



# THE MARSHALL TIME MODULATOR™

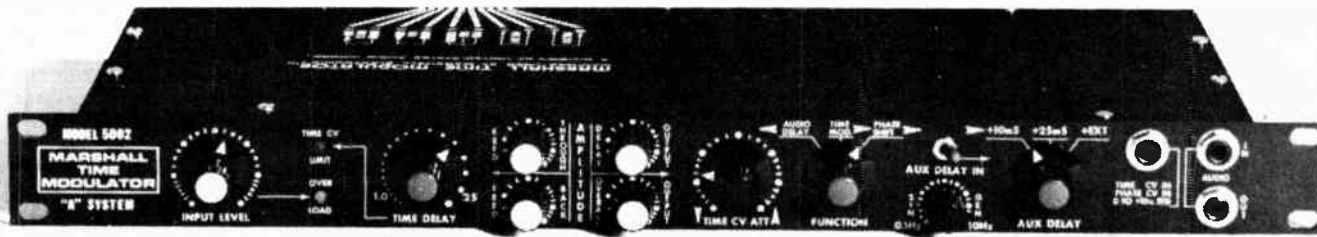

## “DOES EVERYTHING A MARSHALL TIME MODULATOR™ DOES.”

Others claim it; we do it.

The Marshall Time Modulator™ started it all, and is now the reference standard to which others compare. Even the effects introduced by the Time Modulator™ have become industry standards: such as Positive Flanging™, Negative Flanging™, ADT™, Cardboard Tube Echo™, Resonant Flanging™ and others.

We have not been sitting back and resting these past three years since the Time Modulator™ was introduced. Every advancement in the technologies that apply to delay processing has been incorporated in the new Time Modulator™, assuring performance and specifications that exceed the very best of the newcomers.

New advances now make the unit even

more versatile; with an internal power supply and up to 400 milliseconds of delay at 95 dB.

Ask your local Marshall representative for our demonstration kit and record, or ask us directly, and see why the first is still the best.



## IT'S WHAT GOES ON BEHIND THE FRONT PANEL THAT KEEPS WHAT'S GOING ON IN FRONT OF IT GOING ON...



The most versatile delay-processor made may deliver performance and specifications that the imitators can't match, but that's not enough for us; and it shouldn't be enough for you. Reliability is the final factor. We have incorporated the results of a year of lab research and two years of violent road testing into the final design of the Marshall Time

Modulator™ for that absolute maximum reliability.

U.V. Epoxy masking on both sides of the circuit board noticeably increases stability in even the most adverse humidity conditions. Silicon shock mounted circuit boards, flexible printed wiring harnesses (checked out to 1,000,000 flexes) extra strong metal work,

special high retention I.C. sockets and much more help assure that the Marshall Time Modulator™ represents the ultimate in performance and reliability. It does make a difference.



MARSHALL ELECTRONIC, 1205 YORK RD. SUITE 14, LUTHERVILLE, MD. 21093, USA (301) 484-2220

Available at:

**Express Sound Co.**  
1833 Newport Blvd.  
Costa Mesa, Ca  
(714) 645-8501

**Audio Concepts**  
7138 Santa Monica Blvd.  
Los Angeles, Ca  
(213) 851-7172

**Everything Audio**  
7037 Laurel Canyon Blvd.  
North Hollywood, Ca  
(213) 982-8200

**Westlake Audio**  
6311 Wilshire Blvd.  
Los Angeles, Ca  
(213) 665-0303

**Accurate Sound Corp.**  
114-5th Avenue  
Redwood City, Ca  
(415) 365-2843

**Sound Genesis**  
2001 Bryant Street  
San Francisco, Ca  
(415) 285-8900

**Bananas et Large**  
802 & 804 4th St.  
San Rafael, Ca  
(415) 457-7800



# 24 TRACK

## •••• TOTAL EXPERIENCE RECORDING STUDIO

6226 Yucca St., Hollywood, CA 90028

(213) 462-6585

Owner: Lonnie Simmons.

Engineers: Frank Clark, Bob Hughes, Ty Blair, Bob Higgins (all engineers are independent — they merely prefer the Total Experience).

Dimensions of Studios: 40' x 20' (large studio); Overdub room 14' x 16'.

Dimensions of Control Rooms: 18' x 15'.

Tape Recorders: 3M Model 79 24 track; 3M Model 79 2 track; Scully Model 280A 4 track; Scully Model 280A 2 track; Ampex AG-440C 2 track.

Mixing Consoles: API Model 2488, 32 in x 24 out, with 8 mixing busses.

Monitor Amplifiers: Harman Kardon Citation Twelve.

Monitor Speakers: Super Red monitoring system with Mastering Lab crossovers.

Outboard Equipment: UREI 1176 LN, LA3A's, UREI 527 graphic EQ, UREI Little Dippers, UREI 550 filters, UREI digital metronome, Kepex's (8), Eventide Phaser, Eventide Omnipressor, Lexicon Delta-T, Cooper Time Cube.

Instruments Available: Yamaha grand piano.

Rates: Please call for rates.

Direction: We try to capture as "live" a sound as possible; i.e. "live" room, "live" echo chambers.



## •••• T.T.G. INC. RECORDING STUDIOS

1441 N. McCadden Pl., Hollywood, CA 90028

(213) 464-7391

Owner: Ami Hadani.

Engineers: Ami Hadani, Allan Emig, Bryan Campbell, Greg Russell, Jonathan Porath, Michael Murphy.

Dimensions of Studios: Studio 1: 65' x 41' plus iso. booth; Studio 2: 31' x 18' plus isolation booth; Studio 3: 40' x 20' plus isolation booth. (Under construction).

Dimensions of Control Rooms: Studio 1: 22' x 16'; Studio 2: 21' x 13'; Studio 3: 20' x 17'. (Under constr.)

Tape Recorders: MCI Model JH 16-24 16/24 track; 3M Model 56/16 16 track; Ampex and MCI 4 & 2 track and mono.

Mixing Consoles: API Model 2488, 24 in x 24 out with add. Fleximix 10 in; Langevin custom, 36 in x 16 out.

Monitor Amplifiers: Crown's, JBL's.

Monitor Speakers: JBL's.

Outboard Equipment: Dolby noise reduction system, UREI, Fairchild, Teletronics limiters, Spectra Sonics Compliter; Lang, API, UREI, Pultec Maves, Cinema Engineering EQ's.

Microphones: Neumann U-87, KM-86, KM-84, M-49; AKG 414, 452; Sennheiser 421, 441; Electro-Voice RE 20, RE-16, 666; RCA 77; Sony C-37; Shure SM-57, 545.

Instruments Available: Pianos, Hammond B-3 organs with Leslie speakers, Celeste, tack pianos, Fender Rhodes.

Extras: 5 acoustic echo chambers, 4 electronic echo chambers, 35mm projection, 35mm mag recorders — 3 stripe or single stripe. Interlock between projection, mag recorders and any tape machine, dummy's (optical or mag).

Rates: Available upon request.

Direction: The studios work with rock groups, contemporary and big bands. We pre-record music for TV shows, record commercials, and scores for motion pictures and TV movies.



## •••• UNITED AUDIO CORPORATION

1519 South Grand Ave., Santa Ana, CA 92705

(714) 547-5466

Owner: Henry Quinn, President and General Manager.

Engineers: First Engineer: Greg Wright. Other engineers: Kurt Bennett, Mike McKay.

Dimensions of Studios: A: 40' x 50'; B: 16' x 20'; C: 16' x 35'.

Dimensions of Control Rooms: A: 16' x 20'; B: 16' x 18'; C: 22' x 18'.

Tape Recorders: 3M Model M-79 16 track; MCI Model JH-114 24 track; Ampex (2) Model 440 2 track; Magnasync transports and Magnetec resolver.

Mixing Consoles: Studio A: Audiotronics Son of 36 Grand, 20 in x 16 out; Studio C: API 2488, 24 in x 24 out.

Monitor Amplifiers: Crown in all rooms.

Monitor Speakers: JBL 4320 in Studio A, Altec 604E Super Reds in Studio C.

Outboard Equipment: All control rooms are equipped with UREI limiters and equalizers; Kepex's and Gain Brains; Eventide Clockworks Harmonizers, Phasers, Flangers, DDL; Lang equalizers; Orban/Parasound stereo synthesizers; AKG BX 20's and live acoustic reverb chambers with variable decay.

Microphones: Assorted Shure and AKG dynamic mics; Sony ECM 377's, C37A's, C37P's; Telefunken U-47, U-48, 251 (tube); Neumann U-47, U-67's, U-87's; Sennheiser 405's; Altec C29A's; RCA 77's and 44's.

Instruments Available: Yamaha grand piano, Hammond C-3 organ with Leslie, Premier drums, Ludwig tympani, chimes, Kawai upright piano, 1873 Knabe grand piano, Mellotron, RMI electric piano, ARP 2600 synthesizer, Gibson 345 guitar, Fender Precision Bass, assorted percussion instruments.

Rates: Available upon request.

Direction: United Audio is a multi-room facility specializing in music recording. Although the opening of Studio C was delayed because we changed console manufacturers from Trident to Automated Processes. The motion picture soundtrack facility, "Cinimax", is now completed and is turning out superb soundtracks for feature length pictures.



## •••• UNITED-WESTERN STUDIOS

6000 Sunset Blvd., Hollywood, CA 90028

(213) 469-3983

Owner: M.T. Putnam.

Engineers: Chuck Britz, Ritchie Schmitt, Ed Perry, Paul Dobbe.

Dimensions of Studios: Various accommodations from 5 to 75 musicians.

Tape Recorders: MCI 24 track; MCI and 3M 16 track; Scully 8 track; Ampex Model ATR 100 2 track; MCI mono.

Mixing Consoles: 3 Harrison's and 2 MCI's.

Monitor Amplifiers: McIntosh.

Monitor Speakers: UREI 813.

Outboard Equipment: Dolbys, flanger, Eventide, DDL, Harmonizer, Kepex, Orban D'Esser, etc.

Microphones: Neumann, AKG, Shure, Sony, Telefunken, Beyer, (too many to enumerate).

Instruments Available: Hammond B-3, Steinway pianos, Fender Rhodes, tack piano, Celeste.

Extras: Pinball, best coffee in town and it's free!

Rates: 16 track from \$85/hr. 24 track from \$110/hr.



## •••• UPSIDE DOWN STUDIO

8512 Santa Monica Blvd., Los Angeles, CA 90069

(213) 652-5837, 659-1333

Owner: Randy Senter.

Engineers: Independent engineers and staff.

Dimensions of Studios: Studio and two isolation booths.

Dimensions of Control Rooms: Approx. 17' x 20' or more. (Just expanding and rebuilding now in Jan.)

Tape Recorders: Studer Model Mark II A-80 VU 24 track; Studer Model Mark II A-80 VU 16 track; Ampex Model AG 440-B 4 track; Studer Model Mark II A-80 VU 2 track; VSO on all machines.

Mixing Consoles: Quad/Eight/Quantum, 32 in x 24 out; (New board coming.)

Monitor Amplifiers: 700B, Phase Linear, McIntosh.

Monitor Speakers: Altec 604E with Mastering Lab crossovers, UREI Time-Align, (Big Reds), JBL 4320's, E.H. Long mixdown speakers.

Outboard Equipment: Two stereo EMT echo chambers and AKG BX-20 E stereo chambers, Eventide Harmonizer, digital delay, flanger, phaser, UREI LA2A, LA3A, 1176 and Inovonics limiters, noise gates, Cooper Time Cube.

Microphones: AKG 452 EB, C-414, C-412; Sennheiser MKH-405, MD-421; Neumann U-87, KM-84, U-67, U-47, U-48 tube, KM-88; Sony ECM-22P; Altec 21-D; Shure SM-58, and other rare tube mics.

Instruments Available: Steinway grand piano, tack hammer piano, Fender Rhodes, clavinet D-6 and D-2, Baldwin stereo harpsichord, Wurlitzer, ARP Pro Soloist, ARP String Ensemble, ARP Odyssey, the new Prophet, RMI electric piano, Yamaha YC-30 organ, various guitars, basses and acces., 8-channel music computer, (4) Oberheim expander modules, Moog drums.

Extras: Kitchen, offices, bedroom with king-size bed, color TV, mirrored ceiling.

Rates: \$50/hr and up.

Direction: Future plans: we are expanding right now. Our control room will house over a dozen keyboards

and synthesizer gear. Philosophy: to bring the music being performed into a closer creative relationship with the studio equipment and the personnel operating it. We are using a music computer with a new software program to interface the 24 track and all the peripheral gear. We have a principle called RHYTHM LOCK™ which controls, for instance, the vibration of a Fender Rhodes to pulsate in time with the music from beginning to the end of the song. The computer can play drums, bass, flashy violin lines, special effects and much more; all in sync with the multi-track for a total of over 30 tracks of programmed material and special effects. This division is called "Automated Music" and "Computracks".



## •••• VALENTINE RECORDING STUDIOS

5330 Laurel Canyon Blvd.,

North Hollywood, CA 91607

(213) 769-1515

Owner: Jimmy Valentine.

Engineers: Jimmy Valentine, James Lloyd, Jay Stanley

Dimensions of Studios: Studio A: 40' x 32' with 20' ceiling. Studio B: 14' x 15'.

Dimensions of Control Rooms: A: 16' x 21'; B: 14' x 12'.

Tape Recorders: MCI Model JH24 24, 16, 8 track; Stephens 16, 8 track; Ampex Model 354/440-4 1, 2, 4 track; Nagra Model 4L 1 track.

Mixing Consoles: MCI Model 416-32, 32 in x 32 out; Universal Audio, 12 in x 12 out.

Monitor Amplifiers: Harman Kardon, Altec Lansing, Universal Audio.

Monitor Speakers: Altec 604E with Mastering Lab crossovers.

Outboard Equipment: Kepex, Gain Brain, Pultec, Cinema, Hi-Cor equalizers and filters, UREI limiters, Altec limiter/compressor, VSO, digital metronome.

Microphones: Neumann, Sony, Shure, RCA, Electro-Voice, Sennheiser.

Instruments Available: Steinway B concert grand piano, Hammond B-3 organ with Leslie speaker, Mason-Hamlin upright piano, Celeste.

Rates: Studio A: mono/2 and 4 track: \$65/hr. 8 track: \$75/hr. 16 track: \$85/hr. 24 track: \$120/hr. Studio B: mono, 2 and 4 track: \$35/hr. 8 track: \$45/hr. 16 track: \$55/hr. (Daytime rates.)

Direction: We intend to continue turning out a professional product for professionals. We are a full-service studio doing film transfers (both 16 and 35mm), cassette duplication, disc-cutting. We've worked with and for most of the major record companies and advertising agencies.



## •••• THE VILLAGE RECORDER

1616 Butler, W. Los Angeles, CA 90025

(213) 478-8227

Owner: Geordie Hormel.

Engineers: Assistant Engineers: Wayne Neuendorf, Lenise Bent, Hernan Rojas, Barbara Issak, Carla Frederick, Suzi Plott.

Rates: Available upon request.



## •••• WESTLAKE AUDIO

6311 Wilshire Blvd. (Mix-down);

8447 Beverly Blvd. (2 track/mix-down rooms)

Los Angeles, CA 90048

(213) 655-0303 and 654-2155

Owner: Glenn Phoenix — President.

Engineers: Dave Rideau, Erik Zabler, Ed Cherney.

Dimensions of Studios: A: 45' x 30'; B: 26' x 26'; Mixing room: 15' x 8'.

Dimensions of Control Rooms: A: 30' x 26'; B: 26' x 26'; Mixing room: 24' x 24'.

Tape Recorders: 3M Model 79 24, 16, 8, 4, 2 track; Studer Model A 80 2 track; Otari 2 track; Nakamichi cassette 1000II; Ampex Model ATR 100.

Mixing Consoles: Harrison Model 4032, 40 in x 32 out; Harrison Model 4832, 48 in x 32 out; API Model 2824, 32 in x 24 out.

Monitor Amplifiers: Crown DC 300A; AB Systems 410

Monitor Speakers: Westlake Audio 2nd Generation High Resolution monitors.

Outboard Equipment: 3 sets EECO SMPTE Dual Cue Synchronizers, all types digital delay, limiters, compressors, equalizers, and other noise toys, Allison automation and video outboard gear.

Microphones: Vast selection.

Instruments Available: Yamaha 9'6" concert grand piano.

Rates: Studio A: \$155/hr, Studio B: \$145/hr, Mix room: \$35/hour.



# express yourself...

we know what you do.  
you record, produce, manage and nurture  
musical arts and artists.

we express ourselves with design  
and installations, service and sales.

the disciplines we pursue  
free you to pursue yours.

we both express ourselves  
when we work together.

harmony is great

ADR	Emilar	Sescom
AKG	EMT	Showco
Allison Research	Eventide Clockworks	Shure
Altec	FRAP	Sony
Amber	Gauss	Soundcraft
Ampex Professional Recorders	JBL Pro	Sound Technology
Ampex Tape	MICMIX	Sound Workshop
Anvil	Micro-Seiki	Stanton
Atlas	3M	Stantron
Auratone	MRL	STL
Belden	MXR	Switchcraft
Beyer	Neumann	Tangent
BGW	Orban/Parasound	Tapco
BiAmp	Otari	Tascam Series
Bud	PAS	TDK
Community Light & Sound	Phillips	Teac
Crown	Quad Eight	Technics
dbx	RAM	Tektronics
Discwasher	Ramko	Uni-Sync/TROUPER
Editall	Revox	UREI
Electro-Voice	Russco	White
el-tech	Sennheiser	Yamaha

**THE**  
**EXPRESS**  
**SOUND CO.**

1833 newport blvd.  
costa mesa, ca. 92627  
(714) 645-8501

... in reverent quest of the last dB.

THE MIX WILL  
NOW BE PUBLISHED  
HERE IN THE NEW  
YORK NASHVILLE  
MEMPHIS WASHING  
TON AND OREGON  
IN ADDITION TO  
CALIFORNIA  
HITS IN THE MIX



# TABER

**MANUFACTURING & ENGINEERING CO**  
 2081 EDISON AVE., SAN LEANDRO, CA 94577  
 (415) 635-3831

**•REPLACEMENT AUDIO HEADS — HEAD RECONDITIONING SERVICE**

Professional sound recording requires critical head quality. Whether your need is new replacement heads or having your heads reconditioned to give you peak performance call TABER for professional audio head service.

**NOTE: FREE head lapping on TABER manufactured heads.**

**•TABERASER**

A required item for every recording studio for efficient bulk tape degaussing of all width audio and video tapes-1/4" to 2".

**•STL TEST TAPES**

Consistent quality year after year has made STL test tapes the most dependable source of test tape for the professional sound studio.

**•TAPE RECORDER OVERHAUL AND REPAIR SERVICE**

For repair, overhaul, replacement parts; conversions, updating electronics on your Ampex or Scully tape recorders call TABER.

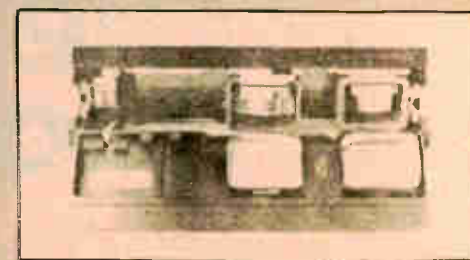
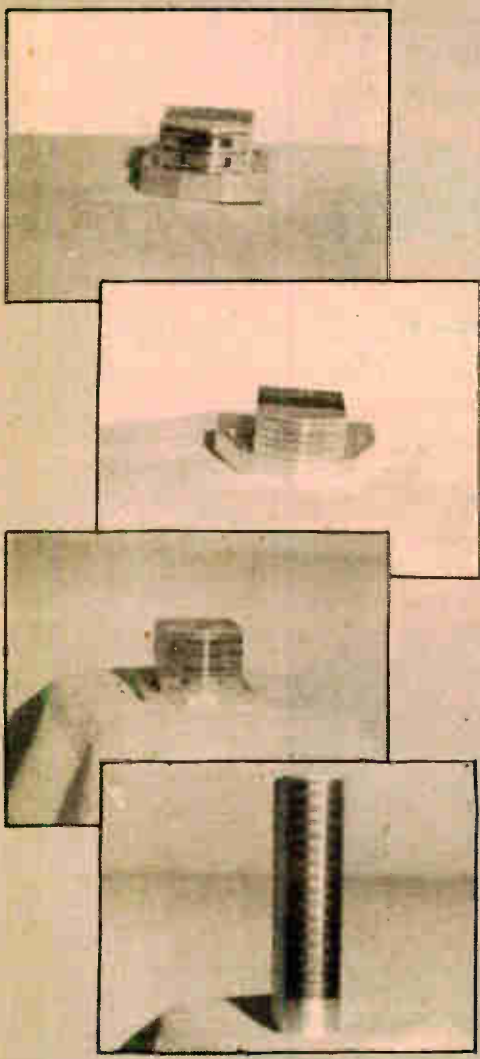

## Should you buy the new Sound Workshop 262 Stereo Reverb or should you retile your bathroom?

That's a tough decision to make. Perhaps you stay up nights pondering this very question. But please take the time, right now, to consider this important matter. Think how great your voice sounds when you're laughing up in the shower. It's because the hard, ultra-smooth surface of the tile takes your normally lifeless voice and bounces it

back and forth adding depth and magnitude. It's called natural reverberation. There are, and have been, devices available which simulate natural reverberation. But a professional quality studio reverb (that sounds as natural as your bathroom) used to cost well over a thousand dollars. Sound Workshop introduces the new 262 Stereo Reverberation System... for well under a thousand dollars. We thought you'd like to know.



**Sound Workshop** Professional Audio Products, Inc.  
 1324 Motor Parkway, Hauppauge, New York 11787 (516) 582-6210



# The Series 1600 Recording Console.

VCA grouping, Automation, Spectrum Analyzer.  
Available with Trans-Amp LZ\*.



**Sound Workshop**  
PROFESSIONAL AUDIO PRODUCTS

Sound Workshop Professional Audio Products, Inc.  
1324 Motor Parkway, Hauppauge, New York 11787 (516) 582-6210

\*Registered trademark of the Valley People, Inc., Nashville, Tennessee.

Write to us for details.

Contact: **The Express Sound Co.**, 1833 Newport Blvd., Costa Mesa, CA (714) 645-8501  
Southern California's exclusive Series 1600 dealer

## Stressing Quality



The Orange County VS-1 Stressor combines several necessary signal processing functions to give you the power to handle problems such as level control, noise, and equalization all in one 3 1/2" package:

- Compressor with adjustable ratio, threshold, attack and release times, for loudness enhancement
- Fast peak limiter with 250:1 slope for overload protection
- Highly effective expander/noise-gate for noise reduction
- Full parametric equalizer with extraordinary tuning capabilities
- Overall performance specs and construction to the highest industry standard

The VS-1 Stressor belongs in your studio as a versatile and powerful production tool. It offers the creative producer/engineer the most control in any single package on the market.

Also investigate the VS-2 Stressor, which offers internally pre-set functions for the budget-conscious user looking for great sound.



**ORANGE COUNTY ELECTRONICS INTERNATIONAL INC.**

Exclusive Sales & Marketing:

**Parasound**

680 Beach Street, San Francisco, Ca. 94109 (415) 673-4544

Dealer Inquiries Invited

Audio Industries Corp., 1419 No. La Brea Ave., Hollywood, Ca 90028 851-4111  
Sierra Audio, 621 So. Glenwood Place, Burbank, Ca 91506 843-8115  
Westlake Audio, 6311 Wilshire Blvd., Los Angeles, Ca 90048 655-0303



# Independent Recording Engineers And Producers of Southern California

The information below was provided by those listed. The Mix cannot assume responsibility for the accuracy of the information.

## THAD ANDERS — PRODUCER

P.O. Box 85588, Los Angeles, CA 90072  
**Experience:** Head of production of Music Industries. Number of albums released. Worked with Made in U.S.A., a rock group and others.  
**Direction:** Rock, MOR, C&W, Disco, Big Band.

## RUE BARCLAY — ENGINEER/PRODUCER

7436 Genesta, Van Nuys, CA 91406  
(213) 342-2636  
**Experience:** 20 years as engineer/producer; rock, soul, commercial, country.  
**Direction:** Seeking to continue my work, also to find financial backing to set up management firm, record label and RMI and ASCAP publishing firms.

## KEVIN K. BEAMISH — ENGINEER/PRODUCER

3562 Barham Blvd., Suite 301, Los Angeles, CA 90068  
(213) 876-6160  
**Experience:** 6 years senior staff engineer at Crystal Sound, Hollywood. Engineered and co-produced pop and R/B artists such as Nigel Olsson, Eric Carmen, The Miracles, Lenny Williams.  
**Direction:** For the artist who wants "state of the ear" in sound coupled with an understanding translator in production.

## BRUCE W. BROWN (DOC BRO) — ENGINEER/PRODUCER

8255 Beverly Blvd., Los Angeles, CA 90048  
(ABC) (213) 658-5990  
**Experience:** Engineered: WAR, Wonder Love, Tom Petty, Tanya Tucker, Freddy Fender, Billy Davis & Marilyn McCoo, Percy Faith, Danny Peck, Levon Helm, Conway Twitty, Loretta Lynn, Eddie Rabbit, Blue Mitchell, Ann Hughes, Pat & Lolly Vagas. Produced: Gambler, Condor, and Rose North.

## LEAN BROWN — PRODUCER/MIXER

3551 Brayton Ave., Long Beach, CA 90807  
(213) 427-6182  
**Experience:** 20 years experience. Produced and mixed over 250 albums for such labels as Zondervan, Sacred, Mark and Monarch Records. 24 track mixes at Capitol Records, Burbank Studios, Matinsound, United Audio, etc. Wife, Mary Jean Brown, is talented composer and orchestral arranger/conductor with over 40 album credits. Special package rates.  
**Direction:** Specializing in total custom album packages. Great interest in contemporary Christian, choral and pipe organ recording. Just completed 3 albums using prototype of Sony PCM-1 Digital Recorder. We are looking for a better way of recording a better sound.

## FANDOLPH BROWN — ENGINEER

2827 Angus St., Los Angeles, CA 90039  
**Experience:** New York: Bell Sound Studios, Electric Lady Studios. Los Angeles: Record Plant, Total Experience.  
**Direction:** Rock & Roll, Jazz, creative engineering.

## STEPHEN BROWN — ENGINEER/PRODUCER

7923 Duchess Dr., Whittier, CA 90606  
(213) 696-5503 office; 696-1590 residence  
**Experience:** Produced a number of albums. Currently producing for Daybreak Records, a contemporary Christian label. Specializes in custom record packages. Has full production 16 track studio to work in. Doing some engineering as well as producing.  
**Direction:** Always on the look for the cleanest sound possible. No matter who the client, or what the project.

## OSKER CADDELL — PRODUCER

2833 Westview St., Los Angeles, CA 90016  
(213) 735-6713  
**Experience:** 8 years.

## ALEX CIMA — ENGINEER/PRODUCER

c/o Music Lab Studios  
1836 Hyperion Ave., Los Angeles, CA 90027  
(213) 666-9000, 662-3965  
**Experience:** Experienced composer/producer/music director/engineer. Solid credits in film scoring, prime time TV, audio logos, commercials, recordings. Synthesizer expert. Top studio work.  
**Direction:** Creative audio signal processing, innovative, experimental. Like all music; country, R&B, disco, avant-garde, rock.

## RICHARD S. CURTIS — ENGINEER/PRODUCER

265 El Cajon Blvd., El Cajon, CA 92020  
(714) 448-8852, 442-0678  
**Experience:** 18 years engineer/producer, songwriter and musician, keyboard and guitar, produced and recorded at Gold Star thru Phil Spector era. Electronics training and experience in studio equipment and repair of all studio devices and machines to 24 track plus, very good at developing sound and/or new gimmicks plus a few "secrets" — noted for magic mixes.  
**Direction:** Engineer/producer, Top 40, R&R, MOR, jazz, remote. "Others will give you a record, I'll give you a hit!"

## DALTERRIA VIII — PRODUCERS

1680 N. Vine, Suite 918, Los Angeles, CA 90028  
(213) 464-8381  
**Experience:** Dalterria VIII is a complete production company who's members' professional careers have included New Birth, Love Machine, The Temptations, Crusaders, Jimi Hendrix, Mandrill, Gary Bartz, Marvin Gaye, Johnny Taylor, Rufus, Gill Scott Herron, Ramsey Lewis, and many more. The staff of Dalterria VIII is two rhythm sections, brass and reed section, background vocalist, arrangers and conductors, 4 and 16 track recording facilities.  
**Direction:** We specialize in progressive music, from the hard rock of Jimi Hendrix to the avant-garde sounds of John Coltrane.

## DOUGLAS DECKER — ENGINEER

(213) 656-2830  
**Experience:** Heider's '69-'71, Larrabee '71, United/Western '72-'76.

## EARL R. DINGMAN — ENGINEER/PRODUCER

Box 4073, Panorama City, CA 91402  
(213) 343-4896 (24-hour message)  
**Experience:** Sound recording, engineering and production at CBS Inc., Studio City, CA; E.A.R. Recording, Los Angeles, CA. Paul Morrow Productions (local recording of radio pilot). Film production: Co-Producer, cutter, photographer and post production supervision on 2 30-sec. color/sound TV spots for Pizante and Gregg. Various documentary and short subject films in B&W and color. Member of ASCAP.  
**Direction:** I have over 12 years combined personal and professional experience in sound recording (mono, stereo and multi-track), still and motion picture photography and production. I'm a pusher, used to mowing down obstacles, but I'm also very flexible. My approach is "The Project FIRST" (Content and quality). My job isn't finished until the "work" is the best it can be.

## DON M. DORSEY — ENGINEER/PRODUCER

2079 June Place., Anaheim, CA 92802  
(714) 971-2828  
**Experience:** 5 years as producer/arranger/engineer in L.A. and Orange County; 3 years as production consultant to Walt Disney Productions. Credits include Main Street Electrical Parade and America On Parade sound tracks as performer/arrang. Several album and demo projects. Also specialize in electronic music and synthesizer production. Staff engineer at I.A.M.

## FRANK FISHER — ENGINEER/PRODUCER

847 S. Euclid Ave., Pasadena, CA 91106  
(213) 681-6106  
**Experience:** Engineering and production for 10 years in L.A., Bay Area and Detroit. Former chief engineer G.M. Recording (Detroit), Chateau Recorders (L.A.); have worked with: Spirit, Supremes, Jackson 5, Dionne Warwick, Seawind, Funkadelics, Gallery, Dennis Coffee, K.C. & Sunshine, Paul Risor, Barrett Strong, Bob Seger, etc.  
**Direction:** Currently working only on projects involving production and label deals. I own a design and consulting company offering my clients full service from recording to concert tour sound and lighting. Only interested in serious production.

## TY FORD — ENGINEER

7311 Victoria Ave., Los Angeles, CA 90043  
(213) 759-4905  
**Direction:** To engineer the mellowest of sounds. And stuff like that.

## BILL GLASSER — ENGINEER/PRODUCER

Hot Lix Productions  
4528 1/2 Rosemont, La Crescenta, CA 91214  
**Experience:** 15 years as a professional guitarist and songwriter; 6 years as a recording engineer; and 4 years of study in film and television production.  
**Direction:** As one of the new breed of recording engineer/producers, I am expanding my abilities in arranging, music business and law, as well as engineering and production techniques to be the complete producer my clients need.

## AL HALL, JR. — PRODUCER

c/o Aljoni Music  
P.O. Box 18918, Los Angeles, CA 90018  
(213) 930-1814  
**Experience:** Orchestrator/arranger for projects with Fantasy, CTI-Motown, Black Jass-Ovation, etc. Producer of 3 LP's and 8 singles. Former sideman with Freddie Hubbard, Marvin Gaye, Ray Charles, Johnny Hammond and others. Composer.  
**Direction:** Although my background consists of working with jazz and R&B artists, I am interested in artists pursuing any direction. I can deal with all types of music. Can work within the framework of most budgets. Interested in new and established talent.

## ROBERT C. HANSEN — ENGINEER

2505 Hermosa, Montrose, CA 91020  
(213) 248-1103  
**Experience:** Sherwood Oaks recording engineer (11-78). Have worked with local groups on demos and live. Bookings for live bands and sound reinforcement a specialty. Experienced musician adept at arranging and composition.  
**Direction:** Upward bound and motivated. Discriminating ear. Flexible, many fresh ideas. Dynamic progressive outlook. References available upon request.

## BRADLEY HARTMAN — ENGINEER/PRODUCER

5233 Fulton, Van Nuys, CA 91401  
(213) 986-9252  
**Experience:** Enactron Studios, Chief Engineer. Credits: Emmylou Harris, Jonathon Edwards, Mary Kay Place, The Band, Jesse Winchester, Willie Nelson, Jimmy Buffet.  
**Direction:** To offer a total scope of audio and video services for the music business. Specializing in live audio and video recording.

## HAL HELLERMAN — ENGINEER/PRODUCER

1720 Lake St., Glendale, CA 91201  
(213) 956-1388, 464-8489  
**Experience:** I have over 5 years engineering and 12 years musical experience. I have worked at Kendun Recorders, Devonshire Sound Studios, Paramount Recording Studios, Total Experience, and others. I am presently chief engineer at Pranava Production Studios. Full list of clients and credits available.  
**Direction:** I am dedicated to turning your musical dreams into reality, through special attention, expertise and creative artistry.

## JAMES E. HENRY — ENGINEER

591 Copper Ave., Vista, CA 92083  
(714) 758-7387  
**Experience:** I've had the pleasure of working with: The Thad Jones Mel Lewis Orchestra, The New Brubek Quartet, Eddy Money, Johnny Almond, Bobby Shew and many others. List of TV, film and album credits upon request.  
**Direction:** Having worked as a staff engineer for a long period of time, I feel I can best serve the needs of my clients as an independent, which allows me to choose the studio which best suits the client's needs; as well as the requirements of the project.

## RON HILLMAN — PRODUCER

P.O. Box 1304, Hollywood, CA 90028  
(213) 654-5399  
**Experience:** Co-produced demos for Motown Records and Cadet Records. Keyboard player, composer, arranger with full selection of keyboards and sound reinforcement equipment available.  
**Direction:** Commercial dance music, disco/rock.

## DON HOLDEN — ENGINEER

Los Angeles, CA  
(213) 789-3929  
**Experience:** 16 years in audio engineering. Designed and built a studio in Burbank. Worked 15 years as staff engineer at RCA in Chicago and Los Angeles. I have done albums with: Don Cornelius Soul Train, D.J. Rogers, Main Ingredient, Bew Birth, Memphis Horns of RCA, Barry Mann, Brian Wilson of Equinox, Patchwork, B.W. Stevenson, Jose Feliciano, John Wayne, John Denver, all of RCA; Jerry Butler for Mercury, Curtis Mayfield for Curtom, dozens of small group and demo albums. All of these albums were also mastered by me. Have done projects for: Jack Jones, Mancini, Richard Harris and Charlie Pride.  
**Direction:** A Master Engineer who is at home in the studio!

## MARK D. JONES — ENGINEER

2414 N. Tustin Ave., H-3, Santa Ana, CA 92705  
(714) 973-1898  
**Experience:** Extensive training on 24-track fully automated computerized consoles and disc mastering at ABC Studios, L.A. Completing Bachelors Degree at Long Beach State University. Also experience on 16-track.  
**Direction:** To help musicians create the ultimate sound and to work with a good production company who needs a young progressive engineer who is very reasonable.

## GUY KATICH — PRODUCER

P.O. Box 3615, Redondo Beach, CA 90277  
**Experience:** Produced two records which have aired all of the west coast area. Have my record company, Dusty Roads Records. Two publishing firms: Simon Songs, Rollin' Songs.  
**Direction:** I'm presently involved in writing booklets for songwriters looking for a producer. I've just released my international booklet on: Promote Your Own Record, in the Rolling Stone. For unknowns who want to release records.

## DAN KATZ — ENGINEER/PRODUCER

8379 1/2 Blackburn Ave., Los Angeles, CA 90048  
(213) 651-5836  
**Experience:** Trained by Doc Siegel. Produced local public affairs radio programs, including documentaries and dramatic shows. Specializes in dramatic and spoken audio productions, radio spots, etc.  
**Direction:** Creative, imaginative audio, spoken and musical. Getting the message across is the most important aspect of the creative engineer/producer.

## CHUCK KIRKPATRICK — ENGINEER/PRODUCER

5112 Sepulveda, #120, Sherman Oaks, CA 91403  
**Experience:** MCI 1 year. Criteria Studios 5 years, Holly-berry Studios 3 years, vocal arranging and guitar, "Layla", "Rainy Night in Georgia", "Don't Play That Song".  
**Direction:** Live and remote recording, 2 to 32 track. "New Wave" and pop production my specialty.

## DAVID LEONARD — ENGINEER

5298 Elvira, Woodland Hills, CA 91364  
(213) 992-1351  
**Experience:** Lynx, Synergy, Stanley Clarke with George Duke, Tom Scott, Harvey Mason, Studio and live recording. Custom contracted sound reinforcement systems and engineering for Chick Corea, Al Jarreau, Kenny Loggins.  
**Direction:** To aid the artist in realizing his/her sound image, on stage and in the studio.

cont'd on page 90



# Independent Recording Engineers and Producers of Southern California

Cont'd from page 89

## TO ALL INDEPENDENT ENGINEERS & PRODUCERS

The Mix will have free listings in all future Recording Studio Directories for independent engineers and producers. If you would like to be included, please fill in and return the coupon below before July 1st, 1979 to

**The Mix**  
**P.O. Box 6395**  
**Albany, CA 94706**  
 Please type or print legibly

name \_\_\_\_\_

address \_\_\_\_\_

city \_\_\_\_\_

state \_\_\_\_\_ zip \_\_\_\_\_

phone \_\_\_\_\_

Engineer     Producer

Experience \_\_\_\_\_

Direction \_\_\_\_\_

**AL & CANDICE McKAY — ENGINEER/PRODUCERS**  
 4841 Bonvue Dr., Hollywood, CA 90027  
 (213) 985-0010  
**Experience:** Guitar player with Earth Wind & Fire, Producer of Curtis, The Brothers album to be released in January of 1979. Also will produce another album on same, doing independent work for other artist.  
**Direction:** To soar Cheelstest Productions to where Kalimba Productions is. To get publishing co., Al McKay Publishing going next year. To produce my lady, Candice.

**JEFF McLANE/C.O.A.T. SOUND SYSTEMS ENGINEER/PRODUCER**  
 1740 N. Gramercy Pl., Suite 101, Hollywood, CA 90028  
 (213) 651-2002  
**Experience:** Founded C.O.A.T. Sound Systems in '75. Toured with Chic, Camco, Cuba Gooding, Ohio Players, doing live mixing. Engineered and produced "Once Upon A Time..." by Cast of a Thousand. Sherwood Oaks and Soundmaster training.  
**Direction:** To bring studio quality to live productions and vice versa. My heart is in English progressive rock.

**EARLE MANKEY — ENGINEER/PRODUCER**  
 1645 Fremont Dr., Thousand Oaks, CA 91360  
 (805) 497-9953  
**Experience:** Engineered for: Beach Boys, Elton John, Eric Carmen, Jeff Barry, Helen Reddy, Sparks, The Runaways, etc. Produced: Helen Reddy, the Quick, The Runaways, Sparks, The Paley Brothers, The Dickies.  
**Direction:** Concentrating on production and developing new talent.

**ROBERT MARGOULEFF AND ASSOCIATES ENGINEER/PRODUCER**  
 1439 N. Stanley Ave., Hollywood, CA 90046  
 (213) 874-1428  
**Experience:** Platinum albums: Stevie Wonder: "Music Of My Mind", "Talking Book", "Innervisions", "Fulfillingness First Finale".  
 Gold Albums: Isley Brothers "Three Plus Three" and "Fight The Power"; Minnie Riperton, "Perfect Angel".  
 Gold Singles: Stevie Wonder, "Super Woman", "Superstitious", "Higher Ground", "Living For The City", "Boogie On Reggae Woman", "Don't You Worry 'bout A Thing", "Sunshine Of My Life"; Isley Brothers, "Fight The Power"; Minnie Riperton, "Loving You"; Bobby Womack, "Lookin' For A Love". Three Grammy Awards.

**LEE R. MILLER — ENGINEER/PRODUCER**  
 10940 Roebling Ave., W. Los Angeles, CA 90024  
 (213) 473-6640, 466-6444  
**Experience:** Have recently engineered on various types of projects including record albums for Don Costa (producer/arranger), feature film scoring for Dino DeLaurentis' "King of the Gypsies", network television soundtracks for "Krofft Superstar Hour". Television/radio commercials for Gladys Knight/Pips. Large scale multimedia presentations for Mattel and Honda Corp., and produced various record projects. I have a University Degree with course work in music, mathematics and computers.  
**Direction:** To be involved in all areas of audio engineering with an emphasis on record engineering and record production. References are available upon request.

**STEVEN MILLER — PRODUCER**  
 (714) 459-0978 San Diego, (415) 522-9727, (415) 494-7434 — San Francisco.  
**Experience:** Dave Liebman, Eddie Henderson, Charlie Haden, Bernie Krause, Andy Narell, Clark Terry, Tubes, Roxz (Japan).  
**Direction:** While my main direction is jazz, I am quite anxious to work with more pop and rock artists. I am also available as a guitar and synthesizer artist so feel free to call and discuss your needs.

**ROBERT MOFFETT — PRODUCER**  
 2152 Canyon Dr., Costa Mesa, CA 92627  
 (714) 646-3838  
**Experience:** Wrote, arranged, produced my first record in 1976. I play drums, sax, piano, bass & guitar and sing. Arranged and produced various club bands, currently building a recording studio.  
**Direction:** I'm looking for people that have got a soul! My life is dedicated to Jesus and all that I do is for His Glory. I prefer to work with sensitive artists, and musicians, Christians or otherwise. It doesn't matter, "We's awl God's Chiluns!"

**DR. RICHIE MOORE — ENGINEER/PRODUCER AUDIO CONSULTANT**  
 220 N. Prospect Ave., Redondo Beach, CA  
 (213) 374-4134  
**Experience:** Ph.D Communications Science. Engineer/mixer staff at Wally Heider's (LA), EMI Studios (Abbey Road), Village Recorder, and The Burbank Studios. Recorded

over 175 albums; 200 singles; and have earned 11 gold albums and 4 platinum. Have scored many films and TV programs. Have worked on the design, construction, and trouble-shooting of many devices in the audio/video industry. Extensive road tours with major groups. Graduate of MCI Technical School 1978. Co-Founder of the University of Sound Arts.  
**Direction:** To continue the very best audio technician service available anywhere. I want to be able to impart my 15 years of experience in the industry to all those who seek it. I am available for production, mixing, and audio consultation, no matter how big or small the project. I own my own extensive analog/digital test equipment, and acoustic measuring devices. I have done this to guarantee quality assurance on all projects I am involved with.

**ANTOINETTE (TONI) MOYA — ENGINEER**  
 P.O. Box 109, Summerland, CA 93067  
 (805) 684-7510 or 736-0612 for message.  
**Experience:** 4 years independent engineer. Have worked with all type groups and supervised 4 and 8 track studios. 3 years in 16 and 24 track facilities. 4 years live engineering - touring. Some production.  
**Direction:** Oriented to live engineering, still enjoying challenge of touring. Looking for active studio environment for extended stable situation. References and resume upon request.

**JOSEPH NICOLETTI — PRODUCER**  
 P.O. Box 2818, Newport Beach, CA 92663  
 (714) 497-3758, (212) 787-5400  
**Experience:** Self Prod. LP on Star Line Records. Radio and TV commercials. Lead singer on Diet Pepsi's new TV and radio commercial, write, perform and produce local and national radio and TV music in New York and Calif., do active publishing (ASCAP).  
**Direction:** Lots of song writing, singing and finding new talent.

**DAVE NODIFF — ENGINEER/PRODUCER**  
 4014 Heffron Dr., Burbank, CA 91505  
 (213) 848-0594  
**Experience:** Los Angeles: The Little Studio, Total Experience, Music Grinder. Boston: Dimension, Mixing Lab, Music Designer's, Recordatory.  
**Direction:** Creative musical engineering and production.

**ANITA PARKER — ENGINEER**  
 6034 Laurel Grove Ave., N. Hollywood, CA 91606  
**Experience:** Demo work: 2 1/2 years. Road experience in live mix-down.  
**Direction:** Record engineering. Looking for an engineer or studio who needs or would like an apprentice with seconding capabilities. Have reached a dead end since coming off the road — I just want to learn and work. Thanks!

**DOUG PARRY — ENGINEER/PRODUCER**  
 9752 Baden Ave., Chatsworth, CA 91311  
 (213) 998-2097  
**Experience:** Ten years musician, writer, and vocals. Recently involved with private production facility producing and engineering. Music publishing with BMI/ASCAP, one Platinum and two Gold Records. Engineering for Crown International Pictures ("Van Nuys Blvd." movie soundtrack and music), Producer — Ken Mansfield. I have also worked with Tom Dowd and Andy Johns (Rod Stewart's "Blondes Have More Fun" album), Bob Margouleff, Producer Johnny Hallyday — French artist), Mark Lyndsey and Fabian Forte — Soundtrack movie for U.A. movie "Jet Set Disco". Own 24-track private production facility.  
**Direction:** Specialize in automated mixing and creative engineering; and continue to be involved with those artists and that music to which I can contribute my musical love and input on a production basis.

**BOB ROSE — ENGINEER**  
 North Hollywood (213) 761-4108  
**Experience:** A proven track record with major artists, producers, studios and albums with recent chart action. (Call for details.)  
**Direction:** The assurance of personable, creative and technical qualifications.

**BRUCE SCHAFER — ENGINEER**  
 Los Angeles, (213) 666-3058  
**Experience:** Past commissions: Columbia Records, Kalimba Productions, A&M Records, United-Western Studios; details on request.  
**Direction:** To provide imaginative, concept music recording and mixing techniques to the industry. Consultant in architectural acoustics.

**RICHARD ALVIN SHANN — PRODUCER**  
 4412 Don Felipe Dr., Los Angeles, CA 90008  
 (213) 292-1719  
**Experience:** 35 years. Musician since 6 years of age. Third partner of first black production team in Memphis, Tenn. Credits: Avantics, Gentrys, MadLads. Have done O'Jays, Larry Hancock, S.O.U.L. and a considerable amount of products that broke even.  
**Direction:** To be able to comprehend the writer artist, and give the buyer something WORTHWHILE.

**MS. MARTI SHARRON — PRODUCER**  
 1200 Olive Dr., #110, Los Angeles, CA 90069  
 (213) 653-6733  
**Experience:** Worked for independent record producers Terry Woodford and Clayton Ivy in the studio and ran their publishing company.

**HOWARD SIEGEL (CHROME PRODUCTIONS) ENGINEER/PRODUCER**  
 1439 N. Stanley Ave., Hollywood, CA 90046  
 (213) 874-1428  
**Experience:** Engineering, associate production, recording studio design/consultant, remote recording, etc. on album projects with Riff Raff for Island, Billy Preston for A&M, Johnny Hallyday for Phonogram, Michael Pinder (of Moody Blues) for Threshold, Inner Circle for Capitol. Formerly asst to chief engineer of Record Plant, L.A. As a consultant have used: Record Plant, L.A., Sausalito, Kendun, Capitol Records, Westlake, A&M, Media Sound, Caribou Ranch, Bearsville, Indigo Ranch.  
**Direction:** Rock N' Roll, progressive rock, R&B. I gained most of my experience in R&B with Producer Robert Margouleff, with Grammy for engineering; but Rock N' Roll is my roots. I'm into engineering and possibly co-producing with self-contained band that knows what they like. I travel the N.Y., L.A., S.F., Colorado Route as a free-lancer.

**RICHARD SIMPSON (THE REFERENCE POINT) — ENGINEER**  
 2618 N. Belburn Pl., Simi Valley, CA 93065  
 (805) 527-3850  
**Experience:** 12 years with major recording studios, RCA. Specializing in disc mastering, presented with 11 Gold Records for my part in making a hit record. Mastering at Contemporary Records, independent direct-to-disc projects for Crystal Clear Records.  
**Direction:** Presently operating my own facility, The Reference Point. Offering my services as disc mastering engineer at my facility or at various other major mastering rooms in the Hollywood area, as an independent. Also available and interested in direct-to-disc projects.

**BOB STARR — PRODUCER**  
 1065 E. Fairview Blvd., Inglewood, CA 90302  
 (213) 672-2349  
**Experience:** I have been recording 15 years and have recorded 8 records.  
**Direction:** Will do more rhythm and blues and disco and some oldie but goodies in the future.

**JOHN-PAUL STOOP — PRODUCER**  
 P.O. Box 3486, Manhattan Beach, CA 90266  
**Experience:** Includes various functions with Poco, Nilsson, Bill Medley, David Soul, Terry Stafford, The Byrds and more. A&M Records, Speciality Records, MGM, Wally Heider Studios, RCA, Devonshire Studios, and ABC Recording Studios.  
**Direction:** To produce singles and albums in various styles of music with the intent of securing good record deals.

**JONATHAN STROMP — ENGINEER**  
 P.O. Box 1243, S. Pasadena, CA 91030  
 (213) 799-5611  
**Experience:** Audio sweetening for video tape productions. Sound reinforcement. Recording on location. Custom LP production.  
**Direction:** Music loving man after high quality sound at affordable cost.

**RAY THOMPSON, INC. — ENGINEER/PRODUCER**  
 11377 Ventura Blvd., Studio City, CA 91604  
 (213) 761-5881

**THUNDER-COMPUTE — PRODUCERS DAMON ALBERTI & SAM KLEINMAN**  
 6362 Hollywood #218, Hollywood, CA 90028  
 (213) HOPE-619 or 467-6089 or 654-3270  
**Experience:** Got airplay on last 5 singles; working with Debbie Reta (most promising vocalist, Calif. and Vicki Carr Scholarship winner), doing the winning song of American Song Festival (top 40 and grand) for 20th, etc.  
**Direction:** We are going for a "tomorrow" sound, and total artist grooming (inside and out of studio). Also recording sci-fi radio active rock and cosmic disco act called "Mezzmerria".

**JAMIE WILSON — ENGINEER**  
 4355 Lyceum Ave., Los Angeles, CA 90066  
 (213) 823-1026, 653-0240  
**Experience:** Numerous classical, jazz, and rock albums, sound tracks, and commercials. 9 years experience.  
**Direction:** Would like to explore new musical concepts, love Rock and New Wave, looking for next wave.

**HOWARD "H. LEE" WOLEN — ENGINEER**  
 5260 Corteen Pl., N. Hollywood, CA 91607  
 (213) 985-0989  
**Experience:** Flo & Eddie, Sweet Inspirations, Robert John, Johnny Baltimore Band, Deborah Washington, Terry Mace, Slim Pickens.  
**Direction:** Funk, R&R, R&B, Jazz.

**DAVID YORI — PRODUCER**  
 821 Westmount Dr., W. Hollywood, CA 90069  
 (213) 659-9767  
**Experience:** In the music business over 10 years. Complete knowledge of studio recording and live mixing. Have worked with over 30 bands in western states. Much video tape experience.  
**Direction:** Production of groups and single artists who want to become recording and performing artists. Interested in video recordings. Dynamic Rock & Roll is my first love.



# THE AUTOMATT

AUTOMATED RECORDING STUDIOS IN SAN FRANCISCO

*for information,  
call Gail Baker  
(415) 777-4111*

827 FOLSOM STREET, SAN FRANCISCO, CALIFORNIA 94107 (415) 777-4111 TELEX: 340116 D RUBINSON SFO

## START YOUR STUDIO For Under \$3000!

- *Bi-polar Differential Inputs*
- *3 Band Parametric EQ (Per Channel)*
- *G10 Glass Epoxy P.C. Boards*
- *Direct Channel Outputs*
- *Joystick Quad Panning*
- *Pink Noise Generator*
- *Solid Teak Cabinetry*
- *8 Main Outputs*
- *Quad Assigning*
- *2 Year Warranty*
- *Talk-back System*

The Q1608 is Carvin's offering for the "ultimate" in a Professional Recording/Road Board. Expandable from a 16 to a 32 Channel system, Carvin consoles are designed to provide the sophistication necessary in the modern recording industry.

The quality of the new Carvin "Quad," like that of all Carvin products, is the highest possible — from use of the best name-brand components, through the craftsmanship of the cabinetry, to the vigorous inspection-testing procedures. Plus, it's made in America.

Naturally, the price remains low, as all Carvin Products are Designed, Manufactured and Sold Directly from Carvin, eliminating distributor and dealer profit costs.

The Q1608 is currently used by a major sound co. for a Broadway Production in N.Y., L.A., & Chicago. For more information Call TOLL FREE 800-854-2235 (Calif. 714-747-1710) Mon — Fri. or send for your FREE Catalog on all Carvin products including Guitars.



**Q1608**

**\$2950**

**Carvin** Dept. MX-17, 1155 Industrial Ave., Escondido, Calif. 92025

# feedback

Dear Mix,

In regard to the January '79 "Brain Tickling" article (Vol 3, No. 1), there is just one more point which I would like to make. One of the charges leveled against Aphex has been that it is a 'black box'. Indeed, until recently the Exciter circuits themselves were encased in steel and epoxy. That procedure came from the desire to protect ourselves from imitators until our patent protection was complete. That situation has been resolved and patent issuance is imminent. Under that legal protection we have opened the circuitry for inspection and invite questions about any aspect of the Aphex theory and circuitry. The Aphex Aural Exciter is not a black box.

I am grateful for the open forum which Mix Magazine has offered us. I thank you also for the time and energy expended to make the demonstration at Heider's S.F. happen.

Sincerely,  
Marvin Caesar  
President  
Aphex Systems Ltd.

Dear Mix,

I enjoyed reading the Mix that I picked up at the AES Show here in New York, last November. The East Coast could sure use something like the Mix!

We are currently looking for bands and musicians to work the East Coast club and concert scene. Also we plan to send some of our local bands out to the West Coast for clubs, concerts, etc.

If you know of any bands, agents or club/theatre owners interested in this kind of exchange program please have them contact me at 201/991-7617 for more details.

Philip J. McCue  
Nova Records, Inc.  
729 Elm Street,  
Kearny, N.J. 07032

Dear Mix,

I picked up two copies of your publication at the recent NAMM show in Anaheim. I would like to know if I qualify for a free subscription. I am an R&D technician involved in design of amplifiers and special effects devices.

I found your January 1979 issue particularly interesting. The Aural Exciter and B&B VCA articles were very informative.

Yours,  
Barry Klein  
Music Man, Inc.  
Anaheim, CA

Dear Barry,

The Mix is distributed for free through studios, music stores, audio dealers, music schools and trade shows.

If you cannot find it at one of these places, either let us know that your favorite hangout has been overlooked or subscribe at \$12 per year and we will get it to your home.

# ADVERTISERS INDEX

## products and services

## retail outlets

AES.....	12	A-1 Audio Rentals.....	80
ARP.....	80	David Abell Pianos.....	80
Automatt.....	91	AIC.....	80,88
BGW.....	4	Accurate.....	71,77,83
BTX.....	4	Acromedia.....	80
Carvin.....	91	Apex Music Co.....	80
Countryman.....	39	Audio Concepts.....	43,80,83
dbx.....	7	Bananas At Large.....	83
Delta Labs.....	43	Braviroff Piano & Music.....	80
Eastern Acoustics.....	45	Burbank Sound.....	69,74,93
Eddcor.....	13	Castle Music Center.....	80
Electro-Voice.....	3,93	Charles Music Store.....	80
IAM.....	61	Coast Recording Equipment.....	80
Lexicon.....	94	Coleman Music Co.....	80
Loft.....	79	Compact Video Sale.....	80
MCI.....	95	Dean's Music City.....	80
MXR.....	27	Everything Audio.....	2,80,83
Marshall.....	83	Express.....	28,80,83,85,87,88
Maxell.....	73	Hanich Music.....	80
MICMIX.....	71	Hollywood Sound Systems.....	80
Music Annex.....	63	LA Sound.....	45
Music Lab.....	79	Leo's.....	45
Nortronics.....	81	Pacific Recording and Engineering.....	80
Orban.....	80	Paramount Sound Systems.....	80
Otari.....	16,17,25	Pro Media.....	94
Peavey.....	48,49	Pro Sound Music.....	80
Quad/Eight.....	back cover	Pro Sound Seattle.....	95
Shure.....	41	Sierra Audio.....	88
Sound Workshop.....	87,88	Sightsinger Music.....	80
TDK.....	57	Sound Genesis.....	45,83
Taber.....	87	Sound System Labs.....	80
Tangent.....	28	Studio Maintenance.....	80
TEAC/Tascam.....	22,23,53	Suntronics.....	25,33,45,53
3M.....	9	Video Systems Network.....	80
UREI.....	21	West L.A. Music.....	80
Uni-Sync.....	55	Westlake Audio.....	80,83,88
White Instruments.....	81		

**CATCH THEM  
IN THE MIX**



# Impeccable sound in a packable size.

**New! S12-2 and S15-3 from Electro-Voice.  
The best small touring systems you can buy.**

They'll do great things for your act. In a lot of ways.

**ACCURATE OUTPUT.**

You can add all the eq you want, and be heard as sweet or as gusty as you want, because what you put in is what comes out. There's no built-in coloration to irritate your audience or drive your sound man up the wall.

**GREAT SOUND.**

These speaker systems have the low end (50 Hz) to give your vocals a full, robust sound. They have the high end (16 KHz) that lets your vocals and instruments sound crisp and lifelike.

**VENTED MIDRANGE.**

It used to be that if you wanted high sound pressure levels in the midranges you had to use a horn. But it took a big horn to keep the sound accurate. Trouble is, big horns just won't fit into small stage system enclosures. So you had to settle for the pinched, "honky" sound typical of small horn drivers. *No more.* The midrange speaker in the S15-3 is a cone. Not just any cone, but a cone in an integral *vented* enclosure coupled to a massive 16 lb. magnet structure. The vent and cone work together to deliver accurate midrange, without coloration, at high sound pressure levels heretofore associated with horns. The vented midrange speaker is an E-V first.

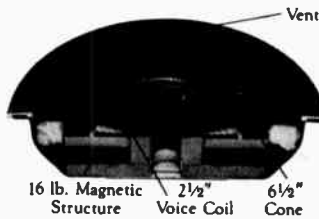

100 watts in will get you 116 dB out at four feet. You won't have to haul around a bank of super-amps to get the sound out where you want it. The wide 120° dispersion of our stage systems lets your audience hear mids and highs clearly, even if they're far off axis. Every seat in the house is now the best seat in the house. Even the ushers will think you sound great.

**COMPACT AND RUGGED.**

The S12-2 and S15-3 are compact. More room for you and your instruments... onstage and off. Our use of the speaker theories of A.N. Thiele and R.H. Small made it possible. We applied them to the development of a computer model for vented enclosures. Result: speakers that deliver the optimum combination of high efficiency and bass response in the smallest package possible. In the most rugged package possible. Constructed of 3/4" plywood. Oversized, recessed handles. Finished in durable black vinyl. Extruded aluminum trim protects *all* edges from damage. Even the grill cloth is rugged. It's actually a metal mesh that protects your drivers from accidental abuse.

**THEY ARE SUPER SYSTEMS.**

These systems have a lot going for you. Accuracy, efficiency, compactness, ruggedness and great sound. Give them a test listen at your E-V music dealer.

**EFFICIENT OPERATION.**

And you get the efficiency to get the sound pressure levels you want. With equipment you can handle.

Find the one nearest you in the listing on the right - or write or call: Electro-Voice, 600 Cecil Street, Buchanan, Michigan 49107. Phone: (616) 695-6831

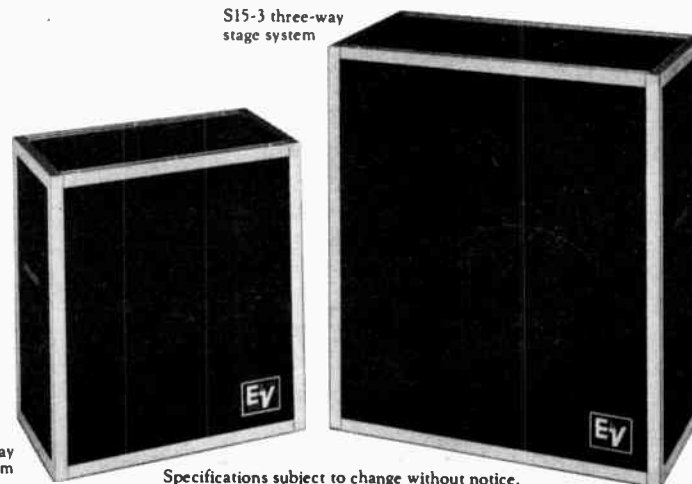

Specifications subject to change without notice.

Available at:



1317 N. San Fernando, Burbank, CA 91504 (213) 841-0062

327 E. 1200 S., Orem, Utah 84057 (801) 224-4848

**E-V Electro-Voice**  
a gulton company  
500 Cecil St., Buchanan, Michigan 49107

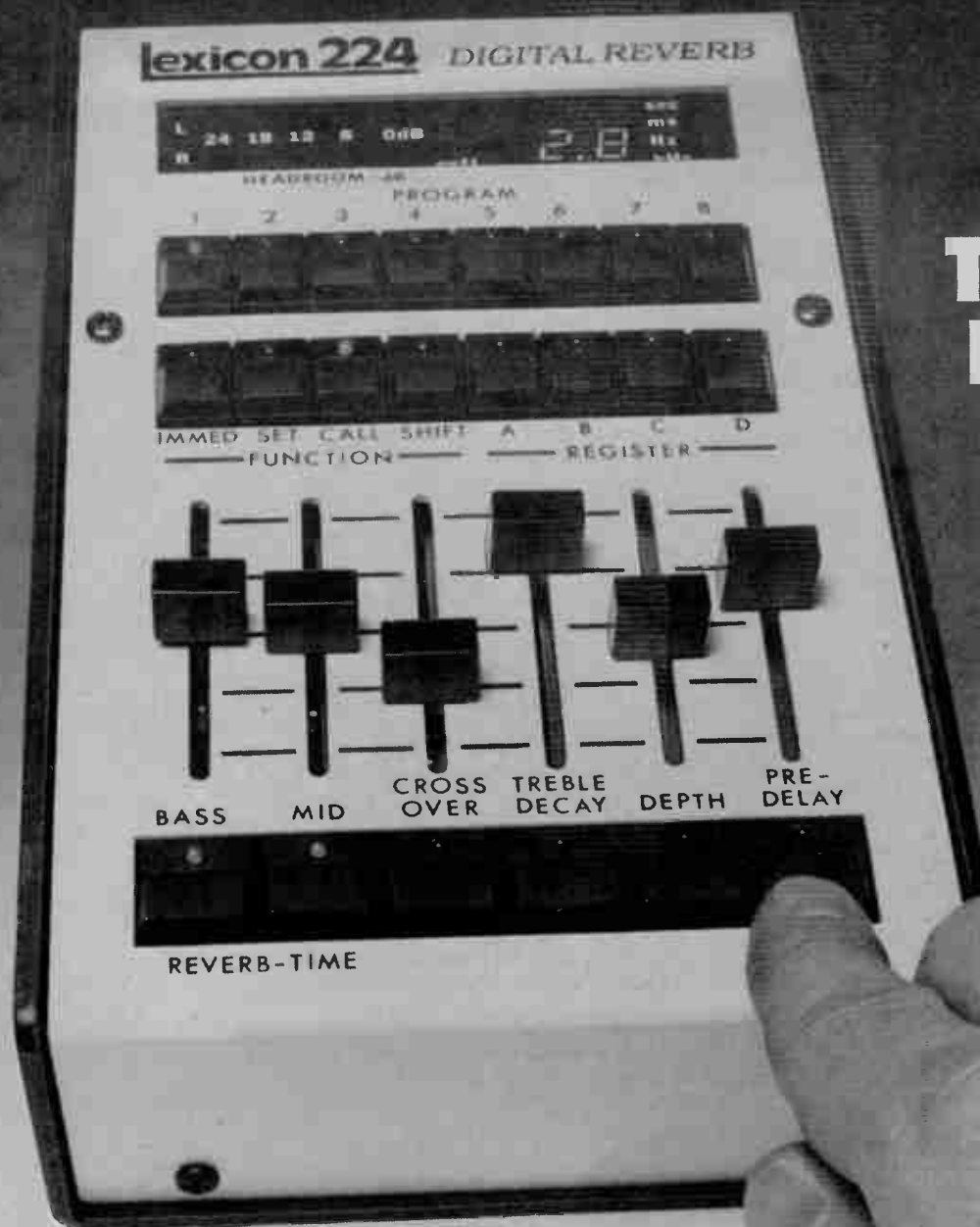

**This new  
Lexicon reverb  
brings  
great sound  
down to size.**

**Model 224 reverberation system  
has the sound, the controls,  
the compactness you've always wanted.**

The remarkable — and remarkably compact — Lexicon 224 digital reverberation system gives you superb sound unmatched by any other system available today — electronic, digital or mechanical. You get smooth, natural decay without coloration, "r wang" or "boing".

And you get unprecedented control over all significant reverberation parameters. It's industry's first reverb with a built-in control memory that provides instant push-button recall of previously set effects.

Model 224 saves studio space and is fully portable. Its 5½" x 8" remote control console puts reverb control right at the producer's fingertips. The system's high speed digital processor holds up to eight different programs and requires only 7 inches of rack space.

Currently available programs include: concert hall programs with stereo input and four outputs that create the space and depth of a live performance with decay times of 0.6 seconds to 70 seconds; acoustic chamber programs that provide sound equal to the best reverberation chambers; plate programs that outperform the highest quality reverberation plates or other mechanical devices with full control of all parameters including pre-delay of up to 256 milliseconds.

Model 224. A major advance from Lexicon. Once you've heard it, you'll never want to do another session without it.

Lexicon, Inc., 60 Turner Street, Waltham, MA 02154 (617) 891-6790

**lexicon**

Available in Northern California at: Pro Media, 185 Berry, Suite 3865, San Francisco, CA 415/957-1383



**We're expanding . . .**

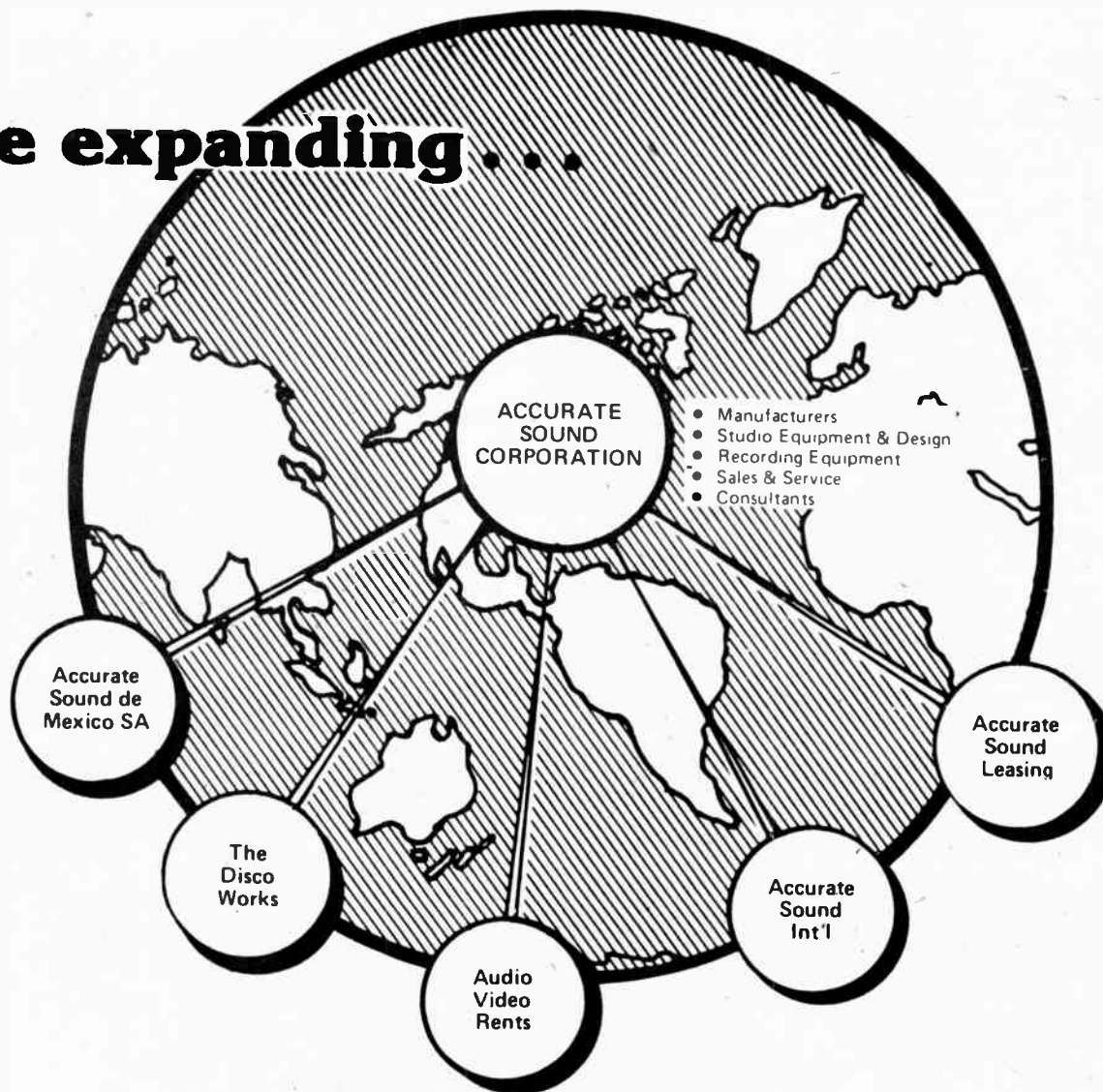

**. . . to meet your needs**

**THE CHALLENGE**

The breathtaking pace of today's technology, and the changing economic climate, require creative concepts and dynamic initiatives on the part of management. That's why at Accurate Sound we are constantly striving to find the answer to your needs. If it takes new ideas, or a new division, to do the best job, we are ready to meet the challenge.

**DESIGNING SOUND**

Anyone can collect hardware. It takes a unique expertise to select the most appropriate hardware, and design a system—your system, that meets your needs. It is the blend of the components, each selected for its ability to satisfy the criteria of the project, that provides for the ideal interface—the harmonious blending of individual components into an integrated whole.

**THE BOTTOM LINE**

We manufacture our own equipment, including high speed magnetic tape duplicators, multi-channel recorders and cassette data recorders. Each is known for quality, performance and dependability. What's more, we stand behind our products —after installation, should you find that it does not do exactly what we promise it will do, we will take it back for a full refund.

Because we're committed to you—your bottom line is our top priority. That's why we also represent many of the world's largest manufacturers in the sound industry. If our equipment won't do, theirs might; and we have no reluctance about supplying you with someone else's brand. Whatever your needs, whenever you need an answer, the right answer, call us.

“ . . . BECAUSE SOUND COMES FROM A SYSTEM ”

CONSULTANT - STUDIO EQUIPMENT AND DESIGN  
RECORDING EQUIPMENT - MANUFACTURING  
SALES & SERVICE.



**accurate sound corporation**

114 Fifth Avenue / Redwood City, California 94063  
(415) 365-2843 / TELEX: ASCO 34-8327



**From Quad/Eight:**

**The forty by forty,  
totally modular,  
fully automated,  
feature-packed,  
super-spec'd,  
recording and mixdown system  
that you thought you couldn't afford.**

**The way you've always heard it should be.**



Shown as Coronado Model M54024CX



**The Artist in Every Engineer**

Quad/Eight Electronics  
Quad/Eight International  
11929 Vose Street, North Hollywood, California 91605  
(213) 764-1516 Telex: 662-446